

# ETSI TS 148 049 V9.2.0 (2010-09)

---

*Technical Specification*

**Digital cellular telecommunications system (Phase 2+);  
Base Station Controller - Cell Broadcast Centre (BSC-CBC)  
interface specification;  
Cell Broadcast Service Protocol (CBSP)  
(3GPP TS 48.049 version 9.2.0 Release 9)**

---



---

**Reference**

RTS/TSGG-0248049v920

---

**Keywords**

GSM

**ETSI**

---

650 Route des Lucioles  
F-06921 Sophia Antipolis Cedex - FRANCE

Tel.: +33 4 92 94 42 00 Fax: +33 4 93 65 47 16

Siret N° 348 623 562 00017 - NAF 742 C  
Association à but non lucratif enregistrée à la  
Sous-Préfecture de Grasse (06) N° 7803/88

---

**Important notice**

Individual copies of the present document can be downloaded from:

<http://www.etsi.org>

The present document may be made available in more than one electronic version or in print. In any case of existing or perceived difference in contents between such versions, the reference version is the Portable Document Format (PDF). In case of dispute, the reference shall be the printing on ETSI printers of the PDF version kept on a specific network drive within ETSI Secretariat.

Users of the present document should be aware that the document may be subject to revision or change of status. Information on the current status of this and other ETSI documents is available at

<http://portal.etsi.org/tb/status/status.asp>

If you find errors in the present document, please send your comment to one of the following services:

[http://portal.etsi.org/chaicor/ETSI\\_support.asp](http://portal.etsi.org/chaicor/ETSI_support.asp)

---

**Copyright Notification**

No part may be reproduced except as authorized by written permission.  
The copyright and the foregoing restriction extend to reproduction in all media.

© European Telecommunications Standards Institute 2010.  
All rights reserved.

**DECT**<sup>TM</sup>, **PLUGTESTS**<sup>TM</sup>, **UMTS**<sup>TM</sup>, **TIPHON**<sup>TM</sup>, the TIPHON logo and the ETSI logo are Trade Marks of ETSI registered for the benefit of its Members.

**3GPP**<sup>TM</sup> is a Trade Mark of ETSI registered for the benefit of its Members and of the 3GPP Organizational Partners.

**LTE**<sup>TM</sup> is a Trade Mark of ETSI currently being registered

for the benefit of its Members and of the 3GPP Organizational Partners.

**GSM**<sup>®</sup> and the GSM logo are Trade Marks registered and owned by the GSM Association.

---

## Intellectual Property Rights

IPRs essential or potentially essential to the present document may have been declared to ETSI. The information pertaining to these essential IPRs, if any, is publicly available for **ETSI members and non-members**, and can be found in ETSI SR 000 314: "*Intellectual Property Rights (IPRs); Essential, or potentially Essential, IPRs notified to ETSI in respect of ETSI standards*", which is available from the ETSI Secretariat. Latest updates are available on the ETSI Web server (<http://webapp.etsi.org/IPR/home.asp>).

Pursuant to the ETSI IPR Policy, no investigation, including IPR searches, has been carried out by ETSI. No guarantee can be given as to the existence of other IPRs not referenced in ETSI SR 000 314 (or the updates on the ETSI Web server) which are, or may be, or may become, essential to the present document.

---

## Foreword

This Technical Specification (TS) has been produced by ETSI 3rd Generation Partnership Project (3GPP).

The present document may refer to technical specifications or reports using their 3GPP identities, UMTS identities or GSM identities. These should be interpreted as being references to the corresponding ETSI deliverables.

The cross reference between GSM, UMTS, 3GPP and ETSI identities can be found under <http://webapp.etsi.org/key/queryform.asp>.

# Contents

Intellectual Property Rights .....	2
Foreword.....	2
Foreword.....	6
1 Scope .....	7
2 References .....	7
3 Definitions and abbreviations.....	7
3.1 Definitions .....	7
3.2 Abbreviations .....	8
4 General .....	9
4.1 Procedure Specification Principles.....	9
4.2 Specification Notations .....	9
5 Transport and Data Link layer.....	9
5.1 General .....	9
5.2 TCP /IP.....	10
5.3 Data Link layer.....	10
6 Functions of CBSP .....	10
7 CBSP Procedures .....	11
7.1 Elementary Procedures.....	11
7.2 Write-Replace.....	11
7.2.1 General.....	11
7.2.2 Successful Operation .....	12
7.2.2.1 General .....	12
7.2.2.2 Broadcast request of a CBS message .....	12
7.2.2.3 Broadcast request of an emergency message .....	13
7.2.2.4 Returning WRITE-REPLACE COMPLETE message to CBC.....	14
7.2.3 Unsuccessful Operation .....	15
7.3 Kill.....	16
7.3.1 General.....	16
7.3.2 Successful Operation .....	16
7.3.2.1 General .....	16
7.3.2.2 Termination of CBS message broadcast .....	16
7.3.2.3 Termination of emergency message broadcast.....	16
7.3.3 Unsuccessful Operation .....	17
7.4 Load Status Enquiry .....	17
7.4.1 General.....	17
7.4.2 Successful Operation .....	18
7.4.3 Unsuccessful Operation .....	19
7.5 Message Status Query .....	19
7.5.1 General.....	19
7.5.2 Successful Operation .....	20
7.5.3 Unsuccessful Operation .....	21
7.6 Set DRX .....	21
7.6.1 General.....	21
7.6.2 Successful Operation .....	22
7.6.3 Unsuccessful Operation .....	23
7.7 Reset.....	23
7.7.1 General.....	23
7.7.2 Successful Operation .....	24
7.7.3 Unsuccessful Operation .....	24
7.7a Keep Alive.....	25
7.7a.1 General.....	25

7.7a.2	Successful Operation .....	25
7.7a.3	Unsuccessful Operation .....	26
7.8	Restart Indication .....	26
7.8.1	General.....	26
7.8.2	Successful Operation .....	26
7.9	Failure Indication .....	27
7.9.1	General.....	27
7.9.2	Successful Operation .....	27
7.10	Error Indication .....	27
7.10.1	General.....	27
7.10.2	Successful Operation .....	28
8	Elements for CBSP Communication .....	28
8.1	Message Functional Definitions and Contents .....	28
8.1.1	General.....	28
8.1.2	Presence .....	29
8.1.3	Message Contents .....	29
8.1.3.1	WRITE-REPLACE .....	29
8.1.3.2	WRITE-REPLACE COMPLETE .....	30
8.1.3.3	WRITE-REPLACE FAILURE .....	31
8.1.3.4	KILL .....	32
8.1.3.5	KILL COMPLETE.....	32
8.1.3.6	KILL FAILURE.....	33
8.1.3.7	LOAD QUERY .....	33
8.1.3.8	LOAD QUERY COMPLETE.....	33
8.1.3.9	LOAD QUERY FAILURE .....	34
8.1.3.10	MESSAGE STATUS QUERY .....	34
8.1.3.11	MESSAGE STATUS QUERY COMPLETE .....	34
8.1.3.12	MESSAGE STATUS QUERY FAILURE.....	35
8.1.3.13	SET-DRX.....	35
8.1.3.14	SET-DRX COMPLETE.....	36
8.1.3.15	SET-DRX FAILURE .....	36
8.1.3.16	RESET .....	36
8.1.3.17	RESET COMPLETE .....	37
8.1.3.18	RESET FAILURE.....	37
8.1.3.18a	KEEP-ALIVE .....	37
8.1.3.18b	KEEP-ALIVE COMPLETE .....	37
8.1.3.19	RESTART .....	38
8.1.3.20	FAILURE.....	38
8.1.3.21	ERROR INDICATION .....	38
8.2	Information Element Definitions.....	39
8.2.1	General.....	39
8.2.2	Message Type .....	40
8.2.3	Message Content.....	41
8.2.4	Old Serial Number .....	41
8.2.5	New Serial Number .....	41
8.2.6	Cell List .....	42
8.2.7	Category.....	44
8.2.8	Repetition Period .....	44
8.2.9	Number of Broadcasts Requested .....	45
8.2.10	Number of Broadcasts Completed List .....	45
8.2.11	Failure List.....	46
8.2.12	Radio Resource Loading List.....	47
8.2.13	Cause .....	48
8.2.14	Data Coding Scheme .....	48
8.2.15	Recovery Indication.....	49
8.2.16	Message Identifier.....	49
8.2.17	Emergency Indicator.....	49
8.2.18	Warning Type .....	50
8.2.19	Warning Security Information .....	50
8.2.20	Channel Indicator.....	50
8.2.21	Number of Pages.....	50

8.2.22	Schedule Period .....	51
8.2.23	Number of Reserved Slots .....	51
8.2.24	Broadcast Message Type .....	52
8.2.25	Warning Period .....	52
8.2.26	Length Indicator .....	52
8.2.27	Keep Alive Repetition Period .....	53
9	List of system parameters .....	53
9.1	Timers in the CBC .....	53
<b>Annex A (informative):</b>	<b>Change History .....</b>	<b>54</b>
History .....		55

---

## Foreword

This Technical Specification (TS) has been produced by the 3<sup>rd</sup> Generation Partnership Project (3GPP).

The contents of the present document are subject to continuing work within the TSG and may change following formal TSG approval. Should the TSG modify the contents of the present document, it will be re-released by the TSG with an identifying change of release date and an increase in version number as follows:

Version x.y.z

where:

- x the first digit:
  - 1 presented to TSG for information;
  - 2 presented to TSG for approval;
  - 3 or greater indicates TSG approved document under change control.
- y the second digit is incremented for all changes of substance, i.e. technical enhancements, corrections, updates, etc.
- z the third digit is incremented when editorial only changes have been incorporated in the document.

---

# 1 Scope

The present document specifies the *Cell Broadcast Service Protocol (CBSP)* between the Cell Broadcast Centre (CBC) and the Base Station Controller (BSC).

---

## 2 References

The following documents contain provisions which, through reference in this text, constitute provisions of the present document.

- References are either specific (identified by date of publication, edition number, version number, etc.) or non-specific.
- For a specific reference, subsequent revisions do not apply.
- For a non-specific reference, the latest version applies. In the case of a reference to a 3GPP document (including a GSM document), a non-specific reference implicitly refers to the latest version of that document *in the same Release as the present document*.

- [1] 3GPP TS 23.041: "Technical realization of Cell Broadcast Service (CBS)".
- [2] 3GPP TS 23.003: "Numbering, addressing and identification".
- [3] 3GPP TS 44.012: "Short Message Service Cell Broadcast (SMS-CB) support on the mobile radio interface".
- [4] 3GPP TS 23.038: "Alphabets and language-specific information".
- [5] 3GPP TS 24.008: "Mobile radio interface Layer 3 specification; Core network protocols".
- [6] IETF RFC 793 (September 1981): "Transmission Control Protocol".
- [7] IETF RFC 2507 (February 1999): "IP header compression".
- [8] IETF RFC 1990 (August 1996): "The PPP Multilink Protocol (MP)".
- [9] IETF RFC 2686 (September 1996): "The Multi-Class Extension to Multi-Link PPP".
- [10] IETF RFC 2509 (February 1999): "IP Header Compression over PPP".
- [11] 3GPP TS 45.002: "Multiplexing and multiple access on the radio path".
- [12] 3GPP TS 44.018: "Mobile radio interface layer 3 specification; Radio Resource Control Protocol".
- [13] 3GPP TS 44.060: "General Packet Radio Service (GPRS); Mobile Station (MS) - Base Station System (BSS) interface; Radio Link Control / Medium Access Control (RLC/MAC) protocol".
- [14] 3GPP TS 23.002: "Network architecture".

---

## 3 Definitions and abbreviations

### 3.1 Definitions

For the purposes of the present document, the following terms and definitions apply:

**CBS message:** An information message broadcasted on the basic or extended cell broadcast channel (CBCH) in unacknowledged mode to mobile stations located within the Cell Broadcast area. A CBS message may contain information such as road traffic or weather information, originating from a Cell Broadcast Entity (CBE) communicating with the CBC (see 3GPP TS 23.041 [1]).



**CBS message reference:** Uniquely identifies a CBS message by the four elements: Message Identifier, Serial Number, Cell Identifier and Channel Indicator.

**Cell Broadcast area:** An area comprising of one or more cells in which the CBS message or the emergency message is broadcasted. A Cell Broadcast area is always contained within a BSC area (see 3GPP TS 23.002 [14]).

**CBS message operational state:** A cell in CBS message operational state is able to broadcast CBS messages.

**Emergency message:** A warning message conveying a small amount of data to indicate the imminent occurrence of an emergency such as earthquake, tsunami etc. The emergency message is broadcasted to mobile stations in idle mode, packet idle mode and dedicated mode (see 3GPP TS 44.018 [12]) and to mobile stations in packet transfer mode and dual transfer mode (see 3GPP TS 44.060 [13]) located within the Cell Broadcast area.

**Emergency message operational state:** A cell in emergency message operational state is able to broadcast emergency messages.

**Emergency message reference:** Uniquely identifies an emergency message by the three elements: Message Identifier, Serial Number and Cell Identifier.

**Elementary Procedure:** CBSP consists of Elementary Procedures (EPs). An Elementary Procedure is a unit of interactions between the CBC and the BSC. These EPs are defined separately and are intended to be used to build up complete sequences in a flexible manner. If the independence between some EPs is restricted, it is described under the relevant EP description. Unless otherwise stated by the restrictions, the EPs may be invoked independently of each other as stand alone procedures, which can be active in parallel. Support of parallel procedures in the BSC is optional.

An EP consists of an initiating message and possibly a response message. Two kinds of EPs are used:

- **Class 1:** Elementary Procedures with response (success or failure).
- **Class 2:** Elementary Procedures without response.

For Class 1 EPs, the types of responses can be as follows:

Successful

- A signalling message explicitly indicates that the EP is successfully completed.

Unsuccessful

- A signalling message explicitly indicates that the EP failed.
- On time supervision expiry (i.e. absence of expected response).

Class 2 EPs are always considered as successful.

## 3.2 Abbreviations

For the purposes of the present document, the following abbreviations apply:

BSC	Base Station Controller
CBC	Cell Broadcast Centre
CBCH	Cell Broadcast Channel
CBE	Cell Broadcast Entity
CBS	Cell Broadcast Service
CBSP	Cell Broadcast Service Protocol
EP	Elementary Procedure
ETWS	Earthquake and Tsunami Warning System
MS	Mobile Station
SMSCB	Short Message Service Cell Broadcast

---

## 4 General

### 4.1 Procedure Specification Principles

The principle for specifying the procedure logic is to specify the functional behaviour of the BSC exactly and completely. The CBC functional behaviour is left unspecified.

The following specification principles have been applied for the procedure text in clause 7:

- The procedure text discriminates between:
  - 1) Functionality which "shall" be executed:
    - The procedure text indicates that the receiving node "shall" perform a certain function Y under a certain condition. If the receiving node supports procedure X but cannot perform functionality Y requested in the REQUEST message of a Class 1 EP, the receiving node shall respond with the message used to report unsuccessful outcome for this procedure, containing an appropriate cause value.
  - 2) Functionality which "shall, if supported" be executed:
    - The procedure text indicates that the receiving node "shall, if supported," perform a certain function Y under a certain condition. If the receiving node supports procedure X, but does not support functionality Y, the receiving node shall proceed with the execution of the EP, possibly informing the requesting node about the not supported functionality.

### 4.2 Specification Notations

For the purposes of the present document, the following notations apply:

Procedure	When referring to an Elementary Procedure in the specification the procedure name is written with the first letters in each word in upper case characters followed by the word "procedure", e.g. Write-Replace procedure.
Message	When referring to a message in the specification the MESSAGE NAME is written with all letters in upper case characters followed by the word "message", e.g. WRITE-REPLACE message.
IE	When referring to an information element (IE) in the specification the <i>Information Element Name</i> is written with the first letters in each word in upper case characters and all letters in Italic font followed by the abbreviation "IE", e.g. <i>Old Serial Number</i> IE.
Value of an IE	When referring to the value of an information element (IE) in the specification the "Value" is written as it is specified in subclause 8.2 enclosed by quotation marks, e.g. "Abstract Syntax Error (Reject)" or "Background".

---

## 5 Transport and Data Link layer

### 5.1 General

TCP over IP shall be supported as the transport for data streams on the BSC-CBC interface. The data link layer is as specified in subclause 5.3.

During normal operation the CBC initiates all message transfer and query operations. The BSC responds to the message transfer and query operations initiated by the CBC.

The BSC only initiates the message transfer in case an error (Failure Indication procedure) or recovery (Restart Indication procedure) is to be reported.

The node initiating the message transfer is also responsible for the establishment of the TCP connection, in case no TCP connection already exist. An already established TCP connection may be used for message transfer.

The initiator of a connection is responsible for the termination of the TCP connection.

## 5.2 TCP /IP

The transport protocol used shall be TCP, which is specified in RFC 793 [6].

The transport bearer is identified by the TCP port number and the IP address (source TCP port number, destination TCP port number, source IP address, destination IP address).

The TCP Destination Port number for CBSP messages is 48049/tcp. It is the registered port number for 3GPP Cell Broadcast Service Protocol CBSP (3gpp-cbsp).

The 3gpp-cbsp destination port number 48049/tcp shall be used by both entities (BSC or CBC) whenever it sets up a new TCP connection. When it sends CBSP messages on an existing TCP connection, the sending entity (BSC or CBC) shall use as TCP destination port number either 48049/tcp if it was the initiator of this TCP connection, or the TCP source port number that was received from the peer entity that had initiated this existing TCP connection.

An IP BSC/CBC-node shall support IPv4. The support of IPv6 is optional.

IP dual stack support is recommended for the potential transition period from IPv4 to IPv6 in the transport network.

## 5.3 Data Link layer

It is recommended that a BSC/CBC using IP transport implement the data link layer using Ethernet.

NOTE: This does not preclude the single implementation and use of any other data link layer protocol fulfilling the GERAN requirements toward the upper layers.

A BSC/CBC using IP transport having interfaces connected via low bandwidth PPP links like E1/T1 shall also support IP Header Compression [7] and the PPP extensions ML/MC-PPP [8], [9]. In this case the negotiation of header compression [7] over PPP shall be performed according to [10].

---

# 6 Functions of CBSP

The CBSP has the following functions:

- Message Handling: This function is responsible for enabling the broadcast of new CBS and emergency messages, replacing CBS and emergency messages currently being broadcasted and for terminating the broadcast of specific CBS and emergency messages. This function may also be used to obtain the message status of a specific CBS message.
- DRX Handling: This function is responsible for the configuration of the SMS CB DRX parameters.
- Load Handling: This function determines the load status of the broadcast channels at any particular point in time.
- Reset: This function terminates the broadcasting of all CBS and emergency messages in one or more cells.
- Error Handling: This function allows reporting of general error situations, for which function specific error messages have not been defined.
- Supervision Handling: This function handles the supervision of the CBSP availability between the CBC and the BSC.

These functions are implemented by one or several CBSP elementary procedures described in clause 7.

## 7 CBSP Procedures

### 7.1 Elementary Procedures

In the following tables, all EPs are divided into Class 1 and Class 2 Procedures.

**Table 7.1.1: Class 1 Procedures**

Elementary Procedure	Initiating Message	Successful Outcome	Unsuccessful Outcome
		Response message	Response message
Write-Replace	WRITE-REPLACE	WRITE-REPLACE COMPLETE	WRITE-REPLACE FAILURE
Kill	KILL	KILL COMPLETE	KILL FAILURE
Load Status Enquiry	LOAD QUERY	LOAD QUERY COMPLETE	LOAD QUERY FAILURE
Message Status Query	MESSAGE STATUS QUERY	MESSAGE STATUS QUERY COMPLETE	MESSAGE STATUS QUERY FAILURE
Set DRX	SET-DRX	SET-DRX COMPLETE	SET-DRX FAILURE
Reset	RESET	RESET COMPLETE	RESET FAILURE
Keep Alive	KEEP-ALIVE	KEEP-ALIVE COMPLETE	-

**Table 7.1.2: Class 2 Procedures**

Elementary Procedure	Message
Restart Indication	RESTART
Failure Indication	FAILURE
Error Indication	ERROR INDICATION

### 7.2 Write-Replace

#### 7.2.1 General

The purpose of the Write-Replace procedure is to broadcast a new CBS message or emergency message or to replace an ongoing CBS message or emergency message broadcast with a new CBS message or emergency message.

## 7.2.2 Successful Operation

### 7.2.2.1 General

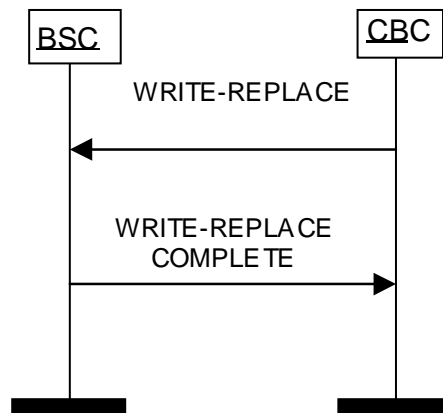

**Figure 7.2.2.1.1: Write-Replace Procedure: Successful Operation**

The Write-Replace procedure is initiated by the CBC sending the WRITE-REPLACE message to the BSC (see figure 7.2.2.1.1).

The WRITE-REPLACE message may be sent as a request to broadcast a new CBS message or emergency message without replacing an ongoing CBS message or emergency message broadcast, or as a request to replace an ongoing CBS message or emergency message broadcast with a new CBS message or emergency message. A WRITE-REPLACE message shall not contain a simultaneous broadcast request of a CBS message and an emergency message.

Broadcast request of a CBS message is defined in subclause 7.2.2.2 while broadcast request of an emergency message is defined in subclause 7.2.2.3.

### 7.2.2.2 Broadcast request of a CBS message

A CBS message is uniquely identified by the four elements *Message Identifier IE*, Cell Identifier field in the *Cell List IE*, Serial Number field in the *New Serial Number IE* or in the *Old Serial Number IE* and the *Channel Indicator IE*. If only the *New Serial Number IE*, and not the *Old Serial Number IE*, is included in the WRITE-REPLACE message, then the BSC shall interpret the message as a write request, i.e. a broadcast request of a new CBS message without replacing an ongoing CBS message broadcast. The new CBS message is identified by the four elements *Message Identifier IE*, the twelve most significant bits of the *New Serial Number IE*, Cell Identifier field in the *Cell List IE* and the *Channel Indicator IE*.

If both the *New Serial Number IE* and the *Old Serial Number IE* are present in the WRITE-REPLACE message, then the BSC shall interpret the message as a replace request, i.e. a request to replace an ongoing CBS message broadcast with a new CBS message. In this case the BSC shall start the Write-Replace procedure by terminating the ongoing CBS message broadcast, as defined in subclause 7.3.2.2, before broadcasting the new CBS message. The replaced CBS message is identified by the four elements *Message Identifier IE*, the twelve most significant bits of the *Old Serial Number IE*, Cell Identifier field in the *Cell List IE* and the *Channel Indicator IE*.

If termination of the replaced CBS message fails in a cell, then the BSC shall not proceed with the broadcast of the new CBS message for this particular cell. After completing the Write-Replace procedure in the remaining cells, the BSC shall return the WRITE-REPLACE FAILURE message to the CBC, see subclause 7.2.3.

A CBS message may be broadcasted on one of two different cell broadcast channels, a basic channel or an extended channel (see 3GPP TS 45.002 [11]), as indicated by the *Channel Indicator IE*.

The BSC initiates broadcasting of the CBS message within the Cell Broadcast area, i.e. in the cell(s) as indicated by the Cell Identifier field in the *Cell List IE*.

The BSC shall broadcast the CBS message according to the value of the *Number of Broadcasts Requested IE* and the *Repetition Period IE*. If the value of *Number of Broadcasts Requested IE* is set to "0", the BSC shall broadcast the CBS

message until the CBC requests otherwise. If the value is different from "0", the BSC shall broadcast the CBS message as many times as indicated in the *Number of Broadcasts Requested* IE.

The *Repetition Period* IE indicates the periodicity of which the CBS message is to be broadcasted.

In the event of a conflict where the BSC has more than one CBS message to send at the same time, the BSC shall decide the order of such CBS messages as an implementation matter.

The BSC shall accept the broadcast request of a CBS message according to the value of the *Category* IE as follows:

- If the value of *Category* IE is indicated as "High Priority", then the BSC shall accept the broadcast request if message slots according to the *Repetition Period* IE are available on the broadcast channel following the scheduling of already accepted high and/or normal priority CBS messages.  
The first broadcast of a high priority CBS message is performed at the earliest opportunity and the subsequent broadcasts according to the *Repetition Period* IE.
- If the value of *Category* IE is indicated as "Normal", then the BSC shall accept the broadcast request if message slots according to the *Repetition Period* IE are available on the broadcast channel following the scheduling of already accepted high and/or normal priority CBS messages.  
The broadcast of a normal priority CBS message is always performed according to the *Repetition Period* IE.
- If the value of *Category* IE is indicated as "Background", then the BSC shall accept the broadcast request if message slots according to the *Repetition Period* IE are available on the broadcast channel following the scheduling of high and/or normal priority CBS messages and/or already accepted background CBS messages.  
The broadcast of a background CBS message is performed according to the *Repetition Period* IE.

NOTE: The repetition frequency of an ongoing CBS message broadcast of type "Background" may be reduced if a CBS message broadcast request of type "Normal" or "High Priority" is received in the BSC for the same cell. If message slots on the particular broadcast channel become available again, the requested repetition period of the background CBS message shall be resumed.

*Number of Pages* IE indicates the total number of pages included in the CBS message, i.e. the number of *Message Content* IE's included in the WRITE-REPLACE message. The BSC shall pass the *Data Coding Scheme* IE and *Message Content* IE transparently to the radio interface protocol.

If the Write-Replace procedure is successful in all cells as indicated in the *Cell List* IE, the BSC shall return the WRITE-REPLACE COMPLETE message to the CBC as described in subclause 7.2.2.4.

If the Write-Replace procedure fails in at least one cell, the BSC shall respond to the CBC by sending the WRITE-REPLACE FAILURE message, see subclause 7.2.3.

After completion of the broadcast according to the associated *Number of Broadcasts Requested* IE and the *Repetition Period* IE, the BSC shall remove any reference to the concerned CBS message.

### 7.2.2.3 Broadcast request of an emergency message

The presence of the *Emergency Indicator* IE indicates that the WRITE-REPLACE message contains an emergency message (e.g. an ETWS Primary Notification message).

An emergency message is uniquely identified by the three elements *Message Identifier* IE, Cell Identifier field in the *Cell List* IE and the Serial Number field in the *New Serial Number* IE or in the *Old Serial Number* IE.

If only the *New Serial Number* IE, and not the *Old Serial Number* IE, is included in the WRITE-REPLACE message, then the BSC shall interpret the message as a write request, i.e. a broadcast request of a new emergency message without replacing an ongoing emergency message broadcast. The new emergency message is identified by the three elements *Message Identifier* IE, the twelve most significant bits of the *New Serial Number* IE and Cell Identifier field in the *Cell List* IE.

If both the *New Serial Number* IE and the *Old Serial Number* IE are present in the WRITE-REPLACE message, then the BSC shall interpret the message as a replace request, i.e. a request to replace an ongoing emergency message broadcast with a new emergency message. The BSC shall then start the Write-Replace procedure by terminating the ongoing emergency message broadcast, as described in subclause 7.3.2.3, before broadcasting the new emergency message. The replaced emergency message is identified by the three elements *Message Identifier* IE, the twelve most significant bits of the *Old Serial Number* IE and Cell Identifier field in the *Cell List* IE.

If termination of the replaced emergency message fails in a cell, then the BSC shall not proceed with the broadcast of the new emergency message for this particular cell. After completing the Write-Replace procedure in the remaining cells, the BSC shall return the WRITE-REPLACE FAILURE message to the CBC, see subclause 7.2.3.

The BSC shall construct and send the emergency message (e.g. an ETWS Primary Notification message) to mobile stations located within the Cell Broadcast area, i.e. to cell(s) as identified by the Cell Identifier field in the *Cell List* IE.

*Warning Type* IE and *Warning Security Information* IE, if present, contains ETWS related warning information. These IE's are sent transparently, as part of the ETWS Primary Notification message, to the mobile station.

The ETWS Primary Notification message is broadcasted to mobile stations in idle mode, packet idle mode and dedicated mode (see 3GPP TS 44.018 [12]) and to mobile stations in packet transfer mode and dual transfer mode (see 3GPP TS 44.060 [13]) located within the Cell Broadcast area.

The BSC shall broadcast the emergency message for the duration of time as indicated in the *Warning Period* IE or until the CBC requests otherwise.

Only one emergency message at the time can be broadcasted in a cell. If a write request is received for a cell where an emergency message broadcast is currently ongoing, the write request is considered as failed, see subclause 7.2.3.

If the Write-Replace procedure is successful in all cell(s) as indicated in the *Cell List* IE, the BSC shall return the WRITE-REPLACE COMPLETE message to the CBC as described in subclause 7.2.2.4.

If the Write-Replace procedure fails in at least one cell, the BSC shall respond to the CBC by sending the WRITE-REPLACE FAILURE message, see subclause 7.2.3.

#### 7.2.2.4 Returning WRITE-REPLACE COMPLETE message to CBC

After completion of the Write-Replace procedure in the BSC, the WRITE-REPLACE COMPLETE message is sent to the CBC containing the *Message Identifier* IE, the *New Serial Number* IE and optionally the *Channel Indicator* IE, if received in the WRITE-REPLACE message, together with the *Number of Broadcasts Completed List* IE or the *Cell List* IE.

Depending on the request of the WRITE-REPLACE message either the *Number of Broadcasts Completed List* IE or the *Cell List* IE is returned in the WRITE-REPLACE COMPLETE message. If the WRITE-REPLACE COMPLETE message is returned to the CBC,

- as a response to a write request operation (i.e. without replacing an ongoing CBS message or emergency message broadcast) then the Cell Identifier for each cell is included in the *Cell List* IE.
- as a response to a replace request operation of an ongoing CBS message broadcast, then the *Number of Broadcasts Completed List* IE contains for each cell the number of broadcasts of the replaced CBS message.
- as a response to a replace request operation of an ongoing emergency message broadcast then the Cell Identifier for each cell is included in the *Cell List* IE.

The *Old Serial Number* IE shall only be provided in the WRITE-REPLACE COMPLETE message if the message is returned as a response to a replace request operation.

When the *Number of Broadcasts Completed List* IE is returned to the CBC as a response to a replace request operation of an ongoing CBS message broadcast and the number of broadcasts is not known for a particular cell, then the Number of Broadcasts Completed field shall be set to value "0" and the Number of Broadcasts Info field shall be set to "unknown" for this cell.

If the actual number of broadcasts for a particular cell is greater than the value reported in the Number of Broadcasts Completed field, then the Number of Broadcasts Info field shall be set to value "overflow" to indicate that the counter for the specific cell has overflowed.

### 7.2.3 Unsuccessful Operation

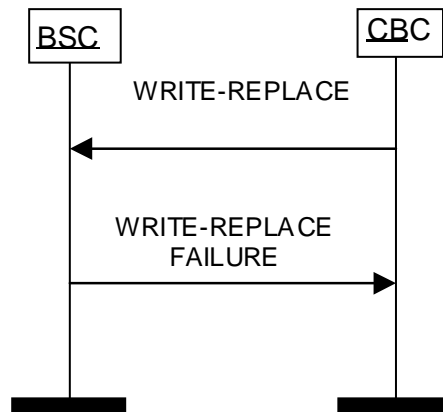

**Figure 7.2.3.1: Write-Replace Procedure: Un-Successful Operation**

If the Write-Replace procedure fails in at least one cell as specified in the *Cell List* IE in the WRITE-REPLACE message, then the BSC shall return the WRITE-REPLACE FAILURE message to the CBC. A list of cell(s) for which the requested write or replace operation can not be completed shall be included in the *Failure List* IE and provided in the WRITE-REPLACE FAILURE message. For each cell in the *Failure List* IE a Cause value is included, identifying the reason for the failure.

The WRITE-REPLACE FAILURE message may also include cell(s) for which the requested write or replace operation is successful. If the Write-Replace procedure is successful in at least one cell in the BSC, this cell shall be identified in the *Number of Broadcasts Completed List* IE or in the *Cell List* IE, see sub-clause 7.2.2.4, and provided in the WRITE-REPLACE FAILURE message.

If the WRITE-REPLACE message sent from the CBC:

- contained a *New Serial Number* IE but not an *Old Serial Number* IE (i.e. a write request operation), and the CBS message or emergency message reference is already in use in the BSC, it shall consider the Write-Replace procedure as failed for this cell. The BSC shall then return the WRITE-REPLACE FAILURE message with the Cell Identifier of this particular cell included in the *Failure List* IE together with the Cause value “Message-reference-already-used”. No entry is made in the *Number of Broadcasts Completed List* IE or in the *Cell List* IE for this particular cell.
- contained both the *New Serial Number* IE and the *Old Serial Number* IE (i.e. a replace request operation), and the old CBS message or emergency message reference is unknown to the BSC (i.e. the BSC can not terminate the CBS message or emergency message) for a particular cell, the BSC shall consider the Write-Replace procedure as failed for this cell. The BSC shall then return the WRITE-REPLACE FAILURE message with the Cell Identifier of this particular cell included in the *Failure List* IE together with the Cause value “Message-reference-not-identified”. No entry is made in the *Number of Broadcasts Completed List* IE or in the *Cell List* IE for this particular cell.  
In this case the *Old Serial Number* IE provided in the WRITE-REPLACE FAILURE message refers to the message for which the *Failure List* IE is supplied.
- contained both the *New Serial Number* IE and the *Old Serial Number* IE, and the new CBS message reference is already in use in the BSC, it shall consider the Write-Replace procedure as failed for this cell. The BSC shall then return the WRITE-REPLACE FAILURE message with the Cell Identifier of this particular cell included in the *Failure List* IE together with the Cause value “Message-reference-already-used”. An entry is made in the *Number of Broadcasts Completed List* IE for the killed CBS message for this particular cell.  
In this case the *New Serial Number* IE provided in the WRITE-REPLACE FAILURE message refers to the message for which the *Failure List* IE is supplied and the *Old Serial Number* IE to the message for which the *Number of Broadcasts Completed List* IE is supplied.



## 7.3 Kill

### 7.3.1 General

The purpose of the Kill procedure is to terminate the broadcast of a specific CBS message or emergency message.

### 7.3.2 Successful Operation

#### 7.3.2.1 General

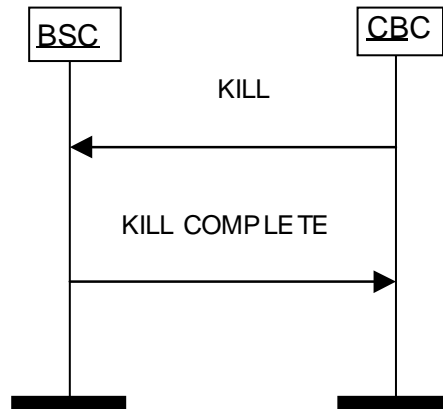

**Figure 7.3.2.1.1: Kill Procedure: Successful Operation**

The Kill procedure is initiated by the CBC sending the KILL message to the BSC (see figure 7.3.2.1.1). The KILL message may be sent in purpose to terminate the broadcasting of a CBS message (see subclause 7.3.2.2) or to terminate the broadcasting of an emergency message (see subclause 7.3.2.3).

#### 7.3.2.2 Termination of CBS message broadcast

Upon receipt of the KILL message the BSC shall stop broadcasting the CBS message identified by the *Message Identifier* IE, the twelve most significant bits of the *Old Serial Number* IE and the *Channel Indicator* IE, for the cell(s) as indicated in the *Cell List* IE.

After termination of the broadcast the BSC shall remove the CBS message, as well as any reference to it, for the cell(s) as indicated in the *Cell List* IE.

The BSC shall respond to the CBC by sending the KILL COMPLETE message containing the *Message Identifier* IE, the *Old Serial Number* IE and the *Channel Indicator* IE. The KILL COMPLETE message also contains the *Number of Broadcasts Completed List* IE indicating for each cell the number of times the CBS message was broadcasted.

If the number of broadcasts is not known for a particular cell, then the Number of Broadcasts Completed field shall be set to value "0" and the Number of Broadcasts Info field shall be set to "unknown" for this cell.

If the actual number of broadcasts for a particular cell is greater than the value reported in the Number of Broadcasts Completed field, then the Number of Broadcasts Info field shall be set to value "overflow" to indicate that the counter for the specific cell has overflowed.

If the Kill procedure fails in at least one cell, the BSC shall respond to the CBC by sending the KILL FAILURE message, see subclause 7.3.3.

#### 7.3.2.3 Termination of emergency message broadcast

Upon receipt of the KILL message the BSC shall stop broadcasting the emergency message identified by the *Message Identifier* IE and the twelve most significant bits of the *Old Serial Number* IE for the cell(s) as indicated in the *Cell List*

IE. After termination of the broadcast the BSC shall remove the emergency message, as well as any reference to it, for the cell(s) as indicated in the *Cell List* IE.

The BSC shall respond to the CBC by sending the KILL COMPLETE message with the *Message Identifier* IE, the *Old Serial Number* IE and the *Cell List* IE, containing the cells for which the kill operation succeeded, included in the message.

If the Kill procedure fails in at least one cell, the BSC shall respond to the CBC by sending the KILL FAILURE message, see subclause 7.3.3.

### 7.3.3 Unsuccessful Operation

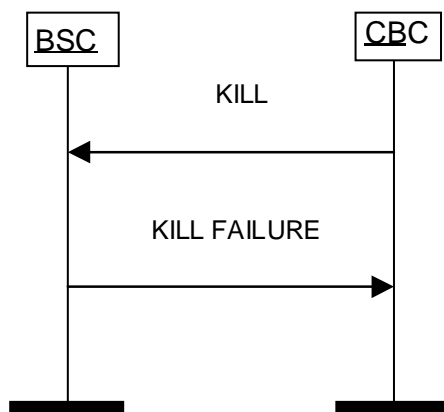

**Figure 7.3.3.1: Kill Procedure: Un-Successful Operation**

If the BSC fails to terminate the broadcasting of the CBS message or the emergency message in at least one cell as indicated in the *Cell List* IE, the BSC shall return the KILL FAILURE message to the CBC. Cell(s) for which the requested kill operation can not be performed (e.g. if the CBS or emergency message reference is not recognized in the BSC) shall be included in the *Failure List* IE and provided in the KILL FAILURE message. For each cell in the *Failure List* IE a Cause value is included, identifying the reason for the failure.

If the Kill procedure is successful in at least one cell in the BSC, this cell shall be identified in the *Number of Broadcasts Completed List* IE, or in the *Cell List* IE, and provided in the KILL FAILURE message, see subclause 7.3.2.2 or 7.3.2.3.

The sum of the cell(s) included in the *Number of Broadcasts Completed List* IE, or in the *Cell List* IE, and the *Failure List* IE shall be equal to the sum of cell(s) as included in the *Cell List* IE in the KILL message.

## 7.4 Load Status Enquiry

### 7.4.1 General

The purpose of the Load Status Enquiry procedure is to obtain the current load status of the CBCH radio resources within a cell.

## 7.4.2 Successful Operation

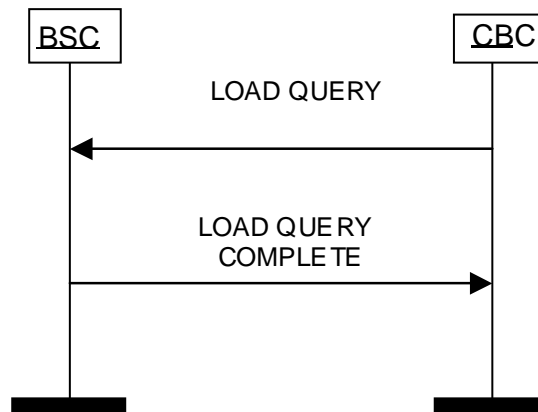

**Figure 7.4.2.1: Load Status Enquiry Procedure: Successful Operation**

The Load Status Enquiry procedure is initiated by the CBC sending the LOAD QUERY message to the BSC (see figure 7.4.2.1) containing a *Cell List* IE, for which cell(s) the current CBCH load status is required, and the *Channel Indicator* IE.

Two CBCH radio resource load values per cell shall be provided by the BSC.

The first value, included in the Radio Resource Load 1 field, shall be calculated as the number of used CBCH message slots in relation to the number of available CBCH message slots. Number of used CBCH message slots is defined as message slots reserved for schedule messages, message slots used for high and normal priority CBS messages according to their requested repetition period and slots reserved for "free message slot reading advised" (see 3GPP TS 44.012 [3]).

NOTE 1: CBCH message slots used for unscheduled scheduled messages shall not be considered as used CBCH message slots when calculating the Radio Resource Load 1 field.

The second value, included in the Radio Resource Load 2 field, shall be calculated as the number of CBCH message slots used for background CBS messages according to their requested repetition period in relation to the number of available CBCH message slots.

NOTE 2: The repetition period of an ongoing background CBS message broadcast may be reduced if a high or normal priority CBS message broadcast request is received in the BSC for the same cell. The calculation of the Radio Resource Load 2 field shall however always be calculated according to the requested repetition period of the background CBS message.

After completion of the CBCH radio resource load calculation for the requested cell(s) the BSC shall respond to the CBC by sending the LOAD QUERY COMPLETE message containing the *Radio Resource Loading List* IE, indicating the current load status of the included cell(s), and the *Channel Indicator* IE.

If the Load Status Enquiry procedure fails in at least one cell, the BSC shall respond to the CBC by sending the LOAD QUERY FAILURE message, see subclause 7.4.3.

### 7.4.3 Unsuccessful Operation

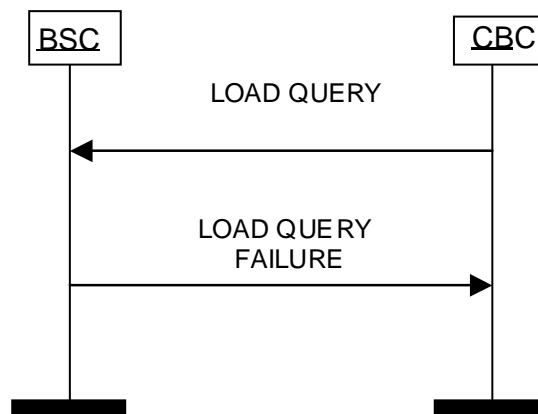

**Figure 7.4.3.1: Load Status Enquiry Procedure: Un-Successful Operation**

If upon receipt of the LOAD QUERY message the BSC can not calculate the current CBCH radio resource load status in one or several cells as indicated in the *Cell List* IE, the BSC shall respond to the CBC by sending the LOAD QUERY FAILURE message. Cell(s), for which the CBCH radio resource load can not be calculated, shall be included in the *Failure List* IE together with a Cause value identifying the reason for the failure.

If the Load Status Enquiry procedure is successful in at least one cell in the BSC, this cell shall be identified in the *Radio Resource Loading List* IE (as well as their current load status) and be included in the LOAD QUERY FAILURE message.

The sum of the cell(s) included in the *Radio Resource Loading List* IE and *Failure List* IE shall be equal to the sum of cell(s) as included in the *Cell List* IE in the LOAD QUERY message.

## 7.5 Message Status Query

### 7.5.1 General

The purpose of the Message Status Query procedure is to obtain the message status of a specific CBS message in the BSC.

## 7.5.2 Successful Operation

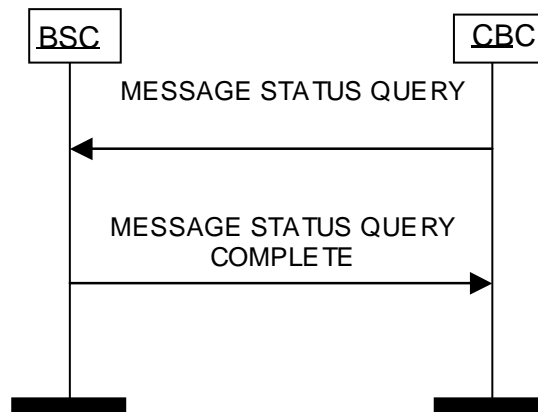

**Figure 7.5.2.1: Message Status Query Procedure: Successful Operation**

The Message Status Query procedure is initiated by the CBC sending the MESSAGE STATUS QUERY message to the BSC (see figure 7.5.2.1) containing the *Old Serial Number IE*, the *Message Identifier IE* and the *Cell List IE*, identifying the cells for which the status query is required, and the *Channel Indicator IE*.

Upon receipt of the MESSAGE STATUS QUERY message the BSC shall report for each cell as indicated in the *Cell List IE*, the total number of broadcasts of the identified CBS message. The number of broadcasts is reported for each cell in the Number of Broadcasts Completed field included in the *Number of Broadcasts Completed List IE*.

The BSC responds to the CBC by sending the MESSAGE STATUS QUERY COMPLETE message, containing the *Message Identifier IE*, the *Old Serial Number IE*, the *Number of Broadcasts Completed List IE* and the *Channel Indicator IE*.

If the actual number of broadcasts for a particular cell is greater than the value reported in the Number of Broadcasts Completed field, the Number of Broadcasts Info field shall be set to value "overflow" to indicate that the counter for the specific cell has overflowed.

If the number of broadcasts is not known for a particular cell, the Number of Broadcasts Completed field shall be set to value "0" and the Number of Broadcasts Info field shall be set to "unknown" for this cell.

If the Message Status Query procedure fails in at least one cell for another reason, the BSC shall respond to the CBC by sending the MESSAGE STATUS QUERY FAILURE message, see subclause 7.5.3.

### 7.5.3 Unsuccessful Operation

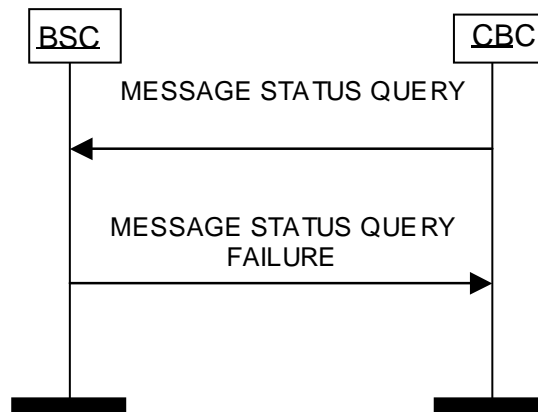

**Figure 7.5.3.1: Message Status Query Procedure: Un-Successful Operation**

If upon receipt of the MESSAGE STATUS QUERY message the BSC can not report the number of CBS message broadcasts in one or several cells as indicated in the *Cell List* IE (e.g. if the CBS message reference is unknown in the BSC) the BSC shall respond by sending the MESSAGE STATUS QUERY FAILURE message to the CBC. Cell(s), for which BSC can not report the number of broadcasts, shall be included in the *Failure List* IE together with a Cause value identifying the reason for the failure.

If the Message Status Query procedure is successful in at least one cell in the BSC, this cell shall be identified in the *Number of Broadcasts Completed List* IE and be included in the MESSAGE STATUS QUERY FAILURE message.

The sum of the cell(s) included in the *Number of Broadcasts Completed List* IE and *Failure List* IE shall be equal to the sum of cell(s) as included in the *Cell List* IE in the MESSAGE STATUS QUERY message.

## 7.6 Set DRX

### 7.6.1 General

The purpose of the Set DRX procedure is to configure SMSCB DRX specific parameters in the BSC. This is an optional procedure in the BSC. If not supported, the BSC may use default values of the SMSCB DRX specific parameters.

## 7.6.2 Successful Operation

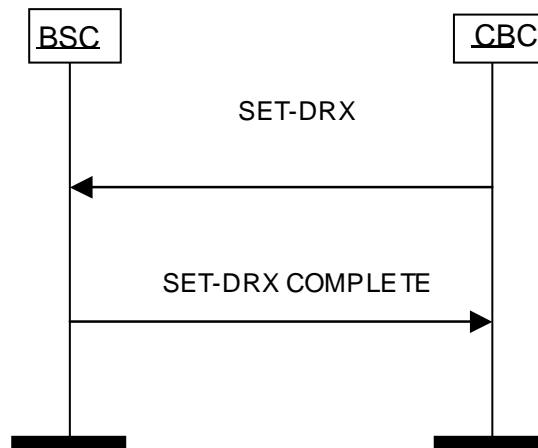

**Figure 7.6.2.1: Set DRX Procedure: Successful Operation**

The Set DRX procedure is initiated by the CBC sending the SET-DRX message to the BSC (see figure 7.6.2.1) containing at least one of the two IE's *Schedule Period IE* and *Number of Reserved Slots IE*, the *Cell List IE* identifying the cell(s) for which the new SMSCB DRX specific parameter(s) is valid for, and the *Channel Indicator IE*.

The *Schedule Period IE* indicates the length of the SMSCB DRX schedule period in number of slots (see 3GPP TS 44.012 [3]). The length of the DRX schedule period shall not be longer than 40 slots since the schedule message can not be built entirely if more than 40 CBS messages have to be described in the schedule period.

The *Number of Reserved Slots IE* indicates the number of slots in the schedule message reserved for "free slots reading advised" which are normally used for broadcasting of incoming high priority CBS messages (see 3GPP TS 44.012 [3]). The value of *Number of Reserved Slots IE* must be given a lower value than the *Schedule Period IE*.

The new SMSCB DRX parameters shall be taken into account starting from the next schedule period in each cell.

After successfully changing the SMSCB DRX parameter(s) for the requested cell(s) the BSC shall respond to the CBC by sending the SET-DRX COMPLETE message with the *Cell List IE* identifying the cell(s) for which the SMSCB DRX parameter(s) is changed, and the *Channel Indicator IE*.

If the Set DRX procedure fails in at least one cell, the BSC shall respond to the CBC by sending the SET-DRX FAILURE message, see subclause 7.6.3.

## 7.6.3 Unsuccessful Operation

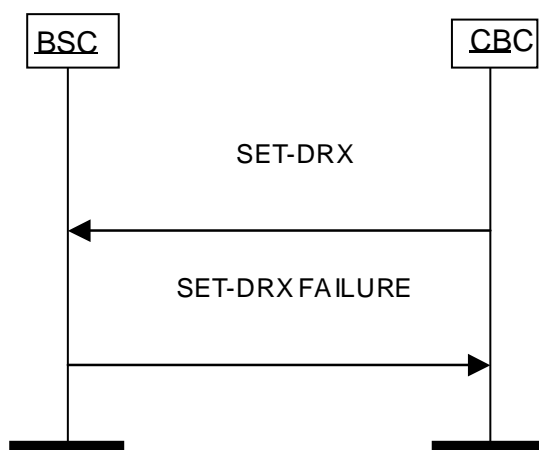

**Figure 7.6.3.1: Set DRX Procedure: Un-Successful Operation**

If upon receipt of the SET-DRX message the BSC can not configure the SMSCB DRX parameters in the cell(s) as indicated in the *Cell List* IE, the BSC shall respond to the CBC by sending the SET-DRX FAILURE message. Cell(s), for which the SMSCB DRX parameters can not be configured, shall be included in the *Failure List* IE together with a Cause value identifying the reason for the failure.

If the Set DRX procedure is successful in at least one cell in the BSC, this cell shall be identified in the *Cell List* IE and be included in the SET-DRX FAILURE message.

The sum of the cell(s) included in the *Cell List* IE and *Failure List* IE shall be equal to the sum of cell(s) as included in the *Cell List* IE in the SET-DRX message.

## 7.7 Reset

### 7.7.1 General

The purpose of the Reset procedure is to terminate broadcasting of all messages (CBS and/or emergency messages) in one or more cells in the BSC.



## 7.7.2 Successful Operation

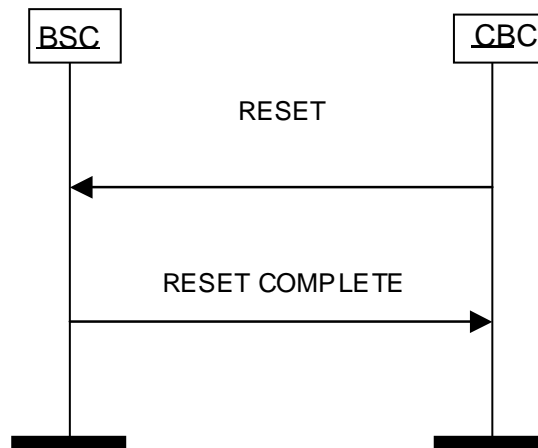

**Figure 7.7.2.1: Reset Procedure: Successful Operation**

The Reset procedure is initiated by the CBC sending the RESET message to the BSC (see figure 7.7.2.1) containing the *Cell List* IE identifying the cells in which the CBS message and emergency message broadcast shall be terminated.

Upon receipt of the RESET message the BSC shall terminate the broadcasting of all CBS messages and/or emergency messages in the indicated cell(s). All CBS messages and/or emergency messages, and any reference to them, related to the indicated cell(s), shall be deleted in the BSC.

The BSC shall respond to the CBC by sending the RESET COMPLETE message with the *Cell List* IE identifying the cell(s) in which the CBS message and/or emergency message broadcast is terminated.

If the Reset procedure, for any reason, fails in at least one cell, the BSC shall respond to the CBC by sending the RESET FAILURE message, see subclause 7.7.3.

## 7.7.3 Unsuccessful Operation

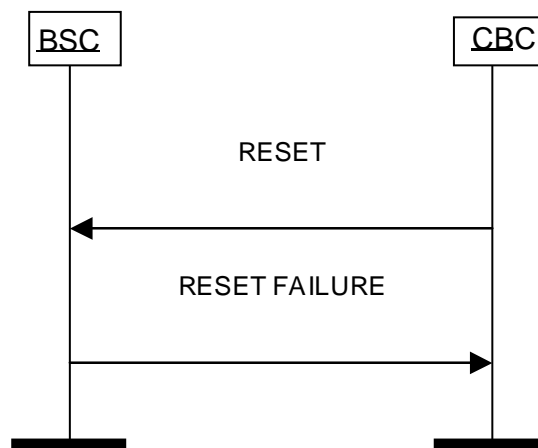

**Figure 7.7.3.1: Reset Procedure: Un-Successful Operation**

If upon receipt of the RESET message the BSC can not terminate the broadcasting of the CBS message and/or the emergency message in the cell(s) as indicated in the *Cell List* IE, the BSC shall respond to the CBC by sending the RESET FAILURE message (see figure 7.7.3.1). Cell(s), in which the Reset procedure is unsuccessful, shall be indicated in the *Failure List* IE together with a Cause value identifying the reason for the failure.

If the Reset procedure is successful in at least one cell in the BSC, this cell shall be identified in the *Cell List* IE and provided in the RESET FAILURE message.

The sum of the cell(s) included in the *Cell List* IE and *Failure List* IE shall be equal to the sum of cell(s) as included in the *Cell List* IE in the RESET message.

## 7.7a Keep Alive

### 7.7a.1 General

The purpose of the Keep Alive procedure is to verify the CBSP communication path between the CBC and the BSC and to supervise the availability of the CBSP communication.

### 7.7a.2 Successful Operation

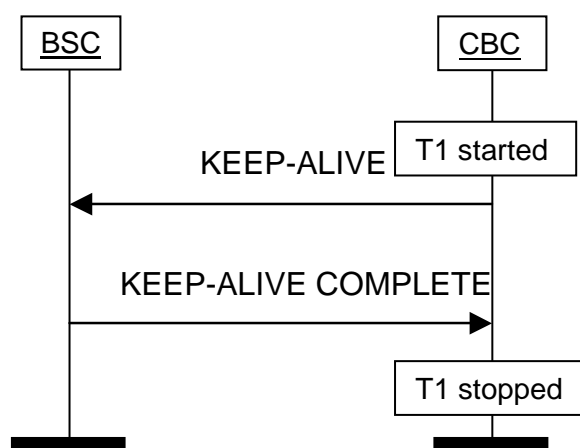

**Figure 7.7a.2.1: Keep Alive Procedure: Successful Operation**

The Keep Alive procedure is initiated by the CBC sending the KEEP-ALIVE message to the BSC (see figure 7.7a.2.1) containing the *Keep Alive Repetition Period* IE indicating the repetition period in which the KEEP-ALIVE message is sent. Upon sending of the KEEP-ALIVE message, the timer T1 is started in the CBC, supervising the response message from the BSC.

At reception of the KEEP-ALIVE message in the BSC, the BSC shall return the KEEP-ALIVE COMPLETE message to the CBC. The BSC may use the value from the *Keep Alive Repetition Period* IE to supervise the KEEP-ALIVE message sent from the CBC. How to supervise the reception of the KEEP-ALIVE message is a BSC implementation matter.

At reception of the KEEP-ALIVE COMPLETE message in the CBC, the timer T1 is stopped.

The KEEP-ALIVE message is sent periodically from the CBC according to the value as indicated in the *Keep Alive Repetition Period* IE.

### 7.7a.3 Unsuccessful Operation

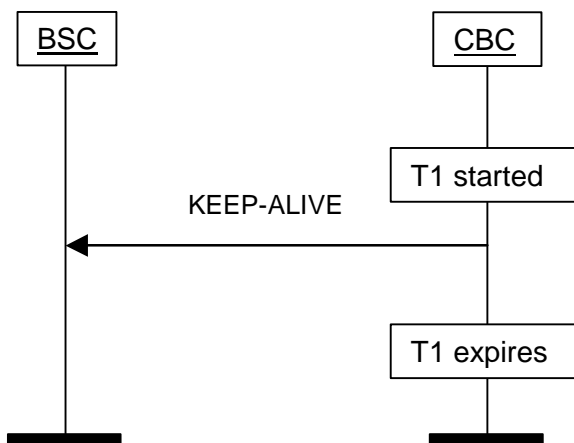

**Figure 7.7a.3.1: Keep Alive Procedure: Unsuccessful Operation**

If the KEEP-ALIVE COMPLETE message is not received in the CBC before the timer T1 expires, the Keep Alive procedure is considered as failed. Appropriate actions to follow in the CBC (e.g. repetition of Keep Alive procedure) are considered as an implementation matter.

## 7.8 Restart Indication

### 7.8.1 General

The purpose of the Restart Indication procedure is to inform the CBC that a cell broadcast related restart has occurred in one or more cells in the BSC. The procedure may also be used to inform the CBC of the current CBS message or emergency message operational state in one or more cells in the BSC independently if a cell broadcast related restart has occurred or not.

### 7.8.2 Successful Operation

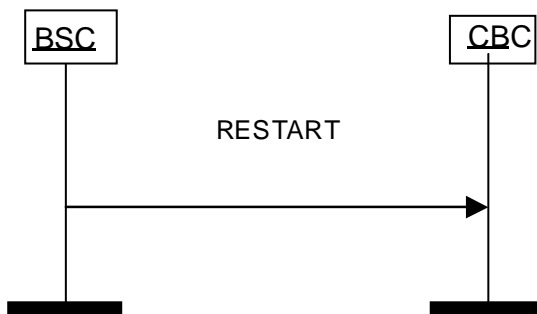

**Figure 7.8.2.1: Restart Indication Procedure: Successful Operation**

The Restart Indication procedure is initiated by the BSC in purpose to inform the CBC of the CBS message operational state or the emergency message operational state in one or more cells in the BSC.

The BSC informs the CBC by sending the RESTART message (see figure 7.8.2.1) containing the *Cell List IE* identifying the cell(s) being in CBS message operational state or in emergency message operational state and the *Recovery Indication IE*, indicating whether the broadcast information data is lost or not in the BSC.

The RESTART message is sent once per broadcast message type as indicated by the *Broadcast Message Type IE*.

## 7.9 Failure Indication

### 7.9.1 General

The purpose of the Failure Indication procedure is to inform the CBC that a cell broadcast related problem is present in one or more cells in the BSC.

### 7.9.2 Successful Operation

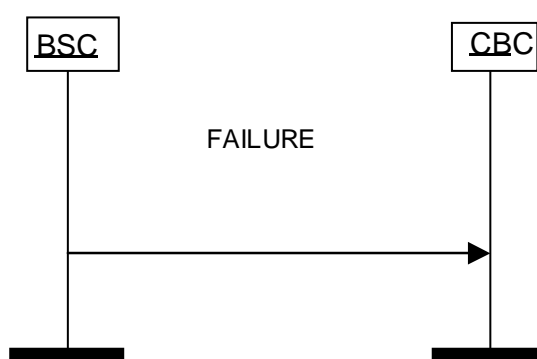

**Figure 7.9.2.1: Failure Indication Procedure: Successful Operation**

The Failure Indication procedure is initiated by the BSC when a cell broadcast related problem occurs in a cell, i.e. when CBS message broadcast or emergency message broadcast is prevented in a cell for whatever reason.

The BSC informs the CBC by sending the FAILURE message (see figure 7.9.2.1) containing the *Failure List IE* identifying the cell(s) having a broadcast related problem. For each cell a Cause value is included, indicating the reason to the failure.

The FAILURE message is sent once per broadcast message type as indicated by the *Broadcast Message Type IE*.

Upon receipt of the FAILURE message, the CBC shall not initiate further WRITE-REPLACE messages for concerned cell(s) until the CBC is informed, by the RESTART message, that the cell(s) have resumed CBS message operational state or emergency message operational state again.

## 7.10 Error Indication

### 7.10.1 General

The purpose of the Error Indication procedure is to inform the CBC that an erroneous CBSP message was received in the BSC provided the detected error can not be reported by an appropriate failure message.

## 7.10.2 Successful Operation

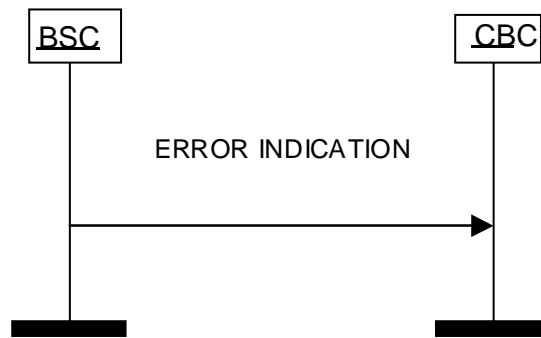

**Figure 7.10.2.1: Error Indication Procedure: Successful Operation**

The Error Indication procedure is initiated by the BSC when a CBSP message is received from the CBC and the content of the CBSP message can not be interpreted by the BSC.

The BSC informs the CBC by sending the ERROR INDICATION message (see figure 7.10.2.1), containing at least the *Cause IE*, identifying the reason for the interpretation problem in the BSC.

Examples of possible cause values for protocol error indications are:

- "Parameter-value-invalid"
- "Unrecognised-message"

The ERROR INDICATION message shall only be sent in case the detected error can not be reported by an appropriate failure message.

# 8 Elements for CBSP Communication

## 8.1 Message Functional Definitions and Contents

### 8.1.1 General

Subclause 8.1 defines the coding and format of the CBSP messages in tabular format.

A CBSP message consists of *Message Type IE*, *Length Indicator IE* and possibly a set of information elements.

For each CBSP message there is, in subclause 8.1.3, a table listing the information elements in their order of appearance in the transmitted CBSP message.

There is no general rule for the order of information elements. The same information elements may appear in various orders depending on the CBSP message.

A CBS message is uniquely identified by the four elements *Message Identifier IE*, *Serial Number IE*, *Channel Indicator IE* and the "Cell Identifier" field included in the *Cell List IE*. This means that even when two CBS messages have the same semantic content (for example the same weather forecast) but in different languages or coding schemes, they are considered as different and must therefore be identified by a different quartet.

An emergency message is uniquely identified by the three elements *Message Identifier IE*, *Serial Number IE* and the "Cell Identifier" field included in the *Cell List IE*.

Table 8.1.1.1 summarizes the CBSP messages.

**Table 8.1.1.1: CBSP messages**

Message name	Reference
WRITE-REPLACE	8.1.3.1
WRITE-REPLACE COMPLETE	8.1.3.2
WRITE-REPLACE FAILURE	8.1.3.3
KILL	8.1.3.4
KILL COMPLETE	8.1.3.5
KILL FAILURE	8.1.3.6
LOAD QUERY	8.1.3.7
LOAD QUERY COMPLETE	8.1.3.8
LOAD QUERY FAILURE	8.1.3.9
MESSAGE STATUS QUERY	8.1.3.10
MESSAGE STATUS QUERY COMPLETE	8.1.3.11
MESSAGE STATUS QUERY FAILURE	8.1.3.12
SET-DRX	8.1.3.13
SET DRX COMPLETE	8.1.3.14
SET-DRX FAILURE	8.1.3.15
RESET	8.1.3.16
RESET COMPLETE	8.1.3.17
RESET FAILURE	8.1.3.18
KEEP-ALIVE	8.1.3.18a
KEEP-ALIVE COMPLETE	8.1.3.18b
RESTART	8.1.3.19
FAILURE	8.1.3.20
ERROR INDICATION	8.1.3.21

## 8.1.2 Presence

All Information Elements in the message descriptions below are marked mandatory, optional or conditional according to table 8.1.2.1.

**Table 8.1.2.1: Meaning of abbreviations used in CBSP messages**

Abbreviation	Meaning
M	IE's marked as Mandatory (M) will always be included in the message.
O	IE's marked as Optional (O) may or may not be included in the message.
C	IE's marked as Conditional (C) will be included in a message only if the condition is fulfilled. Otherwise the IE is not included.

## 8.1.3 Message Contents

### 8.1.3.1 WRITE-REPLACE

The WRITE-REPLACE message is sent from the CBC to the BSC in order to broadcast a new CBS message or to replace an ongoing CBS message broadcast. This message may also be sent in order to broadcast a new emergency message or to replace an ongoing emergency message broadcast.

Direction: CBC → BSC

Table 8.1.3.1.1: WRITE-REPLACE message content

INFORMATION ELEMENT	REFERENCE	TYPE	LENGTH
Message Type	8.2.2	M	1
Length Indicator	8.2.26	M	3
Message Identifier	8.2.16	M	3
New Serial Number	8.2.5	M	3
Old Serial Number	8.2.4	O	3
Cell List	8.2.6	M	4+m to 4+mn
Channel Indicator	8.2.20	O (note 1)	2
Category	8.2.7	C (note 2)	2
Repetition Period	8.2.8	C (note 2)	3
Number of Broadcasts Requested	8.2.9	C (note 2)	3
Number of Pages	8.2.21	C (note 2)	2
Data Coding Scheme	8.2.14	C (note 2)	2
Message Content (Page 1)	8.2.3	C (note 2)	84
Message Content (Page 2)	8.2.3	O	84
Message Content (Page 3)	8.2.3	O	84
Message Content (Page 4)	8.2.3	O	84
Message Content (Page 5)	8.2.3	O	84
Message Content (Page 6)	8.2.3	O	84
Message Content (Page 7)	8.2.3	O	84
Message Content (Page 8)	8.2.3	O	84
Message Content (Page 9)	8.2.3	O	84
Message Content (Page 10)	8.2.3	O	84
Message Content (Page 11)	8.2.3	O	84
Message Content (Page 12)	8.2.3	O	84
Message Content (Page 13)	8.2.3	O	84
Message Content (Page 14)	8.2.3	O	84
Message Content (Page 15)	8.2.3	O	84
Emergency Indicator	8.2.17	O (note 1)	2
Warning Type	8.2.18	C (note 3)	3
Warning Security Information	8.2.19	C (note 3)	51
Warning Period	8.2.25	C (note 3)	2
NOTE 1: Only one of these two optional IEs shall be present in the message. <i>Channel Indicator</i> IE is included if and only if the message contains a CBS message. <i>Emergency Indicator</i> IE is included if and only if the message contains an emergency message.			
NOTE 2: This IE is included if and only if the <i>Channel Indicator</i> IE is present in the message.			
NOTE 3: This IE is included if and only if the <i>Emergency Indicator</i> IE is present in the message and the <i>Emergency Indicator</i> IE indicates ETWS information.			

If only the *New Serial Number* IE, and not the *Old Serial Number* IE, is included in the WRITE-REPLACE message, the BSC shall interpret the message as a write request operation.

If both *New Serial Number* IE and *Old Serial Number* IE are included in the WRITE-REPLACE message, the BSC shall interpret the message as a replace request operation.

### 8.1.3.2 WRITE-REPLACE COMPLETE

The WRITE-REPLACE COMPLETE message is sent from the BSC to the CBC to indicate a successful Write-Replace procedure.

Direction: BSC → CBC

**Table 8.1.3.2.1: WRITE-REPLACE COMPLETE message content**

INFORMATION ELEMENT	REFERENCE	TYPE	LENGTH
Message Type	8.2.2	M	1
Length Indicator	8.2.26	M	3
Message Identifier	8.2.16	M	3
New Serial Number	8.2.5	M	3
Old Serial Number	8.2.4	O (note 1)	3
Number of Broadcasts Completed List	8.2.10	O (note 2)	4+m+3 to 4+(m+3)n
Cell List	8.2.6	O	4+m to 4+mn
Channel Indicator	8.2.20	O (note 1)	2
NOTE 1: This IE is only included in the message if it was received in the WRITE-REPLACE message.			
NOTE 2: This IE is only included in the message if the message is sent as a response to a replace request operation of a CBS message.			

If the WRITE-REPLACE COMPLETE message is returned to the CBC as a response to a write request operation of a CBS message or an emergency message, the Cell Identifier for each cell is included in the *Cell List* IE.

If the WRITE-REPLACE COMPLETE message is returned to the CBC as a response to a replace request operation of a CBS message, the *Number of Broadcasts Completed List* IE may contain for each cell the number of broadcasts of the replaced CBS message. In this case the *Old Serial Number* IE refers to the message for which the number of broadcasts completed information is supplied.

If the WRITE-REPLACE COMPLETE message is returned to the CBC as a response to a replace request operation of an emergency message, the Cell Identifier for each cell is included in the *Cell List* IE. In this case the *Old Serial Number* IE is referring to the cell(s) included in the *Cell List* IE.

### 8.1.3.3 WRITE-REPLACE FAILURE

The WRITE-REPLACE FAILURE message is sent from the BSC to the CBC to indicate that the Write-Replace procedure failed in at least one cell.

Direction: BSC → CBC

**Table 8.1.3.3.1: WRITE-REPLACE FAILURE message content**

INFORMATION ELEMENT	REFERENCE	TYPE	LENGTH
Message Type	8.2.2	M	1
Length Indicator	8.2.26	M	3
Message Identifier	8.2.16	M	3
New Serial Number	8.2.5	M	3
Old Serial Number	8.2.4	O (note 2)	3
Failure List	8.2.11	M	4+m+1 to 4+(m+1)n
Number of Broadcasts Completed List	8.2.10	O (note 1)	4+m+3 to 4+(m+3)n
Cell List	8.2.6	O	4+m to 4+mn
Channel Indicator	8.2.20	O (note 2)	2
NOTE 1: This IE is only included in the message if the requested kill operation in the WRITE-REPLACE message is successful in at least one cell.			
NOTE 2: This IE is only included in the message if it was received in the WRITE-REPLACE message.			

If the WRITE-REPLACE FAILURE message is returned to the CBC as a response to a write request operation:



- The *Failure List* IE contains a list of cells for which the requested write operation failed. For each cell a Cause value is included, indicating the reason to the failure.
- The *Cell List* IE, if present, contains the cells for which the requested write operation succeeded.

If the WRITE-REPLACE FAILURE message is returned to the CBC as a response to a replace request operation:

- The *Failure List* IE contains a list of cells for which the requested kill operation failed and/or cells for which the requested kill operation succeeded but for which the subsequent write operation failed. For each cell a Cause value is included, indicating the reason to the failure.
- The *Number of Broadcasts Completed List* IE, if present, contains the cells for which the kill operation of the replaced CBS message succeeded. In this case the *Old Serial Number* IE refers to the message for which the number of broadcasts completed information is supplied.
- The *Cell List* IE, if present, contains the cells for which the kill operation of the replaced emergency message succeeded. In this case the *Old Serial Number* IE refers to the cell(s) included in the *Cell List* IE.

### 8.1.3.4 KILL

The KILL message is sent from the CBC to the BSC in order to stop broadcasting of a specific CBS message or emergency message. Any reference to the CBS message or emergency message shall be removed in the BSC.

Direction: CBC → BSC

**Table 8.1.3.4.1: KILL message content**

INFORMATION ELEMENT	REFERENCE	TYPE	LENGTH
Message Type	8.2.2	M	1
Length Indicator	8.2.26	M	3
Message Identifier	8.2.16	M	3
Old Serial Number	8.2.4	M	3
Cell List	8.2.6	M	4+m to 4+mn
Channel Indicator	8.2.20	O (note 1)	2
NOTE 1: This IE is only included if the message refers to a CBS message.			

### 8.1.3.5 KILL COMPLETE

The KILL COMPLETE message is sent from the BSC to the CBC indicating a successful Kill procedure.

Direction: BSC → CBC

**Table 8.1.3.5.1: KILL COMPLETE message content**

INFORMATION ELEMENT	REFERENCE	TYPE	LENGTH
Message Type	8.2.2	M	1
Length Indicator	8.2.26	M	3
Message Identifier	8.2.16	M	3
Old Serial Number	8.2.4	M	3
Number of Broadcasts Completed List	8.2.10	O	4+m+3 to 4+(m+3)n
Cell List	8.2.6	O	4+m to 4+mn
Channel Indicator	8.2.20	O (note 1)	2
NOTE 1: This IE is only included in the message if it was received in the KILL message.			

The *Number of Broadcasts Completed List* IE, if present, contains for each cell the total number of broadcasts of the killed CBS message.

The *Cell List* IE, if present, contains the cells in which the emergency message is successfully terminated.

### 8.1.3.6 KILL FAILURE

The KILL FAILURE message is sent from the BSC to the CBC to indicate that the Kill procedure failed in at least one cell.

Direction: BSC → CBC

**Table 8.1.3.6.1: KILL FAILURE message content**

INFORMATION ELEMENT	REFERENCE	TYPE	LENGTH
Message Type	8.2.2	M	1
Length Indicator	8.2.26	M	3
Message Identifier	8.2.16	M	3
Old Serial Number	8.2.4	M	3
Failure List	8.2.11	M	4+m+1 to 4+(m+1)n
Number of Broadcasts Completed List	8.2.10	O (note 1)	4+m+3 to 4+(m+3)n
Cell List	8.2.6	O (note 1)	4+m to 4+mn
Channel Indicator	8.2.20	O (note 2)	2
NOTE 1: This IE is only included in the message if the requested kill operation is successful in at least one cell.			
NOTE 2: This IE is only included in the message if it was received in the KILL message.			

The *Failure List* IE contains a list of cells for which the requested kill operation failed. For each cell a Cause value is included, indicating the reason to the failure.

The *Number of Broadcasts Completed List* IE, if present, contains a list of cells for which the kill operation of the CBS message succeeded.

The *Cell List* IE, if present, contains the cells in which the emergency message is successfully terminated.

### 8.1.3.7 LOAD QUERY

The LOAD QUERY message is sent from the CBC to the BSC in order to obtain current load status of the CBCH radio resources of indicated cell(s).

Direction: CBC → BSC

**Table 8.1.3.7.1: LOAD QUERY message content**

INFORMATION ELEMENT	REFERENCE	TYPE	LENGTH
Message Type	8.2.2	M	1
Length Indicator	8.2.26	M	3
Cell List	8.2.6	M	4+m to 4+mn
Channel Indicator	8.2.20	M	2

### 8.1.3.8 LOAD QUERY COMPLETE

The LOAD QUERY COMPLETE message is sent from the BSC to the CBC to indicate a successful Load Query procedure.

Direction: BSC → CBC

**Table 8.1.3.8.1: LOAD QUERY COMPLETE message content**

INFORMATION ELEMENT	REFERENCE	TYPE	LENGTH
Message Type	8.2.2	M	1
Length Indicator	8.2.26	M	3
Radio Resource Loading List	8.2.12	M	4+m+2 to 4+(m+2)n
Channel Indicator	8.2.20	M	2

### 8.1.3.9 LOAD QUERY FAILURE

The LOAD QUERY FAILURE message is sent from the BSC to the CBC indicating that the Load Query procedure failed in at least one cell.

Direction: BSC → CBC

**Table 8.1.3.9.1: LOAD QUERY FAILURE message content**

INFORMATION ELEMENT	REFERENCE	TYPE	LENGTH
Message Type	8.2.2	M	1
Length Indicator	8.2.26	M	3
Failure List	8.2.11	M	4+m+1 to 4+(m+1)n
Channel Indicator	8.2.20	M	2
Radio Resource Loading List	8.2.12	O (note 1)	4+m+2 to 4+(m+2)n
NOTE 1: This IE is only included in the message if the Load Query procedure is successful in at least one cell.			

The *Failure List* IE contains a list of cells for which the current load status of the CBCH radio resources can not be obtained. For each cell a Cause value is included, indicating the reason to the failure.

### 8.1.3.10 MESSAGE STATUS QUERY

The MESSAGE STATUS QUERY message is sent from the CBC to the BSC in order to obtain current status of a specific CBS message.

Direction: CBC → BSC

**Table 8.1.3.10.1: MESSAGE STATUS QUERY message content**

INFORMATION ELEMENT	REFERENCE	TYPE	LENGTH
Message Type	8.2.2	M	1
Length Indicator	8.2.26	M	3
Message Identifier	8.2.16	M	3
Old Serial Number	8.2.4	M	3
Cell List	8.2.6	M	4+m to 4+mn
Channel Indicator	8.2.20	M	2

### 8.1.3.11 MESSAGE STATUS QUERY COMPLETE

The MESSAGE STATUS QUERY COMPLETE message is sent from the BSC to the CBC to indicate a successful Message Status Query procedure.

Direction: BSC → CBC

**Table 8.1.3.11.1: MESSAGE STATUS QUERY COMPLETE message content**

INFORMATION ELEMENT	REFERENCE	TYPE	LENGTH
Message Type	8.2.2	M	1
Length Indicator	8.2.26	M	3
Message Identifier	8.2.16	M	3
Old Serial Number	8.2.4	M	3
Number of Broadcasts Completed List	8.2.10	M	4+m+3 to 4+(m+3)n
Channel Indicator	8.2.20	M	2

### 8.1.3.12 MESSAGE STATUS QUERY FAILURE

The MESSAGE STATUS QUERY FAILURE message is sent from the BSC to the CBC indicating that the Message Status Query procedure failed in at least one cell.

Direction: BSC → CBC

**Table 8.1.3.12.1: MESSAGE STATUS QUERY FAILURE message content**

INFORMATION ELEMENT	REFERENCE	TYPE	LENGTH
Message Type	8.2.2	M	1
Length Indicator	8.2.26	M	3
Message Identifier	8.2.16	M	3
Old Serial Number	8.2.4	M	3
Failure List	8.2.11	M	4+m+1 to 4+(m+1)n
Channel Indicator	8.2.20	M	2
Number of Broadcasts Completed List	8.2.10	O (note 1)	4+m+3 to 4+(m+3)n
NOTE 1: This IE is only included in the message if the Message Status Query procedure is successful in at least one cell.			

The *Failure List* IE contains a list of cells for which the broadcast status can not be obtained. For each cell a Cause value is included, indicating the reason to the failure.

### 8.1.3.13 SET-DRX

The SET-DRX message is sent from the CBC to set SMSCB DRX specific parameters in the BSC.

Direction: CBC → BSC

**Table 8.1.3.13.1: SET-DRX message content**

INFORMATION ELEMENT	REFERENCE	TYPE	LENGTH
Message Type	8.2.2	M	1
Length Indicator	8.2.26	M	3
Cell List	8.2.6	M	4+m to 4+mn
Channel Indicator	8.2.20	M	2
Schedule Period	8.2.22	O (note 1)	2
Number of Reserved Slots	8.2.23	O (note 1)	2
NOTE 1: At least one of the two IEs <i>Schedule Period</i> IE or <i>Reserved Slots</i> IE must be included in the message.			

### 8.1.3.14 SET-DRX COMPLETE

The SET-DRX COMPLETE message is sent from the BSC to the CBC indicating a successful Set DRX procedure.

Direction: BSC → CBC

**Table 8.1.3.14.1: SET-DRX COMPLETE message content**

INFORMATION ELEMENT	REFERENCE	TYPE	LENGTH
Message Type	8.2.2	M	1
Length Indicator	8.2.26	M	3
Cell List	8.2.6	M	4+m to 4+mn
Channel Indicator	8.2.20	M	2

The *Cell List* IE contains a list of cells for which the SMSCB DRX parameters are successfully changed.

### 8.1.3.15 SET-DRX FAILURE

The SET-DRX FAILURE message is sent from the BSC to the CBC indicating that the Set DRX procedure failed in at least one cell.

Direction: BSC → CBC

**Table 8.1.3.15.1: SET-DRX FAILURE message content**

INFORMATION ELEMENT	REFERENCE	TYPE	LENGTH
Message Type	8.2.2	M	1
Length Indicator	8.2.26	M	3
Failure List	8.2.11	M	4+m+1 to 4+(m+1)n
Channel Indicator	8.2.20	M	2
Cell List	8.2.6	O (note 1)	4+m to 4+mn
NOTE 1: This IE is only included in the message if the Set DRX procedure is successful in at least one cell.			

The *Failure List* IE contains a list of cells for which the SMSCB DRX parameters can not be changed. For each cell a Cause value is included, indicating the reason to the failure.

### 8.1.3.16 RESET

The RESET message is sent from the CBC to the BSC in order to stop broadcasting of all messages (CBS and/or emergency messages) in one or more cells. All CBS messages and/or emergency messages related to the indicated cell(s) shall be deleted.

Direction: CBC → BSC

**Table 8.1.3.16.1: RESET message content**

INFORMATION ELEMENT	REFERENCE	TYPE	LENGTH
Message Type	8.2.2	M	1
Length Indicator	8.2.26	M	3
Cell List	8.2.6	M	4+m to 4+mn

### 8.1.3.17 RESET COMPLETE

The RESET COMPLETE message is sent from the BSC to the CBC to indicate a successful Reset procedure.

Direction: BSC → CBC

**Table 8.1.3.17.1: RESET COMPLETE message content**

INFORMATION ELEMENT	REFERENCE	TYPE	LENGTH
Message Type	8.2.2	M	1
Length Indicator	8.2.26	M	3
Cell List	8.2.6	M	4+m to 4+mn

The *Cell List* IE contains a list of cells for which the Reset procedure is successfully performed.

### 8.1.3.18 RESET FAILURE

The RESET FAILURE message is sent from the BSC to the CBC indicating that the Reset procedure failed in at least one cell.

Direction: BSC → CBC

**Table 8.1.3.18.1: RESET FAILURE message content**

INFORMATION ELEMENT	REFERENCE	TYPE	LENGTH
Message Type	8.2.2	M	1
Length Indicator	8.2.26	M	3
Failure List	8.2.11	M	4+m+1 to 4+(m+1)n
Cell List	8.2.6	O (note 1)	4+m to 4+mn
NOTE 1: This IE is only included in the message if the Reset procedure succeeded for at least one cell.			

The *Failure List* IE contains a list of cells for which the Reset procedure failed. For each cell a Cause value is included, indicating the reason to the failure.

The *Cell List* IE, if present, contains a list of cells for which the Reset procedure is successfully performed.

### 8.1.3.18a KEEP-ALIVE

The KEEP-ALIVE message is sent from the CBC to the BSC in order to verify the CBSP communication path between the CBC and the BSC.

Direction: CBC → BSC

**Table 8.1.3.18a.1: KEEP-ALIVE message content**

INFORMATION ELEMENT	REFERENCE	TYPE	LENGTH
Message Type	8.2.2	M	1
Length Indicator	8.2.26	M	3
Keep Alive Repetition Period	8.2.27	M	2

### 8.1.3.18b KEEP-ALIVE COMPLETE

The KEEP-ALIVE COMPLETE message is sent from the BSC to the CBC in response to the KEEP-ALIVE message.

Direction: BSC → CBC

**Table 8.1.3.18b.1: KEEP-ALIVE COMPLETE message content**

INFORMATION ELEMENT	REFERENCE	TYPE	LENGTH
Message Type	8.2.2	M	1
Length Indicator	8.2.26	M	3

### 8.1.3.19 RESTART

The RESTART message is sent to inform the CBC of the CBS message operational state or the emergency message operational state for cells included in the *Cell List* IE.

Direction: BSC → CBC

**Table 8.1.3.19.1: RESTART message content**

INFORMATION ELEMENT	REFERENCE	TYPE	LENGTH
Message Type	8.2.2	M	1
Length Indicator	8.2.26	M	3
Cell List	8.2.6	M	4+m to 4+mn
Broadcast Message Type	8.2.24	M	2
Recovery Indication	8.2.15	M	2

The *Recovery Indication* IE indicates whether CBS message or emergency message related data is lost for the indicated cell(s). Note that the *Recovery Indication* IE does not indicate if the parameters set by the Set DRX procedure are available or not.

The *Broadcast Message Type* IE indicates the type of broadcast message the RESTART message is referring to.

### 8.1.3.20 FAILURE

The FAILURE message is sent from the BSC to indicate a cell broadcast related problem in one or more of its cells. Cells included in the *Failure List* IE are not in CBS message operational state or in emergency message operational state.

Direction: BSC → CBC

**Table 8.1.3.20.1: FAILURE message content**

INFORMATION ELEMENT	REFERENCE	TYPE	LENGTH
Message Type	8.2.2	M	1
Length Indicator	8.2.26	M	3
Failure List	8.2.11	M	4+m+1 to 4+(m+1)n
Broadcast Message Type	8.2.24	M	2

The *Broadcast Message Type* IE indicates the type of broadcast message the FAILURE message is referring to.

### 8.1.3.21 ERROR INDICATION

The ERROR INDICATION message is sent from the BSC to the CBC in response to any CBC request which can not be interpreted in the BSC.

Direction: BSC → CBC

**Table 8.1.3.21.1: ERROR INDICATION message content**

INFORMATION ELEMENT	REFERENCE	TYPE	LENGTH
Message Type	8.2.2	M	1
Length Indicator	8.2.26	M	3
Cause	8.2.13	M	2
Message Identifier	8.2.16	O	3
New Serial Number	8.2.5	O	3
Old Serial Number	8.2.4	O	3
Channel Indicator	8.2.20	O (note 1)	2
NOTE 1: This IE is only included in the message if it was received in the request message from the CBC.			

## 8.2 Information Element Definitions

### 8.2.1 General

Subclause 8.2 presents the CBSP IE definitions in tabular format.

The following conventions are assumed for the sequence of transmission of bits and bytes:

- Each bit position is marked as 1 to 8. Bit 1 is the least significant bit and is transmitted first;
- In an element octets are identified by numbers, octet 1 is transmitted first, then octet 2, etc.

When a field extends over more than one octet, the order of bit values progressively decreases as the octet number increases. The least significant bit of the field is represented by the lowest numbered bit of the highest numbered octet of the field.

For variable length elements a length indicator in binary format is included, indicating the number of octets following in the element.

All fields within Information Elements are mandatory unless otherwise specified. The Information Element Identifier shall always be included.

All spare bits are set to "0".



Table 8.2.1.1: Information elements used and their coding

Element Identifier Coding	Element name	Reference
0000 0001	Message Content	8.2.3
0000 0010	Old Serial Number	8.2.4
0000 0011	New Serial Number	8.2.5
0000 0100	Cell List	8.2.6
0000 0101	Category	8.2.7
0000 0110	Repetition Period	8.2.8
0000 0111	Number of Broadcasts Requested	8.2.9
0000 1000	Number of Broadcasts Completed List	8.2.10
0000 1001	Failure List	8.2.11
0000 1010	Radio Resource Loading List	8.2.12
0000 1011	Cause	8.2.13
0000 1100	Data Coding Scheme	8.2.14
0000 1101	Recovery Indication	8.2.15
0000 1110	Message Identifier	8.2.16
0000 1111	Emergency Indicator	8.2.17
0001 0000	Warning Type	8.2.18
0001 0001	Warning Security Information	8.2.19
0001 0010	Channel Indicator	8.2.20
0001 0011	Number of Pages	8.2.21
0001 0100	Schedule Period	8.2.22
0001 0101	Number of Reserved Slots	8.2.23
0001 0110	Broadcast Message Type	8.2.24
0001 0111	Warning Period	8.2.25
0001 1000	Keep Alive Repetition Period	8.2.27

## 8.2.2 Message Type

*Message Type* IE uniquely identifies the message being sent. It is a single octet element, mandatory in all messages.

All unassigned codes are reserved for future use.

Table 8.2.2.1: Message types for CBSP messages

8 7 6 5 4 3 2 1	Message name
0 0 0 0 0 0 0 0	Reserved
0 0 0 0 0 0 0 1	WRITE-REPLACE
0 0 0 0 0 0 1 0	WRITE-REPLACE COMPLETE
0 0 0 0 0 0 1 1	WRITE-REPLACE FAILURE
0 0 0 0 0 1 0 0	KILL
0 0 0 0 0 1 0 1	KILL COMPLETE
0 0 0 0 0 1 1 0	KILL FAILURE
0 0 0 0 0 1 1 1	LOAD QUERY
0 0 0 0 1 0 0 0	LOAD QUERY COMPLETE
0 0 0 0 1 0 0 1	LOAD QUERY FAILURE
0 0 0 0 1 0 1 0	MESSAGE STATUS QUERY
0 0 0 0 1 0 1 1	MESSAGE STATUS QUERY COMPLETE
0 0 0 0 1 1 0 0	MESSAGE STATUS QUERY FAILURE
0 0 0 0 1 1 0 1	SET-DRX
0 0 0 0 1 1 1 0	SET DRX COMPLETE
0 0 0 0 1 1 1 1	SET-DRX FAILURE
0 0 0 1 0 0 0 0	RESET
0 0 0 1 0 0 0 1	RESET COMPLETE
0 0 0 1 0 0 1 0	RESET FAILURE
0 0 0 1 0 0 1 1	RESTART
0 0 0 1 0 1 0 0	FAILURE
0 0 0 1 0 1 0 1	ERROR INDICATION
0 0 0 1 0 1 1 0	KEEP-ALIVE
0 0 0 1 0 1 1 1	KEEP-ALIVE COMPLETE

### 8.2.3 Message Content

*Message Content* IE contains the user information of the CBS message. The user information of the *Message Content* IE will be broadcasted over the radio interface (see 3GPP TS 44.012 [3]) together with the Serial Number, Message Identifier and Data Coding Scheme.

The *Message Content* IE is a fixed length element coded as follows:

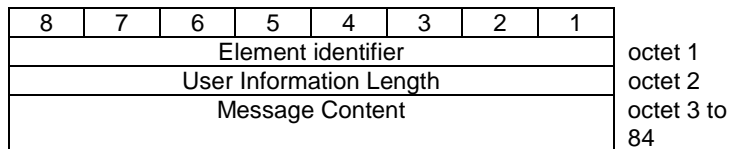

**Figure 8.2.3.1: *Message Content* information element**

The "User Information Length" field is coded as the binary value of number of octets of the "Message Content" field containing user information. When the user information is less than 82 octets, the remaining octets of the "Message Content" field must be filled with padding bits (see 3GPP TS 23.038 [4]).

In the case where the user information is encoded using the GSM 7 bit default alphabet and the last character terminates at an octet boundary, the "User Information Length" field indicates the number of octets of user information. In the case where the last character does not terminate at an octet boundary, this field indicates the number of octets up to the octet boundary immediately following the last GSM 7 bit default alphabet character of user information.

The "User Information Length" field is coded as follows:

0000 0000	reserved
0000 0001	one octet of user information
:: ::	
0101 0010	82 octets of user information

All other values are reserved.

In the case where the user information is GSM 7 bit default alphabet encoded, the appropriate padding characters and bit-fill are added to the end of the user information to complete the Message Content (see 3GPP TS 23.038 [4]).

In the case where the user information is 8 bit encoded, the appropriate padding octets are added to the end of the user information to complete the Message Content (see 3GPP TS 23.038 [4]).

### 8.2.4 Old Serial Number

*Old Serial Number* IE is a fixed length element which together with the *Message Identifier* IE, *Cell Identifier* IE and the *Channel Indicator* IE enables identification of an existing CBS message. *Old Serial Number* IE together with the *Message Identifier* IE and the *Cell Identifier* IE enables identification of an existing emergency message.

The coding is as follows:

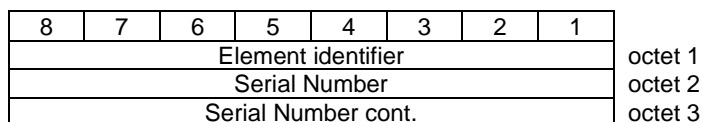

**Figure 8.2.4.1: *Old serial Number* information element**

Octets 2-3 are coded as the 'Serial-Number' defined in 3GPP TS 23.041 [1].

### 8.2.5 New Serial Number

*New Serial Number* IE is a fixed length element which together with the *Message Identifier* IE, *Cell Identifier* IE and *Channel Indicator* IE enables identification of a new CBS message. *New Serial Number* IE together with the *Message Identifier* IE and the *Cell Identifier* IE enables identification of a new emergency message.

The *New Serial Number* IE is altered every time the CBS message, or the emergency message, with a given Message Identifier is changed.

The coding is as follows:

8	7	6	5	4	3	2	1	
Element identifier								octet 1
Serial Number								octet 2
Serial Number cont.								octet 3

**Figure 8.2.5.1: New Serial Number information element**

Octets 2-3 are coded as the 'Serial-Number' defined in 3GPP TS 23.041 [1].

## 8.2.6 Cell List

The *Cell List* IE identifies a sequence of one or more cells to which the CBS message or emergency message apply. The *Cell List* IE must include at least one cell.

This element is of variable length containing the following fields:

8	7	6	5	4	3	2	1	
Element identifier								octet 1
Length								octet 2
Length cont.								octet 3
Spare				Cell identification discriminator				octet 4
Cell identification 1								octet 5 to 4+m
...								
Cell identification n								.. to 4+mn

**Figure 8.2.6.1: Cell List information element**

The Length depends on the Cell identification discriminator (bits 1 to 4 of octet 4) as well as the number of cells to be identified.

The coding of the Cell identification discriminator is a binary number indicating if the whole or a part of Cell Global identification, CGI, according to 3GPP TS 23.003 [2] is used for cell identification of the cells in the list. The Cell identification discriminator is coded as follows:

0000	The whole Cell Global Identification, CGI, is used to identify the cells.
0001	Location Area Code, LAC, and Cell Identity, CI, is used to identify the cells.
0010	Cell Identity, CI, is used to identify the cells.
0100	Location Area Identification, LAI, is used to identify all cells within a Location Area.
0101	Location Area Code, LAC, is used to identify all cells within a location area.
0110	All cells in the BSC are identified.

All other values are reserved.

The coding of the Cell Identifications 1 to n (octets 5 to 4+nm) depends on the Cell identification discriminator (bits 1 to 4 of octet 4). Below the coding of the i-th Cell Identification is shown for each Cell identification discriminator (with "i" in the range 1 to n):

NOTE: No coding is specified for Cell identification discriminator value "0110" as no additional information is required.

**Coding of the i-th Cell Identification for Cell identification discriminator = 0000**

8	7	6	5	4	3	2	1	
MCC dig 2				MCC dig 1				octet x+1
MNC dig 3				MCC dig 3				octet x+2
MNC dig 2				MNC dig 1				octet x+3
LAC								octet x+4
LAC cont.								octet x+5
CI value								octet x+6
CI value cont.								octet x+7

**Figure 8.2.6.2: Coding of the i-th Cell Identification for Cell identification discriminator = 0000**

Where  $x = 4 + 7(i-1)$ .

The octets (x+1)-(x+5) are coded as shown in 3GPP TS 24.008 [5], Table 'Location Area Identification information element'.

The octets (x+6)-(x+7) are coded as shown in 3GPP TS 24.008 [5], Table 'Cell Identity information element'.

*MNC dig 3* digit shall be set to '1111' if 2-digit MNC is used.

**Coding of i-th Cell Identification for Cell identification discriminator = 0001**

8	7	6	5	4	3	2	1	
LAC								octet x+1
LAC cont.								octet x+2
CI value								octet x+3
CI value cont.								octet x+4

**Figure 8.2.6.3: Coding of the i-th Cell Identification for Cell identification discriminator = 0001**

Where  $x = 4 + 4(i-1)$

The octets (x+1)-(x+2) are coded as shown in 3GPP TS 24.008 [5], Table 'Location Area Identification information element'.

The octets (x+3)-(x+4) are coded as shown in 3GPP TS 24.008 [5], Table 'Cell Identity information element'.

**Coding of i-th Cell Identification for Cell identification discriminator = 0010**

8	7	6	5	4	3	2	1	
CI value								octet x+1
CI value cont.								octet x+2

**Figure 8.2.6.4: Coding of the i-th Cell Identification for Cell identification discriminator = 0010**

Where  $x = 4 + 2(i-1)$

The octets (x+1)-(x+2) are coded as shown in 3GPP TS 24.008 [5], Table 'Cell Identity information element'.

**Coding of i-th Cell Identification for Cell identification discriminator = 0100**

8	7	6	5	4	3	2	1	
MCC dig 2				MCC dig 1				octet x+1
MNC dig 3				MCC dig 3				octet x+2
MNC dig 2				MNC dig 1				octet x+3
LAC								octet x+4
LAC cont.								octet x+5

**Figure 8.2.6.5: Coding of the i-th Cell Identification for Cell identification discriminator = 0100**

Where  $x = 4 + 5(i-1)$

The octets (x+1)-(x+5) are coded as shown in 3GPP TS 24.008 [5], Table 'Location Area Identification information element'.

*MNC dig 3* digit shall be set to '1111' if 2-digit MNC is used.

**Coding of i-th Cell Identification for Cell identification discriminator = 0101**

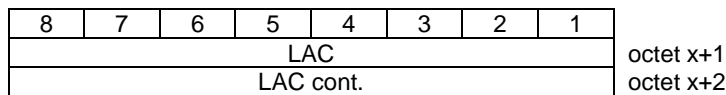

**Figure 8.2.6.6: Coding of the i-th Cell Identification for Cell identification discriminator = 0101**

Where  $x = 4 + 2(i-1)$

The octets (x+1)-(x+2) are coded as shown in 3GPP TS 24.008 [5], Table 'Location Area Identification information element'.

**8.2.7 Category**

Category IE indicates the priority of the CBS message.

It is a fixed length element coded as follows:

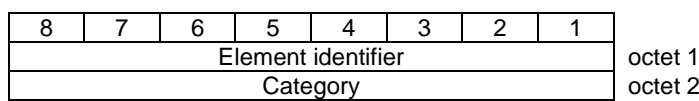

**Figure 8.2.7.1: Category information element**

The Category field is coded as follows:

- 0000 0000 High Priority; The CBS message shall be broadcasted if message slots according to the associated repetition period are available on the CBCH following the scheduling of already accepted high and/or normal priority CBS messages. The first broadcast of the CBS message shall be done at the earliest opportunity and the subsequent broadcasts according to the associated repetition period.
- 0000 0001 Background; The CBS message shall be broadcasted if message slots according to the associated repetition period are available on the CBCH following the scheduling of high and/or normal priority CBS messages and/or already accepted background messages.
- 0000 0010 Normal; The CBS message shall be broadcasted if message slots according to the associated repetition period are available on the CBCH following the scheduling of already accepted high and/or normal priority CBS messages.

All other values are reserved.

**8.2.8 Repetition Period**

Repetition Period IE indicates the periodicity of which the CBS message is to be broadcasted. The minimum period in which a CBS message consisting of one page may be broadcasted over the air interface is a period of 1.883 s.

The Repetition Period IE is a fixed length element coded as follows:

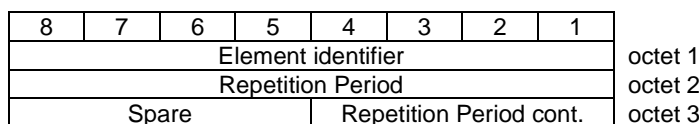

**Figure 8.2.8.1: Repetition Period information element**

The value of the "Repetition Period" field has the range 1 to 4 095 where each unit represent the value of one minimum period, i.e. 1.883 s.

The "Repetition Period" field is coded as follows:

- 0000 0000 0000 reserved
- 0000 0000 0001 1.883 second
- ...
- 1111 1111 1111 7 710.885 seconds

In the event of a conflict where the BSC has more than one CBS message to send at the same time, the BSC shall decide the order of such CBS messages as an implementation matter.

## 8.2.9 Number of Broadcasts Requested

*Number of Broadcasts Requested* IE indicates the number of times a CBS message is to be broadcasted.

It is a fixed length element coded as follows:

8	7	6	5	4	3	2	1	
Element identifier								octet 1
Number of Broadcasts Requested								octet 2
Number of Broadcasts Requested cont.								octet 3

**Figure 8.2.9.1: *Number of Broadcasts Requested* information element**

The coding of the "Number of Broadcasts Requested" field is the binary value of octet 2 and 3. It may take any value from 0 up to 65 535.

If the "Number of Broadcasts Requested" field is set to value "0" then the CBS message shall be broadcasted indefinitely until CBC request otherwise.

## 8.2.10 Number of Broadcasts Completed List

*Number of Broadcasts Completed List* IE indicates the number of times a CBS message has been sent to each cell specified in the *Cell List* IE. The *Number of Broadcasts Completed List* IE must contain at least one cell.

This element is of variable length containing the following fields:

8	7	6	5	4	3	2	1	
Element identifier								octet 1
Length								octet 2
Length cont.								octet 3
Spare				Cell identification discriminator				octet 4
Cell identification 1								octet 5 to 4+m
Number of Broadcasts Completed 1								octet 4+m+1
Number of Broadcasts Completed cont. 1								octet 4+m+2
Spare				Number of Broadcasts Info 1				octet 4+m+3
...								...
Cell identification n								.. to 4+(m+3)n-3
Number of Broadcasts Completed n								.. to 4+(m+3)n-2
Number of Broadcasts Completed cont. n								.. to 4+(m+3)n-1
Spare				Number of Broadcasts Info n				.. to 4+(m+3)n

**Figure 8.2.10.1: *Number of Broadcasts Completed List* information element**

The Length (octet 2 and 3) depends on the Cell identification discriminator (bits 1 to 4 of octet 4) as well as the number of cells to be identified.

The coding of the Cell identification discriminator is a binary number indicating if the whole or a part of Cell Global identification, CGI, according to 3GPP TS 23.003 [2] is used for cell identification of the cells in the list. The Cell identification discriminator is coded as follows:

0000	The whole Cell Global Identification, CGI, is used to identify the cells.
0001	Location Area Code, LAC, and Cell Identity, CI, is used to identify the cells.
0010	Cell Identity, CI, is used to identify the cells.

All other values are reserved.

The coding of the Cell Identifications 1 to n (octets 5 to 4+nm+ n3-3) depends on the Cell identification discriminator (bits 1 to 4 of octet 4). The coding of the i-th Cell Identification for each Cell identification discriminator (with "i" in the range 1 to n) is defined in subclause 8.2.6.

The Number of Broadcasts Completed field contains the number of times a CBS message (i.e. all pages of a CBS message) has been broadcasted in the specific cell. The value range of the field is 0 to 65 535.

The Number of Broadcasts Info field may contain some additional information to the broadcasted CBS message. The Number of Broadcasts Info field is coded as follows:

- 0000 No additional information: The number of completed broadcasts indicated in the Number of Broadcasts Completed field is valid.
- 0001 Overflow: The counter for the number of completed broadcasts in the specific cell has overflowed. The actual number of completed broadcasts is greater than the value indicated in the Number of Broadcasts Completed field.
- 0010 Unknown: Indicates that there is no information regarding the number of completed broadcasts in the BSC for the CBS message. The value indicated in the Number of Broadcasts Completed field is undefined in this case.

All other values are reserved.

### 8.2.11 Failure List

*Failure List* IE identifies the list of cells for which the BSC could not complete the request. The *Failure List* IE must contain at least one cell.

This element is of variable length containing the following fields:

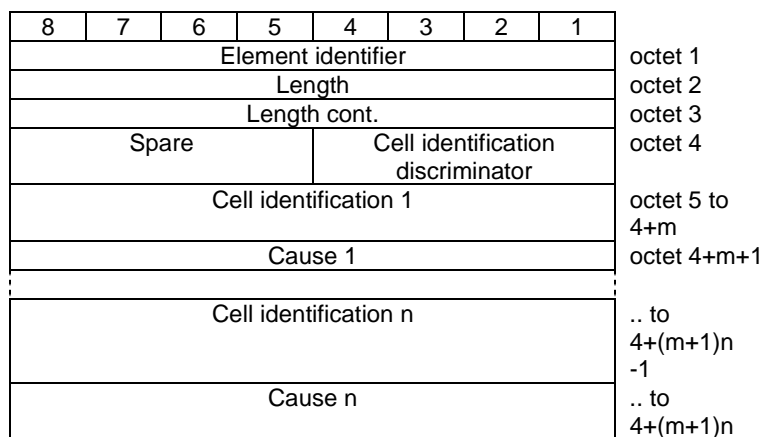

**Figure 8.2.11.1: Failure List information element**

The Length depends on the Cell identification discriminator (bits 1 to 4 of octet 4) as well as the number of cells to be identified.

The coding of the Cell identification discriminator is a binary number indicating if the whole or a part of Cell Global identification, CGI, according to 3GPP TS 23.003 [2] is used for cell identification of the cells in the list. The Cell identification discriminator is coded as follows:

- 0000 The whole Cell Global Identification, CGI, is used to identify the cells.
- 0001 Location Area Code, LAC, and Cell Identity, CI, is used to identify the cells.
- 0010 Cell Identity, CI, is used to identify the cells.

All other values are reserved.

The coding of the Cell Identifications 1 to n (octets 5 to 4+nm+n-1) depends on the Cell identification discriminator (bits 1 to 4 of octet 4). The coding of the i-th Cell Identification for each Cell identification discriminator (with "i" in the range 1 to n) is defined in subclause 8.2.6.

The "Cause" field is coded as defined in subclause 8.2.13.

## 8.2.12 Radio Resource Loading List

*Radio Resource Loading List* IE contains a list of the predicted short term load of the CBCH in each cell. The *Radio Resource Loading List* IE must contain at least one cell.

This element is of variable length containing the following fields:

8	7	6	5	4	3	2	1	
Element identifier								octet 1
Length								octet 2
Length cont.								octet 3
Spare				Cell identification discriminator				octet 4
Cell identification 1								octet 5 to 4+m
Radio Resource Load 1 1								octet 4+m+1
Radio Resource Load 2 1								octet 4+m+2
...								
Cell identification n								.. to 4+(m+2)n -2
Radio Resource Load 1 n								.. to 4+(m+2)n-1
Radio Resource Load 2 n								.. to 4+(m+2)n

**Figure 8.2.12.1: *Radio Resource Loading List* information element**

The Length depends on the Cell identification discriminator (bits 1 to 4 of octet 4) as well as the number of cells to be identified.

The coding of the Cell identification discriminator is a binary number indicating if the whole or a part of Cell Global identification, CGI, according to 3GPP TS 23.003 [2] is used for cell identification of the cells in the list. The Cell identification discriminator is coded as follows:

0000	The whole Cell Global Identification, CGI, is used to identify the cells.
0001	Location Area Code, LAC, and Cell Identity, CI, is used to identify the cells.
0010	Cell Identity, CI, is used to identify the cells.

All other values are reserved.

The coding of the Cell Identifications 1 to n (octets 5 to 4+nm+n-1) depends on the Cell identification discriminator (bits 1 to 4 of octet 4). The coding of the i-th Cell Identification for each Cell identification discriminator (with "i" in the range 1 to n) is defined in subclause 8.2.6.

The Radio Resource Load 1 field reflects the number of used CBCH message slots in relation to the number of available CBCH message slots expressed as a percentage. Number of used CBCH message slots is defined as message slots reserved for schedule messages, message slots used for high and normal priority CBS messages according to their requested repetition period and slots reserved for "free message slot reading advised".

The Radio Resource Load 2 field reflects the number of CBCH message slots used for background CBS messages according to their requested repetition period in relation to the number of available CBCH message slots expressed as a percentage.

If the broadcast periodicity of a background CBS message is reduced due to the reception of a high or normal priority CBS message broadcast request for the same cell, the requested repetition period for the background CBS message shall be taken into account. In this case the total sum of the CBCH radio resource load as indicated in Radio Resource Load 1 and Radio Resource Load 2 fields will exceed 100 %.

Radio Resource Load 1 and Radio Resource Load 2 fields are coded as a binary number representing a percentage load of the CBCH.

0000 0000	no CBCH load in the cell
0000 0001	1 % CBCH load in the cell



:::  
0110 0100      100 % CBCH load in the cell

All other values are reserved.

## 8.2.13 Cause

*Cause* IE indicates the reason for a particular error event in the BSC.

The *Cause* IE is a fixed length element coded as follows:

8	7	6	5	4	3	2	1	
Element identifier								octet 1
Cause Value								octet 2

**Figure 8.2.13.1: Cause information element**

The "Cause Value" field is coded as follows:

0000 0000	Parameter-not-recognised: Sent when the recipient (CBC or BSC) is unable to act upon the message received due to an unrecognised parameter. A message should not be rejected only because a parameter is not recognised as this would prevent extensions to the service.
0000 0001	Parameter-value-invalid: Sent when a failure occurred due to the value of a parameter being invalid, e.g. out of range, or when the combinations of two or more parameter values are invalid.
0000 0010	Message-reference-not-identified: Sent when the BSC does not recognise the Message Reference of a CBS message or an emergency message.
0000 0011	Cell-identity-not-valid: Sent when the BSC does not recognise a cell identity.
0000 0100	Unrecognised-message: Sent when the BSC does not recognise the CBSP message at all.
0000 0101	Missing-mandatory-element: Sent when a mandatory element is missing in the CBSP message.
0000 0110	BSC-capacity-exceeded: Sent when a WRITE-REPLACE message fails due to the BSC cannot meet the requested repetition period or when the Set-DRX parameters cannot be applied because of cell loading.
0000 0111	Cell-memory-exceeded: Sent when the local cell memory has been exceeded.
0000 1000	BSC-memory-exceeded: Sent when the BSC is unable to store a CBS message or an emergency message as the BSC memory has been exceeded.
0000 1001	Cell-broadcast-not-supported: Sent when the CBCH related radio resource is not configured for a cell.
0000 1010	Cell-broadcast-not-operational: Sent when the CBCH related radio resource is not available due to maintenance activities or error conditions in the BSC.
0000 1011	Incompatible-DRX-parameter: Sent when the DRX parameter(s) cannot be applied.
0000 1100	Extended-channel-not-supported: Sent when a WRITE-REPLACE message fails because the extended channel is not configured in the cell.
0000 1101	Message-reference-already-used: Sent when the BSC is unable to act upon the WRITE-REPLACE message since the same Message Reference was received in a previous WRITE-REPLACE message.
0000 1110	Unspecified-error: Sent when none of the above Cause Values apply.

All other values are reserved.

## 8.2.14 Data Coding Scheme

*Data Coding Scheme* IE identifies the alphabet or coding employed for the message characters and message handling in the mobile station. The *Data Coding Scheme* IE is a fixed length element sent transparently from the CBC to the mobile station.

It is coded as follows:

8	7	6	5	4	3	2	1	
Element identifier								octet 1
Data Coding Scheme								octet 2

**Figure 8.2.14.1: Data Coding Scheme information element**

The "Data Coding Scheme" field is coded as the 'CBS Data Coding Scheme' defined in 3GPP TS 23.038 [4].

## 8.2.15 Recovery Indication

*Recovery Indication* IE indicates if the CBS message or emergency message related data is lost or still available in the BSC.

It is a fixed length element coded as follows:

8	7	6	5	4	3	2	1
Element identifier							
Spare				Recovery Indication			

octet 1  
octet 2

**Figure 8.2.15.1: *Recovery Indication* information element**

The "Recovery Indication" field is coded as follows:

0000	CBS/emergency message data available
0001	CBS/emergency message data lost

All other values are reserved.

## 8.2.16 Message Identifier

*Message Identifier* IE is a fixed length element identifying the source and type of the CBS message or emergency message. Together with New/Old Serial Number, Cell Identifier and Channel Indicator the *Message Identifier* IE enables identification of a CBS message. Together with New/Old Serial Number and Cell Identifier the *Message Identifier* IE enables identification of an emergency message.

The coding is as follows:

8	7	6	5	4	3	2	1
Element identifier							
Message Identifier							
Message Identifier cont.							

octet 1  
octet 2  
octet 3

**Figure 8.2.16.1: *Message Identifier* information element**

Octets 2-3 are coded as the 'Message-Identifier' defined in 3GPP TS 23.041 [1].

## 8.2.17 Emergency Indicator

*Emergency Indicator* IE indicates that the WRITE-REPLACE message contains an emergency message (e.g. an ETWS Primary Notification message) to be further transferred to the mobile station.

The *Emergency Indicator* IE is a fixed length element coded as follows:

8	7	6	5	4	3	2	1
Element identifier							
Spare				Emergency Indicator			

octet 1  
octet 2

**Figure 8.2.17.1: *Emergency Indicator* information element**

The "Emergency Indicator" field is coded as follows:

0000	reserved
0001	ETWS information available

All other values are reserved.

## 8.2.18 Warning Type

*Warning Type* IE is sent transparently from the CBC to the mobile station containing ETWS related warning information.

The *Warning Type* IE is a fixed length element coded as follows:

8	7	6	5	4	3	2	1	
Element identifier								octet 1
Warning Type								octet 2
Warning Type cont.								octet 3

**Figure 8.2.18.1: *Warning Type* information element**

Octets 2-3 are coded as the 'Warning-Type' defined in 3GPP TS 23.041 [1].

## 8.2.19 Warning Security Information

*Warning Security Information* IE is sent transparently from the CBC to the mobile station. It is only included when the ETWS related warning information is sent with security.

The *Warning Security Information* IE is a fixed length element coded as follows:

8	7	6	5	4	3	2	1	
Element identifier								octet 1
Warning Security Information								octet 2 to 51

**Figure 8.2.19.1: *Warning Security Information* information element**

The "Warning Security Information" field is coded as the 'Warning-Security-Information' defined in 3GPP TS 23.041 [1].

## 8.2.20 Channel Indicator

*Channel Indicator* IE indicates the type of cell broadcast channel (CBCH) to be used for broadcasting of the CBS message. The CBCH can be of type basic or extended (see 3GPP TS 45.002 [11]).

The *Channel Indicator* IE is a fixed length element coded as follows:

8	7	6	5	4	3	2	1	
Element identifier								octet 1
Spare				Channel Indicator				octet 2

**Figure 8.2.20.1: *Channel Indicator* information element**

The Channel Indicator field is coded as follows:

0000	basic channel
0001	extended channel (support of extended channel is optional in the BSC/MS)

All other values are reserved.

## 8.2.21 Number of Pages

*Number of Pages* IE indicates the total number of pages in the CBS message, i.e. the number of *Message Content* IEs included in the WRITE-REPLACE message.

The *Number of Pages* IE is a fixed length element coded as follows:

8	7	6	5	4	3	2	1
Element identifier							
Spare				Number of Pages			

octet 1  
octet 2

**Figure 8.2.21.1: Number of Pages information element**

The "Number of Pages" field is coded as the binary value of the total number of pages in the CBS message. It is coded as follows:

0000	reserved
0001	one page
::::	
1111	fifteen pages

## 8.2.22 Schedule Period

*Schedule Period* IE indicates the SMSCB DRX schedule period length.

The *Schedule Period* IE is a fixed length element coded as follows:

8	7	6	5	4	3	2	1
Element identifier							
Schedule Period							

octet 1  
octet 2

**Figure 8.2.22.1: Schedule Period information element**

The "Schedule Period" field is coded as the binary value of number of slots in the Schedule message (see 3GPP TS 44.012 [3]).

0000 0000	no schedule period
0000 0001	1 slot
::::	
0010 1000	40 slots

All other values are reserved.

**NOTE:** The maximum value of the schedule period length is limited to 40 since the schedule message cannot be built entirely if more than 40 CBS messages have to be described in the period (see 3GPP TS 44.012 [3]).

The "Schedule Period" field must be given a higher value than the *Reserved Slots* IE.

If the "Schedule Period" field is set to value "0", the SMSCB DRX mode of operation shall not be used.

## 8.2.23 Number of Reserved Slots

*Number of Reserved Slots* IE indicates the number of reserved slots in the Schedule message (see 3GPP TS 44.012 [3]).

The *Number of Reserved Slots* IE is a fixed length element coded as follows:

8	7	6	5	4	3	2	1
Element identifier							
Number of Reserved Slots							

octet 1  
octet 2

**Figure 8.2.23.1: Number of Reserved Slots information element**

The "Number of Reserved Slots" field is coded as the binary value of number of "free slots reading advised" in the Schedule message (see 3GPP TS 44.012 [3]). The reserved slots in a SMSCB DRX schedule period can be used for broadcasting of incoming high priority CBS messages.

0000 0000	no reserved slots
0000 0001	1 reserved slot
::::	
0010 1000	40 reserved slots

All other values are reserved.

The "Number of Reserved Slots" field must be given a lower value than the *Schedule Period* IE.

## 8.2.24 Broadcast Message Type

*Broadcast Message Type* IE indicates if the information included in the CBSP message is referring to CBS message broadcasting or emergency message broadcasting.

The *Broadcast Message Type* IE is a fixed length element coded as follows:

8	7	6	5	4	3	2	1	
Element identifier								octet 1
Spare				Broadcast Message Type				octet 2

**Figure 8.2.24.1: *Broadcast Message Type* information element**

The Broadcast Message Type field is coded as follows:

0000	CBS message broadcasting
0001	emergency message broadcasting

All other values are reserved.

## 8.2.25 Warning Period

*Warning Period* IE indicates the length of the period during which the emergency message is to be broadcasted in the BSC.

The *Warning Period* IE is a fixed length element coded as follows:

8	7	6	5	4	3	2	1	
Element identifier								octet 1
Warning Period								octet 2

**Figure 8.2.25.1: *Warning Period* information element**

The Warning Period field is coded as follows:

0000 0000	unlimited
0000 0001	1 second
::::	in 1 second step
0000 1010	10 seconds
::::	in 2 second step
0001 0100	30 seconds
::::	in 5 second step
0010 0110	2 minutes
::::	in 10 second step
0101 0110	10 minutes
::::	in 30 second step
1011 1010	60 minutes

All other values are reserved.

If the Warning Period field is set to value "0", the emergency message is broadcasted until the CBC requests otherwise

## 8.2.26 Length Indicator

*Length Indicator* IE indicates the number of octets in the set of information elements included in the CBSP message.

The *Length Indicator* IE is a fixed length element coded as follows:

8	7	6	5	4	3	2	1	
Length Indicator								octet 1
Length Indicator cont.								octet 2
Length Indicator cont.								octet 3

**Figure 8.2.26.1: Length Indicator information element**

The Length Indicator field is coded as the binary value of the number of octets in the set of information elements included in the CBSP message, excluding the 1 octet of the *Message Type* IE and the 3 octets of the *Length Indicator* IE itself.

If the CBSP message does not contain a set of information elements (e.g. KEEP-ALIVE COMPLETE message) then the binary value of the Length Indicator field is coded as zero.

## 8.2.27 Keep Alive Repetition Period

*Keep Alive Repetition Period* IE indicates the periodicity of the KEEP-ALIVE message sent from the CBC,

The *Keep Alive Repetition Period* IE is a fixed length element coded as follows:

8	7	6	5	4	3	2	1	
Element identifier								octet 1
Keep Alive Repetition Period								octet 2

**Figure 8.2.27.1: Keep Alive Repetition Period information element**

The Keep Alive Repetition Period field is coded as follows:

0000 0000	reserved
0000 0001	1 second
:::	in 1 second step
0000 1010	10 seconds
:::	in 2 second step
0001 0100	30 seconds
:::	in 5 second step
0010 0110	2 minutes

All other values are reserved.

---

# 9 List of system parameters

## 9.1 Timers in the CBC

The description of timers below should be considered as a brief summary. The precise details are found in clause 7, which should be considered as the definitive description.

**T1:** This timer is started when the KEEP-ALIVE message is sent from the CBC to the BSC. It is stopped at the reception of the KEEP-ALIVE COMPLETE message in the CBC.

At expiry, the Keep Alive procedure is considered as failed.

The value of the timer is network dependent.

---

## Annex A (informative): Change History

Date/ TSG#	TDoc	CR	Rev	Subject/Comment	Version
Jan 2010				Creation of v9.0.0 based on tdoc GP-092388 approved at GP-44	9.0.0
GP-45	GP-100418	0001	4	Introduction of Keep Alive procedure in CBSP	9.1.0
GP-45	GP-100329	0002	1	Introduction of length indicator for CBSP messages	9.1.0
GP-45	GP-100131	0003		Correction to WRITE-REPLACE FAILURE message	9.1.0
GP-45	GP-100330	0004		Clarifications and improvements to the handling of background CBS messages	9.1.0
GP-46	GP-100959	0005	1	Correction on repetition frequency for "background" CBS message broadcast	9.2.0

---

## History

<b>Document history</b>		
V9.0.0	February 2010	Publication
V9.1.0	March 2010	Publication
V9.2.0	September 2010	Publication