

ETSI TS 145 001 V13.0.0 (2016-01)



**Digital cellular telecommunications system (Phase 2+) (GSM);
Physical layer on the radio path;
General description
(3GPP TS 45.001 version 13.0.0 Release 13)**



ReferenceRTS/TSGG-0145001vd00

KeywordsLTE

ETSI

650 Route des Lucioles
F-06921 Sophia Antipolis Cedex - FRANCE

Tel.: +33 4 92 94 42 00 Fax: +33 4 93 65 47 16

Siret N° 348 623 562 00017 - NAF 742 C
Association à but non lucratif enregistrée à la
Sous-Préfecture de Grasse (06) N° 7803/88

Important notice

The present document can be downloaded from:

<http://www.etsi.org/standards-search>

The present document may be made available in electronic versions and/or in print. The content of any electronic and/or print versions of the present document shall not be modified without the prior written authorization of ETSI. In case of any existing or perceived difference in contents between such versions and/or in print, the only prevailing document is the print of the Portable Document Format (PDF) version kept on a specific network drive within ETSI Secretariat.

Users of the present document should be aware that the document may be subject to revision or change of status. Information on the current status of this and other ETSI documents is available at

<http://portal.etsi.org/tb/status/status.asp>

If you find errors in the present document, please send your comment to one of the following services:

<https://portal.etsi.org/People/CommitteeSupportStaff.aspx>

Copyright Notification

No part may be reproduced or utilized in any form or by any means, electronic or mechanical, including photocopying and microfilm except as authorized by written permission of ETSI.

The content of the PDF version shall not be modified without the written authorization of ETSI.

The copyright and the foregoing restriction extend to reproduction in all media.

© European Telecommunications Standards Institute 2016.

All rights reserved.

DECT™, **PLUGTESTS™**, **UMTS™** and the ETSI logo are Trade Marks of ETSI registered for the benefit of its Members. **3GPP™** and **LTE™** are Trade Marks of ETSI registered for the benefit of its Members and of the 3GPP Organizational Partners.

GSM® and the GSM logo are Trade Marks registered and owned by the GSM Association.

Intellectual Property Rights

IPRs essential or potentially essential to the present document may have been declared to ETSI. The information pertaining to these essential IPRs, if any, is publicly available for **ETSI members and non-members**, and can be found in ETSI SR 000 314: *"Intellectual Property Rights (IPRs); Essential, or potentially Essential, IPRs notified to ETSI in respect of ETSI standards"*, which is available from the ETSI Secretariat. Latest updates are available on the ETSI Web server (<https://ipr.etsi.org/>).

Pursuant to the ETSI IPR Policy, no investigation, including IPR searches, has been carried out by ETSI. No guarantee can be given as to the existence of other IPRs not referenced in ETSI SR 000 314 (or the updates on the ETSI Web server) which are, or may be, or may become, essential to the present document.

Foreword

This Technical Specification (TS) has been produced by ETSI 3rd Generation Partnership Project (3GPP).

The present document may refer to technical specifications or reports using their 3GPP identities, UMTS identities or GSM identities. These should be interpreted as being references to the corresponding ETSI deliverables.

The cross reference between GSM, UMTS, 3GPP and ETSI identities can be found under <http://webapp.etsi.org/key/queryform.asp>.

Modal verbs terminology

In the present document "**shall**", "**shall not**", "**should**", "**should not**", "**may**", "**need not**", "**will**", "**will not**", "**can**" and "**cannot**" are to be interpreted as described in clause 3.2 of the [ETSI Drafting Rules](#) (Verbal forms for the expression of provisions).

"**must**" and "**must not**" are **NOT** allowed in ETSI deliverables except when used in direct citation.

Contents

| | |
|-------------------------------------------------------------------------------------------|----|
| Intellectual Property Rights | 2 |
| Foreword..... | 2 |
| Modal verbs terminology..... | 2 |
| Foreword..... | 5 |
| 1 Scope | 6 |
| 1.1 References | 6 |
| 1.2 Abbreviations | 7 |
| 1.2a Definitions | 7 |
| 1.3 Restrictions..... | 7 |
| 2 Set of channels | 7 |
| 3 Reference configuration | 10 |
| 4 The block structures | 12 |
| 5 Multiple access and timeslot structure | 15 |
| 5.1 Hyperframes, superframes and multiframes..... | 16 |
| 5.2 Time slots and bursts..... | 16 |
| 5.2a Training sequences | 19 |
| 5.2a.1 General..... | 19 |
| 5.2a.2 VAMOS..... | 19 |
| 5.2a.3 Extended TSC Sets | 19 |
| 5.3 Channel organization..... | 19 |
| 6 Frequency hopping capability | 24 |
| 7 Coding and interleaving | 24 |
| 7.1 General | 24 |
| 7.2 Packet Traffic and Control Channels..... | 29 |
| 7.2.1 Channel coding for PDTCH..... | 29 |
| 7.2.1.1 Channel coding for GPRS PDTCH..... | 29 |
| 7.2.1.2 Channel coding for EGPRS and EGPRS2 PDTCH | 30 |
| 7.2.2 Channel coding for PACCH, PBCCH, PAGCH, PPCH, CPBCCCH, CPAGCH, CPPCH, and CSCH..... | 36 |
| 7.2.3 Channel Coding for the PRACH and MPRACH | 36 |
| 7.2.4 Channel coding for EC-PDTCH, EC-PACCH, EC-AGCH, EC-PCH, EC-BCCH and EC-SCH..... | 36 |
| 8 Modulations..... | 36 |
| 9 Transmission and reception..... | 36 |
| 10 Other layer 1 functions | 39 |
| 11 Performance | 39 |
| 12 Flexible layer one | 39 |
| 12.1 Set of transport channels | 40 |
| 12.2 Transport block structure..... | 40 |
| 12.3 Channel organisation..... | 40 |
| 12.4 Transport channel coding/multiplexing for FLO..... | 40 |
| 13 Voice services over Adaptive Multi-user Channels on One Slot (VAMOS)..... | 41 |
| 13.1 General | 41 |
| 13.2 Network and MS Support for VAMOS..... | 42 |
| 13.3 Downlink Functionality..... | 43 |
| 13.3.1 Modulation..... | 43 |
| 13.3.1.1 Selection of modulation format..... | 43 |
| 13.3.2 Burst Format | 44 |
| 13.3.3 Associated Control Channels..... | 44 |

| | | |
|-------------------------------|------------------------------------------------------|-----------|
| 13.3.3.1 | FACCH | 44 |
| 13.3.3.2 | SACCH | 44 |
| 13.4 | Uplink Functionality..... | 44 |
| 13.4.1 | Modulation, Burst Format and Training Sequence | 44 |
| 13.4.2 | Associated Control Channels..... | 44 |
| 13.4.2.1 | FACCH | 44 |
| 13.4.2.2 | SACCH | 44 |
| 13.5 | Channel Mode Adaptation..... | 44 |
| Annex A (informative): | Reference configuration | 45 |
| Annex B (informative): | Relations between specification | 46 |
| Annex C (informative): | Change history | 47 |
| History | | 50 |

Foreword

This Technical Specification has been produced by the 3rd Generation Partnership Project (3GPP).

The contents of the present document are subject to continuing work within the TSG and may change following formal TSG approval. Should the TSG modify the contents of the present document, it will be re-released by the TSG with an identifying change of release date and an increase in version number as follows:

Version x.y.z

where:

- x the first digit:
 - 1 presented to TSG for information;
 - 2 presented to TSG for approval;
 - 3 or greater indicates TSG approved document under change control.
- y the second digit is incremented for all changes of substance, i.e. technical enhancements, corrections, updates, etc.
- z the third digit is incremented when editorial only changes have been incorporated in the document.

1 Scope

The present document is an introduction to the 45 series of the digital cellular telecommunications systems GSM technical specifications. It is not of a mandatory nature, but consists of a general description of the organization of the physical layer with reference to the technical specifications where each part is specified in detail. It introduces furthermore, the reference configuration that will be used throughout this series of technical specifications.

1.1 References

The following documents contain provisions which, through reference in this text, constitute provisions of the present document.

- References are either specific (identified by date of publication, edition number, version number, etc.) or non-specific.
- For a specific reference, subsequent revisions do not apply.
- For a non-specific reference, the latest version applies. In the case of a reference to a 3GPP document (including a GSM document), a non-specific reference implicitly refers to the latest version of that document *in the same Release as the present document*.

- [1] 3GPP TR 21.905: 'Vocabulary for 3GPP Specifications'.
- [2] 3GPP TR 23.003: 'Numbering, Addressing and Identification'.
- [3] 3GPP TS 23.034: 'High Speed Circuit Switched Data (HSCSD); Stage 2'.
- [4] 3GPP TS 43.020: 'Security-related Networks Functions'.
- [5] 3GPP TS 43.022: 'Functions related to Mobile Station (MS) in idle mode and group receive mode'.
- [6] 3GPP TR 43.030: 'Radio network planning aspects'
- [7] 3GPP TS 43.052: 'Lower layers of the GSM Cordless Telephony System (CTS) radio interface; Stage 2'.
- [8] 3GPP TS 43.064: 'Overall description of the GPRS radio interface; Stage 2'.
- [9] 3GPP TS 44.003: 'Mobile Station - Base Station System (MS - BSS) Interface Channel Structures and Access Capabilities'.
- [10] 3GPP TS 44.018: 'Mobile radio interface layer 3 specification; Radio Resource Control Protocol'
- [11] 3GPP TS 44.021: 'Rate Adaption on the Mobile Station - Base Station System (MS-BSS) Interface'
- [12] 3GPP TS 44.060: 'General Packet Radio Service (GPRS); Mobile Station (MS) - Base Station System (BSS) interface; Radio Link Control/ Medium Access Control (RLC/MAC) protocol'.
- [13] 3GPP TS 45.002: 'Multiplexing and multiple access on the radio path'.
- [14] 3GPP TS 45.003: 'Channel coding'.
- [15] 3GPP TS 45.004: 'Modulation'.
- [16] 3GPP TS 45.005: 'Radio transmission and reception'.
- [17] 3GPP TS 45.008: 'Radio subsystem link control'.
- [18] 3GPP TS 45.009: 'Link adaptation'.
- [19] 3GPP TS 45.010: 'Radio subsystem synchronization'.

- [20] 3GPP TS 45.056: 'GSM Cordless Telephony System (CTS); Phase 1; CTS-FP Radio subsystem'.
 [21] 3GPP TR 45.902: 'Flexible Layer One'.
 [22] 3GPP TR 45.914: 'Circuit Switched Voice Capacity Evolution for GERAN'.

1.2 Abbreviations

Abbreviations used in the present document are listed in 3GPP TR 21.905. In addition to abbreviations in 3GPP TR 21.905 the following abbreviations apply:

| | |
|-------|--------------------------------------------------------------|
| BTTI | Basic Transmission Time Interval |
| CC | Coverage Class |
| FANR | Fast Ack/Nack Reporting |
| PAN | Piggy-backed Ack/Nack |
| PCS | PAN Check Sequence |
| RTTI | Reduced Transmission Time Interval |
| VAMOS | Voice services over Adaptive Multi-user Channels on One Slot |
| AQPSK | Adaptive Quadrature Phase Shift Keying |

1.2a Definitions

Coverage Class: see definition in 3GPP TS 43.064 [8].

EC-EGPRS: see definition in 3GPP TS 43.064 [8].

Extended Coverage: see definition in 3GPP TS 43.064 [8].

1.3 Restrictions

Independently of what is stated elsewhere in this and other 3GPP specifications, mobile station support for PBCCH and PCCCH is optional for A/Gb-mode of operation. The network shall never enable PBCCH and PCCCH.

2 Set of channels

The radio subsystem provides a certain number of logical channels that can be separated into two categories according to 3GPP TS 44.003, 3GPP TS 43.064 and 3GPP TS 43.052:

- 1) The traffic channels (TCH): they are intended to carry two types of user information streams: encoded speech and data. The following types of traffic channels are defined: Bm or full-rate (TCH/F), Lm or half-rate (TCH/H), cell broadcast (CBCH), full rate packet data (PDTCH/F) and half rate packet data (PDTCH/H) traffic channels. For the purpose of this series of technical specifications, the following traffic channels are distinguished:
 - full rate speech TCH (TCH/FS);
 - enhanced full rate speech TCH (TCH/EFS)
 - half rate speech TCH (TCH/HS);
 - adaptive full rate speech TCH (TCH/AFS);
 - adaptive half rate speech TCH (TCH/AHS);
 - adaptive half rate 8-PSK speech TCH (O-TCH/AHS);
 - adaptive full rate wideband speech (TCH/WFS)
 - adaptive full rate 8-PSK wideband speech (O-TCH/WFS)
 - adaptive half rate 8-PSK wideband speech (O-TCH/WHs)

- 28,8 kbit/s full rate data E-TCH (E-TCH/F28.8);
- 32,0 kbit/s full rate data E-TCH (E-TCH/F32.0);
- 43,2 kbit/s full rate data E-TCH (E-TCH/F43.2);
- 14,4 kbit/s full rate data TCH (TCH/F14.4);
- 9,6 kbit/s full rate data TCH (TCH/F9.6);
- 4,8 kbit/s full rate data TCH (TCH/F4.8);
- 4,8 kbit/s half rate data TCH (TCH/H4.8);
- $\leq 2,4$ kbit/s full rate data TCH (TCH/F2.4);
- $\leq 2,4$ kbit/s half rate data TCH (TCH/H2.4);
- cell broadcast channel (CBCH);
- full rate packet data traffic channel (PDTCH/F);
- extended coverage full rate packet data traffic channel (EC-PDTCH/F);
- half rate packet data traffic channel (PDTCH/H).

Adaptive speech traffic channels are channels for which part of the radio bandwidth is reserved for transmission of in band signalling to allow in call adaptation of the speech and channel codec. 8 full rate block structures for TCH/AFS, 8 half rate block structures for O-TCH/AHS, 6 half rate block structures for TCH/AHS, 3 full rate block structures for TCH/WFS, 5 full rate block structures for O-TCH/WFS and 3 half rate block structures for O-TCH/WHS are defined.

All channels are bi-directional unless otherwise stated. Unidirectional downlink full rate channels, TCH/FD are defined as the downlink part of the corresponding TCH/F. Unidirectional uplink full rate channels are FFS.

The assigned uplink and downlink (EC-)PDTCHs are used independently of each other. Dependent assignment of uplink and downlink is possible. A PDTCH/F may be defined either in BTTI configuration or in RTTI configuration. An EC-PDTCH/F shall be defined in BTTI configuration.

Multislot configurations for circuit switched connections are defined as multiple (1 up to 8) full rate channels assigned to the same MS. At least one channel shall be bi-directional (TCH/F). The multislot configuration is symmetric if all channels are bi-directional (TCH/F) and asymmetric if at least one channel is unidirectional (TCH/FD).

High Speed Circuit Switched Data (HSCSD) is an example of multislot configuration, in which all channels shall have the same channel mode.

NOTE: For the maximum number of timeslots to be used for a HSCSD configuration, see 3GPP TS 23.034.

Multislot configurations for packet switched connections are defined as multiple (1 up to 8) (EC-)PDTCH/Us and one (EC-)PACCH for one mobile originated communication, or multiple (1 up to 8) (EC-)PDTCH/Ds and one (EC-)PACCH for one mobile terminated communication respectively, assigned to the same MS. In this context 'assignment' refers to the list of PDCHs in BTTI configuration or PDCH-pairs in RTTI configuration that may dynamically carry the (EC-)PDTCHs for that specific MS. The (EC-)PACCH shall have the same TTI configuration of the PDTCH that it is associated with. The rules for mapping of (EC-)PACCH onto physical channels are specified in 3GPP TS 44.060. In the case of point-to-multipoint transmission for MBMS, multiple (1 up to 5) PDTCH/Ds and one PACCH can be assigned for simultaneous communication with multiple mobiles.

Multislot configurations for dual transfer mode are defined as one bi-directional, traffic channel (TCH/H, O-TCH/H, TCH/F, O-TCH/F or E-TCH/F) and one packet channel combination. The packet channel combination may consist of multiple PDTCH/Us and one PACCH for one mobile originated communication, or multiple PDTCH/Ds and one PACCH for one mobile terminated communication respectively, assigned to the same MS. The PDTCHs may be transmitted either in BTTI configuration or in RTTI configuration. The rules for mapping of PACCH onto physical channels are specified in 3GPP TS 44.060.

An MS capable of dual transfer mode (DTM) shall support, as a minimum, DTM multislot class 5, which utilises the two-timeslot channelization method, i.e. a single TCH/F or O-TCH/F plus a single PDTCH/F. In addition, the MS supporting DTM shall support TCH/H + PDCH/F configuration with the adaptive multirate (AMR) speech coder for voice coding.

- 2) The signalling channels: these can be sub-divided into BCCH (broadcast control channel, including packet broadcast control channel (PBCCH), and extended coverage broadcast control channel (EC-BCCH)) (see sub-clause 1.3), CCCH (common control channel, including packet common control channel (PCCCH) and extended coverage common control channel (EC-CCCH)) (see sub-clause 1.3), SDCCH (stand-alone dedicated control channel), (P)ACCH ((packet) associated control channel, including extended coverage packet associated control channel (EC-PACCH)), packet timing advance control channel (PTCCH) and CTSCCH (CTS control channel). An associated control channel is always assigned in conjunction with, either a TCH, or an SDCCH. A packet associated control channel is always assigned in conjunction to one or multiple (EC-)PDTCH, concurrently assigned to one MS. Two types of ACCH for circuit switched connections are defined: continuous stream (slow ACCH) and burst stealing mode (fast ACCH). For the purpose of this series of technical specifications, the following signalling channels are distinguished:
- stand-alone dedicated control channel, four of them mapped on the same basic physical channel as the CCCH (SDCCH/4);
 - stand-alone dedicated control channel, eight of them mapped on a separate basic physical channel (SDCCH/8);
 - full rate fast associated control channel (FACCH/F);
 - enhanced circuit switched full rate fast associated control channel (E-FACCH/F);
 - half rate fast associated control channel (FACCH/H);
 - full rate octal fast associated control channel (O-FACCH/F);
 - half rate octal fast associated control channel (O-FACCH/H);
 - slow, TCH/F, O-TCH/F or E-TCH/F associated, control channel (SACCH/TF);
 - slow, TCH/F or O-TCH/F associated, control channel for enhanced power control (SACCH/TPF);
 - slow, TCH/H or O-TCH/H associated, control channel (SACCH/TH);
 - slow, TCH/H or O-TCH/H associated, control channel for enhanced power control (SACCH/TPH);
 - slow, TCH/F, O-TCH/F or E-TCH/F associated, control channel for multislot configurations (SACCH/M);
 - slow, TCH/F or O-TCH/F associated, control channel for enhanced power control in multislot configurations (SACCH/MP);
 - slow, TCH/F associated, control channel for CTS (SACCH/CTS);
 - slow, SDCCH/4 associated, control channel (SACCH/C4);
 - slow, SDCCH/8 associated, control channel (SACCH/C8);
 - packet associated control channel (PACCH);
 - extended coverage associated control channel (EC-PACCH);
 - packet timing advance control channel (PTCCH);
 - broadcast control channel (BCCH);
 - packet broadcast control channel (PBCCH);
 - extended coverage broadcast channel (EC-BCCH);
 - random access channel (i.e. uplink CCCH) (RACH);
 - packet random access channel (i.e. uplink PCCCH) (PRACH);

- extended coverage random access channel (i.e. uplink EC-CCCH) (EC-RACH);
- paging channel (part of downlink CCCH) (PCH);
- extended coverage paging channel (part of downlink EC-CCCH) (EC-PCH);
- packet paging channel (part of downlink PCCCH) (PPCH);
- access grant channel (part of downlink CCCH) (AGCH);
- packet access grant channel (part of downlink PCCCH) (PAGCH);
- extended coverage access grant channel (part of downlink EC-CCCH) (EC-AGCH);
- notification channel (part of downlink CCCH) (NCH);
- CTS beacon channel (part of downlink CTSCCH) (CTSBCH-FB and CTSBCH-SB);
- CTS paging channel (part of downlink CTSCCH) (CTSPCH);
- CTS access request channel (part of uplink CTSCCH) (CTSARCH);
- CTS access grant channel (part of downlink CTSCCH) (CTSAGCH);
- enhanced inband associated control channel (E-IACCH);
- enhanced power control channel (EPCCH);
- enhanced power control channel for multislot configurations (EPCCH/M);
- packet random access channel for MBMS (MPRACH).

All associated control channels have the same direction (bi-directional or unidirectional) as the channels they are associated to. The unidirectional SACCH/MD, SACCH/MPD or EPCCH/MD are defined as the downlink part of SACCH/M, SACCH/MP or EPCCH/M respectively.

When there is no need to distinguish between different sub-categories of the same logical channel, only the generic name will be used, meaning also all the sub-categories, irrespective of modulation used (SACCH will mean all categories of SACCHs, SACCH/T will mean both the slow, TCH associated, control channels with and without enhanced power control, etc.). Also EC-channels are considered to be a sub-category of the same logical channels as non-EC-channels, unless otherwise stated.

The logical channels mentioned above are mapped on physical channels that are described in this set of technical specifications. The different physical channels provide for the transmission of information pertaining to higher layers according to a block structure.

3 Reference configuration

For the purpose of elaborating the physical layer specification, a reference configuration of the transmission chain is used as shown in annex A. This reference configuration also indicates which parts are dealt with in details in which technical specification. It shall be noted that only the transmission part is specified, the receiver being specified only via the overall performance requirements. With reference to this configuration, the technical specifications in the 45 series address the following functional units:

- 3GPP TS 45.002: burst building, and burst multiplexing;
- 3GPP TS 45.003: coding, reordering and partitioning, and interleaving;
- 3GPP TS 45.004: differential encoding, and modulation;
- 3GPP TS 45.005: transmitter, antenna, and receiver (overall performance).

NOTE: 3GPP TS 45.056 addresses the transmitter and receiver of the CTS-FP.

This reference configuration defines also a number of points of vocabulary in relation to the name of bits at different levels in the configuration. It must be outlined, in the case of the encrypted bits, that they are named only with respect to their position after the encryption unit, and not to the fact that they pertain to a flow of information that is actually encrypted.

4 The block structures

The different block structures are described in more detail in 3GPP TS 45.003. A summarised description appears in table 1, in terms of net bit rate, length and recurrence of blocks.

Table 1: Channel block structures

| Type of channel | net bit rate (kbit/s) | block length (bits) | block recurrence (ms) |
|-------------------------------------------------------------|-----------------------|---------------------|-----------------------|
| full rate speech TCH ¹ | 13,0 | 182 + 78 | 20 |
| enhanced full rate speech TCH ¹ | 12,2 | 170 + 74 | 20 |
| half rate speech TCH ² | 5,6 | 95 + 17 | 20 |
| Adaptive full rate speech TCH (12,2 kbit/s) | 12,2 | 244 | 20 |
| Adaptive full rate speech TCH (10,2 kbit/s) | 10,2 | 204 | 20 |
| Adaptive full rate speech TCH (7,95 kbit/s) | 7,95 | 159 | 20 |
| Adaptive full rate speech TCH (7,4 kbit/s) | 7,4 | 148 | 20 |
| Adaptive full rate speech TCH (6,7 kbit/s) | 6,7 | 134 | 20 |
| Adaptive full rate speech TCH (5,9 kbit/s) | 5,9 | 118 | 20 |
| Adaptive full rate speech TCH (5,15 kbit/s) | 5,15 | 103 | 20 |
| Adaptive full rate speech TCH (4,75 kbit/s) | 4,75 | 95 | 20 |
| Adaptive half rate speech TCH (7,95 kbit/s) ⁸ | 7,95 | 123 + 36 | 20 |
| Adaptive half rate speech TCH (7,4 kbit/s) ⁸ | 7,4 | 120 + 28 | 20 |
| Adaptive half rate speech TCH (6,7 kbit/s) ⁸ | 6,7 | 110 + 24 | 20 |
| Adaptive half rate speech TCH (5,9 kbit/s) ⁸ | 5,9 | 102 + 16 | 20 |
| Adaptive half rate speech TCH (5,15 kbit/s) ⁸ | 5,15 | 91 + 12 | 20 |
| Adaptive half rate speech TCH (4,75 kbit/s) ⁸ | 4,75 | 83 + 12 | 20 |
| Adaptive half rate 8-PSK speech TCH (12,2 kbit/s) | 12,2 | 244 | 20 |
| Adaptive half rate 8-PSK speech TCH (10,2 kbit/s) | 10,2 | 204 | 20 |
| Adaptive half rate 8-PSK speech TCH (7,95 kbit/s) | 7,95 | 159 | 20 |
| Adaptive half rate 8-PSK speech TCH (7,4 kbit/s) | 7,4 | 148 | 20 |
| Adaptive half rate 8-PSK speech TCH (6,7 kbit/s) | 6,7 | 134 | 20 |
| Adaptive half rate 8-PSK speech TCH (5,9 kbit/s) | 5,9 | 118 | 20 |
| Adaptive half rate 8-PSK speech TCH (5,15 kbit/s) | 5,15 | 103 | 20 |
| Adaptive half rate 8-PSK speech TCH (4,75 kbit/s) | 4,75 | 95 | 20 |
| Wideband Adaptive full rate speech TCH (12,65 kbit/s) | 12,65 | 253 | 20 |
| Wideband Adaptive full rate speech TCH (8,85 kbit/s) | 8,85 | 177 | 20 |
| Wideband Adaptive full rate speech TCH (6,60 kbit/s) | 6,60 | 132 | 20 |
| Wideband Adaptive full rate 8-PSK speech TCH (23,85 kbit/s) | 23,85 | 477 | 20 |
| Wideband Adaptive full rate 8-PSK speech TCH (15,85 kbit/s) | 15,85 | 317 | 20 |
| Wideband Adaptive full rate 8-PSK speech TCH (12,65 kbit/s) | 12,65 | 253 | 20 |
| Wideband Adaptive full rate 8-PSK speech TCH (8,85 kbit/s) | 8,85 | 177 | 20 |
| Wideband Adaptive full rate 8-PSK speech TCH (6,6 kbit/s) | 6,60 | 132 | 20 |

(continued)

| Type of channel | net bit rate (kbit/s) | block length (bits) | block recurrence (ms) |
|-------------------------------------------------------------|-------------------------------|---------------------|-----------------------|
| Wideband Adaptive half rate 8-PSK speech TCH (12,65 kbit/s) | 12,65 | 253 | 20 |
| Wideband Adaptive half rate 8-PSK speech TCH (8,85 kbit/s) | 8,85 | 177 | 20 |
| Wideband Adaptive half rate 8-PSK speech TCH (6,6 kbit/s) | 6,60 | 132 | 20 |
| data E-TCH (43,2 kbit/s) ³ | 43,5 | 870 | 20 |
| data E-TCH (32,0 kbit/s) ³ | 32,0 | 640 | 20 |
| data E-TCH (28,8 kbit/s) ³ | 29,0 | 580 | 20 |
| data TCH (14,4 kbit/s) ³ | 14,5 | 290 | 20 |
| data TCH (9,6 kbit/s) ³ | 12,0 | 60 | 5 |
| data TCH (4,8 kbit/s) ³ | 6,0 | 60 | 10 |
| data TCH ($\leq 2,4$ kbit/s) ³ | 3,6 | 36 | 10 |
| PDTCH/F (CS-1) | 9,05 | 181 | - |
| PDTCH/F (CS-2) | 13,4 | 268 | - |
| PDTCH/F (CS-3) | 15,6 | 312 | - |
| PDTCH/F (CS-4) | 21,4 | 428 | - |
| PDTCH/H (CS-1) | 4,525 | 181 | - |
| PDTCH/H (CS-2) | 6,7 | 268 | - |
| PDTCH/H (CS-3) | 7,8 | 312 | - |
| PDTCH/H (CS-4) | 10,7 | 428 | - |
| EC-PDTCH/F (MCS-1/16) ^{10,18} | 2,65 | 212 | - |
| EC-PDTCH/F (MCS-1/8) ^{10,17} | 5,3 | 212 | - |
| EC-PDTCH/F (MCS-1/4) ^{10,16} | 10,6 | 212 | - |
| (EC-)PDTCH/F (MCS-1) ^{10,15} | 10,6 (21,2) ¹¹ | 212 | - |
| (EC-)PDTCH/F (MCS-2) ^{10,15} | 13,0 (26,0) ¹¹ | 260 | - |
| (EC-)PDTCH/F (MCS-3) ^{10,15} | 16,6 (33,2) ¹¹ | 332 | - |
| (EC-)PDTCH/F (MCS-4) ^{10,15} | 19,4 (38,8) ¹¹ | 388 | - |
| (EC-)PDTCH/F (MCS-5) ^{10,15} | 24,05 (48,1) ¹¹ | 481 | - |
| (EC-)PDTCH/F (MCS-6) ^{10,15} | 31,25 (62,5) ¹¹ | 625 | - |
| (EC-)PDTCH/F (MCS-7) ^{10,15} | 47,45 (94,9) ¹¹ | 949 | - |
| (EC-)PDTCH/F (MCS-8) ^{10,15} | 57,05 (114,1) ¹¹ | 1141 | - |
| (EC-)PDTCH/F (MCS-9) ^{10,15} | 61,85 (123,7) ¹¹ | 1237 | - |
| PDTCH/F (DAS-5) ¹³ | 23,75 (47,50) ¹¹ | 475 | - |
| PDTCH/F (DAS-6) ¹³ | 28,55 (57,10) ¹¹ | 571 | - |
| PDTCH/F (DAS-7) ¹³ | 34,15 (68,30) ¹¹ | 683 | - |
| PDTCH/F (DAS-8) ¹³ | 46,90 (93,80) ¹¹ | 938 | - |
| PDTCH/F (DAS-9) ¹³ | 56,50 (113,00) ¹¹ | 1130 | - |
| PDTCH/F (DAS-10) ¹³ | 67,60 (135,20) ¹¹ | 1352 | - |
| PDTCH/F (DAS-11) ¹³ | 84,40 (168,80) ¹¹ | 1688 | - |
| PDTCH/F (DAS-12) ¹³ | 101,20 (202,40) ¹¹ | 2024 | - |
| PDTCH/F (DBS-5) ¹³ | 23,80 (47,60) ¹¹ | 476 | - |
| PDTCH/F (DBS-6) ¹³ | 31,00 (62,00) ¹¹ | 620 | - |
| PDTCH/F (DBS-7) ¹³ | 46,85 (93,70) ¹¹ | 937 | - |
| PDTCH/F (DBS-8) ¹³ | 61,25 (122,50) ¹¹ | 1225 | - |
| PDTCH/F (DBS-9) ¹³ | 69,95 (139,90) ¹¹ | 1399 | - |
| PDTCH/F (DBS-10) ¹³ | 91,559 (183,10) ¹¹ | 1831 | - |
| PDTCH/F (DBS-11) ¹³ | 112,30 (224,60) ¹¹ | 2246 | - |
| PDTCH/F (DBS-12) ¹³ | 121,90 (243,80) ¹¹ | 2438 | - |
| PDTCH/F (UAS-7) ¹⁴ | 47,65 (95,30) ¹¹ | 953 | - |
| PDTCH/F (UAS-8) ¹⁴ | 57,25 (114,50) ¹¹ | 1145 | - |
| PDTCH/F (UAS-9) ¹⁴ | 62,05 (124,10) ¹¹ | 1241 | - |

| Type of channel | net bit rate (kbit/s) | block length (bits) | block recurrence (ms) |
|-------------------------------------------------------|-------------------------------------------------|-------------------------|---------------------------------|
| PDTCH/F (UAS-10) ¹⁴ | 71,00 (142,00) ¹¹ | 1420 | - |
| PDTCH/F (UAS-11) ¹⁴ | 80,60 (161,20) ¹¹ | 1612 | - |
| PDTCH/F (UBS-5) ¹⁴ | 24,20 (48,40) ¹¹ | 484 | - |
| PDTCH/F (UBS-6) ¹⁴ | 31,40 (62,80) ¹¹ | 628 | - |
| PDTCH/F (UBS-7) ¹⁴ | 47,55 (95,10) ¹¹ | 951 | - |
| PDTCH/F (UBS-8) ¹⁴ | 61,95 (123,90) ¹¹ | 1239 | - |
| PDTCH/F (UBS-9) ¹⁴ | 70,95 (141,90) ¹¹ | 1419 | - |
| PDTCH/F (UBS-10) ¹⁴ | 92,55 (185,10) ¹¹ | 1851 | - |
| PDTCH/F (UBS-11) ¹⁴ | 113,60 (227,20) ¹¹ | 2272 | - |
| PDTCH/F (UBS-12) ¹⁴ | 123,20 (246,40) ¹¹ | 2464 | - |
| PDTCH/H (MCS-1) ¹⁰ | 5,3 | 212 | - |
| PDTCH/H (MCS-2) ¹⁰ | 6,5 | 260 | - |
| PDTCH/H (MCS-3) ¹⁰ | 8,3 | 332 | - |
| PDTCH/H (MCS-4) ¹⁰ | 9,7 | 388 | - |
| PDTCH/H (MCS-5) ¹⁰ | 12,025 | 481 | - |
| PDTCH/H (MCS-6) ¹⁰ | 15,625 | 625 | - |
| PDTCH/H (MCS-7) ¹⁰ | 23,725 | 949 | - |
| PDTCH/H (MCS-8) ¹⁰ | 28,525 | 1141 | - |
| PDTCH/H (MCS-9) ¹⁰ | 30,925 | 1237 | - |
| full rate FACCH (FACCH/F) | 9,2 | 184 | 20 |
| half rate FACCH (FACCH/H) | 4,6 | 184 | 40 |
| enhanced circuit switched full rate FACCH (E-FACCH/F) | 9,2 | 184 | 20 |
| full rate octal FACCH (O-FACCH/F) | 9,2 | 184 | 20 |
| half rate octal FACCH (O-FACCH/H) | 4,6 | 184 | 40 |
| SDCCH | 598/765 ($\approx 0,782$) | 184 | 3 060/13 (235) |
| SACCH (with TCH) ⁴ | 115/300 ($\approx 0,383$) | 168 + 16 | 480 |
| SACCH (with SDCCH) ⁴ | 299/765 ($\approx 0,391$) | 168 + 16 | 6 120/13 (≈ 471) |
| PACCH/F ⁷ | - | 181 (204) ¹² | - |
| EC-PACCH, downlink ^{15,16,17,18} | - | 80 | - |
| EC-PACCH, uplink ^{15,16,17,18} | - | 64 | - |
| PACCH/H ⁷ | - | 181 | - |
| BCCH | 598/765 ($\approx 0,782$) | 184 | 3 060/13 (≈ 235) |
| EC-BCCH | 598/ (16*765) ($\approx 0,049$) | 184 | 16*3 060/13 ($\approx 3 766$) |
| PBCCH ⁶ | s*181/120 ($\approx 1,508$) | 181 | 120 |
| AGCH ⁵ | n*598/765 ($\approx 0,782$) | 184 | 3 060/13 (≈ 235) |
| EC-AGCH | 20*286/765 ($\approx 7,477$) ¹⁵ | 88 | 3 060/13 (≈ 235) |
| | 5*286/(765) ($\approx 1,869$) ¹⁶ | | 3 060/13 (≈ 235) |
| | 2*286/(765) ($\approx 0,748$) ¹⁷ | | 3 060/13 (≈ 235) |
| | 286/(4*765) ($\approx 0,093$) ¹⁸ | | 4*3 060/13 (≈ 942) |
| PAGCH ⁷ | | 181 | |
| NCH ⁵ | m*598/765 ($\approx 0,782$) | 184 | 3 060/13 (≈ 235) |
| PCH ⁵ | p*598/765 ($\approx 0,782$) | 184 | 3 060/13 (≈ 235) |
| EC-PCH | 16*286/765 ($\approx 5,982$) ¹⁵ | 88 | 3 060/13 (≈ 235) |
| | 4*286/(765) ($\approx 1,495$) ¹⁶ | | 3 060/13 (≈ 235) |
| | 2*286/(8*765) ($\approx 0,748$) ¹⁷ | | 3 060/13 (≈ 235) |
| | 286/(4*765) ($\approx 0,093$) ¹⁸ | | 4*3 060/13 (≈ 942) |
| PPCH ⁷ | | 181 | |
| RACH ⁵ | r*26/765 ($\approx 0,034$) | 8 | 3 060/13 (≈ 235) |
| PRACH (8 bit Access Burst) ⁷ | r*26/765 ($\approx 0,034$) | 8 | |

| Type of channel | net bit rate (kbit/s) | block length (bits) | block recurrence (ms) |
|--------------------------------------------------------------------------------------------------------------------------------------------------------------------------------------------------------------------------------------------------------------------------------------------------------------------------------------------------------------------------------------------------------------------------------------------------------------------------------------------------------------------------------------------------------------------------------------------------------------------------------------------------------------------------------------------------------------------------------------------------------------------------------------------------------------------------------------------------------------------------------------------------------------------------------------------------------------------------------------------------------------------------------------------------------------------------------------------------------------------------------------------------------------------------------------------------------------------------------------------------------------------------------------------------------------------------------------------------------------------------------------------------------------------------------------------------------------------------------------------------------------------------------------------------------------------------------------------------------------------------------------------------------------------------------------------------------------------------------------------------------------------------------------------------------------------------------------------------------------------------------------------------------------------------------------------------------------------------------------------------------------------------------------------------------------------------------------------------------------------------------------------------------------------------------------------------------------------------------------------------------------------------------------------------------------------------------------------------------------------------------------------------------------------------------------------------------------------------------------------------------------------------------------------------------------------------------------------------------------------------------------------------------------------------------------------------------------------------------------------------------------------------------------------------------------------------------------------------------------------------------------------------------------------------------------------------------------------------------------------------------------------------------------------------------------------------------------------------------|--------------------------------------------------------------------------------------------------------------------------------------------------------------------------------------------------|---------------------|------------------------------------------------------------------------------------------------------------------------|
| EC-RACH (11 bit Access Burst) | 51*143/3060 ($\approx 2,383$) ¹⁵ 12*143/3060 ($\approx 0,561$) ¹⁶ 6*143/3060 ($\approx 0,280$) ¹⁷ 143/(2*3060) ($\approx 0,023$) ¹⁸ | 11 | 3 060/13 (≈ 235) 3 060/13 (≈ 235) 3 060/13 (≈ 235) 2*3 060/13 (≈ 471) |
| PRACH (11 bit Access Burst) ⁷ | r*143/3060 ($\approx 0,047$) | 11 | |
| MPRACH (8 bit Access Burst) ⁷ | r*26/765 ($\approx 0,034$) | 8 | |
| MPRACH (11 bit Access Burst) ⁷ | r*143/3060 ($\approx 0,047$) | 11 | |
| CBCH | 598/765 ($\approx 0,782$) | 184 | 3 060/13 (≈ 235) |
| CTSBCH-SB | 25/240 ($\approx 0,104$) | 25 | 240 |
| CTSPCH | 184/240 ($\approx 0,767$) | 184 | 240 |
| CTSARCH | 14*25/240 ($\approx 0,104$) | 25 | 240 |
| CTSAGCH | 2*184/240 ($\approx 0,767$) | 184 | 240 |
| <p>NOTE 1: For full rate speech, the block is divided into two classes according to the importance of the bits (182 bits for class I and 78 bits for class II). For enhanced full rate speech, the block is divided into two classes according to the importance of the bits (170 bits for class I and 74 bits for class II).</p> <p>NOTE 2: For half rate speech, the block is divided into two classes according to the importance of the bits (95 bits for class I and 17 bits for class II).</p> <p>NOTE 3: For data services, the net bit rate is the adaptation rate as defined in 3GPP TS 44.021.</p> <p>NOTE 4: On SACCH, 16 bits are reserved for control information on layer 1, and 168 bits are used for higher layers.</p> <p>NOTE 5: CCCH channels are common to all users of a cell; the total number of blocks (m, n, p, r) per recurrence period is adjustable on a cell by cell basis and depends upon the parameters (BS_CC_CHANs, BS_BCCH_SDCCH_COMB, BS_AG_BLKs_RES and NCP) broadcast on the BCCH and specified in 3GPP TS 45.002 and 3GPP TS 44.018.</p> <p>NOTE 6: The total number of PBCCH blocks (s) is adjustable on a cell by cell basis and depends upon the parameter BS_PBCCH_BLKs broadcast on the first PBCCH block and specified in 3GPP TS 45.002 and 3GPP TS 44.018.</p> <p>NOTE 7: The net bit rate for these channels in a cell can change dynamically and depends on how PDCH are configured in a cell, and upon the parameters BS_PBCCH_BLKs, BS_PAG_BLKs_RES and BS_PRACH_BLKs broadcast on the PBCCH and specified in 3GPP TS 45.002 and 3GPP TS 44.018, as well as upon how certain blocks on the PDCH are used (indicated by the message type).</p> <p>NOTE 8: For adaptive half rate speech, the blocks are divided into two classes according to the importance of the bits (the first number in the block length corresponds to the class I bits, the second number corresponds to the class II bits).</p> <p>NOTE 9: CTSBCH, CTSARCH, CTSPCH and CTSAGCH are only used in CTS.</p> <p>NOTE 10: For EGPRS PDTCH, the block length in bits excludes the USF bits (downlink traffic) and all the error-check bits, but includes the tail bits. For transmission using FANR, they also exclude the PAN bits. For Turbo coded coding schemes (DAS-5 to DAS-12 and DBS-5 to DBS-12) the tail bits are not included in this calculation.</p> <p>NOTE 11: The value outside the bracket applies for transmission using BTTI configuration, whereas the value in bracket refers to the case of transmission using RTTI configuration.</p> <p>NOTE 12: The value in bracket applies to TBFs using FANR (see 3GPP TS 44.060), when transmission of the PACCH uses MCS-0.</p> <p>NOTE 13: These channels are available only for the EGPRS2 downlink.</p> <p>NOTE 14: These channels are available only for the EGPRS2 uplink.</p> <p>NOTE 15: Applies to EC-EGPRS operation for CC1.</p> <p>NOTE 16: Applies to EC-EGPRS operation for CC2.</p> <p>NOTE 17: Applies to EC-EGPRS operation for CC3.</p> <p>NOTE 18: Applies to EC-EGPRS operation for CC4.</p> | | | |

5 Multiple access and timeslot structure

The access scheme is Time Division Multiple Access (TDMA) with eight basic physical channels per carrier. The carrier separation is 200 kHz. A physical channel is therefore defined as a sequence of TDMA frames, a time slot number (modulo 8) and a frequency hopping sequence.

The basic radio resource is a time slot lasting $\approx 576,9 \mu\text{s}$ (15/26 ms) and transmitting information at a modulation rate of $\approx 270,833 \text{ ksymbol/s}$ (1 625/6 ksymbol/s) when the symbol period is the normal symbol period (see 3GPP TS 45.010) or at a modulation rate of 325 ksymbol/s for when the symbol period is the reduced symbol period (see 3GPP

TS 45.010). This means that the time slot duration, including guard time, is 156,25 symbols long when the symbol period is the normal symbol period (see 3GPP TS 45.010) or 187,5 symbols long when the symbol period is the reduced symbol period (see 3GPP TS 45.010).

We shall describe successively the time frame structures, the time slot structures and the channel organization. The appropriate specifications will be found in 3GPP TS 45.002.

5.1 Hyperframes, superframes and multiframes

A diagrammatic representation of all the time frame structures is in figure 1. The longest recurrent time period of the structure is called hyperframe and has a duration of 3 h 28 mn 53 s 760 ms (or 12 533,76 s). The TDMA frames are numbered modulo this hyperframe (TDMA frame number, or FN, from 0 to 2 715 647). This long period is needed to support cryptographic mechanisms defined in 3GPP TS 43.020.

One hyperframe is subdivided in 2 048 superframes which have a duration of 6,12 seconds. The superframe is the least common multiple of the time frame structures. The superframe is itself subdivided in multiframes; four types of multiframes exist in the system:

- a 26- multiframe (51 per superframe) with a duration of 120 ms, comprising 26 TDMA frames. This multiframe is used to carry TCH (and SACCH/T) and FACCH;
- a 51- multiframe (26 per superframe) with a duration of $\approx 235,4$ ms (3 060/13 ms), comprising 51 TDMA frames. This multiframe is used to carry BCCH, EC-BCCH, CCCH (NCH, AGCH, PCH and RACH), EC-CCCH (EC-AGCH, EC-PCH and EC-RACH) and SDCCH (and SACCH/C).
- a 52-multiframe (25,5 per superframe) with a duration of 240 ms, comprising 52 TDMA frames. This multiframe is used to carry PBCCH, PCCCH (PAGCH, PPCH and PRACH), PACCH, EC-PACCH, PDTCH, EC-PDTCH, PTCCH and MPRACH. The 52-multiframe is not shown in Figure 1, but can be seen as two 26-multiframes, with TDMA frames numbered from 0 to 51. For Compact, this 52-multiframe (51 per superframe) is used to carry CFCCH, CSCH, CPBCCH, CPCCCH (CPAGCH, CPPCH, and CPRACH), PACCH, PDTCH, and PTCCH.
- a 52-multiframe (25,5 per superframe) for CTS, with a duration of 240 ms, comprising 52 TDMA frames. This multiframe is used to carry CTSCCH (CTSBCH, CTSPCH, CTSARCH and CTSAGCH). The 52-multiframe for CTS is shown in Figure 2b.

A TDMA frame, comprising eight time slots has a duration of $\approx 4,62$ (60/13) ms.

5.2 Time slots and bursts

The time slot is a time interval of $\approx 576,9$ μ s (15/26 ms), that is 156,25 symbol¹ duration when using the normal symbol period (see 3GPP TS 45.010) or 187,5 symbol duration when using the reduced symbol period (see 3GPP TS 45.010), and its physical content is called a burst. Five different types of bursts exist in the system. A diagram of these bursts appears in figure 1.

- normal burst (NB): this burst is used to carry information on traffic and control channels, except for RACH, EC-RACH, PRACH, and CPRACH. It contains 116 encrypted symbol and includes a guard time of 8,25 symbol duration ($\approx 30,46$ μ s);
- frequency correction burst (FB): this burst is used for frequency synchronization of the mobile. It is equivalent to an unmodulated carrier, shifted in frequency, with the same guard time as the normal burst. It is broadcasted together with the BCCH. The repetition of FBs is also named frequency correction channel (FCCH). For Compact, FB is broadcast together with the CPBCCH and the repetition of FBs is also named Compact frequency correction channel (CFCCH). In CTS, the frequency correction burst is broadcast in the CTSBCH-FB channel;
- synchronization burst (SB): this burst is used for time synchronization of the mobile. It contains a long training sequence and carries the information of the TDMA frame number (FN) and base station identity code (BSIC, see

¹ One symbol is one to five bits depending on the modulation used: GMSK, QPSK, 8PSK, 16QAM and 32 QAM.

3GPP TR 23.003). It is broadcast together with the frequency correction burst. The repetition of synchronization bursts is also named synchronization channel (SCH). For Compact, the repetition of synchronization bursts is also named Compact synchronization channel (CSCH). For EC-EGPRS the repetition of synchronization bursts is also named Extended Coverage synchronization channel (EC-SCH). In this case the synchronization burst carries additional information apart from TDMA frame number and BSIC (see 3GPP TS 45.002). In CTS, the synchronization burst is used for the CTSBCH-SB and the CTSARCH, and it carries different information depending on the channel using it;

- access burst (AB): this burst is used for random access and is characterized by a longer guard period (68,25 bit duration or 252 μ s) to cater for burst transmission from a mobile which does not know the timing advance at the first access (or after handover). This allows for a distance of 35 km. In exceptional cases of cell radii larger than 35 km, some possible measures are described in 3GPP TR 43.030. The access burst is used in the (P)RACH, CPRACH, MPRACH and EC-RACH, after handover, on the uplink of a channel used for a voice group call in order to request the use of that uplink, as well as on the uplink of the PTCCH to allow estimation of the timing advance for MS in packet transfer mode;
- higher symbol rate burst (HB): this burst is used to carry information on full rate packet data traffic channels using higher symbol rate (see 3GPP TS 45.004). It contains 138 encrypted symbols and includes a guard time of 10,5 reduced symbol periods (see 3GPP TS 45.010).

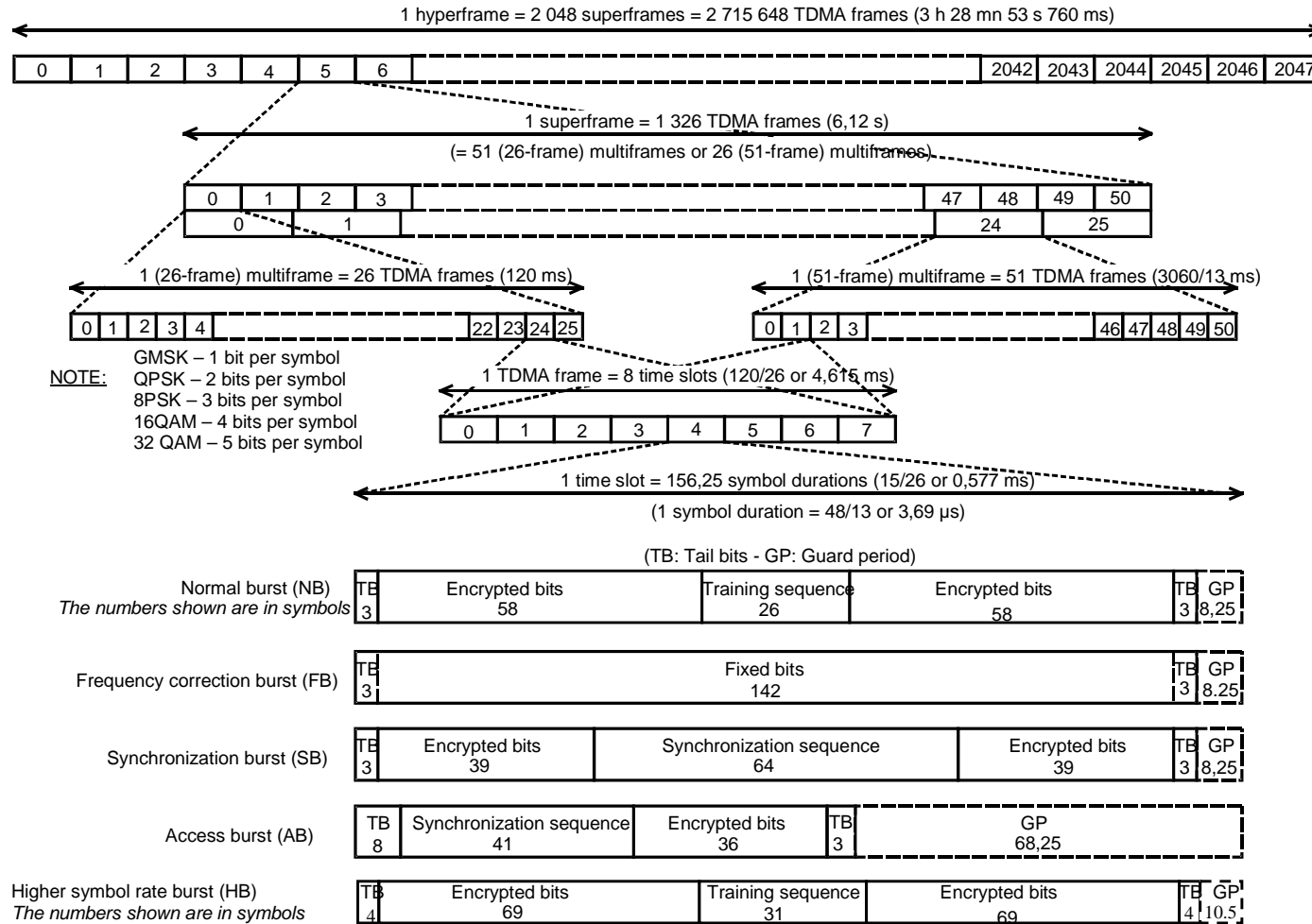

Figure 1: Time frames time slots and bursts

5.2a Training sequences

5.2a.1 General

As shown in Figure 1, all burst types except the frequency correction burst contain a training sequence (also referred to as a synchronization sequence). Its purpose is to facilitate synchronization, channel estimation and blind detection of modulation on the radio interface.

For normal bursts (NB) and higher symbol rate bursts (HB) a set of eight training sequences is defined for each modulation (GMSK, 8PSK, 16QAM and 32QAM for NB, and QPSK, 16QAM and 32QAM for HB) to facilitate training sequence planning, i.e., avoiding that strong interfering bursts have the same training sequence as the wanted signal bursts.

All training sequences are defined in 3GPP TS 45.002.

5.2a.2 VAMOS

For VAMOS, a second set of eight training sequences (TSC Set 2) is defined for GMSK modulated normal bursts (see 3GPP TS 45.002). Two GMSK training sequences are used to form the AQPSK training sequence (see 3GPP TS 45.002) for the downlink VAMOS modulation, see subclass 13.3.

5.2a.3 Extended TSC Sets

When using extended TSC Sets, additional sets, each of eight training sequences, are defined for the different modulations when using normal bursts. The number of additional TSC Sets depends on the domain (circuit switched or packet switched) they operate in.

For the circuit switched domain, two new GMSK sets, referred to as GMSK TSC Set 3 and GMSK TSC Set 4 are defined.

For the packet switched domain, including EGPRS and EGPRS2-A, one additional set of eight training sequences is defined for each of GMSK, 8PSK, 16QAM and 32QAM normal bursts, referred to as TSC Set 2 for 8PSK, 16QAM and 32QAM modulation, while for GMSK, TSC Set 3, which is identical to TSC Set 3 used for circuit switched channels, is used.

An MS indicating support for Extended TSC Sets (see 3GPP TS 24.008) shall support all additional TSC Sets applicable to its modulation capabilities for both circuit switched and packet switched channels. Especially, if such an MS supports GMSK modulated circuit switched channels, it shall support GMSK TSC Set 1, GMSK TSC Set 2, GMSK TSC Set 3 and GMSK TSC Set 4 regardless of its support for VAMOS (see 3GPP TS 24.008).

5.3 Channel organization

The channel organization for the traffic channels (TCH), FACCHs and SACCH/T uses the 26-frame multiframe. It is organized as described in figure 2, where only one time slot per TDMA frame is considered.

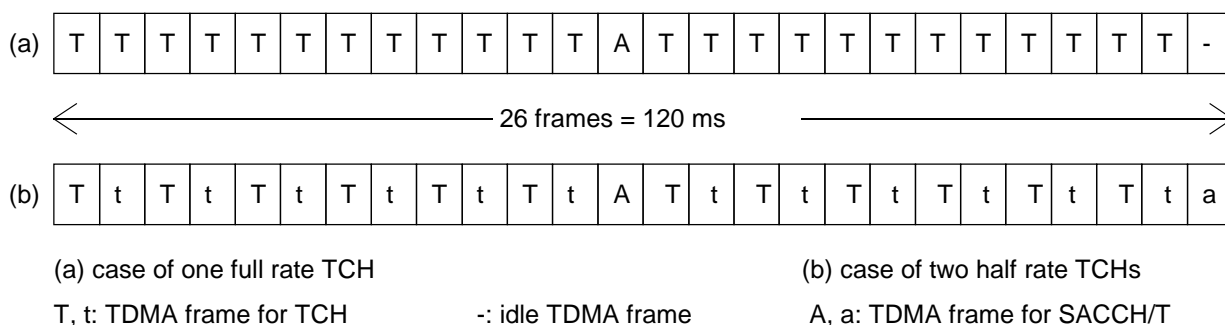

Figure 2: Traffic channel organization.

The FACCH is transmitted by pre-empting half or all of the information bits of the bursts of the TCH to which it is associated (see 3GPP TS 45.003).

The channel organization for the control channels (except FACCHs and SACCH/T) uses the 51-frame multiframe. It is organized in the downlink and uplink as described in figure 3.

The channel organization for packet data channels uses the 52- multiframe. Full rate packet data channels in BTTI configuration are organized as described in figure 2a1, and in RTTI configuration in figure 2a3. Half rate packet data channels can be organized as described in figure 2a2.

52 TDMA Frames

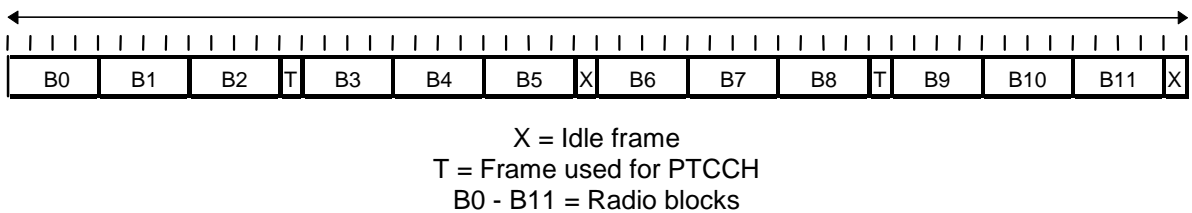

Figure 2a1: 52- multiframe for PDCH/Fs in BTTI configuration.

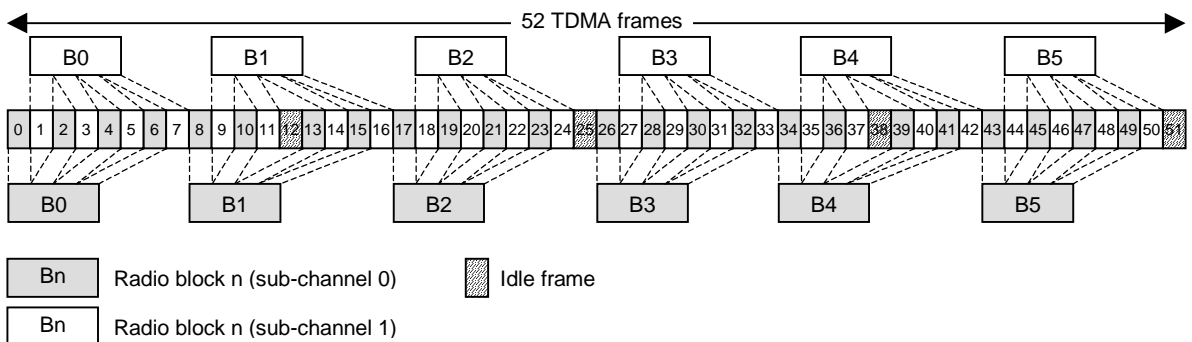

Figure 2a2: 52- multiframe for PDCH/Hs.

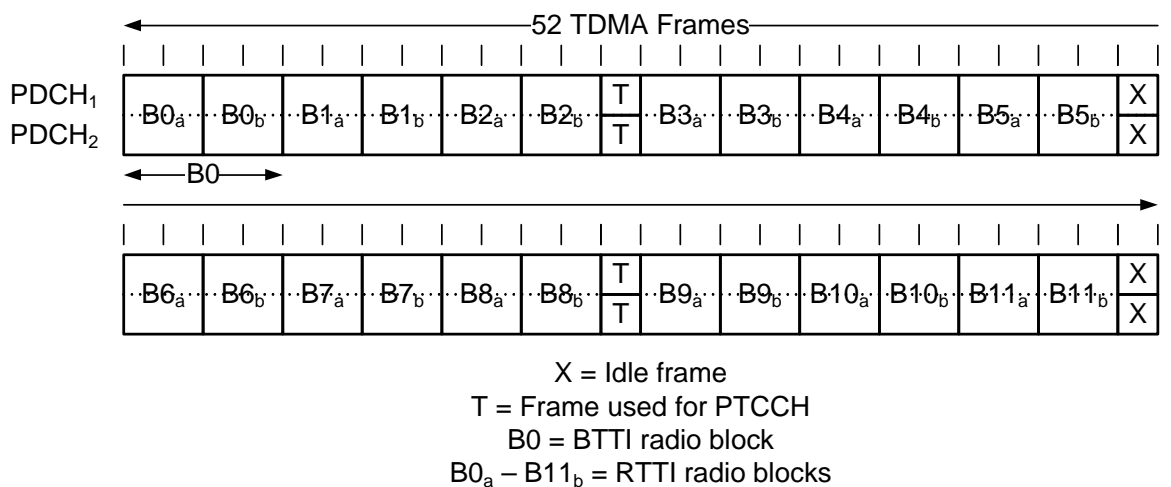
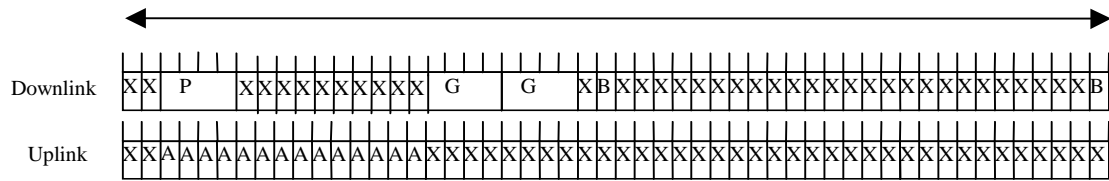

Figure 2a3: 52- multiframe for a PDCH-pair in RTTI configuration.

The channel organization for CTS control channels uses the 52-multiframe. It is organized as described in figure 2b.

52 TDMA Frames



- A: TDMA frame for CTSARCH
- B: TDMA frame for CTSBCH
- P: TDMA frame for CTSPCH
- G: TDMA frame for CTSAGCH
- X: Idle frame

Figure 2b: 52-multiframe for CTS.

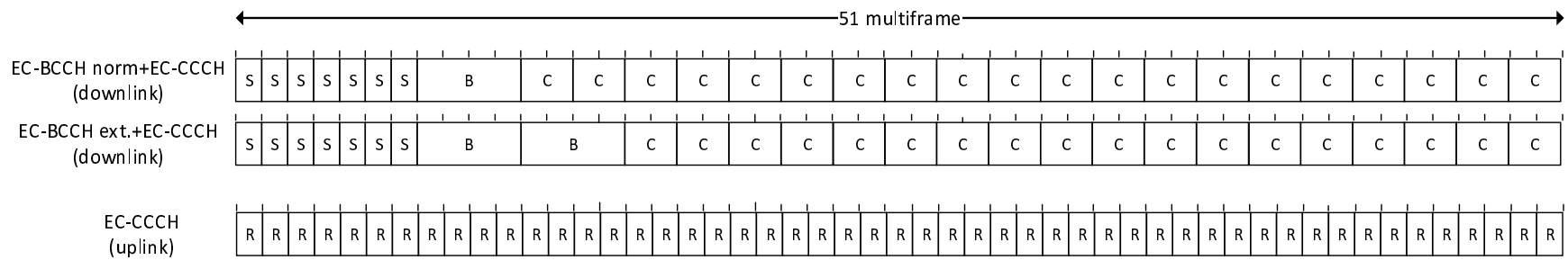

S: TDMA frame for synchronization burst (EC-SCH)
 B: TDMA frame for EC-BCCH
 C: TDMA frame for EC-CCCH
 R: TDMA frame for EC-RACH

Figure 3a: Channel organization in the 51-frame multiframe for EC-EGPRS.

6 Frequency hopping capability

The frequency hopping capability is optionally used by the network operator on all or part of its network. The main advantage of this feature is to provide diversity on one transmission link (especially to increase the efficiency of coding and interleaving for slowly moving mobile stations) and also to average the quality on all the communications through interferers diversity. It is implemented on all mobile stations.

The principle of slow frequency hopping is that every mobile transmits its time slots according to a sequence of frequencies that it derives from an algorithm. The frequency hopping occurs between time slots and, therefore, a mobile station transmits (or receives) on a fixed frequency during one time slot ($\approx 577 \mu\text{s}$) and then must hop before the time slot on the next TDMA frame. Due to the time needed for monitoring other base stations the time allowed for hopping is approximately 1 ms, according to the receiver implementation. The receive and transmit frequencies are always duplex frequencies.

The frequency hopping sequences are orthogonal inside one cell (i.e. no collisions occur between communications of the same cell), and independent from one cell to an homologue cell (i.e. using the same set of RF channels, or cell allocation). The hopping sequence is derived by the mobile from parameters broadcast at the channel assignment, namely, the mobile allocation (set of frequencies on which to hop), the hopping sequence number of the cell (which allows different sequences on homologue cells) and the index offset (to distinguish the different mobiles of the cell using the same mobile allocation). The non-hopping case is included in the algorithm as a special case. The different parameters needed and the algorithm are specified in 3GPP TS 45.002.

In case of multi band operation frequency hopping channels in different bands of operation, e.g. between channels in GSM and DCS, is not supported. Frequency hopping within each of the bands supported shall be implemented in the mobile station.

It must be noted that the basic physical channel supporting the BCCH and the basic physical channel supporting EC-BCCH does not hop.

For COMPACT, frequency hopping is not permitted on CPBCCH or CPCCCH for a specific amount of blocks. On other frequency hopping channels, a reduced mobile allocation is used on the corresponding blocks.

In CTS, the frequency hopping capability shall be used. The frequency hopping sequences are independently chosen by each CTS-FP. The hopping sequence is derived by the CTS-MS from parameters transmitted during the attachment procedure. The different parameters needed and the algorithm are specified in 3GPP TS 45.002. It must be noted that the basic physical channels supporting the CTSBCH and some other particular channels do not hop (see 3GPP TS 45.002).

7 Coding and interleaving

7.1 General

A brief description of the coding schemes that are used for the logical channels mentioned in clause 2, plus the synchronization channel (SCH, see subclause 5.2), is made in the following tables. For all the types of channels the following operations are made in this order:

- external coding (block coding);
- internal coding (convolutional or turbo coding);
- interleaving.

After coding, the different channels (except RACH, SCH, CTSBCH-SB and CTSARCH) are constituted by blocks of coded information bits plus coded header (the purpose of the header is to distinguish between TCH and FACCH blocks). These blocks are interleaved over a number of bursts. The block size and interleaving depth are channel dependent. All these operations are specified in 3GPP TS 45.003.

For the adaptive speech traffic channels, a signaling codeword is attached to the block of coded information bits before interleaving. The signaling codeword is a block code representation of a 2-bits inband information word (rate $\frac{1}{4}$ for the

adaptive full rate speech traffic channels, $\frac{1}{2}$ for the adaptive half rate speech traffic channels, rate $\frac{1}{6}$ for the adaptive half rate 8-PSK speech and 8-PSK wideband speech traffic channels, and rate $\frac{1}{12}$ for the adaptive full rate 8-PSK wideband speech traffic channels).

| Type of channel | bits/block data+parity+tail ¹ | convolutional code rate | coded bits per block | interleaving depth |
|---------------------------|---------------------------------------------|----------------------------|-------------------------|--------------------|
| TCH/FS | | | 456 | 8 |
| class I ² | 182 + 3 + 4 | ½ | 378 | |
| class II | 78 + 0 + 0 | - | 78 | |
| TCH/EFS | | | 456 | 8 |
| class I ² | 170 + 15 + 4 | ½ | 378 | |
| class II | 74 + 4 + 0 | - | 78 | |
| TCH/HS | | | 228 | 4 |
| class I ³ | 95+3+6 | 104/211 | 211 | |
| class II | 17+0+0 | | 17 | |
| TCH/AFS12.2 ⁴ | | | 456 | 8 |
| Class I ⁵ | 244 + 6 + 4 | 127/224 | 448 | |
| TCH/AFS10.2 ⁴ | | | 456 | 8 |
| Class I ⁶ | 204 + 6 + 4 | 107/224 | 448 | |
| TCH/AFS7.95 ⁴ | | | 456 | 8 |
| Class I ⁷ | 159 + 6 + 6 | 171/448 | 448 | |
| TCH/AFS7.4 ⁴ | | | 456 | 8 |
| Class I ⁸ | 148 + 6 + 4 | 79/224 | 448 | |
| TCH/AFS6.7 ⁴ | | | 456 | 8 |
| Class I ⁹ | 134 + 6 + 4 | 9/28 | 448 | |
| TCH/AFS5.9 ⁴ | | | 456 | 8 |
| Class I ¹⁰ | 118 + 6 + 6 | 65/224 | 448 | |
| TCH/AFS5.15 ⁴ | | | 456 | 8 |
| Class I ¹¹ | 103 + 6 + 4 | 113/448 | 448 | |
| TCH/AFS4.75 ⁴ | | | 456 | 8 |
| Class I ¹² | 95 + 6 + 6 | 107/448 | 448 | |
| TCH/AHS7.95 ¹³ | | | 228 | 4 |
| Class I ¹⁴ | 123 + 6 + 4 | 133/188 | 188 | |
| Class II | 36+0+0 | | 36 | |
| TCH/AHS7.4 ¹³ | | | 228 | 4 |
| Class I ¹⁵ | 120 + 6 + 4 | 65/98 | 196 | |
| Class II | 28+0+0 | | 28 | |
| TCH/AHS6.7 ¹³ | | | 228 | 4 |
| Class I ¹⁶ | 110 + 6 + 4 | 3/5 | 200 | |
| Class II | 24+0+0 | | 24 | |
| TCH/AHS5.9 ¹³ | | | 228 | 4 |
| Class I ¹⁷ | 102 + 6 + 4 | 7/13 | 208 | |
| Class II | 16+0+0 | | 16 | |
| TCH/AHS5.15 ¹³ | | | 228 | 4 |
| Class I ¹⁸ | 91 + 6 + 4 | 101/212 | 212 | |
| Class II | 12+0+0 | | 12 | |
| TCH/AHS4.75 ¹³ | | | 228 | 4 |
| Class I ¹⁹ | 83 + 6 + 6 | 95/212 | 212 | |
| Class II | 12+0+0 | | 12 | |

(continued)

| (continued) | | | | |
|------------------------------|---------------------------------|----------------------------|-------------------------|--------------------|
| Type of channel | bits/block data+parity+tail1 | convolutional code rate | coded bits per block | interleaving depth |
| TCH/WFS12.65 ⁴ | | | 456 | 8 |
| Class I ²³ | 253 + 6 + 4 | 263/448 | 448 | |
| TCH/WFS8.85 ⁴ | | | 456 | 8 |
| Class I ²⁴ | 177 + 6 + 4 | 187/448 | 448 | |
| TCH/WFS6.6 ⁴ | | | 456 | 8 |
| Class I ²⁵ | 132 + 8 + 4 | 9/28 | 448 | |
| O-TCH/WFS23.85 ²⁷ | | | 1368 | 8 |
| Class I ²³ | 477 + 6 + 6 | 163/448 | 1344 | |
| O-TCH/WFS15.85 ²⁷ | | | 1368 | 8 |
| Class I ²³ | 317 + 6 + 6 | 47/192 | 1344 | |
| O-TCH/WFS12.65 ²⁷ | | | 1368 | 8 |
| Class I ²³ | 253 + 6 + 6 | 14/71 | 1344 | |
| O-TCH/WFS8.85 ²⁷ | | | 1368 | 8 |
| Class I ²⁴ | 177 + 6 + 6 | 9/64 | 1344 | |
| O-TCH/WFS6.6 ²⁷ | | | 1368 | 8 |
| Class I ²⁸ | 132 + 6 + 6 | 3/28 | 1344 | |
| O-TCH/WHS12.65 ²⁶ | | | 684 | 4 |
| Class I ²³ | 253 + 6 + 6 | 265/672 | 672 | |
| O-TCH/WHS8.85 ²⁶ | | | 684 | 4 |
| Class I ²⁴ | 177 + 6 + 6 | 9/32 | 672 | |
| O-TCH/WHS6.6 ²⁶ | | | 684 | 4 |
| Class I ²⁸ | 132 + 6 + 6 | 3/14 | 672 | |
| O-TCH/AHS12.2 ²⁶ | | | 684 | 4 |
| Class I ⁵ | 244 + 6 + 6 | 8/21 | 672 | |
| O-TCH/AHS10.2 ²⁶ | | | 684 | 4 |
| Class I ⁶ | 204 + 6 + 6 | 9/28 | 672 | |
| O-TCH/AHS7.95 ²⁶ | | | 684 | 4 |
| Class I ⁷ | 159 + 6 + 6 | 57/224 | 672 | |
| O-TCH/AHS7.4 ²⁶ | | | 684 | 4 |
| Class I ⁸ | 148 + 6 + 6 | 5/21 | 672 | |
| O-TCH/AHS6.7 ²⁶ | | | 684 | 4 |
| Class I ⁹ | 134 + 6 + 6 | 73/336 | 672 | |
| O-TCH/AHS5.9 ²⁶ | | | 684 | 4 |
| Class I ¹⁰ | 118 + 6 + 6 | 65/336 | 672 | |
| O-TCH/AHS5.15 ²⁶ | | | 684 | 4 |
| Class I ¹¹ | 103 + 6 + 6 | 115/672 | 672 | |
| O-TCH/AHS4.75 ²⁶ | | | 684 | 4 |
| Class I ¹² | 95 + 6 + 6 | 107/672 | 672 | |
| TCH/F14.4 | 290 + 0 + 4 | 294/456 | 294/456 | 19 |
| TCH/F9.6 | 4*60 + 0 + 4 | 244/456 | 456 | 19 |
| TCH/F4.8 | 60 + 0 + 16 | 1/3 | 228 | 19 |

| | | | | |
|----------|--------------|---------|-----|----|
| TCH/H4.8 | 4*60 + 0 + 4 | 244/456 | 456 | 19 |
| TCH/F2.4 | 72 + 0 + 4 | 1/6 | 456 | 8 |
| TCH/H2.4 | 72 + 0 + 4 | 1/3 | 228 | 19 |

(continued)

| (continued) | | | | |
|---------------------------------------------------------------------------|---------------------------------------------|----------------------------|-------------------------|--------------------|
| Type of channel | bits/block data+parity+tail ¹ | convolutional code rate | coded bits per block | interleaving depth |
| FACCH/F | 184 + 40 + 4 | 1/2 | 456 | 8 |
| E-FACCH/F | 184 + 40 + 4 | 1/2 | 456 | 4 |
| FACCH/H | 184 + 40 + 4 | 1/2 | 456 | 6 |
| O-FACCH/F | 184 + 40 + 6 | 1/6 | 1368 | 8 |
| O-FACCH/H | 184 + 40 + 6 | 1/6 | 1368 | 6 |
| SDCCHs, SACCHs ²⁰ , BC CH, EC-BCCH, NCH, AGCH, PCH, CBCH | 184 + 40 + 4 | 1/2 | 456 | 4 |
| EC-AGCH, EC-PCH | 88+18+0 | 106/116 | 116 | 1 |
| EC-PACCH, downlink | 80+18+0 | 98/114 | 114 | 1 |
| EC-PACCH, uplink | 64+18+0 | 82/116 | 116 | 1 |
| SACCH/TP | 184 + 18 + 6 + 40 ²¹ | 1/2 | 456 | 4 |
| SACCH/MP | | | | |
| E-IACCH | 3 | 1/8 ²² | 24 | 4 |
| EPCCH | 3 | 1/4 ²² | 12 | 1 |
| RACH | 8 + 6 + 4 | 1/2 | 36 | 1 |
| EC-SCH | 25 + 10 + 4 | 1/2 | 78 | 1 |
| SCH | 25 + 10 + 4 | 1/2 | 78 | 1 |
| CTSBCH-SB | 25 + 10 + 4 | 1/2 | 78 | 1 |
| CTSPCH | 184 + 40 + 4 | 1/2 | 456 | 4 |
| CTSARCH | 25 + 10 + 4 | 1/2 | 78 | 1 |
| CTSAGCH | 184 + 40 + 4 | 1/2 | 456 | 4 |

| |
|-------------------------------------------------------------------------------------------------------------------------------------------------------------------------------------------------------------------------------------------------------------------------------------------------------------------------|
| NOTE 1: The tail bits mentioned here are the tail bits of the convolutional code. |
| NOTE 2: The 3 parity bits for TCH/FS detect an error on 50 bits of class I. |
| NOTE 3: The 3 parity bits for TCH/HS detect an error on 22 bits of class I. |
| NOTE 4: For TCH/AFS and TCH/WFS an 8 bits in band signalling codeword is attached to the block of coded information before interleaving. A dedicated block structure to carry the comfort noise information associated with the adaptive full rate speech traffic channels is also specified in 3GPP TS 45.003. |
| NOTE 5: The 6 parity bits for TCH/AFS12.2 and O-TCH/AHS12.2 detect an error on 81 bits of class I. |
| NOTE 6: The 6 parity bits for TCH/AFS10.2 and O-TCH/AHS10.2 detect an error on 65 bits of class I. |
| NOTE 7: The 6 parity bits for TCH/AFS7.95 and O-TCH/AHS7.95 detect an error on 75 bits of class I. |
| NOTE 8: The 6 parity bits for TCH/AFS7.4 and O-TCH/AHS7.4 detect an error on 61 bits of class I. |
| NOTE 9: The 6 parity bits for TCH/AFS6.7 and O-TCH/AHS6.7 detect an error on 55 bits of class I. |
| NOTE 10: The 6 parity bits for TCH/AFS5.9 and O-TCH/AHS5.9 detect an error on 55 bits of class I. |
| NOTE 11: The 6 parity bits for TCH/AFS5.15 and O-TCH/AHS5.15 detect an error on 49 bits of class I. |
| NOTE 12: The 6 parity bits for TCH/AFS4.75 and O-TCH/AHS4.75 detect an error on 39 bits of class I. |
| NOTE 13: For TCH/AHS a 4 bits in band signalling codeword is attached to the block of coded information before interleaving A dedicated block structure to carry the comfort noise information associated with the adaptive half rate speech traffic channels is also specified in 3GPP TS 45.003. |
| NOTE 14: The 6 parity bits for TCH/AHS7.95 detect an error on 67 bits of class I. |
| NOTE 15: The 6 parity bits for TCH/AHS7.4 detect an error on 61 bits of class I. |
| NOTE 16: The 6 parity bits for TCH/AHS6.7 detect an error on 55 bits of class I. |
| NOTE 17: The 6 parity bits for TCH/AHS5.9 detect an error on 55 bits of class I. |
| NOTE 18: The 6 parity bits for TCH/AHS5.15 detect an error on 49 bits of class I. |
| NOTE 19: The 6 parity bits for TCH/AHS4.75 detect an error on 39 bits of class I. |
| NOTE 20: with the exception of SACCH/TP and SACCH/MP |
| NOTE 21: 40 uncoded dummy bits are inserted for the mapping of the enhanced power control signalling |
| NOTE 22: block code is applied |
| NOTE 23: The 6 parity bits for TCH/WFS12.65, O-TCH/WFS23.85, O-TCH/WFS15.85, O-TCH/WFS12.65 and O-TCH/WFS12.65 detect an error on 72 bits of class I. |
| NOTE 24: The 6 parity bits for TCH/WFS8.85, O-TCH/WFS8.85 and O-TCH/WFS8.85 detect an error on 64 bits of class I. |
| NOTE 25: The 8 parity bits for TCH/WFS6.60 detect an error on 54 bits of class I. |
| NOTE 27: For O-TCH/WFS a 24 bits in band signalling codeword is attached to the block of coded information before interleaving. A dedicated block structure to carry the comfort noise information associated with the adaptive full rate 8PSK wideband speech traffic channels is also specified in 3GPP TS 45.003. |
| NOTE 28: The 6 parity bits for O-TCH/WFS6.6 and O-TCH/WFS6.6 detect an error on 54 bits of class I. |

| Type of channel | bits/block data+parity+tail1 | Reed-Solomon code rate | convolutional code rate | coded bits per block | interleaving depth |
|-----------------|---------------------------------|---------------------------|----------------------------|-------------------------|--------------------|
| E-TCH/F43.2 | 870 + 0 + 6 | N/A | 876/1368 | 1368 | 19 |
| E-TCH/F32.0 | 640 + 0 + 6 | N/A | 646/1392 | 1392 | 12 |
| E-TCH/F28.8 | 580 + 0 + 6 | 73/85 | 686/1368 | 1368 | 19 |

7.2 Packet Traffic and Control Channels

All packet traffic and control channels, except PRACH, use rectangular interleaving of one Radio Block over four bursts in consecutive TDMA frames of one PDCH. As an exception, in RTTI configuration, the PDTCH uses rectangular interleaving of one Radio Block over four bursts in two consecutive TDMA frames of a PDCH-pair.

7.2.1 Channel coding for PDTCH

7.2.1.1 Channel coding for GPRS PDTCH

Four different coding schemes, CS-1 to CS-4, are defined for the GPRS Radio Blocks carrying RLC data blocks. For the Radio Blocks carrying RLC/MAC Control blocks code CS-1 is always used. The exceptions are messages that use

the existing Access Burst (see 3GPP TS 45.003, e.g. Packet Channel Request). An additional coding scheme is defined for the Access Burst that includes 11 information bits.

The first step of the coding procedure is to add a Block Check Sequence (BCS) for error detection. For CS-1 - CS-3, the second step consists of pre-coding USF (except for CS-1), adding four tail bits and a convolutional coding for error correction that is punctured to give the desired coding rate. For CS-4 there is no coding for error correction.

The details of the codes are shown in the table below, including:

- the length of each field;
- the number of coded bits (after adding tail bits and convolutional coding);
- the number of punctured bits;
- the data rate, including the RLC header and RLC information.

| Scheme | Code rate | USF | Pre-coded USF | Radio Block excl. USF and BCS | BCS | Tail | Coded bits | Punctured bits |
|--------|---------------|-----|---------------|-------------------------------|-----|------|------------|----------------|
| CS-1 | $\frac{1}{2}$ | 3 | 3 | 181 | 40 | 4 | 456 | 0 |
| CS-2 | $\approx 2/3$ | 3 | 6 | 268 | 16 | 4 | 588 | 132 |
| CS-3 | $\approx 3/4$ | 3 | 6 | 312 | 16 | 4 | 676 | 220 |
| CS-4 | 1 | 3 | 12 | 428 | 16 | - | 456 | - |

CS-1 is the same coding scheme as specified for SDCCH. It consists of a half rate convolutional code for FEC and a 40 bit FIRE code for BCS (and optionally FEC). CS-2 and CS-3 are punctured versions of the same half rate convolutional code as CS-1 for FEC. CS-4 has no FEC.

The USF has 8 states, which are represented by a binary 3 bit field in the MAC Header.

All coding schemes are mandatory for MSs supporting GPRS. Only CS-1 is mandatory for the network.

7.2.1.2 Channel coding for EGPRS and EGPRS2 PDTCH

Nine different modulation and coding schemes, MCS-1 to MCS-9, are defined for the EGPRS Radio Blocks (4 bursts, 20ms in case of BTTI configuration or 10ms in case of RTTI configuration) carrying RLC data blocks. Further, 16 more modulation and coding schemes, DAS-5 to DAS-12 and DBS-5 to DBS-12, are defined for EGPRS2 downlink radio blocks (4 bursts, 20ms in case of BTTI configuration or 10ms in case of RTTI configuration) carrying RLC data blocks and 13 more modulation and coding schemes, UAS-7 to UAS-11 and UBS-5 to UBS-12, are defined for EGPRS2 uplink radio blocks (4 bursts, 20ms in case of BTTI configuration or 10ms in case of RTTI configuration) carrying RLC data blocks. For the Radio Blocks carrying RLC/MAC Control blocks code CS-1 is always used, except in the case of RTTI configuration, when code MCS-0 may be used in the downlink (see subclause 7.2.2). The exceptions are messages that use the existing Access Burst (see 3GPP TS 45.003, e.g. Packet Channel Request). An additional coding scheme is defined for the Access Burst that includes 11 information bits.

To ensure strong header protection, the header part of the Radio Block is independently coded from the data part of the Radio Block (8 bit CRC calculated over the header -excl. USF- for error detection, followed by rate 1/3 convolutional coding – and possibly puncturing – for error correction). Additionally, for transmission using FANR, a PAN field is included which is independently coded from the header and data parts of the Radio Block (the coding is the same as for the header part).

For EGPRS (see 3GPP TS 44.060), the MCSs are divided into different families A, B and C. Each family has a different basic unit of payload (see 3GPP TS 43.064). Different code rates within a family are achieved by transmitting a different number of payload units within one Radio Block. For families A and B, 1, 2 or 4 payload units are transmitted, for family C, only 1 or 2 payload units are transmitted.

For EGPRS2 (see 3GPP TS 44.060), the coding schemes are divided into different families A, B and C. Each family has a different basic unit of payload (see 3GPP TS 43.064). Different code rates within a family are achieved by transmitting a different number of payload units within one Radio Block. For family A, 1, 2, 4, 6 or 8 payload units are

transmitted, for family B, 1, 2, 3, 4, 6 or 9 payload units are transmitted, for family C, only 1 or 2 payload units are transmitted.

For EGPRS, when 4 payload units are transmitted (MCS-7, MCS-8 and MCS-9), these are splitted into two separate RLC blocks (i.e. with separate sequence numbers and block check sequences).

For EGPRS2, when 4 payload units are transmitted (UAS-7 to UAS-9, UBS-7, UBS-8, DAS-8, DAS-9, DBS-7 and DBS-8), these are split into two separate RLC blocks (i.e. with separate sequence numbers and block check sequences). When 6 payload units are transmitted (UAS-10, UAS-11, UBS-9, UBS-10, DAS-10, DAS-11, DBS-9 and DBS-10), these are split into three separate RLC blocks (i.e. with separate sequence numbers and block check sequences), except for DAS-10 for which they are split into two separate RLC blocks. When 8 payload units are transmitted (DBS-11, DBS-12, UBS-11 and UBS-12), these are split into four separate RLC blocks (i.e. with separate sequence numbers and block check sequences). When 9 payload units are transmitted (DAS-12), these are split into three separate RLC blocks (i.e. with separate sequence numbers and block check sequences).

The first step of the coding procedure is to add a Block Check Sequence (BCS) for error detection.

In case of convolutional coding, the second step consists of adding six tail bits (TB) and a 1/3 rate convolutional coding for error correction that is punctured to give the desired coding rate.

In case of turbo coding, the second step consists of 1/3 rate turbo coding for error correction (see 3GPP TS 45.003) that is punctured to give the desired coding rate.

The USF has 8 states, which are represented by a binary 3 bit field in the MAC Header. The USF is encoded to 12 symbols for bursts using legacy symbol rate and 16 symbols for bursts using higher symbol rate, (this results in 12 bits for GMSK modes, 32 bits for QPSK modes, 36 bits for 8PSK modes, 48 bits for 16-QAM modes at legacy symbol rate (See 3GPP TS 45.004), 64 bits for 16-QAM at higher symbol rate (see 3GPP TS 45.004), 60 bits for 32-QAM at legacy symbol rate and 80 bits for 32-QAM at higher symbol rate).

MSs supporting EGPRS shall support MCS-1 to MCS-9 in downlink and MCS-1 to MCS-4 in uplink. In case an MS supporting EGPRS is 8-PSK capable in uplink, it shall also support MCS-5 to MCS-9 in uplink. A network supporting EGPRS may support only some of the MCSs.

MSs supporting EGPRS2 (see 3GPP TS 44.060) shall support EGPRS coding schemes MCS-1 to MCS-9 in downlink and uplink.

MSs supporting EGPRS2-A (see 3GPP TS 44.060) in the downlink shall support DAS-5 to DAS-12.

MSs supporting EGPRS2-B (see 3GPP TS 44.060) in the downlink shall support DAS-5 to DAS-12 and DBS-5 to DBS-12.

MSs supporting EGPRS2-A in the uplink shall support UAS-7 to UAS-11.

MSs supporting EGPRS2-B in the uplink shall support UAS-7 to UAS-11 and UBS-5 to UBS-12.

A network supporting EGPRS2-A in downlink (respectively uplink) may support only some of DAS-5 to DAS-12 (respectively UAS-7 to UAS-11).

A network supporting EGPRS2-B in downlink (respectively uplink) may support only some of DBS-5 to DBS-12 (respectively UBS-5 to UBS-12).

The details of the EGPRS coding schemes are shown in Table 7.2.1.2.1. An exhaustive description of the EGPRS coding schemes can be found in 3GPP TS 45.003.

Table 7.2.1.2.1 - Coding parameters for the EGPRS coding schemes

| Scheme | Code rate (Note 2) | Header Code rate | PAN Code rate (if present) | Modulation | RLC blocks per Radio Block (20ms) | Raw Data within one Radio Block (Note 1) | Family | BCS | Tail payload | HCS | PCS (if present) | Data rate kb/s (Note 3) |
|---------------------------------------------------------------------------------------------------------------------------------------------------------------------------------------------------------------------------------------------------------------------------------------------------------------------------------------------------------------------------------------------------------------------------------------------------------------------|-----------------------|---------------------|----------------------------------|------------|--------------------------------------------|------------------------------------------------------|--------|------|-----------------|--------------|------------------------|-------------------------------|
| MCS-9 | 1,0 | 0,36 | n/a | 8PSK | 2 | 2x592 | A | 2 | 2x6 | 8 | 10 | 59,2 |
| MCS-8 | 0,92 (0,98) | 0,36 | 0,42 | | 2 | 2x544 | A | | | | | 54,4 |
| MCS-7 | 0,76 (0,81) | 0,36 | 0,42 | | 2 | 2x448 | B | | | | | 44,8 |
| MCS-6 | 0,49 (0,52) | 1/3 | 0,39 | | 1 | 592 48+544 | A | 12 | 6 | | | 29,6 27,2 |
| MCS-5 | 0,37 (0,40) | 1/3 | 0,39 | | 1 | 448 | B | | | | | 22,4 |
| MCS-4 | 1,0 | 0,53 | n/a | GMSK | 1 | 352 | C | | | 17,6 | | |
| MCS-3 | 0,85 (0,96) | 0,53 | 0,63 | | 1 | 296 48+248 and 296 | A | | | 14,8 13,6 | | |
| MCS-2 | 0,66 (0,75) | 0,53 | 0,63 | | 1 | 224 | B | 11,2 | | | | |
| MCS-1 | 0,53 (0,60) | 0,53 | 0,63 | | 1 | 176 | C | 8,8 | | | | |
| <p>Note 1: The italic caption indicates the 6 octets of padding when retransmitting MCS-8 block with MCS-3 or MCS-6. For MCS-3, the 6 octets of padding are sent every second block (see 3GPP TS 44.060).</p> <p>Note 2: The number in bracket indicates the coding rate for transmission using FANR, when the PAN is present.</p> <p>Note 3: These data rates are applicable for BTTI configuration. The data rates are doubled in case of RTTI configuration.</p> | | | | | | | | | | | | |

The details of the EGPRS2 coding schemes are shown in the table below. An exhaustive description of the EGPRS2 coding schemes can be found in 3GPP TS 45.003.

Table 7.2.1.2.2: Coding parameters for the EGPRS2 coding schemes

| Scheme | Code rate (Note 5) | Header Code rate | PAN code rate (if present) | Modulation | RLC blocks per Radio Block (20ms) | Raw Data within one Radio Block | Family | BCS | Tail payload | HCS | PCS | Data rate kb/s (Note 6) |
|--------|-----------------------|------------------|-------------------------------|-------------------|--------------------------------------|---------------------------------|--------|------|--------------|-----|-----|----------------------------|
| DAS-12 | 0,96 (0,99) | 0,38 | 0.38 | 32QAM (Note 4) | 3 | 658 | B | 3x12 | (Note 7) | 8 | 10 | 98,4 |
| DAS-11 | 0,80 (0,83) | 0,38 | 0.38 | | 3 | 546 | A | 3x12 | (Note 7) | | | 81,6 |
| DAS-10 | 0,64 (0,66) | 0,33 | 0.38 | | 2 | 658 | B | 2x12 | (Note 7) | | | 65,6 |
| DAS-9 | 0,68 (0,70) | 0,34 | 0.38 | 16QAM (Note 4) | 2 | 546 | A | 2x12 | (Note 7) | | | 54,4 |
| DAS-8 | 0,56 (0,58) | 0,34 | 0.38 | | 2 | 450 | B | 2x12 | (Note 7) | | | 44,8 |
| DAS-7 | 0,54 (0,57) | 0,33 | 0.38 | 8PSK (Note 4) | 1 | 658 | B | 12 | (Note 7) | | | 32,8 |
| DAS-6 | 0,45 (0,48) | 0,33 | 0.38 | | 1 | 546 | A | 12 | (Note 7) | | | 27,2 |
| DAS-5 | 0,37 (0,39) | 0,33 | 0.38 | | 1 | 450 | B | 12 | (Note 7) | | | 22,4 |
| DBS-12 | 0,98 (1,00) | 0,37 | 0.54 | 32QAM (Note 3) | 4 | 594 | A | 4x12 | (Note 7) | | | 118,4 |
| DBS-11 | 0,91 (0,93) | 0,37 | 0.38 | | 4 | 546 | A | 4x12 | (Note 7) | | | 108,8 |
| DBS-10 | 0,72 (0,75) | 0,34 | 0.38 | | 3 | 594 | A | 3x12 | (Note 7) | | | 88,8 |
| DBS-9 | 0,71 (0,73) | 0,34 | 0.38 | 16QAM (Note 3) | 3 | 450 | B | 3x12 | (Note 7) | | | 67,2 |
| DBS-8 | 0,60 (0,63) | 0,31 | 0.38 | | 2 | 594 | A | 2x12 | (Note 7) | | | 59,2 |
| DBS-7 | 0,47 (0,48) | 0,31 | 0.38 | | 2 | 450 | B | 2x12 | (Note 7) | | | 44,8 |
| DBS-6 | 0,63 (0,69) | 0,31 | 0.38 | | QPSK (Note 3) | 1 | 594 | A | 1x12 | | | (Note 7) |

| | | | | | | | | | | | | |
|--------|----------------|------|------|-------------------|-------------------|-----|-----|------|----------|-----|--|-------|
| DBS-5 | 0,49 (0,53) | 0,31 | 0,38 | | 1 | 450 | B | 1x12 | (Note 7) | | | 22,4 |
| UAS-11 | 0,95 (0,99) | 0,36 | 0,38 | 16QAM (Note 2) | 3 | 514 | A | 3x12 | 3x6 | | | 76,8 |
| UAS-10 | 0,84 (0,87) | 0,36 | 0,38 | | 3 | 450 | B | 3x12 | 3x6 | | | 67,2 |
| UAS-9 | 0,71 (0,74) | 0,36 | 0,38 | | 2 | 594 | A | 2x12 | 2x6 | | | 59,2 |
| UAS-8 | 0,62 (0,64) | 0,36 | 0,38 | | 2 | 514 | A | 2x12 | 2x6 | | | 51,2 |
| UAS-7 | 0,55 (0,57) | 0,36 | 0,38 | | 2 | 450 | B | 2x12 | 2x6 | | | 44,8 |
| UBS-12 | 0,96 (0,99) | 0,35 | 0,38 | | 32QAM (Note 1) | 4 | 594 | A | 4x12 | 4x6 | | |
| UBS-11 | 0,89 (0,91) | 0,35 | 0,38 | 4 | | 546 | A | 4x12 | 4x6 | | | 108,8 |
| UBS-10 | 0,71 (0,73) | 0,35 | 0,36 | 3 | | 594 | A | 3x12 | 3x6 | | | 88,8 |
| UBS-9 | 0,70 (0,72) | 0,32 | 0,36 | 16QAM (Note 1) | 3 | 450 | B | 3x12 | 3x6 | | | 67,2 |
| UBS-8 | 0,60 (0,61) | 0,33 | 0,38 | | 2 | 594 | A | 2x12 | 2x6 | | | 59,2 |
| UBS-7 | 0,46 (0,47) | 0,33 | 0,38 | | 2 | 450 | B | 2x12 | 2x6 | | | 44,8 |
| UBS-6 | 0,62 (0,67) | 0,35 | 0,38 | QPSK (Note 1) | 1 | 594 | A | 12 | 6 | | | 29,6 |
| UBS-5 | 0,47 (0,51) | 0,35 | 0,38 | | 1 | 450 | B | 12 | 6 | | | 22,4 |

Note 1: These coding schemes use the higher symbol rate (See 3GPP TS 45.004) and are only available in the uplink

Note 2: These coding schemes use the normal symbol rate (See 3GPP TS 45.004) and are only available in the uplink

Note 3: These coding schemes use the higher symbol rate (See 3GPP TS 45.004) and are only available in the downlink

Note 4: These coding schemes use the normal symbol rate (See 3GPP TS 45.004) and are only available in the downlink

Note 5: The number in bracket indicates the code rate for transmission using FANR, when the PAN is present

Note 6: These data rates apply in case of BTTI configuration, the data rates are doubled in case of RTTI configuration.

Note 7: The turbo code is terminated using 2x3 tail bits resulting in 12 coded bits per RLC block.

7.2.2 Channel coding for PACCH, PBCCH, PAGCH, PPCH, CPBCCH, CPAGCH, CPPCH, and CSCH

The channel coding for the PBCCH, PAGCH, PPCH, CPBCCH, CPAGCH, and CPPCH corresponds to the coding scheme CS-1. The channel coding for the PACCH corresponds to the coding scheme CS-1; in case of RTTI configuration, the channel coding for the downlink PACCH corresponds to the coding scheme MCS-0 if BTTI USF mode is used and may correspond to either CS-1 or MCS-0 if RTTI USF mode is used. The channel coding for the CSCH is identical to SCH.

7.2.3 Channel Coding for the PRACH and MPRACH

Two types of packet random access burst may be transmitted on the PRACH and MPRACH: an 8 information bits random access burst or an 11 information bits random access burst called the extended packet random access burst. The MS shall support both random access bursts. The channel coding used for the burst carrying the 8 data bit packet random access uplink message is identical to the coding of the random access burst on the RACH. The channel coding used for the burst carrying the 11 data bit packet random access uplink message is a punctured version of the coding of the random access burst on the RACH.

7.2.4 Channel coding for EC-PDTCH, EC-PACCH, EC-AGCH, EC-PCH, EC-BCCH and EC-SCH

The channel coding for the EC-BCCH corresponds to the coding scheme CS-1. EC-PACCH, EC-AGCH, and EC-PCH are all defined by separate coding schemes, see 3GPP TS 45.003. The channel coding for the EC-SCH is identical to SCH, apart from an applied cyclic shift of the encoded bits. The channel coding for the EC-PDTCH is identical to PDTCH for EGPRS, see subclause 7.2.1.2.

8 Modulations

The modulation scheme may be one of gaussian MSK (GMSK) with $BT = 0,3$, AQPSK, QPSK, 8-PSK, 16QAM or 32QAM depending on the type of channel. As already mentioned the modulation rate is either the normal symbol rate, $1\ 625/6$ ksymbol/s ($\approx 270,83$ ksymbol/s) (see 3GPP TS 45.004) or the higher symbol rate, 325 ksymbol/s (see 3GPP TS 45.004). These schemes are specified in detail in 3GPP TS 45.004.

9 Transmission and reception

The modulated stream is then transmitted on a radio frequency carrier. The frequency bands and channel arrangements are the following:

- i) T-GSM 380 band:
 - for T-GSM 380, the system is required to operate in the following band:
 - 380,2 MHz to 389,8 MHz: mobile transmit, base receive;
 - 390,2 MHz to 399,8 MHz base transmit, mobile receive.
- ii) T-GSM 410 band:
 - for T-GSM 410, the system is required to operate in the following band:
 - 410,2 MHz to 419,8 MHz: mobile transmit, base receive;
 - 420,2 MHz to 429,8 MHz base transmit, mobile receive.

- iii) GSM 450 Band;

For GSM 450, the system is required to operate in the following frequency band:

450,4 – 457,6 MHz: mobile transmit, base receive;

460,4 – 467,6 MHz: base transmit, mobile receive;

iv) GSM 480 Band;

For GSM 480, the system is required to operate in the following frequency band:

478,8 – 486 MHz: mobile transmit, base receive;

488,8 – 496 MHz: base transmit, mobile receive;

v) GSM 710 Band;

For GSM 710, the system is required to operate in the following frequency band:

728 – 746 MHz: base transmit, mobile receive;

698 – 716 MHz: mobile transmit, base receive;

vi) GSM 750 Band;

For GSM 750, the system is required to operate in the following frequency band:

777 – 793 MHz: mobile transmit, base receive;

747 – 763 MHz: base transmit, mobile receive;

vii) T-GSM 810 Band;

For T-GSM 810, the system is required to operate in the following band:

806 - 821 MHz: mobile transmit, base receive

851 - 866 MHz: base transmit, mobile receive

viii) GSM 850 Band;

For 850, the system is required to operate in the following band:

824 - 849 MHz: mobile transmit, base receive

869 - 894 MHz: base transmit, mobile receive

ix) Standard or primary GSM 900 Band, P-GSM;

For Standard GSM 900 Band, the system is required to operate in the following frequency band:

890 - 915 MHz: mobile transmit, base receive

935 - 960 MHz: base transmit, mobile receive

x) Extended GSM 900 Band, E-GSM (includes Standard GSM 900 band);

For Extended GSM 900 Band, the system is required to operate in the following frequency band:

880 - 915 MHz: mobile transmit, base receive

925 - 960 MHz: base transmit, mobile receive

xi) Railways GSM 900 Band, R-GSM (includes Standard and Extended GSM 900 Band);

For Railways GSM 900 Band, the system is required to operate in the following frequency band:

876 - 915 MHz: mobile transmit, base receive

921 - 960 MHz: base transmit, mobile receive

xii) Void

xiii) DCS 1 800 Band;

For DCS 1 800, the system is required to operate in the following frequency band:

1 710 - 1 785 MHz: mobile transmit, base receive

1 805 - 1 880 MHz: base transmit, mobile receive

xiv) PCS 1900 Band;

For PCS 1900, the system is required to operate in the following frequency band;

1850-1910 MHz: mobile transmit, base receive

1930-1990 MHz: base transmit, mobile receive

xv) Extended Railways GSM 900 Band, ER-GSM (includes Railways GSM 900 Band);

For Extended Railways GSM 900 Band, the system is required to operate in the following frequency band:

873 - 915 MHz: mobile transmit, base receive

918 - 960 MHz: base transmit, mobile receive

NOTE 1: The term GSM 400 is used for any GSM system, which operates in any 400 MHz band including T-GSM 380.

NOTE 2: The term GSM 700 is used for any GSM system, which operates in any 700 MHz band.

NOTE 3: The term GSM 850 is used for any GSM system, which operates in any 850 MHz band but excluding T-GSM 810.

NOTE 4: The term GSM 900 is used for any GSM system, which operates in the frequency band 876-915 MHz in the UL and 921-960 MHz in the DL.

NOTE 5: The BTS may cover a complete band, or the BTS capabilities may be restricted to a subset only, depending on the operator needs.

NOTE 6: The term ER-GSM 900 is used for the GSM system, which in addition to GSM 900 operates in the frequency band 873-876 MHz in the UL and 918-921 MHz in the DL.

Operators may implement networks on a combination of the frequency bands above to support multi band mobile stations.

The RF channel spacing is 200 kHz, allowing for 41 (T-GSM 380), 41 (T-GSM 410), 35 (GSM 450), 35 (GSM 480), 89 (GSM 710), 74 (GSM 750), 74 (T-GSM 810), 124 (GSM 850), 209 (ER-GSM 900), 194 (GSM 900), 374 (DCS 1 800) and 299 (PCS 1900) radio frequency channels, thus leaving a guard band of 200 kHz at each end of the sub-bands.

The specific RF channels, together with the requirements on the transmitter and the receiver will be found in 3GPP TS 45.005 and in 3GPP TS 45.056 for the CTS-FP.

In order to allow for low power consumption for different categories of mobiles (e.g. vehicle mounted, hand-held, ..), different power classes have been defined. For GSM 400, GSM 700, T-GSM 810, GSM 850, ER-GSM 900 and GSM 900 there are four power classes with the maximum power class having 8 W peak output power (ca 1 W mean output power) and the minimum having 0,8 W peak output power. For DCS 1 800 there are three power classes of 4 W peak output power, 1 W peak output power (ca 0,125 W mean) and 0,25 W peak output power. For PCS 1900 there are three power classes of 2 watts, 1 watt and 0,25 watt peak output power.

Multi band mobile stations may have any combinations of the allowed power classes for each of the bands supported.

The power classes are specified in 3GPP TS 45.005 and in 3GPP TS 45.056 for CTS-FP.

The requirements on the overall transmission quality together with the measurement conditions are also in 3GPP TS 45.005 and in 3GPP TS 45.056 for CTS-FP.

10 Other layer 1 functions

The transmission involves other functions. These functions may necessitate the handling of specific protocols between BS and MS. Relevant topics for these cases are:

- 1) The power control mechanisms which adjust the output level of the mobile station (and optionally of the base station) in order to ensure that the required quality is achieved with the less possible radiated power. Power levels with 2 dB steps have been defined for that purpose. This is described in 3GPP TS 45.008 and 3GPP TS 45.005.
- 2) The synchronization of the receiver with regard to frequency and time (time acquisition and time frame alignment). The synchronization problems are described in 3GPP TS 45.010.
- 3) The hand-over and quality monitoring which are necessary to allow a mobile to continue a call during a change of physical channel. This can occur either because of degradation of the quality of the current serving channel, or because of the availability of another channel which can allow communication at a lower Tx power level, or to prevent a MS from grossly exceeding the planned cell boundaries. In the case of duplex point-to-point connections, the choice of the new channel is done by the network (base station control and MSC) based on measurements (on its own and on adjacent base stations) that are sent on a continuous basis by the mobile station via the SACCHs. The requirements are specified in 3GPP TS 45.008.
- 4) The measurements and sub-procedures used in the first selection or reselection of a base station by a mobile are specified in 3GPP TS 45.008. The overall selection and reselection procedures, together with the idle mode activities of a mobile are defined in 3GPP TS 43.022.
- 5) The measurements and sub-procedures used by an MS in selecting a base station for reception of a voice group or a voice broadcast call are specified in 3GPP TS 45.008. The overall voice group and voice broadcast cell change procedures, being similar to the reselection procedures related to the idle mode activities of an MS, are defined in 3GPP TS 43.022.
- 6) For the adaptive speech traffic channels the inband signalling carries the required information to adapt the speech and channel codec modes to the propagation conditions. The coding of the in band signalling is specified in 3GPP TS 45.009. An example of codec adaptation algorithm is also provided in 3GPP TS 45.009.

11 Performance

Under typical urban fading conditions (i.e. multipath delays no greater than 5 μ s), the quality threshold for full-rate speech and PDTCH/CS-1 is reached at a C/I value of approximately 9 dB. The maximum sensitivity is approximately -104 dBm for base stations and GSM mobiles and -102 dBm for GSM small MSs and PCS 1900 MS s and -100 dBm for DCS 1 800 hand-helds (see 3GPP TS 45.005).

For EC-EGPRS, the logical channels operate in what is referred to as extended coverage, where, under typical urban fading conditions, the quality threshold for EC-PDTCH/MCS-1 is reached at a C/I of approximately [TBD] dB. The maximum sensitivity is approximately [TBD] dBm for base station and [TBD] dBm for EC-EGPRS MS.

Multi band MSs shall meet the requirements on each band of operation respectively.

Multi band MSs shall meet the requirements on each band of operation respectively

12 Flexible layer one

With the Flexible Layer One (FLO), the physical layer offers transport channels to the MAC sublayer of Layer 2 (see 3GPP TR 45.902). Figure 4 shows the radio interface protocol architecture around FLO. On transport channels, transport blocks (TB) are exchanged between the MAC sublayer and the physical layer on a Transmission Time Interval basis (TTI). A transport channel is characterized by how the information is transferred over the radio interface. FLO is configured by Layer 3.

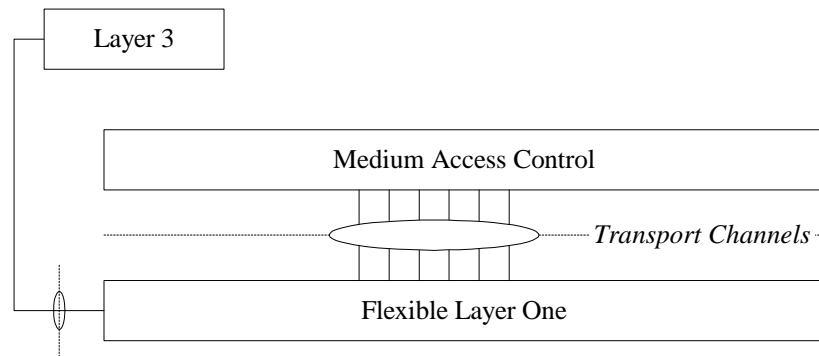

Figure 4: Radio interface protocol architecture around the physical layer for FLO

In the following subclauses, the new concepts and definitions introduced by FLO are explained. The multiple access and timeslot structure of section 5, the frequency hopping capability of section 6, the modulations of section 8, the transmission and reception of section 9, and the other layer 1 functions of section 10 remain unchanged and can be used as such by FLO.

12.1 Set of transport channels

The offered transport channels are Dedicated CHannels (DCH). A DCH can be either full rate (DCH/F) or half rate (DCH/H) depending on the rate of the dedicated basic physical subchannel on which they are used.

12.2 Transport block structure

A summarised description of the transport block structure for FLO appears in table 2, in terms of net bit rate, length and recurrence of blocks.

Table 2: Transport block structures

| Type of transport channel | net bit rate (kbit/s) | block length (bits) | block recurrence (ms) ¹ |
|---------------------------|-----------------------|---------------------|------------------------------------|
| DCH/F | 0,05 - 68,5 | 1 - 1370 | 20 |
| DCH/H | 0,05 - 34,1 | 1 - 682 | 20 |

NOTE 1: or transmission time interval (TTI).

12.3 Channel organisation

The channel organization for FLO uses the 26-frame multiframe structure, as described in figure 2 of section 5.3, where T depicts a TDMA frame that can be used to transmit transport block(s).

12.4 Transport channel coding/multiplexing for FLO

The coding/multiplexing unit of FLO is a combination of error detection, forward error correction, rate matching, multiplexing and interleaving.

The transport channels offered by FLO (DCHs) are used to transmit data flows with a negotiated QoS over the radio interface. A number of transport channels can be active at the same time and multiplexed at the physical layer. The configuration of a transport channel is denoted the Transport Format (TF). A number of different transport formats can be associated to one transport channel. Layer 3 controls the configuration of the transport formats. Only a limited number of combinations of the transport formats of the different TrCHs are allowed. A valid combination is called a Transport Format Combination (TFC). The set of valid TFCs is called the Transport Format Combination Set (TFCS). In every radio packet, the Transport Format Combination Indicator (TFCI) tells which TFC is used. The following coding/multiplexing steps can be identified:

- CRC attachment: error detection is provided on each transport block through a cyclic redundancy check (CRC). Layer 3 configures the size of the CRC to be used. Code blocks are output from the CRC attachment.

- Channel coding: after CRC attachment, the code blocks are processed through channel coding (1/3 rate convolutional code), producing encoded blocks.
- Rate matching: in rate matching, bits of an encoded block on a transport channel are repeated or punctured to ensure that the total bit rate after TrCH multiplexing is identical to the total channel bit rate of the assigned basic physical channel. Outputs from the rate matching are called radio frames. The rate matching produces one radio frame per encoded block, i.e. per TrCH.
- Multiplexing of transport channels: for every radio packet to be transmitted, one radio frame from each TrCH is delivered to the TrCH multiplexing. These radio frames are serially multiplexed into a Coded Composite Transport CHannel (CCTrCH).
- TFCI mapping: the coded TFCI is appended at the beginning of the CCTrCH to form a radio packet.
- Interleaving: the radio packet is interleaved and then mapped on bursts. The interleaving can be either block diagonal or block rectangular and is configured by Layer 3.

13 Voice services over Adaptive Multi-user Channels on One Slot (VAMOS)

13.1 General

VAMOS allows multiplexing of two users simultaneously on the same physical resource in the circuit switched mode both in downlink and in uplink, using the same timeslot number, ARFCN and TDMA frame number. Hence, a basic physical channel capable of VAMOS supports up to 4 TCH channels along with their associated control channels (FACCH and SACCH).

The channel organization for TCH, FACCH and SACCH/T in VAMOS mode shall be done as described in 3GPP TS 45.002. Some exemplary channel organizations are depicted in Figure 5, where only one time slot per TDMA frame is considered.

The FACCH is transmitted by pre-empting half or all of the information bits of the bursts of the TCH to which it is associated (see 3GPP TS 45.003).

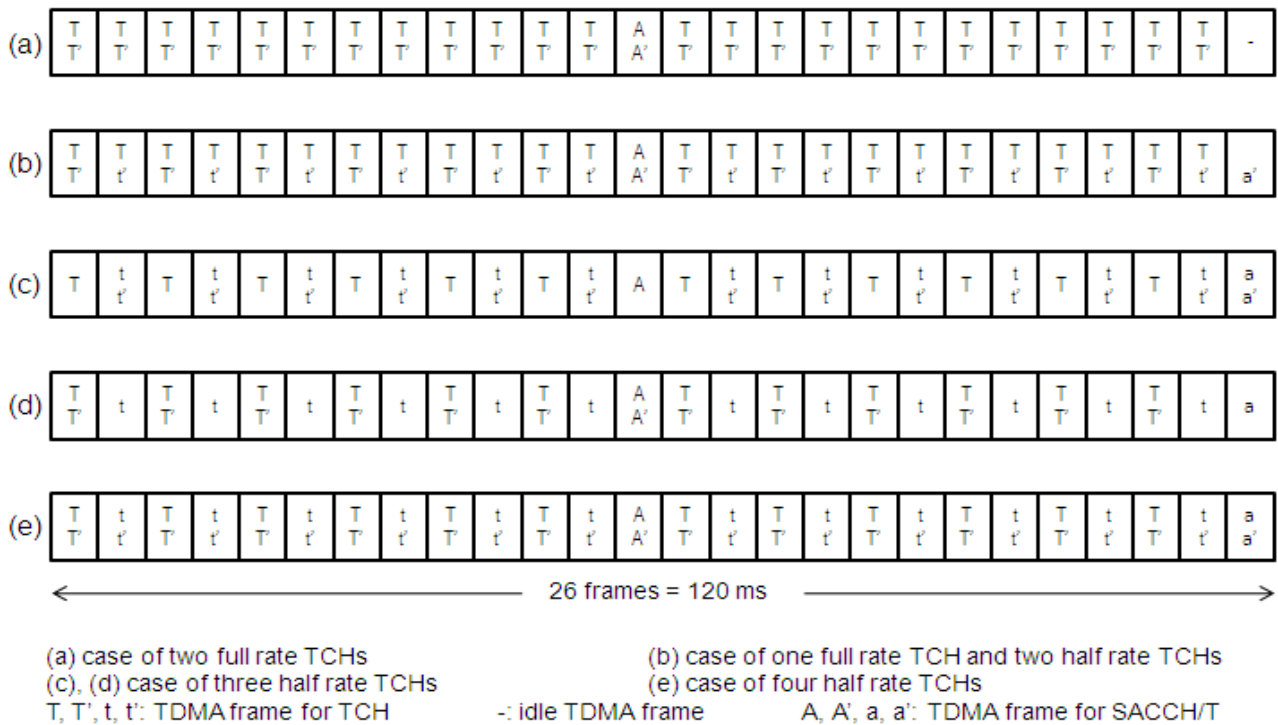

Figure 5: TCH and ACCH organization in VAMOS mode

A pair of TCH channels along with their associated control channels sharing the same timeslot number, ARFCN and TDMA frame number is referred to as a *VAMOS pair*. Up to 2 *VAMOS pairs* can be supported by a basic physical channel capable of VAMOS. The TCH channels along with their associated control channels in a *VAMOS pair* are said to be in *VAMOS mode* and are referred to as *VAMOS subchannels*. In a *VAMOS pair*, each *VAMOS subchannel* shall be assigned a training sequence which is different from the training sequence assigned to the other *VAMOS subchannel* in that *VAMOS pair* (see 3GPP TS 45.002).

The following combinations of TCH channels along with their corresponding associated control channels are allowed to form a *VAMOS pair*:

- i) 2 full rate TCH channels where each TCH/F channel is a TCH/FS, TCH/EFS, TCH/AFS or TCH/WFS channel.
- ii) 1 full rate TCH channel where the TCH/F channel is a TCH/FS, TCH/EFS, TCH/AFS or TCH/WFS and 1 half rate TCH channel where the TCH/H channel is a TCH/HS or TCH/AHS channel.
- iii) 2 half rate TCH channels where each TCH/H channel is a TCH/HS or TCH/AHS channel.

Note 1: In combination ii) the basic physical channel capable of VAMOS may support two *VAMOS pairs*, one pair with TCH/F and TCH/H sub-channel number 0 and another pair with the same TCH/F paired with TCH/H sub-channel number 1

Note 2: In combination iii) the basic physical channel capable of VAMOS may support two *VAMOS pairs*, one sharing TCH/H sub-channel number 0 and one sharing TCH/H sub-channel number 1.

13.2 Network and MS Support for VAMOS

A network supporting VAMOS may assign a mobile station not indicating explicit support for VAMOS on a *VAMOS pair* provided the training sequence assigned on the corresponding *VAMOS subchannel* is chosen from a TSC Set (see 3GPP TS 45.002) supported by the MS.

An MS shall indicate whether or not it supports VAMOS (see 3GPP TS 24.008). For an MS supporting VAMOS, multiple levels of support are defined. An MS supporting VAMOS shall indicate the supported VAMOS level (see 3GPP TS 24.008).

- An MS supporting VAMOS I, VAMOS II or VAMOS III (see 3GPP TS 24.008) shall support the set of training sequences in TSC Set 1 and TSC Set 2 (see 3GPP TS 45.002).
- If an MS indicates support for VAMOS II or VAMOS III (see 3GPP TS 24.008) then the MS shall support the mapping of logical channels onto the physical channels as shown in table 1a and/or table 1b of 3GPP TS 45.002.
- An MS indicating support for VAMOS shall also indicate support for either 'Downlink Advanced Receiver Performance – phase I' or 'Downlink Advanced Receiver Performance – phase II', and for 'Repeated SACCH and Repeated Downlink FACCH' (see 3GPP TS 24.008). If an MS supports VAMOS III, then irrespective of whether it indicates DARP I or DARP II capability, it shall meet DARP II GMSK speech channel and associated control channel performance requirements.
- If at least one MS assigned to a *VAMOS pair* indicates explicit support for VAMOS, then the network shall use training sequences for the two subchannels in the *VAMOS pair* according to one of the following options:
 - a training sequence from TSC Set 1 for one of the *VAMOS subchannels* and the training sequence with the same training sequence code from TSC Set 2 for the other *VAMOS subchannel*.
 - a training sequence chosen from TSC Set 3 for one of the *VAMOS subchannels* and the training sequence with the same training sequence code from TSC Set 4 for the other *VAMOS subchannel*. This option may be used only if both MS have indicated support for Extended TSC Sets for circuit switched channels (see 3GPP TS 24.008).

13.3 Downlink Functionality

In downlink, a pair of corresponding bits from the TCHs and associated control channels in a *VAMOS pair* shall be mapped on to an AQPSK modulation symbol (see 3GPP TS 45.004) and shall be received by 2 different mobile stations in the same cell. Each MS shall decode the desired signal of its TCH and associated control channels, and shall perform the radio link measurements as stated in 3GPP TS 45.008.

13.3.1 Modulation

The data from both subchannels of a *VAMOS pair* shall be mapped onto the AQPSK symbols pair wise as shown in the Figure 6. Detailed description of modulation and pulse shaping is provided in 3GPP TS 45.004.

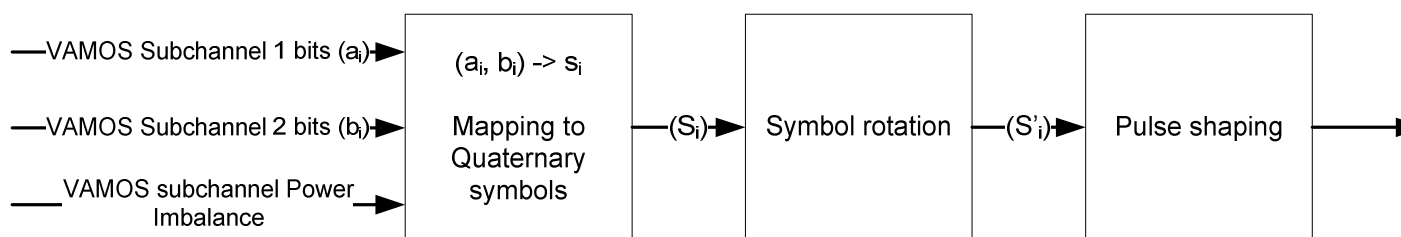

Figure 6: AQPSK Modulation to map bits from a *VAMOS pair* on a burst in downlink

13.3.1.1 Selection of modulation format

In downlink, for a *VAMOS pair*, when DTX is employed for the TCH channels, AQPSK modulation as shown above shall be used when on a given physical resource both the TCH channels in the *VAMOS pair* have bursts scheduled for transmission simultaneously. If only one of the TCH channels in a *VAMOS pair* has bursts scheduled for transmission, with the other TCH channel being in DTX state (having no bursts scheduled for transmission, see 3GPP TS 45.008), the BSS shall send GMSK normal bursts. If none of the TCH channels in the *VAMOS pair* has bursts scheduled for transmission, then nothing is transmitted.

NOTE: A burst scheduled for transmission in downlink for a *VAMOS subchannel* may contain bits from one of the following types of frames: speech frame, FACCH frame, SACCH frame, SID frame, SID_UPDATE frame, SID_FIRST frame, ONSET frame, RATSCCH frame.

13.3.2 Burst Format

When the modulation format used is GMSK (see sub clause 13.3.1.1), the burst format used in downlink is GMSK normal burst at normal symbol rate (see 3GPP TS 45.002). When the modulation format used is AQPSK (see sub clause 13.3.1.1), the burst format used in downlink is normal burst for the AQPSK modulation (see 3GPP TS 45.002).

13.3.3 Associated Control Channels

13.3.3.1 FACCH

The channel coding for FACCH associated to a TCH in *VAMOS mode* is identical to the corresponding coding for the single user case, i.e. FACCH/F for full rate or FACCH/H for half rate. (see 3GPP TS 45.002 and 3GPP TS 45.003). Repeated FACCH may be used in downlink.

13.3.3.2 SACCH

The channel coding for SACCH associated to a TCH in *VAMOS mode* is identical to the corresponding coding for the single user case, i.e. SACCH/TF, SACCH/TPF for full rate or SACCH/TH, SACCH/TPH for half rate (see 3GPP TS 45.002 and 3GPP TS 45.003). The TDMA frame mapping for SACCH in *VAMOS mode* is done as described in 3GPP TS 45.002. Repeated SACCH may be used in downlink.

13.4 Uplink Functionality

In uplink, when in *VAMOS mode*, two GMSK modulated signals are transmitted simultaneously on the same radio resource, identified by the same timeslot number, ARFCN and TDMA frame number, in a given cell by two different mobile stations. The BSS shall decode the TCH and the associated control channels for the two desired signals and shall perform radio link control procedures for the two *VAMOS subchannels* as stated in 3GPP TS 45.008.

13.4.1 Modulation, Burst Format and Training Sequence

Each mobile station in *VAMOS mode* shall use in uplink GMSK modulation, normal burst format at normal symbol rate and use the training sequence assigned by the BSS.

13.4.2 Associated Control Channels

13.4.2.1 FACCH

In uplink FACCH transmission associated to a TCH in *VAMOS mode* is identical to the single user case, i.e. FACCH/F for full rate or FACCH/H for half rate (see 3GPP TS 45.002 and 3GPP TS 45.003).

13.4.2.2 SACCH

In uplink the channel coding of SACCH associated to a TCH in *VAMOS mode* is identical to the single user case, i.e. SACCH/TF or SACCH/TPF for full rate and SACCH/TH or SACCH/TPH for half rate (see 3GPP TS 45.002 and 3GPP TS 45.003). The TDMA frame mapping for SACCH in *VAMOS mode* is done as described in 3GPP TS 45.002. Repeated SACCH may be used in uplink.

13.5 Channel Mode Adaptation

Channel Mode Adaptation is used for assigning individual TCH channels in *VAMOS mode* or in single user TCH mode. Assignments are performed according to decisions made by the BSS and if necessary, are communicated to the respective MS in layer 3 control messages. If the physical resource and the TSC assigned on the physical resource do not change, the channel mode adaptation shall be performed without signalling on the associated FACCH. Both uplink and downlink channel modes are changed during the channel mode adaptation process.

Annex A (informative): Reference configuration

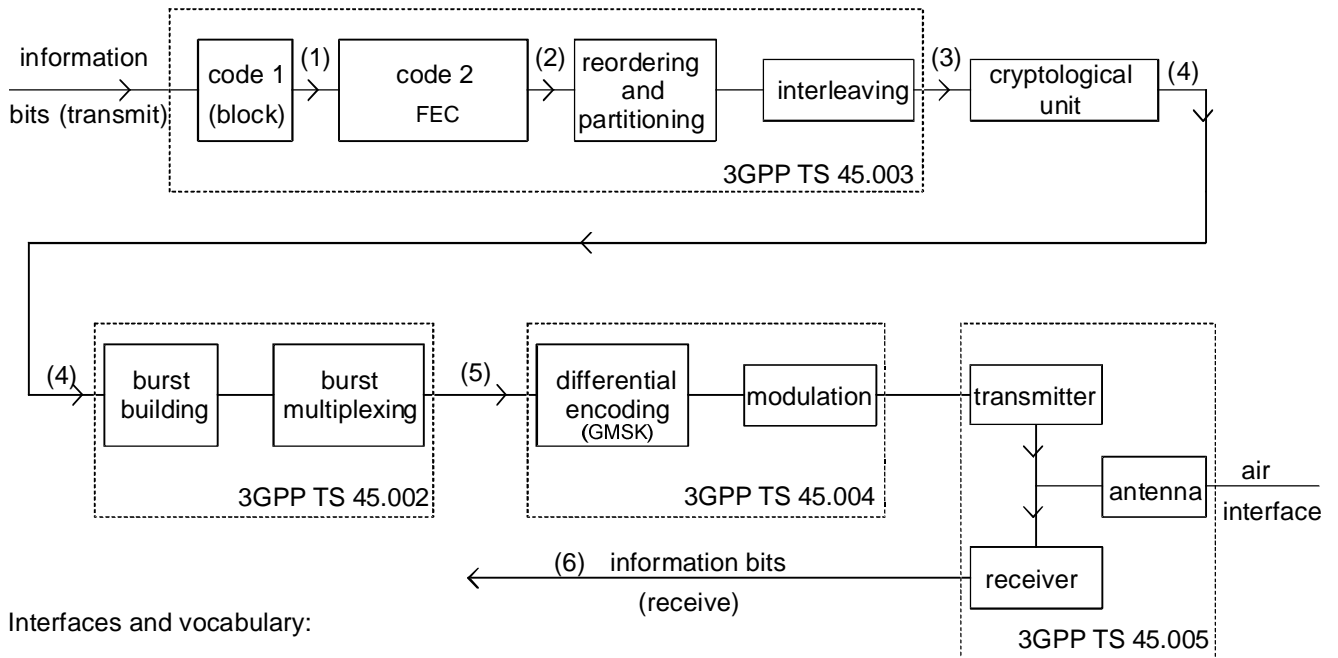

Interfaces and vocabulary:

- (1) info + parity bits
- (2) coded bits
- (3) interleaved bits
- (4) encrypted bits
- (5) modulating bits
- (6) information bits (receive)

REFERENCE CONFIGURATION

Annex B (informative): Relations between specification

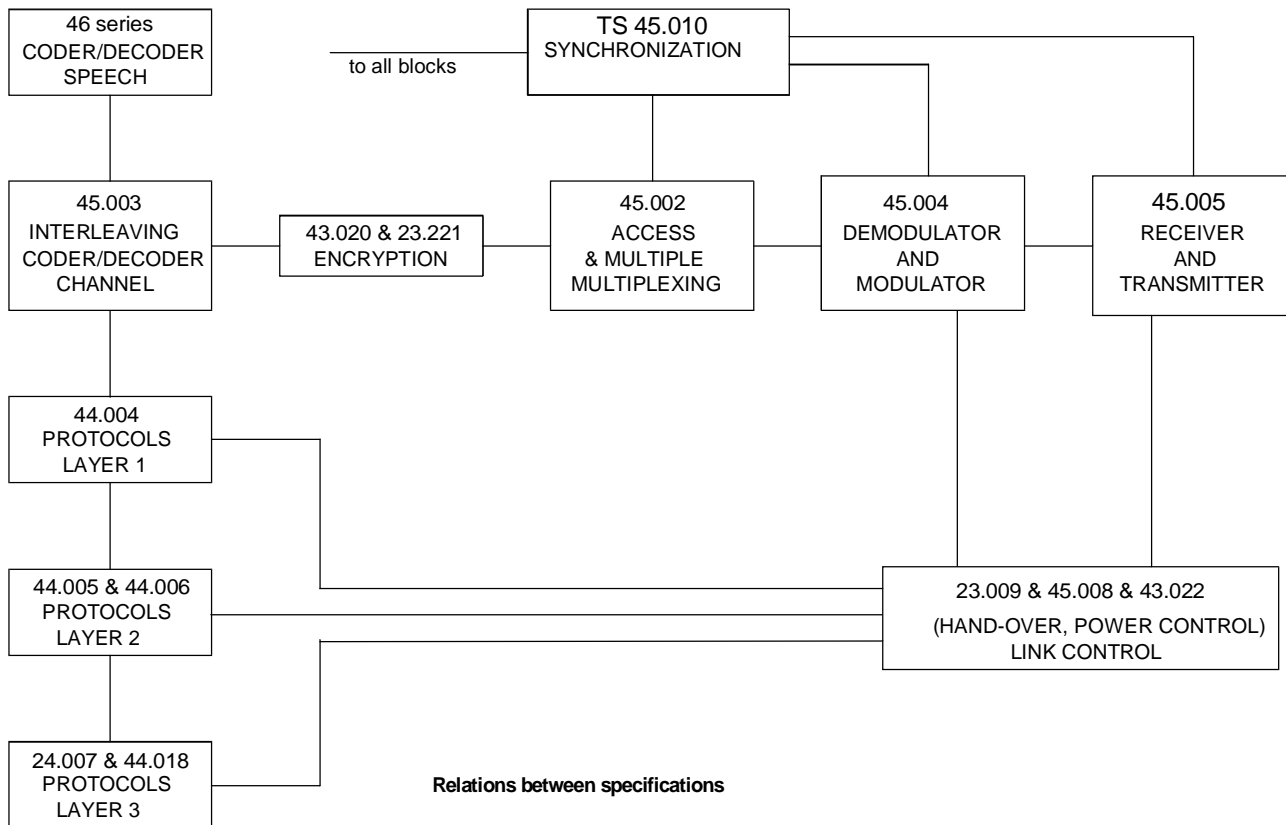

Annex C (informative): Change history

| SPEC | SMG# | CR | PHASE | VERS | NEW_VERS | SUBJECT |
|----------------|------|------|-------|--------|----------|----------------------------------------------------------------------------|
| 05.01 | S18 | A005 | 2+ | 4.6.0 | 5.0.0 | Addition of ASCII features |
| 05.01 | S20 | A006 | 2+ | 5.0.0 | 5.1.0 | Introduction of high speed circuit switched data |
| 05.01 | s21 | A007 | 2+ | 5.1.0 | 5.2.0 | Introduction of R-GSM band |
| 05.01 | s22 | A009 | 2+ | 5.2.0 | 5.3.0 | Clarification of the frequency definition text in section 9 |
| 05.01 | s24 | A010 | R97 | 5.3.0 | 6.0.0 | Introduction of GPRS |
| 05.01 | s25 | A012 | R97 | 6.0.0 | 6.1.0 | 14.4kbps Data Service |
| 05.01 | s25 | A013 | R97 | 6.0.0 | 6.1.0 | Renaming of GPRS RR states |
| 05.01 | s28 | A014 | R98 | 6.1.1 | 7.0.0 | Harmonization between GSM and PCS 1900 standard |
| 05.01 | s28 | A015 | R98 | 6.1.1 | 7.0.0 | Introduction of CTS in 05.01 |
| 05.01 | s28 | A016 | R98 | 6.1.1. | 7.0.0 | Introduction of AMR in 05.01 |
| 05.01 | s29 | A017 | R99 | 7.0.0. | 8.0.0 | Introduction of GSM 400 in 05.01 |
| 05.01 | s29 | A018 | R99 | 7.0.0 | 8.0.0 | 05.01 changes for ECSD FACCH |
| 05.01 | s30 | A020 | R99 | 8.0.1 | 8.1.0 | Correction of AMR Block Structure Parameters, Introduction of TCH/EFS |
| 05.01 | s30 | A021 | R99 | 8.0.1 | 8.1.0 | Introduction of the definition of the PDTCH for EGPRS |
| 05.01 | s30 | A022 | R99 | 8.0.1 | 8.1.0 | EDGE Compact logical channels |
| 05.01 | s30b | A023 | R99 | 8.1.0 | 8.2.0 | Support of Slow Frequency Hopping for EGPRS COMPACT |
| 05.01 | s31 | A024 | R99 | 8.2.0 | 8.3.0 | Complete Frequency Hopping on COMPACT |
| 05.01 | s32 | A026 | R99 | 8.3.0 | 8.4.0 | Definition of PDCH/H and alignment with DTM |
| | | | | | | September 2000 - 3GPP TSG-GERAN |
| 05.01 | G01 | A028 | R99 | 8.4.0 | 8.5.0 | CR 05.01-A028 DTM (R99) |
| 05.01 | G01 | A029 | R99 | 8.4.0 | 8.5.0 | CR 05.01-A029 DTM+EGPRS (R99) |
| 05.01 | G01 | A031 | R99 | 8.4.0 | 8.5.0 | CR 05.01-A031 Minimum Mobile Station Class and Channelization Capabilities |
| GERAN | | | | | | Release 4 |
| 05.01 / 45.001 | G01 | A030 | Rel4 | 8.5.0 | 4.0.0 | CR 05.01-A030 Introduction of GSM 700 (Release 4) |
| | | | | 4.0.0 | 4.0.1 | Oct 2000: References corrected. |

| Change history | | | | | | | |
|----------------|------------|-----------|------|-----|--------------------------------------------------------------------------------|--------|--------|
| Date | TSG GERAN# | TSG Doc. | CR | Rev | Subject/Comment | Old | New |
| 2001-01 | 03 | GP-010240 | 001 | | Introduction of Wideband AMR for GMSK modulated speech channel | 4.0.1 | 5.0.0 |
| 2001-08 | 06 | GP-011917 | 003 | 1 | Introduction of EPC channels | 5.0.0 | 5.1.0 |
| 2001-11 | 07 | GP-012350 | 004 | | Introduction of adaptive half rate speech channels with 8-PSK modulation | 5.1.0 | 5.2.0 |
| 2001-11 | 07 | GP-012364 | 006 | | Correction of description Wideband AMR channel coding | 5.1.0 | 5.2.0 |
| 2001-11 | 07 | GP-012767 | 008 | 1 | Correction of references to relevant 3GPP TSs | 5.1.0 | 5.2.0 |
| 2001-11 | 07 | GP-012509 | 010 | | Coding rate of MCS3 | 5.1.0 | 5.2.0 |
| 2002-04 | 09 | GP-021168 | 012 | 1 | Alignment of number of codecs for WB-AMR to proposed set | 5.2.0 | 5.3.0 |
| 2002-04 | 09 | GP-020885 | 013 | | Decimal Sign | 5.2.0 | 5.3.0 |
| 2002-04 | 09 | GP-021204 | 014 | 1 | Introduction of AMR-WB on 8PSK modulated speech traffic channels | 5.2.0 | 5.3.0 |
| 2002-06 | 10 | GP-021434 | 016 | | Corrections and clean up | 5.3.0 | 5.4.0 |
| 2002-06 | 10 | GP-021629 | 018 | | Miscellaneous corrections | 5.3.0 | 5.4.0 |
| 2002-11 | 12 | GP-023113 | 020 | | CRC Sizes for AMR-WB | 5.4.0 | 5.5.0 |
| 2002-11 | 12 | GP-023321 | 019 | 2 | Implementation of new frequency ranges | 5.5.0 | 6.0.0 |
| 2003-04 | 14 | GP-030986 | 023 | 1 | MCS-3 padding for MCS-8 retransmission | 6.0.0 | 6.1.0 |
| 2003-11 | 17 | GP-032459 | 024 | 2 | Flexible Layer One | 6.1.0 | 6.2.0 |
| 2003-11 | 17 | GP-032556 | 027 | | Correction due to change of DTM core capability | 6.1.0 | 6.2.0 |
| 2004-02 | 18 | GP-040362 | 028 | | Correction on MS support of EGPRS coding schemes | 6.2.0 | 6.3.0 |
| 2004-06 | 20 | GP-041231 | 030 | | Correction of Figure 2a1 | 6.3.0 | 6.4.0 |
| 2004-11 | 22 | GP-042469 | 034 | | Introduction of MBMS | 6.4.0 | 6.5.0 |
| 2004-11 | 22 | GP-042785 | 035 | | Removal of PTM-M | 6.4.0 | 6.5.0 |
| 2004-11 | 22 | GP-042879 | 038 | 1 | FLO-compatible quick fix for VT over GERAN | 6.4.0 | 6.5.0 |
| 2005-04 | 24 | GP-050779 | 042 | | Introduction of GSM 710 | 6.5.0 | 7.0.0 |
| 2005-06 | 25 | GP-051714 | 043 | 1 | Introduction of T-GSM 810 | 7.0.0 | 7.1.0 |
| 2005-11 | 27 | GP-052846 | 0045 | 1 | MBMS transfer mode | 7.1.0 | 7.2.0 |
| 2006-06 | 30 | GP-061109 | 0046 | | Correction of terminology: "allocation" vs. "assignment" | 7.2.0 | 7.3.0 |
| 2007-05 | 34 | GP-070789 | 0049 | | Miscellaneous corrections | 7.3.0 | 7.4.0 |
| 2007-08 | 35 | GP-071514 | 0047 | 2 | Introduction of Reduced TTI and Fast Ack/Nack Reporting | 7.4.0 | 7.5.0 |
| 2007-08 | 35 | GP-071491 | 0050 | 1 | Introduction of RED HOT and HUGE | 7.4.0 | 7.5.0 |
| 2007-11 | 36 | GP-071673 | 0051 | | Removal of RL TBF in FANR procedures and miscellaneous corrections | 7.5.0 | 7.6.0 |
| 2007-11 | 36 | GP-071699 | 0052 | | Corrections for REDHOT, HUGE and LATRED | 7.5.0 | 7.6.0 |
| 2008-02 | 37 | GP-080365 | 0053 | 1 | Corrections for LATRED | 7.6.0 | 7.7.0 |
| 2008-08 | 39 | GP-081414 | 0055 | 2 | Aligning GSM 700 frequency range and usage with other 3GPP access technologies | 7.7.0 | 7.8.0 |
| 2008-12 | 40 | | | | Version for Release 8 | 7.8.0 | 8.0.0 |
| 2009-05 | 42 | GP-091047 | 0057 | 2 | Introduction of VAMOS | 8.0.0 | 9.0.0 |
| 2009-11 | 44 | GP-092159 | 0063 | 2 | TSC Pairing for VAMOS aware UEs | 9.0.0 | 9.1.0 |
| 2009-11 | 44 | GP-092347 | 0066 | 1 | Removal of mandatory support for P-channels by mobile stations in A/Gb mode | 9.0.0 | 9.1.0 |
| 2009-11 | 44 | GP-092350 | 0068 | 2 | Removal T-GSM 900 | 9.0.0 | 9.1.0 |
| 2010-03 | 45 | GP-100612 | 0058 | 5 | Introduction of Shifted SACCH scheme for VAMOS | 9.1.0 | 9.2.0 |
| 2010-09 | 47 | GP-101551 | 0071 | 2 | Introduction of VAMOS performance levels | 9.2.0 | 9.3.0 |
| 2011-03 | 49 | | | | Version for Release 10 | 9.3.0 | 10.0.0 |
| 2011-11 | 52 | GP-111848 | 0074 | 2 | Clarification of mandatory DARP and Repeated ACCH support for VAMOS feature | 10.0.0 | 10.1.0 |
| 2012-09 | 55 | | | | Version for Release 11 | 10.1.0 | 11.0.0 |
| 2013-08 | 59 | GP-130857 | 0076 | 3 | TCRT: Introduction of ER-GSM band | 11.0.0 | 12.0.0 |
| 2013-08 | 59 | GP-130892 | 0077 | 3 | Introduction of VAMOS III MS | 11.0.0 | 12.0.0 |
| 2014-11 | 64 | GP-140945 | 0078 | 4 | Introduction of extended TSC sets | 12.0.0 | 12.1.0 |
| 2015-11 | 68 | GP-151219 | 0079 | 4 | Introduction of EC-EGPRS, Multiple access and timeslot structure | 12.1.0 | 13.0.0 |

| | | | | | | | |
|---------|----|-----------|------|---|---------------------------------------------------------------|--------|--------|
| 2015-11 | 68 | GP-151220 | 0080 | 4 | Introduction of EC-EGPRS, Coding interleaving and performance | 12.1.0 | 13.0.0 |
|---------|----|-----------|------|---|---------------------------------------------------------------|--------|--------|

History

| Document history | | |
|-------------------------|--------------|-------------|
| V13.0.0 | January 2016 | Publication |
| | | |
| | | |
| | | |
| | | |