

ETSI TS 144 004 V16.0.0 (2020-09)



**Digital cellular telecommunications system (Phase 2+) (GSM);
GSM/EDGE Layer 1;
General Requirements
(3GPP TS 44.004 version 16.0.0 Release 16)**



Reference

RTS/TSGR-0644004vg00

Keywords

GSM

ETSI

650 Route des Lucioles
F-06921 Sophia Antipolis Cedex - FRANCE

Tel.: +33 4 92 94 42 00 Fax: +33 4 93 65 47 16

Siret N° 348 623 562 00017 - NAF 742 C
Association à but non lucratif enregistrée à la
Sous-Préfecture de Grasse (06) N° 7803/88

Important notice

The present document can be downloaded from:

<http://www.etsi.org/standards-search>

The present document may be made available in electronic versions and/or in print. The content of any electronic and/or print versions of the present document shall not be modified without the prior written authorization of ETSI. In case of any existing or perceived difference in contents between such versions and/or in print, the prevailing version of an ETSI deliverable is the one made publicly available in PDF format at www.etsi.org/deliver.

Users of the present document should be aware that the document may be subject to revision or change of status.

Information on the current status of this and other ETSI documents is available at

<https://portal.etsi.org/TB/ETSIDeliverableStatus.aspx>

If you find errors in the present document, please send your comment to one of the following services:

<https://portal.etsi.org/People/CommiteeSupportStaff.aspx>

Copyright Notification

No part may be reproduced or utilized in any form or by any means, electronic or mechanical, including photocopying and microfilm except as authorized by written permission of ETSI.

The content of the PDF version shall not be modified without the written authorization of ETSI.

The copyright and the foregoing restriction extend to reproduction in all media.

© ETSI 2020.

All rights reserved.

DECT™, **PLUGTESTS™**, **UMTS™** and the ETSI logo are trademarks of ETSI registered for the benefit of its Members.

3GPP™ and **LTE™** are trademarks of ETSI registered for the benefit of its Members and of the 3GPP Organizational Partners.

oneM2M™ logo is a trademark of ETSI registered for the benefit of its Members and of the oneM2M Partners.

GSM® and the GSM logo are trademarks registered and owned by the GSM Association.

Intellectual Property Rights

Essential patents

IPRs essential or potentially essential to normative deliverables may have been declared to ETSI. The information pertaining to these essential IPRs, if any, is publicly available for **ETSI members and non-members**, and can be found in ETSI SR 000 314: "*Intellectual Property Rights (IPRs); Essential, or potentially Essential, IPRs notified to ETSI in respect of ETSI standards*", which is available from the ETSI Secretariat. Latest updates are available on the ETSI Web server (<https://ipr.etsi.org/>).

Pursuant to the ETSI IPR Policy, no investigation, including IPR searches, has been carried out by ETSI. No guarantee can be given as to the existence of other IPRs not referenced in ETSI SR 000 314 (or the updates on the ETSI Web server) which are, or may be, or may become, essential to the present document.

Trademarks

The present document may include trademarks and/or tradenames which are asserted and/or registered by their owners. ETSI claims no ownership of these except for any which are indicated as being the property of ETSI, and conveys no right to use or reproduce any trademark and/or tradename. Mention of those trademarks in the present document does not constitute an endorsement by ETSI of products, services or organizations associated with those trademarks.

Legal Notice

This Technical Specification (TS) has been produced by ETSI 3rd Generation Partnership Project (3GPP).

The present document may refer to technical specifications or reports using their 3GPP identities. These shall be interpreted as being references to the corresponding ETSI deliverables.

The cross reference between 3GPP and ETSI identities can be found under <http://webapp.etsi.org/key/queryform.asp>.

Modal verbs terminology

In the present document "**shall**", "**shall not**", "**should**", "**should not**", "**may**", "**need not**", "**will**", "**will not**", "**can**" and "**cannot**" are to be interpreted as described in clause 3.2 of the [ETSI Drafting Rules](#) (Verbal forms for the expression of provisions).

"**must**" and "**must not**" are **NOT** allowed in ETSI deliverables except when used in direct citation.

Contents

Intellectual Property Rights	2
Legal Notice	2
Modal verbs terminology.....	2
Foreword.....	6
1 Scope	7
1a References	7
2 Interfaces to the physical layer	8
2.1 Interface to the Data Link Layer	9
2.1a Interface to the Radio Link Control and Medium Access Control layer	9
2.1b Flexible Layer One Interface to the Radio Link Control and Medium Access Control layer	9
2.2 Interface to radio resource management.....	10
2.3 Interface to other functional units.....	10
3 Service of the physical layer	10
3.1 Service Access Point	10
3.2 Service of the physical layer.....	12
3.2.1 Specific services of the physical layer in the MS	13
4 Primitives of the physical layer	14
4.1 Generic names of primitives between layers 1 and 2 for the transfer of layer 2 frames and RLC/MAC blocks	14
4.2 Generic names of primitives between layer 1 and the RR-management entity of layer 3	14
4.3 Primitive types.....	15
4.4 Parameter definition	15
5 Physical layer procedures	17
5.0 General	17
5.1 States of the physical layer	17
5.2 Control procedures	18
5.3 Physical layer interface procedures	18
6 Physical layer protocol header	18
6.0 General	18
6.1 Physical layer protocol fields and procedures	18
7 Block transmission	19
7.0 General	19
7.1 SACCH downlink block format	19
7.1.1 <i>A/Gb mode</i>	19
7.1.2 <i>Iu mode</i>	20
7.2 SACCH uplink block format	21
7.2.1 <i>A/Gb mode</i>	21
7.2.2 <i>Iu mode</i>	21
7.3 FACCH/SDCCH/CCCH/BCCH/CBCH downlink block format	21
7.3.1 CCCH/BCCH/CBCH downlink block format	21
7.3.2 FACCH/SDCCH downlink block format	22
7.3.2.1 <i>A/Gb mode</i>	22
7.3.2.2 <i>Iu mode</i>	22
7.4 FACCH/SDCCH uplink block format.....	23
7.4.1 <i>A/Gb mode</i>	23
7.4.2 <i>Iu mode</i>	23
7.4a RACH uplink / Uplink access burst block format	23
7.5 PBCCH/PCCCH downlink/PACCH block format	24
7.6 PDTCH block formats.....	25
7.6.1 PDTCH block type 1 (CS-1) format	25
7.6.2 PDTCH block type 2 (CS-2) format	25

7.6.3	PDTCH block type 3 (CS-3) format	26
7.6.4	PDTCH block type 4 (CS-4) format	26
7.6.5	PDTCH block type 5 (MCS-1) format.....	26
7.6.6	PDTCH block type 6 (MCS-2) format.....	27
7.6.7	PDTCH block type 7 (MCS-3) format.....	27
7.6.8	PDTCH block type 8 (MCS-4) format.....	28
7.6.9	PDTCH block type 9 (MCS-5) format.....	28
7.6.9.1	Uplink	28
7.6.9.2	Downlink.....	29
7.6.10	PDTCH block type 10 (MCS-6) format.....	29
7.6.10.1	Uplink	29
7.6.10.2	Downlink.....	29
7.6.11	PDTCH block type 11 (MCS-7) format.....	30
7.6.11.1	Uplink	30
7.6.11.2	Downlink.....	30
7.6.12	PDTCH block type 12 (MCS-8) format.....	31
7.6.12.1	Uplink	31
7.6.12.2	Downlink.....	31
7.6.13	PDTCH block type 13 (MCS-9) format.....	32
7.6.13.1	Uplink	32
7.6.13.2	Downlink.....	32
7.6.14	PDTCH block type 14 (UAS-7) format (uplink only)	33
7.6.15	PDTCH block type 15 (UAS-8) format (uplink only)	33
7.6.16	PDTCH block type 16 (UAS-9) format (uplink only)	34
7.6.17	PDTCH block type 17 (UAS-10) format (uplink only)	35
7.6.18	PDTCH block type 18 (UAS-11) format (uplink only)	35
7.6.19	PDTCH block type 19 (UBS-5) format (uplink only)	36
7.6.20	PDTCH block type 20 (UBS-6) format (uplink only)	36
7.6.21	PDTCH block type 21 (UBS-7) format (uplink only)	36
7.6.22	PDTCH block type 22 (UBS-8) format (uplink only)	37
7.6.23	PDTCH block type 23 (UBS-9) format (uplink only)	37
7.6.24	PDTCH block type 24 (UBS-10) format (uplink only).....	38
7.6.25	PDTCH block type 25 (UBS-11) format (uplink only).....	38
7.6.26	PDTCH block type 26 (UBS-12) format (uplink only).....	39
7.6.27	PDTCH block type 27 (DAS-5) format (downlink only)	39
7.6.28	PDTCH block type 28 (DAS-6) format (downlink only)	40
7.6.29	PDTCH block type 29 (DAS-7) format (downlink only)	41
7.6.30	PDTCH block type 30 (DAS-8) format (downlink only)	41
7.6.31	PDTCH block type 31 (DAS-9) format (downlink only)	42
7.6.32	PDTCH block type 32 (DAS-10) format (downlink only)	42
7.6.33	PDTCH block type 33 (DAS-11) format (downlink only)	43
7.6.34	PDTCH block type 34 (DAS-12) format (downlink only)	43
7.6.35	PDTCH block type 35 (DBS-5) format (downlink only).....	44
7.6.36	PDTCH block type 36 (DBS-6) format (downlink only).....	44
7.6.37	PDTCH block type 37 (DBS-7) format (downlink only).....	44
7.6.38	PDTCH block type 38 (DBS-8) format (downlink only).....	45
7.6.39	PDTCH block type 39 (DBS-9) format (downlink only).....	45
7.6.40	PDTCH block type 40 (DBS-10) format (downlink only).....	46
7.6.41	PDTCH block type 41 (DBS-11) format (downlink only).....	46
7.6.42	PDTCH block type 42 (DBS-12) format (downlink only).....	47
7.7	PRACH uplink/PACCH uplink short acknowledgement block formats	47
7.8	PTCCH downlink block format.....	48
7.9	PTCCH uplink block formats.....	49
7.9a	Transport block formats (<i>Iu mode</i>).....	49
7.9a.1	Generic transport block format	49
7.9a.2	Transport block format for signalling TFC.....	49
7.9b	EC-BCCH/EC-CCCH/EC-PDTCH/EC-PACCH block formats	50
7.9b.1	EC-BCCH	50
7.9b.2	EC-CCCH	50
7.9b.2.1	EC-PCH/EC-AGCH.....	50
7.9b.2.2	EC-RACH	50
7.9b.3	EC-PDTCH.....	50

7.9b.4	EC-PACCH.....	51
7.9b.4.1	Downlink.....	51
7.9b.4.2	Uplink	51
7.10	Order of bit transmission.....	51
8	Vocabulary	52
Annex A (informative):	Change History	54
History		55

Foreword

This Technical Specification has been produced by the 3rd Generation Partnership Project (3GPP).

The contents of the present document are subject to continuing work within the TSG and may change following formal TSG approval. Should the TSG modify the contents of the present document, it will be re-released by the TSG with an identifying change of release date and an increase in version number as follows:

Version x.y.z

where:

- x the first digit:
 - 1 presented to TSG for information;
 - 2 presented to TSG for approval;
 - 3 or greater indicates TSG approved document under change control.
- y the second digit is incremented for all changes of substance, i.e. technical enhancements, corrections, updates, etc.
- z the third digit is incremented when editorial only changes have been incorporated in the document.

1 Scope

The present document defines the service offered by the physical layer (3GPP TS 45-series of Technical Specifications) of the MS-BS interface (3GPP TS 45- and 44-series of Technical Specifications). Its main objective is to be a guidance for the interface between the 3GPP Technical Specifications in the 45-series and the 44-series. It also specifies the format of signalling channels and the order of bit transmission.

As far as possible, the present document makes use of the layering principles of the Reference Model for Open System Interconnection (OSI) as contained in ITU-T Recommendations X.200 and X.210.

1a References

The following documents contain provisions which, through reference in this text, constitute provisions of the present document.

- References are either specific (identified by date of publication, edition number, version number, etc.) or non-specific.
- For a specific reference, subsequent revisions do not apply.
- For a non-specific reference, the latest version applies. In the case of a reference to a 3GPP document (including a GSM document), a non-specific reference implicitly refers to the latest version of that document *in the same Release as the present document*.

- [1] 3GPP TR 21.905: "Vocabulary for 3GPP Specifications".
- [2] 3GPP TS 22.011: "Service accessibility".
- [3] 3GPP TS 43.013: "Discontinuous Reception (DRX) in the GSM System".
- [4] 3GPP TS 43.020: "Security-related network functions".
- [5] Void.
- [6] Void.
- [7] 3GPP TS 44.003: "Mobile Station - Base Station System (MS - BSS) interface; Channel structures and access capabilities".
- [8] 3GPP TS 44.005: "Data Link (DL) layer; General aspects".
- [9] 3GPP TS 44.006: "Mobile Station - Base Station System (MS - BSS) interface; Data Link (DL) layer specification".
- [10] Void.
- [11] 3GPP TS 44.018: "Mobile radio interface layer 3 specification; Radio Resource Control Protocol".
- [12] Void.
- [13] Void.
- [14] 3GPP TS 44.012: "Short Message Service Cell Broadcast (SMSCB) support on the mobile radio interface".
- [15] Void.
- [16] Void.
- [17] Void.
- [17a] 3GPP TS 44.060: "General Packet Radio Service (GPRS); Mobile Station (MS) - Base Station System (BSS) interface; Radio Link Control/Medium Access Control (RLC/MAC) protocol".

- [18] Void.
- [19] Void.
- [20] Void.
- [21] Void.
- [22] Void.
- [23] Void.
- [24] Void.
- [25] Void.
- [26] Void.
- [26a] Void.
- [26b] Void.
- [27] 3GPP TS 45.001: "Physical Layer on the Radio Path (General Description)".
- [28] 3GPP TS 45.002: "Multiplexing and multiple access on the radio path".
- [29] 3GPP TS 45.003: "Channel coding".
- [30] Void.
- [31] 3GPP TS 45.005: "Radio transmission and reception".
- [32] 3GPP TS 45.008: "Radio subsystem link control".
- [33] 3GPP TS 45.010: "Radio subsystem synchronization".
- [34] Void.
- [35] ITU-T Recommendation X.200: "Information technology; Open Systems Interconnection; Basic Reference Model: The basic model".
- [36] ITU-T Recommendation X.210: "Information technology - Open systems interconnection - Basic Reference Model: Conventions for the definition of OSI services".
- [37] 3GPP TS 48.058: "Base Station Controller - Base Transceiver Station (BCS-BTS) Interface Layer 3 Specification".
- [38] 3GPP TR 45.902: "Flexible Layer One".
- [39] 3GPP TS 43.064: "Overall description of the GPRS radio interface; Stage 2".

2 Interfaces to the physical layer

The physical layer (layer 1) is the lowest layer in the OSI Reference Model and it supports all functions required for the transmission of bit streams on the physical medium. These bit streams are transferred on traffic channels, packet data traffic channels and control channels as defined in 3GPP TS 44.003.

NOTE: For GSM application the physical layer may also be referred to as the radio subsystem. However, the radio subsystem supports functions additional to those described in the present document.

The physical layer interfaces the Data Link Layer, the Radio Link Control and Medium Access Control layer and the supported functional units of the application (figure 2).

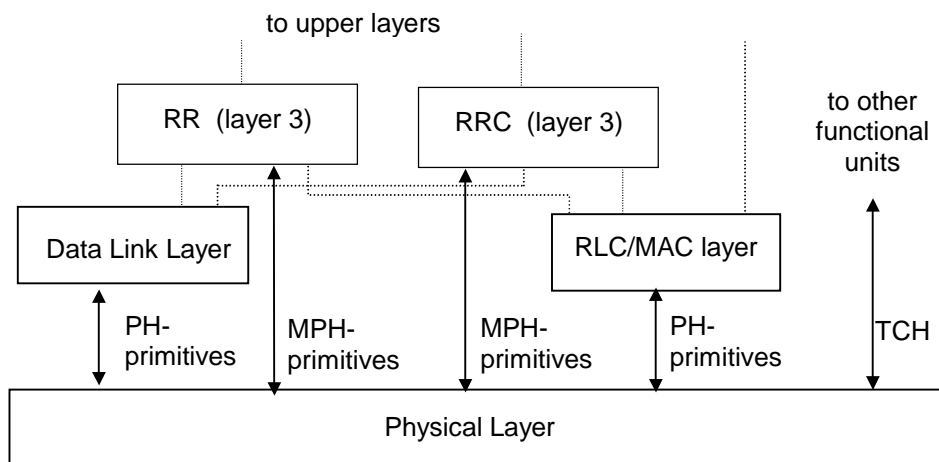

Figure 2: Interfaces with the Physical Layer

2.1 Interface to the Data Link Layer

The physical layer interfaces the data link layer. On this interface control channels are supported. The data link layer is specified in 3GPP TS 44.005 and 44.006. Communication between the Physical Layer and the Data Link Layer is in an abstract way performed by means of PH-primitives. They do not constrain implementations.

NOTE: The terms physical layer and layer 1, and data link layer and layer 2, will be used synonymously in the present document.

The PH-primitives exchanged between the physical layer and the data link layer are used for the transfer of layer 2 frames. They are also used to indicate the establishment of channels to layer 2.

2.1a Interface to the Radio Link Control and Medium Access Control layer

The physical layer interfaces the Radio Link Control and Medium Access Control (RLC/MAC) layer. On this interface packet data control channels and packet data traffic channels are supported when MS is operating in *A/Gb mode*; when MS is operating in *Iu mode*, traffic channels, dedicated control channels, packet data control channels and packet data traffic channels are supported. The RLC/MAC layer is specified in 3GPP TS 44.060 (*A/Gb mode*). Communication between the Physical Layer and the RLC/MAC layer is in an abstract way performed by means of PH-primitives. They do not constrain implementations.

The PH-primitives exchanged between the physical layer and the RLC/MAC layer are used for the transfer of RLC/MAC blocks. They are also used to indicate the establishment of packet data physical channels (*A/Gb mode*) or shared basic physical subchannels (*Iu mode*) to the RLC/MAC layer.

2.1b Flexible Layer One Interface to the Radio Link Control and Medium Access Control layer

In *Iu mode*, when the Flexible Layer One is used the physical layer interfaces the Radio Link Control and Medium Access Control (RLC/MAC) layer (see 3GPP TR 45.902). On this interface transport channels are supported. Communication between the Physical Layer and the RLC/MAC layer is in an abstract way performed by means of PH-primitives. They do not constrain implementations.

The PH-primitives exchanged between the physical layer and the RLC/MAC layer are used for the transfer of transport blocks.

2.2 Interface to radio resource management

The physical layer interfaces the radio resource management (RR or RRC) entity of layer 3 in the MS and in the network. When the MS is operating in *A/Gb mode* the radio resource management is provided by the RR entity whilst when operating in *Iu mode* the radio resource management is provided by the RRC entity.

Communication is performed in an abstract way by means of MPH-primitives. They do not constrain implementations.

The primitives exchanged with the RR-management entity are related to the assignment of channels, physical layer system information (including measurement results), etc.

2.3 Interface to other functional units

The physical layer interfaces other functional units in the MS and in the network for supporting traffic channels. These interfaces are described in the 26, 27 and 46 series of Technical Specifications.

3 Service of the physical layer

The physical layer supports transfer of bit streams on the radio medium according to the Technical Specifications of the 45-series. The scope of the 45-series of Technical Specifications is the definition of a framework for operation on the radio medium. The application of this framework on the radio medium results in a transmission service. General characteristics of the service obtained by applying the framework of the 45-series at the operation on the radio medium are described in this clause.

3.1 Service Access Point

In the Reference Model for Open System Interconnection, Service Access Points (SAPs) of a layer are defined as gates through which services are offered to an adjacent higher layer (figure 3.1.a). Through a SAP the physical layer offers a service to the data link layer. The SAP is used both for the control of the service providing entity (in case this is the physical layer; commands related to the establishment and release of channels) and the transfer of data (in case of the physical layer; the transfer of bits). The physical layer service access points defined in the present document differ from the OSI physical layer Service Access Points; the layer 3 RR-management instead of the data link layer controls the SAPs (establishment and release of channels).

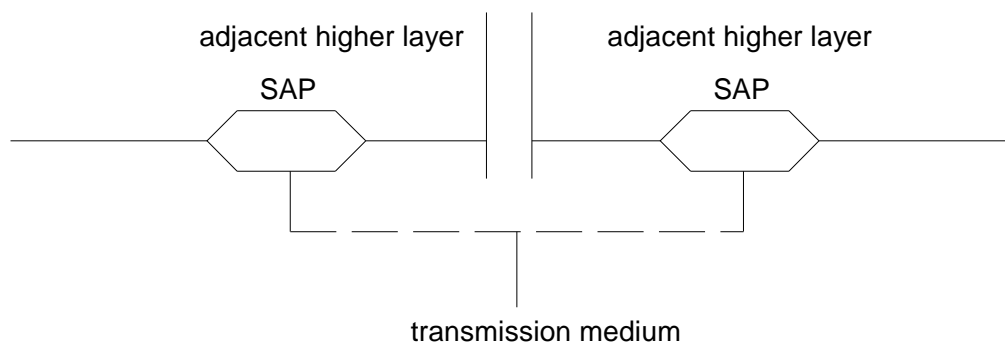

Figure 3.1.a: Service Access Point principle

On the physical layer of the GSM system a SAP is defined between the physical layer and the data link layer for each control channel (figure 3.1.b, figure 3.1.b1 and figure 3.1.b2). The characteristics of SAPs (channels) are listed in 3GPP TS 44.003.

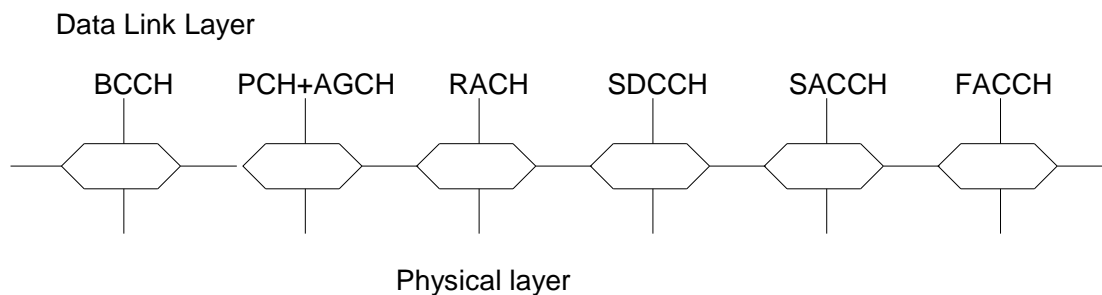

Figure 3.1.b: SAPs between the physical layer and the data link layer when the MS is operating in *A/Gb mode*

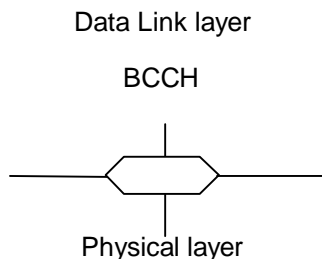

Figure 3.1.b1: SAPs between the physical layer and the data link layer when the MS is capable of operating in *Iu mode*

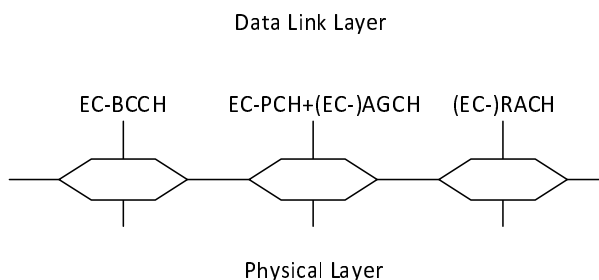

Figure 3.1.b2: SAPs between the physical layer and the data link layer when the MS has enabled EC operation (see 3GPP TS 43.064) and is operating in *A/Gb mode*.

Moreover, on the physical layer of the GSM system a SAP is defined between the physical layer and the RLC/MAC layer for the packet data control channels, dedicated control channels (*Iu mode*), traffic channels (*Iu mode*) and the packet data traffic channel and the transport channels (FLO in *Iu mode*) (see figure 3.1.c, figure 3.1.d and figure 3.1.e). Multiplexing of these channels is controlled by the RLC/MAC layer, see 3GPP TS 44.060 (*A/Gb mode*). The characteristics of channels are listed in 3GPP TS 44.003.

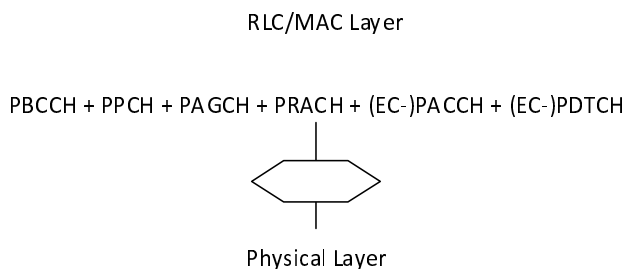

Figure 3.1.c: SAP between the physical layer and the RLC/MAC layer when the MS is operating in *A/Gb mode*

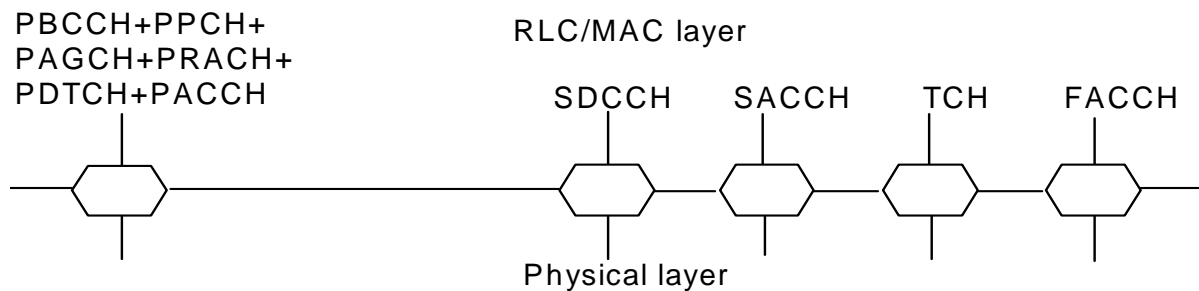

Figure 3.1.d: SAP between the physical layer and the RLC/MAC layer when the MS is operating in *Iu mode*

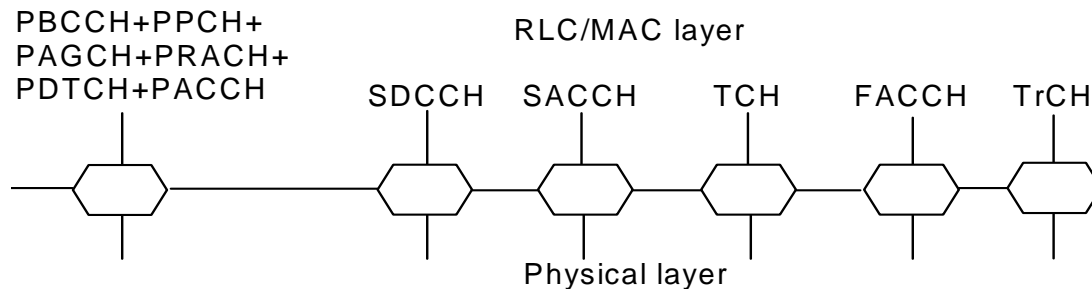

Figure 3.1.e: SAP between the physical layer and the RLC/MAC layer when the MS is operating in *Iu mode with FLO*

3.2 Service of the physical layer

The physical layer offers a transmission service on a limited set of logical channels. Additionally with FLO in *Iu mode*, the physical layer offers a transmission service on transport channels. The BS and MS access capabilities and the characteristics of logical channels (SAPs) are defined in 3GPP TS 44.003.

NOTE: Between 3GPP TS 44.003 and the 3GPP TS 45.0xx series there is a slight difference in terminology. The "channels" mentioned in 3GPP TS 44.003 are "logical channels" according to the 3GPP TS 45.0xx series (especially 3GPP TS 45.002). The "CCCH", a channel name commonly used in the 3GPP TS 44.0xx series, covers the logical channels of the type RACH, PCH and AGCH. Similarly, the "PCCCH" covers the logical channels of the type PPCH, PAGCH and PRACH.

For an MS operating in *A/Gb mode*, logical channels are multiplexed on physical channels. Physical channels are the units scheduled on the radio medium. Some are reserved by the network for common use (e.g. a combination of CCCH and BCCH), others are assigned to dedicated connections with MSs (dedicated physical channels), or are assigned to a shared usage between MSs for packet switched data traffic (packet data physical channels). In time, the combination of logical channels used on an assigned physical channel may change. Allowed combinations of logical channels on a physical channel are defined in 3GPP TS 44.003. Data on SAPs of control channels is exchanged in discrete blocks with a size of 23 or 21 (SACCH) octets. Data on a SAP of packet data traffic channels is exchanged in discrete blocks with a size dependent on the block type (see clause 7).

For an MS operating in *Iu mode*, logical channels are multiplexed on basic physical subchannels. Basic physical subchannels are the units scheduled on the radio medium. Some basic physical channels are reserved by the network for common use (e.g. BCCH); dedicated basic physical subchannels are assigned to dedicated connections with MSs, shared basic physical subchannels are assigned to a shared usage between MSs for packet switched data traffic. In time, the combination of logical channels used on an assigned basic physical subchannel may change. Allowed combinations of logical channels on a basic physical subchannel are defined in 3GPP TS 44.003. Data on SAPs of control channels is exchanged in discrete blocks with a size of 23 or 21 (SACCH) octets. Data on a SAP of packet data traffic channels is exchanged in discrete blocks with a size dependent on the block type (see clause 7).

For an MS operating in *Iu mode with FLO*, transport channels are multiplexed on dedicated basic physical subchannels. The combination of transport channels used on an assigned basic physical subchannel may change in time. Data on SAPs of transport channels is exchanged in discrete transport blocks.

Synchronization between layer 1 and layer 2 (data link layer) is provided for piggy-backing of RR (receive ready) frames, and the starting of timers (T200). See also 3GPP TS 44.006. Synchronization between the physical layer and the RLC/MAC layer is provided for the handling of timers, and the multiplexing of logical channels. See also 3GPP TS 44.060 (*A/Gb mode*).

- **Error detection:**

The physical layer offers an error protected transmission service, it includes error detection functions and to a lower level, error correction functions. Erroneous received frames are not offered to the data link layer or the RLC/MAC layer. The probability of one or more errors in a physical block transferred by the physical layer is defined in 3GPP TS 45.005. Due to not specified methods of quality detection, the probability of residual errors in transferred blocks may vary between implementations.

- **Encryption:**

Security related functions implemented at the physical layer are described in 3GPP TS 43.020.

An overview of the functions specified in the 45-series which create the service of the physical layer can be found in 3GPP TS 45.001.

3.2.1 Specific services of the physical layer in the MS

The access capability service of the physical layer in the MS differs depending on the nature of the channel (traffic, packet data traffic or broadcast/common channels).

- **Establishment of dedicated physical channels (*A/Gb Mode*):**

Establishment of dedicated physical channels on the physical layer is controlled by the radio resources management of layer 3 (3GPP TS 44.018). During operation on a dedicated physical channel, the physical layer measures the signals of neighbouring base stations and the signal quality of the used dedicated physical channel. Measurements are transferred to layer 3, measurement control information is offered by layer 3.

- **Establishment of dedicated basic physical subchannels (*Iu mode*):**

Establishment of dedicated basic physical subchannels on the physical layer is controlled by the radio resources management of layer 3 (3GPP TS 44.018). During operation on a dedicated basic physical subchannel, the physical layer measures the signals of neighbouring base stations and the signal quality of the used dedicated basic physical subchannel. Measurements are transferred to layer 3, measurement control information is offered by layer 3.

- **Establishment of packet data physical channels (*A/Gb mode*):**

Establishment of packet data physical channels on the physical layer is controlled by the radio resource management of layer 3. Packet access and the reservation of radio resource on packet data physical channels is controlled by the RLC/MAC layer in co-operation with layer 3 (3GPP TS 44.060). During operation on packet data physical channels, the physical layer measures the signals of neighbouring base stations and the signal quality of the used packet data physical channel. Measurements are transferred to layer 3, measurement control information is offered by layer 3.

- **Establishment of shared basic physical subchannels (*Iu mode*):**

Establishment of shared basic physical subchannels on the physical layer is controlled by the radio resource management of layer 3. Packet access and the reservation of radio resource on shared basic physical subchannels is controlled by the RLC/MAC layer in co-operation with layer 3. During operation on shared basic physical subchannels, the physical layer measures the signals of neighbouring base stations and the signal quality of the used shared basic physical subchannel. Measurements are transferred to layer 3, measurement control information is offered by layer 3.

- **cell/PLMN selection in idle mode or in packet mode:**

In idle mode or in packet mode, the physical layer selects the best cell with its BCCH/CCCH in close co-operation with layer 3, meeting requirements for PLMN selection specified in 3GPP TS 22.011. The idle mode procedures are not modelled within the present document. Examples of procedures for cell selection are described in 3GPP TS 45.008. The physical layer performs automatic crossover.

4 Primitives of the physical layer

The Physical layer interacts with other entities as illustrated in figure 2.1. The interactions with the data link layer of Dm channels and the interactions with the RLC/MAC layer of packet data physical channels (*A/Gb mode*), shared or dedicated basic physical subchannels (*Iu mode*) are shown in terms of primitives where the primitives represent the logical exchange of information and control between the physical layer and adjacent layers. They do not specify or constrain implementations. The interactions between the physical layer and layer 1 entities for Bm/Lm channels are for further study. For the physical layer two sets of primitives are defined:

- **Primitives between physical layer and data link layer and RLC/MAC layer respectively:**

PH - Generic name - Type: Parameters.

- **Primitives between layer 1 and the RR-management layer 3 entity:**

MPH - Generic name - Type: Parameters.

4.1 Generic names of primitives between layers 1 and 2 for the transfer of layer 2 frames and RLC/MAC blocks

The following primitive generic names are defined on the SAPs between the physical layer and the data link layer:

a) PH-DATA:

The PH-DATA primitives are used on a SAP to pass message units containing frames used for data link layer and RLC/MAC layer respective peer-to-peer communications to and from the physical layer.

b) PH-RANDOM ACCESS:

The PH-RANDOM ACCESS (PH-RA) primitives are used on the SAP of the RACH and the PRACH to request and confirm (in the MS) the sending of a random access frame and to indicate (in the network) the arrival of a random access frame. For MS operating in *A/Gb mode*, the random access protocols are specified in 3GPP TS 44.018 and 3GPP TS 44.060 respectively.

c) PH-CONNECT:

The PH-CONNECT primitive is used on a SAP to indicate that the physical connection on the corresponding control channel or packet data physical channel (*A/Gb mode*) or shared basic physical subchannel (*Iu mode*) has been established.

d) PH-READY-TO-SEND:

The PH-READY-TO-SEND primitive is used by the physical layer to trigger, if applicable, piggy backing, the start of timer for the data link layer or the RLC/MAC layer and the forwarding a data unit to the physical layer. It is passed to the upper layer just before a new physical block is transmitted.

e) PH-EMPTY-FRAME:

The PH-EMPTY-FRAME primitive can be used by the data link layer and the RLC/MAC layer to indicate that no frame has to be transmitted after receiving the PH-READY-TO-SEND primitive. It enables polling of several upper layer entities by the physical layer and support DTX.

4.2 Generic names of primitives between layer 1 and the RR-management entity of layer 3

The following primitive generic name is defined between layer 1 and the RR-management entity of layer 3:

- MPH-INFORMATION:

MPH-INFORMATION (MPH-INFO) primitives are used for the control of the physical layer by the RR-management of layer 3. This information activates and deactivates, configures and deconfigures, through

connects and disconnects physical, logical and transport channels. It is also used for the transfer of measurements and measurement control information from layer 1 to layer 3.

4.3 Primitive types

The primitive types defined in the present document are:

a) REQUEST:

The REQUEST primitive type is used when a higher layer is requesting a service from a lower layer.

b) INDICATION:

The INDICATION primitive type is used by a layer providing a service to notify the next higher layer of activities in the layer. This activities are directly related to the occurrence of a REQUEST primitive on the peer-protocol side.

c) RESPONSE:

The RESPONSE primitive type is used by a layer to acknowledge receipt from the INDICATION primitive type.

d) CONFIRM:

The CONFIRM primitive type is used by the layer providing the requested service to confirm that the activity has been completed.

4.4 Parameter definition

Primitives contain a variable amount of parameters. The primitives with included parameters are listed in table 4.1.

Table 4.1: Primitives of the physical layer

primitive	entity	direction	message unit					
			channel control parameters	system information	absolute frame No.	measurement		
MPH-INFO-REQ	MS/BS	RR(L3)	PH(L1)	x	x			
MPH-INFO-CON	MS/BS	PH(L1)	RR(L3)	x	x			
MPH-INFO-IND	MS/BS	PH(L1)	RR(L3)	x	x		x	
PH-CONNECT-IND	MS/BS	PH(L1)	DL(L2) RLC/MAC	x				
PH-READY-TO-SEND	MS/BS	PH(L1)	DL(L2) RLC/MAC	x		x		
PH-EMPTY-FRAME	MS/BS	DL(L2) RLC/MAC	PH(L1)	x				
PH-DATA-REQ	MS/BS	DL(L2) RLC/MAC	PH(L1)	x	x			
PH-DATA-IND	MS/BS	PH(L1)	DL(L2) RLC/MAC	x	x		x	
PH-RA-REQ	MS	DL(L2) RLC/MAC	PH(L1)	x				
PH-RA-IND	BS	PH(L1)	DL(L2) RLC/MAC	x		x		
PH-RA-CON	MS	PH(L1)	DL(L2) RLC/MAC	x		x		

Parameters involved in the primitive exchange with the physical layer are:

a) Message unit:

The message unit contains peer-to-peer information of a layer. It is transferred by the physical layer to the peer layer.

b) Channel control parameters:

These parameters contain information for channel control, specified in 3GPP TS 44.018 and 3GPP TS 44.060 for MS operating in *A/Gb mode*.

c) System information:

This information is exchanged in the cell/PLMN selection procedures. It may also contain control information for DRX (sleep mode, see 3GPP TS 43.013).

d) Absolute Frame Number:

The absolute frame number is used (in combination with a random access identifier) to uniquely identify a random access.

e) Measurements:

This parameter is used to report the quality of a dedicated physical channel (MS and network) and to report the quality of surrounding BCCH carriers (MS only).

5 Physical layer procedures

5.0 General

The main body of physical layer procedures is specified in 3GPP TS 44.018 and 3GPP TS 44.060 for MS operating in *A/Gb mode*, and 3GPP TS 45.008.

5.1 States of the physical layer

In the physical layer of the MS the following states are defined:

NULL: the equipment is switched off;

SEARCHING BCH: the physical layer tracks the best BCCH;

BCH: the physical layer listens to a BCCH/CCCH, PBCCH/PCCCH or EC-BCCH/EC-CCCH and is able to do random access;

TUNING DCH: For MS operating in *A/Gb mode* the physical layer seizes on a respective dedicated physical channel or packet data physical channel; for MS operating in *Iu mode* the physical layer seizes on a basic physical subchannel;

DCH: For MS operating in *A/Gb mode* the physical layer has seized a respective dedicated physical channel or packet data physical channel and may establish and through connect logical channels; For MS operating in *Iu mode* the physical layer has seized a basic physical subchannel and may establish and through connect logical channels.

NOTE: BCH = Bcch/ccch physical CHannel, pbccch/pccch or ec-bcch/ec-ccch physical channel;
DCH = Dedicated physical CHannel or packet data physical channel for MS operating in *A/Gb mode*;
Dedicated basic physical subCHannel or shared basic physical subchannel for MS operating in *Iu mode*.

Figure 5.1 gives a general state diagram of the physical layer. All state transitions of the physical layer are controlled by MPH-INFORMATION primitives.

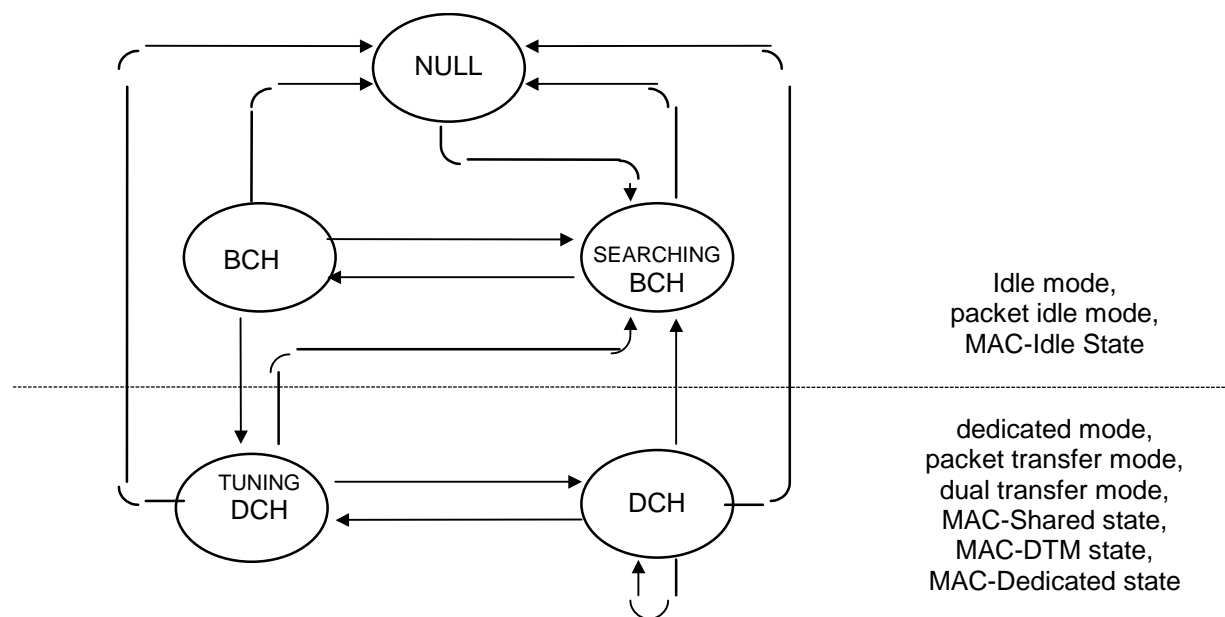

Figure 5.1: States of the physical layer in the MS

The states of the physical layer in the network are not specified. The states in the network will reflect the other characteristics of operation on channels.

5.2 Control procedures

Requirements and examples of procedures for idle mode and for packet mode operation of the MS are specified in 3GPP TS 22.011 and 45.008. In the idle mode and packet mode procedures the physical layer tracks the best cell and may tune on their BCCH/PBCCH/EC-BCCH in order to enable layer 3 to read the system information of the BCCH/PBCCH/EC-BCCH. This system information of the BCCH/PBCCH/EC-BCCH is used in the selection process.

5.3 Physical layer interface procedures

Three types of primitives are defined for the communication between the physical layer and the data link layer both in the MS and the network. When a control channel, packet data physical channel (*A/Gb mode*), or a shared basic physical subchannel (*Iu mode*) is being established, a PH-CONNECT-INDICATION is offered to the data link layer or the RLC/MAC layer, the one which is applicable, on the corresponding SAP. On an established full duplex control channel (DCCHs) in both MS and network, on an established packet data physical channel (*A/Gb mode*), or a shared basic physical subchannel (*Iu mode*) or on the established BCCH/CCCH in the MS, physical blocks received correctly are offered on the corresponding SAP in PH-DATA-INDICATION primitives. On a full duplex control channel (DCCHs) or on the BCCH/CCCH in the network, the data link layer will offer physical blocks to be transmitted in PH-DATA-REQUEST primitives. On a packet data physical channel (*A/Gb mode*) or shared basic physical subchannel (*Iu mode*), the RLC/MAC layer will offer physical blocks to be transmitted in PH-DATA-REQUEST primitives.

In the MS in idle mode or in packet idle mode, random accesses on RACH, on PRACH or on EC-RACH can be offered in PH-RANDOM ACCESS-REQUEST primitives. The physical layer of the MS will perform a random access as soon as possible. The physical layer of the MS will confirm the data link layer or the RLC/MAC layer, the one which is applicable, the transmission of the random access attempt in a PH-RANDOM ACCESS-CONFIRM. This confirmation contains the absolute frame number in which the random access is transmitted. The physical layer of the BS offers correctly received random accesses to the data link layer or the RLC/MAC layer, the one which is applicable, in a PH-RANDOM ACCESS-INDICATION. This indication contains the absolute frame number in which the random access is received.

6 Physical layer protocol header

6.0 General

The physical layer implements a peer-to-peer protocol for the control of timing advance, power control and Repeated SACCH at the operation on dedicated physical channels (*A/Gb mode*) or dedicated basic physical subchannels (*Iu mode*), and further, for the control of timing advance at the operation on packet data physical channels (*A/Gb mode*) or shared basic physical subchannels (*Iu mode*). For this purpose a two octet physical header is defined on all blocks transferred via the SACCH, a logical channel always present on a dedicated physical channel (*A/Gb mode*) or dedicated basic physical subchannel (*Iu mode*). Further more, a 16 octet information field is defined on downlink blocks transferred via the PTCCH, a logical channel present on a packet data physical channel (*A/Gb mode*) or shared basic physical subchannel (*Iu mode*).

6.1 Physical layer protocol fields and procedures

Procedures for handling the ordered and actual power level fields are specified in 3GPP TS 45.005 and 45.008. The ordered MS power level field and the actual MS power level field are coded as the binary representation of the "power control level", see 3GPP TS 45.005.

Procedures for handling the ordered and actual timing advance fields are specified in 3GPP TS 45.010. The numbers corresponding to the timing advance steps in 3GPP TS 45.010 are included binary coded in the 7 bit or in case of GSM 400 8 bit ordered and actual timing advance fields of the physical layer header.

For all the bands except GSM 400, the values 0 to 63 are valid TA values. The bit pattern "1111111" indicates that the field does not contain a timing advance value. All other bit combinations (64 to 126 decimal) are reserved. For all bands except GSM 400 bit 8 is set to spare.

For GSM 400, the values 0 to 219 decimal are valid TA values. The bit pattern "11111111" indicates that the field does not contain a timing advance value. The remaining values 220 to 254 are reserved.

A MS in packet transfer mode (*A/Gb mode*) or MAC-shared state (*Iu mode*) which is assigned a TAI shall, when receiving a PTCCH downlink block on the packet data physical channel (*A/Gb mode*) or shared basic physical subchannel (*Iu mode*) containing PACCH, read the corresponding ordered timing advance field in that PTCCH block. The ordered timing advance fields corresponding to other TAIs than the assigned one shall be ignored.

Procedures for handling the FPC_EPC (Fast Power Control/Enhanced Power Control) field (bit 6 of octet 1 in the SACCH downlink block) are specified in 3GPP TS 45.008 and 3GPP TS 48.058. The FPC_EPC field has different interpretation depending on the channel mode of the channel to which the SACCH is associated, and whether that channel is in EPC mode..

If the channel mode is such that FPC may be used, the FPC_EPC field indicates whether Fast Measurement Reporting and Power Control mechanism is used. It is coded as follows:

Value:

- 0 Fast Power Control not in use,
- 1 Fast Power Control in use.

If the channel is in EPC mode, the FPC_EPC field indicates whether EPC procedures are used for MS (uplink) power control. It is coded as follows:

Value:

- 0 EPC not in use for MS power control,
- 1 EPC in use for MS power control.

If the channel mode is such that FPC may not be used and the channel is not in EPC mode, the MS shall ignore the value of the FPC_EPC field.

Procedures for handling the SRO (SACCH Repetition Order) and the SRR (SACCH Repetition Request) fields are specified in 3GPP TS 44.006. They are coded as follows:

Value:

- 0 Repeated SACCH not required
- 1 Repeated SACCH required

7 Block transmission

7.0 General

The format of the blocks transmitted on the physical interface depends on the mode (*A/Gb* or *Iu mode*) in which the MS is connected to the network, as specified in this section.

7.1 SACCH downlink block format

7.1.1 *A/Gb mode*

The 23 octets of SACCH blocks are used in the downlink in the following way:

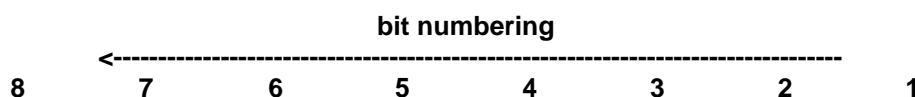

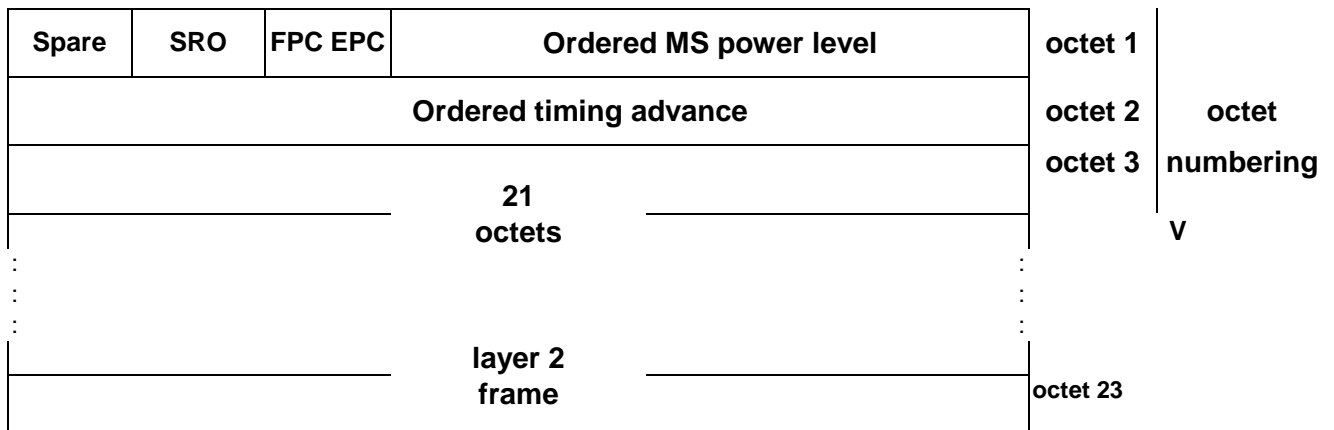

NOTE: The numbering convention specified in 3GPP TS 44.006 applies.

Figure 7.1.1: SACCH downlink block format for MS operating in *A/Gb mode*

7.1.2 *lu mode*

The 23 octets of SACCH blocks are used in the downlink in the following way:

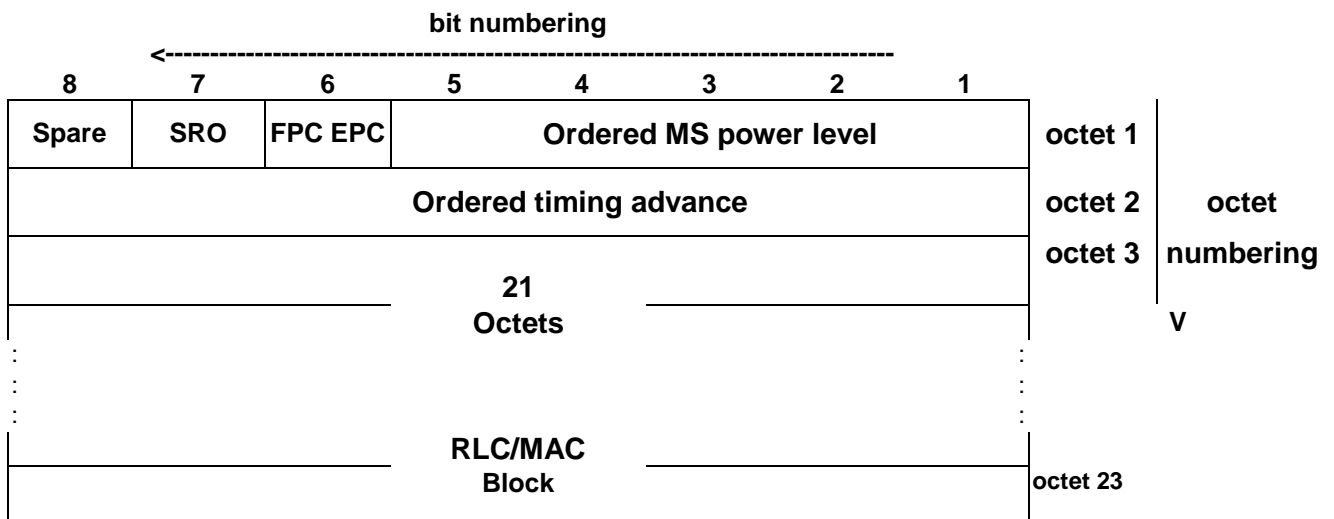

NOTE: The numbering convention specified in 3GPP TS 44.060 applies.

Figure 7.1.2: SACCH downlink block format for MS operating in *lu mode*

7.2 SACCH uplink block format

7.2.1 A/Gb mode

The 23 octets of SACCH blocks are used in the uplink in the following way:

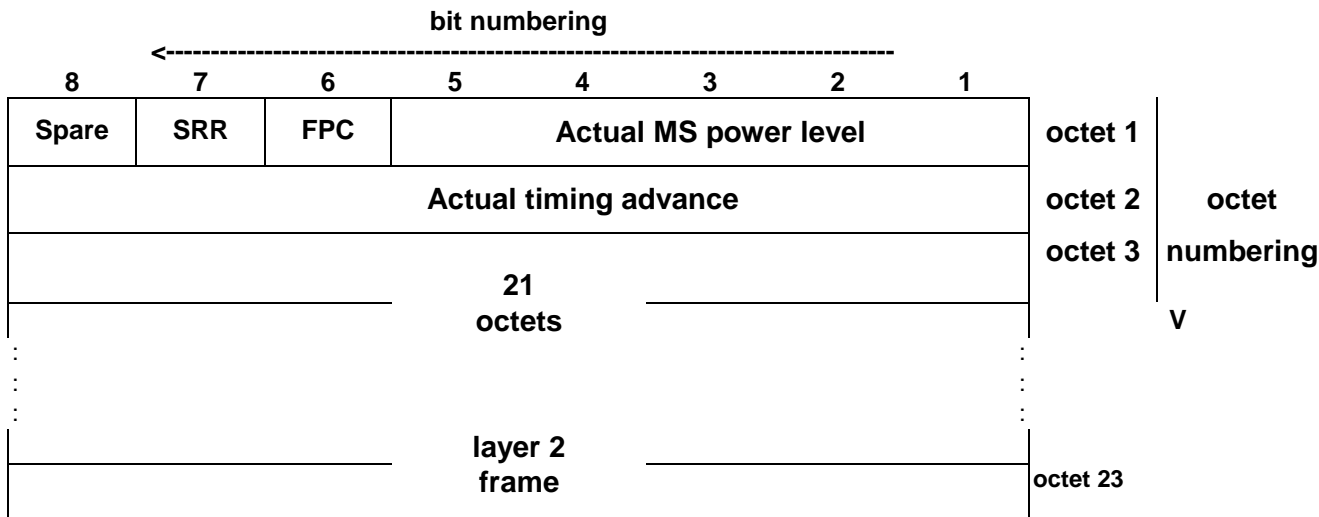

NOTE: The numbering convention specified in 3GPP TS 44.006 applies.

Figure 7.2.1: SACCH uplink block format for MS operating in A/Gb mode

7.2.2 lu mode

The 23 octets of SACCH blocks are used in the uplink in the following way:

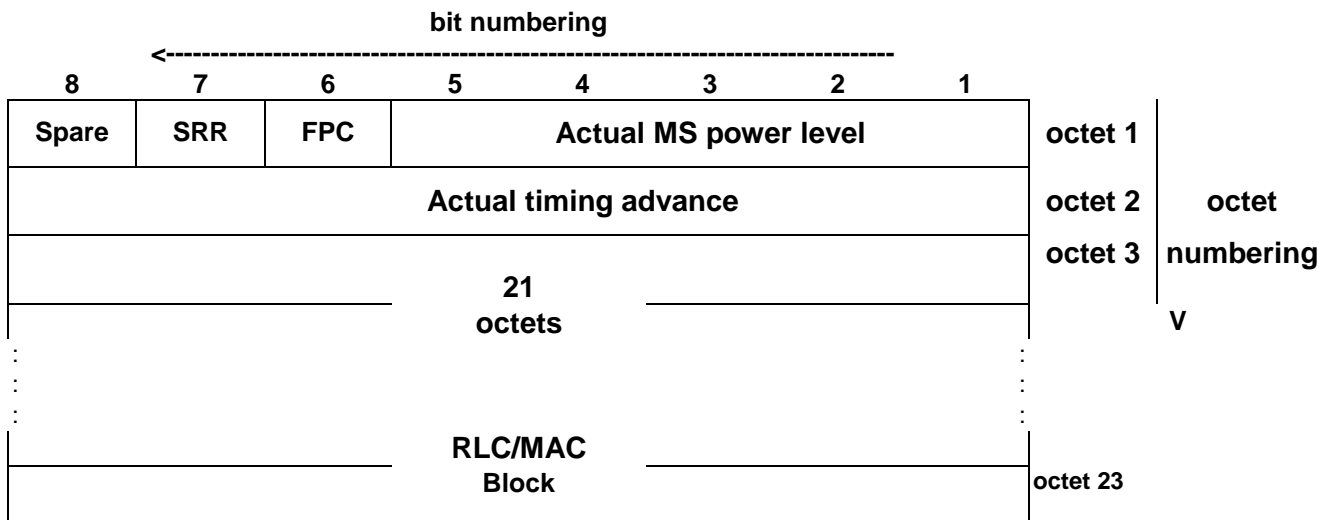

NOTE: The numbering convention specified in 3GPP TS 44.060 applies.

Figure 7.2.2: SACCH uplink block format for MS operating in lu mode

7.3 FACCH/SDCCH/CCCH/BCCH/CBCH downlink block format

7.3.1 CCCH/BCCH/CBCH downlink block format

The 23 octets blocks are used in the downlink in the following way:

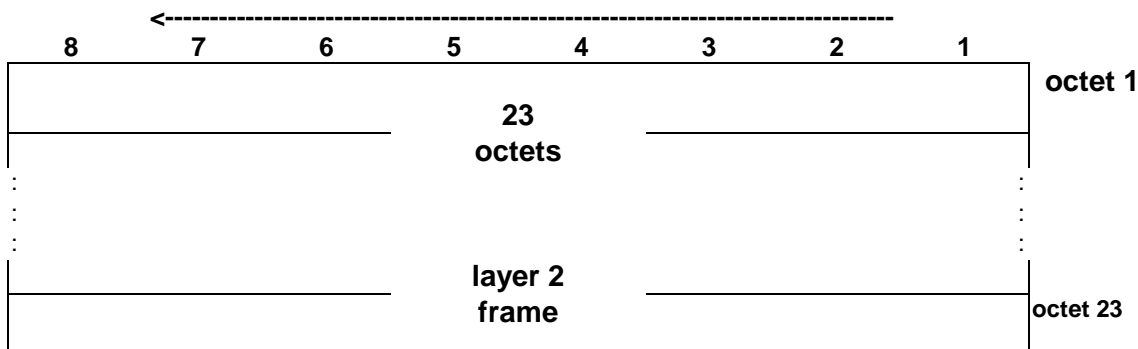

NOTE: The numbering convention specified in 3GPP TS 44.006 and 44.012 applies.

Figure 7.3.1: BCCH/CCCH/CBCH downlink block format

7.3.2 FACCH/SDCCH downlink block format

7.3.2.1 A/Gb mode

The 23 octets blocks are used in the downlink in the following way:

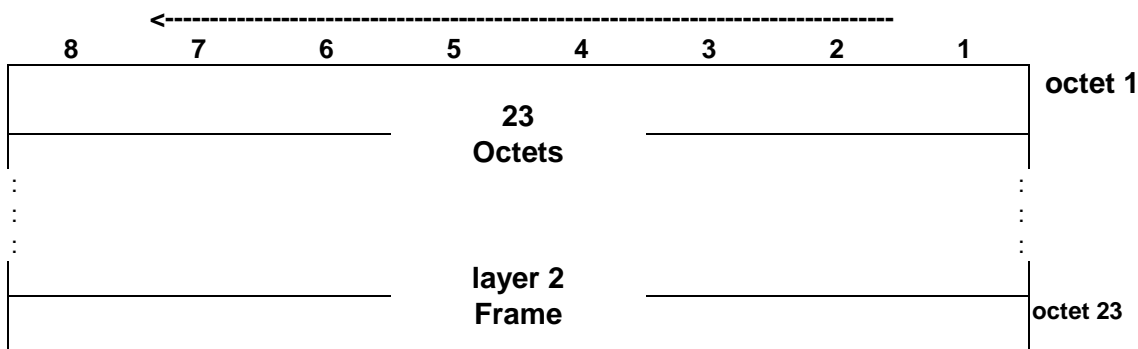

NOTE: The numbering convention specified in 3GPP TS 44.006 and 3GPP TS 44.012 applies.

Figure 7.3.2.1: FACCH/SDCCH downlink block format for MS operating in A/Gb mode

7.3.2.2 lu mode

The 23 octets blocks are used in the downlink in the following way:

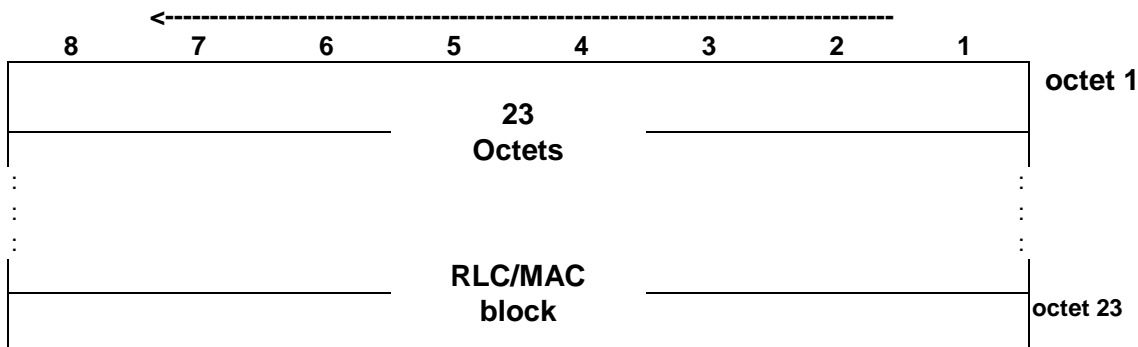

NOTE: The numbering convention specified in 3GPP TS 44.060 applies.

Figure 7.3.2.2: FACCH/SDCCH downlink block format for MS operating in lu mode

7.4 FACCH/SDCCH uplink block format

7.4.1 A/Gb mode

The 23 octets blocks are used in the uplink in the following way:

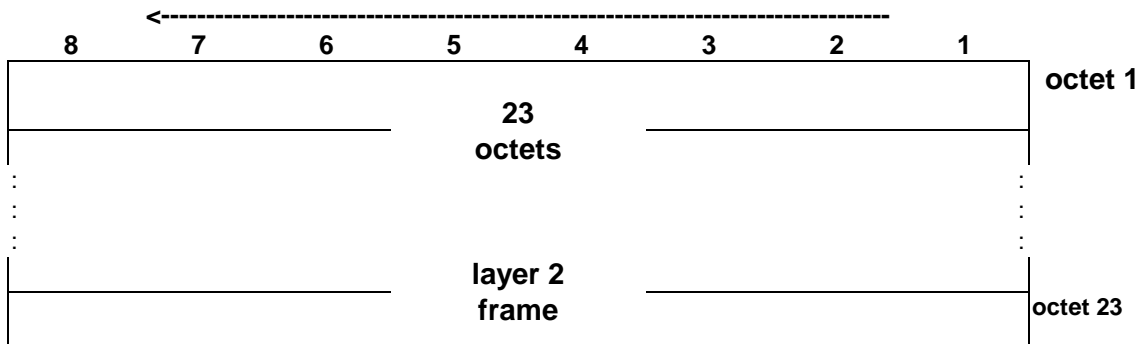

NOTE: The numbering convention specified in 3GPP TS 44.006 applies.

Figure 7.4.1: FACCH/SDCCH uplink block format for MS operating in A/Gb mode

7.4.2 lu mode

The 23 octets blocks are used in the uplink in the following way:

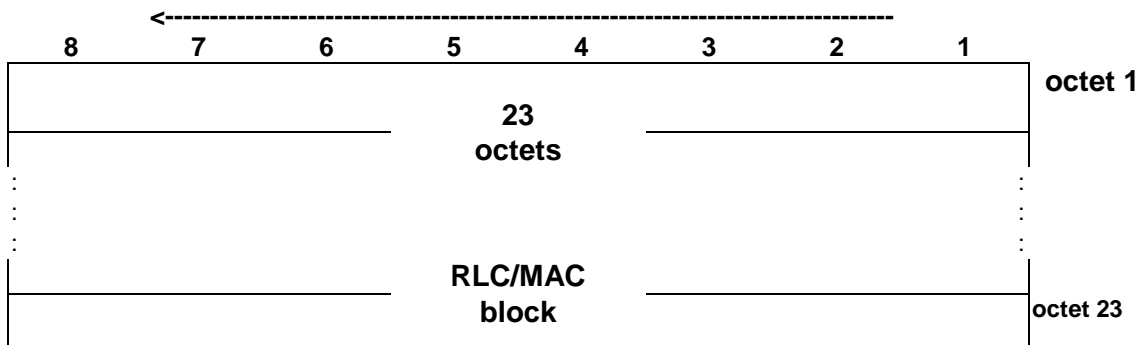

NOTE: The numbering convention specified in 3GPP TS 44.060 applies.

Figure 7.4.2: FACCH/SDCCH uplink block format for MS operating in lu mode

7.4a RACH uplink / Uplink access burst block format

Two alternative RACH uplink / Uplink access burst block formats are specified. The 8 bit (1 octet) blocks are used in the uplink in the following way:

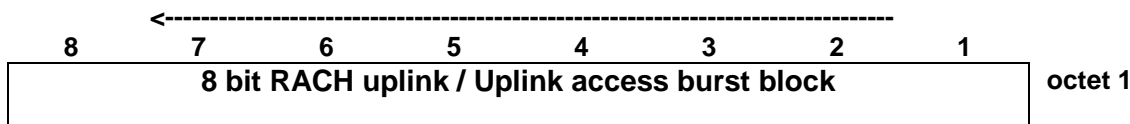

NOTE: The numbering convention specified in 3GPP TS 44.018 applies.

Figure 7.4a.a: 8 bit RACH uplink / Uplink access burst block format

The 11 bit blocks are used in the uplink in the following way:



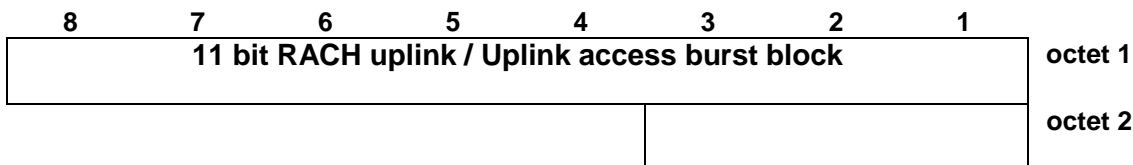

NOTE: The numbering convention specified in 3GPP TS 44.060 applies.

Figure 7.4a.b: 11 bit RACH uplink / Uplink access burst block format

7.5 PBCCH/PCCCH downlink/PACCH block format

The 184 bit (23 octets) blocks, or 187 bit blocks in case an eTFI is included in a downlink PACCH block, are used in the following way:

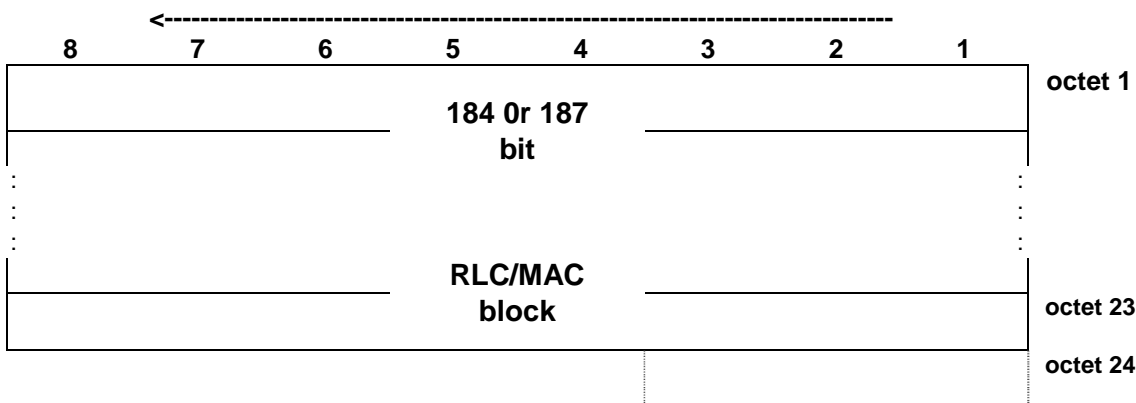

NOTE: The numbering convention specified in 3GPP TS 44.060 applies.

Figure 7.5: PBCCH/PCCCH downlink/PACCH blockformat

Messages transmitted on the downlink PACCH may use an alternative block format. This format applies to RTTI configuration, for messages encoded using MCS-0 (see 3GPP TS 44.060). In this case, the 207 bit blocks, or 210 bit blocks in case an eTFI is included in a downlink PACCH block, are used in the downlink in the following way:

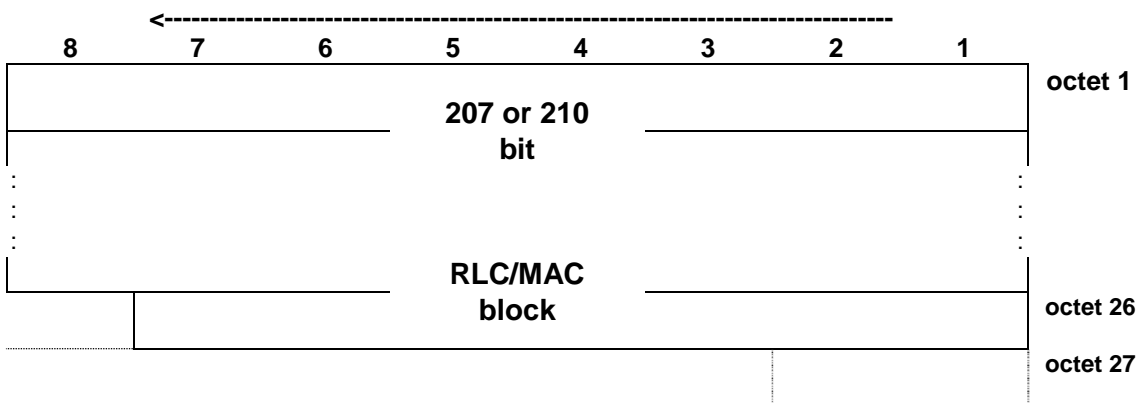

NOTE: The numbering convention specified in 3GPP TS 44.060 applies.

Figure 7.5a: PACCH downlink block format for MCS-0

EGPRS Packet Downlink Ack/Nack DLMC messages transmitted on the uplink PACCH may use CS-3 as an alternative block format when commanded by the network for a DLMC configuration (see 3GPP TS 44.060). In this case, the 315 bit blocks are used in the uplink in following way:

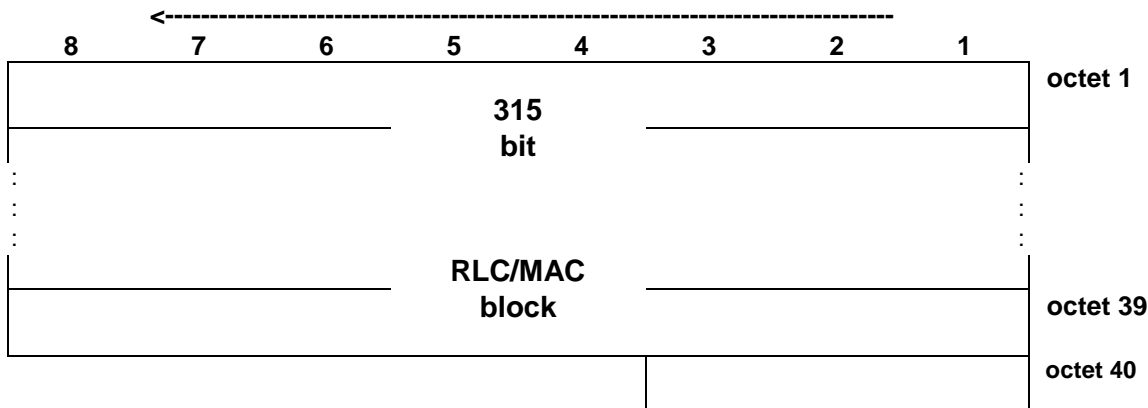

NOTE: The numbering convention specified in 3GPP TS 44.060 applies.

Figure 7.5b: PACCH uplink block format for CS-3

7.6 PDTCH block formats

Unless explicitly stated otherwise, the block formats shown hereafter are valid for both uplink and downlink directions.

7.6.1 PDTCH block type 1 (CS-1) format

The 184 bit (23 octets) blocks are used in the following way:

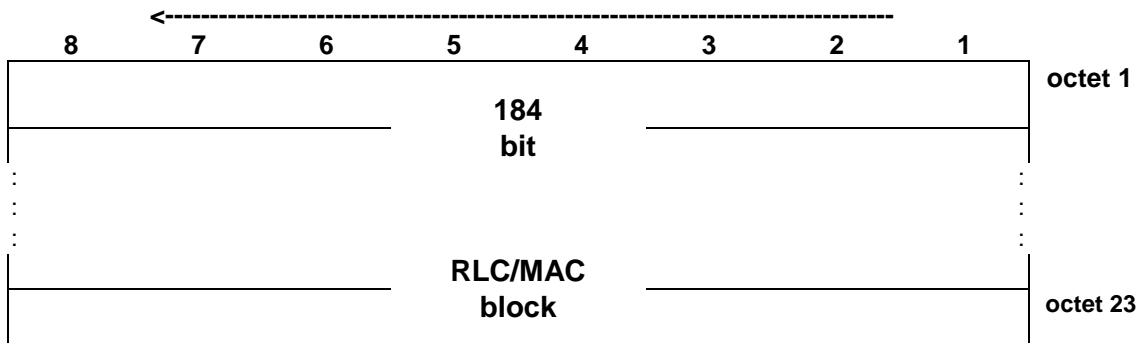

NOTE: The numbering convention specified in 3GPP TS 44.060 applies.

Figure 7.6.1: PDTCH block type 1 (CS-1) format

7.6.2 PDTCH block type 2 (CS-2) format

The 271 bit blocks are used in the following way:

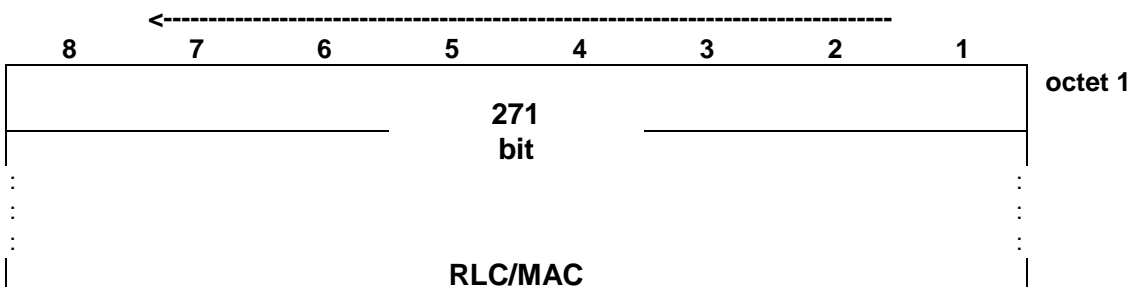



NOTE: The numbering convention specified in 3GPP TS 44.060 applies.

Figure 7.6.2: PDTCH block type 2 (CS-2) format

7.6.3 PDTCH block type 3 (CS-3) format

The 315 bit blocks are used in the following way:

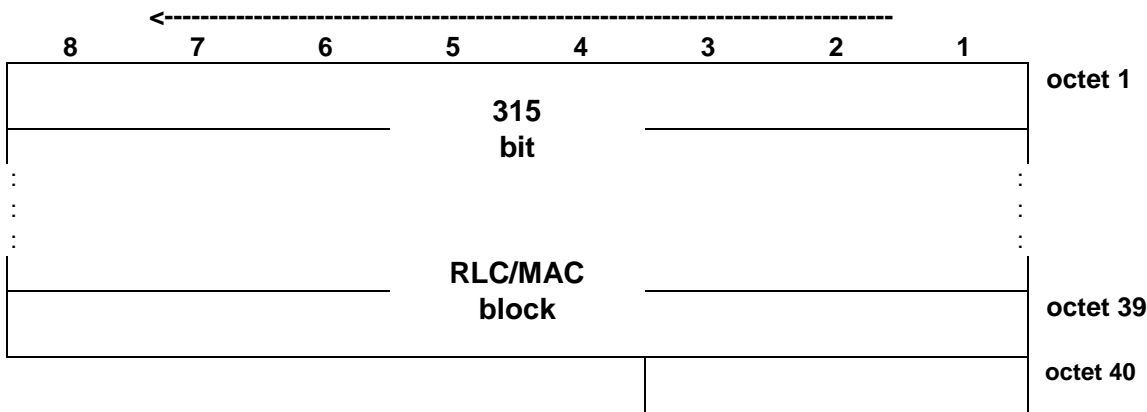

NOTE: The numbering convention specified in 3GPP TS 44.060 applies.

Figure 7.6.3: PDTCH block type 3 (CS-3) format

7.6.4 PDTCH block type 4 (CS-4) format

The 431 bit blocks are used in the following way:

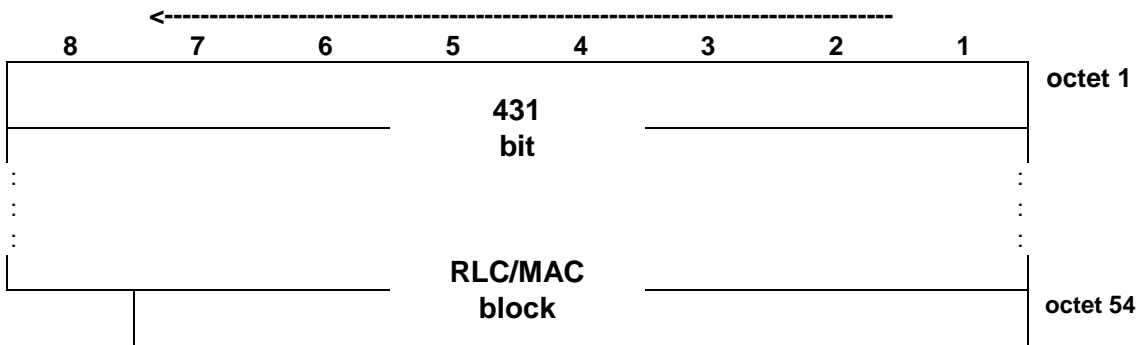

NOTE: The numbering convention specified in 3GPP TS 44.060 applies.

Figure 7.6.4: PDTCH block type 4 (CS-4) format

7.6.5 PDTCH block type 5 (MCS-1) format

The 209 bit blocks, or in case an eTFI is included in a downlink block, 212 bit blocks, or in case a PAN is included, 234 bit blocks, or in case both a PAN and an eTFI are included, 237 bit blocks, are used in the following way:

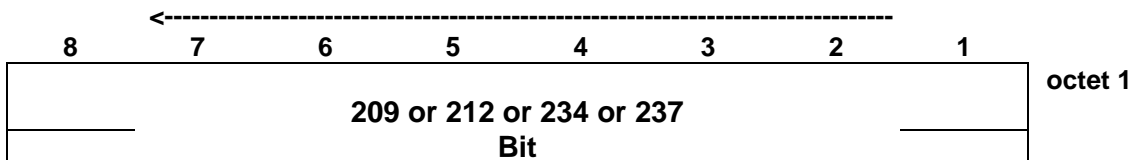

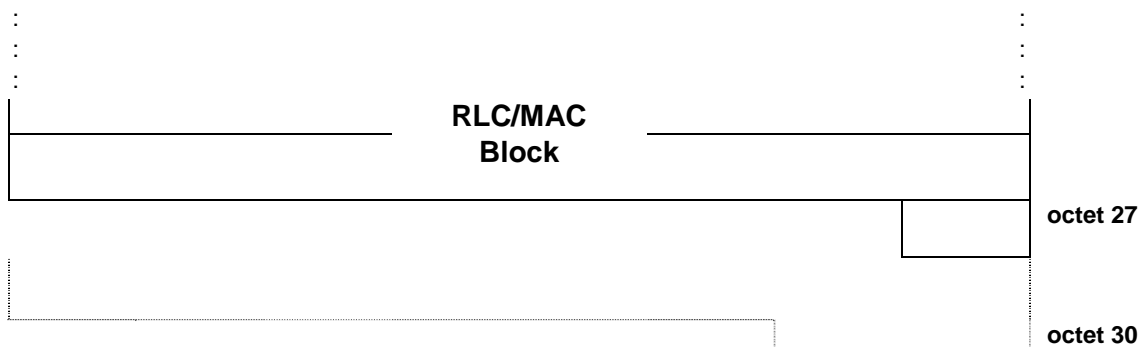

NOTE: The numbering convention specified in 3GPP TS 44.060 applies.

Figure 7.6.5: PDTCH block type 5 (MCS-1) format

7.6.6 PDTCH block type 6 (MCS-2) format

The 257 bit blocks, or in case an eTFI is included in a downlink block, 260 bit blocks, or in case a PAN is included, 282 bit blocks, or in case both a PAN and an eTFI are included, 285 bit blocks, are used in the following way:

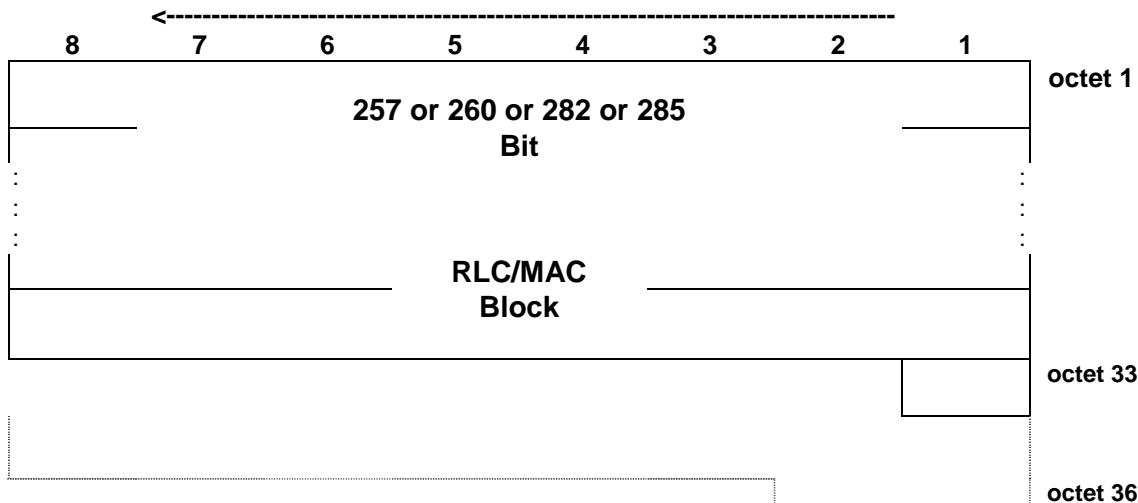

NOTE: The numbering convention specified in 3GPP TS 44.060 applies.

Figure 7.6.6: PDTCH block type 6 (MCS-2) format

7.6.7 PDTCH block type 7 (MCS-3) format

The 329 bit blocks, or in case an eTFI is included in a downlink block, 332 bit blocks or in case a PAN is included, 354 bit blocks, or in case both a PAN and an eTFI are included, 357 bit blocks, are used in the following way:

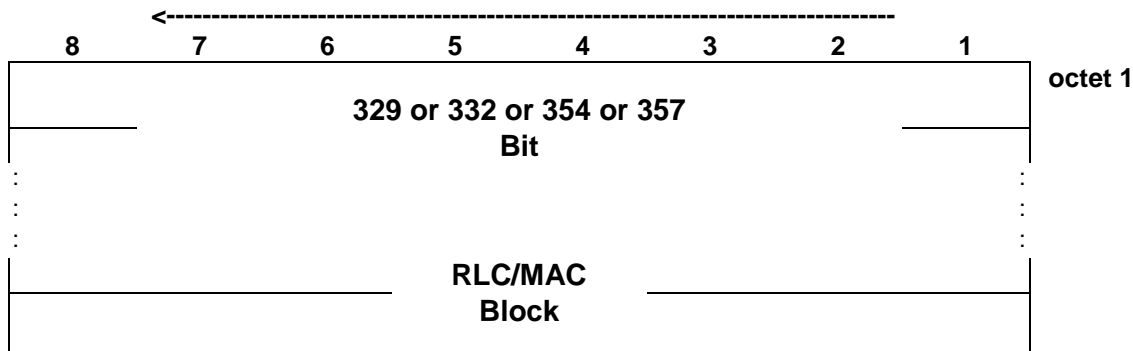

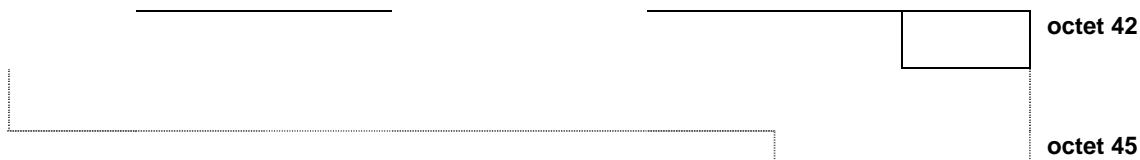

NOTE: The numbering convention specified in 3GPP TS 44.060 applies.

Figure 7.6.7: PDTCH block type 7 (MCS-3) format

7.6.8 PDTCH block type 8 (MCS-4) format

The 385 bit blocks , or in case an eTFI is included in a downlink block, 388 bit blocks are used in the following way:

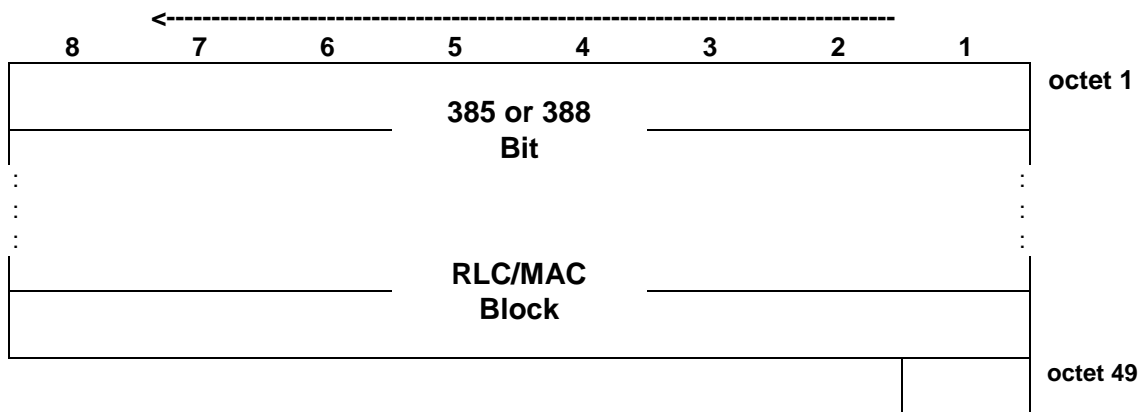

NOTE: The numbering convention specified in 3GPP TS 44.060 applies.

Figure 7.6.8: PDTCH block type 8 (MCS-4) format

7.6.9 PDTCH block type 9 (MCS-5) format

7.6.9.1 Uplink

The 487 bit blocks, or in case a PAN is included, 512 bit blocks, or in case both a PAN and an eTFI are included, 515 bit blocks, are used in the following way:

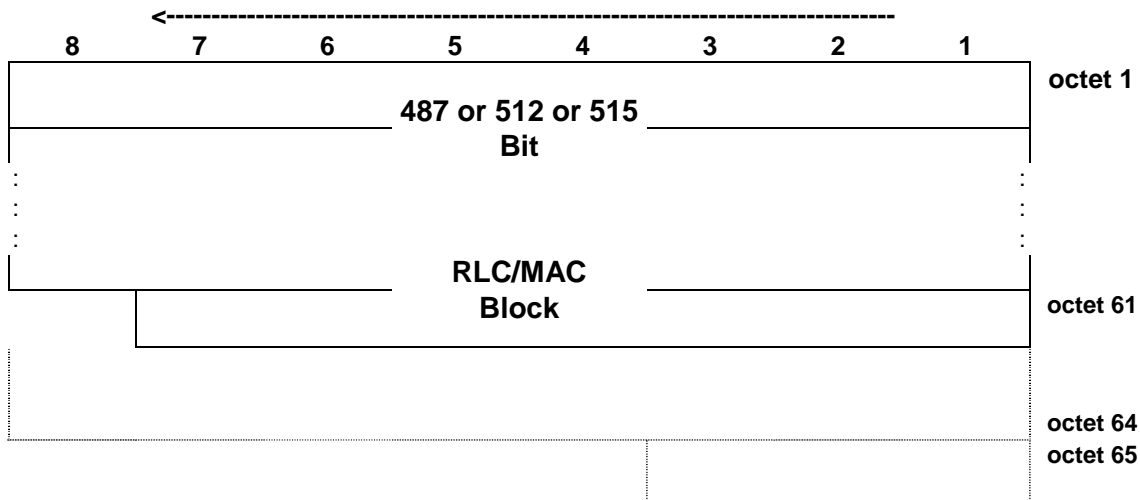

NOTE: The numbering convention specified in 3GPP TS 44.060 applies.

Figure 7.6.9.1: PDTCH block type 9 (MCS-5) uplink format

7.6.9.2 Downlink

The 478 bit blocks, or in case an eTFI is included, 481 bit blocks, or in case a PAN is included, 503 bit blocks, or in case both a PAN and an eTFI are included, 506 bit blocks, are used in the following way:

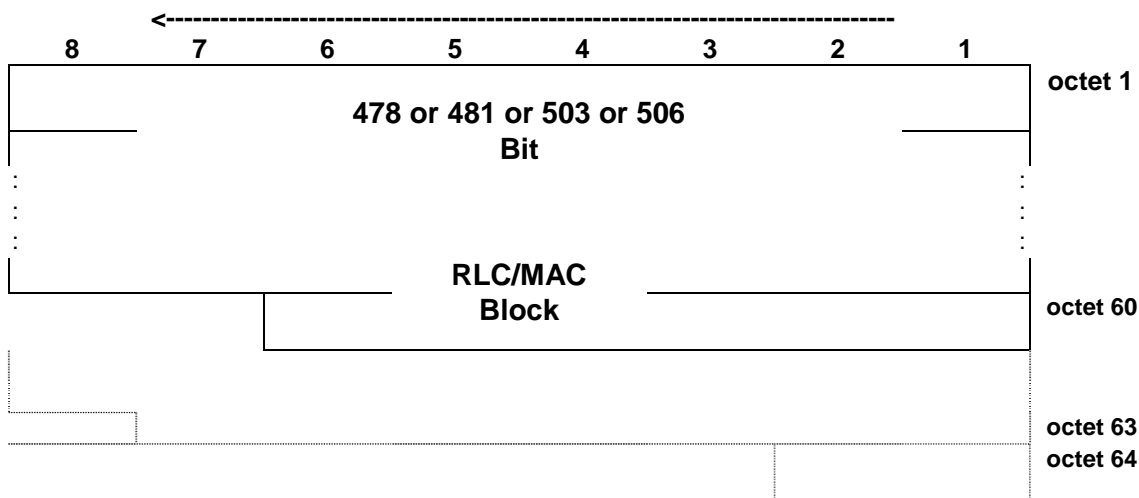

NOTE: The numbering convention specified in 3GPP TS 44.060 applies.

Figure 7.6.9.2: PDTCH block type 9 (MCS-5) downlink format

7.6.10 PDTCH block type 10 (MCS-6) format

7.6.10.1 Uplink

The 631 bit blocks, or in case a PAN is included, 656 bit blocks, or in case both a PAN and an eTFI are included, 659 bit blocks, are used in the following way:

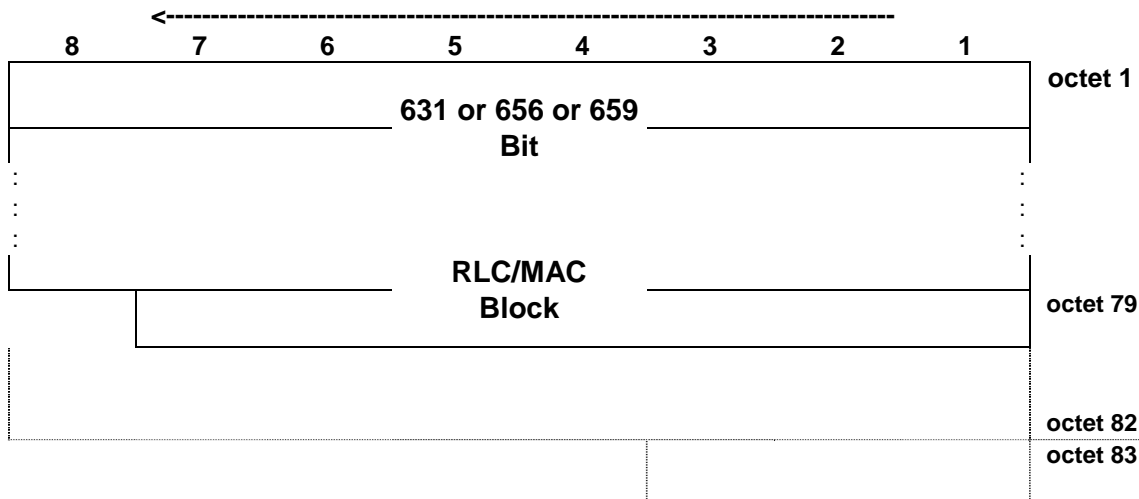

NOTE: The numbering convention specified in 3GPP TS 44.060 applies.

Figure 7.6.10.1: PDTCH block type 10 (MCS-6) uplink format

7.6.10.2 Downlink

The 622 bit blocks, or in case an eTFI is included, 625 bit blocks, or in case a PAN is included, 647 bit blocks, or in case both a PAN and an eTFI are included, 650 bit blocks, are used in the following way:

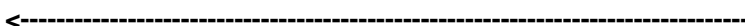

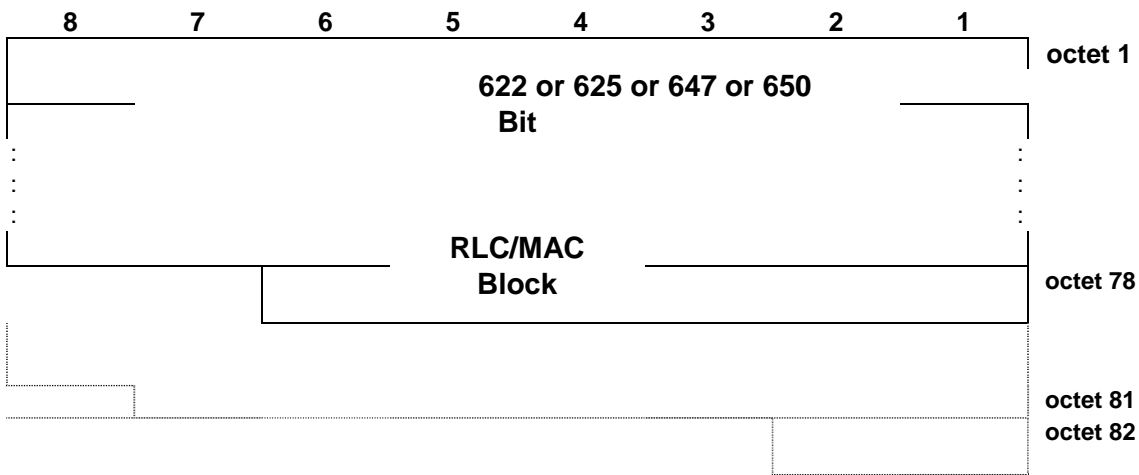

NOTE: The numbering convention specified in 3GPP TS 44.060 applies.

Figure 7.6.10.2: PDTCH block type 10 (MCS-6) downlink format

7.6.11 PDTCH block type 11 (MCS-7) format

7.6.11.1 Uplink

The 946 bit blocks, or in case both a PAN and an eTFI are included, 974 bit blocks, or in case a PAN is included, 971 bit blocks, are used in the following way:

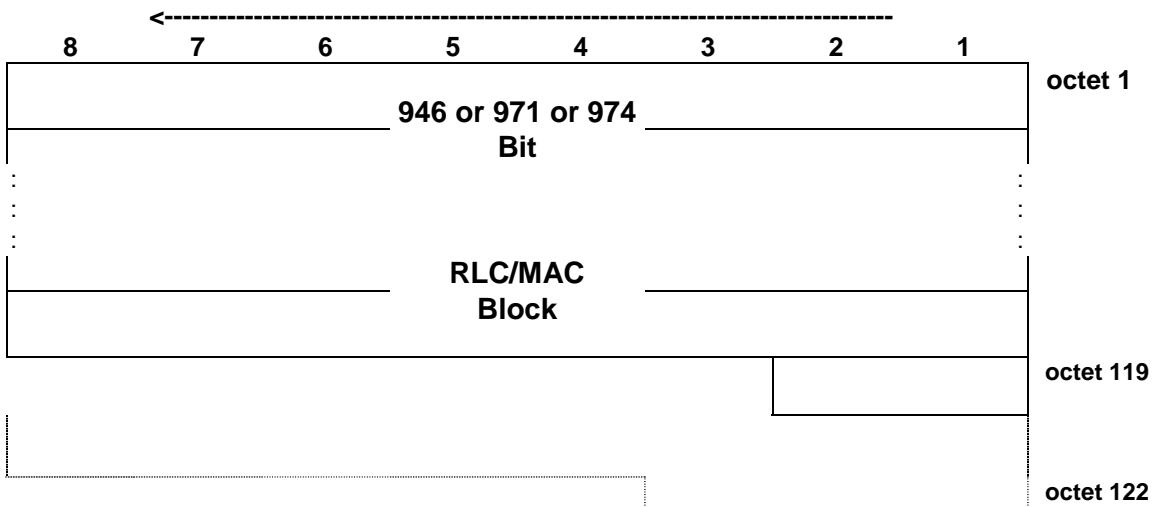

NOTE: The numbering convention specified in 3GPP TS 44.060 applies.

Figure 7.6.11.1: PDTCH block type 11(MCS-7) uplink format

7.6.11.2 Downlink

The 940 bit blocks, or in case an eTFI is included, 943 bit blocks, or in case a PAN is included, 965 bit blocks, or in case both a PAN and an eTFI are included, 968 bit blocks, are used in the following way:

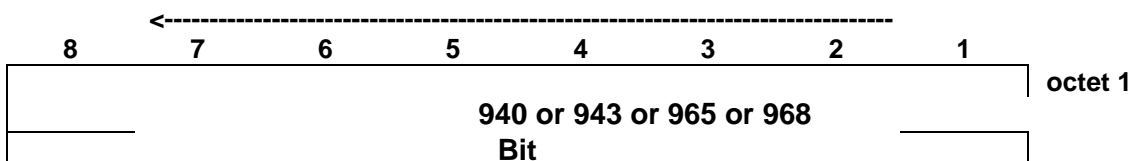

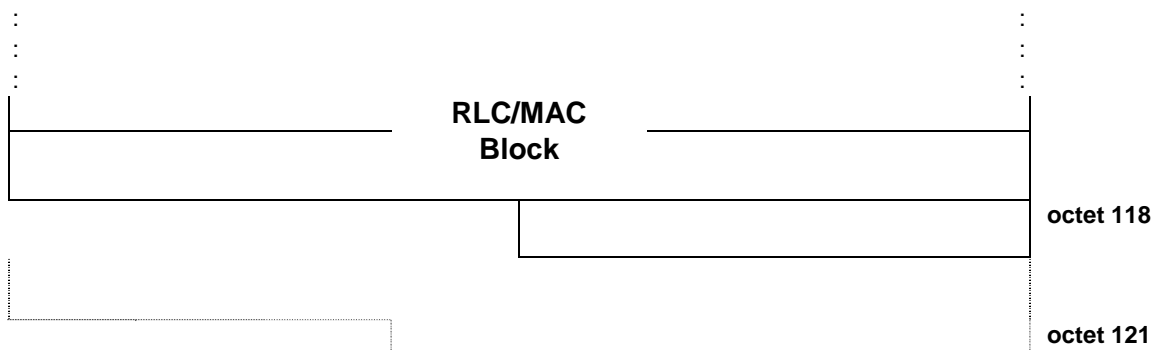

NOTE: The numbering convention specified in 3GPP TS 44.060 applies.

Figure 7.6.11.2: PDTCH block type 11 (MCS-7) downlink format

7.6.12 PDTCH block type 12 (MCS-8) format

7.6.12.1 Uplink

The 1138 bit blocks, or in case both a PAN and an eTFI are included, 1166 bit blocks, or in case a PAN is included, 1163 bit blocks, are used in the following way:

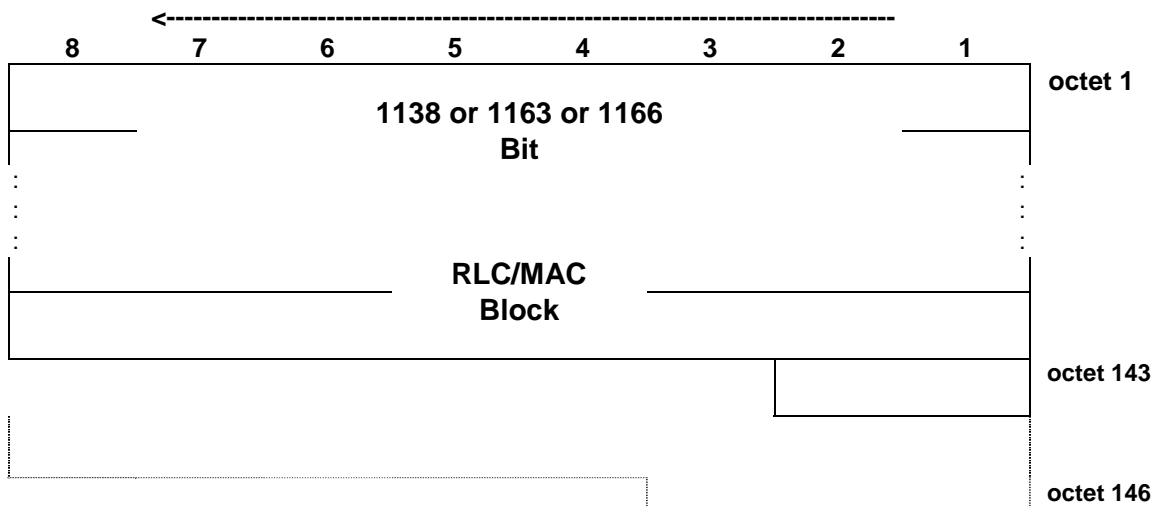

NOTE: The numbering convention specified in 3GPP TS 44.060 applies.

Figure 7.6.12.1: PDTCH block type 12 (MCS-8) uplink format

7.6.12.2 Downlink

The 1132 bit blocks, or in case an eTFI is included, 1135 bit blocks, or in case a PAN is included, 1157 bit blocks, or in case both a PAN and an eTFI are included, 1160 bit blocks, are used in the following way:

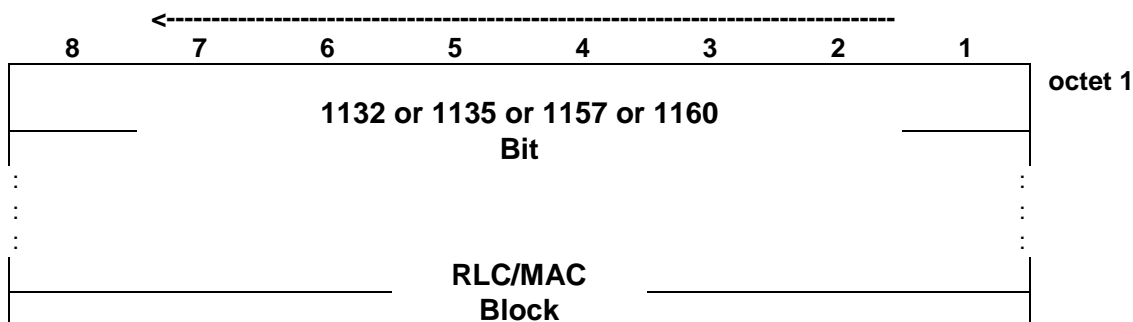

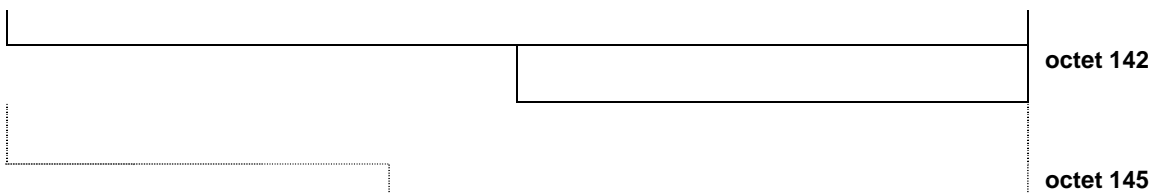

NOTE: The numbering convention specified in 3GPP TS 44.060 applies.

Figure 7.6.12.2: PDTCH block type 12 (MCS-8) downlink format

7.6.13 PDTCH block type 13 (MCS-9) format

7.6.13.1 Uplink

The 1234 bit blocks are used in the following way:

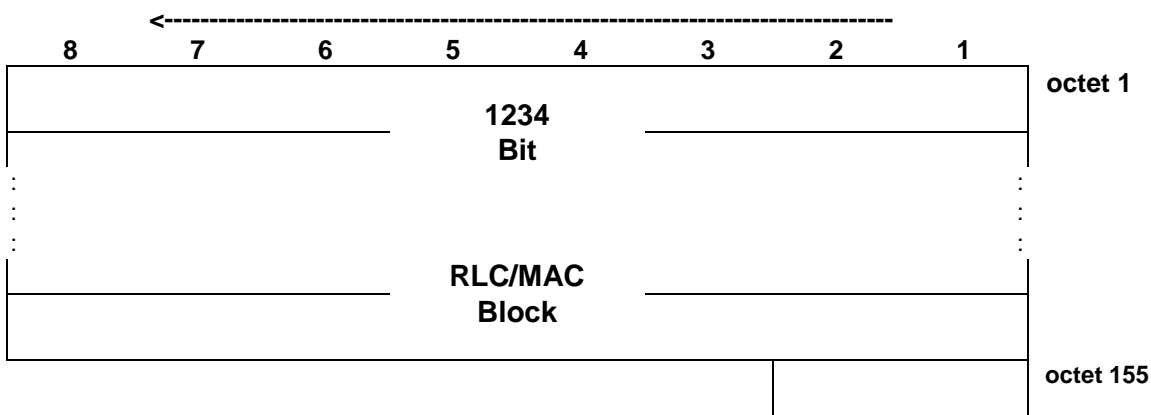

NOTE: The numbering convention specified in 3GPP TS 44.060 applies.

Figure 7.6.13.1: PDTCH block type 13 (MCS-9) uplink format

7.6.13.2 Downlink

The 1228 bit blocks, or in case an eTFI is included, 1231 bit blocks, are used in the following way:

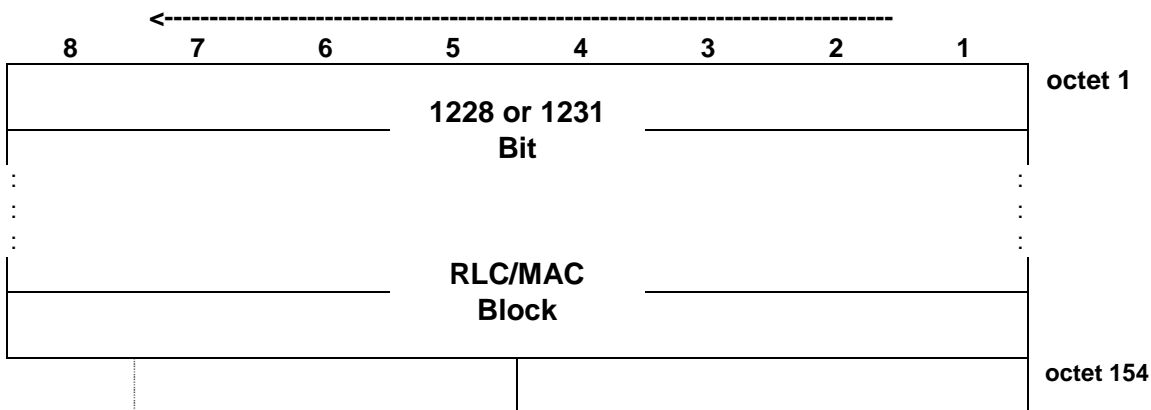

NOTE: The numbering convention specified in 3GPP TS 44.060 applies.

Figure 7.6.13.2: PDTCH block type 13 (MCS-9) downlink format

7.6.14 PDTCH block type 14 (UAS-7) format (uplink only)

The blocks of 941 bits, or in case a PAN is included, 966 bits, or in case both a PAN and an eTFI are included, 969 bits, are used in the following way:

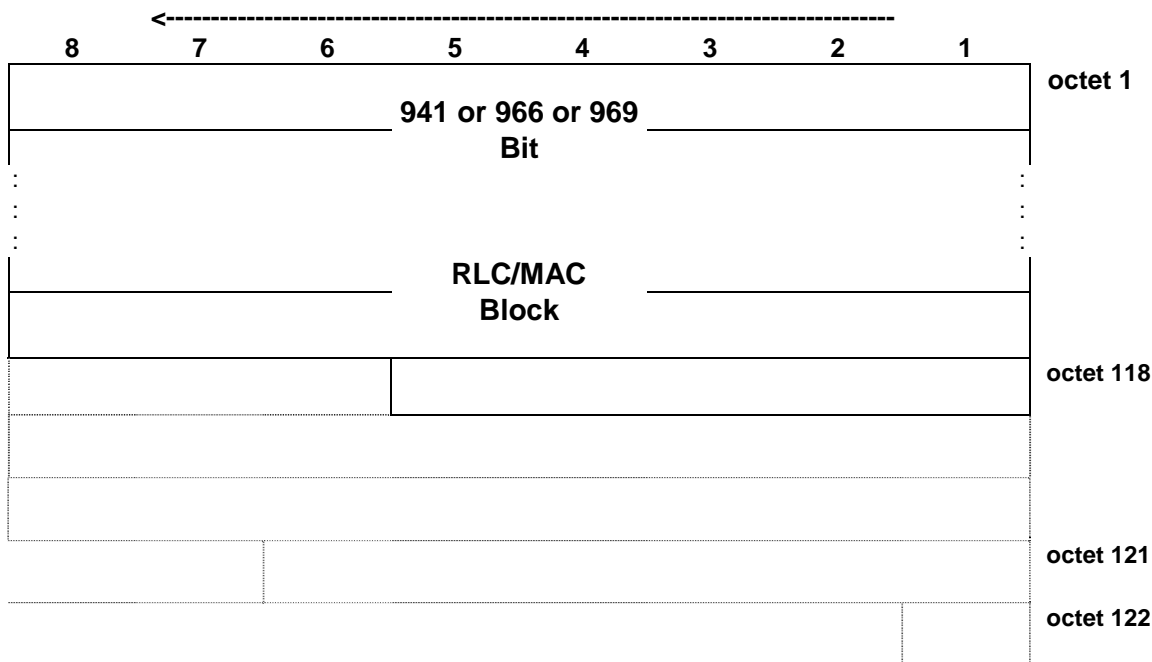

NOTE: The numbering convention specified in 3GPP TS 44.060 applies.

Figure 7.6.14.1: PDTCH block type 14 (UAS-7) format

7.6.15 PDTCH block type 15 (UAS-8) format (uplink only)

The blocks of 1069 bits, or in case a PAN is included, 1094 bits, or in case both a PAN and an eTFI are included, 1097 bits, are used in the following way:

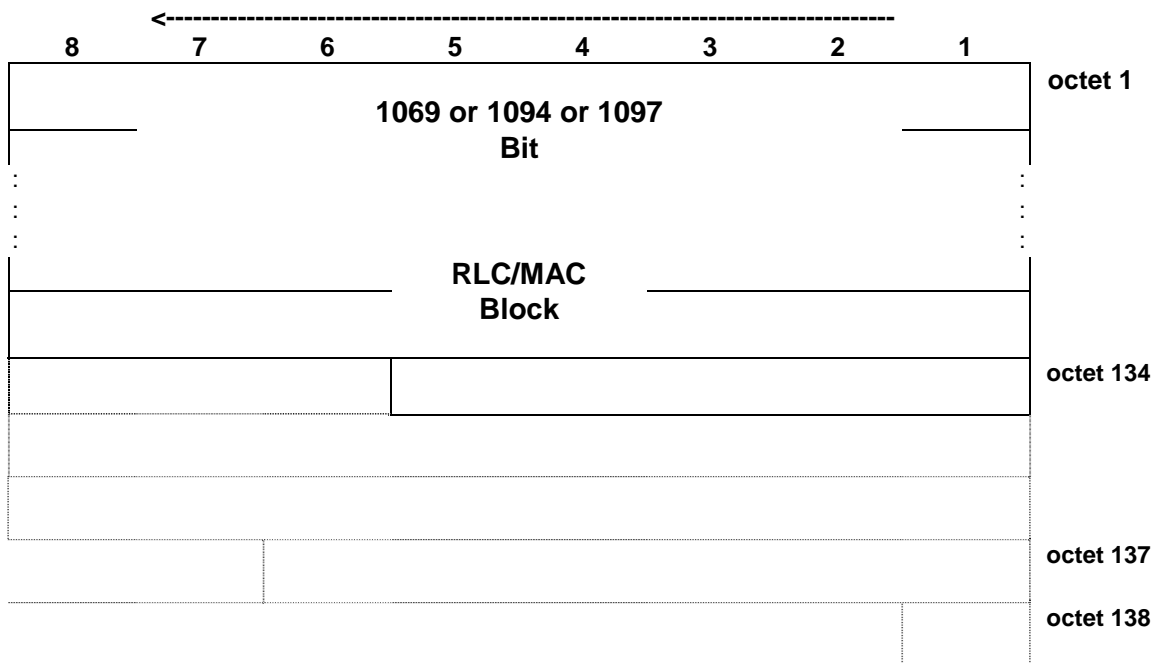

NOTE: The numbering convention specified in 3GPP TS 44.060 applies.

Figure 7.6.15.1: PDTCH block type 15 (UAS-8) format

7.6.16 PDTCH block type 16 (UAS-9) format (uplink only)

The blocks of 1229 bits, or in case a PAN is included, 1254 bits, or in case both a PAN and an eTFI are included, 1257 bits, are used in the following way:

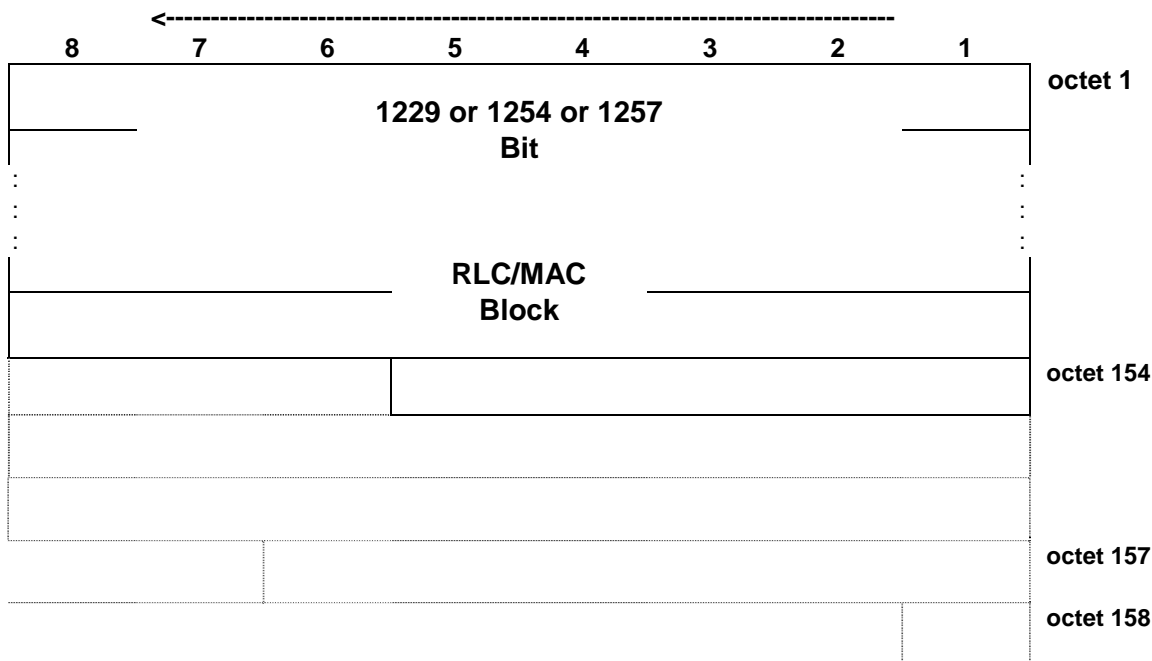

NOTE: The numbering convention specified in 3GPP TS 44.060 applies.

Figure 7.6.16.1: PDTCH block type 16 (UAS-9) format

7.6.17 PDTCH block type 17 (UAS-10) format (uplink only)

The blocks of 1402 bits, or in case a PAN is included, 1427 bits, or in case both a PAN and an eTFI are included, 1430 bits, are used in the following way:

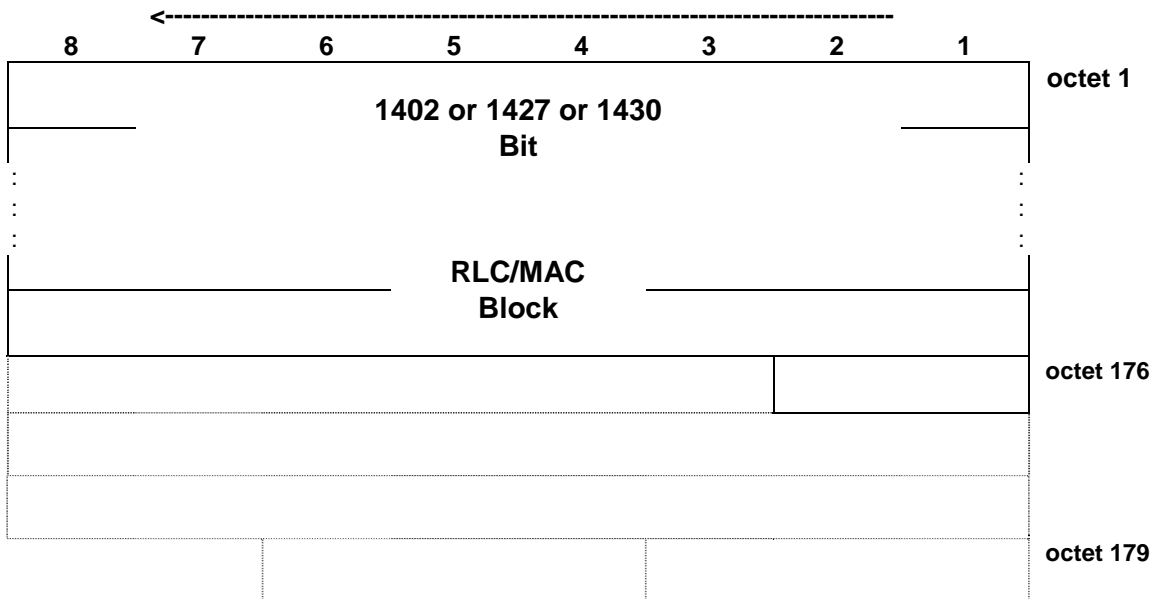

NOTE: The numbering convention specified in 3GPP TS 44.060 applies.

Figure 7.6.17.1: PDTCH block type 17 (UAS-10) format

7.6.18 PDTCH block type 18 (UAS-11) format (uplink only)

The blocks of 1594 bits, or in case a PAN is included, 1619 bits, or in case both a PAN and an eTFI are included, 1622 bits, are used in the following way:

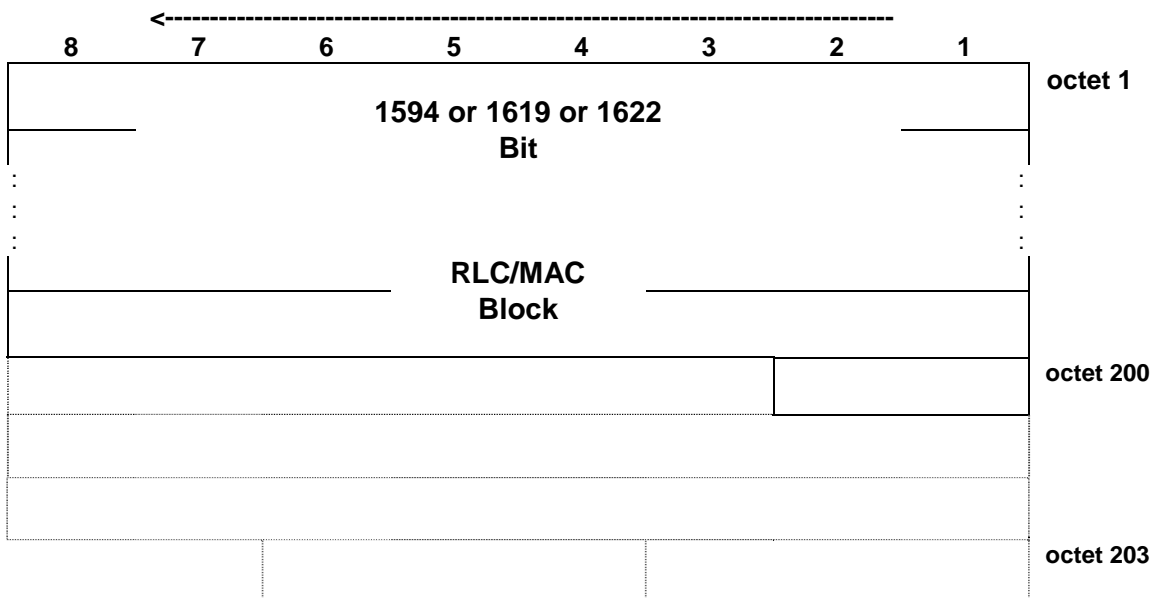

NOTE: The numbering convention specified in 3GPP TS 44.060 applies.

Figure 7.6.18.1: PDTCH block type 18 (UAS-11) format

7.6.19 PDTCH block type 19 (UBS-5) format (uplink only)

The blocks of 479 bits, or in case a PAN is included, 504 bits, are used in the following way:

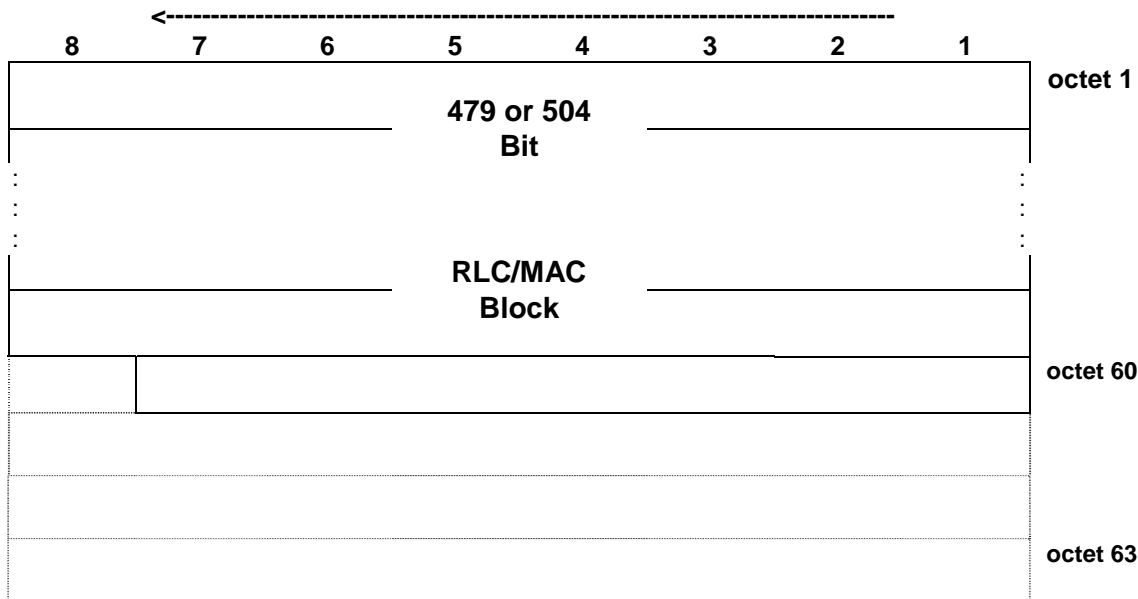

NOTE: The numbering convention specified in 3GPP TS 44.060 applies.

Figure 7.6.19.1: PDTCH block type 19 (UBS-5) format

7.6.20 PDTCH block type 20 (UBS-6) format (uplink only)

The blocks of 623 bits, or in case a PAN is included, 648 bits, are used in the following way:

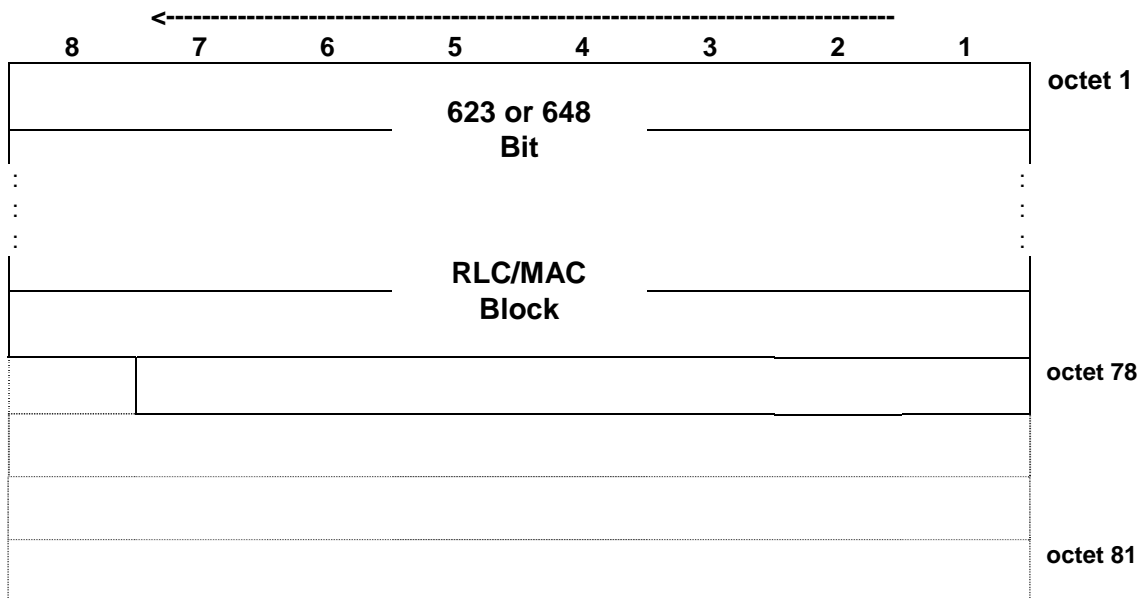

NOTE: The numbering convention specified in 3GPP TS 44.060 applies.

Figure 7.6.20.1: PDTCH block type 20 (UBS-6) format

7.6.21 PDTCH block type 21 (UBS-7) format (uplink only)

The blocks of 940 bits, or in case a PAN is included, 965 bits, are used in the following way:

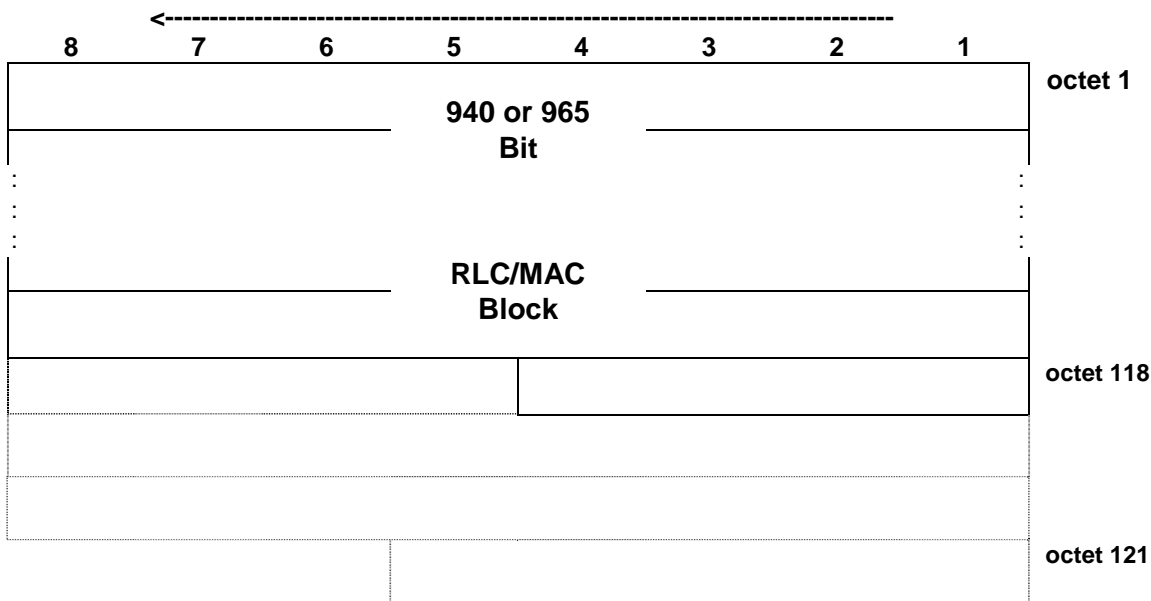

NOTE: The numbering convention specified in 3GPP TS 44.060 applies.

Figure 7.6.21.1: PDTCH block type 21 (UBS-7) format

7.6.22 PDTCH block type 22 (UBS-8) format (uplink only)

The blocks of 1228 bits, or in case a PAN is included, 1253 bits, are used in the following way:

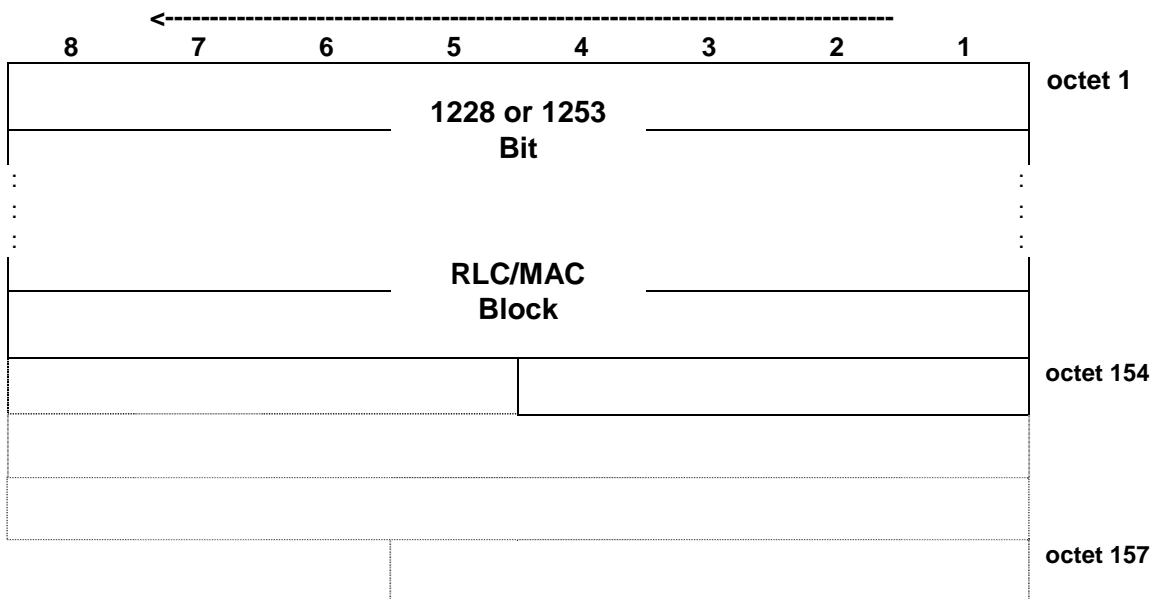

NOTE: The numbering convention specified in 3GPP TS 44.060 applies.

Figure 7.6.22.1: PDTCH block type 22 (UBS-8) format

7.6.23 PDTCH block type 23 (UBS-9) format (uplink only)

The blocks of 1402 bits, or in case a PAN is included, 1427 bits, are used in the following way:

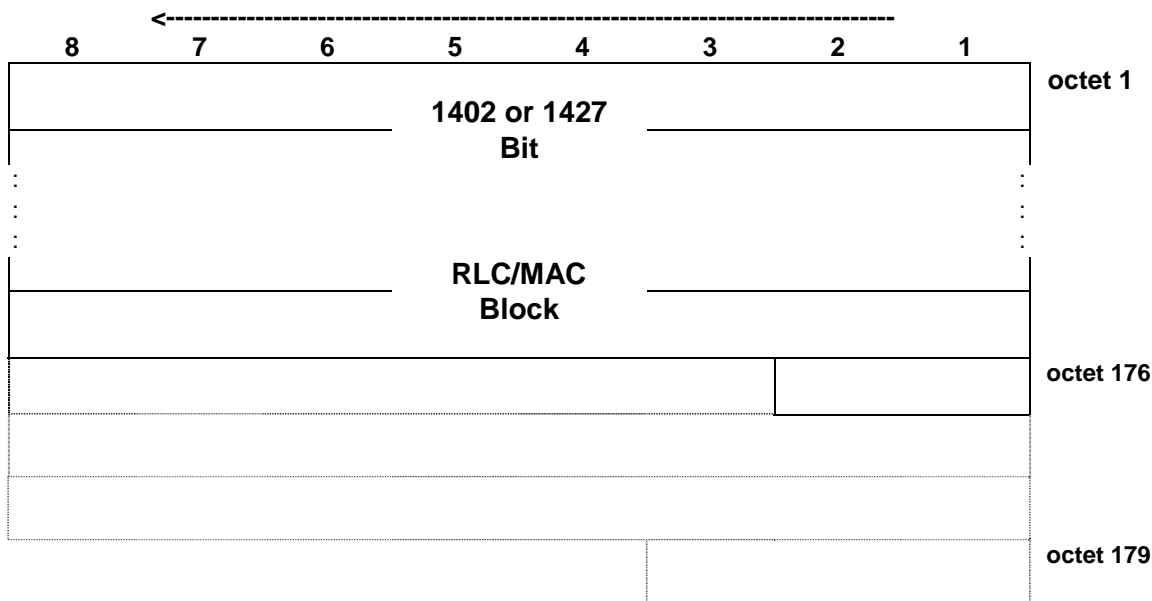

NOTE: The numbering convention specified in 3GPP TS 44.060 applies.

Figure 7.6.23.1: PDTCH block type 23 (UBS-9) format

7.6.24 PDTCH block type 24 (UBS-10) format (uplink only)

The blocks of 1834 bits, or in case a PAN is included, 1859 bits, are used in the following way:

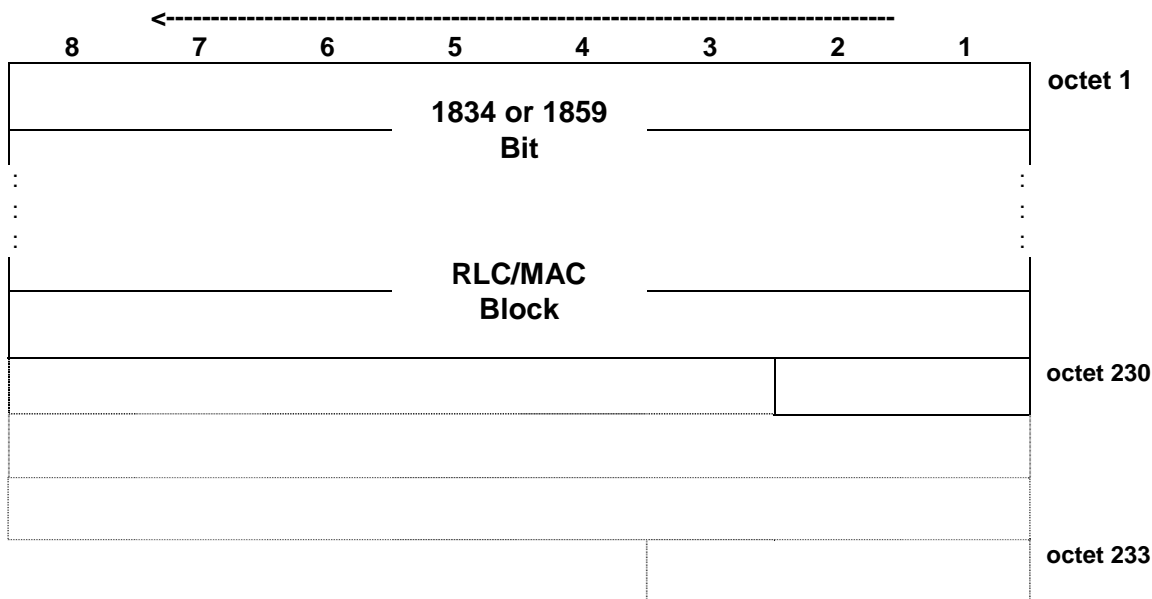

NOTE: The numbering convention specified in 3GPP TS 44.060 applies.

Figure 7.6.24.1: PDTCH block type 24 (UBS-10) format

7.6.25 PDTCH block type 25 (UBS-11) format (uplink only)

The blocks of 2248 bits, or in case a PAN is included, 2273 bits, are used in the following way:

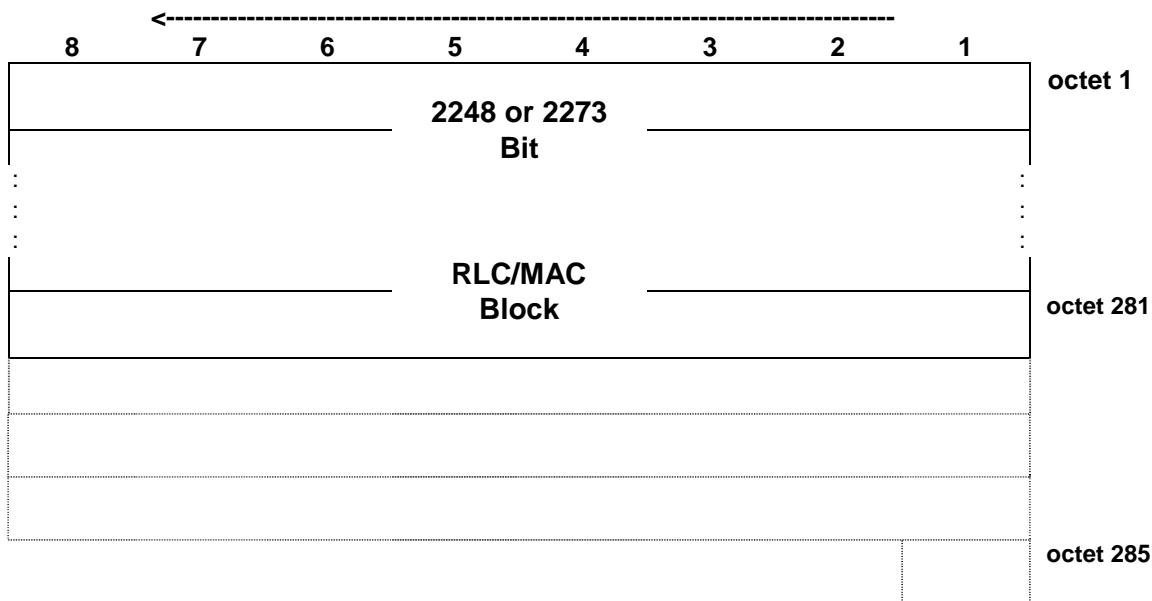

NOTE: The numbering convention specified in 3GPP TS 44.060 applies.

Figure 7.6.25.1: PDTCH block type 25 (UBS-11) format

7.6.26 PDTCH block type 26 (UBS-12) format (uplink only)

The blocks of 2440 bits, or in case a PAN is included, 2465 bits, are used in the following way:

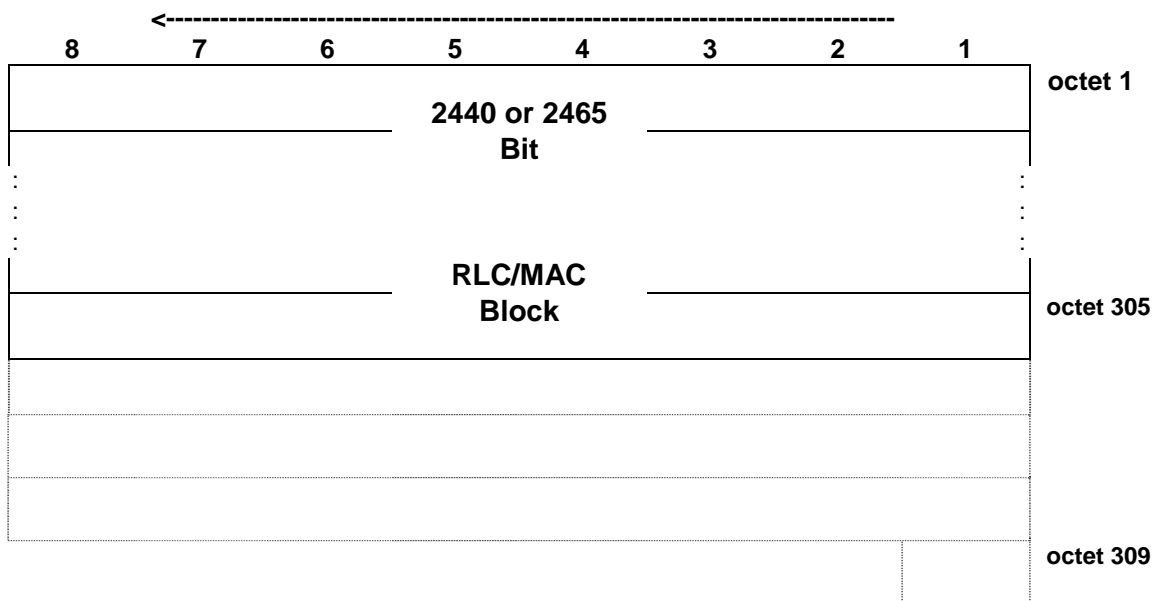

NOTE: The numbering convention specified in 3GPP TS 44.060 applies.

Figure 7.6.26.1: PDTCH block type 26 (UBS-12) format

7.6.27 PDTCH block type 27 (DAS-5) format (downlink only)

The blocks of 478 bits, or in case an eTFI is included, 481 bit blocks, or in case a PAN is included, 503 bits, or in case both a PAN and an eTFI are included, 506 bit blocks, are used in the following way:

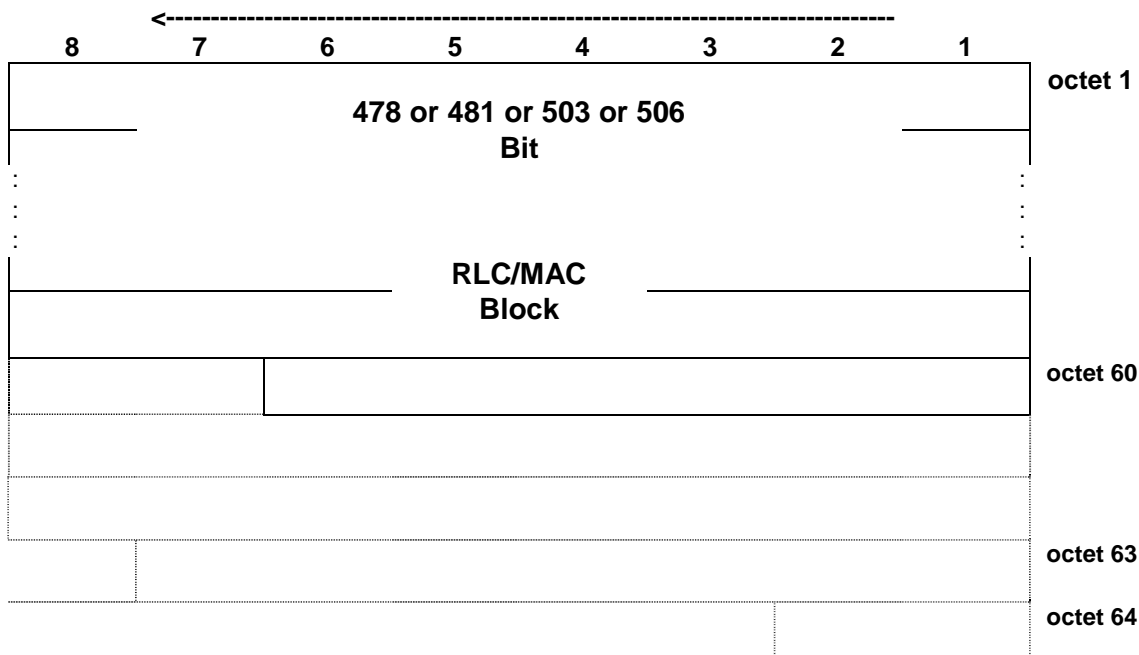

NOTE: The numbering convention specified in 3GPP TS 44.060 applies.

Figure 7.6.27.1: PDTCH block type 27 (DAS-5) format

7.6.28 PDTCH block type 28 (DAS-6) format (downlink only)

The blocks of 574 bits, or in case an eTFI is included, 577 bit blocks, or in case a PAN is included, 599 bits, or in case both a PAN and an eTFI are included, 602 bit blocks, are used in the following way:

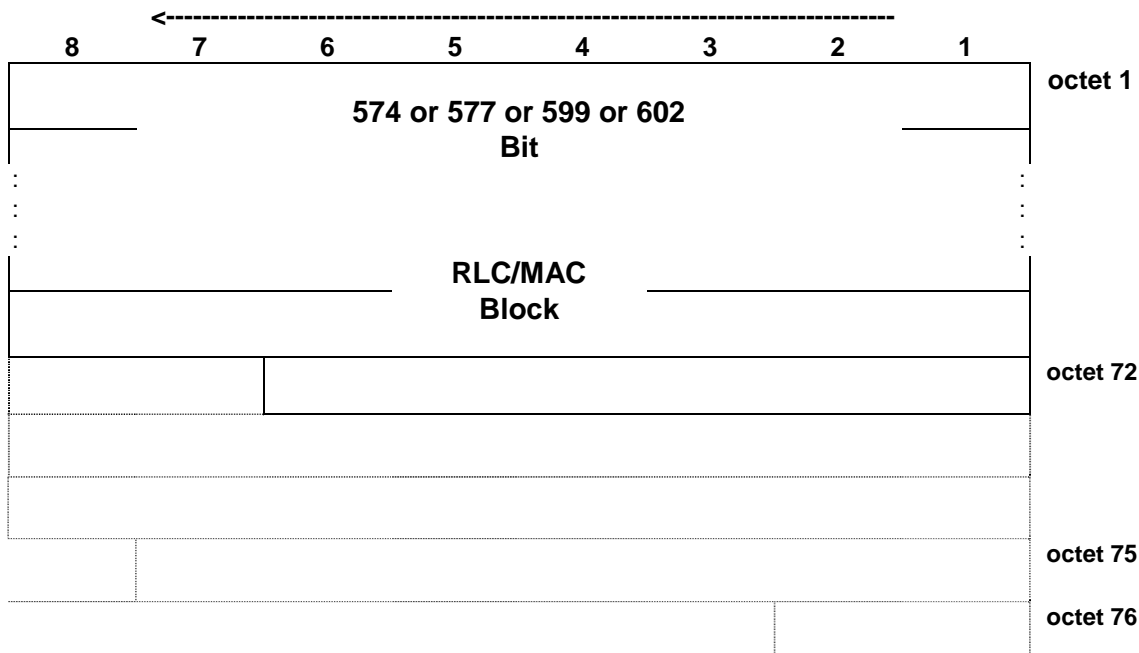

NOTE: The numbering convention specified in 3GPP TS 44.060 applies.

Figure 7.6.28.1: PDTCH block type 28 (DAS-6) format

7.6.29 PDTCH block type 29 (DAS-7) format (downlink only)

The blocks of 686 bits, or in case an eTFI is included, 689 bit blocks, or in case a PAN is included, 711 bits, or in case both a PAN and an eTFI are included, 714 bit blocks, are used in the following way:

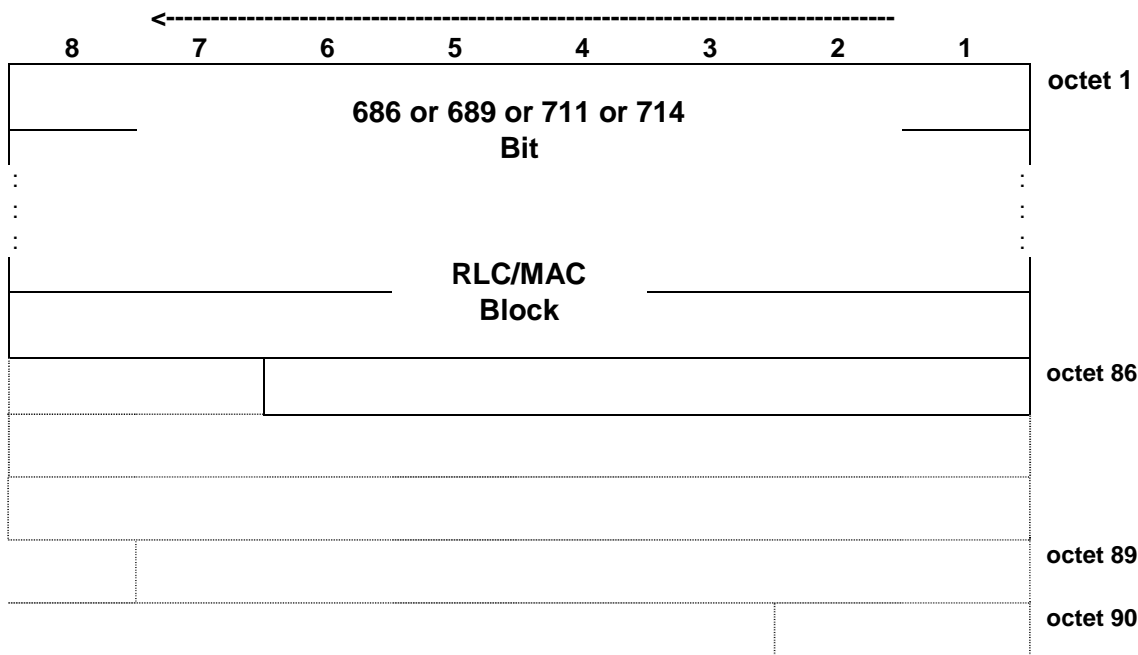

NOTE: The numbering convention specified in 3GPP TS 44.060 applies.

Figure 7.6.29.1: PDTCH block type 29 (DAS-7) format

7.6.30 PDTCH block type 30 (DAS-8) format (downlink only)

The blocks of 941 bits, or in case an eTFI is included, 944 bit blocks, or in case a PAN is included, 966 bits, or in case both a PAN and an eTFI are included, 969 bit blocks, are used in the following way:

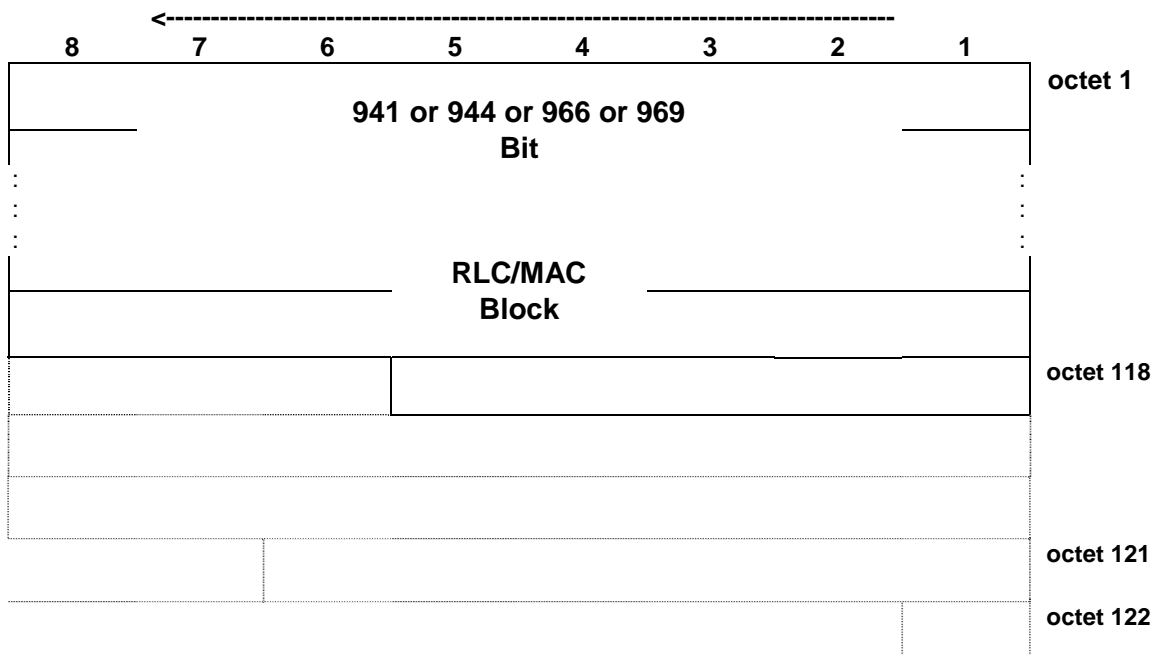

NOTE: The numbering convention specified in 3GPP TS 44.060 applies.

Figure 7.6.30.1: PDTCH block type 30 (DAS-8) format

7.6.31 PDTCH block type 31 (DAS-9) format (downlink only)

The blocks of 1133 bits, or in case an eTFI is included, 1136 bit blocks, or in case a PAN is included, 1158 bits, or in case both a PAN and an eTFI are included, 1161 bit blocks, are used in the following way:

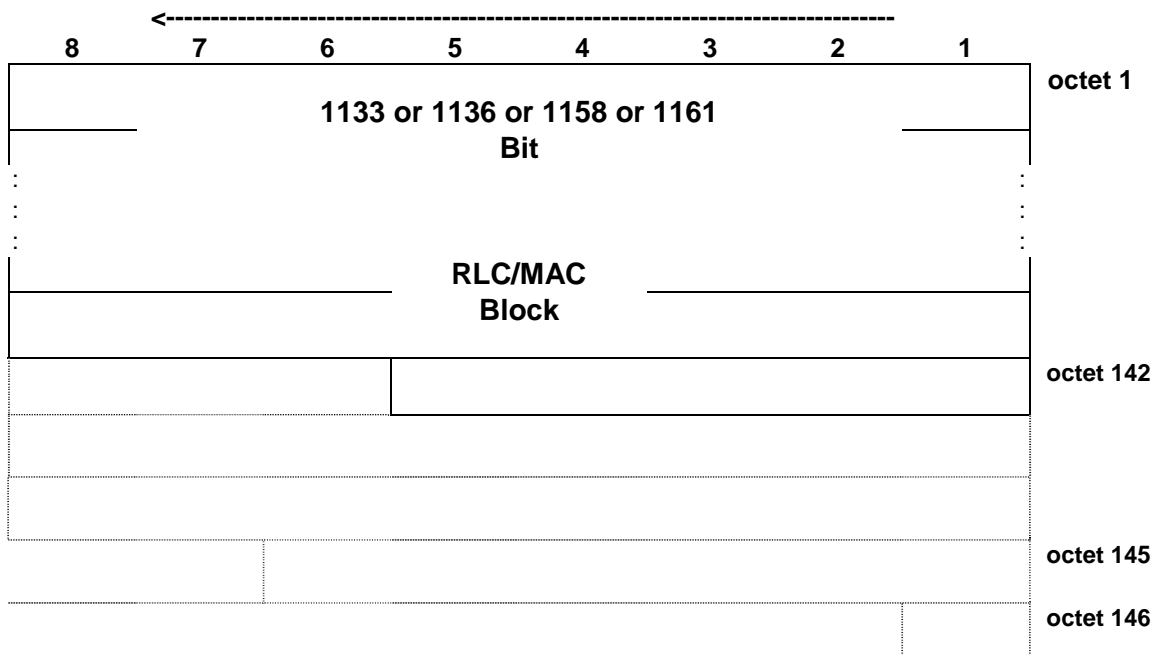

NOTE: The numbering convention specified in 3GPP TS 44.060 applies.

Figure 7.6.31.1: PDTCH block type 31 (DAS-9) format

7.6.32 PDTCH block type 32 (DAS-10) format (downlink only)

The blocks of 1355 bits, or in case an eTFI is included, 1358 bit blocks, or in case a PAN is included, 1380 bits, or in case both a PAN and an eTFI are included, 1383 bit blocks, are used in the following way:

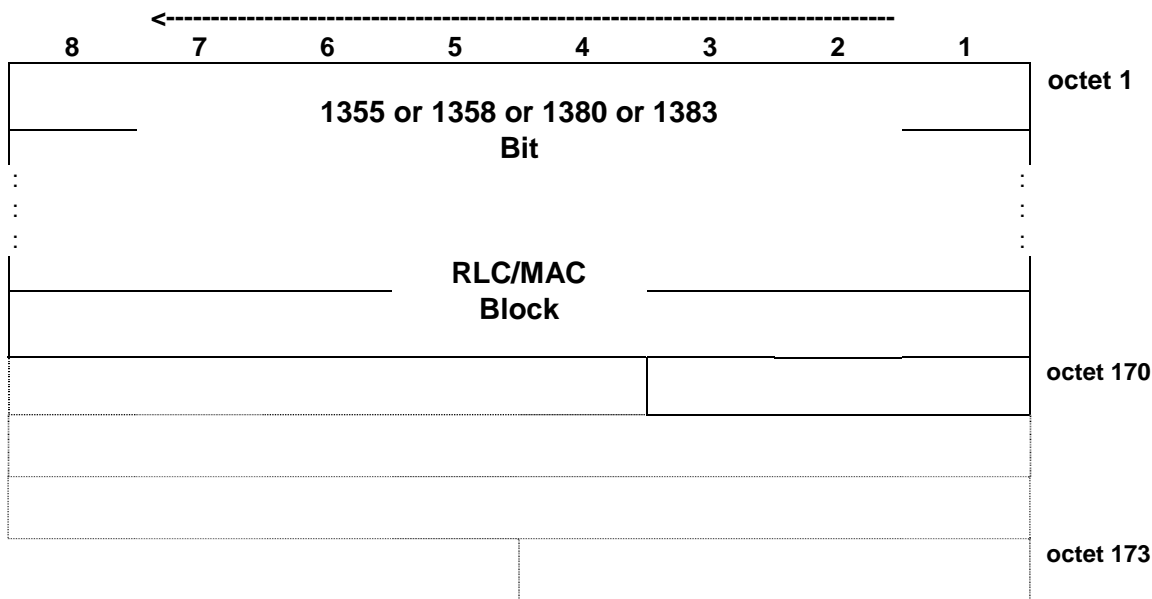

NOTE: The numbering convention specified in 3GPP TS 44.060 applies.

Figure 7.6.32.1: PDTCH block type 32 (DAS-10) format

7.6.33 PDTCH block type 33 (DAS-11) format (downlink only)

The blocks of 1691 bits, or in case an eTFI is included, 1694 bit blocks, or in case a PAN is included, 1716 bits, or in case both a PAN and an eTFI are included, 1719 bit blocks, are used in the following way:

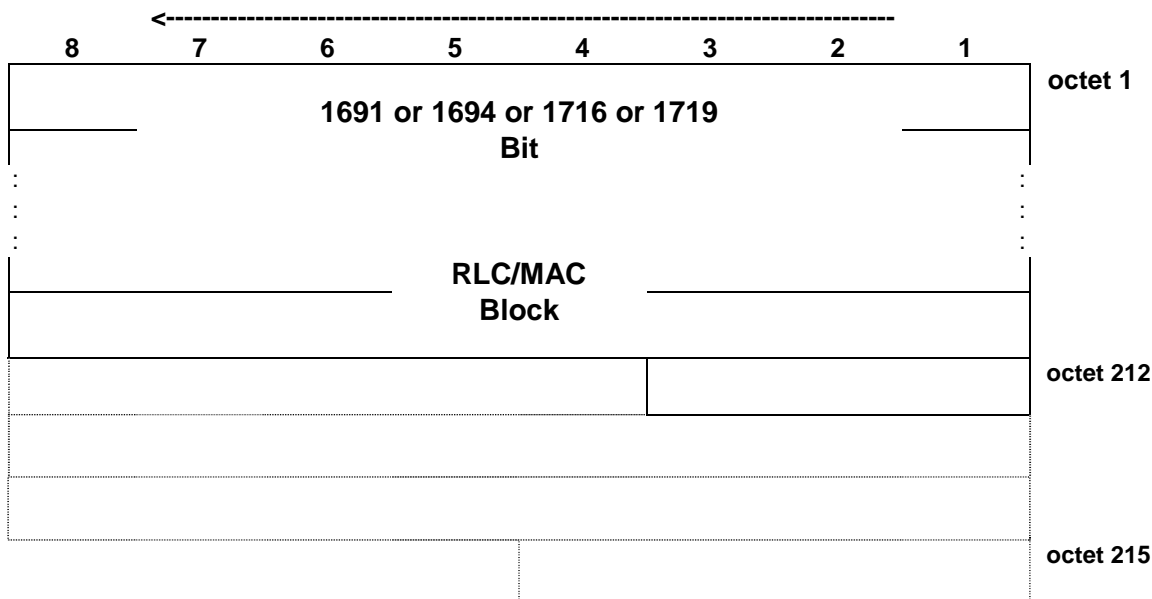

NOTE: The numbering convention specified in 3GPP TS 44.060 applies.

Figure 7.6.33.1: PDTCH block type 33 (DAS-11) format

7.6.34 PDTCH block type 34 (DAS-12) format (downlink only)

The blocks of 2027 bits, or in case an eTFI is included, 2030 bit blocks, or in case a PAN is included, 2052 bits, or in case both a PAN and an eTFI are included, 2055 bit blocks, are used in the following way:

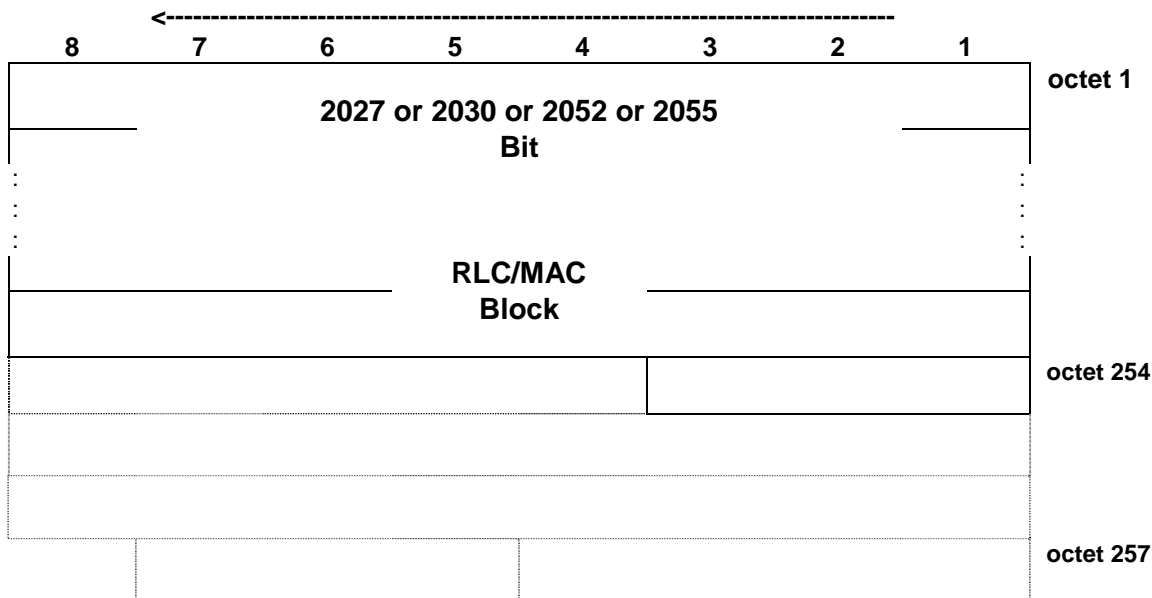

NOTE: The numbering convention specified in 3GPP TS 44.060 applies.

Figure 7.6.34.1: PDTCH block type 34 (DAS-12) format

7.6.35 PDTCH block type 35 (DBS-5) format (downlink only)

The blocks of 480 bits, or in case a PAN is included, 505 bits, are used in the following way:

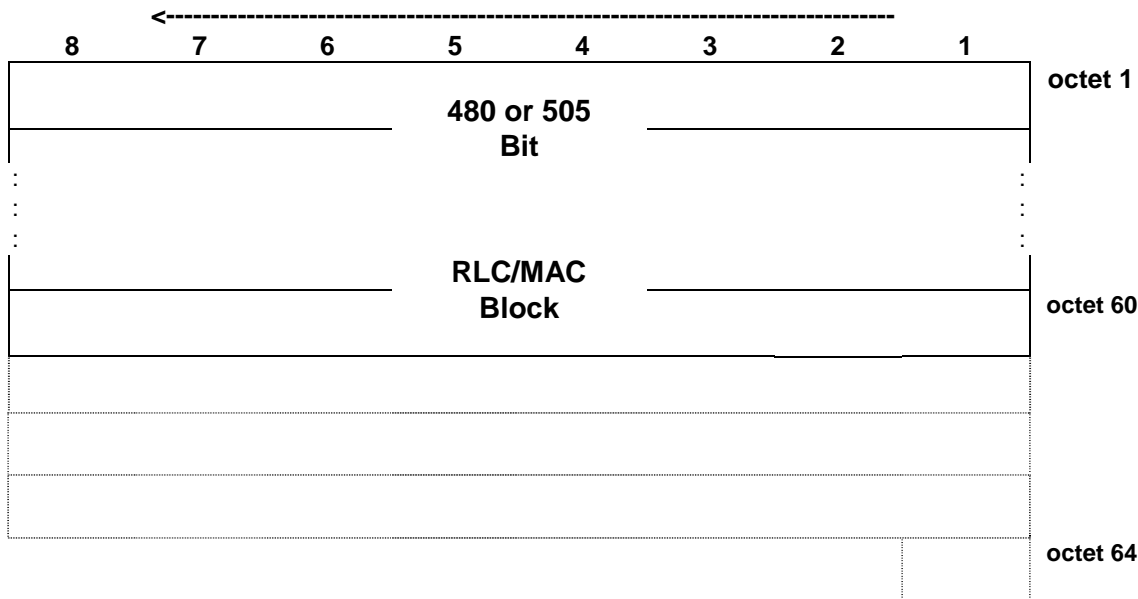

NOTE: The numbering convention specified in 3GPP TS 44.060 applies.

Figure 7.6.35.1: PDTCH block type 35 (DBS-5) format

7.6.36 PDTCH block type 36 (DBS-6) format (downlink only)

The blocks of 624 bits, or in case a PAN is included, 649 bits, are used in the following way:

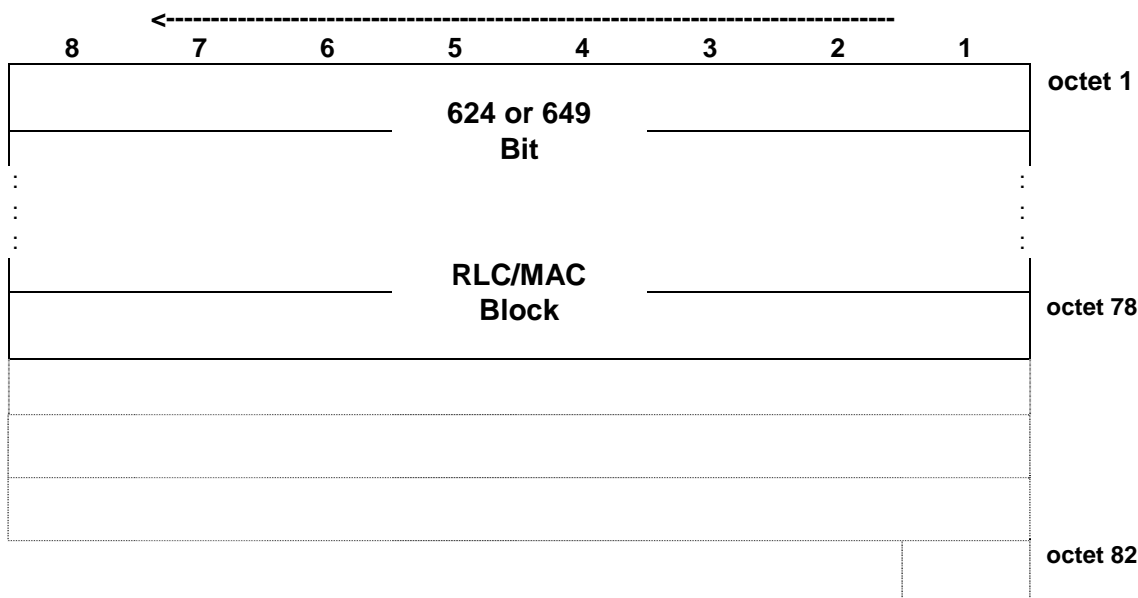

NOTE: The numbering convention specified in 3GPP TS 44.060 applies.

Figure 7.6.36.1: PDTCH block type 36 (DBS-6) format

7.6.37 PDTCH block type 37 (DBS-7) format (downlink only)

The blocks of 941 bits, or in case a PAN is included, 966 bits, are used in the following way:

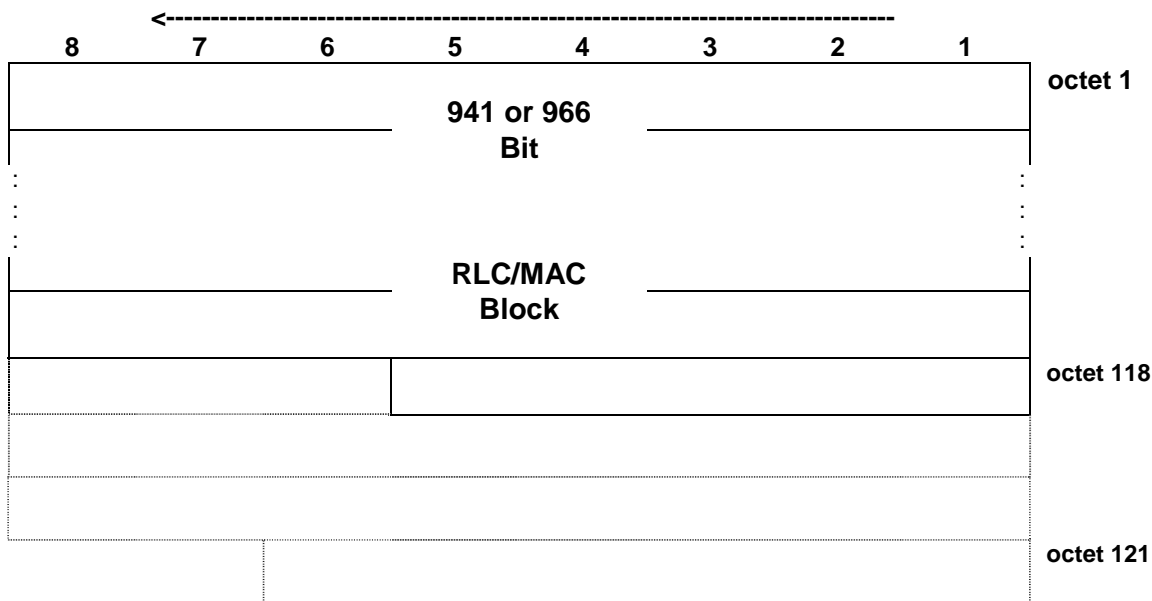

NOTE: The numbering convention specified in 3GPP TS 44.060 applies.

Figure 7.6.37.1: PDTCH block type 37 (DBS-7) format

7.6.38 PDTCH block type 38 (DBS-8) format (downlink only)

The blocks of 1229 bits, or in case a PAN is included, 1254 bits, are used in the following way:

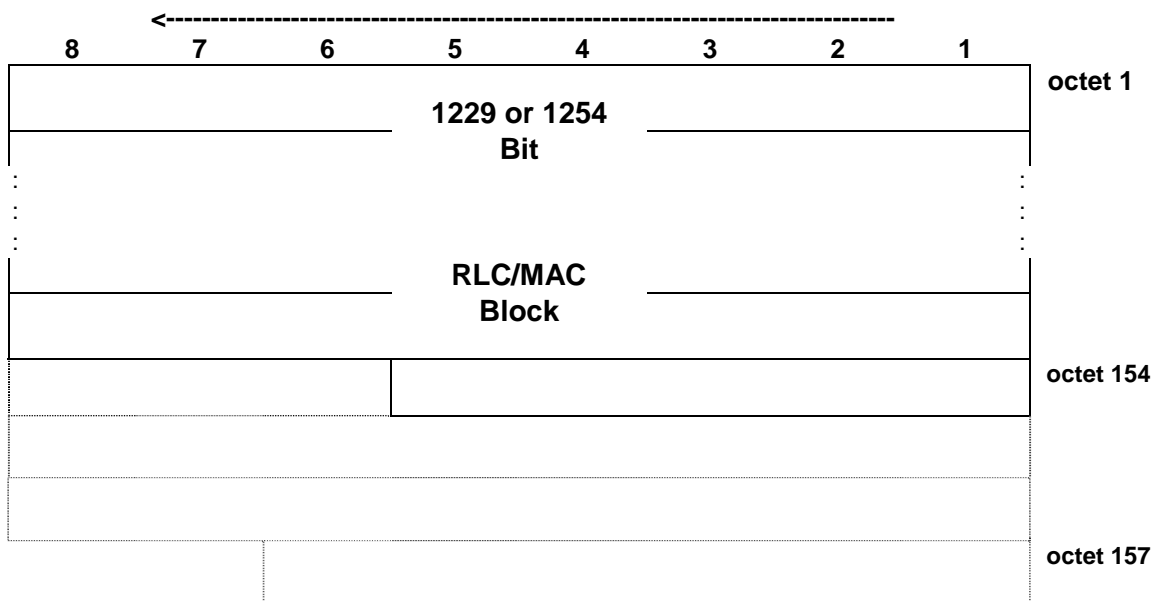

NOTE: The numbering convention specified in 3GPP TS 44.060 applies.

Figure 7.6.38.1: PDTCH block type 38 (DBS-8) format

7.6.39 PDTCH block type 39 (DBS-9) format (downlink only)

The blocks of 1403 bits, or in case a PAN is included, 1428 bits, are used in the following way:

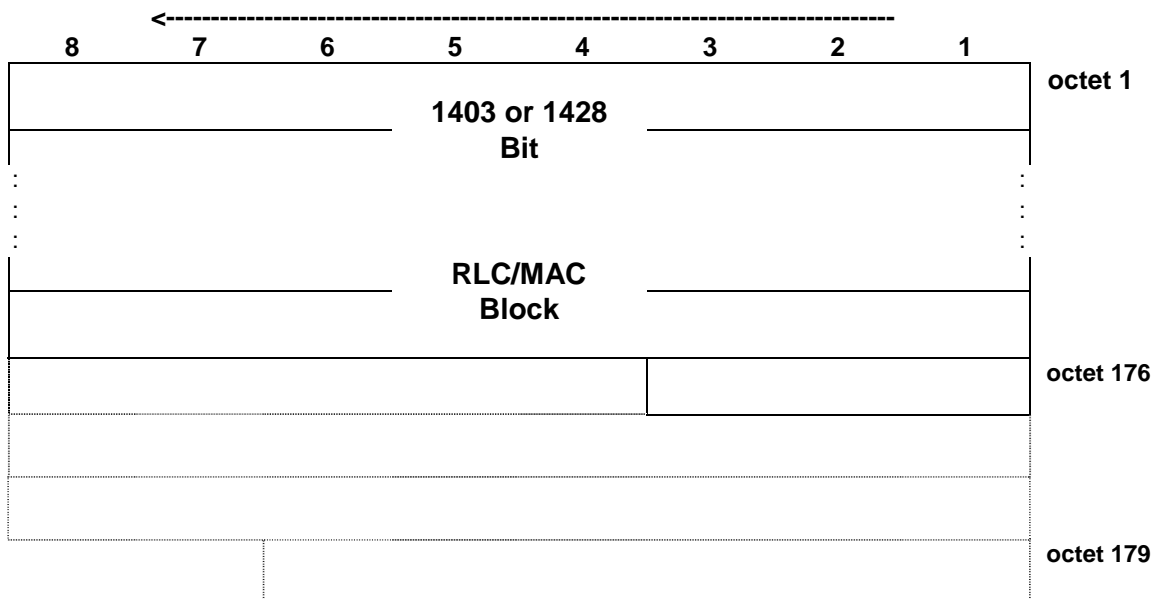

NOTE: The numbering convention specified in 3GPP TS 44.060 applies.

Figure 7.6.39.1: PDTCH block type 39 (DBS-9) format

7.6.40 PDTCH block type 40 (DBS-10) format (downlink only)

The blocks of 1835 bits, or in case a PAN is included, 1860 bits, are used in the following way:

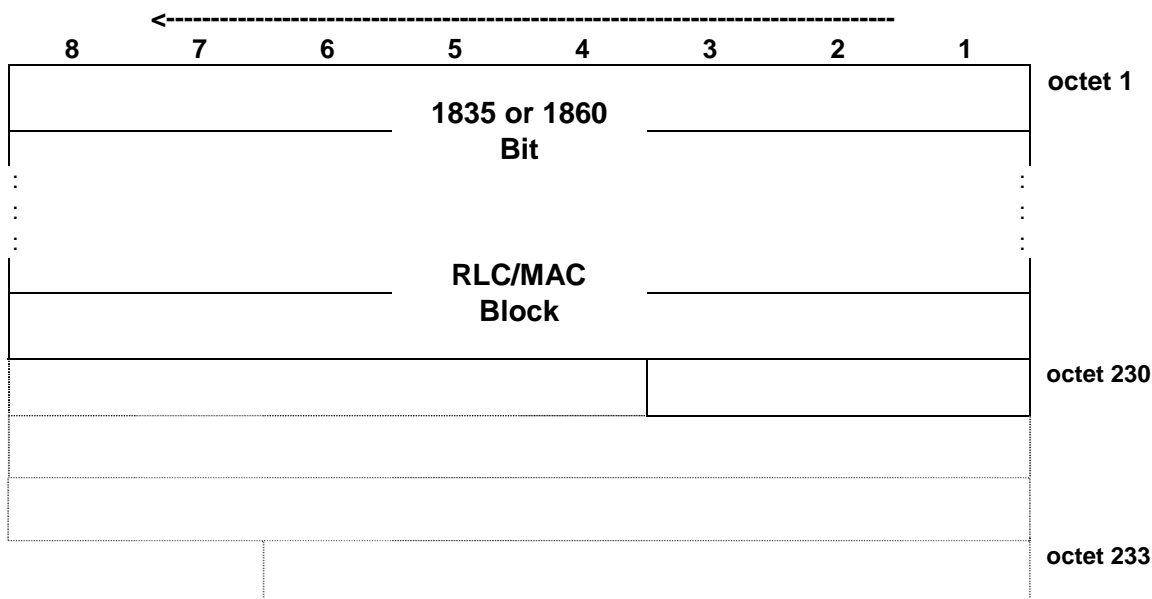

NOTE: The numbering convention specified in 3GPP TS 44.060 applies.

Figure 7.6.40.1: PDTCH block type 40 (DBS-10) format

7.6.41 PDTCH block type 41 (DBS-11) format (downlink only)

The blocks of 2249 bits, or in case a PAN is included, 2274 bits, are used in the following way:

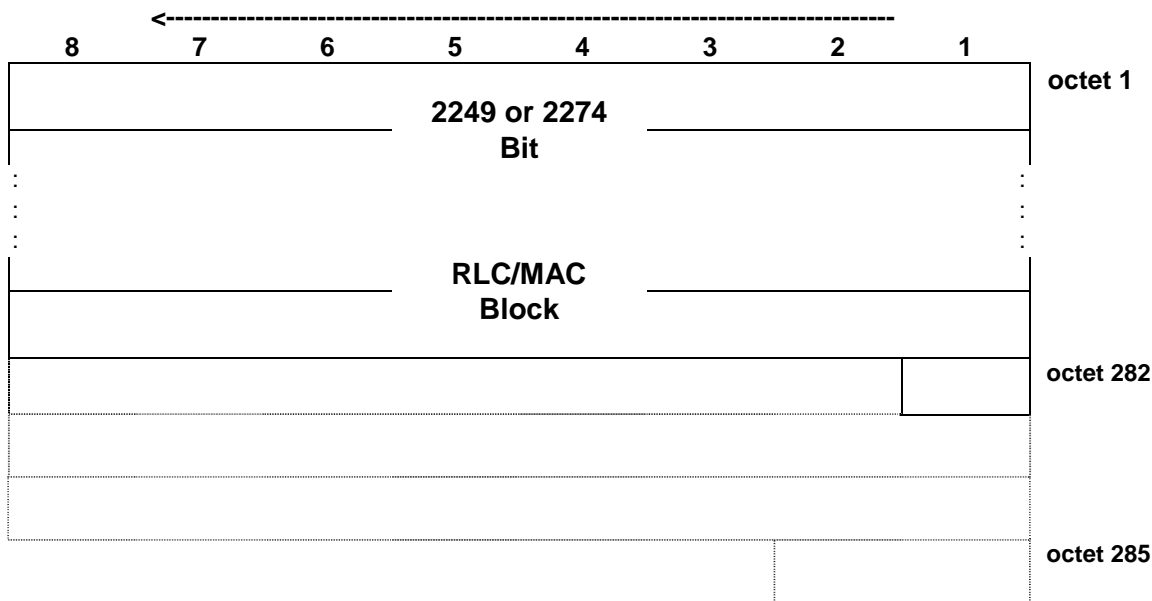

NOTE: The numbering convention specified in 3GPP TS 44.060 applies.

Figure 7.6.41.1: PDTCH block type 41 (DBS-11) format

7.6.42 PDTCH block type 42 (DBS-12) format (downlink only)

The blocks of 2441 bits, or in case a PAN is included, 2466 bits, are used in the following way:

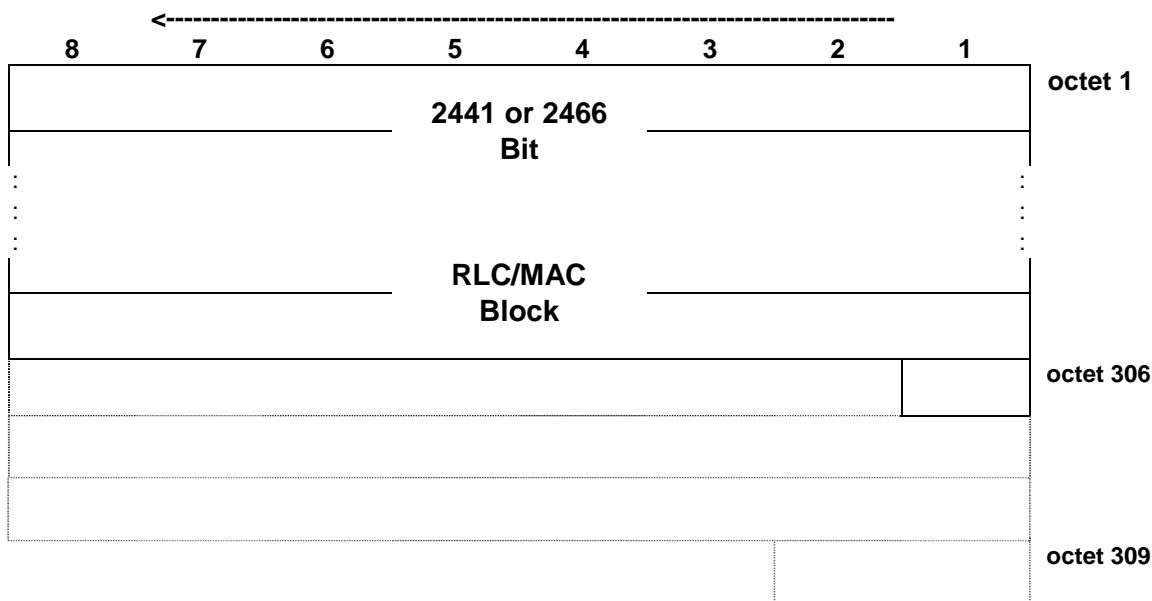

NOTE: The numbering convention specified in 3GPP TS 44.060 applies.

Figure 7.6.42.1: PDTCH block type 42 (DBS-12) format

7.7 PRACH uplink/PACCH uplink short acknowledgement block formats

Two alternative PRACH uplink/PACCH uplink short acknowledgement block formats are specified. The 8 bit (1 octet) blocks are used in the uplink in the following way:



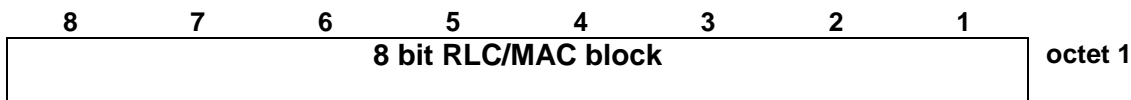

NOTE: The numbering convention specified in 3GPP TS 44.060 applies.

Figure 7.7.a: PRACH uplink/PACCH uplink short acknowledgement block format

The 11 bit blocks are used in the uplink in the following way:

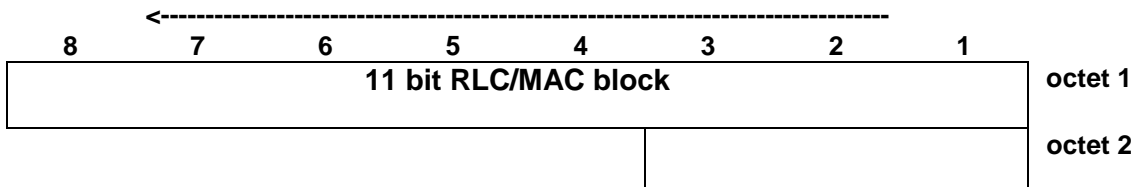

NOTE: The numbering convention specified in 3GPP TS 44.060 applies.

Figure 7.7.b: PRACH uplink/PACCH uplink short acknowledgement block format

7.8 PTCCH downlink block format

The 184 bit (23 octets) blocks are used in the downlink in the following way:

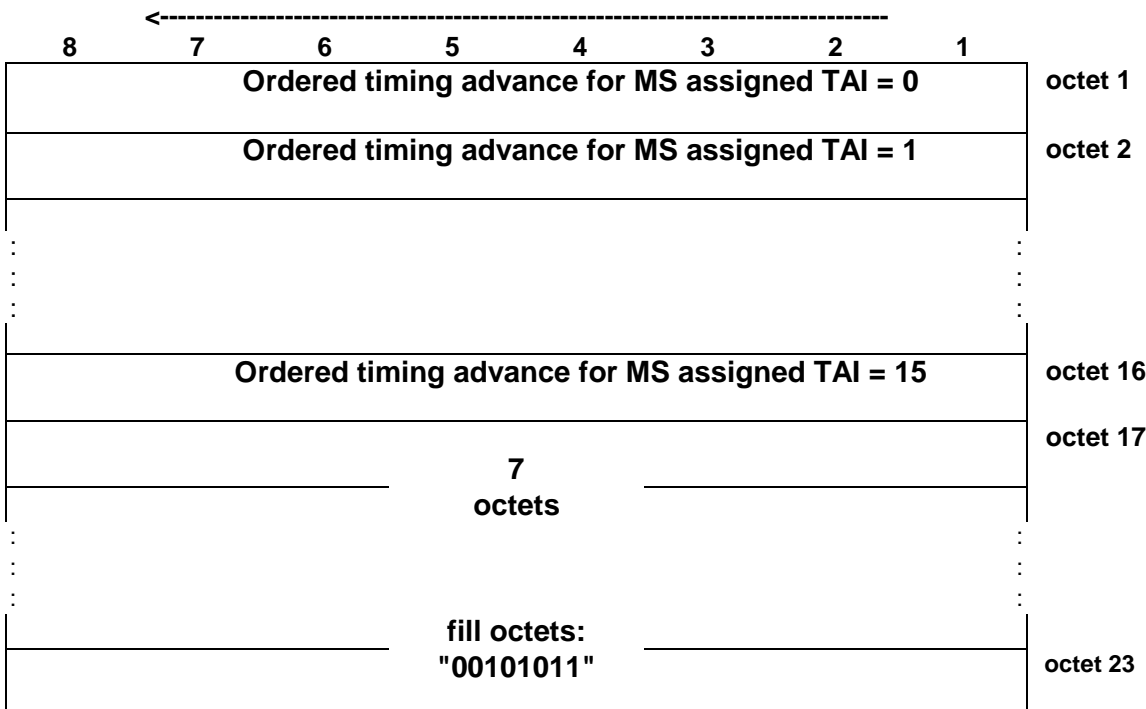

Figure 7.8: PTCCH downlink block format

The field mapping convention in this clause is that when a field is contained within a single octet, the highest bit number of the field represents the highest order value and lowest bit number of the field represents the lowest order value.

Spare bits are encoded with the binary value "0". Fill octets are encoded with the binary value "00101011".

7.9 PTCCH uplink block formats

Two alternative PTCCH uplink block formats are specified. The 8 bit (1 octet) blocks are used in the uplink in the following way:

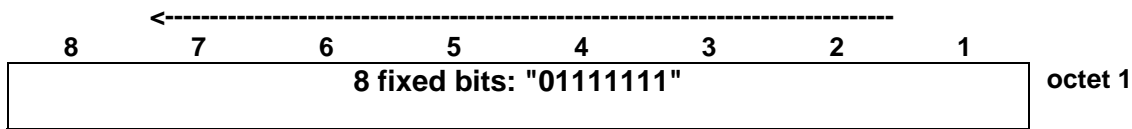

Figure 7.9.a: PTCCH uplink block format

The 11 bit blocks are used in the uplink in the following way:

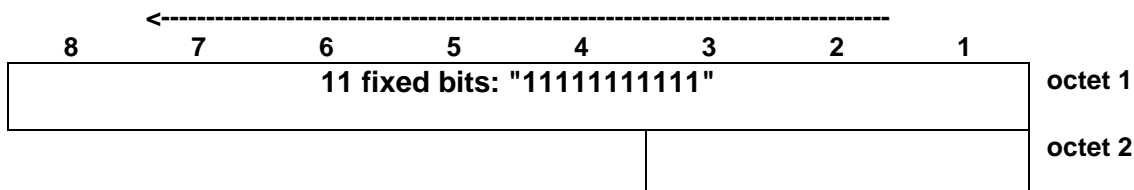

Figure 7.9.b: PTCCH uplink block format

The field mapping convention of sub-clause 7.10 applies. In the addition, when a field spans more than one octet, the order of bit values within each octet progressively decreases as the octet number increases. In that part of a field contained in a given octet the lowest bit number represents the lowest order value.

7.9a Transport block formats (*lu mode*)

7.9a.1 Generic transport block format

When FLO is used, a transport block may be of any size between 1 and 450 bits for GMSK channels, and between 1 and 1370 bits for 8PSK channels. Each transport block contains one RLC/MAC block.

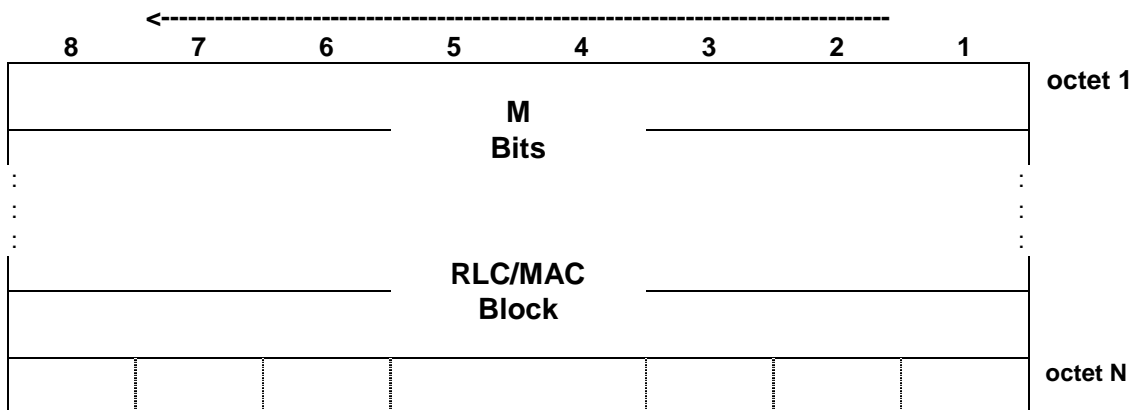

NOTE 1: The N-th octet may contain fewer than 8 bits

NOTE 2: The numbering convention specified in 3GPP TS 44.060 applies

Figure 7.9a.1 Transport block format

7.9a.2 Transport block format for signalling TFC

A TFC is defined that shall be used for signalling. It may also be used for data. For this TFC, the transport block format contains 23 octets.

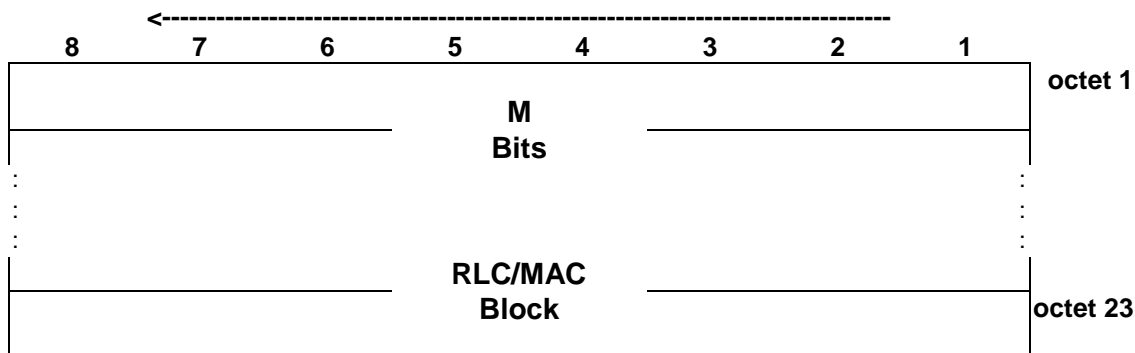

NOTE: The numbering convention specified in 3GPP TS 44.060 applies

Figure 7.9a.2 Transport block format for TFC for signalling

7.9b EC-BCCH/EC-CCCH/EC-PDTCH/EC-PACCH block formats

7.9b.1 EC-BCCH

See subclause 7.3.1.

7.9b.2 EC-CCCH

7.9b.2.1 EC-PCH/EC-AGCH

The 11 octets blocks are used in the downlink in the way shown in figure 7.9b.1.

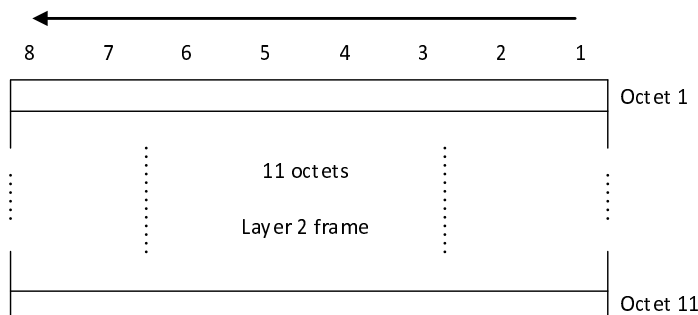

Figure 7.9b.1: EC-PCH/EC-AGCH downlink block format

7.9b.2.2 EC-RACH

See subclause 7.4a for the 11 bit RACH format.

7.9b.3 EC-PDTCH

See subclause 7.6.5 to 7.6.13 for MCS-1 to MCS-9 respectively for the case that no eTFI and no PAN is included in the block.

In the downlink the first three bits in the first octet are carried by the USF and the value of this field may vary between different blind physical layer transmissions (i.e. for EC-PDTCH/D/4, EC-PDTCH/D/8, EC-PDTCH/D/16).

7.9b.4 EC-PACCH

7.9b.4.1 Downlink

The 10 octets block is used in the downlink in the way shown in figure 7.9b.2.

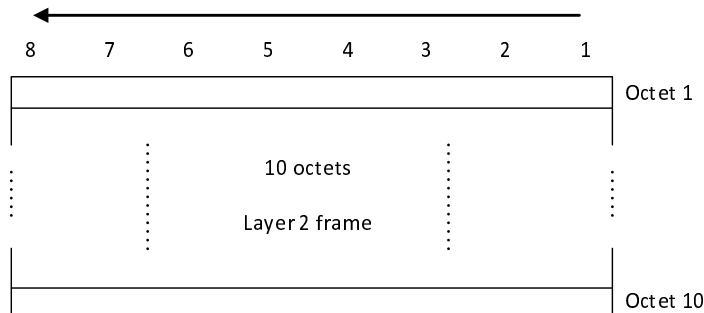

Figure 7.9b.2: EC-PACCH downlink block format

A 3-bit USF may optionally be added to the block. A different USF value may be included in each block when several blind physical layer transmissions are used in the downlink (i.e. for EC-PACCH/D/4, EC-PACCH/D/8 and EC-PACCH/D/16).

7.9b.4.2 Uplink

The 8 octets block is used in the uplink in the way shown in figure 7.9b.3.

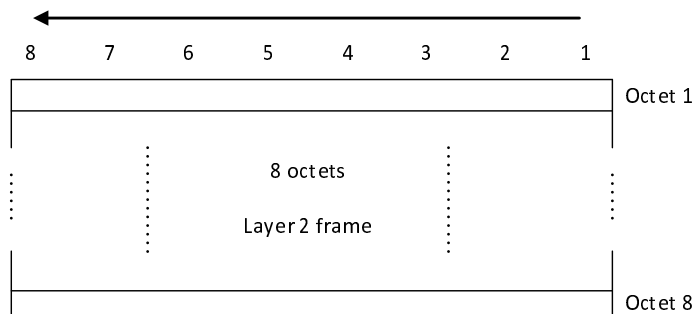

Figure 7.9b.3: EC-PACCH uplink block format

If the EC-PACCH is transmitted using Access Bursts, it is referred to as EC-PACCH short acknowledgement block format and follows the format described in subclause 7.7 for the 11-bit RLC/MAC block.

7.10 Order of bit transmission

On channels for normal burst transmission having a block format with an integer N number of octets, the N octets are mapped onto 8N bits, d(0) to d(8N-1), defined in 3GPP TS 45.003 clause 4 and 5 as follows:

Bit m of octet n shall be transmitted as bit $d((n-1)*8+m-1)$ with $m=(1..8)$ and $n=(1..N)$.

On channels for normal burst transmission having a block format with a non-integer number of octets, or for transmission having a defined block format but which does not follow the normal burst transmission, the octets are mapped onto M bits, d(0) to d(M-1), defined in 3GPP TS 45.003 clause 5 as follows:

Bit m of octet n shall be transmitted as bit $d(8(n-1) + m-1)$ with $n = (1 .. ((M-1) \text{ DIV } 8) + 1)$ and $m = (1 .. \min(8, (M - 8(n-1))))$, and where 'DIV' is the integer division operator.

8 Vocabulary

The terminology used in the present document is as follows:

- **Idle mode:**

In this mode the MS is not allocated any dedicated physical channel; when the MS is operating in *A/Gb mode* it listens to the CCCH and the BCCH, whilst when operating in *Iu mode* it listens to the PCCCH and the PBCCH.

- **Dedicated mode:**

In this mode the MS is allocated a dedicated physical channel, at least containing two logical channels, only one of them being a SACCH.

- **Downlink Multi Carrier (DLMC):**

Downlink Multi Carrier is a feature allowing resources for a downlink TBF (and optionally an uplink TBF) to be assigned to a mobile station on two or more radio frequency channels in the same or different frequency bands using EGPRS or EGPRS2-A.

- **DLMC configuration:**

A DLMC configuration is one in which a mobile station in packet transfer mode has a downlink TBF where radio resources are configured on two or more radio frequency channels in the same or in different frequency bands. A mobile station in a DLMC configuration with an uplink TBF can only transmit RLC/MAC blocks for the uplink TBF on one radio frequency channel in any given radio block period whereas RLC/MAC blocks for the downlink TBF can be transmitted on one or more frequency channels in any given radio block period.

- **Packet mode:**

In this mode the MS is ready to access and operate on a packet data physical channel (*A/Gb mode*) or shared basic physical subchannel (*Iu mode*). When the MS is operating in *A/Gb mode*, packet mode includes the sub-states packet idle mode and packet transfer mode (see 3GPP TS 44.060). When the MS is operating in *Iu mode*, packet mode includes the sub-states MAC-Idle and MAC-Shared.

- **Packet Idle Mode:**

In packet idle mode, the mobile station is prepared to transfer LLC PDUs on packet data physical channels. The mobile station is not allocated any radio resource on a packet data physical channel; it listens to the PBCCH and PCCCH or, if those are not provided by the network, to the BCCH and the CCCH.

- **Packet Transfer Mode:**

In packet transfer mode, the mobile station is prepared to transfer LLC PDUs on packet data physical channels. The mobile station is allocated radio resource on one or more packet data physical channels for the transfer of LLC PDUs.

- **Dual Transfer Mode:**

In dual transfer mode, the mobile station is allocated radio resources providing an RR connection (3GPP TS 44.018) and a Temporary Block Flow on one or more packet data physical channels. The allocation of radio resource for the RR connection and the Temporary Block Flow is co-ordinated by the network in agreement with the capabilities of the mobile station in dual transfer mode.

- **MAC-dedicated:**

A MAC-control-entity state where a DBPSCH is assigned and no SBPSCH is assigned. This state only applies in *Iu mode*.

- **MAC-DTM:**

A MAC-control-entity state where at least one DBPSCH and one SBPSCH are assigned. This state only applies in *Iu mode*.

- **MAC-Idle:**

A MAC-control-entity state where no basic physical subchannel is assigned.

- **MAC-Shared:**

A MAC-control-entity state where at least one shared basic physical subchannel is assigned.

- **Physical block:**

The physical block is the minimal unit which can be transferred by the physical layer.

- **Dedicated physical channel:**

The physical blocks scheduled on the radio medium assigned to a dedicated connection with a MS.

- **Packet data physical channel:**

The physical blocks scheduled on the radio medium assigned to a shared usage between MSs for packet switched data traffic.

- **Physical channel:**

A **physical channel** uses a combination of frequency and time division multiplexing and is defined in terms of a radio frequency channel sequence and a timeslot sequence. A physical channel uses the same timeslot number in every TDMA frame. The complete definition of a particular physical channel consists of a description in the frequency domain, and a description in the time domain (see 3GPP TS 45.002).

- **Basic physical channel:**

A **basic physical channel** is defined as a physical channel for which the TDMA frame number sequence is 0,1,.. FN_MAX, where FN_MAX is the maximum TDMA frame number for a hyperframe (i.e. all TDMA frames on a timeslot).

- **Basic physical subchannel:**

A **basic physical subchannel** is defined as a basic physical channel or a part of a basic physical channel and an associated multiframe structure. A basic physical subchannel can either be shared or dedicated.

Annex A (informative): Change History

TSG #	TSG Doc.	CR	Rev	Subject/Comment	New
January 2015	-	-	-	Rel-13 version created based on version 12.0.0	13.0.0
GP-70	GP-160291	0019		Introduction of EC-GSM-IoT	13.1.0

Change history							
Date	Meeting	TDoc	CR	Rev	Cat	Subject/Comment	New version
2017-03	RP-75	-	-	-	-	Release 14 version (frozen at TSG-75)	14.0.0
2017-09	RP-77	RP-171597	0022	-	A	Removal of references to TS 44.118 and TS 44.160	14.1.0
2018-06	RP-80	-	-	-	-	Release 15 version (frozen at TSG-80)	15.0.0
2020-07	RP-88e	-	-	-	-	Upgrade to Rel-16 version without technical change	16.0.0

History

Document history		
V16.0.0	September 2020	Publication