

# ETSI TS 143 068 V10.0.0 (2011-05)

*Technical Specification*

**Digital cellular telecommunications system (Phase 2+);  
Voice Group Call Service (VGCS);  
Stage 2  
(3GPP TS 43.068 version 10.0.0 Release 10)**



---

**Reference**

RTS/TSGC-0143068va00

---

**Keywords**

GSM

**ETSI**

650 Route des Lucioles  
F-06921 Sophia Antipolis Cedex - FRANCE

---

Tel.: +33 4 92 94 42 00 Fax: +33 4 93 65 47 16

Siret N° 348 623 562 00017 - NAF 742 C  
Association à but non lucratif enregistrée à la  
Sous-Préfecture de Grasse (06) N° 7803/88

---

**Important notice**

---

Individual copies of the present document can be downloaded from:

<http://www.etsi.org>

The present document may be made available in more than one electronic version or in print. In any case of existing or perceived difference in contents between such versions, the reference version is the Portable Document Format (PDF). In case of dispute, the reference shall be the printing on ETSI printers of the PDF version kept on a specific network drive within ETSI Secretariat.

Users of the present document should be aware that the document may be subject to revision or change of status. Information on the current status of this and other ETSI documents is available at

<http://portal.etsi.org/tb/status/status.asp>

If you find errors in the present document, please send your comment to one of the following services:

[http://portal.etsi.org/chaicor/ETSI\\_support.asp](http://portal.etsi.org/chaicor/ETSI_support.asp)

---

**Copyright Notification**

---

No part may be reproduced except as authorized by written permission.  
The copyright and the foregoing restriction extend to reproduction in all media.

© European Telecommunications Standards Institute 2011.  
All rights reserved.

**DECT™**, **PLUGTESTS™**, **UMTS™**, **TIPHON™**, the TIPHON logo and the ETSI logo are Trade Marks of ETSI registered for the benefit of its Members.

**3GPP™** is a Trade Mark of ETSI registered for the benefit of its Members and of the 3GPP Organizational Partners.

**LTE™** is a Trade Mark of ETSI currently being registered

for the benefit of its Members and of the 3GPP Organizational Partners.

**GSM®** and the GSM logo are Trade Marks registered and owned by the GSM Association.

---

## Intellectual Property Rights

IPRs essential or potentially essential to the present document may have been declared to ETSI. The information pertaining to these essential IPRs, if any, is publicly available for **ETSI members and non-members**, and can be found in ETSI SR 000 314: "*Intellectual Property Rights (IPRs); Essential, or potentially Essential, IPRs notified to ETSI in respect of ETSI standards*", which is available from the ETSI Secretariat. Latest updates are available on the ETSI Web server (<http://webapp.etsi.org/IPR/home.asp>).

Pursuant to the ETSI IPR Policy, no investigation, including IPR searches, has been carried out by ETSI. No guarantee can be given as to the existence of other IPRs not referenced in ETSI SR 000 314 (or the updates on the ETSI Web server) which are, or may be, or may become, essential to the present document.

---

## Foreword

This Technical Specification (TS) has been produced by ETSI 3rd Generation Partnership Project (3GPP).

The present document may refer to technical specifications or reports using their 3GPP identities, UMTS identities or GSM identities. These should be interpreted as being references to the corresponding ETSI deliverables.

The cross reference between GSM, UMTS, 3GPP and ETSI identities can be found under <http://webapp.etsi.org/key/queryform.asp>.

# Contents

|  |    |
|--|----|
| Intellectual Property Rights .....   | 2  |
| Foreword.....  | 2  |
| Foreword.....  | 6  |
| 1 Scope .....  | 7  |
| 2 References .....   | 7  |
| 3 Definitions and abbreviations.....   | 8  |
| 3.1 Definitions .....  | 8  |
| 3.2 Abbreviations .....  | 9  |
| 4 Main concepts .....  | 9  |
| 4.1 Group definition .....   | 9  |
| 4.2 Group conversations.....   | 9  |
| 4.2.1 Group call initiation.....   | 9  |
| 4.2.1.1 Normal operation with successful outcome .....                                     | 9  |
| 4.2.1.2 Exceptional procedures .....   | 11 |
| 4.2.2 On-going group calls .....   | 11 |
| 4.2.2.1 Normal operation with successful outcome .....                                     | 11 |
| 4.2.2.2 Exceptional procedures .....   | 14 |
| 4.2.3 Leaving of a group call without termination.....                                     | 14 |
| 4.2.4 Group call termination.....  | 14 |
| 4.2.5 Acknowledgements.....  | 15 |
| 4.2.6 Transactions between the mobile station and the network.....                         | 15 |
| 4.2.7 Processing of originator-to-dispatcher information .....                             | 15 |
| 4.2.8 Transfer of application-specific data to group call members.....                     | 15 |
| 4.2.8.1 General .....  | 15 |
| 4.2.8.2 Sending of application-specific data .....   | 16 |
| 4.2.8.2.1 By the talking service subscriber.....   | 16 |
| 4.2.8.2.2 By a listener.....   | 16 |
| 4.2.8.3 Sending a confirmation of receipt of application-specific data.....                | 17 |
| 4.2.8.4 Distributing application-specific data to a voice group call.....                  | 17 |
| 4.2.8.4.1 Distribution via the MSC.....  | 17 |
| 4.2.8.4.2 Immediate distribution by the BSC .....  | 18 |
| 5 General architecture .....   | 18 |
| 5.1 Group Call Register (GCR).....   | 18 |
| 5.2 Voice group call responsibility.....   | 20 |
| 6 Compatibility issues .....   | 20 |
| 7 Transmission .....   | 20 |
| 7.1 Transmission architecture.....   | 20 |
| 7.1a Transmission architecture – A interface circuit sharing.....                          | 20 |
| 7.1a.1 Transmission architecture – General .....   | 20 |
| 7.1a.2 Transmission architecture – Control Plane .....                                     | 21 |
| 7.1a.3 Transmission architecture – User Plane.....   | 21 |
| 7.1b Transmission architecture – A interface link sharing .....                            | 21 |
| 7.1b.1 Transmission architecture – General .....   | 21 |
| 7.1b.2 Transmission architecture – Control Plane .....                                     | 22 |
| 7.1b.3 Transmission architecture – User Plane.....   | 22 |
| 7.2 Radio channels .....   | 22 |
| 7.3 Data confidentiality .....   | 24 |
| 8 Information storage .....  | 25 |
| 8.1 Information stored in the GCR .....  | 25 |
| 8.1.1 Information used for routing of service subscriber originated voice group calls..... | 25 |
| 8.1.2 Group call attributes.....   | 26 |

|            |   |     |
|------------|---|-----|
| 8.1.2.1    | Group call area .....   | 26  |
| 8.1.2.2    | Dispatcher identities .....   | 27  |
| 8.1.2.3    | No activity time .....  | 27  |
| 8.1.2.4    | Priorities .....  | 27  |
| 8.1.3      | Transient GCR Data .....  | 28  |
| 8.2        | Information managed per subscriber .....  | 28  |
| 8.2.1      | Stored in the HLR .....   | 28  |
| 8.2.2      | Stored in the VLR .....   | 28  |
| 8.2.3      | Stored in the SIM .....   | 28  |
| 8.2.3a     | Stored in the USIM .....  | 29  |
| 8.3        | Information used for routing of dispatcher originated voice group calls .....                     | 29  |
| 9          | Identities .....  | 29  |
| 9.1        | Elementary identities for group calls .....   | 29  |
| 9.2        | Use of identities in the network .....  | 30  |
| 10         | Operation and maintenance aspects .....   | 32  |
| 11         | Function and information flows .....  | 32  |
| 11.1       | Group management .....  | 32  |
| 11.2       | Group membership management .....   | 32  |
| 11.3       | Call management .....   | 32  |
| 11.3.1     | Call establishment .....  | 32  |
| 11.3.1.1   | Service subscriber call establishment .....   | 32  |
| 11.3.1.1.1 | Initial stage .....   | 32  |
| 11.3.1.1.2 | Establishment of the transmission means .....   | 34  |
| 11.3.1.1.3 | Release of the dedicated transmission means of the calling service subscriber .....               | 35  |
| 11.3.1.1.4 | Release of the dedicated transmission means of mobile stations responding to a notification ..... | 36  |
| 11.3.1.1.5 | void .....  | 36  |
| 11.3.1.1.6 | void .....  | 36  |
| 11.3.1.2   | Dispatcher call establishment .....   | 36  |
| 11.3.1.3   | Notification procedures .....   | 36  |
| 11.3.1.4   | Destination service subscribers .....   | 39  |
| 11.3.1.5   | Destination dispatchers .....   | 39  |
| 11.3.2     | Call release .....  | 39  |
| 11.3.2.1   | Call termination by the calling subscriber .....  | 39  |
| 11.3.2.2   | Call termination by dispatchers .....   | 39  |
| 11.3.2.3   | Call termination on expiry of no activity timer .....   | 40  |
| 11.3.3     | Leaving of a dispatcher .....   | 40  |
| 11.3.4     | Leaving and returning to a voice group call .....   | 40  |
| 11.3.5     | Cell change .....   | 40  |
| 11.3.5.1   | Listening subscriber .....  | 40  |
| 11.3.5.2   | Talking subscriber .....  | 40  |
| 11.3.5.3   | Dispatcher .....  | 41  |
| 11.3.6     | New calls .....   | 41  |
| 11.3.7     | Uplink and Downlink management .....  | 41  |
| 11.3.7.1   | Uplink transmission management .....  | 41  |
| 11.3.7.1a  | Transfer of a talking service subscriber to a dedicated connection .....                          | 43  |
| 11.3.7.1b  | Release of the dedicated transmission means of a talking service subscriber .....                 | 43  |
| 11.3.7.2   | Mute/Unmute downlink of the talker .....  | 43  |
| 11.3.7a    | Signalling procedures for the user plane .....  | 48  |
| 11.3.7a.1  | Group call re-establishment by the BSS .....  | 48  |
| 11.3.8     | Overview of signalling .....  | 48  |
| 11.3.9     | Short Message Service (SMS) .....   | 111 |
| 11.3.9.1   | Delivering SMS to the voice group call .....  | 111 |
| 11.3.9.2   | Point-to-point short message during an ongoing voice group call .....                             | 113 |
| 11.4       | Functional requirement of Anchor MSC .....  | 114 |
| 11.5       | Functional requirement of Relay MSC .....   | 125 |
| 11.5A      | Functional requirement of group call serving MSC (within a RANflex pool) .....                    | 136 |
| 11.5B      | Functional requirement of VMSC (within a RANflex pool) .....                                      | 138 |
| 11.6       | Functional requirement of GCR .....   | 142 |
| 11.7       | Functional requirement of VLR .....   | 145 |

|                               |   |            |
|-------------------------------|---|------------|
| 12                            | Content of messages.....                          | 149        |
| 12.1                          | Messages on the B-interface (MSC-VLR) .....       | 149        |
| 12.1.1                        | Allocate Group Call Number.....                   | 149        |
| 12.1.2                        | Allocate Group Call Number ack .....              | 150        |
| 12.1.3                        | Allocate Group Call Number negative response..... | 150        |
| 12.1.4                        | Release Group Call Number .....                   | 150        |
| 12.1.5                        | Send Group Call Info.....                         | 150        |
| 12.1.6                        | Send Group Call Info ack .....                    | 150        |
| 12.1.7                        | Send Group Call Info negative response.....       | 151        |
| 12.2                          | Messages on the E-interface (MSC-MSC) .....       | 151        |
| 12.2.1                        | Prepare Group Call .....                          | 151        |
| 12.2.2                        | Prepare Group Call ack.....                       | 151        |
| 12.2.3                        | Prepare Group Call negative response.....         | 151        |
| 12.2.4                        | Send Group Call End Signal .....                  | 152        |
| 12.2.5                        | Forward Group Call Signalling.....                | 153        |
| 12.2.6                        | Process Group Call Signalling.....                | 153        |
| 12.2.7                        | MT Forward Short Message for VGCS Request .....   | 154        |
| 12.2.8                        | MT Forward Short Message for VGCS Response.....   | 154        |
| 12.2.9                        | Send Group Call Info.....                         | 155        |
| 12.2.10                       | Send Group Call Info ack .....                    | 155        |
| 12.2.11                       | Send Group Call Info negative response.....       | 156        |
| 12.3                          | Messages on the I-interface (MSC-GCR) .....       | 156        |
| 12.3.1                        | GCR Interrogation .....                           | 156        |
| 12.3.2                        | GCR Interrogation ack.....                        | 158        |
| 12.3.3                        | GCR interrogation negative response .....         | 158        |
| 12.3.4                        | Call released.....                                | 159        |
| 12.3.5                        | GCR SMS Interrogation .....                       | 159        |
| 12.3.6                        | GCR SMS Interrogation Response .....              | 159        |
| 13                            | List of system parameters.....                    | 159        |
| 13.1                          | Timers .....                                      | 159        |
| 13.1.1                        | Txx.....  | 159        |
| 13.1.2                        | T1.....   | 159        |
| 13.1.3                        | T2.....   | 160        |
| 13.1.4                        | Tbb.....  | 160        |
| 13.1.5                        | Ttv.....  | 160        |
| 13.1.6                        | Tast .....  | 160        |
| 13.1.7                        | T3.....   | 160        |
| <b>Annex A (informative):</b> | <b>Change History .....</b>                       | <b>161</b> |
| History .....                 |   | 165        |

---

# Foreword

This Technical Specification has been produced by the 3<sup>rd</sup> Generation Partnership Project (3GPP).

The contents of the present document are subject to continuing work within the TSG and may change following formal TSG approval. Should the TSG modify the contents of the present document, it will be re-released by the TSG with an identifying change of release date and an increase in version number as follows:

Version x.y.z

where:

- x the first digit:
  - 1 presented to TSG for information;
  - 2 presented to TSG for approval;
  - 3 or greater indicates TSG approved document under change control.
- y the second digit is incremented for all changes of substance, i.e. technical enhancements, corrections, updates, etc.
- z the third digit is incremented when editorial only changes have been incorporated in the document.

---

# 1 Scope

The present document specifies the stage two description of the Voice Group Call Service (VGCS) which allows speech conversation of a predefined group of service subscribers in half duplex mode on the radio link taking into account multiple subscribers involved in the group call per cell.

---

# 2 References

The following documents contain provisions which, through reference in this text, constitute provisions of the present document.

- References are either specific (identified by date of publication, edition number, version number, etc.) or non-specific.
- For a specific reference, subsequent revisions do not apply.
- For a non-specific reference, the latest version applies. In the case of a reference to a 3GPP document (including a GSM document), a non-specific reference implicitly refers to the latest version of that document *in the same Release as the present document*.

- [1] Void.
- [1a] 3GPP TR 21.905: "Vocabulary for 3GPP Specifications".
- [2] 3GPP TS 42.068: "Voice Group Call Service (VGCS); Stage 1".
- [3] 3GPP TS 43.022: "Functions related to Mobile Station (MS) in idle mode".
- [4] 3GPP TS 23.067: "enhanced Multi-Level Precedence and Pre-emption service (eMLPP); Stage 2".
- [5] 3GPP TS 44.018: "Mobile radio interface layer 3 specification; Radio Resource Control Protocol".
- [6] 3GPP TS 45.008: "Radio subsystem link control".
- [7] 3GPP TS 24.008: "Mobile radio interface Layer 3 specification; Core network protocols; Stage 3".
- [8] ITU-T Recommendation E.164: "The international public telecommunication numbering plan".
- [9] 3GPP TS 42.009(Rel-4): "Security aspects".
- [10] 3GPP TS 43.020: "Security related network functions".
- [11] 3GPP TS 44.068: "Group Call Control (GCC) protocol".
- [12] 3GPP TS 22.083: "Call Waiting (CW) and Call Hold (HOLD) supplementary services; Stage 1".
- [13] 3GPP TS 29.002: "Mobile Application Part (MAP) specification".
- [14] 3GPP TS 23.040: "Technical realization of the Short Message Service (SMS)".
- [15] 3GPP TS 24.011: "Point-to-Point (PP) Short Message Service (SMS) support on mobile radio interface".
- [16] 3GPP TS 28.062: "Inband Tandem Free Operation (TFO) of Speech Codecs; Service Description; Stage 3".
- [17] 3GPP TS 23.236: "Intra-domain connection of Radio Access Network (RAN) nodes to multiple Core Network (CN) nodes".



## 3 Definitions and abbreviations

### 3.1 Definitions

For the purposes of the present document, the terms and definitions given in 3GPP TS 42.068 and the following apply:

**group call anchor MSC:** the MSC responsible for managing and maintaining a particular voice group call  
The group call anchor MSC is determined as the one controlling the cells of the group call area (see also group call relay MSC). For voice group call services where the group call area exceeds one MSC area, the group call anchor MSC is predefined in the network.

**Group Call Attributes (GCA):** group call area, dispatcher identities, and the non-activity time which results in the release of the voice group call by the network

**group call relay MSC:** the MSC controlling cells of a group call area which are not under control of the group call anchor MSC for those voice group call services where the group call area exceeds one MSC area

**Group Call Register (GCR):** functionality in the network containing the group call attributes

**group call serving MSC:** In a RANflex configuration the group call serving MSC of a location area is a group call anchor MSC or a group call relay MSC that controls the group call signalling for this location area. A location area within the pool area has a unique group call serving MSC. For a service subscriber located in this location area the visited MSC may be different from the location area's group call serving MSC.

In a RANflex configuration all location areas within a BSC service area are assigned to the same group call serving MSC.

**group members:** service subscribers entitled to belong to a particular group classified by a certain group identification (group ID)

**group mode dedicated channel:** In this mode, a mobile station participating in an ongoing voice group call is allocated at least two dedicated channels, only one of them being a SACCH

**notification:** notifications are given on common control channels or dedicated channels in order to inform group members which are either in idle mode or in dedicated mode or participating in a voice group call or voice broadcast call on the existence of voice group calls

**Notification Channel (NCH):** common control channel on which the notifications are sent by the network (equivalent to a paging channel)

**originator-to-dispatcher information:** information sent by the service subscriber originating a voice group call to the network during call setup for distribution to the dispatchers to be attached to the group call during call setup

**RANflex configuration:** A network configuration that allows a location area to be served by multiple MSCs in parallel. For details see 3GPP TS 23.236 [17]

**voice group call channel:** combined uplink/downlink to be allocated in a cell of the group call area for a particular voice group call  
The uplink can be used by the presently talking service subscriber only. All mobile stations of the listening service subscribers in one cell shall listen to the common downlink.

**voice group call member:** any group member or dispatcher participating in an on going voice group call

**point-to-point short message:** information that may be transferred between a mobile station and a Service Center

**time-critical application-specific data:** application-specific data which shall be transferred within the time limitation specified in 3GPP TS 42.068.

For the purposes of the present document, the following terms and definitions given in 3GPP TS 24.008 [7] apply.

**dedicated mode**  
**group receive mode**  
**group transmit mode**

## 3.2 Abbreviations

For the purpose of the present document, the abbreviations given in 3GPP TR 21.905 [1a] and the following apply:

|       |   |
|-------|---|
| AMR   | Adaptive Multi-Rate                             |
| CC    | Country Code                                    |
| D-ATT | Downlink Attach                                 |
| DA    | Downlink Attach                                 |
| DRX   | Discontinuous reception                         |
| DTMF  | Dual Tone Multi Frequency                       |
| EFR   | Enhanced Full Rate                              |
| eMLPP | enhanced Multi-Level Precedence and Pre-emption |
| GCA   | Group Call Attributes                           |
| GCR   | Group Call Register                             |
| NCH   | Notification Channel                            |
| NDC   | National Destination Code                       |
| SN    | Subscriber Number                               |
| UA    | Uplink Attach                                   |
| VBS   | Voice Broadcast Service                         |
| VGCS  | Voice Group Call Service                        |

---

## 4 Main concepts

### 4.1 Group definition

Service subscribers can become group members on a PLMN wide basis to one or more groups pre-defined in the network by a corresponding group identification (group ID). The membership enables them to initiate or receive voice group calls associated with that group ID. Certain dispatchers connected to external networks also require the capability to initiate or receive voice group calls.

A prefix can be used together with the group ID to define a subset of the group members and to restrict the group of service subscribers able to receive a voice group call to this subset.

In addition to subscriber details in the HLR, it is necessary for the mobile station to be aware of its group membership by storing details on the SIM/USIM. This is required because it shall respond to notification messages which include only the group ID (i.e. no IMSI or TMSI details).

Having become a group member, each service subscriber can set to active state or deactive state the group ID or any one out of his several group IDs on the SIM/USIM. In active state the subscriber can initiate voice group calls to that group. When in deactive state the subscriber can not make voice group calls to the group and the mobile station ignores any notification for that group.

If no NCH is defined in the cell, mobiles shall assume VGCS service is not available on that cell.

### 4.2 Group conversations

#### 4.2.1 Group call initiation

##### 4.2.1.1 Normal operation with successful outcome

A group call area can be restricted to a single MSC area or can exceed one MSC area. In a RANflex configuration a group call area can be restricted to a single pool area or can exceed one pool area.

A voice group call shall be initiated by a calling service subscriber by a related input function, e.g. via MMI, specifying the selected service and the group ID dialled or by a calling dispatcher by the MSISDN address (see subclause 9.2). As

an option, a calling service subscriber may add a prefix to the group ID. As an option, the request of the calling service subscriber to set up a voice group call may specify information to be sent as originator-to-dispatcher information to the network; in this case the originator-to-dispatcher information is included in the signalling for call setup from the mobile station to the network. It is the responsibility of the input function to ensure that the originator-to-dispatcher information has a correct format (in particular, an allowed length).

As a further option, the request of the calling subscriber may indicate one of the following talker priorities, listed in ascending order of talker priority:

- normal subscriber;
- privileged subscriber;
- emergency subscriber.

A mobile station supporting the use of talker priorities shall check with the SIM/USIM whether the subscriber is allowed to use the requested talker priority for the respective group ID before signalling the talker priority to the network.

On reception of a VGCS setup request with a talker priority different from "normal subscriber", the MSC shall check with the VLR whether the subscriber has a subscription to use this talker priority. If the subscriber is not allowed to use the requested talker priority, the MSC shall reduce the talker priority to a value the subscriber is allowed to use. In any case the talker priority used by the MSC shall be signalled back to the calling service subscriber in the Connect message.

If a VGCS setup request with talker priority "emergency subscriber" is received by the network and the subscription check is successful, the network shall set the emergency mode for this voice group call. The emergency mode may be reset during the voice group call (see subclause 4.2.2.1).

If a prefix is added to the group ID, the MSC shall ignore the prefix when performing the subscription check.

The MSC in which a voice group call is initiated obtains the group call attributes by requesting the Group Call Register (GCR, see clause 5). Without a RANflex configuration or in a RANflex configuration, if visited MSC and group call serving MSC are identical, the MSC performs a local GCR interrogation.

The local GCR interrogation after call initiation also determines whether the MSC shall act as anchor or as relay MSC. If the MSC is not the anchor MSC then the call will be "forwarded" from the relay to the respective anchor MSC (information also delivered by GCR) and further "call-establishment" is done by the anchor MSC as described in the following.

In a RANflex configuration the VMSC in which a voice group call is initiated may be different from the group call serving MSC of the voice group call initiating subscriber's location area. In this case the VMSC derives the identity of the group call serving MSC from the initiating subscriber's LAC and requests the group call anchor MSC address from the group call serving MSC's GCR by means of the SEND\_GROUP\_CALL\_INFO MAP service. The call is then "forwarded" from the VMSC to the anchor MSC and further "call-establishment" is done by the anchor MSC as described in the following.

When a calling service subscriber or calling dispatcher initiates a voice group call, one voice group call channel shall be established in each cell of the group call area and notifications for that call shall be sent in each of these cells. As an alternative, voice group call channels may only be established in cells in reaction to responses received from mobile stations on the notifications using notification response procedure. At the same time standard connections to dispatchers in the mobile network or in an external network shall be established. If originator-to-dispatcher information has been received in the signalling for call setup from the mobile station to the network and if the originating MSC supports processing of originator-to-dispatcher information, this information is transformed into user-to-user information and sent to the dispatchers as UUS1 when setting up the standard connections.

A voice group call channel shall consist of a combined uplink/downlink. The uplink will be used exclusively by the presently talking service subscriber. All mobile stations of the listening service subscribers in one cell shall only listen to the same common downlink.

During call establishment there are different options for the network to allocate a speech channel for the calling service subscriber:

In the first option, the calling service subscriber shall have its dedicated standard connection during call establishment and for the first period when he will be the talking service subscriber up to the time when the network decides that he

shall join the voice group call channel. The mobile station of the calling service subscriber shall then go to the voice group call channel and the dedicated standard connection shall be released.

In the second option, the network shall allocate a dedicated signalling channel (e.g. SDCCH) to be used by the mobile station up to the time when the voice group call channel in the originating cell is established and the network decides that the mobile station shall join the voice group call channel.

Only one voice group call channel shall be established in each cell for any given voice group call, although there may be a number of simultaneous voice group calls within the same cell.

Destination service subscribers shall be notified on the voice group call in each cell. These voice group call notification messages shall be broadcast on the Notification CHannel (NCH).

The notification messages use the group ID rather than individual TMSIs/IMSI. If the length of the group ID is less than 8 decimal digits, then the group call area ID is used in order to enable a resolution in the case of overlapping group call areas. A service subscriber's mobile station needs to be able to recognise notification messages for those group IDs subscribed to and presently activated. If the mobile station supports the use of prefixes with group IDs and has stored prefixes for a group ID, it shall take these prefixes into account following detection of a match of the group ID.

The network may also send messages on appropriate voice group call channel FACCHs, in order to notify group call members who may participate in other voice group calls. In addition, also paging information messages for standard calls may be sent in order to inform group call members on actually paged point-to-point calls.

Further the network may provide notification on the voice group call to service subscribers who have subscribed to the paged group ID and which are in dedicated mode. The process of broadcasting messages on NCHs is to be carried out throughout the call in order to provide the "late entry" facility whereby group members entering the area can join the call.

If the emergency mode is set for a voice group call, the network shall include an emergency mode indication in the voice group call notification messages sent on the NCH, the group call channel FACCHs of all other ongoing voice group calls, voice broadcast calls, and the FACCHs associated with dedicated channels.

On receiving notification of a voice group call a group call member's mobile station shall adjust to the nominated channel to receive the voice group call if this channel was described in the notification message and receive the information on the downlink. Whilst receiving, the mobile station shall not transmit on the uplink SACCH. This group receive mode is different to the normal idle mode or dedicated mode. If no channel description was provided in the notification message, the mobile station shall establish a dedicated connection by use of the notification response procedure in order to respond to the notification. The network may then provide the mobile station with a channel description for the voice group call.

As a further mobile station option, the mobile station may read its paging subchannel in the current cell while in group receive mode or in group transmit mode in order to receive paging messages for mobile terminated calls.

#### 4.2.1.2 Exceptional procedures

Completion of links into congested cells where pre-emption did not occur is required.

On receiving details of a voice group call the user may choose to move to the notified call or the mobile station may automatically move to the notified call if the new call is of higher priority than the existing call and automatic acceptance applies for this priority level.

### 4.2.2 On-going group calls

#### 4.2.2.1 Normal operation with successful outcome

Within each voice group call starting from the instant where the calling service subscriber first becomes a listening service subscriber, one service subscriber has the access at any one time to the uplink of the voice group call channel and his speech is then broadcast on all voice group call channel downlinks accordingly. The mobile station of the talking service subscriber who uses the uplink of the voice group call channel can be commanded by the network to mute or unmute the downlink of the voice group channel when needed. The mobile station is commanded:

- to mute the downlink in order to avoid non intelligible echoes (in this case, the talking service subscriber can not hear dispatcher's voice); and

- to unmute the downlink in order to hear dispatcher's voice .

DTMF shall be used by dispatchers to trigger network signalling to mute and un-mute the downlink of a talking service subscriber as described in subclause 11.3.7.2.

If more than one service subscriber applies for the uplink, contention resolution shall be performed in the network. Contention resolution shall be performed in the group call anchor MSC.

Additionally, in order to speed up the uplink access procedure, the BSS may grant the uplink prior to contention resolution being performed by the group call anchor MSC. This would mean that more than one service subscriber may access to the uplink and the respective speech may be combined in the group call bridge and broadcast onto all voice group call downlink channels during a transitional period. The anchor MSC shall then select one of the talking subscribers and pre-empt the uplink use of the other talking subscribers.

Dispatchers' voice involved shall be broadcast on the voice group call channel downlink at any time. Mobile dispatchers are provided with a standard link and thus with a dedicated permanent uplink different from the voice group call channel.

All non-dispatcher group call members are provided with an indication on the voice group call channel of whether the uplink is in use. If a network supports the use of talker priorities, it shall indicate the talker priority of the current talking service subscriber together with this uplink busy indication, and repeat the uplink busy indication periodically. When the uplink is not in use, any non-dispatcher group call member can request access to the uplink. Any speech from dispatchers is combined with any speech from a talking service subscriber.

The talker priorities specified in subclause 4.2.1.1 can be included by the mobile station in the uplink access message or priority uplink request message and used by the network to prioritize between different uplink requests or between an uplink request and the priority of the current talker. A mobile station shall not include a talker priority different from "normal subscriber" in the uplink access message and shall not send a priority uplink request message, if the network has indicated in the uplink busy message that talker priorities are not supported.

An uplink request with talker priority "normal subscriber" is signalled as an uplink request without talker priority.

If a subscriber requests for the uplink while the uplink is in use, a mobile station supporting the use of talker priorities shall signal the request to the network only if:

- the subscriber is allowed to use the requested talker priority for the respective group ID;
- the network supports the use of talker priorities. The mobile station shall assume that the network supports talker priorities, until the mobile station receives an uplink busy indication containing no talker priority information; and
- the requested talker priority is higher than the talker priority of the current talking service subscriber. The mobile station shall consider the talker priority of the current talking service subscriber to be "normal subscriber", until it receives an uplink busy indication indicating the actual talker priority.

If the BSS receives an uplink access message with a talker priority different from "normal subscriber", a BSS supporting the use of talker priorities shall delay the sending of the uplink request message to the MSC, until the MS identity, IMSI or TMSI, is received from the MS with the subsequent layer 3 message talker indication. The BSS shall then include in the uplink request message the layer 3 message, the requested talker priority, and the cell identity of the cell where the uplink access message was received.

If the BSS receives a layer 3 message priority uplink request, it shall include the MS identity received from the MS in the uplink request message. The BSS shall also include, in the uplink request message, the requested talker priority and the cell identity of the cell where the priority uplink request message was received.

The BSS shall send the uplink request message to the MSC only if the uplink is free or if the talker priority included in the uplink access is higher than the talker priority of the current talking service subscriber. If the layer 3 message is transmitted in the uplink request message, the BSS may omit the sending of the uplink request confirm message.

In a RANflex configuration, if the group call serving MSC receives an uplink request message it shall check by analysing the NRI of the requesting subscriber's TMSI whether it is the requesting subscriber's VMSC. If it is not, the group call serving MSC shall retrieve the IMSI and information about subscribed talker priorities from the VLR of the VMSC by means of the MAP service SEND\_GROUP\_CALL\_INFO. During this MAP operation the VMSC shall check the subscription for the group ID.

In any configuration, if the MSC receives a talker request with a talker priority different from "normal subscriber" from the BSS, the MSC shall check whether the subscriber has a subscription to use this priority:

- if the subscriber is allowed to use the requested priority, the network shall disconnect the uplink allocated to the current talking service subscriber and assign the uplink to the requesting service subscriber;
- otherwise, the network shall reject the uplink request with cause value "requested option not authorized".

If a talker request with talker priority "emergency subscriber" is received from a subscriber who has a subscription to use this priority, the network shall additionally set the emergency mode and signal the emergency mode indication

- to the listeners of the group call, and
- to the other group members in the group call area with the group ID active, regardless whether they are in idle mode or dedicated mode, or participate in a different group call,

until the emergency mode is reset by a subscriber with a specific subscription to do this. If the uplink is busy then the indication to the listeners shall be given periodically every T1 seconds. The emergency mode indication has no influence on the talker priority handling.

If a subscriber requests to reset of the emergency mode, a mobile station supporting the use of talker priorities shall send an uplink access message or priority uplink request message indicating "emergency mode reset request" only if

- the subscriber has a subscription for this request for the respective group ID; and
- the network indicates that the emergency mode is set.

If the BSS receives an uplink access message with an "emergency mode reset request", a BSS supporting the use of talker priorities shall wait until the MS provides the MS identity, IMSI or TMSI, with the subsequent layer 3 message talker indication. Then the BSS shall send an emergency reset indication to the MSC including the layer 3 message and the cell identity of the cell where the uplink access message was received.

If the BSS receives a layer 3 message priority uplink request, it shall include the MS identity received from the MS in the emergency reset indication. The BSS shall also include, in the emergency reset indication message, the cell identity of the cell where the priority uplink request message was received.

If the MSC receives an emergency reset indication from the BSS, the MSC shall check whether the subscriber has a subscription for this request. If so, the network shall:

- stop sending the emergency mode indication; and
- set the talker priority to "normal subscriber", if the uplink status is uplink busy with talker priority "emergency subscriber".

If the subscriber has no subscription for the request or if the emergency mode is not set, then the MSC shall discard the request.

The receipt of an "emergency mode reset request" does not trigger a talker change.

If more than one service subscriber applies for the uplink, the one with the highest talker priority shall be accepted. An uplink access message or priority uplink request message with an "emergency mode reset request" shall be treated with higher priority than any uplink request with talker priority "normal subscriber", "privileged subscriber" or "emergency subscriber". If several requests with the same highest priority are received, contention resolution between these requests shall be performed in the network. For the ranking of uplink access messages by the BSC, if the network additionally supports the transfer of time-critical application-specific data, see subclause 4.2.8.2.2 a.

Contention resolution shall be performed by the BSC, relay MSC or anchor MSC which is the first to detect that more than one request with the same highest priority was received. An MSC performing contention resolution shall select the service subscriber whose request was received first by the MSC and pre-empt the uplink use of the other service subscribers. For contention resolution performed by the BSC see subclause 11.3.7.1.

Mobile stations shall support the reception of additional information related to the current talking service subscriber. The transmission of additional information is optional for the network. If additional information is provided, then it is periodically repeated by the network as long as the current talking service subscriber keeps the uplink. The additional information consists of a string of up to 17 octets and is stored in the HLR as part of the subscription data of the subscriber. The contents and the encoding of the additional information is operator specific.

The release of the uplink is triggered by the user and indicated by the mobile station to the network. The network shall then indicate to the listening mobile stations that the uplink is free.

Mobile stations in group receive mode use the group receive mode procedure (see 3GPP TS 43.022) to "camp-on" in a new cell to be able to listen to the group call channel. The mobile station may find the voice group call channel details of a new cell on the related NCH.

A network may decide not to establish voice group call channels in all cells. Instead, notifications containing no channel description may be provided. If a mobile station moves to such a cell, it must establish a dedicated connection and respond to the notification by use of the notification response procedure in order to receive the voice group call. The network may then establish a voice group call channel and inform the mobile station on the channel position.

If the uplink reply procedure is applicable for the voice group call, the network may obtain knowledge on whether mobile stations are listening in a cell by sending an uplink access request (perform uplink reply procedure) in an uplink free message on the voice group call channel downlink when no talking service subscriber is present in the cell. Mobile stations receiving such a request shall use uplink reply procedure and send uplink access bursts on the voice group call channel uplink with the establishment cause "reply on uplink access request". If no uplink access bursts are received by the network, the network may decide to release the voice group call channel in that cell and then provide notifications containing no channel description.

**NOTE:** Concerning security aspects, whilst authentication and membership checking of mobile call originators and of mobile uplink users can be carried out, it is not possible to authenticate service subscribers in group receive mode if they have not before established a dedicated connection to respond to a notification. No equivalent of a group "TMSI" is provided to protect the "identity" of established voice group calls.

The network may decide to reconfigure an existing voice group call's physical channel configuration, frequencies and/or hopping sequences as well as the cell channel description. For the cell in which the group call is being reconfigured, the network informs any listeners in group receive mode and any talker in group transmit mode of the change in VGCS channel description by using the VGCS reconfiguration procedure (see 3GPP TS 44.018 [5]). Mobile stations on receipt of the VBS/VGCS reconfiguration messages shall remain on the existing group channel until indicated starting time and then apply the new configuration to the VGCS call that the mobile station is currently involved in.

#### 4.2.2.2 Exceptional procedures

When a talking subscriber's mobile station loses contact with the network, the network must detect this loss and set the uplink free so that other mobile stations may access the uplink. The talking subscriber's mobile station which has lost the contact with the network shall return immediately to the group receive mode.

If a mobile station in group receive mode indicates a failure due to radio link time-out, the mobile station shall behave as specified in 3GPP TS 45.008 and go back to idle mode, possibly in another cell, as determined by the cell re-selection algorithm. If a notification is received for the same call, the mobile station shall try to reconnect.

#### 4.2.3 Leaving of a group call without termination

A service subscriber can leave the voice group call at any point by "deselecting" it via an MMI function. Having deselected the voice group call the mobile station returns to idle mode and "ignores" any further notification messages related to that voice group call.

**NOTE:** If a service subscriber does not wish to participate in calls to a particular group ID for long periods of time, the group ID shall be switched to deactive state by the subscriber.

The service subscriber shall have the capability to reselect the voice group call. The mobile station shall not ignore notification messages to that call any more.

The dispatcher shall be able to leave a voice group call without terminating it.

#### 4.2.4 Group call termination

A voice group call can only be terminated by the calling service subscriber, by calling dispatcher, by an entitled dispatcher or due to no activity timer expiry (see subclauses 8.1.2.3 and 11.3.2.3).

The calling service subscriber can terminate the call only if he has access to the uplink. He shall remain the calling service subscriber during the length of the particular voice group call even if he leaves the call and then returns to it later.

An entitled dispatcher can terminate the call at any time by using a network defined user operation (via DTMF).

## 4.2.5 Acknowledgements

The acknowledgement is an application option.

For voice group calls which are identified by an acknowledgement flag mobile stations which have acknowledgement facilities have to return an acknowledgement message with a predefined content in a predefined manner.

The acknowledgement shall be sent using an appropriate data service, to a predefined address or with a predefined short code stored on the SIM/USIM card. The network may apply geographical routing to a predefined acknowledgement service centre.

## 4.2.6 Transactions between the mobile station and the network

Mobile stations which are in group receive mode may support the reception of short messages to voice group calls, but shall not perform any other transactions with the network while adjusted to the voice group call channel. They shall leave the group receive mode and act in a standard way to perform any transaction if necessary and return to the voice group call afterwards.

Mobile stations which have access to the voice group call channel uplink shall not perform any transactions for supplementary services, but may support the transmission and reception of short messages as specified in subclause 11.3.9.

## 4.2.7 Processing of originator-to-dispatcher information

The calling service subscriber may include originator-to-dispatcher information during call setup. If the originating MSC supports processing of originator-to-dispatcher information, it transforms the received originator-to-dispatcher information into UUS1, and sends it:

- if the originating MSC is not the voice group call anchor MSC: to the voice group call anchor MSC;
- if the originating MSC is the voice group call anchor MSC: to the dispatchers to be attached to the group call during call setup of the connections to these dispatchers.

The anchor MSC receiving UUS1 in a voice group call setup from an originating relay MSC forwards this UUS1 to the dispatchers to be attached to the group call during call setup of the connections to these dispatchers.

**Transformation of originator-to-dispatcher information:** Originator-to-dispatcher information can be compressed or uncompressed.

- Decompression of compressed originator-to-dispatcher information is specified in 3GPP TS 44.068.
- The transformation of uncompressed originator-to-dispatcher information into UUS1 is the UUS1 containing the same user-user IE as the originator-to-dispatcher information.
- The transformation of compressed originator-to-dispatcher information into UUS1 is the UUS1 resulting from transforming the decompressed originator-to-dispatcher information into UUS1.

## 4.2.8 Transfer of application-specific data to group call members

### 4.2.8.1 General

Mobile stations may support the transmission of application-specific data to other group call members or VGCS applications in the network, and the reception of application-specific data from other group call members or VGCS applications in the network during an ongoing voice group call, in parallel to the voice conversation.

Service subscribers can request the transmission of application-specific data while they are talker or listener.



**Editor's note: The transmission and reception of application-specific data by dispatchers is ffs.**

A mobile station supporting the transmission of application-specific data shall check with the USIM whether the subscriber is allowed to transmit application-specific data for the respective group ID before starting the signalling procedures specified in subclause 4.2.8.

The procedure specified in the following subclauses supports the transfer of application-specific data.

The same procedure can also be used by the receiver of application-specific data to confirm the reception of application-specific data.

**NOTE:** For the exact upper limit of application-specific data that can be sent in a single transmission see 3GPP TS 44.018 [5]. The upper limit will be chosen so that the application-specific data together with the necessary control information fit into a single SABM frame.

The support of the transfer of application-specific data by the network is an operator option.

The exact format of the application-specific data is out of scope of the 3GPP specifications. If roaming service subscribers from other PLMNs are to be supported or if a group call area includes cells from more than one PLMN, the use of application-specific data requires coordination between the operators.

## 4.2.8.2 Sending of application-specific data

### 4.2.8.2.1 By the talking service subscriber

When application-specific data is to be sent and the talking subscriber is allowed to transmit application-specific data for the respective group ID, the mobile station of the talking service subscriber shall send a DATA INDICATION (Application\_Data) message to the network on the uplink of the dedicated channel or group call channel. On receipt of the application-specific data, the network shall transmit these data to the other group call members as specified in subclause 4.2.8.4.

**NOTE:** If the talker has to release the uplink before sending application-specific data, the MS follows the procedures specified in subclause 4.2.8.2.2.

### 4.2.8.2.2 By a listener

When application-specific data is to be sent and the network indicates the uplink as free, the listener shall use the group call channel uplink for the signalling as specified in item a) below.

Otherwise, when the network does not indicate the uplink as free, the channel to be used by the listener is indicated by the network in the "uplink access indication" IE sent in periodic transmissions of the UPLINK BUSY message. If the talking service subscriber uses the group call channel uplink in the current cell, the RACH shall be used, see item b) below; otherwise the group call channel uplink shall be used, see item a) below.

#### **a) Sending application-specific data via the group call channel uplink**

When application-specific data is to be sent and the listener is allowed to transmit application-specific data for the respective group ID, the mobile station of the listener shall send an UPLINK ACCESS message with an appropriate establishment cause ("UL request for sending application-specific data") on the group call channel uplink to the BSS.

It is an operator option whether the BSS treats an UPLINK ACCESS message with establishment cause "UL request for sending application-specific data" with higher or lower priority than UPLINK ACCESS messages with any other establishment cause. The same order of priorities applies to all voice group calls in a network. If the BSS grants the uplink of the group call channel, then the MS sends a SABM (DATA INDICATION) message with its mobile identity and the application data to the network. The serving BSS responds with a UA (DATA INDICATION) message and releases the group call channel uplink. The MS returns to group receive mode.

On receipt of the DATA INDICATION message, the BSC shall add the cell identifier of the cell where the application data were sent from and passes the L3 information by sending the UPLINK APPLICATION DATA message to the MSC.

On receipt the UPLINK APPLICATION DATA message, the MSC shall distribute the data to all members of the group call (see subclause 4.2.8.4).

NOTE 1: Procedure a) is used to achieve the transfer time target for time-critical data. If all MSCs and BSCs involved in the voice group call support the feature "talker channel parameter", the "talker channel parameter" can be used to ensure that the voice group call channel uplink is available for the uplink access and the transmission of time-critical application-specific data.

NOTE 2: In a network that is intended to support the transfer of time-critical data, the BSS will usually be configured to treat an uplink request for sending application-specific data with higher priority than any other uplink requests.

#### **b) Sending application-specific data via the RACH**

When application-specific data is to be sent and the listener is allowed to transmit application-specific data for the respective group ID, the mobile station of the listener shall leave the group call and send a CHANNEL REQUEST message with an appropriate establishment cause on the RACH to the BSS in order to request an SDCCH. When a new layer 2 connection is established on a SDCCH channel the data can be sent by the mobile station to the network with the DATA INDICATION 2 message on the main DCCH (figure 7j).

In order to indicate to the network which group call the application-specific data is addressed to, the DATA INDICATION 2 message shall include the group call reference.

On receipt of the DATA INDICATION 2 message the BSC shall add the cell identifier of the cell from which the application data was sent and pass the L3 information in the UPLINK APPLICATION DATA message to the MSC.

On receipt of the UPLINK APPLICATION DATA message, the MSC shall distribute the data to all members of the group call (see subclause 4.2.8.4).

#### **4.2.8.3 Sending a confirmation of receipt of application-specific data**

On receiving application-specific data, any service subscriber can send a confirmation to the network which will send the confirmation to the ongoing group call.

For the purpose of identifying the received data, the confirmation shall include the data\_id which was received in the message that contained the application data that is being confirmed.

The further proceeding is as described in 4.2.8.2.1 and 4.2.8.2.2 (see also figure 7i).

#### **4.2.8.4 Distributing application-specific data to a voice group call**

##### **4.2.8.4.1 Distribution via the MSC**

On receipt of the UPLINK APPLICATION DATA, the MSC shall check if the sending subscriber has a subscription to the group ID. If yes, the MSC shall distribute the application-specific data dependent on the distribution parameter included in the DATA INDICATION or DATA INDICATION 2 message; otherwise the MSC shall discard the UPLINK APPLICATION DATA message.

If the application-specific data are to be sent to the listeners and the talking service subscriber, the MSC shall proceed as follows:

If the MSC is the anchor MSC, it shall put the application data and optionally the mobile subscriber's MSISDN into the BSSMAP message NOTIFICATION DATA and distribute the message towards all relay MSCs and all BSSs in its MSC area involved in the group call (figure 7f). If the MSC receives an indication from the originating BSC that the application-specific data were immediately distributed to the originating BSS area (see subclause 4.2.8.4.2), the MSC shall not send the BSSMAP message NOTIFICATION DATA to the originating BSS.

If the MSC is a relay MSC, it shall put the application data and optionally the mobile subscriber's MSISDN into the BSSMAP message NOTIFICATION DATA and distribute the message to the anchor MSC and all BSSs of the relay MSC area. If the MSC receives an indication from the originating BSC that the application-specific data were immediately distributed to the originating BSS area (see subclause 4.2.8.4.2), the MSC shall not send the BSSMAP message NOTIFICATION DATA to the originating BSS. On receiving the NOTIFICATION DATA message from the relay MSC, the anchor MSC shall send the message towards all BSSs in its MSC area involved in the group call and to all relay MSCs except the relay MSC from which the NOTIFICATION DATA was received (figure 7h). The BSS shall broadcast the notification data to all listeners and talking service subscriber in the NOTIFICATION APPLICATION DATA message on the FACCH.

The network may repeat the NOTIFY APPLICATION DATA message for application-specific data on the group call channel downlink. If a mobile station receives the NOTIFY APPLICATION DATA message more than once, it shall deliver only the first received message to its local application and discard any received repetitions of the message.

The mechanism how the mobile station detects a repetition of the NOTIFY APPLICATION DATA message is application-specific.

*Editor's note: The sending of application-specific data to other destinations (e.g. dispatchers or applications) is ffs.*

#### 4.2.8.4.2 Immediate distribution by the BSC

As a network option, on receipt of application-specific data from the MS, the BSS may distribute the application-specific data immediately to the cells within the BSC area belonging to the group call area, if the distribution parameter included in the DATA INDICATION message or DATA INDICATION 2 message indicates that the application-specific data are to be sent to the service subscribers. In addition, the BSC shall send the application-specific data to the MSC with an indication that the application-specific data were already distributed to the originating BSC area.

When this network option is used, the BSS cannot include the mobile subscriber's MSISDN in the NOTIFY APPLICATION DATA message broadcast immediately to the cells within the BSC area. Furthermore, the BSS cannot check if the sending subscriber has a subscription for the group ID.

If the network option of immediate distribution of application-specific data by the BSS is activated, then during the establishment phase of the voice group call the BSC shall store the cell identities of the cells belonging to the group call area and served by the BSC.

NOTE: If this option is activated no subscription check by the MSC is possible. It is also not possible to include the mobile subscriber's MSISDN in the NOTIFY APPLICATION DATA message.

---

## 5 General architecture

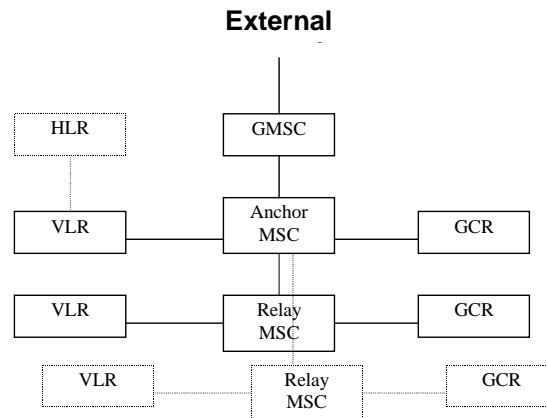
### 5.1 Group Call Register (GCR)

The general architecture of GSM is maintained. In addition, a network function is required which is used for registration of the group call attributes, the Group Call Register (GCR).

The GCR function is mainly a database function, holding information about voice group calls.

NOTE 1: The GCR implementation is not specified. It may be realized e.g. as a new network node, in a PABX directly attached to an MSC, inside an MSC or as an HLR. The interface between the GCR function and other functions is not specified in the GSM technical specifications. As a consequence, the functional split between MSC and GCR as developed in the present document is only indicative, and other functional splits can be implemented.

The GCR data for a specific voice group call is set at the creation of the group call attributes, and can be subsequently modified. No support for these functions is specified in the GSM technical specifications.



**Figure 1: Functional architecture with a Group Call Register**

The signalling between the entities shown in figure 1, for the two cases of service subscriber and dispatcher originated calls, shall be as defined in the following.

**Service subscriber originated:** The service subscriber's VMSC shall perform subscription checking against VLR records. In a RANflex configuration it shall then derive from the service subscriber's current location area the group call serving MSC which may be different from the VMSC.

Without a RANflex configuration or in a RANflex configuration, if the VMSC is the group call serving MSC, the VMSC shall consult its GCR to determine the group call attributes related to its MSC area and whether it is the group call anchor MSC for that voice group call. If it is not, the GCR shall provide with the group call attributes the routing information identifying the group call anchor MSC to the originating MSC. The originating MSC shall then route the voice group call to the anchor MSC.

In a RANflex configuration, if the VMSC is not the group call serving MSC, the VMSC shall consult the group call serving MSC's GCR by means of the MAP service SEND\_GROUP\_CALL\_INFO and retrieve the group call anchor MSC address. The originating MSC shall then route the voice group call to the anchor MSC.

If the initiation of the voice group call had specified originator-to-dispatcher information and processing of originator-to-dispatcher information is supported by the originating MSC, the originator-to-dispatcher information is transformed by the originating MSC into UUS1 and sent to the anchor MSC. If the originating MSC is the group call anchor MSC, along with the group call attributes, the GCR shall provide information on all group call relay MSCs to be involved.

The group call anchor MSC shall set up links to all group call relay MSCs. It shall also initiate setup of point-to-point connections to the dispatchers associated to the voice group call (see subclause 8.1.2.2); if UUS1 information has been received in the signalling for call setup from the originating MSC, this UUS1 information is included in the setup of point-to-point connections to the dispatchers. Each MSC involved in a voice group call obtains its proper group call attributes from the GCR related to the MSC.

The IMSI of the calling service subscriber must be provided to and stored in the anchor MSC and each relay MSC in order to allow the calling service subscriber to clear the group call later on.

**Dispatcher originated:** In the case of dispatchers calling from an external network, the call request, in the form of an ISDN number, shall be received at a GMSC. The number shall be analysed and the call shall be directly routed to the group call anchor MSC by the GMSC based on the called identity without requesting an HLR. The group call anchor MSC shall interrogate the GCR and obtain the group call attributes. If an identical voice group call is currently in progress, the dispatcher shall be connected to this call and no new call shall be initiated. When interrogating the GCR, the identity of the calling dispatcher is compared with the list of dispatchers which are allowed to initiate the call. If the dispatcher is not in the list, or an identity is not provided, the network shall reject the call.

NOTE 2: Optionally dispatchers may also be user of the GSM network in which the VGCS service is provided or may directly be connected to a PABX containing the GCR. Dispatcher which are registered for a certain voice group call and which have also a subscription for VGCS with the same group ID as the voice group call for which they are dispatcher shall deactivate this group ID when they are located in the corresponding group call area in order to avoid conflicts between paging for the dispatcher and notifications for the group ID.

## 5.2 Voice group call responsibility

The MSC responsible for the voice group call is the one nominated within the GCR or the one to which the call is routed from the GMSC in the case of a dispatcher originated call. This MSC is termed the group call anchor MSC.

If the group call area extends beyond one MSC area then any MSCs controlling cells in the area outside of the group call anchor MSC are referred to as group call relay MSCs.

In a RANflex configuration a given location area within the pool area is served (with group call services) by a single predefined group call serving MSC which for a specific group call is either anchor or relay MSC.

---

# 6 Compatibility issues

VGCS can not be used with standard Phase 1 or Phase 2 mobile stations. A dedicated mobile station with VGCS capability is required.

A mobile station with VGCS capability shall also provide the complete functionality in order to allow the use of Phase 2 services.

Standard Phase 1 and Phase 2 mobile stations in a network shall not be impacted by the presence of VGCS services in that network due to VGCS signalling, also if the mobile station is operated with a SIM/USIM of a VGCS service subscriber.

---

# 7 Transmission

## 7.1 Transmission architecture

A conference bridge is required to connect the transmission paths of the nominated cells. The bridge is to be located within the group call anchor MSC. The group call anchor MSC is responsible for setting up all connections, both to the nominated cells (voice group call channels) in the group call anchor MSC (in a RANflex configuration, to those cells of the group call area that belong to a location area for which the group call anchor MSC is the group call serving MSC) and in any related group call relay MSC, and to the dispatchers. Except when a calling service subscriber, served by a relay MSC, is on the initial dedicated link, there shall be one link towards every relay MSC and a distribution function in the relay MSCs and from there one link per cell within the group call relay MSC (in a RANflex configuration, per cell of the group call area that belongs to a location area for which the group call relay MSC is the group call serving MSC) which is involved in the voice group call. While the calling service subscriber is on a dedicated link served by his VMSC, there is an additional link from the anchor MSC to the VMSC serving the calling service subscriber and an additional link from the VMSC serving the calling service subscriber to the cell serving the calling service subscriber. There shall be no secondary bridges in BSCs.

While a talker served by a relay MSC is on any other dedicated or group channel than the initial dedicated channel, the following applies: The distribution function shall be implemented using a secondary conference bridge at the relay MSC so that VGCS talker speech sent on the current channel uplink is transmitted to local relay cells as well as being transmitted over the link back to the anchor MSC, for distribution to the rest of the network, dispatchers and nominated cells at other relay MSCs.

The conference bridge shall not mute the uplink speech.

### 7.1a Transmission architecture – A interface circuit sharing

#### 7.1a.1 Transmission architecture – General

The MSC and BSC shall negotiate during the setup of a voice group call whether A-interface circuit sharing is supported by both entities. When this optional feature is supported by both entities, the same A-interface circuit can be shared for all cells belonging to a BSC for a given voice group call.

A conference bridge is required to connect the transmission paths of the nominated cells. The bridge is to be located within the group call anchor MSC. The group call anchor MSC is responsible for setting up all connections, both to the nominated cells (voice group call channels) in the group call anchor MSC and in any related group call relay MSC, and to the dispatchers

The BSC contains a distribution function that distributes speech sent from the MSC to each of the nominated cells.

## 7.1a.2 Transmission architecture – Control Plane

The control plane signalling shall be the same as in sub-clause 7.1.

## 7.1a.3 Transmission architecture – User Plane

In the case of an originator that is not on the initial dedicated link, there shall be one link from the anchor MSC towards every relay MSC. There will be one link from each of these relay MSCs and the group call anchor MSC to each BSC controlled by the respective MSC and involved in the voice group call. Each of these BSCs contains a distribution function that distributes speech received from the MSC to each cell involved in the group call.

When an originator, served by a relay MSC, is on the initial dedicated link, there is an additional link from the anchor MSC to the relay MSC serving the originator and an additional link from the relay MSC serving the originator to the cell serving the originator.

When an originator, served by an anchor MSC, is on the initial dedicated link, there shall be one link from the anchor MSC towards every relay MSC. There will be one link from each of these MSCs and the group call anchor MSC to each BSC controlled by the respective MSC and involved in the voice group call. Each of these BSCs contains a distribution function, with one link to each cell and involved in the group call. There is an additional link from the anchor MSC to the cell serving the originator.

While a talker served by an anchor MSC is on any other dedicated or group channel than the initial dedicated channel, the following distribution functions shall be implemented:

- conference bridge at the anchor MSC so that VGCS talker speech sent on the current channel uplink is transmitted to local cells as well as being transmitted over the links to the relay MSCs, for distribution to the rest of the network, dispatchers and nominated cells at other relay MSCs;
- distribution point at the BSC so that speech sent from the MSC is distributed to each of the nominated cells.

While a talker served by a relay MSC is on any other dedicated or group channel than the initial dedicated channel, the following distribution functions shall be implemented:

- secondary conference bridge at the relay MSC so that VGCS talker speech sent on the current channel uplink is transmitted to local cells as well as being transmitted over the link back to the anchor MSC, for distribution to the rest of the network, dispatchers and nominated cells at other relay MSCs;
- distribution point at the BSC so that speech sent from the MSC is distributed to each of the nominated cells.

The conference bridge shall not mute the uplink speech.

## 7.1b Transmission architecture – A interface link sharing

### 7.1b.1 Transmission architecture – General

The MSC and BSC shall negotiate during the setup of a voice group call whether A-interface link sharing is supported by both entities. When this optional feature is supported by both entities, the same A-interface link (user and control plane) can be shared for all cells belonging to a BSC for a given voice group call.

A conference bridge is required to connect the transmission paths of the nominated cells. The bridge is to be located within the group call anchor MSC. The group call anchor MSC is responsible for setting up a single A-interface link (i.e. A-interface circuit and resource controlling SCCP connection) to each BSC containing nominated cells in the group call anchor MSC and links to any group call relay MSCs and to the dispatchers.

Each BSC is responsible for setting up a speech and signalling connection (voice group call channel) to each nominated cell in the group call area served by this BSC. The BSC contains a distribution function that distributes speech and resource control related signalling from the MSC to each of the nominated cells.

### 7.1b.2 Transmission architecture – Control Plane

The MSC shall inform the BSC of the cells required to be setup for the group call in the VGCS ASSIGNMENT REQUEST. This message shall contain the list of group call area cells served by this BSC. If the entire list of cell identifiers does not fit into the message or if different methods of radio resource allocation (e.g. "immediate allocation" or "delay allowed") are to be used for different cells controlled by the BSC, the MSC shall send one or more VGCS AREA CELL INFO messages containing the remaining cell identifiers or the cell identifiers of cells using a different method of radio resource allocation. Once a channel could be established to the cell of origin or, if the cell of origin is not served by this BSC, to any other cell, the VGCS ASSIGNMENT RESULT shall be sent to the MSC and timer T<sub>ast</sub> shall be started. Timer T<sub>ast</sub> is used to measure the duration between periodic reports from the BSC to the MSC of group call area cells for which channels have been assigned or released since the last periodic report. When timer T<sub>ast</sub> expires, if new cells in the group call area have been established or existing ones have been released, pre-empted or failed, the MSC shall be informed of the changes. If no changes have taken place nothing shall be sent. Timer T<sub>ast</sub> shall be started again to measure the period of time until the next report. The timer shall be stopped when the call is released.

Once all cells for a given group call area served by a BSC are established this BSC shall immediately send a VGCS ASSIGNMENT\_STATUS message to the MSC indicating this and restart timer T<sub>ast</sub>. This information shall be used by the MSC to determine the conditions for call set up as described in subclause 11.3.1.1.2.

The BSS is responsible to establish the channel to the different cells and manage the signalling accordingly (e.g. HO decisions, pre-emption, re-establishment of cells, priority uplink decision). The A-interface link (user and control plane) between MSC and BSC shall only be released when the call is released.

When the network supports uplink access option (i) as defined in subclause 7.2 (i.e. indication in uplink busy instructs the MS to use the group call channel to send the uplink access message if the talker on the group call channel is not in the same cell as the MS) the network shall include talker priority information in all relevant A-interface messages on the resource controlling SCCP connection, to distinguish between messages related to the current talker and messages related to the subscriber requesting the uplink.

### 7.1b.3 Transmission architecture – User Plane

The transmission architecture of the user plane as specified in subclause 7.1a.3 applies.

## 7.2 Radio channels

In each cell of the group call area one voice group call channel may be established consisting of a downlink received by all service subscribers' mobile stations and an uplink which shall be used by the talking subscriber's mobile station only.

If the network allocates a dedicated traffic channel for the calling service subscriber, his mobile station shall use the dedicated standard uplink/downlink which is connected to the conference bridge up to the instant where the network decides that the mobile station shall join the voice group call channel and the dedicated connection is released.

The network may decide to switch a talking subscriber's mobile station from the voice group call channel to a dedicated standard uplink/downlink at any time. The talking subscriber's voice group call channel and the dedicated channel may belong to different cells within the group call area, i.e. the network may request the talker to perform a handover. The dedicated connection shall then be maintained up to the instance where the network decides that the mobile station shall join the voice group call channel again and the dedicated connection is released.

When the network indicates the uplink as free, the mobile station uses the group call channel uplink to signal an uplink request, "emergency mode reset request" or uplink request for sending application-specific data.

When the network does not indicate the uplink as free, there are two options for the mobile station how to signal an uplink request with talker priority higher than "normal subscriber", an "emergency mode reset request" or an uplink request for sending application-specific data:

- i) if the priority uplink access parameter broadcast on the NCH indicates "RACH access" but the latest UPLINK BUSY message received in the cell indicates that the group call channel uplink shall be used, the mobile station sends an uplink access message on the group call channel uplink; otherwise, the mobile station temporarily leaves the group receive mode and sends a channel request message on the RACH. Once a dedicated connection has been established by the network, the mobile station sends a layer 3 message PRIORITY UPLINK REQUEST or DATA INDICATION 2. The PRIORITY UPLINK REQUEST message contains the MS identity (IMSI or TMSI), the group call reference, random reference, the type of request and the token broadcast by the BSS, if the BSS broadcasts a token. On receipt of this information, the network shall release the dedicated connection, and the mobile station shall return to the group receive mode and continue to listen on the downlink of the group call channel for further instructions from the network.

NOTE 1: The indication in uplink busy instructs the MS to use the group call channel uplink to send the uplink access message if the talker on the group call channel is not in the same cell as the MS.

If the mobile station releases the uplink on request of the subscriber, it shall use the group call channel uplink for signalling subsequent uplink requests, until it performs a cell change or receives either an UPLINK BUSY message indicating that RACH shall be used or a VGCS UPLINK GRANT message destined for a different mobile station.

- ii) If the priority uplink access parameter broadcast on the NCH indicates "group call channel uplink access" then the mobile station always sends an uplink access message on the group call channel uplink. If this option is used, the network shall always establish and maintain a dedicated channel for the talking service subscriber.

NOTE 2: Otherwise, with option (ii) the BSC would not be able to detect the requests of higher privileged talkers in the cell where the current talking service subscriber is located.

Support of both options is mandatory for a mobile station supporting the use of talker priorities or transfer of application-specific data and optional for the network. A network supporting the use of talker priorities or transfer of time-critical application-specific data shall indicate the default procedure to be used on the NCH (i.e. either "RACH access" or "group call channel uplink access"). The indication shall have the same value throughout the network. If the "talker channel parameter" is used in a network, then the value of the indication shall be set to "RACH access".

A listening subscriber's mobile station which responds to a notification because no description of the voice group call channel was provided in the notification may be assigned a dedicated standard uplink/downlink up to the instant where the radio access network decides that the mobile station shall join the voice group call channel and the dedicated connection is released.

Voice group call channels shall be standard full rate or half rate speech channels, EFR speech channels, full rate AMR speech or half rate AMR speech channels. The support of voice group call channels other than full rate speech is a network option. A specific voice group call can use either the same speech codec type in all cells of the group call area or different speech codec types in different cells of the group call area. Those implementations are optional for the network operator.

When establishing an AMR half rate or AMR full rate speech channel, the BSC shall select a suitable AMR codec configuration:

- for a dedicated channel used by a talking service subscriber, the BSC may select any configuration permitted for a point-to-point call;
- for a voice group call channel the BSC shall select one of the preferred configurations as defined in 3GPP TS 28.062 [16], Table 7.11.3.1.3-2. For the downlink the BSC shall disable the rate adaptation mechanism and apply a single codec mode until the channel is released. If the talking service subscriber uses the voice group call channel uplink and the BSC selected a multi-mode configuration, the BSC shall apply the rate adaptation mechanism for the uplink.

Within a cell the BSC shall select the same codec configuration for all voice group and voice broadcast calls using the same AMR codec type, AMR FR or AMR HR, respectively. The selected configuration shall be broadcast on the NCH, as long as at least one voice group or voice broadcast call using the respective AMR codec type is active.

When A-interface circuit sharing or A-interface link sharing applies there is one A-interface circuit allocated for the group call per BSC. Therefore the same speech codec is applied for all voice group channels in the part of the group call area served by one BSC if the TRAU is located between the MSC and the BSC-internal distribution function for speech (see subclause 7.1a.1 and 7.1b.1).



Mobile station using the uplink are in group transmit mode. Signalling for this RR mode is specified in 3GPP TS 44.018. Mobile stations not using the uplink and not in dedicated mode shall ignore any signalling concerned only with uplink usage.

Full standard duplex channels shall be provided to all dispatchers listed in the GCR. These may be provided either via GSM, or via an external network. The links to the dispatchers are connected to the conference bridge.

If the mobile station of the talking service subscriber joins the voice group call channel, it will transmit on the uplink of the voice group call channel.

## 7.3 Data confidentiality

Data confidentiality on the radio can be provided as a network option.

If data confidentiality is provided, both the uplink and the downlink of the voice group call channel within a cell of the group call area shall be ciphered using voice group ciphering keys derived from the same group key, see 3GPP TS 43.020 [10].

The group key is related to the group ID. For each group ID, there is a number of group keys stored on the USIM which are identified by a group key number. The group key number identifying the group key to be used for a particular voice group call is provided with the notification to the mobile stations. Mobile stations which have a dedicated connection shall be informed of the group key number before they join the voice group call channel.

USIM based VGCS ciphering uses a concept of short term keys where the short term key is derived by the GCR and the USIM from the group key and a RAND (random number) parameter. The actual voice group ciphering key is then derived by the BSS and the ME from the short term key, the cell global identifier, and a Cell Global Count parameter.

To include a subscriber into a voice group the required group data (including the 2 master group keys) shall be stored on the USIM, e.g. during the personalisation process or via OTA (over-the-air). To exclude a subscriber from a voice group the group data shall be deleted from the USIM. If a USIM is lost or stolen, all USIMs of the remaining members of the voice groups that this USIM is a member of need to be changed (e.g. via OTA or manual provisioning).

Details on data confidentiality for voice group calls are provided in 3GPP TS 42.009 [9] and 3GPP TS 43.020 [10].

**NOTE 1:** USIM based VGCS ciphering is not compatible with SIM based VGCS ciphering which has not been completely specified. The SIM specifications contain no support for the storage of the group keys. A pre-Rel-6 VGCS capable mobile station will be able to participate in an un-ciphered group call, if it is part of that group.

If data confidentiality is provided, then for a mobile station in group mode dedicated channel the uplink and the downlink of the dedicated channel shall be ciphered using the individual ciphering key of the service subscriber.

**NOTE 2:** The individual ciphering key is the key generated during a previous authentication procedure.

In order to start the ciphering for the calling service subscriber, the MSC serving the mobile station shall initiate a cipher mode control procedure during call setup, while the mobile station is in group mode dedicated channel. When ciphering was started successfully, the mobile station shall apply the individual ciphering key until it leaves group mode dedicated channel or a new cipher mode control procedure is performed successfully.

In order to start the ciphering on the dedicated channel, if the network decides to move a talking subscriber's mobile station from group transmit mode to group mode dedicated channel, the network shall include cipher mode setting information in the assignment command or handover command message (see 3GPP TS 43.020 [10], Annex F 3.2). On the dedicated channel the mobile station shall apply the individual ciphering key until it leaves group mode dedicated channel or a new cipher mode control procedure is performed successfully.

If data confidentiality is provided, then for a mobile dispatcher the uplink and the downlink of the dedicated channel shall be ciphered using the individual ciphering key of the dispatcher.

If data confidentiality is provided, the priority uplink request procedure can be validated by a handshake between the requesting MS and the BSS. A 32 bit token is generated randomly and broadcast by the BSS on the ciphered downlink of the voice group call channel and stored in the MS. When the MS sends a priority uplink request it includes the token as a parameter and the BSS checks this against its stored value. If it matches the request is processed further. If it does not match, the request is ignored. A new token is broadcast on the ciphered downlink of the voice group call channel

each time a match occurs and each time a periodic UPLINK\_BUSY message is sent (i.e. every T1 seconds) (refer to Figure 7e in section 11.3.8).

If data confidentiality is provided for point-to-point SMS over the CS domain, the network shall broadcast an SMS data confidentiality indication in NOTIFICATION/ NCH messages, NOTIFICATION/ FACCH messages and in the Connect message sent to the calling service subscriber of a voice group call.

If guaranteed privacy is provided for SMS over the CS domain (see 3GPP TS 42.068 [2]), the network shall broadcast an SMS guaranteed privacy indication in NOTIFICATION/ NCH messages, NOTIFICATION/ FACCH messages and in the Connect message sent to the calling service subscriber of a voice group call.

NOTE 3: For backward compatibility with legacy networks the coding of these indications in NOTIFICATION messages is chosen so that the default settings are SMS data confidentiality = "on" and SMS guaranteed privacy = "on".

---

## 8 Information storage

### 8.1 Information stored in the GCR

#### 8.1.1 Information used for routing of service subscriber originated voice group calls

Without a RANflex configuration, the GCR shall hold for a related MSC area for each group ID and cell from which voice group calls can be established by service subscribers the group call reference to be used for a voice group call to be established and an indication whether the originating MSC is the group call anchor MSC.

In a RANflex configuration, the GCR shall hold for a related MSC area (i.e. for those location areas for which the related MSC is the group call serving MSC) for each group ID and cell (within those location areas for which the related MSC is the group call serving MSC) from which voice group calls can be established by service subscribers the group call reference to be used for a voice group call to be established and an indication whether the group call serving MSC is the group call anchor MSC.

Without a RANflex configuration or in a RANflex configuration, if the VMSC is the group call serving MSC:

If the VMSC is the group call anchor MSC, the GCR shall provide the group call attributes related to that group call reference as defined in subclause 8.1.2 to the VMSC and the VMSC shall establish the voice group call.

If the VMSC is not the anchor MSC, the GCR shall provide the group call reference plus the routing information identifying the anchor MSC to the VMSC and the VMSC shall route the voice group call to the anchor MSC.

In a RANflex configuration, if the VMSC is different from the group call serving MSC:

If the group call serving MSC is a relay MSC for the group call, the GCR shall provide the group call reference plus the routing information identifying the anchor MSC to the group call serving MSC which passes this information to the VMSC.

If the group call serving MSC is the anchor MSC for the group call, the GCR shall provide the group call reference to the group call serving MSC which adds the routing information identifying the anchor MSC (i.e. its own MSC address) and passes the information to the VMSC.

Then the VMSC shall route the voice group call to the anchor MSC.

NOTE: In case the GCR function is distributed over different physical entities, each may hold only the information needed to treat requests coming from the MSCs connected to the physical GCR entity.

## 8.1.2 Group call attributes

Each MSC involved in a voice group call requests its proper group call attributes from its related GCR. For any group call reference the GCR shall provide the corresponding group call attributes to the requesting MSC. These lists shall be programmed by the service provider at registration of the network specific service configuration.

The contents of each list related to requests of the group call anchor MSC is as follows:

- a list of cells inside the MSC area of the group call anchor MSC (in a RANflex configuration, the cells belonging to a location area for which the group call anchor MSC is the group call serving MSC) into which the call is to be sent (part of the group call area), see subclause 8.1.2.1;
- a list of group call relay MSCs into which the call is to be sent;
- information on the cipher algorithm and the group key to be used for this voice group call;
- information on the codecs allowed for this voice group call. As an operator option, the EFR codec, standard half rate codec, AMR half rate codec, and AMR full rate codec can be supported;

NOTE: A pre-Rel-7 VGCS capable mobile station will not be able to participate in a group call using the EFR codec, AMR half rate codec or AMR full rate codec, if the mobile station is part of that group

- a list of identities of dispatchers to which a dedicated link is to be established, see subclause 8.1.2.2;
- a list of identities of dispatchers which are allowed to initiate the voice group call, see subclause 8.1.2.2;
- a list of identities of dispatchers which are allowed to terminate the voice group call, see subclause 8.1.2.2;
- the length of time over which no activity is detected before the voice group call is automatically terminated, see subclause 8.1.2.3;
- the default priority level related to the voice group call if eMLPP applies, see subclause 8.1.2.4;
- a status flag indicating if a voice group call with the related group call reference is on-going, see subclause 11.3.1.1.1;
- a talker channel parameter indicating if the network shall always establish and maintain a dedicated channel for the talking service subscriber;
- an indication whether the uplink reply procedure is applicable for this voice group call.

The contents of each list related to requests of a group call relay MSC is as follows:

- a list of cells inside the MSC area of the requesting MSC (in a RANflex configuration, cells belonging to a location area for which the requesting MSC is the group call serving MSC) into which the call is to be sent (part of the group call area), see subclause 8.1.2.1;
- identity of the group call anchor MSC;
- a status flag indicating if a voice group call with the related group call reference is on-going, see subclause 11.3.1.1.1.

### 8.1.2.1 Group call area

The group call area is defined as a list of cells inside the network. The cells shall be defined by their cell identification consisting of the Location Area Code and the Cell Identity as defined in 3GPP TS 24.008 and are therefore uniquely identified in the network.

In the case the group call area extends over several MSCs, only the cells belonging to the requesting MSC (in a RANflex configuration, cells belonging to location areas for which the requesting MSC is the group call serving MSC) are included in the group call attributes.

### 8.1.2.2 Dispatcher identities

Dispatcher identities shall be ISDN numbers or MSISDN numbers with the structure according to ITU-T Recommendation E.164. They shall correspond both to the number to be used to establish a call toward the dispatcher and the number provided as calling line identification when the call is originated by a dispatcher.

The list of dispatcher identities is used by the anchor MSC to establish dedicated communication paths to each dispatcher and connect them to the conference bridge of the call.

The list of dispatcher identities which are allowed to initiate voice group calls is used by the anchor MSC for verification for a voice group call establishment by a dispatcher.

The list of dispatcher identities which are allowed to terminate voice group calls is used by the anchor MSC for verification for a voice group call release by a dispatcher.

### 8.1.2.3 No activity time

A timer in the anchor MSC used to release the voice group call because of "no activity" can be set to a fixed value or can be set to a value defined for each voice group call.

A group call is defined to be in the state of "no activity" in the anchor MSC, if the following conditions are all fulfilled:

- the uplink is free;
- no dispatcher is connected;
- no short message is waiting in the anchor MSC to be sent to the voice group call; and
- no application-specific data are waiting in the anchor MSC to be relayed.

The anchor MSC shall check for the state of "no activity" if any of the following events occur:

- an uplink release is indicated to the anchor MSC;
- a dispatcher leaves the ongoing group call;
- the anchor MSC has completed the distribution of a short message to the voice group call; or
- the anchor MSC has completed the relay of application-specific data.

The anchor MSC has to start the "no activity" timer, when the conditions for "no activity" are all fulfilled.

The timer shall be stopped and reset each time any of the following events occurs:

- an uplink request is indicated to the anchor MSC;
- a dispatcher joins the ongoing group call;
- a short message to the voice group call is received by the anchor MSC; or
- application-specific data are received by the anchor MSC.

When a variable timer is provided, there shall be sufficient timers such that one can be associated with each on-going group call. The corresponding time shall be stored in the GCR.

The length of the timer is not specified in the GSM technical specifications.

### 8.1.2.4 Priorities

If the eMLPP supplementary service is applied to a voice group call, the priority level shall be stored in the GCR. For further details see 3GPP TS 23.067.

### 8.1.3 Transient GCR Data

The relay MSC, and in a RANflex configuration the group call serving MSC of the initiating service subscriber's current LAC, if this MSC is different from the VMSC, interrogate the GCR twice when setting up the voice group call: The first GCR interrogation is triggered in the relay MSC by the service subscriber or in a RANflex configuration in the group call serving MSC by the MAP service SEND\_GROUP\_CALL\_INFO received from the VMSC. The second GCR interrogation is triggered in the relay MSC by the MAP service Prepare Group Call or in a RANflex configuration, if the anchor MSC is the group call serving MSC, by receiving the IAM from the VMSC.

At the first GCR interrogation the GCR shall store transient data in the GCR which are retrieved with the second GCR interrogation. These data are:

- the initiating service subscriber's IMSI;
- the initiating service subscriber's talker priority;
- the initiating service subscriber's additional information; and
- the originating cell id.

## 8.2 Information managed per subscriber

### 8.2.1 Stored in the HLR

The following additional information shall be stored in the HLR:

- the subscription option for voice group calls which can be made in the HPLMN only or also in case of roaming;
- a list of all the group IDs a service subscriber is entitled to use.
- optionally, for each group ID a list of the talker priorities the service subscriber is allowed to use. The permission to use talker priority "normal subscriber" is implied by the subscription for the group ID and does not need to be stored explicitly;

**Editor's note : Whether the HLR additionally stores for each group ID if the subscriber is allowed to transmit application-specific data is ffs.**

- optionally, an information element containing operator specific additional information about the subscriber.

The group IDs are defined in subclause 9.1.

A service subscriber shall not be provided with more than 50 group IDs.

### 8.2.2 Stored in the VLR

The list of all the group IDs and related subscription data a service subscriber is entitled to use shall be brought forward to a VLR at the same time as other subscriber information is copied, and VLR entries shall be modified when corresponding HLR records are changed.

### 8.2.3 Stored in the SIM

The information detailed in subclause 8.2.1, except for the operator specific additional information about the subscriber, also needs to be stored on the SIM. The service subscriber shall be able to deactivate or reactivate a group ID by MMI interaction so that the mobile station ignores notification messages to this group ID, when the group ID is deactivated.

If prefixes are used together with group IDs, these prefixes are not stored on the SIM. Moreover the group IDs on the SIM are stored without any prefix.

### 8.2.3a Stored in the USIM

The information detailed in subclause 8.2.1, except for the operator specific additional information about the subscriber, also needs to be stored on the USIM. The service subscriber shall be able to deactivate or reactivate a group ID by MMI interaction so that the mobile station ignores notification messages to this group ID, when the group ID is deactivated.

For each group ID where data confidentiality may be applied, the USIM needs to store the cipher algorithm to be used and the possible group keys.

For each group ID the USIM needs to store indications whether the service subscriber is allowed to transmit application-specific data.

If prefixes are used together with group IDs, these prefixes are not stored on the USIM. Moreover the group IDs on the USIM are stored without any prefix.

## 8.3 Information used for routing of dispatcher originated voice group calls

Routing of dispatcher originated calls shall be performed on the MSISDN number received at a GMSC in the Initial\_Address\_Message.

- Because the group call reference is included in the called MSISDN number as defined in subclause 9.2d the routing information can be derived by the routing function of the GMSC. The GMSC afterwards directly routes the call request to the group call anchor MSC without requesting an HLR.

---

# 9 Identities

## 9.1 Elementary identities for group calls

### a) Group ID

The group ID is a sequence of decimal digits with a maximum length depending on the composition of the group call reference defined under c). The length of Group ID shall be in a range of 1 to 8 digits.

The mobile station derives the group ID from the group call reference by identifying the longest group ID amongst those stored in the SIM/USIM and matching the least significant digits of the group call reference. If no group ID is stored in the SIM that matches the least significant digits of the group call reference, the mobile station is not able to derive the group ID from the group call reference.

NOTE 1: The network should use Group IDs matching an initial part of other group IDs with greatest care, if at all.

EXAMPLE: A mobile station storing the group IDs 678, 2 678 and 42 678 (and only those) in the SIM will derive group ID 2 678 from group call reference 13 452 678.

For definition of Group ID on the radio interface, A interface and Abis interface, see 3GPP TS 44.068 [11].

For definition of Group ID coding on MAP protocol interfaces, see 3GPP TS 29.002 [13].

### b) Group call area ID

The group call area ID is a sequence of decimal digits uniquely assigned to a group call area in one network and with a maximum length depending on the composition of the group call reference defined under c).

### c) Group call reference

Each voice group call in one network is uniquely identified by its Group call reference. The group call reference is a concatenated sequence of the group ID (as the least significant part) and the group call area ID (as the most significant part). The group call reference shall have a maximum length of 8 decimal digits. The composition of the group call area ID and the group ID can be specific for each network operator.

|                    |          |
|--------------------|----------|
| Group call area ID | Group ID |
|--------------------|----------|

The group call reference is equal to the group ID when the group ID has a length of 8 decimal digits.

For definition of Group Call Reference (with leading zeros inserted as necessary) on the radio interface, A interface and Abis interface, see 3GPP TS 24.008 [7], 3GPP TS 44.018[5] and 3GPP TS 44.068 [11].

For definition of Group Call Reference coding (also known as ASCII Call Reference, Voice Group Call Reference or Voice Broadcast Call Reference) on MAP protocol interfaces, see 3GPP TS 29.002 [13].

NOTE 2: If prefixes are used together with group IDs, the least significant digit of the group call area ID contains the prefix.

## 9.2 Use of identities in the network

For each voice group call the identifications as defined in the following shall be used within the network for the related purpose mentioned.

For voice group call services which are to operate in more than one PLMN, group identities have to be co-ordinated between the network operators involved.

### a) Identities used for GCR requests for service subscriber originated voice group calls

For a service subscriber originated call, the identity of the call used by the MSC in which the call is originated to interrogate the GCR shall consist of the originating serving cell identity as defined in 3GPP TS 48.008 and the group ID as defined in subclause 9.1. In a RANflex configuration the same identity is used by the group call serving MSC to interrogate the GCR when it receives the MAP Send Group Call Info service.

|                     |          |
|---------------------|----------|
| Originating cell ID | Group ID |
|---------------------|----------|

A service subscriber initiating a voice group call has to call the wanted group ID. The MSC in which the call is originated shall accumulate from the BSS the called group ID and the originating cell ID.

If the group call area exceeds one MSC area, the identity used to interrogate the GCR by an MSC in which the call was not originated shall consist of the group call reference as defined in subclause 9.1, except for the case in a RANflex configuration where the GCR interrogation in the group call serving MSC is triggered by receipt of the MAP Send Group Call Info service.

If the group call area exceeds one MSC area and the call was originated

- in a relay MSC; or
- in a RANflex configuration in a location area for which a relay MSC is the group call serving MSC,

this relay MSC will perform a second GCR interrogation when the anchor MSC sets up the link to the relay MSC (see subclause 11.5). The relay MSC shall use the group call reference as defined in subclause 9.1 as the identity for the second GCR interrogation.

### b) Identities used for GCR requests for dispatcher originated voice group calls

In case of dispatcher originated call the identity used by the MSC to interrogate the GCR shall consist of the group call reference as defined in subclause 9.1.

### c) Identities used for notifications to service subscribers

Identities used for notification messages shall consist of the group call reference as defined in subclause 9.1.

**d) Identities used by dispatchers for voice group call establishment**

For dispatcher originated calls an MSISDN is dialled. The Country Code (CC) and National Destination Code (NDC) are used as normal for routing purposes. The CC and NDC may be omitted for internal calls. The numbering scheme is based on ITU-T Recommendation E.164. The Subscriber Number (SN) is used to indicate:

- the request of a group call by use of a prefix. The length of the prefix shall be 1 to 2 digits;
- the wanted group call reference as defined in subclause 9.1.

|           |            |               |                             |
|-----------|------------|---------------|-----------------------------|
| <b>CC</b> | <b>NDC</b> | <b>Prefix</b> | <b>Group call reference</b> |
|-----------|------------|---------------|-----------------------------|

**e) Identities used for VLR requests for service subscriber originated group calls**

The group ID shall be used on the B-Interface for VLR requests.

**f) Anchor MSC address for routing of service subscriber originated calls from originating MSC to anchor MSC**

For service subscriber originated calls an anchor MSC address is used as called party address to route the call from the originating MSC to the anchor MSC. The anchor MSC address structure is the same as for dispatcher originated calls (see subclause d)) The Country Code (CC) and National Destination Code (NDC) are used as normal for routing purposes. The numbering scheme is based on ITU-T Recommendation E.164. The Subscriber Number (SN) is used to indicate:

- the request of a group call by use of a prefix. The length of the prefix shall be 1 to 2 digits; the actual value of the prefix may be different than the one dialled by dispatchers.
- the wanted group call reference as defined in subclause 9.1.

|           |            |               |                             |
|-----------|------------|---------------|-----------------------------|
| <b>CC</b> | <b>NDC</b> | <b>Prefix</b> | <b>Group call reference</b> |
|-----------|------------|---------------|-----------------------------|

**g) Identities used for notifications to dispatchers**

Identities used for notification messages to dispatchers shall be identical to those used by dispatchers to initiate calls as described in subclause d).

A notification identity is presented to a dispatcher terminal by making use of CLIP. Between the anchor MSC and MSC to which the dispatcher is attached, the information may be carried using the Calling Party Number parameter or Generic Number Parameter as agreed between the network operators. The Country Code (CC) and National Destination Code (NDC) are used as normal for routing purposes. The numbering scheme is based on ITU-T Recommendation E.164. The Subscriber Number (SN) is used to indicate:

- the indication of a group call by use of a prefix. The length of the prefix shall be 1 to 2 digits; the actual value of the prefix shall be the same as the one dialled by dispatchers
- the group call reference as defined in subclause 9.1.

|           |            |               |                             |
|-----------|------------|---------------|-----------------------------|
| <b>CC</b> | <b>NDC</b> | <b>Prefix</b> | <b>Group call reference</b> |
|-----------|------------|---------------|-----------------------------|

The Screening Indicator shall be set to "Network Provided"

The Type of Number shall be set to "International"



---

## 10 Operation and maintenance aspects

NOTE: A list and short description of the operation and maintenance aspects will be given. This includes the options and parameters which can be set by the operator:

- handling of timers;
- registration aspects; etc.

---

## 11 Function and information flows

### 11.1 Group management

The group call attributes, as given in subclause 8.1 shall be entered and modified by the service provider. A list providing information on necessary Operation and Maintenance actions is given in clause 10.

### 11.2 Group membership management

Once the membership is established, the individual membership of the group can be placed in an active or deactive state on the SIM/USIM by the user. If a subscriber has a group ID in an active state, the subscriber is able to establish voice group calls corresponding to that group ID.

In a deactive state the mobile station prevents the service subscriber from establishing calls using the group ID and the corresponding notifications need to be "ignored" by the mobile station.

The active state and deactive state entries may be password protected as an implementation option.

Group IDs are listed in the subscription data within the network and on the SIM/USIM. The SIM/USIM must be returned to the network operator or service provider for updating if the subscription is to be changed.

NOTE 1: Updating of subscription data over the radio interface is not considered. However, this shall not preclude future applications if corresponding mechanisms may be implemented.

Users can interrogate their mobile stations to determine to which groups they are members and which subscriptions are currently in an active state.

NOTE 2: Distribution and management of group ID prefixes is outside the scope of this specification.

### 11.3 Call management

#### 11.3.1 Call establishment

A voice group call can be established by either a service subscriber or by a dispatcher.

##### 11.3.1.1 Service subscriber call establishment

###### 11.3.1.1.1 Initial stage

The initial signalling from the calling service subscriber informs the network that a voice group call is required and details the group ID; it may specify originator-to-dispatcher information. No information relative to the group call area is given by the calling service subscriber. As an option the calling service subscriber may add a prefix to the group ID, which is taken into account by the network when selecting the area.

The network shall perform a number of checks in order to determine how to handle the call:

- check of the ability of the subscriber to establish the call;
- check whether the call can be initiated from the cell;
- check of the existence of an on-going call of the same group call reference.

The originating MSC shall check the VLR records for the ability of the subscriber to start the call. If the service subscriber has no subscription for the voice group call service with the indicated group ID, the call shall be released. In addition, the VLR shall return barring and identity presentation restriction checks to the MSC.

In a RANflex configuration the originating MSC shall then derive the group call serving MSC address from the originating location area. If the group call serving MSC is different from the originating MSC then the group call serving MSC's GCR is interrogated by means of the MAP service SEND\_GROUP\_CALL\_INFO. The interrogation request contains the originating Cell Id and the Group Id. It also contains the initiating service subscriber's IMSI, the actual talker priority, and subscribed additional information. If the group call serving MSC is a relay MSC for the group call, then its GCR shall derive the anchor MSC address and the group call reference from the originating Cell Id and Group Id, and return it to the VMSC. If the group call serving MSC is the anchor MSC for the group call, then its GCR shall derive the group call reference from the originating Cell Id and Group Id, and return it to the VMSC.

Without RANflex configuration or if in a RANflex configuration the originating MSC is the group call serving MSC (derived from the originating location area) it shall then request information from the GCR by giving the group ID and the originating cell ID as defined in subclause 9.2.

If the group ID has a length of 8 decimal digits, the operator can define for this group ID only one group call and one group call area within his network. If the length of the group ID is less than 8 decimal digits, the operator can define more than one group call using the same group ID, but different group call areas. Because of the possibility of overlapping group call areas, each call requires a unique reference, assigned by the GCR related to the originating MSC or the group call serving MSC (in a RANflex configuration). The group call reference shall be composed of the group ID and a group call area ID (see clause 9).

If the length of the group ID is less than 8 decimal digits, the GCR first derives the group call area ID from the group ID and the originating cell ID. If no group call area ID is related to the group ID and originating cell ID, the call shall be released. If a group call area ID is related to the group ID and originating cell ID, the GCR shall transfer the corresponding group call attributes to the MSC. From that moment until the MSC indicates the contrary, the call shall be considered as on-going by the GCR.

In a network supporting prefixes together with group IDs, the operator can define more than one group call area for a specific combination of group ID and originating cell ID. In such a network, if the calling service subscriber has added a prefix to the group ID, the GCR shall derive the group call area ID from the prefix. The last digit of the group call area ID shall match the prefix. If the prefix is not provided or does not match the last digit of the group call area IDs to be considered, the network shall select a default value for the prefix and derive the group call area ID from this default prefix. The default value for the prefix is dependent on the network of the originating MSC.

NOTE 1: Typically, the group call area ID derived from the default prefix value will select a complete group call membership, not a subset, and the group call area will include the group call areas derived from the other prefix values.

NOTE 2: A mobile station not supporting the use of prefixes with group IDs can only set up voice group calls to the group defined by the default prefix.

If the group ID has a length of 8 decimal digits, the group call reference is equal to the group ID. The GCR shall check whether the call was initiated within the group call area stored in the GCR. If not, the call shall be released; otherwise, the GCR shall transfer the corresponding group call attributes to the MSC. From that moment until the MSC indicates the contrary, the call shall be considered as on-going by the GCR.

The GCR of the relay MSC and in a RANflex configuration, if the group call serving MSC of the initiating service subscriber's current LAC is different from the VMSC, the GCR of this group call serving MSC shall store the initiating service subscriber's IMSI, talker priority, additional information and originating cell id for later processing.

If the originating MSC is not the group call anchor MSC for the voice group call as indicated in the GCR, then the voice group call request shall be passed to the group call anchor MSC; in that case, if the initiation of the voice group call had specified originator-to-dispatcher information and processing of originator-to-dispatcher information is supported by the

MSC, the originator-to-dispatcher information is transformed by the originating MSC into UUS1 and sent to the anchor MSC.

Without RANflex configuration or if in a RANflex configuration the originating MSC is the group call serving MSC, it shall additionally include the address of the originating relay MSC in the calling party number of the IAM when passing the call request to the anchor MSC. In a RANflex configuration, if the originating MSC is different from the group call serving MSC, the VMSC shall include the address of the group call serving MSC in the calling party number of the IAM.

If the group call reference is composed of Group ID and group call area ID, it is possible that two service subscribers or a service subscriber and a dispatcher or two dispatchers may attempt to establish a call using the same group ID and corresponding to the same group call area ID. If the two voice group calls are established with the same group ID but for different group call areas then separate voice group calls shall be established. If the group call areas overlap, it is up to receiving mobile station to determine which call to participate in. If more than one call is made to identical group ID and group call area, the network shall reject all but one of the call attempts.

If the group ID has a length of 8 decimal digits, if more than one call attempt is made to the same group ID, the network shall reject all but one of the call attempts.

A service subscriber which is entitled by his subscription to establish voice group calls while roaming shall only be able to use supra-PLMN group IDs as defined in subclause 9.1 in case of roaming. In case of roaming, the mobile station shall only react on notifications for supra-PLMN group IDs.

If the GCR receives a new interrogation related to a group call reference where the call is indicated as on-going in the GCR, the GCR shall provide the on-going status together with the group call reference back to the MSC. The MSC shall then release the call with a cause user busy in case of a service subscriber originated call request. The mobile station of the service subscriber shall then look for notifications of the respective group ID on the NCH and join the voice group call. In case of a dispatcher originated voice group call request, the MSC shall join the dispatcher to the conference bridge of the voice group call.

Authentication of the calling service subscriber can be performed by the network as for normal calls.

#### 11.3.1.1.2 Establishment of the transmission means

A voice group call channel shall be established in all the cells throughout the identified group call area using physical channels selected by the BSCs as appropriate. The downlink channels shall be established without any return signalling from mobile stations. Whilst the downlink channel is being established, the MSC shall form a conference bridge containing the appropriate channels to all BTSs in the group call area or in case of A-interface link sharing to all BSCs in the group call area. The MSC is responsible for adding dispatchers to the conference bridge.

Alternatively, the network may establish voice group call channels in a cell on demand, i.e. if mobile stations respond to the notifications as defined in subclause 4.2.2.1 (see "uplink reply procedure"). As a network option the applicability of the uplink reply procedure for a voice group call can be controlled by the GCR of the anchor MSC. If the anchor MSC supports this feature, it shall allow all affected BSCs to establish voice group call channels on demand only if the GCR indicates that the uplink reply procedure is applicable. If the relay MSC supports this feature, it shall allow all affected BSCs to establish voice group call channels on demand only if the anchor MSC indicates during the establishment of the voice group call that the uplink reply procedure is applicable.

In parallel, a dedicated suitable traffic channel may be allocated to the calling service subscriber if not already the case.

If the "talker channel parameter" is used and indicates that the network shall always establish and maintain a dedicated channel for the talking service subscriber, a dedicated suitable traffic channel shall be allocated to the calling service subscriber. If there are not sufficient radio resources in the originating cell to allocate a dedicated channel and a group call channel, the group call establishment fails and the voice group shall be released.

The call will be considered established provided that at least the downlink channel in the originating cell, in the case of a service subscriber originated voice group call, or the downlink channel in any one cell within the group call area, in the case of a dispatcher originated voice group call, is established. The MSC shall signal to the calling service subscriber that this has occurred so that he knows when to start speaking. If a voice group call does not meet the above conditions in a pre-set time (Txx) then the call shall be released.

The mobile station shall indicate connection to the subscriber. If channels could not be established in particular cells because of congestion, channels are allocated to these cells as soon as possible.

The MSC may retry the VGCS Assignment procedure to establish channels in cells where they are missing. If supported, the procedure may be initiated when:

- i) congestion (i.e. a lack of A-interface circuits) prevented the VGCS ASSIGNMENT REQUEST message from being sent to the BSS;
- ii) a VGCS ASSIGNMENT FAILURE message is received and the cause value indicates an acceptable reason for retry (e.g. no radio resource available);
- iii) the radio and terrestrial resources for the group call channel are cleared (group call on-going) and the cause value indicates an acceptable reason for retry (e.g. pre-emption);
- iv) no response to the VGCS ASSIGNMENT REQUEST message is received (this is determined by the MSC in an implementation-dependent manner such as expiry of a timer); or
- v) no response is received following receipt of a VGCS QUEUING INDICATION (this is determined by the MSC in an implementation-dependent manner such as expiry of a timer).

**NOTE:** If A-interface link sharing or group call re-establishment by the BSS apply, the BSC is responsible for establishing/re-establishing channels in cells and scenario (ii) and (iii) do not apply, unless A-interface resources also need to be re-established (e.g. when the PCM system serving the A-interface circuit fails (equipment failure)). Scenario (v) does not apply to A-interface link sharing and group call re-establishment by the BSS.

The MSC may repeat the VGCS assignment procedure until a VGCS ASSIGNMENT RESULT message is received, the call is released or an unacceptable reason for retry (e.g. protocol error between BSS and MSC) is received by the MSC. The time between subsequent retries is implementation-dependent. The MSC shall send each retry of the VGCS ASSIGNMENT REQUEST over a new resource-controlling SCCP connection.

If a message is received with an unacceptable reason for retry then existing procedures apply. I.e. the MSC shall initiate the clearing of the radio and terrestrial resources, if necessary, and no further attempts to establish a group call channel in the cell are made.

While using the retry procedure the MSC shall maintain the call controlling SCCP connection to a BSS until the call is released or until the MSC decides to stop any further attempts to establish group call channels for the call on a BSS where no cells are established.

#### 11.3.1.1.3 Release of the dedicated transmission means of the calling service subscriber

The calling service subscriber shall be given a dedicated connection up to the time where the network requests him to join the voice group call channel. If the calling service subscriber is not talking, the network requests him to join the voice group call channel as a listener by use of a channel release procedure. Otherwise, the network shall request him to join the voice group call channel as a talker by either a channel assignment procedure or a handover procedure or a channel mode modify procedure.

If the "talker channel parameter" is used and indicates that the network shall always establish and maintain a dedicated channel for the talking service subscriber, then the network shall not request the calling service subscriber to join the group call channel as long as he is talking.

For the time when the voice group call is established until the calling service subscriber becomes a listening service subscriber for the first time, the "uplink busy" flag is set (see subclause 11.3.8). Mobile stations shall be programmed such that if they originate the call, they indicate to the user that it is required that an indication of the desire to speak should be made if he wants to speak. If this is not done within a certain time, the mobile station sends an UPLINK\_REL message to the network and the uplink shall become free.

#### 11.3.1.1.4 Release of the dedicated transmission means of mobile stations responding to a notification

Mobile stations which respond to a notification for which no description of the voice group call channel was given in the notification message may be given a dedicated connection up to the time where the network requests the mobile station to join the voice group call channel. If the service subscriber is not talking, the network requests him to join the voice group call channel as a listener by use of a channel release procedure. Otherwise, the network shall request him to join the voice group call channel as a talker by either a channel assignment procedure or a handover procedure or a channel mode modify procedure.

11.3.1.1.5 void

11.3.1.1.6 void

#### 11.3.1.2 Dispatcher call establishment

In the case of dispatchers originated calls the call request, in the form of an MSISDN number, shall be received at a GMSC. Such a call can be treated by the GMSC as a normal mobile terminated call. In this case, the GMSC shall interrogate an HLR, determined on the basis of the MSISDN number. The HLR in turn may either interrogate the appropriate MSC/VLR to obtain an MSRN, or may supply an MSRN predefined in the HLR and related to the respective group call reference in the MSC/VLR. If the HLR interrogates the MSC/VLR for the MSRN, the HLR shall provide this MSC/VLR with the related IMSI including the group call reference as defined in clause 9.

Alternatively, the call request can be forwarded directly to the related group call anchor MSC on basis of the GMSC's internal routing table. In this case, the group call reference shall already be included in the requested MSISDN number as defined in clause 9.

When interrogated by the group call anchor MSC, the GCR shall check if the calling line identity is within the list of dispatcher identities allowed to establish the voice group call. If not the case, the call shall be rejected.

After reception of the call request, the group call anchor MSC checks whether an on-going call of the same group call reference exists, in which case the group call anchor MSC shall add the dispatcher to the call.

At the point at which notification messages are sent to mobile stations, a tone is relayed to the calling dispatcher to inform the dispatcher that the message can commence.

#### 11.3.1.3 Notification procedures

Different notification procedures shall be applied in relation to the mode of the mobile station as presented in Table 1 and Table 2 and defined in the following sections.

**Table 1: Overview on different information messages for new or on-going calls**

| <b>MS states:</b>   | <b>Incoming call type: VBS or VGCS call</b> | <b>point-to-point call</b>        |
|---|---|-----------------------------------|
| Idle mode   | (section a)                                 | (standard paging)                 |
| Group mode, dedicated channel   | (section b)                                 | (section c)                       |
| group receive mode and group transmit mode  | (section b)                                 | (section c)                       |
| dedicated mode  | (section b)                                 | (standard Call Waiting)<br>(note) |
| NOTE: only for point to point calls with certain restrictions as defined in 3GPP TS 22.083. |   |                                   |

**Table 2: Overview on different information messages for incoming point-to-point short messages**

| <b>MS states:</b>             | <b>Incoming point-to-point short messages</b> |
|-------------------------------|---|
| Idle mode                     | (standard paging)                             |
| group mode, dedicated channel | (standard SMS delivery) (note)                |
| group receive mode            | (section c)                                   |
| group transmit mode           | (standard SMS delivery or section c) (note)   |
| dedicated mode                | (standard SMS delivery) (note)                |
| NOTE: see subclause 11.3.9.2. |   |

**a) Notification for mobile stations in idle mode**

Once the voice group call channel has been established in a cell or the network is waiting to receive notification responses to establish a voice group call channel, notifications shall be broadcast on the NCH in that cell.

The position of the NCH is derived from the system information of the BCCH.

The notification messages shall include the group call reference and possibly the description of the voice group call channel, the call priority if eMLPP is applied, the group cipher key number, and the emergency mode indication, if applicable.

A notification message can contain no, one or more notifications.

The notification process needs to continue throughout the duration of the group call, in order to permit the "late entry" of other mobile stations. Mobile stations moving into the group call area which are in idle mode shall be directed to the voice group call channel by the notification messages, possibly by means of the notification response procedure.

The scheduling of the notification messages in a cell shall be managed by the BSS. Information can be added in the messages to limit the required reception of NCH messages. The following constraints shall be met:

- the three first initial notifications (i.e. the first for a given group call) shall have priority over subsequent notifications (i.e. the messages for an on-going group call) and must be sent as soon as possible;

NOTE 1: In addition initial notification messages for calls with or above an operator defined priority level can be sent on all possible paging or access grant channels to reduce the delay for those mobile stations which are not using Discontinuous reception (DRX).

- afterwards, an on-going group call in the cell shall be periodically notified on the NCH.

Since the information for the establishment of a voice group call is sent onto the NCH rather than on the PCH as for normal point-to-point calls, the mobile station must listen to the PCH as well as to the NCH. A "reduced NCH monitoring" mechanism can be used to save power in the mobile station when listening to the NCH.

A mobile station able to receive voice group calls either, depending on the implementation:

- can use the "reduced NCH monitoring" mechanism. When entering a cell, the mobile station shall listen to the NCH to get the notifications of the voice group calls on-going in the cell. Afterwards, the mobile station needs to listen to the NCH only if it is informed on the availability of a notification for a new voice group call. This shall be based on the NCH status information provided, as indicated in 3GPP TS 44.018;
- do not apply the "reduced NCH monitoring" mechanism and read all possible paging or access grant channels.

**b) Notifications for mobile stations in group mode dedicated channel, group receive, group transmit or dedicated mode**

In addition to sending initial notification messages on the NCH for the voice group call, the BSS can provide initial notification into on-going voice broadcast, group calls and point to point calls informing mobile stations partaking in these calls of new voice group calls that are being set-up in the cell.

NOTE 2: The additional notification into on-going voice broadcast and group calls and point to point calls should be provided by the BSS if the priority level of the new call is equal or higher than the O&M defined priority level.

In order to do this the BSS sends initial notification messages on FACCH to all other ongoing voice broadcast, group calls, and point to point calls in the cell. The initial notification message on FACCH shall contain the group call reference, the priority level if eMLPP applies, possibly the TCH description which allows the mobile station to connect directly to the new call without reading the NCH, and the emergency mode indication, if applicable.

An indication of change of notifications in the current cell may be provided on SACCH by the BSS.

When the emergency mode is set or reset for a voice group call ongoing in a cell, the BSS shall send additional notifications on FACCH to all on-going voice broadcast, group calls, and point-to-point calls in the respective cell.

As a mobile station option, the mobile station may read the NCH of the current cell while in group mode dedicated channel, group receive, group transmit or dedicated mode in order to be notified on other voice group calls.

NOTE 3: Mobile stations may require an additional receiver to read the NCH in order to ensure a higher probability of receiving notifications for all present voice group calls without degradation of the received speech quality.

Late entry of mobile stations into ongoing high priority group calls and voice group calls in emergency mode is covered by the following mechanisms:

- Late entrance in dedicated mode

If a mobile station in dedicated mode is moving into an area where a group call (VGCS or VBS) with priority level equal or higher to an operator specific setting or a voice group call in emergency mode is ongoing, the BSS shall resend the notification message to the mobile station on FACCH, if the mobile station has ASCI capabilities. This notification shall be triggered by completion of the dedicated channel assignment.

Sending periodical notification on FACCH to the mobile station in dedicated mode is optional, and is done as long as the group call (VGCS or VBS) with priority level equal or higher to an operator specific setting, is ongoing or as long as the emergency mode is set for the voice group call, with a repetition period given by an operator specific setting.

- Late entrance in group receive or group transmit mode

When a group call (VGCS or VBS) with priority level equal or higher to an operator specific setting, is established, or when the emergency mode is set for a voice group call, the BSS shall send periodical notification on FACCH to all ongoing voice broadcast and group calls in the cell, except on the FACCH of the group call (VGCS or VBS) which has initiated this periodical notification. By this method the mobile station in group receive or group transmit mode moving into this cell is notified. Periodical notification on FACCH is done as long as the group call (VGCS or VBS) with priority level equal or higher to an operator specific setting, is ongoing, or as long as the emergency mode is set for the voice group call, with a repetition period given by an operator specific setting.

NOTE 3a: The operator determined Periodical FACCH notification period shall be a BSS specific operator setting and be a minimum of 1s and maximum of 5s.

### c) Paging into on-going voice group calls

Paging into on-going voice group calls shall be provided as an implementation option.

In addition to establishing the links for the voice group call, the network can provide paging information into on-going voice group calls informing mobile stations partaking in a voice group call of new incoming point-to-point calls. The network can also provide paging information into ongoing voice group calls informing mobile stations in group receive mode or group transmit mode of incoming point-to-point short messages.

The mobile station shall be ready to receive a paging message on the FACCH containing the mobile subscriber identity and the priority level if eMLPP applies.

In the event of a reorganisation of the PCH the BSS shall inform the mobile stations via the SACCH that paging reorganisation has occurred. A mobile station receiving this indication shall decode the BCCH in order to obtain the new paging configuration.

As a mobile station option, the mobile station may read its paging subchannel in the current cell in group receive mode or group transmit mode in order to receive paging messages.

NOTE 4: Mobile stations may require an additional receiver to read its PCH subchannel in order to ensure a higher probability of receiving all relevant paging messages without degradation of the received speech quality. The additional receiver may be the same as used for reception of the NCH described under b) above.

#### 11.3.1.4 Destination service subscribers

Mobile stations of destination service subscribers which are in idle mode shall listen to notification messages on the NCH and move to the voice group call channel or respond to the notification.

Mobile stations which are busy shall either pre-empt the current call (if eMLPP is applied and the new call is of a sufficient priority), or shall provide the service subscriber with an indication similar to call waiting, when applicable.

If the mobile station supports group IDs with prefixes and has stored prefixes for the group ID in the notification, the mobile station shall only react as described previously in this subclause if the last digit of the group call area ID included in the group call reference matches the default prefix or one of the prefixes stored for the group ID. If the last digit of the group call area ID does not match then the mobile station shall not react as described previously in this subclause, but may still react by making an acknowledgement as defined in subclause 4.2.5.

NOTE: In a network supporting the use of prefixes together with the group ID, a mobile station not supporting the use of prefixes will react to notification messages and can participate in any voice group call for a group ID for which it has a subscription, regardless of any prefix used for setting up the voice group call.

#### 11.3.1.5 Destination dispatchers

Destination dispatchers are connected into the voice group call as a standard point-to-point call. The notification of the identity of the received group call shall be supplied in the Calling Line Identity, formatted according to sub-clause 9.2.

### 11.3.2 Call release

The voice group call can be terminated by the calling service subscriber or the calling dispatcher clearing it down, or by any dispatcher nominated in the GCR allowed to terminate the call.

#### 11.3.2.1 Call termination by the calling subscriber

The calling service subscriber will need to gain the uplink before he can issue a termination request.

If the mobile station uses the uplink with a talker priority different from "normal subscriber" it shall include this talker priority in the termination request message. If the network supports uplink access option (i) as defined in subclause 7.2 and A-interface link sharing applies, the MSC shall compare the talker priority included in the termination request message with the talker priority stored for the current talker. If they are equal, the termination request is processed further; otherwise the MSC discards the termination request message.

The MSC has to store the identity of the calling service subscriber and to check it against the identity of the service subscriber which sends the voice group call termination request. If they are equal, the MSC shall accept the termination request and release all resources. On the radio interface a channel release message shall be sent on the FACCH of all cells in the group call area and then all resources are freed.

#### 11.3.2.2 Call termination by dispatchers

A dispatcher entitled to terminate the call can be a mobile subscriber or a fixed line subscriber. The dispatcher may use out-of-band DTMF messages as a means for the control of the call termination, if it is a mobile dispatcher, or DTMF tones, if it is a fixed line dispatcher.

If the call is terminated by a mobile dispatcher using DTMF, the out-of-band messages START\_DTMF(X) and STOP\_DTMF are sent via the radio interface towards the network. If the out-of-band DTMF messages are sent by a mobile dispatcher who is not controlled by the anchor MSC, the DTMF messages will be converted by the controlling MSC (e.g. relay MSC or visited MSC) into DTMF tones and these DTMF tones will be sent through the network to the anchor MSC.

If a fixed dispatcher initiates DTMF tones, the DTMF tones will be sent through the network to the anchor MSC.



Both in case of a mobile and a fixed line dispatcher the anchor MSC is responsible for the detection and collection of the out-of-band or in-band DTMF signals. After the evaluation of the DTMF signals, the anchor MSC shall trigger the appropriate function (see the figures 7b to 7d in 11.3.8).

In order to avoid the erroneous detection of the specific DTMF tone sequence for call termination by the MSC, this sequence shall consist of at least three DTMF digits.

### 11.3.2.3 Call termination on expiry of no activity timer

A time-out mechanism is required such that, if the anchor MSC does not detect any activity (as specified in subclause 8.1.2.3) within a pre-set time, the call is terminated by the anchor MSC. For this a timer shall be provided with a length as defined in the group call attributes in the GCR.

The network may provide an in-band indication, e.g. a tone, to inform the participants of the group call about the forthcoming expiry of the "no activity" timer.

## 11.3.3 Leaving of a dispatcher

A dispatcher can disconnect from the call at any time without terminating the call. In order to terminate the call a dispatcher who is entitled to do this must use the explicit signalling described in subclause 11.3.2.2.

## 11.3.4 Leaving and returning to a voice group call

A service subscriber shall automatically disconnect from the call when leaving the group call area.

A service subscriber shall be able to disconnect from the voice group call by a de-selection/re-selection process.

A mobile station shall leave the voice group call by no longer listening to the voice group call downlink and returning to idle mode. A voice group call is returned to by listening to the periodic notification messages for that call, and reacting on them appropriately.

## 11.3.5 Cell change

### 11.3.5.1 Listening subscriber

In all cases change of cell shall be initiated and performed by the service subscriber's mobile station. In order for the service subscribers changing from one cell to another within the group call area a cell list for the neighbouring cells belonging to this group call area is periodically broadcast on the downlink SACCH of the voice group call. In this case, mobile stations entering a new cell shall perform cell change according to the algorithm C2, see 3GPP TS 45.008 and 3GPP TS 43.022.

Mobile stations which want to enter a cell shall listen to the BCCH and to the NCH to determine which channel they shall retune to so that they can continue with the voice group call if available in that cell.

**NOTE:** Mobile stations may require an additional receiver to read the BCCH and NCH of the neighbour cells in order to ensure a higher probability of receiving the relevant messages without degradation of the received speech quality. The additional receiver may be the same as used in subclause 11.3.1.3.

Mobile stations entering a new location area shall perform location updating as normal.

### 11.3.5.2 Talking subscriber

Standard mobile station assisted handover shall be used for the cell change of the talking service subscriber as defined in 3GPP TS 45.008.

If the "talker channel parameter" indicates that the network shall always establish and maintain a dedicated channel for the talking service subscriber, the channel allocated by the network in the target cell shall always be a dedicated channel.

If the network supports uplink access option (i) as defined in subclause 7.2, collision cases between a handover of the talking service subscriber to a voice group call channel and an uplink access message on the same group call channel uplink shall be treated in the following way:

- when the BSS allocates the handover resources for the talking service subscriber, the BSS shall send an updated UPLINK BUSY message in the target cell and no longer accept uplink access messages on this group call channel uplink ;
- when the BSS already granted the uplink to another subscriber , the BSS shall delay the resource allocation for the handover of the current talker to the same cell. If the MSC accepts the uplink request for the new talker , the BSS shall cancel the handover resource allocation . Additionally, if the current talker is served by the BSS, the BSS shall release the current talker. Otherwise, if the MSC does not accept the uplink request for the new talker, the BSS shall release the new talker and proceed with the handover of the current talker.

If the talking subscriber leaves the group call area or enters a BSC area not belonging to the service area, the uplink shall not be maintained by the network.

If the BSS does not know if one or more of the target cells are outside the group call area, the BSS shall use the MSC controlled handover procedure. The MSC shall reject the handover in the case that all target cells are outside the GCA and as an option release the uplink.

In a RANflex configuration, if the target cell belongs to a location area for which the group call serving MSC is not the old cell's serving MSC, an inter MSC handover shall be performed.

### 11.3.5.3 Dispatcher

Dispatchers which are mobile subscribers shall change the cell by standard handover procedures.

### 11.3.6 New calls

Any service subscriber originated new voice group calls which have identical group ID and group call area to on-going voice group calls shall be rejected by the network with cause busy. The mobile station shall then read the notifications for the corresponding group ID on the NCH.

For any dispatcher originated new voice group calls which are identical to on-going voice group calls as described above the network shall include the dispatcher in the on-going call.

Otherwise, new calls are treated as detailed in subclause 11.3.8. In the case of congestion, voice group calls are treated according to their priority with each BSC treating each downlink depending on the situation in each cell to which the call is sent. Therefore, it is possible that a voice group call might be established only in a subset of the required cells.

In the case where there are no conference bridges free, and pre-emption is not performed, then the call request shall be rejected.

In the case of group members involved in group or point-to-point calls who have been informed of a new voice group call, the mobile station shall make a decision as to which to monitor as if both the on-going call and new call were point-to-point calls, and follow the procedure defined in 3GPP TS 23.067.

### 11.3.7 Uplink and Downlink management

#### 11.3.7.1 Uplink transmission management

The downlink FACCH channel shall be used to indicate whether the uplink is in use.

If a request to talk is made by the user and the uplink has been free the mobile station shall start to transmit UPLINK\_ACCESS messages as defined in the 3GPP TS 44.018.

If the network supports the use of talker priorities, a mobile station supporting the use of talker priorities may

- send a request to talk even if an uplink busy indication is received, if the talker priority of the new request is higher than the talker priority of the current talking service subscriber; or
- send an emergency mode reset request, if the emergency mode indication is signalled by the network.

If a VGCS\_UPLINK\_GRANT message is received by the mobile station with a different request reference than that of the access made by the mobile station, the mobile station shall not signal for a further 1 s.

If in this time the uplink becomes busy, and the network does not support the use of talker priorities, the mobile station shall indicate to the user that the access has been denied.

If in this time the uplink becomes busy, and the network indicates in the UPLINK\_BUSY message a talker priority equal or higher than the talker priority used by the mobile station in the UPLINK\_ACCESS message or PRIORITY\_UPLINK\_REQUEST message, the mobile station shall indicate to the user that the access has been denied; otherwise, it shall resend the UPLINK\_ACCESS message or PRIORITY\_UPLINK\_REQUEST message, respectively.

The user shall be provided with a short indication immediately after the reception of the VGCS\_UPLINK\_GRANT which indicates that he can speak. Contention caused by simultaneous access messages on the uplink of the voice group call channel shall be resolved as for standard random access procedures. If the uplink access is rejected a further indication shall be provided to the user to inform him that his access attempt was not successful.

The network then shall send an UPLINK\_BUSY message on the FACCH of the voice group call channel downlink in all cells involved in the group call.

Signalling messages for call establishment and termination on the voice group call channel shall then only apply for the mobile station currently using the uplink. All other mobile stations shall not respond to this downlink signalling. Once the request to talk is over, this shall be indicated to the network by the mobile station, an UPLINK\_FREE message is broadcast on all FACCHs in the group call area.

If the network supports the use of talker priorities, the BSS shall include the priority of the current talker in the UPLINK\_BUSY message and shall repeat the message on the FACCH every T1 seconds.

If the network supports uplink access option (i) as defined in subclause 7.2, the BSS shall indicate in the UPLINK\_BUSY message which channel shall be used by service subscribers for an uplink request in the current cell. The UPLINK\_BUSY message can contain two different indications. The mobile station of the service subscriber shall act:

- according to the "uplink access indication for talker priority" when signalling an uplink request with talker priority higher than "normal subscriber" or an "emergency mode reset request; or
- according to the "uplink access indication for data" when signalling an uplink request for sending application-specific data.

If both indications are included in the UPLINK\_BUSY message, they should be set to the same value.

If the "talker channel parameter" is used and indicates that the network shall always establish and maintain a dedicated channel for the talking service subscriber, then the BSS shall set any uplink access indication included in the uplink busy message (i.e. "uplink access indication for data", "uplink access indication for talker priority", or both) to "group call channel uplink access".

Otherwise, the BSS shall apply the following procedures:

If the talking service subscriber uses the group call channel uplink in the current cell, the BSS shall indicate in the UPLINK\_BUSY message that the RACH shall be used; otherwise it shall indicate that the group call channel uplink shall be used. The BSS shall immediately send an updated UPLINK\_BUSY message:

- in the handover target cell when the BSS allocates the resources for a handover of the talking service subscriber to the voice group call channel in the target cell;
- in the handover target cell when BSS releases the resources allocated for the handover of the talking service subscriber to the voice group call channel in the target cell, because handover failed;
- in the handover source cell after reception of a HANDOVER\_SUCCEEDED message;
- in the current cell after the talking service subscriber has been switched within the cell from the group call channel to a dedicated channel or vice versa.

When the BSS receives an indication from the MSC that the emergency mode is set in the network, the BSS shall immediately send an UPLINK\_BUSY message on the FACCH and include also the "emergency mode indication".

If the BSS receives a VGCS Additional Info message from the MSC, an ADDITIONAL\_INFO message is broadcasted on the FACCHs of the voice group call channel downlink in all cells involved in the current group call. If the BSS receives the additional information in the UPLINK\_SEIZED\_CMD, UPLINK\_REQUEST\_ACKNOWLEDGE or UPLINK\_REJECT\_CMD message then the BSS may include the information in the UPLINK\_BUSY message instead of sending it in a separate ADDITIONAL\_INFO message on the group call channel downlink. The BSS shall repeat the ADDITIONAL\_INFO message on the SACCHs of the respective voice group call channels every T2 seconds, until the uplink is released, or the BSS receives an Uplink Release Command message or Uplink Seized Command message for the respective voice group call from the MSC.

If the BSS receives a VGCS Additional Info message from the MSC and the current talker on a dedicated channel is pre-empted by another service subscriber with a higher talker priority, the BSS shall transmit the additional information about the new talker also to the current talker when releasing his dedicated channel.

#### 11.3.7.1a Transfer of a talking service subscriber to a dedicated connection

The network may decide to switch a talking service subscriber's mobile station from the voice group call channel to a dedicated standard uplink/downlink at any time. The talking subscriber's voice group call channel and the dedicated channel may belong to different cells within the group call area, i.e. the network may request the talker to perform a handover. The dedicated connection shall then be maintained up to the instance where the network decides that the mobile station shall join the voice group call channel again.

If the "talker channel parameter" is used and indicates that the network shall always establish and maintain a dedicated channel for the talking service subscriber, a dedicated traffic channel shall be allocated to the talking service subscriber. If there are not sufficient radio resources to allocate a suitable dedicated channel in a cell within the group call area, the MSC shall release the uplink of the voice group call channel used by the talking service subscriber.

#### 11.3.7.1b Release of the dedicated transmission means of a talking service subscriber

For the release of the dedicated transmission means of a talking service subscriber the procedures specified in subclause 11.3.1.1.3 apply accordingly.

#### 11.3.7.2 Mute/Unmute downlink of the talker

This subclause applies to networks where the talking service subscriber may use the voice group call channel. The handling of the Mute/Unmute requests by the anchor MSC is shown in Figure 1a.

The mobile station of the talking service subscriber shall mute the downlink to avoid non intelligible echoes when it is commanded by the network to mute the downlink. On request of the dispatcher, the network can command the mobile station of talking service subscriber to mute or unmute the downlink.

If a dispatcher originates a VGCS call, he is allowed to talk immediately when the VGCS call is established. If a dispatcher joins or re-joins an ongoing VGCS call, he is allowed to talk to the ongoing VGCS call at any time without need to indicate this by any kind of signalling. If there is a talking service subscriber using the uplink of the group call channel, he will not be able to hear the dispatcher's voice.

If a dispatcher wishes to talk to the talking service subscriber and all members of the ongoing group call, he shall indicate his wish by means of an operator-defined operation (via DTMF). If the dispatcher has finished speaking, he shall indicate this by means of another operator defined operation (via DTMF). These operations will trigger the network to command the talking service subscriber's MS to mute or unmute the downlink of voice group call channel.

When the network has detected a valid unmute request from a dispatcher it may optionally indicate the recognition of this request by playing a "grant tone" to be received by the requesting dispatcher only. The grant tone will be sent in-band. The attributes of the grant tone (e.g. frequency and duration) are network operator specific.

A dispatcher can be a mobile subscriber or a fixed line subscriber. The dispatcher uses out-of-band DTMF messages if it is a mobile dispatcher, or DTMF tones, if it is a fixed line dispatcher. In case of a mobile dispatcher, the out-of-band messages START\_DTMF(X) and STOP\_DTMF are sent via the radio interface towards the network. If the out-of-band DTMF messages are sent by a mobile dispatcher who is not controlled by the anchor MSC, the DTMF messages will be converted by the controlling MSC (e.g. visited MSC) into DTMF tones and these DTMF tones will be sent through the network to the anchor MSC. If a fixed line dispatcher initiates DTMF tones, the DTMF tones will be sent through the network to the anchor MSC.

NOTE: The transport of DTMF tones within the network is detailed in figures 7b, 7c and 7d.

Both for mobile and fixed line dispatchers the anchor MSC is responsible for the detection and collection of the out-of-band or inband DTMF signals. After the evaluation of the DTMF signals, the anchor MSC shall trigger the appropriate action (i.e. send/not send the SET\_PARAMETER message according to previous paragraphs, playing of the optional grant tone).

The DTMF sequences used for signalling are implementation specific. These two DTMF sequences shall not be the same.

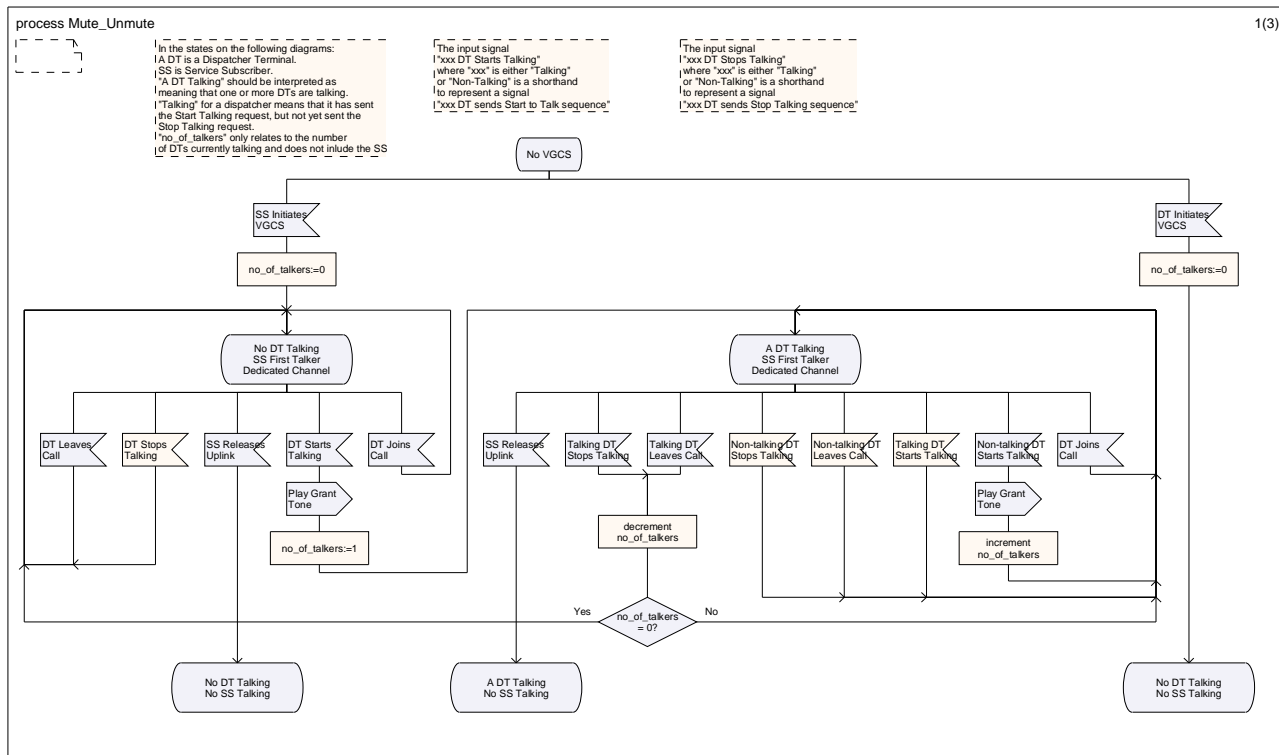


Figure 1a: Handling of Mute/Unmute Requests in Anchor MSC (Sheet 1 of 3)

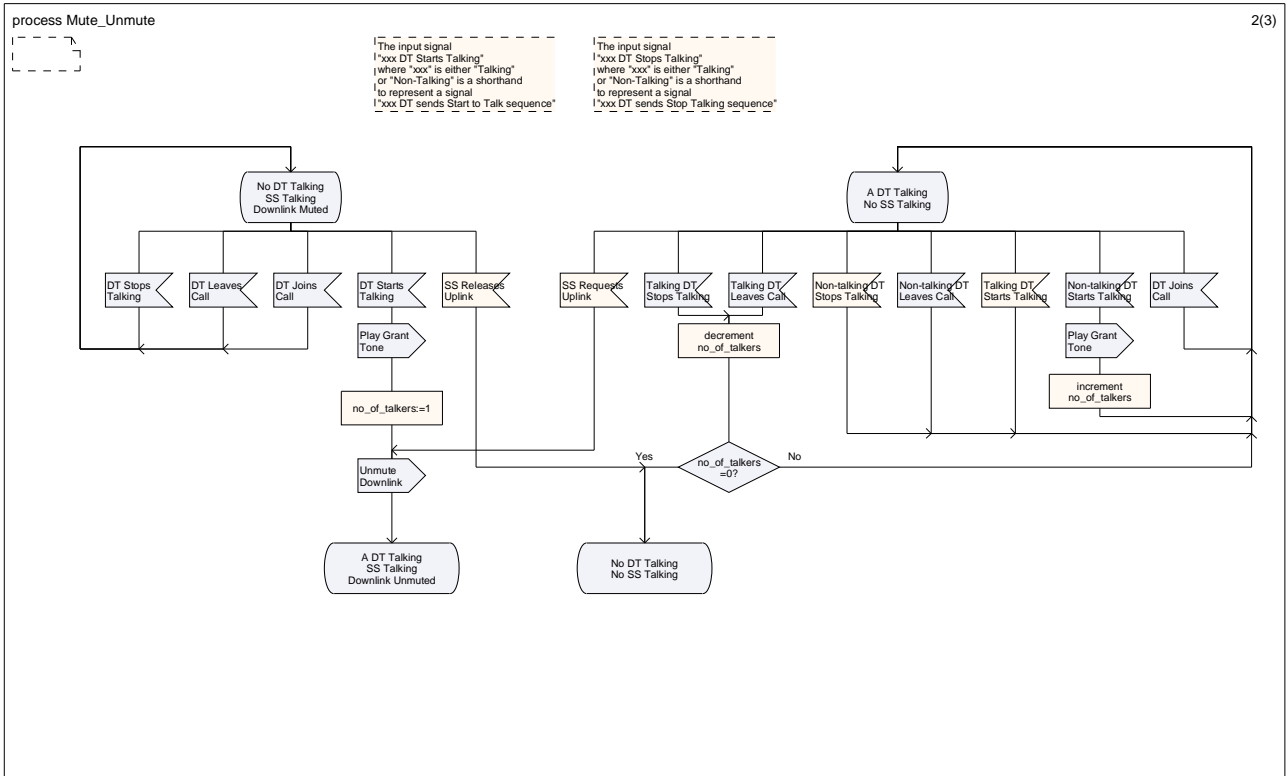


Figure 1a: Handling of Mute/Unmute Requests in Anchor MSC (Sheet 2 of 3)

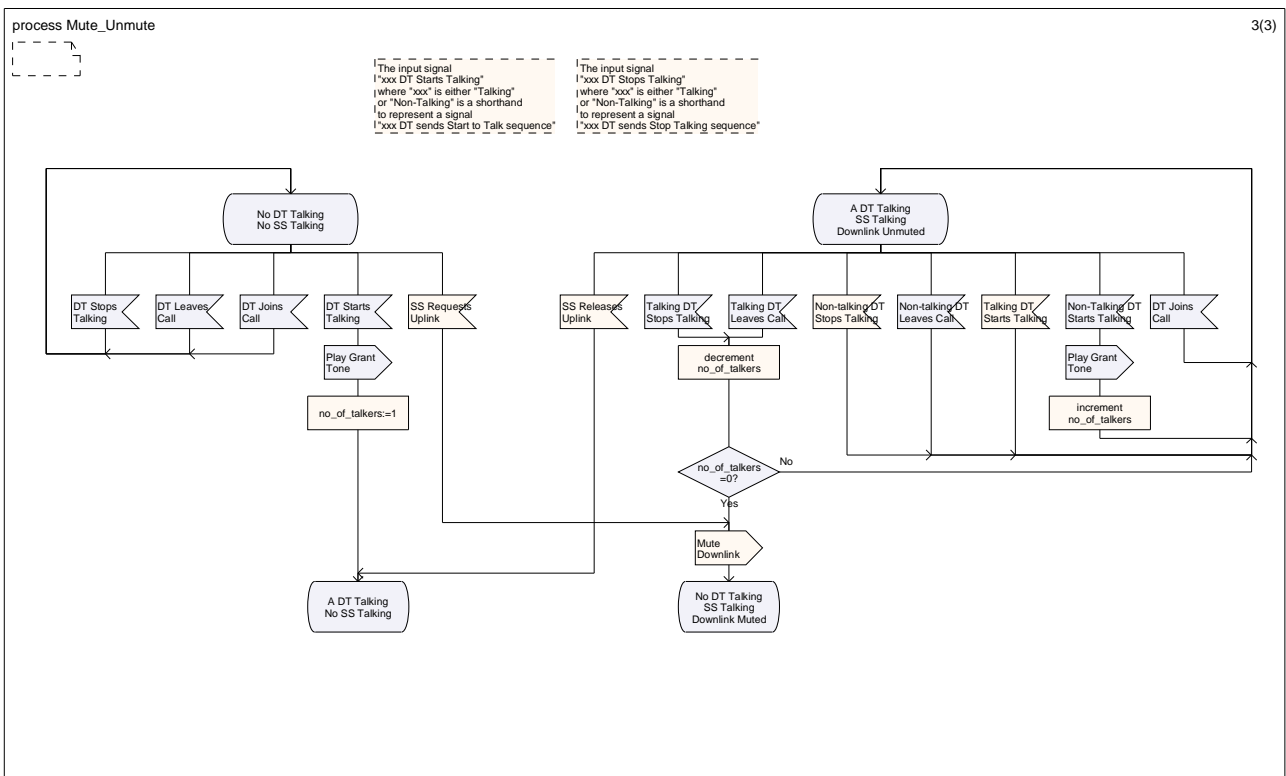


Figure 1a: Handling of Mute/Unmute Requests in Anchor MSC (Sheet 3 of 3)

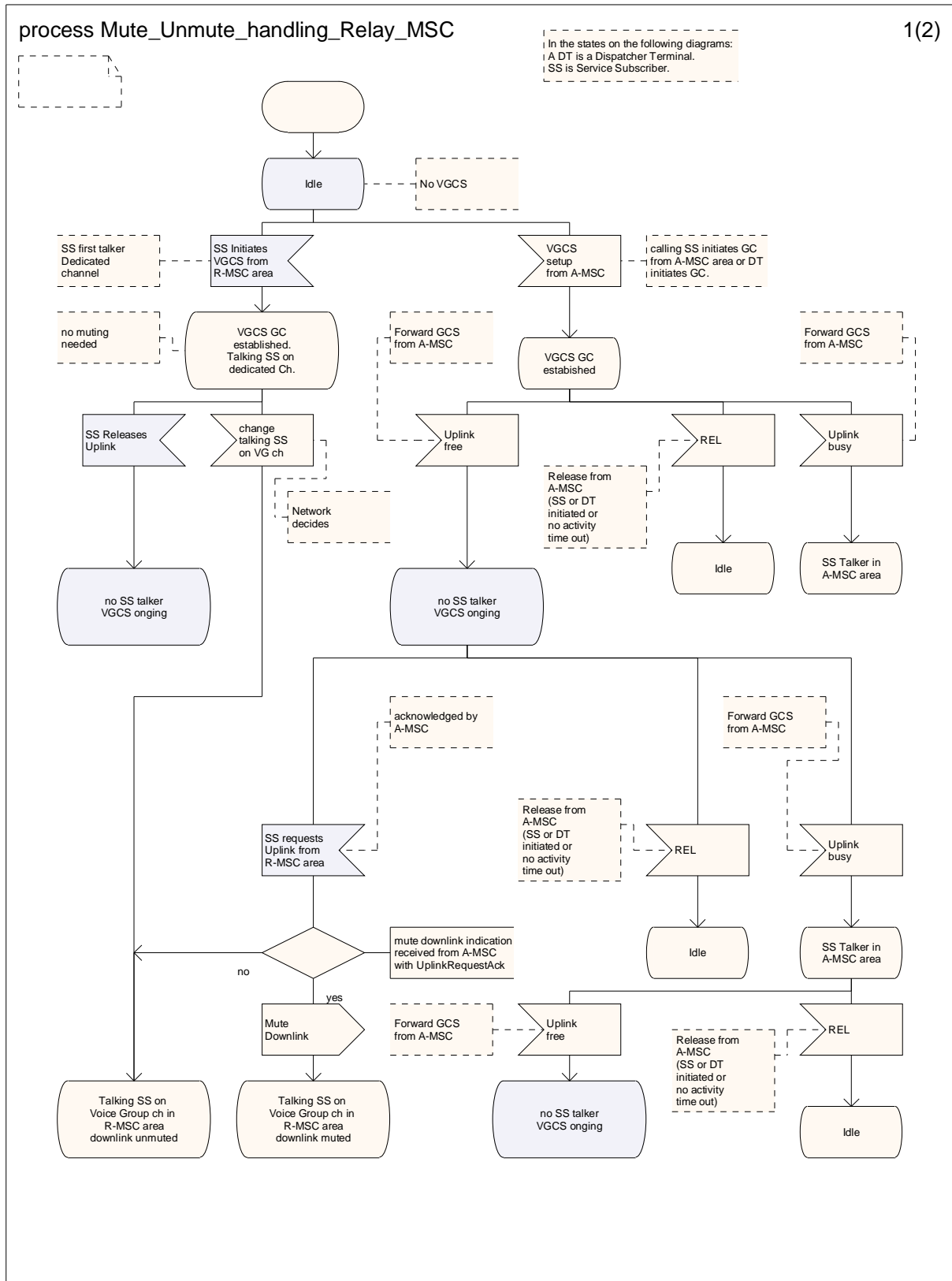


Figure 1b: Handling of Mute/Unmute Requests in Relay MSC (Sheet 1 of 2)

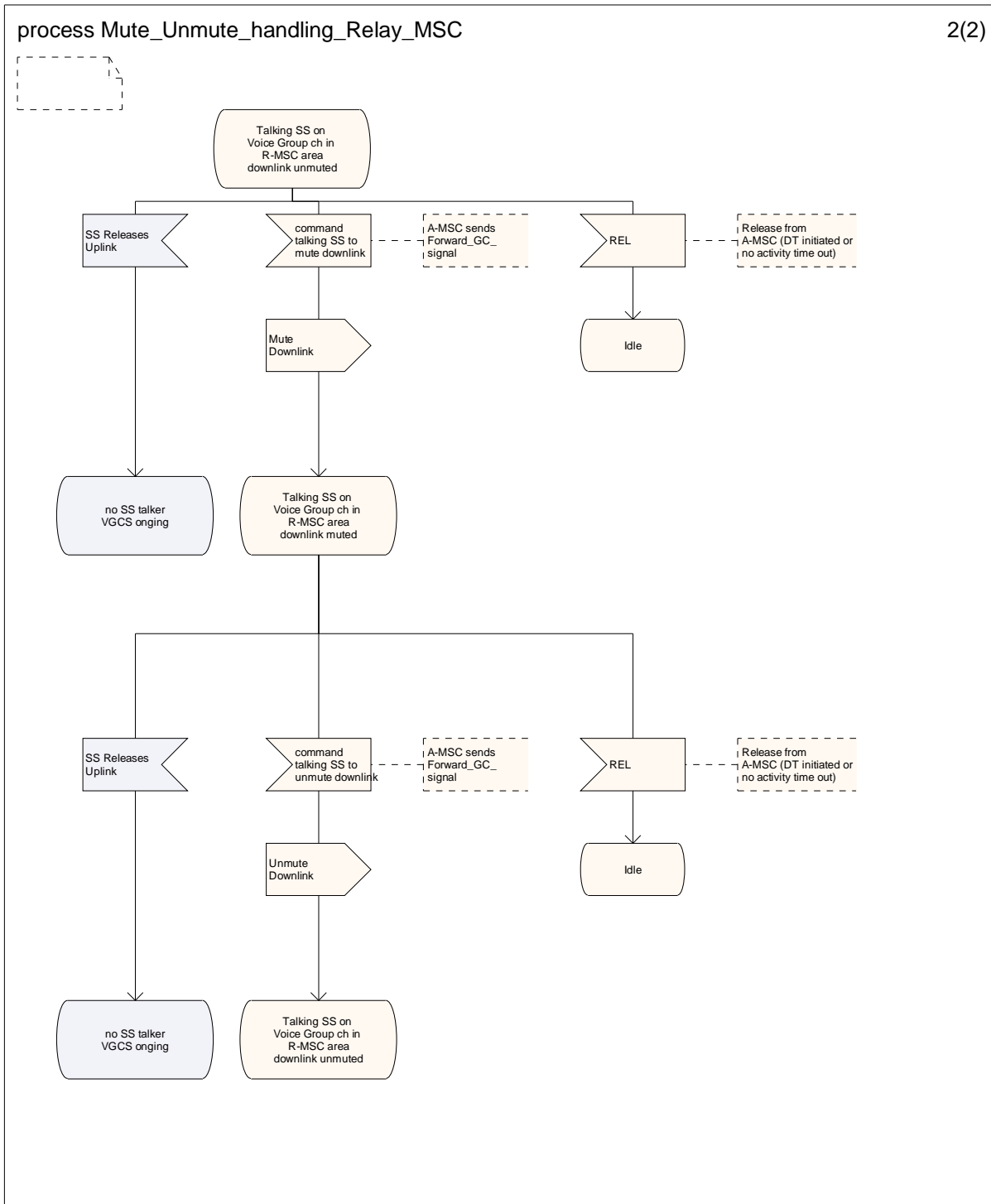


Figure 1b: Handling of Mute/Unmute Requests in Relay MSC (Sheet 2 of 2)



## 11.3.7a Signalling procedures for the user plane

### 11.3.7a.1 Group call re-establishment by the BSS

The MSC and BSS negotiate during the setup of a voice group call whether "group call re-establishment by the BSS" is supported by both entities.

If "group call re-establishment by the BSS" is supported by both entities or the network uses a transmission architecture with A-interface link sharing, the following procedures apply:

- i) If the BSS needs to release the group call channel in a cell due to an equipment failure or another BSS-generated reason (e.g. preemption), the BSS shall inform the MSC of the failure with either:
  - Uplink Release Indication and VGCS Assignment Status message if the group call channel is serving the current talker; or
  - VGCS Assignment Status message if the group call channel is not serving the current talker.

The terrestrial resource for the group call channel is not released by the MSC.

- ii) When the condition that caused the failure is subsequently removed, the BSS shall re-allocate a radio resource for the group call channel and inform the MSC of the recovery with a VGCS Assignment Status message.
- iii) If A-interface link sharing is used, each of the VGCS ASSIGNMENT STATUS messages in item (i) and (ii) shall be sent after expiry of timer T<sub>ast</sub>.

Otherwise, if "group call re-establishment by the BSS" is not supported by both entities and the network does not use a transmission architecture with A-interface link sharing, the following procedures apply:

- i) If the BSS needs to release the group call channel in a cell due to an equipment failure or another BSS-generated reason (e.g. preemption), the BSS shall inform the MSC of the failure with either:
  - Uplink Release Indication if the group call channel is serving the current talker; or
  - Clear Request if the group call channel is not serving the current talker.
- ii) The MSC shall then initiate the clearing of the radio and terrestrial resources for the group call channel. If supported, the MSC may retry the VGCS Assignment procedure for the cell, depending on the reason for release.

Group call re-establishment by the BSS does not apply to the dedicated link of the talker. If the BSS needs to release the dedicated channel of the talker due to an equipment failure or another BSS-generated reason (e.g. preemption), the BSS shall inform the MSC of the failure with an Uplink Release Indication. The MSC shall then initiate the clearing of the radio and terrestrial resources for the dedicated channel.

## 11.3.8 Overview of signalling

In this overview, the messages required to implement the specified concept are identified, and brief details are given of each message.

A diagrammatic representation of the voice group call message structure proposed and actions required are given in figures 2 to 7d.

Summary of figures in this subclause:

Figure 2: voice group call establishment by a service subscriber roaming in the anchor MSC area;

Figure 3: voice group call establishment by a service subscriber roaming in the relay MSC area;

Figure 3a: voice group call establishment by a service subscriber in a RANflex configuration;

Figure 3b: voice group call establishment by a mobile dispatcher of fixed line dispatcher;

Figure 4: uplink access request in the anchor MSC area without talker priority (uplink free);

Figure 4a: uplink access request in the anchor MSC area with talker priority "privileged subscriber" (uplink free, subsequent talker on dedicated channel);

Figure 4b: uplink access request in the anchor MSC area with talker priority "emergency subscriber" (uplink busy, access via group call channel uplink, subsequent talker on dedicated channel);

Figure 4c: uplink access in the anchor MSC area with "emergency mode reset request" (uplink busy, access via group call channel uplink);

Figure 4d: uplink access request in the anchor MSC area with talker priority "privileged subscriber" (uplink busy, access via RACH, subsequent talker on group call channel uplink);

Figure 4e: uplink access in the anchor MSC area with "emergency mode reset request" (uplink busy, access via RACH);

Figure 5: uplink access request in the relay MSC area without talker priority (uplink free);

Figure 5a: uplink access request in the relay MSC area with talker priority "privileged subscriber" (uplink busy, access via RACH, subsequent talker on group call channel uplink);

Figure 5b: dispatcher indicates wish to speak, talker attached to the anchor MSC;

Figure 5c: dispatcher indicates wish to speak, talker attached to the relay MSC;

Figure 5d: mobile dispatcher roaming in a non-Anchor MSC area indicates wish to speak, talker attached to the anchor MSC;

Figure 6: uplink release requested by the network;

Figure 6a: uplink release requested by the network; preemption of the current talker by a privileged talker;

Figure 6b: uplink release, talker on a dedicated link (normal case);

Figure 6c: uplink release, talker on a dedicated link (loss of radio contact or equipment failure (TRX, PCM, ...));

Figure 6d: uplink release, talker on group call channel (normal case);

Figure 6e: uplink release, talker on group call channel (loss of radio contact);

Figure 6f: uplink release, talker on group call channel (equipment failure (TRX, PCM, ...)), group call re-establishment by the BSS not supported;

Figure 6g: release after equipment failure (TRX, PCM, ...) concerning a cell not serving the talker, group call re-establishment by the BSS not supported;

Figure 6h: A-interface link sharing used or group call re-establishment by the BSS supported: Uplink release for the talker on group call channel after equipment failure (TRX, PCM ...)

Figure 6i: A-interface link sharing used or group call re-establishment by the BSS supported: Release after equipment failure (TRX, PCM, ...) concerning a cell not serving the talker;

Figure 6j: A-interface link sharing used or group call re-establishment by the BSS supported: Release after equipment failure concerning the link between MSC and BSS;

Figure 7: termination of the group call by the calling service subscriber;

Figure 7a: voice group call establishment by a service subscriber using immediate setup;

Figure 7b: signalling for DTMF digit entry by an entitled mobile dispatcher controlled by the anchor MSC;

Figure 7c: signalling for DTMF digit entry by an entitled mobile dispatcher controlled by a visited MSC;

Figure 7d: signalling for DTMF digit entry by an entitled fixed line dispatcher;

Figure 7e: Validation of Priority Uplink Requests for a ciphered group call;

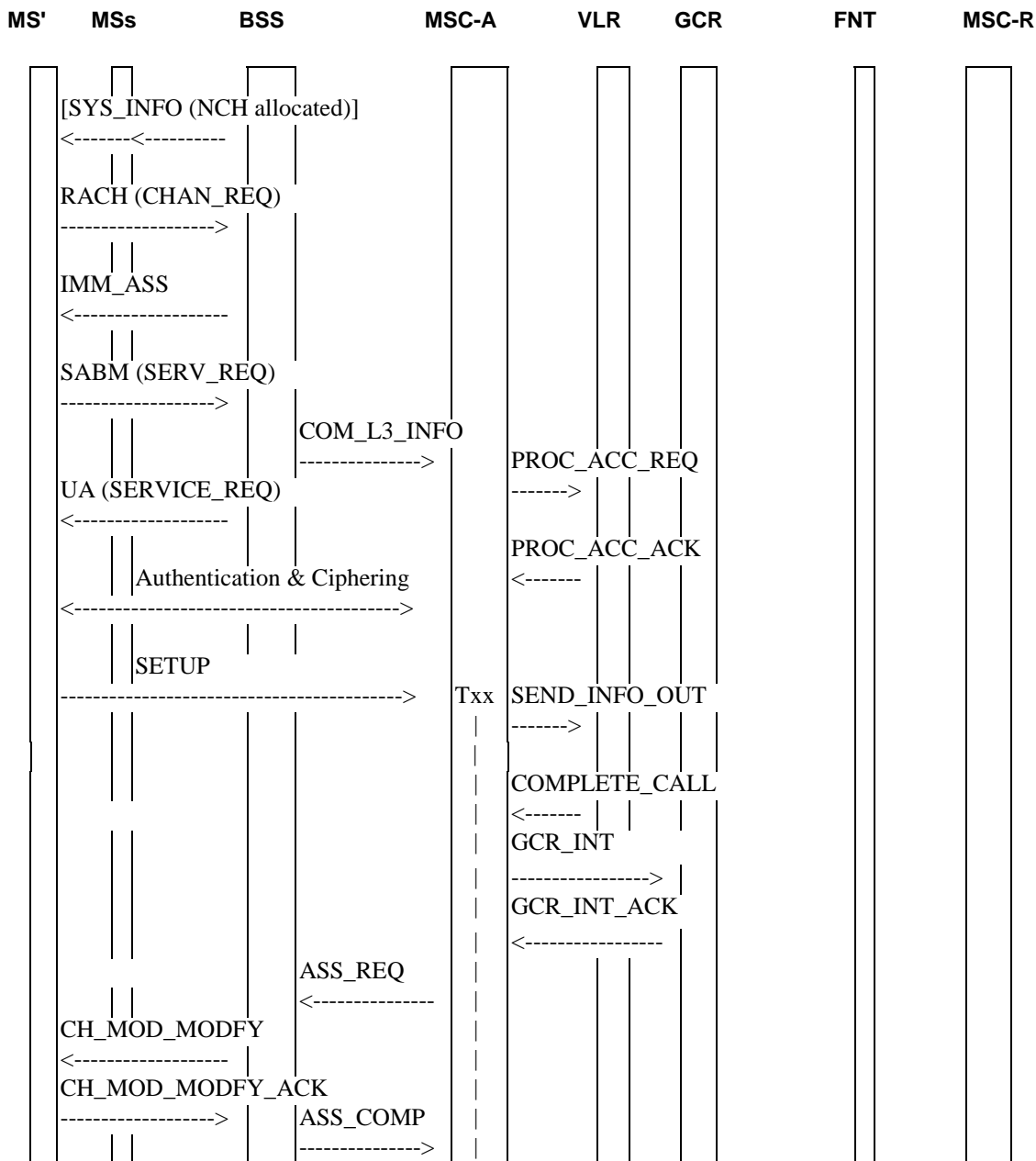
Figure 7f: A listener in the anchor MSC area sends application-specific data to the other group call members, while the group call channel uplink in the cell is free;

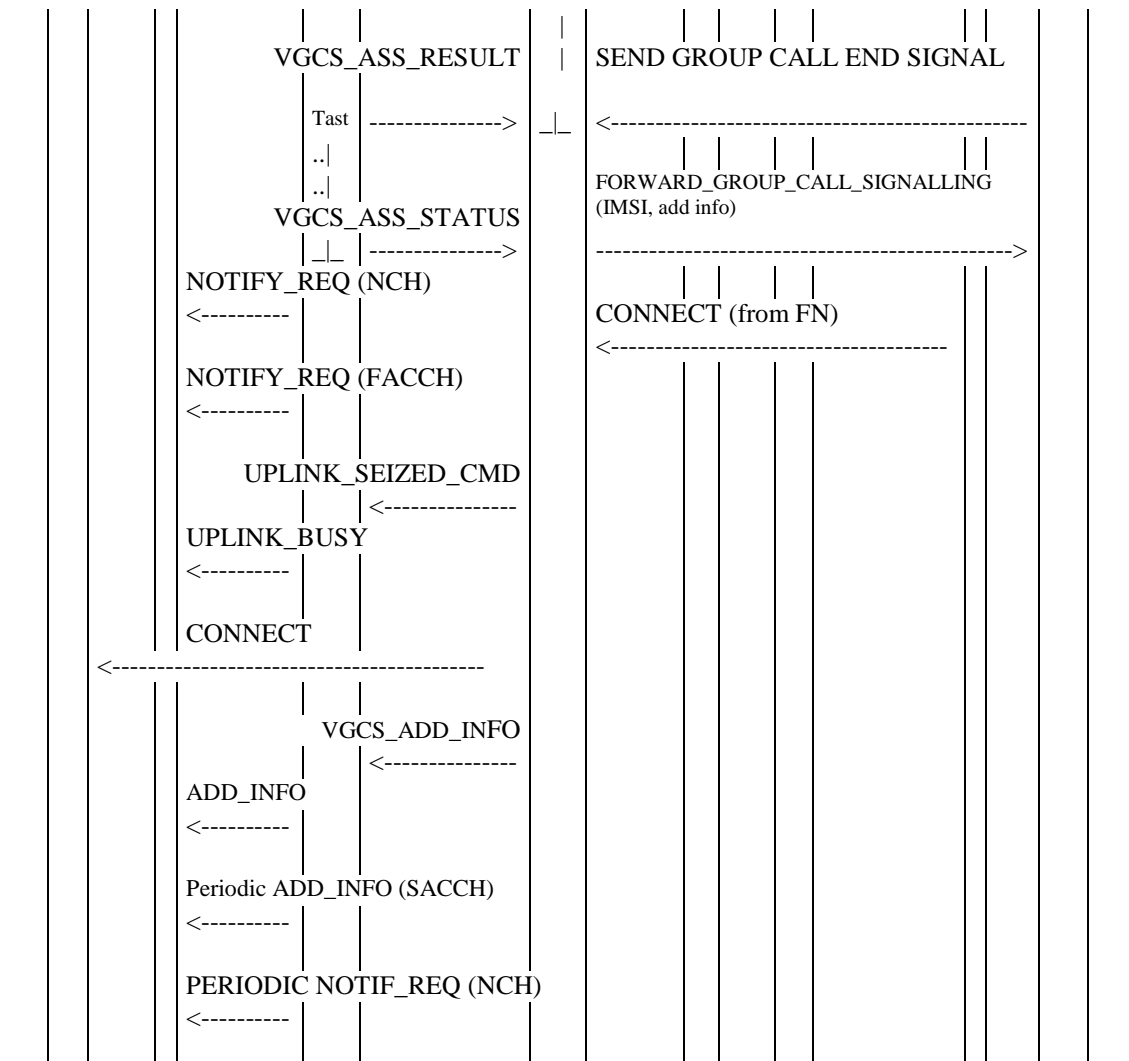
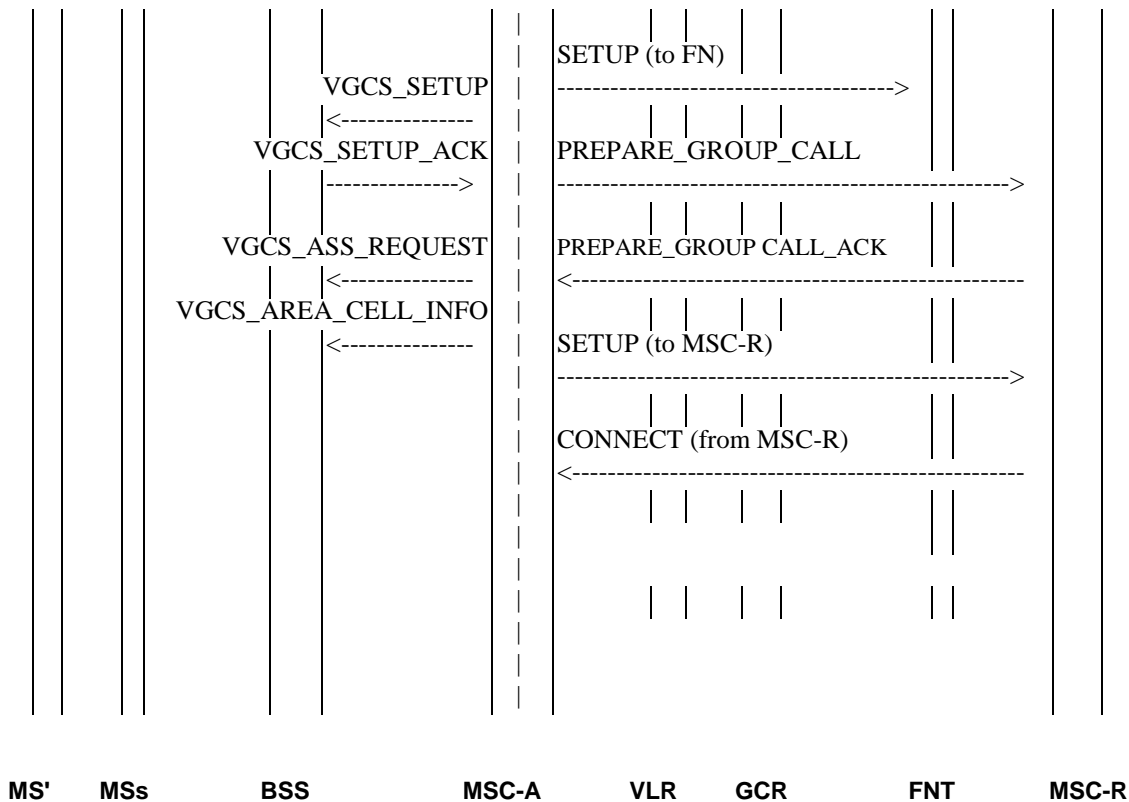
Figure 7g: A talker in the anchor MSC area sends application-specific data to the other group call members;

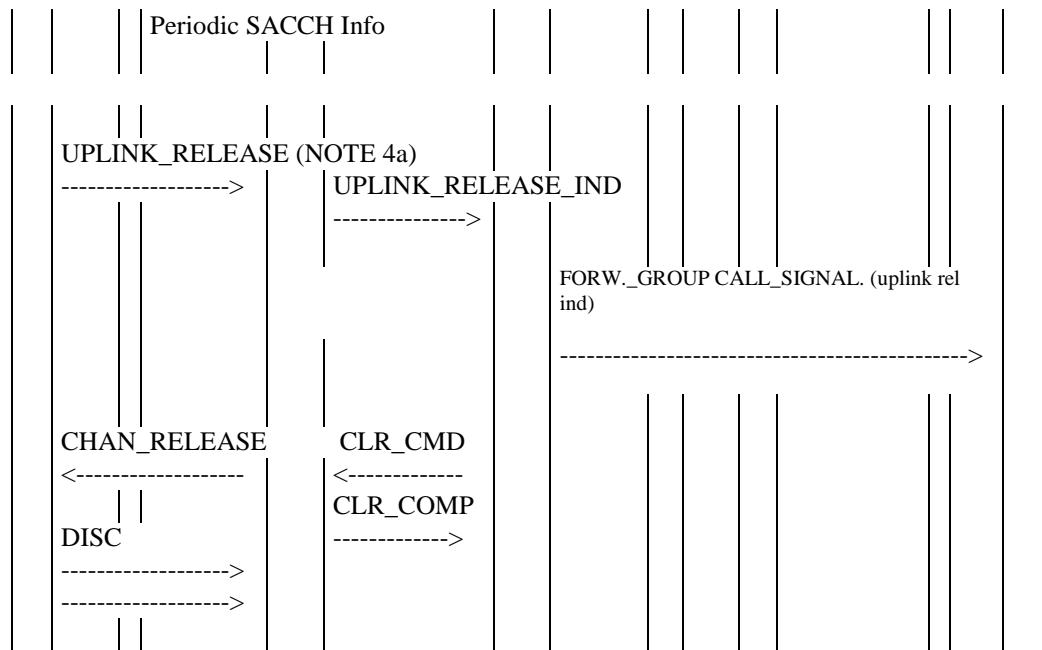
Figure 7h: A listener in a relay MSC area sends application-specific data to the other group call members, while the group call channel uplink in the cell is free;

Figure 7i: After receiving application-specific data, a service subscriber in the anchor MSC area sends a confirmation for the received data to the other group call members, while the group call channel uplink in the cell is free;

Figure 7j: A listener in the anchor MSC area sends application-specific data that is not time-critical via RACH to the other group call members, while the talker is using the group call channel uplink in the same cell.







NOTE: MS' = calling service subscriber mobile station;  
 MSs = destination service subscriber mobile stations;  
 FNT = fixed network user terminal;  
 MSC-A = anchor MSC;  
 MSC-R = relay MSC.

**Figure 2: Signalling information required for establishing voice group calls by a service subscriber roaming in the anchor MSC area**

**SYS\_INFO (NCH allocated):** Message used to indicate if the NCH is allocated on the CCCH in the cell.

**Initial RACH CHAN\_REQ:** Standard message.

**IMM\_ASS:** Standard message sent on the AGCH.

**SERV\_REQ (voice group call):** Modified form of the current call request message L3-MM CM SERVICE REQUEST sent on the allocated channel. Teleservice Voice group call is indicated.

**UA (SERV\_REQ):** This message is used to acknowledge the layer 2 link and provide contention resolution of the service request.

**COM\_L3\_INFO:** The MSC is provided with initial information about the voice group call.

NOTE 1: Messages flows for authentication and ciphering are not represented although performed as normal.

**PROC\_ACC\_REQ:** The MAP\_PROCESS\_ACC\_REQ message is sent to the VLR to check the requested VGCS teleservice against the subscription data.

**PROC\_ACC\_ACK:** The MAP\_PROCESS\_ACC\_ACK message acknowledges the requested service.

**Authentication and Ciphering:** Authentication and Ciphering may be performed. Acknowledgement of the service request can also be performed by sending the CM SERVICE ACCEPT.

**SETUP:** The MSC is provided with details about the voice group call. Optionally this message may contain a talker priority.

NOTE 2: Alternatively, an IMMEDIATE\_SETUP may have been sent as the initial message including all details of the voice group call. In this case no SETUP message must be sent.

**SEND\_INFO\_OUT:** The requested group ID is transferred to the VLR in the MAP\_SEND\_INFO\_FOR\_OUTGOING\_CALL message.

**COMPLETE\_CALL:** The VLR returns the MAP\_COMPLETE\_CALL message confirming the use of the requested group ID. The VLR also returns additional information about the calling service subscriber, if available.

**GCR\_INT:** The group call attributes are requested from the GCR through the GCR Interrogation message sent by the MSC.

**GCR\_INT\_ACK:** The requested information is returned from the GCR in the GCR Interrogation Ack message.

**ASSIGNMENT\_REQUEST:** Standard message.

**CHAN\_MOD\_MODIFY:** Standard message to modify the channel mode in case of very early assignment.

**CHAN\_MOD\_MODIFY\_ACK:** Standard message to acknowledge the modification of the channel mode.

**ASSIGNMENT\_COMPLETE:** Standard message.

NOTE 3: Alternatively, early assignment or OACSU procedures might be applied with the corresponding assignment messages not presented in figure 2.

**VGCS\_SETUP:** This message is sent from the MSC to all affected BSCs, [one dedicated message for each BSC,] including the group call reference with the eMLPP priority, and optionally the call priority.

**VGCS\_SETUP\_ACK:** Acknowledgement message from the affected BSC in answer to the VGCS\_SETUP message. If the setup is not successful, a VGCS\_SETUP\_REFUSE message shall be sent instead.

**VGCS\_ASSIGNMENT\_REQ:** This message is sent from the MSC to all affected BSCs, [one dedicated message for every requested channel in a cell] including the group call reference, the channel type and possibly the call priority and details on the ciphering.

NOTE 4: As an operator option the voice group call channels, the links to them and optionally also the links to dispatchers can already be established and permanently reserved in order to speed up the call set-up for emergency voice group calls.

In case of A-interface link sharing this message shall contain a list of all cells in the group call area served by this BSC. If the entire list of cell identifiers does not fit into the message, one or more VGCS AREA CELL INFO messages with additional cell identifier lists shall be sent. If the cell of origin is served by this BSC, the cell shall be included in the VGCS ASSIGNMENT REQUEST message.

**VGCS\_AREA\_CELL\_INFO:** This message shall contain the cell IDs that did not fit into the VGCS ASSIGNMENT REQUEST message in case of A-interface link sharing.

**VGCS\_ASSIGNMENT RESULT:** Acknowledgement message from the affected BSC in answer to the assignment requests. If the assignment is not successful, a VGCS\_ASSIGNMENT\_FAILURE message shall be sent instead.

In case of A-interface link sharing this message shall be sent as soon as a channel could be established to the cell of origin or, if the cell of origin is not served by this BSC, to any other cell. Then timer T<sub>ast</sub> shall be started.

**T<sub>ast</sub>:** In a network supporting A-interface link sharing timer T<sub>ast</sub> shall be used to measure the duration between periodic reports from the BSC to the MSC of Group Call Area cells for which channels have been assigned or released since the last periodic report. When timer T<sub>ast</sub> expires, if new cells in the Group Call Area have been established or existing ones have been released, pre-empted or failed, the MSC shall be informed of the changes (see subclause 7.1b). Timer T<sub>ast</sub> shall be started again to measure the period of time until the next report. The timer shall be stopped when the call is released.

**VGCS\_ASSIGNMENT\_STATUS:** This message shall be sent in case of A-interface link sharing from the BSC to inform the MSC about the status of the channel establishment to the cells of a given VGCS call. This message shall be sent after timer T<sub>ast</sub> expires and new channels are established or existing channels were released, pre-empted or failed. This message shall also be immediately sent, and T<sub>ast</sub> restarted, when all cells for a given group call area served by the BSC are established, indicating this.

**SETUP to fixed network users:** Based on the information determined about the users of external networks to be involved in the call, the MSC shall initiate calls to these users in the normal manner, depending on their mode of connection into the MSC, and shall connect them into the conference bridge. Alternatively normal calls to GSM subscribers may be established for dispatchers being GSM subscribers which are not presented in the diagram.

**PREPARE\_GROUP\_CALL:** The group call attributes are sent to every relay MSC and a Group Call number for call set-up to is requested.

**PREPARE\_GROUP\_CALL\_ACK:** The Group Call number for call set-up is returned to the anchor MSC.

**SETUP to MSC-R:** The ISUP connection is set-up to the relay MSC.

**CONNECT from MSC-R:** Set-up of the ISUP connection to the relay MSC is confirmed.

**SEND\_GROUP\_CALL\_END\_SIGNAL:** Indicates to the anchor MSC that at least one voice group call channel has been established in the relay MSC area.

**FORWARD\_GROUP\_CALL\_SIGNALLING (IMSI, additional info):** The IMSI of the service subscriber who has established the voice group call and who is allowed to terminate the call is sent to every relay MSC. If the network supports the use of talker priorities, the message includes also the talker priority. Furthermore, the message provides additional information about the current talking service subscriber, if available.

**Txx:** Timer implemented in the MSC which is started with receipt of the SETUP message from the calling service subscriber. If the timer expires before the conditions for establishment have been met, as per subclause 11.3.1.1.2, then the call shall be released.

**NOTIF\_REQ (NCH):** Messages for notification which contain the group call reference, the priority of the call if eMLPP is applied, and possibly the channel description of the voice group call channel to which the mobile stations shall listen and the number of the group key used for ciphering.

**NOTIF\_REQ (FACCH):** Message for notification sent on the FACCH to the mobile stations currently involved in other calls. The notification on the FACCH shall include the group call reference, and the priority level and may also include the channel description and the group ciphering key numbers.

**UPLINK\_SEIZED\_CMD:** If the network supports the use of talker priorities, this message informs the BSS about the talker priority of the current talking service subscriber and about the status of the emergency mode. The MSC may also include additional information about the current talking service subscriber, if the information is available when sending this message.

**UPLINK\_BUSY:** If the network supports the use of talker priorities, this connectionless RR message is sent on the downlink FACCH to inform all mobile stations about the talker priority of the current talking service subscriber and about the status of the emergency mode. The network may also include additional information about the current talking service subscriber, if the information is available when sending this message and there is sufficient space available in the message. The message is repeated on the FACCH every T1 seconds.

**VGCS\_ADD\_INFO:** The MSC sends additional information about the current talking service subscriber to all BSCs, unless the information was already included in the UPLINK\_SEIZED\_CMD message.

**ADD\_INFO:** The BSCs broadcast the additional information on the FACCH to all listeners. , unless the information was already included in the UPLINK\_BUSY message

**Periodic ADD\_INFO (SACCH):** The message is repeated on the SACCH every T2 seconds.

**Periodic NOTIF\_REQ (NCH):** The notifications are sent periodically so that mobile stations moving into the area can join the voice group call.

**Periodic SACCH Info:** Periodic messages sent on SACCH. This message may include:

- information of changes of notifications;
- information used for cell re-selection.

**CONNECT:** Information to the mobile station of the calling service subscriber that the VGCS is established with the related group call reference as the connected number. The CONNECT message is sent as soon as conditions for establishment are met, as per subclause 11.3.1.1.2. If the SETUP message from the calling subscriber contained a talker priority, the MSC returns the talker priority used by the network. This will be lower than the requested talker priority, if the subscription check for the requested talker priority was unsuccessful.

**UPLINK\_RELEASE:** When the calling service subscriber wants to become a listening service subscriber for the first time, a message indicating release of the uplink is required to be sent from the MS to the BSS in order to set the uplink free.

NOTE 4a: For different cases of uplink release and the related message flows refer to Figure 6.b to 6.g.

**UPLINK\_RELEASE\_INDICATION:** The BSS informs the MSC on the uplink release.

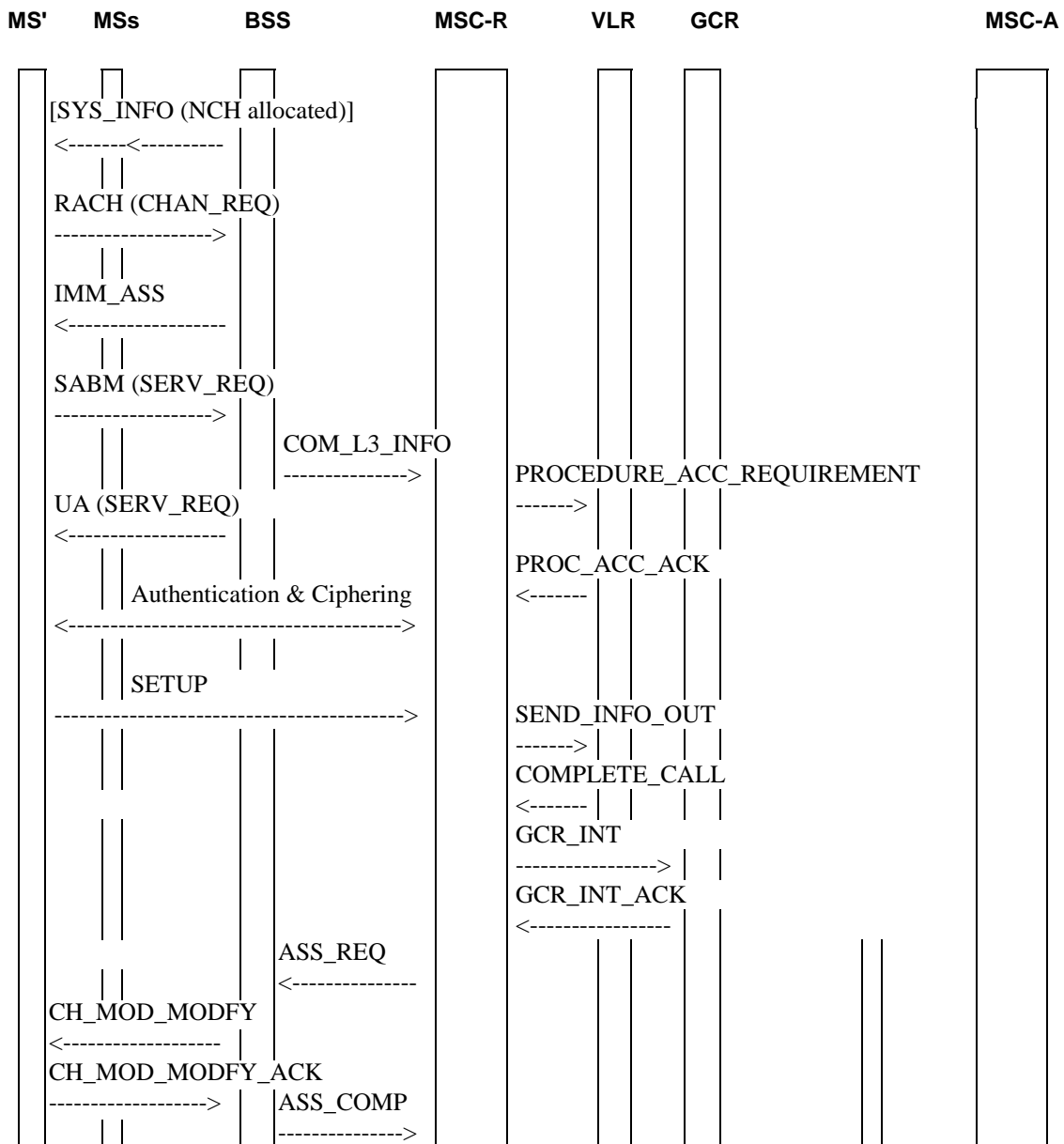
**FORWARD\_GROUP\_CALL\_SIGNALLING (uplink release indication):** This message is sent to every relay MSC to indicate that the uplink is free.

**CLEAR COMMAND :** The MSC requests the BSS to clear radio and terrestrial resources associated with originator dedicated link if not already done.

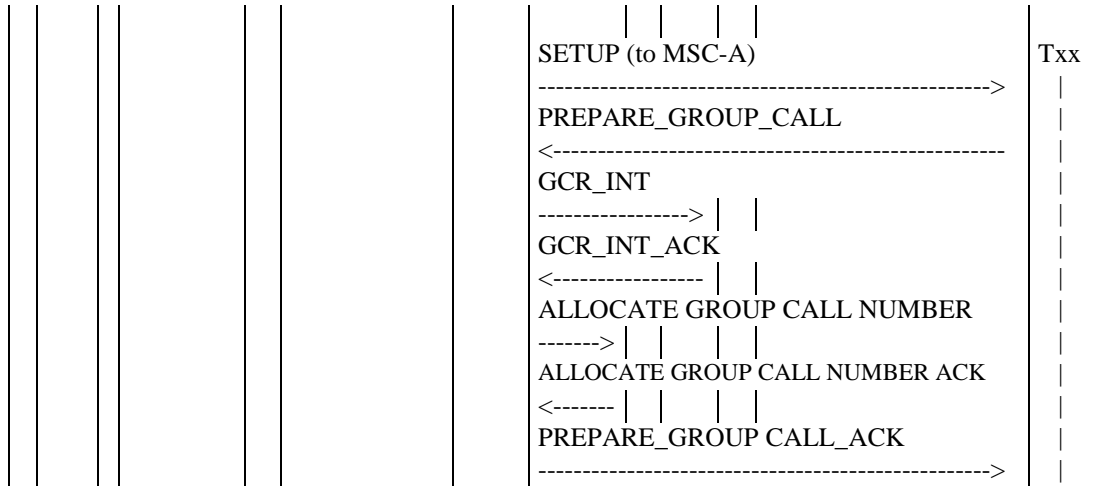
**CHAN\_RELEASE:** The BSS sends a channel release message to the calling service subscriber's mobile station including the channel description of the voice group call channel to which the mobile station shall tune to.

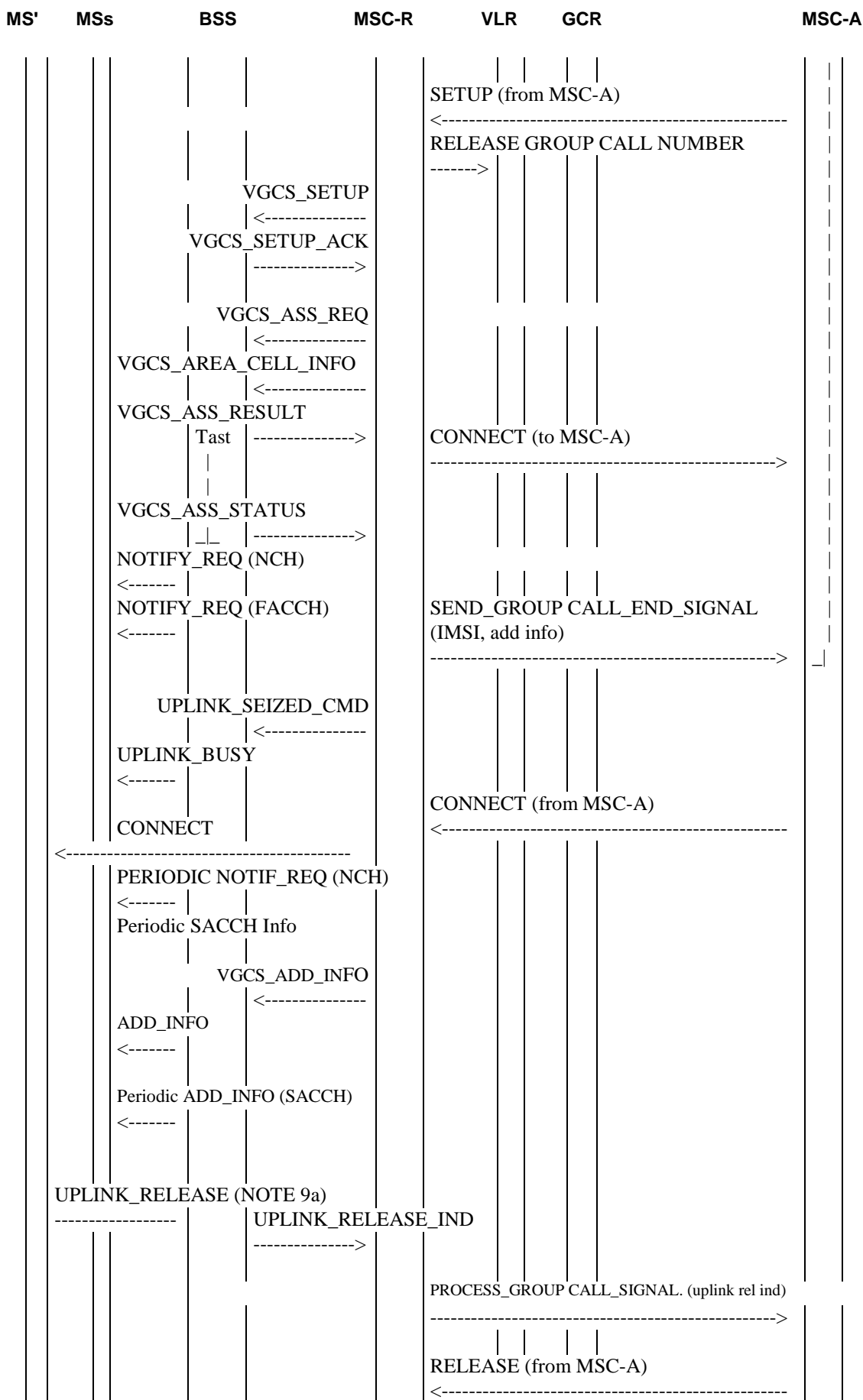
NOTE 5: Alternatively, if no UPLINK\_RELEASE has been sent to the network by the mobile station, the network may transfer the mobile station to the voice group call channel by the channel mode modify procedure or by an assignment procedure or by a handover procedure.

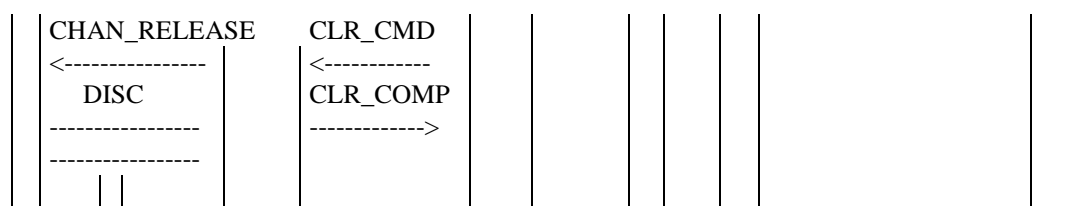
**DISC:** Two layer 2 disconnect messages shall be sent by the mobile station to the network.











NOTE: MS' = calling service subscriber mobile station;  
 MSs = destination service subscriber mobile stations;  
 MSC-A = anchor MSC;  
 MSC-R = relay MSC

**Figure 3: Signalling information required for establishing voice group calls by a service subscriber roaming in the relay MSC area**

**SYS\_INFO (NCH allocated):** Message used to indicate if the NCH is allocated on the CCCH in the cell.

**Initial RACH CHAN\_REQ:** Standard message.

**IMM\_ASS:** Standard message sent on the AGCH.

**SERV\_REQ (voice group call):** Modified form of the current call request message L3-MM CM SERVICE REQUEST sent on the allocated channel. Teleservice Voice group call is indicated.

**UA (SERV\_REQ):** This message is used to acknowledge the layer 2 link and provide contention resolution of the service request.

**COM\_L3\_INFO:** The MSC is provided with initial information about the voice group call.

NOTE 6: Messages flows for authentication and ciphering are not represented although performed as normal.

**PROC\_ACC\_REQ:** The MAP\_PROCESS\_ACC\_REQ message is sent to the VLR to check the requested VGCS teleservice against the subscription data.

**PROC\_ACC\_ACK:** The MAP\_PROCESS\_ACC\_ACK message acknowledges the requested service.

**Authentication & Ciphering:** Authentication and Ciphering may be performed. Acknowledgement of the service request can also be performed by sending the CM SERVICE ACCEPT.

**SETUP:** The MSC is provided with details about the voice group call. Optionally this message may contain a talker priority.

NOTE 7: Alternatively, an IMMEDIATE\_SETUP may have been send as the initial message including all details of the voice group call. In this case no SETUP message must be sent.

**SEND\_INFO\_OUT:** The requested group ID is transferred to the VLR in the MAP\_SEND\_INFO\_FOR\_OUTGOING\_CALL message.

**COMPLETE\_CALL:** The VLR returns the MAP\_COMPLETE\_CALL message confirming the use of the requested group ID. The VLR also returns additional information about the calling service subscriber, if available.

**GCR\_INT:** The group call attributes are requested from the GCR through the GCR Interrogation message sent by the MSC.

**GCR\_INT\_ACK:** The requested information (MSC-A address) is returned from the GCR in the GCR Interrogation Ack message.

**ASSIGNMENT\_REQUEST:** Standard message.

**CHAN\_MOD\_MODIFY:** Standard message to modify the channel mode in case of very early assignment.

**CHAN\_MOD\_MODIFY\_ACK:** Standard message to acknowledge the modification of the channel mode.

**ASSIGNMENT\_COMPLETE:** Standard message.

NOTE 8: Alternatively, early assignment or OACSU procedures might be applied with the corresponding assignment messages not presented in figure 3.

**SETUP to MSC-A:** Based on information received from the GCR the relay MSC shall set-up a dedicated connection for the calling service subscriber to the anchor MSC. The address of the calling service subscriber's relay MSC shall be sent as calling party number.

**PREPARE\_GROUP\_CALL:** The group call attributes (parts) are received from the anchor MSC.

**GCR\_INT:** The group call attributes are requested from the GCR through the GCR Interrogation message sent by the MSC.

**GCR\_INT\_ACK:** The requested information (cell list) is returned from the GCR in the GCR Interrogation Ack message.

**ALLOCATE\_GROUP\_CALL\_NUMBER:** The Group Call number is requested from the VLR.

**ALLOCATE\_GROUP\_CALL\_NUMBER\_ACK:** The Group Call number is returned from the VLR.

**PREPARE\_GROUP\_CALL\_ACK:** The Group Call number is sent to MSC-A.

**SETUP from MSC-A:** The ISUP connection is set-up between MSC-A and MSC-R.

**RELEASE\_GROUP\_CALL\_NUMBER:** The VLR is requested to release the Group Call number.

**VGCS\_SETUP:** This message is sent from the MSC to all affected BSCs, [one dedicated message for each BSC,] including the group call reference with the eMLPP priority, and optionally the call priority.

**VGCS\_SETUP\_ACK:** Acknowledgement message from the affected BSC in answer to the VGCS\_SETUP setup message. If the setup is not successful, a VGCS\_SETUP\_REFUSE message shall be sent instead.

**VGCS\_ASSIGNMENT\_REQ:** This message is sent from the MSC to all affected BSCs, [one dedicated message for every requested channel in a cell,] including the group call reference, the channel type and possibly the call priority and details on the ciphering.

NOTE 9: As an operator option the voice group call channels, the links to them and optionally also the links to dispatchers can already be established and permanently reserved in order to speed up the call set-up for emergency voice group calls.

In case of A-interface link sharing this message shall contain a list of all cells in the group call area served by this BSC. If the entire list of cell identifiers does not fit into the message, one or more VGCS AREA CELL INFO messages with additional cell identifier lists shall be sent. If the cell of origin is served by this BSC, the cell shall be included in the VGCS ASSIGNMENT REQUEST message.

**VGCS\_AREA\_CELL\_INFO:** This message shall contain the cell IDs that did not fit into the VGCS ASSIGNMENT REQUEST message in case of A-interface link sharing.

**VGCS\_ASSIGNMENT\_RESULT:** Acknowledgement message from the affected BSC in answer to the assignment requests. If the assignment is not successful, a VGCS\_ASSIGNMENT\_FAILURE message shall be sent instead.

In case of A-interface link sharing this message shall be sent as soon as a channel could be established to the cell of origin or, if the cell of origin is not served by this BSC, to any other cell. Then timer T<sub>ast</sub> shall be started.

**T<sub>ast</sub>:** In a network supporting A-interface link sharing timer T<sub>ast</sub> shall be used to measure the duration between periodic reports from the BSC to the MSC of Group Call Area cells for which channels have been assigned or released since the last periodic report. When timer T<sub>ast</sub> expires, if new cells in the Group Call Area have been established or existing ones have been released, pre-empted or failed the MSC shall be informed of the changes (see subclause 7.1b). Timer T<sub>ast</sub> shall be started again to measure the period of time until the next report. The timer shall be stopped when the call is released.

**VGCS\_ASSIGNMENT\_STATUS:** This message shall be sent in case of A-interface link sharing from the BSC to inform the MSC about the status of the channel establishment to the cells of a given VGCS call. This message shall be sent after timer T<sub>ast</sub> expires and new channels are established or existing channels are released, pre-empted or failed. This message shall also be immediately sent, and T<sub>ast</sub> restarted, when all cells for a given group call area served by the BSC are established, indicating this.

**CONNECT to MSC-A:** Set-up of the ISUP connection from the anchor MSC is confirmed.

**SEND\_GROUP\_CALL\_END\_SIGNAL (IMSI, additional info):** Indicates to the anchor MSC that conversation can start. In addition the IMSI of calling service subscriber who has established the voice group call and who is allowed to terminate the call is included. If the network supports the use of talker priorities, the message includes also the talker priority. Furthermore, the message provides additional information about the current talking service subscriber, if available.

**NOTIF\_REQ (NCH):** Messages for notification which contain the group call reference, the priority of the call if eMLPP is applied, and possibly the channel description of the voice group call channel to which the mobile stations shall listen and the number of the group key used for ciphering.

**NOTIF\_REQ (FACCH):** Message for notification sent on the FACCH to the mobile stations currently involved in other calls. The notification on the FACCH shall include the group call reference, and the priority level and may include also the channel description and the group ciphering key numbers.

**UPLINK\_SEIZED\_CMD:** If the network supports the use of talker priorities, this message informs the BSS about the talker priority of the current talking service subscriber and about the status of the emergency mode. The MSC may also include additional information about the current talking service subscriber, if the information is available when sending this message.

**UPLINK\_BUSY:** If the network supports the use of talker priorities, this connectionless RR message is sent on the downlink FACCH to inform all mobile stations about the talker priority of the current talking service subscriber and about the status of the emergency mode. The network may also include additional information about the current talking service subscriber, if the information is available when sending this message and there is sufficient space available in the message. The message is repeated on the FACCH every T1 seconds.

**VGCS\_ADD\_INFO:** The MSC sends additional information about the current talking service subscriber to all BSCs, unless the information was already included in the UPLINK\_SEIZED\_CMD message.

**ADD\_INFO:** The BSCs broadcast the additional information on the FACCH to all listeners, unless the information was already included in the UPLINK\_BUSY message.

**Periodic ADD\_INFO (SACCH):** The message is repeated on the SACCH every T2 seconds.

**Periodic NOTIF\_REQ (NCH):** The notifications are sent periodically so that mobile stations moving into the area can join the voice group call.

**Periodic SACCH Info:** Periodic messages sent on the downlink of the SACCH informing mobile stations of:

- information of changes of notifications;
- information used for cell re-selection.

**CONNECT (from MSC-A):** Call set-up of the dedicated connection for the calling service subscriber is confirmed.

**CONNECT:** Information to the mobile station of the calling service subscriber that the VGCS is established with the related group call reference as the connected number. The CONNECT message is sent as soon as conditions for establishment are met, as per subclause 11.3.1.1.2. If the SETUP message from the calling subscriber contained a talker priority, the MSC returns the talker priority used by the network. This will be lower than the requested talker priority, if the subscription check for the requested talker priority was unsuccessful.

**UPLINK\_RELEASE:** When the calling service subscriber wants to become a listening service subscriber for the first time, a message indicating release of the uplink is required to be sent from the MS to the BSS in order to set the uplink free.

NOTE 9a: For different cases of uplink release and the related message flows refer to Figure 6.b to 6.g.

**UPLINK\_RELEASE\_INDICATION:** The BSS informs the MSC on the uplink release.

**PROCESS\_GROUP\_CALL\_SIGNALLING (uplink release indication):** To indicate to the anchor MSC that the uplink is free.

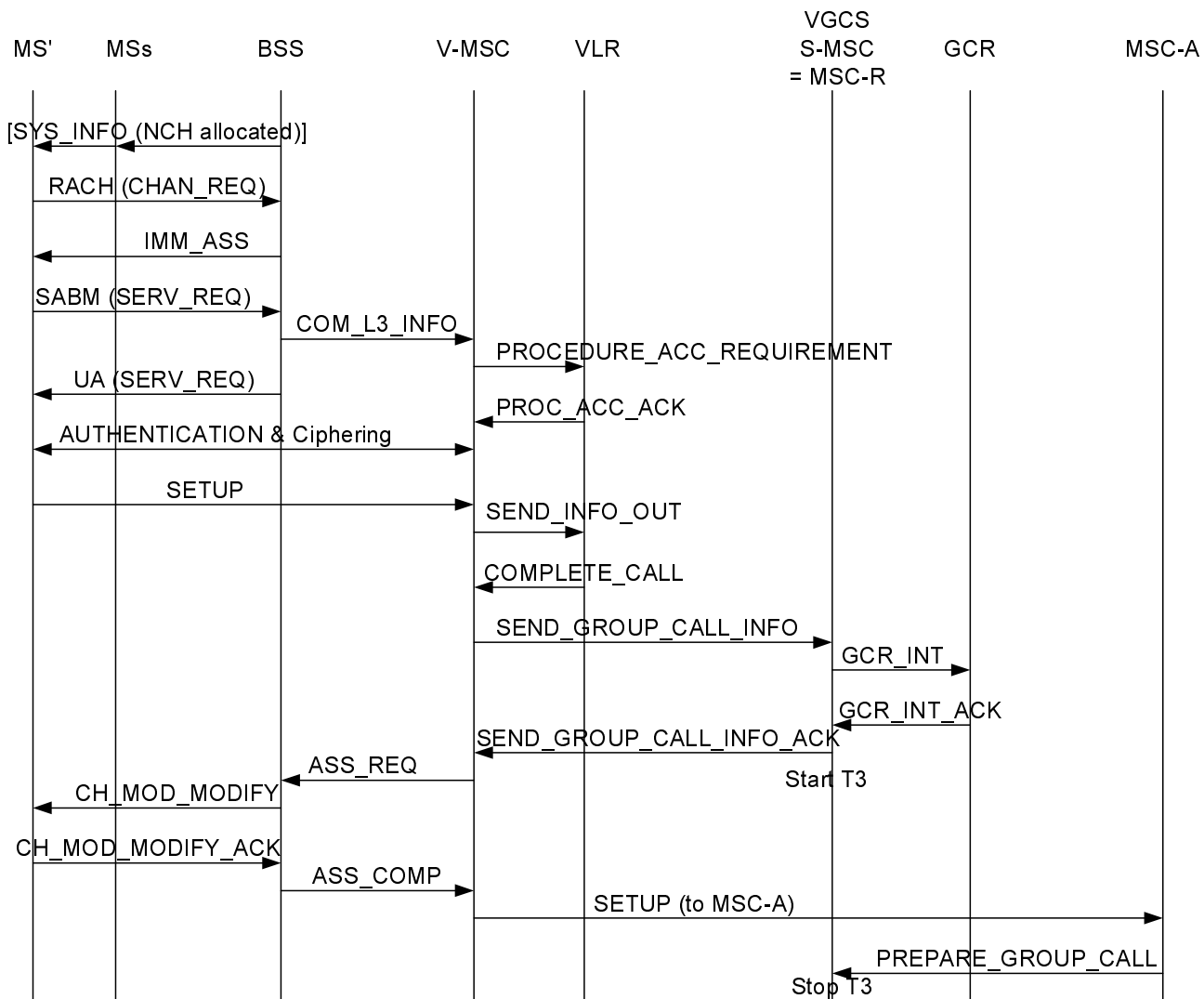
**CLEAR\_COMMAND:** The MSC requests the BSS to clear radio and terrestrial resources associated with originator dedicated link if not already done.

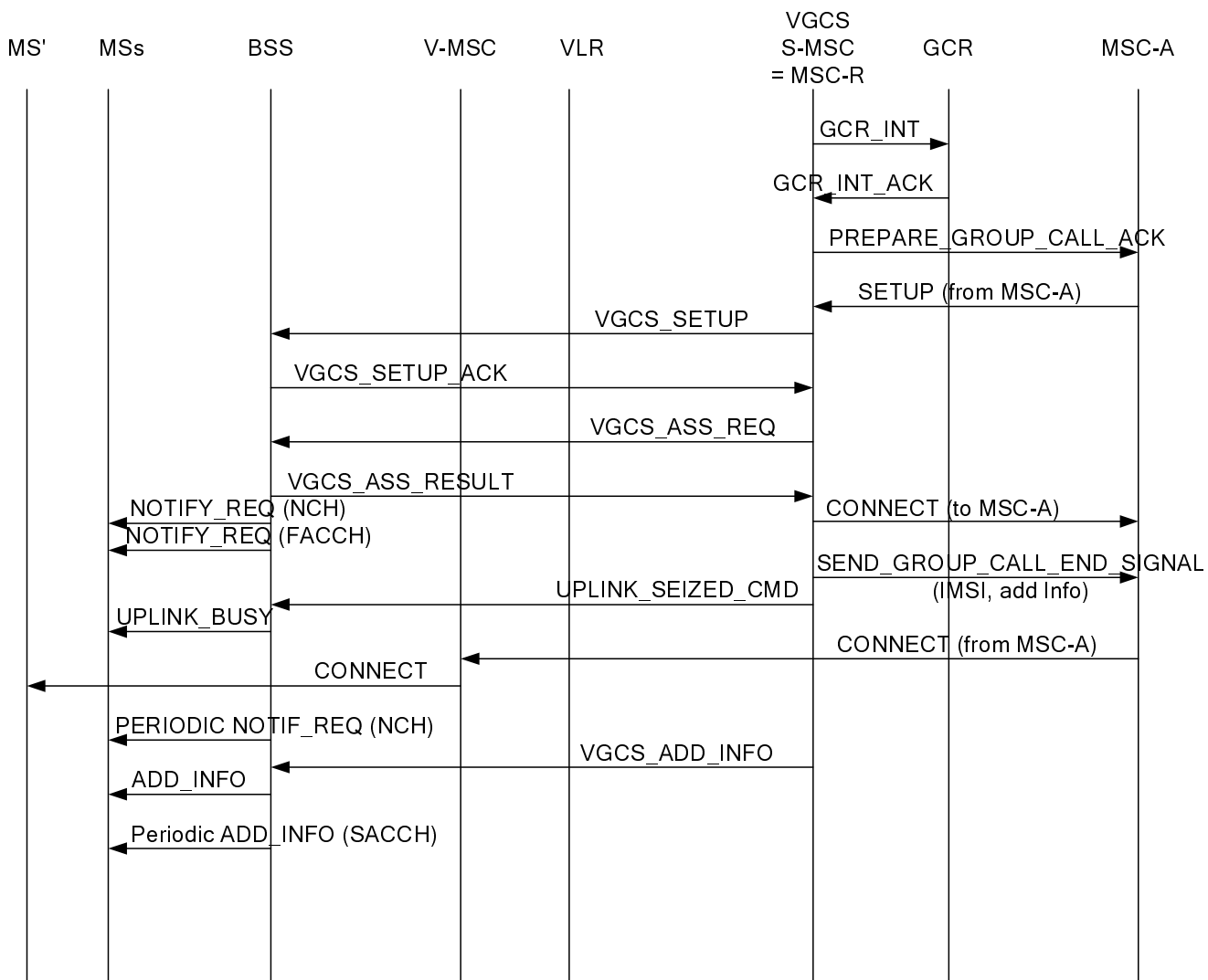
**CHAN\_RELEASE:** The BSS sends a channel release message to the calling service subscriber's mobile station including the channel description of the voice group call channel to which the mobile station shall tune to.

NOTE 10: Alternatively, if no UPLINK\_RELEASE has been sent to the network by the mobile station, the network may transfer the mobile station to the voice group call channel by the channel mode modify procedure or by an assignment procedure or by a handover procedure.

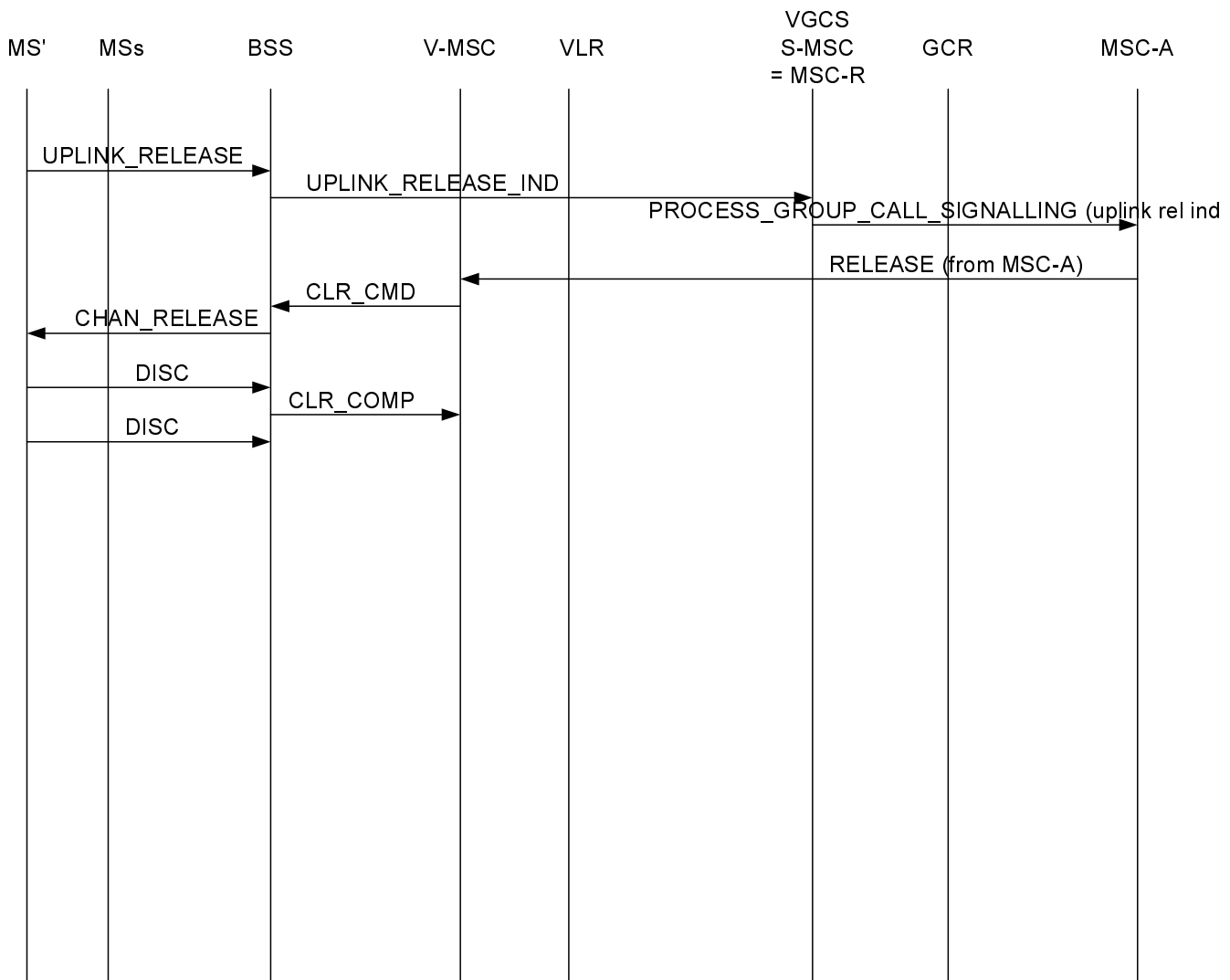
**DISC:** Two layer 2 disconnect messages shall be sent by the mobile station to the network.

**RELEASE from MSC-A:** The dedicated connection for the calling service subscriber is released with cause 'normal, unspecified'.









NOTE: MS' = calling service subscriber mobile station;  
 MSs = destination service subscriber mobile stations;  
 MSC-A = anchor MSC;  
 MSC-R = relay MSC;  
 V-MSC = visited MSC

**Figure 3a: Signalling information required for establishing voice group calls by a service subscriber in a RANflex configuration**

**SYS\_INFO (NCH allocated):** Message used to indicate if the NCH is allocated on the CCCH in the cell.

**Initial RACH CHAN\_REQ:** Standard message.

**IMM\_ASS:** Standard message sent on the AGCH.

**SERV\_REQ (voice group call):** Modified form of the current call request message L3-MM CM SERVICE REQUEST sent on the allocated channel. Teleservice Voice group call is indicated.

**UA (SERV\_REQ):** This message is used to acknowledge the layer 2 link and provide contention resolution of the service request.

**COM\_L3\_INFO:** The MSC is provided with initial information about the voice group call.

NOTE 10a: Messages flows for authentication and ciphering are not represented although performed as normal.

**PROC\_ACC\_REQ:** The MAP\_PROCESS\_ACC\_REQ message is sent to the VLR to check the requested VGCS teleservice against the subscription data.

**PROC\_ACC\_ACK:** The MAP\_PROCESS\_ACC\_ACK message acknowledges the requested service.

**Authentication & Ciphering:** Authentication and Ciphering may be performed. Acknowledgement of the service request can also be performed by sending the CM SERVICE ACCEPT.

**SETUP:** The MSC is provided with details about the voice group call. Optionally this message may contain a talker priority.

NOTE 10b: Alternatively, an IMMEDIATE\_SETUP may have been sent as the initial message including all details of the voice group call. In this case no SETUP message must be sent.

**SEND\_INFO\_OUT:** The requested group ID is transferred to the VLR in the MAP\_SEND\_INFO\_FOR\_OUTGOING\_CALL message.

**COMPLETE\_CALL:** The VLR returns the MAP\_COMPLETE\_CALL message confirming the use of the requested group ID. The VLR also returns additional information about the calling service subscriber, if available.

**SEND\_GROUP\_CALL\_INFO:** The MSC derives from the originating cell's LAC the address of the group call serving MSC and sends MAP\_SEND\_GROUP\_CALL\_INFO to it, to retrieve the MSC-A address. The message may also contain talker priority and additional info.

**GCR\_INT:** The group call reference and MSC-A address are requested from the GCR through the GCR Interrogation message sent by the MSC.

**GCR\_INT\_ACK:** The requested information (MSC-A address) is returned from the GCR in the GCR Interrogation Ack message.

**SEND\_GROUP\_CALL\_INFO\_ACK:** The requested information is returned to the visited MSC.

**ASSIGNMENT\_REQUEST:** Standard message.

**CHAN\_MOD\_MODIFY:** Standard message to modify the channel mode in case of very early assignment.

**CHAN\_MOD\_MODIFY\_ACK:** Standard message to acknowledge the modification of the channel mode.

**ASSIGNMENT\_COMPLETE:** Standard message.

NOTE 10c: Alternatively, early assignment or OACSU procedures might be applied with the corresponding assignment messages not presented in figure 3a.

**SETUP to MSC-A:** Based on information received from the group call serving MSC the VMSC shall set-up a dedicated connection for the calling service subscriber to the anchor MSC. The address of the calling service subscriber's group call serving MSC shall be sent as calling party number.

**PREPARE\_GROUP CALL:** The group call attributes (parts) are received from the anchor MSC.

**GCR\_INT:** The group call attributes are requested from the GCR through the GCR Interrogation message sent by the MSC.

**GCR\_INT\_ACK:** The requested information (cell list) is returned from the GCR in the GCR Interrogation Ack message.

**ALLOCATE GROUP CALL NUMBER (not shown in figure 3a):** MSC-R requests the group call number from its associated VLR

**ALLOCATE GROUP CALL NUMBER ACK (not shown in figure 3a):** The Group Call number is returned from the VLR.

**PREPARE\_GROUP\_CALL\_ACK:** The Group Call number is sent to MSC-A.

**SETUP from MSC-A:** The ISUP connection is set-up between MSC-A and MSC-R.

**RELEASE GROUP CALL NUMBER (not shown in figure 3a):** The VLR is requested to release the Group Call number.

**VGCS\_SETUP:** This message is sent from the MSC to all affected BSCs, [one dedicated message for each BSC,] including the group call reference with the eMLPP priority, and optionally the call priority.

**VGCS\_SETUP\_ACK:** Acknowledgement message from the affected BSC in answer to the VGCS\_SETUP setup message. If the setup is not successful, a VGCS\_SETUP\_REFUSE message shall be sent instead.

**VGCS\_ASSIGNMENT\_REQ:** This message is sent from the MSC to all affected BSCs, [one dedicated message for every requested channel in a cell,] including the group call reference, the channel type and possibly the call priority and details on the ciphering.

NOTE 10d: As an operator option the voice group call channels, the links to them and optionally also the links to dispatchers can already be established and permanently reserved in order to speed up the call set-up for emergency voice group calls.

**VGCS\_ASSIGNMENT\_RESULT:** Acknowledgement message from the affected BSC in answer to the assignment requests. If the assignment is not successful, a VGCS\_ASSIGNMENT\_FAILURE message shall be sent instead.

**CONNECT to MSC-A:** Set-up of the ISUP connection from the anchor MSC is confirmed.

**SEND\_GROUP\_CALL\_END\_SIGNAL (IMSI, additional info):** Indicates to the anchor MSC that conversation can start. In addition the IMSI of calling service subscriber who has established the voice group call and who is allowed to terminate the call is included. If the network supports the use of talker priorities, the message includes also the talker priority. Furthermore, the message provides additional information about the current talking service subscriber, if available.

**NOTIF\_REQ (NCH):** Messages for notification which contain the group call reference, the priority of the call if eMLPP is applied, and possibly the channel description of the voice group call channel to which the mobile stations shall listen and the number of the group key used for ciphering.

**NOTIF\_REQ (FACCH):** Message for notification sent on the FACCH to the mobile stations currently involved in other calls. The notification on the FACCH shall include the group call reference, and the priority level and may include also the channel description and the group ciphering key numbers.

**UPLINK\_SEIZED\_CMD:** If the network supports the use of talker priorities, this message informs the BSS about the talker priority of the current talking service subscriber and about the status of the emergency mode.

**UPLINK\_BUSY:** If the network supports the use of talker priorities, this connectionless RR message is sent on the downlink FACCH to inform all mobile stations about the talker priority of the current talking service subscriber and about the status of the emergency mode. The message is repeated on the FACCH every T1 seconds.

**VGCS\_ADD\_INFO:** The MSC sends additional information about the current talking service subscriber to all BSCs.

**ADD\_INFO:** The BSCs broadcast the additional information on the FACCH to all listeners.

**Periodic ADD\_INFO (SACCH):** The message is repeated on the SACCH every T2 seconds.

**Periodic NOTIF\_REQ (NCH):** The notifications are sent periodically so that mobile stations moving into the area can join the voice group call.

**Periodic SACCH Info:** Periodic messages sent on the downlink of the SACCH informing mobile stations of:

- information of changes of notifications;
- information used for cell re-selection.

**CONNECT (from MSC-A):** Call set-up of the dedicated connection for the calling service subscriber is confirmed.

**CONNECT:** Information to the mobile station of the calling service subscriber that the VGCS is established with the related group call reference as the connected number. If the SETUP message from the calling subscriber contained a talker priority, the MSC returns the talker priority used by the network. This will be lower than the requested talker priority, if the subscription check for the requested talker priority was unsuccessful.

**UPLINK\_RELEASE:** When the calling service subscriber wants to become a listening service subscriber for the first time, a message indicating release of the uplink is required to be sent from the MS to the BSS in order to set the uplink free.

NOTE 10e: For different cases of uplink release and the related message flows refer to Figure 6.b to 6.g.

**UPLINK\_RELEASE\_INDICATION:** The BSS informs the MSC on the uplink release.

**PROCESS\_GROUP\_CALL\_SIGNALLING (uplink release indication):** To indicate to the anchor MSC that the uplink is free.

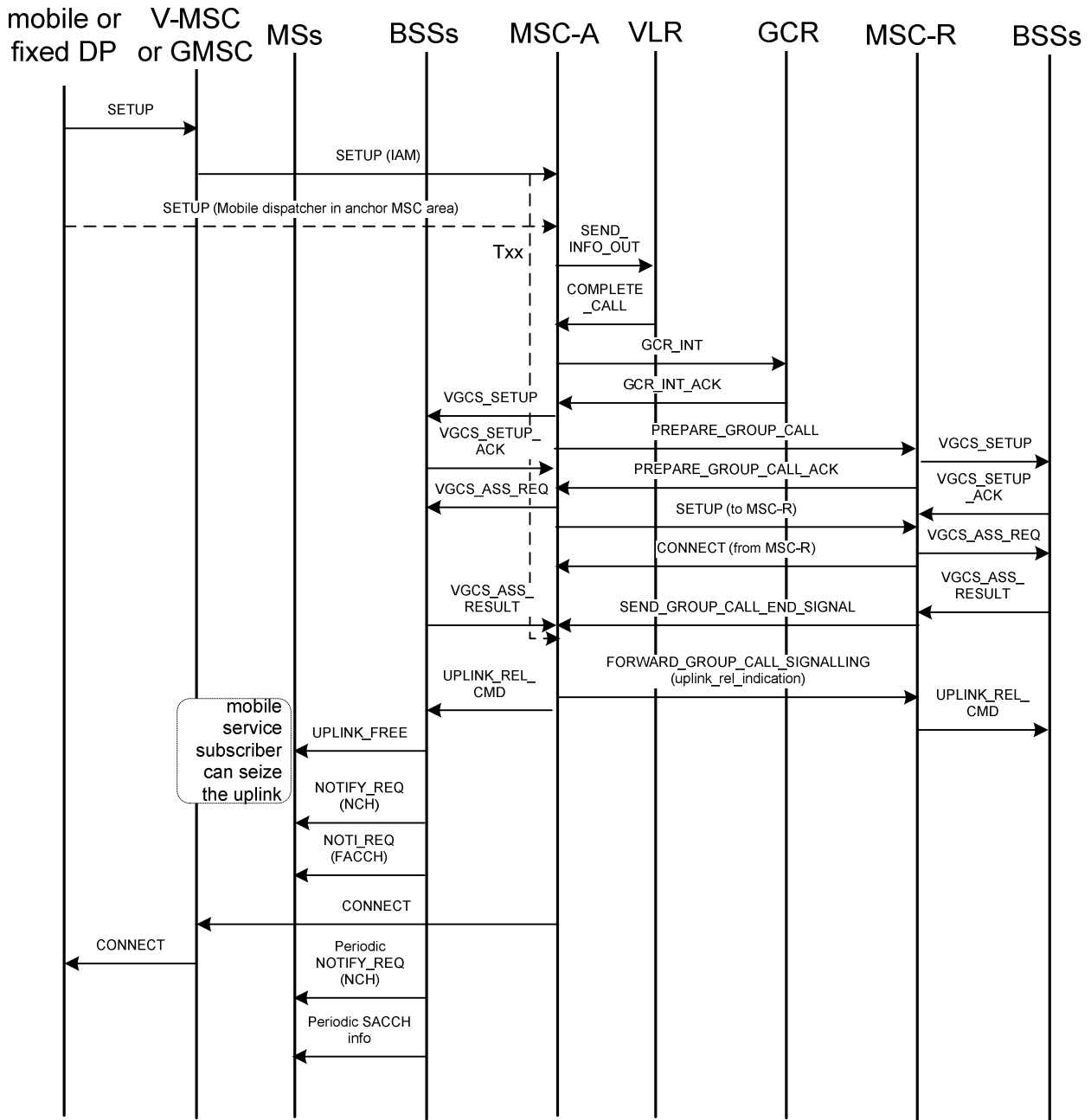
**CLEAR COMMAND:** The MSC requests the BSS to clear radio and terrestrial resources associated with originator dedicated link if not already done.

**CHAN\_RELEASE:** The BSS sends a channel release message to the calling service subscriber's mobile station including the channel description of the voice group call channel to which the mobile station shall tune to.

NOTE 10f: Alternatively, if no UPLINK\_RELEASE has been sent to the network by the mobile station, the network may transfer the mobile station to the voice group call channel by the channel mode modify procedure or by an assignment procedure or by a handover procedure.

**DISC:** Two layer 2 disconnect messages shall be sent by the mobile station to the network.

**RELEASE from MSC-A:** The dedicated connection for the calling service subscriber is released.



NOTE: DP = dispatcher;  
 MSs = destination subscriber mobile stations;  
 MSC-A = anchor MSC;  
 MSC-R = relay MSC;  
 V-MSC = visited MSC;  
 GMSC = Gateway MSC

**Figure 3b: Signalling information required for establishing voice group calls by a mobile dispatcher or fixed line dispatcher**

**SETUP:** Mobile dispatcher or fixed line dispatcher sets up a VGCS call. The visited MSC or the Gateway MSC receives the SETUP message with details about the voice group call including the Group Call Reference within the MSISDN dialled by the originating dispatcher.

**SETUP (IAM):** The visited MSC or the Gateway MSC sends an IAM message to the anchor MSC of the group call based on the called party MSISDN number.

**SETUP (Mobile dispatcher in anchor MSC area):** If the originating mobile dispatcher is located in the anchor MSC area, the SETUP message with details about the voice group call including the Group Call Reference within the

MSISDN dialled by the originating dispatcher is received directly by the anchor MSC (further messages regarding the standard SETUP procedure are not drawn in the Fig.)

**SEND\_INFO\_OUT:** The requested group ID is transferred to the VLR in the internal MAP\_SEND\_INFO\_FOR\_OUTGOING\_CALL message.

**COMPLETE\_CALL:** The VLR returns the MAP\_COMPLETE\_CALL message confirming the use of the requested group ID.

**GCR\_INT:** The group call attributes are requested from the GCR through the GCR Interrogation message sent by the MSC.

**GCR\_INT\_ACK:** The requested information is returned from the GCR in the GCR Interrogation Ack message.

**VGCS\_SETUP:** Anchor MSC sends to BSS's a VGCS SETUP message across VGCS call controlling SCCP connection to initiate a VGCS call set-up procedures.

**VGCS SETUP ACK:** After receiving the VGCS\_SETUP message, BSS will allocate resources to the call and returns VGCS SETUP ACK message to the MSC. This connection is established for the lifetime of the VGCS call.

**VGCS\_ASSIGNMENT\_REQ:** This message is sent from the MSC to all affected BSCs, [ including the group call reference, the channel type and possibly the call priority and details on the ciphering.

**PREPARE\_GROUP CALL:** The group call attributes are sent to every relay MSC and a Group Call number for call set-up to is requested.

**PREPARE\_GROUP CALL ACK:** The Group Call number for call set-up is returned to the anchor MSC.

**SETUP to MSC-R:** The ISUP connection is set-up to the relay MSC.

**VGCS\_SETUP:** Relay MSC sends to BSS's a VGCS SETUP message to initiate a VGCS call set-up procedures.

**VGCS SETUP ACK:** After receiving the VGCS\_SETUP message, BSS will allocate resources to the call and returns VGCS SETUP ACK message to the MSC. This connection is established for the lifetime of the VGCS call.

**VGCS\_ASSIGNMENT\_REQ:** This message is sent from the relay MSC to all affected BSCs, [ including the group call reference, the channel type and possibly the call priority and details on the ciphering.

**CONNECT from MSC-R:** Set-up of the ISUP connection to the relay MSC is confirmed.

**VGCS\_ASSIGNMENT RESULT:** Acknowledgement message from the affected BSC in answer to the assignment requests. If the assignment is not successful, a VGCS\_ASSIGNMENT\_FAILURE message shall be sent instead.

**SEND\_GROUP CALL\_END\_SIGNAL:** Indicates to the anchor MSC that at least one voice group call channel has been established in the relay MSC area.

**Txx:** Timer implemented in the anchor MSC which is started with receipt of the SETUP message from the dispatcher. If the timer expires before the conditions for establishment have been met, as per subclause 11.3.1.1.2, then the call shall be released.

**FORWARD\_GROUP CALL\_SIGNALLING (uplink release indication):** The anchor MSC indicates to all relay MSCs that the uplink is free. On receipt of the uplink free indication the relay MSC shall send an UPLINK RELEASE message to every BSS of the group call area to indicate that the uplink free.

**UPLINK\_REL\_CMD and UPLINK\_FREE:** After having received the VGCS SETUP ACK, the MSC sends to BSCs the UPLINK RELEASE CMD in order to indicate that the call has been initiated by a dispatcher. As a consequence, UPLINK FREE is sent on the common channel(s). Then a service subscriber can request the uplink by using Uplink Request procedure.

**NOTIF\_REQ (NCH):** Messages for notification which contain the group call reference, the priority of the call if eMLPP is applied, and possibly the channel description of the voice group call channel to which the mobile stations shall listen and the number of the group key used for ciphering.

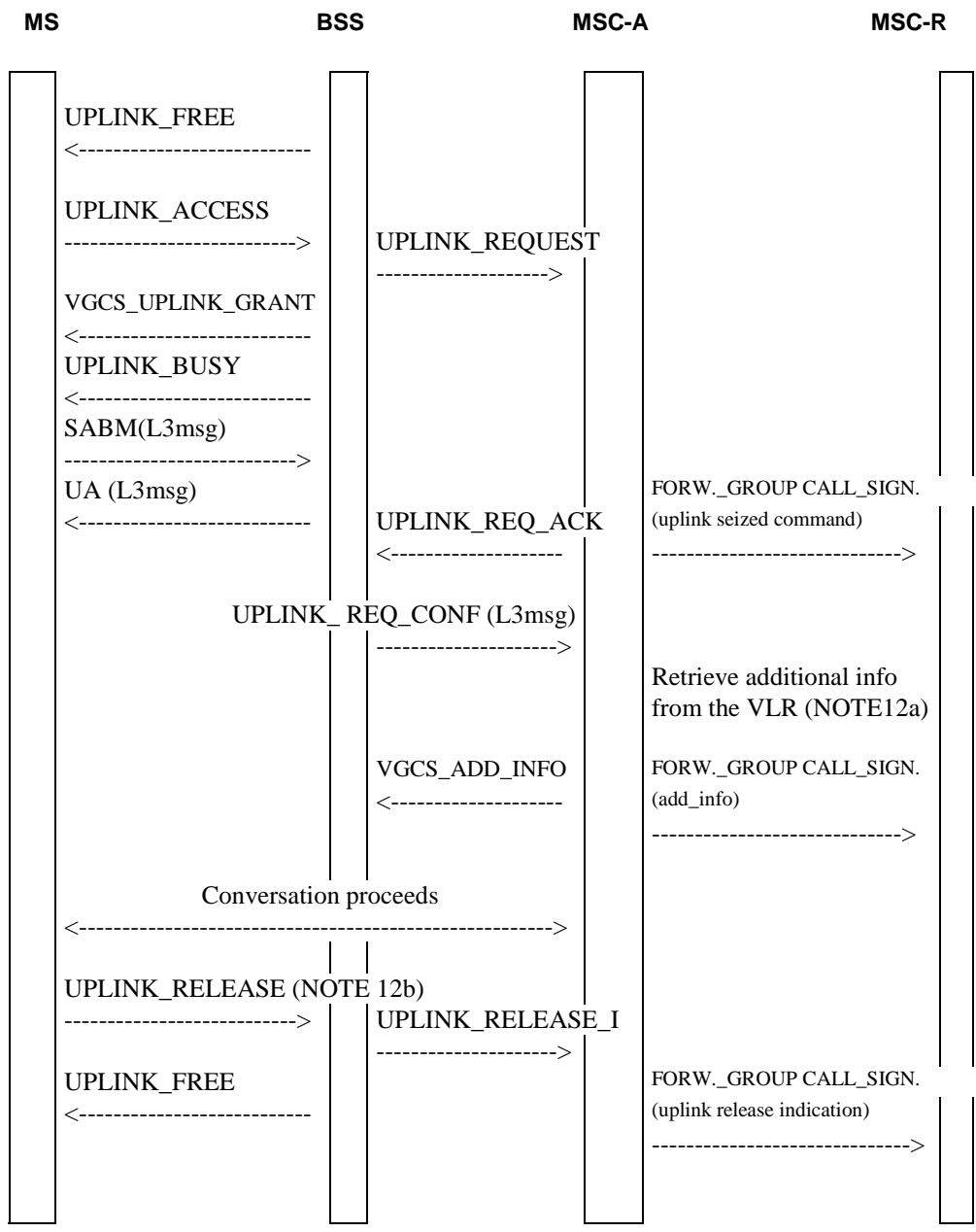
**NOTIF\_REQ (FACCH):** Message for notification sent on the FACCH to the mobile stations currently involved in other calls. The notification on the FACCH shall include the group call reference; and the priority level and may also include the channel description and the group ciphering key numbers.

**CONNECT:** Information to the originating that the VGCS is established with the related group call reference as the connected number.

**Periodic NOTIF\_REQ (NCH):** The notifications are sent periodically so that mobile stations moving into the area can join the voice group call.

**Periodic SACCH Info:** Periodic messages sent on SACCH. This message may include:

- information of changes of notifications;
- information used for cell re-selection.



**Figure 4: Signalling information required for the voice group call uplink access in the anchor MSC without talker priority (normal case, without contention resolution)**

**UPLINK\_FREE:** This connectionless RR message is repeatedly sent by the BSS on the main signalling link (FACCH) to inform all mobile stations of the voice group call members that the uplink is free.

**UPLINK\_ACCESS:** This is sent on the uplink of the voice group call channel using random access procedures. The UPLINK\_ACCESS message is similar to a channel request but sent on the group call channel uplink. The establishment cause for subsequent talker uplink request as defined in 3GPP TS 44.018 shall be used for this purpose. The mobile station may send repeated UPLINK\_ACCESS messages (see 3GPP TS 44.018).

**UPLINK\_REQUEST:** The request for the uplink is indicated to the MSC. Only one request per BSC shall be forwarded.

**VGCS\_UPLINK\_GRANT:** The reply to the uplink request sent on the voice group channel downlink containing information for synchronisation of the mobile station to the network and uplink access contention resolution. The VGCS\_UPLINK\_GRANT message shall therefore include a request reference (reflecting the UPLINK\_ACCESS) and the physical information required for transmission on the voice group call channel uplink. On receipt of a VGCS\_UPLINK\_GRANT, the related mobile station can start to send speech directly.

NOTE 11: UPLINK\_FREE messages are stopped immediately.

**UPLINK\_BUSY:** This connectionless RR message is sent on the downlink FACCH to inform all mobile stations that the uplink is now busy.

NOTE 12: The order of UPLINK\_BUSY and SABM message is independent.

**SABM(L3msg):** The layer 2 link is set up and layer 3 information on classmark and mobile station identity included.

**UA(L3msg):** The layer 2 link is acknowledged and the layer 3 information reflected for contention resolution.

**UPLINK\_REQUEST\_ACKNOWLEDGE:** The anchor MSC acknowledges the uplink to one BSC. If uplink requests have been made by more than one BSC or MSC-R, all remaining uplink requests shall be rejected by an UPLINK\_REJECT\_CMD which is not presented in figure 4. On reception of an UPLINK\_REJECT\_CMD the BSS shall send an UPLINK\_REL to the related mobile station, followed by an UPLINK\_BUSY to indicate to the mobile stations that the uplink is in use. The MSC shall send to other BSCs which did not send an uplink request an UPLINK\_SEIZED\_CMD message which is not presented in figure 4. On reception of an UPLINK\_SEIZED\_CMD the BSS shall send an UPLINK\_BUSY to indicate to the mobile stations that the uplink is in use.

**FORWARD\_GROUP\_CALL\_SIGNALLING (uplink seized command):** This message is sent to all relay MSCs, to inform all mobile stations roaming in parts of the group call area which are controlled by relay MSCs, that the uplink is now busy.

**UPLINK\_REQUEST\_CONFIRM:** The BSS confirms the uplink use to the MSC together with the mobile station identity.

NOTE 12a: In a RANflex configuration the uplink requesting subscriber's VMSC may be different from his current location area's group call serving MSC. In this case the retrieval of info from the (distant) VLR is done by means of the MAP service SEND\_GROUP\_CALL\_INFO.

**VGCS\_ADD\_INFO:** The MSC sends additional information about the new talking service subscriber to all BSCs. The BSCs broadcast ADD\_INFO messages containing the additional information to all listeners (not shown in figure 4).

**FORWARD\_GROUP\_CALL\_SIGNALLING (additional info):** This message is sent to all relay MSCs to provide information about the new talking service subscriber.

**Conversation proceeds:** Once the mobile station has control of the uplink, it shall be able to communicate directly. The two-way nature of the conference bridge will ensure that they are already connected to all appropriate downlink channels.

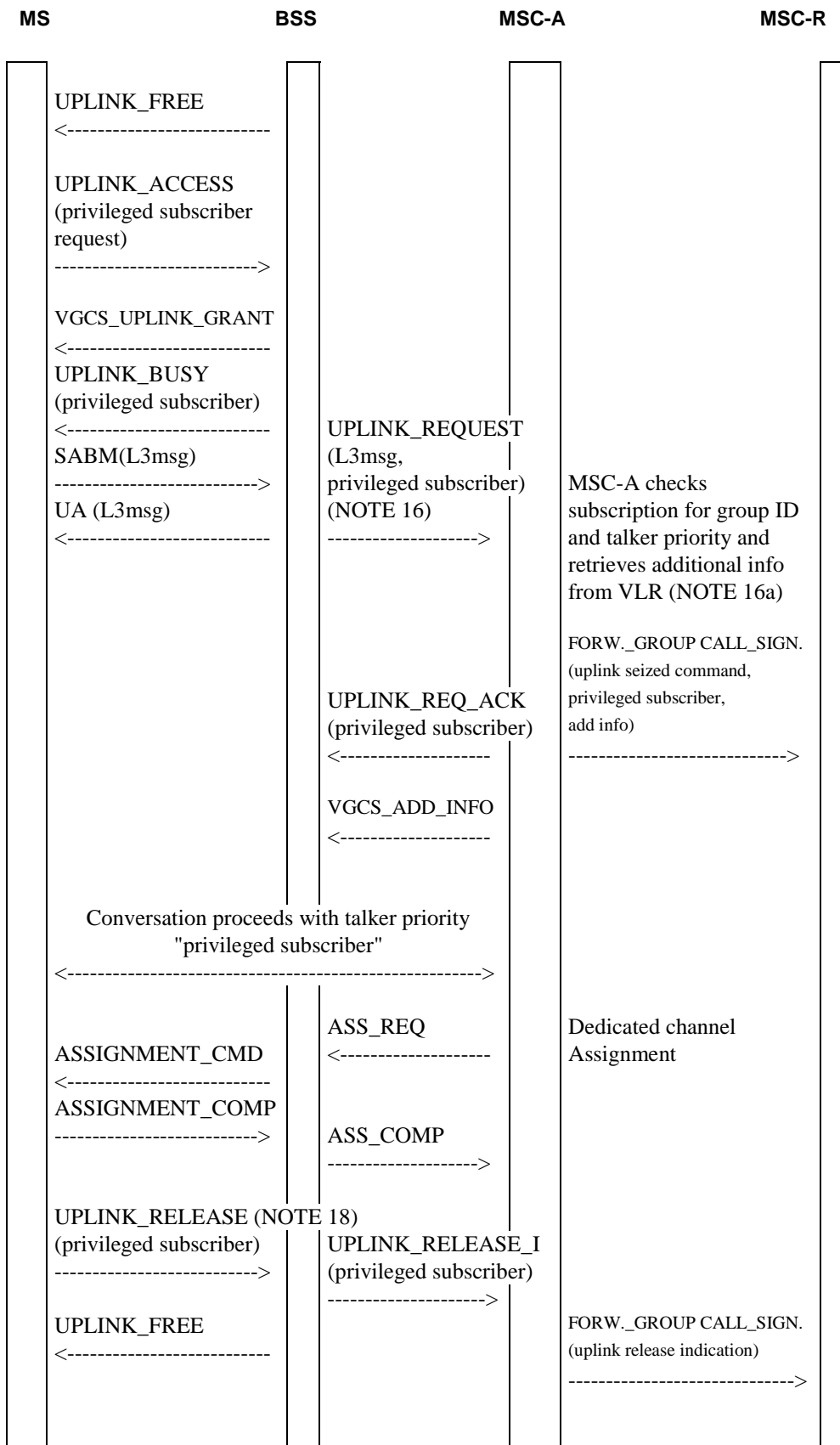
**UPLINK\_RELEASE:** When the service subscriber who has access to the uplink wants to release the channel, then a message indicating release of the uplink is required to be sent from the MS to the BSS on the FACCH.

NOTE 12b: For different cases of uplink release and the related message flows refer to Figure 6.b to 6.g.

**UPLINK\_RELEASE\_INDICATION:** The BSS informs the MSC on the uplink release.

**FORWARD\_GROUP\_CALL\_SIGNALLING (uplink release indication):** The anchor MSC indicates to all relay MSCs that the uplink is free. On receipt of the uplink free indication the relay MSC shall send an UPLINK RELEASE message to every BSS of the group call area to indicate that the uplink free.





NOTE: The figure describes the handling, if MSC decides to have a subsequent talker on a dedicated channel.

**Figure 4a: Signalling information required for the voice group call uplink access in the anchor MSC with talker priority "privileged subscriber" (normal case, without contention resolution, subsequent talker on dedicated channel)**

**UPLINK\_FREE:** This connectionless RR message is repeatedly sent by the BSS on the main signalling link (FACCH) to inform all mobile stations of the voice group call members that the uplink is free.

**UPLINK\_ACCESS:** This is sent on the uplink of the voice group call channel using random access procedures. The UPLINK\_ACCESS message is similar to a channel request but sent on the group call channel uplink. The establishment cause for a privileged subscriber request as defined in 3GPP TS 44.018 shall be used for this purpose. The mobile station may send repeated UPLINK\_ACCESS messages (see 3GPP TS 44.018).

**VGCS\_UPLINK\_GRANT:** The reply to the uplink request sent on the voice group channel downlink containing information for synchronisation of the mobile station to the network and uplink access contention resolution. The VGCS\_UPLINK\_GRANT message shall therefore include a request reference (reflecting the UPLINK\_ACCESS) and the physical information required for transmission on the voice group call channel uplink. On receipt of a VGCS\_UPLINK\_GRANT, the related mobile station can start to send speech directly.

NOTE 13: UPLINK\_FREE messages are stopped immediately.

**UPLINK\_BUSY:** This connectionless RR message is sent on the downlink FACCH to inform all mobile stations that the uplink is now busy. If the network supports talker priorities, then the UPLINK\_BUSY indicates the talker priority of the current talking service subscriber to all listening service subscribers and additionally, if the emergency mode is set in the network, the emergency mode indication. The message is repeated on the FACCH every T1 seconds.

NOTE 14: The order of UPLINK\_BUSY and SABM message is independent.

**SABM(L3msg):** The layer 2 link is set up and layer 3 information on classmark and mobile station identity included.

**UA(L3msg):** The layer 2 link is acknowledged and the layer 3 information reflected for contention resolution.

NOTE 15: Dedicated signalling connection on the main DCCH needs to be established.

**UPLINK\_REQUEST:** The request for the uplink containing the MS identity and the talker priority is indicated to the MSC. Only one request per BSS shall be forwarded.

NOTE 16: As the BSS supports the use of talker priorities and receives from the MS a talker priority different from "normal subscriber", the BSS delays the sending of the UPLINK\_REQUEST message to the MSC, until SABM(L3msg) with the MS identity is received from the MS. Then the BSS includes the layer 3 message, the talker priority, and the cell identity of the cell where the UPLINK\_ACCESS message was received in the UPLINK\_REQUEST message. In this case the UPLINK\_REQUEST\_CONFIRM message may be omitted by the BSS.

NOTE 16a: In a RANflex configuration the uplink requesting subscriber's VMSC may be different from his current location area's group call serving MSC. In this case the retrieval of info from the (distant) VLR is done by means of the MAP service SEND\_GROUP\_CALL\_INFO.

**UPLINK\_REQUEST\_ACKNOWLEDGE:** The anchor MSC acknowledges the uplink to one BSC. If uplink requests have been made by more than one BSC or MSC-R, all remaining uplink requests shall be rejected by an UPLINK\_REJECT\_CMD which is not presented in figure 4a. On reception of an UPLINK\_REJECT\_CMD the BSS shall send an UPLINK\_REL to the related mobile station, followed by an UPLINK\_BUSY to indicate to the mobile stations that the uplink is in use. The MSC shall send to other BSCs which did not send an uplink request an UPLINK\_SEIZED\_CMD message which is not presented in figure 4a. On reception of an UPLINK\_SEIZED\_CMD the BSS shall send an UPLINK\_BUSY to indicate to the mobile stations that the uplink is in use.

The anchor MSC may also include additional information about the new talking service subscriber in the UPLINK\_REQUEST\_ACKNOWLEDGE, UPLINK\_REJECT\_CMD and UPLINK\_SEIZED\_CMD messages, if the information is available when sending these messages. The BSS may include the additional information in the UPLINK\_BUSY messages, if the information is available when sending these messages and there is sufficient space available in the messages.

**FORWARD\_GROUP\_CALL\_SIGNALLING (uplink seized command, privileged subscriber, additional info):** This message is sent to all relay MSCs, to inform all mobile stations roaming in parts of the group call area which are controlled by relay MSCs that the uplink is now busy for a talker with talker priority "privileged subscriber". Furthermore, the message provides additional information about the new talking service subscriber, if available.

**UPLINK\_REQUEST\_CONFIRM:** The BSS confirms the uplink use to the MSC together with the mobile station identity.

**ASS\_REQ:** This message contains details of the resource(s) required for the dedicated connection.

**ASSIGNMENT\_CMD:** This message contains details of the resource(s) required and triggers the assignment procedure of the dedicated channel at the MS.

**ASSIGNMENT\_COMP:** Standard message.

**ASS\_COMP:** Standard message.

**VGCS\_ADD\_INFO:** The MSC sends additional information about the new talking service subscriber to all BSCs, unless the information was already included in the UPLINK\_REQUEST\_ACKNOWLEDGE, UPLINK\_REJECT\_CMD and UPLINK\_SEIZED\_CMD messages. The BSCs broadcast ADD\_INFO messages containing the additional information to all listeners (not shown in figure 4a) , unless the information was already included in the UPLINK\_BUSY messages.

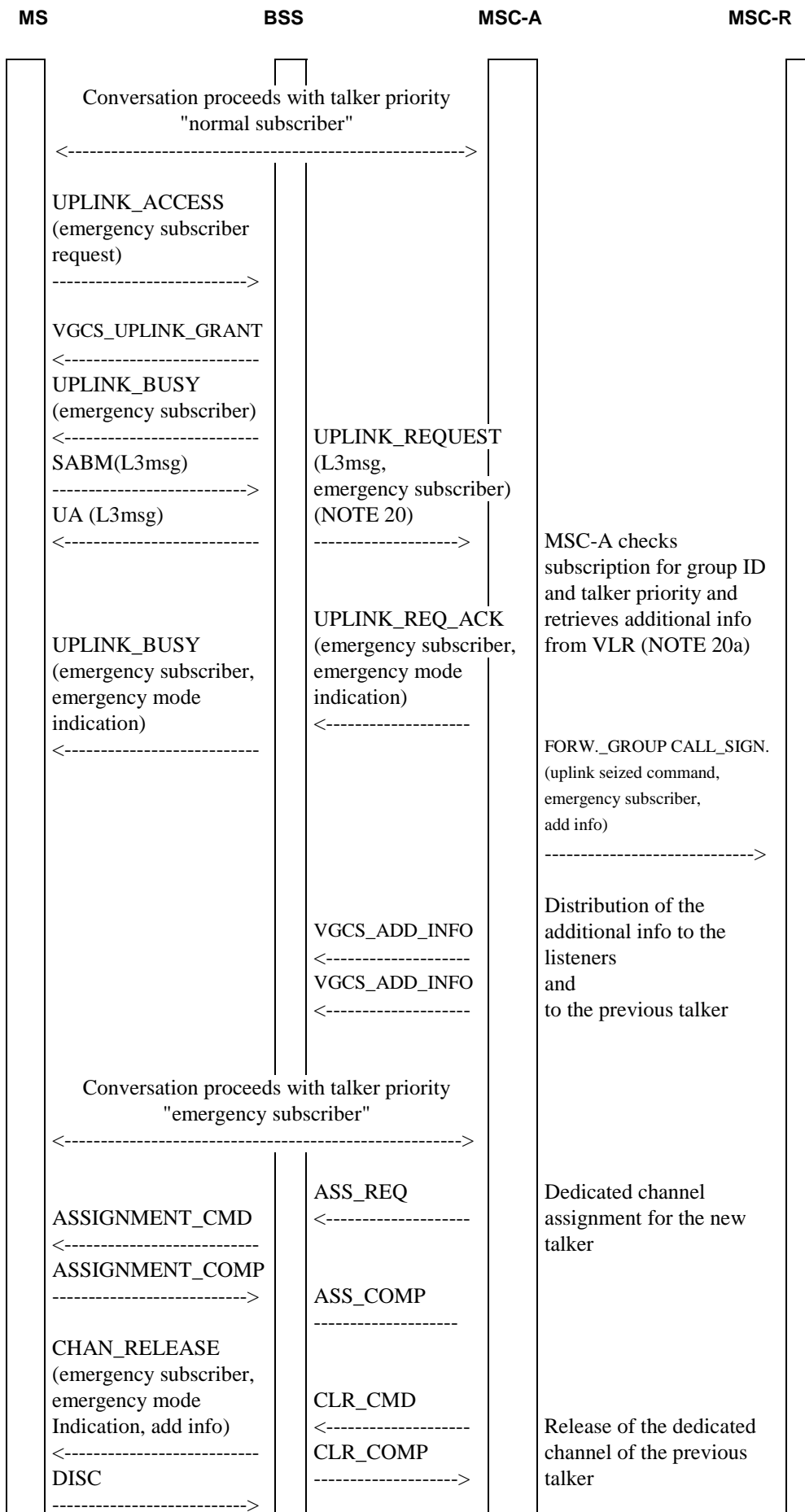
**Conversation proceeds:** Once the mobile station has control of the uplink, it shall be able to communicate directly. The two-way nature of the conference bridge will ensure that they are already connected to all appropriate downlink channels.

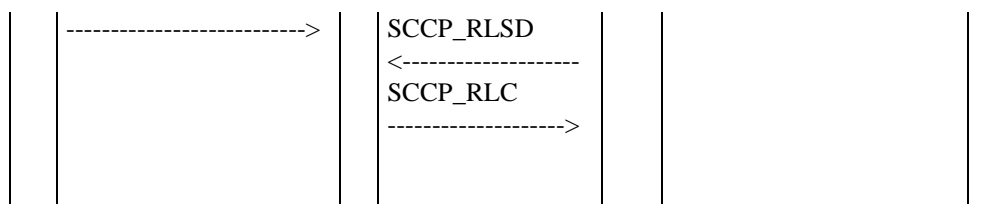
**UPLINK\_RELEASE:** When the service subscriber who has access to the uplink wants to release the channel, then a message indicating release of the uplink is required to be sent from the MS to the BSS on the FACCH.

NOTE 17: For different cases of uplink release and the related message flows refer to Figure 6b to 6g.

**UPLINK\_RELEASE\_INDICATION:** The BSS informs the MSC of the uplink release.

**FORWARD\_GROUP\_CALL\_SIGNALLING (uplink release indication):** The anchor MSC indicates to all relay MSCs that the uplink is free. On receipt of the uplink free indication the relay MSC shall send an UPLINK RELEASE message to every BSS of the group call area to indicate that the uplink free.





NOTE: The figure describes the handling, if the MSC decides to have a subsequent talker on a dedicated channel.

**Figure 4b: Signalling information required for the voice group call uplink access in the anchor MSC with talker priority "emergency subscriber" and pre-emption of the current talker (normal case, subsequent talker on dedicated channel, without contention resolution)**

**UPLINK\_ACCESS:** This is sent on the uplink of the voice group call channel using random access procedures. The UPLINK\_ACCESS message is similar to a channel request but sent on the group call channel uplink. The establishment cause for an emergency subscriber request as defined in 3GPP TS 44.018 shall be used for this purpose. The mobile station may send repeated UPLINK\_ACCESS messages (see 3GPP TS 44.018).

**VGCS\_UPLINK\_GRANT:** The reply to the uplink request sent on the voice group channel downlink containing information for synchronisation of the mobile station to the network and uplink access contention resolution. The VGCS\_UPLINK\_GRANT message shall therefore include a request reference (reflecting the UPLINK\_ACCESS) and the physical information required for transmission on the voice group call channel uplink. On receipt of a VGCS\_UPLINK\_GRANT, the related mobile station can start to send speech directly.

**UPLINK\_BUSY:** This connectionless RR message is sent on the downlink FACCH to inform all mobile stations that the uplink is now busy. UPLINK\_BUSY indicates the talker priority "emergency subscriber" of the new talking service subscriber to all listening service subscribers.

NOTE 18: The order of UPLINK\_BUSY and SABM message is independent.

**SABM(L3msg):** The layer 2 link is set up and layer 3 information on classmark and mobile station identity included.

**UA(L3msg):** The layer 2 link is acknowledged and the layer 3 information reflected for contention resolution.

NOTE 19: Dedicated signalling connection on the main DCCH needs to be established.

**UPLINK\_REQUEST:** The request for the uplink containing the MS identity and the talker priority is indicated to the MSC. Only one request per BSS shall be forwarded.

NOTE 20: As the BSS supports the use of talker priorities and receives from the MS a talker priority different from "normal subscriber", the BSS delays the sending of the UPLINK\_REQUEST message to the MSC, until SABM(L3msg) with the MS identity is received from the MS. Then the BSS includes the layer 3 message, the talker priority, and the cell identity of the cell where the UPLINK\_ACCESS message was received in the UPLINK\_REQUEST message. In this case the UPLINK\_REQUEST\_CONFIRM message may be omitted by the BSS.

NOTE 20a: In a RANflex configuration the uplink requesting subscriber's VMSC may be different from his current location area's group call serving MSC. In this case the retrieval of info from the (distant) VLR is done by means of the MAP service SEND\_GROUP\_CALL\_INFO.

**UPLINK\_REQUEST\_ACKNOWLEDGE:** The anchor MSC acknowledges the uplink to one BSC, including the talker priority and the emergency mode indication. If uplink requests have been made by more than one BSC or MSC-R, all remaining uplink requests shall be rejected by an UPLINK\_REJECT\_CMD with an emergency mode indication (not presented in figure 4b). On reception of an UPLINK\_REJECT\_CMD the BSS shall send an UPLINK\_REL to the related mobile station, followed by an UPLINK\_BUSY to indicate to the mobile stations that the uplink is in use. The MSC shall send to other BSCs which did not send an uplink request an UPLINK\_SEIZED\_CMD message with an emergency mode indication (not presented in figure 4b). On reception of an UPLINK\_SEIZED\_CMD the BSS shall send an UPLINK\_BUSY to indicate to the mobile stations that the uplink is in use.

The anchor MSC may also include additional information about the new talking service subscriber in the UPLINK\_REQUEST\_ACKNOWLEDGE, UPLINK\_REJECT\_CMD and UPLINK\_SEIZED\_CMD messages, if the information is available when sending these messages. The BSS may include the additional information in the UPLINK\_BUSY messages, if the information is available when sending these messages and there is sufficient space available in the messages.

**UPLINK\_BUSY:** This connectionless RR message is sent on the downlink FACCH to inform all mobile stations that the uplink is now busy with talker priority "emergency subscriber" and that the emergency mode is set in the network. The message is repeated on the FACCH every T1 seconds.

**FORWARD\_GROUP\_CALL\_SIGNALLING (uplink seized command, emergency subscriber, add info):** This message is sent to all relay MSCs, to inform all mobile stations roaming in parts of the group call area which are controlled by relay MSCs, that the uplink is now busy for a talker with talker priority "emergency subscriber" and that the emergency mode indication shall be signalled. Furthermore, the message provides additional information about the new talking service subscriber, if available.

**ASS\_REQ:** This message contains details of the resource(s) required for the dedicated connection.

**ASSIGNMENT\_CMD:** This message contains details of the resource(s) required and triggers the assignment procedure of the dedicated channel at the MS.

**ASSIGNMENT\_COMP:** Standard message.

**ASS\_COMP:** Standard message.

**VGCS\_ADD\_INFO:** The MSC sends additional information about the new talking service subscriber to all BSCs, unless the information was already included in the UPLINK\_REQUEST\_ACKNOWLEDGE, UPLINK\_REJECT\_CMD and UPLINK\_SEIZED\_CMD messages. The BSCs broadcast ADD\_INFO messages containing the additional information to all listeners (not shown in figure 4b), unless the information was already included in the UPLINK\_BUSY messages. Additionally, the MSC sends the additional information on the dedicated connection for the previous talker, before this connection is released.

**CLEAR COMMAND:** The MSC requests the BSS to clear radio and terrestrial resources associated with previous talker.

**CLEAR\_COMP:** Standard message.

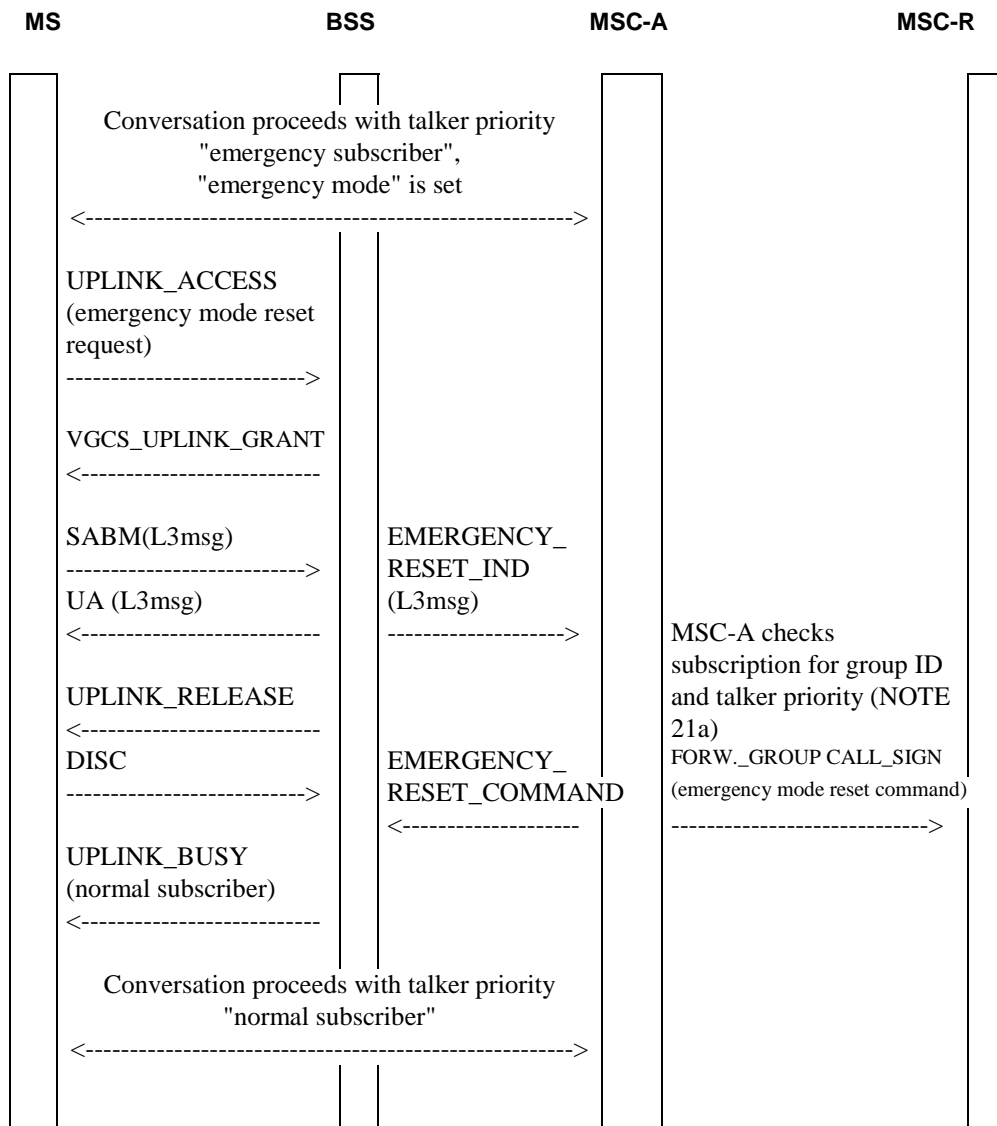
**CHAN\_RELEASE:** The BSS sends a channel release message to the previous talker's mobile station including the channel description of the voice group call channel to which the mobile station shall tune to. Additionally the BSS includes the talker priority of the new talker and the additional information, if available, and the emergency mode indication, if applicable.

**DISC:** Two layer 2 disconnect messages shall be sent by the mobile station to the network.

**SCCP\_RLSD:** Standard message.

**SCCP\_RLC:** Standard message.

**Conversation proceeds:** Once the mobile station has control of the uplink, it shall be able to communicate directly. The two-way nature of the conference bridge will ensure that they are already connected to all appropriate downlink channels.



**Figure 4c: Signalling information required for the voice group call uplink access in the anchor MSC with "emergency mode reset request"**

**UPLINK\_ACCESS:** This is sent on the uplink of the voice group call channel using random access procedures. The UPLINK\_ACCESS message is similar to a channel request but sent on the group call channel uplink. The establishment cause for emergency mode reset request as defined in 3GPP TS 44.018 shall be used for this purpose.

**EMERGENCY\_RESET\_IND:** The reception of an emergency mode reset request is indicated to the MSC. Only one request per BSC shall be forwarded.

NOTE 21: The BSS delays the sending of the EMERGENCY\_RESET\_IND message to the MSC, until SABM(L3msg) with the MS identity is received from the MS. Then the BSS includes the layer 3 message and the cell identity of the cell where the UPLINK\_ACCESS message was received in the EMERGENCY\_RESET\_IND message.

NOTE 21a: In a RANflex configuration the uplink requesting subscriber's VMSC may be different from his current location area's group call serving MSC. In this case the retrieval of info from the (distant) VLR is done by means of the MAP service SEND\_GROUP\_CALL\_INFO.

**VGCS\_UPLINK\_GRANT:** The reply to the uplink request sent on the voice group channel downlink containing information for synchronisation of the mobile station to the network and uplink access contention resolution. The VGCS\_UPLINK\_GRANT message shall therefore include a request reference (reflecting the UPLINK\_ACCESS) and the physical information required for transmission on the voice group call channel uplink.

**SABM(L3msg):** The layer 2 link is set up and layer 3 information on classmark and mobile station identity included.

**UA(L3msg):** The layer 2 link is acknowledged and the layer 3 information reflected for contention resolution.

**UPLINK\_RELEASE:** When the BSS has forwarded the emergency mode reset request it releases the layer 2 link. A message indicating release of the uplink is required to be sent from the BSS to the MS on the FACCH.

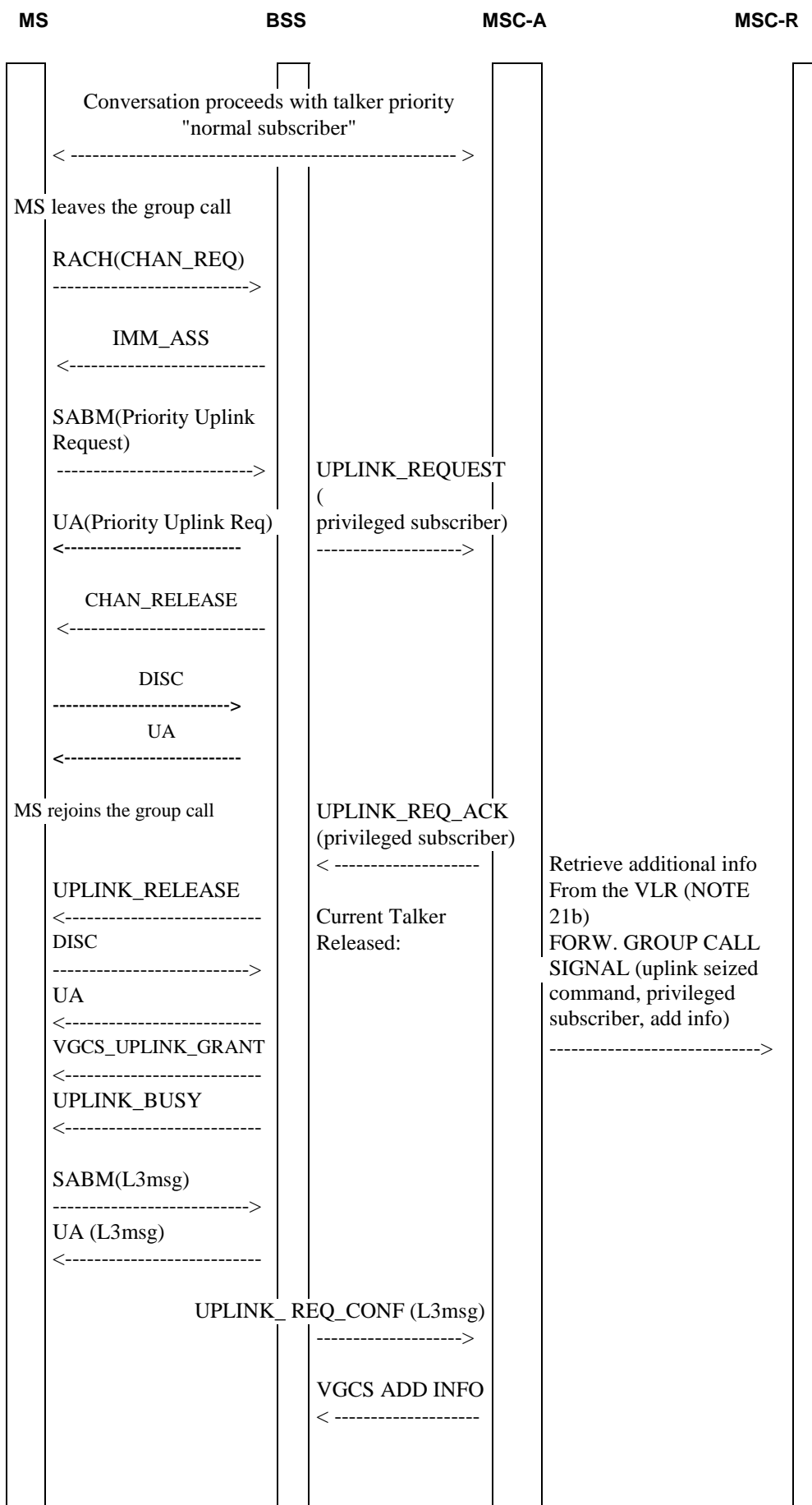
**EMERGENCY\_RESET\_COMMAND:** The anchor MSC commands all BSCs involved in the voice group call to reset the emergency mode. If the BSC receives an EMERGENCY\_RESET\_COMMAND message, it changes the content of the NCH to indicate "no emergency mode" and the talker priority of the current talking service subscriber to "normal subscriber", if the previous uplink status was uplink busy with talker priority "emergency subscriber".

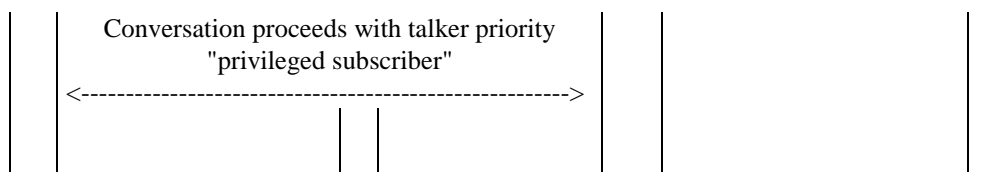
**FORWARD\_GROUP\_CALL\_SIGNALLING (emergency mode reset command):** This message is sent to all relay MSCs, to inform all BSCs controlled by relay MSCs that the emergency mode indication shall not be sent any longer and that the talker priority of the current talking service subscriber is changed to "normal subscriber", if the previous uplink status was uplink busy with talker priority "emergency subscriber".

**UPLINK\_BUSY:** This connectionless RR message is sent on the downlink FACCH to inform all mobile stations that the voice group call is no longer in emergency mode and that the talker priority was changed to "normal subscriber", if the previous uplink status was uplink busy with talker priority "emergency subscriber". The message is repeated on the FACCH every T1 seconds.

**Conversation proceeds:** The conversation of the current talker is not interrupted.







**Figure 4d: Signalling information required for the voice group call uplink request via RACH with talker priority "privileged subscriber" in the anchor MSC and pre-emption of the current talker (normal case, without contention resolution)**

**RACH(CHAN\_REQ):** Standard message to request an SDCCH.

**IMM\_ASS:** Standard message sent on the AGCH.

**SABM (PRIORITY\_UPLINK\_REQ):** L3 message PRIORITY\_UPLINK\_REQ sent on the allocated channel.

**UA (PRIORITY\_UPLINK\_REQ):** This message is used to acknowledge the layer 2 link and provide contention resolution of the priority uplink request.

**UPLINK\_BUSY** (not presented in figure 4d): If validation of Priority Uplink Requests applies for the group call, the BSS, on receipt of a valid Priority Uplink Request, shall send an UPLINK\_BUSY on the downlink FACCH to inform all mobile stations that a priority request has been made and to provide a new token. The message is sent on Tbb expiry.

**CHAN\_RELEASE:** The BSS sends a channel release message to the service subscriber's mobile station.

**DISC:** Standard message to release the layer 2 link.

**UA:** Standard message to acknowledge release of the layer 2 link.

**UPLINK\_REQUEST:** The request for the uplink containing the MS identity and the talker priority is indicated to the MSC. Only one request per BSS shall be forwarded.

**UPLINK\_REQUEST\_ACKNOWLEDGE (privileged subscriber):** The anchor MSC acknowledges the uplink to one BSS. If uplink requests have been made by more than one BSS or MSC-R, all remaining uplink requests shall be rejected by an UPLINK\_REJECT\_CMD which is not presented in figure 4d. On reception of an UPLINK\_REJECT\_CMD the BSS shall send an UPLINK\_REL to the related mobile station, followed by an UPLINK\_BUSY to indicate to the mobile stations that the uplink is in use. The MSC shall send to other BSSs which did not send an uplink request an UPLINK\_SEIZED\_CMD message which is not presented in figure 4d. On reception of an UPLINK\_SEIZED\_CMD the BSS shall send an UPLINK\_BUSY to indicate to the mobile stations that the uplink is in use.

The anchor MSC may also include additional information about the new talking service subscriber in the UPLINK\_REQUEST\_ACKNOWLEDGE, UPLINK\_REJECT\_CMD and UPLINK\_SEIZED\_CMD messages, if the information is available when sending these messages. The BSS may include the additional information in the UPLINK\_BUSY messages, if the information is available when sending these messages and there is sufficient space available in the messages.

**UPLINK\_RELEASE:** Upon receipt of an UPLINK\_REQUEST\_ACKNOWLEDGE, UPLINK\_REJ or UPLINK\_SEIZED\_CMD indicating the talker priority of the new talker, the BSS releases the current talker from the uplink by sending a message requesting release of the uplink to the mobile station on the FACCH.

**DISC:** Standard message to release the layer 2 link.

**UA:** Standard message to acknowledge release of the layer 2 link.

NOTE 21b: In a RANflex configuration the uplink requesting subscriber's VMSC may be different from his current location area's group call serving MSC. In this case the retrieval of info from the (distant) VLR is done by means of the MAP service SEND\_GROUP\_CALL\_INFO.

**FORWARD\_GROUP\_CALL\_SIGNALLING (uplink seized command, privileged subscriber, add info):** This message is sent to all relay MSCs, to inform all mobile stations roaming in parts of the group call area which are controlled by relay MSCs, that the uplink is now busy for a talker with talker priority "privileged subscriber". Furthermore, the message provides additional information about the new talking service subscriber, if available.

**VGCS\_UPLINK\_GRANT:** The reply to the priority uplink request sent on the voice group channel downlink containing information for synchronisation of the mobile station to the network and uplink access contention resolution. The VGCS\_UPLINK\_GRANT message shall therefore include a request reference (reflecting the PRIORITY\_UPLINK\_REQUEST) and the physical information required for transmission on the voice group call channel uplink. On receipt of a VGCS\_UPLINK\_GRANT, the related mobile station can start to send speech directly.

**UPLINK\_BUSY:** This connectionless RR message is sent on the downlink FACCH to inform all mobile stations that the uplink is now busy. If the network supports talker priorities, then the UPLINK\_BUSY indicates the talker priority of the current talking service subscriber to all listening service subscribers and additionally, if the emergency mode is set in the network, the emergency mode indication. The message is repeated on the FACCH every T1 seconds. If validation of Priority Uplink Requests applies each periodic UPLINK\_BUSY message shall include a new token (i.e. a new token is broadcast every T1 seconds).

NOTE: The order of UPLINK\_BUSY and SABM message is independent.

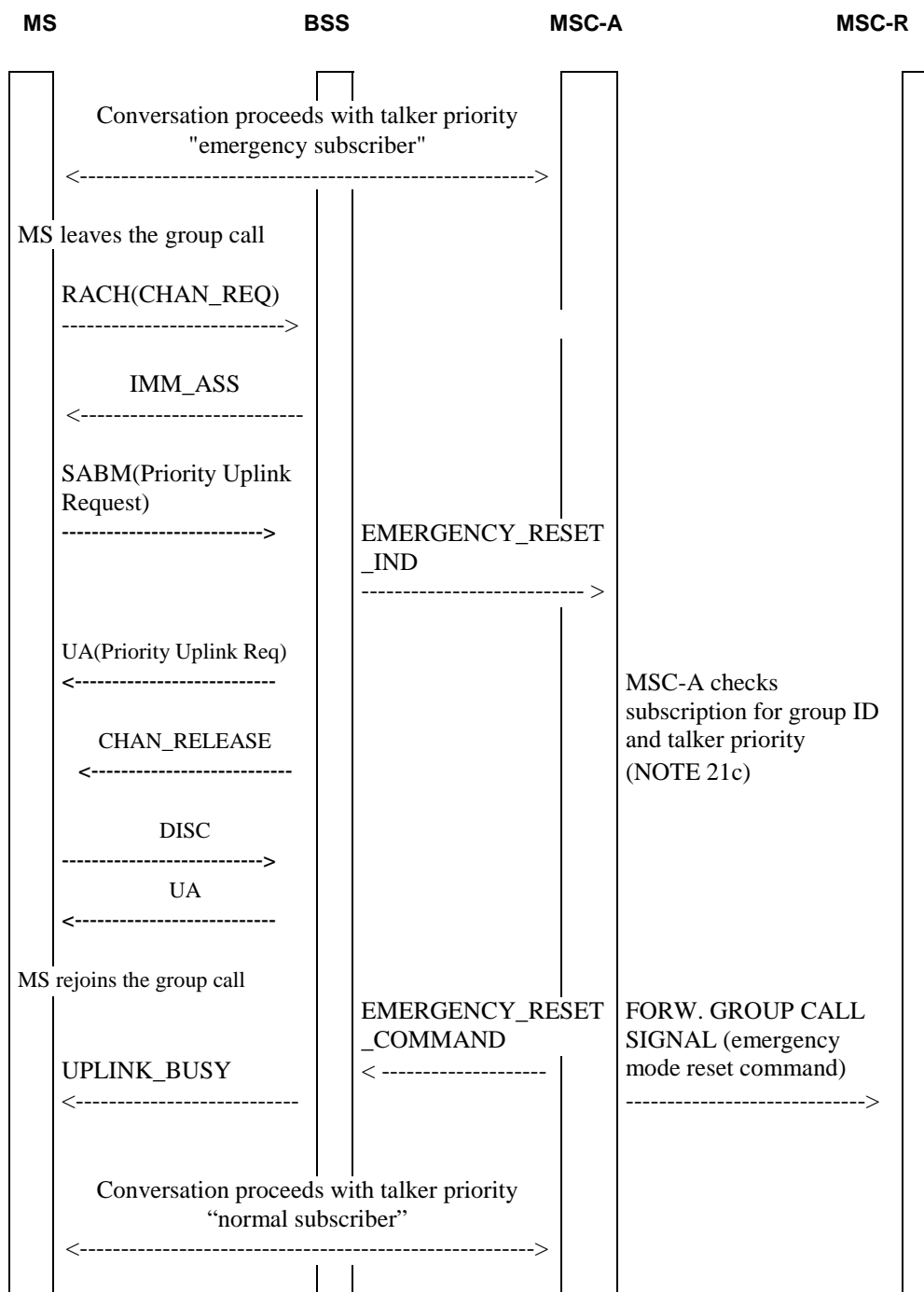
**SABM(L3msg):** The layer 2 link is set up and layer 3 information on classmark and mobile station identity included.

**UA(L3msg):** The layer 2 link is acknowledged and the layer 3 information reflected for contention resolution.

**UPLINK\_REQUEST\_CONFIRM:** The BSS confirms the uplink use to the MSC together with the mobile station identity, classmark information and optionally the CKSN.

**VGCS\_ADD\_INFO:** The MSC sends additional information about the new talking service subscriber to all BSCs, unless the information was already included in the UPLINK\_REQUEST\_ACKNOWLEDGE, UPLINK\_REJECT\_CMD and UPLINK\_SEIZED\_CMD messages. The BSCs broadcast ADD\_INFO messages containing the additional information to all listeners (not shown in figure 4d), unless the information was already included in the UPLINK\_BUSY messages.

**Conversation proceeds:** Once the mobile station has control of the uplink, it shall be able to communicate directly. The two-way nature of the conference bridge will ensure that they are already connected to all appropriate downlink channels.



**Figure 4e: Signalling information required for the voice group call uplink request via RACH with "emergency mode reset request" in the anchor MSC (normal case, without contention resolution)**

**RACH(CHAN\_REQ):** Standard message to request an SDCCH.

**IMM\_ASS:** Standard message sent on the AGCH.

**SABM (PRIORITY\_UPLINK\_REQ):** L3 message PRIORITY\_UPLINK\_REQ sent on the allocated channel.

**UA (PRIORITY\_UPLINK\_REQ):** This message is used to acknowledge the layer 2 link and provide contention resolution of the priority uplink request.

**CHAN\_RELEASE:** The BSS sends a channel release message to the service subscriber's mobile station.

**DISC:** Standard message to release the layer 2 link.

**UA:** Standard message to acknowledge release of the layer 2 link.

**UPLINK\_BUSY** (not presented in figure 4e): If validation of Priority Uplink Requests applies for the group call, the BSS, on receipt of a valid Priority Uplink Request, shall send an UPLINK\_BUSY on the downlink FACCH to inform all mobile stations that a priority request has been made and to provide a new token. The message is sent on Tbb expiry.

**EMERGENCY\_RESET\_IND:** The reception of an emergency mode reset request is indicated to the MSC. Only one request per BSS shall be forwarded.

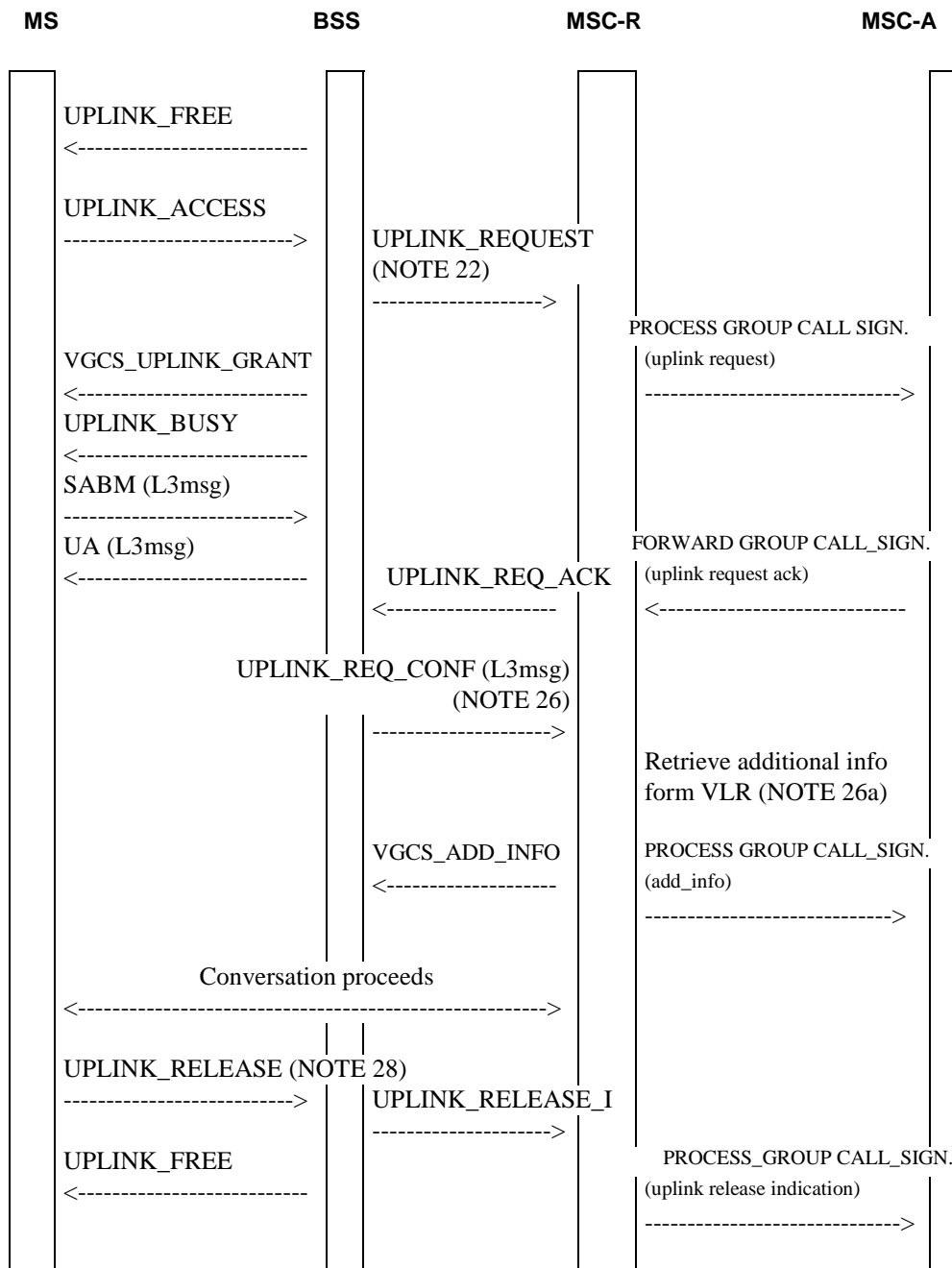
**EMERGENCY\_RESET\_COMMAND:** The anchor MSC commands all BSCs involved in the voice group call to reset the emergency mode. If the BSC receives an EMERGENCY\_RESET\_COMMAND message, it changes the content of the NCH to indicate "no emergency mode" and the talker priority of the current talking service subscriber to "normal subscriber", if the previous uplink status was uplink busy with talker priority "emergency subscriber".

NOTE 21c: In a RANflex configuration the uplink requesting subscriber's VMSC may be different from his current location area's group call serving MSC. In this case the retrieval of info from the (distant) VLR is done by means of the MAP service SEND\_GROUP\_CALL\_INFO.

**FORWARD\_GROUP\_CALL\_SIGNALLING (emergency mode reset command):** This message is sent to all relay MSCs, to inform all BSCs controlled by relay MSCs that the emergency mode indication shall not be sent any longer and that the talker priority of the current talking service subscriber is changed to "normal subscriber", if the previous uplink status was uplink busy with talker priority "emergency subscriber".

**UPLINK\_BUSY:** This connectionless RR message is sent on the downlink FACCH to inform all mobile stations that the voice group call is no longer in emergency mode and that the talker priority was changed to "normal subscriber", if the previous uplink status was uplink busy with talker priority "emergency subscriber". The message is repeated on the FACCH every T1 seconds. . If validation of Priority Uplink Requests applies each periodic UPLINK\_BUSY message shall include a new token (i.e. a new token is broadcast every T1 seconds).

**Conversation proceeds:** The conversation of the current talker is not interrupted.



**Figure 5: Signalling information required for the voice group call uplink access in the relay MSC without talker priority (normal case, without contention resolution)**

**UPLINK\_FREE:** This connectionless RR message is repeatedly sent by the BSS on the main signalling link (FACCH) to inform all mobile stations of the voice group call members that the uplink is free.

**UPLINK\_ACCESS:** This is sent on the uplink of the voice group call channel using random access procedures. The UPLINK\_ACCESS message is similar to a channel request but sent on the group call channel uplink. The establishment cause for subsequent talker uplink request as defined in 3GPP TS 44.018 shall be used for this purpose. The mobile station may send repeated UPLINK\_ACCESS messages (see 3GPP TS 44.018).

**UPLINK\_REQUEST:** The request for the uplink is indicated to the MSC. Only one request per BSC shall be forwarded.

NOTE 22: If the BSS supports the use of talker priorities and receives from the MS a talker priority different from "normal subscriber", the BSS delays the sending of the UPLINK\_REQUEST message to the MSC, until SABM(L3msg) is received from the MS. Then the BSS includes the layer 3 message, the talker priority, and the cell identity of the cell where the UPLINK\_ACCESS message was received in the UPLINK\_REQUEST message. In this case the UPLINK\_REQUEST\_CONFIRM message may be omitted by the BSS.

**VGCS\_UPLINK\_GRANT:** The reply to the uplink request sent on the voice group channel downlink containing information for synchronisation of the mobile station to the network and uplink access contention resolution. The VGCS\_UPLINK\_GRANT message shall therefore include a request reference (reflecting the UPLINK\_ACCESS) and the physical information required for transmission on the voice group call channel uplink. On receipt of a VGCS\_UPLINK\_GRANT, the related mobile station can start to send speech directly.

NOTE 23: UPLINK\_FREE messages are stopped immediately.

**UPLINK\_BUSY:** This connectionless RR message is sent on the downlink FACCH to inform all mobile stations that the uplink is now busy.

NOTE 24: If the BSS supports the use of talker priorities, then it indicates the talker priority of the current talking service subscriber and the status of the emergency mode in the UPLINK\_BUSY message and repeats the message on the FACCH every T1 seconds.

NOTE 25: The order of UPLINK\_BUSY and SABM message is independent.

**SABM (L3msg):** The layer 2 link is set up and layer 3 information on classmark and mobile station identity included.

**UA (L3msg):** The layer 2 link is acknowledged and the layer 3 information reflected for contention resolution.

**PROCESS\_GROUP\_CALL\_SIGNALLING (uplink request):** This message is sent to the anchor MSC, to indicate that the uplink is requested by a subscriber roaming in the relay MSC area.

NOTE 26: If the UPLINK\_REQUEST message contained the layer 3 message, the message provides additional information about the new talking service subscriber, if available.

**FORWARD\_GROUP\_CALL\_SIGNALLING (uplink request ack):** This message is sent to the relay MSC, to indicate that the uplink is granted to the mobile station roaming in parts of the group call area which are controlled by relay MSC.

**UPLINK\_REQUEST\_ACKNOWLEDGE:** The relay MSC acknowledges the uplink to one BSC. If uplink requests have been made by more than one BSC, all remaining uplink requests shall be rejected by an UPLINK\_REJECT\_CMD which is not presented in figure 5. On reception of an UPLINK\_REJECT\_CMD the BSS shall send an UPLINK\_REL to the related mobile station, followed by an UPLINK\_BUSY to indicate to the mobile stations that the uplink is in use. The MSC shall send to other BSCs which did not send an uplink request an UPLINK\_SEIZED\_CMD message which is not presented in figure 5. On reception of an UPLINK\_SEIZED\_CMD the BSS shall send an UPLINK\_BUSY to indicate to the mobile stations that the uplink is in use. If the BSS supports the use of talker priorities, then it indicates the talker priority of the current talking service subscriber and the status of the emergency mode in the UPLINK\_BUSY message and repeats the message on the FACCH every T1 seconds.

**UPLINK\_REQUEST\_CONFIRM :** The BSS confirms the uplink use to the MSC together with the mobile station identity.

NOTE 26a: In a RANflex configuration the uplink requesting subscriber's VMSC may be different from his current location area's group call serving MSC. In this case the retrieval of info from the (distant) VLR is done by means of the MAP service SEND\_GROUP\_CALL\_INFO.

**VGCS\_ADD\_INFO:** The MSC sends additional information about the new talking service subscriber to all BSCs. The BSCs broadcast ADD\_INFO messages containing the additional information to all listeners (not shown in figure 5).

**PROCESS\_GROUP\_CALL\_SIGNALLING (additional info):** This message is sent to the anchor MSC to provide information about the new talking service subscriber. The anchor MSC forwards the message to all other relay MSCs.

NOTE 27: This message is omitted, if the additional info was already included in the PROCESS\_GROUP\_CALL\_SIGNALLING (uplink request) message.

**Conversation proceeds:** Once the mobile station has control of the uplink, it shall be able to communicate directly. The two-way nature of the conference bridge will ensure that they are already connected to all appropriate downlink channels.

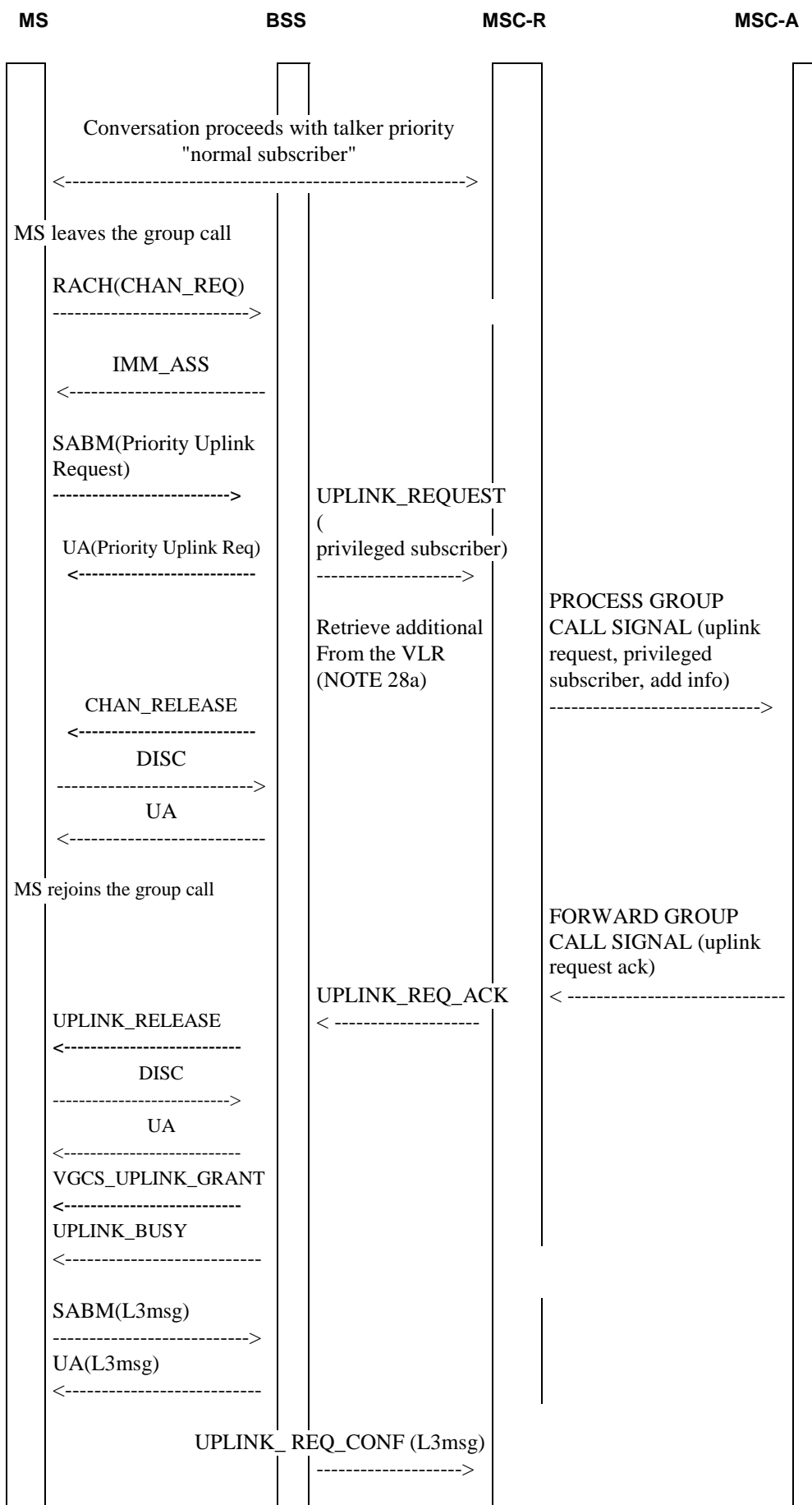
**UPLINK\_RELEASE:** When the service subscriber who has access to the uplink wants to release the channel, then a message indicating release of the uplink is required to be sent from the MS to the BSS on the FACCH.

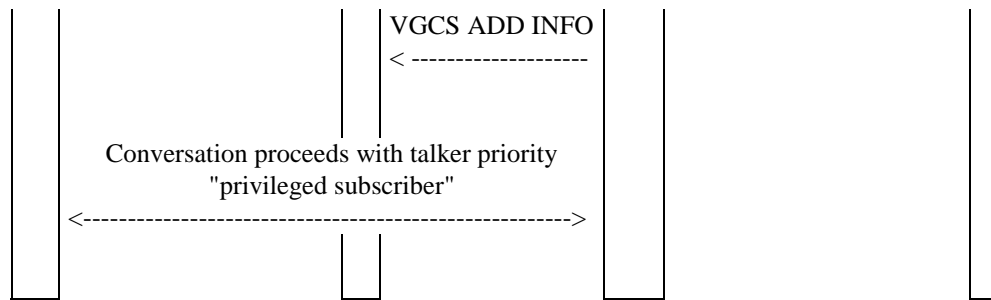
NOTE 28: For different cases of uplink release and the related message flows refer to Figure 6.b to 6.g.

**UPLINK\_RELEASE\_INDICATION:** The BSS informs the MSC on the uplink release.

**PROCESS\_GROUP CALL\_SIGNALLING (uplink release indication):** The relay MSC indicates to the anchor MSC that the uplink is free.







**Figure 5a: Signalling information required for the voice group call uplink request via RACH with talker priority "privileged subscriber" in the relay MSC (normal case, without contention resolution)**

**RACH(CHAN\_REQ):** Standard message to request an SDCCH.

**IMM\_ASS:** Standard message sent on the AGCH.

**SABM (PRIORITY\_UPLINK\_REQ):** L3 message PRIORITY\_UPLINK\_REQ sent on the allocated channel.

**UA (PRIORITY\_UPLINK\_REQ):** This message is used to acknowledge the layer 2 link and provide contention resolution of the service request.

**CHAN\_RELEASE:** The BSS sends a channel release message to the service subscriber's mobile station.

**DISC:** Standard message to release the layer 2 link.

**UA:** Standard message to acknowledge release of the layer 2 link.

**UPLINK\_BUSY** (not presented in figure 5a): If validation of Priority Uplink Requests applies for the group call, the BSS, on receipt of a valid Priority Uplink Request, shall send an UPLINK\_BUSY on the downlink FACCH to inform all mobile stations that a priority request has been made and to provide a new token. The message is sent on Tbb expiry.

**UPLINK\_REQUEST:** The request for the uplink is indicated to the MSC. Only one request per BSS shall be forwarded.

NOTE 28a: In a RANflex configuration the uplink requesting subscriber's VMSC may be different from his current location area's group call serving MSC. In this case the retrieval of info from the (distant) VLR is done by means of the MAP service SEND\_GROUP\_CALL\_INFO.

**PROCESS\_GROUP\_CALL\_SIGNALLING (uplink request, privileged subscriber, add info):** This message is sent to the anchor MSC, to indicate that the uplink is requested by a subscriber with talker priority "privileged subscriber" roaming in the relay MSC area. Furthermore, the message provides additional information about the service subscriber requesting the uplink, if additional information is available.

**FORWARD\_GROUP\_CALL\_SIGNALLING (uplink request ack):** This message is sent to the relay MSC, to indicate that the uplink is granted to the mobile station roaming in parts of the group call area which are controlled by the relay MSC.

**UPLINK\_REQUEST\_ACKNOWLEDGE:** The relay MSC acknowledges the uplink to one BSC. If uplink requests have been made by more than one BSC, all remaining uplink requests shall be rejected by an UPLINK\_REJECT\_CMD which is not presented in figure 5a. On reception of an UPLINK\_REJECT\_CMD the BSS shall send an UPLINK\_REL to the related mobile station, followed by an UPLINK\_BUSY to indicate to the mobile stations that the uplink is in use. The MSC shall send to other BSCs which did not send an uplink request an UPLINK\_SEIZED\_CMD message which is not presented in figure 5a. On reception of an UPLINK\_SEIZED\_CMD the BSS shall send an UPLINK\_BUSY to indicate to the mobile stations that the uplink is in use.

The anchor MSC may also include additional information about the new talking service subscriber in the UPLINK\_REQUEST\_ACKNOWLEDGE, UPLINK\_REJECT\_CMD and UPLINK\_SEIZED\_CMD messages, if the information is available when sending these messages.

**UPLINK\_RELEASE:** Upon receipt of an UPLINK\_REQUEST\_ACKNOWLEDGE, UPLINK\_REJECT\_CMD or UPLINK\_SEIZED\_CMD indicating the talker priority of the new talker, the BSC releases the current talker from the uplink by sending a message requesting release of the uplink to the mobile station on the FACCH.

**DISC:** Standard message to release the layer 2 link.

**UA:** Standard message to acknowledge release of the layer 2 link.

**VGCS\_UPLINK\_GRANT:** The reply to the priority uplink request sent on the voice group channel downlink containing information for synchronisation of the mobile station to the network and uplink access contention resolution. The VGCS\_UPLINK\_GRANT message shall therefore include a request reference (reflecting the PRIORITY\_UPLINK\_REQUEST) and the physical information required for transmission on the voice group call channel uplink. On receipt of a VGCS\_UPLINK\_GRANT, the related mobile station can start to send speech directly.

**UPLINK\_BUSY:** This connectionless RR message is sent on the downlink FACCH to inform all mobile stations that the uplink is now busy. If the network supports talker priorities, then the UPLINK\_BUSY indicates the talker priority of the current talking service subscriber to all listening service subscribers and additionally, if the emergency mode is set in the network, the emergency mode indication. The message is repeated on the FACCH every T1 seconds. If validation of Priority Uplink Requests applies each periodic UPLINK\_BUSY message shall include a new token (i.e. a new token is broadcast every T1 seconds). The BSS may include the additional information about the new talking service subscriber in the UPLINK\_BUSY message, if the information is available when sending this message and there is sufficient space available in the message.

NOTE: The order of UPLINK\_BUSY and SABM message is independent.

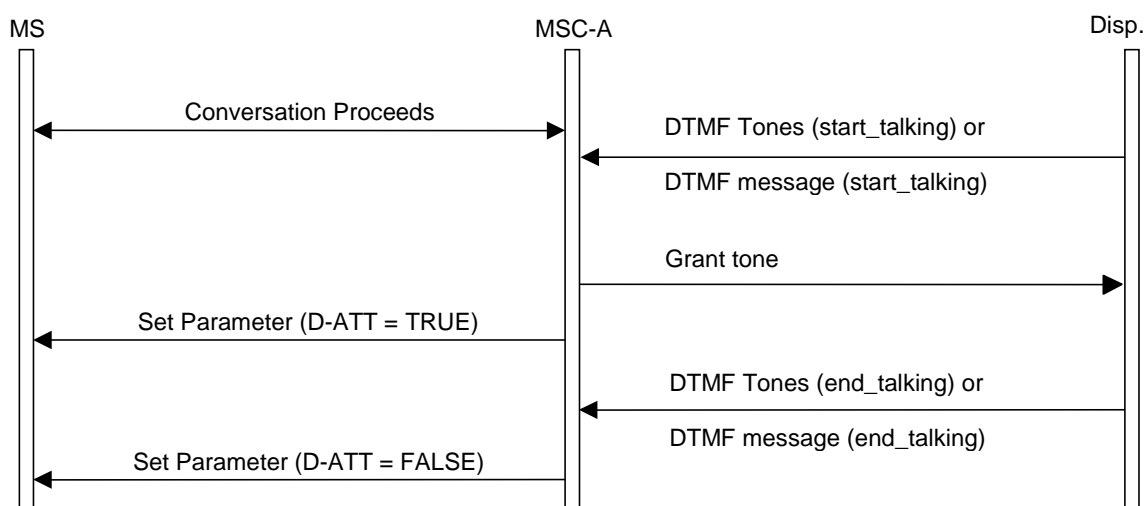
**SABM (L3msg):** The layer 2 link is set up and layer 3 information on classmark and mobile station identity included.

**UA (L3msg):** The layer 2 link is acknowledged and the layer 3 information reflected for contention resolution.

**UPLINK\_REQUEST\_CONFIRM:** The BSS confirms the uplink use to the MSC together with the mobile station identity, classmark information and optionally the CKSN.

**VGCS\_ADD\_INFO:** The MSC sends additional information about the new talking service subscriber to all BSCs, unless the information was already included in the UPLINK\_REQUEST\_ACKNOWLEDGE, UPLINK\_REJECT\_CMD and UPLINK\_SEIZED\_CMD messages. The BSCs broadcast ADD\_INFO messages containing the additional information to all listeners (not shown in figure 5a), unless the information was already included in the UPLINK\_BUSY messages.

**Conversation proceeds:** Once the mobile station has control of the uplink, it shall be able to communicate directly. The two-way nature of the conference bridge will ensure that they are already connected to all appropriate downlink channels.



**Figure 5b: Signalling information required when the talker is attached to the Anchor MSC and a dispatcher sends DTMF signals**

**Conversation proceeds:** The talker is in control of the uplink (see figure 4) and is attached to the Anchor MSC. The mobile station's downlink is muted to prevent any distracting echo being heard by the mobile station user.

**DTMF Tones (start\_talking) or DTMF message (start\_talking):** This signalling indicates the dispatcher's unmute request to the MSC. DTMF Tones are used by a fixed line dispatcher while the DTMF message is used by a mobile dispatcher.

**Grant Tone:** The Anchor MSC may optionally play an in-band tone to the dispatcher to indicate that the dispatcher's request is recognized and that the downlink of the talking service subscriber will be unmuted. The attributes of the grant tone (e.g. frequency and duration) are network operator specific.

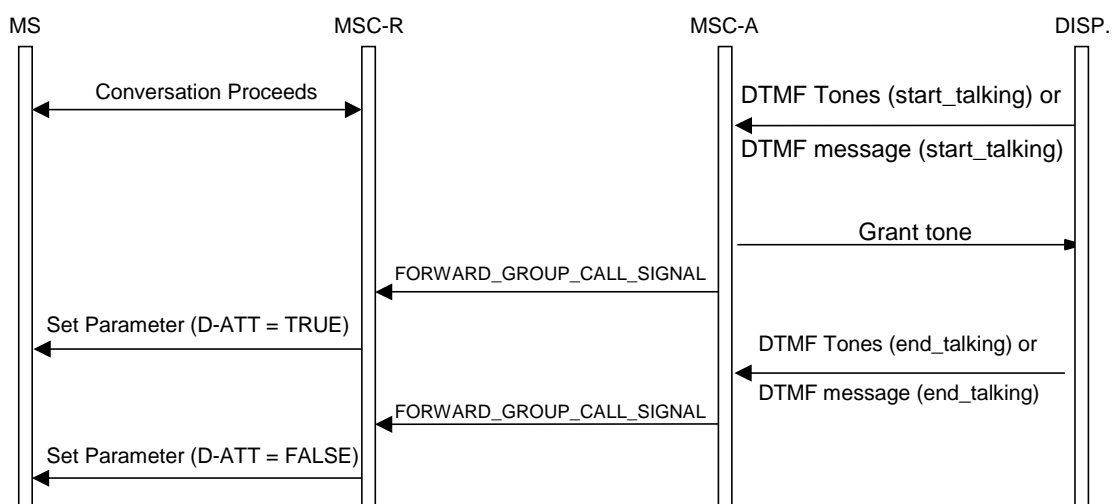
**Set Parameter (D-ATT = TRUE):** The Anchor MSC sends this message to the mobile station to unmute the downlink so that the user can hear what the dispatcher says.

NOTE 29: This message is sent only when the downlink of the talker is muted.

**DTMF Tones (end\_talking) or DTMF message (end\_talking):** This signalling indicates the dispatcher's mute request to the MSC. DTMF Tones are used by a fixed line dispatcher while the DTMF message is used by a mobile dispatcher.

**Set Parameter (D-ATT = FALSE):** Once the dispatcher indicates that he has finished speaking, the Anchor MSC mutes the talker's downlink.

NOTE 30: This message is only sent when all dispatchers who have sent the unmuting request have finished their talk.



**Figure 5c: Signalling information required when the talker is attached to a Relay MSC and a dispatcher sends DTMF signals**

**Conversation proceeds:** The talker is in control of the uplink (see figure 4) and is attached to a Relay MSC. The mobile station's downlink is muted to prevent any distracting echo being heard by the mobile station user.

**DTMF Tones (start\_talking or DTMF message (start\_talking):** This signalling indicates the dispatcher's unmute request to the MSC. DTMF Tones are used by a fixed line dispatcher while the DTMF message is used by a mobile dispatcher.

**Grant Tone:** The Anchor MSC may optionally play an in-band tone to the dispatcher to indicate that the dispatcher's request is recognized and that the downlink of the talking service subscriber will be unmuted. The attributes of the grant tone (e.g. frequency and duration) are network operator specific.

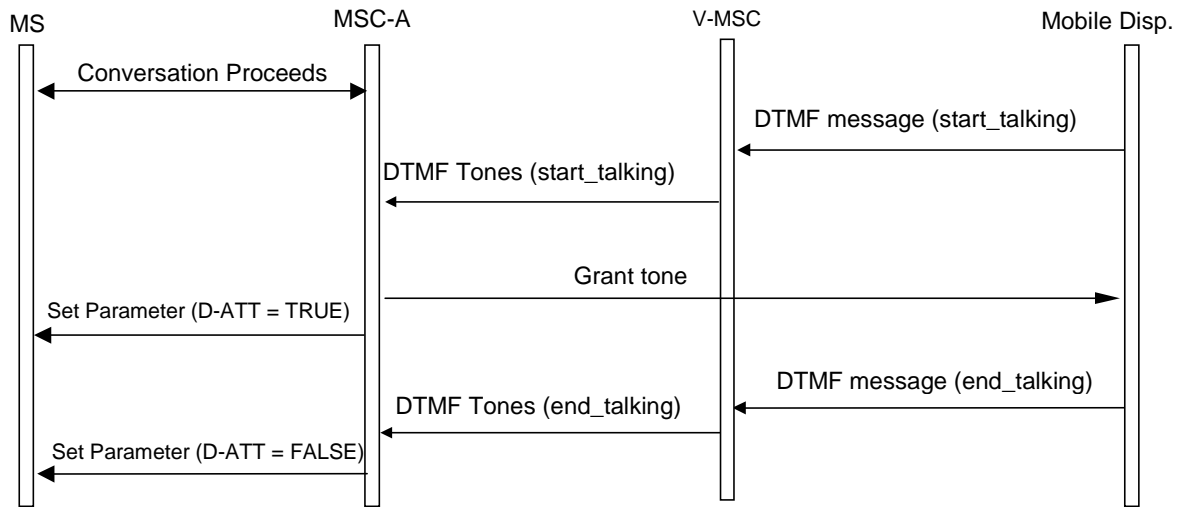
**FORWARD\_GROUP\_CALL\_SIGNAL:** This message is sent to the Relay MSC when anchor MSC wants to change the mute/unmute status of the talking service subscriber. In this case **stateAttributes::DA = TRUE**, is set.

**Set Parameter (D-ATT = TRUE/FALSE):** The Relay MSC sends this message to the talker when a FORWARD GROUP CALL SIGNAL containing a STATE\_ATTRIBUTES information element is received. The D-ATT field is set as received in STATE\_ATTRIBUTES element.

**DTMF Tones (end\_talking) or DTMF message (end\_talking):** This signalling indicates the dispatcher's mute request to the MSC. DTMF Tones are used by a fixed line dispatcher while the DTMF message is used by a mobile dispatcher.

**FORWARD\_GROUP\_CALL\_SIGNAL:** This message is sent to the Relay MSC when the anchor MSC wants to change the mute/unmute status of the talking service subscriber. In this case **stateAttributes:DA = FALSE** is set.

**Set Parameter (D-ATT = FALSE):** Once the dispatcher indicates that he has finished speaking, the MSC mutes the talker’s downlink again.



**Figure 5d: Signalling information required when the talker is attached to the Anchor MSC and a mobile dispatcher who is roaming in a non-Anchor MSC area sends DTMF signals**

**Conversation proceeds:** The talker is in control of the uplink (see figure 4) and is attached to the Anchor MSC. The mobile station’s downlink is muted to prevent any distracting echo being heard by the mobile station user.

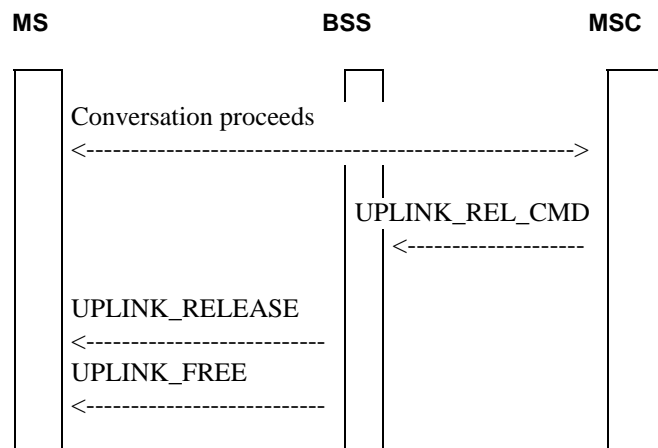
**DTMF message (start\_talking):** This signalling indicates the mobile dispatcher’s unmute request to visited MSC. On reception of the DTMF message, the visited MSC will convert it into DTMF tones and send these DTMF tones through the network to the anchor MSC.

**Grant Tone:** The Anchor MSC may optionally play an in-band tone to the dispatcher to indicate that the dispatcher’s request is interpreted as a request to talk and that the downlink of the talking service subscriber will be unmuted. The attributes of the grant tone (e.g. frequency and duration) are network operator specific.

**Set Parameter (D-ATT = TRUE):** The Anchor MSC sends this message to the talker to force his mobile station to unmute its downlink so that the user can hear what the dispatcher says.

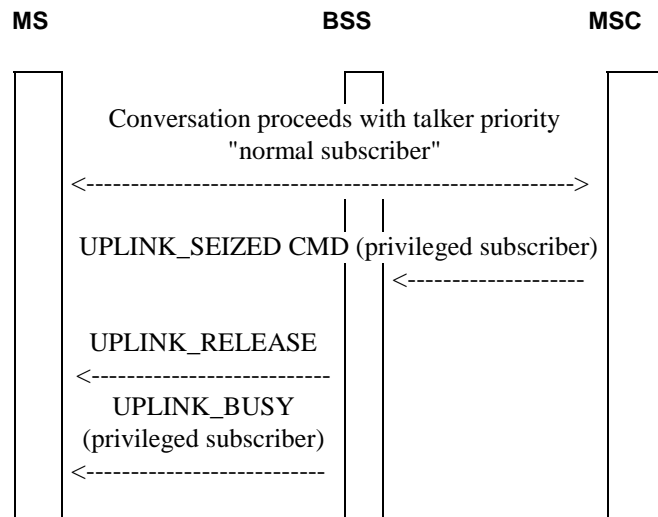
**DTMF message (end\_talking):** This signalling indicates the mobile dispatcher’s mute request to the MSC.

**Set Parameter (D-ATT = FALSE):** Once the dispatcher indicates that he has finished speaking, the Anchor MSC mutes the talker’s downlink.



**Figure 6: Signalling information required for the voice group call uplink release requested by the network**

**UPLINK\_REL\_CMD:** When the network wants to release the uplink for any reason, except when a service subscriber with a higher priority has seized the uplink, then a message requesting release of the uplink is required to be sent from the network to the mobile station on the FACCH.

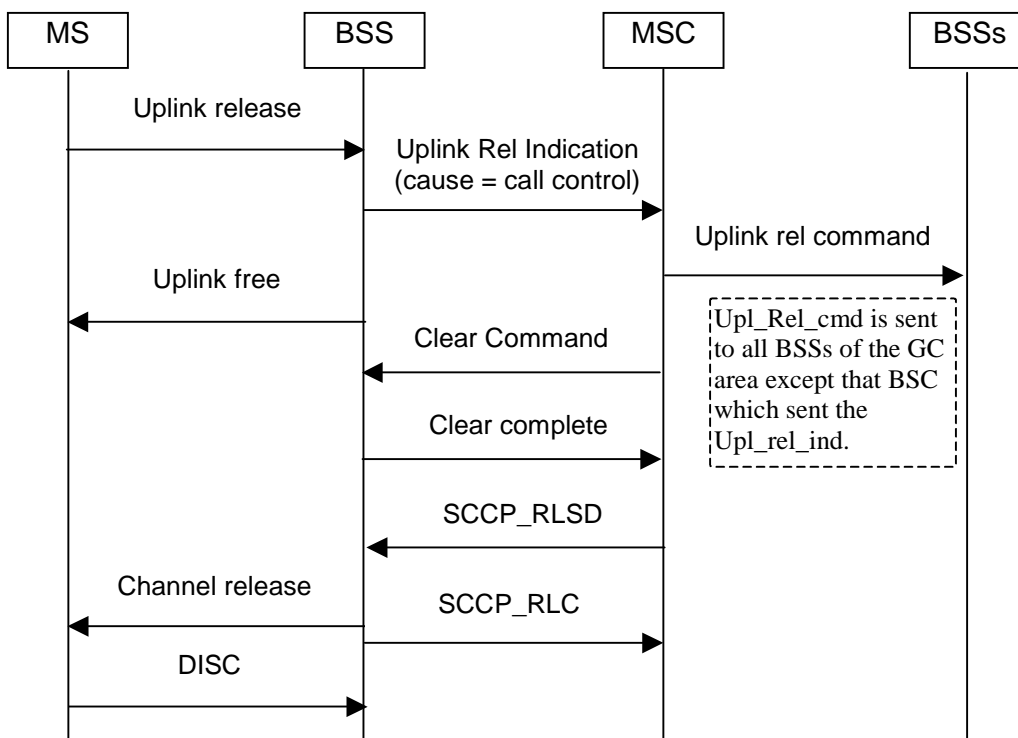


**Figure 6a: Signalling information required for the voice group call uplink release requested by the network; preemption of the current talker by a privileged service subscriber**

**UPLINK\_SEIZED\_CMD:** When the network wants to release the uplink because a service subscriber with a higher priority has seized the uplink in another BSS area, an UPLINK\_SEIZED\_CMD indicating the talker priority of the new talking service subscriber is sent by the MSC. If the BSS has sent an UPLINK\_REQUEST to the MSC, the MSC will either send UPLINK\_REQUEST\_ACKNOWLEDGE or UPLINK\_REJECT instead of the UPLINK\_SEIZED\_CMD.

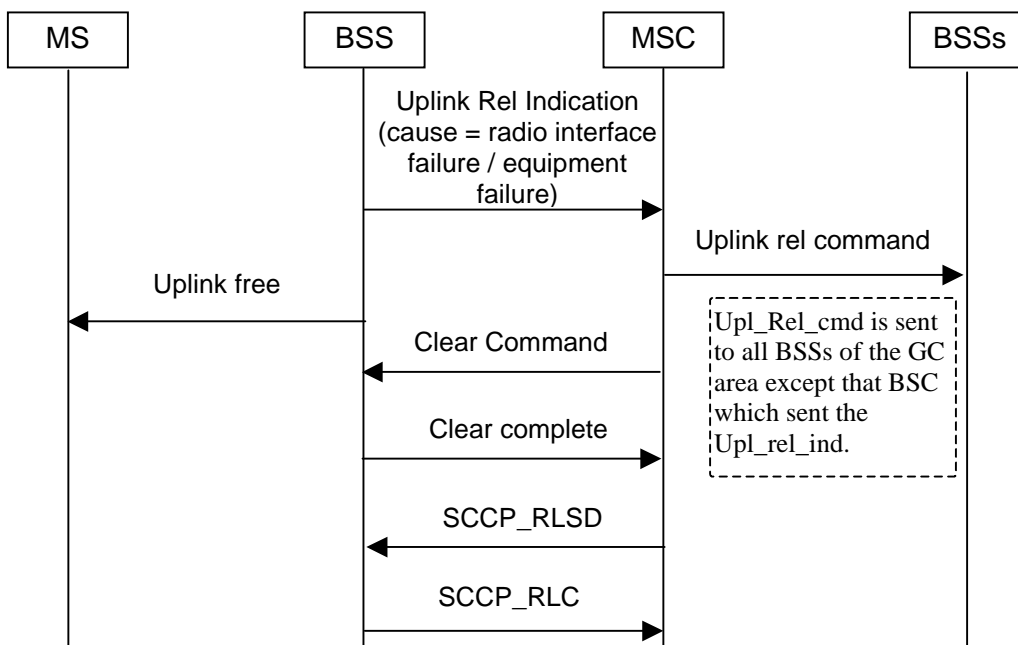
The following figures 6.b to 6.g show the message flows applicable for the uplink release in normal and error cases, dependent on whether the talker is

- on a dedicated link (e.g. the talker is the originator); or
- on the group call channel (e.g. the talker is a subsequent talker).



NOTE: The messages CLEAR CMD, CLEAR COM, etc., are used to release the dedicated connection of the talker.

Figure 6.b: Uplink release for the talker on a dedicated link: normal case



NOTE: The messages CLEAR CMD, CLEAR COM, etc., are used to release the dedicated connection of the talker. The same message flow applies for all cause values different from "call control".

Figure 6.c: Uplink release for the talker on a dedicated link: loss of radio contact or equipment failure (TRX, PCM ...)

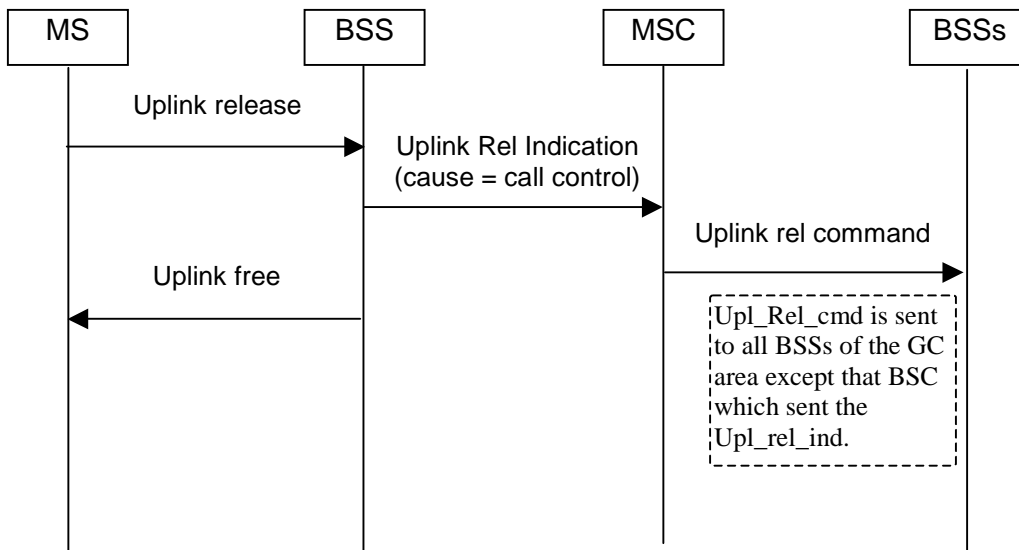


Figure 6.d: Uplink release for the talker on group call channel: normal case

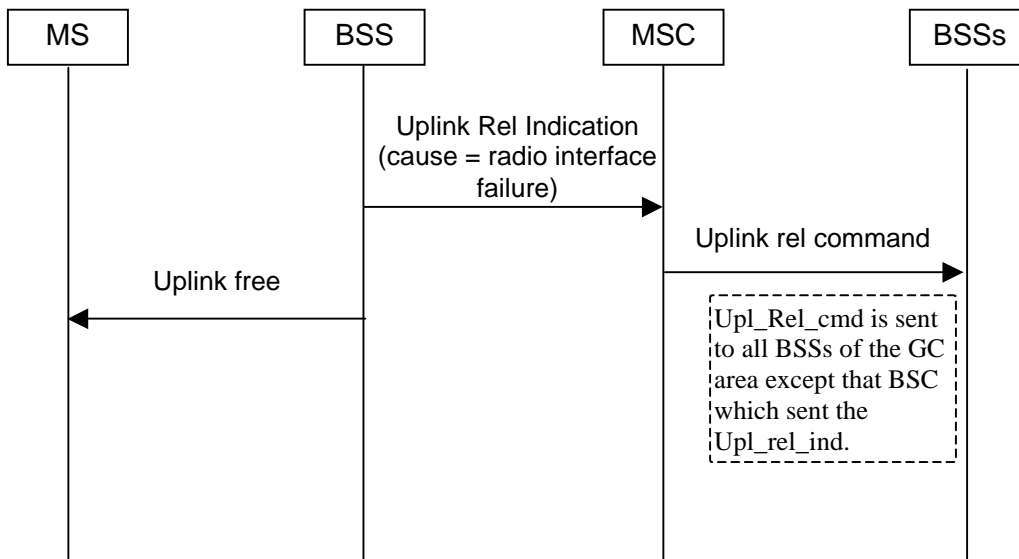
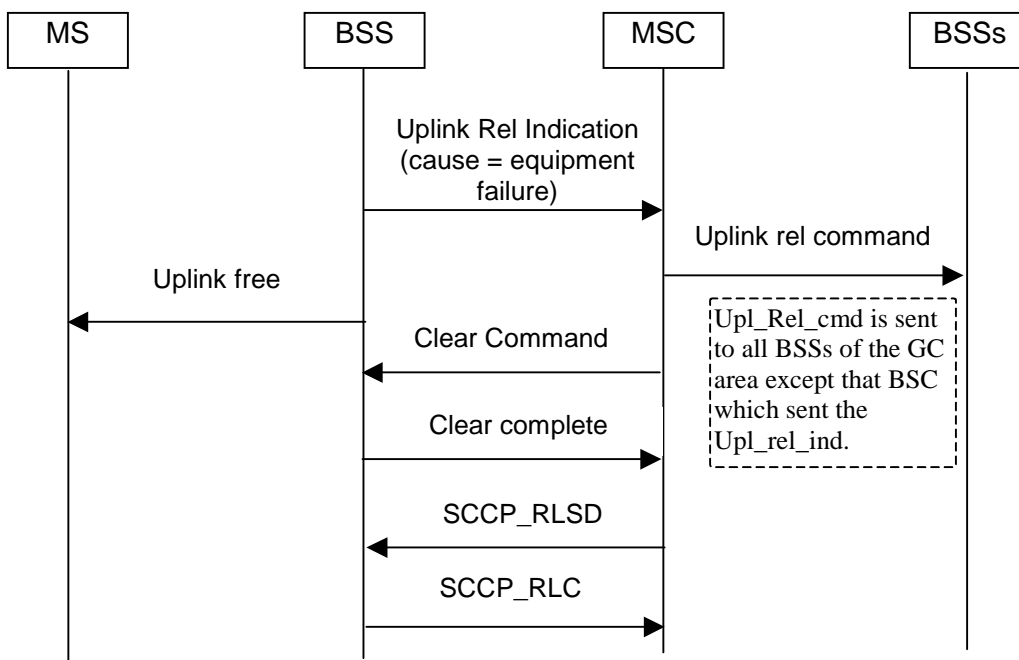


Figure 6.e: Uplink release for the talker on group call channel: loss of radio contact

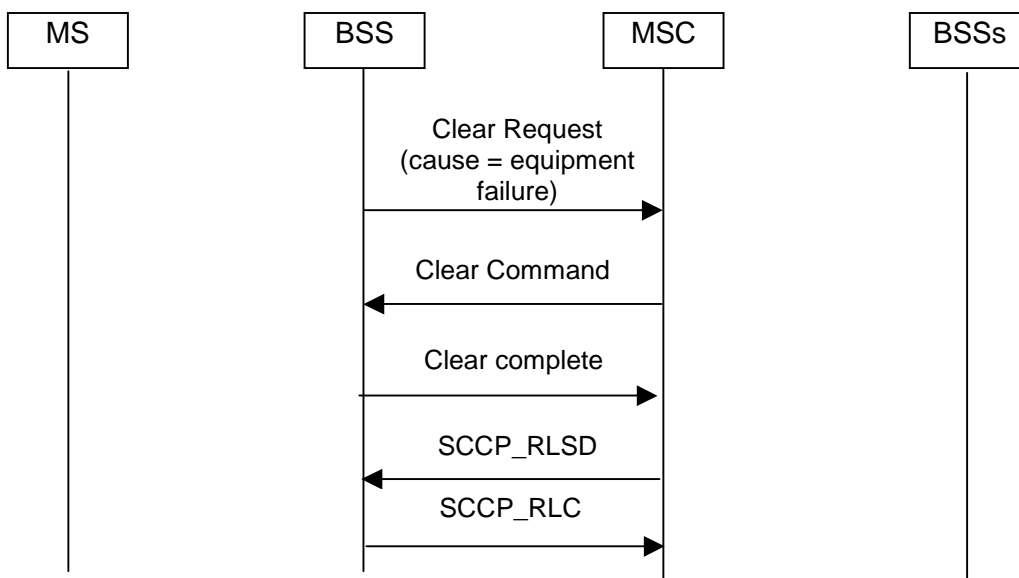




NOTE: The messages CLEAR CMD, CLEAR COM, etc., are used to release the radio and terrestrial resources for the cell serving the talker. The same message flow applies for all cause values different from "call control", and "radio interface failure".

**Figure 6.f: Uplink release for the talker on group call channel after equipment failure (TRX, PCM ...), group call re-establishment by the BSS not supported**

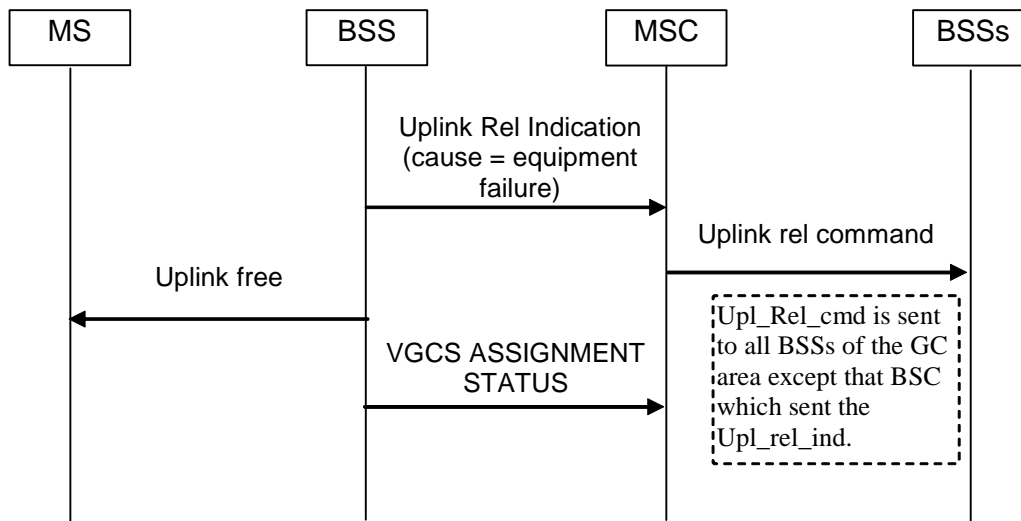
The BSC shall send the message UPLINK RELEASE INDICATION with cause value "equipment failure" or another appropriate cause value, if a failure concerning the cell that is serving the talker was detected and the radio and terrestrial resources related to this cell shall be released (see figure 6.5). After receipt of the UPLINK RELEASE INDICATION message the MSC shall send a CLEAR COMMAND message for the respective cell. The BSC does not send CLEAR REQUEST in addition to UPLINK RELEASE INDICATION in order to avoid conflicts.



NOTE: The messages CLEAR CMD, CLEAR COM, etc., are used to release the radio and terrestrial resources for the cell not serving the talker. The same message flow applies also for all other cause values.

**Figure 6.g: Release after equipment failure (TRX, PCM ...) concerning a cell that is not serving the talker, group call re-establishment by the BSS not supported**

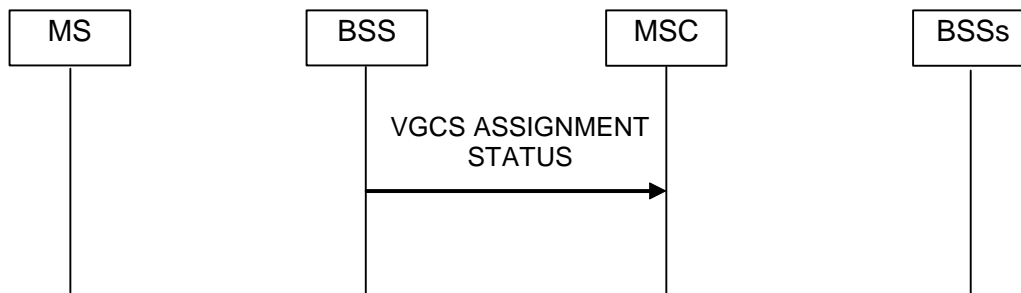
The BSC shall send the message CLEAR REQUEST with cause value "equipment failure" or another appropriate cause value, if a failure concerning a cell not serving the talker was detected and the resources related to this cell shall be released (see figure 6.g). After receipt of the CLEAR REQUEST message the MSC shall send a CLEAR COMMAND message for the respective cell.



NOTE: The terrestrial resource for the group call channel is not released.

**Figure 6.h: A-interface link sharing used or group call re-establishment by the BSS supported: Uplink release for the talker on group call channel after equipment failure (TRX, PCM ...)**

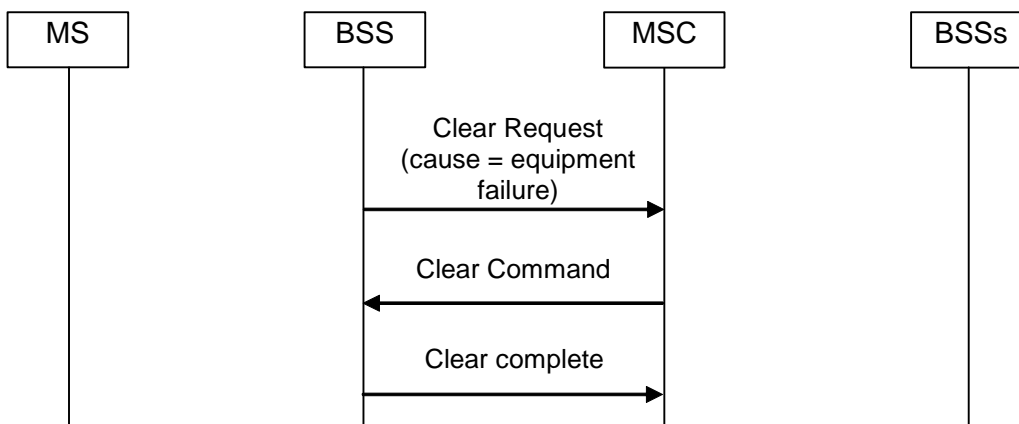
If A-interface link sharing is used or group call re-establishment by the BSS is supported, the BSC shall send the message UPLINK RELEASE INDICATION with cause value "equipment failure" or another appropriate cause value, if a failure concerning the cell that is serving the talker was detected. In addition the BSC shall send the VGCS ASSIGNMENT STATUS message indicating that the connection to this cell is no longer established (see figure 6.h). If A-interface link sharing is used, the VGCS ASSIGNMENT STATUS message shall be sent on expiry of timer T<sub>ast</sub>.



NOTE: The terrestrial resource for the group call channel is not released.

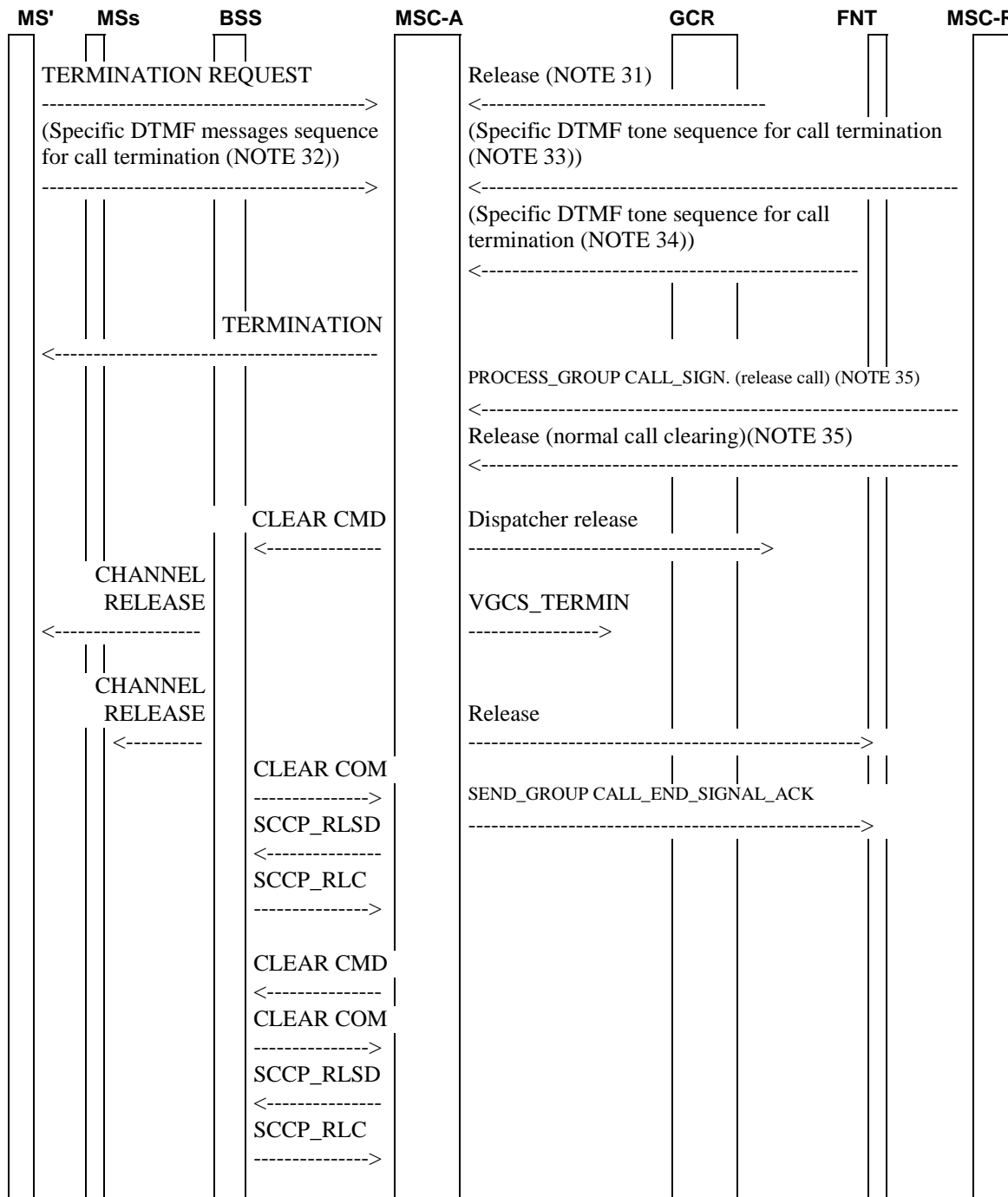
**Figure 6.i: A-interface link sharing used or group call re-establishment by the BSS supported: Release after equipment failure (TRX, PCM ...) concerning a cell that is not serving the talker**

If A-interface link sharing is used or group call re-establishment by the BSS is supported, and a failure concerning a cell that is not serving the talker was detected, the BSC shall send the VGCS ASSIGNMENT STATUS message indicating that the connection to this cell is no longer established (see figure 6.i). If A-interface link sharing is used, the VGCS ASSIGNMENT STATUS message shall be sent on expiry of timer T<sub>ast</sub>.



**Figure 6.j: A-interface link sharing used or group call re-establishment by the BSS supported: Release after equipment failure concerning the link between MSC and BSS**

If A-interface link sharing is used or group call re-establishment by the BSS is supported, the BSC shall send the message CLEAR REQUEST with cause value "equipment failure" or another appropriate cause value, if a failure concerning the link between MSC and BSS was detected and the resources related to this connection shall be released (see figure 6.h). After receipt of the CLEAR REQUEST message the MSC shall send a CLEAR COMMAND message for the respective connection and try to establish a new connection.



**Figure 7: Signalling required to disconnect the group call**

**TERMINATION REQUEST:** An authorized mobile station can send a TERMINATION REQUEST message to clear down the entire voice group call. To do this, the mobile station must have access to the uplink. The network has to check the IMSI to verify the calling service subscriber. If the IMSI of the mobile station which has uplink access is presently not known to the network, the network shall send an identity request to the mobile station

NOTE 31: Alternatively an authorized dispatcher can terminate the voice group call in which case a release message is received from the external network.

NOTE 32: Alternatively an authorized mobile dispatcher can terminate the voice group call by using a specific DTMF message sequence. If the mobile dispatcher is controlled by the anchor MSC, the specific DTMF message sequence is received by the anchor MSC (see figure 7b).

NOTE 33: If the mobile dispatcher is controlled by a relay MSC, the specific DTMF message sequence is received by the relay MSC. The relay MSC converts the DTMF messages into DTMF tones and sends them towards the anchor MSC (see figure 7c).

NOTE 34: Alternatively an authorized fixed line dispatcher can terminate the voice group call by using a specific DTMF tone sequence. In this case, the specific DTMF tone sequence is received by the anchor MSC (see figure 7d).

NOTE 35: Alternatively an authorized mobile station currently served by a relay MSC can clear down the entire group call in which case either a Release (normal call clearing) is received from the relay MSC (for the case when the calling service subscriber still has the initial dedicated connection to MSC-A) or a PROCESS\_GROUP\_CALL\_SIGNALLING message indicating call release is received from the relay MSC (when the calling service subscriber is on the group call channel or has a dedicated connection to the relay MSC).

**CLEAR CMD:** This message is sent from the MSC to the BSS via each Resource Controlling SCCP connection to clear radio and terrestrial resources.

**VGCS\_TERMININ:** The MSC informs the GCR that the voice group call with the related group call reference is terminated.

**CHANNEL RELEASE:** CHANNEL RELEASE messages are sent on all downlink FACCH to the service subscribers. The CHANNEL RELEASE messages shall be repeated for a predefined period in order to provide a high probability that the listening mobile stations receive the message.

- CHANNEL RELEASE message is sent using I frame for the talker.
- CHANNEL RELEASE messages are sent using UI frames for listeners.

In addition, release messages are sent to all related dispatchers and relay MSCs. If the group call termination is initiated by an entitled dispatcher, and there is a dedicated connection for the calling service subscriber between the anchor MSC and the relay MSC, the anchor MSC shall release this connection with cause 'normal call clearing'.

**SEND\_GROUP\_CALL\_END\_SIGNAL\_ACK:** The dialogues to all relay MSCs are closed.

**CLEAR COMPLETE:** standard message.

**SCCP\_RLSD:** standard message sent via resource controlling SCCP connection.

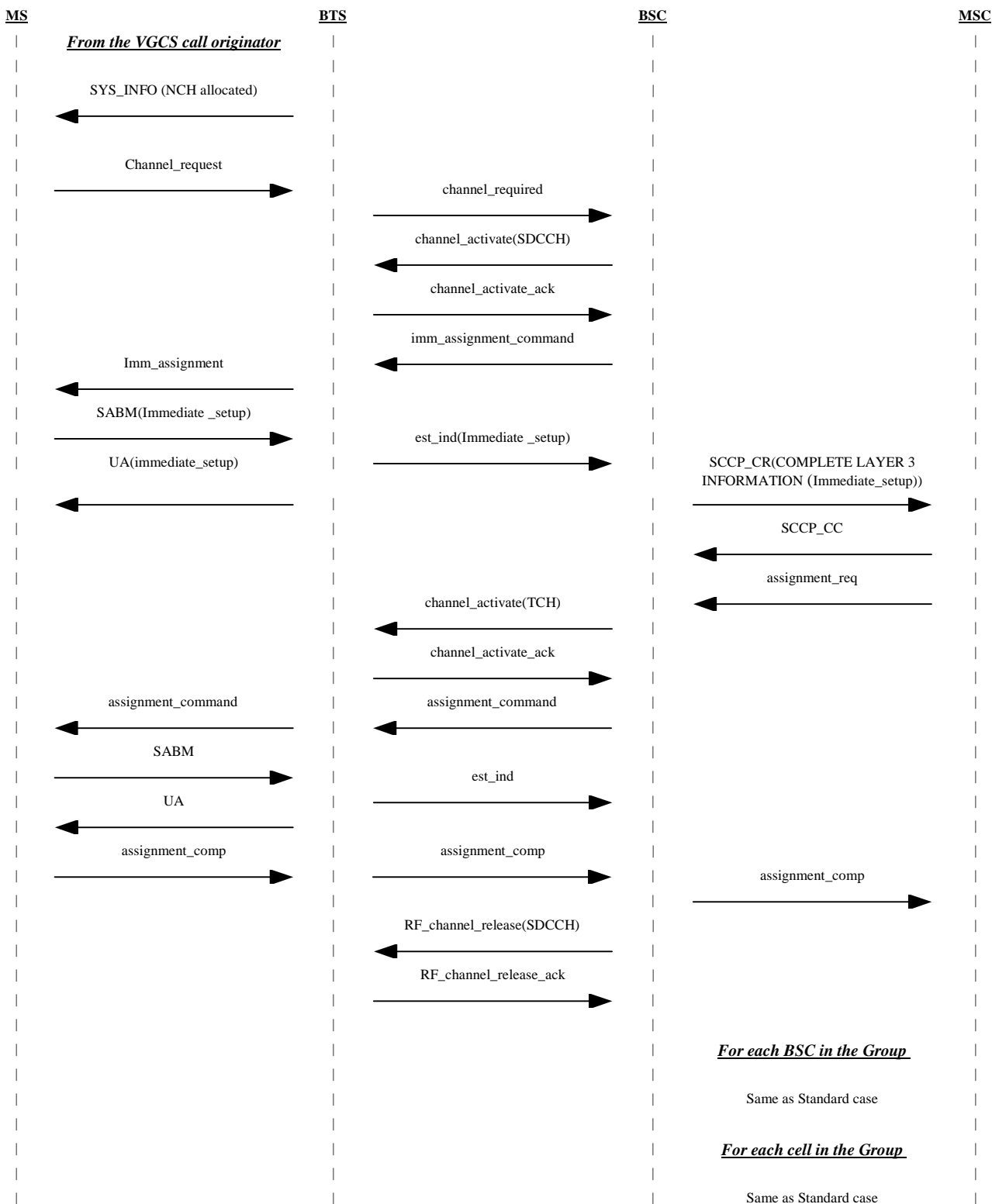
**SCCP\_RLC:** standard message.

**CLEAR CMD:** This message is sent from the MSC to the BSS via the Call Controlling SCCP connection, after all the terrestrial resources associated with the BSS for this group call have been released.

**CLEAR COMPLETE:** standard message.

**SCCP\_RLSD:** standard message sent via call controlling SCCP connection.

**SCCP\_RLC:** standard message.



**Figure 7a: Signalling information required for establishing voice group calls by a service subscriber using immediate setup**

**SYS\_INFO (NCH allocated):** Message used to indicate if the NCH is allocated on the CCCH in the cell.

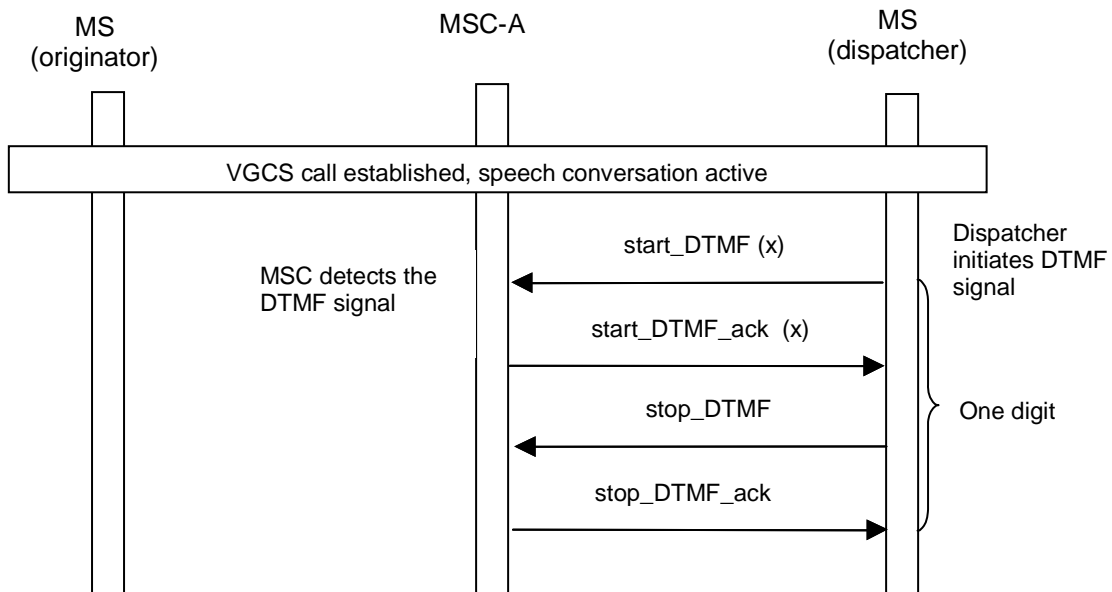
**Initial RACH CHAN\_REQ:** Standard message.

**IMM\_ASSIGNMENT:** Standard message sent on the AGCH.

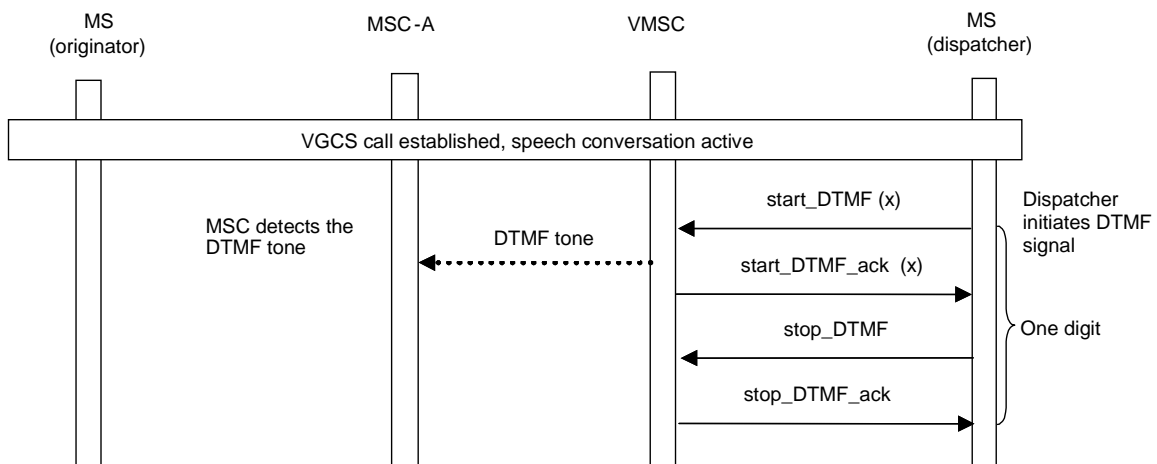
**IMMEDIATE\_SETUP:** This message including all details of the voice group call is sent by the MS to the network in order to set-up a group call immediately, i.e. without previous establishment of an MM connection.

**UA (IMMEDIATE\_SETUP):** This message is used to acknowledge the layer 2 link and provide contention resolution of the immediate setup.

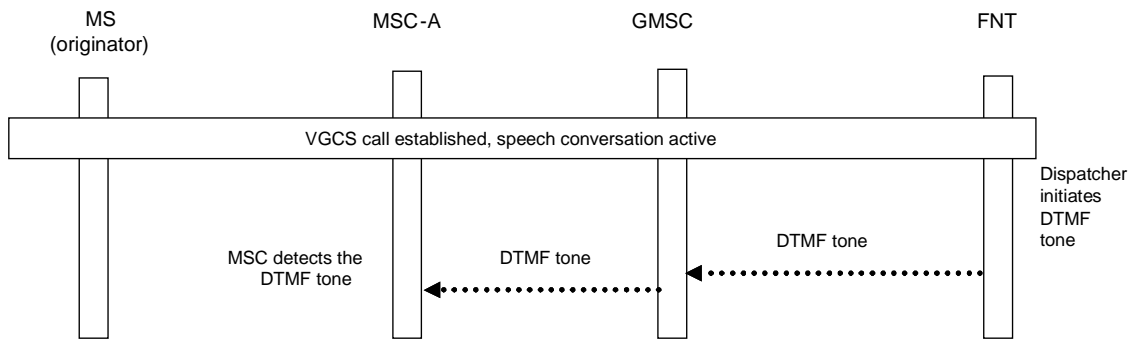
NOTE 36: Authentication and/ or activation of Ciphering may be performed before or after sending a CONNECT message. If ciphering has not been activated before sending a CONNECT message, a CM\_SERVICE ACCEPT may be sent before the CONNECT message by the MSC, however sending of the CM\_SERVICE\_ACCEPT is not mandatory.



**Figure 7b: Signalling required for communication of DTMF digit entry by an entitled mobile dispatcher, if the mobile dispatcher is controlled by the anchor MSC of the group call.**

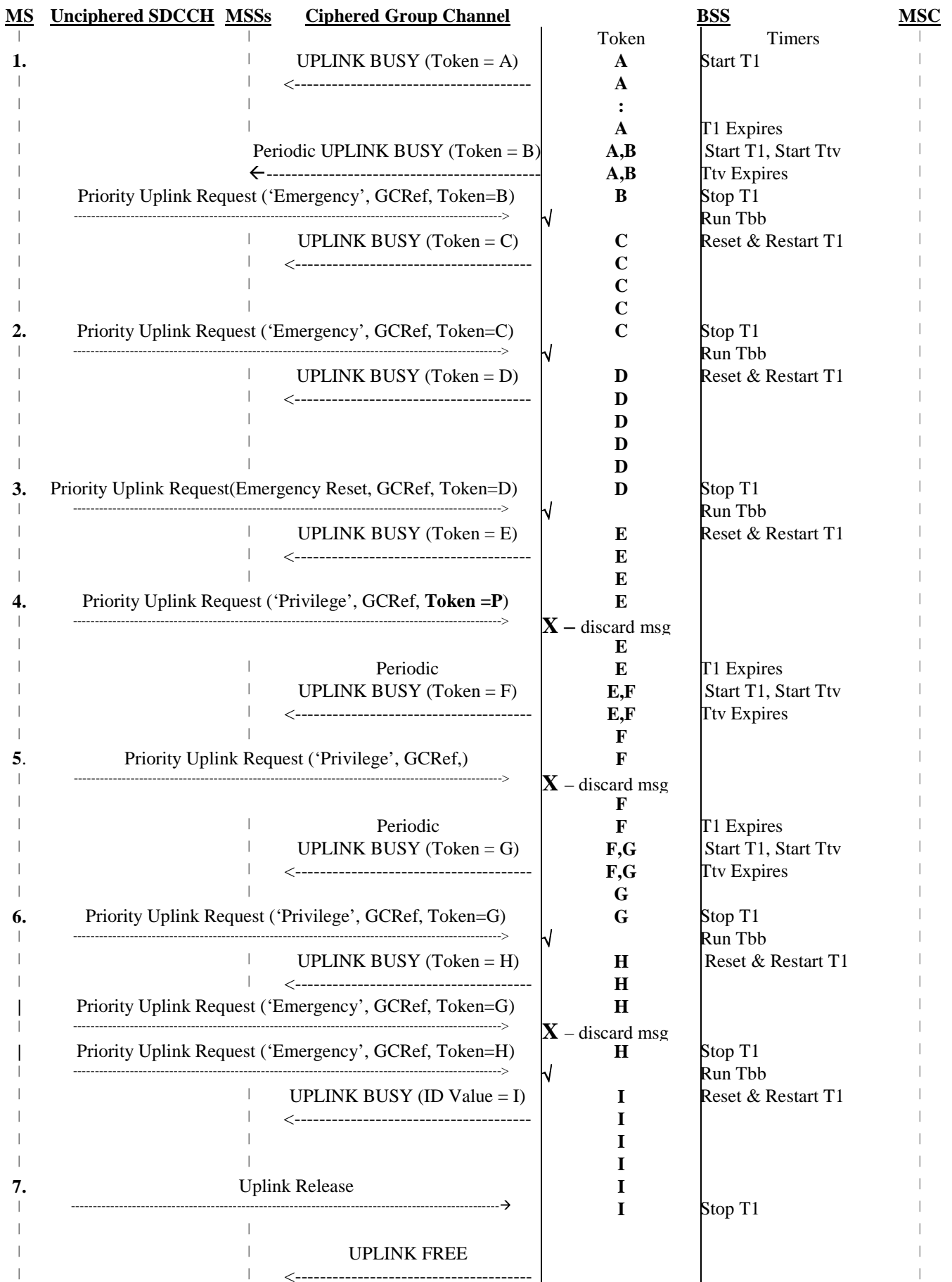


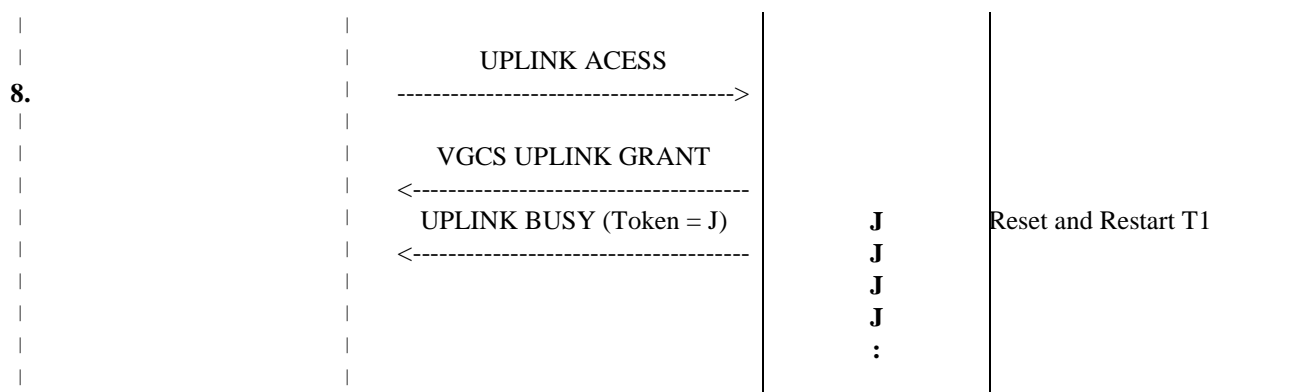
**Figure 7c: Signalling required for communication of DTMF digit entry by an entitled mobile dispatcher, if the mobile dispatcher is controlled by a visited MSC (could be a relay MSC) of the group call.**



**Figure 7d: Signalling required for communication of DTMF digit entry by an entitled fixed line dispatcher.**







**Figure 7e: Validation of Priority Uplink Requests for ciphered group calls**

**NOTE:**

MS = service subscriber requesting priority access to the uplink

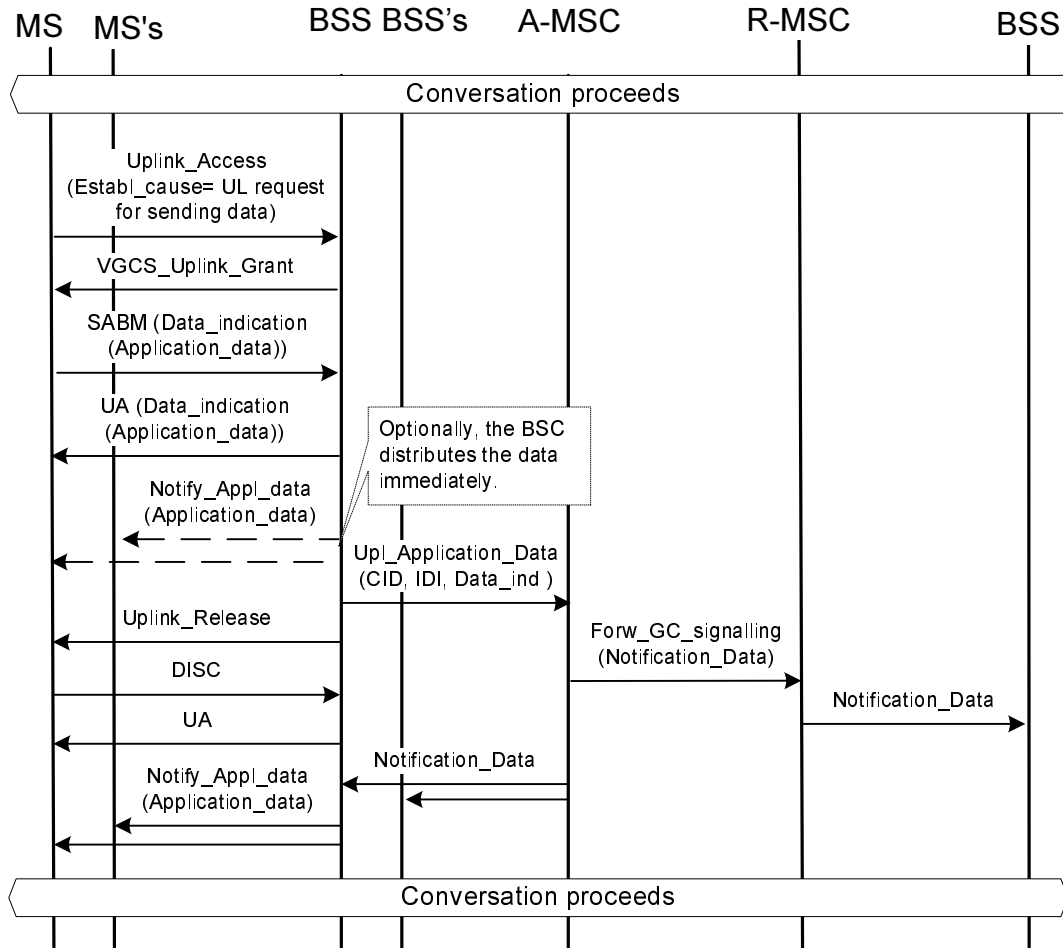
MSs = all service subscribers in the group, in this BSS area

Token (A, B...J) = 32bit random number, generated by the BSS. Broadcast in UPLINK BUSY messages on the ciphered group channel downlink (FACCH)

**Figure 7e Scenarios:**

1. For a service subscriber originated group call, if the call is ciphered, the BSS includes a token in the first UPLINK BUSY message sent on the group channel downlink. For a dispatcher originated group call, if the call is ciphered, the BSS includes a token in the first UPLINK BUSY message sent after the first successful uplink access by a service subscriber. A new token is sent in each periodic UPLINK BUSY message, every T1 seconds. If the old token has not been used it remains valid for a further Ttv seconds along with the new token. Once Ttv expires only the new token is valid. (If, within Ttv seconds, a Priority Uplink Request is received with the old token, the request is accepted, the old and new tokens are invalidated and an UPLINK BUSY, with another new token and the priority of the accepted request, is sent after Tbb ms on the group channel downlink.)
2. Subscriber on the group call with 'Privilege' or 'Emergency' subscription requests the uplink. Token matches in BSS. A new token, and the priority of the accepted request, are sent after Tbb ms in an UPLINK BUSY on the group channel downlink to ensure higher priority requests can still be made in the cells covered by this BSS. Timer T1 is reset and restarted.
3. Subscriber on the group call with 'Emergency Mode Reset' subscription requests an 'Emergency Mode Reset'. Token matches in BSS. A new token is sent after Tbb ms in an UPLINK BUSY on the group channel downlink. Timer T1 is reset and restarted.
4. User not on the group call makes fraudulent uplink request. Token does not match in BSS. BSS discards message. BSS continues to broadcast tokens in periodic UPLINK BUSY messages.
5. Subscriber on the group call with a 'Privilege', 'Emergency' or 'Emergency Mode Reset' subscription requests the uplink. No token included in the request. BSS discards message. BSS continues to broadcast tokens in periodic UPLINK BUSY messages.
6. Subscriber with a 'Privilege' subscription requests the uplink. Token matches in BSS. A new token, and the priority of the accepted request (i.e. 'Privilege'), are sent after Tbb ms in an UPLINK BUSY on the group channel downlink, however a subscriber with an 'Emergency' subscription requests the uplink before the new token has been received by the MS (use of the old token, causes the message to be discarded by BSS). On receipt of the UPLINK BUSY with new token and priority 'Privilege', the MS resends the Priority Uplink Request ('Emergency') with the new token.
7. When a subscriber releases the uplink, timer T1 is stopped and the BSS broadcasts UPLINK FREE. A token is not broadcast while the uplink is free.

8. A subscriber requests the uplink by sending an UPLINK ACCESS on the group channel uplink. The BSS grants the uplink and a UPLINK BUSY including a new token, and the current talker priority, is sent on the group channel downlink. A new token and the current talker priority is also sent in UPLINK BUSY on the group channel downlink if the uplink becomes busy because it is granted in another BSS or MSC area and an UPLINK\_REJECT\_CMD or UPLINK\_SEIZED\_CMD is received by the BSS.



**Figure 7f: A listener in the anchor MSC area sends application-specific data to the other group call members, while the group call channel uplink in the cell is free**

**UPLINK\_ACCESS (Establishment\_cause=UL Request for sending application-specific data):** This message is sent on the uplink of the voice group call channel using random access procedures. The UPLINK ACCESS message is similar to a channel request but sent on the group call channel uplink.

**VGCS\_UPLINK\_GRANT:** The BSS grants the uplink of its group call channel immediately. The reply to the uplink request sent on the voice group channel downlink containing information for synchronisation of the mobile station to the network and uplink access contention resolution. The VGCS\_UPLINK\_GRANT message shall therefore include a request reference (reflecting the UPLINK\_ACCESS) and the physical information required for transmission on the voice group call channel uplink.

**SABM (DATA\_INDICATION (Application\_data)):** The MS sends a SABM message with its mobile station identity and the Application data to the BSS.

**UA (DATA\_INDICATION (Application\_data)):** This message is used to acknowledge the layer 2 link and provide contention resolution of the data indication.

**NOTIFY\_APPLICATION\_DATA (Application\_data):** If the network option of immediate distribution of application-specific data by the BSS is activated, on receiving the application data sent from the MS, the BSS broadcasts the application data immediately to the cells within the BSC area in a notification message on the FACCH. Optionally, the NOTIFY\_APPLICATION\_DATA message for application-specific data is repeated on the group call

channel downlink. As a prerequisite for the immediate distribution, during the establishment phase of the voice group call the BSC stored the cell identities of the cells belonging to the group call area and served by the BSC.

**UPLINK\_APPLICATION\_DATA (CID, IDI, DATA\_INDICATION):** The BSS adds the sender's cell identifier (CID) and passes the L3 information (DATA\_INDICATION) via the UPLINK\_APPLICATION\_DATA message to the MSC. If the BSC has immediately distributed the application data to its BSC area, the BSC shall additionally include the Immediate Distribution Indicator (IDI).

**UPLINK\_RELEASE:** The BSS immediately releases the uplink by sending this message to the MS on the FACCH.

**DISC:** Standard message to release the layer 2 link.

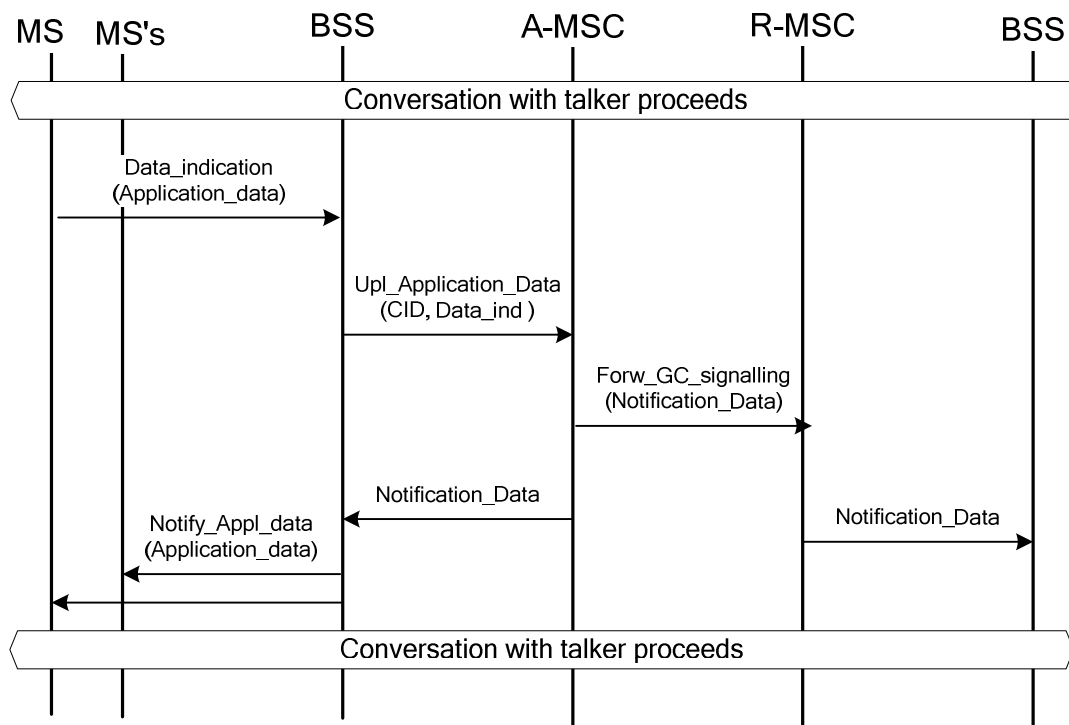
**UA:** Standard message to acknowledge release of the layer 2 link. The mobile station returns to group receive mode.

**FORWARD\_GROUP\_CALL\_SIGNALLING (NOTIFICATION\_DATA):** On receipt of the UPLINK\_APPLICATION\_DATA message, the anchor MSC shall put the application data and optionally the mobile subscriber's MSISDN into the BSSMAP message NOTIFICATION\_DATA and distribute the message towards all relay MSCs.

*Editor's note: The condition for including the MSISDN in the BSSMAP message NOTIFICATION\_DATA is ffs.*

**NOTIFICATION\_DATA:** The MSC sends NOTIFICATION\_DATA messages with the application data to all BSSs in their MSC area involved in the group call. If the originating BSC has immediately distributed the application data to its BSC area, the MSC shall not send the NOTIFICATION\_DATA message to the originating BSC.

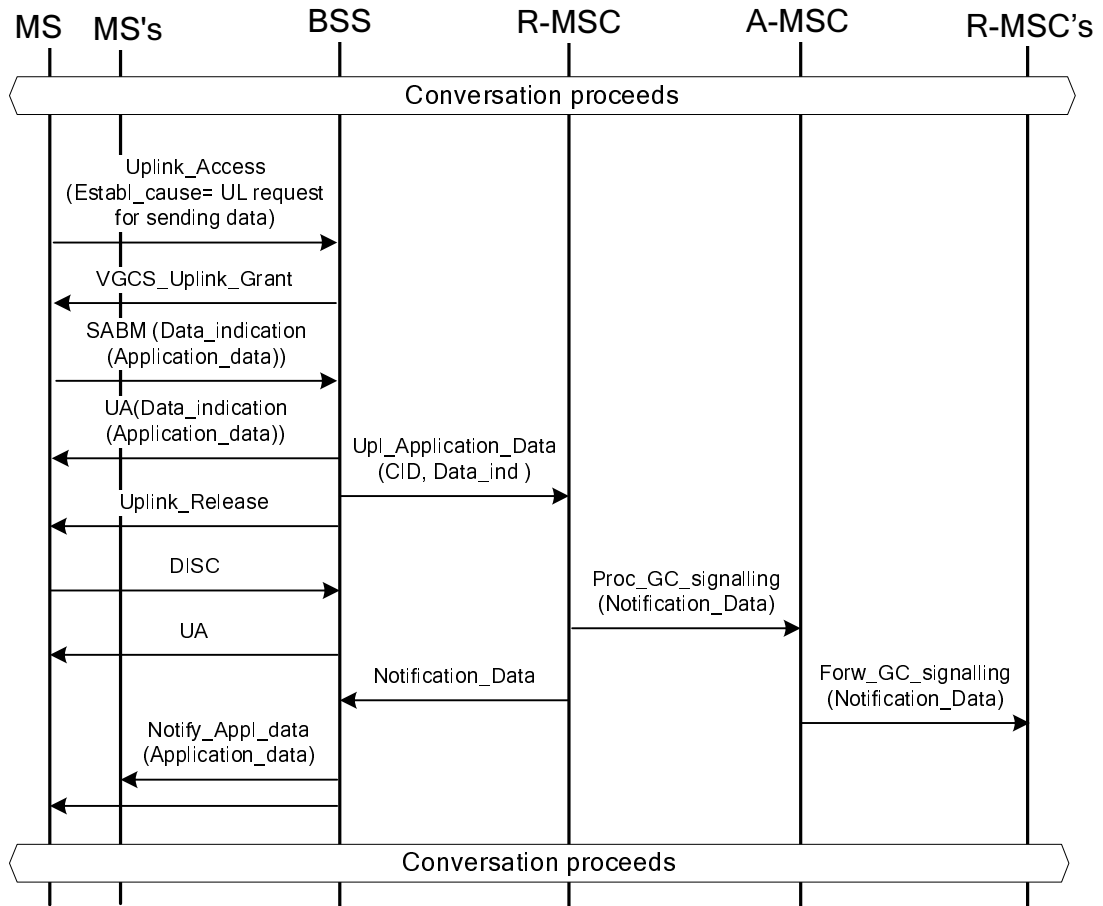
**NOTIFY\_APPLICATION\_DATA (Application\_data):** The BSS broadcasts the application data to all listeners and the talker, if any, in a notification message on the FACCH. Optionally the NOTIFY\_APPLICATION\_DATA message for application-specific data is repeated on the group call channel downlink. (The broadcast of the application data by the other BSSs is not shown in figure 7f.)



**Figure 7g: A talker in the anchor MSC area sends application-specific data to the other group call members.**

**DATA\_INDICATION (Application\_data):** Since the talker has the uplink and a layer 2 link is established, the MS can send the application data to the BSS.

For the meaning of the other messages see figure 7f. The option of immediate distribution of the application-specific data by the BSC can be applied also in figure 7g, although it is not shown in the message flow (for details see figure 7f).



**Figure 7h: A listener in a relay MSC area sends application-specific data to the other group call members, while the group call channel uplink in the cell is free.**

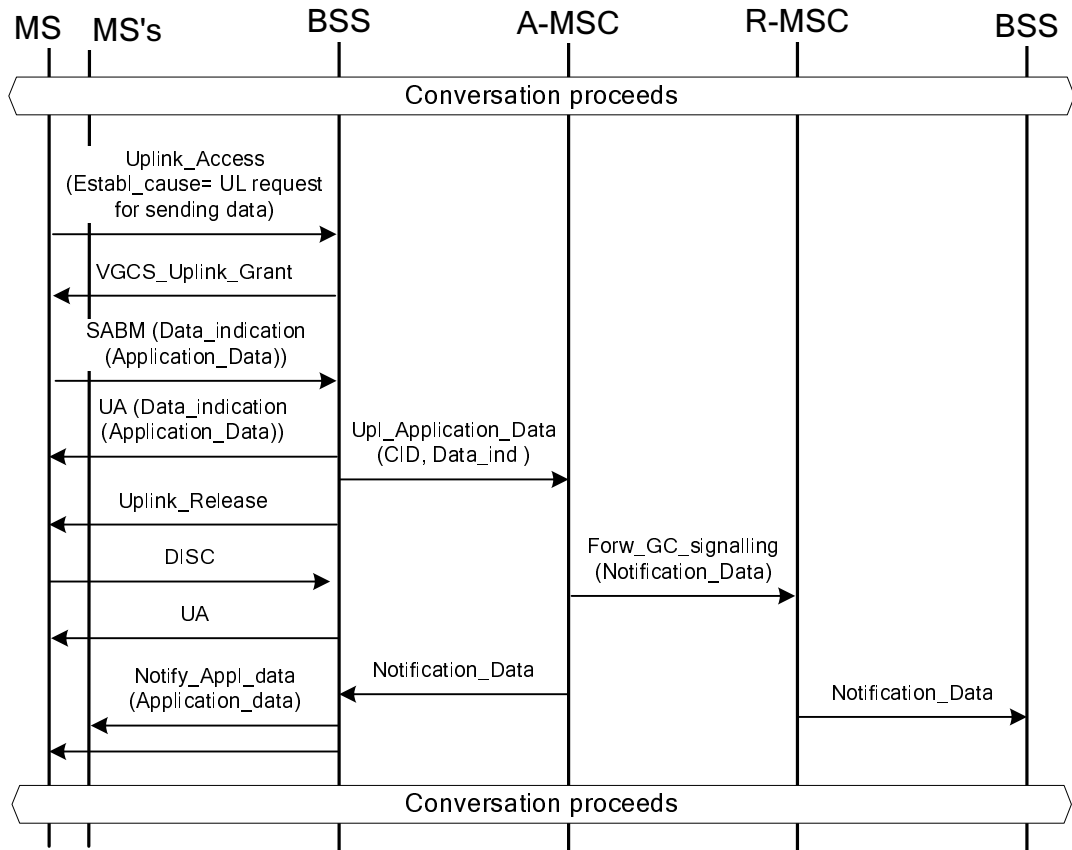
In the following only the messages different from figure 7f are explained:

**PROCESS\_GROUP CALL\_SIGNALLING (NOTIFICATION\_DATA):** On receipt of the UPLINK\_APPLICATION\_DATA message the relay MSC shall put the application data and optionally the mobile subscriber's MSISDN into the BSSMAP message NOTIFICATION\_DATA and send the message to the anchor MSC.

*Editor's note: The condition for including the MSISDN in the BSSMAP message NOTIFICATION\_DATA is for FFS.*

**FORWARD\_GROUP CALL\_SIGNALLING (NOTIFICATION\_DATA):** On receipt of the NOTIFICATION\_DATA, the anchor MSC shall forward the message to all relay MSCs except the relay MSC from which the NOTIFICATION\_DATA was received. The relay MSCs shall send the NOTIFICATION\_DATA messages with the application data to all BSSs in their MSC area involved in the group call. The BSSs shall broadcast the data to all listeners.

For the meaning of the other messages see figure 7f. The option of immediate distribution of the application-specific data by the BSC can be applied also in figure 7h, although it is not shown in the message flow (for details see figure 7f).



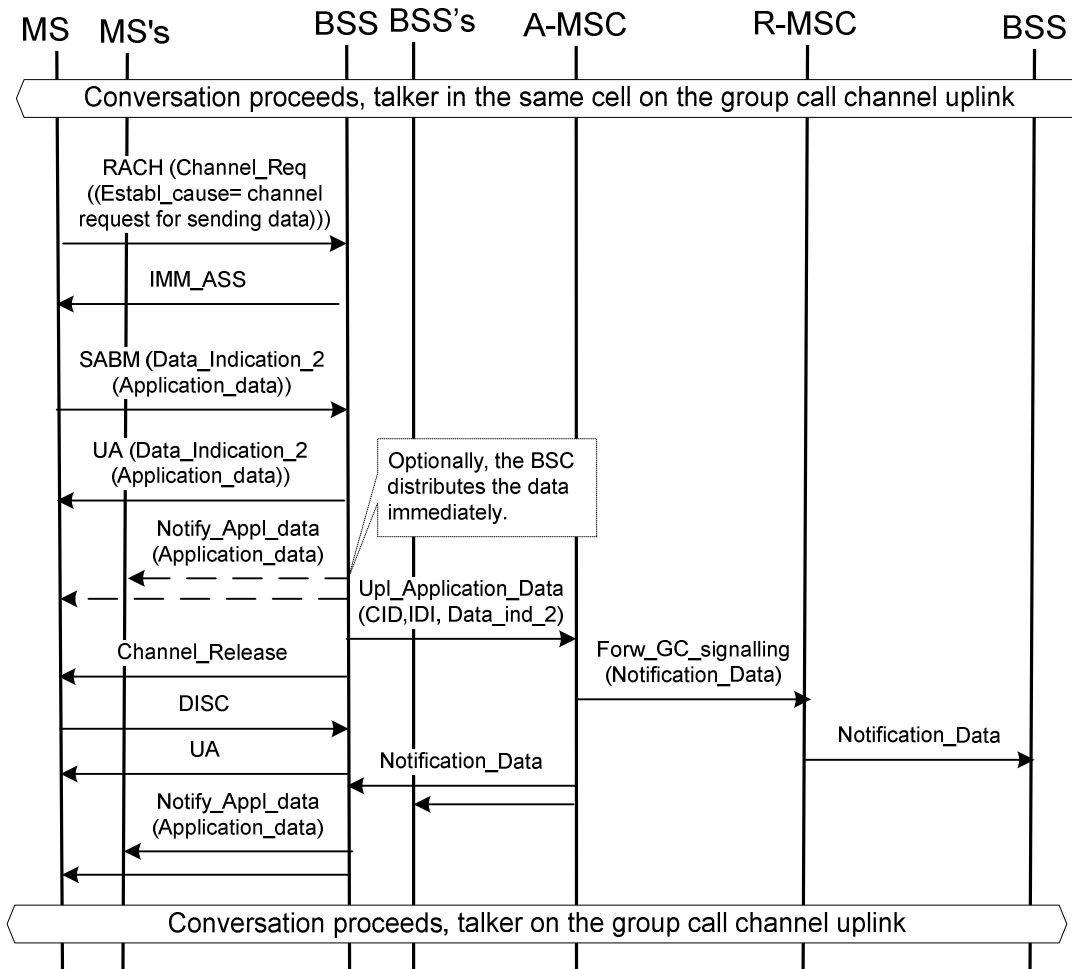
**Figure 7i: After receiving application-specific data, a service subscriber in the anchor MSC area sends a confirmation for the received data to the other group call members, while the group call channel uplink in the cell is free.**

**UPLINK\_ACCESS (Establishment\_cause=UL Request for sending application-specific data):** This message is sent on the uplink of the voice group call channel using random access procedures. The UPLINK\_ACCESS message is similar to a channel request but sent on the group call channel uplink.

**VGCS\_UPLINK\_GRANT:** The BSS grants the Uplink of its group call channel immediately. The reply to the uplink request sent on the voice group channel downlink containing information for synchronisation of the mobile station to the network and uplink access contention resolution. The VGCS\_UPLINK\_GRANT message shall therefore include a request reference (reflecting the UPLINK\_ACCESS) and the physical information required for transmission on the voice group call channel uplink.

**SABM (DATA\_INDICATION (Application\_data)):** The MS sends a SABM message with its mobile station identity and the Application\_data to the BSS. For the purpose of identifying the received data, the data\_id which was received in the message that contained the application data that is being confirmed shall be included in the message.

For the meaning of the other messages see figure 7f. The option of immediate distribution of the application-specific data by the BSC can be applied also in figure 7i, although it is not shown in the message flow (for details see figure 7f).



**Figure 7j: A listener in the anchor MSC area sends application-specific data that are not time-critical via RACH to the other group call members, while the talker is using the group call channel uplink in the same cell.**

**RACH (CHAN\_REQ):** The network supports uplink access option (i) as defined in subclause 7.2, and the talker is on the group call channel in the same cell as the mobile station of the listener; therefore, the "uplink access indication for data" in the uplink busy message instructs the mobile station to use the RACH when application-specific data is to be sent.

The mobile station leaves the group receive mode and sends the CHANNEL\_REQUEST message with an appropriate establishment cause via the RACH to request an SDCCH.

**IMM\_ASS:** Standard message sent on the AGCH.

**SABM (DATA\_INDICATION\_2 (Application\_data)):** The MS sends a SABM message with its mobile station identity and the Application\_data to the BSS on SDCCH. The network determines from the group call reference included in the message which group call is addressed by this message.

**UA (DATA\_INDICATION\_2 (Application\_data)):** This message is used to acknowledge the layer 2 link and provide contention resolution of the data indication 2.

NOTE 1: Optionally, on receipt of the UA (DATA\_INDICATION\_2 (Application\_data)) the mobile station performs a local release of the layer 2 link, i.e. without exchange of DISC/UA, and returns to group receive mode.

**NOTIFY\_APPLICATION\_DATA (Application\_data):** If the network option of immediate distribution of application-specific data by the BSC is activated, on receiving the application data sent from the MS, the BSS broadcasts the application data immediately to the cells within the BSC area in a notification message on the FACCH. Optionally, the NOTIFY\_APPLICATION\_DATA message for application-specific data is repeated on the group call

channel downlink. As a prerequisite for the immediate distribution, during the establishment phase of the voice group call the BSC stored the cell identities of the cells belonging to the group call area and served by the BSC.

**UPLINK\_APPLICATION\_DATA (CID, IDI, DATA\_INDICATION\_2):** The BSS adds the sender's cell identifier (CID) and passes the L3 information (DATA\_INDICATION\_2) via the UPLINK\_APPLICATION\_DATA message to the MSC. If the BSC has immediately distributed the application data to its BSC area, the BSC shall additionally include the Immediate Distribution Indicator (IDI).

**CHANNEL\_RELEASE:** The BSS immediately releases the uplink by sending this message to the MS on the SDCCH including the channel description of the voice group call channel to which the mobile station shall tune to. The mobile station returns to group receive mode.

NOTE 2: If the mobile station performed a local release of the layer 2 link, the following two messages will not be exchanged. Instead T3109 in the BSS will expire and the BSS will release the channel.

**DISC:** Standard message to release the layer 2 link.

**UA:** Standard message to acknowledge release of the layer 2 link. The mobile station returns to group receive mode.

**NOTIFICATION\_DATA:** The MSC sends NOTIFICATION\_DATA messages with the application data to all BSSs in their MSC area involved in the group call. If the originating BSC has immediately distributed the application data to its BSC area, the MSC shall not send the NOTIFICATION\_DATA message to the originating BSC.

**NOTIFY\_APPLICATION\_DATA (Application\_data):** The BSS broadcasts the application data to all listeners and the talker, if any, in a notification message on the FACCH. Optionally the NOTIFY\_APPLICATION\_DATA message for application-specific data is repeated on the group call channel downlink. (The broadcast of the application data by the other BSSs is not shown in figure 7j.)

For the meaning of the other messages see figure 7f.

## 11.3.9 Short Message Service (SMS)

### 11.3.9.1 Delivering SMS to the voice group call

If the talking service subscriber, the listening service subscriber, the dispatcher in a voice group call, or any initiator of short messages who is not part of the voice group call wants to send a short message to the voice group call, it shall use the numbering scheme based on ITU-T Recommendation E.164 as the destination address illustrated below.

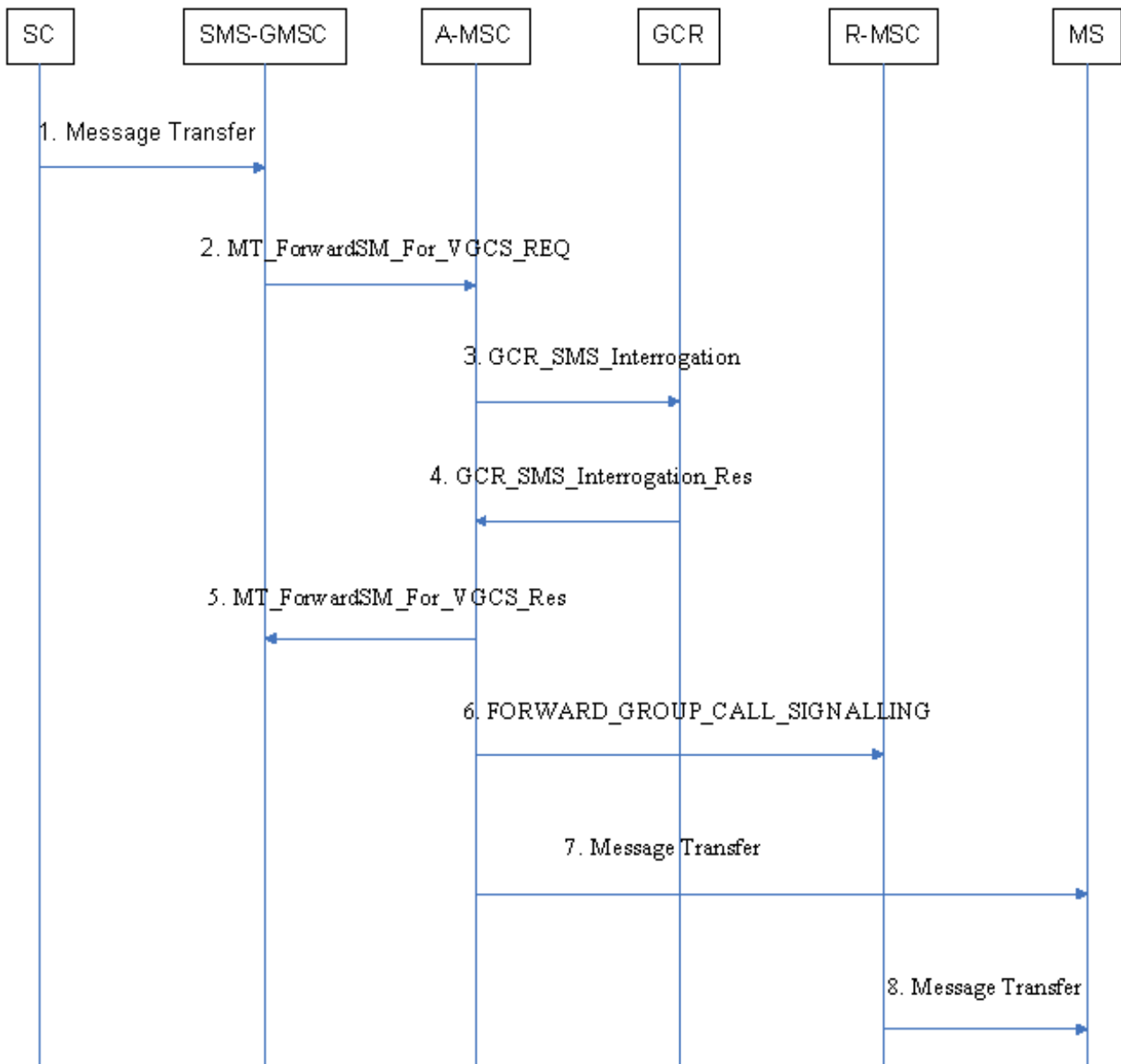
|           |            |               |                             |
|-----------|------------|---------------|-----------------------------|
| <b>CC</b> | <b>NDC</b> | <b>Prefix</b> | <b>Group call reference</b> |
|-----------|------------|---------------|-----------------------------|

The Country Code (CC) and National Destination Code (NDC) are used as normal for routing purposes. The CC and NDC may be omitted for internal SMS. The Subscriber Number (SN) is used to indicate:

- the request of an SMS to a voice group call by use of a prefix. The length of the prefix shall be 1 to 2 digits. The value of the prefix shall be the same as the value used by a dispatcher when originating the voice group call (see subclause 9.2 d);
- the wanted group call reference as defined in subclause 9.1.

When receiving the short message, the SC may send Delivery Report message containing the received group call reference of the voice group to the sender of the short message, and furthermore the SC shall attempt to deliver the short message to the voice group call addressed by the group call reference. Figure 7f shows the MT SMS delivery procedure.





**Figure 7f: Successful MT short message transfer attempt to a voice group call**

- 1) The SC sends a Message Transfer message to forward a short message to the SMS-GMSC.
- 2) The SMS-GMSC sends the MT\_ForwardSM\_For\_VGCS\_REQ message to transfer the received short message to the A-MSC using the routing information derived from the group call reference.
- 3) The A-MSC sends the GCR\_SMS\_Interrogation message to the GCR to retrieve the voice group call attributes for short message transfer.
- 4) The GCR sends the GCR\_SMS\_Interrogation\_Res message to the A-MSC containing the voice group call status and optionally the list of identities of dispatchers.
- 5) The A-MSC sends the MT\_ForwardSM\_For\_VGCS\_RES message to the SMS-GMSC containing the status of the voice group call and optionally a list of identities of dispatchers if received from the GCR. Optionally, if the voice group call is currently ongoing, the SMS-GMSC may initiate point to point short message transfer attempts to the dispatchers of the voice group call.
- 6) If the voice group call is established, the A-MSC sends the FORWARD\_GROUP\_CALL\_SIGNALLING message to deliver the short message to all related R-MSCs in the voice group call.
- 7) If the voice group call is established, the A-MSC sends Message Transfer message to deliver the short message to the MSs participating in the voice group call within its MSC area.

- 8) If the voice group call is established, the R-MSCs sends Message Transfer message to deliver the short message to the MSs participating in the voice group call within its MSC area.

### 11.3.9.2 Point-to-point short message during an ongoing voice group call

In this subclause the term point-to-point short message is used for mobile terminating short messages destined to a single subscriber and for mobile originating short messages, regardless whether their final destination is a single subscriber or a voice group call.

For the transmission and reception of point-to-point short messages via CS domain during an ongoing voice group call, an MS and a network supporting this functionality shall apply the procedures specified in 3GPP TS 23.040 [14] and 3GPP TS 24.011 [15] as follows:

- a) When the talking service subscriber is on a dedicated channel, point-to-point short messages to be sent or received via the CS domain shall be transmitted on the SACCH of the dedicated channel. If the talking service subscriber requests to release the uplink while a short message transfer is ongoing, the MS shall initiate the release of the uplink and abort the transfer of the short message.
- b) When the talking service subscriber is on a voice group call channel, the MS shall send mobile originating short messages via the CS domain on the SACCH of the voice group call channel, if at least one of the following conditions is fulfilled:
- the short message is destined to the ongoing voice group call of the talker;
  - the network broadcasts neither an SMS data confidentiality indication nor an SMS guaranteed privacy indication on the NCH; or
  - the network broadcasts an SMS data confidentiality indication, but no SMS guaranteed privacy indication on the NCH, and the voice group call channel is ciphered.

Otherwise the MS shall leave the voice group call, send the short message as specified in 3GPP TS 24.011 [15] and return to the group call in group receive mode afterwards, if possible.

If the talking service subscriber requests to release the uplink while a short message transfer on the voice group call channel is ongoing, the MS shall initiate the release of the uplink and abort the transfer of the short message.

- c) When the talking service subscriber is on a voice group call channel, the network may deliver mobile terminating point-to-point short messages via the CS domain on the SACCH of the voice group call channel, if at least one of the following conditions is fulfilled:
- the network does not broadcast an SMS data confidentiality indication on the NCH; or
  - the network broadcasts an SMS data confidentiality indication on the NCH, and the voice group call channel is ciphered.

Otherwise the network shall perform paging into the ongoing voice group call as described in subclause 11.3.1.3 c). The paging information on the FACCH of the voice group call channel shall indicate explicitly that the paging is for a short message. When the paging is received in group transmit mode, the reception of the paging shall be indicated to the subscriber. It is then up to the subscriber to respond to the paging or not. On request of the subscriber to respond to the paging, the MS in group transmit mode shall release the uplink, leave the voice group call, receive the short message as specified in 3GPP TS 24.011 [15], and return to the group call in group receive mode afterwards, if possible.

If the talking service subscriber requests to release the uplink while a short message transfer on the voice group call channel is ongoing, the MS shall initiate the release of the uplink and abort the transfer of the short message.

- d) If an MS on a voice group call channel is not the endpoint of the layer 2 link for acknowledged message transfer, it shall ignore point-to-point short messages received on the SACCH of the voice group call channel.
- e) On request of a listening service subscriber to send a point-to-point short message, the MS in group receive mode shall leave the voice group call, send the short message as specified in 3GPP TS 24.011 [15], and return to the group call in group receive mode afterwards, if possible.

For the delivery of a point-to-point short message to a listening service subscriber, the network shall perform paging into ongoing voice group calls by means of the notification procedure as described in subclause 11.3.1.3. The notification messages on the FACCH of the voice group call channel shall indicate explicitly that the paging is for a short message. When the paging is received in group receive mode, the reception of the paging shall be indicated to the subscriber. It is then up to the subscriber to respond to the paging or not. On request of the subscriber to respond to the paging, the MS in group receive mode shall leave the voice group call, receive the short message as specified in 3GPP TS 24.011 [15], and return to the group call in group receive mode afterwards, if possible.

For the transmission and reception of point-to-point short messages via PS domain during an ongoing voice group call, class A mobile stations supporting this functionality shall apply the procedures specified in 3GPP TS 23.040 [14] and 3GPP TS 24.011 [15].

**Editor's note: For DTM mobile stations the transmission and reception of point-to-point short messages via PS domain during an ongoing voice group call is ffs.**

## 11.4 Functional requirement of Anchor MSC

The VGCS handling process in the anchor MSC is shown in figure 8.

### Successful call set-up

When the VGCS handling process in the anchor MSC receives a VGCS call set-up request from either a dispatcher or a service subscriber currently located in the anchor MSC's area or a service subscriber currently located in a relay MSC's area, or - in a RANflex configuration - from a service subscriber currently registered in a VMSC, it interrogates its associated GCR to retrieve the group call attributes, and waits for a response.

If the GCR returns a positive response containing the group call attributes, the anchor MSC

sets up the downlinks to the cells inside the MSC area of the group call anchor MSC into which the call is to be sent.; If the "talker channel parameter" is used, the anchor MSC shall additionally send the parameter to the affected BSCs;

sets up the connections to the dispatchers to which a dedicated link is to be established;

sets up the connections to the relay MSCs into which the call is to be sent;

starts the No Activity Timer;

sends Forward Group Call Signalling messages containing the IMSI of the service subscriber who has initiated the call - if the call was not initiated by a dispatcher - to all relay MSCs (however not to the relay MSC from which the IMSI was received within the Send Group Call End Signal message if the call was initiated by a service subscriber located in the relay MSC area). In a RANflex configuration simultaneous group call setup of two service subscribers may result in two Send Group Call End Signal messages being received by the anchor MSC from two different relay MSCs, with both messages containing an IMSI. In this situation the anchor MSC shall discard the IMSI received from the relay MSC whose MSC address does not match the CLI from the IAM received and accepted from the originating MSC). If the network supports talker priorities, the anchor MSC includes the talker priority of the service subscriber who has initiated the call in the Forward Group Call Signalling messages; and

waits for uplink management messages.

### Procedure Set-up Connections to Relay MSCs and BSCs

The procedure is shown in figure 9.

The procedure

- sets up the downlinks to the cells inside the MSC area of the group call anchor MSC into which the call is to be sent. If the network supports talker priorities, the anchor MSC additionally sends the talker priority of the service subscriber who has initiated the call and, if applicable, the "emergency mode indication" with Uplink Seized Command messages" to the affected BSCs;
- sends PREPARE\_GROUP\_CALL messages to all relay MSCs and waits for the responses. If the "talker channel parameter" is used, the anchor MSC shall include this parameter in the PREPARE\_GROUP\_CALL messages.

If a positive response containing a Group Call number is received from a relay MSC, the anchor MSC constructs an IAM using the Group Call number as called party address, sends it to the relay MSC and waits for the SEND\_GROUP\_CALL\_END\_SIGNAL message.

If a SEND\_GROUP\_CALL\_END\_SIGNAL message without IMSI is received from a relay MSC, this indicates to the anchor MSC that at least one downlink to a cell has been successfully connected in the relay MSC area.

If the call was originated by a service subscriber in a relay MSC area and a SEND\_GROUP\_CALL\_END\_SIGNAL message with the IMSI of the originator is received from this relay MSC, this indicates to the anchor MSC that the downlink to the originating cell has been successfully connected. If the negative response on the PREPARE\_GROUP\_CALL message is received from originating relay MSC, the call shall be released.

Relay MSCs that do not send positive responses to the PREPARE\_GROUP\_CALL message are no longer considered to belong to the list of relay MSCs for this VGCS call.

If, after receipt of a positive response containing a Group Call number from a relay MSC, the anchor MSC receives an ABORT from the relay MSC, the relay MSC will no longer be considered to belong to the list of relay MSCs for this VGCS call.

Optionally in both cases the anchor MSC may retry to establish the connection to the relay MSC, instead of no longer considering the relay MSC to belong to the list of relay MSCs.

If an ABORT message is received from the relay MSC the anchor MSC releases the connection, established with the Group Call number, to the relay MSC and the relay MSC is no longer considered to belong to the list of relay MSCs for this VGCS call.

If a Release message for the connection established with the Group Call number is received from a relay MSC, then the anchor MSC sends an ABORT message to that relay MSC and the relay MSC is no longer considered to belong to the list of relay MSCs for this VGCS call.

#### **Unsuccessful call set-up**

If the call set-up is unsuccessful (i.e. conditions for call establishment have not been met as per subclause 11.3.1.1.2) the anchor MSC sends a SEND\_GROUP\_CALL\_END\_SIGNAL\_ACK message or ABORT (depending on the state of the MAP dialogue) to all relay MSCs, releases the connections to the relay MSCs, releases all connections to dispatchers, all downlinks to cells inside the anchor MSC area are released, the GCR is informed that the call is no longer on-going and the process returns to the idle state.

#### **Negative response received from the GCR**

If the GCR returns a negative response to the anchor MSC indicating that the call is already on-going, the anchor MSC checks whether the call was initiated by a dispatcher. If so, the dispatcher is connected to the on-going call and the process returns to the idle state. If the call was initiated by a service subscriber, a Release message indicating "user busy" is returned in order to force the mobile station of the service subscriber to look for notifications of the respective group ID on the NCH and join the group call.

If the negative response from the GCR indicates any other reason than "on-going call" the VGCS call set-up request is rejected by sending a release message back to the initiator and the process returns to the idle state.

#### **Uplink management**

If an anchor MSC not supporting talker priorities receives an Uplink Release Indication message from a BSC, the anchor MSC marks the uplink as free, sends Forward Group Call Signalling messages indicating "uplink release indication" to all relay MSCs, sends Uplink Release command messages to all other BSCs, restarts the No Activity Timer and waits for further uplink management messages.

If an anchor MSC supporting talker priorities receives an Uplink Release Indication message from a BSC, the anchor MSC compares the talker priority included in the Uplink Release Indication with the stored talker priority. If they are equal, the anchor MSC proceeds as specified above for the anchor MSC not supporting talker priorities; otherwise the anchor MSC discards the Uplink Release Indication.

If the anchor MSC receives an Uplink Request message without talker priority or with talker priority "normal subscriber" from a BSC, it checks whether the uplink is marked as free. If so, an Uplink Request Acknowledge message is returned to the BSC, Forward Group Call Signalling messages indicating that the uplink is no longer free are sent to all relay MSCs, Uplink Seized Command messages are sent to all other BSCs, the uplink is marked busy and the

process waits for further uplink management messages. If the uplink was not free when receiving the Uplink Request message, the request is rejected.

If an anchor MSC supporting talker priorities receives an Uplink Request message with a talker priority higher than "normal subscriber" from a BSC, and the uplink is free or it was seized by the current talker with a lower talker priority, the anchor MSC checks whether the subscriber has the subscription for the requested talker priority for this group ID. In a RANflex configuration this check may require retrieval of information from the visited MSC/VLR by means of the MAP service SEND\_GROUP\_CALL\_INFO. If so, the anchor MSC:

- stores the received data;
- sends Forward Group Call Signalling messages indicating "uplink seized command" with the requested talker priority to the relay MSCs;
- returns an Uplink Request Acknowledge message with the requested talker priority to the BSC which has requested the uplink;
- sends Uplink Seized Command messages with the requested talker priority to all other BSCs;
- releases the current talker by sending a Clear Command message, if the talker is on a dedicated channel and is located in the anchor MSC;
- marks the uplink busy; and
- waits for further uplink management messages.

Additionally,

- if the requested talker priority is "emergency subscriber", the anchor MSC sets the emergency mode and includes the "emergency mode indication" in the Uplink Request Acknowledge message and the Uplink Seized Command messages; furthermore the anchor MSC alerts all active dispatchers with an appropriate emergency indication (e.g. in-band tone or announcement); furthermore the anchor MSC alerts all inactive dispatchers by setting up dedicated connections with an appropriate emergency indication (e.g. special CLI prefix or postfix, and in-band tone or announcement) and connects the dispatchers to the voice group call.
- if the anchor MSC supports the transmission of additional subscriber-related information, it interrogates the VLR to get the "additional information" assigned to the new talker. In a RANflex configuration this may require retrieval of information from the visited MSC/VLR by means of the MAP service SEND\_GROUP\_CALL\_INFO. If "additional information" is available, the anchor MSC includes the "additional information" in the Forward Group Call Signalling messages indicating "uplink seized command" to all relay MSCs and sends VGCS Additional Info messages to all BSCs involved in the call and connected to the anchor MSC. Furthermore, the anchor MSC sends a VGCS Additional Info message on the dedicated connection to the BSC serving the current talker, before it releases the current talker.

If an anchor MSC supporting talker priorities receives an Uplink Request message with a talker priority higher than "normal subscriber" from a BSC, and the uplink was seized by the current talker with the same or a higher talker priority, then the anchor MSC sends an Uplink Reject Command message with the current talker priority to the BSC.

If the anchor MSC receives an Uplink Request Confirm message from a BSC, it stores the received data and waits for further uplink management messages. Additionally, if the anchor MSC supports the transmission of additional subscriber-related information, it interrogates the VLR to get the "additional information" assigned to the subscriber. In a RANflex configuration this interrogation may require retrieval of information from the visited MSC/VLR by means of the MAP service SEND\_GROUP\_CALL\_INFO. If "additional information" is available, the relay MSC sends VGCS Additional Info messages to all BSCs involved in the call and connected to this relay MSC, and Forward Group Call Signalling messages with the additional info to all relay MSCs.

If an anchor MSC supporting talker priorities receives an Emergency Reset Indication from a BSC and the subscription check is successful, the anchor MSC resets the emergency mode, sends Emergency Reset Command messages to all BSCs involved in the call and connected to the anchor MSC, and Forward Group Call Signalling messages indicating "emergency reset command" to all relay MSCs. If the talker priority at receipt of the Emergency Reset Indication is "emergency subscriber", then it is changed in the anchor MSC to "normal subscriber"; furthermore the anchor MSC alerts all active dispatchers with an appropriate emergency indication (e.g. in-band tone or announcement); furthermore the anchor MSC alerts all inactive dispatchers by setting up dedicated connections with an appropriate emergency indication (e.g. special CLI prefix or postfix, and in-band tone or announcement) and connects the dispatchers to the voice group call.

If an anchor MSC not supporting talker priorities receives a Process Group Call Signalling message indicating "uplink release indication" from a relay MSC, the anchor MSC marks the uplink as free, sends Forward Group Call Signalling messages indicating "uplink release indication" to all other relay MSCs, sends Uplink Release command messages to all BSCs, restarts the No Activity Timer and waits for further uplink management messages. If there is a dedicated connection for the talking service subscriber between the relay MSC and the anchor MSC, the anchor MSC shall release this connection with cause 'normal, unspecified'.

If an anchor MSC supporting talker priorities receives a Process Group Call Signalling message indicating "uplink release indication" from a relay MSC, the anchor MSC compares the talker priority included in the Process Group Call Signalling message with the stored talker priority. If they are equal, the anchor MSC proceeds as specified above for the anchor MSC not supporting talker priorities; otherwise the anchor MSC discards the Process Group Call Signalling message.

If the anchor MSC receives a Process Group Call Signalling message from a relay MSC indicating "uplink request" without talker priority or with talker priority "normal subscriber", it checks whether the uplink is marked as free. If so, a Forward Group Call Signalling message indicating "uplink request acknowledgement" is returned to the relay MSC, Forward Group Call Signalling messages indicating that the uplink is no longer free are sent to all other relay MSCs, Uplink Seized Command messages are sent to all BSCs, the uplink is marked busy and the process waits for further uplink management messages. If the uplink was not free when receiving the Process Group Call Signalling message (Uplink Request), the request is rejected.

If an anchor MSC supporting talker priorities receives a Process Group Call Signalling message from a relay MSC indicating "uplink request" with a talker priority higher than "normal subscriber", and the uplink is free or it was seized by the current talker with a lower talker priority, then the anchor MSC:

- returns a Forward Group Call Signalling message indicating "uplink request acknowledgement" with the requested talker priority to the relay MSC;
- sends Forward Group Call Signalling messages indicating "uplink seized command" and the requested talker priority to all other relay MSCs;
- sends Uplink Seized Command messages with the requested talker priority to all BSSs involved in the call;
- releases the current talker by sending a Clear Command message, if the talker is on a dedicated channel and is located in the anchor MSC;
- marks the uplink as busy; and
- waits for further uplink management messages.

Additionally,

- if the requested talker priority in the Process Group Call Signalling message from the relay MSC is "emergency subscriber", the anchor MSC sets the emergency mode and includes the "emergency mode indication" in the Uplink Seized Command messages; furthermore the anchor MSC alerts all active dispatchers with an appropriate emergency indication (e.g. in-band tone or announcement); furthermore the anchor MSC alerts all inactive dispatchers by setting up dedicated connections with an appropriate emergency indication (e.g. special CLI prefix or postfix, and in-band tone or announcement) and connects the dispatchers to the voice group call.
- if "additional information" about the new talker was included in the Process Group Call Signalling message from the relay MSC, the anchor MSC includes the "additional information" in the Forward Group Call Signalling messages indicating "uplink seized command" to all other relay MSCs and sends VGCS Additional Info messages to all BSCs involved in the call and connected to the anchor MSC. Furthermore, the anchor MSC sends a VGCS Additional Info message on the dedicated connection to the BSC serving the current talker, before it releases the current talker.

If an anchor MSC supporting talker priorities receives a Process Group Call Signalling message from a relay MSC indicating "uplink request" with a talker priority higher than "normal subscriber", and the uplink was seized by the current talker with the same or a higher talker priority, then the anchor MSC returns a Forward Group Call Signalling message indicating "uplink reject command" with the current talker priority to the relay MSC.

If the anchor MSC receives a Process Group Call Signalling message with "additional info" from a relay MSC, the anchor MSC sends VGCS Additional Info messages to all BSCs involved in the group call and connected to the anchor MSC, and Forward Group Call Signalling messages with "additional info" to all other relay MSCs.

If an anchor MSC supporting talker priorities receives a Process Group Call Signalling message with "emergency mode reset command" from a relay MSC, the anchor MSC resets the emergency mode, sends Forward Group Call Signalling messages with "emergency mode reset command" to all other relay MSCs, and sends Emergency Reset Command messages to all BSCs involved in the call and connected to the anchor MSC. If the talker priority at receipt of the "emergency mode reset command" is "emergency subscriber", then it is changed in the anchor MSC to "normal subscriber"; furthermore the anchor MSC alerts all active dispatchers with an appropriate emergency indication (e.g. in-band tone or announcement); furthermore the anchor MSC alerts all inactive dispatchers by setting up dedicated connections with an appropriate emergency indication (e.g. special CLI prefix or postfix, and in-band tone or announcement) and connects the dispatchers to the voice group call.

If the anchor MSC receives an ABORT message from a relay MSC, the connection to the relay MSC is released and the relay MSC is no longer considered to be part of the call.

### Call release

If the anchor MSC receives the specific DTMF message sequence or the specific DTMF tone sequence for call termination from an entitled dispatcher (see figures 7b to 7d) or a Termination Request message from the initiating service subscriber who currently has access to the uplink, it sends Send Group Call End Signal ACK messages to all relay MSCs, sends Release messages to all relay MSCs, sends Release messages to all dispatchers and BSCs, informs the GCR that the call is no longer on-going and the process returns to the idle state. If the group call termination is initiated by an entitled dispatcher, and there is a dedicated connection for the talking service subscriber between the anchor MSC and the relay MSC, the anchor MSC shall release this connection with cause 'normal call clearing'.

If the anchor MSC receives a Process Group Call Signalling message from a relay MSC indicating "release group call" or an ISUP Release message from a relay MSC indicating "Normal call clearing" for the calling service subscriber's dedicated connection to the anchor MSC, then the anchor MSC sends Send Group Call End Signal ACK messages to all relay MSCs, sends Release messages to all relay MSCs, sends Release messages to all dispatchers and BSCs, informs the GCR that the call is no longer on-going and the process returns to the idle state.

If the anchor MSC receives an ISUP Release message from a relay MSC with cause value other than "Normal call clearing" for the calling service subscribers dedicated connection to the anchor MSC, then the anchor MSC shall send Uplink Release Command messages to all BSCs and Forward Group Call Signalling messages with Uplink Release Indication parameter to all relay MSCs.

If the no activity time in the anchor MSC expires, i.e. "no activity" (as specified in subclause 8.1.2.3) has been detected for the time specified in the GCR, the anchor MSC sends Send Group Call End Signal ACK messages to all relay MSCs, sends Release messages to all relay MSCs, sends Release messages to all dispatchers and BSCs, informs the GCR that the call is no longer on-going and the process returns to the idle state.

### SM MT delivery

When the VGCS handling process in the A-MSC receives an MT\_ForwardSM\_for\_VGCS\_REQ message from a SMS-GMSC, the A-MSC shall interrogate the GCR to retrieve the group call attributes for short message transfer. The A-MSC shall deliver to the SMS-GMSC the status of the voice group call and optionally a list of identities of dispatchers within the MT\_ForwardSM\_for\_VGCS\_RES message.

If the voice group call is established, the A-MSC shall distribute the short message TPDU to all connected relay MSCs using the FORWARD\_GROUP\_CALL\_SIGNALLING message and shall deliver the short message to the relevant cells using the already established downlink channel for the voice group call.

If the voice group call is not established, the A-MSC shall discard the short message TPDU.

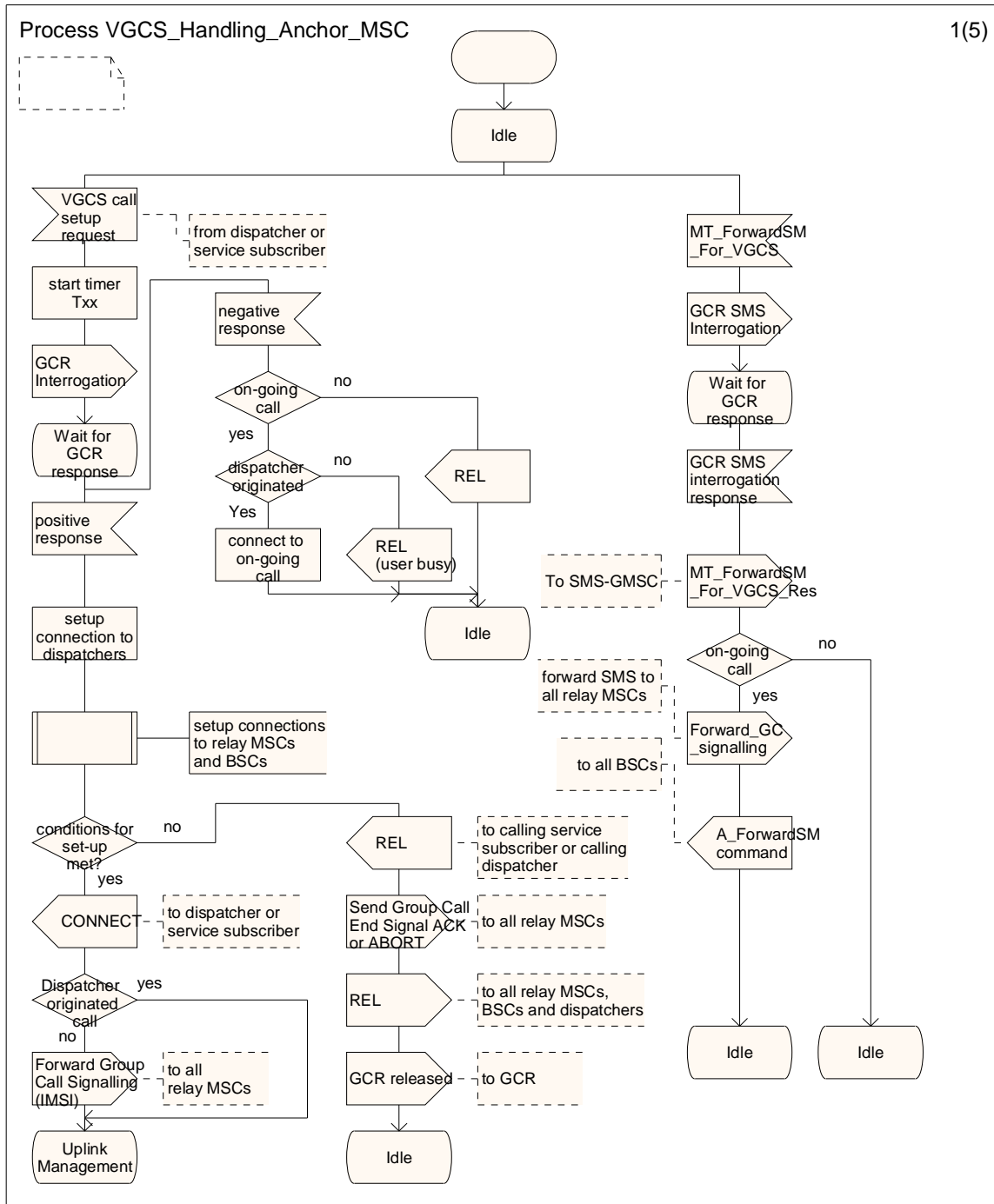


Figure 8: The VGCS handling process in the anchor MSC (sheet 1 of 5)



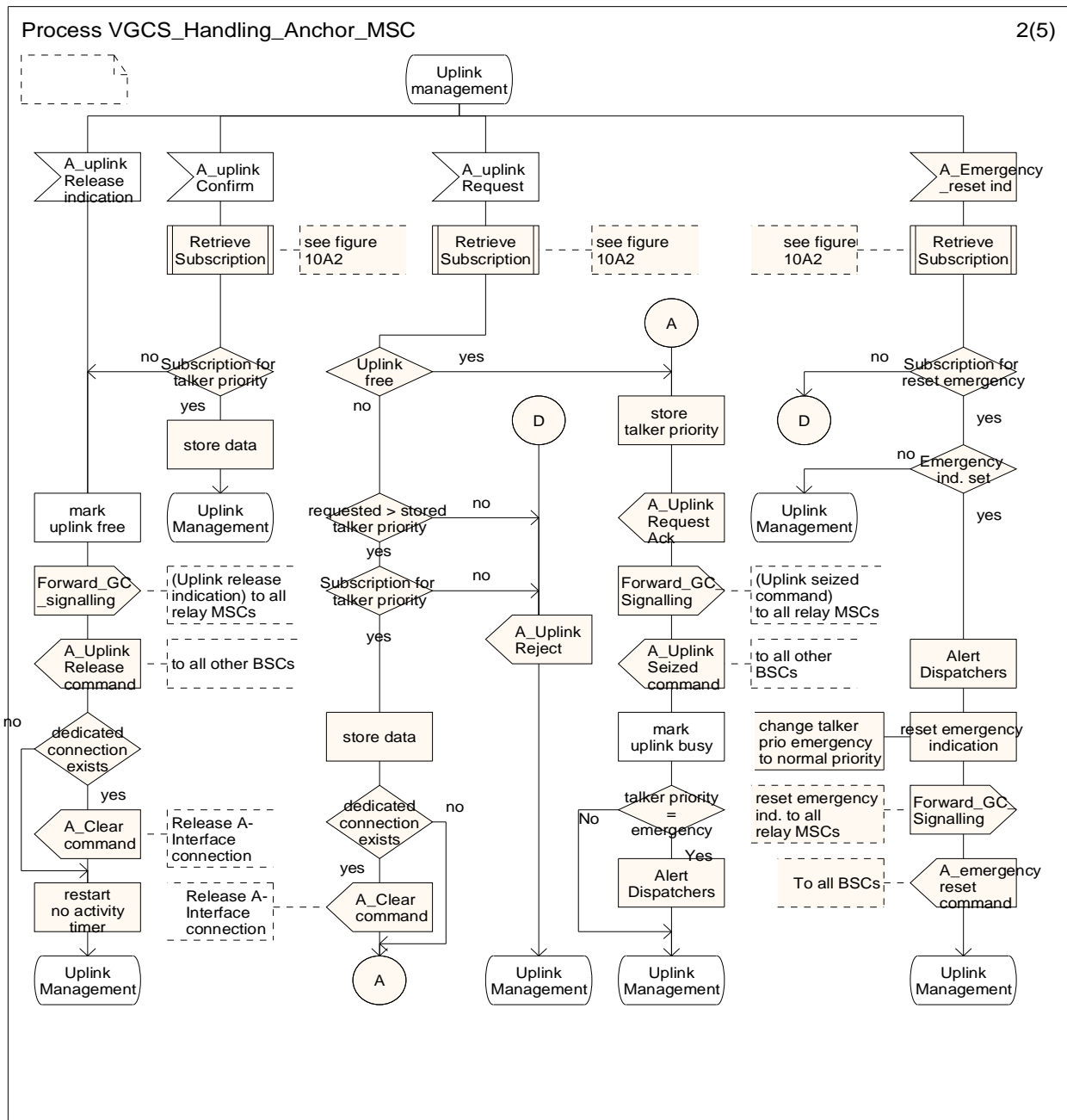


Figure 8: The VGCS handling process in the anchor MSC (sheet 2 of 5)

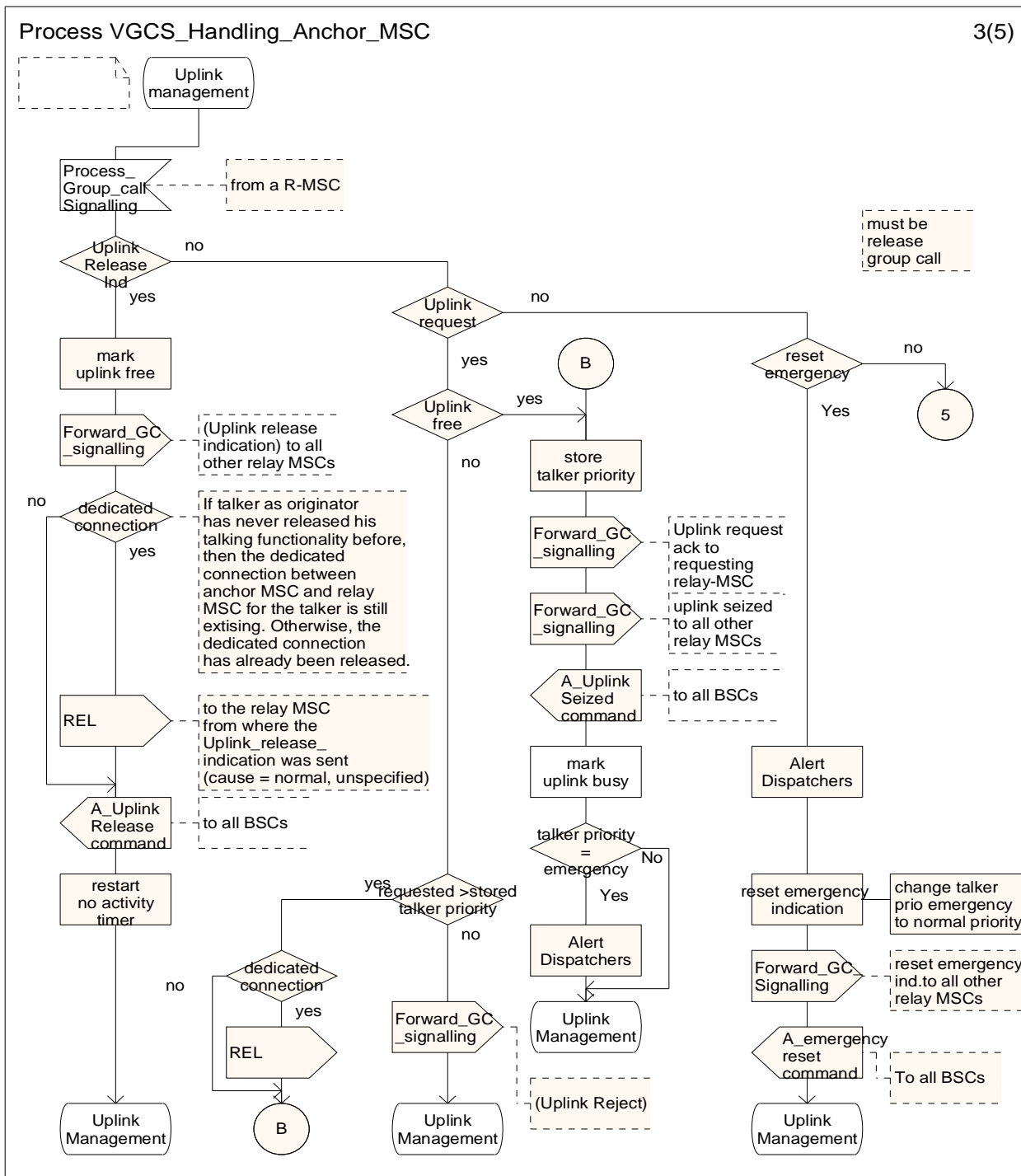


Figure 8: The VGCS handling process in the anchor MSC (sheet 3 of 5)

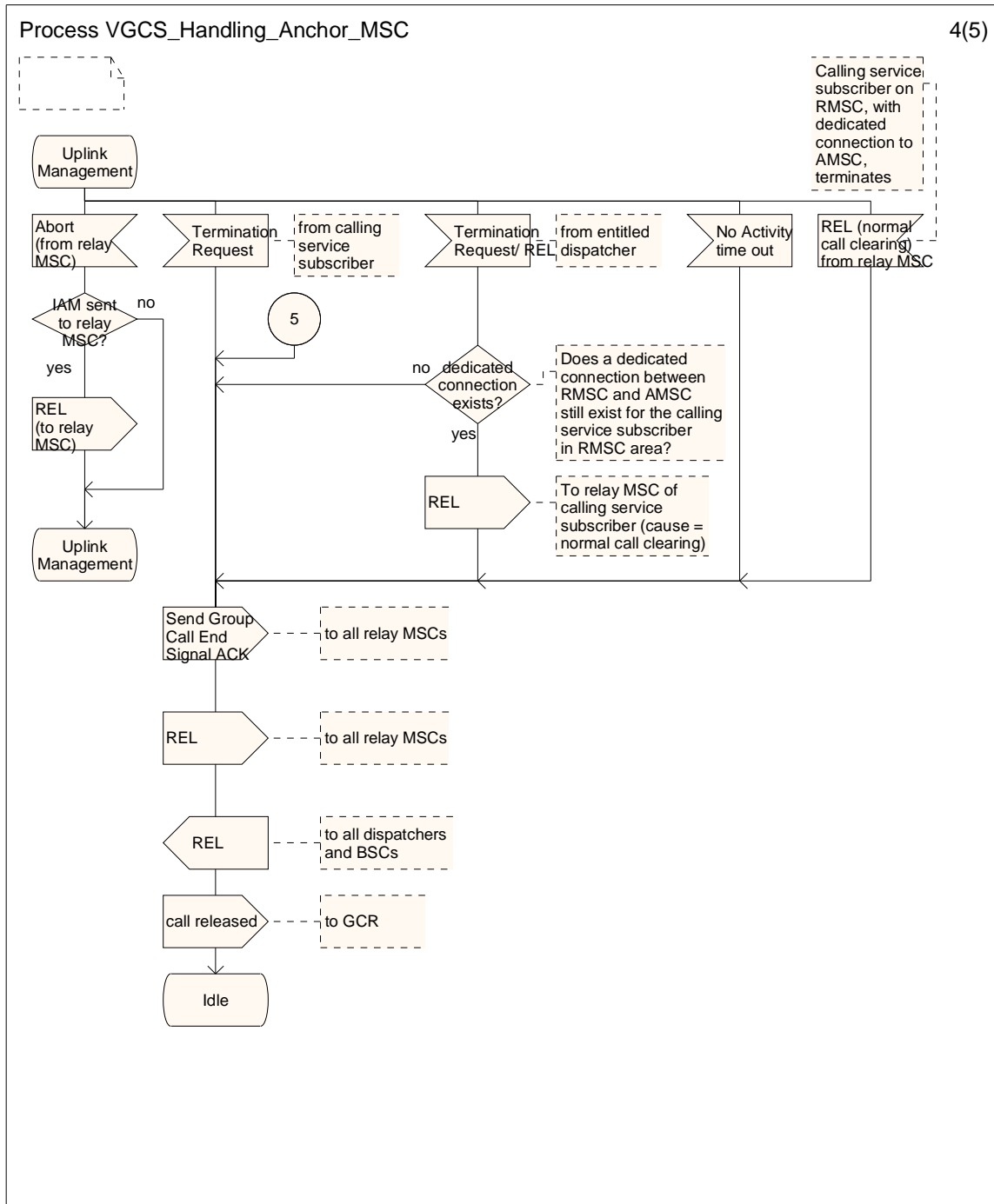


Figure 8: The VGCS handling process in the anchor MSC (sheet 4 of 5)

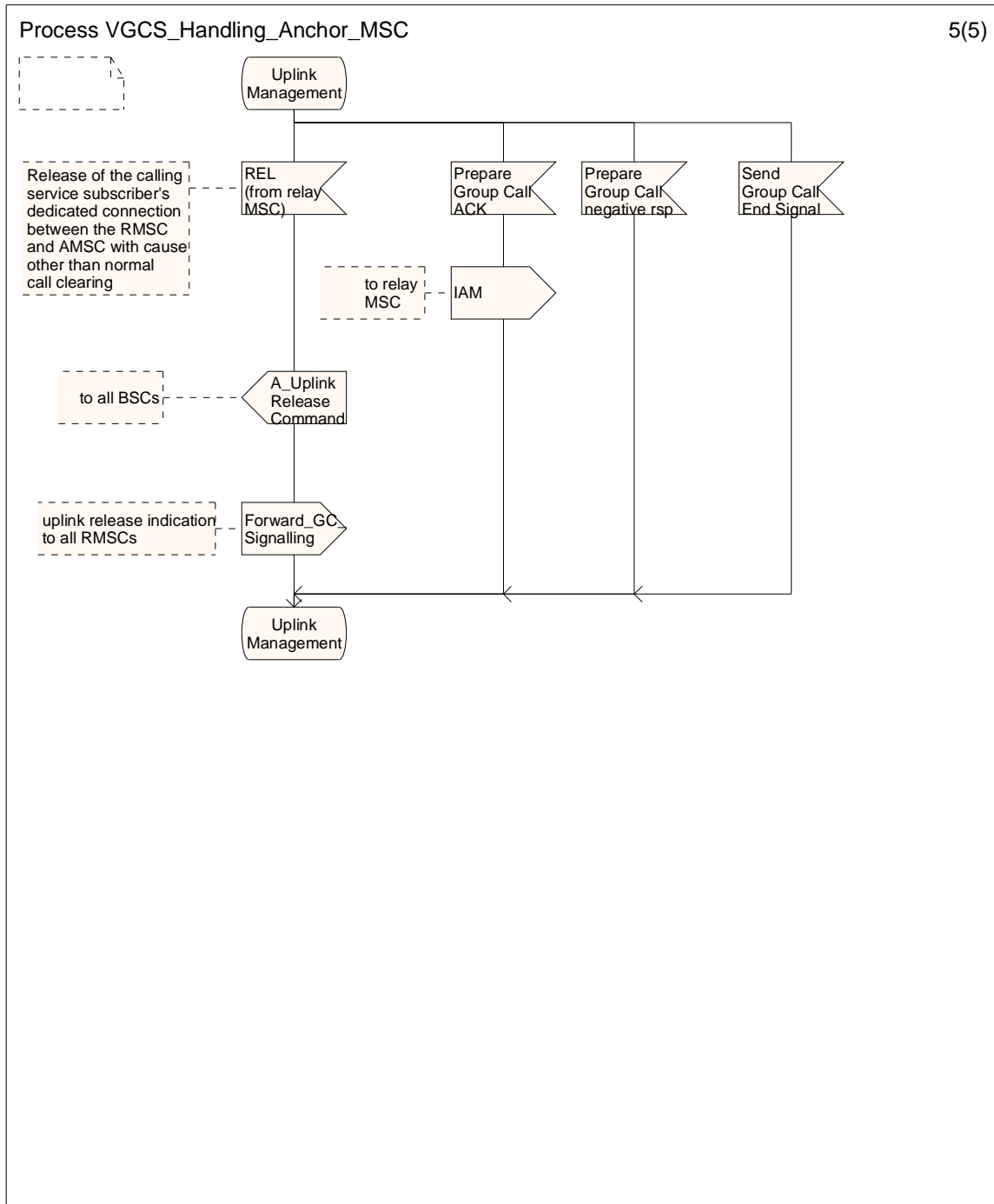


Figure 8: The VGCS handling process in the anchor MSC (sheet 5 of 5)

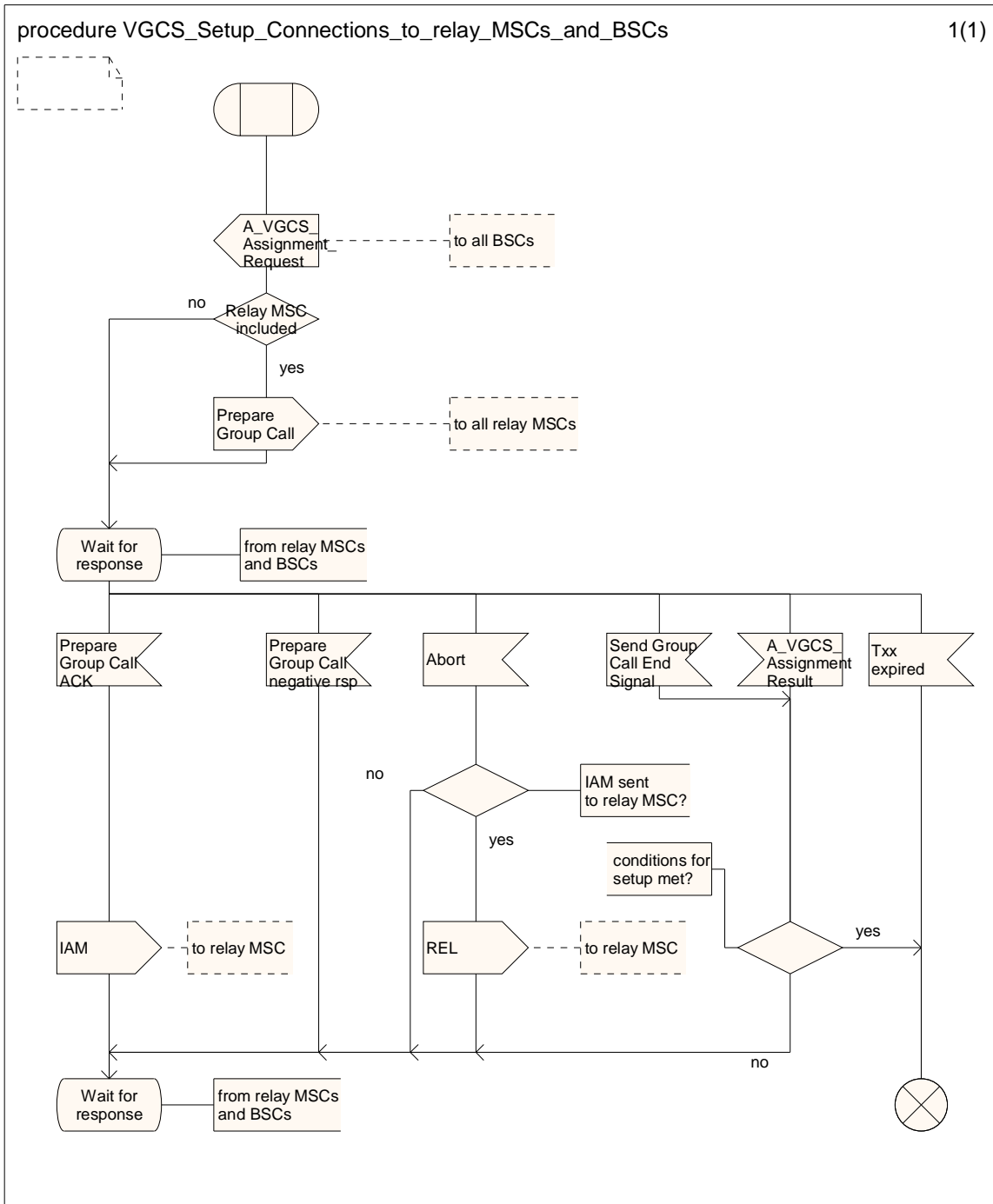


Figure 9: Procedure Set-up Connections to Relay MSCs and BSCs (sheet 1 of 1)

## 11.5 Functional requirement of Relay MSC

The VGCS handling process in the relay MSC is shown in figure 10.

### Successful call set-up initiated by a service subscriber

When the VGCS handling process in the relay MSC receives a VGCS call set-up request from a service subscriber currently located in a relay MSC's area, it interrogates its associated GCR to retrieve the anchor MSC address and waits for a response.

If the GCR returns a positive response containing the anchor MSC address, the relay MSC sets up a dedicated connection for the initiating service subscriber to the anchor MSC by constructing an IAM with CLI set to the address of this relay MSC, sending it to the anchor MSC, and waits for call release.

### Negative response received from the GCR

If the GCR returns a negative response to the relay MSC indicating that the call is already on-going, the relay MSC sends a Release message indicating "user busy" to the service subscriber in order to force the mobile station of the service subscriber to look for notifications of the respective group ID on the NCH and join the group call.

If the negative response from the GCR indicates any other reason than "on-going call" the VGCS call set-up request is rejected by sending a release message back to the initiator and the process returns to the idle state.

### Successful call set-up initiated by the anchor MSC

When the VGCS handling process in the relay MSC receives a PREPARE\_GROUP\_CALL message from the anchor MSC, it interrogates its associated GCR to retrieve the list of cells inside the relay MSC area into which the call is to be sent.

If the GCR returns a positive response, the relay MSC requests a Group Call number from its VLR.

If the VLR returns a Group Call number, a PREPARE\_GROUP\_CALL acknowledgement containing the Group Call number is returned to the anchor MSC and the relay MSC waits for the incoming call.

If the incoming call identified by the Group Call number is received, the relay MSC releases the Group Call number and sets up the downlinks to the cells inside the relay MSC area into which the call is to be sent.

If the "talker channel parameter" is used, the relay MSC shall additionally send the parameter to the affected BSCs

If the network supports talker priorities and the group call was initiated by a service subscriber currently located in the relay MSC's area, then the relay MSC additionally sends the talker priority of the service subscriber who has initiated the call and, if applicable, the "emergency mode indication" with Uplink Seized Command messages to the affected BSCs.

If the group call was initiated by a service subscriber currently located in the relay MSC's area, then the relay MSC shall send a SEND\_GROUP\_CALL\_END\_SIGNAL message, including the IMSI of the service subscriber, to the anchor MSC when the downlink has been set up successfully to the originating cell. Additionally, if the network supports talker priorities, the relay MSC includes the talker priority of the service subscriber in the SEND\_GROUP\_CALL\_END\_SIGNAL message.

If the call was not originated by a service subscriber from the relay MSC area, the relay MSC shall send a SEND\_GROUP\_CALL\_END\_SIGNAL message without IMSI information element to the anchor MSC as soon as a downlink has been set up successfully to any cell.

Then the relay MSC waits for uplink management messages.

### Negative response received from the GCR II

If the GCR returns a negative response to the relay MSC, the relay MSC returns a PREPARE\_GROUP\_CALL negative response to the anchor MSC and returns to the idle state.

### No Group Call number received from VLR

If the VLR could not allocate a Group Call number, the relay MSC returns a PREPARE\_GROUP\_CALL negative response to the anchor MSC, informs the GCR that the call is no longer on-going and returns to the idle state.

### **Abort received from VLR**

If the VLR indicates that the Group Call number supervision timer has expired, the relay MSC sends an ABORT message to the anchor MSC, informs the GCR that the call is no longer on-going and returns to the idle state.

### **Abort received from Anchor MSC**

If, after returning a PREPARE\_GROUP\_CALL acknowledgement containing the Group Call number, an ABORT is received from the anchor MSC the relay MSC releases the Group Call number, informs the GCR that the call is no longer on-going and returns to the idle state.

### **Abort initiated by Relay MSC**

The relay MSC may Abort the dialogue by sending an ABORT message to the anchor MSC (e.g. if the relay MSC fails to establish any downlinks in its area). The relay MSC also releases any resources, informs the GCR that the call is no longer on-going and returns to the idle state.

### **Unsuccessful call set-up**

Unsuccessful call set-up is determined in the anchor MSC (as per subclause 11.3.1.1.2). The relay MSC follows the procedures specified for "Abort received from Anchor MSC" and "Call release".

### **Uplink management**

If a relay MSC not supporting talker priorities receives an Uplink Release Indication message from a BSC, the relay MSC marks the uplink as free, sends a Process Group Call Signalling message indicating "uplink release indication" to the anchor MSC, sends Uplink Release Command messages to all other BSCs, and waits for further uplink management messages.

NOTE: If there is a dedicated connection for the talking service subscriber between the relay MSC and the anchor MSC, the anchor MSC will release this connection with cause 'normal, unspecified'.

If a relay MSC supporting talker priorities receives an Uplink Release Indication message from a BSC, the relay MSC compares the talker priority included in the Uplink Release Indication with the stored talker priority. If they are equal, the relay MSC proceeds as specified above for the relay MSC not supporting talker priorities, except that it includes the talker priority in the Process Group Call Signalling message to the anchor MSC; otherwise the relay MSC discards the Uplink Release Indication.

If the relay MSC receives an Uplink Request message without talker priority or with talker priority "normal subscriber" from a BSC, the relay MSC checks whether the uplink is marked as free. If so, a Process Group Call Signalling message indicating "uplink request" is sent to the anchor MSC, Uplink Seized Command messages are sent to all other BSCs, the uplink is marked busy and the process waits for further uplink management messages. If the uplink was not free when receiving the Uplink Request, the request is rejected.

If a relay MSC supporting talker priorities receives an Uplink Request message with a talker priority higher than "normal subscriber" from a BSC and the uplink is free or it was seized by the current talker with a lower talker priority, the relay MSC checks whether the subscriber has the subscription for the requested talker priority for that group ID. In a RANflex configuration this check may require retrieval of information from the visited MSC/VLR by means of the MAP service SEND\_GROUP\_CALL\_INFO. If so, the relay MSC:

- stores the received data;
- sends a Process Group Call Signalling message indicating "uplink request" and the requested talker priority to the anchor MSC;
- sends Uplink Seized Command messages with the requested talker priority to all other BSCs involved in the call and connected to this relay MSC;
- releases the current talker by sending a Clear Command message, if the talker is on a dedicated channel and is located in this relay MSC;
- marks the uplink as busy; and
- waits for further uplink management messages.

Additionally,

- if the requested talker priority is "emergency subscriber", the relay MSC sets the emergency mode and includes the "emergency mode indication" in the Uplink Seized Command messages;
- if the relay MSC supports the transmission of additional subscriber-related information, it interrogates the VLR to get the "additional information" assigned to the new talker. In a RANflex configuration this may require retrieval of information from the visited MSC/VLR by means of the MAP service SEND\_GROUP\_CALL\_INFO. If "additional information" is available, the relay MSC includes the "additional information" in the Process Group Call Signalling message indicating "uplink request" to the anchor MSC.

If a relay MSC supporting talker priorities receives an Uplink Request message with a talker priority higher than "normal subscriber" from a BSC, and the uplink was seized by the current talker with the same or a higher talker priority, then the relay MSC sends an Uplink Reject Command message with the current talker priority to the BSC.

If the relay MSC receives an Uplink Request Confirm message from a BSC, it stores the data and waits for further uplink management messages. Additionally, if the relay MSC supports the transmission of additional subscriber-related information, it interrogates the VLR to get the "additional information" assigned to the subscriber. In a RANflex configuration this interrogation may require retrieval of information from the visited MSC/VLR by means of the MAP service SEND\_GROUP\_CALL\_INFO. If "additional information" is available, the relay MSC sends VGCS Additional Info messages to all BSCs involved in the call and connected to this relay MSC, and a Forward Group Call Signalling message with the additional info to the anchor MSC.

If a relay MSC supporting talker priorities receives an Emergency Reset Indication from a BSC and the subscription check is successful, the relay MSC sends a Progress Group Call Signalling message with "emergency mode reset command" to the anchor MSC and Emergency Reset Command messages to all BSCs involved in the call and connected to this relay MSC, and waits for further uplink management messages. If the talker priority at receipt of the Emergency Reset Indication is "emergency subscriber", then it is changed in the relay MSC to "normal subscriber".

If the relay MSC receives a Forward Group Call Signalling message from an anchor MSC indicating "uplink release indication", it marks the uplink as free, sends Uplink Release command messages to all BSCs and waits for further uplink management messages.

If the relay MSC receives a Forward Group Call Signalling message from an anchor MSC indicating "uplink seized command" with or without talker priority, then the relay MSC

marks the uplink as busy,

sends Uplink Seized Command messages with the requested talker priority to all BSCs involved in the call and connected to this relay MSC;

- releases the current talker by sending a Clear Command message, if the talker is on a dedicated channel and is located in this relay MSC; and
- waits for further uplink management messages.

Additionally,

- if the Forward Group Call Signalling message from the anchor MSC contained the talker priority "emergency subscriber", the relay MSC sets the emergency mode and includes the "emergency mode indication" in the Uplink Seized Command messages;
- if "additional information" about the new talker was included in the Forward Group Call Signalling message from the anchor MSC, the relay MSC sends VGCS Additional Info messages to all BSCs involved in the call and connected to the relay MSC. Furthermore, the relay MSC sends a VGCS Additional Info message on the dedicated connection to the BSC serving the current talker, before it releases the current talker.

If the relay MSC receives a Forward Group Call Signalling message with the "additional info", the relay MSC sends VGCS Additional Info message to all BSCs involved in the group call and connected to this relay MSC, and waits for further uplink management messages.

If the relay MSC receives a Forward Group Call Signalling message from an anchor MSC indicating "uplink reject command" with or without talker priority, it returns an Uplink Reject message to the BSC which has requested the uplink and waits for further uplink management messages. If the "uplink reject command" included a talker priority, the relay MSC includes the talker priority in the Uplink Reject Command message



If the relay MSC receives a Forward Group Call Signalling message from an anchor MSC indicating "uplink request acknowledgement" with or without talker priority, then the relay MSC

- returns an Uplink Request Acknowledge message with the requested talker priority to the BSC which has requested the uplink;
- sets up a dedicated connection for the new talker to the anchor MSC (implementation option);
- releases the current talker by sending a Clear Command message, if the talker is on a dedicated channel and is located in this relay MSC; and
- waits for further uplink management messages.

Additionally,

- if the requested talker priority is "emergency subscriber", the relay MSC includes the "emergency mode indication" in the Uplink Request Acknowledge messages;
- if "additional information" about the new talker is available, the relay MSC sends VGCS Additional Info messages to all BSCs involved in the call and connected to the relay MSC. Furthermore, the relay MSC sends a VGCS Additional Info message on the dedicated connection to the BSC serving the current talker, before it releases the current talker.

If a relay MSC supporting talker priorities receives a Forward Group Call Signalling message with "emergency mode reset command" from the anchor MSC, the relay MSC resets the emergency mode, sends Emergency Reset Command messages to all BSCs involved in the call and connected to this relay MSC, and waits for further uplink management messages. If the talker priority at receipt of the "emergency mode reset command" is "emergency subscriber", then it is changed in the relay MSC to "normal subscriber".

If the relay MSC receives a Forward Group Call Signalling message from an anchor MSC indicating "uplink release command", it sends an Uplink Release Command message to the BSC which currently has access to the uplink and waits for further uplink management messages.

If the relay MSC receives an ABORT message from a anchor MSC, it sends release messages to all BSCs, informs the GCR that the call is no longer on-going and the process returns to the idle state.

### **Call release**

When receiving a release message, with cause 'normal call clearing' from the anchor MSC for the dedicated connection which was set-up for the initiating service subscriber located in the relay MSC area, the relay MSC releases the connection to the service subscriber and the process returns to the idle state.

When the initiating service subscriber releases the call while a dedicated connection to the anchor MSC is established, the relay MSC sends a release message with cause 'normal call clearing' for the dedicated connection to the anchor MSC and the process returns to the idle state.

When the initiating service subscriber releases the call, while on a group call channel or a dedicated connection to the relay MSC, the relay MSC sends a Process Group Call Signalling message to the anchor MSC indicating "release group call" and waits for the Release message and the Send Group Call End Signal Acknowledgement from the anchor MSC.

When receiving a Send Group Call End Signal Acknowledgement or ABORT from the anchor MSC, or a release message for the connection that was set up using the Group Call number, the relay MSC releases all downlinks to cells inside the relay MSC area, informs the GCR that the call is no longer on-going and the process returns to the idle state.

### **SM MT delivery**

When the VGCS handling process in the R-MSC receives a FORWARD\_GROUP\_CALL\_SIGNALLING message containing a short message TPDU from the A-MSC, the R-MSC shall deliver the short message to the relevant cells using the already established downlink channel for the voice group call.

Process VGCS\_Handling\_Relay\_MSC

1(7)

Uplink management in Relay MSC. HO cases not covered.

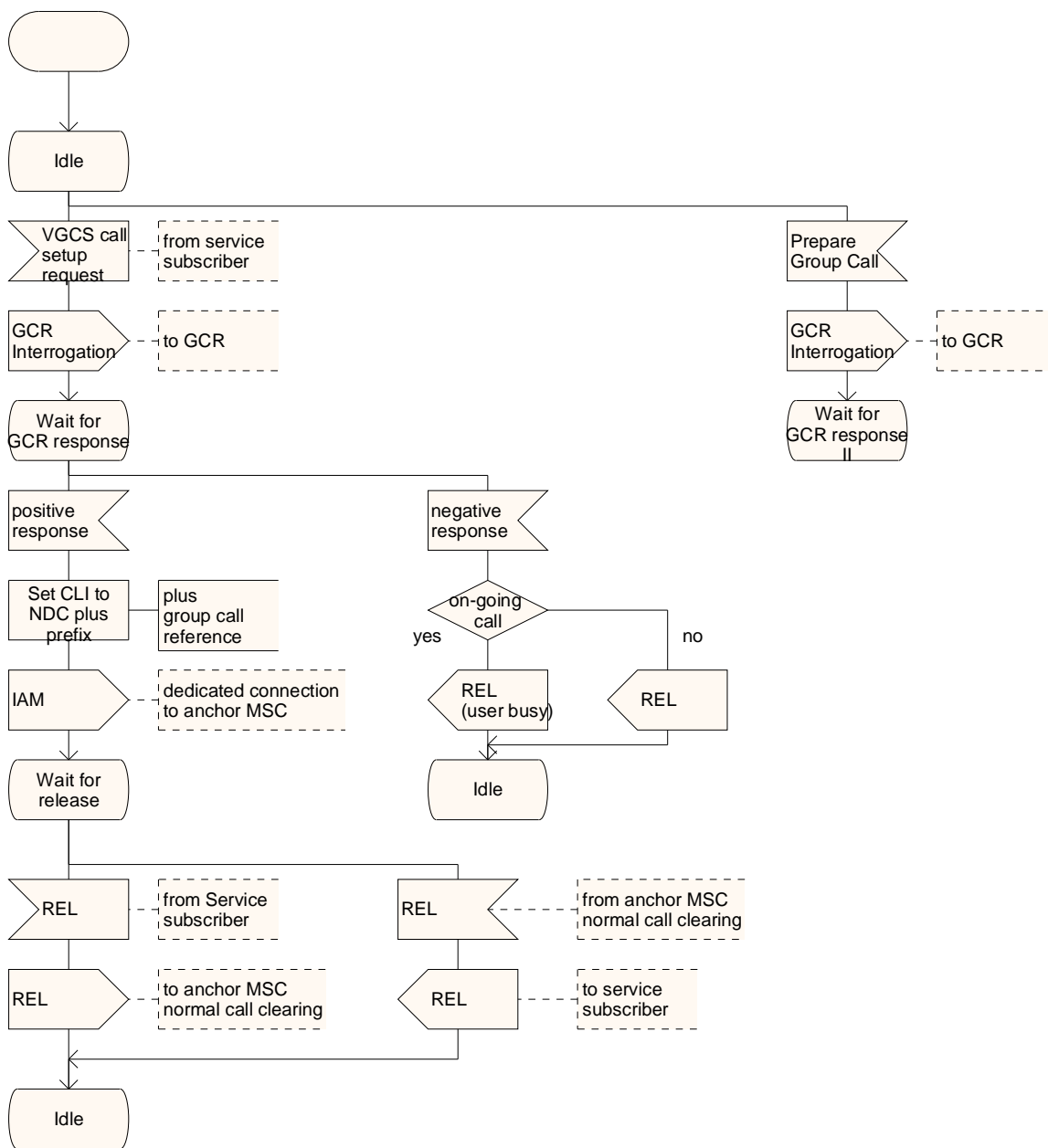


Figure 10: The VGCS handling process in the relay MSC (sheet 1 of 7)

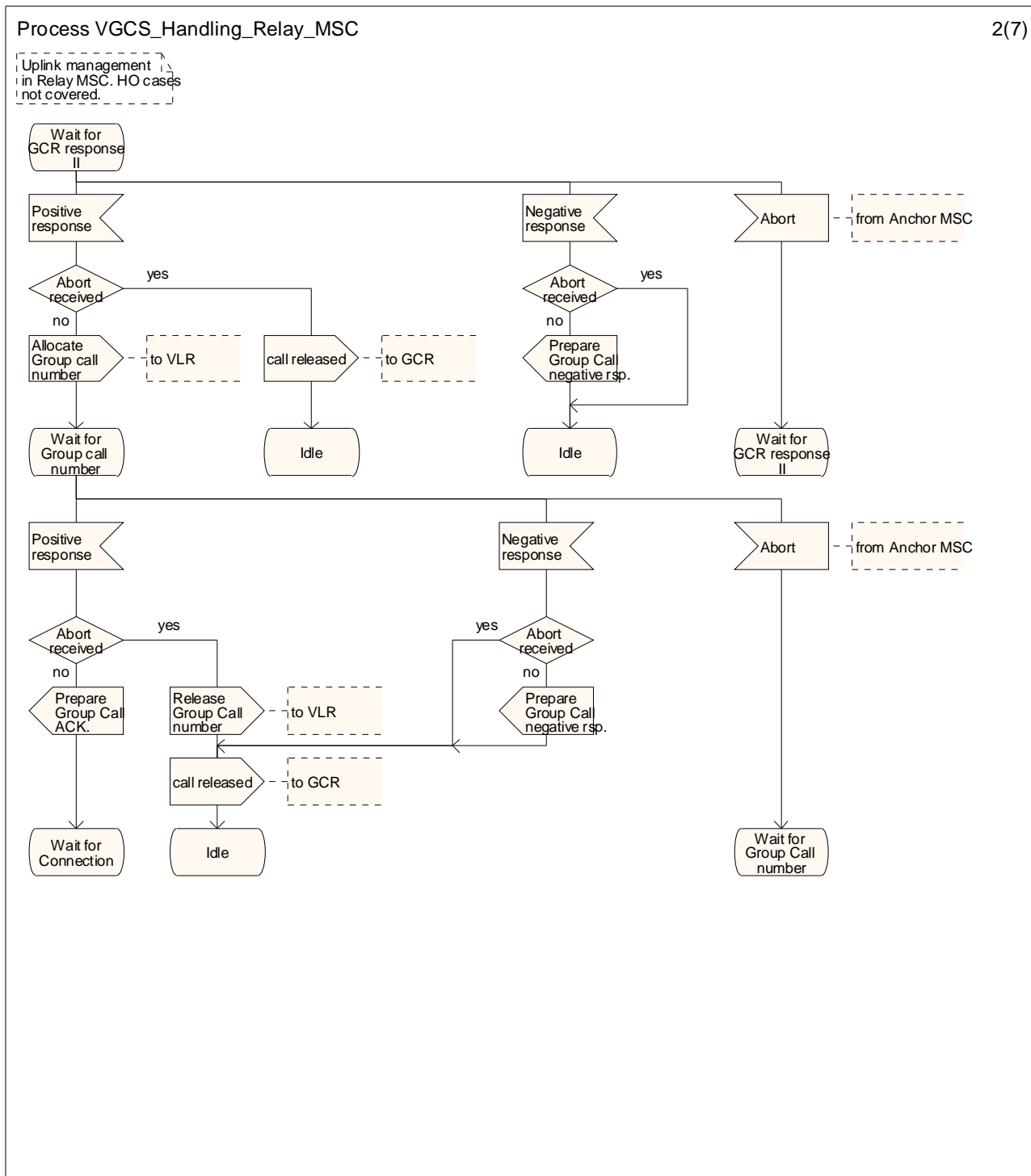


Figure 10: The VGCS handling process in the relay MSC (sheet 2 of 7)

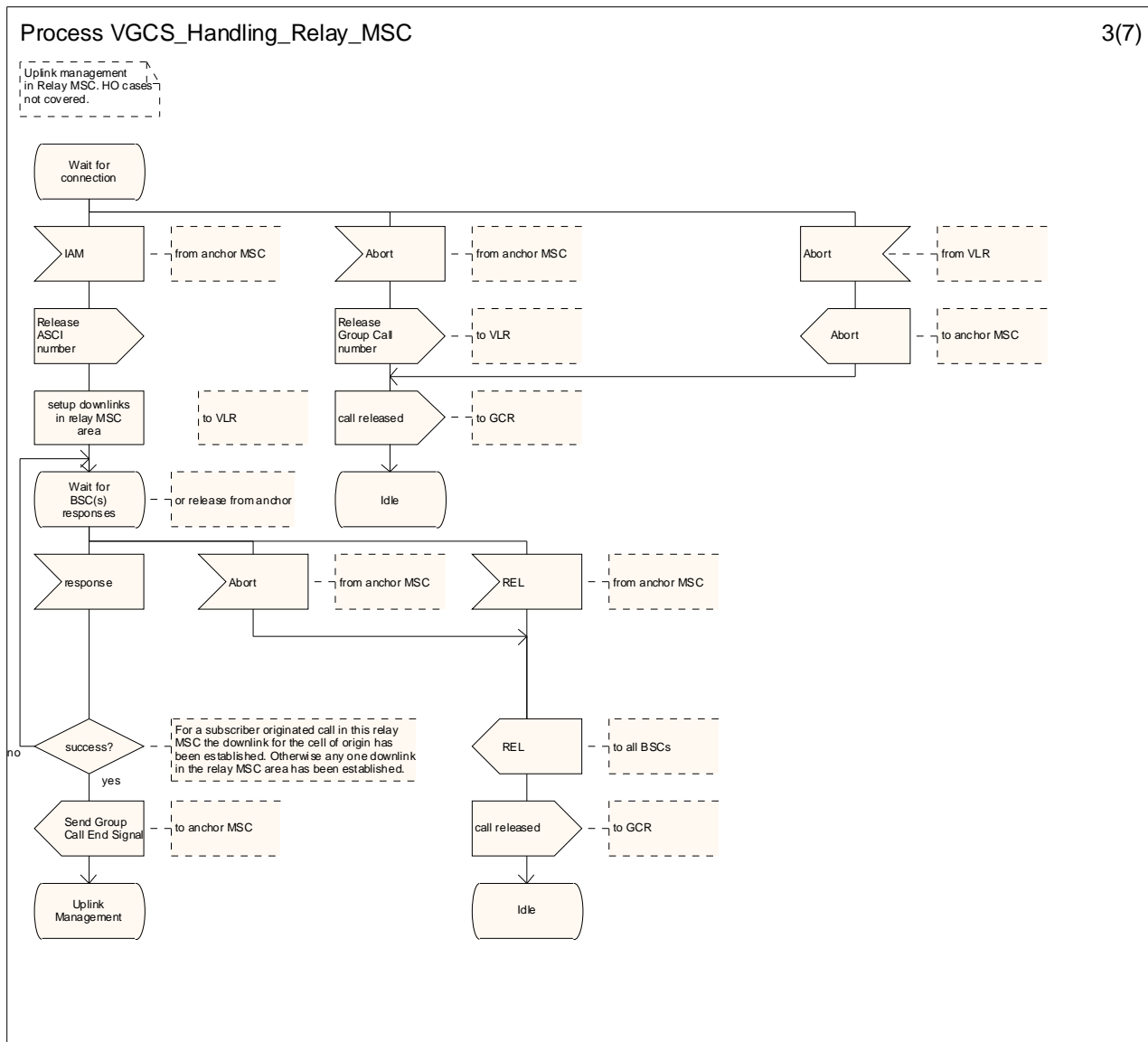
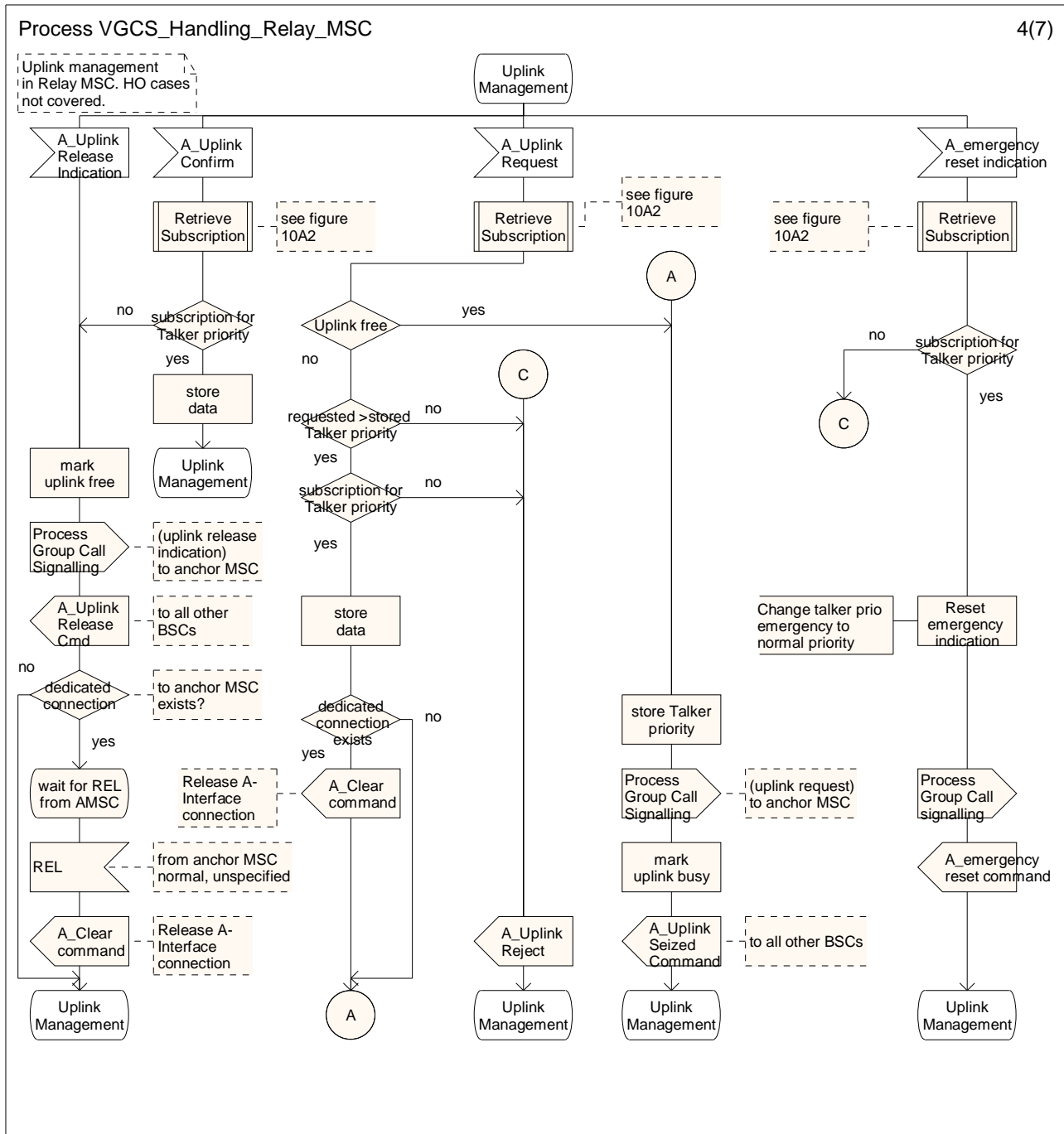


Figure 10: The VGCS handling process in the relay MSC (sheet 3 of 7)



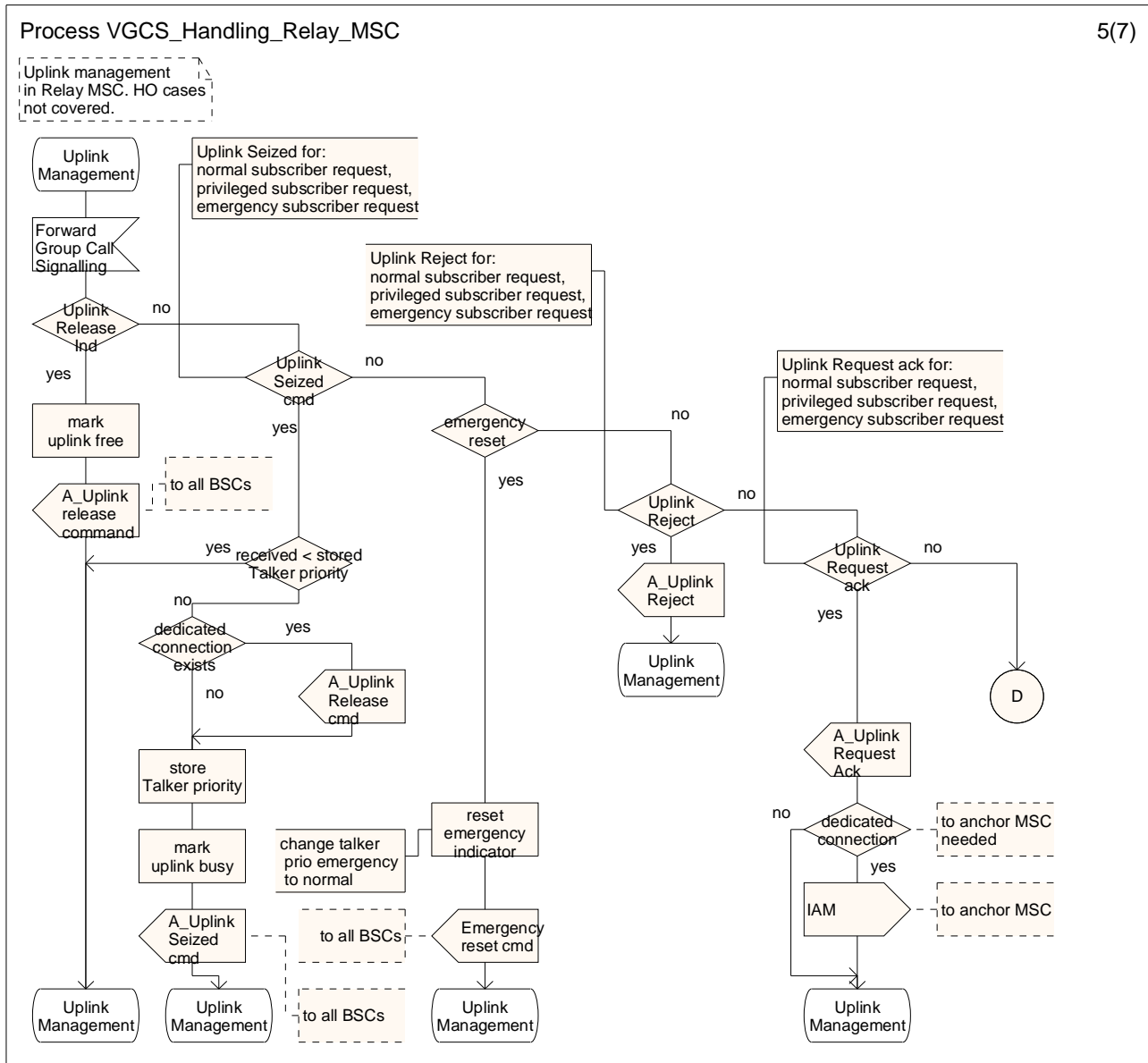


Figure 10: The VGCS handling process in the relay MSC (sheet 5 of 7)

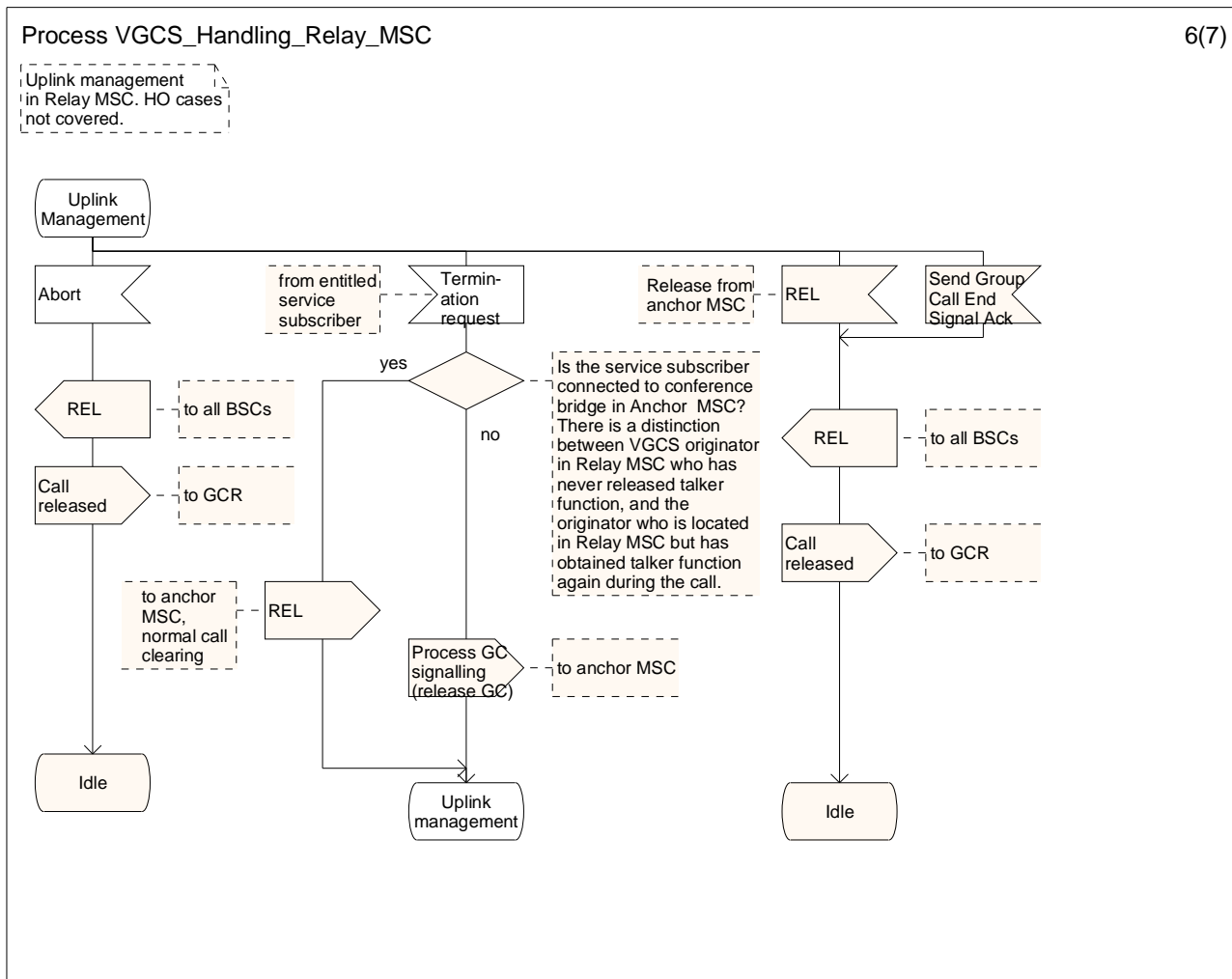


Figure 10: The VGCS handling process in the relay MSC (sheet 6 of 7)

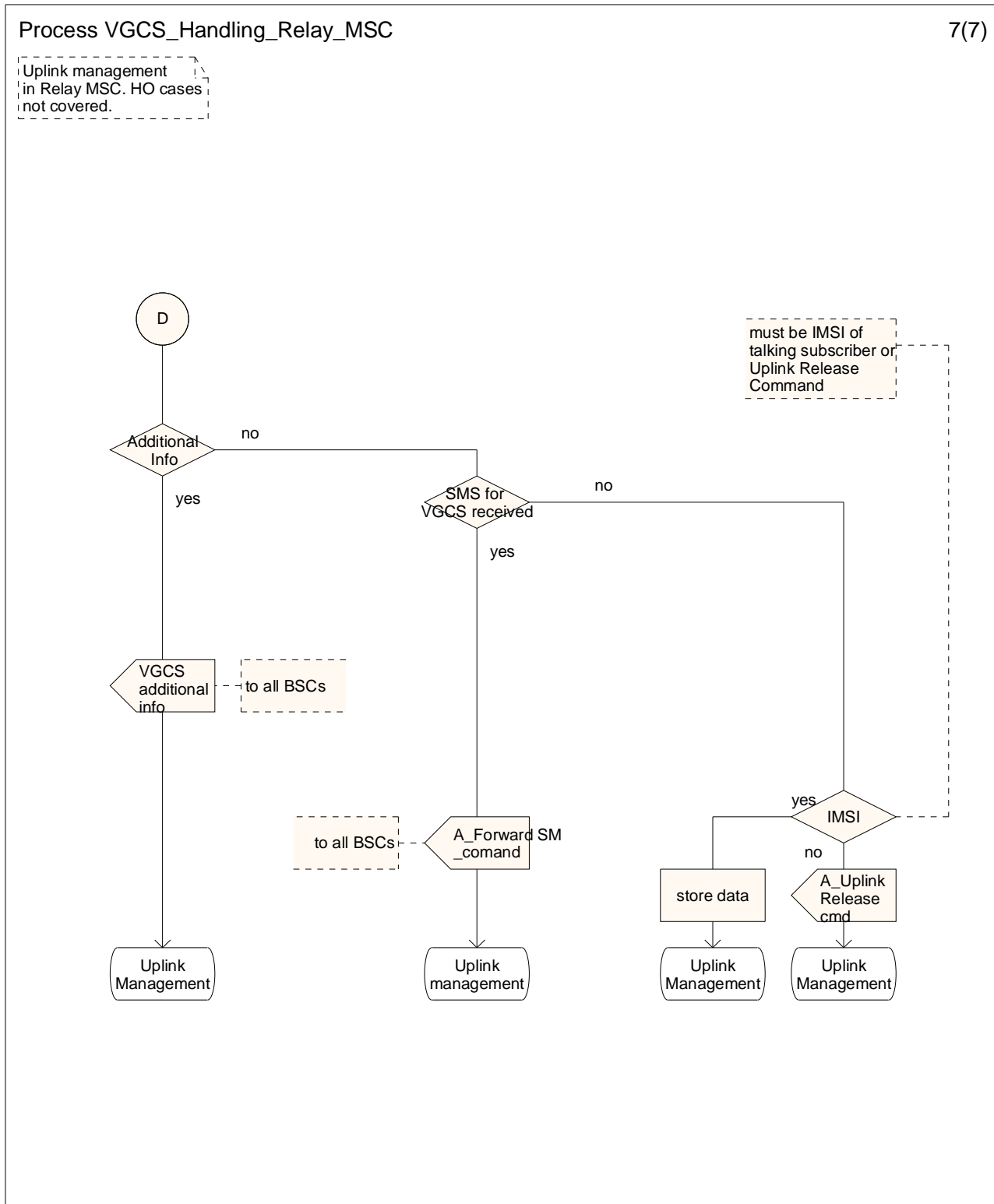


Figure 10: The VGCS handling process in the relay MSC (sheet 7 of 7)



## 11.5A Functional requirement of group call serving MSC (within a RANflex pool)

The process in the group call serving MSC is shown in figure 10A1.

The group call serving MSC is either the anchor MSC or a relay MSC.

### **Successful call set-up initiated by a service subscriber**

When receiving a SEND\_GROUP\_CALL\_INFO interrogation request from a VMSC, the group call serving MSC interrogates its associated GCR to retrieve the Group Call Reference and the Anchor MSC address from the given cell Id / Group Id pair and return this information to the VMSC. The group call serving MSC shall temporarily store in its associated GCR the initiating subscriber's talker priority, his subscribed additional information and his IMSI as received in the interrogation request from the VMSC. The group call serving MSC shall then wait for the group call being set up: If the group call serving MSC is the anchor MSC, it waits for an IAM from the VMSC; if the group call serving MSC is a relay MSC, it waits for a PREPARE\_GROUP\_CALL from the anchor MSC.

Waiting for the group call being set up shall be supervised by a timer T3.

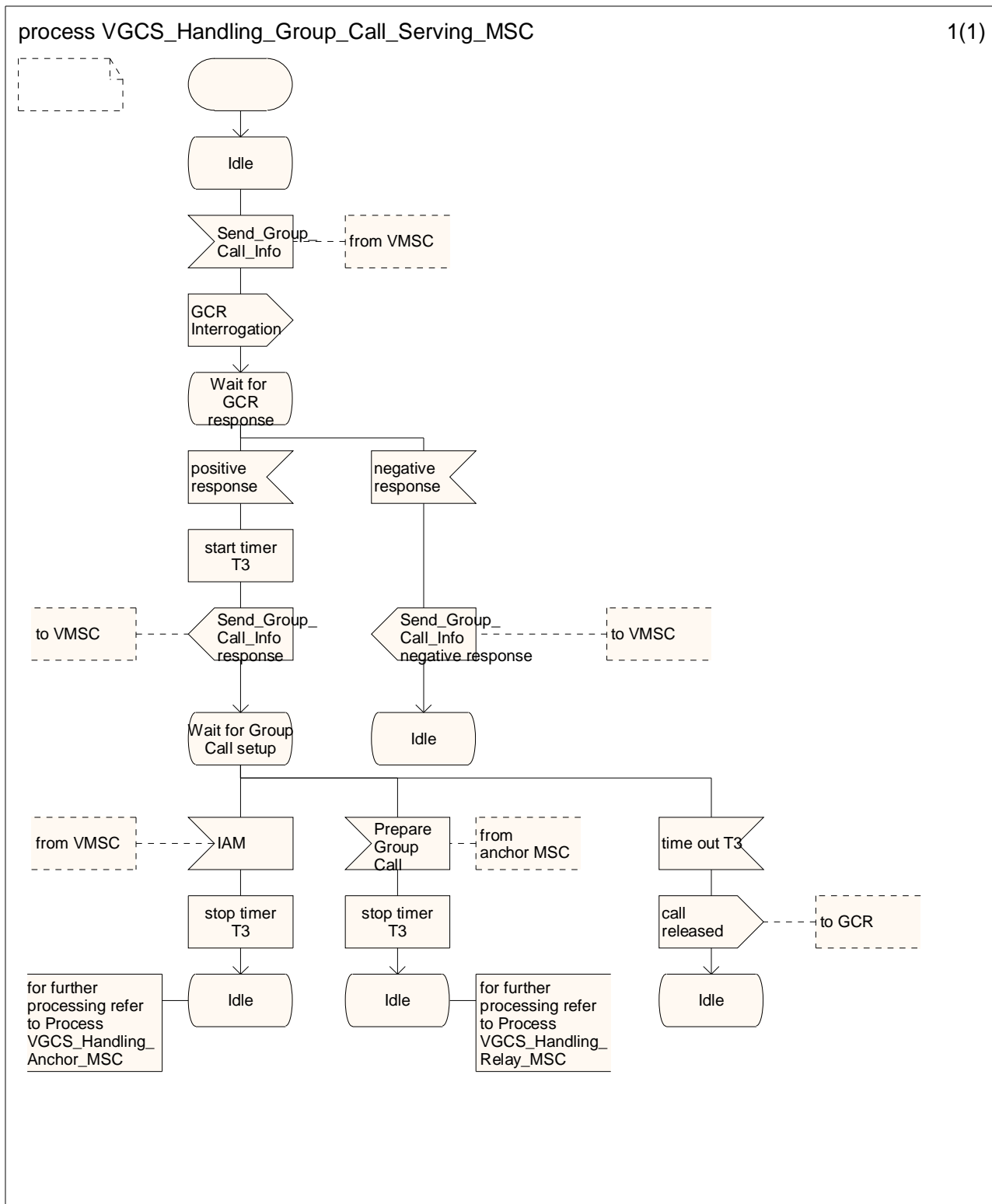
When receiving IAM from the visited MSC, timer T3 is stopped and processing continues in the process VGCS\_Handling\_Anchor\_MSC after reception of the VGCS call setup request in Idle state.

When receiving PREPARE\_GROUP\_CALL from the anchor MSC, timer T3 is stopped and processing continues in the process VGCS\_Handling\_Relay\_MSC after reception of PREPARE GROUP CALL in Idle state.

### **Unsuccessful call set-up**

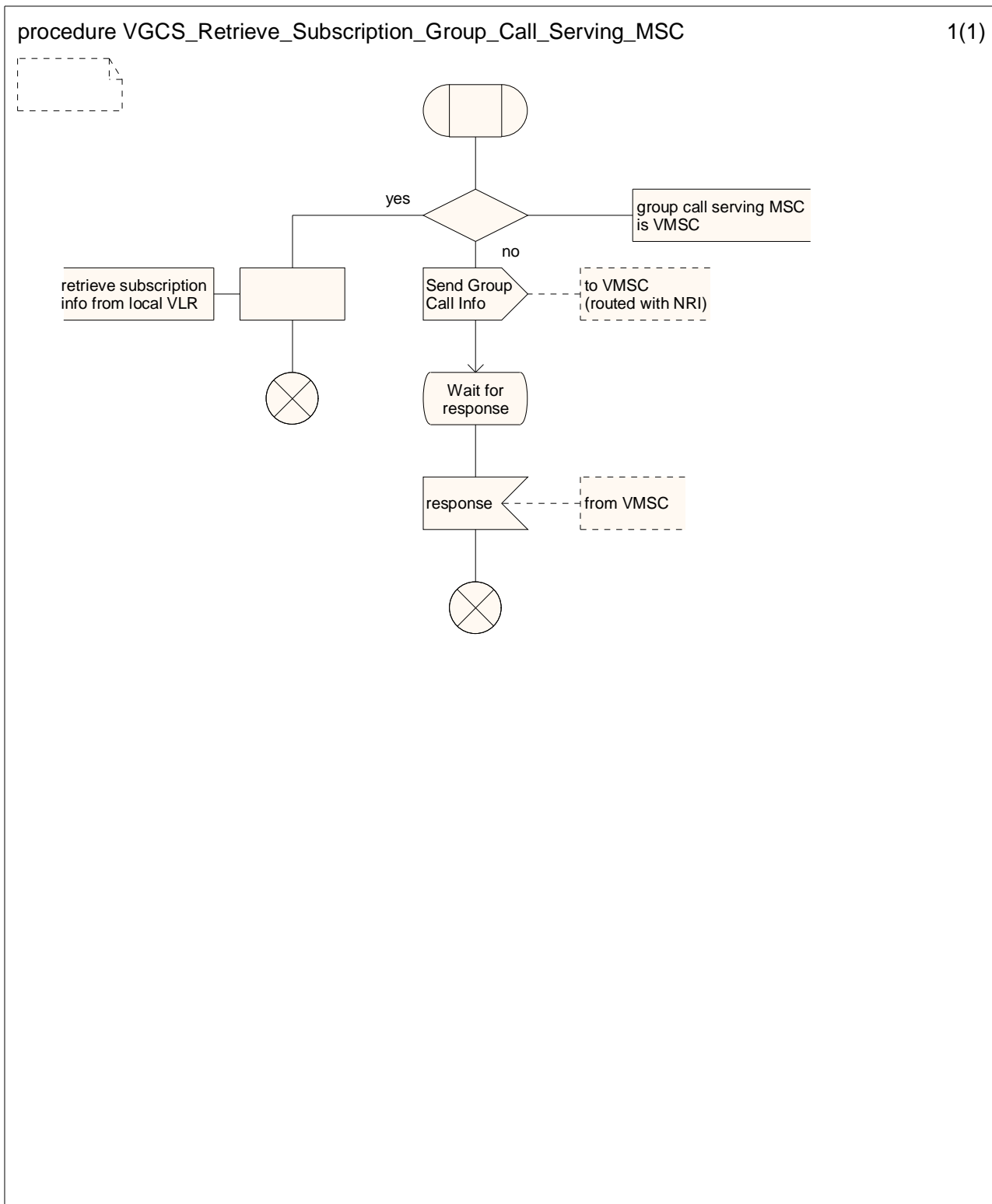
If the group call reference could not be retrieved or the GCR returns a negative response indicating "on-going call" to the group call serving MSC, an error indication is returned to the VMSC and the process returns to the idle state.

At timeout of timer T3 the temporarily stored initiating subscriber's talker priority, his subscribed additional information and his IMSI shall be deleted from the GCR.



**Figure 10A1: The VGCS handling process in the group call serving MSC (sheet 1 of 1)**

The procedure in the group call serving MSC to retrieve subscription information from the VMSC is shown in figure 10A2.



**Figure 10A2: The VGCS subscription info retrieval procedure in the group call serving MSC (sheet 1 of 1)**

### 11.5B Functional requirement of VMSC (within a RANflex pool)

The process in the visited MSC is shown in figure 10B.

**Successful call set-up initiated by a service subscriber**

When the VGCS handling process in the originating MSC receives a VGCS call set-up request from a service subscriber, the VMSC derives the address of the group call serving MSC from the requesting subscriber's current LAC. If the VMSC is the group call serving MSC of the requesting subscriber's current LAC, processing continues in the process VGCS\_Handling\_Anchor\_MSC or VGCS\_Handling\_Relay\_MSC after reception of the VGCS call setup request in Idle state. Otherwise, the visited MSC interrogates the group call serving MSC by means of the MAP service SEND\_GROUP\_CALL\_INFO to retrieve the anchor MSC address and Group Call Reference and waits for a response.

If the group call serving MSC returns a positive response containing the anchor MSC address and the anchor MSC is not the visited MSC, the originating MSC sets up a dedicated connection for the initiating service subscriber to the anchor MSC by constructing an IAM with CLI set to the address of the group call serving MSC, sending it to the anchor MSC, and waits for call release. If the VMSC is the anchor MSC, processing continues in the process VGCS\_Handling\_Anchor\_MSC after reception of the VGCS call setup request in Idle state.

#### **Negative response received from the group call serving MSC**

If the group call serving MSC returns a negative response to the originating MSC indicating that the call is already on-going, the originating MSC sends a Release message indicating "user busy" to the service subscriber in order to force the mobile station of the service subscriber to look for notifications of the respective group ID on the NCH and join the group call.

If the negative response from the group call serving MSC indicates any other reason than "on-going call" the VGCS call set-up request is rejected by sending a release message back to the initiator and the process returns to the idle state.

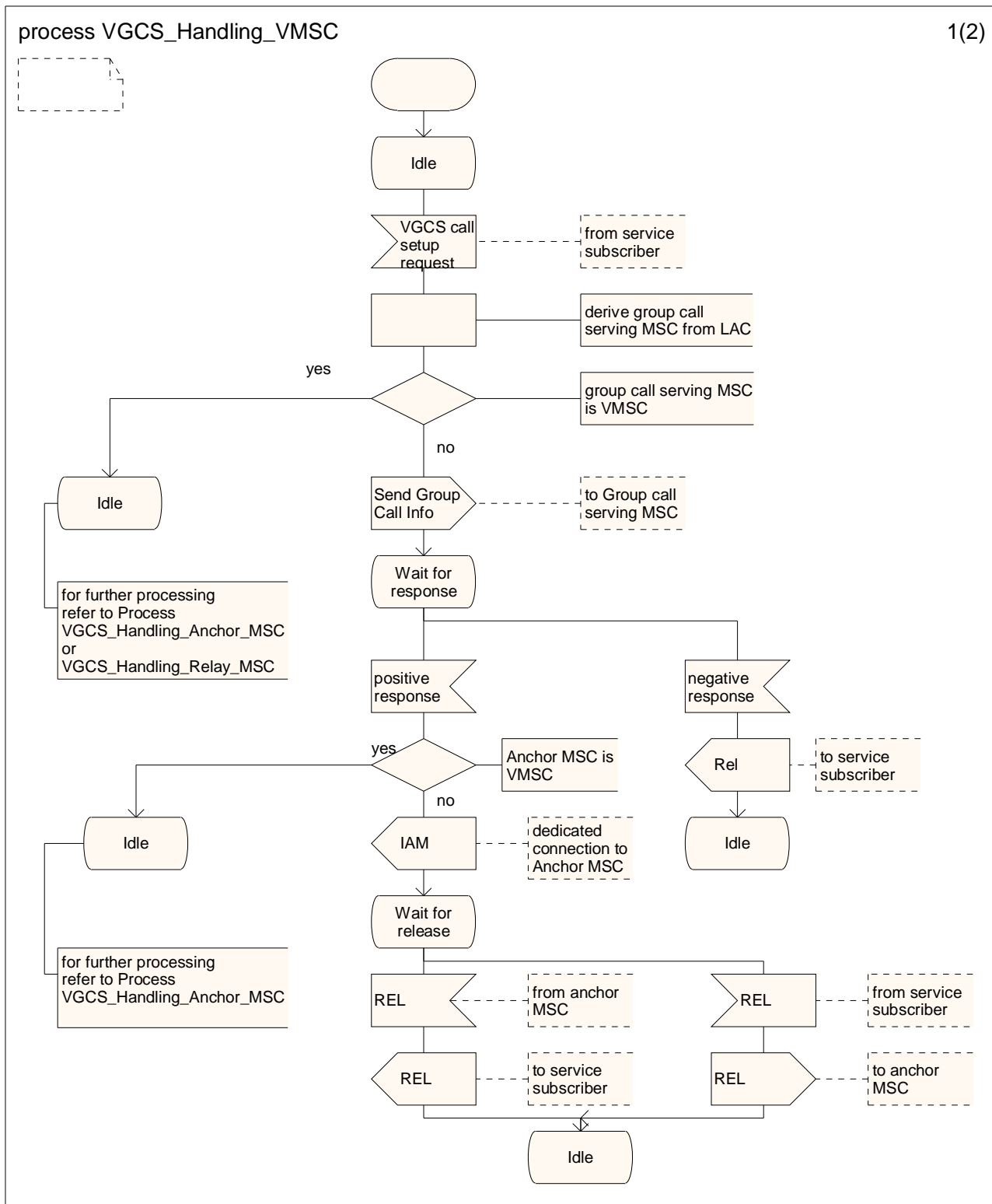


Figure 10B: The VGCS handling process in the VMSC (sheet 1 of 2)

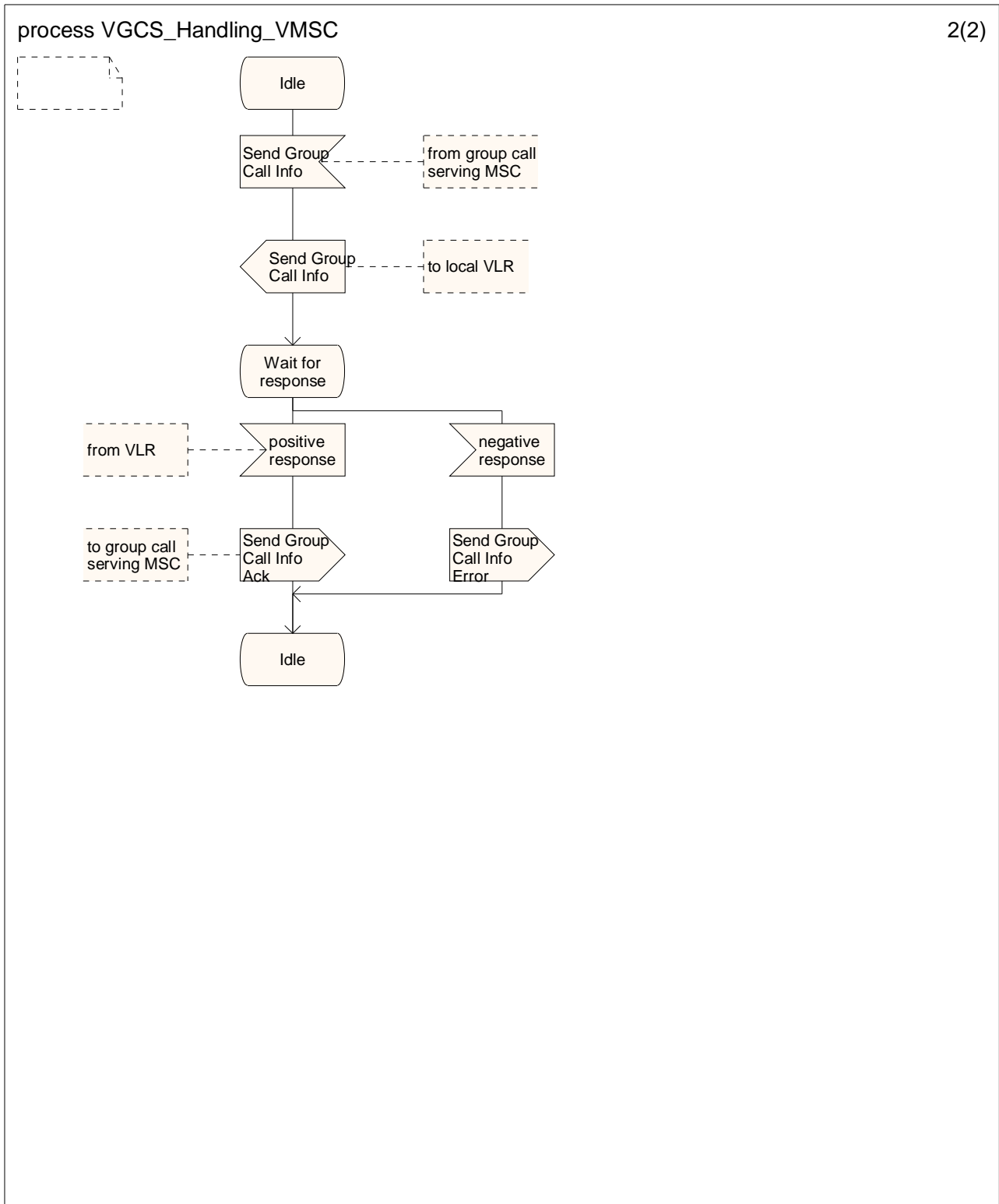


Figure 10B: The VGCS handling process in the VMSC (sheet 2 of 2)

## 11.6 Functional requirement of GCR

The process in the GCR is shown in figure 11.

### Service subscriber initiated call

If the GCR receives an interrogation request for a call initiated by a service subscriber who is located in the MSC area of the associated MSC, the GCR calculates the group call reference from the Group ID and the originating cell ID.

If the group call reference was successfully calculated, the GCR checks whether a VGCS call with that group call reference is already on-going.

If the call is not marked as on-going, the GCR checks whether an anchor MSC address is stored in its group call reference record. If this is the case, a positive response including the anchor MSC address is returned to the MSC, the IMSI of the initiating service subscriber is stored in the GCR and the process returns to the idle state. If no anchor MSC address is stored (i.e. the associated MSC is anchor MSC with respect to this group call reference) the GCR marks its group call reference record with "on-going call" and returns a positive response including the group call attributes to the MSC and the process returns to the idle state.

If the group call reference could not be successfully calculated from the Group ID and the originating cell ID, the GCR returns a negative response indicating "failure" to the MSC and the process returns to the idle state.

If the call was marked as on-going, the GCR returns a negative response indicating "on-going call" to the MSC and the process returns to the idle state.

### IAM initiated call

If the GCR receives an interrogation request for a call initiated by a dispatcher or by a service subscriber who is not located in the MSC area of the associated MSC, the GCR checks the CLI of the initiator against the list of identities of dispatchers which are allowed to initiate the voice group call and against the stored relay MSC addresses in order to determine whether the initiator is allowed to set-up the call. If the check is successful the GCR checks whether a VGCS call with the same group call reference is already on-going.

If the call is not marked as on-going, the GCR marks its group call reference record with "on-going call" and returns a positive response including the group call attributes to the MSC and the process returns to the idle state.

If the CLI check was not successful, the GCR returns a negative response indicating "failure" to the MSC and the process returns to the idle state.

If the call was marked as on-going, the GCR returns a negative response indicating "on-going call" to the MSC and the process returns to the idle state.

### Anchor MSC triggered call

If the GCR (associated to a relay MSC) receives an interrogation request for a call triggered by the anchor MSC, the GCR deletes the IMSI of the initiating service subscriber which is possibly stored in its record, marks its group call reference record with "on-going call", returns a positive response including the list of cells inside the MSC area of the requesting MSC in which the call is to be sent to the MSC and the process returns to the idle state.

### VMSC triggered call (in a RANflex configuration)

If the GCR (associated to a group call serving MSC) receives an interrogation request for a call triggered by the VMSC, the GCR

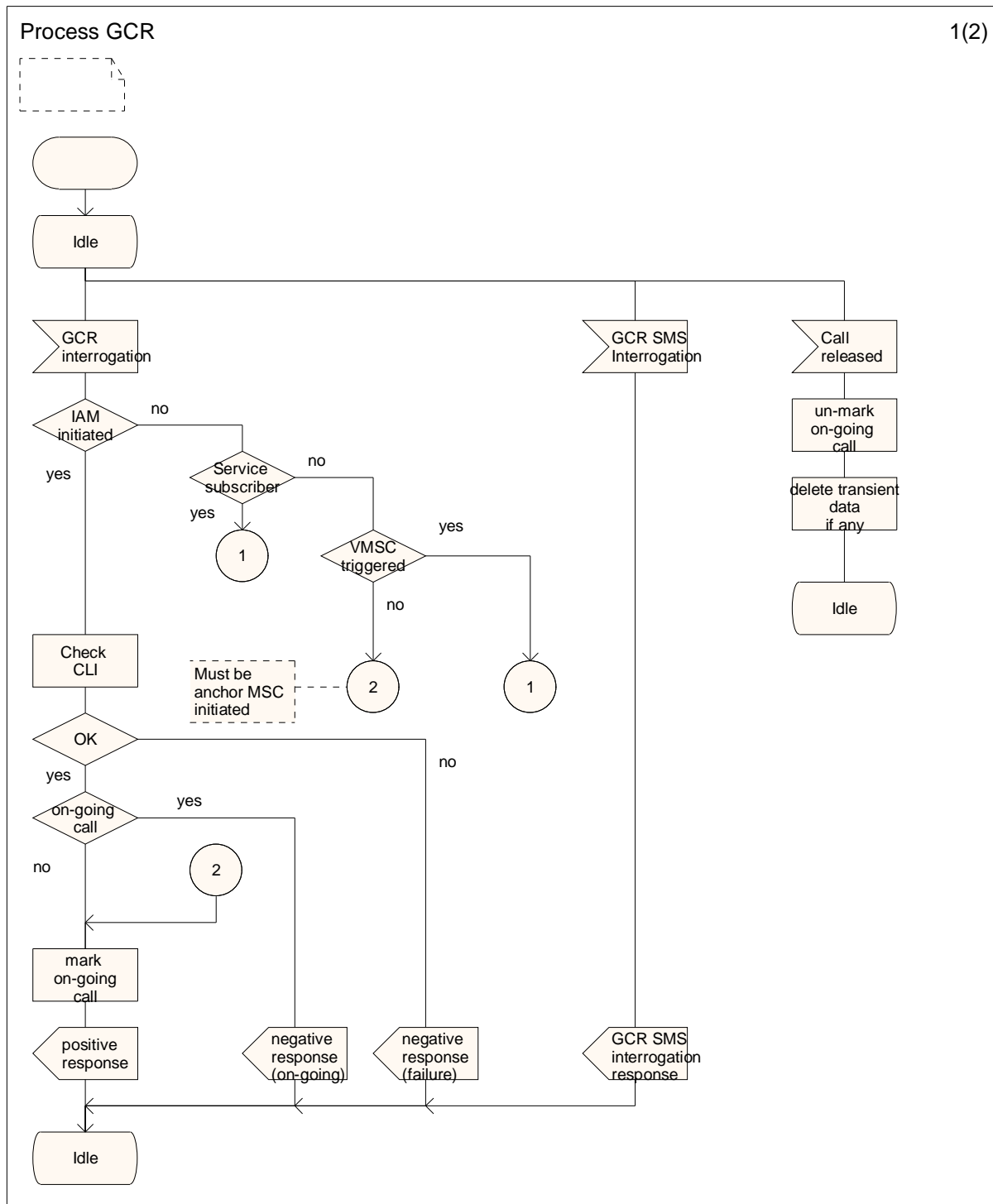
- calculates the group call reference from the Group ID and the originating cell ID ;
- stores the IMSI, talker priority and additional information received with the request ;
- marks its group call reference record with "on-going call"; and
- returns a positive response including group call reference and , if the group call serving MSC is a relay MSC, the anchor MSC address.

### Call release

If the GCR receives a call released indication from the MSC, the "on-going call" indicator in the group call reference record is reset and the process returns to the idle state.

**SM MT delivery**

When receiving an interrogation request from the A-MSC, the GCR shall check if the voice group call is established or not and shall send a response containing the voice group call attributes for short message transfer to the A-MSC.



**Figure 11: The process in the GCR (sheet 1 of 2)**



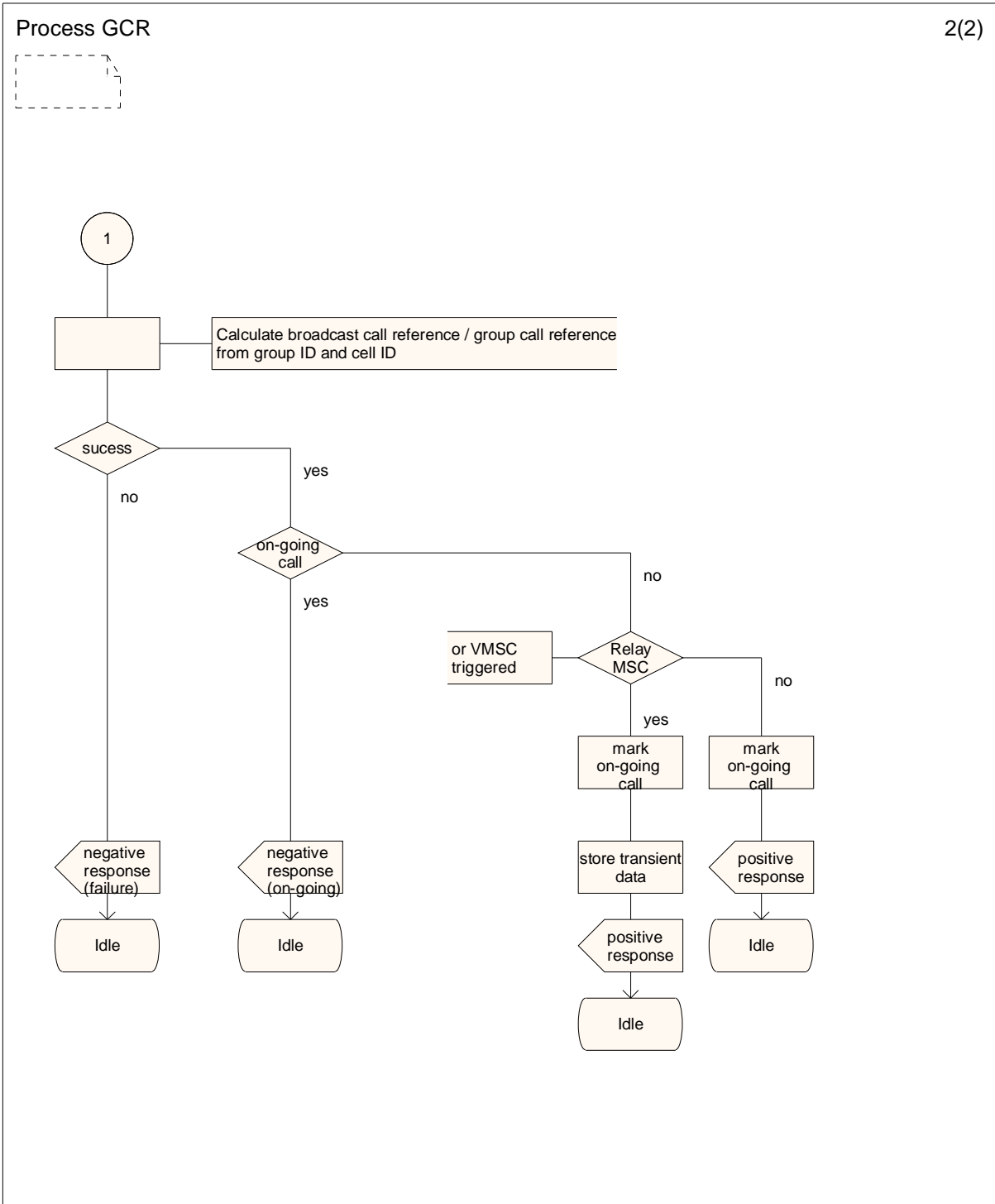


Figure 11: The process in the GCR (sheet 2 of 2)

## 11.7 Functional requirement of VLR

The Group Call number allocation process in the VLR is shown in figure 12.

### **Successful procedure**

When receiving a request from the relay MSC to allocate a Group Call number, the VLR checks if a Group Call number is available. If so it selects a Group Call number, marks the number as allocated, returns a positive response including the Group Call number to the MSC, starts a supervision timer and waits for removal of the Group Call number. If the VLR receives a request to release the Group Call number, the VLR marks the Group Call number as free and the process returns to the idle state.

### **No Group Call number available**

If no Group Call number is available, the VLR returns a negative response indicating "no Group Call number available" to the MSC and the process returns to the idle state.

### **Supervision timer expires**

If the supervision timer expires, the VLR indicates to the relay MSC that the dialogue has to be aborted.

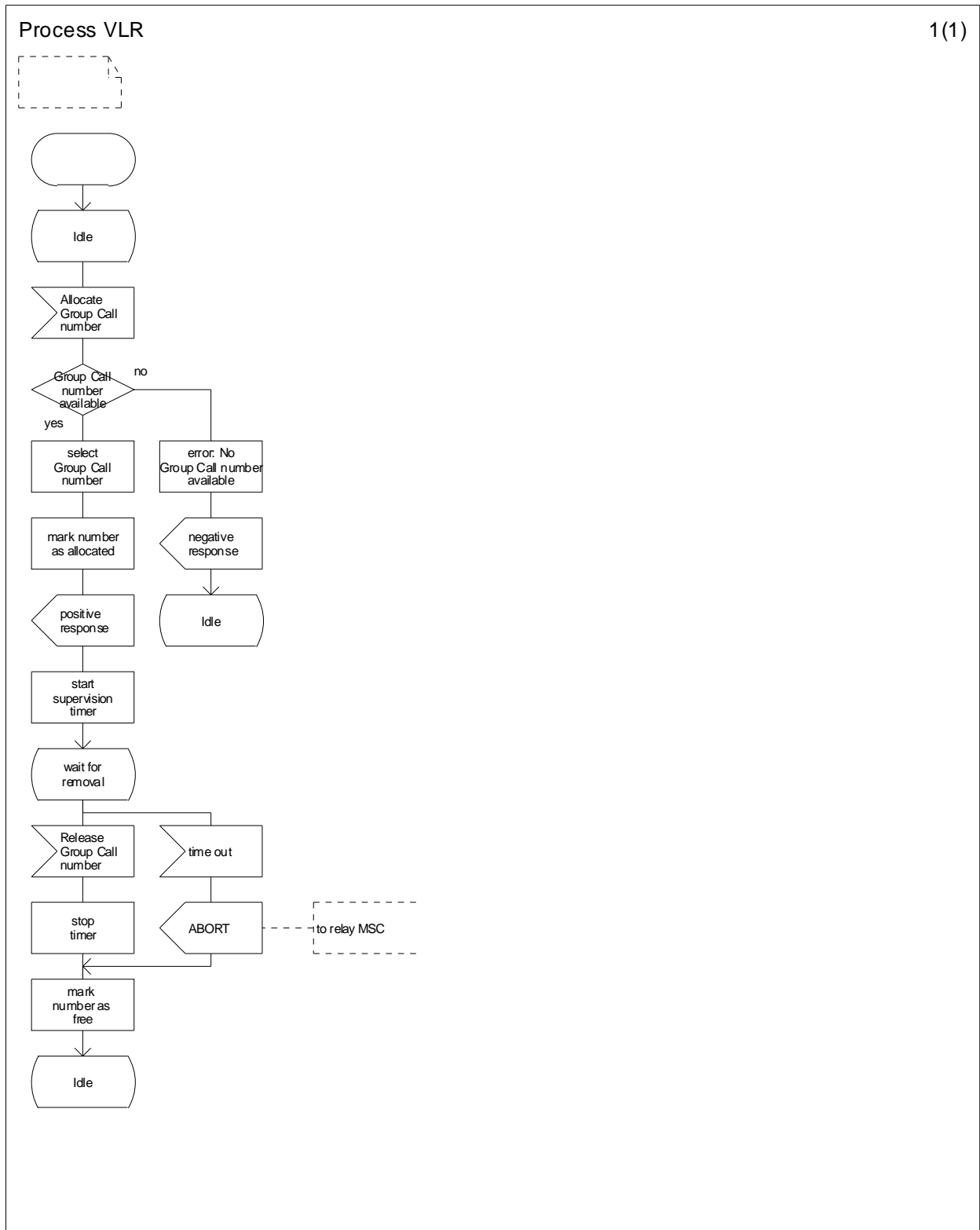


Figure 12: The Group Call number allocation process in the VLR

## 11.8 Functional requirement of SMS Gateway MSC

### SM MT delivery

When receiving a short message TPDU from the SC, the SMS-GMSC shall inspect the parameters and identify the group call reference.

NOTE: The SMS-GMSC may be identical to the MSC.

If the parameters are incorrect then the SMS-GMSC shall return the appropriate error information to the SC in a failure report (see clauses 9 and 10 of 3GPP TS23.040 [14]).

If no errors are found within the parameters the SMS-GMSC shall send the MT\_ForwardSM\_For\_VGCS\_REQ message to transfer the received short message to the A-MSC using the routing information derived from the group call reference.

If the SMS-GMSC receives the MT\_ForwardSM\_For\_VGCS\_RES message indicating the voice group call is established and including a list of identities of dispatchers, it may optionally initiate point-to-point short message transfer attempts to the dispatchers who are connected to the voice group call.

If the SMS-GMSC receives the MT\_ForwardSM\_For\_VGCS\_RES message indicating the voice group call is not established, it shall either

- i) discard the short message and return the appropriate error information to the SC, or
- ii) initiate point to point short message transfer attempts to the members of the group.

NOTE: How the routing information of the voice group call subscribers for the point to point SMS transfer can be derived from the group call reference is out of scope of this specification and implementation dependent. This can be achieved e.g. by an internal or external database.

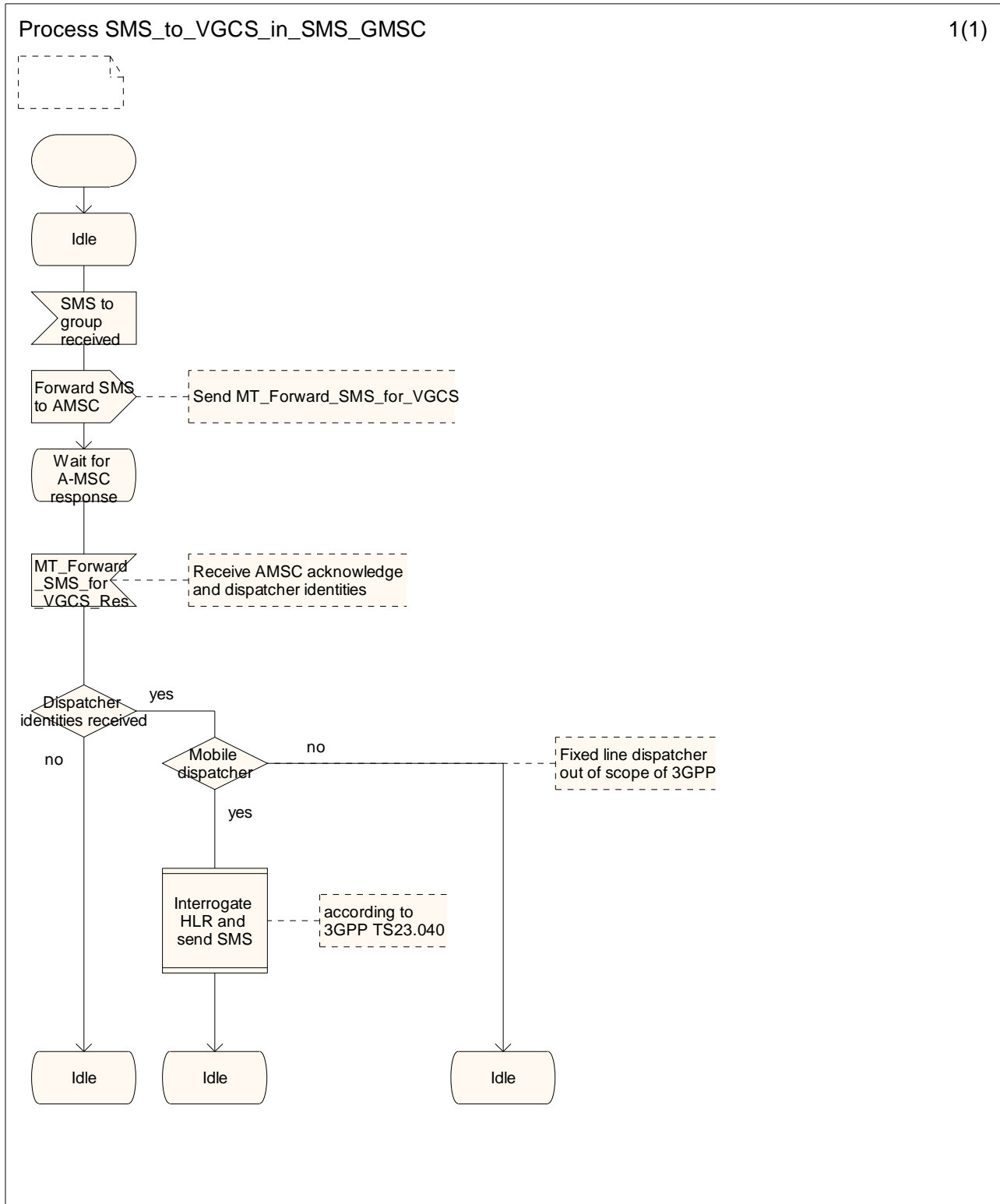


Figure 13: The process in the SMS-GMSC (sheet 1 of 1)

---

## 12 Content of messages

This clause specifies the content of the following messages:

On the B-interface (MSC-VLR):

- Allocate Group Call Number;
- Allocate Group Call Number ack;
- Allocate Group Call Number negative response;
- Release Group Call Number;
- Send Group Call Info;
- Send Group Call Info ack;
- Send Group Call Info negative response.

On the E-interface (MSC-MSC):

- Prepare Group Call;
- Prepare Group Call ack;
- Prepare Group Call negative response;
- Send Group Call End Signal;
- Forward Group Call Signalling;
- Process Group Call Signalling;
- Send Group Call Info;
- Send Group Call Info ack;
- Send Group Call Info negative response.

On the I-interface (MSC-GCR):

- GCR Interrogation;
- GCR Interrogation ack;
- GCR Interrogation negative response;
- Call Released.

In the tables which follow, information elements are shown as mandatory (M), conditional (C) or optional (O). A mandatory information element shall always be present. A conditional information element shall be present if certain conditions are fulfilled; if those conditions are not fulfilled it shall be absent. An optional element may be present or absent, at the discretion of the application at the sending entity.

### 12.1 Messages on the B-interface (MSC-VLR)

#### 12.1.1 Allocate Group Call Number

No information element is required.

## 12.1.2 Allocate Group Call Number ack

The following information element is required.

| Information element name | Required | Description  |
|--------------------------|----------|--|
| Group Call number        | M        | E.164 number required to route the call from the anchor MSC to the relay MSC |

## 12.1.3 Allocate Group Call Number negative response

The negative response information element can take the following value:

- No Group Call number available.

## 12.1.4 Release Group Call Number

The following information element is required.

| Information element name | Required | Description  |
|--------------------------|----------|--|
| Group Call number        | M        | E.164 number required to route the call from the anchor MSC to the relay MSC |

## 12.1.5 Send Group Call Info

The following information elements are required.

| Information element name | Required | Description   |
|--------------------------|----------|---|
| TMSI                     | M        | TMSI of the service subscriber for whom the request is sent             |
| Group ID                 | M        | see clause 9.   |
| Teleservice              | M        | The teleservice Voice Group Call indicates that the request is for VGCS |

## 12.1.6 Send Group Call Info ack

The following information elements are required.

| Information element name | Required | Description  |
|--------------------------|----------|--|
| IMSI                     | M        | IMSI of the service subscriber for whom the request is sent  |
| Additional info          | C        | Must be present if VGCS additional info is supported and additional info is assigned to the subscriber.  |
| Additional subscriptions | C        | Must be present if privilegedUplinkRequest , emergencyUplinkRequest or emergencyReset is subscribed by the service subscriber for whom the message is sent |

## 12.1.7 Send Group Call Info negative response

The negative response information element can take the following value:

- group Id not subscribed;
- unknown subscriber.

## 12.2 Messages on the E-interface (MSC-MSC)

### 12.2.1 Prepare Group Call

The following information elements are required.

| Information element name               | Required | Description  |
|--|----------|--|
| Teleservice                            | M        | The teleservice Voice Group Call indicates that a VGCS call has to be prepared   |
| Group call reference                   | M        | see clause 9   |
| Cipher Algorithm, Group Key and Number | M        | Information on the cipher algorithm and group key to be used   |
| Priority                               | C        | The default priority level must be present if eMLPP applies  |
| Codec Info                             | M        | Information on the codecs allowed for the VGCS call  |
| Talker channel parameter               | O        | Indicates whether the network shall always establish and maintain a dedicated channel for the talking service subscriber                             |
| Uplink Reply Indicator                 | O        | Indicates that the uplink reply procedure is applicable for the voice group call. Must be present if the GCR provides the corresponding information. |

### 12.2.2 Prepare Group Call ack

The following information element is required.

| Information element name | Required | Description  |
|--------------------------|----------|--|
| Group Call number        | M        | E.164 number required to route the call from the anchor MSC to the relay MSC |

### 12.2.3 Prepare Group Call negative response

The negative response information element can take the following value:

- No Group Call number available.



## 12.2.4 Send Group Call End Signal

The following information element is required.

| <b>Information element name</b> | <b>Required</b> | <b>Description</b>  |
|---------------------------------|-----------------|---|
| IMSI                            | C               | The IMSI of the service subscriber who has initiated the call. Must be present if the call was initiated by a service subscriber in the relay MSC area  |
| Talker priority                 | C               | Must be present if the call was set up by a service subscriber in the relay MSC area with a talker priority higher than "normal subscriber"             |
| Additional info                 | C               | Must be present if VGCS additional info is supported and additional info is assigned to the currently talking service subscriber in the relay MSC area. |

## 12.2.5 Forward Group Call Signalling

The following information elements are required.

| Information element name            | Required | Description   |
|-------------------------------------|----------|---|
| IMSI                                | C        | IMSI of the service subscriber who has initiated the call. Must be present if the message is used to transfer the IMSI to the relay MSC   |
| Uplink Request Acknowledgement flag | C        | Must be present if the message is used as positive acknowledgement of an uplink request   |
| Uplink Release Indication flag      | C        | Must be present if the message is used to indicate to the relay MSC that the uplink is no longer busy   |
| Uplink Reject Command flag          | C        | Must be present if the message is used as negative acknowledgement of an uplink request   |
| Uplink Seized Command flag          | C        | Must be present if the message is used to indicate to the relay MSC that the uplink has become busy   |
| Uplink Release Command flag         | C        | Must be present if the message is used to indicate to the relay MSC that the uplink which is currently under control of the relay MSC has to be released  |
| State Attributes                    | C        | Must be present if the message is used to indicate to the relay MSC that the downlink for a talker served by the relay MSC has to be muted or unmuted.  |
| Talker priority                     | C        | Must be present in the same message as the Uplink Request Acknowledgement flag or Uplink Seized Command flag and is set to the talker priority of the new talking service subscriber, if this talker priority is higher than "normal subscriber".<br>Must be present in the same message as the Uplink Reject Command flag and is set to the talker priority of the currently talking service subscriber, if this talker priority is higher than "normal subscriber". |
| Additional info                     | C        | Must be present if VGCS additional info is supported and the message is used to transfer additional info assigned to the currently talking service subscriber to the relay MSC.<br><br>Must be present in the same message as the Uplink Request Acknowledgement flag, Uplink Reject Command flag, or Uplink Seized Command flag, if a talker priority is included in the same message.   |
| Emergency Mode Reset Command flag   | C        | Must be present if the message is used to indicate to the relay MSC that the emergency mode indication shall no longer be signalled   |
| SM TPDU                             | C        | The short message transfer protocol data unit received from the Service Centre. Must be present if the message is used to transfer the short message TPDU received from the SC.   |
| Notification Data                   | C        | Must be present if the message is used to indicate to the relay MSC that application-specific data shall be distributed in its area   |

## 12.2.6 Process Group Call Signalling

The following information elements are required.

| Information element name          | Required | Description  |
|-----------------------------------|----------|--|
| Uplink Request flag               | C        | Must be present if the message is used to request uplink control from the anchor MSC   |
| Uplink Release Indication flag    | C        | Must be present if the message is used to indicate to the anchor MSC that the uplink has become free   |
| Talker priority                   | C        | Must be present in the same message as the Uplink Request flag or Uplink Release Indication flag and is set to the talker priority of the service subscriber requesting or releasing the uplink, if this talker priority is higher than "normal subscriber"  |
| Additional info                   | C        | Must be present if VGCS additional info is supported and the message is used to transfer additional info assigned to the currently talking service subscriber to the anchor MSC.<br><br>Must be present in the same message as the Uplink Request flag, if the flag applies to a subscriber with a talker priority higher than "normal subscriber" |
| Emergency Mode Reset Command flag | C        | Must be present if the message is used to indicate to the anchor MSC that the emergency mode indication shall no longer be signalled   |
| Release Group Call flag           | C        | Must be present if the message is used to indicate to the anchor MSC that the VGCS call shall be released  |
| Notification Data                 | C        | Must be present if the message is used to indicate to the anchor MSC that application-specific data shall be distributed   |

### 12.2.7 MT Forward Short Message for VGCS Request

The following information elements are required.

| Information element name | Required | Description   |
|--------------------------|----------|---|
| Group call reference     | M        | see clause 9  |
| SM Originating Address   | M        | The originating address used by the short message service relay sub-layer protocol. |
| SM TPDU                  | M        | The short message transfer protocol data unit received from the Service Centre.     |

### 12.2.8 MT Forward Short Message for VGCS Response

The following information elements are required.

| Information element name       | Required | Description  |
|--------------------------------|----------|--|
| Status of the voice group call | M        | Indicating whether the voice group call is established or not. |
| Dispatcher List                | O        | A list of dispatcher identities received from the GCR.         |

## 12.2.9 Send Group Call Info

The following information elements are required.

| Information element name | Required | Description  |
|--------------------------|----------|--|
| Teleservice              | M        | The teleservice Voice Group Call indicates that the request is for VGCS  |
| Requested Info           | M        | Indicates whether<br>a) IMSI, Additional Info, and Additional Subscriptions or<br>b) Anchor MSC Address and Group Call Reference are requested                             |
| TMSI                     | C        | TMSI of the service subscriber for whom the request is sent.<br>Shall be present if IMSI, Additional Info and Additional Subscriptions are requested.                      |
| Group ID                 | M        | see clause 9.  |
| Cell Id                  | C        | Identification of the cell where the group call initiating service subscriber is located.<br>Shall be present if Anchor MSC Address and Group Call Reference are requested |
| IMSI                     | C        | IMSI of the service subscriber for whom the request is sent.<br>Shall be present if Anchor MSC Address and Group Call Reference are requested                              |
| Additional info          | C        | Shall be present if subscribed and if Anchor MSC Address and Group Call Reference are requested  |
| Talker priority          | C        | Shall be present if Anchor MSC Address and Group Call Reference are requested and the talker priority is higher than "normal subscriber"                                   |

## 12.2.10 Send Group Call Info ack

The following information elements are required.

| Information element name | Required | Description   |
|--------------------------|----------|---|
| IMSI                     | C        | IMSI of the service subscriber for whom the request is sent.<br>Shall be present if it was requested.   |
| Additional info          | C        | Shall be present if requested and VGCS additional info is supported and additional info is assigned to the subscriber.  |
| Additional subscriptions | C        | Shall be present if requested and privilegedUplinkRequest , emergencyUplinkRequest or emergencyReset is subscribed by the service subscriber for whom the message is sent |
| Anchor MSC Address       | C        | E.164 number required to route the call from the VMSC to the anchor MSC. Shall be present if requested  |
| Group call reference     | C        | see clause 9. Shall be present if requested.  |

## 12.2.11 Send Group Call Info negative response

The negative response information element can take the following value:

- group Id not subscribed;
- unknown subscriber;
- ongoing call;
- failure.

## 12.3 Messages on the I-interface (MSC-GCR)

### 12.3.1 GCR Interrogation

The following information elements are required.

| Information element name         | Required | Description   |
|----------------------------------|----------|---|
| Group call reference             | C        | see clause 9. Must be present if the VGCS call was initiated by a dispatcher or by a service subscriber in the relay MSC area and the receiving GCR is associated to the anchor MSC, or if the receiving GCR is associated to a relay MSC and the GCR interrogation was triggered by a Prepare Group Call message received from the anchor MSC.   |
| Group ID                         | C        | see clause 9. Must be present if one of the following conditions is fulfilled:<br>1) the MSC is the visited MSC of the service subscriber initiating the VGCS call, except if the MSC is a relay MSC and the GCR interrogation was triggered by a Prepare Group Call message received from the anchor MSC;<br>2) the GCR interrogation was triggered by a Send Group Call Info message received from the VMSC.                      |
| Originating Cell ID              | C        | see clause 9. Must be present if one of the following conditions is fulfilled:<br>1) the MSC is the visited MSC of the service subscriber initiating the VGCS call, except if the MSC is a relay MSC and the GCR interrogation was triggered by a Prepare Group Call message received from the anchor MSC;<br>2) the GCR interrogation was triggered by a Send Group Call Info message received from the VMSC.                      |
| CLI                              | C        | Calling Line Identity of the initiating dispatcher, or the relay MSC number in case of service subscriber originated VGCS call in the relay MSC, or in a RANflex configuration, if the relay MSC is different from the VMSC, the MSC number of the group call serving MSC of the service subscriber initiating the VGCS call. Must be present if the MSC is not the visited MSC of the service subscriber initiating the VGCS call. |
| Relay MSC indicator              | M        | A flag indicating whether the GCR interrogation was triggered from a Prepare Group Call message received from the anchor MSC  |
| Group Call Serving MSC indicator | C        | A flag indicating whether the GCR interrogation was triggered from a Send Group Call Info message received from the VMSC. May be set to "yes" in a RANflex configuration only.  |
| IMSI                             | C        | IMSI of the service subscriber who has initiated the VGCS call. Must be present if the MSC is the visited MSC of the service subscriber initiating the VGCS call, or the GCR interrogation was triggered by a Send Group Call Info message received from the VMSC   |
| Talker priority                  | C        | Talker priority of the service subscriber who has initiated   |

|                        |   |   |
|------------------------|---|---|
|                        |   | the VGCS call. Must be present if the MSC is the visited MSC of the service subscriber initiating the VGCS call, or the GCR interrogation was triggered by a Send Group Call Info message containing a talker priority received from the VMSC   |
| Additional info        | C | Additional info of the service subscriber who has initiated the VGCS call. Must be present if the MSC is the visited MSC of the service subscriber initiating the VGCS call, or the GCR interrogation was triggered by a Send Group Call Info message containing additional info received from the VMSC |
| Uplink Reply Indicator | O | Indicates that the uplink reply procedure is applicable for the voice group call. Must be present if the MSC is the anchor MSC and the related flag exists and is set in the GCR  |

### 12.3.2 GCR Interrogation ack

The following information elements are required.

| Information element name     | Required | Description  |
|------------------------------|----------|--|
| Group call reference         | C        | Must be present if the GCR receives an interrogation request containing a Group ID and an Originating Cell ID.   |
| Cell List                    | C        | A list of cells inside the MSC area into which the call is to be sent. Must be present if a) no anchor MSC address is present in the group call reference record and the GCR interrogation was not triggered by a Send Group Call Info message, or b) the relay MSC indicator was set in the GCR Interrogation message |
| Anchor MSC Address           | C        | E.164 number required to route the call from the relay MSC and in a RANflex configuration from the VMSC to the anchor MSC. Must be present if the anchor MSC Address is present in the group call reference record   |
| Relay MSC List               | C        | A list of relay MSCs into which the call is to be sent. Must be present if a relay MSC list is present in the group call reference record and the GCR interrogation was not triggered by a Send Group Call Info message  |
| Group Key and Number         | C        | Information on the cipher algorithm and the group key to be used. Must be present if Group Key and Number is present in the group call reference record and the GCR interrogation was not triggered by a Send Group Call Info message  |
| Codec Information            | C        | Information on the codecs allowed for the voice broadcast call. Must be present if Codec Info is present in the group call reference record and the GCR interrogation was not triggered by a Send Group Call Info message  |
| Establish to Dispatcher List | C        | A list of identities of dispatchers to which a dedicated link is to be established. Must be present if included in the group call reference record. Note that the CLI possibly received with the GCR interrogation message must not be included  |
| Release from Dispatcher List | C        | A list of identities of dispatchers which are allowed to terminate the voice group call. Must be present if included in the group call reference record and the GCR interrogation was not triggered by a Send Group Call Info message  |
| Priority                     | C        | The default priority level related to the voice group call if eMLPP applies. Must be present if included in the group call reference record and the GCR interrogation was not triggered by a Send Group Call Info message  |
| IMSI                         | C        | IMSI of the service subscriber who has initiated the VGCS call. Must be present if the Relay MSC Indicator was set in the GCR interrogation message and the IMSI is present in the group call reference record   |
| No Activity Time             | C        | The length of the time over which no activity is detected before the voice group call is automatically terminated  |
| Talker priority              | C        | Talker priority of the service subscriber who has initiated the VGCS call. Must be present if talker priority is present in the group call reference record  |
| Additional info              | C        | Additional Info of the service subscriber who has initiated the VGCS call. Must be present if additional info is present in the group call reference record  |
| Originating Cell ID          | C        | Must be present if originating cell id is present in the group call reference record   |
| Talker channel parameter     | O        | Indicates whether the network shall always establish and maintain a dedicated channel for the talking service subscriber   |

### 12.3.3 GCR interrogation negative response

The negative response information element can take the following value:

- on-going call;
- failure.

### 12.3.4 Call released

The following information element is required.

| Information element name | Required | Description  |
|--------------------------|----------|--------------|
| Group call reference     | M        | see clause 9 |

### 12.3.5 GCR SMS Interrogation

The following information element is required.

| Information element name | Required | Description  |
|--------------------------|----------|--------------|
| Group call reference     | M        | see clause 9 |

### 12.3.6 GCR SMS Interrogation Response

The following information elements are required.

| Information element name       | Required | Description   |
|--------------------------------|----------|---|
| Status of the voice group call | M        | Indicating whether the voice group call is established or not.                    |
| Dispatcher List                | O        | A list of identities of dispatchers connected to an established voice group call. |

---

## 13 List of system parameters

### 13.1 Timers

#### 13.1.1 Txx

This is a supervision timer on the anchor MSC for the setup of the voice group call. It is started on receipt of a SETUP message from the calling subscriber when the calling subscriber is in the anchor MSC area and on receipt of an ISUP IAM from the relay MSC when the calling subscriber is in the relay MSC area. Refer to subclause 11.3.1.1.2 for procedures on expiry.

The value of timer Txx is operator specific.

#### 13.1.2 T1

In a network supporting talker priorities or uplink access option (i) as defined in subclause 7.2, the uplink busy message on the FACCH of the voice group call channel downlink is repeated by the BSS every T1 seconds (see subclause 11.3.7.1).

The value of timer T1 is operator specific. Its default value is 5 seconds.



### 13.1.3 T2

In a network supporting the transmission of additional subscriber-related information, the additional info message on the SACCH of the voice group call channel downlink is repeated by the BSS every T2 seconds, until the current talker releases the uplink or is released by the network (see subclause 11.3.7.1).

The value of timer T2 is operator specific. Its default value is 5 seconds.

### 13.1.4 Tbb

In a network supporting validation of Priority Uplink Requests, the timer Tbb supervises the broadcast of a new token (Y) after a valid Priority Uplink Request has been received.

If a Priority Uplink Request is received, and the token matches the token in the BSS (X) then the request is accepted, token X is invalidated and Tbb is started. On Tbb expiry a new token (Y), and the priority of the accepted request, is sent in the uplink busy message on the FACCH of the voice group call channels. The Tbb timer should be set to a value that allows other service subscribers who sent a Priority Uplink Request with token X, at the same time as the one accepted by the network, to be back on the voice group call channel in order to receive the new token (Y).

The default value for Tbb is 500ms..

### 13.1.5 Ttv

In a network supporting validation of Priority Uplink Requests, the timer Ttv supervises an additional validity period for an unused token (A). When T1 (supervising the periodic uplink busy) expires a new token (B) is sent in the uplink busy message on the FACCH of the voice group call channels and timer Ttv is started. If a Priority Uplink Request is received before Ttv expires and the token matches either token in the BSS (A or B), the request is considered to be valid, both tokens (A and B) in the BSS are invalidated and Ttv is stopped. If Ttv expires (i.e. no valid Priority Uplink Request has been received within Ttv seconds) the unused token (A) is invalidated.

The value of timer Ttv is operator specific. The value chosen should allow for the reception of requests from service subscribers who have left the group call channel before receipt of the UPLINK\_BUSY with new token (B). Its default value is 1s.

### 13.1.6 Tast

In a network supporting A-interface link sharing timer Tast shall be used to measure the duration between periodic reports from the BSC to the MSC of Group Call Area cells for which channels have been assigned or released, pre-empted or failed since the last periodic report. When timer Tast expires, if new cells in the Group Call Area have been established or existing ones have been released, pre-empted or failed, the MSC shall be informed of the changes (see subclause 7.1b). If no changes have occurred nothing shall be sent. Timer Tast shall be restarted to measure the period of time until the next report. The timer shall be stopped when the call is released.

The value of timer Tast is operator specific. Its default value is 5 seconds.

### 13.1.7 T3

In a RANflex configuration the group call serving MSC when receiving Send Group Call Info from the VMSC shall supervise the setup of the group call by timer T3. T3 is started when a positive Send Group Call Info result is returned to the VMSC and it is stopped when the group call is set up. At timeout the temporarily stored transient data are deleted from the GCR.

The value of timer T3 is operator specific. Its default value is 5 seconds.

## Annex A (informative): Change History

| TSG#      | TSG doc             | WG doc    | Spec           | CR   | R ev | Ph    | C at | Old vers     | New vers      | Title  | WI         |
|-----------|---------------------|-----------|----------------|------|------|-------|------|--------------|---------------|--|------------|
| S#31      |                     | Feb 2000  | 03.68          |      |      |       |      |              | 8.0.0         | Specification version upgrade to Release 1999 version 8.0.0  |            |
| CN#7      | email before SMG#32 | Apr 2000  | 03.68          | A017 |      | R99   |      | 8.0.0        | 8.1.0         | VGCS Signalling Flows  | ASCI       |
| CN#7      | email before SMG#32 | Apr 2000  | 03.68          | A019 |      | R99   |      | 8.0.0        | 8.1.0         | Data Flow for Fast Call setup  | ASCI       |
| CN#7      | email before SMG#32 | Apr 2000  | 03.68          | A022 |      | R99   |      | 8.0.0        | 8.1.0         | Recommendation to use DTMF tones for VGCS talking subscriber downlink un-muting  | ASCI       |
| S#32C N#8 | NP-000275           | N1-000738 | 03.68          | A024 |      | R99   | F    | 8.1.0        | 8.2.0         | Call Release clarification at the Relay MSC  | ASCI       |
| S#32C N#8 | NP-000275           | N1-000739 | 03.68          | A025 |      | R99   | F    | 8.1.0        | 8.2.0         | Speech transmission architecture clarification   | ASCI       |
| S#32C N#8 | NP-000275           | N1-000740 | 03.68          | A026 |      | R99   | D    | 8.1.0        | 8.2.0         | Clarification of anchor MSC address format   | ASCI       |
| S#32C N#8 | NP-000276           | N1-000676 | 03.68          | A023 |      | R4    | B    | 8.2.0        | 9.0.0         | Introduction of Originator-to-dispatcher information into VGCS   | ASCI       |
| S#32C N#8 | NP-000276           | N1-000767 | 03.68          | A027 |      | R4    | F    | 8.2.0        | 9.0.0         | VGCS service accessibility   | ASCI       |
| S#32C N#8 | NP-000276           | N1-000769 | 03.68          | A028 |      | R4    | C    | 8.2.0        | 9.0.0         | talker outside Group Call Area   | ASCI       |
| S#32C N#8 | NP-000276           | N1-000771 | 03.68          | A029 |      | R4    | F    | 8.2.0        | 9.0.0         | Notification response & uplink reply procedure definition  | ASCI       |
| S#32C N#8 | NP-000276           | N1-000773 | 03.68          | A030 |      | R4    | F    | 8.2.0        | 9.0.0         | Release dataFlow correction  | ASCI       |
|           |                     |           | 03.68 / 43.068 |      |      |       |      | 03.68 v9.0.0 | 43.068 v4.0.0 | Conversion to 3GPP TS format   | -          |
| CN#9      | NP-000449           | N1-000873 | 43.068         | 001  |      | R4    | F    | 4.0.0        | 4.1.0         | Uplink Release dataFlow correction   | ASCI       |
| CN#9      | NP-000449           | N1-000915 | 43.068         | 002  |      | R4    | F    | 4.0.0        | 4.1.0         | Correction in the Notification procedure   | ASCI       |
| CN#9      | NP-000449           | N1-000918 | 43.068         | 003  |      | R4    | B    | 4.0.0        | 4.1.0         | Identification of Group ID - The longest GID has to be matched   | ASCI       |
| Oct 2000  |                     |           |                |      |      |       |      | 4.1.0        | 4.1.1         | GSM references revert to pre-Release-4 spec number format.   |            |
| NP-10     | NP-000667           | N1-001171 | 43.068         | 004  |      | Rel-4 | F    | 4.1.1        | 4.2.0         | Call Waiting is not applicable to an originator/talker in dedicated mode   | ASCI       |
| NP-10     | NP-000667           | N1-001181 | 43.068         | 005  |      | REL-4 | F    | 4.1.1        | 4.2.0         | Wrong Field Name for OTDI  | ASCI       |
| NP-10     | NP-000667           | N1-001401 | 43.068         | 006  | 1    | REL-4 | F    | 4.1.1        | 4.2.0         | DTMF precision   | ASCI       |
|           |                     |           | 43.068         |      |      | Rel-4 |      | 4.2.0        | 4.2.1         | ETSI/MCC cleanup on references and editorials (version 4.2.1 was never issued in 2000-12, but 4.2.0 was the correct from the DBase). | 05.05.2002 |
| NP-16     |                     |           | 43.068         |      |      | Rel-5 |      | 4.2.1        | 5.0.0         | CN plenary decision to make this TS also for Release 5.  | June 2002  |
|           |                     |           | 43.068         |      |      | Rel-5 |      | 5.0.0        | 5.0.1         | Editorial correction, changing Note 1 to 15 and Note 2 to 16 in fig. 7, subclause 11.3.8.  | 27.06.2002 |
| NP-17     | NP-020383           | N1-021687 | 43.068         | 007  |      | Rel-5 | F    | 5.0.1        | 5.1.0         | ASCI VGCS call termination by dispatchers using DTMF   | Sept 2002  |
| NP-18     | NP-020675           |           | 43.068         | 008  | 4    | Rel-5 | F    | 5.1.0        | 5.2.0         | MS late entry notification   | Dec 2002   |

|       |           |           |        |     |   |       |   |       |       |   |            |
|-------|-----------|-----------|--------|-----|---|-------|---|-------|-------|---|------------|
| NP-21 | NP-030408 | N1-031204 | 43.068 | 010 | 1 | Rel-5 | A | 5.2.0 | 5.3.0 | Correction of uplink release management   | Sept 2003  |
| NP-21 | NP-030407 | N1-031210 | 43.068 | 012 | 1 | Rel-5 | A | 5.2.0 | 5.3.0 | Correction to definition of Group-ID, Group call area ID and Group Call Reference   | Sept 2003  |
| NP-21 | NP-030409 | N1-031217 | 43.068 | 013 | 1 | Rel-5 | F | 5.2.0 | 5.3.0 | Correction to MS Late Entry description   | Sept 2003  |
| NP-21 | NP-030410 | N1-031332 | 43.068 | 014 | 2 | Rel-6 | F | 5.3.0 | 6.0.0 | Dispatcher signalled mute/unmute of talkers downlink and correction and update of incorrect implementation of CR 03.68 A022 | Sept 2003  |
| NP-24 | NP-040203 | N1-041073 | 43.068 | 016 | 1 | Rel-6 | F | 6.0.0 | 6.1.0 | Correction of PCH re-organization notification  | June 2004  |
| NP-25 | NP-040373 | N1-041527 | 43.068 | 019 | 1 | Rel-6 | A | 6.1.0 | 6.2.0 | Correction on notification for first talker of VGCS call  | Sept 2004  |
| NP-25 | NP-040329 | N1-041547 | 43.068 | 020 | 1 | Rel-6 | B | 6.1.0 | 6.2.0 | Introduction of USIM based ciphering for VGCS   | Sept 2004  |
| NP-26 | NP-040515 | N1-042061 | 43.068 | 021 | 1 | Rel-6 | C | 6.2.0 | 6.3.0 | Addition of VGCS reconfiguration procedure  | Dec 2004   |
| NP-26 | NP-040515 | N1-042075 | 43.068 | 022 | 2 | Rel-6 | F | 6.2.0 | 6.3.0 | Group Call Reference handling by the MSC during VGCS call establishment   | Dec 2004   |
| NP-26 | NP-040515 | N1-041768 | 43.068 | 023 |   | Rel-6 | D | 6.2.0 | 6.3.0 | Notification Response procedure   | Dec 2004   |
| NP-26 | NP-040515 | N1-041769 | 43.068 | 024 |   | Rel-6 | D | 6.2.0 | 6.3.0 | Clarification on Immediate Setup procedure  | Dec 2004   |
| NP-26 | NP-040515 | N1-041803 | 43.068 | 027 |   | Rel-6 | B | 6.2.0 | 6.3.0 | USIM based ciphering on dedicated channels  | Dec 2004   |
| NP-27 | NP-050067 | N1-050043 | 43.068 | 031 |   | Rel-6 | A | 6.3.0 | 6.4.0 | Correction of the conditions for establishment of a voice group call  | March 2005 |
| NP-27 | NP-050076 | N1-050281 | 43.068 | 036 | 1 | Rel-6 | F | 6.3.0 | 6.4.0 | EPRT Inter-PLMN Group Call notification for dispatchers   | March 2005 |
| CP-28 | CP-050057 | C1-050469 | 43.068 | 041 |   | Rel-6 | A | 6.4.0 | 6.5.0 | Correction on the use of calling subscriber and destination subscriber  | June 2005  |
| CP-28 | CP-050073 | C1-050722 | 43.068 | 028 | 3 | Rel-7 | B | 6.5.0 | 7.0.0 | Support of talker priorities and talker identity presentation   | June 2005  |
| CP-28 | CP-050073 | C1-050742 | 43.068 | 043 | 2 | Rel-7 | B | 6.5.0 | 7.0.0 | VGCS Broadcast Point in the BSS   | June 2005  |
| CP-29 | CP-050361 | C1-051117 | 43.068 | 047 | 1 | Rel-7 | A | 7.0.0 | 7.1.0 | Error correction  | Sept 2005  |
| CP-29 | CP-050361 | C1-050903 | 43.068 | 051 |   | Rel-7 | A | 7.0.0 | 7.1.0 | Correction of USIM based ciphering on dedicated channels  | Sept 2005  |
| CP-29 | CP-050365 | C1-051112 | 43.068 | 048 | 2 | Rel-7 | B | 7.0.0 | 7.1.0 | EFR for VGCS  | Sept 2005  |
| CP-29 | CP-050365 | C1-050901 | 43.068 | 049 |   | Rel-7 | B | 7.0.0 | 7.1.0 | Delivery of information about the subsequent talker to the previous talker  | Sept 2005  |
| CP-29 | CP-050365 | C1-051118 | 43.068 | 054 | 1 | Rel-7 | F | 7.0.0 | 7.1.0 | Correction on the uplink transmission management  | Sept 2005  |
| CP-29 | CP-050365 | C1-050945 | 43.068 | 055 |   | Rel-7 | F | 7.0.0 | 7.1.0 | Enhancement on the dedicated channel Assignment procedure   | Sept 2005  |
| CP-29 | CP-050365 | C1-051120 | 43.068 | 058 | 1 | Rel-7 | B | 7.0.0 | 7.1.0 | Delivery of short message to voice group call   | Sept 2005  |
| CP-30 | CP-050549 | C1-051580 | 43.068 | 060 | 1 | Rel-7 | B | 7.1.0 | 7.2.0 | VGCS A-interface link sharing   | Dec 2005   |
| CP-30 | CP-050549 | C1-051583 | 43.068 | 063 | 1 | Rel-7 | B | 7.1.0 | 7.2.0 | AMR for VGCS  | Dec 2005   |
| CP-30 | CP-050549 | C1-051692 | 43.068 | 059 | 2 | Rel-7 | B | 7.1.0 | 7.2.0 | Talker priority: Priority Uplink Request validation mechanism   | Dec 2005   |
| CP-30 | CP-050549 | C1-051693 | 43.068 | 064 | 3 | Rel-7 | B | 7.1.0 | 7.2.0 | Point to point short message  | Dec 2005   |

|       |           |           |        |      |   |       |   |       |       |  |            |
|-------|-----------|-----------|--------|------|---|-------|---|-------|-------|--|------------|
|       |           |           |        |      |   |       |   |       |       | during an ongoing voice group call   | 2005       |
| CP-30 | CP-050549 | C1-051449 | 43.068 | 068  |   | Rel-7 | D | 7.1.0 | 7.2.0 | Editorial corrections  | Dec 2005   |
| CP-31 | CP-060123 | C1-060243 | 43.068 | 0069 | 1 | Rel-7 | F | 7.2.0 | 7.3.0 | Data confidentiality for p-t-p SMS in an active voice group call   | March 2006 |
| CP-31 | CP-060122 | C1-060058 | 43.068 | 0070 | - | Rel-7 | B | 7.2.0 | 7.3.0 | Clarification of prefix for an SMS to an active voice group call   | March 2006 |
| CP-31 | CP-060122 | C1-060108 | 43.068 | 0071 | 1 | Rel-7 | B | 7.2.0 | 7.3.0 | Enhanced support of AMR for VGCS   | March 2006 |
| CP-31 | CP-060113 | C1-060496 | 43.068 | 0073 | 2 | Rel-7 | A | 7.2.0 | 7.3.0 | Correction of muting/un-muting procedure   | March 2006 |
| CP-31 | CP-060122 | C1-060242 | 43.068 | 0074 | - | Rel-7 | B | 7.2.0 | 7.3.0 | Correction of the distribution of emergency indications  | March 2006 |
| CP-31 | CP-060122 | C1-060545 | 43.068 | 0076 | 1 | Rel-7 | C | 7.2.0 | 7.3.0 | Modification of conditions for VGCS call establishment   | March 2006 |
| CP-31 | CP-060122 | C1-060547 | 43.068 | 0078 | 1 | Rel-7 | F | 7.2.0 | 7.3.0 | Addition to group call SM procedures   | March 2006 |
| CP-31 | CP-060122 | C1-060549 | 43.068 | 0080 | 1 | Rel-7 | F | 7.2.0 | 7.3.0 | EPRT - Corrections and clarifications to the procedures for releasing the calling service subscribers dedicated connection to the anchor MSC | March 2006 |
| CP-31 | CP-060122 | C1-060550 | 43.068 | 0081 | 1 | Rel-7 | F | 7.2.0 | 7.3.0 | EPRT - Correction/ clarification of voice group call termination procedures  | March 2006 |
| CP-31 | CP-060122 | C1-060570 | 43.068 | 0082 | 2 | Rel-7 | F | 7.2.0 | 7.3.0 | Clarification of the no activity time  | March 2006 |
| CP-31 | CP-060122 | C1-060566 | 43.068 | 0083 | 2 | Rel-7 | B | 7.2.0 | 7.3.0 | Indication of the channel to be used for uplink requests   | March 2006 |
|       |           |           | 43.068 |      |   | Rel-7 |   | 7.3.0 | 7.3.1 | SDL source files updated   | April 2006 |
| CP-32 | CP-060273 | C1-061101 | 43.068 | 0075 | 2 | Rel-7 | B | 7.3.1 | 7.4.0 | Addition of interoperability with RANflex  | June 2006  |
| CP-32 | CP-060272 | C1-061103 | 43.068 | 0084 | 2 | Rel-7 | C | 7.3.1 | 7.4.0 | Optimized delivery of the additional information   | June 2006  |
| CP-32 | CP-060272 | C1-060728 | 43.068 | 0085 |   | Rel-7 | F | 7.3.1 | 7.4.0 | EPRT: Add signalling flow for a dispatcher originated VGCS   | June 2006  |
| CP-32 | CP-060272 | C1-061100 | 43.068 | 0086 | 1 | Rel-7 | F | 7.3.1 | 7.4.0 | Group Call Re-establishment by the BSS   | June 2006  |
| CP-32 | CP-060276 | C1-060982 | 43.068 | 0088 | 1 | Rel-7 | F | 7.3.1 | 7.4.0 | TC-RT Clarification on use of the Uplink Reply Procedure   | June 2006  |
| CP-32 | CP-060272 | C1-060983 | 43.068 | 0089 | 1 | Rel-7 | B | 7.3.1 | 7.4.0 | Talker priority and A-interface link sharing interaction   | June 2006  |
| CP-32 | CP-060276 | C1-060861 | 43.068 | 0094 |   | Rel-7 | F | 7.3.1 | 7.4.0 | Correction of Figure 6   | June 2006  |
| CP-32 | CP-060272 | C1-060862 | 43.068 | 0095 |   | Rel-7 | F | 7.3.1 | 7.4.0 | Correction of Figure 6a  | June 2006  |
| CP-33 | CP-060464 | C1-061910 | 43.068 | 0097 |   | Rel-7 |   | 7.4.0 | 7.5.0 | Failure cases during VGCS call establishment   | Sept 2006  |
| CP-33 | CP-060464 | C1-061503 | 43.068 | 0098 |   | Rel-7 |   | 7.4.0 | 7.5.0 | Common AMR configurations for VGCS and VBS   | Sept 2006  |
| CP-33 | CP-060464 | C1-061819 | 43.068 | 0100 |   | Rel-7 |   | 7.4.0 | 7.5.0 | EVGCS-Remove the limitation of speech version in A interface sharing   | Sept 2006  |
| CP-33 | CP-060464 | C1-061556 | 43.068 | 0103 |   | Rel-7 |   | 7.4.0 | 7.5.0 | Indicate the originating relay MSC address to anchor MSC   | Sept 2006  |
| CP-33 | CP-060464 | C1-061908 | 43.068 | 0105 |   | Rel-7 |   | 7.4.0 | 7.5.0 | Extension of Group ID  | Sept 2006  |
| CP-33 | CP-060464 | C1-061916 | 43.068 | 0110 |   | Rel-7 |   | 7.4.0 | 7.5.0 | Correction for radio resource assignment   | Sept 2006  |
| CP-33 | CP-060470 | C1-061816 | 43.068 | 0096 |   | Rel-7 |   | 7.4.0 | 7.5.0 | Corrections to interoperability with RANflex   | Sept 2006  |
| CP-34 | CP-060664 | C1-062423 | 43.068 | 0117 | 1 | Rel-7 |   | 7.5.0 | 7.6.0 | Emergency set/reset alert to dispatchers   | Dec 2006   |
| CP-34 | CP-060664 | C1-062420 | 43.068 | 0112 | 2 | Rel-7 |   | 7.5.0 | 7.6.0 | Corrections to SMS procedures during ongoing voice group call  | Dec 2006   |
| CP-34 | CP-060664 | C1-062424 | 43.068 | 0119 | 1 | Rel-7 |   | 7.5.0 | 7.6.0 | Optimized channel allocation of the calling subscriber   | Dec 2006   |

|       |           |           |        |      |   |        |   |       |        |  |                |
|-------|-----------|-----------|--------|------|---|--------|---|-------|--------|--|----------------|
| CP-34 | CP-060664 | C1-062422 | 43.068 | 0116 | 1 | Rel-7  |   | 7.5.0 | 7.6.0  | Clarifications to the case when a group ID with 8 digits is used                           | Dec 2006       |
| CP-34 | CP-060665 | C1-062111 | 43.068 | 0114 | - | Rel-7  |   | 7.5.0 | 7.6.0  | Condition for the inclusion of parameters in the GCR interrogation message                 | Dec 2006       |
| CP-34 | CP-060665 | C1-062113 | 43.068 | 0115 | - | Rel-7  |   | 7.5.0 | 7.6.0  | Addition of Teleservice Code to SendGroupCallInfo  | Dec 2006       |
| CP-34 | CP-060672 | C1-062509 | 43.068 | 0118 | 1 | Rel-8  |   | 7.6.0 | 8.0.0  | Introduction of sending application-specific data to group call members                    | Dec 2006       |
| CP-36 | CP-070371 | C1-070684 | 43.068 | 0133 | - | Rel-8  | A | 8.0.0 | 8.1.0  | TCRT: Definition of BSSAP procedure for release of VGCS call controlling connections       | June 2007      |
| CP-36 | CP-070376 | C1-070973 | 43.068 | 0132 | 1 | Rel-8  | A | 8.0.0 | 8.1.0  | TCRT: Silent (re-)joining dispatcher, immediately talking dispatcher                       | June 2007      |
| CP-36 | CP-070376 | C1-070975 | 43.068 | 0130 | 2 | Rel-8  | A | 8.0.0 | 8.1.0  | Retry of the VGCS Assignment procedure   | June 2007      |
| CP-36 | CP-070387 | C1-070686 | 43.068 | 0135 | - | Rel-8  | A | 8.0.0 | 8.1.0  | Correction of condition for cell specific speech version                                   | June 2007      |
| CP-36 | CP-070387 | C1-070685 | 43.068 | 0134 | - | Rel-8  | A | 8.0.0 | 8.1.0  | Alignment of SDLs with condition for successful call setup                                 | June 2007      |
| CP-36 | CP-070394 | C1-071380 | 43.068 | 0140 | 3 | Rel-8  | B | 8.0.0 | 8.1.0  | TCRT: Distribution of time-critical application data by BSC to its broadcast area          | June 2007      |
| CP-36 | CP-070394 | C1-071374 | 43.068 | 0138 | 3 | Rel-8  | C | 8.0.0 | 8.1.0  | Talker channel parameter   | June 2007      |
| CP-36 | CP-070394 | C1-070755 | 43.068 | 0136 | - | Rel-8  | D | 8.0.0 | 8.1.0  | Correction of place of message flows for EVA   | June 2007      |
| CP-37 | CP-070602 | C1-072114 | 43.068 | 0142 | 2 | Rel-8  | F | 8.1.0 | 8.2.0  | Correction to the talker channel parameter   | Sept 2007      |
| CP-37 | CP-070604 | C1-071620 | 43.068 | 0141 |   | Rel-8  | F | 8.1.0 | 8.2.0  | TCRT: Correction to process VGCS_Handling_Relay_MSC  | Sept 2007      |
| CP-38 | CP-070793 | C1-072829 | 43.068 | 0143 |   | Rel-8  | F | 8.2.0 | 8.3.0  | TCRT: Removal of the support of long application-specific data                             | Dec 2007       |
| CP-38 | CP-070815 | C1-072830 | 43.068 | 0144 |   | Rel-8  | F | 8.2.0 | 8.3.0  | TCRT: Paging for incoming p-t-p transaction to service subscriber in an ongoing group call | Dec 2007       |
| CP-39 | CP-080136 | C1-080453 | 43.068 | 0148 | 1 | Rel-8  | C | 8.3.0 | 8.4.0  | TCRT: Warning tone for call termination due to time out of voice inactivity time           | March 2008     |
| CP-39 | CP-080129 | C1-080452 | 43.068 | 0147 | 1 | Rel-8  | F | 8.3.0 | 8.4.0  | TCRT: Clarification of the channel to be used for uplink access                            | March 2008     |
| CP-39 | CP-080123 | C1-080536 | 43.068 | 0146 | 1 | Rel-8  | A | 8.3.0 | 8.4.0  | TCRT: Clean up of the requirement of sending SMS to non established group calls            | March 2008     |
| CP-40 | CP-080351 | C1-081646 | 43.068 | 0149 |   | Rel-8  | B | 8.4.0 | 8.5.0  | TCRT: Closing some open issues concerning the transmission of application-specific data    | June 2008      |
| CP-40 | CP-080361 | C1-081648 | 43.068 | 0150 |   | Rel-8  | F | 8.4.0 | 8.5.0  | TCRT: Clarification of conditions for start and stop of voice inactivity timer             | June 2008      |
| CP-46 |           |           |        |      |   | Rel-9  |   | 8.5.0 | 9.0.0  | Upgrade to Rel-9   | Dec 2009       |
| CP-47 | CP-100135 | C1-100476 | 43.068 | 0151 |   | Rel-9  | C | 9.0.0 | 9.1.0  | TCRT: Uplink reply procedure   | March 2010     |
| CP-49 | CP-100501 | C1-102316 | 43.068 | 0152 |   | Rel-9  | F | 9.1.0 | 9.2.0  | TC-RT: Use of application data for group calls involving more than one PLMN                | September 2010 |
| CP-50 | CP-100763 | C1-104237 | 43.068 | 0153 | 1 | Rel-10 | B | 9.2.0 | 10.0.0 | TC-RT: Introduction of group IDs with prefix   | December 2010  |

---

# History

| <b>Document history</b> |          |             |
|-------------------------|----------|-------------|
| V10.0.0                 | May 2011 | Publication |
|                         |          |             |
|                         |          |             |
|                         |          |             |
|                         |          |             |