

# ETSI TS 143 033 V6.0.0 (2004-12)

---

*Technical Specification*

**Digital cellular telecommunications system (Phase 2+);  
Lawful Interception;  
Stage 2  
(3GPP TS 43.033 version 6.0.0 Release 6)**



---

Reference

RTS/TSGS-0343033v600

---

Keywords

GSM

**ETSI**

650 Route des Lucioles  
F-06921 Sophia Antipolis Cedex - FRANCE

Tel.: +33 4 92 94 42 00 Fax: +33 4 93 65 47 16

Siret N° 348 623 562 00017 - NAF 742 C  
Association à but non lucratif enregistrée à la  
Sous-Préfecture de Grasse (06) N° 7803/88

---

**Important notice**

Individual copies of the present document can be downloaded from:

<http://www.etsi.org>

The present document may be made available in more than one electronic version or in print. In any case of existing or perceived difference in contents between such versions, the reference version is the Portable Document Format (PDF). In case of dispute, the reference shall be the printing on ETSI printers of the PDF version kept on a specific network drive within ETSI Secretariat.

Users of the present document should be aware that the document may be subject to revision or change of status. Information on the current status of this and other ETSI documents is available at

<http://portal.etsi.org/tb/status/status.asp>

If you find errors in the present document, please send your comment to one of the following services:

[http://portal.etsi.org/chaicor/ETSI\\_support.asp](http://portal.etsi.org/chaicor/ETSI_support.asp)

---

**Copyright Notification**

No part may be reproduced except as authorized by written permission.  
The copyright and the foregoing restriction extend to reproduction in all media.

© European Telecommunications Standards Institute 2004.  
All rights reserved.

**DECT™**, **PLUGTESTS™** and **UMTS™** are Trade Marks of ETSI registered for the benefit of its Members.  
**TIPHON™** and the **TIPHON logo** are Trade Marks currently being registered by ETSI for the benefit of its Members.  
**3GPP™** is a Trade Mark of ETSI registered for the benefit of its Members and of the 3GPP Organizational Partners.

---

## Intellectual Property Rights

IPRs essential or potentially essential to the present document may have been declared to ETSI. The information pertaining to these essential IPRs, if any, is publicly available for **ETSI members and non-members**, and can be found in ETSI SR 000 314: *"Intellectual Property Rights (IPRs); Essential, or potentially Essential, IPRs notified to ETSI in respect of ETSI standards"*, which is available from the ETSI Secretariat. Latest updates are available on the ETSI Web server (<http://webapp.etsi.org/IPR/home.asp>).

Pursuant to the ETSI IPR Policy, no investigation, including IPR searches, has been carried out by ETSI. No guarantee can be given as to the existence of other IPRs not referenced in ETSI SR 000 314 (or the updates on the ETSI Web server) which are, or may be, or may become, essential to the present document.

---

## Foreword

This Technical Specification (TS) has been produced by ETSI 3rd Generation Partnership Project (3GPP).

The present document may refer to technical specifications or reports using their 3GPP identities, UMTS identities or GSM identities. These should be interpreted as being references to the corresponding ETSI deliverables.

The cross reference between GSM, UMTS, 3GPP and ETSI identities can be found under <http://webapp.etsi.org/key/queryform.asp>.

# Contents

Intellectual Property Rights .....	2
Foreword.....	2
Foreword.....	6
1 Scope .....	7
2 References .....	7
3 Definitions and abbreviations.....	8
3.1 Definitions .....	8
3.2 Abbreviations .....	8
4 Functional architecture .....	8
5 Activation, deactivation and interrogation .....	9
5.1 Activation .....	10
5.1.1 X1_1-interface .....	10
5.1.2 X1_2-interface (IRI) .....	11
5.1.3 X1_3-interface (IP) .....	11
5.2 Deactivation .....	12
5.2.1 X1_1-interface .....	12
5.2.2 X1_2-interface (IRI) .....	13
5.2.3 X1_3-interface (IP) .....	13
5.3 Interrogation .....	14
5.3.1 Interrogation of the MSC/VLR and the GMSC .....	14
5.3.2 Interrogation of Delivery Functions.....	14
6 Invocation of Lawful Interception.....	15
6.1 Provision of Intercept Product - Circuit Switched.....	16
6.1.1 Void .....	16
6.1.2 Two stubline configuration (circuit switched data or speech) to LEA.....	17
6.1.3 X3-interface .....	17
6.2 Provision of Intercept Product - Short Message Service .....	18
6.3 Provision of Intercept Related Information .....	18
6.3.1 X2-interface .....	19
6.3.2 Structure of the events .....	19
6.3.3 Call Related events .....	21
6.3.3.1 Call establishment .....	21
6.3.3.2 Answer .....	21
6.3.3.3 Supplementary Services .....	22
6.3.3.4 Handover.....	22
6.3.3.5 Release .....	22
6.3.4 Non Call Related events .....	23
6.3.4.1 SMS.....	23
6.3.4.2 Location update.....	23
6.3.4.3 Subscriber Controlled Input (SCI) .....	23
6.4 Intercept cases for supplementary services .....	24
6.4.1 Interception of Multiparty call.....	24
6.4.1.1 Intercept Product only for Multiparty .....	24
6.4.1.2 Intercept Related Information for Multiparty.....	25
6.4.2 Interception for Call Forwarding / Call Deflection.....	25
6.4.3 Interception on Call Hold / Call Waiting .....	25
6.4.4 Interception after ECT .....	25
7 Security.....	26
7.1 Security .....	26
7.1.1 Administration security.....	26
7.1.2 IRI security .....	26

7.1.2.1	Normal operation .....	26
7.1.2.2	Communication failure.....	26
7.1.3	IP security .....	27
7.1.4	Security aspects of Lawful Interception charging.....	27
7.1.5	Other security issues .....	27
7.1.5.1	Log files .....	27
7.1.5.2	Data consistency .....	27
<b>Annex A (normative): Information flows for Lawful Interception invocation.....</b>		<b>28</b>
A.1	Mobile originated circuit switched calls.....	28
A.2	Mobile terminated circuit switched calls.....	29
A.3	Call hold / call waiting .....	30
A.4	Multiparty calls .....	31
A.5	Call forwarding / call deflection.....	34
A.5.1	Unconditional call forwarding.....	34
A.5.2	Call forwarding on not reachable (IMSI detached).....	34
A.5.3	Call forwarding on busy (network determined).....	35
A.5.4	Call forwarding on not reachable (no response to paging/radio channel failure).....	35
A.5.5	Call forwarding on no reply .....	36
A.5.6	Call forwarding on busy (user determined)/call deflection .....	36
A.5.7	Call waiting / call forwarding on no reply.....	37
A.6	Explicit call transfer .....	39
<b>Annex B (normative): Interception for GPRS.....</b>		<b>41</b>
B.1	Architecture.....	41
B.2	Activation, deactivation and interrogation .....	41
B.2.1	Activation.....	42
B.2.1.1	X1_1p-interface .....	42
B.2.1.2	X1_2p-interface (IRI) .....	43
B.2.1.3	X1_3p-interface (IP).....	44
B.2.2	Deactivation .....	45
B.2.2.1	X1_1p-interface .....	45
B.2.2.2	X1_2p-interface (IRI) .....	46
B.2.2.3	X1_3p-interface (IP).....	46
B.2.3	Interrogation.....	47
B.2.3.1	Interrogation of the SGSN and GGSN.....	47
B.2.3.2	Interrogation of Delivery Functions.....	47
B.3	Invocation of Lawful Interception.....	48
B.3.1	Provision of Intercept Product - GPRS.....	49
B.3.1.1	X3p-interface .....	49
B.3.2	Provision of Intercept Product - Short Message Service .....	50
B.3.3	Provision of Intercept Related Information .....	50
B.3.3.1	X2p-interface .....	51
B.3.3.2	Structure of the events .....	51
B.3.3.3	GPRS related events .....	52
B.3.3.3.1	GPRS attach .....	52
B.3.3.3.2	GPRS detach .....	53
B.3.3.3.3	GPRS PDP context activation.....	53
B.3.3.3.4	Start of interception with PDP context active .....	53
B.3.3.3.5	GPRS PDP context deactivation .....	54
B.3.3.3.6	Cell and/or RA update.....	54
B.3.3.3.7	SMS.....	54
B.3.4	Intercept cases for supplementary services .....	54
B.4	Security.....	55
B.4.1	Security .....	55
B.4.1.1	Administration security.....	55

B.4.1.2	IRI security .....	55
B.4.1.2.1	Normal operation .....	55
B.4.1.2.2	Communication failure.....	55
B.4.1.3	IP security .....	56
B.4.1.4	Security aspects of Lawful Interception billing .....	56
B.4.1.5	Other security issues .....	56
B.4.1.5.1	Log files .....	56
B.4.1.5.2	Data consistency .....	56
B.5	Information flows for Lawful Interception invocation (informative) .....	57
B.5.1	GPRS attach .....	57
B.5.2	Mobile originated GPRS detach .....	57
B.5.3	Network initiated GPRS detach.....	58
B.5.4	Intra SGSN Routing Area Update .....	58
B.5.5	Inter SGSN Routing Area Update .....	59
B.5.6	PDP Context Activation .....	60
B.5.7	Start of interception with PDP context active.....	60
B.5.8	MS initiated PDP Context Deactivation.....	61
B.5.9	Network initiated PDP Context Deactivation.....	61
B.5.10	SMS.....	62
<b>Annex C (informative):</b>	<b>Change history .....</b>	<b>63</b>
History .....		64

---

# Foreword

This Technical Specification has been produced by the 3<sup>rd</sup> Generation Partnership Project (3GPP).

The contents of the present document are subject to continuing work within the TSG and may change following formal TSG approval. Should the TSG modify the contents of the present document, it will be re-released by the TSG with an identifying change of release date and an increase in version number as follows:

Version x.y.z

where:

- x the first digit:
  - 1 presented to TSG for information;
  - 2 presented to TSG for approval;
  - 3 or greater indicates TSG approved document under change control.
- y the second digit is incremented for all changes of substance, i.e. technical enhancements, corrections, updates, etc.
- z the third digit is incremented when editorial only changes have been incorporated in the document.

---

# 1 Scope

The present document gives the stage 2 description of Lawful Interception within a PLMN for circuit switched systems and GPRS. It does not address the interface between the PLMN and the LEA lawful intercepted product and related information collection functions. This is outside the scope of the GSM standard.

The structure of the present document is as follows:

- clause 4 covers the architecture of the interception system;
- clause 5 describes how interception is activated, deactivated and interrogated within the interception system;
- clause 6 describes how the system is provisioned, defines events at which interception takes place and what kind of information is generated at each event;
- clause 7 provides brief descriptions of various intercept cases;
- clause 8 reviews security requirements for access to the interception system;
- annex A provides information flows to illustrate when intercepted traffic and related data is generated;
- annex B describes an interception system for GPRS. The annex is subdivided into 5 sections that are identical in structure to clauses 4 through 8, but applicable to a GPRS clause rather than a GSM circuit switched system.

---

# 2 References

The following documents contain provisions which, through reference in this text, constitute provisions of the present document.

- References are either specific (identified by date of publication, edition number, version number, etc.) or non-specific.
- For a specific reference, subsequent revisions do not apply.
- For a non-specific reference, the latest version applies. In the case of a reference to a 3GPP document (including a GSM document), a non-specific reference implicitly refers to the latest version of that document *in the same Release as the present document*.

- [1] GSM 01.04: "Digital cellular telecommunications system (Phase 2+); Abbreviations and acronyms".
- [2] 3GPP TS 41.033: "Digital cellular telecommunications system (Phase 2+); Lawful Interception requirements for GSM".
- [3] 3GPP TS 42.033: "Digital cellular telecommunications system (Phase 2+); Lawful Interception stage 1".
- [4] GSM 03.60: "Digital cellular telecommunications system (Phase 2+); GPRS Service description stage 2".



## 3 Definitions and abbreviations

### 3.1 Definitions

Definitions can be found in 3GPP TS 42.033 in the stage 1 description of Lawful interception and in GSM 03.60, the stage 2 service description for GPRS.

### 3.2 Abbreviations

In addition to those below abbreviations used in the present document are listed in GSM 01.04.

ADMF	Administration Function
DF2	Delivery Function 2
DF2P	Delivery Function 2 for GPRS
DF3	Delivery Function 3
DF3P	Delivery Function 3 for GPRS
GCI	Global Cell Identity
GSN	GPRS Support Node (i.e.SGSN or GGSN)
IA	Interception Area
IP	Intercept Product
IRI	Intercept Related Information
LEA	Law Enforcement Agency
SCI	Subscriber Controlled Input

## 4 Functional architecture

The following picture contains the reference configuration for the lawful interception. The various entities and interfaces are described in more detail in the succeeding subclauses.

There is one Administration Function (ADMF) in the network. Together with the delivery functions it is used to hide from the MSC/VLR and GMSC that there might be multiple activations by different Law Enforcement Agencies (LEAs) on the same target.

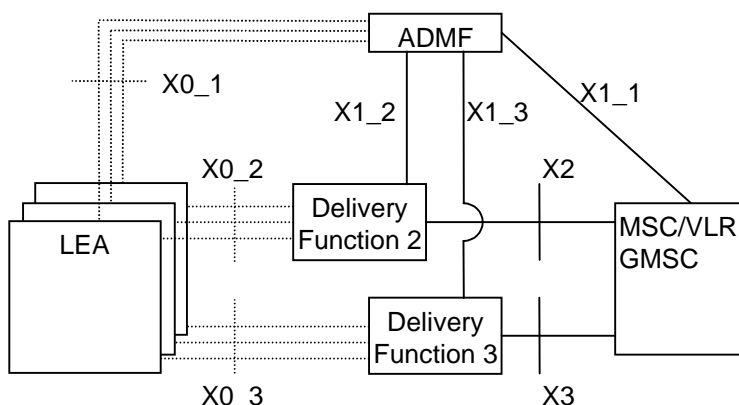
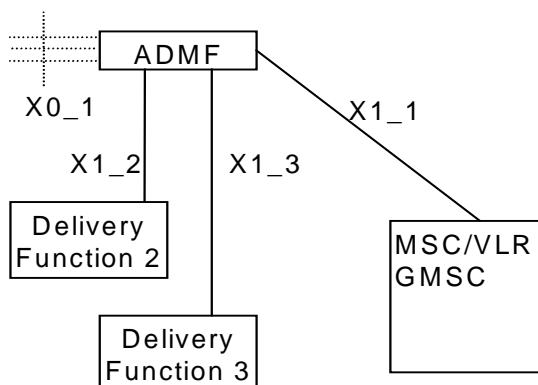

**Figure 1: Reference configuration**

The reference configuration is only a logical representation of the entities involved in lawful interception and does not mandate separate physical entities. This allows for higher levels of integration.

## 5 Activation, deactivation and interrogation

The following picture shows the extract from the reference configuration which is relevant for activation, deactivation and interrogation of the lawful interception.



**Figure 2: Functional model for Lawful Interception activation, deactivation and interrogation**

In addition to the typical GSM functional entities, a new functional entity is introduced - the ADMF - the Lawful Interception administration function. The ADMF:

- interfaces with all the LEAs that may require interception in the PLMN;
- keeps the intercept activities of individual LEAs separate;
- interfaces to the PLMN.

NOTE: The X1\_1, X1\_2 and X1\_3-interfaces together are functionally equivalent to the X1-interface represented in 3GPP TS 41.033.

Every physical MSC/VLR and GMSC is linked by an own X1\_1-interface to the ADMF. Consequently, every single MSC/VLR and GMSC performs interception (activation, deactivation, interrogation as well as invocation) independently from other MSC/VLRs and GMSCs. The X0\_1-interface represents the interface between the requester of the lawful interception and the Lawful administration function; it is included for completeness, but is beyond the scope of standardization.

In case of location dependent interception the following network/national options exist:

- target location versus Interception Areas (IAs) check in the MSC/VLR and Delivery Functions (DFs);
- target location versus IAs check in the DFs (physical collocation of the DFs to the MSC/VLR, GMSC is required).

NOTE: The IA is previously defined by a set of cells. From the location of the target this set of cells permits to find the relevant IA.

## 5.1 Activation

The following pictures show the information flow for the activation of the Lawful interception.

### 5.1.1 X1\_1-interface

The message sent from the ADMF to the MSC/VLR and GMSC respectively (X1\_1-interface) contains the:

- identity of the target (MSISDN, IMSI or IMEI) (see note 4);
- information whether the intercept product shall be provided (see note 1);
- information whether the intercept related information shall be provided (see note 1);
- address of Delivery Function 2 (DF2) for the intercept related information (see note 2);
- address of Delivery Function 3 (DF3) for the circuit switched intercept product (see note 3);
- IA in case of location dependent interception.

NOTE 1: As an option, the filtering whether intercept product and/or intercept related information has to be provided can be part of the delivery functions. If the option is used, the corresponding information can be omitted on the X1\_1-interface, while "information not present" means "intercept product and related information has to be provided" for the MSC. Furthermore the delivery function which is not requested has to be "pseudo-activated", in order to prevent error cases at invocation.

NOTE 2: As an option, only a single DF2 is used by and known to every MSC in the network. In this case the address of DF2 can be omitted.

NOTE 3: As an option, only a single DF3 is used by and known to every MSC in the network. In this case the address of DF3 can be omitted.

NOTE 4: Interception of IMEI is not applicable at the GMSC.

If after activation subsequently Intercept Product (IP) or Intercept Related Information (IRI) has to be activated (or deactivated) an "activation change request" with the same identity of the target is to be sent.

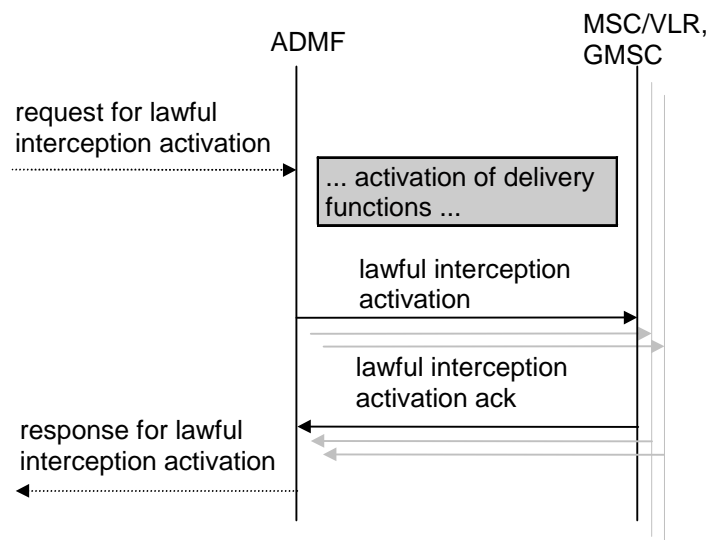

**Figure 3: Information flow on X1\_1-interface for Lawful Interception activation**

Interception of a target can be activated on request from different LEAs and each LEA may request interception via a different identity. In this case, each identity of the target on which to intercept will need to be sent via separate activation message from ADMF to MSC/VLR and GMSC on the X1\_1-interface. Each activation can be for IP only, IRI only, or both IP and IRI.

When several LEAs request activation on the same identity then the ADMF determines that there are existing activations on the identity. In this case, the ADMF will not send an additional activation message to the MSC/VLR and GMSC except when the activation needs to change from IP only or IRI only to IP and IRI. In that case an activation change message will be sent to the MSC/VLR and GMSC.

### 5.1.2 X1\_2-interface (IRI)

For the delivery of IRI the message sent from the ADMF to the Delivery Function contains:

- the identity of the target;
- the address for delivery of IRI (= LEA address);
- which subset of information shall be delivered;
- a DF2 activation identity, which uniquely identifies the activation for DF2 and is used for further interrogation or deactivation, respectively;
- the IA in case of location dependent interception;
- the warrant reference number if required by national option.

If a target is intercepted by several LEAs and/or several identities simultaneously, a single activation of delivery is necessary for each combination of LEA and identity.

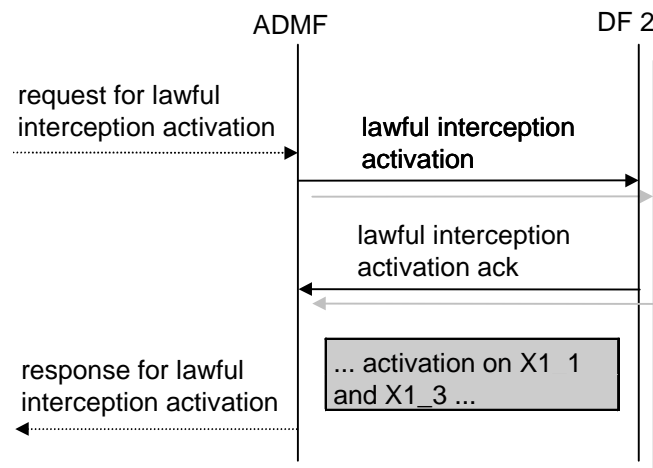

**Figure 4: Information flow on X1\_2-interface for Lawful Interception activation**

### 5.1.3 X1\_3-interface (IP)

For the delivery of circuit switched intercept product the message sent from the ADMF to the Delivery Function contains:

- the identity of the target;
- the address of delivery for IP (= LEA address);
- a DF3 activation identity, which uniquely identifies the activation for delivery function 3 and is used for further interrogation or deactivation, respectively;
- the IA in case of location dependent interception;
- the warrant reference number if required by national option.

If a target is intercepted by several LEAs and/or several identities simultaneously, a single activation of delivery is necessary for each combination of LEA and identity.

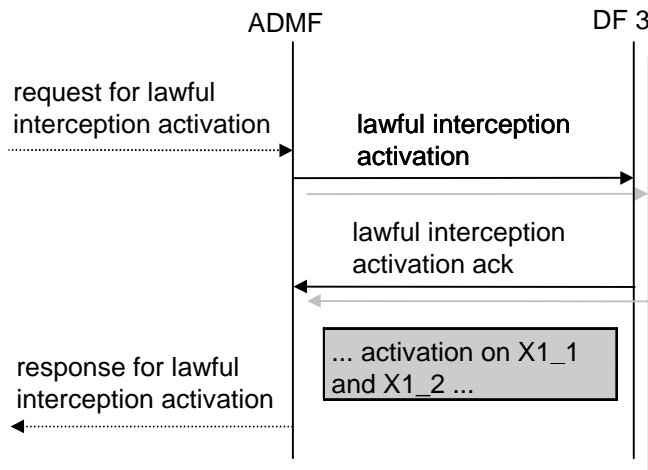

Figure 5: Information flow on X1\_3-interface for Lawful Interception activation

## 5.2 Deactivation

The following picture shows the information flow for the deactivation of the Lawful interception.

### 5.2.1 X1\_1-interface

The messages sent from the ADMF to the MSC/VLR and GMSC for deactivation contains:

- the identity of the target;
- the possible relevant IAs in case of location dependent interception.

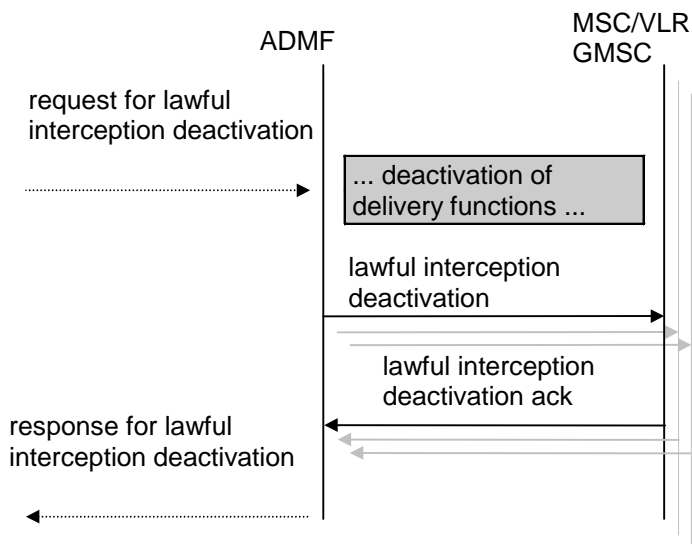

Figure 6: Information flow on X1\_1-interface for Lawful Interception deactivation

If interception of a target has been activated via different identities then a separate deactivation message will need to be sent from the ADMF to the MSC/VLR and the GMSC for each identity.

When several LEAs requested activation on the same identity and subsequently request deactivation then the ADMF determines that there are remaining activations on the identity. In this case, the ADMF will not send a deactivation message to the MSC/VLR and the GMSC except when the activation needs to change from IP and IRI to IP only or IRI only. In that case an activation change message will be sent to the MSC/VLR and the GMSC.

### 5.2.2 X1\_2-interface (IRI)

The ADMF sent for the deactivation to the Delivery Function 2 of the Intercept Related Information:

- a DF2 activation id, which uniquely identifies the activation to be deactivated for DF2.

If a target is intercepted by several LEAs and/or several identities simultaneously, a single deactivation is necessary for each combination of LEA and identity.

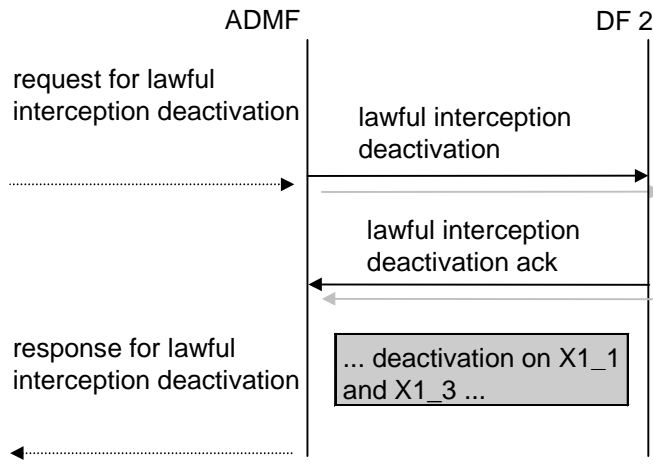

Figure 7: Information flow on X1\_2-interface for Lawful Interception deactivation

### 5.2.3 X1\_3-interface (IP)

For the deactivating the delivery of the IP the message from the ADMF to the Delivery Function contains:

- a DF3 activation id, which uniquely identifies the activation to be deactivated for DF3.

If a target is intercepted by several LEAs and/or several identities simultaneously, a single deactivation is necessary for each combination of LEA and identity.

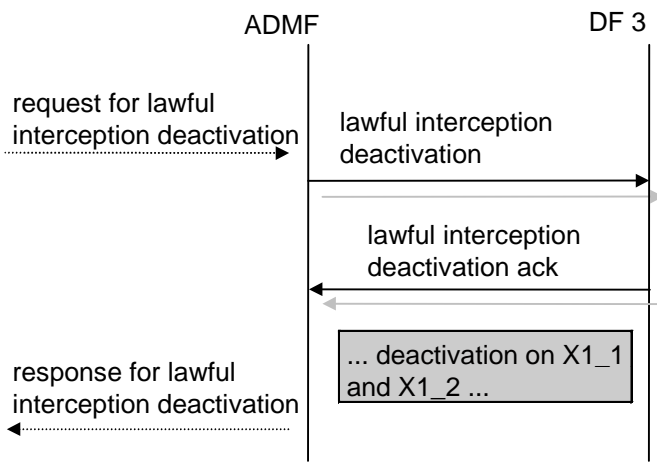

Figure 8: Information flow on X1\_3-interface for Lawful Interception deactivation

### 5.3 Interrogation

The purpose of interrogation is consistency checking for the interception function. It can be use e.g. for audit functionality, but this is beyond the scope of the present document.

Interrogation of all activations for a given LEA is an ADMF filter function.

#### 5.3.1 Interrogation of the MSC/VLR and the GMSC

The following picture shows the information flow for the interrogation of the Lawful interception. It must be possible to interrogate

- a specific activation at this MSC/VLR or GMSC for a given target identity;
- all activations at this MSC/VLR or GMSC.

As result of the interrogation the activation status and data are returned.

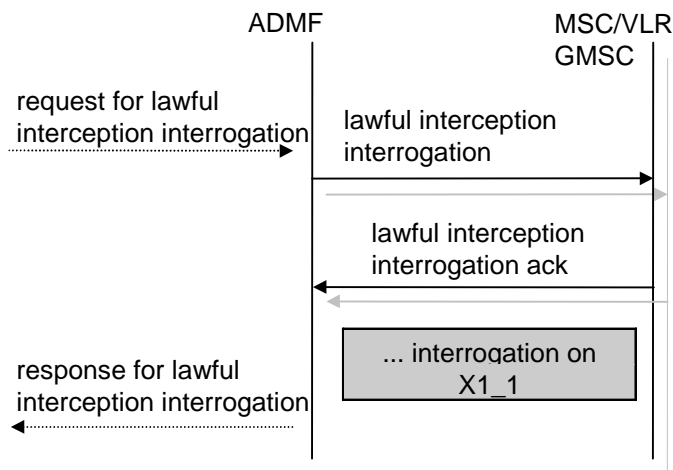

Figure 9: Interrogation of the Lawful Interception (MSC/VLR, GMSC)

#### 5.3.2 Interrogation of Delivery Functions

The following picture shows the information flow for the interrogation of the Lawful interception. It must be possible to interrogate:

- a specific activation at a Delivery Function for a given activation id;
- all activations at a Delivery Function for a given target identity;
- all activations at a Delivery Function.

As result of the interrogation the activation status and data are returned.

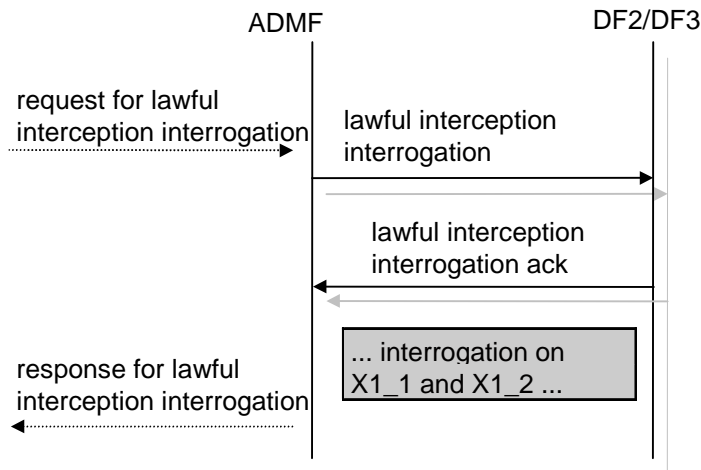

Figure 10: Interrogation of the Lawful Interception (Delivery Functions)

## 6 Invocation of Lawful Interception

The following picture shows the extract from the reference configuration which is relevant for the invocation of the lawful interception.

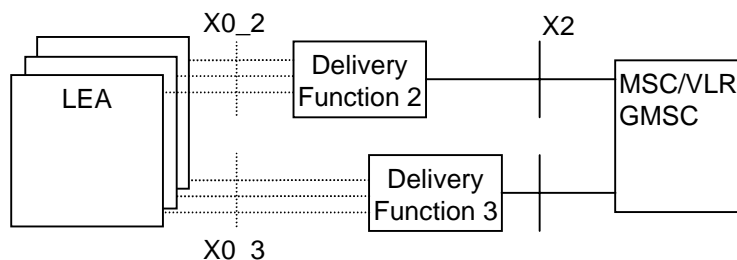

Figure 11: Functional model for Lawful Interception invocation

The X0\_2 and X0\_3-interfaces represent the interfaces between the LEA and two delivery functions. Both interfaces are subject to national requirements. They are included for completeness, but are beyond the scope of standardization. The delivery functions are used:

- to convert the information on the X2-interface to the corresponding information on the X0\_2-interface;
- to distribute the intercept related information to the relevant LEA(s) (based on IAs, if defined);
- to distribute the intercept product to the relevant LEA(s) (based on IAs, if defined).

In case a call is selected based on several identities (MSISDN, IMSI, IMEI) of the same target, the MSC/VLR or GMSC will deliver IP and IRI only once to the DF2 and DF3. DF2 and DF3 will then distribute the information to the relevant LEA that requested interception on a particular target identity.

For the delivery of the IP and IRI the MSC/VLR or GMSC provides correlation number and target identity to the DF2 and DF3 which is used there in order to select the different LEAs where the product shall be delivered to.

**NOTE:** If interception has been activated for both parties of the call both IP and IRI will be delivered for each party as separate intercept activity.

The location dependency check occurs at the establishment of each call. Subsequent dependency checks for simultaneous calls are not required, but can be a national option.

If a target is marked using an IA in the MSC/VLR, the MSC/VLR shall perform a location dependency check at call set-up. Only if the target's location matches the IA the call is intercepted.



If a target is marked using an IA in the DF2, the DF2 shall perform a location dependency check at reception of the first IRI for the call. Only if the target's location matches the IA for certain LEAs the IRI is relayed to these LEAs. All subsequent IRIs for the call are sent to the same LEAs.

If a target is marked using an IA in the DF3, the DF3 shall perform a location dependency check at reception of the IP. Only if the target's location matches the IA for certain LEAs the IP is relayed to these LEAs.

Gateway intercept is not possible when optimal routing is employed.

## 6.1 Provision of Intercept Product - Circuit Switched

Depending on the existing possibilities within the MSC/VLR or GMSC the access method for the delivering of call content can be bridged/ T-connection (see figure 12) or looped access (see figure 13).

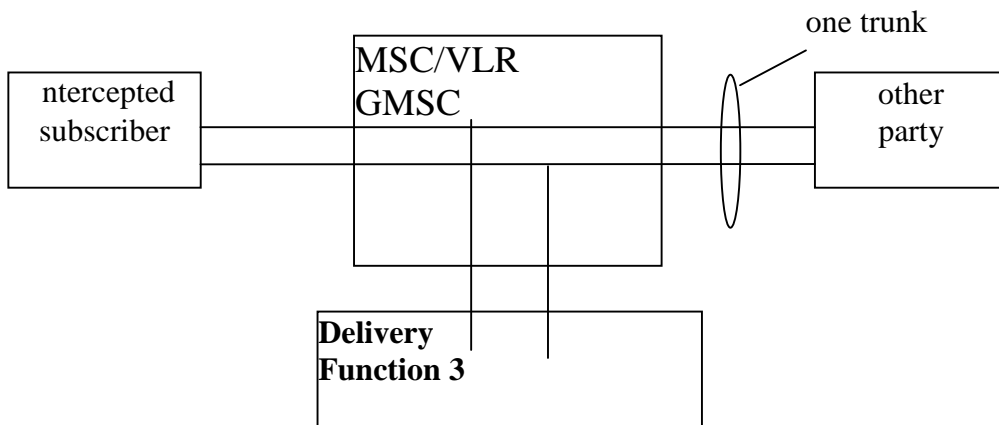

Figure 12: Bridged Access

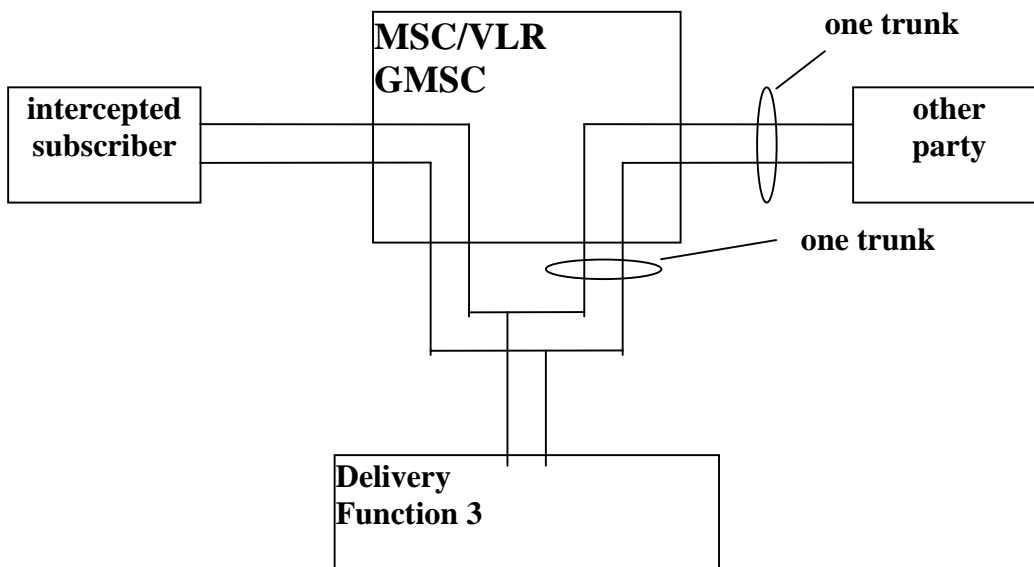

Figure 13: Looped access

### 6.1.1 Void

## 6.1.2 Two stubline configuration (circuit switched data or speech) to LEA

Figure 16 shows the configuration for a circuit switched data call. The signals of both parties of the configuration to be intercepted are delivered separately to the requesting function. Again the requesting function itself has no impact on the connection between the subscribers. Optionally this configuration can be used for speech, too.

If in the MSC/VLR or GMSC it isn't known if a call is a data or speech call, it will be assumed that it is a data call.

The two stublines towards the requesting function are established in parallel to the call set up. For both stublines the address is used which has been provided during activation.

For multi-monitoring the DF3 must be able combine the two stublines to one, if one of the different LEAs wants this.

**NOTE:** For data calls it is necessary to provide means for fast call establishment towards the LEA so that it doesn't miss the beginning of the data transmission.

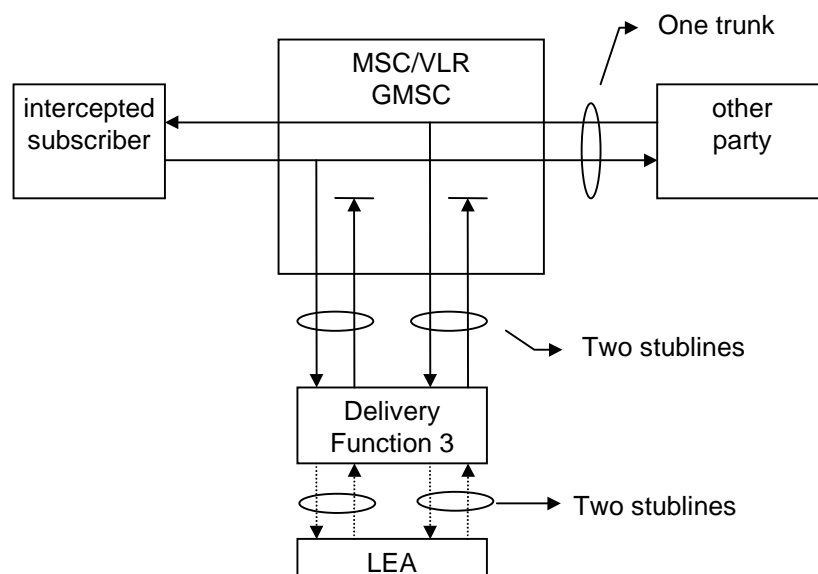

**Figure 16: Two stubline configuration to the LEA for the interception of a circuit switched data or speech call**

## 6.1.3 X3-interface

The following information needs to be transferred from the MSC/VLR or the GMSC to the DF3 in order to allow the DF3 to perform its functionality:

- the identity of the target (MSISDN, IMSI or IMEI); note 1
- the target location (if available) or the IAs in case of location dependent interception. note 1
- correlation number (IRI <-> CC);
- signal indicator (direction indication – Signal from target or signal to target); note 2

NOTE 1: For DF3 internal use only.

NOTE 2: e.g. integer, CC from target = 1, CC from other party = 2.

Additional information may be provided if required by national laws.

## 6.2 Provision of Intercept Product - Short Message Service

Figure 17 shows an SMS transfer from the MSC to the LEA. Quasi-parallel to the delivery from / to the mobile subscriber a message, which contains the contents of the SMS, is generated and sent via the Delivery Function 2 to the LEA in the same way as the Intercept Related Information.

The IRI will be delivered to the LEA:

- for a SMS-MO, when the SMS-Centre receives the SMS;
- for a SMS-MT, when the MS receives the SMS.

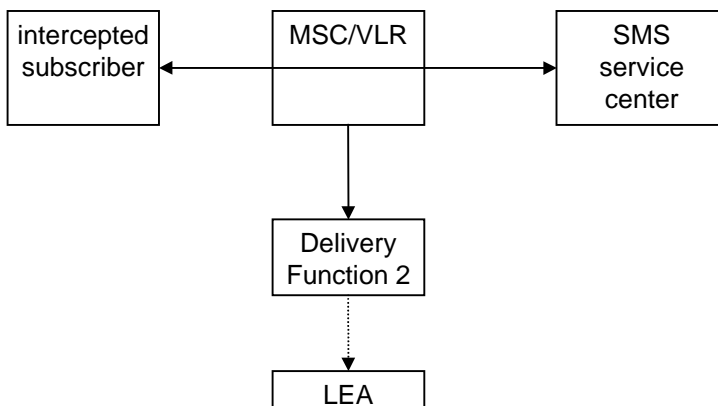

Figure 17: Provision of Intercept Product - Short Message Service

## 6.3 Provision of Intercept Related Information

Intercept Related Information (Events) are necessary at the Begin and End of the call, for all supplementary services during a call and for information which are not call associated. There are call related events and non call related events

Figure 18 shows the transfer of intercept related information to the DF2. If an event for / from a mobile subscriber occurs, the MSC/VLR or GMSC sends the relevant data to the DF2.

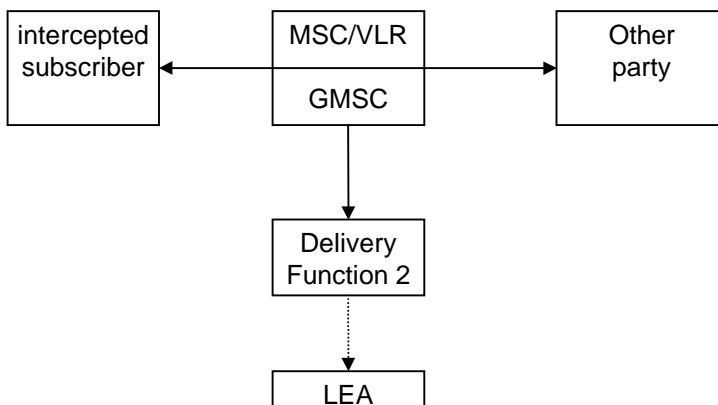

Figure 18: Provision of Intercept Related Information

### 6.3.1 X2-interface

The following information needs to be transferred from the MSC/VLR or the GMSC to the DF2 in order to allow a DF2 to perform its functionality:

- identity of the target (MSISDN, IMSI or IMEI);
- the target location (if available) or the IAs in case of location dependent interception;
- events and associated parameters as defined in subclauses 6.3.3 and 6.3.4 may be provided.

### 6.3.2 Structure of the events

There are eight different events in which the information is sent to the DF2 if this is required. There are call related and non call related events. Details are described in following subclause. The events for interception are configurable (if the are sent to DF2) in the MSC/VLR or GMSC and can be suppressed in the DF2.

It is a implementation option if the redundant information will be sent for each further event.

The following events are applicable to the MSC/VLR:

Call related events:

- Call establishment;
- Answer;
- Supplementary service;
- Handover;
- Release.

Non call related events:

- SMS;
- Location update;
- Subscriber controlled input.

The following events are applicable to the GMSC:

Call related events:

- Call establishment;
- Answer;
- Supplementary service;
- Release.

A set of information is used to generate the events. The events transmit the information from MSC/VLR or GMSC to DF2. This set of information can be extended in MSC/VLR or GMSC, if this is necessary in a specific country. DF2 can extend this information if this is necessary in a specific country e.g. a unique number for each surveillance warrant.

observed MSISDN	Target Identifier with the MSISDN of the target subscriber (monitored subscriber).
observed IMSI	Target Identifier with the IMSI of the target subscriber (monitored subscriber).
observed IMEI	Target Identifier with the IMEI of the target subscriber (monitored subscriber), it must be checked for each call over the radio interface
event type	Description which type of event is delivered: Establishment, Answer, Supplementary service, Handover, Release, SMS, Location update, Subscriber controlled input
event date	Date of the event generation in the MSC/VLR or GMSC
event time	Time of the event generation in the MSC/VLR or GMSC
dialled number	Dialled phone number before digit modification, IN-modification etc.
connected number	number of the answering party
other party address	Directory number of the other party for MOC Calling party for MTC
SMS-Centre address	number of the involved SMS-Centre
call direction	Information if the monitored subscriber is calling or called e.g. MOC/MTC or originating/ terminating in or/out
correlation number	Unique number for each call sent to the DF, to help the LEA, to have a correlation between each call and the IRI
cell id	Cell number of the target; for the location information
location area code	Location-area-code of the target defines the Location Area in a PLMN
basic service	Information about Tele service or bearer service.
supplementary service	Supplementary services used by the target e.g. CF, CW, ECT
forwarded to number	Forwarded to number at CF
call release reason	Call release reason of the target call
SMS	The SMS content with header which is sent with the SMS-service
SCI	Non call related Subscriber Controlled Input (SCI) which the MSC/VLR receives from the ME

## 6.3.3 Call Related events

### 6.3.3.1 Call establishment

For call establishment a call establishment-event is generated. At the begin of a call when the MSC/VLR or GMSC wants to reach the subscriber this event is generated. This information will be delivered to the DF2 if available:

observed MSISDN
observed IMSI
observed IMEI
event type
event date
event time
dialled number
other party address
call direction
correlation number
cell id
location area code
basic service
supplementary service

### 6.3.3.2 Answer

If the called party answers, a answer- event is generated. This information will be delivered to the DF2 if available:

observed MSISDN
observed IMSI
observed IMEI
event type
event date
event time
dialled number
other party address
connected party
call direction
correlation number
cell id
location area code
basic service
supplementary service

### 6.3.3.3 Supplementary Services

For supplementary services event are generated with the information which supplementary service is used e.g. Call Forwarding (CF), Call Waiting (CW), Explicit Call Transfer (ECT), Multi Party (MPTY), Call Hold and information correlated to the service like the forwarded to number. This information will be delivered to the DF2 if available:

observed MSISDN
observed IMSI
observed IMEI
event type
event date
event time
dialled number
other party address
call direction
correlation number
cell id
location area code
basic service
supplementary service
forwarded to number

### 6.3.3.4 Handover

For each handover a handover-event with the information about the new location (cell-id) is generated. This information will be delivered to the DF2 if available:

observed MSISDN
observed IMSI
observed IMEI
event type
event date
event time
correlation number
cell id
location area code

### 6.3.3.5 Release

For release of the observed call a release-event is generated, this is for the common (end) release of call and also for all failed call attempts, with the information about the reason for failed call attempts. This information will be delivered to the DF2 if available:

observed MSISDN
observed IMSI
observed IMEI
event type
event date
event time
dialled number
other party address
call direction
correlation number
cell id
location area code
basic service
call release reason

## 6.3.4 Non Call Related events

### 6.3.4.1 SMS

For MO-SMS the event is generated in the MSC/VLR, when the SMS-Centre successfully receives the SMS; for MT-SMS the event is generated in the MSC/VLR when the target receives the message. This information will be delivered to the DF2 if available:

observed MSISDN
observed IMSI
observed IMEI
event type
event date
event time
SMS-Centre address
call direction
cell id
location area code
SMS

### 6.3.4.2 Location update

For location updates a Location update-event is generated, with the new location (location area) information. This information will be delivered to the DF2 if available:

observed MSISDN
observed IMSI
observed IMEI
event type
event date
event time
cell id
location area code

### 6.3.4.3 Subscriber Controlled Input (SCI)

For subscriber controlled inputs (e.g. this are activations, deactivations and changes of services) a SCI-event is generated with information about the SCI. This information will be delivered to the DF2 if available:

observed MSISDN
observed IMSI
observed IMEI
event type
event date
event time
cell id
location area code
SCI



## 6.4 Intercept cases for supplementary services

### 6.4.1 Interception of Multiparty call

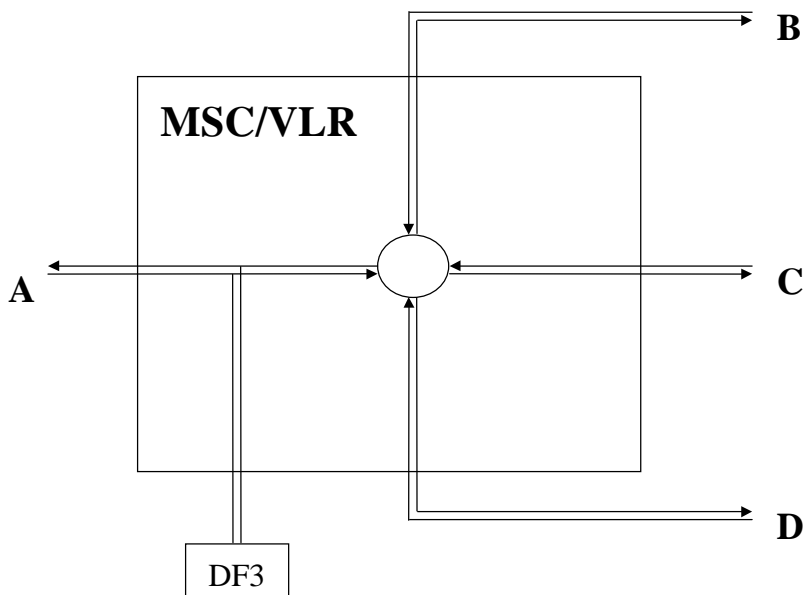

Figure 19: Option 1: Interception of Multiparty for IP

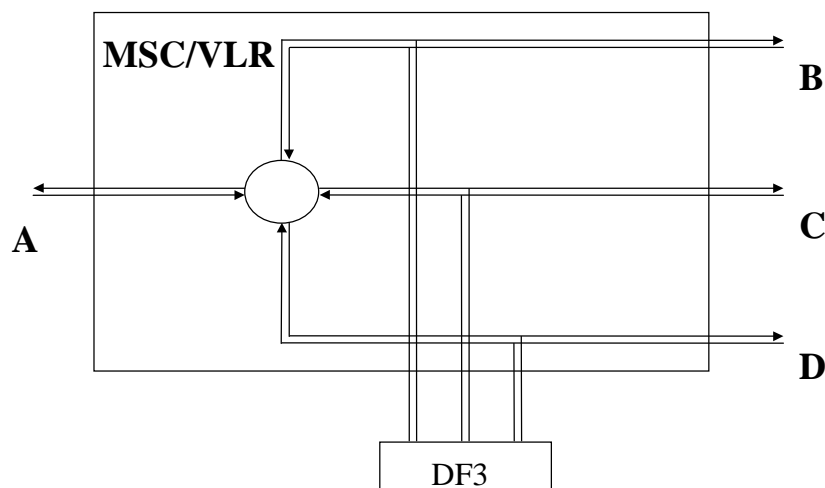

Figure 20: Option 2: Interception of Multiparty for IP

#### 6.4.1.1 Intercept Product only for Multiparty

One correlation number for each leg of a call. Call Content is delivered like it is in figure 19 or in figure 20 if subscriber A is monitored.

If one of B, C or D is monitored, the surveillance of intercept product works like an ordinary telephony call.

### 6.4.1.2 Intercept Related Information for Multiparty

In the event is the information about B, C and D if subscriber A is monitored. If one of B, C or D is monitored in the events is only the information about A but not the other parties of the conference.

### 6.4.2 Interception for Call Forwarding / Call Deflection

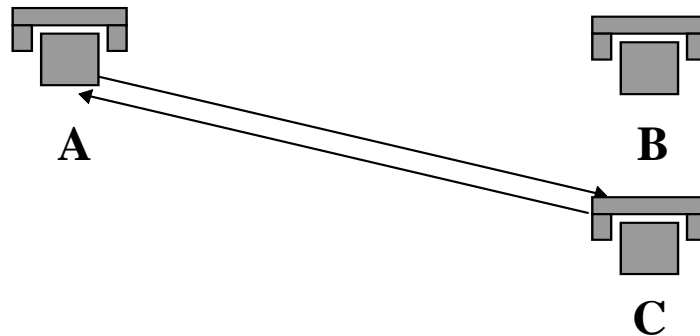

**Figure 21: Interception for Call Forwarding / Deflection**

For delivery of the Intercept Product it doesn't matter which of the three is monitored.

For Intercept Related Information it depends who is monitored:

- If subscriber A is monitored the number of A and B are mandatory in the event information and the number of C if available.
- If subscriber B is monitored the number of B and C are mandatory in the event information and the number of A if available.
- If subscriber C is monitored the number of C is mandatory in the event information and the number of A if available.

When optimal routing is employed, interception of call forwarding by party B may be unavailable.

### 6.4.3 Interception on Call Hold / Call Waiting

For interception on call hold it depends which method is used, if it is like in figure 19 no interception on call hold is possible, with the method like in figure 20 it is also possible to hear what the subscriber on hold is talking.

### 6.4.4 Interception after ECT

For interception on Explicit Call Transfer (ECT) it depends which method is used, if it is like in figure 19 no interception on call hold is possible, with the method like in figure 20 it is also possible to hear what the subscriber on hold is talking. The explicit transfer is handled similar to a forwarded call.

---

## 7 Security

### 7.1 Security

The security requirements are valid for the whole Lawful Interception system, i.e. rules and procedures shall be used for all involved entities, ADMF, GMSC, MSC/VLR and DF.

#### 7.1.1 Administration security

The administration of the lawful interception function, i.e. Activation, Deactivation and Interrogation of Lawful Interception, in the GMSC, MSC/VLR and the DFs must be done secure as described below:

- It shall be possible to configure the authorised user access to Activation, Deactivation and Interrogation of Lawful Interception separately for every physical or logical port at the GMSC, MSC/VLR and DF. This configuration possibility shall be password protected.
- Normally only the ADMF is allowed to have access to the lawful interception functionality in the GMSC, MSC/VLR and DF.
- The communication link between ADMF, GMSC, MSC/VLR, DF2 and DF3 shall be secure and shall support security mechanisms, e.g.:
  - authentication;
  - Closed User Group (CUG);
  - Connected Line Presentation (COLP);
  - encryption.
- No network entities or remote access shall be capable to manipulate or to eavesdrop lawful interception data in the GMSC, MSC/VLR or the DF.

#### 7.1.2 IRI security

##### 7.1.2.1 Normal operation

The transmission of the IRI shall be done in a secure manner.

When DF2 is a physically separate from the MSC, the X2-interface shall support security mechanisms, e.g.:

- authentication;
- CUG;
- COLP;
- encryption.

##### 7.1.2.2 Communication failure

Depending on the national law in case of communication failure IRI may be buffered in the GMSC and MSC/VLR. After successful transmission of IRI the whole buffer must be deleted. It shall be possible to delete the content buffer via command or a timer, in an unrestoreable fashion.

### 7.1.3 IP security

The transmission of the IP shall be done in a secure manner.

When DF3 is physically separate from the MSC, the X3-interface shall support security mechanisms, e.g.:

- authentication;
- CUG;
- COLP;
- encryption.

In case of transmission failure no buffering will be done.

### 7.1.4 Security aspects of Lawful Interception charging

Charging information shall be available at the DFs and the ADMF. Charging information for Lawful Interception shall be separated from "regular" GSM billing data.

Charging data transmission to the Lawful Interception billing system shall be done in a secure manner.

In case of transmission failure data shall be buffered/stored in a secure way. After successful transmission data shall be deleted in an unrestorable fashion.

### 7.1.5 Other security issues

#### 7.1.5.1 Log files

Log files shall be generated by the ADMF, DF2, DF3 and the MSC/VLR. All log files are retrievable by the ADMF, and are maintained by the ADMF.

#### 7.1.5.2 Data consistency

The administration function in the PLMN shall be capable to perform a periodic consistency check to ensure whether the target list of MSISDN, IMSI or IMEI is the same in all involved MSCs in the PLMN and the DFs. The reference data base is the ADMF data base.

# Annex A (normative): Information flows for Lawful Interception invocation

The following figures show the information flows for the invocation of Lawful Interception for various types of calls. The figures show some of the basic signalling messages of the target calls and the events on the X2 and X3-interfaces. The ISUP messages to and from the network are shown for informational purposes only; some of them may not be sent or may be combined in certain networks.

## A.1 Mobile originated circuit switched calls

Figure A.1 shows the interception of a basic mobile originated circuit switched speech or data call where the originating mobile (A) is the target for interception. B is not necessarily also a mobile subscriber and resides on a different exchange.

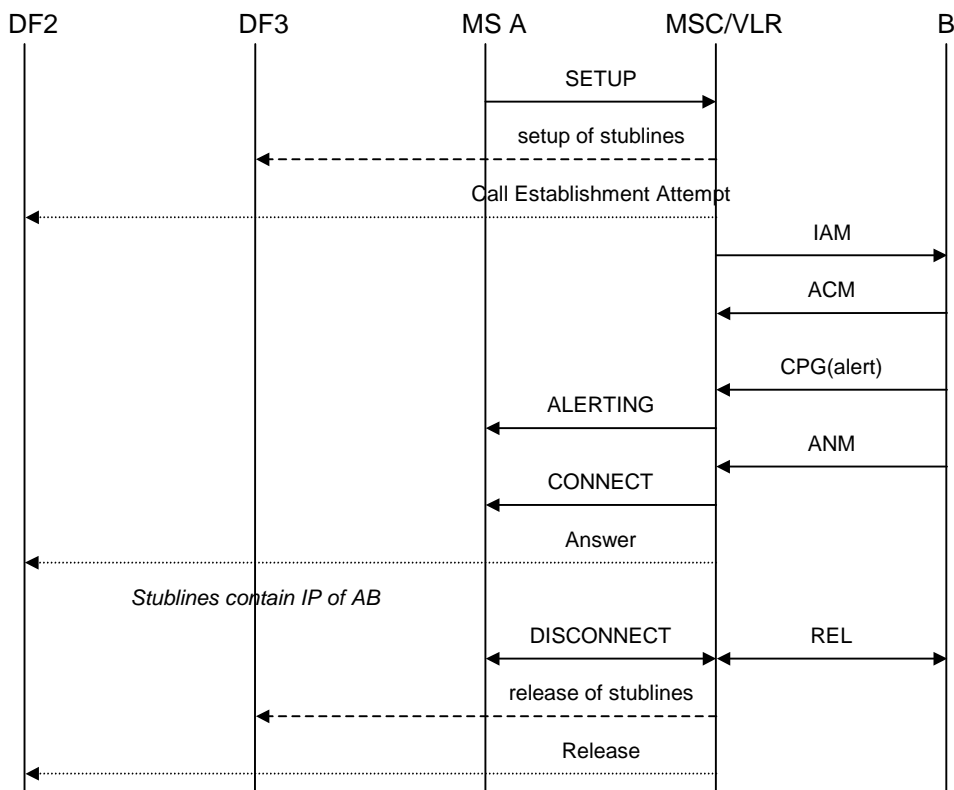

**Figure A.1: Interception of mobile originated circuit switched calls**

In figure A.1 the result (answer) of the set-up of the stublines is not shown. This assumes no special action is taken in case of failure.

## A.2 Mobile terminated circuit switched calls

Figure A.2 shows the interception of a basic mobile terminated circuit switched speech or data call where the terminating mobile (B) is the target for interception. A is not necessarily also a mobile subscriber and resides on a different exchange.

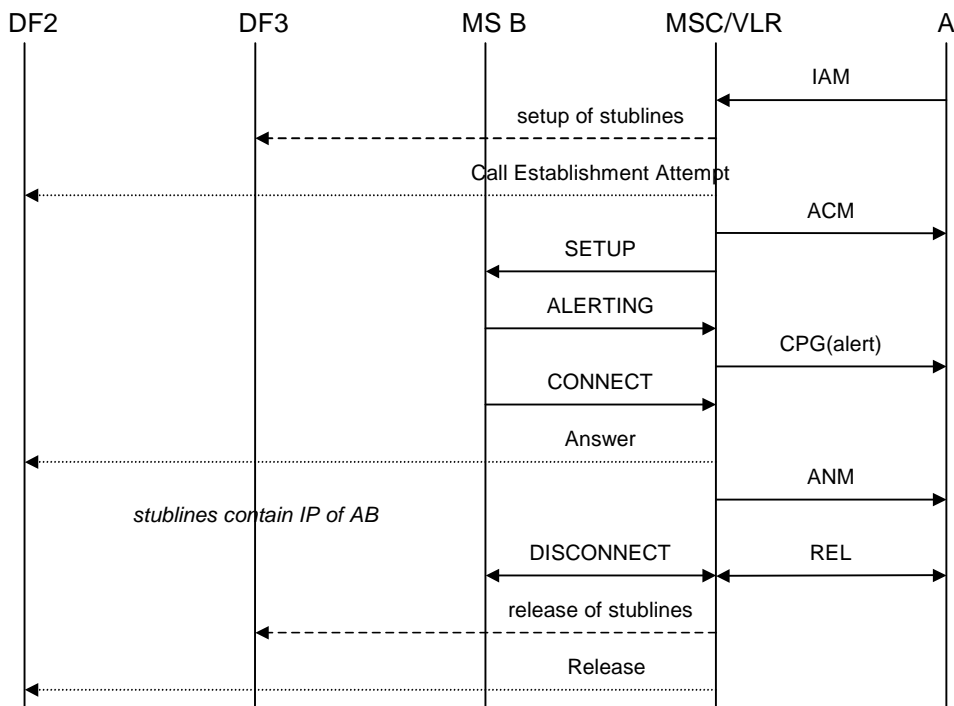

Figure A.2: Interception of mobile terminated circuit switched calls

### A.3 Call hold / call waiting

Figures A.3 and A.4 show the interception of calls involving call hold / call waiting. Figure A.3 covers the case where one pair of stublines is used per target, figure A.4 covers the case where a pair of stublines is used for each target call. The mobile that receives the waiting call (A) is the target for interception.

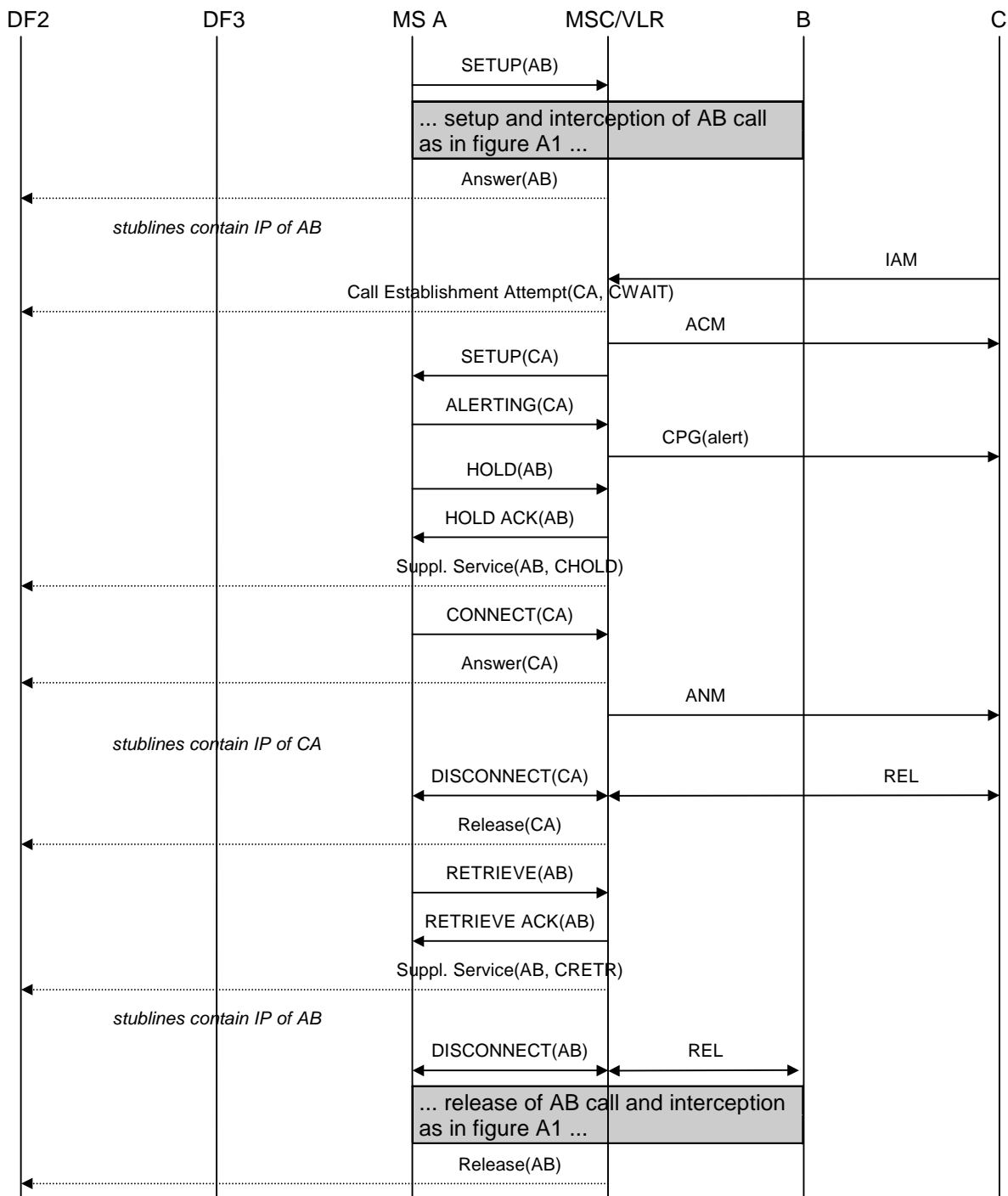

Figure A.3: Interception of call hold / call waiting - stublines per target

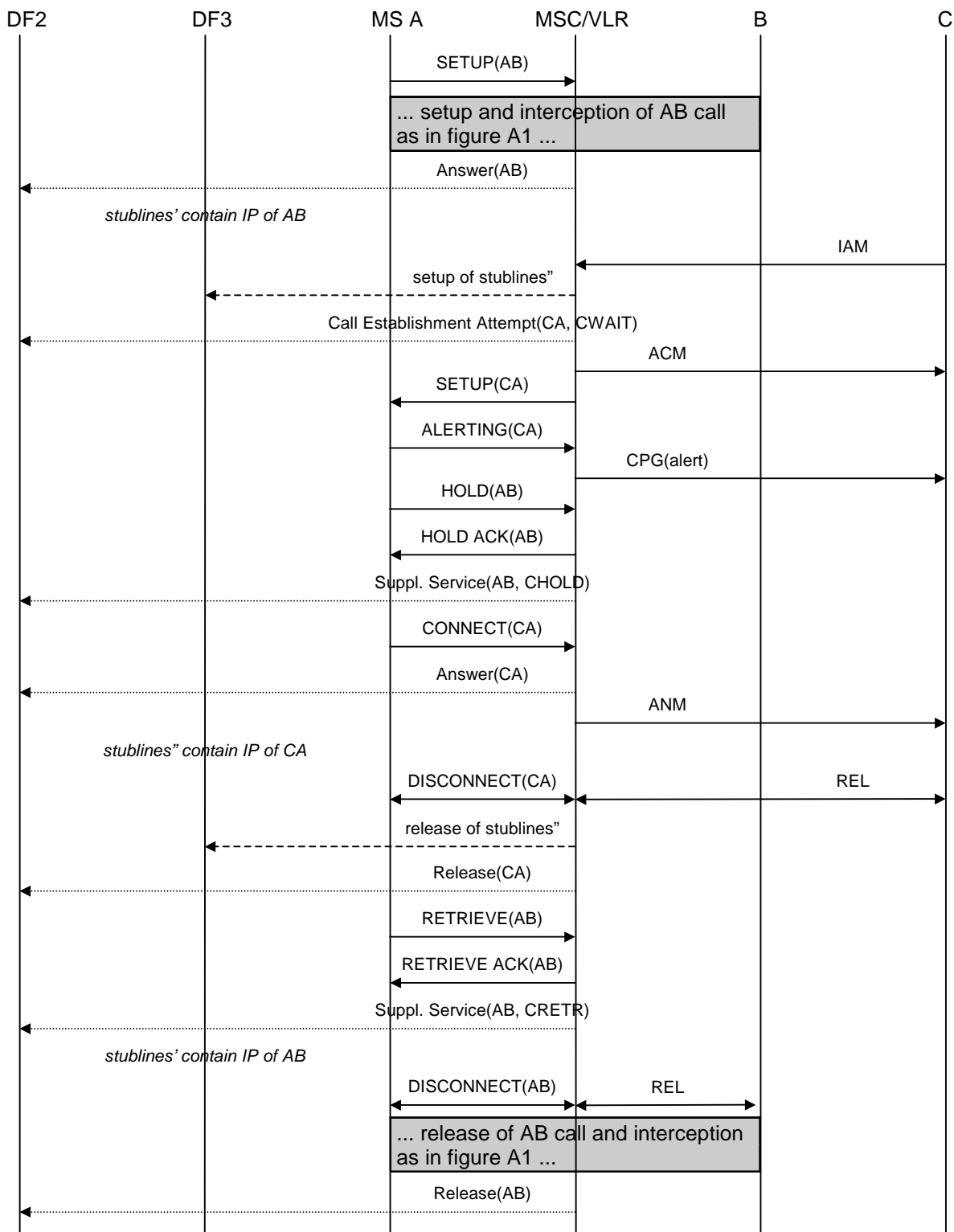

Figure A.4: Interception of call hold / call waiting - stublines per target call

## A.4 Multiparty calls

Figures A.5 and A.6 show the interception of multiparty calls. Figure A.5 covers the case where one pair of stublines is used per target, figure A.6 covers the case where a pair of stublines is used for each target call. The mobile setting up the multiparty call (A) is the target for interception.



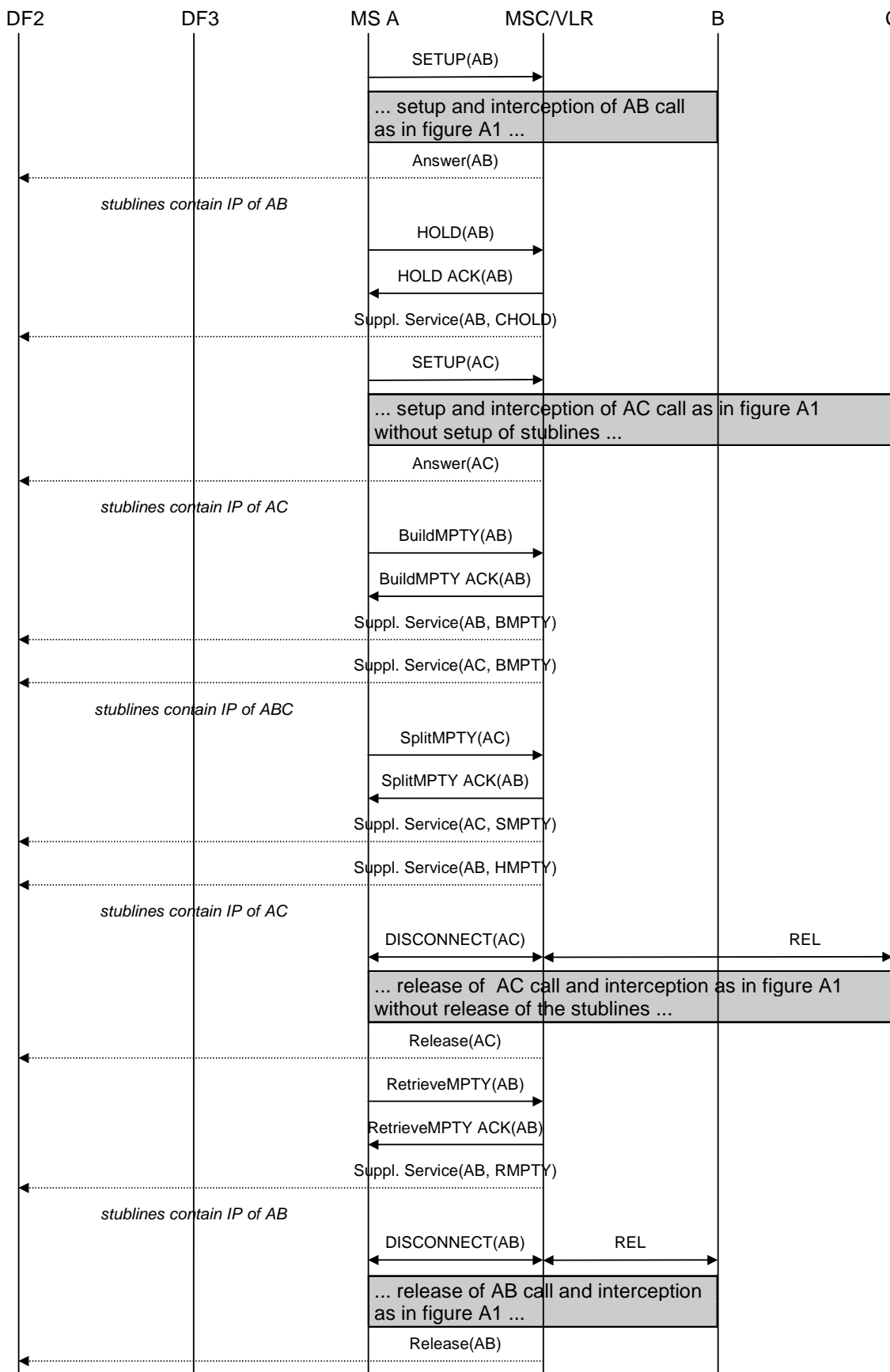

Figure A.5: Interception of multiparty calls - sublines per target

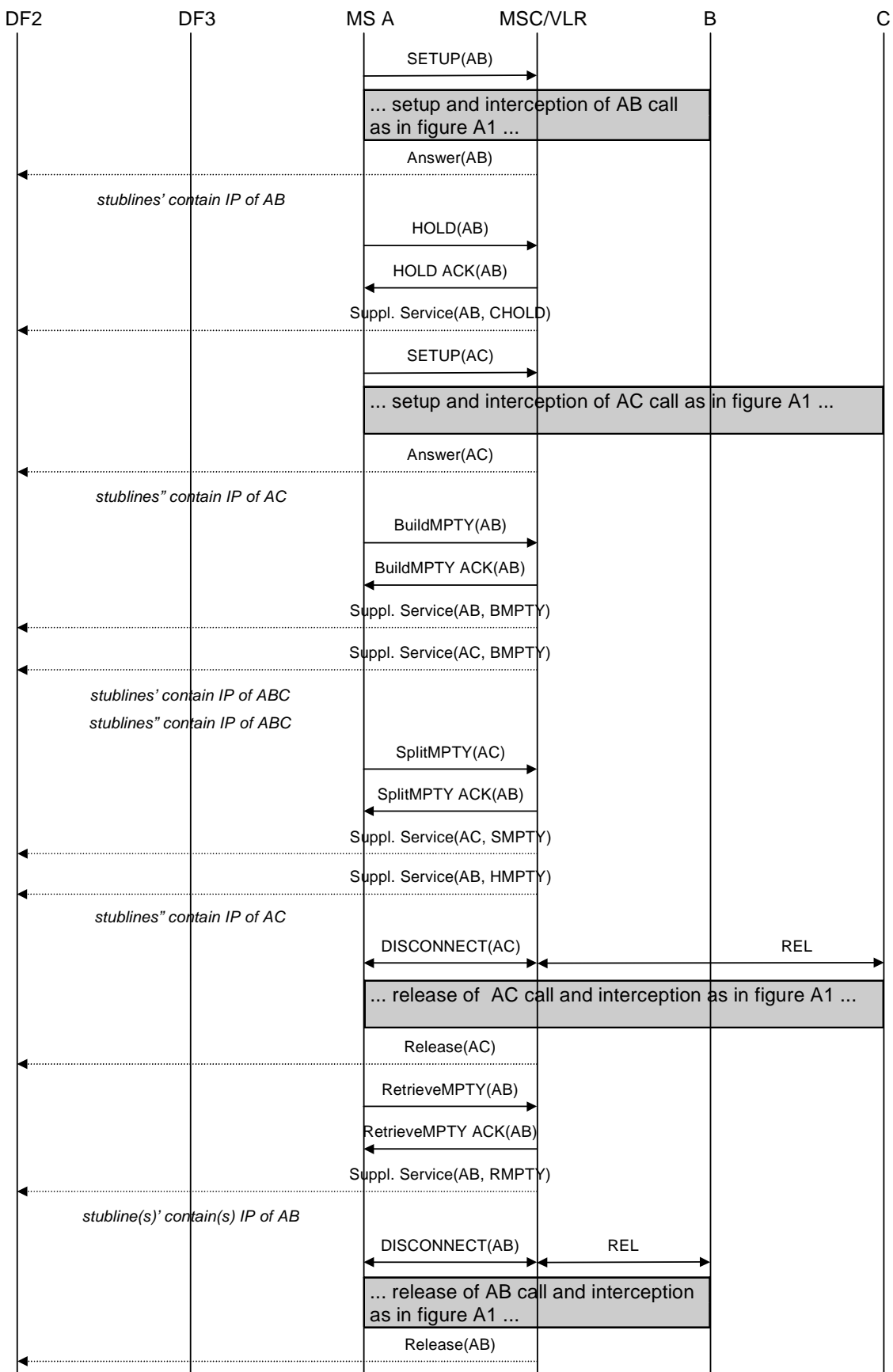

Figure A.6: Interception of multiparty calls - stublines per target call

## A.5 Call forwarding / call deflection

The following pictures show the information flows for the interception of forwarded calls. Information flows will be given for three typical cases of call forwarding. All other types of call forwarding / call deflection are intercepted similar to one of these.

### A.5.1 Unconditional call forwarding

Figure A.7 shows the interception of unconditionally forwarded calls. The mobile that activated unconditional call forwarding (B) is the target for interception. In this case interception will be performed at the GMSC, where the SRI request for B is issued and subsequently the SRI response indicating that the call must be forwarded is received back.

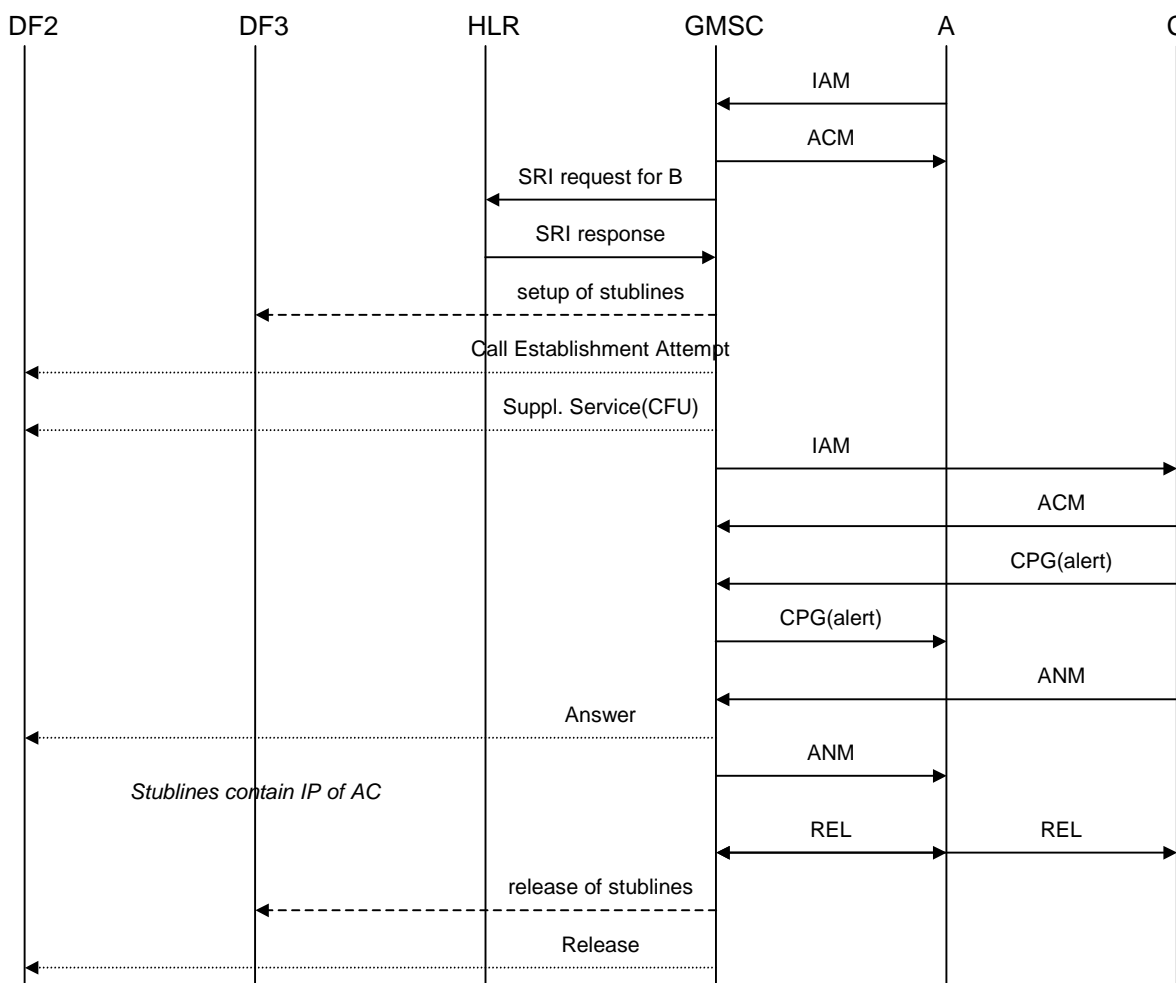

Figure A.7: Interception of unconditional call forwarding

### A.5.2 Call forwarding on not reachable (IMSI detached)

Call forwarding on not reachable because the IMSI is detached is also handled on the GMSC. Interception of this type of call forwarding is similar to interception of unconditional call forwarding.

### A.5.3 Call forwarding on busy (network determined)

Figure A.8 shows the interception of call forwarding on busy (network determined). The mobile that activated call forwarding on busy (B) is the target for interception. In this case interception will be performed at the MSC/VLR where B resides, where the busy condition is detected and the call is forwarded.

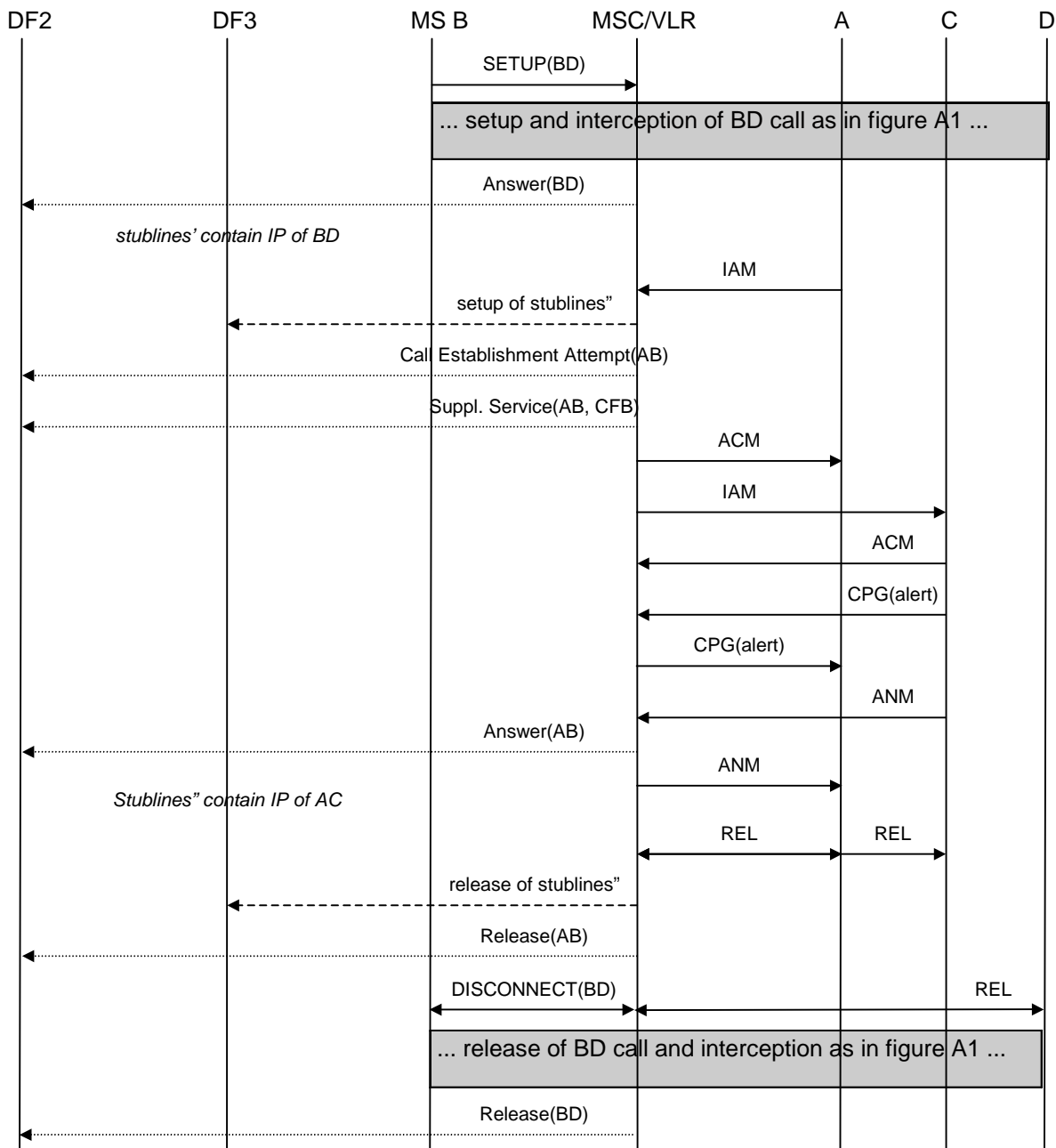

Figure A.8: Interception of call forwarding on busy (network determined)

### A.5.4 Call forwarding on not reachable (no response to paging/radio channel failure)

Call forwarding on not reachable because of no response to paging or radio channel failure is also handled on the MSC/VLR similar to call forwarding on busy (network determined). Interception of this type of call forwarding is therefore done in the same way.

### A.5.5 Call forwarding on no reply

Figure A.9 shows the interception of call forwarding on no reply. The mobile that activated call forwarding on no reply (B) is the target for interception. In this case interception will be performed at the MSC/VLR where B resides, where the no reply condition is detected and the call is forwarded. Initially, the interception is similar to the interception of a basic mobile terminated circuit switched speech of data call. On no reply time-out, the interception will continue on the forwarded call to C.

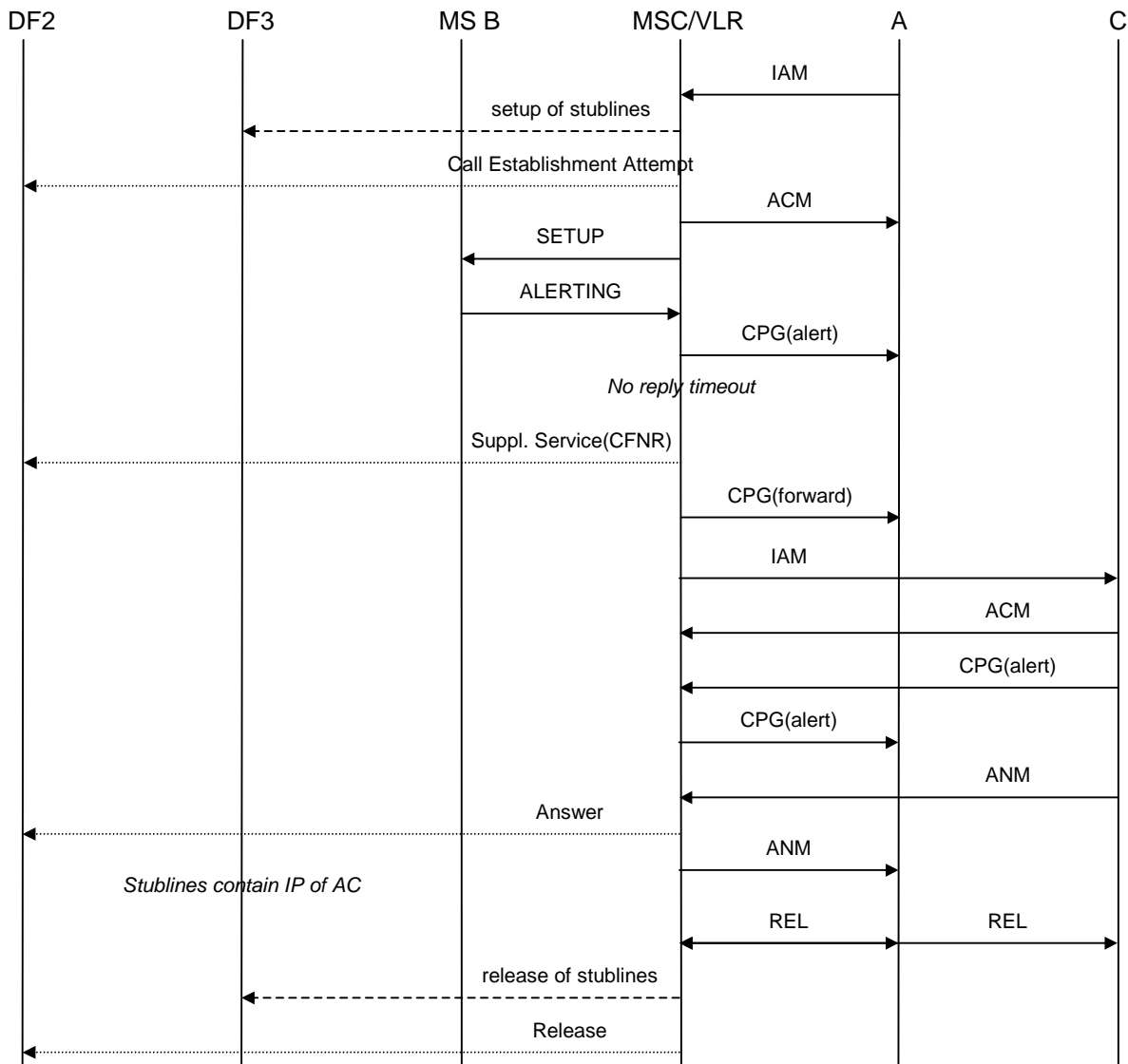

**Figure A.9: Interception of call forwarding on no reply**

In figure A.9 the release of the stublines is done after the forwarded call is released by A or C. It is a national option not to support interception of forwarded calls. In that case, the release of the stublines is done after the call is forwarded and B is no longer involved.

### A.5.6 Call forwarding on busy (user determined)/call deflection

Call forwarding on busy (user determined) and call deflection are also handled on the MSC/VLR similar to call forwarding on no reply. Interception of this type of call forwarding is therefore done in the same way.

### A.5.7 Call waiting / call forwarding on no reply

Figures A.10 and A.11 show the interception of a call involving both call waiting and call forwarding on no reply. Figure A.10 covers the case where one pair of stublines is used per target, figure A.11 covers the case where a pair of stublines is used for each target call. The mobile that activated call forwarding on no reply and receives the waiting call (B) is the target for interception. In figure A.10 a new (pair of) stublines needs to be set up when the call is forwarded since the first (pair of) stublines is still used for the initial call.

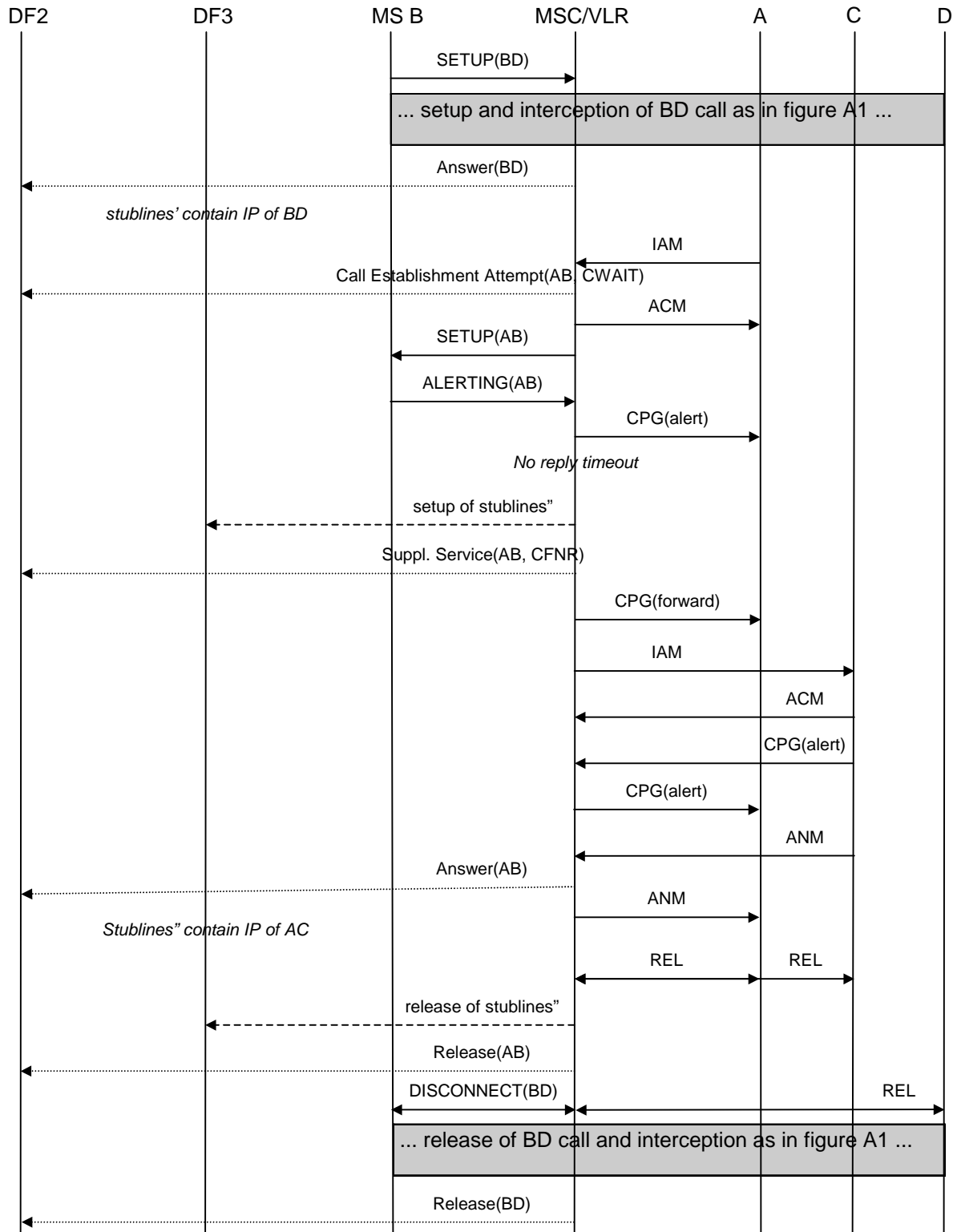

Figure A.10: Interception of call waiting / call forwarding on no reply - stublines per target

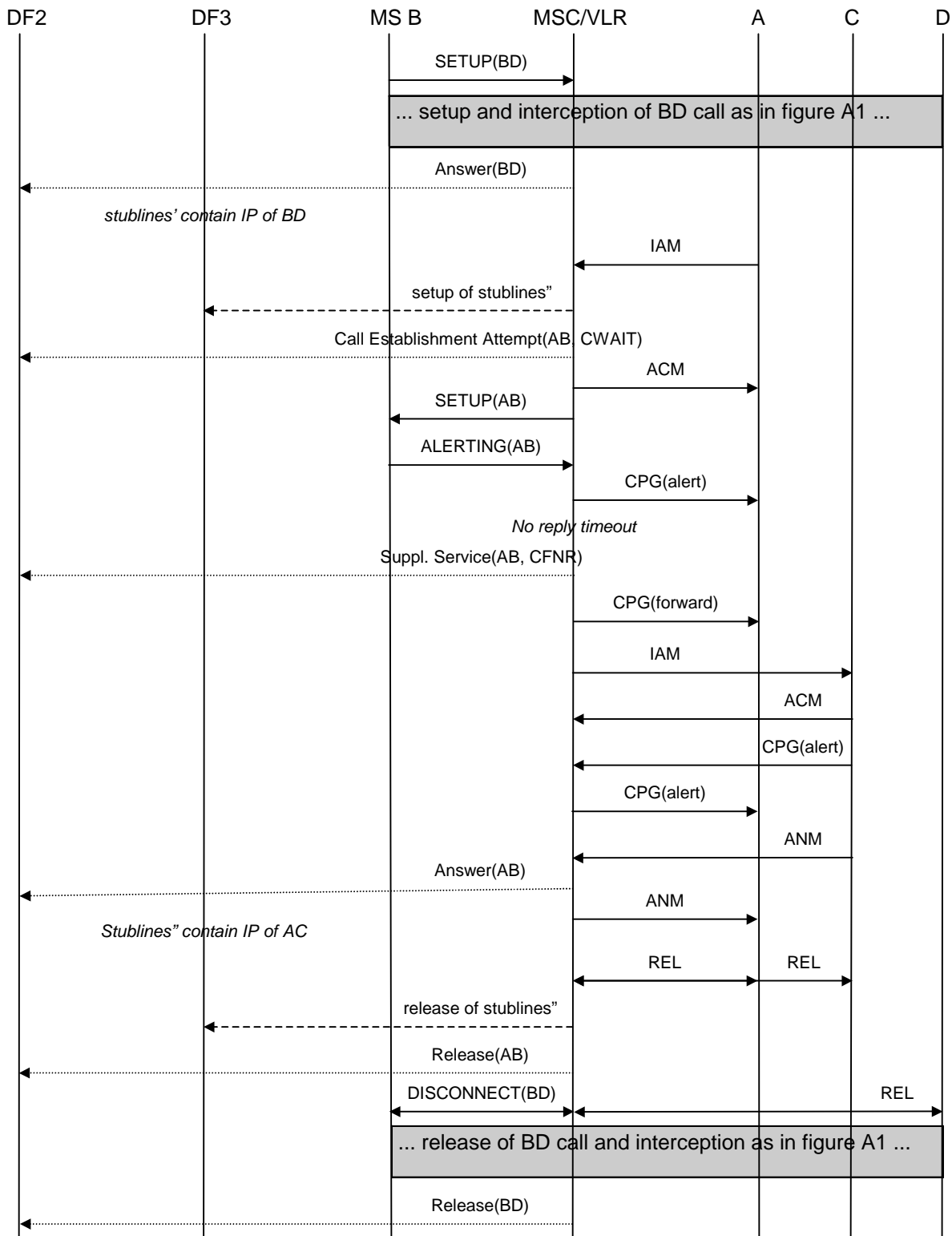

Figure A.11: Interception of call waiting / call forwarding on no reply - stublines per target call

## A.6 Explicit call transfer

Figures A.12 and A.13 show the interception of explicit call transfer. Figure A.12 covers the case where one pair of stublines is used per target, figure A.13 covers the case where a pair of stublines is used for each target call. The mobile transferring the call (B) is the target for interception.

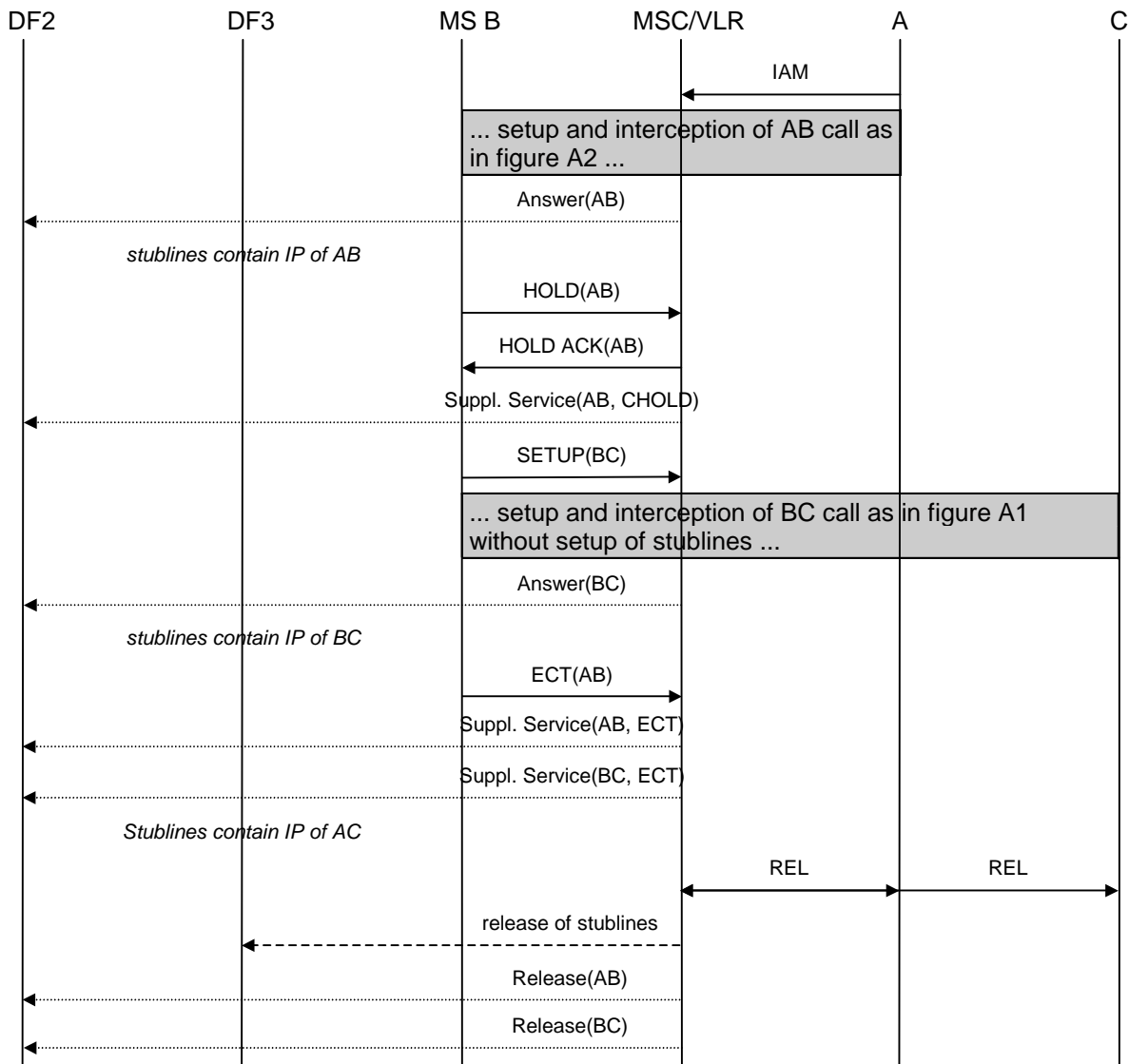
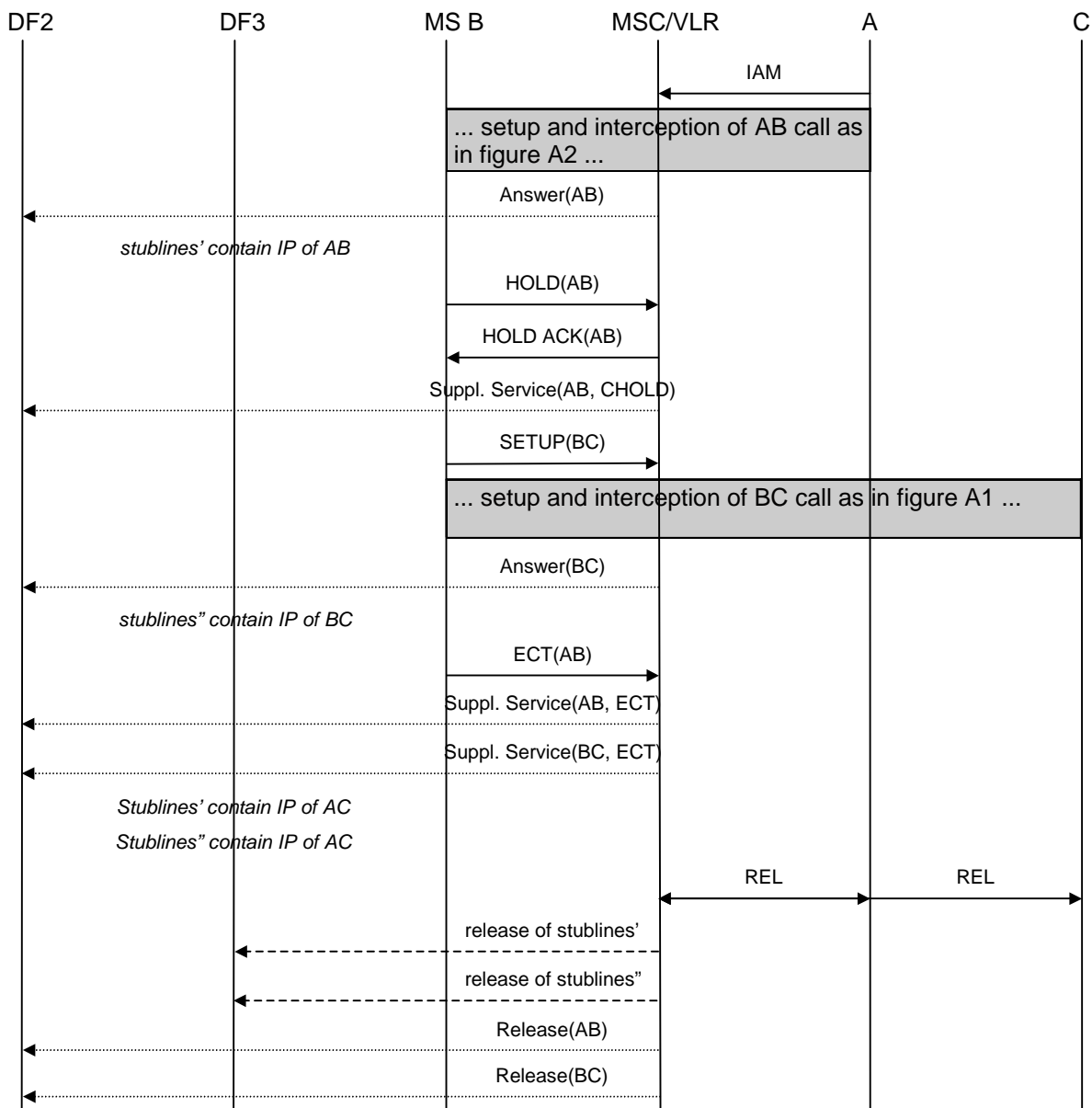

Figure A.12: Interception of explicit call transfer - stublines per target





**Figure A.13: Interception of explicit call transfer - stublines per target call**

In figures A.12 and A.13 the release of the stublines is done after the transferred call is released by A or C. It is a national option not to support interception of transferred calls. In that case, the release of the stublines is done after the call is transferred and B is no longer involved.

# Annex B (normative): Interception for GPRS

## B.1 Architecture

The following picture contains the reference configuration for the lawful interception for GPRS systems. The various entities and interfaces are described in more detail in the succeeding sections. Interception takes place within the SGSN. As a national option, the GGSN may be used for interception.

There is one Administration Function (ADMF) in the network. Together with the delivery functions it is used to hide from the SGSN and GGSN that there might be multiple activations by different Law Enforcement Agencies (LEAs) on the same target.

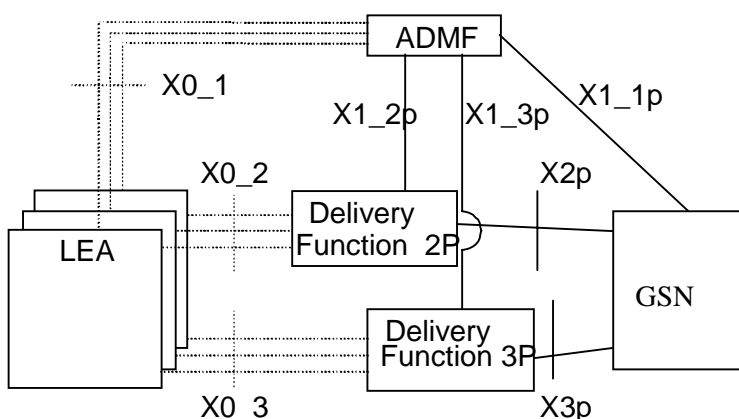
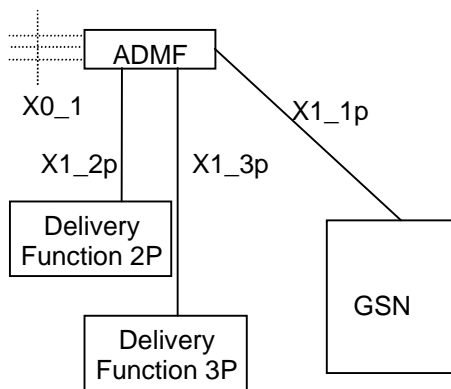

**Figure B.1: Reference configuration for GPRS**

The GSN (GPRS Support Node) can be SGSN or GGSN. The reference configuration is only a logical representation of the entities involved in lawful interception and does not mandate separate physical entities. This allows for higher levels of integration.

## B.2 Activation, deactivation and interrogation

The following picture shows the extract from the reference configuration which is relevant for activation, deactivation and interrogation of the lawful interception for the GPRS system.



**Figure B.2: Functional model for GPRS Lawful Interception activation, deactivation and interrogation**

In addition to the typical GPRS functional entities, a new functional entity is introduced - the ADMF - the Lawful Interception administration function. The ADMF:

- interfaces with all the LEAs that may require interception in the PLMN;
- keeps the intercept activities of individual LEAs separate;
- interfaces to the PLMN.

Every physical SGSN or GGSN is linked by an own X1\_1p-interface to the ADMF. Consequently, every single SGSN or GGSN performs interception (activation, deactivation, interrogation as well as invocation) independently from other SGSNs or GGSNs. The X0\_1-interface represents the interface between the requester of the lawful interception and the Lawful administration function; it is included for completeness, but is beyond the scope of the present document.

The target identity for GPRS interception can be the IMSI, MSISDN or IMEI.

NOTE 1: Interception by MSISDN works only with the basic MSISDN.

In case of location dependent interception the following network/national options exist:

target location versus Interception Areas (IAs) check in the SGSN and Delivery Functions (DFs);

target location versus IAs check in the DFs. (physical co-location of the SGSN and DFs may be required by national law).

NOTE 2: The IA is previously defined by a set of cells. From the location of the target this set of cells permits to find the relevant IAs.

NOTE 3: The GGSN is not used for interception when location dependent interception is invoked in the network.

## B.2.1 Activation

The following pictures show the information flow for the activation of the Lawful interception.

### B.2.1.1 X1\_1p-interface

The message sent from the ADMF to the GSN through the X1\_1p interface contains the following:

- identity of the target ;
- information whether the IP shall be provided (see note 1);
- information whether the IRI shall be provided (see note 1);
- address of Delivery Function 2 (DF2P) for the IRI (see note 2);
- address of Delivery Function 3 (DF3P) for GPRS product (see note 3);
- IA in case of location dependent interception.

NOTE 1: As an option, the filtering whether intercept product and/or intercept related information has to be provided can be part of the delivery functions. If the option is used, the corresponding information can be omitted on the X1\_1p-interface, while "information not present" means "intercept product and related information has to be provided" for the GSN. Furthermore the delivery function which is not requested has to be "pseudo-activated", in order to prevent error cases at invocation.

NOTE 2: As an option, only a single DF2P is used by and known to every SGSN or GGSN in the network. In this case the address of DF2P can be omitted.

NOTE 3: As an option, only a single DF3P is used by and known to every SGSN or GGSN in the network. In this case the address of DF3P can be omitted.

If after activation subsequently IP (Intercepted product) or IRI has to be activated an "activation change request" with the same target ID is to be sent.

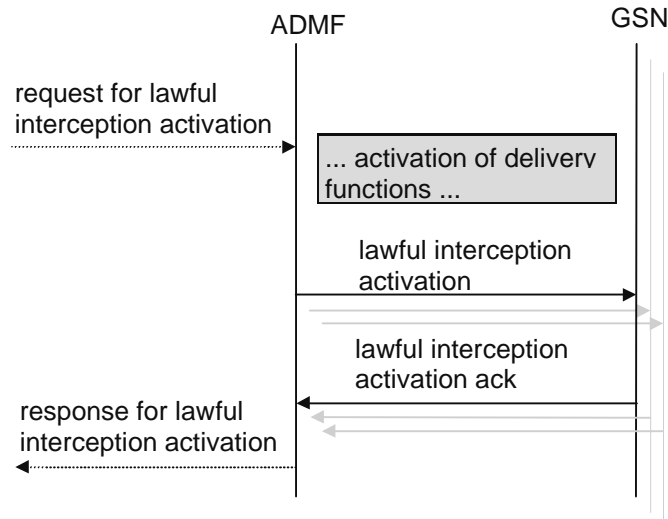

**Figure B.3: Information flow on X1\_1p-interface for Lawful Interception activation**

Interception of a target can be activated on request from different LEAs and each LEA may request interception via a different identity. In this case, each identity of the target on which to intercept will need to be sent via separate activation message from ADMF to GSN on the X1\_1p-interface. Each activation can be for IP only, IRI only, or both IP and IRI.

When several LEAs request activation on the same identity then the ADMF determines that there are existing activations on the identity. In this case, the ADMF will not send an additional activation message to the GSN except when the activation needs to change from IP only or IRI only to IP and IRI. In that case an activation change message will be sent to the GSN.

### B.2.1.2 X1\_2p-interface (IRI)

For the delivery of IRI the message sent from the ADMF to the Delivery Function contains:

- the identity of the target;
- the address for delivery of IRI (= LEA address);
- which subset of information shall be delivered;
- a DF2P activation identity, which uniquely identifies the activation for DF2P and is used for further interrogation or deactivation, respectively;
- the warrant reference number if required by national option;
- IA in case of location dependent interception.

If a target is intercepted by several LEAs and/or several identities simultaneously, a single activation of delivery is necessary for each combination of LEA and identity.

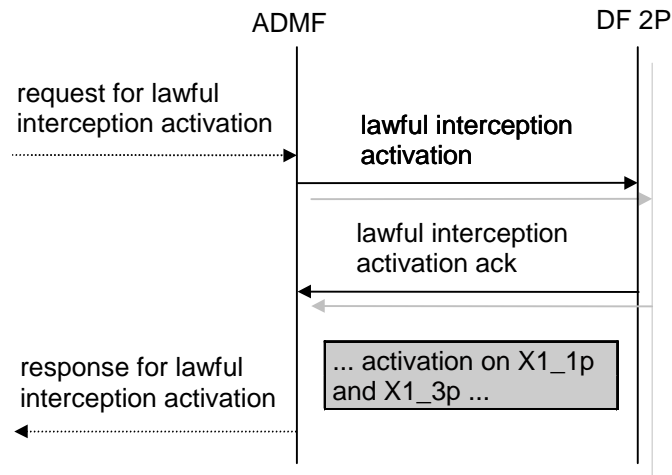

**Figure B.4: Information flow on X1\_2p-interface for Lawful Interception activation**

### B.2.1.3 X1\_3p-interface (IP)

For the delivery of GPRS intercept product the message sent from the ADMF to the Delivery Function contains:

- the identity of the target;
- the address of delivery for IP (= LEA address);
- a DF3 activation identity, which uniquely identifies the activation for delivery function 3 and is used for further interrogation or deactivation, respectively;
- the warrant reference number if required by national option;
- IA in case of location dependent interception.

If a target is intercepted by several LEAs and/or several identities simultaneously, a single activation of delivery is necessary for each combination of LEA and identity.

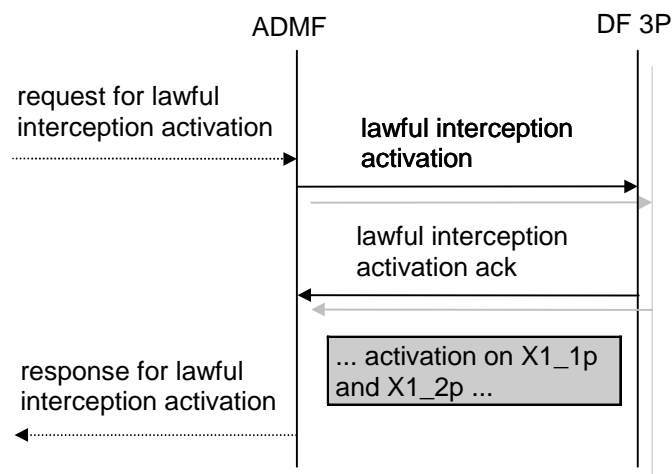

**Figure B.5: Information flow on X1\_3p-interface for Lawful Interception activation**

## B.2.2 Deactivation

The following picture shows the information flow for the deactivation of the Lawful interception.

### B.2.2.1 X1\_1p-interface

The messages sent from the ADMF to the GSN for deactivation contains:

- the identity of the target;
- IA in case of location dependent interception.

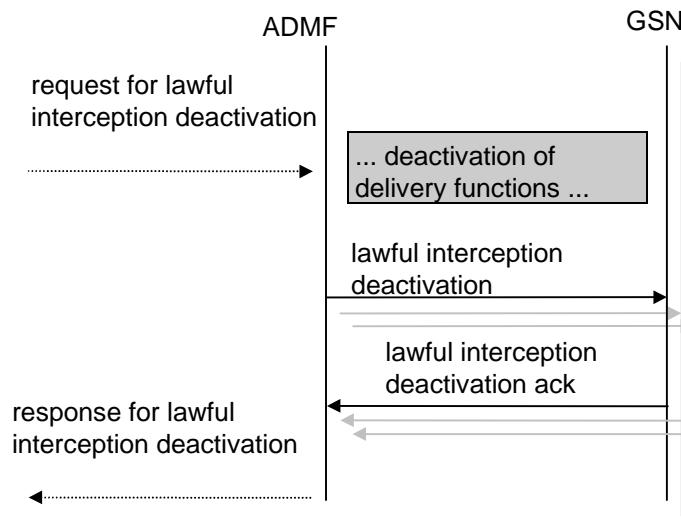

**Figure B.6: Information flow on X1\_1p-interface for Lawful Interception deactivation**

If interception of a target has been activated via different identities then a separate deactivation message will need to be sent from the ADMF to the GSN for each identity.

When several LEAs requested activation on the same identity and subsequently request deactivation then the ADMF determines that there are remaining activations on the identity. In this case, the ADMF will not send a deactivation message to the GSN except when the activation needs to change from IP and IRI to IP only or IRI only. In that case an activation change message will be sent to the GSN.

### B.2.2.2 X1\_2p-interface (IRI)

The ADMF sent for the deactivation to the Delivery Function 2 of the Intercept Related Information:

- a DF2P activation id, which uniquely identifies the activation to be deactivated for DF2P.

If a target is intercepted by several LEAs and/or several identities simultaneously, a single deactivation is necessary for each combination of LEA and identity.

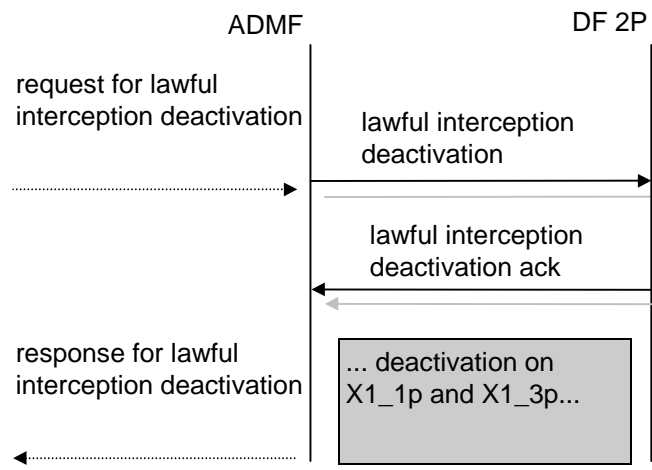

Figure B.7: Information flow on the X1\_2p-interface for Lawful Interception deactivation

### B.2.2.3 X1\_3p-interface (IP)

For the deactivating the delivery of the IP the message from the ADMF to the Delivery Function contains:

- a DF3P activation id, which uniquely identifies the activation to be deactivated for DF3P.

If a target is intercepted by several LEAs and/or several identities simultaneously, a single deactivation is necessary for each combination of LEA and identity.

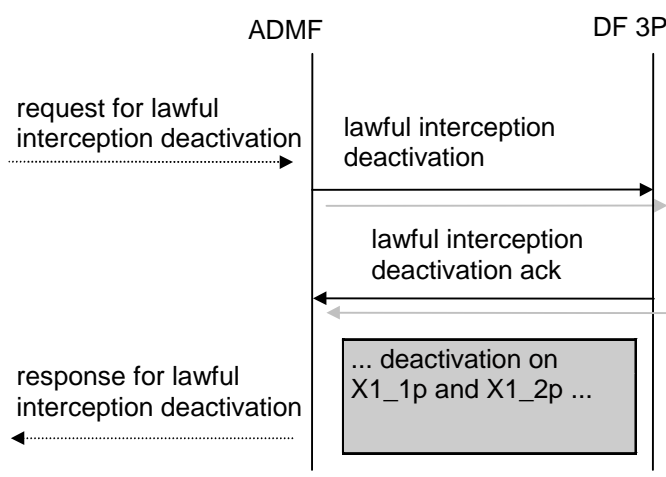

Figure B.8: Information flow X1\_3p-interface for Lawful Interception deactivation

## B.2.3 Interrogation

The purpose of interrogation is consistency checking for the interception function. It can be use e.g. for audit functionality, but this is beyond the scope of the present document.

Interrogation of all activations for a given LEA is an ADMF filter function.

### B.2.3.1 Interrogation of the SGSN and GSN

The following picture shows the information flow for the interrogation of the Lawful interception. It must be possible to interrogate

- a specific activation at this GSN for a given target identity;
- all activations at this GSN.

As result of the interrogation the activation status and data are returned.

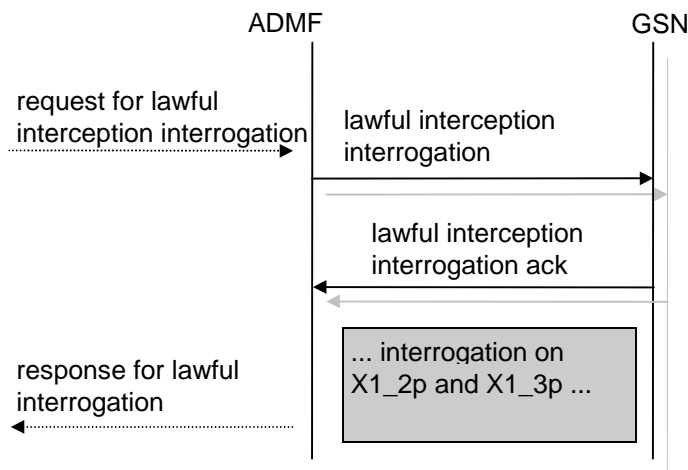

**Figure B.9: Interrogation of the Lawful Interception (GSN)**

### B.2.3.2 Interrogation of Delivery Functions

The following picture shows the information flow for the interrogation of the Lawful interception. It must be possible to interrogate:

- a specific activation at a Delivery Function for a given activation id;
- all activations at a Delivery Function for a given target identity;
- all activations at a Delivery Function.

As result of the interrogation the activation status and data are returned.



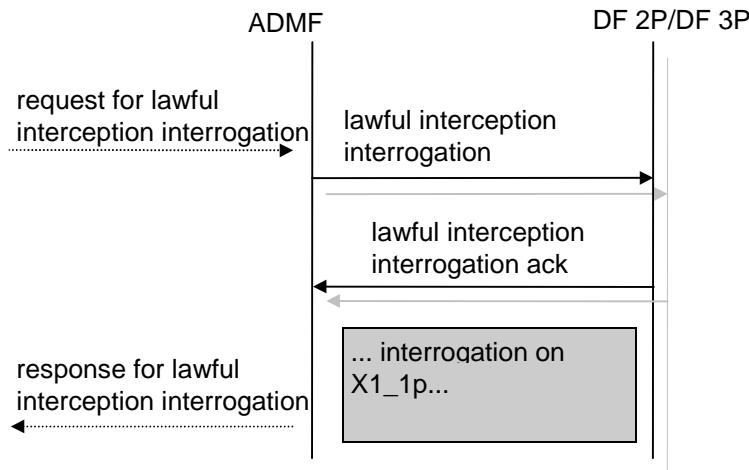

Figure B.10: Interrogation of the Lawful Interception (Delivery Functions)

## B.3 Invocation of Lawful Interception

The following picture shows the extract from the reference configuration which is relevant for the invocation of the lawful interception.

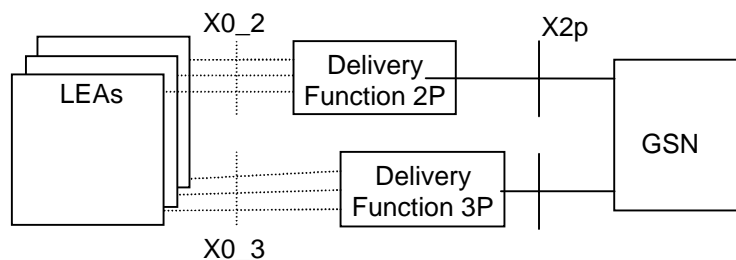

Figure B.11: Functional model for GPRS Lawful Interception invocation

The X0\_2 and X0\_3-interfaces represent the interfaces between the LEA and two delivery functions. Both interfaces are subject to national requirements. They are included for completeness, but are beyond the scope of the present document. The delivery functions are used:

- to convert the information on the X2p-interface to the corresponding information on the X0\_2-interface;
- to distribute the intercept related information to the relevant LEA(s);
- to distribute the intercept product to the relevant LEA(s).

In case a packet data communication is selected based on several identities (MSISDN, IMSI, IMEI, ...) of the same target, the SGSN or GGSN will deliver IP and IRI only once to the DF2P and DF3P. DF2P and DF3P will then distribute the information to the relevant LEA that requested interception on a particular target identity.

For the delivery of the IP and IRI the SGSN or GGSN provides correlation number and target identity to the DF2P and DF3P which is used there in order to select the different LEAs where the product shall be delivered to.

The correlation number is unique in the whole PLMN and is used to correlate IP with IRI and the different IRI's of one PDP context.

The correlation number shall be generated by using existing parameters related to the PDP context.

NOTE: If interception has been activated for both parties of the packet data communication both IP and IRI will be delivered for each party as separate intercept activity.

In case of location dependent interception :

- for each target, the location dependency check occurs at each packet data session establishment or release and at each cell and/or RA update to determine permanently the relevant IAs (and deduce, the possible LEAs within these IAs),
- concerning the IRI:
  - when an IA is left, a GPRS detach event is sent when changing SGSNs or a cell and/or RA update event is sent when changing IAs inside the same SGSN to DF2P.
  - when a new IA is entered a cell and/or RA update event is sent to DF2P and, optionally, a Start of Interception with Active PDP Context event for each PDP context
- concerning the IP, when crossing IAs, the IP is not sent anymore to the DF3P of the old IA but sent to the DF3P of the new IA.

### B.3.1 Provision of Intercept Product - GPRS

The access method for the delivering of GPRS Intercept Product is based on duplication of packets without modification at GSN. The duplicated packets with additional information in the header are sent to DF3P for further delivery via a tunnel.

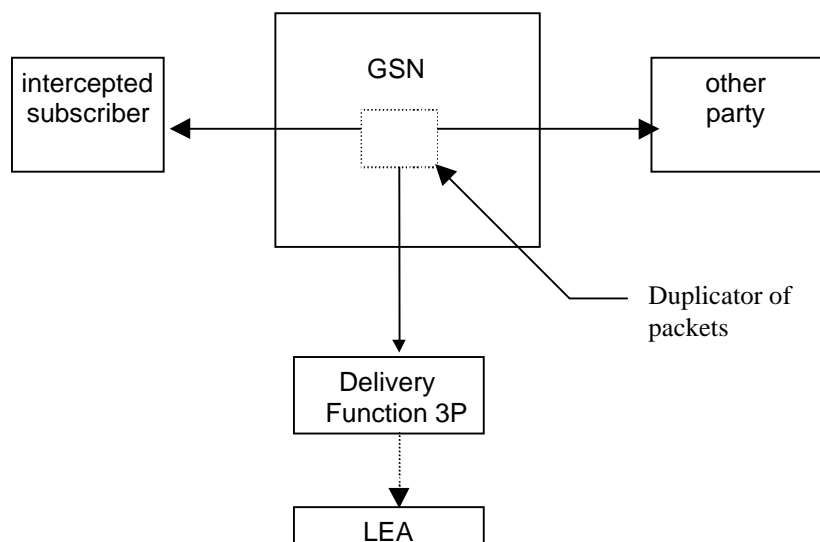

Figure B.12: Configuration for interception of GPRS product data

#### B.3.1.1 X3p-interface

The following information needs to be transferred from the GSN to the DF3P in order to allow the DF3P to perform its functionality:

- the identity of the target;
- correlation number;
- the target location (if available) or the IAs in case of location dependent interception.

Additional information may be provided as a national option.

### B.3.2 Provision of Intercept Product - Short Message Service

Figure B13 shows an SMS transfer from the SGSN to the LEA. Quasi-parallel to the delivery from / to the mobile subscriber a message, which contains the contents of the SMS, is generated and sent via the Delivery Function 2P to the LEA in the same way as the Intercept Related Information.

The IRI will be delivered to the LEA:

- for a SMS-MO, when the SMS-Centre receives the SMS;
- for a SMS-MT, when the MS receives the SMS.

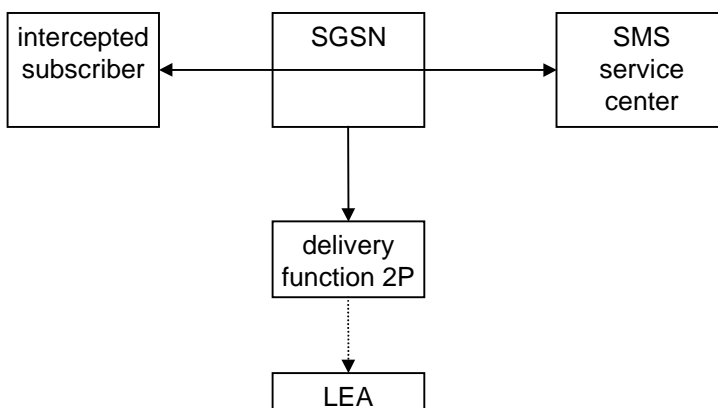

Figure B.13: Provision of Intercept Product - Short Message Service

### B.3.3 Provision of Intercept Related Information

Intercept Related Information (Events) are necessary at the GPRS Attach, GPRS Detach, PDP Context Activation, Start of intercept with PDP context active, PDP Context Deactivation, Cell and/or RA update, and SMS events.

Figure B14 shows the transfer of intercept related information to the DF2P. If an event for / from a mobile subscriber occurs, the GSN sends the relevant data to the DF2P.

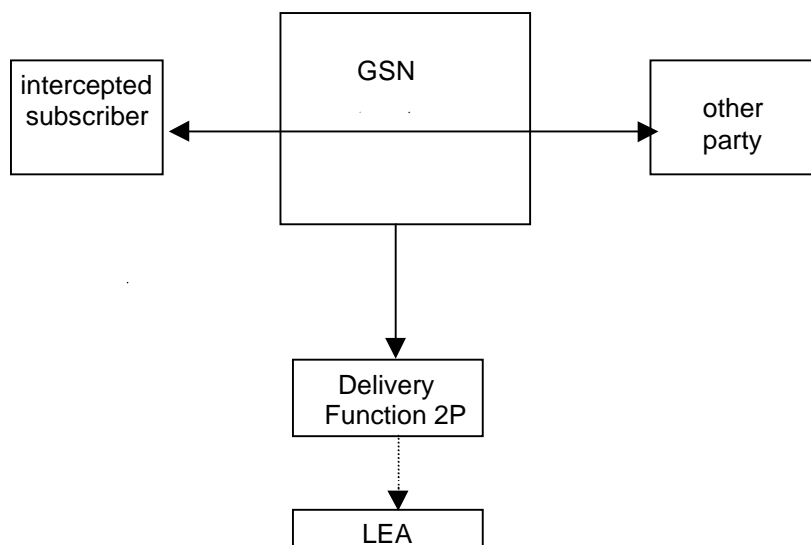

Figure B.14: Provision of Intercept Related Information

### B.3.3.1 X2p-interface

The following information needs to be transferred from the GSN to the DF2P in order to allow a DF2P to perform its functionality:

- identity of the target (MSISDN, IMSI, IMEI);
- events and associated parameters as defined in section B.3.3.2 and B.3.3.3 may be provided;
- the target location (if available) or the IAs in case of location dependent interception.

### B.3.3.2 Structure of the events

There are seven different events in which the information is sent to the DF2P if this is required. Details are described in following section. The events for interception are configurable (if they are sent to DF2P) in the SGSN or GGSN and can be suppressed in the DF2P.

**The following events are applicable to SGSN:**

- GPRS attach;
- GPRS detach;
- PDP context activation;
- Start of intercept with PDP context active;
- PDP context deactivation;
- Cell and /or RA update;
- SMS.

NOTE: GGSN interception is a national option

The following events are applicable to GGSN:

- PDP context activation ;
- PDP context deactivation ;
- Start of interception with PDP context active.

A set of fields as shown below is used to generate the events. The events transmit the information from GSN to DF2P. This set of fields as shown below can be extended in the GSN, if this is necessary as a national option. DF2P can extend this information if this is necessary as a national option e.g. a unique number for each surveillance warrant.

observed MSISDN MSISDN of the target subscriber (monitored subscriber)
observed IMSI IMSI of the target subscriber (monitored subscriber)
observed IMEI IMEI of the target subscriber (monitored subscriber),it must be checked for each activation over the radio interface.
event type Description which type of event is delivered: PDP attach, PDP detach, PDP context activation, Start of intercept with PDP context active, PDP context deactivation, SMS, Cell and/or RA update,
event date Date of the event generation in the GSN
event time Time of the event generation in the GSN
PDP address The PDP address of the target subscriber. Note that this address might be dynamic.
Access Point Name The APN of the access point.
Routing Area Code The routing area code of the target defines the RA in a PLMN.
PDP Type The used PDP type.
Correlation Number The correlation number is used to correlate IP and IRI.
SMS The SMS content with header which is sent with the SMS-service. The header also includes the SMS-Centre address.
CGI Cell Global Identity
Failed attach reason Reason for failed attach of the target subscriber.
Failed context activation reason Reason for failed context activation of the target subscriber.
IAs The observed Interception Areas

### B.3.3.3 GPRS related events

#### B.3.3.3.1 GPRS attach

For attach an attach-event is generated. When an attach activation is generated from the mobile to SGSN this event is generated. These fields will be delivered to the DF2P if available:

Observed MSISDN
Observed IMSI
Observed IMEI
Event Type
Event Time
Event Date
CGI
Routing area code
Failed attach reason
IAs (if applicable)

### B.3.3.3.2 GPRS detach

For detach a detach-event is generated, this is for the common (end) detach. These fields will be delivered to the DF2P if available:

Observed MSISDN
Observed IMSI
Observed IMEI
Event Type
Event Time
Event Date
CGI
Routing Area code
IAs (if applicable)

### B.3.3.3.3 GPRS PDP context activation

For PDP context activation a PDP context activation-event is generated. When a PDP context activation is generated from the mobile to GSN this event is generated. These fields will be delivered to the DF2P if available:

Observed MSISDN
Observed IMSI
Observed IMEI
PDP address of observed party
Event Type
Event Time
Event Date
Correlation number
Access Point Name
PDP Type
CGI
Routing area code
Failed context activation reason
IAs (if applicable)

### B.3.3.3.4 Start of interception with PDP context active

This event will be generated if interception for a target is started and if the target has at least one PDP context active. If more than one PDP context are open for each of them an event record is generated. These fields will be delivered to the DF2P if available:

Observed MSISDN
Observed IMSI
Observed IMEI
PDP address of observed party
Event Type
Event Time
Event Date
Correlation number
Access Point Name
PDP Type
CGI
Routing area code
IAs (if applicable)

### B.3.3.3.5 GPRS PDP context deactivation

At PDP context deactivation a PDP context deactivation-event is generated. These fields will be delivered to the DF2P if available:

Observed MSISDN
Observed IMSI
Observed IMEI
PDP address of observed party
Event Type
Event Time
Event Date
Correlation number
Access point name
CGI
Routing area code
IAs (if applicable)

### B.3.3.3.6 Cell and/or RA update

For each cell and/or RA update an update-event with the fields about the new location is generated. These fields will be delivered to the DF2P if available:

Observed MSISDN
Observed IMSI
Observed IMEI
Event Type
Event Time
Event Date
CGI
Routing area code
IAs (if applicable)

### B.3.3.3.7 SMS

For MO-SMS the event is generated in the SGSN, when the SMS-Centre successfully receives the SMS; for MT-SMS the event is generated in the SGSN when the target receives the message. This fields will be delivered to the DF2P if available:

Observed MSISDN
Observed IMSI
Observed IMEI
Event Type
Event Time
Event Date
CGI
Routing area code
SMS
IAs (if applicable)

## B.3.4 Intercept cases for supplementary services

Supplementary services may be used with GPRS. However they are not standardised and therefore Lawful Interception interwork cases can not be defined.

---

## B.4 Security

### B.4.1 Security

The security requirements are valid for the whole Lawful Interception system, i.e. rules and procedures shall be used for all involved entities, GSN and the DF.

#### B.4.1.1 Administration security

The administration of the LI function, i.e. Activation, Deactivation and Interrogation of Lawful Interception, in the GSN and the DFs must be done secure as described below:

- It shall be possible to configure the authorised user access to Activation, Deactivation and Interrogation of Lawful Interception separately for every physical or logical port at the GSN and DF. This configuration possibility shall be password protected.
- Normally only the ADMF is allowed to have access to the LI functionality in the GSN and DF.
- The communication link between ADMF, GSN, DF2P, and DF3P shall be secure and shall support security mechanisms, e.g.:
  - CUG / VPN;
  - COLP;
  - authentication;
  - encryption.
- No network entities or remote equipment shall be able to access or manipulate LI data in the GSN or the DF.

#### B.4.1.2 IRI security

##### B.4.1.2.1 Normal operation

The transmission of the IRI shall be done in a secure manner.

When DF2P is physically separate from the GSN, the X2p-interface shall support security mechanisms, e.g.:

- CUG/VPN;
- COLP;
- authentication;
- encryption.

##### B.4.1.2.2 Communication failure

Depending on the national law in case of communication failure IRI may be buffered in the GSN. After successful transmission of IRI the whole buffer must be deleted. It shall be possible to delete the content buffer via command or a timer, in an unrestoreable fashion.



### B.4.1.3 IP security

The transmission of the IP shall be done in a secure manner.

When DF3P is physically separate from the GSN, the X3p-interface shall support security mechanisms, e.g.:

- CUG/VPN;
- COLP;
- authentication;
- encryption.

In case of transmission failure no buffering will be done.

### B.4.1.4 Security aspects of Lawful Interception billing

Billing information shall be available at the DFs and the ADMF. Billing information for Lawful Interception shall be separated from "regular" GPRS billing data.

Billing data transmission to the Lawful Interception billing system shall be done in a secure manner.

In case of transmission failure billing-data shall be buffered/stored in a secure way. After successful transmission billing data shall be deleted in an unrestorable fashion.

### B.4.1.5 Other security issues

#### B.4.1.5.1 Log files

Log files shall be generated by the ADMF, DF2P, DF3P and the GSN. All log files are retrievable by the ADMF, and are maintained by the ADMF in a secure manner.

#### B.4.1.5.2 Data consistency

The administration function in the PLMN shall be capable to perform a periodic consistency check to ensure whether the target list of MSISDN, IMSI or IMEI is the same in all involved SGSNs in the PLMN and the DFs. The reference data base is the ADMF data base.

## B.5 Information flows for Lawful Interception invocation (informative)

The following figures show the information flows for the invocation of Lawful Interception for GPRS and typical scenarios. The figures show some of the basic signalling messages of the target packet data communication and the events on the X2P and X3P-interfaces. The dotted lines indicate signalling depending on whether IP and/or IRI information has been requested. GGSN may setup/release packet tunnels and send IRI information depending on national requirements.

The use of the GGSN for interception is a national option.

### B.5.1 GPRS attach

Figure B.15 shows the interception of a basic GPRS attach where the mobile (A) is the target for interception.

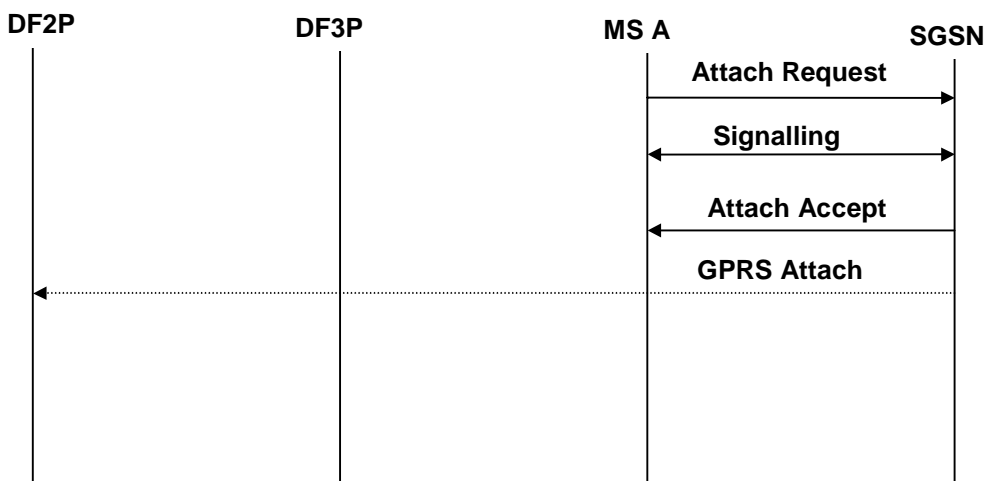

Figure B.15: Interception of mobile originated GPRS attachment

### B.5.2 Mobile originated GPRS detach

Figure B.16 shows the interception of a mobile originated GPRS detach where the originating mobile (A) is the target for interception.

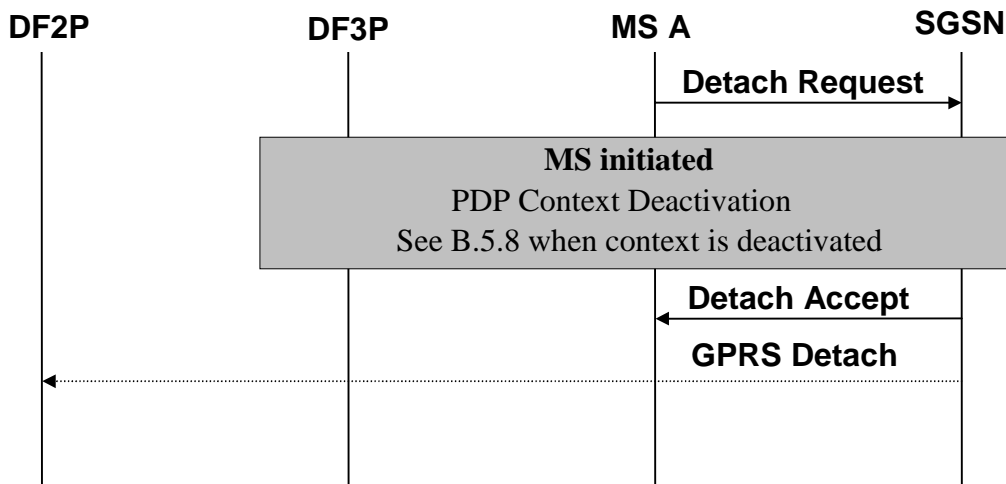

Figure B.16: Interception of mobile originated GPRS detachment

### B.5.3 Network initiated GPRS detach

Figure B.17 shows the interception of a network initiated (by SGSN or HLR) GPRS detach where the mobile (A) is the target for interception.

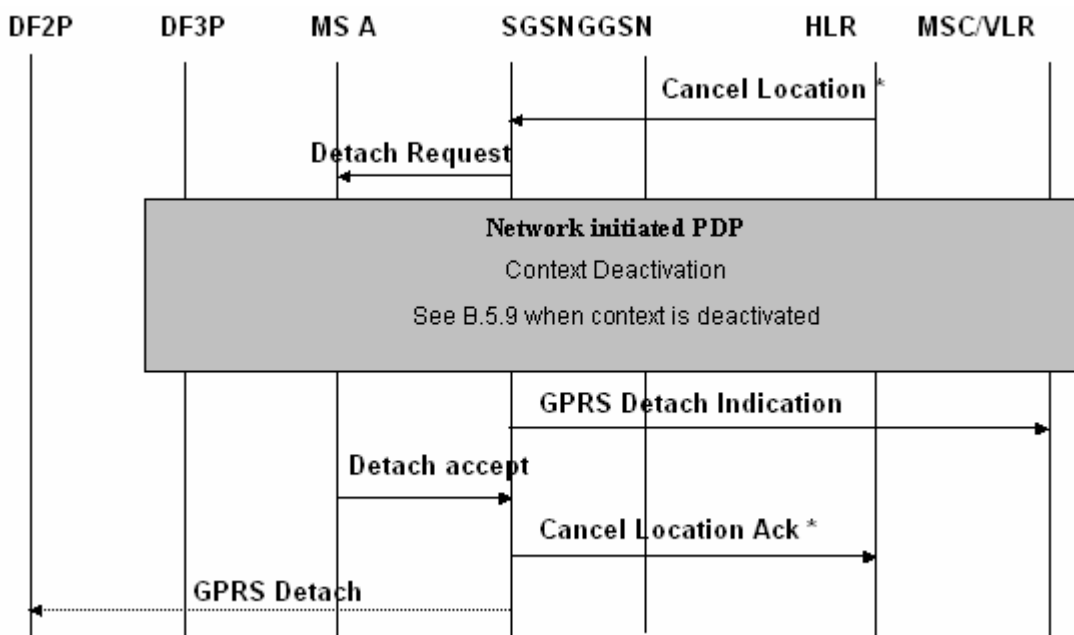

Figure B.17: Interception of network initiated GPRS detach

NOTE: \* Additional signals in case of HLR initiated

### B.5.4 Intra SGSN Routing Area Update

Figure B.18 shows the interception of an Intra Routing Area Update where the mobile (A) is the target for interception. The sequence is the same for the combined RA / LA Update procedure but additional signalling is performed between the SGSN and MSC/VLR, HLR and the old MSC/VLR before the Routing Area Update Accept message is sent to the MS.

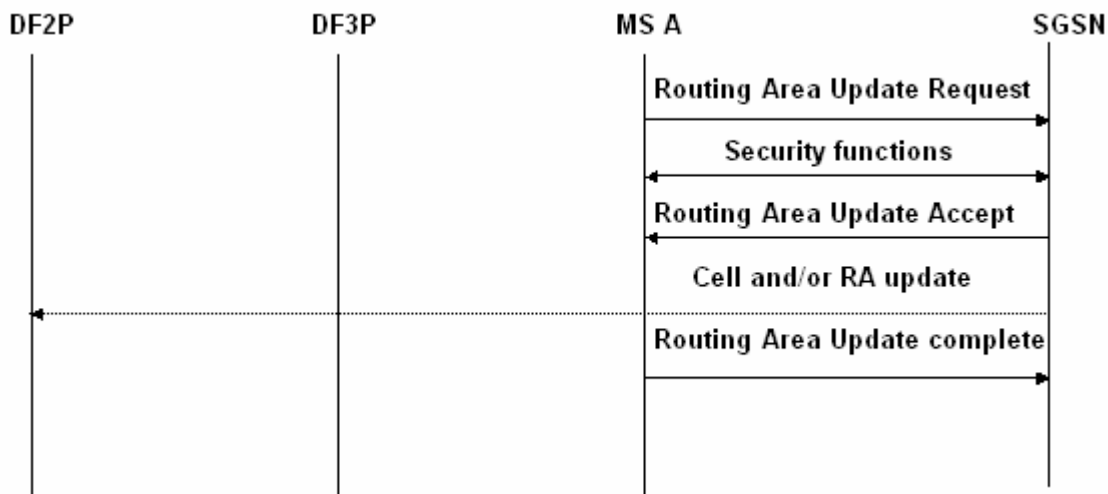

Figure B.18: Interception of an Intra Routing Area Update

### B.5.5 Inter SGSN Routing Area Update

Figure B.19 shows the interception of an Inter Routing Area Update where the mobile (A) is the target for interception. The sequence is the same for the combined RA / LA Update procedure but additional signalling is performed between the SGSN and MSC/VLR, HLR and the old MSC/VLR before the Routing Area Update Accept message is sent to the MS. In case of PDP context not being active less signalling is required.

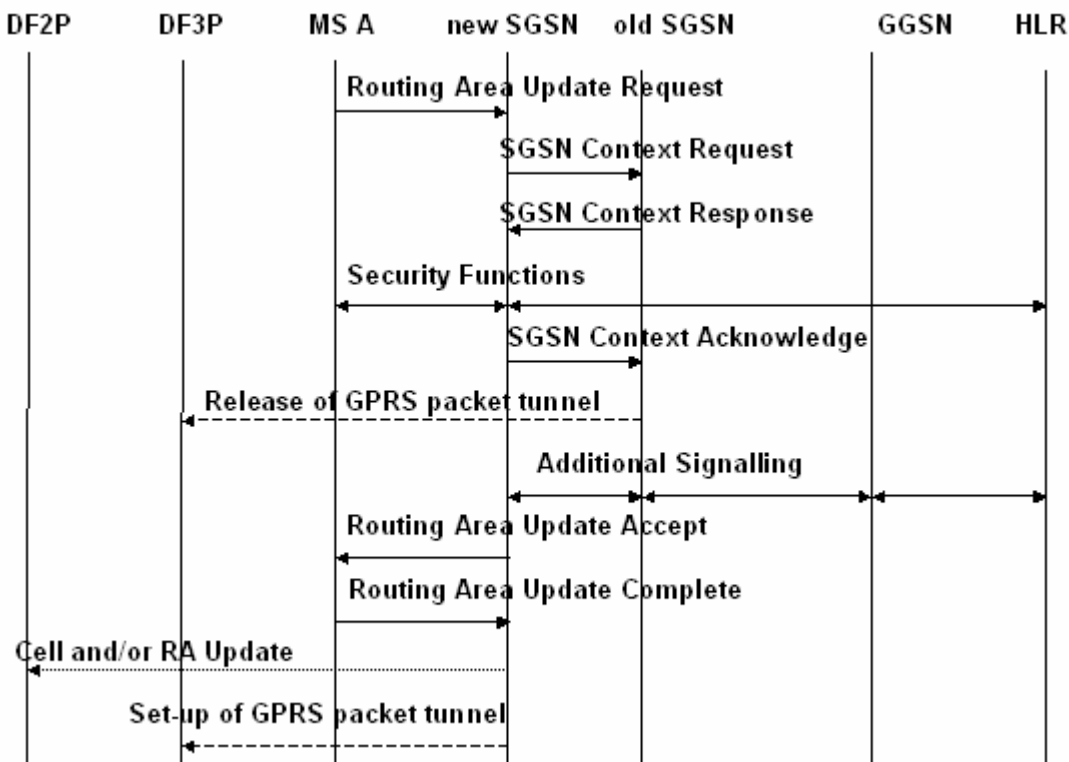

Figure B.19: Interception of an Inter Routing Area Update

### B.5.6 PDP Context Activation

Figure B.20 shows the interception of a PDP Context activation where the mobile (A) is the target for interception. The sequence for a network initiated PDP Context activation is analogous but is preceded by the SGSN sending a Request PDP Context Activation to the MS.

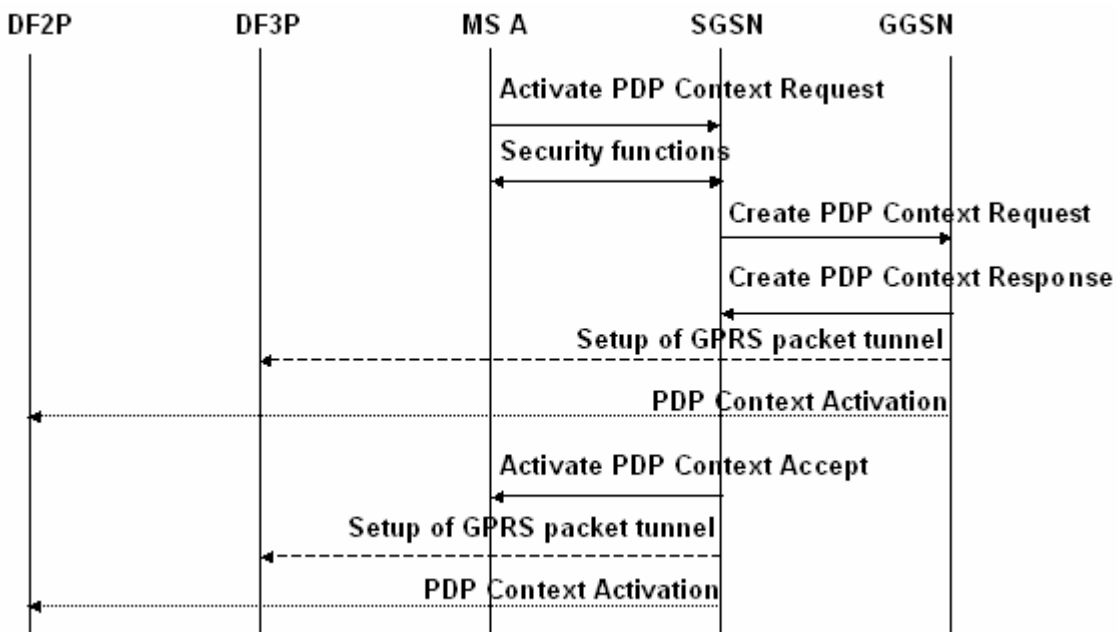

Figure B.20: Interception of a PDP Context Activation

### B.5.7 Start of interception with PDP context active

A tunnel is established to DF3P and an event is sent to DF2P.

### B.5.8 MS initiated PDP Context Deactivation

Figure B.21 shows the interception of a MS initiated PDP Context deactivation where the mobile (A) is the target for interception.

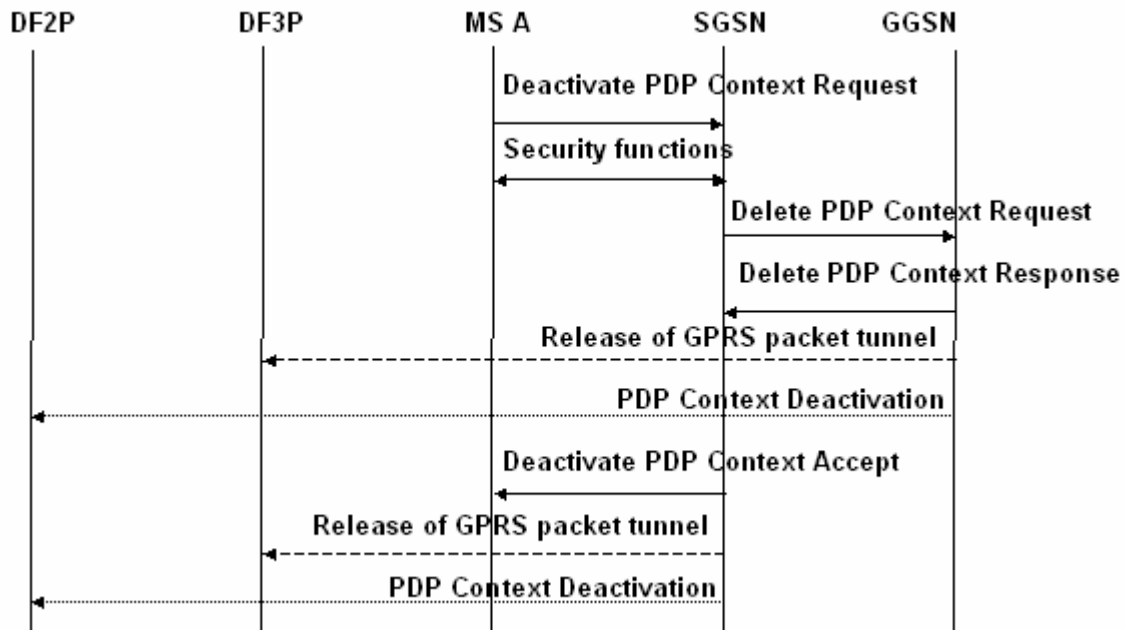

Figure B.21: Interception of a PDP Context Deactivation

### B.5.9 Network initiated PDP Context Deactivation

Figure B.22 shows the interception of a Network initiated PDP Context deactivation where the mobile (A) is the target for interception. The GGSN may send, (depending on national requirements) the PDP Context deactivation and release the GPRS packet tunnel after the Delete PDP Context Response has been sent or received, (signalling between the SGSN and the GGSN is not shown here).

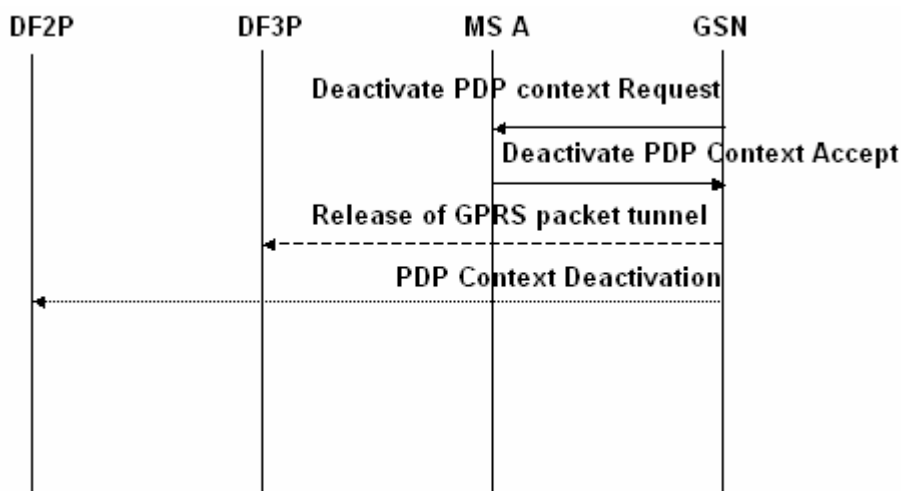

Figure B.22: Interception of a Network initiated PDP Context Deactivation

### B.5.10 SMS

Figure B.23 and B.24 shows the interception of a Mobile-terminated SMS and a Mobile-originated SMS transfer where the mobile (A) is the target for interception.

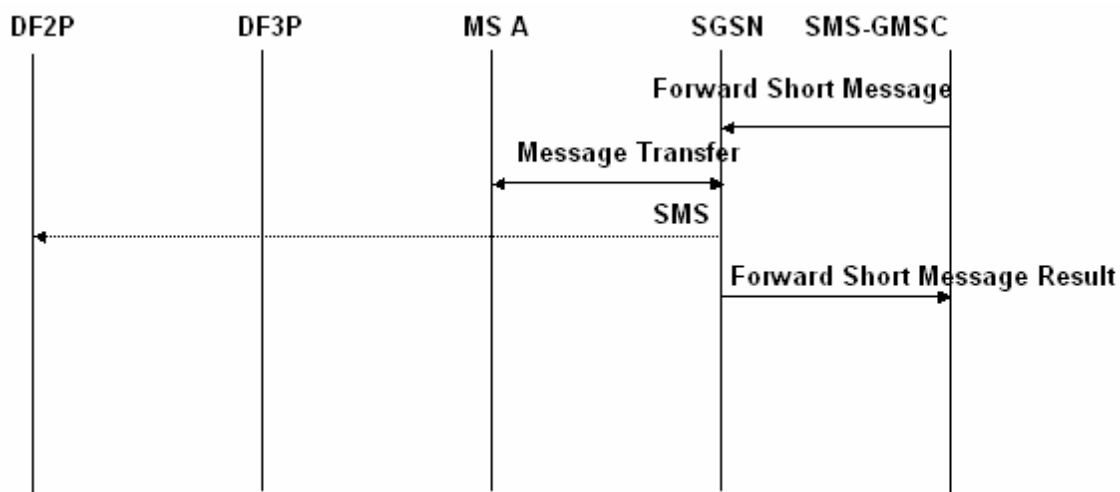

Figure B.23: Interception of a Mobile-terminated SMS transfer

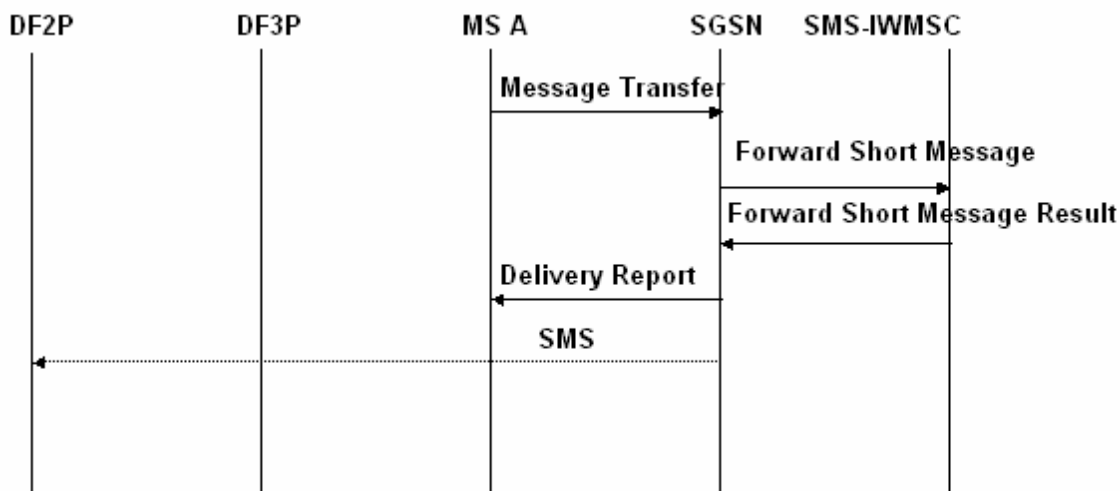

Figure B.24: Interception of a Mobile-originated SMS transfer

## Annex C (informative): Change history

Change history								
Date	TSG #	TSG Doc	CR	Rev	Cat	Subject/Comment	Old	New
04-2000	-	-	-	-	-	Release 1999 version (only circuit switched LI)	7.1.0	8.0.0
12-2000	SP-10	SP-000623	003		A	Addition of parameters to the X3-Interface	8.0.0	8.1.0
12-2000	SP-10	SP-000670	005	1	A	Deletion of mono-mode and addition of optimal routing	8.0.0	8.1.0
03-2001	SP-11	-	-	-	-	Upgrade to Release 4 (and 3GPP numbering)	03.33 v 8.1.0	43.033 v 4.0.0
06-2002	SP-16	-	-	-	-	Upgrade to Release 5	4.0.0	5.0.0
12-2004	SP-26	-	-	-	-	Upgrade to Release 6	5.0.0	6.0.0



---

## History

<b>Document history</b>		
V6.0.0	December 2004	Publication