

ETSI TS 138 523-1 V17.0.0 (2022-10)



**LTE;
5G;
5GS;
User Equipment (UE) conformance specification;
Part 1: Protocol
(3GPP TS 38.523-1 version 17.0.0 Release 17)**



Reference

RTS/TSGR-0538523-1vh00

Keywords

5G,LTE

ETSI

650 Route des Lucioles
F-06921 Sophia Antipolis Cedex - FRANCE

Tel.: +33 4 92 94 42 00 Fax: +33 4 93 65 47 16

Siret N° 348 623 562 00017 - APE 7112B
Association à but non lucratif enregistrée à la
Sous-Préfecture de Grasse (06) N° w061004871

Important notice

The present document can be downloaded from:

<http://www.etsi.org/standards-search>

The present document may be made available in electronic versions and/or in print. The content of any electronic and/or print versions of the present document shall not be modified without the prior written authorization of ETSI. In case of any existing or perceived difference in contents between such versions and/or in print, the prevailing version of an ETSI deliverable is the one made publicly available in PDF format at www.etsi.org/deliver.

Users of the present document should be aware that the document may be subject to revision or change of status.

Information on the current status of this and other ETSI documents is available at

<https://portal.etsi.org/TB/ETSIDeliverableStatus.aspx>

If you find errors in the present document, please send your comment to one of the following services:

<https://portal.etsi.org/People/CommitteeSupportStaff.aspx>

If you find a security vulnerability in the present document, please report it through our
Coordinated Vulnerability Disclosure Program:

<https://www.etsi.org/standards/coordinated-vulnerability-disclosure>

Notice of disclaimer & limitation of liability

The information provided in the present deliverable is directed solely to professionals who have the appropriate degree of experience to understand and interpret its content in accordance with generally accepted engineering or other professional standard and applicable regulations.

No recommendation as to products and services or vendors is made or should be implied.

No representation or warranty is made that this deliverable is technically accurate or sufficient or conforms to any law and/or governmental rule and/or regulation and further, no representation or warranty is made of merchantability or fitness for any particular purpose or against infringement of intellectual property rights.

In no event shall ETSI be held liable for loss of profits or any other incidental or consequential damages.

Any software contained in this deliverable is provided "AS IS" with no warranties, express or implied, including but not limited to, the warranties of merchantability, fitness for a particular purpose and non-infringement of intellectual property rights and ETSI shall not be held liable in any event for any damages whatsoever (including, without limitation, damages for loss of profits, business interruption, loss of information, or any other pecuniary loss) arising out of or related to the use of or inability to use the software.

Copyright Notification

No part may be reproduced or utilized in any form or by any means, electronic or mechanical, including photocopying and microfilm except as authorized by written permission of ETSI.

The content of the PDF version shall not be modified without the written authorization of ETSI.

The copyright and the foregoing restriction extend to reproduction in all media.

© ETSI 2022.
All rights reserved.

Intellectual Property Rights

Essential patents

IPRs essential or potentially essential to normative deliverables may have been declared to ETSI. The declarations pertaining to these essential IPRs, if any, are publicly available for **ETSI members and non-members**, and can be found in ETSI SR 000 314: "*Intellectual Property Rights (IPRs); Essential, or potentially Essential, IPRs notified to ETSI in respect of ETSI standards*", which is available from the ETSI Secretariat. Latest updates are available on the ETSI Web server (<https://ipr.etsi.org/>).

Pursuant to the ETSI Directives including the ETSI IPR Policy, no investigation regarding the essentiality of IPRs, including IPR searches, has been carried out by ETSI. No guarantee can be given as to the existence of other IPRs not referenced in ETSI SR 000 314 (or the updates on the ETSI Web server) which are, or may be, or may become, essential to the present document.

Trademarks

The present document may include trademarks and/or tradenames which are asserted and/or registered by their owners. ETSI claims no ownership of these except for any which are indicated as being the property of ETSI, and conveys no right to use or reproduce any trademark and/or tradename. Mention of those trademarks in the present document does not constitute an endorsement by ETSI of products, services or organizations associated with those trademarks.

DECT™, **PLUGTESTS™**, **UMTS™** and the ETSI logo are trademarks of ETSI registered for the benefit of its Members. **3GPP™** and **LTE™** are trademarks of ETSI registered for the benefit of its Members and of the 3GPP Organizational Partners. **oneM2M™** logo is a trademark of ETSI registered for the benefit of its Members and of the oneM2M Partners. **GSM®** and the GSM logo are trademarks registered and owned by the GSM Association.

Legal Notice

This Technical Specification (TS) has been produced by the ETSI 3rd Generation Partnership Project (3GPP).

The present document may refer to technical specifications or reports using their 3GPP identities. These shall be interpreted as being references to the corresponding ETSI deliverables.

The cross reference between 3GPP and ETSI identities can be found under <http://webapp.etsi.org/key/queryform.asp>.

Modal verbs terminology

In the present document "**shall**", "**shall not**", "**should**", "**should not**", "**may**", "**need not**", "**will**", "**will not**", "**can**" and "**cannot**" are to be interpreted as described in clause 3.2 of the [ETSI Drafting Rules](#) (Verbal forms for the expression of provisions).

"**must**" and "**must not**" are **NOT** allowed in ETSI deliverables except when used in direct citation.

Contents

Intellectual Property Rights	2
Legal Notice	2
Modal verbs terminology.....	2
Foreword.....	25
1 Scope	27
2 References	27
3 Definitions, symbols and abbreviations	29
3.1 Definitions	29
3.2 Symbols.....	29
3.3 Abbreviations	29
4 Overview	29
4.1 Test methodology.....	29
4.1.1 Testing of optional functions and procedures	29
4.1.2 Test interfaces and facilities.....	30
4.2 Implicit testing.....	30
4.3 Repetition of tests.....	30
4.4 Handling of differences between conformance requirements in different releases of core specifications.....	30
5 Reference conditions, generic and test procedures, test parameters.....	31
5.1 Reference conditions	31
5.2 Generic and test procedures.....	31
5.3 Test parameters	31
5.3.1 PLMNs.....	31
5.3.2 Cells	31
5.3.3 USIM	32
5.3.4 Messages and Information Elements (IEs)	32
6 Idle mode and RRC Inactive state operations	32
6.1 NR idle mode operations.....	32
6.1.1 NG-RAN Only PLMN Selection.....	32
6.1.1.1 PLMN selection of RPLMN, HPLMN/EHPLMN, UPLMN and OPLMN / Automatic mode	32
6.1.1.2 PLMN selection of "Other PLMN/access technology combinations" / Automatic mode.....	39
6.1.1.3 Cell reselection of ePLMN in manual mode	44
6.1.1.4 PLMN selection in shared network environment / Automatic mode	48
6.1.1.5 PLMN selection of RPLMN, HPLMN/EHPLMN, UPLMN and OPLMN / Automatic mode / User reselection.....	54
6.1.1.6 PLMN selection / Periodic reselection / MinimumPeriodicSearchTimer	58
6.1.1.7 PLMN selection of RPLMN or (E)HPLMN; Automatic mode	61
6.1.1.8 PLMN selection of RPLMN or (E)HPLMN; Manual mode	64
6.1.2 NG-RAN Only Cell Selection	68
6.1.2.1 Cell selection / Qrxlevmin & Cell reselection (Intra NR)	68
6.1.2.2 Cell selection / Qqualmin / Intra NR / Serving cell becomes non-suitable (Srxlev > 0, Squal < 0).....	77
6.1.2.3 Cell selection / Intra NR / Serving cell becomes non-suitable (S<0, MIB Indicated barred).....	85
6.1.2.4 Cell reselection for interband operation	90
6.1.2.5 Cell reselection for interband operation using Pcompensation / Between FDD and TDD	94
6.1.2.6 Void.....	98
6.1.2.7 Cell reselection / Equivalent PLMN	98
6.1.2.8 Cell reselection / Equivalent PLMN / Single Frequency operation	102
6.1.2.9 Cell reselection using Qhyst, Qoffset and Tresselection	104
6.1.2.10 Void.....	111
6.1.2.11 Area Specific SIBs using systemInformationAreaID.....	111
6.1.2.12 Cell reselection using cell status and cell reservations / cellReservedForOtherUse	117

6.1.2.13	Cell reselection using cell status and cell reservations / Access Identity 0, 1, 2 and 12 to 14 – cellReservedForOperatorUse	120
6.1.2.14	Cell reselection using cell status and cell reservations / Access Identity 11 or 15 - cellReservedForOperatorUse	123
6.1.2.15	Cell reselection in shared network environment	126
6.1.2.16	Inter-frequency cell reselection (equal priority).....	129
6.1.2.17	Cell reselection / Cell-specific reselection parameters provided by the network in a neighbouring cell list.....	131
6.1.2.18	Cell reselection, Sintrasearch, Snonintrasearch.....	134
6.1.2.19	Speed-dependent cell reselection	140
6.1.2.20	Inter-frequency cell reselection according to cell reselection priority provided by SIBs.....	145
6.1.2.21	Cell reselection, SIntraSearchQ and SnonIntraSearchQ	150
6.1.2.22	Inter-frequency cell reselection based on common priority information with parameters ThreshX, HighQ, ThreshX, LowQ and ThreshServing, LowQ	159
6.1.2.23	Cell reselection / MFBI.....	166
6.1.2.24	173	
6.1.2.25	173	
6.1.2.26	Cell Selection / RedCap	173
6.2	Multi-mode environment.....	178
6.2.1	Inter-RAT PLMN selection	178
6.2.1.1	Inter-RAT PLMN Selection / Selection of correct RAT for OPLMN / Automatic mode.....	178
6.2.1.2	Inter-RAT PLMN Selection / Selection of correct RAT for UPLMN / Automatic mode.....	180
6.2.1.3	Inter-RAT PLMN Selection / Selection of correct PLMN and RAT in shared network environment / Automatic mode.....	183
6.2.1.4	Inter-RAT PLMN Selection / Selection of correct RAT from the OPLMN list / Manual mode	187
6.2.1.5	Inter-RAT Background HPLMN Search / Search for correct RAT for HPLMN / Automatic Mode	190
6.2.2	Inter-RAT Cell Selection	194
6.2.2.1	Inter-RAT cell selection / From NR RRC_IDLE to EUTRA_Idle / Serving cell becomes non-suitable	194
6.2.2.2	Inter-RAT cell selection / From E-UTRA_Idle to NR RRC_IDLE / Serving cell becomes non-suitable	201
6.2.3	Inter-RAT Cell Reselection	208
6.2.3.1	Inter-RAT cell reselection / From E-UTRA_IDLE to NR RRC_IDLE (lower priority & higher priority, Srxlev based).....	208
6.2.3.2	Inter-RAT cell reselection / From E-UTRA_IDLE to NR RRC_IDLE (lower priority & higher priority, Squal based)	215
6.2.3.3	Inter-RAT cell reselection / From NR RRC_IDLE to E-UTRA_IDLE (lower priority & higher priority, Srxlev based).....	223
6.2.3.4	Inter-RAT cell reselection / From NR RRC_IDLE to E-UTRA_IDLE (lower priority & higher priority, Squal based)	229
6.2.3.5	Inter-RAT cell reselection / From NR RRC_IDLE to E-UTRA_IDLE according to RAT priority provided by dedicated signalling (RRCRelease).....	236
6.2.3.6	Inter-RAT cell reselection / From E-UTRA_IDLE to NR RRC_IDLE according to RAT priority provided by dedicated signalling (RRConnRelease).....	244
6.2.3.7	Inter-RAT cell reselection / From NR RRC_IDLE to E-UTRA RRC_IDLE, Snonintrasearch.	249
6.2.3.8	Inter-RAT cell reselection / From E-UTRA RRC_IDLE to NR RRC_IDLE, Snonintrasearch	253
6.2.3.9	Void.....	259
6.2.3.10	Inter-RAT cell reselection / From E-UTRA_IDLE to NR RRC_IDLE / schedulingInfoList-v12j0	259
6.2.3.11	Inter-RAT cell reselection / From E-UTRA_IDLE to NR RRC_IDLE / schedulingInfoListExt-r12	267
6.3	5GS Steering of Roaming.....	275
6.3.1	Steering of Roaming	275
6.3.1.1	Steering of UE in roaming during registration/security check successful using List Type 1	275
6.3.1.2	Steering of UE in roaming during registration/security check successful but SOR Transparent container indicates ACK has been NOT been requested.....	281
6.3.1.3	Steering of UE in roaming during registration/security check unsuccessful/Automatic mode ..	287
6.3.1.4	Steering of UE in roaming during registration/security check unsuccessful/Manual mode.....	290
6.3.1.5	Steering of UE in roaming during registration/UE configured to receive Steering of Roaming information but does not receive Steering of Roaming from Network	294
6.3.1.6	Void.....	299

6.3.1.7	Steering of UE in roaming during registration/security check unsuccessful but emergency service pending to be activated.....	299
6.3.1.8	Steering of UE in roaming after registration/Automatic PLMN selection mode	304
6.3.1.9	Steering of UE in roaming after registration/Manual PLMN selection mode.....	308
6.3.1.10	Steering of UE in roaming during mobility update registration	311
6.4	UE Procedures in RRC_INACTIVE state.....	315
6.4.1	NG-RAN Only PLMN Selection in RRC_INACTIVE state	315
6.4.1.1	PLMN Selection/Higher priority/HPLMN in Automatic PLMN Selection Mode.....	315
6.4.1.2	Cell reselection of ePLMN in manual mode	322
6.4.2	Cell Selection/Qrxlevmin & Cell Reselection (Intra NR in RRC_INACTIVE state).....	329
6.4.2.1	Cell Selection/Qrxlevmin & Cell Reselection (Intra NR in RRC_INACTIVE state).....	329
6.4.2.2	Inter-frequency cell reselection according to cell reselection priority provided by SIBs in RRC_INACTIVE state.....	337
6.4.3	Inter-RAT Cell Reselection	342
6.4.3.1	Inter-RAT cell reselection From NR RRC_INACTIVE to E-UTRA RRC_IDLE (lower priority & higher priority, Srxlev based).....	342
6.5	SNPN and CAG Selection.....	349
6.5.1	SNPN Only Selection	349
6.5.1.1	SNPN Selection in Manual Mode	349
6.5.1.2	SNPN Selection in Automatic Mode.....	352
6.5.1.3	SNPN / User Reselection in Automatic Mode	355
6.5.2	CAG (Closed Access Group).....	357
6.5.2.1	CAG Selection in Manual Mode.....	357
6.5.2.2	CAG Selection in Automatic Mode	363
6.5.2.3	CAG / Limited Service / No Suitable cell	369
6.5.2.4	CAG / cell reselection / Within allowed CAG / non-CAG cell to CAG cell	374
6.5.2.5	Void.....	379
6.5.2.6	CAG / cell reservation.....	379
7	Layer 2.....	387
7.1	NR Layer 2.....	387
7.1.0	Common test case specific values for Layer 2.....	387
7.1.1	MAC.....	387
7.1.1.0	Default Pre-Test Conditions for all MAC test cases	387
7.1.1.1	Random Access Procedures	389
7.1.1.1.1	Correct selection of RACH parameters / Random access preamble and PRACH resource explicitly signalled to the UE by RRC / contention free random access procedure	389
7.1.1.1.1a	Correct selection of RACH parameters / Random access preamble and PRACH resource explicitly signalled to the UE by PDCCH Order / contention free random access procedure.....	397
7.1.1.1.2	Random access procedure / Successful / C-RNTI Based / Preamble selected by MAC itself	404
7.1.1.1.3	Random access procedure / Successful / SI request	418
7.1.1.1.4	Random access procedure / Successful / Beam Failure / Preamble selected by MAC itself / Non Contention Free RACH procedure	427
7.1.1.1.5	Random access procedure / Successful / Supplementary Uplink	442
7.1.1.1.6	Random access procedure / Successful/ Temporary C-RNTI Based / Preamble selected by MAC itself.....	447
7.1.1.1.7	Random access procedure / Successful/ Temporary C-RNTI Based / Preamble selected by MAC itself.....	460
7.1.1.1.8	Correct selection of RACH parameters / 2-step RACH/MSG4 and PRACH resource explicitly signalled to the UE by RRC / contention free random access procedure	467
7.1.1.1.9	Random access procedure / Successful / 2-step RACH/C-RNTI Based / Preamble selected by MAC itself.....	477
7.1.1.1.10	Random access procedure / 2-step RACH/not complete/ RA_TYPE to 4-stepRA	492
7.1.1.1.11 to 7.1.1.1.15	498
7.1.1.1.16	Random access procedure / RedCap UE identification / Msg3-based / CCCH1	498
7.1.1.1.17	Random access procedure / RedCap UE identification / Msg1-based.....	500
7.1.1.1.18	Random access procedure / Msg3 repetition indication / Random access resources selection.....	504
7.1.1.2	Downlink Data Transfer.....	506
7.1.1.2.1	Correct Handling of DL MAC PDU / Assignment / HARQ process	506

7.1.1.2.2	Correct Handling of DL HARQ process PDSCH Aggregation	516
7.1.1.2.3	Correct HARQ process handling / CCCH	522
7.1.1.2.4	Correct HARQ process handling / BCCH	525
7.1.1.2.5	Correct HARQ process handling / DL grant prioritization	528
7.1.1.3	Uplink Data Transfer	530
7.1.1.3.1	Correct Handling of UL MAC PDU / Assignment / HARQ process	530
7.1.1.3.2	Logical channel prioritization handling	540
7.1.1.3.2b	Logical channel prioritization handling with Mapping restrictions	543
7.1.1.3.3	Correct handling of MAC control information / Scheduling requests	551
7.1.1.3.4	Correct handling of MAC control information / Buffer status / UL data arrive in the UE Tx buffer / Regular BSR	555
7.1.1.3.5	Correct handling of MAC control information / Buffer Status / UL resources are allocated / Padding BSR	564
7.1.1.3.6	Correct handling of MAC control information / Buffer status / Periodic BSR timer expires	570
7.1.1.3.7	UE power headroom reporting / Periodic reporting / DL pathloss change reporting	576
7.1.1.3.8	UE power headroom reporting / SCell activation / DL pathloss change reporting	583
7.1.1.3.8.1	UE power headroom reporting / SCell activation / DL pathloss change reporting/ Intra- band Contiguous CA	583
7.1.1.3.8.2	UE power headroom reporting / SCell activation / DL pathloss change reporting / Inter- band CA	591
7.1.1.3.8.3	UE power headroom reporting / SCell activation / DL pathloss change reporting / Intra- band non-Contiguous CA	592
7.1.1.3.9	Correct Handling of UL HARQ process / PUSCH Repetition Type A / PUSCH Aggregation	592
7.1.1.3.10	Correct Handling of HARQ process / Multiple CORESETPoolIndex	599
7.1.1.3.11	Correct handling of UL grant prioritization	601
7.1.1.3.12	Correct Handling of UL HARQ process / PUSCH Repetition Type B	608
7.1.1.3.13	Logical channel prioritization handling with Mapping restrictions / physical layer priority	618
7.1.1.4	Transport Size Selection	622
7.1.1.4.1	DL-SCH Transport Block Size Selection	622
7.1.1.4.1.0	Common parameters for DL-SCH Transport Block Size Selection	622
7.1.1.4.1.1	DL-SCH Transport Block Size selection / DCI format 1_0	623
7.1.1.4.1.2	Void	631
7.1.1.4.1.3	DL-SCH transport block size selection / DCI format 1_1 / RA type 0/RA Type 1 / 2 Codewords enabled	631
7.1.1.4.1.4	DL-SCH transport block size selection / DCI format 1_1 / RA type 0/RA Type 1 / 2 Codewords enabled / 256QAM	642
7.1.1.4.1.5	DL-SCH transport block size selection / DCI format 1_2	654
7.1.1.4.2	UL-SCH Transport Block Size Selection	665
7.1.1.4.2.0	Common parameters for UL-SCH Transport Block Size Selection	665
7.1.1.4.2.1	UL-SCH Transport Block Size selection / DCI format 0_0 / Transform precoding disabled	667
7.1.1.4.2.2	Void	678
7.1.1.4.2.3	UL-SCH transport block size selection / DCI format 0_1 / RA type 0/RA Type 1 / Transform precoding disabled	678
7.1.1.4.2.4	UL-SCH transport block size selection / DCI format 0_1 / RA type 0/RA Type 1 / 256QAM / Transform precoding disabled	694
7.1.1.4.2.5	UL-SCH Transport Block Size selection / DCI format 0_0 / Transform precoding and 64QAM	709
7.1.1.4.2.6	UL-SCH Transport Block Size selection / DCI format 0_2	720
7.1.1.5	Discontinuous reception	736
7.1.1.5.0	DRX Common Definitions	736
7.1.1.5.1	DRX operation / Short cycle not configured / Parameters configured by RRC	736
7.1.1.5.2	DRX operation / Short cycle not configured / Long DRX command MAC control element reception	741
7.1.1.5.3	DRX operation / Short cycle configured / Parameters configured by RRC	746
7.1.1.5.4	DRX operation / Short cycle configured / DRX command MAC control element reception	749
7.1.1.5.5	DRX operation / Short cycle configured / Long DRX command MAC control element reception	755
7.1.1.6	Semi-Persistent Scheduling	759

7.1.1.6.1	Correct handling of DL assignment / Semi-persistent case	759
7.1.1.6.2	Correct handling of UL grant / configured grant Type 1	766
7.1.1.6.3	Correct handling of UL grant / configured grant Type 2	776
7.1.1.6.4	Correct handling of DL assignment / Multi Semi-persistent configuration.....	785
7.1.1.6.5	Correct handling of UL grant / Multi configured uplink grants	792
7.1.1.7	Activation/Deactivation of SCells.....	802
7.1.1.7.1	Activation/Deactivation of SCells / Activation/Deactivation MAC control element reception / sCellDeactivationTimer.....	802
7.1.1.7.1.1	Activation/Deactivation of SCells / Activation/Deactivation MAC control element reception / sCellDeactivationTimer / Intra-band Contiguous CA.....	802
7.1.1.7.1.2	Activation/Deactivation of SCells / Activation/Deactivation MAC control element reception / sCellDeactivationTimer / Inter-Band CA	807
7.1.1.7.1.3	Activation/Deactivation of SCells / Activation/Deactivation MAC control element reception / sCellDeactivationTimer / Intra-band non-Contiguous CA.....	808
7.1.1.8	Bandwidth Part (BWP) operation	808
7.1.1.8.1	Bandwidth Part (BWP) operation UL/DL	808
7.1.1.8.2	827	
7.1.1.8.3	Separate BWP / IDLE / RedCap.....	827
7.1.1.9	MAC Reconfiguration and Reset	832
7.1.1.9.1	MAC Reset	832
7.1.1.10	Other Procedures.....	837
7.1.1.10.1	DataInactivityTimer expiry	837
7.1.1.10.2	Recommended Bit Rate	839
7.1.1.11	NR Dual Connectivity.....	842
7.1.1.11.1	DC power headroom reporting / PSCell activation and DL pathloss change reporting	842
7.1.1.12	UE power saving.....	848
7.1.1.12.1	Void.....	848
7.1.1.12.2	Void.....	848
7.1.1.12.3	DRX adaptation / UE wakeup indication	848
7.1.1.12.4	DRX adaptation / SCell dormancy indication	859
7.1.1.12.4.1	DRX adaptation / SCell dormancy indication / Intra-band Contiguous CA	859
7.1.1.12.4.2	DRX adaptation / SCell dormancy indication / Intra-band non Contiguous CA	868
7.1.1.12.4.3	DRX adaptation / SCell dormancy indication / Inter-band CA.....	868
7.1.2	RLC	869
7.1.2.1	Default Pre-Test Conditions for all RLC test cases.....	869
7.1.2.1.1	Default Pre-Test Conditions for AM RLC test cases.....	869
7.1.2.1.2	Default Pre-Test Conditions for UM RLC test cases.....	870
7.1.2.2	RLC Unacknowledged mode	870
7.1.2.2.1	UM RLC / Segmentation and reassembly / 6-bit SN / Segmentation Info (SI) field.....	870
7.1.2.2.2	UM RLC / Segmentation and reassembly / 12-bit SN / Segmentation Info (SI) field.....	875
7.1.2.2.3	UM RLC / 6-bit SN / Correct use of sequence numbering.....	876
7.1.2.2.4	UM RLC / 12-bit SN / Correct use of sequence numbering.....	880
7.1.2.2.5	UM RLC / Receive Window operation and t-Reassembly expiry.....	883
7.1.2.2.6	UM RLC / RLC re-establishment procedure.....	888
7.1.2.3	RLC Acknowledged Mode	891
7.1.2.3.1	AM RLC / 12-bit SN / Segmentation and reassembly / Segmentation Info (SI) field.....	891
7.1.2.3.2	AM RLC / 18-bit SN / Segmentation and reassembly / Segmentation Info (SI) field.....	895
7.1.2.3.3	AM RLC / 12-bit SN / Correct use of sequence numbering.....	896
7.1.2.3.4	AM RLC / 18-bit SN / Correct use of sequence numbering.....	900
7.1.2.3.5	AM RLC / 12-bit SN / Control of transmit window / Control of receive window	901
7.1.2.3.5a	AM RLC / 18-bit SN / Control of transmit window / Control of receive window	905
7.1.2.3.6	AM RLC / Polling for status.....	906
7.1.2.3.7	AM RLC / Receiver status triggers	911
7.1.2.3.8	AM RLC / Reconfiguration of RLC parameters by upper layers.....	916
7.1.2.3.9	AM RLC / Reassembling of AMD PDUs	921
7.1.2.3.10	AM RLC / Re-transmission of RLC PDU with and without re-segmentation	928
7.1.2.3.11	AM RLC / RLC re-establishment procedure.....	935
7.1.3	PDCP	940
7.1.3.0	Default Pre-Test Conditions for all PDCP test cases	940
7.1.3.1	Maintenance of PDCP sequence numbers for radio bearers	941
7.1.3.1.1	Maintenance of PDCP sequence numbers / User plane / 12 bit SN	941
7.1.3.1.2	Maintenance of PDCP sequence numbers / User plane / 18 bit SN	946

7.1.3.2	PDCP integrity protection	946
7.1.3.2.1	Integrity protection / Correct functionality of integrity algorithm SNOW3G / SRB / DRB	946
7.1.3.2.2	Integrity protection / Correct functionality of integrity algorithm AES / SRB / DRB	954
7.1.3.2.3	Integrity protection / Correct functionality of integrity algorithm ZUC / SRB / DRB	954
7.1.3.3	PDCP Ciphering and deciphering	955
7.1.3.3.1	Ciphering and deciphering / Correct functionality of encryption algorithm SNOW3G / SRB / DRB	955
7.1.3.3.2	Ciphering and deciphering / Correct functionality of encryption algorithm AES / SRB / DRB	960
7.1.3.3.3	Ciphering and deciphering / Correct functionality of encryption algorithm ZUC / SRB / DRB	960
7.1.3.4	PDCP Handover	961
7.1.3.4.1	PDCP handover / Lossless handover / PDCP sequence number maintenance / PDCP status report to convey the information on missing or acknowledged PDCP SDUs at handover / In-order delivery and duplicate elimination in the downlink	961
7.1.3.4.2	PDCP handover / Non-lossless handover / PDCP sequence number maintenance	970
7.1.3.4.3	PDCP handover / DAPS handover / Status reporting / Intra-frequency	974
7.1.3.4.4	PDCP handover / DAPS handover / Status reporting / Inter-frequency	981
7.1.3.5	PDCP other	982
7.1.3.5.1	PDCP Discard.....	982
7.1.3.5.2	PDCP Uplink Routing / Split DRB	985
7.1.3.5.3	PDCP Data Recovery	989
7.1.3.5.4	PDCP reordering / Maximum re-ordering delay below t-Reordering / t-Reordering timer operations	995
7.1.3.5.5	PDCP Duplication	999
7.1.3.5.6	PDCP Duplication / 3 RLC entities.....	1004
7.1.3.5.6.1	PDCP Duplication / 3 RLC entities / Intra-band Contiguous CA.....	1004
7.1.3.5.6.2	PDCP Duplication / 3 RLC entities / Intra-band non-Contiguous CA	1012
7.1.3.5.7	Ethernet header compression and decompression / Correct functionality of ethernet header compression and decompression	1012
7.1.4	SDAP	1016
7.1.4.1	SDAP Data Transfer and PDU Header Handling UL/DL.....	1016
7.1.4.2	SDAP Data Transfer handling without Header UL/DL	1024
8	RRC.....	1031
8.1	NR RRC	1031
8.1.1	RRC connection management procedures	1031
8.1.1.1	Paging	1031
8.1.1.1.1	RRC / Paging for connection / Multiple paging records.....	1031
8.1.1.1.2	RRC / Paging for connection / Shared network environment.....	1035
8.1.1.2	RRC connection establishment	1041
8.1.1.2.1	RRC connection establishment / Return to idle state after T300 expiry / connEstFailOffsetValidity / T300 expired.....	1041
8.1.1.2.2	Void.....	1046
8.1.1.2.3	RRC connection establishment / RRC Reject with wait time.....	1046
8.1.1.2.4	RRC connection establishment / Extended and spare fields in SI	1048
8.1.1.3	RRC release.....	1051
8.1.1.3.1	RRC connection release / Redirection to another NR frequency.....	1051
8.1.1.3.2	RRC connection release / Redirection from NR to E-UTRA	1054
8.1.1.3.3	RRC connection release / Success / With priority information / T320 expiry.....	1057
8.1.1.3.4	RRC connection release / Success / With priority information / T320 expiry / E-UTRA ..	1067
8.1.1.3.5	Void.....	1075
8.1.1.3.6	Void.....	1075
8.1.1.3.7	RRC connection release / Success / Deprioritisation / Frequency / T325 expiry	1075
8.1.1.3.7a	RRC connection release / Success / Deprioritisation / NR / T325 expiry	1077
8.1.1.3.7b	RRC connection release / Success / Deprioritisation / Deletion of Stored deprioritisation request	1079
8.1.1.4	RRC resume	1081
8.1.1.4.1	RRC resume / Suspend-Resume / RNA update / Success / Short message for SI update ..	1081
8.1.1.4.2	RRC resume / Suspend-Resume / RRC setup / T319 expiry.....	1091
8.1.1.4.3	Void.....	1096

8.1.1.4.4	RRC resume / Suspend-Resume / RRC reconfiguration / Active MCG SCell addition / Intra-band Contiguous CA	1096
8.1.1.4.5	RRC resume / Suspend-Resume / RRC reconfiguration / Active MCG SCell addition / Intra-band non-Contiguous CA	1097
8.1.1.4.6	RRC resume / Suspend-Resume / RRC reconfiguration / Active MCG SCell addition / Inter-band CA.....	1098
8.1.1.4.7	RRC resume / Suspend-Resume / RRC setup / Active SCG SCell addition / Intra-band Contiguous CA	1098
8.1.1.4.8	RRC resume / Suspend-Resume / RRC setup / Active SCG SCell addition / Intra-band non-Contiguous CA	1100
8.1.1.4.9	RRC resume / Suspend-Resume / RRC setup / Active SCG SCell addition / Inter-band CA	1100
8.1.2	RRC reconfiguration.....	1101
8.1.2.1	Radio bearer establishment / reconfiguration / release.....	1101
8.1.2.1.1	RRC reconfiguration / DRB / SRB / Establishment / Modification / Release / Success	1101
8.1.2.1.2	RRC reconfiguration / RRC bearer establishment / uplinkTxDirectCurrentList	1108
8.1.2.1.3	Void.....	1111
8.1.2.1.4	RRC reconfiguration / Dedicated RLF timer.....	1111
8.1.2.1.5	NR CA / RRC reconfiguration / SCell addition / modification / release / Success	1114
8.1.2.1.5.1	NR CA / RRC reconfiguration / SCell addition / modification / release / Success / Intra-band Contiguous CA.....	1114
8.1.2.1.5.2	NR CA / RRC reconfiguration / SCell addition / modification / release / Success / Inter-band CA	1117
8.1.2.1.5.3	NR CA / RRC reconfiguration / SCell addition / modification / release / Success / Intra-band non-contiguous CA	1118
8.1.3	Measurement configuration control and reporting.....	1118
8.1.3.1	Intra NR measurements.....	1118
8.1.3.1.1	Measurement configuration control and reporting / Intra NR measurements / Event A1 / Event A2.....	1118
8.1.3.1.2	Measurement configuration control and reporting / Event A3 / Measurement of Neighbour NR cell / Intra-frequency measurements	1128
8.1.3.1.3	Measurement configuration control and reporting / Event A3 / Measurement of Neighbour NR cell / Inter-frequency measurements	1135
8.1.3.1.4	Measurement configuration control and reporting / Event A3 / Measurement of Neighbour NR cell / Inter-band measurements	1137
8.1.3.1.5	Measurement configuration control and reporting / Event A4 / Measurement of Neighbour NR cell / Intra-frequency measurements	1139
8.1.3.1.6	Measurement configuration control and reporting / Event A4 / Measurement of Neighbour NR cell / Inter-frequency measurements	1148
8.1.3.1.7	Measurement configuration control and reporting / Event A4 / Measurement of Neighbour NR cell / Inter-band measurements	1150
8.1.3.1.8	Measurement configuration control and reporting / Event A5 / Measurement of Neighbour NR cell / Intra-frequency measurements	1152
8.1.3.1.9	Measurement configuration control and reporting / Event A5 / Measurement of Neighbour NR cell / Inter-frequency measurements	1161
8.1.3.1.10	Measurement configuration control and reporting / Event A5 / Measurement of Neighbour NR cell / Inter-band measurements	1163
8.1.3.1.11	Measurement configuration control and reporting / Intra NR measurements / Two simultaneous events A3 (intra and inter-frequency measurements) / RSRQ based measurements	1165
8.1.3.1.12	Measurement configuration control and reporting / Intra NR measurements / Two simultaneous events A5 (intra and inter-frequency measurements) / SINR based measurements	1173
8.1.3.1.13	Measurement configuration control and reporting / SS/PBCH block based / CSI-RS based intra-frequency measurements / Measurement of Neighbour NR cell.....	1182
8.1.3.1.14	Void.....	1199
8.1.3.1.14A	Measurement configuration control and reporting / SS/PBCH block based / CSI-RS based inter-frequency measurements / Measurement of Neighbour NR cell.....	1199
8.1.3.1.15	Void.....	1204
8.1.3.1.15A	Measurement configuration control and reporting / Intra NR measurements / Blacklisting.....	1204

8.1.3.1.16	Measurement configuration control and reporting / Intra NR measurements / Whitelisting	1216
8.1.3.1.17	NR CA / Measurement configuration control and reporting / Intra NR measurements / Event A6	1225
8.1.3.1.17.1	NR CA / Measurement configuration control and reporting / Intra NR measurements / Event A6 / Intra-band Contiguous CA	1225
8.1.3.1.17.2	NR CA / Measurement configuration control and reporting / Intra NR measurements / Event A6 / Inter-band CA	1234
8.1.3.1.17.3	NR CA / Measurement configuration control and reporting / Intra NR measurements / Event A6 / Intra-band non Contiguous CA	1236
8.1.3.1.18	NR CA / Measurement configuration control and reporting / Intra NR measurements / Additional measurement reporting	1236
8.1.3.1.18.1	NR CA / Measurement configuration control and reporting / Intra NR measurements / Additional measurement reporting / Intra-band Contiguous CA	1236
8.1.3.1.18.2	NR CA / Measurement configuration control and reporting / Intra NR measurements / Additional measurement reporting / Inter-band CA	1247
8.1.3.1.18.3	NR CA / Measurement configuration control and reporting / Intra NR measurements / Additional measurement reporting / Intra-band non Contiguous CA	1248
8.1.3.1.19	Measurement configuration control and reporting / Inter-frequency measurements/ SFTD	1249
8.1.3.1.20	Measurement configuration control and reporting / Measurement Gaps / gapFR1	1254
8.1.3.1.21	Measurement configuration control and reporting / Measurement Gaps / gapFR2	1261
8.1.3.1.22	Void	1268
8.1.3.1.23	Measurement configuration control and reporting / Intra NR measurements / Periodic reporting / Continuation of the measurements after RRC Resume	1268
8.1.3.2	Inter-RAT measurements	1275
8.1.3.2.1	Measurement configuration control and reporting / Inter-RAT measurements / Event B1 / Measurement of E-UTRA cells	1275
8.1.3.2.2	Measurement configuration control and reporting / Inter-RAT measurements / Event B2 / Measurement of E-UTRA cells	1284
8.1.3.2.3	Measurement configuration control and reporting / Inter-RAT measurements / Event B2 / Measurement of E-UTRA cells / RSRQ based measurements	1292
8.1.3.2.4	Measurement configuration control and reporting / Inter-RAT measurements / Event B2 / Measurement of E-UTRA cells / SINR based measurements	1301
8.1.3.2.5	Void	1309
8.1.3.2.6	Measurement configuration control and reporting / Inter-RAT measurements / Event B1 / NR to UTRA	1309
8.1.3.2.7	Measurement configuration control and reporting / Inter-RAT measurements / Event B2 / NR to UTRA	1315
8.1.3.2.8	Measurement configuration control and reporting / Inter-RAT measurements / Periodic reporting / NR to UTRA	1323
8.1.3.3	Measurement for self-optimized networks	1330
8.1.3.3.1	Measurement configuration control and reporting / CGI reporting of NR cell	1330
8.1.3.3.2	Measurement configuration control and reporting / CGI reporting of E-UTRA cell	1340
8.1.3.4	Measurement relaxation	1352
8.1.3.4.1	Measurement relaxation / Stationary criterion / Redcap	1352
8.1.4	Handover	1356
8.1.4.1	Intra NR handover	1356
8.1.4.1.1	Void	1356
8.1.4.1.2	Intra NR handover / Success / Inter-frequency	1356
8.1.4.1.3	Void	1370
8.1.4.1.4	Void	1370
8.1.4.1.5	Intra NR handover / Failure / Re-establishment successful	1370
8.1.4.1.6	Intra NR handover / Failure / Re-establishment failure	1376
8.1.4.1.7	NR CA / Intra NR handover / Success / PCell Change and SCell addition / SCell release	1380
8.1.4.1.7.1	NR CA / Intra NR handover / Success / PCell Change and SCell addition / SCell release / Intra-band Contiguous CA	1380
8.1.4.1.7.2	NR CA / Intra NR handover / Success / PCell Change and SCell addition / SCell release / Inter-band CA	1385
8.1.4.1.7.3	NR CA / Intra NR handover / Success / PCell Change and SCell addition / SCell release / Intra-band non-contiguous CA	1386
8.1.4.1.8	NR CA / Intra NR handover / Success / PCell Change / SCell no Change	1386

8.1.4.1.8.1	NR CA / Intra NR handover / Success / PCell Change / SCell no Change / Intra-band Contiguous CA	1386
8.1.4.1.8.2	NR CA / Intra NR handover / Success / PCell Change / SCell no Change / Inter-band CA.....	1391
8.1.4.1.8.3	NR CA / Intra NR handover / Success / PCell Change / SCell no Change / Intra-band non-contiguous CA	1391
8.1.4.1.9	NR CA / Intra NR handover / Failure / Re-establishment successful.....	1392
8.1.4.1.9.1	NR CA / Intra NR handover / Failure / Re-establishment successful / Intra-band Contiguous CA	1392
8.1.4.1.9.2	NR CA / Intra NR handover / Failure / Re-establishment successful / Inter-band CA	1402
8.1.4.1.9.3	NR CA / Intra NR handover / Failure / Re-establishment successful / Intra-band non-contiguous CA	1403
8.1.4.1.10	eCall Only mode / Intra NR handover / Success / Inter-frequency	1403
8.1.4.2	Inter-RAT handover	1412
8.1.4.2.1	Inter-RAT handover from NR	1412
8.1.4.2.1.1	Inter-RAT handover / From NR to E-UTRA / Success	1412
8.1.4.2.1.2	Inter-RAT handover / From NR to EN-DC / Success	1417
8.1.4.2.2	Inter-RAT handover to NR.....	1424
8.1.4.2.2.1	Inter-RAT handover / From E-UTRA to NR / Success	1424
8.1.4.3	DAPS handover.....	1429
8.1.4.3.1	DAPS handover with key change / Success / Intra-frequency.....	1429
8.1.4.3.2	DAPS handover / HO Failure and source link available / HO Success and RLF in source / Intra-frequency	1439
8.1.4.3.3	1452	
8.1.4.3.4	DAPS handover with key change / Success / Inter-frequency.....	1452
8.1.4.3.5	DAPS handover / HO Failure and source link available / HO Success and RLF in source / Inter-frequency	1453
8.1.4.4	Conditional handover	1454
8.1.4.4.1	Conditional handover / Success / A3 / A5 / A3+A5.....	1454
8.1.4.4.2	Conditional handover / modify conditional handover configuration.....	1465
8.1.4.4.3	Conditional handover / Failure	1475
8.1.4.4.4	Conditional handover / legacy Handover / legacy Handover Failure	1484
8.1.5	RRC others.....	1494
8.1.5.1	UE capability transfer	1494
8.1.5.1.1	UE capability transfer / Success	1494
8.1.5.2	SI change / On-demand SIB.....	1522
8.1.5.2.1	Void.....	1522
8.1.5.2.2	SI change / Notification of BCCH modification / Short message for SI update in NR RRC_CONNECTED state.....	1522
8.1.5.3	PWS notification	1525
8.1.5.3.1	PWS notification / PWS reception in NR RRC_IDLE state.....	1525
8.1.5.3.2	PWS notification / PWS reception in NR RRC_INACTIVE state	1527
8.1.5.3.3	PWS notification / PWS reception in NR RRC_CONNECTED state.....	1528
8.1.5.3.4	PWS notification / PWS reception using dedicatedSystemInformationDelivery	1529
8.1.5.4	Counter check	1534
8.1.5.4.1	Counter check / Reception of CounterCheck message by the UE.....	1534
8.1.5.5	Redirection to NR	1539
8.1.5.5.1	Redirection to NR / From E-UTRA / Success	1539
8.1.5.6	Radio link failure	1543
8.1.5.6.1	Radio link failure / RRC connection re-establishment success	1543
8.1.5.6.2	Void.....	1551
8.1.5.6.3	Radio link failure / T311 expiry	1551
8.1.5.6.4	Void.....	1554
8.1.5.6.5	NR CA / No Radio Link Failure on SCell / RRC Connection Continues on PCell.....	1554
8.1.5.6.5.1	NR CA / No Radio Link Failure on SCell / RRC Connection Continues on PCell / Intra-band Contiguous CA.....	1554
8.1.5.6.5.2	NR CA / No Radio Link Failure on SCell / RRC Connection Continues on PCell / Inter-band CA	1558
8.1.5.6.5.3	NR CA / No Radio Link Failure on SCell / RRC Connection Continues on PCell / Intra-band non-Contiguous CA	1558
8.1.5.7	Failure information.....	1559
8.1.5.7.1	Failure information / RLC failure / MCG.....	1559

8.1.5.7.1.1	Failure information / RLC failure / MCG / Intra-band Contiguous CA.....	1559
8.1.5.7.1.2	Failure information / RLC failure / MCG / Inter-band CA.....	1565
8.1.5.7.1.3	Failure information / RLC failure / MCG / Intra-band non Contiguous CA.....	1565
8.1.5.8	Processing delay.....	1566
8.1.5.8.1	Processing delay / RRC_Idle to RRC_Connected / RRC_Inactive to RRC_Connected / Success / Latency check	1566
8.1.5.8.2	Processing delay / RRC_Inactive to RRC_Connected / Success / Latency check / SCell addition.....	1575
8.1.5.8.2.1	Processing delay / RRC_Inactive to RRC_Connected / Success / Latency check / SCell addition / Intra-band Contiguous CA.....	1575
8.1.5.8.2.2	Processing delay / RRC_Inactive to RRC_Connected / Success / Latency check / SCell addition / Inter-band CA	1579
8.1.5.8.2.3	Processing delay / RRC_Inactive to RRC_Connected / Success / Latency check / SCell addition / Intra-band non-Contiguous CA.....	1580
8.1.5.9	Message Segment transfer.....	1580
8.1.5.9.1	RACS / UL Message Segment transfer / UECapabilityInformation	1580
8.1.5.9.2	RRC reconfiguration / DL segment transfer.....	1586
8.1.5.10	UE Assistance Information	1591
8.1.5.10.1	UE Assistance Information/ Release Preference	1591
8.1.5.11	Idle/Inactive measurements.....	1595
8.1.5.11.1	Idle/Inactive measurements / Idle mode / SIB11 configuration / Measurement of NR cells.....	1595
8.1.5.11.2	Void.....	1601
8.1.5.11.2	Idle/Inactive measurements / Idle mode / RRCRelease configuration / Measurement of NR cells.....	1601
8.1.5.11.3	Idle/Inactive measurements / Inactive mode / SIB11 configuration / Measurement of NR cells.....	1607
8.1.5.11.4	Idle/Inactive measurements / Inactive mode / RRCRelease configuration / Measurement of NR cells	1615
8.1.6	SON and MDT support for NR.....	1621
8.1.6.1	Intra NR MDT.....	1621
8.1.6.1.1	Immediate MDT	1621
8.1.6.1.1.1	Immediate MDT / Measurement reporting / Location information	1621
8.1.6.1.1.2	Immediate MDT / Measurement / Latency metrics for UL PDCP Packet Delay per DRB	1628
8.1.6.1.2	Logged MDT.....	1636
8.1.6.1.2.1	Logged MDT / RRC_IDLE / Logging and reporting / Intra-frequency measurement..	1636
8.1.6.1.2.2	Logged MDT / RRC_INACTIVE / Logging and reporting / Inter-frequency measurement	1644
8.1.6.1.2.3	Logged MDT / Intra-frequency measurement, logging and reporting	1652
8.1.6.1.2.4	Logged MDT/ RRC_IDLE / Logging and reporting / periodic measurement trigger...	1662
8.1.6.1.2.5	Logged MDT/ RRC_IDLE / Logging and reporting / event-based trigger.....	1670
8.1.6.1.2.6	Logged MDT/ RRC_IDLE / Logging and reporting / event-based trigger/ out-of- coverage.....	1679
8.1.6.1.2.7	Logged MDT / Logging and reporting / Indication of logged measurements at NR reestablishment	1687
8.1.6.1.2.8	Logged MDT / Logging and reporting / Reporting at RRC reconfiguration	1690
8.1.6.1.2.9	Logged MDT / Location information	1697
8.1.6.1.2.10	Logged MDT / Maintaining logged measurement configuration / UE mobility.....	1703
8.1.6.1.2.11	Logged MDT / UE state transitions	1709
8.1.6.1.2.12	Logged MDT / Release of logged MDT measurement configuration / Expire of duration timer	1714
8.1.6.1.2.13	Logged MDT / Release of logged MDT measurement configuration / Reception of new logged measurement configuration.....	1721
8.1.6.1.3	Radio Link Failure report	1727
8.1.6.1.3.1	Radio Link Failure / Reporting of Intra-frequency measurements	1727
8.1.6.1.3.2	Radio Link Failure / Reporting of Inter-frequency measurements	1736
8.1.6.1.3.3	Radio Link Failure / Reporting at RRC connection establishment and reestablishment	1738
8.1.6.1.3.4	Radio Link Failure / Reporting at NR handover	1746
8.1.6.1.3.5	Radio Link Failure / Location information	1752
8.1.6.1.3.6	Radio Link Failure / Random access problem	1758

8.1.6.1.3.7	Radio Link Failure / Logging and reporting / Reporting at intra NR handover / PLMN list	1763
8.1.6.1.4	Connection Establishment Failure.....	1770
8.1.6.1.4.1	Connection Establishment Failure / Logging and reporting / T300 expiry.....	1770
8.1.6.1.4.2	Connection Establishment Failure / Logging and reporting / RRC Resume.....	1774
8.1.6.1.4.3	Connection Establishment Failure / Logging and reporting / Reporting at intra-NR handover	1778
8.1.6.1.4.4	Connection Establishment Failure / Logging and reporting / Reporting at RRC connection re-establishment.....	1782
8.1.6.1.4.5	Connection Establishment Failure / Logging and reporting / Location Information	1785
8.1.6.1.4.6	Connection Establishment Failure / Logging and reporting / Reporting of Intra-frequency measurements.....	1788
8.1.6.1.4.7	Connection Establishment Failure / Logging and reporting / Reporting of Inter-frequency measurements.....	1793
8.1.6.1.4.8	Connection Establishment Failure / Logging and reporting / RACH failure report	1797
8.1.6.2	Inter-RAT MDT	1802
8.1.6.2.1	Inter-RAT MDT / Immediate MDT / Periodic reporting of E-UTRAN/ Location information	1802
8.1.6.2.2	Inter-RAT MDT / Logged MDT / E-UTRA Inter-RAT measurement, logging and reporting	1809
8.1.6.2.3	Inter-RAT MDT / Radio Link Failure / Reporting at E-UTRA Inter-RAT handover	1816
8.1.6.2.4	Inter-RAT MDT / Connection Establishment Failure / Logging and reporting / Reporting of E-UTRA measurement	1826
8.1.6.3	Inter-System MDT	1832
8.1.6.3.1	Inter-System MDT / Immediate MDT.....	1832
8.1.6.3.1.1	Inter-System MDT / Immediate MDT / Measurement reporting / Bluetooth measurement collection.....	1832
8.1.6.3.1.2	Inter-System MDT / Immediate MDT / Measurement reporting / WLAN measurement collection.....	1838
8.1.6.3.1.3	Inter-System MDT / Immediate MDT / Measurement reporting / Sensor measurement collection.....	1842
8.1.6.3.2	Inter-System MDT / Logged MDT.....	1845
8.1.6.3.2.1	Inter-System MDT / Logged MDT / Logging and reporting / Bluetooth measurement collection.....	1845
8.1.6.3.2.2	Inter-System MDT / Logged MDT / Logging and reporting / WLAN measurement collection.....	1850
8.1.6.3.2.3	Inter-System MDT / Logged MDT / Logging and reporting / Sensor measurement collection.....	1853
8.1.6.3.3	Inter-System MDT / Radio Link Failure	1856
8.1.6.3.3.1	Inter-System MDT / Radio Link Failure / Logging and reporting / Bluetooth measurement collection.....	1856
8.1.6.3.3.2	Inter-System MDT / Radio Link Failure / Logging and reporting / WLAN measurement collection.....	1862
8.1.6.3.3.3	Inter-System MDT / Radio Link Failure / Logging and reporting / Sensor measurement collection.....	1866
8.1.6.3.4	Inter-System MDT / Connection Establishment Failure	1869
8.1.6.3.4.1	Inter-System MDT / Connection Establishment Failure / Logging and reporting / Bluetooth measurement collection.....	1869
8.1.6.3.4.2	Inter-System MDT / Connection Establishment Failure / Logging and reporting / WLAN measurement collection	1874
8.1.6.3.4.3	Inter-System MDT / Connection Establishment Failure / Logging and reporting / Sensor measurement collection	1877
8.1.6.4	SON / RACH Optimisation.....	1880
8.1.6.4.1	SON / RACH logging and reporting	1880
8.1.7	Non-public networks.....	1885
8.1.7.1	Measurement for self-optimized networks.....	1885
8.1.7.1.1	Measurement configuration control and reporting / CGI reporting of NR NPN cell	1885
8.2	MR-DC RRC.....	1890
8.2.1	UE Capability	1890
8.2.1.1	UE capability transfer / Success.....	1890
8.2.1.1.1	UE capability transfer / Success / EN-DC.....	1890
8.2.1.1.2	UE capability transfer / Success / NE-DC.....	1933

8.2.1.2	Void.....	1969
8.2.2	Radio Bearer Addition, Modification and Release	1969
8.2.2.1	Radio Bearer Addition, Modification and Release / SRB	1969
8.2.2.1.1	SRB3 Establishment, Reconfiguration and Release / NR addition, modification and release / EN-DC.....	1969
8.2.2.1.2	SRB3 Establishment, Reconfiguration and Release / NR addition, modification and release / NR-DC.....	1977
8.2.2.2	Split SRB Establishment and Release	1985
8.2.2.2.1	Split SRB Establishment and Release / EN-DC	1985
8.2.2.2.2	Split SRB Establishment and Release / NR-DC	1994
8.2.2.2.3	Split SRB Establishment and Release / NE-DC	2002
8.2.2.3	Simultaneous SRB3 and Split SRB / Sequential message flow on SRB3 and Split SRB	2007
8.2.2.3.1	Simultaneous SRB3 and Split SRB / Sequential message flow on SRB3 and Split SRB with one UL path / EN-DC.....	2007
8.2.2.3.2	Simultaneous SRB3 and Split SRB / Sequential message flow on SRB3 and Split SRB with one UL path / NR-DC.....	2016
8.2.2.4	PSCell addition, modification and release / SCG DRB	2024
8.2.2.4.1	PSCell addition, modification and release / SCG DRB / EN-DC.....	2024
8.2.2.4.2	PSCell addition, modification and release / SCG DRB / NR-DC	2034
8.2.2.4.3	PSCell addition, modification and release / SCG DRB / NE-DC.....	2040
8.2.2.5	PSCell addition, modification and release / Split DRB	2050
8.2.2.5.1	PSCell addition, modification and release / Split DRB / EN-DC.....	2050
8.2.2.5.2	PSCell addition, modification and release / Split DRB / NR-DC.....	2059
8.2.2.5.3	PSCell addition, modification and release / Split DRB / NE-DC.....	2066
8.2.2.6	Bearer Modification / MCG DRB	2076
8.2.2.6.1	Bearer Modification / MCG DRB / SRB / PDCP version change / EN-DC.....	2076
8.2.2.7	Bearer Modification / Handling for bearer type change without security key change	2087
8.2.2.7.1	Bearer Modification / Handling for bearer type change without security key change / EN-DC	2087
8.2.2.7.2	Bearer Modification / Handling for bearer type change without security key change / NR-DC	2099
8.2.2.7.3	Bearer Modification / Handling for bearer type change without security key change / NE-DC	2109
8.2.2.8	Bearer Modification / Handling for bearer type change with security key change	2115
8.2.2.8.1	Bearer Modification / Handling for bearer type change with security key change / EN-DC	2115
8.2.2.8.2	Bearer Modification / Handling for bearer type change with security key change / NR-DC	2136
8.2.2.8.3	Bearer Modification / Handling for bearer type change with security key change / NE-DC	2155
8.2.2.9	Bearer Modification / Uplink data path / Split DRB Reconfiguration	2164
8.2.2.9.1	Bearer Modification / Uplink data path / Split DRB Reconfiguration / EN-DC	2164
8.2.2.9.2	Bearer Modification / Uplink data path / Split DRB Reconfiguration / NR-DC	2171
8.2.2.9.3	Bearer Modification / Uplink data path / Split DRB Reconfiguration / NE-DC	2176
8.2.3	Measurement Configuration Control and Reporting / Handovers	2181
8.2.3.1	Measurement configuration control and reporting / Inter-RAT measurements / Event B1 / Measurement of NR cells.....	2181
8.2.3.1.1	Measurement configuration control and reporting / Inter-RAT measurements / Event B1 / Measurement of NR cells / EN-DC.....	2181
8.2.3.1.2	Measurement configuration control and reporting / Inter-RAT measurements / Event B1 / Measurement of NR cells / NE-DC.....	2190
8.2.3.2	Measurement configuration control and reporting / Inter-RAT measurements / Event B1 / Measurement of NR cells / RSRQ based measurements.....	2206
8.2.3.2.1	Measurement configuration control and reporting / Inter-RAT measurements / Event B1 / Measurement of NR cells / RSRQ based measurements / EN-DC.....	2206
8.2.3.2.2	Measurement configuration control and reporting / Inter-RAT measurements / Event B1 / Measurement of NR cells / NE-DC.....	2215
8.2.3.3	Measurement configuration control and reporting / Inter-RAT measurements / Periodic reporting / Measurement of NR cells.....	2231
8.2.3.3.1	Measurement configuration control and reporting / Inter-RAT measurements / Periodic reporting / Measurement of NR cells / EN-DC	2231
8.2.3.4	Measurement configuration control and reporting / Event A1 / Measurement of NR PSCell	2241

8.2.3.4.1	Measurement configuration control and reporting / Event A1 / Measurement of NR PSCell / EN-DC.....	2241
8.2.3.4.2	Measurement configuration control and reporting / Event A1 / Measurement of E-UTRA PSCell / NE-DC.....	2250
8.2.3.5	Measurement configuration control and reporting / Event A2 / Measurement of NR PSCell	2257
8.2.3.5.1	Measurement configuration control and reporting / Event A2 / Measurement of NR PSCell / EN-DC.....	2257
8.2.3.5.2	Measurement configuration control and reporting / Event A2 / Measurement of E-UTRA PSCell / NE-DC.....	2262
8.2.3.6	Measurement configuration control and reporting / Event A3 / Measurement of Neighbour NR cells	2270
8.2.3.6.1	Measurement configuration control and reporting / Event A3 / Measurement of Neighbour NR cells / Intra-frequency measurements / EN-DC	2270
8.2.3.6.1a	Measurement configuration control and reporting / Event A3 / Measurement of Neighbour NR cell / Inter-frequency measurements / EN-DC	2277
8.2.3.6.1b	Measurement configuration control and reporting / Event A3 / Measurement of Neighbour NR cell / Inter-band measurements / EN-DC	2280
8.2.3.6.2	Measurement configuration control and reporting / Event A3 / Measurement of Neighbour E-UTRA and NR cells / Intra-frequency measurements / NE-DC	2282
8.2.3.6.2a	Measurement configuration control and reporting / Event A3 / Measurement of Neighbor E-UTRA and NR cell / Inter-frequency measurements / NE-DC	2295
8.2.3.6.2b	Measurement configuration control and reporting / Event A3 / Measurement of Neighbor E-UTRA and NR cell / Inter-band measurements / NE-DC.....	2299
8.2.3.7	Measurement configuration control and reporting / Event A4 (intra-frequency, inter-frequency and inter-band measurements) / Measurement of Neighbour NR cell	2303
8.2.3.7.1	Measurement configuration control and reporting / Event A4 / Measurement of Neighbour NR cell / Intra-frequency measurements / EN-DC	2303
8.2.3.7.1a	Measurement configuration control and reporting / Event A4 / Measurement of Neighbour NR cell / Inter-frequency measurements / EN-DC	2312
8.2.3.7.1b	Measurement configuration control and reporting / Event A4 / Measurement of Neighbour NR cell / Inter-band measurements / EN-DC	2315
8.2.3.7.2	Measurement configuration control and reporting / Event A4 / Measurement of Neighbour E-UTRA and NR cells / Intra-frequency measurements / NE-DC	2318
8.2.3.7.2a	Measurement configuration control and reporting / Event A4 / Measurement of Neighbour E-UTRA and NR cells / Inter-frequency measurements / NE-DC	2332
8.2.3.7.2b	Measurement configuration control and reporting / Event A4 / Measurement of Neighbour E-UTRA and NR cells / Inter-band measurements / NE-DC	2335
8.2.3.8	Measurement configuration control and reporting / Event A5 / Measurement of Neighbour NR cell.....	2336
8.2.3.8.1	Measurement configuration control and reporting / Event A5 / Measurement of Neighbour NR cell / Intra-frequency measurements / EN-DC	2336
8.2.3.8.1a	Measurement configuration control and reporting / Event A5 / Measurement of Neighbour NR cell / Inter-frequency measurements / EN-DC	2346
8.2.3.8.1b	Measurement configuration control and reporting / Event A5 / Measurement of Neighbour NR cell / Inter-band measurements / EN-DC	2349
8.2.3.8.2	Measurement configuration control and reporting / Event A5 / Measurement of Neighbour E-UTRA and NR cells / Intra-frequency measurements / NE-DC	2352
8.2.3.8.2a	Measurement configuration control and reporting / Event A5 / Measurement of Neighbour E-UTRA and NR cells / Inter-frequency measurements / NE-DC	2367
8.2.3.8.2b	Measurement configuration control and reporting / Event A5 / Measurement of Neighbour E-UTRA and NR cells / Inter-bandInter-band measurements / NE-DC	2370
8.2.3.9	Measurement configuration control and reporting / SS/PBCH block based / CSI-RS based intra-frequency measurements / Measurement of Neighbour NR cell.....	2371
8.2.3.9.1	Measurement configuration control and reporting / SS/PBCH block based / CSI-RS based Intra-frequency measurements / Measurement of Neighbour NR Cell / EN-DC	2371
8.2.3.10	Measurement configuration control and reporting / SS/PBCH block based / CSI-RS based inter-frequency measurements / Measurement of Neighbour NR cell.....	2389
8.2.3.10.1	Measurement configuration control and reporting / SS/PBCH block based /CSI-RS based Inter-frequency measurements/ Measurement of Neighbour NR Cell / EN-DC	2389
8.2.3.11	Measurement configuration control and reporting / Measurement Gaps	2409
8.2.3.11.1	Measurement configuration control and reporting / Measurement Gaps / NR FR1 / EN-DC	2409

8.2.3.11.2	Measurement configuration control and reporting / Measurement Gaps / NR FR2 / EN-DC	2423
8.2.3.11.3	Measurement configuration control and reporting / Measurement Gaps / NR-DC	2431
8.2.3.12	Measurement configuration control and reporting / Inter-RAT measurements / Event B2 / Measurement of NR cells.....	2436
8.2.3.12.1	Measurement configuration control and reporting / Inter-RAT measurements / Event B2 / Measurement of NR cells / EN-DC.....	2436
8.2.3.12.2	Measurement configuration control and reporting / Inter-RAT measurements / Event B2 / Measurement of E-UTRA cells / NE-DC.....	2446
8.2.3.13	PCell Handover with SCG change / Reconfiguration with sync / SCG DRB	2456
8.2.3.13.1	PCell Handover with SCG change / Reconfiguration with sync / SCG DRB / EN-DC	2456
8.2.3.14	SCG change / Reconfiguration with sync / Split DRB.....	2462
8.2.3.14.1	SCG change / Reconfiguration with sync / Split DRB / EN-DC.....	2462
8.2.3.14.2	SCG change / Reconfiguration with sync / Split DRB / NR-DC.....	2467
8.2.3.15	Measurement configuration control and reporting / Two simultaneous events A2 and A3 (intra-frequency measurements) / Measurement of Neighbour NR cells.....	2473
8.2.3.15.1	Measurement configuration control and reporting / Two simultaneous events A2 and A3 (intra-frequency measurements) / Measurement of Neighbour NR cells / EN-DC	2473
8.2.3.16	Measurement configuration control and reporting / SRB3	2482
8.2.3.16.1	Measurement configuration control and reporting / SRB3 / Intra NR measurements / EN-DC	2482
8.2.3.16.2	Measurement configuration control and reporting / SRB3 / Intra NR measurements / NR-DC	2488
8.2.3.17	Measurement configuration control and reporting / SFTD:	2494
8.2.3.17.1	Measurement configuration control and reporting / SFTD / EN-DC	2494
8.2.3.17.2	Measurement configuration control and reporting / SFTD / NR-DC	2501
8.2.3.18	Conditional PSCell change	2508
8.2.3.18.1	Conditional PSCell change / Success / EN-DC	2508
8.2.3.18.2	Conditional PSCell change / Failure / EN-DC	2516
8.2.3.18.3	Conditional PSCell change / PCell change / PSCell change / EN-DC	2524
8.2.4	Carrier Aggregation	2535
8.2.4.1	NR CA / NR SCell addition / modification / release / Success	2535
8.2.4.1.1	NR CA / NR SCell addition / modification / release / Success / EN-DC	2535
8.2.4.1.1.1	NR CA / NR SCell addition / modification / release / Success / EN-DC / Intra-band Contiguous CA	2535
8.2.4.1.1.2	NR CA / NR SCell addition / modification / release / Success / EN-DC / Intra-band non-Contiguous CA	2545
8.2.4.1.1.3	NR CA / NR SCell addition / modification / release / Success / EN-DC / Inter-band CA.....	2545
8.2.4.1.1.4	NR CA / NR SCell addition / modification / release / Success / EN-DC / Active SCG SCell addition / Intra-band Contiguous CA	2546
8.2.4.1.2	NR CA / NR SCell addition / modification / release / Success / NR-DC / Active SCG SCell addition	2556
8.2.4.1.2.1	NR CA / NR SCell addition / modification / release / Success / NR-DC / Active SCG SCell addition / Intra-band Contiguous CA	2556
8.2.4.1.2.2	NR CA / NR SCell addition / modification / release / Success / NR-DC / Active SCG SCell addition / Inter-band CA	2560
8.2.4.1.2.3	NR CA / NR SCell addition / modification / release / Success / NR-DC / Active SCG SCell addition / Intra-band non-contiguous CA.....	2561
8.2.4.2	NR CA / Simultaneous PSCell and SCell addition / PSCell and SCell change / CA Release ..	2561
8.2.4.2.1	NR CA / Simultaneous PSCell and SCell addition / PSCell and SCell change / CA Release / EN-DC.....	2561
8.2.4.2.1.1	NR CA / Simultaneous PSCell and SCell addition / PSCell and SCell change / CA Release / EN-DC / Intra-band Contiguous CA	2561
8.2.4.2.1.2	NR CA / Simultaneous PSCell and SCell addition / PSCell and SCell change / CA Release / EN-DC / Intra-band non-Contiguous CA	2574
8.2.4.2.1.3	NR CA / Simultaneous PSCell and SCell addition / PSCell and SCell change / CA Release / EN-DC / Inter-band CA.....	2575
8.2.4.3	NR CA / SCell change / Intra-NR measurement event A6 / SRB3.....	2575
8.2.4.3.1	NR CA / SCell change / Intra-NR measurement event A6 / SRB3 / EN-DC	2575
8.2.4.3.1.1	NR CA / SCell change / Intra-NR measurement event A6 / SRB3 / EN-DC / Intra-band Contiguous CA	2575

8.2.4.3.1.2	NR CA / SCell change / Intra-NR measurement event A6 / SRB3 / EN-DC / Intra-band non-Contiguous CA	2587
8.2.4.3.1.3	NR CA / SCell change / Intra-NR measurement event A6 / SRB3 / EN-DC / Inter-band CA	2587
8.2.5	Reconfiguration Failure / Radio link failure	2589
8.2.5.1	Radio link failure / PSCell addition failure	2589
8.2.5.1.1	Radio link failure / Random access problem / EN-DC	2589
8.2.5.1.2	Radio link failure / Random access problem / NR-DC	2591
8.2.5.2	Radio link failure / PSCell out of sync indication	2594
8.2.5.2.1	Radio link failure / PSCell out of sync indication / EN-DC	2594
8.2.5.2.2	Radio link failure / PSCell out of sync indication / NR-DC	2597
8.2.5.3	Radio link failure / rlc-MaxNumRetx failure	2601
8.2.5.3.1	Radio link failure / rlc-MaxNumRetx failure / EN-DC	2601
8.2.5.3.2	Radio link failure / rlc-MaxNumRetx failure / NR-DC	2604
8.2.5.3.3	Radio link failure / rlc-MaxNumRetx failure / NE-DC	2607
8.2.5.4	Reconfiguration failure / SCG change failure	2609
8.2.5.4.1	Reconfiguration failure / SCG change failure / EN-DC	2609
8.2.5.4.2	Reconfiguration failure / SCG change failure / NR-DC	2613
8.2.5.5	Reconfiguration failure / SCG Reconfiguration failure / SRB3	2617
8.2.5.5.1	Void	2617
8.2.5.6	Reconfiguration failure / SCG Reconfiguration failure / SRB1	2617
8.2.5.6.1	Void	2617
8.2.6	MR-DC RRC others	2617
8.2.6.1	Failure information / RLC failure / SCG	2617
8.2.6.1.1	Failure information / RLC failure / SCG / EN-DC	2617
8.2.6.1.1.1	Failure information / RLC failure / SCG / EN-DC / Intra-band Contiguous CA	2617
8.2.6.1.1.2	Failure information / RLC failure / SCG / EN-DC / Inter-band CA	2625
8.2.6.1.1.3	Failure information / RLC failure / SCG / EN-DC / Intra-band non Contiguous CA	2626
8.2.6.1.2	Failure information / RLC failure / SCG / NR-DC	2626
8.2.6.1.2.1	Failure information / RLC failure / SCG / NR-DC / Intra-band Contiguous CA	2626
8.2.6.1.2.2	Failure information / RLC failure / SCG / NR-DC / Inter-band CA	2635
8.2.6.1.2.3	Failure information / RLC failure / SCG / NR-DC / Intra-band non Contiguous CA	2635
8.2.6.2	Processing delay	2636
8.2.6.2.1	Processing delay / PSCell addition / SCG DRB / Success / Latency check / EN-DC	2636
8.2.6.2.2	Processing delay / Latency check / NR-DC	2639
8.2.6.3	Idle/Inactive measurements	2644
8.2.6.3.3	Idle/Inactive measurements / Inactive mode / NE-DC / SIB11 configuration	2644
8.2.6.3.4	Idle/Inactive measurements / Inactive mode / NE-DC / RRCRelease configuration	2651
8.2.6.3.5	Idle/Inactive measurements / Idle mode / NE-DC / SIB11 configuration	2657
8.2.6.3.6	Idle/Inactive measurements / Idle mode / NE-DC / RRCRelease configuration	2660
8.2.7	2664	
8.2.7.1	2664	
8.2.7.2	RRC Resume	2664
8.2.7.2.1	RRC Resume / NR-DC	2664
9	Mobility management	2669
9.1	5GS mobility management	2669
9.1.1	Primary authentication and key agreement	2669
9.1.1.1	EAP based primary authentication and key agreement / EAP-AKA' related procedures	2669
9.1.1.2	EAP based primary authentication and key agreement / Reject	2673
9.1.1.3	EAP based primary authentication and key agreement / EAP message transport / Abnormal	2678
9.1.1.4	5G AKA based primary authentication and key agreement / 5G-AKA related procedures	2684
9.1.1.5	5G AKA based primary authentication and key agreement / Reject	2690
9.1.1.6	5G AKA based primary authentication and key agreement / Abnormal	2693
9.1.2	Security mode control	2697
9.1.2.1	NAS security mode command	2697
9.1.2.2	Protection of initial NAS signalling messages	2702
9.1.2.3	Integrity protection / Correct functionality of 5G NAS integrity algorithm / SNOW3G	2705
9.1.2.4	Integrity protection / Correct functionality of 5G NAS integrity algorithm / AES	2708
9.1.2.5	Integrity protection / Correct functionality of 5G NAS integrity algorithm / ZUC	2709
9.1.2.6	Ciphering and deciphering / Correct functionality of 5G NAS encryption algorithm / SNOW3G	2709

9.1.2.7	Ciphering and deciphering / Correct functionality of 5G NAS encryption algorithm / AES...	2712
9.1.2.8	Ciphering and deciphering / Correct functionality of 5G NAS encryption algorithm / ZUC ..	2712
9.1.3	Identification.....	2713
9.1.3.1	Identification procedure	2713
9.1.4	Generic UE configuration update	2718
9.1.4.1	Generic UE configuration update / New 5G-GUTI, NITZ, registration requested, network slicing indication, new allowed NSSAI / Acknowledgement from the UE	2718
9.1.5	Registration.....	2729
9.1.5.1	Initial registration.....	2729
9.1.5.1.1	Initial registration / Success / 5G-GUTI reallocation, last visited TAI.....	2729
9.1.5.1.2	Initial registration / 5GS services / Equivalent PLMN list handling	2733
9.1.5.1.3	Initial registration / 5GS services / NSSAI handling	2737
9.1.5.1.3a	Initial registration / 5GS services / NSSAI handling / NSSAI storage	2746
9.1.5.1.4	Initial registration / 5GS services / MICO mode / TAI list handling.....	2755
9.1.5.1.5	Initial registration / Abnormal / Failure after 5 attempts	2757
9.1.5.1.6	Initial registration / Rejected / Illegal UE.....	2762
9.1.5.1.7	Void.....	2764
9.1.5.1.8	Initial registration / Rejected / Serving network not authorized	2764
9.1.5.1.9	Initial registration / Abnormal / Change of cell into a new tracking area.....	2767
9.1.5.1.10	Initial registration / Rejected / PLMN not allowed.....	2769
9.1.5.1.11	Initial registration / Rejected / Tracking area not allowed.....	2772
9.1.5.1.12	Initial registration / Rejected / Roaming not allowed in this tracking area.....	2775
9.1.5.1.13	Initial registration / Rejected / No suitable cells in tracking area	2779
9.1.5.1.14	Initial registration / Rejected / Congestion / Abnormal / T3346.....	2781
9.1.5.1.15	Initial registration / Success / Extended and spare fields in CAG information list.....	2785
9.1.5.2	Mobility and periodic registration update	2792
9.1.5.2.1	Mobility registration update / TAI list handling	2792
9.1.5.2.2	Periodic registration update / Accepted.....	2797
9.1.5.2.3	2800	
9.1.5.2.4	Mobility registration update / The lower layer requests NAS signalling connection recovery	2800
9.1.5.2.5	Void.....	2803
9.1.5.2.6	Void.....	2803
9.1.5.2.7	Mobility and periodic registration update / Rejected / UE identity cannot be derived by the network.....	2803
9.1.5.2.8	Mobility and periodic registration update / Rejected / Implicitly de-registered	2805
9.1.5.2.9	Void.....	2808
9.1.6	De-registration	2808
9.1.6.1	UE-initiated de-registration.....	2808
9.1.6.1.1	UE-initiated de-registration / Switch off / Abnormal / De-registration and 5GMM common procedure collision	2808
9.1.6.1.2	UE-initiated de-registration / Normal de-registration / Abnormal / Transmission failure without TAI change from lower layers, de-registration and 5GMM common procedure collision, T3521 timeout.....	2812
9.1.6.1.3	UE-initiated de-registration / Abnormal / Change of cell into a new tracking area.....	2817
9.1.6.1.4	Void.....	2819
9.1.6.2	Network-initiated de-registration	2819
9.1.6.2.1	Network-initiated de-registration / De-registration for 3GPP access / Re-registration required.....	2819
9.1.6.2.2	Network-initiated de-registration / De-registration for 3GPP access / Re-registration not required.....	2821
9.1.7	Service request.....	2823
9.1.7.1	Service request / Idle mode uplink user data transport / Rejected / Restricted service area, abnormal / T3517, T3525.....	2823
9.1.7.2	Service request / Connected mode user data transport / Abnormal / T3517	2829
9.1.8	SMS over NAS	2835
9.1.8.1	SMS over NAS / MO and MT SMS over NAS / Idle mode	2835
9.1.8.2	SMS over NAS / Multiple MO and MT SMS over NAS / Connected mode	2842
9.1.9	RACS.....	2847
9.1.9.1	RACS / Network assigned UE radio capability ID	2847
9.1.9.2	RACS / UE configuration update / UE radio capability ID	2850

9.1.9.3	RACS / PLMN change within registration area / From NW assigned to Manufacturer assigned UE Radio Capability ID	2853
9.1.9.4	RACS / USIM change / Handling of URCID	2857
9.1.9.5	RACS / Handling of delete indication for NW assigned UE radio capability ID.....	2859
9.1.9.6	RACS / Change in radio capability / NW assigned URCID	2865
9.1.9.7	RACS / Inter-system mobility registration update / Handling of UE radio capability ID.....	2867
9.1.10	Network slice-specific authentication and authorization	2872
9.1.10.1	NSSAA / EAP message transport / Success.....	2872
9.1.10.2	Network slice-specific authentication and authorization / EAP message transport / Abnormal	2878
9.1.10.3	NSSAA / Initial registration / Rejected NSSAI, pending NSSAI	2881
9.1.10.4	NSSAA / Initial registration / Reject.....	2890
9.1.10.5	2894	
9.1.10.6	NSSAA / UE configuration update / Rejected NSSAI.....	2894
9.1.11	SNPN / Mobility management aspects	2898
9.1.11.1	SNPN / Initial registration / Rejected / Temporarily not authorized for this SNPN.....	2898
9.1.11.2	SNPN / Initial registration / Rejected / Permanently not authorized for this SNPN	2902
9.1.11.3	SNPN / EAP based primary authentication and key agreement / EAP-AKA' related procedures	2906
9.1.12	NSAC / Mobility management aspects.....	2910
9.1.12.1	NSAC / Initial registration / Back-off timer.....	2910
9.1.12.2	NSAC / Initial registration / Back-off timer is not provided or zero	2915
9.1.12.3	NSAC / Initial registration / Rejected / equivalent PLMNs	2919
9.2	5GS Non-3GPP Access Mobility Management	2923
9.2.1	Primary authentication and key agreement procedure	2923
9.2.1.1	EAP based primary authentication and key agreement.....	2923
9.2.1.2	5G AKA based primary authentication and key agreement	2925
9.2.2	Security Mode Control.....	2928
9.2.2.1	NAS security mode command.....	2928
9.2.2.2	Protection of initial NAS signalling messages	2934
9.2.3	Void	2935
9.2.4	Generic UE configuration.....	2935
9.2.4.1	Generic UE configuration update.....	2935
9.2.5	Registration.....	2944
9.2.5.1	Initial Registration.....	2944
9.2.5.1.1	Initial registration / Success / 5G-GUTI reallocation, Last visited TAI	2944
9.2.5.1.2	Initial registration / 5GS services / NSSAI handling	2947
9.2.5.1.3	Void.....	2955
9.2.5.1.4	Initial registration / Rejected / Congestion / Abnormal cases / T3346	2955
9.2.5.2	Mobility Registration	2958
9.2.5.2.1	Void.....	2958
9.2.5.2.2	Mobility registration update/Change of SMS over NAS capability	2958
9.2.6	De-registration	2960
9.2.6.1	UE-initiated de-registration.....	2960
9.2.6.1.1	UE-initiated de-registration / switch off	2960
9.2.6.2	Network-initiated de-registration	2964
9.2.6.2.1	Network-initiated de-registration / De-registration for Non-3GPP access / Re-registration required.....	2964
9.2.6.2.2	Network-initiated de-registration / De-registration for Non 3GPP access / Re-registration not required.....	2966
9.2.7	Service request.....	2970
9.2.7.1	Service request / IDLE mode uplink user data transport / Rejected / Restricted service area, Abnormal / T3517	2970
9.2.7.2	Service request / CMM CONNECTED mode/uplink user data transport / Abnormal / T3517	2973
9.2.8	SMS over NAS	2975
9.2.8.1	SMS over NAS / MO SMS over NAS - 5GMM-Idle mode.....	2975
9.3	Inter-system mobility	2978
9.3.1	5GS-EPC Inter-system mobility	2978
9.3.1.1	Inter-system mobility registration update / Single-registration mode with N26 / 5GMM-IDLE / 5GC to EPC.....	2978
9.3.1.2	Inter-system mobility registration update / Single-registration mode with N26 / 5GMM-IDLE / EPC to 5GC.....	2979

9.3.1.3	Inter-system mobility and periodic registration update / Rejected / Single-registration mode with N26 / Handling of EPC relevant parameters	2984
10	Session management	2987
10.1	5GS session management	2987
10.1.1	PDU session authentication and authorization.....	2987
10.1.1.1	PDU session authentication and authorization / During the UE-requested PDU session procedure.....	2987
10.1.1.2	PDU session authentication and authorization / After the UE-requested PDU session procedure.....	2992
10.1.2	Network-requested PDU session modification	2997
10.1.2.1	Network-requested PDU session modification / Accepted	2997
10.1.2.2	Network-requested PDU session modification / Abnormal / PDU session in state PDU SESSION INACTIVE.....	3009
10.1.3	Network-requested PDU session release	3011
10.1.3.1	Void.....	3011
10.1.3.2	Network-requested PDU session release / Insufficient resources, insufficient resources for specific slice and DNN, abnormal / Invalid PDU session identity.....	3011
10.1.4	UE-requested PDU session establishment	3021
10.1.4.1	UE-requested PDU session establishment / Abnormal / T3580.....	3021
10.1.5	UE-requested PDU session modification.....	3024
10.1.5.1	UE-requested PDU session modification	3024
10.1.6	UE-requested PDU session release.....	3027
10.1.6.1	UE-requested PDU session release / Abnormal / Collision with network-requested PDU session modification procedure	3027
10.1.6.2	UE-requested PDU session release / Abnormal / Collision with network-requested PDU session release procedure.....	3030
10.1.7	Network-requested PDU session release	3033
10.1.7.1	SNPN / Network-requested PDU session release / Accepted / Insufficient resources / T3396, Accepted / Insufficient resources for specific slice and DNN / T3584.....	3033
10.1.8	3039	
10.1.8.1	NSAC / PDU session establishment reject / Maximum number of PDU sessions reached / Back-off timer is neither zero nor deactivated.....	3039
10.1.8.2	NSAC / PDU session establishment reject / Maximum number of PDU sessions reached / Back-off timer is deactivated.....	3044
10.1.8.3	NSAC / PDU session establishment reject / Maximum number of PDU sessions reached / Back-off timer is zero or not included	3050
10.2	EN-DC session management.....	3056
10.2.1	Network initiated procedures.....	3056
10.2.1.1	Default EPS bearer context activation.....	3056
10.2.1.2	Dedicated EPS bearer context activation	3060
10.2.2	UE initiated procedures	3064
10.2.2.1	EPS bearer resource allocation / modification	3064
10.3	5GS Non-3GPP Access Session Management	3073
10.3.1	PDU session authentication and authorization.....	3073
10.3.1.1	PDU session authentication and authorization / during the UE-requested PDU session procedure.....	3073
10.3.2	Network-requested PDU session modification	3076
10.3.2.1	Network-requested PDU session modification / Accepted/Rejected	3076
10.3.3	Network-requested PDU session Release	3081
10.3.3.1	Network-requested PDU session release / accepted/ with and without reactivation	3081
10.3.4	UE-requested PDU session establishment	3085
10.3.4.1	UE-requested PDU session establishment / Abnormal / T3580	3085
10.3.5	UE-requested PDU session modification.....	3086
10.3.5.1	UE-requested PDU session modification/Success	3086
10.3.6	UE-requested PDU session release.....	3087
10.3.6.1	UE-requested PDU session release / Abnormal / Collision with network-requested PDU session modification procedure	3087
11	Multi-layer and Services	3089
11.1	5GS / EPS Fallback	3089

11.1.1	MO MMTEL voice call setup from NR RRC_IDLE / EPS Fallback with redirection / Single registration mode with N26 interface / Success.....	3089
11.1.1a	MO MMTEL enhanced voice service call setup from NR RRC_IDLE / EPS Fallback with redirection / Single registration mode with N26 interface / Success	3094
11.1.2	MO MMTEL voice call setup from NR RRC_IDLE / EPS Fallback with redirection / Single registration mode without N26 interface / Success.....	3099
11.1.3	MO MMTEL voice call setup from NR RRC_CONNECTED / EPS Fallback with handover / Single registration mode with N26 interface / Success.....	3112
11.1.3a	MO MMTEL enhanced voice service call setup from NR RRC_CONNECTED / EPS Fallback with handover / Single registration mode with N26 interface / Success.....	3121
11.1.4	MO MMTEL voice call setup from NR RRC_CONNECTED / EPS Fallback with redirection / Single registration mode with N26 interface / E-UTRAN cell selection using cell status barred / Success.....	3127
11.1.5	MO MMTEL voice call setup from NR RRC_CONNECTED / EPS Fallback with redirection / Single registration mode without N26 interface / E-UTRAN cell selection using cell status reservation / Success.....	3138
11.1.6	MT MMTEL voice call setup from NR RRC_IDLE / EPS Fallback with redirection / Single registration mode without N26 interface / Success.....	3149
11.1.7	Emergency call setup from NR RRC_IDLE / Emergency Services Fallback to EPS with redirection / Single registration mode with N26 interface / Success.....	3160
11.1.8	MO MMTEL voice call setup from NR RRC_CONNECTED / EPS Fallback with handover / Single registration mode with N26 interface / voiceFallbackIndication.....	3169
11.1.9	MO MMTEL voice call setup from NR RRC_IDLE / EPS Fallback with redirection / Single registration mode with N26 interface / voiceFallbackIndication.....	3177
11.2	5G-SRVCC.....	3182
11.2.1	5G-SRVCC from NG-RAN to 3GPP UTRAN.....	3182
11.3	Unified Access Control (UAC).....	3190
11.3.1	UAC / Access Identity 0 / 0% access probability / MTSI MO speech call / SMSoIP.....	3190
11.3.1a	UAC / Access Identity 0 / 0% access probability / Uplink user data transfer / RRC_INACTIVE.....	3200
11.3.2	UAC / Access Identity 0 / 0% access probability / Paging for MT access/Emergency call.....	3210
11.3.3	UAC / Access Identity 0 / AC8 / RRC_INACTIVE / RNA update / RRC resume	3221
11.3.4	UAC / Access Identity 0 / Registration procedure for mobility and periodic registration update / Barring per PLMN / Implicit AC barring list	3225
11.3.5	UAC / Access Identity 1 / New cell not in the country of its HPLMN/EHPLMN 0% access probability / MPS indicator / HPLMN/0%/100% accessibility AC5 / MMTEL-Video call.....	3234
11.3.6	UAC / Access Identity 2 / New cell not in the country of its HPLMN/EHPLMN 0% access probability / MCS indicator / HPLMN/0%/100% accessibility AC7 / RRC_INACTIVE.....	3247
11.3.7	UAC / Access Identity 11..15 / High priority access / HPLMN/0% accessibility AC2 / Emergency call	3262
11.3.8	UAC / Access Identity 0 / NR RRC_IDLE / Cell re-selection while T390 is running	3270
11.3.9	UAC / Access Identity 0 / ODAC / PLMN / RPLMN / not EPLMN	3280
11.3.10	UAC / Access Identity 0 / AC9 / 0% access probability / SIP Re-registration.....	3287
11.4	Emergency Services	3299
11.4.1	5GMM-REGISTERED.NORMAL-SERVICE / 5GMM-IDLE / Emergency call / Utilising emergency number stored on the USIM / New emergency PDU session / Network failing the authentication check (5G AKA)	3299
11.4.2	5GMM-DEREGISTERED.LIMITED-SERVICE / Emergency call / Utilisation of emergency numbers stored on the ME / Initial registration for emergency services / Handling of forbidden PLMNs.....	3304
11.4.3	5GMM-DEREGISTERED.NO-SUPI / Emergency call / Utilisation of emergency numbers stored on the ME / Initial registration for emergency services.....	3309
11.4.4	5GMM-REGISTERED.ATTEMPTING-REGISTRATION-UPDATE T3346 running / Emergency call establishment / 5GMM-REGISTERED.NORMAL-SERVICE / Emergency call establishment before T3396 expiry.....	3313
11.4.5	5GMM-REGISTERED.LIMITED-SERVICE / 5GMM-IDLE / Emergency call establishment and release / Handling of 5GS forbidden tracking areas for roaming.....	3318
11.4.6	5GMM-REGISTERED.NON-ALLOWED-SERVICE / Emergency call establishment and release / Handling of non-allowed tracking areas	3321
11.4.7	Handling of Local and Extended emergency numbers / Mobility	3324
11.4.8	Handling of Local and extended emergency numbers / Switch-off and maximum local numbers storage.....	3335

11.4.9	5GMM-DEREGISTERED.LIMITED-SERVICE No suitable cells in tracking area / Emergency call establishment and release.....	3340
11.4.10	Void	3345
11.4.10a	5GMM-REGISTERED.NORMAL-SERVICE / N26 interface not supported / N1 mode to S1 mode transfer of an existing emergency PDU session.....	3345
11.4.11	5GMM-REGISTERED.NORMAL-SERVICE / N26 interface not supported / S1 mode to N1 mode transfer of an existing emergency PDN connection.....	3350
11.4.12	5GMM-REGISTERED.NORMAL-SERVICE / 5GMM-IDLE / Emergency call / Disabling N1 mode / Emergency call establishment over EPS / Success	3355
11.5	eCall over IMS	3360
11.5.1	eCall Only mode / T3444 / eCall inactivity procedure / Removal of eCall only restriction after an eCall over IMS / 5GS to EPS.....	3360
11.5.2	eCall Only mode / T3445 / eCall inactivity procedure / Removal of eCall only restriction after a call to URI for test service / 5GS to EPS.....	3366
11.5.3		3371
11.5.4	eCall Only mode / 5GS supports IMS voice over PS session / 5GS supports emergency service / eCall over IMS is supported on 5GS / RACH failure in NR cell / eCall over EPS	3371
11.5.5	eCall Only mode / Limited service state / Call to URI for test service should not be attempted / eCall over IMS should be attempted / 5GS	3374
11.5.6	eCall capable / 5GS supports IMS voice over PS session / 5GS supports emergency service / eCall over IMS is not supported / eCall using the CS domain / emergency call over IMS if eCall using the CS domain is not available / UTRA	3376
11.5.7	eCall Only mode / SRVCC Handover to CS domain / UTRAN / MSD Update / Success / 5GS..	3379
11.5.8	eCall Only mode / 5GS supports IMS voice over PS session / 5GS supports emergency service / eCall over IMS is supported / RACH failure in NR cell / eCall using the CS domain.....	3386
11.5.9	eCall Only mode / Manual initiation / Emergency registration / Abnormal case / IMS CN sends 486 (Busy Here) / UE performs eCall in CS domain / UTRAN or GERAN / 5GS.....	3389
11.5.10	eCall Only mode / Automatic initiation / Emergency registration / Abnormal case / IMS CN sends 600 (Busy Everywhere) / UE performs eCall in CS domain / UTRAN or GERAN / 5GS	3394
11.5.11	eCall Only mode / Automatic initiation / Emergency registration / Abnormal case / IMS CN sends 603 (Decline) / UE performs eCall in CS domain / UTRAN or GERAN / 5GS	3398
11.5.12	eCall Only mode / 5GS supports IMS voice over PS session / 5GS supports emergency service / eCall over IMS is not supported on 5GS / eCall over EPS	3402
11.5.13	eCall capable / Manual initiation / MSD Transfer failure / UE performs eCall in CS domain after Timer expiry / UTRAN or GERAN / 5GS	3405
11.6	3GPP PS Data Off	3410
11.6.1	Data Off / MO Voice Call.....	3410
11.6.2	Data Off / MO Video Call	3414
11.6.3	Data Off / SMSoIP.....	3417
11.7	eDRX /Redcap.....	3423
11.7.2	eDRX / Inactive	3423
11.8		3425
11.8.1 to 11.8.4		3425
11.8.5	Inter-system mobility between untrusted Non-3GPP and 3GPP system/Handover from 5GS to EPC/ePDG	3425
12	NR sidelink.....	3431
12.1	PC5-only operation.....	3431
12.1.1	PC5-only operation / Sidelink communication.....	3431
12.1.1.1		3431
12.1.1.2	PC5-only operation / Sidelink communication / Reception	3431
12.1.2	PC5-only operation / Sidelink synchronization related procedure.....	3433
12.1.2.1	PC5-only operation / Sidelink synchronization related procedure / Synchronization reference source (re-)selection.....	3433
12.1.2.2	PC5-only operation / Sidelink synchronization related procedure / SL-SSB transmission Initiation and Cease.....	3442
12.1.3	PC5-only operation / Measurement configuration and reporting via PC5 RRC	3446
12.1.3.1	PC5-only operation / Measurement configuration and reporting via PC5 RRC / PSBCH-RSRP measurement configuration.....	3446
12.1.3.2	PC5-only operation / Measurement configuration and reporting via PC5 RRC / PSBCH-RSRP measurement reporting / Event S1 and S2	3451

12.1.3.3	PC5-only operation / Measurement configuration and reporting via PC5 RRC / PSBCH-RSRP measurement reporting / Periodical reporting	3457
12.1.4	PC5-only operation / Sidelink Reconfiguration via PC5 RRC	3462
12.1.4.1	PC5-only operation / Sidelink Reconfiguration via PC5 RRC / SL-DRB management / initiating UE side.....	3462
12.1.4.2	PC5-only operation / Sidelink Reconfiguration via PC5 RRC / SL DRB management / Peer UE side	3467
12.1.5	PC5-only operation / Sidelink CSI reporting	3471
12.1.5.1	PC5-only operation / Sidelink CSI reporting / Configuration.....	3471
12.1.5.2	PC5-only operation / Sidelink CSI reporting / Reporting	3476
12.1.6	PC5-only operation / Sidelink failure	3481
12.1.6.1	PC5-only operation / Sidelink failure / PC5 RRC reconfiguration failure / Initiating UE side	3481
12.1.6.2	PC5-only operation / Sidelink failure / PC5 RRC reconfiguration failure / Peer UE side	3483
12.1.6.3	PC5-only operation / Sidelink failure / Sidelink radio link failure / Transmission side.....	3486
12.1.7	PC5-only operation / Sidelink UE capability transfer via PC5 RRC	3489
12.1.7.1	PC5-only operation / Sidelink UE capability transfer via PC5 RRC / One-way and two-way transfer	3489
12.2	Inter-carrier concurrent operation.....	3494
12.2.1	Inter-carrier concurrent operation / Sidelink communication	3494
12.2.1.1	3494	
12.2.1.2	Inter-carrier concurrent operation / Sidelink communication / RRC_IDLE / Reception	3494
12.2.1.3	Inter-carrier concurrent operation / Sidelink communication / RRC_CONNECTED / Transmission / Network scheduling.....	3500
12.2.1.4	3507	
12.2.1.5	3507	
12.2.1.6	Inter-carrier concurrent operation / Sidelink communication / RRC_CONNECTED / Reception	3507
12.2.2	Inter-carrier concurrent operation / Sidelink synchronization related procedure.....	3514
12.2.2.1	Inter-carrier concurrent operation / Sidelink synchronization related procedure / Synchronization reference source (re-)selection	3514
12.2.2.2	Inter-carrier concurrent operation / Sidelink synchronization related procedure / SL-SSB transmission Initiation and Cease.....	3528
12.2.3	Inter-carrier concurrent operation / Measurement configuration and reporting via Uu RRC	3534
12.2.3.1	Inter-carrier concurrent operation / Measurement configuration and reporting via Uu RRC / CBR measurement reporting / Event C1 and C2	3534
12.2.3.2	Inter-carrier concurrent operation / Measurement configuration and reporting via Uu RRC / CBR measurement reporting / Periodical reporting	3546
12.2.4	Inter-carrier concurrent operation / Sidelink Reconfiguration via Uu RRC	3552
12.2.4.1	Inter-carrier concurrent operation / Sidelink Reconfiguration via Uu RRC / SL DRB management / transmission side.....	3552
12.2.5	Inter-carrier concurrent operation / Measurement configuration and reporting via PC5 RRC	3564
12.2.5.1	Inter-carrier concurrent operation / Measurement configuration and reporting via PC5 RRC / SL-RSRP measurement configuration	3564
12.2.5.2	Inter-carrier concurrent operation / Measurement configuration and reporting via PC5 RRC / SL-RSRP measurement reporting / Event S1 and S2.....	3569
12.2.5.3	Inter-carrier concurrent operation / Measurement configuration and reporting via PC5 RRC / PSBCH-RSRP measurement reporting / Periodical reporting	3577
12.2.6	Inter-carrier concurrent operation / Sidelink Reconfiguration via PC5 RRC	3583
12.2.6.1	Inter-carrier concurrent operation / Sidelink Reconfiguration via PC5 RRC / SL DRB management / Initiating UE side.....	3583
12.2.7	Inter-carrier concurrent operation / Sidelink CSI reporting	3586
12.2.7.1	Inter-carrier concurrent operation / Sidelink CSI reporting / Configuration	3586
12.2.7.2	Inter-carrier concurrent operation / Sidelink CSI reporting / Reporting	3591
12.2.8	Inter-carrier concurrent operation / Sidelink failure	3595
12.2.8.1	Inter-carrier concurrent operation / Sidelink CSI reporting / Reporting	3595
12.2.8.2	Inter-carrier concurrent operation / Sidelink failure / PC5 RRC Reconfiguration Failure / Peer UE side.....	3601
12.2.8.3	Inter-carrier concurrent operation / Sidelink failure / Sidelink radio link failure / transmission side	3602
13	V2X NAS layer	3609
13.1	V2X policy provisioning	3609

13.1.1	V2X policy provisioning / Precedence / Validity timer expires / geographical area changes	3609
13.2	PC5 unicast.....	3617
13.2.1	PC5 unicast / link establishment / Reject / Conflict Layer 2 ID	3617
13.2.2	PC5 unicast / link Security Mode	3620
13.2.3	PC5 unicast / Link modification	3623
13.2.4	PC5 unicast / link Release / Reestablish PC5 unicast link to same UE	3630
13.2.5	PC5 unicast / link identifier update.....	3635
13.2.6	PC5 unicast / link keep alive.....	3639
Annex A (informative):	Change history	3643
History		3695

Foreword

This Technical Specification has been produced by the 3rd Generation Partnership Project (3GPP).

The contents of the present document are subject to continuing work within the TSG and may change following formal TSG approval. Should the TSG modify the contents of the present document, it will be re-released by the TSG with an identifying change of release date and an increase in version number as follows:

Version x.y.z

where:

- x the first digit:
 - 1 presented to TSG for information;
 - 2 presented to TSG for approval;
 - 3 or greater indicates TSG approved document under change control.
- y the second digit is incremented for all changes of substance, i.e. technical enhancements, corrections, updates, etc.
- z the third digit is incremented when editorial only changes have been incorporated in the document.

In the present document, modal verbs have the following meanings:

- shall** indicates a mandatory requirement to do something
- shall not** indicates an interdiction (prohibition) to do something

The constructions "shall" and "shall not" are confined to the context of normative provisions, and do not appear in Technical Reports.

The constructions "must" and "must not" are not used as substitutes for "shall" and "shall not". Their use is avoided insofar as possible, and they are not used in a normative context except in a direct citation from an external, referenced, non-3GPP document, or so as to maintain continuity of style when extending or modifying the provisions of such a referenced document.

- should** indicates a recommendation to do something
- should not** indicates a recommendation not to do something
- may** indicates permission to do something
- need not** indicates permission not to do something

The construction "may not" is ambiguous and is not used in normative elements. The unambiguous constructions "might not" or "shall not" are used instead, depending upon the meaning intended.

- can** indicates that something is possible
- cannot** indicates that something is impossible

The constructions "can" and "cannot" are not substitutes for "may" and "need not".

- will** indicates that something is certain or expected to happen as a result of action taken by an agency the behaviour of which is outside the scope of the present document
- will not** indicates that something is certain or expected not to happen as a result of action taken by an agency the behaviour of which is outside the scope of the present document
- might** indicates a likelihood that something will happen as a result of action taken by some agency the behaviour of which is outside the scope of the present document

might not indicates a likelihood that something will not happen as a result of action taken by some agency the behaviour of which is outside the scope of the present document

In addition:

is (or any other verb in the indicative mood) indicates a statement of fact

is not (or any other negative verb in the indicative mood) indicates a statement of fact

The constructions "is" and "is not" do not indicate requirements.

The present document is part 1 of a multi-part deliverable covering the 5G System (5GS) User Equipment (UE) protocol conformance specification, as identified below:

- **3GPP TS 38.523-1: "5GS; User Equipment (UE) conformance specification; Part 1: Protocol"** (the present document).
- 3GPP TS 38.523-2 [2]: "5GS; User Equipment (UE) conformance specification; Part 2: Applicability of protocol test cases".
- 3GPP TS 38.523-3 [3]: "5GS; User Equipment (UE) conformance specification; Part 3: Protocol Test Suites".

1 Scope

The present document specifies the protocol conformance testing for the 3GPP UE connecting to the 5G System (5GS) via its radio interface(s).

The following information can be found in the present document (first part of a multi-part test specification):

- the overall test structure;
- the test configurations;
- the conformance requirement and references to the core specifications;
- the test purposes; and
- a brief description of the test procedure, the specific test requirements and short message exchange table.

The applicability of the individual test cases is specified in the ICS proforma specification (3GPP TS 38.523-2 [2]). The Test Suites are specified in part 3 (3GPP TS 38.523-3 [3]).

The present document is valid for UE implemented according to 3GPP Releases starting from Release 15 up to the Release indicated on the cover page of the present document.

2 References

The following documents contain provisions which, through reference in this text, constitute provisions of the present document.

- References are either specific (identified by date of publication, edition number, version number, etc.) or non-specific.
- For a specific reference, subsequent revisions do not apply.
- For a non-specific reference, the latest version applies. In the case of a reference to a 3GPP document (including a GSM document), a non-specific reference implicitly refers to the latest version of that document *in the same Release as the present document*.

- [1] 3GPP TR 21.905: "Vocabulary for 3GPP Specifications".
- [2] 3GPP TS 38.523-2: "5GS; UE conformance specification; Part 2: Implementation Conformance Statement (ICS) proforma specification".
- [3] 3GPP TS 38.523-3: "5GS; User Equipment (UE) conformance specification; Part 3: Protocol Test Suites".
- [4] 3GPP TS 38.508-1: "5GS; User Equipment (UE) conformance specification; Part 1: Common test environment".
- [5] 3GPP TS 38.508-2: "5GS; User Equipment (UE) conformance specification; Part 2: Common Implementation Conformance Statement (ICS) proforma".
- [6] 3GPP TS 38.509: "5GS; Special conformance testing functions for User Equipment (UE)".
- [7] 3GPP TS 36.508: "Evolved Universal Terrestrial Radio Access (E-UTRA) and Evolved Universal Terrestrial Radio Access (E-UTRAN); Common Test Environments for User Equipment (UE) Conformance Testing".
- [8] 3GPP TS 36.509: "Evolved Universal Terrestrial Radio Access (E-UTRA) and Evolved Universal Terrestrial Radio Access Network (E-UTRAN); Special conformance testing functions for User Equipment (UE)".
- [9] 3GPP TS 38.113: "New Radio (NR); Requirements for support of radio resource management".

- [10] 3GPP TS 36.133: "Evolved Universal Terrestrial Radio Access (E-UTRA); Requirements for support of radio resource management".
- [11] 3GPP TS 36.331: "Evolved Universal Terrestrial Radio Access (E-UTRA); Radio Resource Control (RRC); Protocol specification".
- [12] 3GPP TS 38.331: "NR; Radio Resource Control (RRC) protocol specification".
- [13] 3GPP TS 36.523-1: "Evolved Universal Terrestrial Radio Access (E-UTRA) and Evolved Packet Core (EPC); User Equipment (UE) conformance specification; Part 1: Protocol conformance specification".
- [14] 3GPP TS 38.212: "NR; Multiplexing and channel coding".
- [15] 3GPP TS 38.214: "NR; Physical layer procedures for data".
- [16] 3GPP TS 38.101-1: "NR; User Equipment (UE) radio transmission and reception; Part 1: Range 1 Standalone".
- [17] 3GPP TS 38.101-2: "NR; User Equipment (UE) radio transmission and reception; Part 2: Range 2 Standalone".
- [18] 3GPP TS 38.321: "NR; Medium Access Control (MAC) protocol specification".
- [19] 3GPP TS 38.323: "NR; Packet Data Convergence Protocol (PDCP) specification".
- [20] 3GPP TS 33.501: "Security Architecture and Procedures for 5G System".
- [21] 3GPP TS 24.301: "Non-Access-Stratum (NAS) protocol for Evolved Packet System (EPS); Stage 3".
- [22] 3GPP TS 24.501: "Non-Access-Stratum (NAS) protocol for 5G System (5GS); Stage 3".
- [23] 3GPP TS 38.306: "NR: User Equipment (UE) radio access capabilities"[24] 3GPP TS 38.211: "NR; Physical channels and modulation".
- [25] 3GPP TS 36.523-3: "Evolved Universal Terrestrial Radio Access (E-UTRA) and Evolved Universal Terrestrial Radio Access (E-UTRAN); User Equipment (UE) conformance specification; Part 3: Abstract Test Suites (ATS)".
- [26] 3GPP TS 38.300: "NR; NR and NG-RAN Overall Description; Stage 2".
- [27] 3GPP TS 38.322: "NR; Radio Link Control (RLC) protocol specification".
- [28] 3GPP TS 37.340: "NR; Multi-connectivity; Overall description; Stage-2".
- [29] 3GPP TS 36.523-2: "Evolved Universal Terrestrial Radio Access (E-UTRA) and Evolved Packet Core (EPC); User Equipment (UE) conformance specification; Part 2: Implementation Conformance Statement (ICS) proforma specification".
- [30] 3GPP TS 38.133: "NR; Requirements for support of radio resource management".
- [31] 3GPP TS 23.502: "Procedures for the 5G System; Stage 2".
- [32] IETF RFC 7296: "Internet Key Exchange Protocol Version 2 (IKEv2)".
- [33] 3GPP TS 24.502: "Access to the 3GPP 5G Core Network (5GCN) via Non-3GPP Access Networks (N3AN); Stage 3".
- [34] 3GPP TS 23.003: "Numbering, addressing and identification".
- [35] 3GPP TS 34.229-1: "Internet Protocol (IP) multimedia call control protocol based on Session Initiation Protocol (SIP) and Session Description Protocol (SDP); User Equipment (UE) conformance specification; Part 1: Protocol conformance specification".
- [36] 3GPP TS 31.102: "Characteristics of the Universal Subscriber Identity Module (USIM) application".

- [37] 3GPP TS 23.501: "System Architecture for the 5G System; Stage 2".
- [38] 3GPP TS 23.122: "Non-Access-Stratum functions related to Mobile Station (MS) in idle mode".
- [39] GSMA PRD IR.88: "LTE and EPC Roaming Guidelines".
- [40] 3GPP TS 27.007: "AT command set for User Equipment (UE)".
- [41] 3GPP TS 34.229-5: "Internet Protocol (IP) multimedia call control protocol based on Session Initiation Protocol (SIP) and Session Description Protocol (SDP); User Equipment (UE) conformance specification; Part 5: Protocol conformance specification using 5G System (5GS)".
- [42] 3GPP TS 22.101: "Service aspects; Service principles".
- [43] 3GPP TS 24.008: "Mobile radio interface Layer 3 specification; Core network protocols; Stage 3".

3 Definitions, symbols and abbreviations

3.1 Definitions

For the purposes of the present document, the terms and definitions given in TR 21.905 [1], specifications referred to in the tests' Conformance requirements clauses and the following apply. A term defined in the present document takes precedence.

Floor: Floor(x) is the largest integer smaller than or equal to x.

Ceil: Ceil (x) is the smallest integer larger than or equal to x.

3.2 Symbols

For the purposes of the present document, symbols defined in specifications referred to in the tests' Conformance requirements clauses and the following apply. A symbol defined in the present document takes precedence.

None.

3.3 Abbreviations

For the purposes of the present document, the abbreviations given in TR 21.905 [1]], specifications referred to in the tests' Conformance requirements clauses and the following apply. An abbreviation defined in the present document takes precedence.

ICS	Implementation Conformance Statement
FFS	For Further Study

4 Overview

4.1 Test methodology

4.1.1 Testing of optional functions and procedures

Any function or procedure which is optional, as indicated in the present document may be subject to a conformance test if it is implemented in the UE.

A declaration by the apparatus supplier (ICS) is used to determine whether an optional function/procedure has been implemented.

4.1.2 Test interfaces and facilities

Detailed descriptions of the UE test interfaces and special facilities for testing are provided in TS 38.509 [6].

4.2 Implicit testing

For some 3GPP signalling and protocol features conformance is not verified explicitly in the present document. This does not imply that correct functioning of these features is not essential, but that these are implicitly tested to a sufficient degree in other tests.

Implicit testing of 5GS requirements may be done also in tests specified in other 3GPP conformance test specifications. For clarity these are listed below:

- Indication for support of EN-DC: if the UE supports E-UTRA-NR dual connectivity, then the UE shall set the DCNR bit to "dual connectivity with NR supported" in the UE network capability IE of the ATTACH REQUEST/TRACKING AREA UPDATE REQUEST message; verified implicitly (the setting of the DCNR bit to 1) by tests specified in TS 36.523-1 [13].

NOTE 1: It is assumed that an UE supporting EN-DC will support EPS (legacy LTE) and therefore it will be tested against all relevant legacy LTE tests.

4.3 Repetition of tests

As a general rule, the test cases specified in the present document are highly reproducible and don't need to be repeated unless otherwise stated. However, the rate of correct UE behaviour such as cell re-selection, measurement and handover is specified statistically, e.g. "at least 90%" [8], [9]. Additionally, in some of the test cases, presented in TS 38.523-3 [3], HARQ retransmissions are not tolerated, because of characteristics of the test case. In such cases a repetition of test may be required. Details are FFS.

4.4 Handling of differences between conformance requirements in different releases of core specifications

The conformance requirements which determine the scope of each test case are explicitly copy-pasted from relevant core specifications in the especially dedicated for this clause of each test with the title 'Conformance requirements'.

NOTE: When in the copy/pasted text there are references to other specifications the reference numbers will not match the reference numbers used in the present document. This approach has been taken in order to allow easy copy and then search for conformance requirements in those specifications.

When differences between conformance requirements in different releases of the cores specifications have impact on the Pre-test conditions, Test procedure sequence or/and the Specific message contents, the Conformance requirements related to different releases are specified separately with clear indication of the Release of the spec from which they were copied.

When there is no Release indicated for a conformance requirement text, this should be understood either as the Conformance requirements in the latest version of the spec with release = the TC Applicability release (which can be found in the column 'Release' for the relevant for the test case entry in the tables in TS 38.523-2 [2], subclause 4.1, or, as the Conformance requirements in the latest version of the spec of the release when the feature was introduced to the core specs.

5 Reference conditions, generic and test procedures, test parameters

5.1 Reference conditions

The reference environments used by all signalling tests in the present document are specified in TS 38.508-1 [4]. If a test requires an environment that is different to those specified in TS 38.508-1 [4] then, this shall be specified in the test itself.

5.2 Generic and test procedures

A set of basic generic procedures for bringing the UE into a specific signalling state, as well as, test procedures comprising well defined actions after the UE enters a specific state are specified in TS 38.508-1 [4]. These procedures are used (referred to) in numerous test cases throughout the present document.

5.3 Test parameters

5.3.1 PLMNs

PLMN identifiers such as PLMN1, PLMN2, etc. are used in test cases to associate a cell with an MCC and MNC for that cell.

Whenever a PLMN identifier is provided explicitly in a test description without explicit MCC and MNC values, the MCC and MNC values corresponding to the PLMN identifier shall be understood as those specified in TS 36.523-1 [42], Table 6.0.1-1.

If no PLMN is explicitly specified in the test then the PLMN(s) specified for the relevant cell(s) in TS 38.508-1 [4] (NR cells) or 36.508 [2] (E-UTRA cells) apply. If no PLMN is explicitly specified in the test nor in the TS 38.508-1 [4] (NR cells) or 36.508 [2] (E-UTRA cells) for the used in the test cell(s) then the PLMN used in the test is the one defined as PLMN1 in TS 36.523-1 [42], Table 6.0.1-1.

5.3.2 Cells

Cell identifiers such as NR Cell 1 and NGC Cell A (for NR cells), or, Cell 1 and Cell A (for E-UTRA cells). are used in test cases to associate a cell with various parameters.

Cells used in the tests throughout the present document are defined in TS 38.508-1 [4], subclauses 4.4.2 and 6.3.2.2 for NR cells, and, TS 36.508 [2], subclauses 4.4.2 and 6.3.2 for E-UTRA cells respectively. Signal levels for signalling tests are defined in TS 38.508-1 [4], subclause 6.2.2 and TS 36.508 [2], subclause 6.2.2.

Associated with the Cells used in the test cases are a number of parameters e.g. Tracing Area Identifiers (TAIs) such as TAI-1, TAI-2, etc., specific MCC and MNC values for the simulated PLMN, etc. For Default NAS parameters for simulated NR cells and Simulated network scenarios for NAS test cases for 5GS these are defined in TS 38.508-1 [4], subclauses 4.4.2 and 6.3.2.1 respectively. Similarly such parameters are defined in TS 36.508 [2] for E-UTRA cells.

Whenever a Cell identifier is provided explicitly in a test description without explicit definition of parameters, the parameters values corresponding to the Cell identifier shall be understood as those specified in TS 38.508-1 [4] or TS 36.523-1 [42] respectively for the cell with that identifier.

Whenever a test in the present document requires cells characteristics, e.g. power level settings, TAIs, MCC/MNC which differ to those specified in TS 38.508-1 [4] for NR cells or in TS 36.508 [2] for E-UTRA cells then, these shall be specified explicitly in the test itself.

5.3.3 USIM

Default USIM fields and signalling test case specific USIM Configurations are specified in TS 38.508-1 [4], subclause 6.4.

Whenever a test in the present document does not provide an explicit reference to a specific USIM Configurations specified in TS 38.508-1 [4], subclause 6.4 then, the default parameters specified in TS 38.508-1 [4], subclause 4.8.3 shall be assumed.

Whenever a test in the present document requires specific USIM settings which do not exist in any of the defined USIM Configurations in TS 38.508-1 [4], it is recommended that a new USIM Configuration is defined and then the configuration is referred from the test. Defining specific USIM setting within a test definition should be avoided.

5.3.4 Messages and Information Elements (IEs)

Default Messages and IE contents, and where applicable IE fields values, used by the tests defined in the present document are specified in TS 38.508-1 [4], subclauses 4.6, 4.7 and 4.7A. For messages exchanged on other RAT e.g. E-UTRAN/EPC these can be found in TS 36.508 [2].

If a test requires a message and/or IE contents and/or IE field value which is different to those specified in TS 38.508-1 [4] then, specific message content shall be specified in the test itself with a derivation path referring to the relevant default message in TS 38.508-1 [4]. Whenever a specific message content is not explicitly provided in a test then this shall be understood as the message having exactly the same content as the default message specified in TS 38.508-1 [4].

NOTE: Similar rules apply to messages exchanged on other RATs and defined elsewhere e.g. in TS 36.508 [2].

6 Idle mode and RRC Inactive state operations

6.1 NR idle mode operations

6.1.1 NG-RAN Only PLMN Selection

6.1.1.1 PLMN selection of RPLMN, HPLMN/EHPLMN, UPLMN and OPLMN / Automatic mode

6.1.1.1.1 Test Purpose (TP)

(1)

```
with { UE in Automatic network selection mode and RPLMN, HPLMN, UPLMN and OPLMN NR cells available
and UE is fitted with a USIM indicating RPLMN should be selected }
ensure that {
  when { UE is switched on or return to coverage }
  then { UE selects a cell of the RPLMN and UE attempts Registration on the selected cell }
}
```

(2)

```
with { UE camped on an NG-RAN VPLMN cell and cells of a higher priority NG-RAN PLMN available }
ensure that {
  when { higher priority PLMN search timer T expires }
  then { UE selects and camps on a cell of the highest priority PLMN and UE attempts Registration
with mobility on the selected cell }
}
```

(3)

```
with { UE in Automatic network selection mode and HPLMN, UPLMN and OPLMN NG-RAN cells available and
UE is fitted with a USIM with Access Technology data files for each PLMN and there are no equivalent
HPLMNs defined}
```

```

ensure that {
  when { UE is switched on or return to coverage }
  then { UE selects a cell of the highest priority PLMN and UE attempts Registration with mobility
on the selected cell }
}

```

(4)

```

with { UE camped on an NR VPLMN cell and cells of a NG-RAN HPLMN available }
ensure that {
  when { higher priority PLMN search timer T expires }
  then { UE selects and camps on a cell of HPLMN and UE attempts Registration on the selected cell
}
}

```

6.1.1.1.2 Conformance requirements

References: The conformance requirements covered in the present TC are specified in: TS 23.122 clauses 4.4.3.1, 4.4.3.1.1 and 4.4.3.3.1. Unless otherwise stated these are Rel-15 requirements.

[TS 23.122, clause 4.4.3.1]

At switch on, or following recovery from lack of coverage, the MS selects the registered PLMN or equivalent PLMN (if it is available) using all access technologies that the MS is capable of and if necessary (in the case of recovery from lack of coverage, see subclause 4.5.2) attempts to perform a Location Registration.

NOTE 1: The MS in automatic network selection mode can end the PLMN search procedure once the registered PLMN or equivalent PLMN is found on an access technology.

NOTE 2: An MS in automatic network selection mode can use location information to determine which PLMNs can be available in its present location.

EXCEPTION: As an alternative option to this, if the MS is in automatic network selection mode and it finds coverage of an EHPLMN, the MS may register to that EHPLMN and not return to the registered PLMN or equivalent PLMN. If the EHPLMN list is not present or is empty, and the HPLMN is available, the MS may register on the HPLMN and not return to the registered PLMN or equivalent PLMN. The operator shall be able to control by SIM configuration whether an MS that supports this option is permitted to perform this alternative behaviour.

EXCEPTION: In A/Gb mode an MS with voice capability, shall not search for CPBCCCH carriers. In A/Gb mode an MS not supporting packet services shall not search for CPBCCCH carriers.

If successful registration is achieved, the MS indicates the selected PLMN.

If there is no registered PLMN, or if registration is not possible due to the PLMN being unavailable or registration failure, the MS follows one of the following two procedures depending on its PLMN selection operating mode. At switch on, if the MS provides the optional feature of user preferred PLMN selection operating mode at switch on then this operating mode shall be used. Otherwise, the MS shall use the PLMN selection mode that was used before switching off.

EXCEPTION: At switch on, if the MS is in manual mode and neither registered PLMN nor PLMN that is equivalent to it is available but EHPLMN is available, then instead of performing the manual network selection mode procedure of subclause 4.4.3.1.2 the MS may select and attempt registration on the highest priority EHPLMN. If the EHPLMN list is not available or is empty and the HPLMN is available, then the MS may select and attempt registration on the HPLMN. The MS shall remain in manual mode.

NOTE 3: If successful registration is achieved, then the current serving PLMN becomes the registered PLMN and the MS does not store the previous registered PLMN for later use.

EXCEPTION: If registration is not possible on recovery from lack of coverage due to the registered PLMN being unavailable, an MS attached to GPRS services, attached via E-UTRAN or registered via the NG-RAN may, optionally, continue looking for the registered PLMN for an implementation dependent time.

NOTE 4: An MS attached to GPRS services, attached via E-UTRAN or registered via the NG-RAN should use the above exception only if one or more PDP contexts, PDN connections or PDU sessions are currently active.

[TS 23.122, clause 4.4.3.1.1]

The MS selects and attempts registration on other PLMN/access technology combinations, if available and allowable, in the following order:

- i) either the HPLMN (if the EHPLMN list is not present or is empty) or the highest priority EHPLMN that is available (if the EHPLMN list is present) ;
- ii) each PLMN/access technology combination in the "User Controlled PLMN Selector with Access Technology" data file in the SIM (in priority order);
- iii) each PLMN/access technology combination in the "Operator Controlled PLMN Selector with Access Technology" data file in the SIM (in priority order);
- iv) other PLMN/access technology combinations with received high quality signal in random order;
- v) other PLMN/access technology combinations in order of decreasing signal quality.

When following the above procedure the following requirements apply:

- a) An MS with voice capability shall ignore PLMNs for which the MS has identified at least one GSM COMPACT.
- b) In A/Gb mode or GSM COMPACT, an MS with voice capability, or an MS not supporting packet services shall not search for CPBCCCH carriers.
- c) In ii and iii, the MS should limit its search for the PLMN to the access technology or access technologies associated with the PLMN in the appropriate PLMN Selector with Access Technology list (User Controlled or Operator Controlled selector list).

An MS using a SIM without access technology information storage (i.e. the "User Controlled PLMN Selector with Access Technology" and the "Operator Controlled PLMN Selector with Access Technology" data files are not present) shall instead use the "PLMN Selector" data file, for each PLMN in the "PLMN Selector" data file, the MS shall search for all access technologies it is capable of. The priority ordering amongst the access technologies is implementation dependent.

- d) In iv and v, the MS shall search for all access technologies it is capable of, before deciding which PLMN to select.
- e) In ii, and iii, a packet only MS which supports GSM COMPACT, but using a SIM without access technology information storage (i.e. the "User Controlled PLMN Selector with Access Technology" and the "Operator Controlled PLMN Selector with Access Technology" data files are not present) shall instead use the "PLMN Selector" data file, for each PLMN in the "PLMN Selector" data file, the MS shall search for all access technologies it is capable of and shall assume GSM COMPACT access technology as the lowest priority radio access technology.
- f) In i, the MS shall search for all access technologies it is capable of. No priority is defined for the preferred access technology and the priority is an implementation issue, but "HPLMN Selector with Access Technology" data file on the SIM may be used to optimise the procedure.
- g) In i, an MS using a SIM without access technology information storage (i.e. the "HPLMN Selector with Access Technology" data file is not present) shall search for all access technologies it is capable of. The priority ordering amongst the access technologies is implementation dependent. A packet only MS which supports GSM COMPACT using a SIM without access technology information storage shall also assume GSM COMPACT access technology as the lowest priority radio access technology.

NOTE 1: For f) and g), the MS in automatic network selection mode can end the PLMN search procedure once the HPLMN or the highest priority EHPLMN is found on an access technology.

NOTE 2: For i, ii and iii, the MS can use location information to determine which PLMNs can be available in its present location.

- h) In v, the MS shall order the PLMN/access technology combinations in order of decreasing signal quality within each access technology. The order between PLMN/access technology combinations with different access technologies is an MS implementation issue.

NOTE 3: Requirements a) and b) apply also to requirement d), so a GSM voice capable MS should not search for GSM COMPACT PLMNs, even if capable of GSM COMPACT.

NOTE 4: Requirements a) and b) apply also to requirement f), so a GSM voice capable MS should not search for GSM COMPACT PLMNs, even if this is the only access technology on the "HPLMN Selector with Access Technology" data file on the SIM.

NOTE 5: High quality signal is defined in the appropriate AS specification.

- i) In i to v, the MS shall not consider PLMNs where voice service was not possible as PLMN selection candidate, unless such PLMN is available in GERAN or UTRAN or no other allowed PLMN is available.
- j) In i to v, if the MS only supports EMM-REGISTERED without PDN connection (see TS 24.301 [23A]), the MS shall not consider PLMNs which do not advertise support of EMM-REGISTERED without PDN connection.
- k) In i to v, if the MS only supports control plane CIoT EPS optimization (see TS 24.301 [23A]) and the UE camps on a E-UTRA cell which is not NB-IoT cell (see TS 36.304 [43], TS 36.331 [22]), the MS shall not consider PLMNs which do not advertise support of EPS services with control plane CIoT EPS optimization.
- l) In i to v, if the MS is in eCall only mode, the MS shall not consider PLMNs which do not advertise support for eCall over IMS, unless such PLMNs are available in GERAN or UTRAN.

NOTE 6: As an implementation option, an MS in eCall only mode that was not able to select any PLMN according to l) can perform a second iteration of i to v with no restriction.

If successful registration is achieved, the MS indicates the selected PLMN.

If registration cannot be achieved because no PLMNs are available and allowable, the MS indicates "no service" to the user, waits until a new PLMN is available and allowable and then repeats the procedure.

If there were one or more PLMNs which were available and allowable, but an LR failure made registration on those PLMNs unsuccessful or an entry in any of the lists "forbidden location areas for roaming", "forbidden tracking areas for roaming", "5GS forbidden tracking areas for roaming", "forbidden location areas for regional provision of service", "forbidden tracking areas for regional provision of service" or "5GS forbidden tracking areas for regional provision of service" prevented a registration attempt, the MS selects the first such PLMN again and enters a limited service state.

[TS 23.122, clause 4.4.3.3.1]

If the MS is in a VPLMN, the MS shall periodically attempt to obtain service on its HPLMN (if the EHPLMN list is not present or is empty) or one of its EHPLMNs (if the EHPLMN list is present) or a higher priority PLMN/access technology combinations listed in "user controlled PLMN selector" or "operator controlled PLMN selector" by scanning in accordance with the requirements that are applicable to i), ii) and iii) as defined in the Automatic Network Selection Mode in subclause 4.4.3.1.1. In the case that the mobile has a stored "Equivalent PLMNs" list the mobile shall only select a PLMN if it is of a higher priority than those of the same country as the current serving PLMN which are stored in the "Equivalent PLMNs" list. For this purpose, a value of timer T may be stored in the SIM. The interpretation of the stored value depends on the radio capabilities supported by the MS:

- For an MS that does not support any of the following: EC-GSM-IoT, Category M1 or Category NB1 (as defined in TS 36.306 [54]), T is either in the range 6 minutes to 8 hours in 6 minute steps or it indicates that no periodic attempts shall be made. If no value for T is stored in the SIM, a default value of 60 minutes is used for T.
- For an MS that only supports any of the following or a combination of: EC-GSM-IoT, Category M1 or Category NB1 (as defined in TS 36.306 [54]), T is either in the range 2 hours to 240 hours, using 2 hour steps from 2 hours to 80 hours and 4 hour steps from 84 hours to 240 hours, or it indicates that no periodic attempts shall be made. If no value for T is stored in the SIM, a default value of 72 hours is used.
- For an MS that supports both:
 - a) any of the following or a combination of: EC-GSM-IoT, Category M1 or Category NB1 (as defined in 3GPP TS 36.306 [54]); and
 - b) any access technology other than the following: EC-GSM-IoT, Category M1 or Category NB1 (as defined in 3GPP TS 36.306 [54]),

then T is interpreted depending on the access technology in use as specified below:

- 1) if the MS is using any of the following at the time of starting timer T: EC-GSM-IoT, Category M1 or Category NB1 (as defined in 3GPP TS 36.306 [54]), T is either in the range 2 hours to 240 hours, using 2 hour steps from 2 hours to 80 hours and 4 hour steps from 84 hours to 240 hours, or it indicates that no

periodic attempts shall be made. If no value for T is stored in the SIM, a default value of 72 hours is used; and

- 2) if the MS is not using any of the following at the time of starting timer T: EC-GSM-IoT, Category M1 or Category NB1 (as defined in 3GPP TS 36.306 [54]), T is either in the range 6 minutes to 8 hours in 6 minute steps or it indicates that no periodic attempts shall be made. If no value for T is stored in the SIM, a default value of 60 minutes is used for T.

If the MS is configured with the MinimumPeriodicSearchTimer as specified in 3GPP TS 24.368 [50] or 3GPP TS 31.102 [40], the MS shall not use a value for T that is less than the MinimumPeriodicSearchTimer. If the value stored in the SIM, or the default value for T (when no value is stored in the SIM), is less than the MinimumPeriodicSearchTimer, then T shall be set to the MinimumPeriodicSearchTimer.

The MS does not stop timer T, as described in 3GPP TS 24.008 [23] and 3GPP TS 24.301 [23A], when it activates power saving mode (PSM) (see 3GPP TS 23.682 [27A]).

The MS can be configured for Fast First Higher Priority PLMN search as specified in 3GPP TS 31.102 [40] or 3GPP TS 24.368 [50]. Fast First Higher Priority PLMN search is enabled if the corresponding configuration parameter is present and set to enabled. Otherwise, Fast First Higher Priority PLMN search is disabled.

The attempts to access the HPLMN or an EHPLMN or higher priority PLMN shall be as specified below:

- a) The periodic attempts shall only be performed in automatic mode when the MS is roaming, and not while the MS is attached for emergency bearer services, is registered for emergency services, has a PDU session for emergency services or has a PDN connection for emergency bearer services;
- b) The MS shall make the first attempt after a period of at least 2 minutes and at most T minutes:
 - only after switch on if Fast First Higher Priority PLMN search is disabled; or
 - after switch on or upon selecting a VPLMN if Fast First Higher Priority PLMN search is enabled.
- c) The MS shall make the following attempts if the MS is on the VPLMN at time T after the last attempt;
- d) Periodic attempts shall only be performed by the MS while in idle mode;
- d1) Periodic attempts may be postponed while the MS is in power saving mode (PSM) (see 3GPP TS 23.682 [27A]).
- d2) Periodic attempts may be postponed while the MS is receiving eMBMS transport service in idle mode (see 3GPP TS 23.246 [68]).
- e) If the HPLMN (if the EHPLMN list is not present or is empty) or a EHPLMN (if the list is present) or a higher priority PLMN is not found, the MS shall remain on the VPLMN.
- f) In steps i), ii) and iii) of subclause 4.4.3.1.1 the MS shall limit its attempts to access higher priority PLMN/access technology combinations to PLMN/access technology combinations of the same country as the current serving VPLMN, as defined in Annex B.
- g) Only the priority levels of Equivalent PLMNs of the same country as the current serving VPLMN, as defined in Annex B, shall be taken into account to compare with the priority level of a selected PLMN.
- h) If the PLMN of the highest priority PLMN/access technology combination available is the current VPLMN, or one of the PLMNs in the "Equivalent PLMNs" list, the MS shall remain on the current PLMN/access technology combination.

6.1.1.1.3 Test description

6.1.1.1.3.1 Pre-test conditions

System Simulator:

- Four multi-PLMN NR Cells as specified in TS 38.508-1 [4] Table 4.4.2.1 are configured broadcasting PLMNs as indicated in Table 6.1.1.1.3.1-1.

- The PLMNs are identified in the test by the identifiers in Table 6.1.1.1.3.1-1 and the PLMN settings are defined in TS 36.523-1 [13] table 6.0.1-1.

Table 6.1.1.1.3.1-1: PLMN identifiers

NR Cell	PLMN name
1	PLMN1
12	PLMN15
13	PLMN16
2	PLMN17

All NR cells are high quality

All NR cells are suitable cells;

System information combination NR-1 as defined in TS 38.508-1 [4] clause 4.4.3.1.2 is used in NR cells

UE:

The UE is in Automatic PLMN selection mode.

USIM configuration as defined in TS 38.508-1 [4] Table 6.4.1-1 will be loaded except for PLMN identifiers in Table 6.1.1.1.3.1-1.

Preamble:

- The UE is registered to NR Cell 12 and then Switched OFF (State ON-B) as defined in TS 38.508-1 [4] Table 4.4A.2-0.

6.1.1.1.3.2 Test procedure sequence

Table 6.1.1.1.3.2-1 for FR1 and Table 6.1.1.1.3.2-2 for FR2 illustrates the downlink power levels and other changing parameters to be applied for the cells at various time instants of the test execution. Row marked "T0" denotes the initial conditions after preamble, while columns marked "T1", "T2" and "T3" are to be applied subsequently in the Main behaviour. The exact instants on which these values shall be applied are described in the texts in this clause.

Table 6.1.1.1.3.2-1: Cell configuration changes over time for FR1

	Parameter	Unit	NR Cell 1	NR Cell 12	NR Cell 13	NR Cell 2	Remarks
T0	SS/PBCH SSS EPRE	dBm/SCS	"Off"	-88	"Off"	"Off"	Power level "Off" is defined in TS 38.508-1 Table 6.2.2.1-3
T1	SS/PBCH SSS EPRE	dBm/SCS	-88	-88	-88	"Off"	Power level "Off" is defined in TS 38.508-1 Table 6.2.2.1-3
T2	SS/PBCH SSS EPRE	dBm/SCS	"Off"	-88	-88	"Off"	Power level "Off" is defined in TS 38.508-1 Table 6.2.2.1-3
T3	SS/PBCH SSS EPRE	dBm/SCS	"Off"	-88	-88	-88	Power level "Off" is defined in TS 38.508-1 Table 6.2.2.1-3

Table 6.1.1.1.3.2-2: Cell configuration changes over time for FR2

	Parameter	Unit	NR Cell 1	NR Cell 12	NR Cell 13	NR Cell 2	Remarks
T0	SS/PBCH SSS EPRE	dBm/SCS	"Off"	[-85]	"Off"	"Off"	Power level "Off" is defined in TS 38.508-1 Table 6.2.2.1-3
T1	SS/PBCH SSS EPRE	dBm/SCS	[-85]	[-85]	[-85]	"Off"	Power level "Off" is defined in TS 38.508-1 Table 6.2.2.1-3

T2	SS/PBCH SSS EPRE	dBm/SCS	"Off"	[-85]	[-85]	"Off"	Power level "Off" is defined in TS 38.508-1 Table 6.2.2.1-3
T3	SS/PBCH SSS EPRE	dBm/SCS	"Off"	[-85]	[-85]	[-85]	Power level "Off" is defined in TS 38.508-1 Table 6.2.2.1-3

Table 6.1.1.1.3.2-2: Main behaviour

St	Procedure	Message Sequence		TP	Verdict
		U - S	Message		
1	SS adjusts cell levels according to row T1 of table 6.1.1.1.3.2-1 for FR1 and table 6.1.1.1.3.2-2 for FR2	-	-	-	-
2	Power on the UE.	-	-	-	-
3	Check: Does the UE send a <i>RRCSetupRequest</i> on NR Cell 12?	-->	<i>RRCSetupRequest</i>	1	P
4-21	Steps 3 to 20a1 of the registration procedure described in TS 38.508-1 subclause 4.5.2.2-2 are performed on NR Cell 12. NOTE: The UE performs registration and the RRC connection is released.	-	-	-	-
22	Check: Does the UE send a <i>RRCSetupRequest</i> on NR Cell 1 after 120 seconds, but before 660seconds (Note 1 and 2) from power on?	-->	<i>RRCSetupRequest</i>	4	P
22 A-22 B	Steps 3-4 of Table 4.5.2.2-2 of the generic procedure in TS 38.508-1 [4] are performed. (Note 3)	-	-	-	-
-	EXCEPTION: Steps 23a1 to 23b5a1 describe behaviour that depends on events happening prior to their execution; the "lower case letter" identifies a step sequence that take place if a specific prior event takes place.	-	-	-	-
23a 1-23a 16a 1	IF 5GS registration type is set as Initial Registration in step 22B, THEN Steps 5 to 20a1 of the generic test procedure in TS 38.508-1 Table 4.5.2.2-2 are performed on NR Cell 1.	-	-	-	-
23b 1-23b 2	Void	-	-	-	-
23b 3-23b 5a1	IF 5GS registration type is set as Mobility Registration in step 22B, THEN Steps 4 to 6a1 of the generic test procedure in TS 38.508-1 Table 4.9.5.2.2-1 are performed on NR Cell 1.	-	-	-	-
24-27	Void	-	-	-	-
28	SS adjusts cell levels according to row T2 of table 6.1.1.1.3.2-1 for FR1 and table 6.1.1.1.3.2-2 for FR2	-	-	-	-
29	Check: Does the UE send a <i>RRCSetupRequest</i> on NR Cell 13?	-->	<i>RRCSetupRequest</i>	3	P
29 A-29 B	Steps 3-4 of Table 4.5.2.2-2 of the generic procedure in TS 38.508-1 [4] are performed. (Note 3)	-	-	-	-
-	EXCEPTION: Steps 29a1 to 29b5a1 describe behaviour that depends on events happening prior to their execution; the "lower case letter" identifies a step sequence that take place if a specific prior event takes place.	-	-	-	-
29a 1-	IF 5GS registration type is set as Initial Registration in step 29B, THEN Steps 5 to	-	-	-	-

29a 16a 1	20a1 of the generic test procedure in TS 38.508-1 Table 4.5.2.2-2 are performed on NR Cell 13.				
29b 1- 29b 2	Void.	-	-	-	-
29b 3- 29b 5a1	IF 5GS registration type is set as Mobility Registration in step 29B, THEN Steps 4 to 6a1 of the generic test procedure in TS 38.508-1 Table 4.9.5.2.2-1 are performed on NR Cell 13.	-	-	-	-
30	SS adjusts cell levels according to row T3 of table 6.1.1.1.3.2-1 for FR1 and table 6.1.1.1.3.2-2 for FR2	-	-	-	-
31	Check: Does the UE send a <i>RRCSetupRequest</i> on NR Cell 2 after 120 seconds, but before 660 seconds after step 30? (Note 1 and 2)	-->	<i>RRCSetupRequest</i>	2	P
31 A- 31 B	Steps 3-4 of Table 4.5.2.2-2 of the generic procedure in TS 38.508-1 [4] are performed. (Note 3)	-	-	-	-
-	EXCEPTION: Steps 32a1 to 32b5a1 describe behaviour that depends on events happening prior to their execution; the "lower case letter" identifies a step sequence that take place if a specific prior event takes place.	-	-	-	-
32a 1- 32a 16a 1	IF 5GS registration type is set as Initial Registration in step 31B, THEN Steps 5 to 20a1 of the generic test procedure in TS 38.508-1 Table 4.5.2.2-2 are performed on NR Cell 2.	-	-	-	-
32b 1- 32b 2	Void	-	-	-	-
32b 3- 32b 5a1	IF 5GS registration type is set as Mobility Registration in step 31B, THEN Steps 4 to 6a1 of the generic test procedure in TS 38.508-1 Table 4.9.5.2.2-1 are performed on NR Cell 2.	-	-	-	-
33- 36	Void	-	-	-	-
<p>Note 1: Following attempts to access the HPLMN/EHPLMN/higher priority PLMN in VPLMN is operator specific setting (Refer to TS 23.122 Rel-15).Hence, window between 120s to T+Tolerance is being used, where the high priority PLMN search timer T defined by EF_{HPPLMN}.</p> <p>Note 2: Tolerance of 5min is added to allow time for the UE to find the proper PLMN.</p> <p>Note 3: The 5GS registration type shall be only set as Mobility Registration for R16 UEs according to TS 24.501 subclause 5.2.3.2.5 specified in Release 16. The EXCEPTION description applies only to R15 UEs.</p>					

6.1.1.1.3.3 Specific message contents

None

6.1.1.2 PLMN selection of "Other PLMN/access technology combinations" / Automatic mode

6.1.1.2.1 Test Purpose (TP)

(1)

with { UE in Automatic network selection mode and EHPLMN, UPLMN and OPLMN/access technology combinations cells available and UE is fitted with a USIM with Access Technology data files for each PLMN }
ensure that {

```

when { UE is switched on or return to coverage }
  then { UE selects a cell of the EHPLMN and UE attempts a Registration on the selected cell }
}

```

(2)

```

with { UE in Automatic network selection mode and UPLMN, OPLMN and other PLMN/access technology
combinations cells available and UE is fitted with a USIM with Access Technology data files for each
PLMN }
ensure that {
  when { UE is switched on or return to coverage }
    then { UE selects a cell of the UPLMN and UE attempts a Registration on the selected cell }
}

```

(3)

```

with { UE in Automatic network selection mode and OPLMN and other PLMN/access technology
combinations cells available and UE is fitted with a USIM with Access Technology data files for each
PLMN }
ensure that {
  when { UE is switched on or return to coverage }
    then { UE selects a cell of the OPLMN and UE attempts a Registration on the selected cell }
}

```

(4)

```

with { UE in Automatic network selection mode and other PLMN/access technology combinations cells
not belonging to any of EHPLMN, UPLMN or OPLMN available }
ensure that {
  when { UE is switched on or return to coverage }
    then { UE selects a cell of other PLMN/access technology combinations and UE attempts a
Registration on the selected cell }
}

```

6.1.1.2.2 Conformance requirements

References: The conformance requirements covered in the current TC are specified in: TS 23.122 clauses 4.4.3.1.1. Unless otherwise stated these are Rel-15 requirements.

[TS 23.122, clause 4.4.3.1.1]

The MS selects and attempts registration on other PLMN/access technology combinations, if available and allowable, in the following order:

- i) either the HPLMN (if the EHPLMN list is not present or is empty) or the highest priority EHPLMN that is available (if the EHPLMN list is present) ;
- ii) each PLMN/access technology combination in the "User Controlled PLMN Selector with Access Technology" data file in the SIM (in priority order);
- iii) each PLMN/access technology combination in the "Operator Controlled PLMN Selector with Access Technology" data file in the SIM (in priority order);
- iv) other PLMN/access technology combinations with received high quality signal in random order;
- v) other PLMN/access technology combinations in order of decreasing signal quality.

When following the above procedure the following requirements apply:

- a) An MS with voice capability shall ignore PLMNs for which the MS has identified at least one GSM COMPACT.
- b) In A/Gb mode or GSM COMPACT, an MS with voice capability, or an MS not supporting packet services shall not search for CPBCCCH carriers.

- c) In ii and iii, the MS should limit its search for the PLMN to the access technology or access technologies associated with the PLMN in the appropriate PLMN Selector with Access Technology list (User Controlled or Operator Controlled selector list).

An MS using a SIM without access technology information storage (i.e. the "User Controlled PLMN Selector with Access Technology" and the "Operator Controlled PLMN Selector with Access Technology" data files are not present) shall instead use the "PLMN Selector" data file, for each PLMN in the "PLMN Selector" data file, the MS shall search for all access technologies it is capable of. The priority ordering amongst the access technologies is implementation dependent.

- d) In iv and v, the MS shall search for all access technologies it is capable of, before deciding which PLMN to select.
- e) In ii, and iii, a packet only MS which supports GSM COMPACT, but using a SIM without access technology information storage (i.e. the "User Controlled PLMN Selector with Access Technology" and the "Operator Controlled PLMN Selector with Access Technology" data files are not present) shall instead use the "PLMN Selector" data file, for each PLMN in the "PLMN Selector" data file, the MS shall search for all access technologies it is capable of and shall assume GSM COMPACT access technology as the lowest priority radio access technology.
- f) In i, the MS shall search for all access technologies it is capable of. No priority is defined for the preferred access technology and the priority is an implementation issue, but "HPLMN Selector with Access Technology" data file on the SIM may be used to optimise the procedure.
- g) In i, an MS using a SIM without access technology information storage (i.e. the "HPLMN Selector with Access Technology" data file is not present) shall search for all access technologies it is capable of. The priority ordering amongst the access technologies is implementation dependent. A packet only MS which supports GSM COMPACT using a SIM without access technology information storage shall also assume GSM COMPACT access technology as the lowest priority radio access technology.

NOTE 1: For f) and g), the MS in automatic network selection mode can end the PLMN search procedure once the HPLMN or the highest priority EHPLMN is found on an access technology.

NOTE 2: For i, ii and iii, the MS can use location information to determine which PLMNs can be available in its present location.

- h) In v, the MS shall order the PLMN/access technology combinations in order of decreasing signal quality within each access technology. The order between PLMN/access technology combinations with different access technologies is an MS implementation issue.

NOTE 3: Requirements a) and b) apply also to requirement d), so a GSM voice capable MS should not search for GSM COMPACT PLMNs, even if capable of GSM COMPACT.

NOTE 4: Requirements a) and b) apply also to requirement f), so a GSM voice capable MS should not search for GSM COMPACT PLMNs, even if this is the only access technology on the "HPLMN Selector with Access Technology" data file on the SIM.

NOTE 5: High quality signal is defined in the appropriate AS specification.

- i) In i to v, the MS shall not consider PLMNs where voice service was not possible as PLMN selection candidate, unless such PLMN is available in GERAN or UTRAN or no other allowed PLMN is available.
- j) In i to v, if the MS only supports EMM-REGISTERED without PDN connection (see 3GPP TS 24.301 [23A]), the MS shall not consider PLMNs which do not advertise support of EMM-REGISTERED without PDN connection.
- k) In i to v, if the MS only supports control plane CIoT EPS optimization (see 3GPP TS 24.301 [23A]) and the UE camps on a E-UTRA cell which is not NB-IoT cell (see 3GPP TS 36.304 [43], 3GPP TS 36.331 [22]), the MS shall not consider PLMNs which do not advertise support of EPS services with control plane CIoT EPS optimization.
- l) In i to v, if the MS is in eCall only mode, the MS shall not consider PLMNs which do not advertise support for eCall over IMS, unless such PLMNs are available in GERAN or UTRAN.

NOTE 6: As an implementation option, an MS in eCall only mode that was not able to select any PLMN according to l) can perform a second iteration of i to v with no restriction.

If successful registration is achieved, the MS indicates the selected PLMN.

If registration cannot be achieved because no PLMNs are available and allowable, the MS indicates "no service" to the user, waits until a new PLMN is available and allowable and then repeats the procedure.

If there were one or more PLMNs which were available and allowable, but an LR failure made registration on those PLMNs unsuccessful or an entry in any of the lists "forbidden location areas for roaming", "forbidden tracking areas for roaming", "5GS forbidden tracking areas for roaming", "forbidden location areas for regional provision of service", "forbidden tracking areas for regional provision of service" or "5GS forbidden tracking areas for regional provision of service" prevented a registration attempt, the MS selects the first such PLMN again and enters a limited service state.

6.1.1.2.3 Test description

6.1.1.2.3.1 Pre-test conditions

System Simulator:

- Four inter-frequency multi-PLMN cells as specified in TS 38.508-1 [4] clause 4.4.1.1.3 are configured broadcasting default PLMNs as indicated in TS 38.508-1 [4] Table 4.4.2-3.
- The PLMNs are identified in the test by the identifiers in Table 6.1.1.2.3.1-1.

Table 6.1.1.2.3.1-1: PLMN identifiers

NR Cell	PLMN name
1	PLMN1
12	PLMN2
13	PLMN3
11	PLMN4

UE:

- The UE is in Automatic PLMN selection mode.
- The UE is equipped with a USIM configuration as defined in TS 38.508-1 [4] Table 6.4.1-4.

Preamble:

- The UE is in state Switched OFF (state 0-A).

6.1.1.2.3.2 Test procedure sequence

Table 6.1.1.2.3.2-1/2 shows the cell configurations used during the test. Subsequent configurations marked "T1", "T2" "T3" "T4" etc are applied at the points indicated in the Main behaviour description in Table 6.1.1.2.3.2-3. Cell powers are chosen for a serving cell and a non-suitable "Off" cell as defined in TS 38.508-1 [4] Table 6.2.2.1-3 for FR1 and Table 6.2.2.2-2 for FR2.

Table 6.1.1.2.3.2-1: Time instances of cell power level and parameter changes for FR1

	Parameter	Unit	NR Cell 1	NR Cell 12	NR Cell 13	NR Cell 11	Remarks
T1	SS/PBCH SSS EPRE	dBm/SCS	-88	-88	-88	"Off"	Power level "Off" is defined in TS 38.508-1 [4] Table 6.2.2.1-3.
T2	SS/PBCH SSS EPRE	dBm/SCS	"Off"	-88	-88	-88	Power level "Off" is defined in TS 38.508-1 [4] Table 6.2.2.1-3.
T3	SS/PBCH SSS EPRE	dBm/SCS	"Off"	"Off"	-88	-88	Power level "Off" is defined in TS 38.508-1 [4] Table 6.2.2.1-3.

							3.
T4	SS/PBCH SSS EPRE	dBm/SCS	"Off"	"Off"	"Off"	-88	Power level "Off" is defined in TS 38.508-1 [4] Table 6.2.2.1-3.

Table 6.1.1.2.3.2-2: Time instances of cell power level and parameter changes for FR2

	Parameter	Unit	NR Cell 1	NR Cell 12	NR Cell 13	NR Cell 11	Remarks
T1	SS/PBCH SSS EPRE	dBm/SCS	-82	-82	-82	"Off"	Power level "Off" is defined in TS 38.508-1 [4] Table 6.2.2.2-2.
T2	SS/PBCH SSS EPRE	dBm/SCS	"Off"	-82	-82	-82	Power level "Off" is defined in TS 38.508-1 [4] Table 6.2.2.2-2.
T3	SS/PBCH SSS EPRE	dBm/SCS	"Off"	"Off"	-82	-82	Power level "Off" is defined in TS 38.508-1 [4] Table 6.2.2.2-2.
T4	SS/PBCH SSS EPRE	dBm/SCS	"Off"	"Off"	"Off"	-82	Power level "Off" is defined in TS 38.508-1 [4] Table 6.2.2.2-2.

Table 6.1.1.2.3.2-3: Main behaviour

St	Procedure	Message Sequence		TP	Verdict
		U - S	Message		
1	SS adjusts cell levels according to row T1 of table 6.1.1.2.3.2-1/2.	-	-	-	-
2	Power on the UE.	-	-	-	-
3	Check: Does the UE send an <i>RRCSetupRequest</i> on NR Cell 1?	-->	NR RRC: <i>RRCSetupRequest</i>	1	P
4-21	Steps 3 to 20a1 of the registration procedure described in TS 38.508-1 [4] subclause 4.5.2.2 are performed on NR Cell 1. NOTE: The UE performs registration and the RRC connection is not released.	-	-	-	-
21 A	The UE is switched off by executing generic procedure in Table 4.9.6.3-1 in TS 38.508-1 [4]	-	-	-	-
22	SS adjusts cell levels according to row T2 of table 6.1.1.2.3.2-1/2.	-	-	-	-
22 A	Void	-	-	-	-
22 B	The UE is Switched ON.	-	-	-	-
23	Check: Does the test result of generic test procedure in TS 38.508-1 [4] Table 4.5.2.2-2 indicate that the UE is camped on NR Cell 12? NOTE: The UE performs registration and the RRC connection is not released.	-->	-	2	P
24-27b 1	Void	-	-	-	-
28	The UE is switched off by executing generic procedure in Table 4.9.6.3-1 in TS 38.508-1 [4].	-	-	-	-
29	SS adjusts cell levels according to row T3 of table 6.1.1.2.3.2-1/2.	-	-	-	-
29 A	Void.	-	-	-	-
29 B	The UE is Switched ON.	-	-	-	-
30	Check: Does the test result of generic test procedure in TS 38.508-1 [4] Table 4.5.2.2-2	-->	-	3	P

	indicate that the UE is camped on NR Cell 13? NOTE: The UE performs registration and the RRC connection is not released.				
31-34b 1	Void.	-	-	-	-
35	The UE is switched off by executing generic procedure in Table 4.9.6.3-1 in TS 38.508-1 [4]				
36	SS adjusts cell levels according to row T4 of table 6.1.1.2.3.2-1/2.	-	-	-	-
36 A	Void.	-	-	-	-
36 B	The UE is Switched ON.	-	-	-	-
37	Check: Does the test result of generic test procedure in TS 38.508-1 [4] Table 4.5.2.2-2 indicate that the UE is camped on NR Cell 11?	-->	-	4	P
38-42b 1	Void.	-	-	-	-

6.1.1.2.3.3 Specific message contents

None

6.1.1.3 Cell reselection of ePLMN in manual mode

6.1.1.3.1 Test Purpose (TP)

(1)

```
with { UE camped normally on a cell and network has downloaded a list of equivalent PLMNs during the
Registration procedure }
ensure that {
  when { Higher ranked cell is a cell of a PLMN in the downloaded equivalent PLMN list }
  then { UE reselects to the equivalent PLMN cell }
}
```

(2)

```
with { UE camped normally on a cell and network has downloaded a list of equivalent PLMNs during
Registration procedure for mobility }
ensure that {
  when { Highest ranked cell is a cell of a PLMN not in the downloaded equivalent PLMN list }
  then { UE does not reselect to the cell }
}
```

6.1.1.3.2 Conformance requirements

References: The conformance requirements covered in the current TC are specified in: TS 23.122, clauses 4.4.3.1.2. Unless otherwise stated these are Rel-15 requirements.

[TS 23.122, clause 4.4.3.1.2]

The MS selects and attempts registration on other PLMN/access technology combinations, if available and allowable, in the following order:

- i) either the HPLMN (if the EHPLMN list is not present or is empty) or the highest priority EHPLMN that is available (if the EHPLMN list is present) ;
- ii) each PLMN/access technology combination in the "User Controlled PLMN Selector with Access Technology" data file in the SIM (in priority order);
- iii) each PLMN/access technology combination in the "Operator Controlled PLMN Selector with Access Technology" data file in the SIM (in priority order);

- iv) other PLMN/access technology combinations with received high quality signal in random order;
- v) other PLMN/access technology combinations in order of decreasing signal quality.

When following the above procedure the following requirements apply:

- a) An MS with voice capability shall ignore PLMNs for which the MS has identified at least one GSM COMPACT.
- b) In A/Gb mode or GSM COMPACT, an MS with voice capability, or an MS not supporting packet services shall not search for CPBCCCH carriers.
- c) In ii and iii, the MS should limit its search for the PLMN to the access technology or access technologies associated with the PLMN in the appropriate PLMN Selector with Access Technology list (User Controlled or Operator Controlled selector list).

An MS using a SIM without access technology information storage (i.e. the "User Controlled PLMN Selector with Access Technology" and the "Operator Controlled PLMN Selector with Access Technology" data files are not present) shall instead use the "PLMN Selector" data file, for each PLMN in the "PLMN Selector" data file, the MS shall search for all access technologies it is capable of. The priority ordering amongst the access technologies is implementation dependent.

- d) In iv and v, the MS shall search for all access technologies it is capable of, before deciding which PLMN to select.
- e) In ii, and iii, a packet only MS which supports GSM COMPACT, but using a SIM without access technology information storage (i.e. the "User Controlled PLMN Selector with Access Technology" and the "Operator Controlled PLMN Selector with Access Technology" data files are not present) shall instead use the "PLMN Selector" data file, for each PLMN in the "PLMN Selector" data file, the MS shall search for all access technologies it is capable of and shall assume GSM COMPACT access technology as the lowest priority radio access technology.
- f) In i, the MS shall search for all access technologies it is capable of. No priority is defined for the preferred access technology and the priority is an implementation issue, but "HPLMN Selector with Access Technology" data file on the SIM may be used to optimise the procedure.
- g) In i, an MS using a SIM without access technology information storage (i.e. the "HPLMN Selector with Access Technology" data file is not present) shall search for all access technologies it is capable of. The priority ordering amongst the access technologies is implementation dependent. A packet only MS which supports GSM COMPACT using a SIM without access technology information storage shall also assume GSM COMPACT access technology as the lowest priority radio access technology.

NOTE 1: For f) and g), the MS in automatic network selection mode can end the PLMN search procedure once the HPLMN or the highest priority EHPLMN is found on an access technology.

NOTE 2: For i, ii and iii, the MS can use location information to determine which PLMNs can be available in its present location.

- h) In v, the MS shall order the PLMN/access technology combinations in order of decreasing signal quality within each access technology. The order between PLMN/access technology combinations with different access technologies is an MS implementation issue.

NOTE 3: Requirements a) and b) apply also to requirement d), so a GSM voice capable MS should not search for GSM COMPACT PLMNs, even if capable of GSM COMPACT.

NOTE 4: Requirements a) and b) apply also to requirement f), so a GSM voice capable MS should not search for GSM COMPACT PLMNs, even if this is the only access technology on the "HPLMN Selector with Access Technology" data file on the SIM.

NOTE 5: High quality signal is defined in the appropriate AS specification.

- i) In i to v, the MS shall not consider PLMNs where voice service was not possible as PLMN selection candidate, unless such PLMN is available in GERAN or UTRAN or no other allowed PLMN is available.

- j) In i to v, if the MS only supports EMM-REGISTERED without PDN connection (see 3GPP TS 24.301 [23A]), the MS shall not consider PLMNs which do not advertise support of EMM-REGISTERED without PDN connection.
- k) In i to v, if the MS only supports control plane CIoT EPS optimization (see 3GPP TS 24.301 [23A]) and the UE camps on a E-UTRA cell which is not NB-IoT cell (see 3GPP TS 36.304 [43], 3GPP TS 36.331 [22]), the MS shall not consider PLMNs which do not advertise support of EPS services with control plane CIoT EPS optimization.
- l) In i to v, if the MS is in eCall only mode, the MS shall not consider PLMNs which do not advertise support for eCall over IMS, unless such PLMNs are available in GERAN or UTRAN.

NOTE 6: As an implementation option, an MS in eCall only mode that was not able to select any PLMN according to l) can perform a second iteration of i to v with no restriction.

If successful registration is achieved, the MS indicates the selected PLMN.

If registration cannot be achieved because no PLMNs are available and allowable, the MS indicates "no service" to the user, waits until a new PLMN is available and allowable and then repeats the procedure.

If there were one or more PLMNs which were available and allowable, but an LR failure made registration on those PLMNs unsuccessful or an entry in any of the lists "forbidden location areas for roaming", "forbidden tracking areas for roaming", "5GS forbidden tracking areas for roaming", "forbidden location areas for regional provision of service", "forbidden tracking areas for regional provision of service" or "5GS forbidden tracking areas for regional provision of service" prevented a registration attempt, the MS selects the first such PLMN again and enters a limited service state.

6.1.1.3.3 Test description

6.1.1.3.3.1 Pre-test conditions

System Simulator

- Three inter-frequency multi-PLMN NR cells.
- Each NR cell has only a single PLMN identity. The PLMNs are identified in the test by the identifiers in Table 6.1.1.3.3.1-1.

Table 6.1.1.3.3.1-1: PLMN identifiers

NR Cell	PLMN name
1	PLMN1
12	PLMN2
13	PLMN3

- System information combination NR-4 as defined in TS 38.508-1 [4] clause 4.4.3.1.2-1 is used in NR cell 1 and NR cell 12.
- System information combination NR-1 as defined in TS 38.508-1 [4] clause 4.4.3.1.2-1 is used in NR cell 13.

UE

- The UE is in Manual PLMN selection mode.

Preamble

- The UE is registered on PLMN1 (NR Cell 1) using the procedure described in TS 38.508-1 [4] clause 4.5.2.2-2 except that the REGISTRATION ACCEPT message indicates PLMN2 in the Equivalent PLMN list as described in Table 6.1.1.3.3.3-3.
- The UE is in state Registered, Idle Mode (state 1N-A) on NR Cell 1 according to TS 38.508-1 [4];

6.1.1.3.3.2 Test procedure sequence

Table 6.1.1.3.3.2-1: Time instances of cell power level and parameter changes for FR1

	Parameter	Unit	NR Cell 1	NR Cell 12	NR Cell 13	Remarks
T1	SS/PBCH SSS EPRE	dBm/SCS	-99	-88	-78	
T2	SS/PBCH SSS EPRE	dBm/SCS	"Off"	"Off"	"Off"	Power level "Off" is defined in TS 38.508-1 [4] Table 6.2.2.1-3

Table 6.1.1.3.3.2-2: Time instances of cell power level and parameter changes for FR2

	Parameter	Unit	NR Cell 1	NR Cell 12	NR Cell 13	Remarks
T1	SS/PBCH SSS EPRE	dBm/SCS	FFS	FFS	FFS	
T2	SS/PBCH SSS EPRE	dBm/SCS	"Off"	"Off"	"Off"	Power level "Off" is defined in TS 38.508-1 [4] Table 6.2.2.2-2

Table 6.1.1.3.3.2-3: Main behaviour

St	Procedure	Message Sequence		TP	Verdict
		U - S	Message		
1	SS adjusts cell levels according to row T1 of table 6.1.1.3.3.2-1/2.	-	-	-	-
2	Check: Does the test result of generic test procedure in TS 38.508-1 [4] subclause 4.9.5.2.2-1 indicate that the UE is camped on NR Cell 12? NOTE: The REGISTRATION REQUEST is accepted with PLMN1 listed as an Equivalent PLMN.	-	-	1	-
3	Check: Does the UE send an <i>RRCSetupRequest</i> on NR Cell 13 within 60s?	-->	NR RRC: <i>RRCSetupRequest</i>	2	F
4	SS adjusts cell levels according to row T2 of table 6.1.1.3.3.2-1/2.	-	-	-	-
5	Set UE to Automatic PLMN selection mode. (Note 1)	-	-	-	-

Note 1: Step 5 is to ensure UE is set back to automatic PLMN selection mode for the next test case.

6.1.1.3.3.3 Specific message contents

Table 6.1.1.3.3.3-1: SIB4 for NR Cell 1 (preamble and all steps, Table 6.1.1.3.3.2-3)

Derivation path: TS 38.508-1 [4] Table 4.6.2-3			
Information Element	Value/Remark	Comment	Condition
SIB4 ::= SEQUENCE {			
interFreqCarrierFreqList SEQUENCE (SIZE (1..maxFreq)) OF InterFreqCarrierFreqInfo {	2 entries		
InterFreqCarrierFreqInfo[1] SEQUENCE {		entry 1	
dl-CarrierFreq	Same downlink NR ARFCN as used for NR Cell 12		
cellReselectionPriority	4		
}			
InterFreqCarrierFreqInfo[2] SEQUENCE {		entry 2	
dl-CarrierFreq	Same downlink NR ARFCN as used for NR Cell 13		
cellReselectionPriority	4		

}			
}			
}			

Table 6.1.1.3.3.3-2: SIB4 for NR Cell 12 (preamble and all steps, Table 6.1.1.3.3.2-3)

Derivation path: TS 38.508-1 [4] Table 4.6.2-3			
Information Element	Value/Remark	Comment	Condition
SIB4 ::= SEQUENCE {			
interFreqCarrierFreqList SEQUENCE (SIZE (1..maxFreq)) OF nterFreqCarrierFreqInfo {	2 entries		
InterFreqCarrierFreqInfo[1] SEQUENCE {		entry 1	
dl-CarrierFreq	Same downlink NR ARFCN as used for NR Cell 1		
cellReselectionPriority	4		
}			
InterFreqCarrierFreqInfo[2] SEQUENCE {		entry 2	
dl-CarrierFreq	Same downlink NR ARFCN as used for NR Cell 13		
cellReselectionPriority	4		
}			
}			
}			

Table 6.1.1.3.3.3-3: REGISTRATION ACCEPT for NR Cell 1 (preamble)

Derivation path: TS 38.508-1 [4] Table 4.7.1-7			
Information Element	Value/Remark	Comment	Condition
Equivalent PLMNs	PLMN2		NR Cell 1

Table 6.1.1.3.3.3-4: REGISTRATION ACCEPT for NR Cell 12 (step 2, Table 6.1.1.3.3.2-3)

Derivation path: TS 38.508-1 [4] Table 4.7.1-7			
Information Element	Value/Remark	Comment	Condition
Equivalent PLMNs	PLMN1		NR Cell 12
Allowed NSSAI			
S-NSSAI			
Length of S-NSSAI contents	'0000 0010'B		
Mapped HPLMN SST	Same as SST		

6.1.1.4 PLMN selection in shared network environment / Automatic mode

6.1.1.4.1 Test Purpose (TP)

(1)

```
with { The UE is in automatic network selection mode and there is a suitable cell with multiple PLMN
identities among which the HPLMN but not the registered PLMN }
ensure that {
  when { the UE is switched on }
    then { the UE attaches to the HPLMN on the shared cell }
}
```

(2)

```
with { the UE in automatic network selection mode and there is a suitable cell with multiple PLMN
identities among which the registered PLMN }
ensure that {
  when { the UE returns to coverage }
}
```

```

    then { the UE performs a registration procedure due to mobility to the registered PLMN on the
shared cell }
}

```

6.1.1.4.2 Conformance requirements

References: The conformance requirements covered in the current TC are specified in: TS 38.304 clause 5.1.1.2, TS 23.122 clauses 4.4.3 and 4.4.3.1.1, TS 38.331 clauses 5.3.3.4, and TS 24.501 clause 5.3.1.1. Unless otherwise stated these are Rel-15 requirements.

[TS 38.304 clause 5.1.1.2]

The UE shall scan all RF channels in the NR bands according to its capabilities to find available PLMNs. On each carrier, the UE shall search for the strongest cell and read its system information, in order to find out which PLMN(s) the cell belongs to. If the UE can read one or several PLMN identities in the strongest cell, each found PLMN (see the PLMN reading in TS 38.331 [3]) shall be reported to the NAS as a high quality PLMN,

...

Once the UE has selected a PLMN, the cell selection procedure shall be performed in order to select a suitable cell of that PLMN to camp on.

[TS 23.122 clauses 4.4.3]

When the MS reselects to a cell in a shared network, and the cell is a suitable cell for multiple PLMN identities received on the BCCH or on the EC-BCCH the AS indicates these multiple PLMN identities to the NAS according to 3GPP TS 44.018 [34], 3GPP TS 44.060 [39], 3GPP TS 25.304 [32] and 3GPP TS 36.304 [43]. The MS shall choose one of these PLMNs. If the registered PLMN is available among these PLMNs, the MS shall not choose a different PLMN.

The MS shall not use the PLMN codes contained in the "HPLMN Selector with Access Technology" data file.

It is possible for the home network operator to identify alternative Network IDs as the HPLMN. If the EHPLMN list is present, and not empty, the entries in the EHPLMN list are used in the network selection procedures. When attempting to select a network the highest priority EHPLMN that is available shall be selected. If the EHPLMN list is present and is empty or if the EHPLMN list is not present, the HPLMN derived from the IMSI is used for network selection procedures.

NOTE 1: The "HPLMN Selector with Access Technology" data file is only used by the MS to get the HPLMN access technologies related to the HPLMN code which corresponds to the PLMN code included in the IMSI if the EHPLMN list is not present or is empty. If the EHPLMN list is present then this data field is applicable to all the entries within the EHPLMN list.

NOTE 2: Different GSM frequency bands (e.g. 900, 1800, 1900, 400) are all considered GSM access technology. An MS supporting more than one band should scan all the bands it's supports when scanning for GSM frequencies. However GSM COMPACT systems which use GSM frequency bands but with the CBPCCH broadcast channel are considered as a separate access technology from GSM.

NOTE 3: The inclusion of the HPLMN derived from the IMSI in the EHPLMN list is allowed. The priority of the HPLMN derived from the IMSI is given by its position in the EHPLMN list, see 3GPP TS 31.102 [40]

[TS 23.122 clause 4.4.3.1.1]

The MS selects and attempts registration on other PLMN/access technology combinations, if available and allowable, in the following order:

- i) either the HPLMN (if the EHPLMN list is not present or is empty) or the highest priority EHPLMN that is available (if the EHPLMN list is present) ;
- ii) each PLMN/access technology combination in the "User Controlled PLMN Selector with Access Technology" data file in the SIM (in priority order);
- iii) each PLMN/access technology combination in the "Operator Controlled PLMN Selector with Access Technology" data file in the SIM (in priority order);
- iv) other PLMN/access technology combinations with received high quality signal in random order;

- v) other PLMN/access technology combinations in order of decreasing signal quality.

When following the above procedure the following requirements apply:

- a) An MS with voice capability shall ignore PLMNs for which the MS has identified at least one GSM COMPACT.
- b) In A/Gb mode or GSM COMPACT, an MS with voice capability, or an MS not supporting packet services shall not search for CPBCCCH carriers.
- c) In ii and iii, the MS should limit its search for the PLMN to the access technology or access technologies associated with the PLMN in the appropriate PLMN Selector with Access Technology list (User Controlled or Operator Controlled selector list).

An MS using a SIM without access technology information storage (i.e. the "User Controlled PLMN Selector with Access Technology" and the "Operator Controlled PLMN Selector with Access Technology" data files are not present) shall instead use the "PLMN Selector" data file, for each PLMN in the "PLMN Selector" data file, the MS shall search for all access technologies it is capable of. The priority ordering amongst the access technologies is implementation dependent.

- d) In iv and v, the MS shall search for all access technologies it is capable of, before deciding which PLMN to select.
- e) In ii, and iii, a packet only MS which supports GSM COMPACT, but using a SIM without access technology information storage (i.e. the "User Controlled PLMN Selector with Access Technology" and the "Operator Controlled PLMN Selector with Access Technology" data files are not present) shall instead use the "PLMN Selector" data file, for each PLMN in the "PLMN Selector" data file, the MS shall search for all access technologies it is capable of and shall assume GSM COMPACT access technology as the lowest priority radio access technology.
- f) In i, the MS shall search for all access technologies it is capable of. No priority is defined for the preferred access technology and the priority is an implementation issue, but "HPLMN Selector with Access Technology" data file on the SIM may be used to optimise the procedure.
- g) In i, an MS using a SIM without access technology information storage (i.e. the "HPLMN Selector with Access Technology" data file is not present) shall search for all access technologies it is capable of. The priority ordering amongst the access technologies is implementation dependent. A packet only MS which supports GSM COMPACT using a SIM without access technology information storage shall also assume GSM COMPACT access technology as the lowest priority radio access technology.

NOTE 1: For f) and g), the MS in automatic network selection mode can end the PLMN search procedure once the HPLMN or the highest priority EHPLMN is found on an access technology.

NOTE 2: For i, ii and iii, the MS can use location information to determine which PLMNs can be available in its present location.

- h) In v, the MS shall order the PLMN/access technology combinations in order of decreasing signal quality within each access technology. The order between PLMN/access technology combinations with different access technologies is an MS implementation issue.

NOTE 3: Requirements a) and b) apply also to requirement d), so a GSM voice capable MS should not search for GSM COMPACT PLMNs, even if capable of GSM COMPACT.

NOTE 4: Requirements a) and b) apply also to requirement f), so a GSM voice capable MS should not search for GSM COMPACT PLMNs, even if this is the only access technology on the "HPLMN Selector with Access Technology" data file on the SIM.

NOTE 5: High quality signal is defined in the appropriate AS specification.

- i) In i to v, the MS shall not consider PLMNs where voice service was not possible as PLMN selection candidate, unless such PLMN is available in GERAN or UTRAN or no other allowed PLMN is available.
- j) In i to v, if the MS only supports EMM-REGISTERED without PDN connection (see 3GPP TS 24.301 [23A]), the MS shall not consider PLMNs which do not advertise support of EMM-REGISTERED without PDN connection.

- k) In i to v, if the MS only supports control plane CIoT EPS optimization (see 3GPP TS 24.301 [23A]) and the UE camps on a E-UTRA cell which is not NB-IoT cell (see 3GPP TS 36.304 [43], 3GPP TS 36.331 [22]), the MS shall not consider PLMNs which do not advertise support of EPS services with control plane CIoT EPS optimization.
- l) In i to v, if the MS is in eCall only mode, the MS shall not consider PLMNs which do not advertise support for eCall over IMS, unless such PLMNs are available in GERAN or UTRAN.

NOTE 6: As an implementation option, an MS in eCall only mode that was not able to select any PLMN according to l) can perform a second iteration of i to v with no restriction.

If successful registration is achieved, the MS indicates the selected PLMN.

If registration cannot be achieved because no PLMNs are available and allowable, the MS indicates "no service" to the user, waits until a new PLMN is available and allowable and then repeats the procedure.

If there were one or more PLMNs which were available and allowable, but an LR failure made registration on those PLMNs unsuccessful or an entry in any of the lists "forbidden location areas for roaming", "forbidden tracking areas for roaming", "5GS forbidden tracking areas for roaming", "forbidden location areas for regional provision of service", "forbidden tracking areas for regional provision of service" or "5GS forbidden tracking areas for regional provision of service" prevented a registration attempt, the MS selects the first such PLMN again and enters a limited service state.

[TS 38.331 clause 5.3.3.4]

The UE shall perform the following actions upon reception of the *RRCSetup*:

...

1> set the content of *RRCSetupComplete* message as follows:

2> if upper layers provide an *5G-S-TMSI*:

3> if the *RRCSetup* is received in response to an *RRCSetupRequest*:

4> set the *ng-5G-S-TMSI-Value* to *ng-5G-S-TMSI-Part2*;

3> else:

4> set the *ng-5G-S-TMSI-Value* to *ng-5G-S-TMSI*;

2> set the *selectedPLMN-Identity* to the PLMN selected by upper layers (TS 24.501 [23]) from the PLMN(s) included in the *plmn-IdentityList* in *SIB1*;

...

1> submit the *RRCSetupComplete* message to lower layers for transmission, upon which the procedure ends

[TS 24.501 clause 5.3.1.1]

The UE NAS also provides the lower layers with the identity of the selected PLMN (see 3GPP TS 38.331 [30]). In a shared network, the UE shall choose one of the PLMN identities as specified in 3GPP TS 23.122 [5].

6.1.1.4.3 Test description

6.1.1.4.3.1 Pre-test conditions

System Simulator:

- NR Cells 1 and 2, as specified in TS 38.508-1 [4] clause 4.4.1.1.3 are configured according to Table 4.4.2-3 in TS 38.508-1 [4] except for multiple broadcasted PLMN identities as shown in Table 6.1.1.4.3.1-1: PLMN identifiers broadcasted by cells in shared network, and NR Cells 1 and 2 with different tracking area codes as shown in Table 6.1.1.4.3.1-2.

Table 6.1.1.4.3.1-1: PLMN identifiers

NR Cell	PLMN names
1	PLMN4 (for preamble)
	PLMN15, PLMN1 (for test body)
2	PLMN15, PLMN1, PLMN16

Table 6.1.1.4.3.1-2: Tracking area codes

NR Cell	TAC	TAI
1	1	TAI-1
2	2	TAI-2

UE:

- The UE is in Automatic PLMN selection mode.
- The UE is equipped with a USIM configuration as defined in TS 38.508-1 [4] Table 6.4.1-5.
- The UE is registered to PLMN4 before it is switched off.

Preamble:

- The UE is in state Switched OFF (state ON-B) according to TS 38.508-1 [4].

6.1.1.4.3.2 Test procedure sequence

Table 6.1.1.4.3.2-1/2 shows the cell configurations used during the test. The configuration T0 indicates the initial conditions. Subsequent configuration marked "T1" is applied at the points indicated in the Main behaviour description in Table 6.1.1.4.3.2-2. Cell powers are chosen for a serving cell and a non-suitable cell as defined in TS 38.508-1 [4] Table 6.2.2.1-3 for FR1 and Table 6.2.2.2-2 for FR2.

Table 6.1.1.4.3.2-1: Time instances of cell power level and parameter changes for FR1

	Parameter	Unit	NR Cell 1	NR Cell 2	Remarks
T0	SS/PBCH SSS EPRE	dBm/SCS	-88	"Off"	Power level "Off" is defined in TS 38.508-1 [4] Table 6.2.2.1-3,
T1	SS/PBCH SSS EPRE	dBm/SCS	"Off"	"Off"	Close the NR Cell 1 to make sure the UE lose coverage. Power level "Off" is defined in TS 38.508-1 [4] Table 6.2.2.1-3,
T2	SS/PBCH SSS EPRE	dBm/SCS	"Off"	-88	Power level "Off" is defined in TS 38.508-1 [4] Table 6.2.2.1-3,

Table 6.1.1.4.3.2-2: Time instances of cell power level and parameter changes for FR2

	Parameter	Unit	NR Cell 1	NR Cell 2	Remarks
T0	SS/PBCH SSS EPRE	dBm/SCS	-95	"Off"	Power level "Off" is defined in TS 38.508-1 [4] Table 6.2.2.2-2.
T1	SS/PBCH SSS EPRE	dBm/SCS	"Off"	"Off"	Close the NR Cell 1 to make sure the UE lose coverage. Power level "Off" is defined in TS 38.508-1 [4] Table 6.2.2.2-2.
T2	SS/PBCH SSS EPRE	dBm/SCS	"Off"	-95	Power level "Off" is defined in TS 38.508-1 [4] Table 6.2.2.2-2.

Table 6.1.1.4.3.2-3: Main behaviour

St	Procedure	Message Sequence	TP	Verdict
----	-----------	------------------	----	---------

		U - S	Message		
1	The SS adjusts cell levels according to row T0 of table 6.1.1.4.3.2-1/2.	-	-	-	-
2	Power on the UE.	-	-	-	-
3	Check: Does the UE transmit an <i>RRCSetupRequest</i> on NR Cell 1?	-->	NR RRC: <i>RRCSetupRequest</i>	1	P
4	The SS transmits an <i>RRCSetup</i> message.	<--	NR RRC: <i>RRCSetup</i>	-	-
5	Check: Does the UE transmit an <i>RRCSetupComplete</i> message indicating the HPLMN (second PLMN in the list)? Note: This message contains an REGISTRATION REQUEST message according to default message contents.	-->	NR RRC: <i>RRCSetupComplete</i>	1	P
6-21	Steps 5 to 20 of the registration procedure described in TS 38.508-1 [4] subclause 4.5.2.2-2 are performed on NR Cell 1. NOTE: The UE performs registration and the RRC connection is released.	-	-	-	-
22	The SS adjusts cell levels according to row T1 of table 6.1.1.4.3.2-1/2 to ensure UE to lose coverage.	-	-	-	-
23	Wait for 15s to allow UE to go out of service	-	-	-	-
24	The SS adjusts cell levels according to row T2 of table 6.1.1.4.3.2-1/2.	-	-	-	-
25	Check: Does the UE transmit an <i>RRCSetupRequest</i> on NR Cell 2?	-->	NR RRC: <i>RRCSetupRequest</i>	2	P
26	SS transmits an <i>RRCSetup</i> message.	<--	NR RRC: <i>RRCSetup</i>	-	-
27-31b 1	Steps 2 to 6b1 of the generic test procedure in TS 38.508-1 [4] subclause 4.9.5.2.2-1 are performed on NR Cell 2. NOTE: The UE performs a registration for mobility procedure and the RRC connection is released.	-	-	-	-

6.1.1.4.3.3 Specific message contents

Table 6.1.1.4.3.3-1: SIB1 for NR Cell 1 (all steps, Table 6.1.1.4.3.2-1)

Derivation Path: 38.508-1 [4] Table 4.6.1-28			
Information Element	Value/remark	Comment	Condition
SIB1 ::= SEQUENCE {			
CellAccessRelatedInfo SEQUENCE {			
PLMN-IdentityInfoList SEQUENCE (SIZE (1..maxPLMN)) OF PLMN-IdentityInfo {	1 entry		
PLMN-IdentityInfo[1] SEQUENCE {		entry 1	
plmn-IdentityList SEQUENCE (SIZE (1..maxPLMN)) OF PLMN-Identity {	2 entries		
plmn-Identity[1]	PLMN15	entry 1	
plmn-Identity[2]	PLMN1	entry 2	
}			
}			
}			
}			
}			

Table 6.1.1.4.3.3-2: SIB1 for NR Cell 2 (all steps, Table 6.1.1.4.3.2-1)

Derivation Path: 38.508-1 [4] Table 4.6.1-28			
Information Element	Value/remark	Comment	Condition
SIB1 ::= SEQUENCE {			
CellAccessRelatedInfo SEQUENCE {			
PLMN-IdentityInfoList SEQUENCE (SIZE (1..maxPLMN)) OF PLMN-IdentityInfo {	1 entry		
PLMN-IdentityInfo[1] SEQUENCE {		entry 1	

plmn-IdentityList SEQUENCE (SIZE (1..maxPLMN)) OF PLMN-Identity {	3 entries		
plmn-Identity[1]	PLMN15	entry 1	
plmn-Identity[2]	PLMN1	entry 2	
plmn-Identity[3]	PLMN16	entry 3	
}			
}			
}			
}			
}			

Table 6.1.1.4.3.3-3: RRCSetupComplete (step 5 and 27, Table 6.1.1.4.3.2-2)

Derivation Path: 38.508-1 [4], Table 4.6.1-22			
Information Element	Value/remark	Comment	Condition
RRCSetupComplete ::= SEQUENCE {			
criticalExtensions CHOICE {			
rrcSetupComplete SEQUENCE {			
selectedPLMN-Identity	2	PLMN1	
}			
}			
}			

6.1.1.5 PLMN selection of RPLMN, HPLMN/EHPLMN, UPLMN and OPLMN / Automatic mode / User reselection

6.1.1.5.1 Test Purpose (TP)

(1)

```
with { UE in Automatic network selection mode registered to UPLMN and RPLMN, UPLMN and OPLMN NG-RAN cells available }
ensure that {
  when { UE is requested to initiate reselection and registration onto an available PLMN }
  then { UE reselects to the cell which belongs to higher priority OPLMN }
}
```

(2)

```
with { UE in Automatic network selection mode registered to OPLMN and only RPLMN NG-RAN cells available }
ensure that {
  when { UE is requested to initiate reselection and registration onto an available PLMN }
  then { UE remains on the current cell which belongs to RPLMN }
}
```

(3)

```
with { UE in Automatic network selection mode registered to OPLMN and RPLMN, UPLMN and OPLMN NG-RAN cells available }
ensure that {
  when { UE is requested to initiate reselection and registration onto an available PLMN }
  then { UE reselects to the cell which belongs to UPLMN }
}
```

(4)

```
with { UE in Automatic network selection mode registered to UPLMN and RPLMN, UPLMN, OPLMN and HPLMN NG-RAN cells available }
ensure that {
  when { UE is requested to initiate reselection and registration onto an available PLMN }
  then { UE reselects to the cell which belongs to HPLMN }
}
```

6.1.1.5.2 Conformance requirements

References: The conformance requirements covered in the current TC are specified in: TS 23.122 clauses 4.4.3.2 and 4.4.3.2.1. Unless otherwise stated these are Rel-15 requirements.

[TS 23.122, clause 4.4.3.2]

At any time the user may request the MS to initiate reselection and registration onto an available PLMN, according to the following procedures, dependent upon the operating mode.

[TS 23.122, clause 4.4.3.2.1]

The MS selects and attempts registration on PLMN/access technology combinations, if available and allowable, in all of its bands of operation in accordance with the following order:

- i) the HPLMN (if the EHPLMN list is not present or is empty) or the highest priority EHPLMN that is available (if the EHPLMN list is present);
- ii) PLMN/access technology combinations contained in the "User Controlled PLMN Selector with Access Technology" data file in the SIM (in priority order) excluding the previously selected PLMN/access technology combination;
- iii) PLMN/access technology combinations contained in the "Operator Controlled PLMN Selector with Access Technology" data file in the SIM (in priority order) excluding the previously selected PLMN/access technology combination;
- iv) other PLMN/access technology combinations with the received high quality signal in random order excluding the previously selected PLMN/access technology combination;
- v) other PLMN/access technology combinations, excluding the previously selected PLMN/access technology combination in order of decreasing signal quality or, alternatively, the previously selected PLMN/access technology combination may be chosen ignoring its signal quality;
- vi) The previously selected PLMN/access technology combination.

The previously selected PLMN/access technology combination is the PLMN/access technology combination which the MS has selected prior to the start of the user reselection procedure.

NOTE 1: If the previously selected PLMN is chosen, and registration has not been attempted on any other PLMNs, then the MS is already registered on the PLMN, and so registration is not necessary.

The equivalent PLMNs list shall not be applied to the user reselection in Automatic Network Selection Mode.

When following the above procedure the requirements a), b), c), e), f), g), h), j), k) and l) in subclause 4.4.3.1.1 apply: Requirement d) shall apply as shown below:

- d) In iv, v, and vi, the MS shall search for all access technologies it is capable of before deciding which PLMN/access technology combination to select.

NOTE 2: High quality signal is defined in the appropriate AS specification.

6.1.1.5.3 Test description

6.1.1.5.3.1 Pre-test conditions

6.1.1.5.3.1 Pre-test conditions

System Simulator:

- Four inter-frequency multi-PLMN cells as specified in TS 38.508-1 [4] clause 4.4.1.2 are configured broadcasting default NAS parameters as indicated in TS 38.508-1 [4] Table 4.4.2-3.
- The PLMNs are identified in the test by the identifiers in Table 6.1.1.5.3.1-1.

Table 6.1.1.5.3.1-1: PLMN identifiers

NR Cell	PLMN name
1	PLMN1
12	PLMN2
3	PLMN3
13	PLMN4

UE:

- The UE is in Automatic PLMN selection mode.
- The UE is equipped with a USIM configuration as defined in TS 38.508-1 [4] Table 6.4.1-6.

Preamble:

- The UE is in state Registered, Idle Mode (state 1N-A) on NR Cell 1 according to TS 38.508-1 [4].

6.1.1.5.3.2 Test procedure sequence

Table 6.1.1.5.3.2-1: Time instances of cell power level and parameter changes for FR1

	Parameter	Unit	NR Cell 1	NR Cell 12	NR Cell 3	NR Cell 13	Remark
T1	SS/PBCH SSS EPRE	dBm/ SCS	-88	-88	"Off"	-88	The power level values are assigned to satisfy $R_{NRCell\ 1} = R_{NRCell\ 12} = R_{NRCell\ 13}$. (NOTE 1).
T2	SS/PBCH SSS EPRE	dBm/ SCS	"Off"	-88	"Off"	"Off"	
T3	SS/PBCH SSS EPRE	dBm/ SCS	-88	"Off"	-88	-88	The power level values are assigned to satisfy $R_{NRCell\ 1} = R_{NRCell\ 3} = R_{NRCell\ 13}$. (NOTE 1).
NOTE 1: Power level "Off" is defined in TS 38.508-1 [4] Table 6.2.2.1-3.							

Table 6.1.1.5.3.2-2: Time instances of cell power level and parameter changes for FR2

	Parameter	Unit	NR Cell 1	NR Cell 12	NR Cell 3	NR Cell 13	Remark
T1	SS/PBCH SSS EPRE	dBm/ SCS	FFS	FFS	"Off"	FFS	The power level values are assigned to satisfy $R_{NRCell\ 1} = R_{NRCell\ 12} = R_{NRCell\ 13}$. (NOTE 1).
T2	SS/PBCH SSS EPRE	dBm/ SCS	"Off"	FFS	"Off"	"Off"	
T3	SS/PBCH SSS EPRE	dBm/ SCS	FFS	"Off"	FFS	FFS	The power level values are assigned to satisfy $R_{NRCell\ 1} = R_{NRCell\ 3} = R_{NRCell\ 13}$. (NOTE 1).
NOTE 1: Power level "Off" is defined in TS 38.508-1 [4] Table 6.2.2.2-2.							

Table 6.1.1.5.3.2-3: Main behaviour

St	Procedure	Message Sequence		TP	Verdict
		U - S	Message		
1	The SS changes the power level setting according to the row "T1" in table 6.1.1.5.3.2-1/2.	-	-	-	-
2	Cause the UE in Automatic network selection mode to initiate user reselection and registration onto an available PLMN. (Note 1)	-	-	-	-
3	Check: Does the UE send an <i>RRCSetupRequest</i> on NR Cell 12?	-->	NR RRC: <i>RRCSetupRequest</i>	1	P

3A-3B	Steps 3-4 of Table 4.5.2.2-2 of the generic procedure in TS 38.508-1 [4] are performed. (Note 2)	-	-	-	-
-	EXCEPTION: Steps 4a1 to 4b5a1 describe behaviour that depends on events happening prior to their execution; the "lower case letter" identifies a step sequence that take place if a specific prior event takes place.	-	-	-	-
4a1-4a16a1	IF 5GS registration type is set as Initial Registration in step 3B, THEN Steps 5 to 20a1 of the generic test procedure in TS 38.508-1 Table 4.5.2.2-2 are performed on NR Cell 12.	-	-	-	-
4b1-4b2	Void	-	-	-	-
4b3-4b5a1	IF 5GS registration type is set as Mobility Registration in step 3B, THEN Steps 4 to 6a1 of the generic test procedure in TS 38.508-1 Table 4.9.5.2.2-1 are performed on NR Cell 12.	-	-	-	-
5-8	Void	-	-	-	-
9	The SS changes the power level setting according to the row "T2" in table 6.1.1.5.3.2-1/2.	-	-	-	-
10	Cause the UE in Automatic network selection mode to initiate user reselection and registration onto an available PLMN. (Note 1)	-	-	-	-
11	Check: Does the UE send an <i>RRCSetupRequest</i> on NR Cell 12 within 90 s?	-->	NR RRC: <i>RRCSetupRequest</i>	2	F
12	The SS changes the power level setting according to the row "T1" in table 6.1.1.5.3.2-1/2.	-	-	-	-
13	Cause the UE in Automatic network selection mode to initiate user reselection and registration onto an available PLMN. (Note 1)	-	-	-	-
14	Check: Does the UE send an <i>RRCSetupRequest</i> on NR Cell 1?	-->	NR RRC: <i>RRCSetupRequest</i>	3	P
14A-14B	Steps 3-4 of Table 4.5.2.2-2 of the generic procedure in TS 38.508-1 [4] are performed. (Note 2)	-	-	-	-
-	EXCEPTION: Steps 15a1 to 15b5a1 describe behaviour that depends on events happening prior to their execution; the "lower case letter" identifies a step sequence that take place if a specific prior event takes place.	-	-	-	-
15a1-15a16a1	IF 5GS registration type is set as Initial Registration in step 14B, THEN Steps 5 to 20a1 of the generic test procedure in TS 38.508-1 Table 4.5.2.2-2 are performed on NR Cell 1.	-	-	-	-
151-15b2	Void	-	-	-	-
15b3-15b5a1	IF 5GS registration type is set as Mobility Registration in step 14B, THEN Steps 4 to 6a1 of the generic test procedure in TS 38.508-1 Table 4.9.5.2.2-1 are performed on NR Cell 1.	-	-	-	-
16-19	Void	-	-	-	-
20	The SS changes the power level setting according to the row "T3" in table 6.1.1.5.3.2-1/2.	-	-	-	-
21	Cause the UE in Automatic network selection mode to initiate user reselection and registration onto an available PLMN. (Note 1)	-	-	-	-
22	Check: Does the UE send an <i>RRCSetupRequest</i> on NR Cell 3?	-->	NR RRC: <i>RRCSetupRequest</i>	4	P
22A-	Steps 3-4 of Table 4.5.2.2-2 of the generic	-	-	-	-

22B	procedure in TS 38.508-1 [4] are performed. (Note 2)				
-	EXCEPTION: Steps 23a1 to 23b5a1 describe behaviour that depends on events happening prior to their execution; the "lower case letter" identifies a step sequence that take place if a specific prior event takes place.	-	-	-	-
23a1 - 23a1 6a1	IF 5GS registration type is set as Initial Registration in step 22B, THEN Steps 5 to 20a1 of the generic test procedure in TS 38.508-1 Table 4.5.2.2-2 are performed on NR Cell 3.	-	-	-	-
23b1 - 23b2	Void	-	-	-	-
23b3 - 23b5 a1	IF 5GS registration type is set as Mobility Registration in step 22B, THEN Steps 4 to 6a1 of the generic test procedure in TS 38.508-1 Table 4.9.5.2.2-1 are performed on NR Cell 3.	-	-	-	-
24- 27	Void	-	-	-	-
<p>Note 1: MMI command "TRIGGER_USER_RESELECTION" to be used. AT command AT+COPS is not suitable to achieve the test purpose.</p> <p>Note 2: The 5GS registration type shall be only set as Mobility Registration for R16 UEs according to TS 24.501 subclause 5.2.3.2.5 specified in Release 16. The EXCEPTION description applies only to R15 UEs.</p>					

6.1.1.5.3.3 Specific message contents

None

6.1.1.6 PLMN selection / Periodic reselection / MinimumPeriodicSearchTimer

6.1.1.6.1 Test Purpose (TP)

(1)

```
with { UE configured with "MinimumPeriodicSearchTimer" }
ensure that {
  when { UE camps on an NG-RAN VPLMN cell upon switch on and cells of a higher priority NG-RAN PLMN
available }
  then { the MS shall make the first attempt to access the HPLMN or an EHPLMN or higher priority
PLMN after a period of at least 2 minutes }
}
```

(2)

```
with { UE configured with "MinimumPeriodicSearchTimer", having made first attempt to higher priority
PLMN and camped on an NG-RAN VPLMN cell and cells of a higher priority NG-RAN PLMN available }
ensure that {
  when { the higher priority PLMN search timer T stored in the USIM or the default value for T is
less than the "MinimumPeriodicSearchTimer" }
  then { UE shall not use a value for T that is less than the "MinimumPeriodicSearchTimer" and
selects and camps on a cell of the highest priority PLMN and attempts a location registration on the
selected cell upon expiry of "MinimumPeriodicSearchTimer" }
}
```

6.1.1.6.2 Conformance requirements

References: The conformance requirements covered in the present test case are specified in: TS 23.122, clause 4.4.3.3.1 Unless otherwise stated these are Rel-15 requirements.

[TS 23.122, clause 4.4.3.3.1]

If the MS is configured with the MinimumPeriodicSearchTimer as specified in 3GPP TS 24.368 [50] or 3GPP TS 31.102 [40], the MS shall not use a value for T that is less than the MinimumPeriodicSearchTimer. If the

value stored in the SIM, or the default value for T (when no value is stored in the SIM), is less than the MinimumPeriodicSearchTimer, then T shall be set to the MinimumPeriodicSearchTimer.

The MS does not stop timer T, as described in 3GPP TS 24.008 [23] and 3GPP TS 24.301 [23A], when it activates power saving mode (PSM) (see 3GPP TS 23.682 [27A]) or mobile initiated connection only mode (MICO) as described in 3GPP TS 24.501 [64].

The MS can be configured for Fast First Higher Priority PLMN search as specified in 3GPP TS 31.102 [40] or 3GPP TS 24.368 [50]. Fast First Higher Priority PLMN search is enabled if the corresponding configuration parameter is present and set to enabled. Otherwise, Fast First Higher Priority PLMN search is disabled.

The attempts to access the HPLMN or an EHPLMN or higher priority PLMN shall be as specified below:

- a) The periodic attempts shall only be performed in automatic mode when the MS is roaming, and not while the MS is attached for emergency bearer services, is registered for emergency services, has a PDU session for emergency services or has a PDN connection for emergency bearer services;
- b) The MS shall make the first attempt after a period of at least 2 minutes and at most T minutes:
 - only after switch on if Fast First Higher Priority PLMN search is disabled; or
 - after switch on or upon selecting a VPLMN if Fast First Higher Priority PLMN search is enabled.
- c) The MS shall make the following attempts if the MS is on the VPLMN at time T after the last attempt;

6.1.1.6.3 Test Description

6.1.1.6.3.1 Pre-test conditions

System Simulator:

- 3 NR cells: NR Cell 11, 12 and 13 as specified in TS 38.508-1 [4] table 4.4.2-3 are configured as shown in Table 6.1.1.6.3.1-1.
- PLMN settings are defined in TS 36.523-1 [13] table 6.0.1-1.

Table 6.1.1.6.3.1-1: PLMN identifiers

NR Cell	PLMN names
NR Cell 11	PLMN1
NR Cell 12	PLMN15
NR Cell 13	PLMN16

UE:

- The UE is in Automatic PLMN selection mode.
- The UE is configured with a value of MinimumPeriodicSearchTimer set to 7 minutes.
- The UE is equipped with a USIM configuration 11 as per TS 38.508-1 [4] Table 6.4.1-11.

Preamble:

- The UE performs a successful registration on PLMN15 after which it is switched OFF (State 0N-B) as per TS 38.508-1 [4] table 4.4A.2-0.

6.1.1.6.3.2 Test procedure sequence

Table 6.1.1.6.3.2-1 and Table 6.1.1.6.3.2-2 shows the cell configurations used during the test. The configuration T0 indicates the initial conditions. Subsequent configurations marked “T1” & “T2” are applied at the point indicated in the

Main behaviour description in Table 6.1.1.6.3.2-3. Cell powers are chosen for a serving cell and a non-suitable "Off" cell as defined in TS 38.508-1 [4] table 6.2.2.1-3.

Table 6.1.1.6.3.2-1: Time instances of cell power level and parameter changes for FR1

	Parameter	Unit	NR Cell 11	NR Cell 12	NR Cell 13	Remark
T0	SS/PBCH SSS EPRE	dBm/SC S	Off	-88	Off	
T1	SS/PBCH SSS EPRE	dBm/SC S	Off	-88	-88	
T2	SS/PBCH SSS EPRE	dBm/SC S	-88	-88	-88	

Table 6.1.1.6.3.2-2: Time instances of cell power level and parameter changes for FR2

	Parameter	Unit	NR Cell 11	NR Cell 12	NR Cell 13	Remark
T0	SS/PBCH SSS EPRE	dBm/SC S	Off	-82	Off	
	Qrxlevmin	dBm	-	-91+ Delta(N Rf2)	-	
T1	SS/PBCH SSS EPRE	dBm/SC S	Off	-82	-82	
	Qrxlevmin		-	-91+ Delta(N Rf2)	-91+ Delta(NRf 3)	
T2	SS/PBCH SSS EPRE	dBm/SC S	-82	-82	-82	
	Qrxlevmin		-91+ Delta(N Rf1)	-91+ Delta(N Rf2)	-91+ Delta(NRf 3)	

Table 6.1.1.6.3.2-3: Main behaviour

St	Procedure	Message Sequence		TP	Verdict
		U - S	Message		
1	SS adjusts cell levels according to row T1 of table 6.1.1.6.3.2-1/2.	-	-	-	-
2	Power on the UE.	-	-	-	-
3- 22a 1	Steps 1 to 20a1 of the registration procedure described in TS 38.508-1 [4] table 4.5.2.2-2 are performed on NR Cell 12.	-	-	-	-
23	Check: Does the UE send an <i>RRCSetupRequest</i> on NR Cell 13 after 120 seconds, but before 720 seconds ("MinimumPeriodicSearchTimer") from power on? (Note 1 and Note 3)	-->	<i>NR RRC: RRCSetupRequest</i>	1	P
23 A- 23 B	Steps 3-4 of Table 4.5.2.2-2 of the generic procedure in TS 38.508-1 [4] are performed. (Note 2)	-	-	-	-
-	EXCEPTION: Steps 23Ca1 to 23Cb3a1 describe behaviour that depends on events happening prior to their execution; the "lower case letter" identifies a step sequence that take place if a specific prior event takes place.	-	-	-	-
23 Ca 1- 23 Ca 16a	IF 5GS registration type is set as Initial Registration in step 23B, THEN Steps 5 to 20a1 of the generic test procedure in TS 38.508-1 Table 4.5.2.2-2 are performed on NR Cell 13.	-	-	-	-

1					
23 Cb 1- 23 Cb 3a1	IF 5GS registration type is set as Mobility Registration in step 23B, THEN Steps 4 to 6a1 of the generic test procedure in TS 38.508-1 Table 4.9.5.2.2-1 are performed on NR Cell 13.	-	-	-	-
24- 28a 1	Void	-	-	-	-
29	SS adjusts cell levels according to row T2 of table 6.1.1.6.3.2-1/2.	-	-	-	-
30	Check: Does the UE send an <i>RRCSetupRequest</i> on NR Cell 11 after 420 seconds ("MinimumPeriodicSearchTimer") from step 24? (Note 1)	-->	<i>NR RRC: RRCSetupRequest</i>	2	P
30 A- 30 B	Steps 3-4 of Table 4.5.2.2-2 of the generic procedure in TS 38.508-1 [4] are performed. (Note 2)	-	-	-	-
-	EXCEPTION: Steps 30Ca1 to 30Cb3a1 describe behaviour that depends on events happening prior to their execution; the "lower case letter" identifies a step sequence that take place if a specific prior event takes place.	-	-	-	-
30 Ca 1- 30 Ca 16a 1	IF 5GS registration type is set as Initial Registration in step 30B, THEN Steps 5 to 20a1 of the generic test procedure in TS 38.508-1 Table 4.5.2.2-2 are performed on NR Cell 11.	-	-	-	-
30 Cb 1- 30 Cb 3a1	IF 5GS registration type is set as Mobility Registration in step 30B, THEN Steps 4 to 6a1 of the generic test procedure in TS 38.508-1 Table 4.9.5.2.2-1 are performed on NR Cell 11.	-	-	-	-
31- 35a 1	Void	-	-	-	-
<p>Note 1: Timers in Steps 23 and 30 are derived from the value defined by the "MinimumPeriodicSearchTimer".</p> <p>Note 2: The 5GS registration type shall be only set as Mobility Registration for R16 UEs according to TS 24.501 subclause 5.2.3.2.5 specified in Release 16. The EXCEPTION description applies only to R15 UEs.</p> <p>Note 3: Tolerance of 5min is added to allow time for the UE to find the proper PLMN.</p>					

6.1.1.6.3.3 Specific message contents

None

6.1.1.7 PLMN selection of RPLMN or (E)HPLMN; Automatic mode

6.1.1.7.1 Test Purpose (TP)

(1)

```

with { UE in Automatic network selection mode and RPLMN, EHPLMN and HPLMN cells available and UE is
fitted with a USIM containing the EHPLMN list and the USIM indicates RPLMN or (E)HPLMN should be
selected }
ensure that {
  when { UE is switched on }
  then { UE selects a cell of the RPLMN or EHPLMN. }
}

```

(2)

```

with { UE in Automatic network selection mode and RPLMN, HPLMN and VPLMN cells available and UE is
fitted with a USIM not containing or containing empty EHPLMN list and the USIM indicates RPLMN or
(E)HPLMN should be selected }
ensure that {
  when { UE is switched on }
    then { UE selects a cell of the RPLMN or HPLMN. }
}

```

6.1.1.7.2 Conformance requirements

References: The conformance requirements covered in the present TC are specified in: TS 38.304 clause 5.1.2.2, TS 23.122 clauses 1.2, 4.4.3.1 and 4.4.3.1.1. Unless otherwise stated these are Rel-15 requirements.

[TS 38.304 clause 5.1.2.2]

The UE shall scan all RF channels in the NR bands according to its capabilities to find available PLMNs. On each carrier, the UE shall search for the strongest cell and read its system information, in order to find out which PLMN(s) the cell belongs to. If the UE can read one or several PLMN identities in the strongest cell, each found PLMN (see the PLMN reading in TS 38.331 [3]) shall be reported to the NAS as a high quality PLMN (but without the RSRP value), provided that the following high-quality criterion is fulfilled:

1. For an NR Cell, the measured RSRP value shall be greater than or equal to -110 dBm.

...

Once the UE has selected a PLMN, the cell selection procedure shall be performed in order to select a suitable cell of that PLMN to camp on.

[TS 23.122, clause 1.2]

Equivalent HPLMN list: To allow provision for multiple HPLMN codes, PLMN codes that are present within this list shall replace the HPLMN code derived from the IMSI for PLMN selection purposes. This list is stored on the USIM and is known as the EHPLMN list. The EHPLMN list may also contain the HPLMN code derived from the IMSI. If the HPLMN code derived from the IMSI is not present in the EHPLMN list then it shall be treated as a Visited PLMN for PLMN selection purposes.

[TS 23.122 clause 4.4.3.1]

At switch on, or following recovery from lack of coverage, the MS selects the registered PLMN or equivalent PLMN (if it is available) using all access technologies that the MS is capable of and if necessary (in the case of recovery from lack of coverage, see subclause 4.5.2) attempts to perform a Location Registration.

NOTE 1: The MS in automatic network selection mode can end the PLMN search procedure once the registered PLMN or equivalent PLMN is found on an access technology.

NOTE 2: An MS in automatic network selection mode can use location information to determine which PLMNs can be available in its present location.

EXCEPTION: As an alternative option to this, if the MS is in automatic network selection mode and it finds coverage of an EHPLMN, the MS may register to that EHPLMN and not return to the registered PLMN or equivalent PLMN. If the EHPLMN list is not present or is empty, and the HPLMN is available, the MS may register on the HPLMN and not return to the registered PLMN or equivalent PLMN. The operator shall be able to control by SIM configuration whether an MS that supports this option is permitted to perform this alternative behaviour.

[TS 23.122 clause 4.4.3.1.1]

The MS selects and attempts registration on other PLMN/access technology combinations, if available and allowable, in the following order:

- i) either the HPLMN (if the EHPLMN list is not present or is empty) or the highest priority EHPLMN that is available (if the EHPLMN list is present);
- ii) each PLMN/access technology combination in the "User Controlled PLMN Selector with Access Technology" data file in the SIM (in priority order);

- iii) each PLMN/access technology combination in the "Operator Controlled PLMN Selector with Access Technology" data file in the SIM (in priority order);
- iv) other PLMN/access technology combinations with received high quality signal in random order;
- v) other PLMN/access technology combinations in order of decreasing signal quality.

6.1.1.7.3 Test description

6.1.1.7.3.1 Pre-test conditions

System Simulator:

- 4 NR Cells as specified in TS 38.508-1 [4] table 4.4.2-3 are configured as shown in Table 6.1.1.7.3.1-1. PLMN settings are defined in TS 36.523-1 [13] table 6.0.1-1.

Table 6.1.1.7.3.1-1: PLMN identifiers

NR Cell	PLMN names
NR Cell 12	PLMN4
NR Cell 1	PLMN1
NR Cell 11	PLMN15
NR Cell 13	PLMN3

UE:

- The UE is in Automatic PLMN selection mode.
- USIM configurations 2 and 3 will be used as specified in tables 6.4.1-2 and 6.4.1-3 in TS 38.508-1 [4]. The points at which each USIM configuration is used is specified in 6.1.1.7.3.2-2.

Preamble:

- The UE performs a successful registration on PLMN4 after which the UE is brought into the state Switched OFF (state ON-B) according to Table 4.4A.2-0 TS 38.508-1 [4].

6.1.1.7.3.2 Test procedure sequence

Table 6.1.1.7.3.2-1 for FR1 and table 6.1.1.7.3.2-2 for FR2 illustrate the downlink power levels to be applied for the cells at various time instants of the test execution. Row marked "T0" denotes the initial conditions after preamble, while columns marked "T1" is to be applied subsequently in the Main behaviour. The exact instants on which these values shall be applied are described in the texts in this clause.

Table 6.1.1.7.3.2-1: Cell configuration changes over time for FR1

	Parameter	Unit	NR Cell 1	NR Cell 12	NR Cell 11	NR Cell 13	Remarks
T0	SS/PBCH SSS EPRE	dBm/SCS	"Off"	-88	-88	"Off"	Power level "Off" is defined in TS 38.508-1 [4] Table 6.2.2.1-3
T1	SS/PBCH SSS EPRE	dBm/SCS	-88	-88	"Off"	-88	Power level "Off" is defined in TS 38.508-1 [4] Table 6.2.2.1-3

Table 6.1.1.7.3.2-2: Cell configuration changes over time for FR2

	Parameter	Unit	NR Cell 1	NR Cell 12	NR Cell 11	NR Cell 13	Remarks
T0	SS/PBCH SSS EPRE	dBm/SCS	"Off"	-82	-82	"Off"	Power level "Off" is defined in TS 38.508-1 [4] Table 6.2.2.1-3
	Qrxlevmin	dBm	-	-91+ Delta(NRf2)	-91+ Delta(NRf1)	-	
T1	SS/PBCH SSS EPRE	dBm/SCS	-82	-82	"Off"	-82	Power level "Off" is defined in TS 38.508-1 [4] Table 6.2.2.1-3
	Qrxlevmin	dBm	-91+ Delta(NRf1)	-91+ Delta(NRf2)	-	-91+ Delta(NRf3)	

Table 6.1.1.7.3.2-3 Main behaviour

St	Procedure	Message Sequence		TP	Verdict
		U - S	Message		
1	Power on the UE with the USIM configuration 2 specified in table 6.4.1-2 TS 38.508-1 [4].	-	-	-	-
2	Check: Does the UE transmit an <i>RRCSetupRequest</i> on NR Cell 12 or NR Cell 11?	-->	NR RRC: <i>RRCSetupRequest</i>	1	P
3-20	Steps 3-20a1 of the registration procedure described in TS 38.508-1 [4] table 4.5.2.2-2 are performed on NR Cell 12 or NR Cell 11. NOTE: The UE performs registration with valid stored security context (see preamble) and the RRC connection is released.	-	-	-	-
21	Void	-	-	-	-
22	The generic test procedure in TS 38.508-1 [4] Table 4.9.6.1-1 of Switch off procedure in RRC_IDLE are performed.	-	-	-	-
23	Void	-	-	-	-
24	The SS adjusts cell levels according to row T1 of table 6.1.1.7.3.2-1.	-	-	-	-
25	The UE is brought back to operation with the USIM configuration 3 specified in table 6.4.1-3 TS 38.508-1 [4].	-	-	-	-
26	Check: Does the UE transmit an <i>RRCSetupRequest</i> on NR Cell 12 or NR Cell 11?	-->	NR RRC: <i>RRCSetupRequest</i>	2	P
27-44	Steps 3 to 20a1 of the registration procedure described in TS 38.508-1 [4] table 4.5.2.2-2 are performed on NR Cell 12 or NR Cell 11.	-	-	-	-

6.1.1.7.3.3 Specific message contents

None

6.1.1.8 PLMN selection of RPLMN or (E)HPLMN; Manual mode

6.1.1.8.1 Test Purpose (TP)

(1)

```

with { UE in Manual network selection mode and EHPLMN and HPLMN cells available and (E)RPLMN cell is
not available and UE is fitted with a USIM containing the EHPLMN list and the UE supports the
exception to manual mode selection mode }
ensure that {
  then { UE is switched on }
  then { UE selects a cell of the highest priority EHPLMN. }
}

```

(2)

```

with { UE in Manual network selection mode and HPLMN and VPLMN cells available and (E)RPLMN cell is
not available and UE is fitted with a USIM not containing or containing empty EHPLMN list and the
UE supports the exception to manual mode selection mode }
ensure that {
  when { UE is switched on }
  then { UE selects a cell of the HPLMN. }
}

```

6.1.1.8.2 Conformance requirements

References: The conformance requirements covered in the present TC are specified in: TS 38.304 clause 5.1.2.2, TS 23.122 clauses 1.2, 4.4.3.1 and 4.4.3.1.2. Unless otherwise stated these are Rel-15 requirements.

[TS 38.304 clause 5.1.2.2]

The UE shall scan all RF channels in the NR bands according to its capabilities to find available PLMNs. On each carrier, the UE shall search for the strongest cell and read its system information, in order to find out which PLMN(s) the cell belongs to. If the UE can read one or several PLMN identities in the strongest cell, each found PLMN (see the PLMN reading in TS 38.331 [3]) shall be reported to the NAS as a high quality PLMN (but without the RSRP value), provided that the following high-quality criterion is fulfilled:

1. For an NR cell, the measured RSRP value shall be greater than or equal to -110 dBm.

...

Once the UE has selected a PLMN, the cell selection procedure shall be performed in order to select a suitable cell of that PLMN to camp on.

[TS 23.122, clause 1.2]

Equivalent HPLMN list: To allow provision for multiple HPLMN codes, PLMN codes that are present within this list shall replace the HPLMN code derived from the IMSI for PLMN selection purposes. This list is stored on the USIM and is known as the EHPLMN list. The EHPLMN list may also contain the HPLMN code derived from the IMSI. If the HPLMN code derived from the IMSI is not present in the EHPLMN list then it shall be treated as a Visited PLMN for PLMN selection purposes.

[TS 23.122 clause 4.4.3.1]

At switch on, or following recovery from lack of coverage, the MS selects the registered PLMN or equivalent PLMN (if it is available) using all access technologies that the MS is capable of and if necessary (in the case of recovery from lack of coverage, see subclause 4.5.2) attempts to perform a Location Registration.

NOTE 1: The MS in automatic network selection mode can end the PLMN search procedure once the registered PLMN or equivalent PLMN is found on an access technology.

NOTE 2: An MS in automatic network selection mode can use location information to determine which PLMNs can be available in its present location.

EXCEPTION: As an alternative option to this, if the MS is in automatic network selection mode and it finds coverage of an EHPLMN, the MS may register to that EHPLMN and not return to the registered PLMN or equivalent PLMN. If the EHPLMN list is not present or is empty, and the HPLMN is available, the MS may register on the HPLMN and not return to the registered PLMN or equivalent PLMN. The operator shall be able to control by SIM configuration whether an MS that supports this option is permitted to perform this alternative behaviour.

[TS 23.122 clause 4.4.3.1.2]

The MS indicates whether there are any PLMNs, which are available using all supported access technologies. This includes PLMNs in the "forbidden PLMNs" list, "forbidden PLMNs for GPRS service" list and PLMNs which only offer services not supported by the MS. An MS which supports GSM COMPACT shall also indicate GSM COMPACT PLMNs (which use PBCCH).

If displayed, PLMNs meeting the criteria above are presented in the following order:

- i)- either the HPLMN (if the EHPLMN list is not present or is empty) or, if one or more of the EHPLMNs are available then based on an optional data field on the SIM either only the highest priority available EHPLMN is to be presented to the user_or all available EHPLMNs are presented to the user in priority order. If the data field is not present on the SIM, then only the highest priority available EHPLMN is presented;
- ii)- PLMN/access technology combinations contained in the " User Controlled PLMN Selector with Access Technology " data file in the SIM (in priority order);
- iii)- PLMN/access technology combinations contained in the "Operator Controlled PLMN Selector with Access Technology" data file in the SIM (in priority order);
- iv)- other PLMN/access technology combinations with received high quality signal in random order;
- v)- other PLMN/access technology combinations in order of decreasing signal quality.

6.1.1.8.3 Test description

6.1.1.8.3.1 Pre-test conditions

System Simulator:

- 3 NR cells: NR Cells 1, 13 and 12 as specified in TS 38.508-1 [4] table 6.3.2.2-1 are configured as shown in Table 6.1.1.8.3.1-1. PLMN settings are defined in TS 36.523-1 [13] table 6.0.1-1.

Table 6.1.1.8.3.1-1: PLMN identifiers

NR Cell	PLMN names
NR Cell 1 (configured during preamble)	PLMN4
NR Cell 1 (configured in test body all steps)	PLMN1
NR Cell 13	PLMN15
NR Cell 12	PLMN3

UE:

- The UE is in Manual PLMN selection mode.
- USIM configurations 2 and 3 will be used as specified in tables 6.4.1-2 and 6.4.1-3 in TS 38.508-1 [4]. The points at which each USIM configuration is used is specified in 6.1.1.8.3.2-2.

Preamble:

- The UE performs a successful registration on PLMN4 after which the UE is brought into the state Switched OFF (state 0N-B) according to Table 4.4A.2-0 TS 38.508-1 [4].

6.1.1.8.3.2 Test procedure sequence

Table 6.1.1.8.3.2-1 for FR1 and table 6.1.1.8.3.2-2 for FR2 illustrate the downlink power levels to be applied for the cells at various time instants of the test execution. Row marked "T0" denotes the initial conditions after preamble, while columns marked "T1" is to be applied subsequently in the Main behaviour. The exact instants on which these values shall be applied are described in the texts in this clause.

Table 6.1.1.8.3.2-1: Cell configuration changes over time for FR1

	Parameter	Unit	NR Cell 1	NR Cell 13	NR Cell 12	Remark
T0	SS/PBCH SSS EPRE	dBm/SCS	-88	-88	"Off"	Power level "Off" is defined in TS 38.508-1 Table 6.2.2.1-3

T1	SS/PBCH SSS EPRE	dBm/SCS	-88	"Off"	-88	Power level "Off" is defined in TS 38.508-1 Table 6.2.2.1-3
----	---------------------	---------	-----	-------	-----	--

Table 6.1.1.8.3.2-2: Cell configuration changes over time for FR2

	Parameter	Unit	NR Cell 1	NR Cell 13	NR Cell 12	Remark
T0	SS/PBCH SSS EPRE	dBm/SCS	-82	-82	"Off"	Power level "Off" is defined in TS 38.508-1 Table 6.2.2.1-3
	Qrxlevmin	dBm	-91+ Delta(NRf1)	-91+ Delta(NRf3)	-	
T1	SS/PBCH SSS EPRE	dBm/SCS	-82	"Off"	-82	Power level "Off" is defined in TS 38.508-1 Table 6.2.2.1-3
	Qrxlevmin	dBm	-91+ Delta(NRf1)	-	-91+ Delta(NRf2)	

Table 6.1.1.8.3.2-3: Main behaviour

St	Procedure	Message Sequence		TP	Verdict
		U - S	Message		
1	Power on the UE with the USIM configuration 2 specified in table 6.4.1-2 TS 38.508-1 [4].	-	-	-	-
2	Check: Does the UE transmit an <i>RRCSetupRequest</i> on NR Cell 13?	-->	NR RRC: <i>RRCSetupRequest</i>	1	P
3 - 20	Steps 3 to 20a1 of the registration procedure described in TS 38.508-1 [4] table 4.5.2.2-2 are performed on NR Cell 13. NOTE: The UE performs registration with valid stored security context (see preamble) and the RRC connection is released.	-	-	-	-
21	Void	-	-	-	-
22	The generic test procedure in TS 38.508-1 [4] Table 4.9.6.1-1 of Switch off procedure in RRC_IDLE are performed.	-	-	-	-
23	Void	-	-	-	-
24	The SS adjusts cell according to row T1 of table 6.1.1.8.3.2-1.	-	-	-	-
25	The UE is brought back to operation with the USIM configuration 3 specified in table 6.4.1-3 TS 38.508-1 [4].	-	-	-	-
26	Check: Does the UE transmit an <i>RRCSetupRequest</i> on NR Cell 1?	-->	NR RRC: <i>RRCSetupRequest</i>	2	P
27- 44	Steps 3 to 20a1 of the registration procedure described in TS 38.508-1 [4] table 4.5.2.2-2 are performed on NR Cell 1.	-	-	-	-

6.1.1.8.3.3 Specific message contents

None

6.1.2 NG-RAN Only Cell Selection

6.1.2.1 Cell selection / Qrxlevmin & Cell reselection (Intra NR)

6.1.2.1.1 Test Purpose (TP)

(1)

```
with { UE in NR RRC_IDLE state }
ensure that {
  when { a cell fulfils all requirements for a suitable cell except the cell selection criteria
which are not fulfilled (Srxlev<0) }
  then { the UE does not consider the cell suitable and no camping on this cell can take place }
}
```

(2)

```
with { UE in NR RRC_IDLE state }
ensure that {
  when { a cell fulfils all requirements for a suitable cell including the cell selection criteria
for a cell which are also fulfilled (Srxlev>0) }
  then { the UE considers the cell suitable and camps on it }
}
```

(3)

```
with { UE in NR RRC_IDLE state }
ensure that {
  when { UE detects the cell ranked as the best cell }
  then { UE reselects the new cell }
}
```

(4)

```
with { UE in NR RRC_IDLE state }
ensure that {
  when { a cell fulfils cell selection criteria but trackingAreaCode is not provided for that PLMN }
  then { the UE considers the cell as barred and no camping on this cell can take place }
}
```

6.1.2.1.2 Conformance requirements

References: The conformance requirements covered in the present TC are specified in: 3GPP TS 38.300 clauses 9.2.1.1, 3GPP TS 38.304 clause 4.1, 4.5, 5.2.1, 5.2.3.1, 5.2.3.2, 5.2.4.6 and 5.3.1. Unless otherwise stated these are Rel-15 requirements.

[TS 38.300, clause 9.2.1.1]

The principles of PLMN selection in NR are based on the 3GPP PLMN selection principles. Cell selection is required on transition from RM-DEREGISTERED to RM-REGISTERED, from CM-IDLE to CM-CONNECTED and from CM-CONNECTED to CM-IDLE and is based on the following principles:

- The UE NAS layer identifies a selected PLMN and equivalent PLMNs;
- Cell selection is always based on CD-SSBs located on the synchronization raster (see subclause 5.2.4):
 - The UE searches the NR frequency bands and for each carrier frequency identifies the strongest cell as per the CD-SSB. It then reads cell system information broadcast to identify its PLMN(s):
 - The UE may search each carrier in turn ("initial cell selection") or make use of stored information to shorten the search ("stored information cell selection").
- The UE seeks to identify a suitable cell; if it is not able to identify a suitable cell it seeks to identify an acceptable cell. When a suitable cell is found or if only an acceptable cell is found it camps on that cell and commence the cell reselection procedure:

- A suitable cell is one for which the measured cell attributes satisfy the cell selection criteria; the cell PLMN is the selected PLMN, registered or an equivalent PLMN; the cell is not barred or reserved and the cell is not part of a tracking area which is in the list of "forbidden tracking areas for roaming";
- An acceptable cell is one for which the measured cell attributes satisfy the cell selection criteria and the cell is not barred.

Transition to RRC_IDLE:

On transition from RRC_CONNECTED to RRC_IDLE, a UE should camp on the last cell for which it was in RRC_CONNECTED or a cell/any cell of set of cells or frequency be assigned by RRC in the state transition message.

Recovery from out of coverage:

The UE should attempt to find a suitable cell in the manner described for stored information or initial cell selection above. If no suitable cell is found on any frequency or RAT, the UE should attempt to find an acceptable cell.

In multi-beam operations, the cell quality is derived amongst the beams corresponding to the same cell (see subclause 9.2.4).

[TS 38.304, clause 4.1]

The RRC_IDLE state and RRC_INACTIVE state tasks can be subdivided into three processes:

- PLMN selection;
- Cell selection and reselection;
- Location registration and RNA update.

PLMN selection, cell reselection procedures, and location registration are common for both RRC_IDLE state and RRC_INACTIVE state. RNA update is only applicable for RRC_INACTIVE state. When UE selects a new PLMN, UE transitions from RRC_INACTIVE to RRC_IDLE.

When a UE is switched on, a public land mobile network (PLMN) is selected by NAS. For the selected PLMN, associated RAT(s) may be set 3GPP TS 23.122 [9]. The NAS shall provide a list of equivalent PLMNs, if available, that the AS shall use for cell selection and cell reselection.

With cell selection, the UE searches for a suitable cell of the selected PLMN, chooses that cell to provide available services, and monitors its control channel. This procedure is defined as "camping on the cell".

The UE shall, if necessary, then register its presence, by means of a NAS registration procedure, in the tracking area of the chosen cell. As an outcome of a successful Location Registration, the selected PLMN then becomes the registered PLMN 3GPP TS 23.122 [9].

If the UE finds a more suitable cell, according to the cell reselection criteria, it reselects onto that cell and camps on it. If the new cell does not belong to at least one tracking area to which the UE is registered, location registration is performed. In RRC_INACTIVE state, if the new cell does not belong to the configured RNA, an RNA update procedure is performed.

If necessary, the UE shall search for higher priority PLMNs at regular time intervals as described in 3GPP TS 23.122 [9] and search for a suitable cell if another PLMN has been selected by NAS.

If the UE loses coverage of the registered PLMN, either a new PLMN is selected automatically (automatic mode), or an indication of available PLMNs is given to the user so that a manual selection can be performed (manual mode).

Registration is not performed by UEs only capable of services that need no registration.

The purpose of camping on a cell in RRC_IDLE state and RRC_INACTIVE state is fourfold:

- a) It enables the UE to receive system information from the PLMN.
- b) When registered and if the UE wishes to establish an RRC connection or resume a suspended RRC connection, it can do this by initially accessing the network on the control channel of the cell on which it is camped.

- c) If the network needs to send a message or deliver data to the registered UE, it knows (in most cases) the set of tracking areas (in RRC_IDLE state) or RNA (in RRC_INACTIVE state) in which the UE is camped. It can then send a "paging" message for the UE on the control channels of all the cells in the corresponding set of areas. The UE will then receive the paging message and can respond.
- d) It enables the UE to receive ETWS and CMAS notifications.

[TS 38.304, clause 4.5]

The cells are categorised according to which services they offer:

acceptable cell:

An "acceptable cell" is a cell on which the UE may camp to obtain limited service (originate emergency calls and receive ETWS and CMAS notifications). Such a cell shall fulfil the following requirements, which is the minimum set of requirements to initiate an emergency call and to receive ETWS and CMAS notification in an NR network:

- The cell is not barred, see subclause 5.3.1;
- The cell selection criteria are fulfilled, see subclause 5.2.3.2.

suitable cell:

A cell is considered as suitable if the following conditions are fulfilled:

- The cell is part of either the selected PLMN or the registered PLMN or PLMN of the Equivalent PLMN list and *trackingAreaCode* is provided for that PLMN;
- The cell selection criteria are fulfilled, see subclause 5.2.3.2.

According to the latest information provided by NAS:

- The cell is not barred, see subclause 5.3.1;
- The cell is part of at least one TA that is not part of the list of "Forbidden Tracking Areas" (TS 22.261 [12]), which belongs to a PLMN that fulfils the first bullet above.

barred cell:

A cell is barred if it is so indicated in the system information, as specified in TS 38.331 [3].

reserved cell:

A cell is reserved if it is so indicated in system information, as specified in TS 38.331 [3].

Following exception to these definitions are applicable for UEs:

- if a UE has an ongoing emergency call, all acceptable cells of that PLMN are treated as suitable for the duration of the emergency call.

[TS 38.304, clause 5.2.1]

UE shall perform measurements for cell selection and reselection purposes as specified in TS 38.133 [8].

The NAS can control the RAT(s) in which the cell selection should be performed, for instance by indicating RAT(s) associated with the selected PLMN, and by maintaining a list of forbidden registration area(s) and a list of equivalent PLMNs. The UE shall select a suitable cell based on RRC_IDLE or RRC_INACTIVE state measurements and cell selection criteria.

In order to expedite the cell selection process, stored information for several RATs, if available, may be used by the UE.

When camped on a cell, the UE shall regularly search for a better cell according to the cell reselection criteria. If a better cell is found, that cell is selected. The change of cell may imply a change of RAT. Details on performance requirements for cell reselection can be found in TS 38.133 [8].

The NAS is informed if the cell selection and reselection result in changes in the received system information relevant for NAS.

For normal service, the UE shall camp on a suitable cell, monitor control channel(s) of that cell so that the UE can:

- receive system information from the PLMN; and
- receive registration area information from the PLMN, e.g., tracking area information; and
- receive other AS and NAS Information; and
- if registered:
 - receive paging and notification messages from the PLMN; and
 - initiate transfer to Connected mode.

For cell selection in multi-beam operations, measurement quantity of a cell is up to UE implementation.

For cell reselection in multi-beam operations, using a maximum number (*nrofSS-BlocksToAverage*) of beams to be considered and a threshold (*absThreshSS-BlocksConsolidation*) which are configured for a cell, the measurement quantity of this cell is derived amongst the beams corresponding to the same cell based on SS/PBCH block as follows:

- if the highest beam measurement quantity value is below the threshold:
 - derive a cell measurement quantity as the highest beam measurement quantity value, where each beam measurement quantity is described in TS 38.215 [11].
- else:
 - derive a cell measurement quantity as the linear average of the power values of up to the maximum number of highest beam measurement quantity values above the threshold.

[TS 38.304, clause 5.2.3.1]

Cell selection is performed by one of the following two procedures:

- a) Initial cell selection (no prior knowledge of which RF channels are NR frequencies):
 1. The UE shall scan all RF channels in the NR bands according to its capabilities to find a suitable cell.
 2. On each frequency, the UE need only search for the strongest cell.
 3. Once a suitable cell is found, this cell shall be selected.
- b) Cell selection by leveraging stored information:
 1. This procedure requires stored information of frequencies and optionally also information on cell parameters from previously received measurement control information elements or from previously detected cells.
 2. Once the UE has found a suitable cell, the UE shall select it.
 3. If no suitable cell is found, the initial cell selection procedure in a) shall be started.

NOTE: Priorities between different frequencies or RATs provided to the UE by system information or dedicated signalling are not used in the cell selection process.

[TS 38.304, clause 5.2.3.2]

The cell selection criterion S is fulfilled when:

$$S_{rxlev} > 0 \text{ AND } S_{qual} > 0$$

where: $S_{rxlev} = Q_{rxlevmeas} - (Q_{rxlevmin} + Q_{rxlevminoffset}) - P_{compensation} - Q_{offsettemp}$

$S_{qual} = Q_{qualmeas} - (Q_{qualmin} + Q_{qualminoffset}) - Q_{offsettemp}$

where:

S _{rxlev}	Cell selection RX level value (dB)
S _{qual}	Cell selection quality value (dB)

$Q_{\text{offset}_{\text{temp}}}$	Offset temporarily applied to a cell as specified in TS 38.331 [3] (dB)
$Q_{\text{rxlevmeas}}$	Measured cell RX level value (RSRP)
Q_{qualmeas}	Measured cell quality value (RSRQ)
Q_{rxlevmin}	Minimum required RX level in the cell (dBm). If the UE supports SUL frequency for this cell, Q_{rxlevmin} is obtained from $RxLevMinSUL$, if present, in <i>SIB1</i> , <i>SIB2</i> and <i>SIB4</i> , additionally, if $Q_{\text{rxlevminoffsetcellSUL}}$ is present in <i>SIB3</i> and <i>SIB4</i> for the concerned cell, this cell specific offset is added to the corresponding Q_{rxlevmin} to achieve the required minimum RX level in the concerned cell; else Q_{rxlevmin} is obtained from $q\text{-RxLevMin}$ in <i>SIB1</i> , <i>SIB2</i> and <i>SIB4</i> , additionally, if $Q_{\text{rxlevminoffsetcell}}$ is present in <i>SIB3</i> and <i>SIB4</i> for the concerned cell, this cell specific offset is added to the corresponding Q_{rxlevmin} to achieve the required minimum RX level in the concerned cell.
Q_{qualmin}	Minimum required quality level in the cell (dB). Additionally, if $Q_{\text{qualminoffsetcell}}$ is signalled for the concerned cell, this cell specific offset is added to achieve the required minimum quality level in the concerned cell.
$Q_{\text{rxlevminoffset}}$	Offset to the signalled Q_{rxlevmin} taken into account in the S_{rxlev} evaluation as a result of a periodic search for a higher priority PLMN while camped normally in a VPLMN 3GPP TS 23.122 [9]
$Q_{\text{qualminoffset}}$	Offset to the signalled Q_{qualmin} taken into account in the S_{qual} evaluation as a result of a periodic search for a higher priority PLMN while camped normally in a VPLMN 3GPP TS 23.122 [9]
$P_{\text{compensation}}$	If the UE supports the additional P_{max} in the <i>NS-PmaxList</i> , if present, in <i>SIB1</i> , <i>SIB2</i> and <i>SIB4</i> : $\max(P_{\text{EMAX1}} - P_{\text{PowerClass}}, 0) - (\min(P_{\text{EMAX2}}, P_{\text{PowerClass}}) - \min(P_{\text{EMAX1}}, P_{\text{PowerClass}}))$ (dB); else: $\max(P_{\text{EMAX1}} - P_{\text{PowerClass}}, 0)$ (dB)
$P_{\text{EMAX1}}, P_{\text{EMAX2}}$	Maximum TX power level of a UE may use when transmitting on the uplink in the cell (dBm) defined as P_{EMAX} in TS 38.101 [15]. P_{EMAX1} and P_{EMAX2} are obtained from the <i>p-Max</i> and <i>NS-PmaxList</i> respectively in <i>SIB1</i> , <i>SIB2</i> and <i>SIB4</i> as specified in TS 38.331 [3].
$P_{\text{PowerClass}}$	Maximum RF output power of the UE (dBm) according to the UE power class as defined in TS 38.101 [15]

The signalled values $Q_{\text{rxlevminoffset}}$ and $Q_{\text{qualminoffset}}$ are only applied when a cell is evaluated for cell selection as a result of a periodic search for a higher priority PLMN while camped normally in a VPLMN (3GPP TS 23.122 [9]). During this periodic search for higher priority PLMN, the UE may check the S criteria of a cell using parameter values stored from a different cell of this higher priority PLMN.

[TS 38.304, clause 5.2.4.6]

The cell-ranking criterion R_s for serving cell and R_n for neighbouring cells is defined by:

$$R_s = Q_{\text{meas},s} + Q_{\text{hyst}} - Q_{\text{offset}_{\text{temp}}}$$

$$R_n = Q_{\text{meas},n} - Q_{\text{offset}} - Q_{\text{offset}_{\text{temp}}}$$

where:

Q_{meas}	RSRP measurement quantity used in cell reselections.
Q_{offset}	For intra-frequency: Equals to $Q_{\text{offset}_{s,n}}$, if $Q_{\text{offset}_{s,n}}$ is valid, otherwise this equals to zero. For inter-frequency: Equals to $Q_{\text{offset}_{s,n}}$ plus $Q_{\text{offset}_{\text{frequency}}}$, if $Q_{\text{offset}_{s,n}}$ is valid, otherwise this equals to $Q_{\text{offset}_{\text{frequency}}}$.
$Q_{\text{offset}_{\text{temp}}}$	Offset temporarily applied to a cell as specified in TS 38.331 [3].

The UE shall perform ranking of all cells that fulfil the cell selection criterion S , which is defined in 5.2.3.2.

The cells shall be ranked according to the R criteria specified above by deriving $Q_{\text{meas},n}$ and $Q_{\text{meas},s}$ and calculating the R values using averaged RSRP results.

If *rangeToBestCell* is not configured, the UE shall perform cell reselection to the highest ranked cell. If this cell is found to be not-suitable, the UE shall behave according to subclause 5.2.4.4.

If *rangeToBestCell* is configured, then the UE shall perform cell reselection to the cell with the highest number of beams above the threshold (i.e. *absThreshSS-BlocksConsolidation*) among the cells whose R value is within *rangeToBestCell* of the R value of the highest ranked cell. If there are multiple such cells, the UE shall perform cell reselection to the highest ranked cell among them. If this cell is found to be not-suitable, the UE shall behave according to subclause 5.2.4.4.

In all cases, the UE shall reselect the new cell, only if the following conditions are met:

- the new cell is better ranked than the serving cell during a time interval $T_{\text{reselectionRAT}}$;
- more than 1 second has elapsed since the UE camped on the current serving cell.

[TS 38.304, clause 5.3.1]

Cell status and cell reservations are indicated in the *MIB* or *SIB1* message as specified in TS 38.331 [3] by means of three fields:

- *cellBarred* (IE type: "barred" or "not barred")
Indicated in *MIB* message. In case of multiple PLMNs indicated in *SIB1*, this field is common for all PLMNs
- *cellReservedForOperatorUse* (IE type: "reserved" or "not reserved")
Indicated in *SIB1* message. In case of multiple PLMNs indicated in *SIB1*, this field is specified per PLMN.
- *cellReservedForOtherUse* (IE type: "true")
Indicated in *SIB1* message. In case of multiple PLMNs indicated in *SIB1*, this field is common for all PLMNs.

When cell status is indicated as "not barred" and "not reserved" for operator use and not "true" for other use,

- All UEs shall treat this cell as candidate during the cell selection and cell reselection procedures.

When cell status is indicated as "true" for other use,

- The UE shall treat this cell as if cell status is "barred".

When cell status is indicated as "not barred" and "reserved" for operator use for any PLMN and not "true" for other use,

- UEs assigned to Access Identity 11 or 15 operating in their HPLMN/EHPLMN shall treat this cell as candidate during the cell selection and reselection procedures if the field *cellReservedForOperatorUse* for that PLMN set to "reserved".
- UEs assigned to an Access Identity 0, 1, 2 and 12 to 14 shall behave as if the cell status is "barred" in case the cell is "reserved for operator use" for the registered PLMN or the selected PLMN.

NOTE 1: Access Identities 11, 15 are only valid for use in the HPLMN/ EHPLMN; Access Identities 12, 13, 14 are only valid for use in the home country as specified in TS 22.261 [12].

When cell status "barred" is indicated or to be treated as if the cell status is "barred",

- The UE is not permitted to select/reselect this cell, not even for emergency calls.
- The UE shall select another cell according to the following rule:
- If the cell is to be treated as if the cell status is "barred" due to being unable to acquire the *MIB*:
 - the UE may exclude the barred cell as a candidate for cell selection/reselection for up to 300 seconds.
 - the UE may select another cell on the same frequency if the selection criteria are fulfilled.
- else:
 - If the cell is to be treated as if the cell status is "barred" due to being unable to acquire the *SIB1* or due to *trackingAreaCode* being absent in *SIB1* as specified in TS 38.331 [3]:
 - The UE may exclude the barred cell as a candidate for cell selection/reselection for up to 300 seconds.

- If the field *intraFreqReselection* in *MIB* message is set to "allowed", the UE may select another cell on the same frequency if re-selection criteria are fulfilled;
 - The UE shall exclude the barred cell as a candidate for cell selection/reselection for 300 seconds.
- If the field *intraFreqReselection* in *MIB* message is set to "not allowed" the UE shall not re-select a cell on the same frequency as the barred cell;
 - The UE shall exclude the barred cell and the cells on the same frequency as a candidate for cell selection/reselection for 300 seconds.

The cell selection of another cell may also include a change of RAT.

6.1.2.1.3 Test description

6.1.2.1.3.1 Pre-test conditions

System Simulator:

- NR Cell 1 and NR Cell 11.
- System information combination NR-2 as defined in TS 38.508-1 [4] clause 4.4.3.1.2 is used in NR cells.

UE:

- None.

Preamble:

- The UE is in state Switched OFF (state 0-A) according to TS 38.508-1 [4].

6.1.2.1.3.2 Test procedure sequence

Table 6.1.2.1.3.2-1/2 illustrate the downlink power levels and other changing parameters to be applied for the cell at various time instants of the test execution. The exact instants on which these values shall be applied are described in the texts in this clause. Configurations marked "T1", "T2", "T3" and "T4" are applied at the points indicated in the Main behaviour description in Table 6.1.2.1.3.2-3.

Table 6.1.2.1.3.2-1: Time instances of cell power level and parameter changes for FR1

	Parameter	Unit	NR Cell 1	NR Cell 11	Remark
T1	SS/PBCH SSS EPRE	dBm/ SCS	-98	Off	The power level value is such to satisfy $S_{rxlevNRCell1} < 0$ but the UE is able to read the PLMN identity
	Qrxlevmin	dBm	-90	-	
	Qrxlevminoffset	dB	0	-	
	Pcompensation	dB	0	-	
T2	SS/PBCH SSS EPRE	dBm/ SCS	-80	Off	The power level is such that $S_{rxlevNRCell1} > 0$
	Qrxlevmin	dBm	-90	-	
	Qrxlevminoffset	dB	0	-	
	Pcompensation	dB	0	-	
T3	SS/PBCH SSS EPRE	dBm/ SCS	-87	-78	The power level values are assigned to satisfy $R_{NRCell1} < R_{NRCell11}$.
	Qrxlevmin	dBm	-90	-90	
	Qrxlevminoffset	dB	0	0	
	Pcompensation	dB	0	0	
T4	SS/PBCH SSS EPRE	dBm/ SCS	-78	-85	The power level values are assigned to satisfy $R_{NRCell1} > R_{NRCell11}$.
	Qrxlevmin	dBm	-90	-90	
	Qrxlevminoffset	dB	0	0	
	Pcompensation	dB	0	0	

Note: The downlink signal level uncertainty is specified in TS 38.508-1 [4] clause 6.2.2.1.

Table 6.1.2.1.3.2-2: Time instances of cell power level and parameter changes for FR2

	Parameter	Unit	NR Cell 1	NR Cell 11	Remark
T1	SS/PBCH SSS EPRE	dBm/ SCS	-100	Off	The power level value is such to satisfy $S_{rxlevNRCell1} < 0$ but the UE is able to read the PLMN identity
	Qrxlevmin	dBm	- 91+Delta(N Rf1)	-	
	Qrxlevminoffset	dB	0	-	
	Pcompensation	dB	0	-	
T2	SS/PBCH SSS EPRE	dBm/ SCS	-82	Off	The power level is such that $S_{rxlevNRCell1} > 0$
	Qrxlevmin	dBm	- 91+Delta(N Rf1)	-	
	Qrxlevminoffset	dB	0	-	
	Pcompensation	dB	0	-	
T3	SS/PBCH SSS EPRE	dBm/ SCS	-91	-82	The power level values are assigned to satisfy $R_{NRCell1} < R_{NRCell11}$.
	Qrxlevmin	dBm	- 100+Delta(NRf1)	- 100+Delta(NRf1)	
	Qrxlevminoffset	dB	0	0	
	Pcompensation	dB	0	0	
T4	SS/PBCH SSS EPRE	dBm/ SCS	-82	-91	The power level values are assigned to satisfy $R_{NRCell1} > R_{NRCell11}$.
	Qrxlevmin	dBm	- 100+Delta(NRf1)	- 100+Delta(NRf1)	
	Qrxlevminoffset	dB	0	0	
	Pcompensation	dB	0	0	

Table 6.1.2.1.3.2-3: Main behaviour

St	Procedure	Message Sequence		TP	Verdict
		U - S	Message		
1	SS adjusts the SS/PBCH EPRE level of NR Cell 1 according to row "T1" in table 6.1.2.1.3.2-1/2.	-	-	-	-
2	The UE is switched on.	-	-	-	-
3	Check: Does the UE send an <i>RRCSetupRequest</i> on NR Cell 1 within the next 60 s?	-->	NR RRC: <i>RRCSetupRequest</i>	1	F
4	SS re-adjusts the SS/PBCH EPRE level of NR Cell 1 level according to row "T2" in table 6.1.2.1.3.2-1/2.	-	-	-	-
5	Check: Does the UE send an <i>RRCSetupRequest</i> on NR Cell 1?	-->	NR RRC: <i>RRCSetupRequest</i>	2	P
6-23	Steps 3 to 20a1 of the registration procedure described in TS 38.508-1 [4] Table 4.5.2.2-2 are performed on NR Cell 1. NOTE: The UE performs registration and the RRC connection is released.	-	-	-	-
-	EXCEPTION: Step 23Aa1 should be executed in case of FR2	-	-	-	-
23Aa1	SS change NR Cell 1 SIB1 with modification of Qrxlevmin.	-	-	-	-
24	The SS changes SS/PBCH EPRE level of NR Cell 11 according to the row "T3" in table 6.1.2.1.3.2-1/2.	-	-	-	-
25-31	Check: Does the test result of generic test procedure in TS 38.508-1 [4] clause 4.9.5 indicate that the UE is camped on NR Cell 11? NOTE 1: The UE performs registration and the RRC connection is released.	-	-	3	-

-	EXCEPTION: Steps 32-34 are not applicable when pc_SNPN_only is set to TRUE.	-	-	-	-
32	SS change NR Cell 1 SIB1.	-	-	-	-
32 A	Wait for 2.1* modification period second for the SS to transmit modified system information (Note 1)				
33	The SS changes SS/PBCH EPRE level of NR Cell 1 and 11 according to the row "T4" in table 6.1.2.1.3.2-1/2.	-	-	-	-
34	Check: Does the UE send an <i>RRCSetupRequest</i> on NR Cell 1 within the next 60 s?	-	-	4	F
Note 1: The modification period, expressed in number of radio frames = modificationPeriodCoeff * defaultPagingCycle.					

6.1.2.1.3.3 Specific message contents

Table 6.1.2.1.3.3-1: SIB1 for NR Cell 1 (preamble)

Derivation Path: TS 38.508-1 [4], Table 4.6.1-28			
Information Element	Value/remark	Comment	Condition
SIB1 ::= SEQUENCE {			
cellSelectionInfo SEQUENCE {			
q-RxLevMin	-45	-90 dBm	FR1
q-RxLevMin	ROUND((-91+Delta(NRf1))/2)		FR2
}			
}			

Table 6.1.2.1.3.3-1A: SIB1 for NR Cell 1 (Step 23Aa1, Table 6.1.2.1.3.2-3)

Derivation Path: TS 38.508-1 [4], Table 4.6.1-28			
Information Element	Value/remark	Comment	Condition
SIB1 ::= SEQUENCE {			
cellSelectionInfo SEQUENCE {			
q-RxLevMin	ROUND([-100+Delta(NRf1)]/2)		FR2
}			
}			

Table 6.1.2.1.3.3-2: SIB1 for NR Cell 1 (Step 32, Table 6.1.2.1.3.2-3)

Derivation Path: TS 38.508-1 [4], Table 4.6.1-28			
Information Element	Value/remark	Comment	Condition
SIB1 ::= SEQUENCE {			
cellSelectionInfo SEQUENCE {			
q-RxLevMin	-45	-90 dBm	FR1
q-RxLevMin	ROUND((-100+Delta(NRf1))/2)	-100+Delta(NRf1) dBm	FR2
}			
cellAccessRelatedInfo	CellAccessRelatedInfo		
}			

Table 6.1.2.1.3.3-3: CellAccessRelatedInfo (Table 6.1.2.1.3.3-2)

Derivation Path: TS 38.508-1 [4], Table 4.6.3-16			
Information Element	Value/remark	Comment	Condition
CellAccessRelatedInfo ::= SEQUENCE {			
plmn-IdentityList	PLMN-IdentityInfoList		
cellReservedForOtherUse	Not present		
}			

Table 6.1.2.1.3.3-4: PLMN-IdentityInfoList (Table 6.1.2.1.3.3-3)

Derivation Path: TS 38.508-1 [4], Table 4.6.3-108			
Information Element	Value/remark	Comment	Condition
PLMN-IdentityInfoList ::= SEQUENCE (SIZE (1..maxPLMN)) OF PLMN-IdentityInfo {	1 entry		
PLMN-IdentityInfo[1] SEQUENCE {		entry 1	
trackingAreaCode	Not present		
}			
}			

6.1.2.2 Cell selection / Qqualmin / Intra NR / Serving cell becomes non-suitable (Srxlev > 0, Squal < 0)

6.1.2.2.1 Test Purpose (TP)

(1)

```
with { UE in NR RRC_IDLE state }
ensure that {
  when { a cell fulfils all requirements for a suitable cell except the cell selection criteria
  which are not fulfilled (Srxlev>0 AND Squal<0) }
  then { the UE does not consider the cell suitable and no camping on this cell can take place }
}
```

(2)

```
with { UE in NR RRC_IDLE state }
ensure that {
  when { a cell fulfils all requirements for a suitable cell including the cell selection criteria
  for a cell which are also fulfilled (Srxlev>0 AND Squal>0) }
  then { the UE considers the cell suitable and camps on it }
}
```

(3)

```
with { UE in NR RRC_IDLE state }
ensure that {
  when { the serving cell becomes non-suitable (Srxlev > 0 and Squal < 0) and there is a suitable
  neighbour cell (Srxlev > 0 and Squal > 0) }
  then { UE selects the suitable neighbour cell }
}
```

6.1.2.2.2 Conformance requirements

References: The conformance requirements covered in the present TC are specified in: 3GPP TS 38.300 clauses 9.2.1.1, 3GPP TS 38.304 clause 4.1, 4.5, 5.2.1, 5.2.3.1, 5.2.3.2, 5.2.4.6 and 5.3.1. Unless otherwise stated these are Rel-15 requirements.

[TS 38.300, clause 9.2.1.1]

The principles of PLMN selection in NR are based on the 3GPP PLMN selection principles. Cell selection is required on transition from RM-DEREGISTERED to RM-REGISTERED, from CM-IDLE to CM-CONNECTED and from CM-CONNECTED to CM-IDLE and is based on the following principles:

- The UE NAS layer identifies a selected PLMN and equivalent PLMNs;
- Cell selection is always based on CD-SSBs located on the synchronization raster (see subclause 5.2.4):
 - The UE searches the NR frequency bands and for each carrier frequency identifies the strongest cell as per the CD-SSB. It then reads cell system information broadcast to identify its PLMN(s):

- The UE may search each carrier in turn ("initial cell selection") or make use of stored information to shorten the search ("stored information cell selection").
- The UE seeks to identify a suitable cell; if it is not able to identify a suitable cell it seeks to identify an acceptable cell. When a suitable cell is found or if only an acceptable cell is found it camps on that cell and commence the cell reselection procedure:
 - A suitable cell is one for which the measured cell attributes satisfy the cell selection criteria; the cell PLMN is the selected PLMN, registered or an equivalent PLMN; the cell is not barred or reserved and the cell is not part of a tracking area which is in the list of "forbidden tracking areas for roaming";
 - An acceptable cell is one for which the measured cell attributes satisfy the cell selection criteria and the cell is not barred.

Transition to RRC_IDLE:

On transition from RRC_CONNECTED to RRC_IDLE, a UE should camp on the last cell for which it was in RRC_CONNECTED or a cell/any cell of set of cells or frequency be assigned by RRC in the state transition message.

Recovery from out of coverage:

The UE should attempt to find a suitable cell in the manner described for stored information or initial cell selection above. If no suitable cell is found on any frequency or RAT, the UE should attempt to find an acceptable cell.

In multi-beam operations, the cell quality is derived amongst the beams corresponding to the same cell (see subclause 9.2.4).

[TS 38.304, clause 4.1]

The RRC_IDLE state and RRC_INACTIVE state tasks can be subdivided into three processes:

- PLMN selection;
- Cell selection and reselection;
- Location registration and RNA update.

PLMN selection, cell reselection procedures, and location registration are common for both RRC_IDLE state and RRC_INACTIVE state. RNA update is only applicable for RRC_INACTIVE state. When UE selects a new PLMN, UE transitions from RRC_INACTIVE to RRC_IDLE.

When a UE is switched on, a public land mobile network (PLMN) is selected by NAS. For the selected PLMN, associated RAT(s) may be set 3GPP TS 23.122 [9]. The NAS shall provide a list of equivalent PLMNs, if available, that the AS shall use for cell selection and cell reselection.

With cell selection, the UE searches for a suitable cell of the selected PLMN, chooses that cell to provide available services, and monitors its control channel. This procedure is defined as "camping on the cell".

The UE shall, if necessary, then register its presence, by means of a NAS registration procedure, in the tracking area of the chosen cell. As an outcome of a successful Location Registration, the selected PLMN then becomes the registered PLMN 3GPP TS 23.122 [9].

If the UE finds a more suitable cell, according to the cell reselection criteria, it reselects onto that cell and camps on it. If the new cell does not belong to at least one tracking area to which the UE is registered, location registration is performed. In RRC_INACTIVE state, if the new cell does not belong to the configured RNA, an RNA update procedure is performed.

If necessary, the UE shall search for higher priority PLMNs at regular time intervals as described in 3GPP TS 23.122 [9] and search for a suitable cell if another PLMN has been selected by NAS.

If the UE loses coverage of the registered PLMN, either a new PLMN is selected automatically (automatic mode), or an indication of available PLMNs is given to the user so that a manual selection can be performed (manual mode).

Registration is not performed by UEs only capable of services that need no registration.

The purpose of camping on a cell in RRC_IDLE state and RRC_INACTIVE state is fourfold:

- a) It enables the UE to receive system information from the PLMN.
- b) When registered and if the UE wishes to establish an RRC connection or resume a suspended RRC connection, it can do this by initially accessing the network on the control channel of the cell on which it is camped.
- c) If the network needs to send a message or deliver data to the registered UE, it knows (in most cases) the set of tracking areas (in RRC_IDLE state) or RNA (in RRC_INACTIVE state) in which the UE is camped. It can then send a "paging" message for the UE on the control channels of all the cells in the corresponding set of areas. The UE will then receive the paging message and can respond.
- d) It enables the UE to receive ETWS and CMAS notifications.

[TS 38.304, clause 4.5]

The cells are categorised according to which services they offer:

acceptable cell:

An "acceptable cell" is a cell on which the UE may camp to obtain limited service (originate emergency calls and receive ETWS and CMAS notifications). Such a cell shall fulfil the following requirements, which is the minimum set of requirements to initiate an emergency call and to receive ETWS and CMAS notification in an NR network:

- The cell is not barred, see subclause 5.3.1;
- The cell selection criteria are fulfilled, see subclause 5.2.3.2.

suitable cell:

A cell is considered as suitable if the following conditions are fulfilled:

- The cell is part of either:
 - the selected PLMN, or
 - the registered PLMN, or
 - a PLMN of the Equivalent PLMN list.
- The cell selection criteria are fulfilled, see subclause 5.2.3.2;

According to the latest information provided by NAS:

- The cell is not barred, see subclause 5.3.1;
- The cell is part of at least one TA that is not part of the list of "Forbidden Tracking Areas" TS 22.261 [12], which belongs to a PLMN that fulfils the first bullet above.

barred cell:

A cell is barred if it is so indicated in the system information TS 38.331 [3].

reserved cell:

A cell is reserved if it is so indicated in system information TS 38.331 [3].

Following exception to these definitions are applicable for UEs:

- if a UE has an ongoing emergency call, all acceptable cells of that PLMN are treated as suitable for the duration of the emergency call.

[TS 38.304, clause 5.2.1]

UE shall perform measurements for cell selection and reselection purposes as specified in TS 38.133 [8].

The NAS can control the RAT(s) in which the cell selection should be performed, for instance by indicating RAT(s) associated with the selected PLMN, and by maintaining a list of forbidden registration area(s) and a list of equivalent

PLMNs. The UE shall select a suitable cell based on RRC_IDLE or RRC_INACTIVE state measurements and cell selection criteria.

In order to expedite the cell selection process, stored information for several RATs, if available, may be used by the UE.

When camped on a cell, the UE shall regularly search for a better cell according to the cell reselection criteria. If a better cell is found, that cell is selected. The change of cell may imply a change of RAT. Details on performance requirements for cell reselection can be found in TS 38.133 [8].

The NAS is informed if the cell selection and reselection result in changes in the received system information relevant for NAS.

For normal service, the UE shall camp on a suitable cell, monitor control channel(s) of that cell so that the UE can:

- receive system information from the PLMN; and
- receive registration area information from the PLMN, e.g., tracking area information; and
- receive other AS and NAS Information; and
- if registered:
 - receive paging and notification messages from the PLMN; and
 - initiate transfer to Connected mode.

For cell selection in multi-beam operations, measurement quantity of a cell is up to UE implementation.

For cell reselection in multi-beam operations, using a maximum number (*nrofSS-BlocksToAverage*) of beams to be considered and a threshold (*absThreshSS-BlocksConsolidation*) which are configured for a cell, the measurement quantity of this cell is derived amongst the beams corresponding to the same cell based on SS/PBCH block as follows:

- if the highest beam measurement quantity value is below the threshold:
 - derive a cell measurement quantity as the highest beam measurement quantity value, where each beam measurement quantity is described in TS 38.215 [11].
- else:
 - derive a cell measurement quantity as the linear average of the power values of up to the maximum number of highest beam measurement quantity values above the threshold.

[TS 38.304, clause 5.2.3.1]

Cell selection is performed by one of the following two procedures:

- a) Initial cell selection (no prior knowledge of which RF channels are NR frequencies):
 1. The UE shall scan all RF channels in the NR bands according to its capabilities to find a suitable cell.
 2. On each frequency, the UE need only search for the strongest cell.
 3. Once a suitable cell is found, this cell shall be selected.
- b) Cell selection by leveraging stored information:
 1. This procedure requires stored information of frequencies and optionally also information on cell parameters from previously received measurement control information elements or from previously detected cells.
 2. Once the UE has found a suitable cell, the UE shall select it.
 3. If no suitable cell is found, the initial cell selection procedure in a) shall be started.

NOTE: Priorities between different frequencies or RATs provided to the UE by system information or dedicated signalling are not used in the cell selection process.

[TS 38.304, clause 5.2.3.2]

The cell selection criterion S is fulfilled when:

$$S_{rxlev} > 0 \text{ AND } S_{qual} > 0$$

$$S_{rxlev} = Q_{rxlevmeas} - (Q_{rxlevmin} + Q_{rxlevminoffset}) - P_{compensation} - Q_{offsettemp}$$

where:

$$S_{qual} = Q_{qualmeas} - (Q_{qualmin} + Q_{qualminoffset}) - Q_{offsettemp}$$

where:

S_{rxlev}	Cell selection RX level value (dB)
S_{qual}	Cell selection quality value (dB)
$Q_{offsettemp}$	Offset temporarily applied to a cell as specified in TS 38.331 [3] (dB)
$Q_{rxlevmeas}$	Measured cell RX level value (RSRP)
$Q_{qualmeas}$	Measured cell quality value (RSRQ)
$Q_{rxlevmin}$	Minimum required RX level in the cell (dBm). If the UE supports SUL frequency for this cell, $Q_{rxlevmin}$ is obtained from $RxLevMinSUL$, if present, in $SIB1$, $SIB2$ and $SIB4$, additionally, if $Q_{rxlevminoffsetcellSUL}$ is present in $SIB3$ and $SIB4$ for the concerned cell, this cell specific offset is added to the corresponding $Q_{rxlevmin}$ to achieve the required minimum RX level in the concerned cell; else $Q_{rxlevmin}$ is obtained from $q-RxLevMin$ in $SIB1$, $SIB2$ and $SIB4$, additionally, if $Q_{rxlevminoffsetcell}$ is present in $SIB3$ and $SIB4$ for the concerned cell, this cell specific offset is added to the corresponding $Q_{rxlevmin}$ to achieve the required minimum RX level in the concerned cell.
$Q_{qualmin}$	Minimum required quality level in the cell (dB). Additionally, if $Q_{qualminoffsetcell}$ is signalled for the concerned cell, this cell specific offset is added to achieve the required minimum quality level in the concerned cell.
$Q_{rxlevminoffset}$	Offset to the signalled $Q_{rxlevmin}$ taken into account in the S_{rxlev} evaluation as a result of a periodic search for a higher priority PLMN while camped normally in a VPLMN 3GPP TS 23.122 [9]
$Q_{qualminoffset}$	Offset to the signalled $Q_{qualmin}$ taken into account in the S_{qual} evaluation as a result of a periodic search for a higher priority PLMN while camped normally in a VPLMN 3GPP TS 23.122 [9]
$P_{compensation}$	If the UE supports the additional P_{max} in the $NS-P_{maxList}$, if present, in $SIB1$, $SIB2$ and $SIB4$: $max(P_{EMAX1} - P_{PowerClass}, 0) - (min(P_{EMAX2}, P_{PowerClass}) - min(P_{EMAX1}, P_{PowerClass}))$ (dB); else: $max(P_{EMAX1} - P_{PowerClass}, 0)$ (dB)
P_{EMAX1} , P_{EMAX2}	Maximum TX power level of a UE may use when transmitting on the uplink in the cell (dBm) defined as P_{EMAX} in TS 38.101 [15]. P_{EMAX1} and P_{EMAX2} are obtained from the $p-Max$ and $NS-P_{maxList}$ respectively in $SIB1$, $SIB2$ and $SIB4$ as specified in TS 38.331 [3].
$P_{PowerClass}$	Maximum RF output power of the UE (dBm) according to the UE power class as defined in TS 38.101 [15]

The signalled values $Q_{rxlevminoffset}$ and $Q_{qualminoffset}$ are only applied when a cell is evaluated for cell selection as a result of a periodic search for a higher priority PLMN while camped normally in a VPLMN (3GPP TS 23.122 [9]). During this periodic search for higher priority PLMN, the UE may check the S criteria of a cell using parameter values stored from a different cell of this higher priority PLMN.

[TS 38.304, clause 5.2.4.6]

The cell-ranking criterion R_s for serving cell and R_n for neighbouring cells is defined by:

$$R_s = Q_{meas,s} + Q_{hyst} - Q_{offsettemp}$$

$$R_n = Q_{meas,n} - Q_{offset} - Q_{offsettemp}$$

where:

Q_{meas}	RSRP measurement quantity used in cell reselections.
------------	--

Qoffset	For intra-frequency: Equals to Qoffset _{s,n} , if Qoffset _{s,n} is valid, otherwise this equals to zero. For inter-frequency: Equals to Qoffset _{s,n} plus Qoffset _{frequency} , if Qoffset _{s,n} is valid, otherwise this equals to Qoffset _{frequency} .
Qoffset _{temp}	Offset temporarily applied to a cell as specified in TS 38.331 [3].

The UE shall perform ranking of all cells that fulfil the cell selection criterion S, which is defined in 5.2.3.2.

The cells shall be ranked according to the R criteria specified above by deriving $Q_{meas,n}$ and $Q_{meas,s}$ and calculating the R values using averaged RSRP results.

If *rangeToBestCell* is not configured, the UE shall perform cell reselection to the highest ranked cell. If this cell is found to be not-suitable, the UE shall behave according to subclause 5.2.4.4.

If *rangeToBestCell* is configured, then the UE shall perform cell reselection to the cell with the highest number of beams above the threshold (i.e. *absThreshSS-BlocksConsolidation*) among the cells whose R value is within *rangeToBestCell* of the R value of the highest ranked cell. If there are multiple such cells, the UE shall perform cell reselection to the highest ranked cell among them. If this cell is found to be not-suitable, the UE shall behave according to subclause 5.2.4.4.

In all cases, the UE shall reselect the new cell, only if the following conditions are met:

- the new cell is better ranked than the serving cell during a time interval $T_{reselection,RAT}$;
- more than 1 second has elapsed since the UE camped on the current serving cell.

[TS 38.304, clause 5.3.1]

Cell status and cell reservations are indicated in the *MIB* or *SIB1* message TS 38.331 [3] by means of three fields:

- *cellBarred* (IE type: "barred" or "not barred")
Indicated in *MIB* message. In case of multiple PLMNs indicated in *SIB1*, this field is common for all PLMNs
- *cellReservedForOperatorUse* (IE type: "reserved" or "not reserved")
Indicated in *SIB1* message. In case of multiple PLMNs indicated in *SIB1*, this field is specified per PLMN.
- *cellReservedForOtherUse* (IE type: "true")
Indicated in *SIB1* message. In case of multiple PLMNs indicated in *SIB1*, this field is common for all PLMNs.

When cell status is indicated as "not barred" and "not reserved" for operator use and not "true" for other use,

- All UEs shall treat this cell as candidate during the cell selection and cell reselection procedures.

When cell status is indicated as "true" for other use,

- The UE shall treat this cell as if cell status is "barred".

When cell status is indicated as "not barred" and "reserved" for operator use for any PLMN and not "true" for other use,

- UEs assigned to Access Identity 11 or 15 operating in their HPLMN/EHPLMN shall treat this cell as candidate during the cell selection and reselection procedures if the field *cellReservedForOperatorUse* for that PLMN set to "reserved".
- UEs assigned to an Access Identity in the range of 0 to 10 and 12 to 14 shall behave as if the cell status is "barred" in case the cell is "reserved for operator use" for the registered PLMN or the selected PLMN.

NOTE 1: Access Identities 11, 15 are only valid for use in the HPLMN/ EHPLMN; Access Identities 12, 13, 14 are only valid for use in the home country as specified in 3GPP TS 22.261 [12].

When cell status "barred" is indicated or to be treated as if the cell status is "barred",

- The UE is not permitted to select/reselect this cell, not even for emergency calls.
- The UE shall select another cell according to the following rule:
- If the cell is to be treated as if the cell status is "barred" due to being unable to acquire the *MIB* or the *SIB1*:

- the UE may exclude the barred cell as a candidate for cell selection/reselection for up to 300 seconds.
- the UE may select another cell on the same frequency if the selection criteria are fulfilled.
- else
 - If the field *intraFreqReselection* in *MIB* message is set to "allowed", the UE may select another cell on the same frequency if re-selection criteria are fulfilled;
 - The UE shall exclude the barred cell as a candidate for cell selection/reselection for 300 seconds.
 - If the field *intraFreqReselection* in *MIB* message is set to "not allowed" the UE shall not re-select a cell on the same frequency as the barred cell;
 - The UE shall exclude the barred cell and the cells on the same frequency as a candidate for cell selection/reselection for 300 seconds.

The cell selection of another cell may also include a change of RAT.

6.1.2.2.3 Test description

6.1.2.2.3.1 Pre-test conditions

System Simulator:

- NR Cell 1 and NR Cell 11 have different tracking areas according to TS 38.508-1 [4] Table 4.4.2-3.
- NR Cell 1 and NR Cell 11 are configured to operate in FR1 bands as defined in TS 38.508-1 [4] clause 6.2.3.
- System information combination NR-2 as defined in TS 38.508-1 [4] clause 4.4.3.1.2, and message contents defined in is used in NR cells.

UE:

- None.

Preamble:

- The UE is in state Switched OFF (state 0-A) according to TS 38.508-1 [4].

6.1.2.2.3.2 Test procedure sequence

Table 6.1.2.2.3.2-1 illustrates the downlink power levels and other changing parameters to be applied for the cell at various time instants of the test execution. The exact instants on which these values shall be applied are described in the texts in this clause. Configurations marked "T1" "T2" and "T3" are applied at the points indicated in the Main behaviour description in Table 6.1.2.2.3.2-3.

Table 6.1.2.2.3.2-1: Time instances of cell power level and parameter changes for FR1

	Parameter	Unit	NR Cell 1	NR Cell 11	Remark
T1	SS/PBCH SSS EPRE	dBm/ SCS	-91	Off	The power level value is such to satisfy $Sr_{xlevNRCell1} > 0$ and $Squal_{NRCell1} < 0$ but the UE is able to read the PLMN identity
	RSRQ	dB	-12.56	-	
	Noc	dBm/ SCS	-94		Noc is applied for NRf1
	Qrxlevmin	dBm	-110	-	
	Qrxlevminoffset	dB	0	-	
	Qqualmin	dB	-12	-	
	Qqualminoffset	dB	0	-	
Pcompensation	dB	0	-		
T2	SS/PBCH SSS EPRE	dBm/ SCS	-78	-115	The power level is such that $Sr_{xlevNRCell1} > 0$ and $Squal_{NRCell1} > 0$
	RSRQ	dB	-10.89	-31.83	

	Noc	dBm/SCS	-94		
	Qrxlevmin	dBm	-110	-110	
	Qrxlevminoffset	dB	0	0	
	Qqualmin	dB	-12	-12	
	Qqualminoffset	dB	0	-0	
	Pcompensation	dB	0	-0	
T3	SS/PBCH SSS EPRE	dBm/SCS	-91	-78	Srxlev _{NRCell1} > 0 and Squal _{NRCell1} < 0
	RSRQ	dB	-12.56	-10.89	
	Noc	dBm/SCS	-94		
	Qrxlevmin	dBm	-110	-110	
	Qrxlevminoffset	dB	0	0	
	Qqualmin	dB	-12	-12	
	Qqualminoffset	dB	0	0	
	Pcompensation	dB	0	0	
	Srxlev*	dB	19	32	NR Cell 11 is suitable cell
	Squal*	dB	-0.56	1.11	
Note: The downlink signal level uncertainty is specified in TS 38.508-1 [4] clause 6.2.2.1					

Table 6.1.2.2.3.2-2: Void

Table 6.1.2.2.3.2-3: Main behaviour

St	Procedure	Message Sequence		TP	Verdict
		U - S	Message		
1	SS adjusts the SS/PBCH EPRE level of NR Cell 1 according to row "T1" in table 6.1.2.2.3.2-1.	-	-	-	-
2	The UE is switched on.	-	-	-	-
3	Check: Does the UE send an <i>RRCSetupRequest</i> on NR Cell 1 within the next 60 s?	-->	NR RRC: <i>RRCSetupRequest</i>	1	F
4	SS re-adjusts the SS/PBCH EPRE level of NR Cell 1 level according to row "T2" in table 6.1.2.2.3.2-1.	-	-	-	-
5	Check: Does the UE send an <i>RRCSetupRequest</i> on NR Cell 1?	-->	NR RRC: <i>RRCSetupRequest</i>	2	P
6-23	Steps 3 to 20 of the registration procedure described in TS 38.508-1 [4] Table 4.5.2.2-2 are performed on NR Cell 1. NOTE: The UE performs registration and the RRC connection is released.	-	-	-	-
24	SS adjusts the SS/PBCH EPRE level of NR Cell 1 and NR Cell 11 according to row "T3" in table 6.1.2.2.3.2-1.	-	-	-	-
25	Check: Does the test result of generic test procedure in TS 38.508-1 [4] Table 4.9.5.2.2-1 indicate that the UE is camped on NR Cell 11? NOTE: The UE performs a registration for mobility procedure and the RRC connection is released.	-	-	3	P

6.1.2.2.3.3 Specific message contents

Table 6.1.2.2.3.3-1: SIB1 (NR Cell 1, Preamble and all steps of Table 6.1.2.2.3.2-3)

Derivation Path: TS 38.508-1 [4], Table 4.6.1-28 with Condition QBASED			
Information Element	Value/remark	Comment	Condition
SIB1 ::= SEQUENCE {			
cellSelectionInfo SEQUENCE {			

q-QualMin	-12		FR1
}			
}			

Table 6.1.2.2.3.3-2: SIB2 (NR Cell 1, Preamble and all steps of Table 6.1.2.2.3.2-3)

Derivation Path: TS 38.508-1 [4], Table 4.6.2-1 with Condition QBASED			
Information Element	Value/remark	Comment	Condition
SIB2 ::= SEQUENCE {			
intraFreqCellReselectionInfo SEQUENCE {			
q-QualMin	-12	-12dB	FR1
}			
}			

6.1.2.3 Cell selection / Intra NR / Serving cell becomes non-suitable (S<0, MIB Indicated barred)

6.1.2.3.1 Test Purpose (TP)

(1)

```
with { UE in NR RRC_IDLE state }
ensure that {
  when { the serving cell becomes non-suitable (S<0) and there is a suitable neighbour cell (S>0) }
  then { UE selects the suitable neighbour cell }
}
```

(2)

```
with { UE in NR RRC_IDLE state }
ensure that {
  when { the serving cell becomes barred and there is a suitable neighbour cell }
  then { UE selects the suitable neighbour cell }
}
```

6.1.2.3.2 Conformance requirements

References: The conformance requirements covered in the present TC are specified in: 3GPP TS 38.304 clause 4.1, 5.2.3.2 and 5.3.1. Unless otherwise stated these are Rel-15 requirements.

[TS 38.304, clause 4.1]

The RRC_IDLE state and RRC_INACTIVE state tasks can be subdivided into three processes:

- PLMN selection;
- Cell selection and reselection;
- Location registration and RNA update.

PLMN selection, cell reselection procedures, and location registration are common for both RRC_IDLE state and RRC_INACTIVE state. RNA update is only applicable for RRC_INACTIVE state. When UE selects a new PLMN, UE transitions from RRC_INACTIVE to RRC_IDLE.

When a UE is switched on, a public land mobile network (PLMN) is selected by NAS. For the selected PLMN, associated RAT(s) may be set 3GPP TS 23.122 [9]. The NAS shall provide a list of equivalent PLMNs, if available, that the AS shall use for cell selection and cell reselection.

With cell selection, the UE searches for a suitable cell of the selected PLMN, chooses that cell to provide available services, and monitors its control channel. This procedure is defined as "camping on the cell".

The UE shall, if necessary, then register its presence, by means of a NAS registration procedure, in the tracking area of the chosen cell. As an outcome of a successful Location Registration, the selected PLMN then becomes the registered PLMN 3GPP TS 23.122 [9].

If the UE finds a more suitable cell, according to the cell reselection criteria, it reselects onto that cell and camps on it. If the new cell does not belong to at least one tracking area to which the UE is registered, location registration is performed. In RRC_INACTIVE state, if the new cell does not belong to the configured RNA, an RNA update procedure is performed.

If necessary, the UE shall search for higher priority PLMNs at regular time intervals as described in 3GPP TS 23.122 [9] and search for a suitable cell if another PLMN has been selected by NAS.

If the UE loses coverage of the registered PLMN, either a new PLMN is selected automatically (automatic mode), or an indication of available PLMNs is given to the user so that a manual selection can be performed (manual mode).

Registration is not performed by UEs only capable of services that need no registration.

The purpose of camping on a cell in RRC_IDLE state and RRC_INACTIVE state is fourfold:

- a) It enables the UE to receive system information from the PLMN.
- b) When registered and if the UE wishes to establish an RRC connection or resume a suspended RRC connection, it can do this by initially accessing the network on the control channel of the cell on which it is camped.
- c) If the network needs to send a message or deliver data to the registered UE, it knows (in most cases) the set of tracking areas (in RRC_IDLE state) or RNA (in RRC_INACTIVE state) in which the UE is camped. It can then send a "paging" message for the UE on the control channels of all the cells in the corresponding set of areas. The UE will then receive the paging message and can respond.
- d) It enables the UE to receive ETWS and CMAS notifications.

[TS 38.304, clause 5.2.3.2]

The cell selection criterion S is fulfilled when:

$$S_{rxlev} > 0 \text{ AND } S_{qual} > 0$$

where:

$$S_{rxlev} = Q_{rxlevmeas} - (Q_{rxlevmin} + Q_{rxlevminoffset}) - P_{compensation} - Q_{offsettemp}$$

$$S_{qual} = Q_{qualmeas} - (Q_{qualmin} + Q_{qualminoffset}) - Q_{offsettemp}$$

where:

S_{rxlev}	Cell selection RX level value (dB)
S_{qual}	Cell selection quality value (dB)
$Q_{offsettemp}$	Offset temporarily applied to a cell as specified in TS 38.331 [3] (dB)
$Q_{rxlevmeas}$	Measured cell RX level value (RSRP)
$Q_{qualmeas}$	Measured cell quality value (RSRQ)
$Q_{rxlevmin}$	Minimum required RX level in the cell (dBm). If the UE supports SUL frequency for this cell, $Q_{rxlevmin}$ is obtained from $RxLevMinSUL$, if present, in <i>SIB1</i> , <i>SIB2</i> and <i>SIB4</i> , additionally, if $Q_{rxlevminoffsetcellSUL}$ is present in <i>SIB3</i> and <i>SIB4</i> for the concerned cell, this cell specific offset is added to the corresponding $Q_{rxlevmin}$ to achieve the required minimum RX level in the concerned cell; else $Q_{rxlevmin}$ is obtained from $q-RxLevMin$ in <i>SIB1</i> , <i>SIB2</i> and <i>SIB4</i> , additionally, if $Q_{rxlevminoffsetcell}$ is present in <i>SIB3</i> and <i>SIB4</i> for the concerned cell, this cell specific offset is added to the corresponding $Q_{rxlevmin}$ to achieve the required minimum RX level in the concerned cell.
$Q_{qualmin}$	Minimum required quality level in the cell (dB). Additionally, if $Q_{qualminoffsetcell}$ is signalled for the concerned cell, this cell specific offset is added to achieve the required minimum quality level in the concerned cell.
$Q_{rxlevminoffset}$	Offset to the signalled $Q_{rxlevmin}$ taken into account in the S_{rxlev} evaluation as a result of a periodic search for a higher priority PLMN

	while camped normally in a VPLMN 3GPP TS 23.122 [9]
$Q_{\text{qualminoffset}}$	Offset to the signalled Q_{qualmin} taken into account in the Squal evaluation as a result of a periodic search for a higher priority PLMN while camped normally in a VPLMN 3GPP TS 23.122 [9]
$P_{\text{compensation}}$	If the UE supports the additionalPmax in the NS-PmaxList, if present, in <i>SIB1</i> , <i>SIB2</i> and <i>SIB4</i> : $\max(P_{\text{EMAX1}} - P_{\text{PowerClass}}, 0) - (\min(P_{\text{EMAX2}}, P_{\text{PowerClass}}) - \min(P_{\text{EMAX1}}, P_{\text{PowerClass}}))$ (dB); else: $\max(P_{\text{EMAX1}} - P_{\text{PowerClass}}, 0)$ (dB)
P_{EMAX1} , P_{EMAX2}	Maximum TX power level of a UE may use when transmitting on the uplink in the cell (dBm) defined as P_{EMAX} in TS 38.101 [15]. P_{EMAX1} and P_{EMAX2} are obtained from the <i>p-Max</i> and <i>NS-PmaxList</i> respectively in <i>SIB1</i> , <i>SIB2</i> and <i>SIB4</i> as specified in TS 38.331 [3].
$P_{\text{PowerClass}}$	Maximum RF output power of the UE (dBm) according to the UE power class as defined in TS 38.101 [15]

The signalled values $Q_{\text{rxlevminoffset}}$ and $Q_{\text{qualminoffset}}$ are only applied when a cell is evaluated for cell selection as a result of a periodic search for a higher priority PLMN while camped normally in a VPLMN (3GPP TS 23.122 [9]). During this periodic search for higher priority PLMN, the UE may check the S criteria of a cell using parameter values stored from a different cell of this higher priority PLMN.

[TS 38.304, clause 5.3.1]

Cell status and cell reservations are indicated in the *MIB* or *SIB1* message TS 38.331 [3] by means of three fields:

- *cellBarred* (IE type: "barred" or "not barred")
Indicated in *MIB* message. In case of multiple PLMNs indicated in *SIB1*, this field is common for all PLMNs
- *cellReservedForOperatorUse* (IE type: "reserved" or "not reserved")
Indicated in *SIB1* message. In case of multiple PLMNs indicated in *SIB1*, this field is specified per PLMN.
- *cellReservedForOtherUse* (IE type: "true")
Indicated in *SIB1* message. In case of multiple PLMNs indicated in *SIB1*, this field is common for all PLMNs.

When cell status is indicated as "not barred" and "not reserved" for operator use and not "true" for other use,

- All UEs shall treat this cell as candidate during the cell selection and cell reselection procedures.

When cell status is indicated as "true" for other use,

- The UE shall treat this cell as if cell status is "barred".

When cell status is indicated as "not barred" and "reserved" for operator use for any PLMN and not "true" for other use,

- UEs assigned to Access Identity 11 or 15 operating in their HPLMN/EHPLMN shall treat this cell as candidate during the cell selection and reselection procedures if the field *cellReservedForOperatorUse* for that PLMN set to "reserved".
- UEs assigned to an Access Identity in the range of 0 to 10 and 12 to 14 shall behave as if the cell status is "barred" in case the cell is "reserved for operator use" for the registered PLMN or the selected PLMN.

NOTE 1: Access Identities 11, 15 are only valid for use in the HPLMN/ EHPLMN; Access Identities 12, 13, 14 are only valid for use in the home country as specified in 3GPP TS 22.261 [12].

When cell status "barred" is indicated or to be treated as if the cell status is "barred",

- The UE is not permitted to select/reselect this cell, not even for emergency calls.
- The UE shall select another cell according to the following rule:
- If the cell is to be treated as if the cell status is "barred" due to being unable to acquire the *MIB* or the *SIB1*:
 - the UE may exclude the barred cell as a candidate for cell selection/reselection for up to 300 seconds.
 - the UE may select another cell on the same frequency if the selection criteria are fulfilled.

- else
 - If the field *intraFreqReselection* in *MIB* message is set to "allowed", the UE may select another cell on the same frequency if re-selection criteria are fulfilled;
 - The UE shall exclude the barred cell as a candidate for cell selection/reselection for 300 seconds.
 - If the field *intraFreqReselection* in *MIB* message is set to "not allowed" the UE shall not re-select a cell on the same frequency as the barred cell;
 - The UE shall exclude the barred cell and the cells on the same frequency as a candidate for cell selection/reselection for 300 seconds.

The cell selection of another cell may also include a change of RAT.

6.1.2.3.3 Test description

6.1.2.3.3.1 Pre-test conditions

System Simulator:

- NR Cell 1 and NR Cell 11 have different tracking areas according to TS 38.508-1 [4] Table 4.4.2-3.
- System information combination NR-2 as defined in TS 38.508-1 [4] clause 4.4.3.1.2 is used in NR cells.

UE:

None.

Preamble:

- UE is in state 1N-A on NR Cell 1(serving cell) according to 38.508-1 [4].

6.1.2.3.3.2 Test procedure sequence

Table 6.1.2.3.3.2-1/2 illustrate the downlink power levels and other changing parameters to be applied for the cells at various time instants of the test execution. The exact instants on which these values shall be applied are described in the texts in this clause. The configuration T0 indicates the initial conditions for preamble. Configurations marked "T1" and "T2" are applied at the points indicated in the Main behaviour description in Table 6.1.2.3.3.2-3.

Table 6.1.2.3.3.2-1: Time instances of cell power level and parameter changes for FR1

	Parameter	Unit	NR Cell 1	NR Cell 11	Remark
T0	SS/PBCH SSS EPRE	dBm/SCS	-88	"Off"	The power level values are assigned to ensure the UE registered on NR Cell 1.
	Qrxlevmin	dBm	-110	-	
T1	SS/PBCH SSS EPRE	dBm/SCS	"Off"	-88	SrxlevNRCell 1 < 0 (NOTE 1)
	Qrxlevmin	dBm	-	-110	
T2	SS/PBCH SSS EPRE	dBm/SCS	-94	-88	SrxlevNRCell 11 > 0, SrxlevNRCell 1 > 0
	Qrxlevmin	dBm	-110	-110	
	cellBarred	-	notBarred	barred	
NOTE 1: Power level "Off" is defined in TS 38.508-1 [4] Table 6.2.2.1-3.					

Table 6.1.2.3.3.2-2: Time instances of cell power level and parameter changes for FR2

	Parameter	Unit	NR Cell 1	NR Cell 11	Remark
T0	SS/PBCH SSS EPRE	dBm/SCS	FFS	"Off"	The power level values are assigned to ensure the UE registered on NR Cell 1.
	Qrxlevmin	dBm	FFS	-	
T1	SS/PBCH SSS EPRE	dBm/	"Off"	FFS	SrxlevNRCell 1 < 0 (NOTE 1)

		SCS			
	Qrxlevmin	dBm	-	FFS	
T2	SS/PBCH SSS EPRE	dBm/ SCS	FFS	FFS	SrxlevNRCell 11 > 0, SrxlevVNRCell 1 > 0
	Qrxlevmin	dBm	FFS	FFS	
	cellBarred	-	notBarred	barred	Serving cell becomes barred
NOTE 1: Power level "Off" is defined in TS 38.508-1 [4] Table 6.2.2.2-2.					

NOTE: If the UE fails the test because of a failure to detect and reselect to a right cell, then the operator may re-run the test.

Table 6.1.2.3.3.2-3: Main behaviour

St	Procedure	Message Sequence		TP	Verdict
		U - S	Message		
1	SS re-adjusts the SS/PBCH EPRE level of NR Cell 1 and NR Cell 11 according to row "T1" in table 6.1.2.3.3.2-1/2.	-	-	-	-
2	Check: Does the test result of generic test procedure in TS 38.508-1 [4] clause 4.9.5 indicate that the UE is camped on NR Cell 11? NOTE: The UE performs a registration for mobility procedure and the RRC connection is released.	-	-	1	-
3	SS changes NR Cell 11 SS/PBCH EPRE level and MIB IE <i>cellBarred</i> according to row "T2" in table 6.1.2.3.3.2-1/2. And SS transmits Short Message on PDCCH addressed to P-RNTI using Short Message field in DCI format 1_0. Bit 1 of Short Message field is set to 1 to indicate the SysInfo Modification.	-	-	-	-
4	Check: Does the test result of generic test procedure in TS 38.508-1 [4] clause 4.9.5 indicate that the UE is camped on NR Cell 1? NOTE: The RRC connection is released and UE is in RRC_IDLE mode.	-	-	2	-

6.1.2.3.3.3 Specific message contents

Table 6.1.2.3.3.3-1: SIB1 for NR Cells 1 and 11 (Preamble and all steps, table 6.1.2.3.3.2-3)

Derivation Path: TS 38.508-1 [4], Table 4.6.1-28			
Information Element	Value/remark	Comment	Condition
SIB1 ::= SEQUENCE {			
cellSelectionInfo SEQUENCE {			
q-RxLevMin	-55	-110 dBm	FR1
	FFS		FR2
}			
}			

Table 6.1.2.3.3.3-2: SIB2 for NR Cells 1 and 11 (Preamble and all steps, table 6.1.2.3.3.2-3)

Derivation Path: TS 38.508-1 [4], Table 4.6.2-1			
Information Element	Value/remark	Comment	Condition
SIB2 ::= SEQUENCE {			
cellReselectionInfoCommon SEQUENCE {			
rangeToBestCell	Not present		
}			
intraFreqCellReselectionInfo SEQUENCE {			
q-RxLevMin	-55	-110 dBm	FR1
	FFS		FR2
t-ReselectionNR	7		

}			
}			

Table 6.1.2.3.3.3-3: MIB for NR Cell 11 (step 3, Table 6.1.2.3.3.2-3)

Derivation Path: TS 38.508-1 [4], Table 4.6.1-6			
Information Element	Value/remark	Comment	Condition
MIB ::= SEQUENCE {			
cellBarred	barred		
}			

6.1.2.4 Cell reselection for interband operation

6.1.2.4.1 Test Purpose (TP)

(1)

```
with { UE in NR RRC_IDLE state }
ensure that {
  when { UE detects the cell re-selection criteria are met for the cell on the different frequency band }
  then { UE reselects the new cell }
}
```

6.1.2.4.2 Conformance requirements

References: The conformance requirements covered in the present TC are specified in TS 38.304: clause 5.2.3.2 and 5.2.4.5. Unless otherwise stated these are Rel-15 requirements.

[TS 38.304, clause 5.2.3.2]

The cell selection criterion S is fulfilled when:

$$S_{rxlev} > 0 \text{ AND } S_{qual} > 0$$

where:

$$S_{rxlev} = Q_{rxlevmeas} - (Q_{rxlevmin} + Q_{rxlevminoffset}) - P_{compensation} - Q_{offsettemp}$$

$$S_{qual} = Q_{qualmeas} - (Q_{qualmin} + Q_{qualminoffset}) - Q_{offsettemp}$$

where:

S _{rxlev}	Cell selection RX level value (dB)
S _{qual}	Cell selection quality value (dB)
Q _{offsettemp}	Offset temporarily applied to a cell as specified in TS 38.331 [3] (dB)
Q _{rxlevmeas}	Measured cell RX level value (RSRP)
Q _{qualmeas}	Measured cell quality value (RSRQ)
Q _{rxlevmin}	Minimum required RX level in the cell (dBm). If the UE supports SUL frequency for this cell, Q _{rxlevmin} is obtained from <i>RxLevMinSUL</i> , if present, in <i>SIB1</i> , <i>SIB2</i> and <i>SIB4</i> , additionally, if Q _{rxlevminoffsetcellSUL} is present in <i>SIB3</i> and <i>SIB4</i> for the concerned cell, this cell specific offset is added to the corresponding Q _{rxlevmin} to achieve the required minimum RX level in the concerned cell; else Q _{rxlevmin} is obtained from <i>q-RxLevMin</i> in <i>SIB1</i> , <i>SIB2</i> and <i>SIB4</i> , additionally, if Q _{rxlevminoffsetcell} is present in <i>SIB3</i> and <i>SIB4</i> for the concerned cell, this cell specific offset is added to the corresponding Q _{rxlevmin} to achieve the required minimum RX level in the concerned cell.
Q _{qualmin}	Minimum required quality level in the cell (dB). Additionally, if Q _{qualminoffsetcell} is signalled for the concerned cell, this cell specific offset is added to achieve the required minimum quality level in the concerned cell.

$Q_{rxlevminoffset}$	Offset to the signalled $Q_{rxlevmin}$ taken into account in the S_{rxlev} evaluation as a result of a periodic search for a higher priority PLMN while camped normally in a VPLMN, as specified in TS 23.122 [9]
$Q_{qualminoffset}$	Offset to the signalled $Q_{qualmin}$ taken into account in the S_{qual} evaluation as a result of a periodic search for a higher priority PLMN while camped normally in a VPLMN, as specified in TS 23.122 [9]
$P_{compensation}$	If the UE supports the additional P_{max} in the NR-NS- $P_{maxList}$, if present, in $SIB1$, $SIB2$ and $SIB4$: $max(P_{EMAX1} - P_{PowerClass}, 0) - (min(P_{EMAX2}, P_{PowerClass}) - min(P_{EMAX1}, P_{PowerClass}))$ (dB); else: $max(P_{EMAX1} - P_{PowerClass}, 0)$ (dB)
P_{EMAX1} , P_{EMAX2}	Maximum TX power level of a UE may use when transmitting on the uplink in the cell (dBm) defined as P_{EMAX} in TS 38.101 [15]. If UE supports SUL frequency for this cell, P_{EMAX1} and P_{EMAX2} are obtained from the p -Max for SUL in $SIB1$ and NR-NS- $P_{maxList}$ for SUL respectively in $SIB1$, $SIB2$ and $SIB4$ as specified in TS 38.331 [3], else P_{EMAX1} and P_{EMAX2} are obtained from the p -Max and NR-NS- $P_{maxList}$ respectively in $SIB1$, $SIB2$ and $SIB4$ for regular UL as specified in TS 38.331 [3].
$P_{PowerClass}$	Maximum RF output power of the UE (dBm) according to the UE power class as defined in TS 38.101 [15]

The signalled values $Q_{rxlevminoffset}$ and $Q_{qualminoffset}$ are only applied when a cell is evaluated for cell selection as a result of a periodic search for a higher priority PLMN while camped normally in a VPLMN (TS 23.122 [9]). During this periodic search for higher priority PLMN, the UE may check the S criteria of a cell using parameter values stored from a different cell of this higher priority PLMN. [TS 38.304, clause 5.2.4.5]

If $threshServingLowQ$ is broadcast in system information and more than 1 second has elapsed since the UE camped on the current serving cell, cell reselection to a cell on a higher priority NR frequency or inter-RAT frequency than the serving frequency shall be performed if:

- A cell of a higher priority NR or EUTRAN RAT/frequency fulfils $S_{qual} > Thresh_{X, HighQ}$ during a time interval $T_{reselection_{RAT}}$

Otherwise, cell reselection to a cell on a higher priority NR frequency or inter-RAT frequency than the serving frequency shall be performed if:

- A cell of a higher priority RAT/ frequency fulfils $S_{rxlev} > Thresh_{X, HighP}$ during a time interval $T_{reselection_{RAT}}$; and
- More than 1 second has elapsed since the UE camped on the current serving cell.

Cell reselection to a cell on an equal priority NR frequency shall be based on ranking for intra-frequency cell reselection as defined in subclause 5.2.4.6.

If $threshServingLowQ$ is broadcast in system information and more than 1 second has elapsed since the UE camped on the current serving cell, cell reselection to a cell on a lower priority NR frequency or inter-RAT frequency than the serving frequency shall be performed if:

- The serving cell fulfils $S_{qual} < Thresh_{Serving, LowQ}$ and a cell of a lower priority NR or E-UTRAN RAT/ frequency fulfils $S_{qual} > Thresh_{X, LowQ}$ during a time interval $T_{reselection_{RAT}}$.

Otherwise, cell reselection to a cell on a lower priority NR frequency or inter-RAT frequency than the serving frequency shall be performed if:

- The serving cell fulfils $S_{rxlev} < Thresh_{Serving, LowP}$ and a cell of a lower priority RAT/ frequency fulfils $S_{rxlev} > Thresh_{X, LowP}$ during a time interval $T_{reselection_{RAT}}$; and
- More than 1 second has elapsed since the UE camped on the current serving cell.

Cell reselection to a higher priority RAT/frequency shall take precedence over a lower priority RAT/frequency if multiple cells of different priorities fulfil the cell reselection criteria.

If more than one cell meets the above criteria, the UE shall reselect a cell as follows:

- If the highest-priority frequency is an NR frequency, the highest ranked cell among the cells on the highest priority frequency(ies) meeting the criteria according to clause 5.2.4.6;
- If the highest-priority frequency is from another RAT, the highest ranked cell among the cells on the highest priority frequency(ies) meeting the criteria of that RAT.

6.1.2.4.3 Test description

6.1.2.4.3.1 Pre-test conditions

System Simulator:

- NR Cell 1 and NR Cell 10.
- System information combination NR-4 as defined in TS 38.508-1 [4] Table 4.4.3.1.2-1 is used in NR cells.

UE:

None.

Preamble:

- The UE is in state 1N-A on NR Cell 1(serving cell) according to TS 38.508-1 [4] Table 4.4A.2-1.

6.1.2.4.3.2 Test procedure sequence

Table 6.1.2.4.3.2-1/2 illustrates the downlink power levels and other changing parameters to be applied for the NR cells at various time instants of the test execution. The exact instants on which these values shall be applied are described in the texts in this clause. The configuration "T0" indicates the initial conditions. Subsequent configurations marked "T1" is applied at the points indicated in the Main behaviour description in Table 6.1.2.4.3.2-3.

Table 6.1.2.4.3.2-1: Time instances of cell power level and parameter changes for conducted test environment

	Parameter	Unit	NR Cell 1	NR Cell 10	Remark
T0	SS/PBCH SSS EPRE	dBm/SCS	-88	Off	The power level values are assigned to ensure the UE registered on NR Cell 1.
T1	SS/PBCH SSS EPRE	dBm/SCS	-88	-78	NR Cell 10 become stronger than Thresh _{NR Cell 10, high} .
Note: Power level "Off" is defined in TS38.508-1 [4] Table 6.2.2.1-3.					

Table 6.1.2.4.3.2-2: Time instances of cell power level and parameter changes for OTA test environment

	Parameter	Unit	NR Cell 1	NR Cell 10	Remark
T0	SS/PBCH SSS EPRE	dBm/SCS	FFS	Off	The power level values are assigned to ensure the UE registered on NR Cell 1.
T1	SS/PBCH SSS EPRE	dBm/SCS	FFS	FFS	NR Cell 10 become stronger than Thresh _{NR Cell 10, high} .
Note: The uncertain downlink signal level is specified in TS 38.508-1 [4] clause FFS.					

Table 6.1.2.4.3.2-3: Main behaviour

St	Procedure	Message Sequence	TP	Verdict
----	-----------	------------------	----	---------

		U - S	Message		
1	The SS changes NR Cell 10 SS/PBCH EPRE level according to the row "T1" in table 6.1.2.4.3.2-1/2.	-	-	-	-
2	Wait for 34 seconds to allow UE to recognise the change.	-	-	-	-
3	Check: Does the test result of generic test procedure in TS 38.508-1 [4] Table 4.9.4.2.2-1 indicate that the UE is camped on NR Cell 10?	-	-	1	-

6.1.2.4.3.3 Specific message contents

Table 6.1.2.4.3.3-1: Conditions for specific message contents in Tables below

Condition	Explanation
NR Cell 1	This condition applies to system information transmitted on NR Cell 1.
NR Cell 10	This condition applies to system information transmitted on NR Cell 10.

Table 6.1.2.4.3.3-2: SIB2 of NR Cell 1 and NR Cell10 (preamble and all steps, Table 6.1.2.4.3.2-3)

Derivation Path: TS 38.508-1 [4], Table 4.6.2-1			
Information Element	Value/remark	Comment	Condition
SIB2::= SEQUENCE {			
cellReselectionServingFreqInfo			
SEQUENCE{			
cellReselectionPriority	1		NR Cell 1
	5		NR Cell 10
}			
}			

Table 6.1.2.4.3.3-3: SIB4 of NR Cell 1 and NR Cell 10 (preamble and all steps, Table 6.1.2.4.3.2-3)

Derivation Path: TS 38.508-1 [4], Table 4.6.2-3			
Information Element	Value/remark	Comment	Condition
SIB4::= SEQUENCE {			
InterFreqCarrierFreqList SEQUENCE (SIZE (1..maxFreq)) OF InterFreqCarrierFreqInfo {	1 entry		
InterFreqCarrierFreqInfo[1] SEQUENCE {		entry 1	
dl-CarrierFreq	Same downlink ARFCN as used for NR Cell 10		NR Cell 1
	Same downlink ARFCN as used for NR Cell 1		NR Cell 10
t-ReselectionNR	7	seconds	
threshX-HighP	10	20 dB	
cellReselectionPriority	5		NR Cell 1
	1		NR Cell 10
}			
}			

6.1.2.5 Cell reselection for interband operation using Pcompensation / Between FDD and TDD

6.1.2.5.1 Test Purpose (TP)

(1)

```
with { UE in NR RRC_IDLE state on a FDD band }
ensure that {
  when { UE detects the cell selection using Pcompensation & reselection criteria is met for the
  cell on a TDD band }
  then { UE reselects the new cell }
}
```

6.1.2.5.2 Conformance requirements

References: The conformance requirements covered in the present TC are specified in TS 38.304: clause 5.2.3.2 and 5.2.4.5. Unless otherwise stated these are Rel-15 requirements.

[TS 38.304, clause 5.2.3.2]

The cell selection criterion S is fulfilled when:

$$S_{rxlev} > 0 \text{ AND } S_{qual} > 0$$

where:

$$S_{rxlev} = Q_{rxlevmeas} - (Q_{rxlevmin} + Q_{rxlevminoffset}) - P_{compensation} - Q_{offsettemp}$$

$$S_{qual} = Q_{qualmeas} - (Q_{qualmin} + Q_{qualminoffset}) - Q_{offsettemp}$$

where:

S_{rxlev}	Cell selection RX level value (dB)
S_{qual}	Cell selection quality value (dB)
$Q_{offsettemp}$	Offset temporarily applied to a cell as specified in TS 38.331 [3] (dB)
$Q_{rxlevmeas}$	Measured cell RX level value (RSRP)
$Q_{qualmeas}$	Measured cell quality value (RSRQ)
$Q_{rxlevmin}$	Minimum required RX level in the cell (dBm). If the UE supports SUL frequency for this cell, $Q_{rxlevmin}$ is obtained from $RxLevMinSUL$, if present, in <i>SIB1</i> , <i>SIB2</i> and <i>SIB4</i> , additionally, if $Q_{rxlevminoffsetcellSUL}$ is present in <i>SIB3</i> and <i>SIB4</i> for the concerned cell, this cell specific offset is added to the corresponding $Q_{rxlevmin}$ to achieve the required minimum RX level in the concerned cell; else $Q_{rxlevmin}$ is obtained from $q-RxLevMin$ in <i>SIB1</i> , <i>SIB2</i> and <i>SIB4</i> , additionally, if $Q_{rxlevminoffsetcell}$ is present in <i>SIB3</i> and <i>SIB4</i> for the concerned cell, this cell specific offset is added to the corresponding $Q_{rxlevmin}$ to achieve the required minimum RX level in the concerned cell.
$Q_{qualmin}$	Minimum required quality level in the cell (dB). Additionally, if $Q_{qualminoffsetcell}$ is signalled for the concerned cell, this cell specific offset is added to achieve the required minimum quality level in the concerned cell.
$Q_{rxlevminoffset}$	Offset to the signalled $Q_{rxlevmin}$ taken into account in the S_{rxlev} evaluation as a result of a periodic search for a higher priority PLMN while camped normally in a VPLMN, as specified in TS 23.122 [9]
$Q_{qualminoffset}$	Offset to the signalled $Q_{qualmin}$ taken into account in the S_{qual} evaluation as a result of a periodic search for a higher priority PLMN while camped normally in a VPLMN, as specified in TS 23.122 [9]
$P_{compensation}$	If the UE supports the additional P_{max} in the NR-NS- $P_{maxList}$, if present, in <i>SIB1</i> , <i>SIB2</i> and <i>SIB4</i> : $max(P_{EMAX1} - P_{PowerClass}, 0) - (min(P_{EMAX2}, P_{PowerClass}) - min(P_{EMAX1}, P_{PowerClass}))$ (dB); else: $max(P_{EMAX1} - P_{PowerClass}, 0)$ (dB)
P_{EMAX1}, P_{EMAX2}	Maximum TX power level of a UE may use when transmitting on the

	uplink in the cell (dBm) defined as P_{EMAX} in TS 38.101 [15]. If UE supports SUL frequency for this cell, P_{EMAX1} and P_{EMAX2} are obtained from the p -Max for SUL in <i>SIB1</i> and <i>NR-NS-PmaxList</i> for SUL respectively in <i>SIB1</i> , <i>SIB2</i> and <i>SIB4</i> as specified in TS 38.331 [3], else P_{EMAX1} and P_{EMAX2} are obtained from the p -Max and <i>NR-NS-PmaxList</i> respectively in <i>SIB1</i> , <i>SIB2</i> and <i>SIB4</i> for regular UL as specified in TS 38.331 [3].
$P_{PowerClass}$	Maximum RF output power of the UE (dBm) according to the UE power class as defined in TS 38.101 [15]

The signalled values $Q_{rxlevminoffset}$ and $Q_{qualminoffset}$ are only applied when a cell is evaluated for cell selection as a result of a periodic search for a higher priority PLMN while camped normally in a VPLMN (TS 23.122 [9]). During this periodic search for higher priority PLMN, the UE may check the S criteria of a cell using parameter values stored from a different cell of this higher priority PLMN.[TS 38.304, clause 5.2.4.5]

If *threshServingLowQ* is broadcast in system information and more than 1 second has elapsed since the UE camped on the current serving cell, cell reselection to a cell on a higher priority NR frequency or inter-RAT frequency than the serving frequency shall be performed if:

- A cell of a higher priority NR or EUTRAN RAT/frequency fulfils $S_{qual} > Thresh_{X, HighQ}$ during a time interval $T_{reselection_{RAT}}$

Otherwise, cell reselection to a cell on a higher priority NR frequency or inter-RAT frequency than the serving frequency shall be performed if:

- A cell of a higher priority RAT/ frequency fulfils $S_{rxlev} > Thresh_{X, HighP}$ during a time interval $T_{reselection_{RAT}}$; and
- More than 1 second has elapsed since the UE camped on the current serving cell.

Cell reselection to a cell on an equal priority NR frequency shall be based on ranking for intra-frequency cell reselection as defined in subclause 5.2.4.6.

If *threshServingLowQ* is broadcast in system information and more than 1 second has elapsed since the UE camped on the current serving cell, cell reselection to a cell on a lower priority NR frequency or inter-RAT frequency than the serving frequency shall be performed if:

- The serving cell fulfils $S_{qual} < Thresh_{Serving, LowQ}$ and a cell of a lower priority NR or E-UTRAN RAT/ frequency fulfils $S_{qual} > Thresh_{X, LowQ}$ during a time interval $T_{reselection_{RAT}}$.

Otherwise, cell reselection to a cell on a lower priority NR frequency or inter-RAT frequency than the serving frequency shall be performed if:

- The serving cell fulfils $S_{rxlev} < Thresh_{Serving, LowP}$ and a cell of a lower priority RAT/ frequency fulfils $S_{rxlev} > Thresh_{X, LowP}$ during a time interval $T_{reselection_{RAT}}$; and
- More than 1 second has elapsed since the UE camped on the current serving cell.

Cell reselection to a higher priority RAT/frequency shall take precedence over a lower priority RAT/frequency if multiple cells of different priorities fulfil the cell reselection criteria.

If more than one cell meets the above criteria, the UE shall reselect a cell as follows:

- If the highest-priority frequency is an NR frequency, the highest ranked cell among the cells on the highest priority frequency(ies) meeting the criteria according to clause 5.2.4.6;
- If the highest-priority frequency is from another RAT, the highest ranked cell among the cells on the highest priority frequency(ies) meeting the criteria of that RAT.

6.1.2.5.3 Test description

6.1.2.5.3.1 Pre-test conditions

System Simulator:

- NR Cell 1 is set to NR FDD mode and NR Cell 10 is set to NR TDD mode.
- System information combination NR-4 as defined in TS 38.508-1 [4] Table 4.4.3.1.2-1 is used in NR cells.

UE:

None.

Preamble:

- The UE is in state 1N-A on NR Cell 1(serving cell) according to TS 38.508-1 [4] Table 4.4A.2-1.

6.1.2.5.3.2 Test procedure sequence

Table 6.1.2.5.3.2-1/2 illustrates the downlink power levels and other changing parameters to be applied for the NR cells at various time instants of the test execution. The exact instants on which these values shall be applied are described in the texts in this clause. The configuration "T0" indicates the initial conditions. Subsequent configuration marked "T1" is applied at the points indicated in the Main behaviour description in Table 6.1.2.5.3.2-3.

Table 6.1.2.5.3.2-1: Time instances of cell power level and parameter changes for conducted test environment

	Parameter	Unit	NR Cell 1	NR Cell 10	Remark
T0	SS/PBCH SSS EPRE	dBm/SCS	-88	Off	The power level values are assigned to ensure the UE registered on NR Cell 1.
T1	SS/PBCH SSS EPRE	dBm/SCS	-88	-80	NR Cell 1 become lower than $Thresh_{serving, low}$ and NR Cell 10 become stronger than $Thresh_{NR Cell 10, low}$.
Note: Power level "Off" is defined in TS38.508-1 [4] Table 6.2.2.1-3.					

Table 6.1.2.5.3.2-2: Time instances of cell power level and parameter changes for OTA test environment

	Parameter	Unit	NR Cell 1	NR Cell 10	Remark
T0	SS/PBCH SSS EPRE	dBm/SCS	FFS	Off	The power level values are assigned to ensure the UE registered on NR Cell 1.
T1	SS/PBCH SSS EPRE	dBm/SCS	FFS	FFS	NR Cell 1 become lower than $Thresh_{serving, low}$ and NR Cell 10 become stronger than $Thresh_{NR Cell 10, low}$.
Note: The uncertain downlink signal level is specified in TS 38.508-1 [4] section FFS.					

Table 6.1.2.5.3.2-3: Main behaviour

St	Procedure	Message Sequence		TP	Verdict
		U - S	Message		
1	The SS changes NR Cell 10 SS/PBCH EPRE	-	-	-	-

	level according to the row "T1" in table 6.1.2.5.3.2-1/2.				
2	Wait for 34 seconds to allow UE to recognise the change.	-	-	-	-
3	Check: Does the test result of generic test procedure in TS 38.508-1 [4] Table 4.9.4.2.2-1 indicate that the UE is camped on NR Cell 10?	-	-	1	-

6.1.2.5.3.3 Specific message contents

Table 6.1.2.5.3.3-1: Conditions for specific message contents in Tables below

Condition	Explanation
NR Cell 1	This condition applies to system information transmitted on NR Cell 1.
NR Cell 10	This condition applies to system information transmitted on NR Cell 10.

Table 6.1.2.5.3.3-2: SIB1 of NR Cell 1 (preamble and all steps, Table 6.1.2.5.3.2-3)

Derivation Path: TS 38.508-1 [4], Table 4.6.1-28			
Information Element	Value/remark	Comment	Condition
SIB1::= SEQUENCE {			
servingCellConfigCommon SEQUENCE{			
uplinkConfigCommon SEQUENCE{			
FrequencyInfoUL SEQUENCE {			
p-Max	33dBm		
}			
}			
}			
}			

Table 6.1.2.5.3.3-3: SIB2 of NR Cell 1 and NR Cell10 (preamble and all steps, Table 6.1.2.5.3.2-3)

Derivation Path: TS 38.508-1 [4], Table 4.6.2-1			
Information Element	Value/remark	Comment	Condition
SIB2::= SEQUENCE {			
cellReselectionServingFreqInfo SEQUENCE{			
threshServingLowP	9	18 dB	NR Cell 1
cellReselectionPriority	5		NR Cell 1
	1		NR Cell 10
}			
}			

Table 6.1.2.5.3.3-4: SIB4 of NR Cell 1 and NR Cell 10 (preamble and all steps, Table 6.1.2.5.3.2-3)

Derivation Path: TS 38.508-1 [4], Table 4.6.2-3			
Information Element	Value/remark	Comment	Condition
SIB4::= SEQUENCE {			
InterFreqCarrierFreqList SEQUENCE (SIZE (1..maxFreq)) OF InterFreqCarrierFreqInfo {	1 entry		
InterFreqCarrierFreqInfo[1] SEQUENCE {		entry 1	
dl-CarrierFreq	Same downlink ARFCN as used for NR Cell 10		NR Cell 1
	Same downlink ARFCN as used for NR Cell 1		NR Cell 10
p-Max	33dBm		NR Cell 1
t-ReselectionNR	7	seconds	
threshX-HighP	14	28 dB	
threshX-LowP	6	12 dB	

cellReselectionPriority	1		NR Cell 1
	5		NR Cell 10
}			
}			
}			

6.1.2.6 Void

6.1.2.7 Cell reselection / Equivalent PLMN

6.1.2.7.1 Test Purpose (TP)

(1)

```
with { UE camped normally on a cell and network has downloaded a list of equivalent PLMNs during the
Registration procedure}
ensure that {
  when { a suitable neighbour cell on an equivalent PLMN becomes better ranked than the suitable
Serving cell}
    then { UE reselects to this equivalent PLMN cell}
}
```

(2)

```
with { UE camped normally on a cell and network has downloaded a list of equivalent PLMNs during the
Registration procedure}
ensure that {
  when { the Serving cell becomes unsuitable due to S<0 and a suitable cell exists on an equivalent
PLMN}
    then {UE reselects to this equivalent PLMN cell}
}
```

(3)

```
with { UE camped normally on a cell and network has downloaded a list of equivalent PLMNs during the
Registration procedure}
ensure that {
  when { the UE evaluates cells for reselection}
    then { UE ignores suitable cells for which the UE has no reselection priority provided}
}
```

6.1.2.7.2 Conformance requirements

References: The conformance requirements covered in the present test case are specified in: TS 23.122, clause 4.4.3, TS 38.304, clause 5.2.4.1. Unless otherwise stated these are Rel-15 requirements.

[TS 38.304, clause 5.2.4.1]

The UE shall only perform cell reselection evaluation for NR frequencies and inter-RAT frequencies that are given in system information and for which the UE has a priority provided.

[TS 23.122, clause 4.4.3]

The Mobile Equipment stores a list of "equivalent PLMNs". This list is replaced or deleted at the end of each location update procedure, routing area update procedure, GPRS attach procedure, tracking area update procedure, EPS attach procedure, and registration procedure. The list is deleted by an MS attached for emergency bearer services after detach or registered for emergency services after deregistration. The stored list consists of a list of equivalent PLMNs as downloaded by the network plus the PLMN code of the registered PLMN that downloaded the list. All PLMNs in the stored list, in all access technologies supported by the PLMN, are regarded as equivalent to each other for PLMN selection, cell selection/re-selection and handover.

6.1.2.7.3 Test Description

6.1.2.7.3.1 Pre-test conditions

System Simulator:

Three inter-frequency multi-PLMN NR Cells as specified in TS 38.508-1 Table 4.4.2.1 are configured broadcasting PLMNs as indicated in Table 6.1.2.7.3.1-1.

The PLMNs are identified in the test by the identifiers in Table 6.1.2.7.3.1-1.

Table 6.1.2.7.3.1-1: PLMN identifiers

NR Cell	PLMN name	MCC	MNC
11	PLMN1	001	11
12	PLMN2	002	21
13	PLMN3	003	31

All NR cells are high quality.

All cells are suitable cells.

System information combination NR-4 as defined in TS 38.508-1 [4] clause 4.4.3.1.3 is used in NR cells

UE:

The UE is in Automatic PLMN selection mode.

Preamble:

The UE is registered on PLMN1 (NR Cell 11) using the procedure described in TS 38.508-1 [4] clause 4.5.2.2 except that the REGISTRATION ACCEPT message indicates PLMN3 in the Equivalent PLMN list as described in Table 6.1.2.7.3.3-1.

The UE is in state Registered, Idle Mode (State 1N-A) on NR Cell 11 according to 38.508-1 [4];

6.1.2.7.3.2 Test procedure sequence

Table 6.1.2.7.3.2-1 for FR1 and Table 6.1.2.7.3.2-2 for FR2 illustrates the downlink power levels and other changing parameters to be applied for the cells at various time instants of the test execution. Row marked "T0" denotes the initial conditions after preamble, while columns marked "T1" and "T2" are to be applied subsequently in the Main behaviour. The exact instants on which these values shall be applied are described in the texts in this clause.

Table 6.1.2.7.3.2-1: Cell configuration changes over time for FR1

	Parameter	Unit	NR Cell 11	NR Cell 12	NR Cell 13	Remarks
T0	SS/PBCH SSS EPRE	dBm/SCS	-78	-89	-100	All NR cells S>0
T1	SS/PBCH SSS EPRE	dBm/SCS	-115	-89	-100	NR Cell 11 S < 0 as described in TS 38.508-1 clause FFS
T2	SS/PBCH SSS EPRE	dBm/SCS	-78	-100	-89	All NR cells S>0
Note 1: The default values (including "not present") for all other parameters influencing cell reselection are suitable for this test. The values are defined in TS 38.508-1 clauses FFS.						

Table 6.1.2.7.3.2-2: Cell configuration changes over time for FR2

	Parameter	Unit	NR Cell 11	NR Cell 12	NR Cell 13	Remarks
--	-----------	------	------------	------------	------------	---------

T0	SS/PBCH SSS EPRE	FFS	FFS	FFS	FFS	All NR cells S>0
T1	SS/PBCH SSS EPRE	FFS	FFS	FFS	FFS	NR Cell 1 S < 0 as described in TS 38.508-1 clause FFS
T2	SS/PBCH SSS EPRE	FFS	FFS	FFS	FFS	All NR cells S>0
Note 1: The default values (including "not present") for all other parameters influencing cell reselection are suitable for this test. The values are defined in TS 38.508-1 clauses FFS.						

Table 6.1.2.7.3.2-3: Main behaviour

St	Procedure	Message Sequence		TP	Verdict
		U - S	Message		
1	Check: Does the UE transmit an <i>RRCSetupRequest</i> message within T seconds? (Note 1)	-->	NR RRC: <i>RRCSetupRequest</i>	1	F
2	SS adjusts cell levels according to row T1 of table 6.1.2.7.3.2-1 for FR1 (or table 6.1.2.7.3.2-2 for FR2)	-	-	-	-
3	Check: Does the test result of generic test procedure in TS 38.508-1 Table 4.9.5.2.2-1 indicate that the UE is camped on NR Cell 13? NOTE: The UE performs a "REGISTRATION REQUEST" procedure with type "mobility registration updating" with PLMN1 and PLMN2 listed as an Equivalent PLMN in the REGISTRATION ACCEPT message; the RRC connection is released.	-		2	-
4	Check: Does the test result of generic test procedure in TS 38.508-1 Table 4.9.5.2.2-1 indicate that the UE is camped on NR Cell 12? NOTE: The UE performs a "REGISTRATION REQUEST" procedure with type "mobility registration updating" with PLMN1 and PLMN3 listed as an Equivalent PLMN in the REGISTRATION ACCEPT message; the RRC connection is released.	-		1	-
5	SS adjusts cell levels according to row T0 of table 6.1.2.7.3.2-1 for FR1 (or table 6.1.2.7.3.2-2 for FR2)	-		-	-
6	Check: Does the UE transmit an <i>RRCSetupRequest</i> message within T seconds? (Note 1)	-->	NR RRC <i>RRCSetupRequest</i>	1,3	F
7	SS adjusts cell levels according to row T2 of table 6.1.2.7.3.2-1 for FR1 (or table 6.1.2.7.3.2-2 for FR2)	-	-	-	-
8	Check: Does the test result of generic test procedure in TS 38.508-1 Table 4.9.5.2.2-1 indicate that the UE is camped on NR Cell 13? NOTE: The UE performs a "REGISTRATION REQUEST" procedure with type "mobility registration updating" with PLMN1 and PLMN2 listed as an Equivalent PLMN in the REGISTRATION ACCEPT message; the RRC connection is released. (Note 2)	-		3	P
Note 1: In Steps 1 and 6, wait T seconds to ensure that the UE has detected, measured and evaluated the neighbour inter-frequency NR cells is provided, see TS 38.133 clause 4.2.2.4, where in T = 100sec for FR1 and 300sec for FR2					
Note 2: In Step 8, the UE moves to Cell 13 because no reselection priority is defined for Cell 1, see Table 6.1.2.7.3.3-4.					

6.1.2.7.3.3 Specific message contents

Table 6.1.2.7.3.3-1: REGISTRATION ACCEPT for NR Cell 11 (preamble)

Derivation path: TS 38.508-1 Table 4.7.1-7			
Information Element	Value/remark	Comment	Condition
Equivalent PLMNs	PLMN3		

Table 6.1.2.7.3.3-2: REGISTRATION ACCEPT for NR Cell 13 (step 3 and 18, Table 6.1.2.7.3.2-3)

Derivation path: TS 38.508-1 Table 4.7.1-7			
Information Element	Value/remark	Comment	Condition
Equivalent PLMNs	PLMN1, 2		

Table 6.1.2.7.3.3-3: REGISTRATION ACCEPT for NR Cell 12 (step 4, Table 6.1.2.7.3.2-3)

Derivation path: TS 38.508-1 Table 4.7.1-7			
Information Element	Value/remark	Comment	Condition
Equivalent PLMNs	PLMN1, 3		

Table 6.1.2.7.3.3-4: SystemInformationBlockType4 for Cell 12 (preamble and all steps, Table 6.1.2.7.3.2-3)

Derivation Path: TS 38.508-1 Table 4.6.2-3			
Information Element	Value/remark	Comment	Condition
SIB4 ::= SEQUENCE { interFreqCarrierFreqList SEQUENCE (SIZE (1..maxFreq)) OF InterFreqCarrierFreqInfo { InterFreqCarrierFreqInfo[1] SEQUENCE { dl-CarrierFreq	2 entries	<i>n</i> denotes the index of the entry entry 1	
cellReselectionPriority	Not present	UE does not have a priority for frequency of Cell 11	
}			
InterFreqCarrierFreqInfo[2] SEQUENCE { dl-CarrierFreq		entry 2	
dl-CarrierFreq	Same downlink EARFCN as used for Cell 13		
}			
lateNonCriticalExtension	Not present		
}			

Table 6.1.2.7.3.3-5: SystemInformationBlockType4 for Cell 13 (preamble and all steps, Table 6.1.2.7.3.2-3)

Derivation Path: TS 38.508-1 Table 4.6.2-3			
Information Element	Value/remark	Comment	Condition
SIB4 ::= SEQUENCE { interFreqCarrierFreqList SEQUENCE (SIZE (1..maxFreq)) OF InterFreqCarrierFreqInfo { InterFreqCarrierFreqInfo[1] SEQUENCE { dl-CarrierFreq	2 entries	<i>n</i> denotes the index of the entry entry 1	
cellReselectionPriority	Not present	UE does not have a priority for frequency of Cell 11	
}			
InterFreqCarrierFreqInfo[2] SEQUENCE { dl-CarrierFreq		entry 2	
dl-CarrierFreq	Same downlink EARFCN		

	as used for Cell 12		
}			
lateNonCriticalExtension	Not present		
}			

6.1.2.8 Cell reselection / Equivalent PLMN / Single Frequency operation

6.1.2.8.1 Test Purpose (TP)

(1)

```
with { UE camped normally on a cell and network has downloaded a list of equivalent PLMNs during the
Registration procedure }
ensure that {
  when { a suitable neighbour cell on an equivalent PLMN becomes better ranked than the suitable
Serving cell }
  then { UE reselects to this equivalent PLMN cell }
}
```

(2)

```
with { UE camped normally on a cell and network has downloaded a list of equivalent PLMNs during the
Registration procedure }
ensure that {
  when { the Serving cell becomes unsuitable due to S<0 and a suitable cell exists on an equivalent
PLMN }
  then { UE reselects to this equivalent PLMN cell }
}
```

6.1.2.8.2 Conformance requirements

References: The conformance requirements covered in the present TC are specified in TS 38.304: clause 5.2.4.1. Unless otherwise stated these are Rel-15 requirements.

[TS 38.304, clause 5.2.4.1]

The UE shall only perform cell reselection evaluation for NR frequencies and inter-RAT frequencies that are given in system information and for which the UE has a priority provided.

6.1.2.8.3 Test description

6.1.2.8.3.1 Pre-test conditions

System Simulator:

- Three intra-frequency multi-PLMN cells.
- The PLMNs are identified in the test by the identifiers in Table 6.1.2.8.3.1-1.
- System information combination NR-3 as defined in TS 38.508-1 [4] clause 4.4.3.1.3 is used in NR cells

Table 6.1.2.8.3.1-1: PLMN identifiers

Cell	PLMN name
1	PLMN1
2	PLMN2
4	PLMN3

- All cells are high quality.
- All cells are suitable cells.

UE:

- The UE is in Automatic PLMN selection mode.

Preamble:

- The UE is registered on PLMN1 (NR Cell 1) using the procedure described in TS 38.508-1 [4] clause 4.5.2.2 except that the REGISTRATION ACCEPT message indicates PLMN3 in the Equivalent PLMN list as described in Table 6.1.2.8.3.3-1.
- The UE is in state Registered, Idle Mode (State 1N-A) on NR Cell 1 according to TS 38.508-1 [4] Table 4.4A.2-1.

6.1.2.8.3.2 Test procedure sequence

Table 6.1.2.8.3.2-1 for FR1 and Table 6.1.2.8.3.2-2 for FR2 illustrates the downlink power levels and other changing parameters to be applied for the cells at various time instants of the test execution. Row marked "T0" denotes the initial conditions after preamble, while columns marked "T1" and "T2" are to be applied subsequently in the Main behaviour. The exact instants on which these values shall be applied are described in the texts in this clause.

Table 6.1.2.8.3.2-1: Cell configuration changes over time for FR1

	Parameter	Unit	NR Cell 1	NR Cell 2	NR Cell 4	Remarks
T0	SS/PBCH SSS EPRE	dBm/SC S	-78	-84	-90	All NR cells S > 0
T1	SS/PBCH SSS EPRE	dBm/SC S	-115	-88	-82	NR Cell 1 S < 0 as described in TS 38.508-1 [4] clause 6.2.2.1
T2	SS/PBCH SSS EPRE	dBm/SC S	-115	-82	-88	

Table 6.1.2.8.3.2-2: Cell configuration changes over time for FR2

	Parameter	Unit	NR Cell 1	NR Cell 2	NR Cell 4	Remarks
T0	SS/PBCH SSS EPRE	FFS	FFS	FFS	FFS	All NR cells S > 0
T1	SS/PBCH SSS EPRE	FFS	FFS	FFS	FFS	NR Cell 1 S < 0 as described in TS 38.508-1 [4] clause 6.2.2.2
T2	SS/PBCH SSS EPRE	FFS	FFS	FFS	FFS	

Table 6.1.2.8.3.2-3: Main behaviour

St	Procedure	Message Sequence		TP	Verdict
		U - S	Message		
1	Check: Does the UE send an <i>RRCSetupRequest</i> within the next T seconds? NOTE: The wait period of T seconds is to ensure that the UE has detected, measured and evaluated the neighbour inter-frequency NR cells is provided, see TS 38.133[30] clause 4.2.2.4, where in T = 100sec for FR1 and 300sec for FR2.	-->	NR RRC: <i>RRCSetupRequest</i>	1	F
2	SS adjusts cell levels according to row T1 of table 6.1.2.8.3.2-1 for FR1 (or table 6.1.2.8.3.2-2 for FR2).	-	-	-	-
3	Check: Does the test result of generic test procedure in TS 38.508-1 [4] subclause 4.9.5 indicate that the UE is camped on NR Cell 4? NOTE: The UE performs a Registration procedure for mobility registration update with PLMN1 and PLMN2 listed as an Equivalent PLMN in the	-	-	2	-

	REGISTRATION ACCEPT message.				
4	SS adjusts cell levels according to row T2 of table 6.1.2.8.3.2-1 for FR1 (or table 6.1.2.8.3.2-2 for FR2).	-	-	-	-
5	Check: Does the test result of generic test procedure in TS 38.508-1 [4] subclause 4.9.5 indicate that the UE is camped on NR Cell 2? NOTE: The UE performs a Registration procedure for mobility registration update with PLMN1 and PLMN3 listed as an Equivalent PLMN in the REGISTRATION ACCEPT message.	-	-	1	-
6	SS adjusts cell levels according to row T1 of table 6.1.2.8.3.2-1 for FR1 (or table 6.1.2.8.3.2-2 for FR2).	-	-	-	-
7	Check: Does the test result of generic test procedure in TS 38.508-1 [4] subclause 4.9.5 indicate that the UE is camped on NR Cell 4, 'connected without release'? NOTE: The UE performs a Registration procedure for mobility registration update with PLMN1 and PLMN2 listed as an Equivalent PLMN in the REGISTRATION ACCEPT message.	-	-	1	-

6.1.2.8.3.3 Specific message contents

Table 6.1.2.8.3.3-1: REGISTRATION ACCEPT for NR Cell 1 (preamble)

Derivation path: TS 38.508-1 [4] Table 4.7.1-7			
Information Element	Value/Remark	Comment	Condition
Equivalent PLMNs	PLMN3		

Table 6.1.2.8.3.3-2: REGISTRATION ACCEPT for NR Cell 4 (steps 3 & 7, Table 6.1.2.8.3.2-3)

Derivation path: TS 38.508-1 [4] Table 4.7.1-7			
Information Element	Value/Remark	Comment	Condition
Equivalent PLMNs	PLMN1, 2		
Allowed NSSAI			
S-NSSAI			
Length of S-NSSAI contents	'0000 0010'B		
Mapped HPLMN SST	Same as SST		

Table 6.1.2.8.3.3-3: REGISTRATION ACCEPT for NR Cell 2 (step 5, Table 6.1.2.8.3.2-3)

Derivation path: TS 38.508-1 [4] Table 4.7.1-7			
Information Element	Value/Remark	Comment	Condition
Equivalent PLMNs	PLMN1, 3		
Allowed NSSAI			
S-NSSAI			
Length of S-NSSAI contents	'0000 0010'B		
Mapped HPLMN SST	Same as SST		

6.1.2.9 Cell reselection using Qhyst, Qoffset and Treselection

6.1.2.9.1 Test Purpose (TP)

(1)

```
with { UE in NR RRC_IDLE state, and the UE is not in high mobility state }
ensure that {
  when { Qhyst is non-zero or its value changes in system information }
  then { UE reselects the highest ranked cell taking the actual Qhyst value into account }
```

```

    }

```

(2)

```

with { UE in NR RRC_IDLE state, and the UE is not in high mobility }
ensure that {
  when { cell reselection criteria are fulfilled during a time interval Treselection }
  then { UE reselects the highest ranked cell after the Treselection interval expires }
}

```

(3)

```

with { UE in NR RRC_IDLE state, and the UE is not in high mobility }
ensure that {
  when { Qoffset is non-zero or its value changes in system information }
  then { UE reselects the highest ranked cell taking the actual Qoffset value into account }
}

```

6.1.2.9.2 Conformance requirements

References: The conformance requirements covered in the present TC are specified in TS 38.304: clause 5.2.4.6. Unless otherwise stated these are Rel-15 requirements.

[TS 38.304, clause 5.2.4.6]

The cell-ranking criterion R_s for serving cell and R_n for neighbouring cells is defined by:

$$R_s = Q_{\text{meas},s} + Q_{\text{hyst}} - Q_{\text{offset,temp}}$$

$$R_n = Q_{\text{meas},n} - Q_{\text{offset}} - Q_{\text{offset,temp}}$$

where:

Q_{meas}	RSRP measurement quantity used in cell reselections.
Q_{offset}	For intra-frequency: Equals to $Q_{\text{offset},s,n}$, if $Q_{\text{offset},s,n}$ is valid, otherwise this equals to zero. For inter-frequency: Equals to $Q_{\text{offset},s,n}$ plus $Q_{\text{offset,frequency}}$, if $Q_{\text{offset},s,n}$ is valid, otherwise this equals to $Q_{\text{offset,frequency}}$.
$Q_{\text{offset,temp}}$	Offset temporarily applied to a cell as specified in TS 38.331 [3].

The UE shall perform ranking of all cells that fulfil the cell selection criterion S , which is defined in 5.2.3.2.

The cells shall be ranked according to the R criteria specified above by deriving $Q_{\text{meas},n}$ and $Q_{\text{meas},s}$ and calculating the R values using averaged RSRP results.

If *rangeToBestCell* is not configured, the UE shall perform cell reselection to the highest ranked cell. If this cell is found to be not-suitable, the UE shall behave according to subclause 5.2.4.4.

If *rangeToBestCell* is configured, then the UE shall perform cell reselection to the cell with the highest number of beams above the threshold (i.e. *absThreshSS-BlocksConsolidation*) among the cells whose R value is within *rangeToBestCell* of the R value of the highest ranked cell. If there are multiple such cells, the UE shall perform cell reselection to the highest ranked cell among them. If this cell is found to be not-suitable, the UE shall behave according to subclause 5.2.4.4.

In all cases, the UE shall reselect the new cell, only if the following conditions are met:

- the new cell is better than the serving cell according to the cell reselection criteria specified above during a time interval $T_{\text{reselection,RAT}}$;
- more than 1 second has elapsed since the UE camped on the current serving cell.

6.1.2.9.3 Test description

6.1.2.9.3.1 Pre-test conditions

System Simulator:

- NR Cell 1, NR Cell 2 and NR Cell 11.
- System information combination NR-3 as defined in TS 38.508-1 [4] Table 4.4.3.1.2-1 is used in NR cells.

UE:

None.

Preamble:

- The UE is in state 1N-A on NR Cell 1(serving cell) according to TS 38.508-1 [4] Table 4.4A.2-1.

6.1.2.9.3.2 Test procedure sequence

Table 6.1.2.9.3.2-1/2 illustrates the downlink power levels and other changing parameters to be applied for the NR cells at various time instants of the test execution. The exact instants on which these values shall be applied are described in the texts in this clause. The configuration "T0" indicates the initial conditions. Subsequent configurations marked "T1", "T2" and so on are applied at the points indicated in the Main behaviour description in Table 6.1.2.9.3.2-3.

Table 6.1.2.9.3.2-1: Time instances of cell power level and parameter changes For FR1

	Parameter	Unit	NR Cell 1	NR Cell 2	NR Cell 11	Remark
T0	SS/PBCH SSS EPRE	dBm/SCS	-88	Off	Off	The power level values are assigned to ensure the UE registered on NR Cell 1.
	Qhyst _s	dB	24	0	0	
	Qoffset _{s,n}	dB	0	0	0	
	Treselectio _{nNR}	S	0	0	0	
T1	SS/PBCH SSS EPRE	dBm/SCS	-94	-88	Off	NR Cell 2 becomes stronger than NR Cell 1 but NR Cell 1 remains the highest ranked one due to Qhyst _{s NR Cell 1} ¹
	Qhyst _s	dB	24	0	0	
	Qoffset _{s,n}	dB	0	0	0	
	Treselectio _{nNR}	S	0	0	0	
T2	SS/PBCH SSS EPRE	dBm/SCS	-94	-88	Off	Qhyst _{s NR Cell 1} change causes NR Cell 2 to become highest ranked cell
	Qhyst _s	dB	0	0	0	
	Qoffset _{s,n}	dB	0	0	0	
	Treselectio _{nNR}	S	0	0	0	
T3	SS/PBCH SSS EPRE	dBm/SCS	-88	-94	Off	NR Cell 1 becomes the strongest and highest ranked one due to power adjustment
	Qhyst _s	dB	0	0	0	
	Qoffset _{s,n}	dB	0	0	0	
	Treselectio _{nNR}	S	0	0	0	
T4	SS/PBCH SSS EPRE	dBm/SCS	-88	-94	Off	Qoffset _{s,n NR Cell1} change to 24dB, Qoffset _{s,n NR Cell 2} remains zero
	Qhyst _s	dB	0	0	0	
	Qoffset _{s,n}	dB	24	0	0	
	Treselectio _{nNR}	S	0	0	0	
T5	SS/PBCH SSS EPRE	dBm/SCS	-94	-88	Off	NR Cell 1 becomes weaker but it remains the highest ranked one due to Qoffset _{s,n NR Cell 1}
	Qhyst _s	dB	0	0	0	
	Qoffset _{s,n}	dB	24	0	0	

	Treselectio nNR	S	0	0	0	
T6	SS/PBCH SSS EPRE	dBm/SCS	-94	-88	Off	NR Cell 2 becomes the highest ranked one due to Qoffset _{s,n} NR Cell 1 change
	Qhyst _s	dB	0	0	0	
	Qoffset _{s,n}	dB	0	0	0	
	Treselectio nNR	S	0	0	0	
T7	SS/PBCH SSS EPRE	dBm/SCS	-88	-94	Off	NR Cell 1 becomes the highest ranked one
	Qhyst _s	dB	0	0	0	
	Qoffset _{s,n}	dB	0	0	0	
	Treselectio nNR	S	0	0	0	
T8	SS/PBCH SSS EPRE	dBm/SCS	-88	Off	-94	TreselectionNR of NR Cell 1 change to 7S
	Qhyst _s	dB	0	0	0	
	Qoffset _{s,n}	dB	0	0	0	
	Treselectio nNR	S	7	0	0	
T9	SS/PBCH SSS EPRE	dBm/SCS	-94	Off	-88	NR Cell 11 becomes the highest ranked one
	Qhyst _s	dB	0	0	0	
	Qoffset _{s,n}	dB	0	0	0	
	Treselectio nNR	S	7	0	0	

Note: Power level "Off" is defined in TS38.508-1 [4] Table 6.2.2.1-3.

Table 6.1.2.9.3.2-2: Time instances of cell power level and parameter changes For FR2

	Parameter	Unit	NR Cell 1	NR Cell 2	NR Cell 11	Remark
T0	SS/PBCH SSS EPRE	dBm/SCS	-82	Off	Off	The power level values are assigned to ensure the UE registered on NR Cell 1.
	Qhyst _s	dB	24	0	0	
	Qoffset _{s,n}	dB	0	0	0	
	Treselectio nNR	S	0	0	0	
T1	SS/PBCH SSS EPRE	dBm/SCS	-91	-82	Off	NR Cell 2 becomes stronger than NR Cell 1 but NR Cell 1 remains the highest ranked one due to Qhyst _s NR Cell 1
	Qhyst _s	dB	24	0	0	
	Qoffset _{s,n}	dB	0	0	0	
	Treselectio nNR	S	0	0	0	
T2	SS/PBCH SSS EPRE	dBm/SCS	-91	-82	Off	Qhyst _s NR Cell 1 change causes NR Cell 2 to become highest ranked cell
	Qhyst _s	dB	0	0	0	
	Qoffset _{s,n}	dB	0	0	0	
	Treselectio nNR	S	0	0	0	
T3	SS/PBCH SSS EPRE	dBm/SCS	-82	-91	Off	NR Cell 1 becomes the strongest and highest ranked one due to power adjustment
	Qhyst _s	dB	0	0	0	
	Qoffset _{s,n}	dB	0	0	0	
	Treselectio nNR	S	0	0	0	
T4	SS/PBCH SSS EPRE	dBm/SCS	-82	-91	Off	Qoffset _{s,n} NR Cell1 change to 24dB, Qoffset _{s,n} NR Cell 2 remains zero
	Qhyst _s	dB	0	0	0	
	Qoffset _{s,n}	dB	24	0	0	
	Treselectio nNR	S	0	0	0	
T5	SS/PBCH SSS EPRE	dBm/SCS	-91	-82	Off	NR Cell 1 becomes weaker but it remains the highest ranked one due

	Qhysts _s	dB	0	0	0	to Qoffset _{s,n} NR Cell 1
	Qoffset _{s,n}	dB	24	0	0	
	Treselectio nNR	S	0	0	0	
T6	SS/PBCH SSS EPRE	dBm/SCS	-91	-82	Off	NR Cell 2 becomes the highest ranked one due to Qoffset _{s,n} NR Cell 1 change
	Qhysts _s	dB	0	0	0	
	Qoffset _{s,n}	dB	0	0	0	
	Treselectio nNR	S	0	0	0	
T7	SS/PBCH SSS EPRE	dBm/SCS	-82	-91	Off	NR Cell 1 becomes the highest ranked one
	Qhysts _s	dB	0	0	0	
	Qoffset _{s,n}	dB	0	0	0	
	Treselectio nNR	S	0	0	0	
T8	SS/PBCH SSS EPRE	dBm/SCS	-82	Off	-94	TreselectionNR of NR Cell 1 change to 7S
	Qhysts _s	dB	0	0	0	
	Qoffset _{s,n}	dB	0	0	0	
	Treselectio nNR	S	7	0	0	
T9	SS/PBCH SSS EPRE	dBm/SCS	-91	Off	-82	NR Cell 11 becomes the highest ranked one
	Qhysts _s	dB	0	0	0	
	Qoffset _{s,n}	dB	0	0	0	
	Treselectio nNR	S	7	0	0	

Table 6.1.2.9.3.2-3: Main behaviour

St	Procedure	Message Sequence		TP	Verdict
		U - S	Message		
1	SS re-adjusts the SSS levels according to row "T1" in table 6.1.2.9.3.2-1/2.	-	-	-	-
1A	Wait for 34[FR1]/130[FR2] seconds, the SS transmits a Paging message on NR Cell 2.	<--	NR RRC: <i>Paging</i>	-	-
2	Check: Does the UE send an NR: <i>RRCSetupRequest</i> on NR Cell 2 within the next 10 seconds?	-->	NR RRC: <i>RRCSetupRequest</i>	1	F
2A	SS resets Qhysts _s NR Cell 1 according to row "T2" in table 6.1.2.9.3.2-1/2, The <i>ValueTag</i> of <i>SIB2</i> in the SI-SchedulingInfo of <i>SIB1</i> is increased on NR Cell 1.	-	-	-	-
3	SS notifies UE of the system information change on NR Cell 1 by send Short Message on PDCCH using P-RNTI.	<--	NR RRC: <i>Paging</i>	-	-
4	Void	-	-	-	-
5	Wait for 2.1* modification period to allow the new system information to take effect.	-	-	-	-
5A	Wait for 8[FR1]/27[FR2] seconds.	-	-	-	-
6	Check: Does the test result of generic test procedure in TS 38.508-1 [4] Table 4.9.4.2.2-1 indicate that the UE is camped on NR Cell 2?	-	-	1	-
7	SS re-adjusts SSS levels according to rows "T3" in table 6.1.2.9.3.2-1/2.	-	-	-	-
8	Wait for 8[FR1]/27[FR2] seconds to allow UE to recognise the change.	-	-	-	-
9	The test result of generic test procedure in TS 38.508-1 [4] Table 4.9.4.2.2-1 indicate that the UE is camped on NR Cell 1.	-	-	-	-
9A	SS changes Qoffset _{s,n} NR Cell 1 according to rows "T4" in table 6.1.2.9.3.2-1/2. The <i>ValueTag</i> of <i>SIB3</i> in the SI-SchedulingInfo of <i>SIB1</i> is increased on NR Cell 1.	-	-	-	-

10	SS notifies UE of the system information change on NR Cell 1 by send Short Message on PDCCH using P-RNTI.	<--	NR RRC: <i>Paging</i>	-	-
11	Void	-	-	-	-
12	Wait for 2.1* modification period to allow the new system information to take effect.	-	-	-	-
13	SS re-adjusts SSS levels according to row "T5" in table 6.1.2.9.3.2-1/2.	-	-	-	-
14	Wait for 8[FR1]/27[FR2] seconds to allow UE to recognise the change.	-	-	-	-
15	Check: Does the test result of generic test procedure in TS 38.508-1 [4] Table 4.9.4.2.2-1 indicate that the UE is still camped on NR Cell 1?	-	-	3	-
15 A	SS resets $Q_{offset_{s,n}}^{NR, Cell1}$ according to row "T6" in table 6.1.2.9.3.2-1/2, The <i>ValueTag</i> of <i>SIB3</i> in the SI-SchedulingInfo of <i>SIB1</i> is increased on NR Cell 1.	-	-	-	-
16	SS notifies UE of the system information change on NR Cell 1 by send Short Message on PDCCH using P-RNTI.	<--	NR RRC: <i>Paging</i>	-	-
17	Void	-	-	-	-
18	Wait for 2.1* modification period to allow the new system information to take effect.	-	-	-	-
18 A	Wait for 8[FR1]/27[FR2] seconds.	-	-	-	-
19	Check: Does the test result of generic test procedure in TS 38.508-1 [4] Table 4.9.4.2.2-1 indicate that the UE is camped on NR Cell 2?	-	-	3	-
20	SS re-adjusts SSS levels according to rows "T7" in table 6.1.2.9.3.2-1/2.	-	-	-	-
21	Wait for 8[FR1]/27[FR2] seconds to allow UE to recognise the change.	-	-	-	-
22	Check: Does the test result of generic test procedure in TS 38.508-1 [4] Table 4.9.4.2.2-1 indicate that the UE is camped on NR Cell 1?	-	-	3	-
22 A	SS changes $T_{reselection}^{NR, Cell 1}$ according to rows "T8" in table 6.1.2.9.3.2-1/2, The <i>ValueTag</i> of <i>SIB2</i> in the SI-SchedulingInfo of <i>SIB1</i> is increased on NR Cell 1.	-	-	-	-
23	SS sends notification of the system information change on NR Cell 1 by send Short Message on PDCCH using P-RNTI.	<--	NR RRC: <i>Paging</i>	-	-
24	Void	-	-	-	-
25	SS re-adjusts cell power levels according to rows "T8" in table 6.1.2.9.3.2-1/2.	-	-	-	-
26	Wait for 34[FR1]/130[FR2] seconds to allow UE to detect Cell 11.	-	-	-	-
27	SS re-adjusts SSS levels according to rows "T9" in table 6.1.2.9.3.2-1/2.	-	-	-	-
28	Check: Does the UE send an NR: <i>RRCSetupRequest</i> on NR Cell 11 within $T_{reselection}^{NR}$ from step 27?	-->	NR RRC: <i>RRCSetupRequest</i>	2	F
29	SS waits for $T_{reselection}^{NR, Cell 1}$ expires after step 27				
30	Check: Does the UE send an NR: <i>RRCSetupRequest</i> on NR Cell 11?	-->	NR RRC: <i>RRCSetupRequest</i>	2	P
31-34	Steps 2 to 5 of the generic test procedure in TS 38.508-1 [4] Table 4.9.5.2.2-1 are performed on NR Cell 11.	-	-	-	-
Note:	The wait time at steps 2 and 26 is $T_{detect, NR, Intra}$ and at Steps 8,14 and 21 it is $T_{evaluate, NR, Intra}$ (as per TS 38.133 [30], clause 4.2.2.3) plus the time to read the system information T_{SI-NR} .				

6.1.2.9.3.3 Specific message contents

Table 6.1.2.9.3.3-1: SIB1 of NR Cell 1 (preamble and all steps, Table 6.1.2.9.3.2-3)

Derivation Path: TS 38.508-1 [4], Table 4.6.1-28			
Information Element	Value/remark	Comment	Condition
SIB1 ::= SEQUENCE {			
si-SchedulingInfo	SI-SchedulingInfo		
}			

Table 6.1.2.9.3.3-2: SI-SchedulingInfo (si-SchedulingInfo in Table 6.1.2.9.3.3-1)

Derivation Path: TS 38.508-1 [4], Table 4.6.3-173			
Information Element	Value/remark	Comment	Condition
SI-SchedulingInfo ::= SEQUENCE {			
schedulingInfoList SEQUENCE (SIZE(1..maxSI-Message)) OF SchedulingInfo {	1 entry		
SchedulingInfo[1] SEQUENCE {		entry 1	
sib-MappingInfo SEQUENCE (SIZE(1..maxSIB)) OF SIB-TypeInfo {	2 entries		
SIB-TypeInfo[1] SEQUENCE {		entry 1	
Type[1]	sibType2		
valueTag[1]	0	The value is increased by 1 in step 4 and step 24	
}			
SIB-TypeInfo[2] SEQUENCE {		entry 2	
Type[2]	sibType3		
valueTag[2]	0	The value is increased by 1 in step 11 and step 17	
}			
}			
}			
}			
}			

Table 6.1.2.9.3.3-3: SIB2 of NR Cell 1 (preamble, Table 6.1.2.9.3.2-3)

Derivation Path: TS 38.508-1 [4], Table 4.6.2-1			
Information Element	Value/remark	Comment	Condition
SIB2 ::= SEQUENCE {			
cellReselectionInfoCommon SEQUENCE {			
q-Hyst	dB24		
}			
}			

Table 6.1.2.9.3.3-4: SIB2 of NR Cell 1 (step 2A, Table 6.1.2.9.3.2-3)

Derivation Path: TS 38.508-1 [4], Table 4.6.2-1			
Information Element	Value/remark	Comment	Condition
SIB2 ::= SEQUENCE {			
cellReselectionInfoCommon SEQUENCE {			
q-Hyst	dB0		
}			
}			

Table 6.1.2.9.3.3-5: SIB3 of NR Cell 1 (step 9A, Table 6.1.2.9.3.2-3)

Derivation Path: TS 38.508-1 [4], Table 4.6.2-2			
Information Element	Value/remark	Comment	Condition
SIB3 ::= SEQUENCE {			
intraFreqNeighCellList SEQUENCE (SIZE (1.. maxCellIntra)) OF IntraFreqNeighCellInfo {	1 entry		
IntraFreqNeighCellInfo[1] SEQUENCE{		entry 1	
q-OffsetCell	dB24		
}			
}			
}			

Table 6.1.2.9.3.3-6: SIB3 of NR Cell 1 (step 15A, Table 6.1.2.9.3.2-3)

Derivation Path: TS 38.508-1 [4], Table 4.6.2-2			
Information Element	Value/remark	Comment	Condition
SIB3 ::= SEQUENCE {			
intraFreqNeighCellList SEQUENCE (SIZE (1.. maxCellIntra)) OF IntraFreqNeighCellInfo {	1 entry		
IntraFreqNeighCellInfo[1] SEQUENCE {		entry 1	
q-OffsetCell	dB0		
}			
}			
}			

Table 6.1.2.9.3.3-7: SIB2 of NR Cell 1 (step 22A, Table 6.1.2.9.3.2-3)

Derivation Path: TS 38.508-1 [4], Table 4.6.2-1			
Information Element	Value/remark	Comment	Condition
SIB2 ::= SEQUENCE {			
intraFreqCellReselectionInfo SEQUENCE			
{			
t-ReselectionNR	7	seconds	
}			
}			

6.1.2.10 Void

6.1.2.11 Area Specific SIBs using systemInformationAreaID

6.1.2.11.1 Test Purpose (TP)

(1)

```
with { UE is in NR RRC_IDLE state }
ensure that {
  when { SIB1 does not include si-RequestConfig and si-BroadcastStatus set to notBroadcasting }
  then { UE sends RRCSystemInfoRequest message and acquires the necessary SIBs }
}
```

(2)

```
with { UE in NR_RRC Idle State }
ensure that {
  when { UE reselects to neighbor cell with same systemInformationAreaID and SIB1 does not include
si-RequestConfig and si-BroadcastStatus set to notBroadcasting }
  then { UE applies system information parameters of previous cell for reselection purposes }
}
```

6.1.2.11.2 Conformance requirements

References: The conformance requirements covered in the present TC are specified in: 3GPP TS 38.304, clause 5.2.4.4, 5.2.4.6 and 5.3.1. Unless otherwise stated these are Rel-15 requirements.

[TS 38.304, clause 5.2.4.2]

Following rules are used by the UE to limit needed measurements:

- If the serving cell fulfils $S_{rxlev} > S_{IntraSearchP}$ and $S_{qual} > S_{IntraSearchQ}$, the UE may choose not to perform intra-frequency measurements.
- Otherwise, the UE shall perform intra-frequency measurements.
- The UE shall apply the following rules for NR inter-frequencies and inter-RAT frequencies which are indicated in system information and for which the UE has priority provided as defined in 5.2.4.1:
 - For a NR inter-frequency or inter-RAT frequency with a reselection priority higher than the reselection priority of the current NR frequency, the UE shall perform measurements of higher priority NR inter-frequency or inter-RAT frequencies according to TS 38.133 [8].
 - For a NR inter-frequency with an equal or lower reselection priority than the reselection priority of the current NR frequency and for inter-RAT frequency with lower reselection priority than the reselection priority of the current NR frequency:
 - If the serving cell fulfils $S_{rxlev} > S_{nonIntraSearchP}$ and $S_{qual} > S_{nonIntraSearchQ}$, the UE may choose not to perform measurements of NR inter-frequencies or inter-RAT frequency cells of equal or lower priority;
 - Otherwise, the UE shall perform measurements of NR inter-frequencies or inter-RAT frequency cells of equal or lower priority according to TS 38.133 [8].

[TS 38.304, clause 5.2.4.6]

If *threshServingLowQ* is broadcast in system information and more than 1 second has elapsed since the UE camped on the current serving cell, cell reselection to a cell on a higher priority NR frequency or inter-RAT frequency than the serving frequency shall be performed if:

- A cell of a higher priority NR or EUTRAN RAT/frequency fulfils $S_{qual} > Thresh_{X, HighQ}$ during a time interval $T_{reselection_{RAT}}$

Otherwise, cell reselection to a cell on a higher priority NR frequency or inter-RAT frequency than the serving frequency shall be performed if:

- A cell of a higher priority RAT/ frequency fulfils $S_{rxlev} > Thresh_{X, HighP}$ during a time interval $T_{reselection_{RAT}}$; and
- More than 1 second has elapsed since the UE camped on the current serving cell.

Cell reselection to a cell on an equal priority NR frequency shall be based on ranking for intra-frequency cell reselection as defined in clause 5.2.4.6.

If *threshServingLowQ* is broadcast in system information and more than 1 second has elapsed since the UE camped on the current serving cell, cell reselection to a cell on a lower priority NR frequency or inter-RAT frequency than the serving frequency shall be performed if:

- The serving cell fulfils $S_{qual} < Thresh_{Serving, LowQ}$ and a cell of a lower priority NR or E-UTRAN RAT/ frequency fulfils $S_{qual} > Thresh_{X, LowQ}$ during a time interval $T_{reselection_{RAT}}$.

Otherwise, cell reselection to a cell on a lower priority NR frequency or inter-RAT frequency than the serving frequency shall be performed if:

- The serving cell fulfils $S_{rxlev} < Thresh_{Serving, LowP}$ and a cell of a lower priority RAT/ frequency fulfils $S_{rxlev} > Thresh_{X, LowP}$ during a time interval $T_{reselection_{RAT}}$; and
- More than 1 second has elapsed since the UE camped on the current serving cell.

Cell reselection to a higher priority RAT/frequency shall take precedence over a lower priority RAT/frequency if multiple cells of different priorities fulfil the cell reselection criteria.

If more than one cell meets the above criteria, the UE shall reselect a cell as follows:

- If the highest-priority frequency is an NR frequency, the highest ranked cell among the cells on the highest priority frequency(ies) meeting the criteria according to clause 5.2.4.6;
- If the highest-priority frequency is from another RAT, the strongest cell among the cells on the highest priority frequency(ies) meeting the criteria of that RAT.

[TS 38.331, clause 5.2.2.2.1]

The UE shall apply the SI acquisition procedure as defined in clause 5.2.2.3 upon cell selection (e.g. upon power on), cell-reselection, return from out of coverage, after reconfiguration with sync completion, after entering the network from another RAT, upon receiving an indication that the system information has changed, upon receiving a PWS notification; and whenever the UE does not have a valid version of a stored SIB.

When the UE acquires a *MIB* or a *SIB1* or an SI message in a serving cell as described in clause 5.2.2.3, and if the UE stores the acquired SIB, then the UE shall store the associated *areaScope*, if present, the first *PLMN-Identity* in the *PLMN-IdentityInfoList*, the *cellIdentity*, the *systemInformationAreaID*, if present, and the *valueTag*, if present, as indicated in the *si-SchedulingInfo* for the SIB. The UE may use a valid stored version of the SI except *MIB*, *SIB1*, *SIB6*, *SIB7* or *SIB8* e.g. after cell re-selection, upon return from out of coverage or after the reception of SI change indication.

NOTE: The storage and management of the stored SIBs in addition to the SIBs valid for the current serving cell is left to UE implementation.

The UE shall:

- 1> delete any stored version of a SIB after 3 hours from the moment it was successfully confirmed as valid;
- 1> for each stored version of a SIB:
 - 2> if the *areaScope* is associated and its value for the stored version of the SIB is the same as the value received in the *si-SchedulingInfo* for that SIB from the serving cell:
 - 3> if the first *PLMN-Identity* included in the *PLMN-IdentityInfoList*, the *systemInformationAreaID* and the *valueTag* that are included in the *si-SchedulingInfo* for the SIB received from the serving cell are identical to the *PLMN-Identity*, the *systemInformationAreaID* and the *valueTag* associated with the stored version of that SIB:
 - 4> consider the stored SIB as valid for the cell;

...

[TS 38.331, clause 5.2.2.3.3]

The UE shall:

...

- 1> else:
 - 2> apply the *timeAlignmentTimerCommon* included in *SIB1*;
 - 2> apply the CCCH configuration as specified in 9.1.1.2;
 - 2> initiate transmission of the *RRCSystemInfoRequest* message in accordance with 5.2.2.3.4;
 - 2> if acknowledgement for *RRCSystemInfoRequest* message is received from lower layers:
 - 3> acquire the requested SI message(s) as defined in subclause 5.2.2.3.2, immediately;

....

[TS 38.331, clause 5.2.2.3.4]

The UE shall set the contents of *RRCSystemInfoRequest* message as follows:

- 1> set the *requested-SI-List* to indicate the SI message(s) that the UE requires to operate within the cell, and for which *si-BroadcastStatus* is set to *notBroadcasting*.

The UE shall submit the *RRCSystemInfoRequest* message to lower layers for transmission.

6.1.2.11.3 Test description

6.1.2.11.3.1 Pre-test conditions

System Simulator:

- NR Cell 1, NR Cell 3 and NR Cell 6.
- System information combination NR-2 as defined in TS 38.508-1 [4] clause 4.4.3.1.2 is used in NR Cells.

UE:

None.

Preamble:

- The UE is in NR RRC Idle mode (state 1N-A) on NR Cell 1 according to 38.508-1 [4] Table 4.4A.2-1.

6.1.2.11.3.2 Test procedure sequence

Table 6.1.2.11.3.2-1/2 illustrate the downlink power levels and other changing parameters to be applied for the cell at various time instants of the test execution. The exact instants on which these values shall be applied are described in the texts in this clause. The configuration T0 indicates the initial conditions for preamble. Configurations marked "T1" and "T2" is applied at the points indicated in the Main behaviour description in Table 6.1.2.11.3.2-3.

Table 6.1.2.11.3.2-1: Time instances of cell power level and parameter changes for FR1

	Parameter	Unit	NR Cell 1	NR Cell 3	NR Cell 6	Remark
T0	SS/PBCH SSS EPRE	dBm/SCS	-88	Off	Off	
T1	SS/PBCH SSS EPRE	dBm/SCS	-95	-80	Off	The power level values are assigned to satisfy $Srxlev_{NRCell3} > Thresh_{X, HighP}$
T2	SS/PBCH SSS EPRE	dBm/SCS	Off	-88	-80	The power level values are assigned to satisfy $R_{NRCell3} < R_{NRCell6}$

Table 6.1.2.11.3.2-2: Time instances of cell power level and parameter changes for FR2

	Parameter	Unit	NR Cell 1	NR Cell 3	NR Cell 6	Remark
T0	SS/PBCH SSS EPRE	dBm/SCS	FFS	Off	Off	
T1	SS/PBCH SSS EPRE	dBm/SCS	FFS	FFS	Off	The power level values are assigned to satisfy $Srxlev_{NRCell3} > Thresh_{X, HighP}$
T2	SS/PBCH SSS EPRE	dBm/SCS	Off	FFS	FFS	The power level values are assigned to satisfy $R_{NRCell3} < R_{NRCell6}$

Table 6.1.2.11.3.2-3: Main behaviour

St	Procedure	Message Sequence		TP	Verdict
		U - S	Message		

0	The SS changes SIB1 as specified as Table 6.1.2.11.3.3-1. Note: The sysinfo combination of NR cell 1 is changed to NR-4.	-	-	-	-
0A	The SS notifies the UE of change of System Information on NR Cell 1 by send Short Message on PDCCH using P-RNTI.	<--	NR PDCCH (DCI 1_0): Short Message	-	-
1	Void	-	-	-	-
2	UE sends <i>RRCSystemInfoRequest</i> message to NR Cell 1 to request SIB4.	-->	NR RRC: <i>RRCSystemInfoRequest</i>	1	P
-	EXCEPTION: After receiving <i>RRCSystemInfoRequest</i> message in step 2, the SS ignores the reception of subsequent <i>RRCSystemInfoRequest</i> .	-	-	-	-
3	NR Cell 1 starts broadcasting <i>SystemInformation</i> message which including SIB4.	<--	NR RRC: <i>SystemInformation</i>	-	-
3A	The SS re-adjusts the SS/PBCH EPRE levels and according to row "T1" in table 6.1.2.11.3.2-1/2.	-	-	-	-
4	Wait 34s to let UE to perform inter-frequency cell reselection to NR Cell 3 (Note 1).	-	-	-	-
4A	Does the UE send <i>RRCSystemInfoRequest</i> message on NR Cell 3 to request SIB4 in the next 5s?			2	F
4B	The test result of generic test procedure in TS 38.508-1 [4] Table 4.9.4.2.2-1 indicate that the UE is camped on NR Cell 3.	-	-	-	-
5	The SS re-adjusts the SS/PBCH EPRE levels and according to row "T2" in table 6.1.2.11.3.2-1/2.	-	-	-	-
6	Void				
6A	Wait 34s to let UE to perform inter-frequency cell reselection to NR Cell 6.(Note 1)	-	-	-	-
7	Check: Does the test result of generic test procedure in TS 38.508-1 [4] Table 4.9.4.2.2-1 indicate that the UE is camped on NR Cell 6?	-	-	2	P
Note 1: The wait time for cell reselection procedure is selected to cover $T_{\text{detect, NR_inter}} (32\text{s}) + T_{\text{SI-NR}} (1280\text{ ms}) = 33.28\text{s}$ rounded up to 34s.					

6.1.2.11.3.3 Specific message contents

Table 6.1.2.11.3.3-1: SIB1 of NR cell 1 and NR cell 3 (All steps in Table 6.1.2.11.3.2-3)

Derivation Path: TS 38.508-1 [4], Table 4.6.1-28 with Condition SIG AND FR1			
Information Element	Value/remark	Comment	Condition
SIB1 ::= SEQUENCE {			
cellSelectionInfo SEQUENCE {			
si-SchedulingInfo	SI-SchedulingInfo-Area	Table 6.1.2.11.3.3-2	
}			

Table 6.1.2.11.3.3-2: SI-SchedulingInfo-Area (Table 6.1.2.11.3.3-1)

Derivation Path: TS 38.508-1 [4], Table 4.6.3-173 with Condition FR1			
Information Element	Value/remark	Comment	Condition
SI-SchedulingInfo ::= SEQUENCE {			
schedulingInfoList SEQUENCE (SIZE (1..maxSI-Message)) OF SchedulingInfo {	2 entries		
SchedulingInfo[1] SEQUENCE {		entry 1	
si-BroadcastStatus	broadcasting		
si-Periodicity	rf32		
sib-MappingInfo SEQUENCE (SIZE (1..maxSIB)) OF SIB-TypeInfo {	1 entry		

SIB-TypeInfo[1] SEQUENCE {		entry 1	
type	sibType2		
}			
}			
SchedulingInfo[2] SEQUENCE {		entry 2	
si-BroadcastStatus	not broadcasting		
si-Periodicity	rf64		
sib-MappingInfo SEQUENCE (SIZE (1..maxSIB)) OF SIB-TypeInfo {	1 entry		
SIB-TypeInfo[1] SEQUENCE {		entry 1	
type	sibType4		
valueTag	0		
areaScope	true		
}			
}			
}			
}			
}			
systemInformationAreaID	'0000 0000 0000 0000 0000 0011'B		
}			

Table 6.1.2.11.3.3-3: RRCSystemInfoRequest (Step 2, Table 6.1.2.11.3.2-3)

Derivation Path: TS 38.508-1 [4], Table 4.6.1-24			
Information Element	Value/remark	Comment	Condition
RRCSystemInfoRequest ::= SEQUENCE {			
criticalExtensions CHOICE {			
rrcSystemInfoRequest-r15 SEQUENCE {			
requested-SI-List	01000000000000000000000000000000	Bit corresponds to SIB4 in <i>schedulingInfoList</i>	
}			
}			
}			

Table 6.1.2.11.3.3-4: SystemInformation (Step 3, Table 6.1.2.11.3.2-3)

Derivation Path: TS 38.508-1 [4], Table 4.6.1-29			
Information Element	Value/remark	Comment	Condition
SystemInformation ::= SEQUENCE {			
criticalExtensions CHOICE {			
systemInformation-r15 SEQUENCE {			
sib-TypeAndInfo SEQUENCE (SIZE (1..maxSIB)) OF CHOICE {	1 entry		
SIB4 SEQUENCE {	As per TS 38.508-1 [4] Table 4.6.2-3		
interFreqCarrierFreqList SEQUENCE (SIZE (1..maxFreq)) OF InterFreqCarrierFreqInfo {	2 entries		
InterFreqCarrierFreqInfo[1] SEQUENCE {		entry 1	
dl-CarrierFreq	Same downlink NR ARFCN as used for NR Cell 3		
smtc	SSB-MTC as defined in TS 38.508-1 [4] Table 4.6.3-185 with condition INTER-FREQ_ODD		
}			
InterFreqCarrierFreqInfo[2] SEQUENCE {		entry 2	
dl-CarrierFreq	Same downlink NR ARFCN as used for NR Cell 6		
smtc	SSB-MTC as defined in TS 38.508-1 [4] Table	smtc of the inter-freq carrier for NR	
}			
}			
}			

	4.6.3-185 with condition INTER-FREQ_ODD	Cell 6 is calculated with respect to NR Cell 3	
}			
}			
}			
}			
}			
}			
}			

6.1.2.12 Cell reselection using cell status and cell reservations / cellReservedForOtherUse

6.1.2.12.1 Test Purpose (TP)

(1)

```
with { UE camped normally in state NR RRC_IDLE }
ensure that {
  when { A higher ranked cell is found with cell status "true" for other use }
  then { UE does not attempt to reselect to the higher ranked cell }
}
```

6.1.2.12.2 Conformance requirements

References: The conformance requirements covered in the present TC are specified in: 3GPP TS 38.304, clause 5.2.4.4, 5.2.4.6 and 5.3.1. Unless otherwise stated these are Rel-15 requirements.

[TS 38.304, clause 5.2.4.4]

For the highest ranked cell (including serving cell) according to cell reselection criteria specified in subclause 5.2.4.6, for the best cell according to absolute priority reselection criteria specified in subclause 5.2.4.5, the UE shall check if the access is restricted according to the rules in subclause 5.3.1.

If that cell and other cells have to be excluded from the candidate list, as stated in subclause 5.3.1, the UE shall not consider these as candidates for cell reselection. This limitation shall be removed when the highest ranked cell changes.

If the highest ranked cell or best cell according to absolute priority reselection rules is an intra-frequency or inter-frequency cell which is not suitable due to being part of the "list of 5GS forbidden TAs for roaming" or belonging to a PLMN which is not indicated as being equivalent to the registered PLMN, the UE shall not consider this cell and other cells on the same frequency, as candidates for reselection for a maximum of 300 seconds. If the UE enters into state *any cell selection*, any limitation shall be removed. If the UE is redirected under NR control to a frequency for which the timer is running, any limitation on that frequency shall be removed.

If the highest ranked cell or best cell according to absolute priority reselection rules is an inter-RAT cell which is not suitable due to being part of the "list of forbidden TAs for roaming" or belonging to a PLMN which is not indicated as being equivalent to the registered PLMN, the UE shall not consider this cell and other cells on the same frequency, as candidates for reselection for a maximum of 300 seconds. If the UE enters into state *any cell selection*, any limitation shall be removed. If the UE is redirected under NR control to a frequency for which the timer is running, any limitation on that frequency shall be removed.

[TS 38.304, clause 5.2.4.6]

The cell-ranking criterion R_s for serving cell and R_n for neighbouring cells is defined by:

$$R_s = Q_{\text{meas},s} + Q_{\text{hyst}} - Q_{\text{offset}_{\text{temp}}}$$

$$R_n = Q_{\text{meas},n} - Q_{\text{offset}} - Q_{\text{offset}_{\text{temp}}}$$

where:

Q_{meas}	RSRP measurement quantity used in cell reselections.
Q_{offset}	For intra-frequency: Equals to $Q_{offset_{s,n}}$, if $Q_{offset_{s,n}}$ is valid, otherwise this equals to zero. For inter-frequency: Equals to $Q_{offset_{s,n}}$ plus $Q_{offset_{frequency}}$, if $Q_{offset_{s,n}}$ is valid, otherwise this equals to $Q_{offset_{frequency}}$.
$Q_{offset_{temp}}$	Offset temporarily applied to a cell as specified in TS 38.331 [3].

The UE shall perform ranking of all cells that fulfil the cell selection criterion S, which is defined in 5.2.3.2.

The cells shall be ranked according to the R criteria specified above by deriving $Q_{meas,n}$ and $Q_{meas,s}$ and calculating the R values using averaged RSRP results.

If *rangeToBestCell* is not configured, the UE shall perform cell reselection to the highest ranked cell. If this cell is found to be not-suitable, the UE shall behave according to subclause 5.2.4.4.

If *rangeToBestCell* is configured, then the UE shall perform cell reselection to the cell with the highest number of beams above the threshold (i.e. *absThreshSS-BlocksConsolidation*) among the cells whose R value is within *rangeToBestCell* of the R value of the highest ranked cell. If there are multiple such cells, the UE shall perform cell reselection to the highest ranked cell among them. If this cell is found to be not-suitable, the UE shall behave according to subclause 5.2.4.4.

In all cases, the UE shall reselect the new cell, only if the following conditions are met:

- the new cell is better than the serving cell according to the cell reselection criteria specified above during a time interval $T_{reselection_{RAT}}$;
- more than 1 second has elapsed since the UE camped on the current serving cell.

[TS 38.304, clause 5.3.1]

Cell status and cell reservations are indicated in the *MIB* or *SIB1* message as specified in TS 38.331 [3] by means of three fields:

- *cellBarred* (IE type: "barred" or "not barred")
Indicated in *MIB* message. In case of multiple PLMNs indicated in *SIB1*, this field is common for all PLMNs
- *cellReservedForOperatorUse* (IE type: "reserved" or "not reserved")
Indicated in *SIB1* message. In case of multiple PLMNs indicated in *SIB1*, this field is specified per PLMN.
- *cellReservedForOtherUse* (IE type: "true")
Indicated in *SIB1* message. In case of multiple PLMNs indicated in *SIB1*, this field is common for all PLMNs.

When cell status is indicated as "not barred" and "not reserved" for operator use and not "true" for other use,

- All UEs shall treat this cell as candidate during the cell selection and cell reselection procedures.

When cell status is indicated as "true" for other use,

- The UE shall treat this cell as if cell status is "barred".

When cell status is indicated as "not barred" and "reserved" for operator use for any PLMN and not "true" for other use,

- UEs assigned to Access Identity 11 or 15 operating in their HPLMN/EHPLMN shall treat this cell as candidate during the cell selection and reselection procedures if the field *cellReservedForOperatorUse* for that PLMN set to "reserved".
- UEs assigned to an Access Identity 1, 2 and 12 to 14 shall behave as if the cell status is "barred" in case the cell is "reserved for operator use" for the registered PLMN or the selected PLMN.

NOTE 1: Access Identities 11, 15 are only valid for use in the HPLMN/ EHPLMN; Access Identities 12, 13, 14 are only valid for use in the home country as specified in TS 22.261 [12].

When cell status "barred" is indicated or to be treated as if the cell status is "barred",

- The UE is not permitted to select/reselect this cell, not even for emergency calls.

- The UE shall select another cell according to the following rule:
- If the cell is to be treated as if the cell status is "barred" due to being unable to acquire the *MIB*:
 - the UE may exclude the barred cell as a candidate for cell selection/reselection for up to 300 seconds.
 - the UE may select another cell on the same frequency if the selection criteria are fulfilled.
- else:
 - If the cell is to be treated as if the cell status is "barred" due to being unable to acquire the *SIB1*:
 - The UE may exclude the barred cell as a candidate for cell selection/reselection for up to 300 seconds.
 - If the field *intraFreqReselection* in *MIB* message is set to "allowed", the UE may select another cell on the same frequency if re-selection criteria are fulfilled;
 - The UE shall exclude the barred cell as a candidate for cell selection/reselection for 300 seconds.
 - If the field *intraFreqReselection* in *MIB* message is set to "not allowed" the UE shall not re-select a cell on the same frequency as the barred cell;
 - The UE shall exclude the barred cell and the cells on the same frequency as a candidate for cell selection/reselection for 300 seconds.

The cell selection of another cell may also include a change of RAT.

6.1.2.12.3 Test description

6.1.2.12.3.1 Pre-test conditions

System Simulator:

- NR Cell 1 and NR Cell 11 in different tracking areas.
- System information combination NR-2 as defined in TS 38.508-1 [4] clause 4.4.3.1.2 is used in NR Cells.

UE:

None.

Preamble:

- The UE is in NR RRC Idle mode (state 1N-A) on NR Cell 1 according to 38.508-1 [4] Table 4.4A.2-1.

6.1.2.12.3.2 Test procedure sequence

Table 6.1.2.12.3.2-1/2 illustrate the downlink power levels and other changing parameters to be applied for the cell at various time instants of the test execution. The exact instants on which these values shall be applied are described in the texts in this clause. The configuration T0 indicates the initial conditions for preamble. Configurations marked "T1" is applied at the points indicated in the Main behaviour description in Table 6.1.2.12.3.2-3.

Table 6.1.2.12.3.2-1: Time instances of cell power level and parameter changes for FR1

	Parameter	Unit	NR Cell 1	NR Cell 11	Remark
T0	SS/PBCH SSS EPRE	dBm/ SCS	-88	Off	
T1	SS/PBCH SSS EPRE	dBm/ SCS	-88	-80	The power level values are assigned to satisfy $R_{NRCell\ 1} < R_{NRCell\ 11}$
	cellReservedFor OtherUse	-	-	True	

Table 6.1.2.12.3.2-2: Time instances of cell power level and parameter changes for FR2

	Parameter	Unit	NR Cell 1	NR Cell 11	Remark
T0	SS/PBCH SSS EPRE	dBm/ SCS	FFS	Off	
T1	SS/PBCH SSS EPRE	dBm/ SCS	FFS	FFS	The power level values are assigned to satisfy $R_{NRCell 1} < R_{NRCell 11}$
	cellReservedFor OtherUse	-	-	True	

Table 6.1.2.12.3.2-3: Main behaviour

St	Procedure	Message Sequence		TP	Verdict
		U - S	Message		
1	The SS re-adjusts the SS/PBCH EPRE levels and according to row "T1" in table 6.1.2.12.3.2-1/2.	-	-	-	-
2	Check: Does the UE initiate a random access procedure on NR Cell 11 within the next 120s?	-	-	1	F
3	Check: Does the test result of generic test procedure in TS 38.508-1 [4] Table 4.9.4.2.2-1 indicate that check UE is in state NR RRC_IDLE on NR Cell 1?	-	-	1	-

6.1.2.12.3.3 Specific message contents

Table 6.1.2.12.3.3-1: SIB1 for NR Cell 11 (Preamble, Table 6.1.2.12.3.2-3)

Derivation Path: TS 38.508-1 [4], Table 4.6.1-5			
Information Element	Value/Remark	Comment	Condition
SIB1 ::= SEQUENCE {			
cellAccessRelatedInfo SEQUENCE {			
cellReservedForOtherUse	true		
}			
}			

6.1.2.13 Cell reselection using cell status and cell reservations / Access Identity 0, 1, 2 and 12 to 14 – cellReservedForOperatorUse

6.1.2.13.1 Test Purpose (TP)

(1)

```

with { UE camped normally in state NR RRC_IDLE and UE fitted with a USIM with at least one of the
following Access Identities set: 0,1,2,12,13,14}
ensure that {
  when { a higher ranked cell is found "reserved" for Operator use }
  then { UE does not attempt to reselect to the higher ranked cell }
}

```

6.1.2.13.2 Conformance requirements

References: The conformance requirements covered in the present TC are specified in: 3GPP TS 38.304, clause 5.3.1. Unless otherwise stated these are Rel-15 requirements.

[TS 38.304, clause 5.3.1]

Cell status and cell reservations are indicated in the *MIB* or *SIB1* message as specified in TS 38.331 [3] by means of three fields:

- *cellBarred* (IE type: "barred" or "not barred")
Indicated in *MIB* message. In case of multiple PLMNs indicated in *SIB1*, this field is common for all PLMNs
- *cellReservedForOperatorUse* (IE type: "reserved" or "not reserved")
Indicated in *SIB1* message. In case of multiple PLMNs indicated in *SIB1*, this field is specified per PLMN.
- *cellReservedForOtherUse* (IE type: "true")
Indicated in *SIB1* message. In case of multiple PLMNs indicated in *SIB1*, this field is common for all PLMNs.

When cell status is indicated as "not barred" and "not reserved" for operator use and not "true" for other use,

- All UEs shall treat this cell as candidate during the cell selection and cell reselection procedures.

When cell status is indicated as "true" for other use,

- The UE shall treat this cell as if cell status is "barred".

When cell status is indicated as "not barred" and "reserved" for operator use for any PLMN and not "true" for other use,

- UEs assigned to Access Identity 11 or 15 operating in their HPLMN/EHPLMN shall treat this cell as candidate during the cell selection and reselection procedures if the field *cellReservedForOperatorUse* for that PLMN set to "reserved".
- UEs assigned to an Access Identity 0, 1, 2 and 12 to 14 shall behave as if the cell status is "barred" in case the cell is "reserved for operator use" for the registered PLMN or the selected PLMN.

NOTE 1: Access Identities 11, 15 are only valid for use in the HPLMN/ EHPLMN; Access Identities 12, 13, 14 are only valid for use in the home country as specified in TS 22.261 [12].

When cell status "barred" is indicated or to be treated as if the cell status is "barred",

- The UE is not permitted to select/reselect this cell, not even for emergency calls.
- The UE shall select another cell according to the following rule:
- If the cell is to be treated as if the cell status is "barred" due to being unable to acquire the *MIB*:
 - the UE may exclude the barred cell as a candidate for cell selection/reselection for up to 300 seconds.
 - the UE may select another cell on the same frequency if the selection criteria are fulfilled.
- else:
 - If the cell is to be treated as if the cell status is "barred" due to being unable to acquire the *SIB1* or due to *trackingAreaCode* being absent in *SIB1* as specified in TS 38.331 [3]:-The UE may exclude the barred cell as a candidate for cell selection/reselection for up to 300 seconds.
 - If the field *intraFreqReselection* in *MIB* message is set to "allowed", the UE may select another cell on the same frequency if re-selection criteria are fulfilled;
 - The UE shall exclude the barred cell as a candidate for cell selection/reselection for 300 seconds.
 - If the field *intraFreqReselection* in *MIB* message is set to "not allowed" the UE shall not re-select a cell on the same frequency as the barred cell;
 - The UE shall exclude the barred cell and the cells on the same frequency as a candidate for cell selection/reselection for 300 seconds.

The cell selection of another cell may also include a change of RAT.

6.1.2.13.3 Test description

6.1.2.13.3.1 Pre-test conditions

System Simulator:

- NR Cell 1 and NR Cell 12 with different tracking areas.
- NR Cell 1 and NR Cell 12 are HPLMN.
- System information combination NR-4 as defined in TS 38.508-1 [4] clause 4.4.3.1.2 is used in NR Cells.

UE:

None.

Preamble:

- The UE is in NR RRC Idle mode (state 1N-A) on NR Cell 1 according to TS 38.508-1 [4] Table 4.4A.2-1.
- The UE switches off and then switches on.
- The UE is in NR RRC Idle mode (state 1N-A) on NR Cell 1 according to TS 38.508-1 [4] Table 4.4A.2-1.

6.1.2.13.3.2 Test procedure sequence

Table 6.1.2.13.3.2-1/2 illustrate the downlink power levels and other changing parameters to be applied for the cell at various time instants of the test execution. The exact instants on which these values shall be applied are described in the texts in this clause. Configurations marked "T0" is applied for Preamble. Configurations marked "T1" is applied at the points indicated in the Main behaviour description in Table 6.1.2.13.3.2-3.

Table 6.1.2.13.3.2-1: Time instances of cell power level and parameter changes for FR1

	Parameter	Unit	NR Cell 1	NR Cell 12	Remark
T0	SS/PBCH SSS EPRE	dBm/ SCS	-88	Off	
T1	SS/PBCH SSS EPRE	dBm/ SCS	-88	-80	The power level values are assigned to satisfy $R_{NRCell\ 1} < R_{NRCell\ 12}$
	cellReservedFor OperatorUse	-	-	Reserved	

Table 6.1.2.13.3.2-2: Time instances of cell power level and parameter changes for FR2

	Parameter	Unit	NR Cell 1	NR Cell 12	Remark
T0	SS/PBCH SSS EPRE	dBm/ SCS	FFS	Off	
T1	SS/PBCH SSS EPRE	dBm/ SCS	FFS	FFS	The power level values are assigned to satisfy $R_{NRCell\ 1} < R_{NRCell\ 12}$
	cellReservedFor OperatorUse	-	-	Reserved	

Table 6.1.2.13.3.2-3: Main behaviour

St	Procedure	Message Sequence		TP	Verdict
		U - S	Message		
1	The SS adjusts the SS/PBCH EPRE levels according to row "T1" in table 6.1.2.13.3.2-1/2.	-	-	-	-
2	Check: Does the UE initiate a random access procedure on NR Cell 12 within the next 120s?	-	-	1	F
3	Check: Does the test result of generic test procedure in TS 38.508-1 [4] Table 4.9.4.2.2-1 indicate that check UE is in state NR RRC_IDLE on NR Cell 1?	-	-	1	-

- UEs assigned to an Access Identity 1, 2 and 12 to 14 shall behave as if the cell status is "barred" in case the cell is "reserved for operator use" for the registered PLMN or the selected PLMN.

NOTE 1: Access Identities 11, 15 are only valid for use in the HPLMN/ EHPLMN; Access Identities 12, 13, 14 are only valid for use in the home country as specified in TS 22.261 [12].

When cell status "barred" is indicated or to be treated as if the cell status is "barred",

- The UE is not permitted to select/reselect this cell, not even for emergency calls.
- The UE shall select another cell according to the following rule:
 - If the cell is to be treated as if the cell status is "barred" due to being unable to acquire the *MIB*:
 - the UE may exclude the barred cell as a candidate for cell selection/reselection for up to 300 seconds.
 - the UE may select another cell on the same frequency if the selection criteria are fulfilled.
 - else:
 - If the cell is to be treated as if the cell status is "barred" due to being unable to acquire the *SIB1*:
 - The UE may exclude the barred cell as a candidate for cell selection/reselection for up to 300 seconds.
 - If the field *intraFreqReselection* in *MIB* message is set to "allowed", the UE may select another cell on the same frequency if re-selection criteria are fulfilled;
 - The UE shall exclude the barred cell as a candidate for cell selection/reselection for 300 seconds.
 - If the field *intraFreqReselection* in *MIB* message is set to "not allowed" the UE shall not re-select a cell on the same frequency as the barred cell;
 - The UE shall exclude the barred cell and the cells on the same frequency as a candidate for cell selection/reselection for 300 seconds.

The cell selection of another cell may also include a change of RAT.

6.1.2.14.3 Test description

6.1.2.14.3.1 Pre-test conditions

System Simulator:

- NR Cell 1 and NR Cell 3 in different tracking areas.
- NR Cell 1 and NR Cell 3 are HPLMN.
- System information combination NR-4 as defined in TS 38.508-1 [4] clause 4.4.3.1.2 is used in NR Cells.

UE:

- The UE is equipped with a USIM containing default values and USIM Configuration 17.

Preamble:

- The UE is in NR RRC Idle mode (state 1N-A) on NR Cell 1 according to TS 38.508-1 [4] Table 4.4A.2-1.

6.1.2.14.3.2 Test procedure sequence

Table 6.1.2.14.3.2-1/2 illustrate the downlink power levels and other changing parameters to be applied for the cell at various time instants of the test execution. The exact instants on which these values shall be applied are described in the texts in this clause. Configurations marked "T0" is applied for Preamble. Configurations marked "T1" is applied at the points indicated in the Main behaviour description in Table 6.1.2.14.3.2-3.

Table 6.1.2.14.3.2-1: Time instances of cell power level and parameter changes for FR1

	Parameter	Unit	NR Cell 1	NR Cell 3	Remark
T0	SS/PBCH SSS EPRE	dBm/ SCS	-88	Off	
T1	SS/PBCH SSS EPRE	dBm/ SCS	-88	-80	The power level values are assigned to satisfy $R_{NRCell\ 1} < R_{NRCell\ 3}$
	cellReservedFor OperatorUse	-	-	Reserved	

Table 6.1.2.14.3.2-2: Time instances of cell power level and parameter changes for FR2

	Parameter	Unit	NR Cell 1	NR Cell 3	Remark
T0	SS/PBCH SSS EPRE	dBm/ SCS	FFS	Off	
T1	SS/PBCH SSS EPRE	dBm/ SCS	FFS	FFS	The power level values are assigned to satisfy $R_{NRCell\ 1} < R_{NRCell\ 3}$
	cellReservedFor OperatorUse	-	-	Reserved	

Table 6.1.2.14.3.2-3: Main behaviour

St	Procedure	Message Sequence		TP	Verdict
		U - S	Message		
1	The SS adjusts the SS/PBCH EPRE levels according to row "T1" in table 6.1.2.14.3.2-1/2.	-	-	-	-
2	Check: Does the test result of test steps 1 to 5 of generic test procedure in TS 38.508-1 [4] Table 4.9.5.2.2-1 indicate that the UE is camped on NR Cell 3?	-	-	1	P

6.1.2.14.3.3 Specific message contents

Table 6.1.2.14.3.3-1: SIB1 for NR Cell 3 (Preamble, Table 6.1.2.14.3.2-3)

Derivation Path: TS 38.508-1 [4], Table 4.6.1-5			
Information Element	Value/Remark	Comment	Condition
SIB1 ::= SEQUENCE {			
cellAccessRelatedInfo SEQUENCE {			
plmn-IdentityList SEQUENCE (SIZE (1..maxPLMN)) OF PLMN-Identity {			
cellReservedForOperatorUse	Reserved		
}			
}			
}			

Table 6.1.2.14.3.3-2: SERVICE REQUEST (Preamble, Table 6.1.2.14.3.2-3; step 4 ,Table 4.5.2.2-4, TS 38.508-1 [4])

Derivation Path: Table 4.7.1-16.			
Information Element	Value/remark	Comment	Condition
Service type	'0101'B	high priority access	

6.1.2.15 Cell reselection in shared network environment

6.1.2.15.1 Test Purpose (TP)

(1)

```
with { the UE is in NR RRC_Idle and registered on the HPLMN }
ensure that {
  when { a cell of a different PLMN but shared with the HPLMN becomes highest ranked cell }
  then { the UE reselects the cell shared with the HPLMN }
}
```

6.1.2.15.2 Conformance requirements

References: The conformance requirements covered in the present TC are specified in: 3GPP TS 23.122, clause 4.4.3, and TS 38.304, clause 5.2.4.6. Unless otherwise stated these are Rel-15 requirements.

[TS 23.122, clause 4.4.3]

The registration on the selected PLMN and the location registration are only necessary if the MS is capable of services which require registration. Otherwise, the PLMN selection procedures are performed without registration.

The ME shall utilise all the information stored in the SIM related to the PLMN selection; e.g. "HPLMN Selector with Access Technology", "User Controlled PLMN Selector with Access Technology", "Forbidden PLMNs", "Equivalent HPLMN", see 3GPP TS 31.102 [40].

The ME shall either utilise the "Operator controlled PLMN Selector with Access Technology" that it has stored locally on the ME, or the Operator controlled PLMN Selector with Access Technology stored in the SIM, for the purposes of PLMN selection.

The "HPLMN Selector with Access Technology", "User Controlled PLMN Selector with Access Technology" and "Operator Controlled PLMN Selector with Access Technology" data files in the SIM include associated access technologies for each PLMN entry, see 3GPP TS 31.102 [40]. The PLMN/access technology combinations are listed in priority order. If an entry indicates more than one access technology, then no priority is defined for the access technologies within this entry and the priority applied to each access technology within this entry is an implementation issue. If no particular access technology is indicated in an entry, it shall be assumed that all access technologies supported by the ME apply to the entry. If an entry only indicates access technologies not supported by the ME, the entry shall be ignored. If an entry indicates at least one access technology supported by the ME, the entry shall be used in the PLMN selection procedures if the other criteria defined for the specific PLMN selection procedures are fulfilled.

The Mobile Equipment stores a list of "equivalent PLMNs". This list is replaced or deleted at the end of each location update procedure, routing area update procedure, GPRS attach procedure, tracking area update procedure, EPS attach procedure, and registration procedure. The list is deleted by an MS attached for emergency bearer services after detach or registered for emergency services after deregistration. The stored list consists of a list of equivalent PLMNs as downloaded by the network plus the PLMN code of the registered PLMN that downloaded the list. All PLMNs in the stored list, in all access technologies supported by the PLMN, are regarded as equivalent to each other for PLMN selection, cell selection/re-selection and handover.

When the MS reselects to a cell in a shared network, and the cell is a suitable cell for multiple PLMN identities received on the BCCH or on the EC-BCCH the AS indicates these multiple PLMN identities to the NAS according to 3GPP TS 44.018 [34], 3GPP TS 44.060 [39], 3GPP TS 25.304 [32] and 3GPP TS 36.304 [43]. The MS shall choose one of these PLMNs. If the registered PLMN is available among these PLMNs, the MS shall not choose a different PLMN.

The MS shall not use the PLMN codes contained in the "HPLMN Selector with Access Technology" data file.

It is possible for the home network operator to identify alternative Network IDs as the HPLMN. If the EHPLMN list is present, and not empty, the entries in the EHPLMN list are used in the network selection procedures. When attempting to select a network the highest priority EHPLMN that is available shall be selected. If the EHPLMN list is present and is empty or if the EHPLMN list is not present, the HPLMN derived from the IMSI is used for network selection procedures.

NOTE 1: The "HPLMN Selector with Access Technology" data file is only used by the MS to get the HPLMN access technologies related to the HPLMN code which corresponds to the PLMN code included in the IMSI if the EHPLMN list is not present or is empty. If the EHPLMN list is present then this data field is applicable to all the entries within the EHPLMN list.

NOTE 2: Different GSM frequency bands (e.g. 900, 1800, 1900, 400) are all considered GSM access technology. An MS supporting more than one band should scan all the bands it's supports when scanning for GSM frequencies. However GSM COMPACT systems which use GSM frequency bands but with the CBPCCH broadcast channel are considered as a separate access technology from GSM.

NOTE 3: The inclusion of the HPLMN derived from the IMSI in the EHPLMN list is allowed. The priority of the HPLMN derived from the IMSI is given by its position in the EHPLMN list, see 3GPP TS 31.102 [40]

[TS 38.304, clause 5.2.4.6]

The cell-ranking criterion R_s for serving cell and R_n for neighbouring cells is defined by:

$$R_s = Q_{\text{meas},s} + Q_{\text{hyst}} - Q_{\text{offset}_{\text{temp}}}$$

$$R_n = Q_{\text{meas},n} - Q_{\text{offset}} - Q_{\text{offset}_{\text{temp}}}$$

where:

Q_{meas}	RSRP measurement quantity used in cell reselections.
Q_{offset}	For intra-frequency: Equals to $Q_{\text{offset}_{s,n}}$, if $Q_{\text{offset}_{s,n}}$ is valid, otherwise this equals to zero. For inter-frequency: Equals to $Q_{\text{offset}_{s,n}}$ plus $Q_{\text{offset}_{\text{frequency}}}$, if $Q_{\text{offset}_{s,n}}$ is valid, otherwise this equals to $Q_{\text{offset}_{\text{frequency}}}$.
$Q_{\text{offset}_{\text{temp}}}$	Offset temporarily applied to a cell as specified in TS 38.331 [3].

The UE shall perform ranking of all cells that fulfil the cell selection criterion S , which is defined in 5.2.3.2.

The cells shall be ranked according to the R criteria specified above by deriving $Q_{\text{meas},n}$ and $Q_{\text{meas},s}$ and calculating the R values using averaged RSRP results.

If *rangeToBestCell* is not configured, the UE shall perform cell reselection to the highest ranked cell. If this cell is found to be not-suitable, the UE shall behave according to subclause 5.2.4.4.

If *rangeToBestCell* is configured, then the UE shall perform cell reselection to the cell with the highest number of beams above the threshold (i.e. *absThreshSS-BlocksConsolidation*) among the cells whose R value is within *rangeToBestCell* of the R value of the highest ranked cell. If there are multiple such cells, the UE shall perform cell reselection to the highest ranked cell among them. If this cell is found to be not-suitable, the UE shall behave according to subclause 5.2.4.4.

In all cases, the UE shall reselect the new cell, only if the following conditions are met:

- the new cell is better ranked than the serving cell during a time interval $T_{\text{reselection}_{\text{RAT}}}$;
- more than 1 second has elapsed since the UE camped on the current serving cell.

6.1.2.15.3 Test description

6.1.2.15.3.1 Pre-test conditions

System Simulator:

- NR Cell 1 (HPLMN)
- NR Cell 11 (primary PLMN: same MCC like HPLMN but different MNC, secondary PLMN: HPLMN)
- System information combination NR-3 as defined in TS 38.508-1 [4] clause 4.4.3.1.3 is used in NR Cells.

UE:

- None.

Preamble:

- The UE is in NR RRC Idle mode (state 1N-A) on NR Cell 1 according to 38.508-1 [4] Table 4.4A.2-1

6.1.2.15.3.2 Test procedure sequence

Table 6.1.2.15.3.2-1/2 illustrate the downlink power levels and other changing parameters to be applied for the cell at various time instants of the test execution. The exact instants on which these values shall be applied are described in the texts in this clause. Row marked "T0" denotes the conditions after the preamble. Configurations marked "T1" is applied at the points indicated in the Main behaviour description in Table 6.1.2.15.3.2-3.

Table 6.1.2.15.3.2-1: Time instances of cell power level and parameter changes for FR1

	Parameter	Unit	NR Cell 1	NR Cell 11	Remark
T0	SS/PBCH SSS EPRE	dBm/ SCS	-88	Off	
T1	SS/PBCH SSS EPRE	dBm/ SCS	-88	-78	The power level values are assigned to satisfy $Sr_{xleVNRCell\ 11} > Sr_{xleVNRCell\ 1}$

Table 6.1.2.15.3.2-2: Time instances of cell power level and parameter changes for FR2

	Parameter	Unit	NR Cell 1	NR Cell 11	Remark
T0	SS/PBCH SSS EPRE	dBm/ SCS	-91	Off	
T1	SS/PBCH SSS EPRE	dBm/ SCS	-91	-82	The power level values are assigned to satisfy $Sr_{xleVNRCell\ 11} > Sr_{xleVNRCell\ 1}$

Table 6.1.2.15.3.2-3: Main behaviour

St	Procedure	Message Sequence		TP	Verdict
		U - S	Message		
1	SS adjusts the SS/PBCH EPRE level of NR Cell 1 and NR Cell 11 according to row "T1" in table 6.1.2.1.3.2-1/2.	-	-	-	-
2	Check: Does the UE transmit an <i>RRCSetupRequest</i> message on NR Cell 11?	-->	NR RRC: <i>RRCSetupRequest</i>	1	P
3	The SS transmits an <i>RRCSetup</i> message.	<--	NR RRC: <i>RRCSetup</i>	-	-
4	Check; Does the UE transmit an <i>RRCSetupComplete</i> message indicating the HPLMN (second PLMN in the list)? Note: this message contains an REGISTRATION REQUEST message indicating "mobility registration updating" to update the registration of the actual tracking area according to default message contents.	-->	NR RRC: <i>RRCSetupComplete</i>	1	P
5 - 7	Steps 4 to 6 of the registration procedure described in TS 38.508-1 [4] Table 4.9.5.2.2-1 are performed on NR Cell 11.	-	-	-	-

6.1.2.15.3.3 Specific message contents

Table 6.1.2.15.3.3-1: SIB1 for NR Cell 1 (Preamble and all steps, Table 6.1.2.15.3.2-3)

Derivation Path: TS 38.508-1 [4], Table 4.6.1-28			
Information Element	Value/remark	Comment	Condition
SIB1 ::= SEQUENCE {			
cellAccessRelatedInfo SEQUENCE {			

plmn-IdentityList SEQUENCE (SIZE (1..maxPLMN)) OF PLMN-Identity {			
plmn-Identity[1]	Set to the same Mobile Country Code and Mobile Network Code stored in EF _{IMSI} on the test USIM card		
}			
}			
}			

Table 6.1.2.15.3.3-2: SIB1 for NR Cell 11 (Preamble and all steps, Table 6.1.2.15.3.2-3)

Derivation Path: TS 38.508-1 [4], Table 4.6.1-28			
Information Element	Value/Remark	Comment	Condition
SIB1 ::= SEQUENCE {			
cellAccessRelatedInfo SEQUENCE {			
plmn-IdentityList SEQUENCE (SIZE (1..maxPLMN)) OF PLMN-Identity {			
plmn-Identity[1]	Set to the same Mobile Country Code stored in EF _{IMSI} on the test USIM, MNC=02	Same MCC like PLMN for NR Cell 1 but different MNC	
plmn-Identity[2]	Set to the same Mobile Country Code and Mobile Network Code stored in EF _{IMSI} on the test USIM card	This is the same PLMN as NR Cell 1	
}			
}			
}			

Table 6.1.2.15.3.3-3: RRCSetupComplete (step 4, Table 6.1.2.15.3.2-3)

Derivation Path: TS 38.508-1 [4], Table 4.6.1-22			
Information Element	Value/remark	Comment	Condition
RRCSetupComplete ::= SEQUENCE {			
criticalExtensions CHOICE {			
rrcSetupComplete SEQUENCE {			
selectedPLMN-Identity	2	HPLMN	
}			
}			
}			

6.1.2.16 Inter-frequency cell reselection (equal priority)

6.1.2.16.1 Test Purpose (TP)

(1)

```
with { UE in NR RRC_IDLE state }
ensure that {
  when { UE detects both intra-frequency and equal priority inter-frequency neighbour cells and the
inter-frequency cell is the highest ranked cell }
  then { UE reselects the inter-frequency cell }
}
```

6.1.2.16.2 Conformance requirements

References: The conformance requirements covered in the present TC are specified in: 3GPP TS 38.304, clause 5.2.4.6. Unless otherwise stated these are Rel-15 requirements.

[TS 38.304, clause 5.2.4.6]

The cell-ranking criterion R_s for serving cell and R_n for neighbouring cells is defined by:

$$R_s = Q_{\text{meas},s} + Q_{\text{hyst}} - Q_{\text{offset}_{\text{temp}}}$$

$$R_n = Q_{\text{meas},n} - Q_{\text{offset}} - Q_{\text{offset}_{\text{temp}}}$$

where:

Q_{meas}	RSRP measurement quantity used in cell reselections.
Q_{offset}	For intra-frequency: Equals to $Q_{\text{offset}_{s,n}}$, if $Q_{\text{offset}_{s,n}}$ is valid, otherwise this equals to zero. For inter-frequency: Equals to $Q_{\text{offset}_{s,n}}$ plus $Q_{\text{offset}_{\text{frequency}}}$, if $Q_{\text{offset}_{s,n}}$ is valid, otherwise this equals to $Q_{\text{offset}_{\text{frequency}}}$.
$Q_{\text{offset}_{\text{temp}}}$	Offset temporarily applied to a cell as specified in TS 38.331 [3].

The UE shall perform ranking of all cells that fulfil the cell selection criterion S , which is defined in 5.2.3.2.

The cells shall be ranked according to the R criteria specified above by deriving $Q_{\text{meas},n}$ and $Q_{\text{meas},s}$ and calculating the R values using averaged RSRP results.

If *rangeToBestCell* is not configured, the UE shall perform cell reselection to the highest ranked cell. If this cell is found to be not-suitable, the UE shall behave according to subclause 5.2.4.4.

If *rangeToBestCell* is configured, then the UE shall perform cell reselection to the cell with the highest number of beams above the threshold (i.e. *absThreshSS-BlocksConsolidation*) among the cells whose R value is within *rangeToBestCell* of the R value of the highest ranked cell. If there are multiple such cells, the UE shall perform cell reselection to the highest ranked cell among them. If this cell is found to be not-suitable, the UE shall behave according to subclause 5.2.4.4.

In all cases, the UE shall reselect the new cell, only if the following conditions are met:

- the new cell is better ranked than the serving cell during a time interval $T_{\text{reselection,RAT}}$;
- more than 1 second has elapsed since the UE camped on the current serving cell.

6.1.2.16.3 Test description

6.1.2.16.3.1 Pre-test conditions

System Simulator:

- NR Cell 1, NR Cell 2 and NR Cell 3 have different tracking areas.
- System information combination NR-5 as defined in TS 38.508-1 [4] clause 4.4.3.1.3 is used in NR Cells.

UE:

None.

Preamble:

- The UE is in NR RRC Idle mode (state 1N-A) on NR Cell 1 (according to 38.508-1 [4] Table 4.4A.2-1).

6.1.2.16.3.2 Test procedure sequence

Table 6.1.2.16.3.2-1/2 illustrate the downlink power levels and other changing parameters to be applied for the cell at various time instants of the test execution. The exact instants on which these values shall be applied are described in the texts in this clause. Row marked "T0" denotes the conditions after the preamble. Configurations marked "T1", "T2" and "T3" are applied at the points indicated in the Main behaviour description in Table 6.1.2.16.3.2-3.

Table 6.1.2.16.3.2-1: Time instances of cell power level and parameter changes for FR1

	Parameter	Unit	NR Cell 1	NR Cell 2	NR Cell 3	Remark
T0	SS/PBCH SSS EPRE	dBm/ SCS	-88	-94	-78	The power level values are set so that $R_{NRCell 2} < R_{NRCell 1} < R_{NRCell 3}$.

Table 6.1.2.16.3.2-2: Time instances of cell power level and parameter changes for FR2

	Parameter	Unit	NR Cell 1	NR Cell 2	NR Cell 3	Remark
T0	SS/PBCH SSS EPRE	dBm/ SCS	FFS	FFS	FFS	

Table 6.1.2.16.3.2-3: Main behaviour

St	Procedure	Message Sequence		TP	Verdict
		U - S	Message		
1	The SS adjusts the SS/PBCH EPRE levels according to row "T0" in table 6.1.2.16.3.2-1/2.	-	-	-	-
2	Check: Does the test result of generic test procedure in TS 38.508-1 [4] Table 4.9.5.2.2-1 indicate that the UE is camped on NR Cell 3?	-	-	1	-

6.1.2.16.3.3 Specific message contents

None.

6.1.2.17 Cell reselection / Cell-specific reselection parameters provided by the network in a neighbouring cell list

6.1.2.17.1 Test Purpose (TP)

(1)

```
with { the UE is in NR RRC_IDLE and SystemInformationBlockType3 contain a cell-specific Qoffset for a neighbour intra frequency cell }
ensure that {
  when { the neighbour cell has lower power than the serving cell but it is higher ranked due to the cell-specific Qoffset }
  then { the UE reselects the neighbour cell with cell-specific Qoffset }
}
```

(2)

```
with { the UE is in RRC_IDLE and SystemInformationBlockType3 contain a black listed cell }
ensure that {
  when { a black listed intra-freq cell becomes higher ranked than the serving cell }
  then { the UE remains camped on the serving cell }
}
```

6.1.2.17.2 Conformance requirements

References: The conformance requirements covered in the present TC are specified in: 3GPP TS 38.304, clause 5.2.4.6. Unless otherwise stated these are Rel-15 requirements.

[TS 38.304, clause 5.2.4.6]

The cell-ranking criterion R_s for serving cell and R_n for neighbouring cells is defined by:

$$R_s = Q_{\text{meas},s} + Q_{\text{hyst}} - Q_{\text{offset,temp}}$$

$$R_n = Q_{\text{meas},n} - Q_{\text{offset}} - Q_{\text{offset,temp}}$$

where:

Q_{meas}	RSRP measurement quantity used in cell reselections.
Q_{offset}	For intra-frequency: Equals to $Q_{\text{offset},s,n}$, if $Q_{\text{offset},s,n}$ is valid, otherwise this equals to zero. For inter-frequency: Equals to $Q_{\text{offset},s,n}$ plus $Q_{\text{offset,frequency}}$, if $Q_{\text{offset},s,n}$ is valid, otherwise this equals to $Q_{\text{offset,frequency}}$.
$Q_{\text{offset,temp}}$	Offset temporarily applied to a cell as specified in TS 38.331 [3].

The UE shall perform ranking of all cells that fulfil the cell selection criterion S, which is defined in 5.2.3.2.

The cells shall be ranked according to the R criteria specified above by deriving $Q_{\text{meas},n}$ and $Q_{\text{meas},s}$ and calculating the R values using averaged RSRP results.

If *rangeToBestCell* is not configured, the UE shall perform cell reselection to the highest ranked cell. If this cell is found to be not-suitable, the UE shall behave according to subclause 5.2.4.4.

If *rangeToBestCell* is configured, then the UE shall perform cell reselection to the cell with the highest number of beams above the threshold (i.e. *absThreshSS-BlocksConsolidation*) among the cells whose R value is within *rangeToBestCell* of the R value of the highest ranked cell. If there are multiple such cells, the UE shall perform cell reselection to the highest ranked cell among them. If this cell is found to be not-suitable, the UE shall behave according to subclause 5.2.4.4.

In all cases, the UE shall reselect the new cell, only if the following conditions are met:

- the new cell is better ranked than the serving cell during a time interval $T_{\text{reselection,RAT}}$;
- more than 1 second has elapsed since the UE camped on the current serving cell.

6.1.2.17.3 Test description

6.1.2.17.3.1 Pre-test conditions

System Simulator:

- NR Cell 1, NR Cell 2 and NR Cell 4 in different tracking areas.
- System information combination NR-3 as defined in TS 38.508-1 [4] clause 4.4.3.1.3 is used in NR Cells.
- NR Cell 1 is transmitting *SIB3* according to specific message contents ($Q_{\text{offset},1,2}$ is -24dB).
- NR Cell 2 is transmitting *SIB3* according to specific message contents (NR Cell 4 is on black list)

UE:

None.

Preamble:

- The UE is in NR RRC Idle mode (state 1N-A) on NR Cell 1 (according to 38.508-1 [4] Table 4.4A.2-1).

6.1.2.17.3.2 Test procedure sequence

Table 6.1.2.15.3.2-1/2 illustrate the downlink power levels and other changing parameters to be applied for the cell at various time instants of the test execution. The exact instants on which these values shall be applied are described in the texts in this clause. Row marked "T0" denotes the conditions after the preamble. Configurations marked "T1", "T2" and "T3" are applied at the points indicated in the Main behaviour description in Table 6.1.2.15.3.2-3.

Table 6.1.2.17.3.2-1: Time instances of cell power level and parameter changes for FR1

	Parameter	Unit	NR Cell 1	NR Cell 2	NR Cell 4	Remark
T0	SS/PBCH SSS EPRE	dBm/ SCS	-88	Off	Off	Only NR Cell 1 is on
T1	SS/PBCH SSS EPRE	dBm/ SCS	-88	-94	Off	NR Cell 2 has lower power but is higher ranked due to cell-specific Qoffset _{1,2}
T2	SS/PBCH SSS EPRE	dBm/ SCS	Off	-94	Off	
T3	SS/PBCH SSS EPRE	dBm/ SCS	Off	-94	-88	NR Cell 4 has higher power than NRCell 2 but is black listed

Table 6.1.2.17.3.2-2: Time instances of cell power level and parameter changes for FR2

	Parameter	Unit	NR Cell 1	NR Cell 2	NR Cell 4	Remark
T0	SS/PBCH SSS EPRE	dBm/ SCS	-82	Off	Off	Only NR Cell 1 is on
T1	SS/PBCH SSS EPRE	dBm/ SCS	-82	-91	Off	NR Cell 2 has lower power but is higher ranked due to cell-specific Qoffset _{1,2}
T2	SS/PBCH SSS EPRE	dBm/ SCS	Off	-91	Off	
T3	SS/PBCH SSS EPRE	dBm/ SCS	Off	-91	-82	NR Cell 4 has higher power than NRCell 2 but is black listed

Table 6.1.2.17.3.2-3: Main behaviour

St	Procedure	Message Sequence		TP	Verdict
		U - S	Message		
1	The SS adjusts the SS/PBCH EPRE levels according to row "T1" in table 6.1.2.17.3.2-1/2.	-	-	-	-
2-6	Check: Does the test result of test steps 1 to 5 of generic test procedure in TS 38.508-1 [4] Table 4.9.5.2.2-1 indicate that the UE is camped on NR Cell 2?	-	-	1	P
7	The SS re-adjusts the SS/PBCH EPRE levels according to row "T2" in table 6.1.2.17.3.2-1/2.	-	-	-	-
8	Wait for 1 second to allow UE to recognise the change.	-	-	-	-
9	The SS transmits an <i>RRCRelease</i> message to release RRC connection and move to RRC_IDLE.	<--	NR RRC: <i>RRCRelease</i>	-	-
10	The SS re-adjusts the SS/PBCH EPRE levels according to row "T3" in table 6.1.2.17.3.2-1/2.	-	-	-	-
11	Check: Does the UE initiate a random access procedure on NR Cell 4 within the next 120s?	-	-	2	F

6.1.2.17.3.3 Specific message contents

Table 6.1.2.17.3.3-1: SIB3 for NR Cell 1 (all steps, Table 6.1.2.17.3.2-3)

Derivation Path: TS 38.508-1 [4], Table 4.6.2-2			
Information Element	Value/Remark	Comment	Condition
SIB3 ::= SEQUENCE {			
intraFreqNeighCellList SEQUENCE {			
physCellId	The cell identity of NR Cell 2 defined in 38.508-1 [4] clause 4.4.2		
q-OffsetCell	dB-24		
}			
}			

Table 6.1.2.17.3.3-2: *SIB3* for NR Cell 2 (all steps, Table 6.1.2.17.3.2-3)

Derivation Path: TS 38.508-1 [4], Table 4.6.2-2			
Information Element	Value/Remark	Comment	Condition
<i>SIB3</i> ::= SEQUENCE {			
intraFreqBlackCellList SEQUENCE {	1 entry		
start	PhysicalCellID of NR Cell 4		
range	Not present		
}			
}			

6.1.2.18 Cell reselection, Sintrasearch, Snonintrasearch

6.1.2.18.1 Test Purpose (TP)

(1)

```
with { UE in NR RRC_IDLE state, and the UE is not in high mobility state }
ensure that {
  when { Sintrasearch is non-zero in system information }
  then { UE performs measurement and reselects the highest ranked cell upon Srxlev < Sintrasearch }
}
```

(2)

```
with { UE in NR RRC_IDLE state, and the UE is not in high mobility state }
ensure that {
  when { Snonintrasearch is non-zero in system information }
  then { UE perform measurement and reselects the cell which belong to the equal priority frequency cell upon Srxlev < Snonintrasearch }
}
```

(3)

```
with { UE in NR RRC_IDLE state, and the UE is not in high mobility state }
ensure that {
  when { Snonintrasearch is non-zero in system information }
  then { UE perform measurement and reselects the cell which belong to the high priority frequency cell upon Srxlev > Snonintrasearch }
}
```

6.1.2.18.2 Conformance requirements

References: The conformance requirements covered in the current TC are specified in: TS 38.304, clauses 5.2.4.1, 5.2.4.5 and 5.2.4.6.

[TS 38.304, clause 5.2.4.1]

Absolute priorities of different NR frequencies or inter-RAT frequencies may be provided to the UE in the system information, in the RRCRelease message, or by inheriting from another RAT at inter-RAT cell (re)selection. In the case of system information, an NR frequency or inter-RAT frequency may be listed without providing a priority (i.e. the field cellReselectionPriority is absent for that frequency). If priorities are provided in dedicated signalling, the UE shall ignore all the priorities provided in system information. If UE is in camped on any cell state, UE shall only apply the priorities provided by system information from current cell, and the UE preserves priorities provided by dedicated signalling and deprioritisationReq received in RRCRelease unless specified otherwise. When the UE in camped normally state, has only dedicated priorities other than for the current frequency, the UE shall consider the current frequency to be the lowest priority frequency (i.e. lower than any of the network configured values).

The UE shall only perform cell reselection evaluation for NR frequencies and inter-RAT frequencies that are given in system information and for which the UE has a priority provided.

In case UE receives RRCRelease with deprioritisationReq, UE shall consider current frequency and stored frequencies due to the previously received RRCRelease with deprioritisationReq or all the frequencies of NR to be the lowest

priority frequency (i.e. lower than any of the network configured values) while T325 is running irrespective of camped RAT. The UE shall delete the stored deprioritisation request(s) when a PLMN selection is performed on request by NAS (TS 23.122 [9]).

NOTE: UE should search for a higher priority layer for cell reselection as soon as possible after the change of priority. The minimum related performance requirements specified in TS 38.133 [8] are still applicable.

The UE shall delete priorities provided by dedicated signalling when:

- the UE enters a different RRC state; or
- the optional validity time of dedicated priorities (T320) expires; or
- a PLMN selection is performed on request by NAS (TS 23.122 [9]).

NOTE 2: Equal priorities between RATs are not supported.

The UE shall not consider any black listed cells as candidate for cell reselection.

The UE shall inherit the priorities provided by dedicated signalling and the remaining validity time (i.e. T320 in NR and E-UTRA), if configured, at inter-RAT cell (re)selection.

NOTE 3: The network may assign dedicated cell reselection priorities for frequencies not configured by system information.

[TS 38.304, clause 5.2.4.5]

If *threshServingLowQ* is broadcast in system information and more than 1 second has elapsed since the UE camped on the current serving cell, cell reselection to a cell on a higher priority NR frequency or inter-RAT frequency than the serving frequency shall be performed if:

- A cell of a higher priority NR or EUTRAN RAT/frequency fulfils $S_{qual} > ThreshX, HighQ$ during a time interval $T_{reselectionRAT}$

Otherwise, cell reselection to a cell on a higher priority NR frequency or inter-RAT frequency than the serving frequency shall be performed if:

- A cell of a higher priority RAT/ frequency fulfils $S_{rxlev} > ThreshX, HighP$ during a time interval $T_{reselectionRAT}$; and
- More than 1 second has elapsed since the UE camped on the current serving cell.

Cell reselection to a cell on an equal priority NR frequency shall be based on ranking for intra-frequency cell reselection as defined in clause 5.2.4.6.

If *threshServingLowQ* is broadcast in system information and more than 1 second has elapsed since the UE camped on the current serving cell, cell reselection to a cell on a lower priority NR frequency or inter-RAT frequency than the serving frequency shall be performed if:

- The serving cell fulfils $S_{qual} < ThreshServing, LowQ$ and a cell of a lower priority NR or E-UTRAN RAT/ frequency fulfils $S_{qual} > ThreshX, LowQ$ during a time interval $T_{reselectionRAT}$.

Otherwise, cell reselection to a cell on a lower priority NR frequency or inter-RAT frequency than the serving frequency shall be performed if:

- The serving cell fulfils $S_{rxlev} < ThreshServing, LowP$ and a cell of a lower priority RAT/ frequency fulfils $S_{rxlev} > ThreshX, LowP$ during a time interval $T_{reselectionRAT}$; and
- More than 1 second has elapsed since the UE camped on the current serving cell.

Cell reselection to a higher priority RAT/frequency shall take precedence over a lower priority RAT/frequency if multiple cells of different priorities fulfil the cell reselection criteria.

If more than one cell meets the above criteria, the UE shall reselect a cell as follows:

- If the highest-priority frequency is an NR frequency, the highest ranked cell among the cells on the highest priority frequency(ies) meeting the criteria according to clause 5.2.4.6;

- If the highest-priority frequency is from another RAT, the strongest cell among the cells on the highest priority frequency(ies) meeting the criteria of that RAT.

[TS 38.304, clause 5.2.4.6]

The cell-ranking criterion R_s for serving cell and R_n for neighbouring cells is defined by:

$$R_s = Q_{\text{meas},s} + Q_{\text{hyst}} - Q_{\text{offsettemp}}$$

$$R_n = Q_{\text{meas},n} - Q_{\text{offset}} - Q_{\text{offsettemp}}$$

where:

Q_{meas}	RSRP measurement quantity used in cell reselections.
Q_{offset}	For intra-frequency: Equals to $Q_{\text{offset}_{s,n}}$, if $Q_{\text{offset}_{s,n}}$ is valid, otherwise this equals to zero. For inter-frequency: Equals to $Q_{\text{offset}_{s,n}}$ plus $Q_{\text{offset}_{\text{frequency}}}$, if $Q_{\text{offset}_{s,n}}$ is valid, otherwise this equals to $Q_{\text{offset}_{\text{frequency}}}$.
$Q_{\text{offsettemp}}$	Offset temporarily applied to a cell as specified in TS 38.331 [3].

The UE shall perform ranking of all cells that fulfil the cell selection criterion S , which is defined in 5.2.3.2.

The cells shall be ranked according to the R criteria specified above by deriving $Q_{\text{meas},n}$ and $Q_{\text{meas},s}$ and calculating the R values using averaged RSRP results.

If *rangeToBestCell* is not configured, the UE shall perform cell reselection to the highest ranked cell. If this cell is found to be not-suitable, the UE shall behave according to clause 5.2.4.4.

If *rangeToBestCell* is configured, then the UE shall perform cell reselection to the cell with the highest number of beams above the threshold (i.e. *absThreshSS-BlocksConsolidation*) among the cells whose R value is within *rangeToBestCell* of the R value of the highest ranked cell. If there are multiple such cells, the UE shall perform cell reselection to the highest ranked cell among them. If this cell is found to be not-suitable, the UE shall behave according to clause 5.2.4.4.

In all cases, the UE shall reselect the new cell, only if the following conditions are met:

- the new cell is better than the serving cell according to the cell reselection criteria specified above during a time interval *TrselectionRAT*;
- more than 1 second has elapsed since the UE camped on the current serving cell.

NOTE: If *rangeToBestCell* is configured but *absThreshSS-BlocksConsolidation* is not configured on an NR frequency, the UE considers that there is one beam above the threshold for each cell on that frequency.

6.1.2.18.3 Test description

6.1.2.18.3.1 Pre-test conditions

System Simulator:

- NR Cell 1, NR Cell 2 and NR Cell 3 as defined in TS 38.508-1 [4] Table 4.4.2-2 is used.
- NR Cell 1 uses System information combination NR-3 as defined in TS 38.508-1 [4] Table 4.4.3.1.2-1 is used in NR cells.
- NR Cell 2 and NR Cell 3 uses System information combination NR-4 as defined in TS 38.508-1 [4] Table 4.4.3.1.2-1 is used in NR cells.

UE:

- None.

Preamble:

- The UE is in state 1N-A on NR Cell 1(serving cell) according to TS 38.508-1 [4] Table 4.4A.2-1.

6.1.2.18.3.2 Test procedure sequence

Table 6.1.2.18.3.2-1/2 illustrates the downlink power levels and other changing parameters to be applied for the NR cells at various time instants of the test execution. The exact instants on which these values shall be applied are described in the texts in this clause. Configurations marked "T1", "T2" and "T3" are applied at the points indicated in the Main behaviour description in Table 6.1.2.13.3.2-2.

Table 6.1.2.18.3.2-1: Time instances of cell power level and parameter changes for FR1

	Parameter	Unit	NR Cell 1	NR Cell 2	NR Cell 3	Remark
T0	SS/PBCH SSS EPRE	dBm/SCS	-88	Off	Off	The power level values are assigned to ensure the UE registered on NR Cell 1.
T1	SS/PBCH SSS EPRE	dBm/SCS	-102	-94	-118	Srxlev of NR Cell 1 is less than Sintrasearch.
	S _{IntraSearch}	dB	20	20	20	
	Srxlev	dB	8	16	-8	
T2	SS/PBCH SSS EPRE	dBm/SCS	-118	-102	-94	Srxlev of NR Cell 2 is less than Snonintrasearch.
	S _{nonIntraSearch}	dB	20	20	20	
	Srxlev	dB	-8	8	16	
T3	S _{nonIntraSearch}	dB	20	20	2	
T4	SS/PBCH SSS EPRE	dBm/SCS	-88	-118	-88	Srxlev of NR Cell 3 is greater than Snonintrasearch but Cell 1 is high priority cell.
	Srxlev	dB	22	22	22	
Note: Power level "Off" is defined in TS 38.508-1 [4] Table 6.2.2.1-3.						

Table 6.1.2.18.3.2-2: Time instances of cell power level and parameter changes for FR2

	Parameter	Unit	NR Cell 1	NR Cell 2	NR Cell 3	Remark
T0	SS/PBCH SSS EPRE	dBm/SCS	FFS	Off	Off	The power level values are assigned to ensure the UE registered on NR Cell 1.
T1	SS/PBCH SSS EPRE	dBm/SCS	FFS	FFS	FFS	Srxlev of NR Cell 1 is less than Sintrasearch.
	S _{IntraSearch}	dB	20	20	20	
	Srxlev	dB	FFS	FFS	FFS	
T2	SS/PBCH SSS EPRE	dBm/SCS	FFS	FFS	FFS	Srxlev of NR Cell 2 is less than Snonintrasearch.
	S _{nonIntraSearch}	dB	20	20	20	
	Srxlev	dB	FFS	FFS	FFS	
T3	S _{nonIntraSearch}	dB	20	20	2	
T4	SS/PBCH SSS EPRE	dBm/SCS	FFS	FFS	FFS	Srxlev of NR Cell 3 is greater than Snonintrasearch but Cell 1 is high priority cell.
	Srxlev	dB	FFS	FFS	FFS	
Note: The uncertain downlink signal level is specified in TS 38.508-1 [4] section FFS						

Table 6.1.2.18.3.2-3: Main behaviour

St	Procedure	Message Sequence		TP	Verdict
		U - S	Message		
1	The SS re-adjusts the SS/PBCH EPRE levels according to row "T1" in table 6.1.2.18.3.2-1/2.	-	-	-	-
2	Wait for 34 seconds to allow UE to recognise the change.	-	-	-	-
3	Check: Does the test result of generic test procedure in TS 38.508-1 [4] Table 4.9.4.2.2-1 indicate that the UE is camped on NR Cell	-	-	1	-

	2?				
4	The SS re-adjusts the SSS levels according to row "T2" in table 6.1.2.18.3.2-1/2.	-	-	-	-
5	Wait for 34 seconds to allow UE to recognise the change.	-	-	-	-
6	Check: Does the test result of generic test procedure in TS 38.508-1 [4] Table 4.9.4.2.2-1 indicate that the UE is camped on NR Cell 3?	-	-	2	-
6A	The SS changes the SnonIntraSearch for NR Cell 3 according to row "T3" in table 6.1.2.18.3.2-1/2, The ValueTag of SIB2 in the SI-SchedulingInfo of SIB1 is increased on NR Cell 3.	-	-	-	-
7	The SS notifies the UE of change of System Information on NR Cell 3 by sending Short Message on PDCCH using P-RNTI.	<--	NR RRC: Paging	-	-
8	Void	-	-	-	-
9	Wait for 2.1* modification period to allow the new system information to take effect.	-	-	-	-
10	The SS re-adjusts the SSS levels according to row "T4" in table 6.1.2.18.3.2-1/2.	-	-	-	-
11	Wait for 120 seconds to allow UE to recognise the change.	-	-	-	-
12	Check: Does the test result of generic test procedure in TS 38.508-1 [4] Table 4.9.4.2.2-1 indicate that the UE is camped on NR Cell 1?	-	-	3	-

6.1.2.18.3.3 Specific message contents

Table 6.1.2.18.3.3-1: Conditions for specific message contents in Tables below

Condition	Explanation
NR Cell 1	This condition applies to system information transmitted on NR Cell 1.
NR Cell 2	This condition applies to system information transmitted on NR Cell 2.
NR Cell 3	This condition applies to system information transmitted on NR Cell 3.

Table 6.1.2.18.3.3-2: SIB2 of NR Cell 1, NR Cell 2 and NR Cell 3 (preamble and all steps, Table 6.1.2.18.3.2-3)

Derivation Path: TS 38.508-1 [4], Table 4.6.2-1			
Information Element	Value/remark	Comment	Condition
SIB2 ::= SEQUENCE {			
cellReselectionServingFreqInfo			
SEQUENCE {			
s-NonIntraSearch	10	20 dB	
cellReselectionPriority	5		NR Cell 1
	1		NR Cell 2 and Cell 3
}			
intraFreqCellReselectionInfo SEQUENCE			
{			
s-IntraSearchP	10	20 dB	
}			
}			

Table 6.1.2.18.3.3-3: SIB4 of NR Cell 2 and NR Cell 3 (preamble and all steps, Table 6.1.2.18.3.2-3)

Derivation Path: TS 38.508-1 [4], Table 4.6.2-3			
Information Element	Value/remark	Comment	Condition
SIB4 ::= SEQUENCE {			

interFreqCarrierFreqList SEQUENCE (SIZE (1..maxFreq)) OF InterFreqCarrierFreqInfo {	1 entry		
InterFreqCarrierFreqInfo[1] SEQUENCE {		entry 1	
dl-CarrierFreq	Same downlink ARFCN as used for NR Cell 3		NR Cell 2
	Same downlink ARFCN as used for NR Cell 1		NR Cell 3
t-ReselectionNR	1		
threshX-HighP	7	14 dBm	NR Cell 3
cellReselectionPriority	5		NR Cell 3
	1		NR Cell 2
}			
}			
}			

Table 6.1.2.18.3.3-4: SIB1 of NR Cell 3 (step 6A, Table 6.1.2.18.3.2-3)

Derivation Path: TS 38.508-1 [4], Table 4.6.1-28			
Information Element	Value/remark	Comment	Condition
SIB1 ::= SEQUENCE {			
si-SchedulingInfo	SI-SchedulingInfo		
}			

Table 6.1.2.18.3.3-5: SI-SchedulingInfo (si-SchedulingInfo in Table 6.1.2.18.3.3-4)

Derivation Path: TS 38.508-1 [4], Table 4.6.3-173			
Information Element	Value/remark	Comment	Condition
SI-SchedulingInfo ::= SEQUENCE {			
schedulingInfoList SEQUENCE (SIZE(1..maxSI-Message)) OF SchedulingInfo {	1 entry		
SchedulingInfo[1] SEQUENCE {		entry 1	
sib-MappingInfo SEQUENCE (SIZE (1..maxSIB)) OF SIB-TypeInfo {	1 entry		
SIB-TypeInfo[1] SEQUENCE {		entry 1	
type	sibType2		
valueTag	1		
}			
}			
}			
}			

Table 6.1.2.18.3.3-6: SIB2 of NR Cell 3 (step 6A, Table 6.1.2.18.3.2-3)

Derivation Path: TS 38.508-1 [4], Table 4.6.2-1			
Information Element	Value/remark	Comment	Condition
SIB2 ::= SEQUENCE {			
cellReselectionServingFreqInfo SEQUENCE {			
s-NonIntraSearchP	1	20 dB	
}			
}			

6.1.2.19 Speed-dependent cell reselection

6.1.2.19.1 Test Purpose (TP)

(1)

```
with { UE in NR RRC_IDLE state and in high mobility state }
ensure that {
  when { UE detects the cell ranked as the best cell taking into account scaling factor }
  then { UE reselects the new cell }
}
```

(2)

```
with { UE in NR RRC_IDLE state and in medium mobility state }
ensure that {
  when { UE detects the cell ranked as the best cell taking into account scaling factor }
  then { UE reselects the new cell }
}
```

6.1.2.19.2 Conformance requirements

References: The conformance requirements covered in the present test case are specified in: TS 38.304, clauses 5.2.4.3.0 and 5.2.4.3.1. TS 38.133, clause 4.2.2.3. Unless otherwise stated these are Rel-15 requirements.

[TS 38.304, clause 5.2.4.3.0]

The UE mobility state is determined if the parameters (TCR_{max}, NCR_H, NCR_M and TCR_{maxHyst}) are broadcasted in system information for the serving cell.

State detection criteria:

...

Medium-mobility state criteria:

- If number of cell reselections during time period T_{CRmax} is greater than or equal to N_{CR_M} but less than or equal to N_{CR_H} .

High-mobility state criteria:

- If number of cell reselections during time period T_{CRmax} is greater than N_{CR_H} .

The UE shall not consider consecutive reselections where a cell is reselected again right after one reselection for mobility state detection criteria.

State transitions:

The UE shall:

- if the criteria for High-mobility state is detected:
 - enter High-mobility state.
- else if the criteria for Medium-mobility state is detected:
 - enter Medium-mobility state.

...

If the UE is in High- or Medium-mobility state, the UE shall apply the speed dependent scaling rules as defined in subclause 5.2.4.3.1.

[TS 38.304, clause 5.2.4.3.1]

UE shall apply the following scaling rules:

- If neither Medium- nor High-mobility state is detected:
 - no scaling is applied.
- If High-mobility state is detected:
 - Add the *sf-High* of "Speed dependent ScalingFactor for Q_{hyst} " to Q_{hyst} if broadcasted in system information;
 - For NR cells, multiply $\text{Treselection}_{\text{NR}}$ by the *sf-High* of "Speed dependent ScalingFactor for $\text{Treselection}_{\text{NR}}$ " if broadcasted in system information;

...

- If Medium-mobility state is detected:
 - Add the *sf-Medium* of "Speed dependent ScalingFactor for Q_{hyst} " to Q_{hyst} if broadcasted in system information;
 - For NR cells, multiply $\text{Treselection}_{\text{NR}}$ by the *sf-Medium* of "Speed dependent ScalingFactor for $\text{Treselection}_{\text{NR}}$ " if broadcasted in system information;

...

In case scaling is applied to any $\text{Treselection}_{\text{RAT}}$ parameter, the UE shall round up the result after all scalings to the nearest second.

[TS 38.133, clause 4.2.2.3]

The UE shall be able to identify new intra-frequency cells and perform SS-RSRP and SS-RSRQ measurements of the identified intra-frequency cells without an explicit intra-frequency neighbour list containing physical layer cell identities.

The UE shall be able to evaluate whether a newly detectable intra-frequency cell meets the reselection criteria defined in TS38.304 within $T_{\text{detect,NR_Intra}}$ when that $\text{Treselection} = 0$. An intra frequency cell is considered to be detectable according to the conditions defined in Annex B.1.2 for a corresponding Band.

The UE shall measure SS-RSRP and SS-RSRQ at least every $T_{\text{measure,NR_Intra}}$ (see table 4.2.2.3-1) for intra-frequency cells that are identified and measured according to the measurement rules.

The UE shall filter SS-RSRP and SS-RSRQ measurements of each measured intra-frequency cell using at least 2 measurements. Within the set of measurements used for the filtering, at least two measurements shall be spaced by at least $T_{\text{measure,NR_Intra}}/2$.

The UE shall not consider a NR neighbour cell in cell reselection, if it is indicated as not allowed in the measurement control system information of the serving cell.

For an intra-frequency cell that has been already detected, but that has not been reselected to, the filtering shall be such that the UE shall be capable of evaluating that the intra-frequency cell has met reselection criterion defined [1] within $T_{\text{evaluate,NR_Intra}}$ when $\text{Treselection} = 0$ as specified in table 4.2.2.3-1 provided that:

- when *rangeToBestCell* is not configured, the cell has at least [3]dB in FR1 or [TBD]dB in FR2 better ranked or
- when *rangeToBestCell* is configured, the cell which has the highest number of beams above the threshold *absThreshSS-BlocksConsolidation* among the cells whose cell-ranking criterion R value as specified in TS 38.304 [1, Section 5.2.4.6] is within *rangeToBestCell* of the R value of the best cell where the best cell has at least [TBD] in FR1 or [TBD]dB in FR2 better ranked, and if there are multiple such cells the UE shall perform cell reselection to the highest ranked cell among them.

When evaluating cells for reselection, the SSB side conditions apply to both serving and non-serving intra-frequency cells.

If $T_{\text{reselection}}$ timer has a non-zero value and the intra-frequency cell is satisfied with the reselection criteria which are defined in TS38.304 [1], the UE shall evaluate this intra-frequency cell for the $T_{\text{reselection}}$ time. If this cell remains satisfied with the reselection criteria within this duration, then the UE shall reselect that cell.

Table 4.2.2.3-1: $T_{\text{detect,NR_Intra}}$, $T_{\text{measure,NR_Intra}}$ and $T_{\text{evaluate,NR_Intra}}$

DRX cycle length [s]	Scaling Factor (N1)		$T_{\text{detect,NR_Intra}}$ [s] (number of DRX cycles)	$T_{\text{measure,NR_Intra}}$ [s] (number of DRX cycles)	$T_{\text{evaluate,NR_Intra}}$ [s] (number of DRX cycles)
	FR1	FR2 ^{Note1}			
0.32	1	[8]	$11.52 \times N1 \times M2$ (36 x N1 x M2)	$1.28 \times N1 \times M2$ (4 x N1 x M2)	$5.12 \times N1 \times M2$ (16 x N1 x M2)
0.64		[5]	$17.92 \times N1$ (28 x N1)	$1.28 \times N1$ (2 x N1)	$5.12 \times N1$ (8 x N1)
1.28		[4]	$32 \times N1$ (25 x N1)	$1.28 \times N1$ (1 x N1)	$6.4 \times N1$ (5 x N1)
2.56		[TBD]	$58.88 \times N1$ (23 x N1)	$2.56 \times N1$ (1 x N1)	$7.68 \times N1$ (3 x N1)
Note 1: Applies for UE supporting power class 2&3&4. For UE supporting power class 1, N1 = [8] for all DRX cycle length.					
Note 2: M2 = 1.5 if SMTC periodicity of measured intra-frequency cell > 20 ms; otherwise M2=1.					

6.1.2.19.3 Test Description

6.1.2.19.3.1 Pre-test conditions

System Simulator:

- 3 NR Cells: NR Cell 1, 2 and 4 as specified in TS 38.508-1 [4] table 4.4.2-3.
- System information combination NR-2 as defined in TS 38.508-1 [4] clause 4.4.3.1.3 is used in NR cell.

UE:

- None.

Preamble:

- NR Cell 1 is set to "Serving Cell" and NR Cell 2 and NR Cell 4 are set to non-suitable "Off" as defined in TS 38.508-1 [4] table 6.2.2.1-3 for FR1 and table 6.2.2.2-2 for FR2.
- The UE is in NR RRC_IDLE state (state 1N-A with PDU session inactive) as defined in TS 38.508-1 [4], table 4.4A.2-1 on NR Cell 1.

6.1.2.19.3.2 Test procedure sequence

Table 6.1.2.19.3.2-1 and Table 6.1.2.19.3.2-2 illustrates the downlink power levels and other changing parameters to be applied for the cells at various time instants of the test execution. The exact instants on which these values shall be applied are described in the texts in this clause.

Table 6.1.2.19.3.2-1: Time instances of cell power level and parameter changes for FR1

	Parameter	Unit	NR Cell 1	NR Cell 2	NR Cell 4	Remark
T1	SS/PBCH SSS EPRE	dBm/SC S	-94	-88	-94	NR Cell 2 becomes the highest ranked cell.
T2	SS/PBCH SSS EPRE	dBm/SC S	-94	-94	-88	NR Cell 4 becomes the highest ranked cell.
T3	SS/PBCH SSS EPRE	dBm/SC S	-88	-94	-94	NR Cell 1 becomes the highest ranked cell.

Table 6.1.2.19.3.2-2: Time instances of cell power level and parameter changes for FR2

	Parameter	Unit	NR Cell 1	NR Cell 2	NR Cell 4	Remark
T1	SS/PBCH SSS EPRE	dBm/SC S	FFS	FFS	FFS	NR Cell 2 becomes the highest ranked cell.
T2	SS/PBCH SSS EPRE	dBm/SC S	FFS	FFS	FFS	NR Cell 4 becomes the highest ranked cell.

T3	SS/PBCH SSS EPRE	dBm/SC S	FFS	FFS	FFS	NR Cell 1 becomes the highest ranked cell.
----	---------------------	-------------	-----	-----	-----	--

Table 6.1.2.19.3.2-3: Main behaviour

St	Procedure	Message Sequence		TP	Verdict
		U - S	Message		
1	The SS changes the power level setting according to the row "T1".	-	-	-	-
2	Wait for 40s for FR1 or 136s for FR2 for the UE to perform cell reselection procedure. (Note 1, Note 5)	-	-	-	-
3	The SS changes the power level setting according to the row "T2".	-	-	-	-
4	Wait for 14s for FR1 or 33s for FR2 for the UE to perform cell reselection procedure. (Note 2, Note 6)	-	-	-	-
5	The SS changes the power level setting according to the row "T3".	-	-	-	-
6	Wait for 14s for FR1 or 33s for FR2 for the UE to perform cell reselection procedure. (Note 3, Note 6)	-	-	-	-
7-8	Void	-	-	-	-
9	The SS changes the TAC of NR Cell 2 to 2.	-	-	-	-
10	The SS changes the power level setting according to the row "T1".	-	-	-	-
11	Check: Does the UE send an <i>RRCSetupRequest</i> on NR Cell 2 within 3s? (Note 7)	-->	NR RRC: <i>RRCSetupRequest</i>	2	F
12	Check: Does the UE send an <i>RRCSetupRequest</i> on NR Cell 2 within 6s for FR1 and 27s for FR2 after step 11? (Note 8, Note 9)	-->	NR RRC: <i>RRCSetupRequest</i>	2	P
13-17	Steps 2 to 6 of the mobility registration updating procedure described in TS 38.508-1 [4] Table 4.9.5.2.2-1 are performed on NR Cell 2.	-	-	-	-
18	Void	-	-	-	-
19	The SS changes the power level setting according to the row "T2".	-	-	-	-
20-25	Void	-	-	-	-
26	Check: Does the UE send an <i>RRCSetupRequest</i> on NR Cell 4 within 2s? (Note 12)	-->	NR RRC: <i>RRCSetupRequest</i>	1	F
27	Check: Does the UE send an <i>RRCSetupRequest</i> on NR Cell 4 within 7s for FR1 and 26s for FR2 after step 26? (Note 13)	-->	NR RRC: <i>RRCSetupRequest</i>	1	P
28-32	Steps 2 to 6 of the mobility registration updating procedure described in TS 38.508-1 [4] Table 4.9.5.2.2-1 are performed on NR Cell 4.	-	-	-	-
<p>Note 1: N_{CR} (number of cell reselection) is 1.</p> <p>Note 2: N_{CR} is 2.</p> <p>Note 3: N_{CR} is 3 and the UE enters medium mobility state because number of cell reselections during time period T_{CRmax} equals N_{CR_M}.</p> <p>Note 4: Void.</p> <p>Note 5: The wait time for reselection to a newly detected intra frequency cell is selected to cover $T_{detect,NR_intra}(25 \cdot 1280ms = 32s \text{ for FR1 and } 25 \cdot 4 \cdot 1280ms = 128s \text{ for FR2}) + T_{reselection}(7s) + 320 \text{ ms system information block type scheduling} = 39.32s$ rounded up to 40s for FR1 and 135.32s rounded up to 136s for FR2.</p> <p>Note 6: The wait time for reselection to an already detected intra frequency cell is selected to cover $T_{evaluate,NR_intra}(6.4s \text{ for FR1 and } 25.6 \text{ for FR2}) + T_{reselection}(7s) + 320 \text{ ms system information block type scheduling} = 13.72s$ rounded up to 14s for FR1 and 32.92s rounded up to 33s for FR2.</p> <p>Note 7: The wait time for evaluating an intra-frequency cell is $T_{reselection}$ after scaling (3.5s). This wait time is rounded down to nearest second (i.e. 3s in this case).</p>					

Note 8:	The wait time for cell reselection procedure is selected to cover $T_{evaluate,NR_intra}$ (6.4s for FR1 and 25.6 for FR2) + Treselection after scaling ($7 \cdot 0.5$) + 320 ms system information block type scheduling = 10.22s rounded up to 11s for FR1 and 29.42s rounded up to 30s for FR2. The actual wait time is 6s which covers 9s - 3s (wait time in step 11) for FR1 and 27s which covers 30s – 3s (wait time in step 11) for FR2.
Note 9:	N_{CR} is 4 and the UE enters high mobility state because number of cell reselections during time period T_{CRmax} greater than N_{CR_H}
Note 10:	Void.
Note 11:	Void.
Note 12:	The wait time for evaluating an intra-frequency cell is Treselection after scaling (2s).
Note 13:	The wait time for cell reselection procedure is selected to cover $T_{evaluate,NR_intra}$ (6.4s for FR1 and 25.6 for FR2) + Treselection after scaling ($7 \cdot 0.25$) + 320 ms system information block type scheduling = 8.47s rounded up to 9s for FR1 and 27.92s rounded up to 28s for FR2. The actual wait time is 7s which covers 9s - 2s (wait time in step 26) for FR1 and 26s which covers 28s – 2s (wait time in step 26) for FR2.

6.1.2.19.3.3 Specific message contents

Table 6.1.2.19.3.3-1: SystemInformationBlockType2 for NR Cell 1, NR Cell 2, and NR Cell 4 (preamble and all steps, Table 6.1.2.19.3.2-3)

Derivation Path: TS 38.508-1 [4], Table 4.6.2-1			
Information Element	Value/remark	Comment	Condition
SIB2 ::= SEQUENCE {			
cellReselectionInfoCommon SEQUENCE			
{			
speedStateReselectionPars SEQUENCE			
{			
MobilityStateParameters SEQUENCE {			
t-Evaluation	s240		
t-HystNormal	s240		
n-CellChangeMedium	3		
n-CellChangeHigh	3		
}			
q-HystSF SEQUENCE {			
sf-Medium	dB0		
sf-High	dB0		
}			
}			
}			
intraFreqCellReselectionInfo SEQUENCE			
{			
t-ReselectionNR	7		
t-ReselectionNR-SF SEQUENCE {			
sf-Medium	oDot50		
sf-High	oDot25		
}			
}			
}			

Table 6.1.2.19.3.3-2: SystemInformationBlockType1 for NR Cell 4 (step 9, Table 6.1.2.19.3.2-3)

Derivation Path: TS 38.508-1 [4], Table 4.6.1-5			
Information Element	Value/remark	Comment	Condition
SIB1 ::= SEQUENCE {			
cellAccessRelatedInfo SEQUENCE {			
PLMN-IdentityInfoList SEQUENCE {			
trackingAreaCode	2		
}			
}			
}			

6.1.2.20 Inter-frequency cell reselection according to cell reselection priority provided by SIBs

6.1.2.20.1 Test Purpose (TP)

(1)

```
with { UE in NR RRC_IDLE state }
ensure that {
  when { UE detects the cell re-selection criteria are met for the cell which belongs to the equal
priority frequency }
  then { UE reselects the cell which belongs to the equal priority frequency }
}
```

(2)

```
with { UE in NR RRC_IDLE state }
ensure that {
  when { UE detects the cell re-selection criteria are met for the cell which belongs to the higher
priority frequency }
  then { UE reselects the cell which belongs to the higher priority frequency }
}
```

(3)

```
with { UE in NR RRC_IDLE state }
ensure that {
  when { UE detects the cell re-selection criteria are met for the cell which belongs to the lower
priority frequency }
  then { UE reselects the cell which belongs to the lower priority frequency }
}
```

6.1.2.20.2 Conformance requirements

References: The conformance requirements covered in the present TC are specified in TS 38.304: clause 5.2.4.1, 5.2.4.2, 5.2.4.5 and 5.2.4.6. Unless otherwise stated these are Rel-15 requirements.

[TS 38.304, clause 5.2.4.1]

Absolute priorities of different NR frequencies or inter-RAT frequencies may be provided to the UE in the system information, in the *RRCRelease* message, or by inheriting from another RAT at inter-RAT cell (re)selection. In the case of system information, an NR frequency or inter-RAT frequency may be listed without providing a priority (i.e. the field *cellReselectionPriority* is absent for that frequency). If priorities are provided in dedicated signalling, the UE shall ignore all the priorities provided in system information. If UE is in *camped on any cell* state, UE shall only apply the priorities provided by system information from current cell, and the UE preserves priorities provided by dedicated signalling and *deprioritisationReq* received in *RRCRelease* unless specified otherwise. When the UE in *camped normally* state, has only dedicated priorities other than for the current frequency, the UE shall consider the current frequency to be the lowest priority frequency (i.e. lower than any of the network configured values).

The UE shall only perform cell reselection evaluation for NR frequencies and inter-RAT frequencies that are given in system information and for which the UE has a priority provided.

In case UE receives *RRCRelease* with *deprioritisationReq*, UE shall consider current frequency and stored frequencies due to the previously received *RRCRelease* with *deprioritisationReq* or all the frequencies of NR to be the lowest priority frequency (i.e. lower than any of the network configured values) while T325 is running irrespective of *camped RAT*. The UE shall delete the stored *deprioritisationReq* request(s) when a PLMN selection is performed on request by NAS (TS 23.122 [9]).

NOTE: UE should search for a higher priority layer for cell reselection as soon as possible after the change of priority. The minimum related performance requirements specified in TS 38.133 [8] are still applicable.

The UE shall delete priorities provided by dedicated signalling when:

- the UE enters a different RRC state; or
- the optional validity time of dedicated priorities (T320) expires; or

- a PLMN selection is performed on request by NAS (TS 23.122 [9]).

NOTE 2: Equal priorities between RATs are not supported.

The UE shall not consider any black listed cells as candidate for cell reselection.

The UE shall inherit the priorities provided by dedicated signalling and the remaining validity time (i.e. T320 in NR and E-UTRA), if configured, at inter-RAT cell (re)selection.

NOTE 3: The network may assign dedicated cell reselection priorities for frequencies not configured by system information.

[TS 38.304, clause 5.2.4.2]

Following rules are used by the UE to limit needed measurements:

- If the serving cell fulfils $S_{rxlev} > S_{IntraSearchP}$ and $S_{qual} > S_{IntraSearchQ}$, the UE may choose not to perform intra-frequency measurements.
- Otherwise, the UE shall perform intra-frequency measurements.
- The UE shall apply the following rules for NR inter-frequencies and inter-RAT frequencies which are indicated in system information and for which the UE has priority provided as defined in 5.2.4.1:
 - For a NR inter-frequency or inter-RAT frequency with a reselection priority higher than the reselection priority of the current NR frequency, the UE shall perform measurements of higher priority NR inter-frequency or inter-RAT frequencies according to TS 38.133 [8].
 - For a NR inter-frequency with an equal or lower reselection priority than the reselection priority of the current NR frequency and for inter-RAT frequency with lower reselection priority than the reselection priority of the current NR frequency:
 - If the serving cell fulfils $S_{rxlev} > S_{nonIntraSearchP}$ and $S_{qual} > S_{nonIntraSearchQ}$, the UE may choose not to perform measurements of NR inter-frequencies or inter-RAT frequency cells of equal or lower priority;
 - Otherwise, the UE shall perform measurements of NR inter-frequencies or inter-RAT frequency cells of equal or lower priority according to TS 38.133 [8].

[TS 38.304, clause 5.2.4.5]

If *threshServingLowQ* is broadcast in system information and more than 1 second has elapsed since the UE camped on the current serving cell, cell reselection to a cell on a higher priority NR frequency or inter-RAT frequency than the serving frequency shall be performed if:

- A cell of a higher priority NR or EUTRAN RAT/frequency fulfils $S_{qual} > Thresh_{X, HighQ}$ during a time interval $T_{reselection_{RAT}}$

Otherwise, cell reselection to a cell on a higher priority NR frequency or inter-RAT frequency than the serving frequency shall be performed if:

- A cell of a higher priority RAT/ frequency fulfils $S_{rxlev} > Thresh_{X, HighP}$ during a time interval $T_{reselection_{RAT}}$; and
- More than 1 second has elapsed since the UE camped on the current serving cell.

Cell reselection to a cell on an equal priority NR frequency shall be based on ranking for intra-frequency cell reselection as defined in clause 5.2.4.6.

If *threshServingLowQ* is broadcast in system information and more than 1 second has elapsed since the UE camped on the current serving cell, cell reselection to a cell on a lower priority NR frequency or inter-RAT frequency than the serving frequency shall be performed if:

- The serving cell fulfils $S_{qual} < Thresh_{Serving, LowQ}$ and a cell of a lower priority NR or E-UTRAN RAT/ frequency fulfils $S_{qual} > Thresh_{X, LowQ}$ during a time interval $T_{reselection_{RAT}}$.

Otherwise, cell reselection to a cell on a lower priority NR frequency or inter-RAT frequency than the serving frequency shall be performed if:

- The serving cell fulfils $Srxlev < Thresh_{Serving, LowP}$ and a cell of a lower priority RAT/ frequency fulfils $Srxlev > Thresh_{X, LowP}$ during a time interval $T_{reselection_{RAT}}$; and
- More than 1 second has elapsed since the UE camped on the current serving cell.

Cell reselection to a higher priority RAT/frequency shall take precedence over a lower priority RAT/frequency if multiple cells of different priorities fulfil the cell reselection criteria.

If more than one cell meets the above criteria, the UE shall reselect a cell as follows:

- If the highest-priority frequency is an NR frequency, the highest ranked cell among the cells on the highest priority frequency(ies) meeting the criteria according to clause 5.2.4.6;
- If the highest-priority frequency is from another RAT, the highest ranked cell among the cells on the highest priority frequency(ies) meeting the criteria of that RAT.

[TS 38.304, clause 5.2.4.6]

The cell-ranking criterion R_s for serving cell and R_n for neighbouring cells is defined by:

$$R_s = Q_{meas,s} + Q_{hyst} - Q_{offset_{temp}}$$

$$R_n = Q_{meas,n} - Q_{offset} - Q_{offset_{temp}}$$

where:

Q_{meas}	RSRP measurement quantity used in cell reselections.
Q_{offset}	For intra-frequency: Equals to $Q_{offset_{s,n}}$, if $Q_{offset_{s,n}}$ is valid, otherwise this equals to zero. For inter-frequency: Equals to $Q_{offset_{s,n}}$ plus $Q_{offset_{frequency}}$, if $Q_{offset_{s,n}}$ is valid, otherwise this equals to $Q_{offset_{frequency}}$.
$Q_{offset_{temp}}$	Offset temporarily applied to a cell as specified in TS 38.331 [3].

The UE shall perform ranking of all cells that fulfil the cell selection criterion S , which is defined in 5.2.3.2.

The cells shall be ranked according to the R criteria specified above by deriving $Q_{meas,n}$ and $Q_{meas,s}$ and calculating the R values using averaged RSRP results.

If *rangeToBestCell* is not configured, the UE shall perform cell reselection to the highest ranked cell. If this cell is found to be not-suitable, the UE shall behave according to subclause 5.2.4.4.

If *rangeToBestCell* is configured, then the UE shall perform cell reselection to the cell with the highest number of beams above the threshold (i.e. *absThreshSS-BlocksConsolidation*) among the cells whose R value is within *rangeToBestCell* of the R value of the highest ranked cell. If there are multiple such cells, the UE shall perform cell reselection to the highest ranked cell among them. If this cell is found to be not-suitable, the UE shall behave according to subclause 5.2.4.4.

In all cases, the UE shall reselect the new cell, only if the following conditions are met:

- the new cell is better than the serving cell according to the cell reselection criteria specified above during a time interval $T_{reselection_{RAT}}$;
- more than 1 second has elapsed since the UE camped on the current serving cell.

6.1.2.20.3 Test description

6.1.2.20.3.1 Pre-test conditions

System Simulator:

- NR Cell 1, NR Cell 3 and NR Cell 6.
- System information combination NR-4 as defined in TS 38.508-1 [4] Table 4.4.3.1.2-1 is used in NR cells.

UE:

None.

Preamble:

- The UE is in state 1N-A on NR Cell 1(serving cell) according to TS 38.508-1 [4] Table 4.4A.2-1.

6.1.2.20.3.2 Test procedure sequence

Table 6.1.2.20.3.2-1/2 illustrates the downlink power levels and other changing parameters to be applied for the NR cells at various time instants of the test execution. The exact instants on which these values shall be applied are described in the texts in this clause. The configuration "T0" indicates the initial conditions. Subsequent configurations marked "T1", "T2" and "T3" are applied at the points indicated in the Main behaviour description in Table 6.1.2.20.3.2-3.

Table 6.1.2.20.3.2-1: Time instances of cell power level and parameter changes for FR1

	Parameter	Unit	NR Cell 1	NR Cell 3	NR Cell 6	Remark
T0	SS/PBCH SSS EPRE	dBm/SCS	-88	Off	Off	The power level values are assigned to ensure the UE registered on NR Cell 1.
T1	SS/PBCH SSS EPRE	dBm/SCS	-88	-78	Off	The power level values are assigned to satisfy $R_{NR\ Cell\ 1} < R_{NR\ Cell\ 3}$.
T2	SS/PBCH SSS EPRE	dBm/SCS	Off	-78	-78	The power level values are assigned to satisfy $Sr_{xlev}_{NR\ Cell\ 1} < 0$ and $Sr_{xlev}_{NR\ Cell\ 6} > Thresh_{NR\ Cell\ 6, high}$.
T3	SS/PBCH SSS EPRE	dBm/SCS	Off	-78	-98	The power level values are assigned to satisfy $Sr_{xlev}_{NR\ Cell\ 6} < Thresh_{serving, low}$ and $Sr_{xlev}_{NR\ Cell\ 3} > Thresh_{NR\ Cell\ 3, low}$, $Sr_{xlev}_{NR\ Cell\ 1} < 0$.
Note: Power level "Off" is defined in TS38.508-1 [4] Table 6.2.2.1-3.						

Table 6.1.2.20.3.2-2: Time instances of cell power level and parameter changes for FR2

	Parameter	Unit	NR Cell 1	NR Cell 3	NR Cell 6	Remark
T0	SS/PBCH SSS EPRE	dBm/SCS	-91	Off	Off	The power level values are assigned to ensure the UE registered on NR Cell 1.
T1	SS/PBCH SSS EPRE	dBm/SCS	-91	-82	Off	The power level values are assigned to satisfy $R_{NR\ Cell\ 1} < R_{NR\ Cell\ 3}$.
T2	SS/PBCH SSS EPRE	dBm/SCS	Off	-82	-82	The power level values are assigned to satisfy $Sr_{xlev}_{NR\ Cell\ 1} < 0$ and $Sr_{xlev}_{NR\ Cell\ 6} > Thresh_{NR\ Cell\ 6, high}$.
T3	SS/PBCH SSS EPRE	dBm/SCS	Off	-82	-100	The power level values are assigned to satisfy $Sr_{xlev}_{NR\ Cell\ 6} < Thresh_{serving, low}$ and $Sr_{xlev}_{NR\ Cell\ 3} > Thresh_{NR\ Cell\ 3, low}$, $Sr_{xlev}_{NR\ Cell\ 1} < 0$.

Table 6.1.2.20.3.2-3: Main behaviour

St	Procedure	Message Sequence		TP	Verdict
		U - S	Message		
1	The SS changes NR Cell 3 SS PBCH SSS EPRE level according to the row "T1" in table 6.1.2.20.3.2-1/2.	-	-	-	-
2	Wait for 66[FR1]/258[FR2] seconds to allow UE to recognise the change.	-	-	-	-
3	Check: Does the test result of generic test procedure in TS 38.508-1 [4] Table 4.9.4.2.2-1 indicate that the UE is camped on NR Cell 3?	-	-	1	-
4	The SS changes NR Cell 1 and NR Cell 6 SSS levels according to the row "T2" in table 6.1.2.20.3.2-1/2.	-	-	-	-
5	Wait for 34[FR1]/130[FR2] seconds to allow UE	-	-	-	-

	to recognise the change.				
6	Check: Does the test result of generic test procedure in TS 38.508-1 [4] Table 4.9.4.2.2-1 indicate that the UE is camped on NR Cell 6?	-	-	2	-
7	The SS changes NR Cell 6 SSS level according to the row "T3" in table 6.1.2.20.3.2-1/2.	-	-	-	-
8	Wait for 8[FR1]/27[FR2] seconds to allow UE to recognise the change.	-	-	-	-
9	Check: Does the test result of generic test procedure in TS 38.508-1 [4] Table 4.9.4.2.2-1 indicate that the UE is camped on NR Cell 3?	-	-	3	-
Note: The wait time at steps 2 and 5 is $K_{\text{carrier}} * T_{\text{detect, NR_Inter}}$ and at Step 8 it is $K_{\text{carrier}} * T_{\text{evaluate, NR_Inter}}$ (as per TS 38.133 [30], clause 4.2.2.4) plus the time to read the system information $T_{\text{SI-NR}}$.					

6.1.2.20.3.3 Specific message contents

Table 6.1.2.20.3.3-1: Conditions for specific message contents in Tables below

Condition	Explanation
NR Cell 1	This condition applies to system information transmitted on NR Cell 1.
NR Cell 3	This condition applies to system information transmitted on NR Cell 3.
NR Cell 6	This condition applies to system information transmitted on NR Cell 6.

Table 6.1.2.20.3.3-2: SIB2 of NR Cell 6 (preamble and all steps, Table 6.1.2.20.3.2-3)

Derivation Path: TS 38.508-1 [4], Table 4.6.2-1			
Information Element	Value/remark	Comment	Condition
SIB2 ::= SEQUENCE {			
cellReselectionServingFreqInfo			
SEQUENCE {			
threshServingLowP	10	20 dB	
cellReselectionPriority	5		
}			
}			

Table 6.1.2.20.3.3-3: SIB4 of NR Cell 1, NR Cell 3 and NR Cell 6 (preamble and all steps, Table 6.1.2.20.3.2-3)

Derivation Path: TS 38.508-1 [4], Table 4.6.2-3			
Information Element	Value/remark	Comment	Condition
SIB4 ::= SEQUENCE {			
interFreqCarrierFreqList SEQUENCE	2 entry		
SIZE (1..maxFreq) OF SEQUENCE {			
dl-CarrierFreq[1]	Same downlink ARFCN as used for NR Cell 6		NR Cell 1
	Same downlink ARFCN as used for NR Cell 6		NR Cell 3
	Same downlink ARFCN as used for NR Cell 3		NR Cell 6
threshX-HighP[1]	10	20 dB	NR Cell 3 and FR1
	9	18 dB	NR Cell 3 and FR2
cellReselectionPriority[1]	5		NR Cell 1
	5		NR Cell 3
dl-CarrierFreq[2]	Same downlink ARFCN as used for NR Cell 3		NR Cell 1
cellReselectionPriority[2]	4		NR Cell 1
}			
}			

6.1.2.21 Cell reselection, SIntraSearchQ and SnonIntraSearchQ

6.1.2.21.1 Test Purpose (TP)

(1)

```
with { UE in NR RRC_IDLE state, and the UE is not in high mobility state }
ensure that {
  when { UE receives non-zero SIntraSearchQ in system information }
  then { UE performs measurement and reselects the highest ranked cell upon Squal < SIntraSearchQ }
}
```

(2)

```
with { UE in NR RRC_IDLE state, and the UE is not in high mobility state }
ensure that {
  when { UE receives non-zero SnonIntraSearchQ in system information }
  then { UE performs measurement and reselects the cell which belongs to the equal priority
frequency cell upon Squal < SnonIntraSearchQ }
}
```

(3)

```
with { UE in NR RRC_IDLE state, and the UE is not in high mobility state }
ensure that {
  when { UE receives non-zero SnonIntraSearchQ in system information }
  then { UE performs measurement and reselects the cell which belongs to the high priority
frequency cell upon Squal > SnonIntraSearchQ }
}
```

6.1.2.21.2 Conformance requirements

References: The conformance requirements covered in the present TC are specified in TS 38.304: clause 5.2.4.1, 5.2.4.2, 5.2.4.5, 5.2.4.6 and 5.2.4.7. Unless otherwise stated these are Rel-15 requirements.

[TS 38.304, clause 5.2.4.1]

Absolute priorities of different NR frequencies or inter-RAT frequencies may be provided to the UE in the system information, in the *RRCRelease* message, or by inheriting from another RAT at inter-RAT cell (re)selection. In the case of system information, an NR frequency or inter-RAT frequency may be listed without providing a priority (i.e. the field *cellReselectionPriority* is absent for that frequency). If priorities are provided in dedicated signalling, the UE shall ignore all the priorities provided in system information. If UE is in *camped on any cell* state, UE shall only apply the priorities provided by system information from current cell, and the UE preserves priorities provided by dedicated signalling and *deprioritisationReq* received in *RRCRelease* unless specified otherwise. When the UE in camped normally state, has only dedicated priorities other than for the current frequency, the UE shall consider the current frequency to be the lowest priority frequency (i.e. lower than any of the network configured values).

The UE shall only perform cell reselection evaluation for NR frequencies and inter-RAT frequencies that are given in system information and for which the UE has a priority provided.

In case UE receives *RRCRelease* with *deprioritisationReq*, UE shall consider current frequency and stored frequencies due to the previously received *RRCRelease* with *deprioritisationReq* or all the frequencies of NR to be the lowest priority frequency (i.e. lower than any of the network configured values) while T325 is running irrespective of camped RAT. The UE shall delete the stored deprioritisation request(s) when a PLMN selection is performed on request by NAS (TS 23.122 [9]).

NOTE: UE should search for a higher priority layer for cell reselection as soon as possible after the change of priority. The minimum related performance requirements specified in TS 38.133 [8] are still applicable.

The UE shall delete priorities provided by dedicated signalling when:

- the UE enters a different RRC state; or
- the optional validity time of dedicated priorities (T320) expires; or

- a PLMN selection is performed on request by NAS (TS 23.122 [9]).

NOTE 2: Equal priorities between RATs are not supported.

The UE shall not consider any black listed cells as candidate for cell reselection.

The UE shall inherit the priorities provided by dedicated signalling and the remaining validity time (i.e. T320 in NR and E-UTRA), if configured, at inter-RAT cell (re)selection.

NOTE 3: The network may assign dedicated cell reselection priorities for frequencies not configured by system information.

[TS 38.304, clause 5.2.4.2]

Following rules are used by the UE to limit needed measurements:

- If the serving cell fulfils $S_{rxlev} > S_{IntraSearchP}$ and $S_{qual} > S_{IntraSearchQ}$, the UE may choose not to perform intra-frequency measurements.
- Otherwise, the UE shall perform intra-frequency measurements.
- The UE shall apply the following rules for NR inter-frequencies and inter-RAT frequencies which are indicated in system information and for which the UE has priority provided as defined in 5.2.4.1:
 - For a NR inter-frequency or inter-RAT frequency with a reselection priority higher than the reselection priority of the current NR frequency, the UE shall perform measurements of higher priority NR inter-frequency or inter-RAT frequencies according to TS 38.133 [8].
 - For a NR inter-frequency with an equal or lower reselection priority than the reselection priority of the current NR frequency and for inter-RAT frequency with lower reselection priority than the reselection priority of the current NR frequency:
 - If the serving cell fulfils $S_{rxlev} > S_{nonIntraSearchP}$ and $S_{qual} > S_{nonIntraSearchQ}$, the UE may choose not to perform measurements of NR inter-frequencies or inter-RAT frequency cells of equal or lower priority;
 - Otherwise, the UE shall perform measurements of NR inter-frequencies or inter-RAT frequency cells of equal or lower priority according to TS 38.133 [8].

[TS 38.304, clause 5.2.4.5]

If *threshServingLowQ* is broadcast in system information and more than 1 second has elapsed since the UE camped on the current serving cell, cell reselection to a cell on a higher priority NR frequency or inter-RAT frequency than the serving frequency shall be performed if:

- A cell of a higher priority NR or EUTRAN RAT/frequency fulfils $S_{qual} > Thresh_{X, HighQ}$ during a time interval $T_{reselection_{RAT}}$

Otherwise, cell reselection to a cell on a higher priority NR frequency or inter-RAT frequency than the serving frequency shall be performed if:

- A cell of a higher priority RAT/ frequency fulfils $S_{rxlev} > Thresh_{X, HighP}$ during a time interval $T_{reselection_{RAT}}$; and
- More than 1 second has elapsed since the UE camped on the current serving cell.

Cell reselection to a cell on an equal priority NR frequency shall be based on ranking for intra-frequency cell reselection as defined in clause 5.2.4.6.

If *threshServingLowQ* is broadcast in system information and more than 1 second has elapsed since the UE camped on the current serving cell, cell reselection to a cell on a lower priority NR frequency or inter-RAT frequency than the serving frequency shall be performed if:

- The serving cell fulfils $S_{qual} < Thresh_{Serving, LowQ}$ and a cell of a lower priority NR or E-UTRAN RAT/ frequency fulfils $S_{qual} > Thresh_{X, LowQ}$ during a time interval $T_{reselection_{RAT}}$.

Otherwise, cell reselection to a cell on a lower priority NR frequency or inter-RAT frequency than the serving frequency shall be performed if:

- The serving cell fulfils $Srxlev < Thresh_{Serving, LowP}$ and a cell of a lower priority RAT/ frequency fulfils $Srxlev > Thresh_{X, LowP}$ during a time interval $T_{reselection_{RAT}}$; and
- More than 1 second has elapsed since the UE camped on the current serving cell.

Cell reselection to a higher priority RAT/frequency shall take precedence over a lower priority RAT/frequency if multiple cells of different priorities fulfil the cell reselection criteria.

If more than one cell meets the above criteria, the UE shall reselect a cell as follows:

- If the highest-priority frequency is an NR frequency, the highest ranked cell among the cells on the highest priority frequency(ies) meeting the criteria according to clause 5.2.4.6;
- If the highest-priority frequency is from another RAT, the highest ranked cell among the cells on the highest priority frequency(ies) meeting the criteria of that RAT.

[TS 38.304, clause 5.2.4.6]

The cell-ranking criterion R_s for serving cell and R_n for neighbouring cells is defined by:

$$R_s = Q_{meas,s} + Q_{hyst} - Q_{offset_{temp}}$$

$$R_n = Q_{meas,n} - Q_{offset} - Q_{offset_{temp}}$$

where:

Q_{meas}	RSRP measurement quantity used in cell reselections.
Q_{offset}	For intra-frequency: Equals to $Q_{offset_{s,n}}$, if $Q_{offset_{s,n}}$ is valid, otherwise this equals to zero. For inter-frequency: Equals to $Q_{offset_{s,n}}$ plus $Q_{offset_{frequency}}$, if $Q_{offset_{s,n}}$ is valid, otherwise this equals to $Q_{offset_{frequency}}$.
$Q_{offset_{temp}}$	Offset temporarily applied to a cell as specified in TS 38.331 [3].

The UE shall perform ranking of all cells that fulfil the cell selection criterion S , which is defined in 5.2.3.2.

The cells shall be ranked according to the R criteria specified above by deriving $Q_{meas,n}$ and $Q_{meas,s}$ and calculating the R values using averaged RSRP results.

If *rangeToBestCell* is not configured, the UE shall perform cell reselection to the highest ranked cell. If this cell is found to be not-suitable, the UE shall behave according to subclause 5.2.4.4.

If *rangeToBestCell* is configured, then the UE shall perform cell reselection to the cell with the highest number of beams above the threshold (i.e. *absThreshSS-BlocksConsolidation*) among the cells whose R value is within *rangeToBestCell* of the R value of the highest ranked cell. If there are multiple such cells, the UE shall perform cell reselection to the highest ranked cell among them. If this cell is found to be not-suitable, the UE shall behave according to subclause 5.2.4.4.

In all cases, the UE shall reselect the new cell, only if the following conditions are met:

- the new cell is better than the serving cell according to the cell reselection criteria specified above during a time interval $T_{reselection_{RAT}}$;
- more than 1 second has elapsed since the UE camped on the current serving cell.

[TS 38.304, clause 5.2.4.7]

5.2.4.7.0 General reselection parameters

Cell reselection parameters are broadcast in system information and are read from the serving cell as follows:

absThreshSS-BlocksConsolidation

This specifies minimum threshold of the beam which can be used for selection of the highest ranked cell, if *rangeToBestCell* is configured.

cellReselectionPriority

This specifies the absolute priority for NR frequency or E-UTRAN frequency.

cellReselectionSubPriority

This specifies the fractional priority value added to cellReselectionPriority for NR frequency or E-UTRAN frequency.

Qoffset_{s,n}

This specifies the offset between the two cells.

Qoffset_{frequency}

Frequency specific offset for equal priority NR frequencies.

Q_{hyst}

This specifies the hysteresis value for ranking criteria.

Qoffset_{temp}

This specifies the additional offset to be used for cell selection and re-selection. It is temporarily used in case the RRC Connection Establishment fails on the cell as specified in TS 38.331 [3].

Q_{qualmin}

This specifies the minimum required quality level in the cell in dB.

Q_{rxlevmin}

This specifies the minimum required Rx level in the cell in dBm.

Q_{rxlevminoffsetcell}

This specifies the cell specific Rx level offset in dB to Q_{rxlevmin}.

Q_{qualminoffsetcell}

This specifies the cell specific quality level offset in dB to Q_{qualmin}.

rangeToBestCell

This specifies the R value range which the cells whose R value is within the range can be a candidate for the highest ranked cell.

Treselection_{RAT}

This specifies the cell reselection timer value. For each target NR frequency and for each RAT other than NR, a specific value for the cell reselection timer is defined, which is applicable when evaluating reselection within NR or towards other RAT (i.e. Treselection_{RAT} for NR is Treselection_{NR}, for E-UTRAN Treselection_{EUTRA}).

NOTE: Treselection_{RAT} is not broadcast in system information but used in reselection rules by the UE for each RAT.

Treselection_{NR}

This specifies the cell reselection timer value Treselection_{RAT} for NR. The parameter can be set per NR frequency as specified in TS 38.331 [3].

Treselection_{EUTRA}

This specifies the cell reselection timer value Treselection_{RAT} for E-UTRAN.

Thresh_{X, HighP}

This specifies the S_{rxlev} threshold (in dB) used by the UE when reselecting towards a higher priority RAT/ frequency than the current serving frequency. Each frequency of NR and E-UTRAN might have a specific threshold.

Thresh_{X, HighQ}

This specifies the Squal threshold (in dB) used by the UE when reselecting towards a higher priority RAT/ frequency than the current serving frequency. Each frequency of NR and E-UTRAN might have a specific threshold.

Thresh_{X, LowP}

This specifies the Srxlev threshold (in dB) used by the UE when reselecting towards a lower priority RAT/ frequency than the current serving frequency. Each frequency of NR and E-UTRAN might have a specific threshold.

Thresh_{X, LowQ}

This specifies the Squal threshold (in dB) used by the UE when reselecting towards a lower priority RAT/ frequency than the current serving frequency. Each frequency of NR and E-UTRAN might have a specific threshold.

Thresh_{Serving, LowP}

This specifies the Srxlev threshold (in dB) used by the UE on the serving cell when reselecting towards a lower priority RAT/ frequency.

Thresh_{Serving, LowQ}

This specifies the Squal threshold (in dB) used by the UE on the serving cell when reselecting towards a lower priority RAT/ frequency.

S_{IntraSearchP}

This specifies the Srxlev threshold (in dB) for intra-frequency measurements.

S_{IntraSearchQ}

This specifies the Squal threshold (in dB) for intra-frequency measurements.

S_{nonIntraSearchP}

This specifies the Srxlev threshold (in dB) for NR inter-frequency and inter-RAT measurements.

S_{nonIntraSearchQ}

This specifies the Squal threshold (in dB) for NR inter-frequency and inter-RAT measurements.

5.2.4.7.1 Speed dependent reselection parameters

Speed dependent reselection parameters are broadcast in system information and are read from the serving cell as follows:

T_{CRmax}

This specifies the duration for evaluating allowed amount of cell reselection(s).

N_{CR_M}

This specifies the maximum number of cell reselections to enter Medium-mobility state.

N_{CR_H}

This specifies the maximum number of cell reselections to enter High-mobility state.

T_{CRmaxHyst}

This specifies the additional time period before the UE can enter Normal-mobility state.

Speed dependent ScalingFactor for Q_{hyst}

This specifies scaling factor for Q_{hyst} in *sf-High* for High-mobility state and *sf-Medium* for Medium-mobility state.

Speed dependent ScalingFactor for T_{reselectionNR}

This specifies scaling factor for T_{reselectionNR} in *sf-High* for High-mobility state and *sf-Medium* for Medium-mobility state.

Speed dependent ScalingFactor for Treselection_{EUTRA}

This specifies scaling factor for Treselection_{EUTRA} in *sf-High* for High-mobility state and *sf-Medium* for Medium-mobility state.

6.1.2.21.3 Test description

6.1.2.21.3.1 Pre-test conditions

System Simulator:

- NR Cell 1, NR Cell 2 and NR Cell 3.
- NR Cell 1, NR Cell 2 and NR Cell 3 are configured to operate in FR1 bands as defined in TS 38.508-1 [4] clause 6.2.3.
- System information combination NR-4 as defined in TS 38.508-1 [4] Table 4.4.3.1.2-1, and message contents defined in clause 4.6.1 and clause 4.6.2 with QBASED condition is used in NR cells.

UE:

None.

Preamble:

- The UE is in state 1N-A on NR Cell 1(serving cell) according to TS 38.508-1 [4] Table 4.4A.2-1.

6.1.2.21.3.2 Test procedure sequence

Table 6.1.2.21.3.2-1 illustrates the downlink power levels and other changing parameters to be applied for the NR cells at various time instants of the test execution. The exact instants on which these values shall be applied are described in the texts in this clause. The configuration "T0" indicates the initial conditions. Subsequent configurations marked "T1", "T2", "T3" and "T4" are applied at the points indicated in the Main behaviour description in Table 6.1.2.21.3.2-3.

Table 6.1.2.21.3.2-1: Time instances of cell power level and parameter changes for FR1

	Parameter	Unit	NR Cell 1	NR Cell 2	NR Cell 3	Remark
T0	SS/PBCH SSS EPRE	dBm/SCS	-88	Off	Off	The power level values are assigned to ensure the UE registered on NR Cell 1.
T1	SS/PBCH SSS EPRE	dBm/SCS	-94	-80	-118	Squal of NR Cell 1 is less than $S_{\text{IntraSearchQ}}$.
	RSRQ	dB	-13.78	-10.96	-34.81	
	Q_{rxlevmin}	dBm	-110	-110	-110	
	Qqualmin	dB	-20	-20	-20	
	$S_{\text{IntraSearchQ}}$	dB	20	20	20	
	Noc	dBm/SCS	-94	-94	-94	
	Srxlev	dB	16	30	-8	
Squal	dB	6.22	9.04	-14.81		
T2	SS/PBCH SSS EPRE	dBm/SCS	-118	-94	-80	Squal of NR Cell 2 is less than $S_{\text{nonIntraSearchQ}}$.
	RSRQ	dB	-34.81	-13.78	-10.96	
	Q_{rxlevmin}	dBm	-110	-110	-110	
	Qqualmin	dB	-20	-20	-20	
	$S_{\text{nonIntraSearchQ}}$	dB	20	20	20	
	Noc	dBm/SCS	-94	-94	-94	
	Srxlev	dB	-8	16	30	
Squal	dB	-14.81	6.22	9.04		
T3	SS/PBCH SSS EPRE	dBm/SCS	-118	-118	-80	
	RSRQ	dB	-34.81	-34.81	-10.96	
	Q_{rxlevmin}	dBm	-110	-110	-110	
	Qqualmin	dB	-20	-20	-20	

	S _{nonIntraSearchQ}	dB	20	20	2		
	Noc	dBm/SCS	-94	-94	-94		
	Srxlev	dB	-8	-8	30		
	Squal	dB	-14.81	-14.81	9.04		
T4	SS/PBCH SSS EPRE	dBm/SCS	-80	-118	-80	Squal of NR Cell 3 is greater than S _{nonIntraSearchQ} but NR Cell 1 is high priority cell.	
	RSRQ	dB	-10.96	-34.81	-10.96		
	Q _{rxlevmin}	dBm	-110	-110	-110		
	Qqualmin	dB	-20	-20	-20		
	S _{nonIntraSearchQ}	dB	20	20	2		
	Noc	dBm/SCS	-94	-94	-94		
	Srxlev	dB	30	-8	30		
	Squal	dB	9.04	-14.81	9.04		
Note: Power level "Off" is defined in TS38.508-1 [4] Table 6.2.2.1-3.							

Table 6.1.2.21.3.2-2: Void

Table 6.1.2.21.3.2-3: Main behaviour

St	Procedure	Message Sequence		TP	Verdict
		U - S	Message		
1	The SS re-adjusts the SS/PBCH EPRE levels according to row "T1" in table 6.1.2.21.3.2-1.	-	-	-	-
2	Wait for 34 seconds to allow UE to recognise the change.	-	-	-	-
3	Check: Does the test result of generic test procedure in TS 38.508-1 [4] Table 4.9.4.2.2-1 indicate that the UE is camped on NR Cell 2?	-	-	1	-
4	The SS re-adjusts the SSS levels according to row "T2" in table 6.1.2.21.3.2-1.	-	-	-	-
5	Wait for 34 seconds to allow UE to recognise the change.	-	-	-	-
6	Check: Does the test result of generic test procedure in TS 38.508-1 [4] Table 4.9.4.2.2-1 indicate that the UE is camped on NR Cell 3?	-	-	2	-
6A	The SS re-adjusts the SSS levels according to row "T3" in table 6.1.2.21.3.2-1.	-	-	-	-
7	Void				
8	The SS changes the S _{nonIntraSearchQ} for NR Cell 3 according to row "T3" in table 6.1.2.21.3.2-1/2, The <i>ValueTag</i> of <i>SIB2</i> in the SI-SchedulingInfo of <i>SIB1</i> is increased on NR Cell 3.	-	-	-	-
8A	The SS notifies the UE of change of System Information on NR Cell 3 by send Short Message on PDCCH using P-RNTI.	<--	NR RRC: <i>Paging</i>	-	-
9	Wait for 2.1* modification period to allow the new system information to take effect.	-	-	-	-
10	The SS re-adjusts the SSS levels according to row "T4" in table 6.1.2.21.3.2-1.	-	-	-	-
11	Wait for 120 seconds to allow UE to recognise the change.	-	-	-	-
12	Check: Does the test result of generic test procedure in TS 38.508-1 [4] Table 4.9.4.2.2-1 indicate that the UE is camped on NR Cell 1?	-	-	3	-

6.1.2.21.3.3 Specific message contents

Table 6.1.2.21.3.3-1: Conditions for specific message contents in Tables below

Condition	Explanation
NR Cell 1	This condition applies to system information transmitted on NR Cell 1.
NR Cell 2	This condition applies to system information transmitted on NR Cell 2.
NR Cell 3	This condition applies to system information transmitted on NR Cell 3.

Table 6.1.2.21.3.3-2: SIB2 of NR Cell 1, NR Cell 2 and NR Cell 3 (preabmle, Table 6.1.2.21.3.2-3)

Derivation Path: TS 38.508-1 [4], Table 4.6.2-1			
Information Element	Value/remark	Comment	Condition
SIB2 ::= SEQUENCE { cellReselectionServingFreqInfo SEQUENCE {			
s-NonIntraSearchP	0	0 dB	
s-NonIntraSearchQ	20	20 dB	
cellReselectionPriority	5		NR Cell 1
	1		NR Cell 2 and Cell 3
}			
intraFreqCellReselectionInfo SEQUENCE			
{			
s-IntraSearchP	0	0 dB	
s-IntraSearchQ	20	20 dB	
}			
}			

Table 6.1.2.21.3.3-3: SIB4 of NR Cell 2 and NR Cell 3 (preabmle and all steps, Table 6.1.2.21.3.2-3)

Derivation Path: TS 38.508-1 [4], Table 4.6.2-3			
Information Element	Value/remark	Comment	Condition
SIB4 ::= SEQUENCE {			
interFreqCarrierFreqList SEQUENCE (SIZE (1..maxFreq)) OF InterFreqCarrierFreqInfo {	1 entry		
InterFreqCarrierFreqInfo[1] SEQUENCE		entry 1	
{			
dl-CarrierFreq	Same downlink ARFCN as used for NR Cell 3		NR Cell 2
	Same downlink ARFCN as used for NR Cell 1		NR Cell 3
t-ReselectionNR	1		
threshX-HighP	7	14 dBm	NR Cell 3
threshX-Q SEQUENCE {			NR Cell 3
threshX-HighQ	20		
threshX-LowQ	5		
}			
cellReselectionPriority	5		NR Cell 3
	1		NR Cell 2
}			
}			
}			
}			

Table 6.1.2.21.3.3-4: SIB1 of NR Cell 3 (step 8, Table 6.1.2.21.3.2-3)

Derivation Path: TS 38.508-1 [4], Table 4.6.1-28			
Information Element	Value/remark	Comment	Condition
SIB1 ::= SEQUENCE {			
si-SchedulingInfo	SI-SchedulingInfo		
}			

Table 6.1.2.21.3.3-4a: SIB4 of NR Cell 3 (step 8, Table 6.1.2.21.3.2-3)

Derivation Path: TS 38.508-1 [4], Table 4.6.2-3			
Information Element	Value/remark	Comment	Condition
SIB4 ::= SEQUENCE {			
interFreqCarrierFreqList SEQUENCE	1 entry		
(SIZE (1..maxFreq)) OF			
InterFreqCarrierFreqInfo {			
InterFreqCarrierFreqInfo[1] SEQUENCE		entry 1	
{			
threshX-Q SEQUENCE {			NR Cell 3
threshX-HighQ	5		
threshX-LowQ	5		
}			
}			
}			
}			

Table 6.1.2.21.3.3-5: SI-SchedulingInfo (si-SchedulingInfo in Table 6.1.2.21.3.3-4)

Derivation Path: TS 38.508-1 [4], Table 4.6.3-173			
Information Element	Value/remark	Comment	Condition
SI-SchedulingInfo ::= SEQUENCE {			
schedulingInfoList SEQUENCE	1 entry		
(SIZE(1..maxSI-Message)) OF			
SchedulingInfo {			
SchedulingInfo[1] SEQUENCE {		entry 1	
sib-MappingInfo SEQUENCE (SIZE	2 entries		
(1..maxSIB)) OF SIB-TypeInfo {			
SIB-TypeInfo[1] SEQUENCE {		entry 1	
type	sibType2		
valueTag	1		
}			
SIB-TypeInfo[2] SEQUENCE {		entry 2	
type	sibType4		
valueTag	1		
}			
}			
}			
}			

Table 6.1.2.21.3.3-6: SIB2 of NR Cell 3 (step 8, Table 6.1.2.21.3.2-3)

Derivation Path: TS 38.508-1 [4], Table 4.6.2-1			
Information Element	Value/remark	Comment	Condition
SIB2 ::= SEQUENCE {			
cellReselectionServingFreqInfo			
SEQUENCE {			
s-NonIntraSearchQ	2	2 dB	
}			
}			

6.1.2.22 Inter-frequency cell reselection based on common priority information with parameters *ThreshX*, *HighQ*, *ThreshX*, *LowQ* and *ThreshServing*, *LowQ*

6.1.2.22.1 Test Purpose (TP)

(1)

```
with { UE in NR RRC_IDLE state }
ensure that {
  when { UE detects the cell re-selection criteria are met for the cell which belongs to the higher
  priority frequency }
  then { UE reselects the cell which belongs to the higher priority frequency }
}
```

(2)

```
with { UE in NR RRC_IDLE state }
ensure that {
  when { UE detects the cell re-selection criteria are met for the cell which belongs to the lower
  priority frequency }
  then { UE reselects the cell which belongs to the lower priority frequency }
}
```

6.1.2.22.2 Conformance requirements

References: The conformance requirements covered in the present TC are specified in TS 38.304: clause 5.2.4.5, and 5.2.4.7. Unless otherwise stated these are Rel-15 requirements.

[TS 38.304, clause 5.2.4.5]

If *threshServingLowQ* is broadcast in system information and more than 1 second has elapsed since the UE camped on the current serving cell, cell reselection to a cell on a higher priority NR frequency or inter-RAT frequency than the serving frequency shall be performed if:

- A cell of a higher priority NR or EUTRAN RAT/frequency fulfils $Squal > Thresh_{X, HighQ}$ during a time interval $T_{reselection_{RAT}}$

Otherwise, cell reselection to a cell on a higher priority NR frequency or inter-RAT frequency than the serving frequency shall be performed if:

- A cell of a higher priority RAT/ frequency fulfils $Srxlev > Thresh_{X, HighP}$ during a time interval $T_{reselection_{RAT}}$; and
- More than 1 second has elapsed since the UE camped on the current serving cell.

Cell reselection to a cell on an equal priority NR frequency shall be based on ranking for intra-frequency cell reselection as defined in clause 5.2.4.6.

If *threshServingLowQ* is broadcast in system information and more than 1 second has elapsed since the UE camped on the current serving cell, cell reselection to a cell on a lower priority NR frequency or inter-RAT frequency than the serving frequency shall be performed if:

- The serving cell fulfils $Squal < Thresh_{Serving, LowQ}$ and a cell of a lower priority NR or E-UTRAN RAT/ frequency fulfils $Squal > Thresh_{X, LowQ}$ during a time interval $T_{reselection_{RAT}}$.

Otherwise, cell reselection to a cell on a lower priority NR frequency or inter-RAT frequency than the serving frequency shall be performed if:

- The serving cell fulfils $Srxlev < Thresh_{Serving, LowP}$ and a cell of a lower priority RAT/ frequency fulfils $Srxlev > Thresh_{X, LowP}$ during a time interval $T_{reselection_{RAT}}$; and
- More than 1 second has elapsed since the UE camped on the current serving cell.

Cell reselection to a higher priority RAT/frequency shall take precedence over a lower priority RAT/frequency if multiple cells of different priorities fulfil the cell reselection criteria.

If more than one cell meets the above criteria, the UE shall reselect a cell as follows:

- If the highest-priority frequency is an NR frequency, the highest ranked cell among the cells on the highest priority frequency(ies) meeting the criteria according to clause 5.2.4.6;
- If the highest-priority frequency is from another RAT, the highest ranked cell among the cells on the highest priority frequency(ies) meeting the criteria of that RAT.

[TS 38.304, clause 5.2.4.7]

5.2.4.7.0 General reselection parameters

Cell reselection parameters are broadcast in system information and are read from the serving cell as follows:

absThreshSS-BlocksConsolidation

This specifies minimum threshold of the beam which can be used for selection of the highest ranked cell, if *rangeToBestCell* is configured.

cellReselectionPriority

This specifies the absolute priority for NR frequency or E-UTRAN frequency.

cellReselectionSubPriority

This specifies the fractional priority value added to *cellReselectionPriority* for NR frequency or E-UTRAN frequency.

Qoffset_{s,n}

This specifies the offset between the two cells.

Qoffset_{frequency}

Frequency specific offset for equal priority NR frequencies.

Q_{hyst}

This specifies the hysteresis value for ranking criteria.

Qoffset_{temp}

This specifies the additional offset to be used for cell selection and re-selection. It is temporarily used in case the RRC Connection Establishment fails on the cell as specified in TS 38.331 [3].

Q_{qualmin}

This specifies the minimum required quality level in the cell in dB.

Q_{rxlevmin}

This specifies the minimum required Rx level in the cell in dBm.

Q_{rxlevminoffsetcell}

This specifies the cell specific Rx level offset in dB to *Q_{rxlevmin}*.

Q_{qualminoffsetcell}

This specifies the cell specific quality level offset in dB to *Q_{qualmin}*.

rangeToBestCell

This specifies the R value range which the cells whose R value is within the range can be a candidate for the highest ranked cell.

T_{reselectionRAT}

This specifies the cell reselection timer value. For each target NR frequency and for each RAT other than NR, a specific value for the cell reselection timer is defined, which is applicable when evaluating reselection within NR or towards other RAT (i.e. $T_{\text{reselection}_{\text{RAT}}}$ for NR is $T_{\text{reselection}_{\text{NR}}}$, for E-UTRAN $T_{\text{reselection}_{\text{EUTRA}}}$).

NOTE: $T_{\text{reselection}_{\text{RAT}}}$ is not broadcast in system information but used in reselection rules by the UE for each RAT.

$T_{\text{reselection}_{\text{NR}}}$

This specifies the cell reselection timer value $T_{\text{reselection}_{\text{RAT}}}$ for NR. The parameter can be set per NR frequency as specified in TS 38.331 [3].

$T_{\text{reselection}_{\text{EUTRA}}}$

This specifies the cell reselection timer value $T_{\text{reselection}_{\text{RAT}}}$ for E-UTRAN.

$\text{Thresh}_{\text{X, HighP}}$

This specifies the S_{rxlev} threshold (in dB) used by the UE when reselecting towards a higher priority RAT/ frequency than the current serving frequency. Each frequency of NR and E-UTRAN might have a specific threshold.

$\text{Thresh}_{\text{X, HighQ}}$

This specifies the Squal threshold (in dB) used by the UE when reselecting towards a higher priority RAT/ frequency than the current serving frequency. Each frequency of NR and E-UTRAN might have a specific threshold.

$\text{Thresh}_{\text{X, LowP}}$

This specifies the S_{rxlev} threshold (in dB) used by the UE when reselecting towards a lower priority RAT/ frequency than the current serving frequency. Each frequency of NR and E-UTRAN might have a specific threshold.

$\text{Thresh}_{\text{X, LowQ}}$

This specifies the Squal threshold (in dB) used by the UE when reselecting towards a lower priority RAT/ frequency than the current serving frequency. Each frequency of NR and E-UTRAN might have a specific threshold.

$\text{Thresh}_{\text{Serving, LowP}}$

This specifies the S_{rxlev} threshold (in dB) used by the UE on the serving cell when reselecting towards a lower priority RAT/ frequency.

$\text{Thresh}_{\text{Serving, LowQ}}$

This specifies the Squal threshold (in dB) used by the UE on the serving cell when reselecting towards a lower priority RAT/ frequency.

$S_{\text{IntraSearchP}}$

This specifies the S_{rxlev} threshold (in dB) for intra-frequency measurements.

$S_{\text{IntraSearchQ}}$

This specifies the Squal threshold (in dB) for intra-frequency measurements.

$S_{\text{nonIntraSearchP}}$

This specifies the S_{rxlev} threshold (in dB) for NR inter-frequency and inter-RAT measurements.

$S_{\text{nonIntraSearchQ}}$

This specifies the Squal threshold (in dB) for NR inter-frequency and inter-RAT measurements.

5.2.4.7.1 Speed dependent reselection parameters

Speed dependent reselection parameters are broadcast in system information and are read from the serving cell as follows:

T_{CRmax}

This specifies the duration for evaluating allowed amount of cell reselection(s).

N_{CR_M}

This specifies the maximum number of cell reselections to enter Medium-mobility state.

N_{CR_H}

This specifies the maximum number of cell reselections to enter High-mobility state.

$T_{CRmaxHyst}$

This specifies the additional time period before the UE can enter Normal-mobility state.

Speed dependent ScalingFactor for Q_{hyst}

This specifies scaling factor for Q_{hyst} in *sf-High* for High-mobility state and *sf-Medium* for Medium-mobility state.

Speed dependent ScalingFactor for $T_{reselection_{NR}}$

This specifies scaling factor for $T_{reselection_{NR}}$ in *sf-High* for High-mobility state and *sf-Medium* for Medium-mobility state.

Speed dependent ScalingFactor for $T_{reselection_{EUTRA}}$

This specifies scaling factor for $T_{reselection_{EUTRA}}$ in *sf-High* for High-mobility state and *sf-Medium* for Medium-mobility state.

6.1.2.22.3 Test description

6.1.2.22.3.1 Pre-test conditions

System Simulator:

- NR Cell 1 and NR Cell 3.
- System information combination NR-4 as defined in TS 38.508-1 [4] Table 4.4.3.1.2-1, and message contents defined in clause 4.6.1 and clause 4.6.2 with QBASED condition is used in NR cells.

UE:

None.

Preamble:

- The UE is in state 1N-A on NR Cell 1(serving cell) according to TS 38.508-1 [4] Table 4.4A.2-1.

6.1.2.22.3.2 Test procedure sequence

Table 6.1.2.22.3.2-1/2 illustrates the downlink power levels and other changing parameters to be applied for the NR cells at various time instants of the test execution. The exact instants on which these values shall be applied are described in the texts in this clause. The configuration "T0" indicates the initial conditions. Subsequent configurations marked "T1" and "T2" are applied at the points indicated in the Main behaviour description in Table 6.1.2.22.3.2-3.

Table 6.1.2.22.3.2-1: Time instances of cell power level and parameter changes for FR1

	Parameter	Unit	NR Cell 1	NR Cell 3	Remark
T0	SS/PBCH SSS EPRE	dBm/SCS	-88	Off	The power level values are assigned to ensure the UE registered on NR Cell 1.
T1	SS/PBCH SSS EPRE	dBm/SCS	-88	-88	The power level values are assigned to satisfy $Srxlev_{NR\ Cell\ 1} > 0$, $Srxlev_{NR\ Cell\ 3} < Thresh_{NR\ Cell\ 3, highP}$, $Squal_{NR\ Cell\ 1} > 0$ and $Squal_{NR\ Cell\ 3} > Thresh_{NR\ Cell\ 3, highQ}$.
	RSRQ	dB	-10.76	-10.76	
	Qqualmin	dB	-20	-20	

T2	Qrxlevmin	dBm	-106	-106	The power level values are assigned to satisfy $Srxlev_{NR\ Cell\ 3} > Thresh_{serving, lowP}$ and $Squal_{NR\ Cell\ 1} > Thresh_{NR\ Cell\ 1, lowQ}$. But $Squal_{NR\ Cell\ 3}$ is larger than $Thresh_{serving, lowQ}$.
	Noc	dBm/SCS	-145	-145	
	SS/PBCH SSS EPRE	dBm/SCS	-88	-94	
	RSRQ	dB	-10.76	-10.76	
	Qqualmin	dB	-20	-20	
	Qrxlevmin	dBm	-106	-106	
T3	Noc	dBm/SCS	-145	-145	The values are assigned to satisfy $Squal_{NR\ Cell\ 3} < Thresh_{serving, lowQ}$ and $Squal_{NR\ Cell\ 3} < Thresh_{NR\ Cell\ 3, highQ}$.
	threshServingLowQ	dB	4	26	
	threshX-HighQ	dB	20	-	
Note: Power level "Off" is defined in TS38.508-1 [4] Table 6.2.2.1-3.					

Table 6.1.2.22.3.2-2: Time instances of cell power level and parameter changes for FR2

	Parameter	Unit	NR Cell 1	NR Cell 3	Remark
T0	SS/PBCH SSS EPRE	dBm/SCS	FFS	Off	The power level values are assigned to ensure the UE registered on NR Cell 1.
T1	SS/PBCH SSS EPRE	dBm/SCS	FFS	FFS	The power level values are assigned to satisfy $Srxlev_{NR\ Cell\ 1} > 0$, $Srxlev_{NR\ Cell\ 3} < Thresh_{NR\ Cell\ 3, highP}$, $Squal_{NR\ Cell\ 1} > 0$ and $Squal_{NR\ Cell\ 3} > Thresh_{NR\ Cell\ 3, highQ}$.
	RSRQ	dB	FFS	FFS	
	Qqualmin	dB	-20	-20	
	Qrxlevmin	dBm	-106	-106	
T2	Noc	dBm/SCS	FFS	FFS	The power level values are assigned to satisfy $Srxlev_{NR\ Cell\ 3} > Thresh_{serving, lowP}$ and $Squal_{NR\ Cell\ 1} > Thresh_{NR\ Cell\ 1, lowQ}$. But $Squal_{NR\ Cell\ 3}$ is larger than $Thresh_{serving, lowQ}$.
	SS/PBCH SSS EPRE	dBm/SCS	FFS	FFS	
	RSRQ	dB	FFS	FFS	
	Qqualmin	dB	-20	-20	
	Qrxlevmin	dBm	-106	-106	
T3	Noc	dBm/SCS	FFS	FFS	The values are assigned to satisfy $Squal_{NR\ Cell\ 3} < Thresh_{serving, lowQ}$ and $Squal_{NR\ Cell\ 3} < Thresh_{NR\ Cell\ 3, highQ}$.
	threshServingLowQ	dB	4	26	
	threshX-HighQ	dB	20	-	
Note: The uncertain downlink signal level is specified in TS 38.508-1 [4] section FFS.					

Table 6.1.2.22.3.2-3: Main behaviour

St	Procedure	Message Sequence		TP	Verdict
		U – S	Message		
1	The SS changes NR Cell 3 SS/PBCH EPRE level according to the row "T1" in table 6.1.2.22.3.2-1/2.	-	-	-	-
2	Wait for 34 seconds to allow UE to recognise the change.	-	-	-	-
3	Check: Does the test result of generic test procedure in TS 38.508-1 [4] Table 4.9.4.2.2-1 indicate that the UE is camped on NR Cell 3?	-	-	1	-
4	The SS changes the SSS level according to the row "T2" in table 6.1.2.22.3.2-1/2.	-	-	-	-
5	Wait for 8 seconds to allow UE to recognise the change.	-	-	-	-
6	The SS transmits a <i>Paging</i> message on NR Cell 1.	<--	NR RRC: <i>Paging</i>	-	-
6A	Check: Does the UE send an <i>RRCSetupRequest</i> on NR Cell 1 within the next 10s?	-->	NR RRC: <i>RRCSetupRequest</i>	2	F
7	The SS changes threshServingLowQ of NR Cell 3 according to the row "T3" in table 6.1.2.22.3.2-1/2. The <i>ValueTag</i> of <i>SIB2</i> in the <i>SI-SchedulingInfo</i> of <i>SIB1</i> is increased on NR Cell 3.	-	-	-	-

	The SS changes threshX-HighQ of NR Cell 1 according to the row "T3" in table 6.1.2.22.3.2-1/2. The ValueTag of SIB4 in the SI-SchedulingInfo of SIB1 is increased on NR Cell 1. The SS notifies the UE of change of System Information on NR Cell 3 and Cell 1 by send SM on PDCCH using P-RNTI.				
8	Wait for 2.1* modification period to allow the new system information to take effect.	-	-	-	-
9	Check: Does the test result of generic test procedure in TS 38.508-1 [4] Table 4.9.4.2.2-1 indicate that the UE is camped on NR Cell 1?	-	-	2	-

6.1.2.22.3.3 Specific message contents

Table 6.1.2.22.3.3-1: Conditions for specific message contents in Tables below

Condition	Explanation
NR Cell 1	This condition applies to system information transmitted on NR Cell 1.
NR Cell 3	This condition applies to system information transmitted on NR Cell 3.

Table 6.1.2.22.3.3-2: SIB2 of NR Cell 1 and NR Cell 3 (preamble and all steps, Table 6.1.2.22.3.2-3)

Derivation Path: TS 38.508-1 [4], Table 4.6.2-1			
Information Element	Value/remark	Comment	Condition
SIB2 ::= SEQUENCE {			
cellReselectionServingFreqInfo	1 entry		
SEQUENCE {			
threshServingLowP	1	2 dB	NR Cell 3
threshServingLowQ	4	4 dB	
cellReselectionPriority	5		NR Cell 3
}			
}			

Table 6.1.2.22.3.3-3: SIB4 of NR Cell 1 and NR Cell 3 (preamble and all steps, Table 6.1.2.22.3.2-3)

Derivation Path: TS 38.508-1 [4], Table 4.6.2-3			
Information Element	Value/remark	Comment	Condition
SIB4 ::= SEQUENCE {			
interFreqCarrierFreqList SEQUENCE (SIZE (1..maxFreq)) OF InterFreqCarrierFreqInfo {	1 entry		
InterFreqCarrierFreqInfo[1] SEQUENCE {		entry 1	
dl-CarrierFreq	Same downlink ARFCN as used for NR Cell 3		NR Cell 1
	Same downlink ARFCN as used for NR Cell 1		NR Cell 3
q-RxLevMin	-50	-100 dBm	
q-QualMin	-20	-20 dB	
t-ReselectionNR	1		
threshX-HighP	10	20 dBm	NR Cell 1
threshX-Q SEQUENCE {			
threshX-HighQ	4	4 dB	NR Cell 1
threshX-LowQ	2	2 dB	NR Cell 3
}			
cellReselectionPriority	5		NR Cell 1
	4		NR Cell 3
}			
}			

Table 6.1.2.22.3.3-4: SIB1 of NR Cell 3 (step 7, Table 6.1.2.22.3.2-3)

Derivation Path: TS 38.508-1 [4], Table 4.6.1-28			
Information Element	Value/remark	Comment	Condition
SIB1 ::= SEQUENCE {			
si-SchedulingInfo	SI-SchedulingInfo		
}			

Table 6.1.2.22.3.3-5: SI-SchedulingInfo (si-SchedulingInfo in Table 6.1.2.22.3.3-4)

Derivation Path: TS 38.508-1 [4], Table 4.6.3-173			
Information Element	Value/remark	Comment	Condition
SI-SchedulingInfo ::= SEQUENCE {			
schedulingInfoList SEQUENCE (SIZE(1..maxSI-Message)) OF SchedulingInfo {	1 entry		
SchedulingInfo[1] SEQUENCE {		entry 1	
sib-MappingInfo SEQUENCE (SIZE(1..maxSIB)) OF SIB-TypeInfo {	1 entry		
SIB-TypeInfo[1] SEQUENCE {		entry 1	
type	sibType2		
valueTag	1		
}			
}			
}			
}			
}			

Table 6.1.2.22.3.3-6: SIB2 of NR Cell 3 (step 7, Table 6.1.2.22.3.2-3)

Derivation Path: TS 38.508-1 [4], Table 4.6.2-1			
Information Element	Value/remark	Comment	Condition
SIB2 ::= SEQUENCE {			
cellReselectionServingFreqInfo SEQUENCE {	1 entry		
threshServingLowQ	26	26 dB	
}			
}			

Table 6.1.2.22.3.3-7: SIB1 of NR Cell 1 (step 7, Table 6.1.2.22.3.2-3)

Derivation Path: TS 38.508-1 [4], Table 4.6.1-28			
Information Element	Value/remark	Comment	Condition
SIB1 ::= SEQUENCE {			
si-SchedulingInfo	SI-SchedulingInfo		
}			

Table 6.1.2.22.3.3-8: SI-SchedulingInfo (si-SchedulingInfo in Table 6.1.2.22.3.3-7)

Derivation Path: TS 38.508-1 [4], Table 4.6.3-173			
Information Element	Value/remark	Comment	Condition
SI-SchedulingInfo ::= SEQUENCE {			
schedulingInfoList SEQUENCE (SIZE(1..maxSI-Message)) OF SchedulingInfo {	1 entry		
SchedulingInfo[1] SEQUENCE {		entry 1	
sib-MappingInfo SEQUENCE (SIZE(1..maxSIB)) OF SIB-TypeInfo {	1 entry		
SIB-TypeInfo[1] SEQUENCE {		entry 1	
type	sibType2		
valueTag	1		
}			
}			
}			
}			
}			

type	sibType4		
valueTag	1		
}			
}			
}			
}			
}			

Table 6.1.2.22.3.3-9: SIB4 of NR Cell 1 (step 7, Table 6.1.2.22.3.2-3)

Derivation Path: TS 38.508-1 [4], Table 4.6.2-3			
Information Element	Value/remark	Comment	Condition
SIB4 ::= SEQUENCE {			
interFreqCarrierFreqList SEQUENCE	1 entry		
(SIZE (1..maxFreq)) OF			
InterFreqCarrierFreqInfo {			
InterFreqCarrierFreqInfo[1] SEQUENCE		entry 1	
{			
dl-CarrierFreq	Same downlink ARFCN as used		
	for NR Cell 3		
threshX-Q SEQUENCE {			
threshX-HighQ	20	20dB	
}			
}			
}			

6.1.2.23 Cell reselection / MFBI

6.1.2.23.1 Test Purpose (TP)

(0)

```
with { UE is switched off }
ensure that {
  when { UE is switched on a MFBI cell with the SIB1 of the first frequency band indicated in
freqBandIndicator is not supported by UE and the second frequency band indicated in
freqBandIndicator is supported by UE}
    then { the UE selects the cell}
}
```

(1)

```
with { UE in NR RRC_IDLE state }
ensure that {
  when { an equal priority NG-RAN Intra-frequency neighbouring cell which has been included in the
frequencyBandList provided by the serving cell becomes available, and, is better ranked than the
serving cell during a time interval TreselectionNR, and, more than 1 second has elapsed since the UE
camped on the current serving cell }
    then { the UE reselects the new cell}
```

(2)

```
with { UE in NR RRC_IDLE state }
ensure that {
  when { an equal priority NG-RAN Inter-frequency neighbouring cell which has been included in the
frequencyBandList provided by the serving cell becomes available, and, is better ranked than the
serving cell during a time interval TreselectionNR, and, more than 1 second has elapsed since the UE
camped on the current serving cell }
    then { the UE reselects the new cell}
```

(3)

```
with { UE in NR RRC_IDLE state }
ensure that {
  when { an equal priority NG-RAN Inter-band neighbouring cell which has been included in the
frequencyBandList provided by the serving cell becomes available, and, is better ranked than the
```

```

serving cell during a time interval  $T_{reselectionNR}$ , and, more than 1 second has elapsed since the UE
camped on the current serving cell }
  then { the UE reselects the new cell}

```

6.1.2.23.2 Conformance requirements

References: The conformance requirements covered in the present TC are specified in: TS 38.304, clause 5.2.4.2, 5.2.4.5, 5.2.4.6 and TS 38.331, clause 5.2.2.4.2. Unless otherwise stated these are Rel-15 requirements.

[TS 38.304, clause 5.2.4.2]

Following rules are used by the UE to limit needed measurements:

- If the serving cell fulfils $S_{rxlev} > S_{intraSearchP}$ and $S_{qual} > S_{intraSearchQ}$, the UE may choose not to perform intra-frequency measurements.
- Otherwise, the UE shall perform intra-frequency measurements.
- The UE shall apply the following rules for NR inter-frequencies and inter-RAT frequencies which are indicated in system information and for which the UE has priority provided as defined in 5.2.4.1:
 - For a NR inter-frequency or inter-RAT frequency with a reselection priority higher than the reselection priority of the current NR frequency, the UE shall perform measurements of higher priority NR inter-frequency or inter-RAT frequencies according to TS 38.133 [8].
 - For a NR inter-frequency with an equal or lower reselection priority than the reselection priority of the current NR frequency and for inter-RAT frequency with lower reselection priority than the reselection priority of the current NR frequency:
 - If the serving cell fulfils $S_{rxlev} > S_{nonIntraSearchP}$ and $S_{qual} > S_{nonIntraSearchQ}$, the UE may choose not to perform measurements of NR inter-frequencies or inter-RAT frequency cells of equal or lower priority;
 - Otherwise, the UE shall perform measurements of NR inter-frequencies or inter-RAT frequency cells of equal or lower priority according to TS 38.133 [8].

[TS 38.304, clause 5.2.4.5]

If *threshServingLowQ* is broadcast in system information and more than 1 second has elapsed since the UE camped on the current serving cell, cell reselection to a cell on a higher priority NR frequency or inter-RAT frequency than the serving frequency shall be performed if:

- A cell of a higher priority NR or EUTRAN RAT/frequency fulfils $S_{qual} > Thresh_{X, HighQ}$ during a time interval $T_{reselectionRAT}$

Otherwise, cell reselection to a cell on a higher priority NR frequency or inter-RAT frequency than the serving frequency shall be performed if:

- A cell of a higher priority RAT/ frequency fulfils $S_{rxlev} > Thresh_{X, HighP}$ during a time interval $T_{reselectionRAT}$; and
- More than 1 second has elapsed since the UE camped on the current serving cell.

Cell reselection to a cell on an equal priority NR frequency shall be based on ranking for intra-frequency cell reselection as defined in clause 5.2.4.6.

If *threshServingLowQ* is broadcast in system information and more than 1 second has elapsed since the UE camped on the current serving cell, cell reselection to a cell on a lower priority NR frequency or inter-RAT frequency than the serving frequency shall be performed if:

- The serving cell fulfils $S_{qual} < Thresh_{Serving, LowQ}$ and a cell of a lower priority NR or E-UTRAN RAT/ frequency fulfils $S_{qual} > Thresh_{X, LowQ}$ during a time interval $T_{reselectionRAT}$.

Otherwise, cell reselection to a cell on a lower priority NR frequency or inter-RAT frequency than the serving frequency shall be performed if:

- The serving cell fulfils $S_{rxlev} < Thresh_{Serving, LowP}$ and a cell of a lower priority RAT/ frequency fulfils $S_{rxlev} > Thresh_{X, LowP}$ during a time interval $T_{reselectionRAT}$; and

- More than 1 second has elapsed since the UE camped on the current serving cell.

Cell reselection to a higher priority RAT/frequency shall take precedence over a lower priority RAT/frequency if multiple cells of different priorities fulfil the cell reselection criteria.

If more than one cell meets the above criteria, the UE shall reselect a cell as follows:

- If the highest-priority frequency is an NR frequency, the highest ranked cell among the cells on the highest priority frequency(ies) meeting the criteria according to clause 5.2.4.6;
- If the highest-priority frequency is from another RAT, the strongest cell among the cells on the highest priority frequency(ies) meeting the criteria of that RAT.

[TS 38.304, clause 5.2.4.6]

The cell-ranking criterion R_s for serving cell and R_n for neighbouring cells is defined by:

$$R_s = Q_{\text{meas},s} + Q_{\text{hyst}} - Q_{\text{offset}_{\text{temp}}}$$

$$R_n = Q_{\text{meas},n} - Q_{\text{offset}} - Q_{\text{offset}_{\text{temp}}}$$

where:

Q_{meas}	RSRP measurement quantity used in cell reselections.
Q_{offset}	For intra-frequency: Equals to $Q_{\text{offset}_{s,n}}$, if $Q_{\text{offset}_{s,n}}$ is valid, otherwise this equals to zero. For inter-frequency: Equals to $Q_{\text{offset}_{s,n}}$ plus $Q_{\text{offset}_{\text{frequency}}}$, if $Q_{\text{offset}_{s,n}}$ is valid, otherwise this equals to $Q_{\text{offset}_{\text{frequency}}}$.
$Q_{\text{offset}_{\text{temp}}}$	Offset temporarily applied to a cell as specified in TS 38.331 [3].

The UE shall perform ranking of all cells that fulfil the cell selection criterion S , which is defined in 5.2.3.2.

The cells shall be ranked according to the R criteria specified above by deriving $Q_{\text{meas},n}$ and $Q_{\text{meas},s}$ and calculating the R values using averaged RSRP results.

If *rangeToBestCell* is not configured, the UE shall perform cell reselection to the highest ranked cell. If this cell is found to be not-suitable, the UE shall behave according to clause 5.2.4.4.

If *rangeToBestCell* is configured, then the UE shall perform cell reselection to the cell with the highest number of beams above the threshold (i.e. *absThreshSS-BlocksConsolidation*) among the cells whose R value is within *rangeToBestCell* of the R value of the highest ranked cell. If there are multiple such cells, the UE shall perform cell reselection to the highest ranked cell among them. If this cell is found to be not-suitable, the UE shall behave according to clause 5.2.4.4.

In all cases, the UE shall reselect the new cell, only if the following conditions are met:

- the new cell is better than the serving cell according to the cell reselection criteria specified above during a time interval $T_{\text{reselection}_{\text{RAT}}}$;
- more than 1 second has elapsed since the UE camped on the current serving cell.

NOTE: If *rangeToBestCell* is configured but *absThreshSS-BlocksConsolidation* is not configured on an NR frequency, the UE considers that there is one beam above the threshold for each cell on that frequency.

[TS 38.331, clause 5.2.2.4.2]

Upon receiving the *SIB1* the UE shall:

- 1> store the acquired *SIB1*;
- ...
- 1> if in `RRC_CONNECTED` while `T311` is not running:
 - 2> disregard the *frequencyBandList*, if received, while in `RRC_CONNECTED`;

- 2> forward the *cellIdentity* to upper layers;
- 2> forward the *trackingAreaCode* to upper layers;
- 2> apply the configuration included in the *-servingCellConfigCommon*;

1> else:

- 2> if the UE supports one or more of the frequency bands indicated in the *frequencyBandList* for downlink, and one or more of the frequency bands indicated in the *frequencyBandList* for uplink for FDD, and they are not downlink only bands, and
- 2> if the UE supports at least one *additionalSpectrumEmission* in the *NR-NS-PmaxList* for a supported band in the downlink and a supported band in uplink for FDD, and
- 2> if the UE supports the bandwidth of the initial uplink BWP and of the initial downlink BWPs indicated in the *locationAndBandwidth* fields in *uplinkConfigCommon*:
 - 3> select the first frequency band in the *frequencyBandList* which the UE supports and for which the UE supports at least one of the *additionalSpectrumEmission* values in *nr-NS-PmaxList*, if present;
 - 3> forward the *cellIdentity* to upper layers;
 - 3> forward the *trackingAreaCode* to upper layers;
 - 3> forward the PLMN identity to upper layers;
 - ...
- 2> else:
 - 3> consider the cell as barred in accordance with TS 38.304 [20]; and
 - 3> perform barring as if *intraFreqReselection* is set to *notAllowed*;

6.1.2.23.3 Test description

6.1.2.23.3.1 Pre-test conditions

System Simulator:

- NR Cell 1, NR Cell 2, NR Cell 3 and NR Cell 10 are configured according to TS 38.508-1 [4] Table 4.4.2-3. NR Cell 1, NR Cell 2 and NR Cell 3 are MFBI capable cells.
- Cell 1 belongs to the frequency which overlaps between bands controlled by IXITs *px_NR_OverlappingNotSupportedBand_MFBI* and *px_NR_PrimaryBand*.
- Cell 10 is defined by IXIT *px_NR_SecondaryBand*.
- Cell 2 belongs to the frequency which overlaps between bands controlled by IXITs *px_NR_OverlappingNotSupportedBand_MFBI* and *px_NR_PrimaryBand*.
- Cell 3 belongs to the frequency which overlaps between bands controlled by IXITs *px_NR_OverlappingNotSupportedBand_MFBI* and *px_NR_PrimaryBand*.
- System information combination NR-4 as defined in TS 38.508 [4] clause 4.4.3.1.2 is used in NR cells.

UE:

- UE does not support the *px_NR_OverlappingNotSupportedBand_MFBI* band.

Preamble:

- UE is in state Switched OFF (state 0N-B) according to 38.508-1 [4].

6.1.2.23.3.2 Test procedure sequence

Table 6.1.2.23.3.2-1/2 illustrate the downlink power levels and other changing parameters to be applied for the cells at various time instants of the test execution. The exact instants on which these values shall be applied are described in the texts in this clause. The configuration marked "T1", "T2", "T3", "T4" and "T5" are applied at the points indicated in the Main behaviour description in Table 6.1.2.23.3.2-3.

Table 6.1.2.23.3.2-1: Time instances of cell power level and parameter changes for conducted test environment

	Parameter	Unit	NR Cell 1	NR Cell 2	NR Cell 3	NR Cell 10	Remark
T1	SS/PBCH SSS EPRE	dBm/ SCS	-88	"Off"	"Off"	"Off"	The power level values are assigned to ensure the UE registered on NR Cell 1.
T2	SS/PBCH SSS EPRE	dBm/ SCS	-94	-88	"Off"	"Off"	The power level values are set so that $R_{Cell\ 1} < R_{Cell\ 2}$.
T3	SS/PBCH SSS EPRE	dBm/ SCS	"Off"	-94	-80	"Off"	The power level values are set so that $R_{Cell\ 1} < R_{Cell\ 3}$.
T4	SS/PBCH SSS EPRE	dBm/ SCS	"Off"	"Off"	-94	-80	The power level values are assigned to ensure the UE registered on NR Cell 10.
T5	SS/PBCH SSS EPRE	dBm/ SCS	-80	"Off"	"Off"	-94	The power level values are set so that $R_{Cell\ 10} < R_{Cell\ 1}$.

Note: Power level "Off" is defined in TS38.508-1 [4] Table 6.2.2.1-3.

Table 6.1.2.23.3.2-2: Time instances of cell power level and parameter changes for OTA test environment

	Parameter	Unit	NR Cell 1	NR Cell 2	NR Cell 3	NR Cell 10	Remark
T1	SS/PBCH SSS EPRE	dBm/ SCS	-91	"Off"	"Off"	"Off"	The power level values are assigned to ensure the UE registered on NR Cell 1.
T2	SS/PBCH SSS EPRE	dBm/ SCS	-91	-82	"Off"	"Off"	The power level values are set so that $R_{Cell\ 1} < R_{Cell\ 2}$.
T3	SS/PBCH SSS EPRE	dBm/ SCS	"Off"	-91	-82	"Off"	The power level values are set so that $R_{Cell\ 1} < R_{Cell\ 3}$.
T4	SS/PBCH SSS EPRE	dBm/ SCS	"Off"	"Off"	-91	-82	The power level values are assigned to ensure the UE registered on NR Cell 10.
T5	SS/PBCH SSS EPRE	dBm/ SCS	-82	"Off"	"Off"	-91	The power level values are set so that $R_{Cell\ 10} < R_{Cell\ 1}$.

Note: Power level "Off" is defined in TS38.508-1 [4] Table 6.2.2.2-2.

Table 6.1.2.23.3.2-3: Main behaviour

St	Procedure	Message Sequence		TP	Verdict
		U - S	Message		
1	The SS changes the SS/PBCH EPRE level according to row "T1" in table 6.1.2.23.3.2-1/2.	-	-	-	-
2	The UE is switched on.	-	-	-	-
3-22a 1	Steps 1 to 20a1 of the registration procedure described in TS 38.508-1 [4] Table 4.5.2.2-2 are performed on NR Cell 1.	-	-	0	P
23	Wait 1 second. (to ensure than 1 second has elapsed since the UE camped on the current serving cell)	-	-	-	-
24	The SS changes the SS/PBCH EPRE level according to row "T2" in table 6.1.2.23.3.2-1/2.	-	-	-	-
24 A	Wait for 34s for FR1 or 130s for FR2 for the UE to perform cell reselection procedure.				

	(Note 1)				
25	Check: Does the test result of generic test procedure in TS 38.508-1 [4] clause 4.9.4 indicate that the UE is camped on NR Cell 2?	-	-	1	P
26	Void				
27	Void				
28	Void				
29-48a	Void				
1					
49	The SS changes the SS/PBCH EPRE level according to row "T3" in table 6.1.2.23.3.2-1/2.	-	-	-	-
50	Wait for 34s for FR1 or 130s for FR2 for the UE to perform cell reselection procedure. (Note 2)	-	-	-	-
51	Check: Does the test result of generic test procedure in TS 38.508-1 [4] clause 4.9.4 indicate that the UE is camped on NR Cell 3?	-	-	2	P
52	Void				
53	The SS changes the SS/PBCH EPRE level according to row "T4" in table 6.1.2.23.3.2-1/2.	-	-	-	-
54	Void				
55-74a	Void				
1					
75	Wait for 34s for FR1 or 130s for FR2 for the UE to perform cell reselection procedure. (Note 2)	-	-	-	-
75 A	The test result of generic test procedure in TS 38.508-1 [4] clause 4.9.4 indicates that the UE is camped on NR Cell 10.				
76	The SS changes the SS/PBCH EPRE level according to row "T5" in table 6.1.2.23.3.2-1/2.	-	-	-	-
76 A	Wait for 34s for FR1 or 130s for FR2 for the UE to perform cell reselection procedure. (Note 2)				
77	Check: Does the test result of generic test procedure in TS 38.508-1 [4] clause 4.9.4 indicate that the UE is camped on NR Cell 1 belonging to the MFBI band (px_NR_PrimaryBand)?	-	-	3	P
<p>Note 1: The wait time for reselection to a newly detected intra frequency cell is selected to cover $T_{\text{detect,NR_Intra}}$ ($25 \cdot 1280\text{ms} = 32\text{s}$ for FR1 and $25 \cdot 4 \cdot 1280\text{ms} = 128\text{s}$ for FR2) + $T_{\text{SI-NR}}$ (1.28s for FR1 and FR2) = 33.28s rounded up to 34s for FR1 and 129.28s rounded up to 130s for FR2.</p> <p>Note 2: The wait time for reselection to a newly detected inter frequency cell is selected to cover $T_{\text{detect,NR_Inter}}$ ($25 \cdot 1280\text{ms} = 32\text{s}$ for FR1 and $25 \cdot 4 \cdot 1280\text{ms} = 128\text{s}$ for FR2) + $T_{\text{SI-NR}}$ (1.28s for FR1 and FR2) = 33.28s rounded up to 34s for FR1 and 129.28s rounded up to 130s for FR2.</p>					

6.1.2.23.3.3 Specific message contents

Table 6.1.2.23.3.3-1: Conditions for specific message contents in Table 6.1.2.23.3.3-4

Condition	Explanation
Cell 3	This condition applies to system information transmitted on Cell 3.
Cell 10	This condition applies to system information transmitted on Cell 10.

Table 6.1.2.23.3.3-2: SIB1 for NR Cell 1, NR Cell 2 and NR Cell 3 (preamble and all steps, Table 6.1.2.23.3.2-3)

Derivation Path: TS 38.508-1 [4], Table 4.6.1-28			
Information Element	Value/remark	Comment	Condition
SIB1 ::= SEQUENCE {			
servingCellConfigCommon SEQUENCE{			
downlinkConfigCommon SEQUENCE{			

frequencyInfoDL SEQUENCE {			
frequencyBandlist SEQUENCE (SIZE (1.. maxNrofMultiBands)) OF NR-MultiBandInfo {	2 entries		
NR-MultiBandInfo[1] SEQUENCE {		entry 1	
freqBandIndicatorNR	An overlapping not supported frequency band MFBI under test (px_NR_OverlappingNotSupportedBand_MFBI).		
}			
NR-MultiBandInfo[2] SEQUENCE {		entry 2	
freqBandIndicatorNR	An overlapping Band under test (px_NR_PrimaryBand).		
}			
}			
uplinkConfigCommon SEQUENCE {			
frequencyInfoUL SEQUENCE {			
frequencyBandlist SEQUENCE (SIZE (1.. maxNrofMultiBands)) OF NR-MultiBandInfo {	2 entries		FDD
NR-MultiBandInfo[1] SEQUENCE {		entry 1	
freqBandIndicatorNR	An overlapping not supported frequency band MFBI under test (px_NR_OverlappingNotSupportedBand_MFBI).		
}			
NR-MultiBandInfo[2] SEQUENCE {		entry 2	
freqBandIndicatorNR	An overlapping Band under test (px_NR_PrimaryBand).		
}			
}			
}			
uplinkConfigCommon SEQUENCE {			
frequencyInfoUL SEQUENCE {			
frequencyBandlist SEQUENCE (SIZE (1.. maxNrofMultiBands)) OF NR-MultiBandInfo {	2 entries		FDD
NR-MultiBandInfo[1] SEQUENCE {		entry 1	
freqBandIndicatorNR	An overlapping not supported frequency band MFBI under test (px_NR_OverlappingNotSupportedBand_MFBI).		
}			
}			
}			

Table 6.1.2.23.3.3-3: SIB4 for NR Cell 1 and NR Cell 2 (preamble and all steps, Table 6.1.2.23.3.2-3)

Derivation Path: TS 38.508-1 [4], Table 4.6.2-3			
Information Element	Value/remark	Comment	Condition
SIB4::= SEQUENCE {			
InterFreqCarrierFreqList SEQUENCE (SIZE (1..maxFreq)) OF InterFreqCarrierFreqInfo {	2 entries		
InterFreqCarrierFreqInfo[1] SEQUENCE		entry 1	

{			
dl-CarrierFreq	Same downlink ARFCN as used for NR Cell 10		
}			
InterFreqCarrierFreqInfo[2] SEQUENCE		entry 2	
{			
dl-CarrierFreq	Same downlink ARFCN as used for NR Cell 3		
frequencyBandlist SEQUENCE (SIZE (1..maxNrofMultiBands)) OF MultiBandInfo {	1 entry		
NR-MultiBandInfo[1] SEQUENCE {		entry 1	
freqBandIndicatorNR	An overlapping Band under test (px_NR_PrimaryBand).		
}			
}			
}			
}			
}			

Table 6.1.2.23.3.3-4: SIB4 for NR Cell 3 and NR Cell 10 (preamble and all steps, Table 6.1.2.23.3.2-3)

Derivation Path: TS 38.508-1 [4], Table 4.6.2-3			
Information Element	Value/remark	Comment	Condition
SIB4::= SEQUENCE {			
InterFreqCarrierFreqList SEQUENCE (SIZE (1..maxFreq)) OF InterFreqCarrierFreqInfo {	1 entry		
InterFreqCarrierFreqInfo[1] SEQUENCE {		entry 1	
dl-CarrierFreq	Same downlink ARFCN as used for NR Cell 1		NR Cell 10
	Same downlink ARFCN as used for NR Cell 10		NR Cell 3
frequencyBandList SEQUENCE (SIZE (1..maxNrofMultiBands)) OF MultiBandInfo {	1 entry		
NR-MultiBandInfo[1] SEQUENCE {		entry 1	
freqBandIndicatorNR	An overlapping Band under test (px_NR_PrimaryBand)		NR Cell 10
	Band for interBand NR Cell 10 (px_NR_SecondaryBand).		NR Cell 3
}			
}			
}			
}			
}			

6.1.2.24

6.1.2.25

6.1.2.26 Cell Selection / RedCap

6.1.2.26.1 Test Purpose (TP)

(1)

with { UE supporting RedCap and in NR RRC_IDLE state }
 ensure that {

```

when { a cell fulfils the requirements for a suitable cell except cell Barred status "true" for
RedCap }
  then { the UE considers the cell as barred and no camping on this cell can take place }

```

(2)

```

with { UE supporting RedCap and in NR RRC_IDLE state }
ensure that {
  when { a cell fulfils the requirements for a suitable cell except intraFreqReselectionRedCap in
SIB1 is absent }
    then { the UE considers the cell as barred and no camping on this cell can take place }
}

```

(3)

```

with { UE supporting RedCap and in NR RRC_IDLE state }
ensure that {
  when { a cell fulfils the requirements for a suitable cell except cell Barred status not "true"
for RedCap }
    then { the UE considers the cell suitable and camps on it }
}

```

6.1.2.26.2 Conformance requirements

References: The conformance requirements covered in the present test case are specified in: TS 38.304, clause 5.3.1 and TS 38.331 clause 5.2.2.4.2. Unless otherwise stated these are Rel-17 requirements.

[TS 38.331, clause 5.2.2.4.2]

Upon receiving the *SIB1* the UE shall:

- 1> store the acquired *SIB1*;
- 1> if the UE is a RedCap UE and it is in *RRC_IDLE* or in *RRC_INACTIVE*, or if the RedCap UE is in *RRC_CONNECTED* while *T311* is running:
 - 2> if *intraFreqReselectionRedCap* is not present in *SIB1*:
 - 3> consider the cell as barred in accordance with TS 38.304 [20];
 - 3> perform barring as if *intraFreqReselectionRedCap* is set to allowed;
 - 2> else:
 - 3> if the *cellBarredRedCap1Rx* is present in the acquired *SIB1* and is set to *barred* and the UE is equipped with 1 Rx branch; or
 - 3> if the *cellBarredRedCap2Rx* is present in the acquired *SIB1* and is set to *barred* and the UE is equipped with 2 Rx branches; or
 - 3> if the *halfDuplexRedCapAllowed* is not present in the acquired *SIB1* and the UE supports only half-duplex FDD operation:
 - 4> consider the cell as barred in accordance with TS 38.304 [20];
 - 4> perform barring based on *intraFreqReselectionRedCap* as specified in TS 38.304 [20];

[TS 38.304, clause 5.3.1]

When cell status "barred" is indicated for RedCap UEs with 1Rx/2Rx or to be treated as if the cell status is "barred",

- The UE is not permitted to select/reselect this cell, not even for emergency calls.
- The UE shall select another cell according to the following rule:
- If the cell is to be treated as if the cell status is "barred" due to being unable to acquire the *SIB1*:
 - the UE may exclude the barred cell as a candidate for cell selection/reselection for up to 300 seconds.

- the UE may select another cell on the same frequency if the selection criteria are fulfilled.
- else:
 - If the field *intraFreqReselectionRedCap* in *SIB1* message is set to "allowed"; or
 - If the cell is to be treated as if the cell status is "barred" due to not supporting RedCap UEs:
 - the UE shall exclude the barred cell as a candidate for cell selection/reselection for 300 seconds.
 - the UE may select another cell on the same frequency if re-selection criteria are fulfilled.
 - If the field *intraFreqReselectionRedCap* in *SIB1* message is set to "not allowed":
 - If the cell operates in licensed spectrum, or if this cell belongs to a PLMN which is indicated as being equivalent to the registered PLMN or the selected PLMN of the UE, or if this cell belongs to the registered SNPN or the selected SNPN of the UE:
 - the UE shall not re-select to another cell on the same frequency as the barred cell and exclude such cell(s) as candidate(s) for cell selection/reselection for 300 seconds.
 - else:
 - the UE may select to another cell on the same frequency if the reselection criteria are fulfilled.
 - the UE shall exclude the barred cell as a candidate for cell selection/reselection for 300 seconds.

[TS 38.306, clause 4.2.21.1]

RedCap UE is the UE with reduced capability:

...

- For FR 1, 1 DL MIMO layer if 1 Rx branch is supported, and 2 DL MIMO layers if 2 Rx branches are supported; for FR2, either 1 or 2 DL MIMO layers can be supported, while 2 Rx branches are always supported. For FR1 and FR2, UE features and corresponding capabilities related to more than 2 UE Rx branches or more than 2 DL MIMO layers, as well as UE features and capabilities related to more than 2 UE Tx branches or more than 2 UL MIMO layers are not supported by RedCap UEs;

6.1.2.26.3 Test description

6.1.2.26.3.1 Pre-test conditions

System Simulator:

- NR Cell 1 and NR Cell 11 have different tracking areas according to TS 38.508-1 [4] Table 4.4.2-3.
- System information combination NR-2 as defined in TS 38.508-1 [4] clause 4.4.3.1.2 is used in NR cells.

UE:

- None

Preamble:

- The UE is in 1N-A state on NR Cell 1 using generic procedure parameter Connectivity (*NR*) and Test loop function(*Off*) according to TS 38.508-1 [4] and SS acquires the *maxNumberMIMO-LayersPDSCH* reported in *UEcapabilityInformation*. (Note: *maxNumberMIMO-LayersPDSCH* is not per-UE capability and UE may report different value in different BAND, so it is recommended to read the *maxNumberMIMO-LayersPDSCH* directly through the *UEcapabilityInformation* not the *pc_maxNumberMIMO_LayersPDSCH*).

6.1.2.26.3.2 Test procedure sequence

Table 6.1.2.26.3.2-1 for FR1 and table 6.1.2.26.3.2-2 for FR2 illustrate the downlink power levels to be applied for the cells at various time instants of the test execution. Row marked "T0" denotes the initial conditions after preamble, while columns marked "T1" is to be applied subsequently in the Main behaviour. The exact instants on which these values shall be applied are described in the texts in this clause.

Table 6.1.2.26.3.2-1: Cell configuration changes over time for FR1

	Parameter	Unit	NR Cell 1	NR Cell 11	Remark
T0	SS/PBCH SSS EPRE	dBm/SCS	-88	"Off"	
T1	SS/PBCH SSS EPRE	dBm/SCS	"Off"	-88	
NOTE 1: Power level "Off" is defined in TS 38.508-1 [4] Table 6.2.2.1-3.					

Table 6.1.2.26.3.2-2: Cell configuration changes over time for FR2

	Parameter	Unit	NR Cell 1	NR Cell 11	Remark
T0	SS/PBCH SSS EPRE	dBm/SCS	-82	"Off"	
T1	SS/PBCH SSS EPRE	dBm/SCS	"Off"	-82	
NOTE 1: Power level "Off" is defined in TS 38.508-1 [4] Table 6.2.2.2-2.					

Table 6.1.2.26.3.2-3: Main behaviour

St	Procedure	Message Sequence		TP	Verdict
		U - S	Message		
1	The SS changes the SIB1 of NR Cell 11 to set cell Barred status to "true".	-	-	-	-
2	Wait for 2.1* modification period to allow the new system information to take effect.(Note 1)	-	-	-	-
3	SS re-adjusts the SS/PBCH EPRE level of NR Cell 1 and NR Cell 11 according to row "T1" in table 6.1.2.26.3.2-1/2.	-	-	-	-
4	Check: Does the UE send an <i>RRCSetupRequest</i> on NR Cell 11 within the next 60 s?	-->	NR RRC: <i>RRCSetupRequest</i>	1	F
5	The SS changes the SIB1 of NR Cell 11 to delete the configuration of cellBarredRedCap-r17	-	-	-	-
6	Check: Does the UE send an <i>RRCSetupRequest</i> on NR Cell 11 after 300s from Step4?	-	-	3	P
7	Steps2-6a1 of generic test procedure in TS 38.508-1 [4] clause 4.9.5 on NR Cell 11. NOTE: The UE performs a registration for mobility procedure and the RRC connection is released.	-	-	-	-
8	The SS changes the SIB1 of NR Cell 1 to set intraFreqReselectionRedCap to not present.	-	-	-	-
9	Wait for 2.1* modification period to allow the new system information to take effect.(Note 1)	-	-	-	-
10	SS re-adjusts the SS/PBCH EPRE level of NR Cell 1 and NR Cell 11 according to row "T0" in table 6.1.2.26.3.2-1/2.				
11	Check: Does the UE send an <i>RRCSetupRequest</i> on NR Cell 1 within the next 60 s?	-->	NR RRC: <i>RRCSetupRequest</i>	2	F
Note 1: The modification period, expressed in number of radio frames = modificationPeriodCoeff * defaultPagingCycle.					

6.1.2.26.3.3 Specific message contents

Table 6.1.2.26.3.3.3-1: SIB1 for NR Cell 11 (step 1, Table 6.1.2.26.3.2-3)

Derivation Path: TS 38.508-1 [4], Table 4.6.1-28			
Information Element	Value/remark	Comment	Condition
SIB1 ::= SEQUENCE {			
nonCriticalExtension SEQUENCE {			
nonCriticalExtension SEQUENCE {			
nonCriticalExtension SEQUENCE {			
RedCap-ConfigCommonSIB-r17 SEQUENCE {			
cellBarredRedCap-r17 SEQUENCE {			
cellBarredRedCap1Rx-r17	Not Barred		FR2
	barred		FR1
cellBarredRedCap2Rx-r17	Not Barred		
	barred		FR2 or 2DL_MIMO_layers
}			
}			
}			
}			
}			

Condition	Explanation
2DL_MIMO_layers	The maxNumberMIMO-LayersPDSCH, SS acquired from UEcapabilityInformation, equals to two layer.

Table 6.1.2.26.3.3.3-2: SIB1 for NR Cell 11 (step 5, Table 6.1.2.26.3.2-3)

Derivation Path: TS 38.508-1 [4], Table 4.6.1-28			
Information Element	Value/remark	Comment	Condition
SIB1 ::= SEQUENCE {			
nonCriticalExtension SEQUENCE {			
nonCriticalExtension SEQUENCE {			
nonCriticalExtension SEQUENCE {			
RedCap-ConfigCommonSIB-r17 SEQUENCE {			
cellBarredRedCap-r17	Not Present		
}			
}			
}			
}			
}			

Table 6.1.2.26.3.3.3-3: SIB1 for NR Cell 1 (step 8, Table 6.1.2.26.3.2-3)

Derivation Path: TS 38.508-1 [4], Table 4.6.1-28			
Information Element	Value/remark	Comment	Condition
SIB1 ::= SEQUENCE {			
nonCriticalExtension SEQUENCE {			
nonCriticalExtension SEQUENCE {			
nonCriticalExtension SEQUENCE {			
intraFreqReselectionRedCap-r17	Not present		
}			
}			
}			
}			

6.2 Multi-mode environment

6.2.1 Inter-RAT PLMN selection

6.2.1.1 Inter-RAT PLMN Selection / Selection of correct RAT for OPLMN / Automatic mode

6.2.1.1.1 Test Purpose (TP)

(1)

```
with { UE pre-set in Automatic network selection mode }
ensure that {
  when { UE is switched on and there are suitable NR and E-UTRAN cells some on the OPLMN list and
some not on the OPLMN list, none of them being part of the RPLMN }
  then { UE selects the highest priority OPLMN and RAT combination, attaches on the selected
cell.}
}
```

(2)

```
with { UE in Automatic network selection mode }
ensure that {
  when { UE returns to coverage and there are suitable NR and E-UTRAN cells some on the OPLMN list
and some not on the OPLMN list , none of them being part of the RPLMN }
  then { UE selects the highest priority OPLMN and RAT combination, attaches on the selected cell.
}
}
```

6.2.1.1.2 Conformance requirements

References: The conformance requirements covered in the present TC are specified in: TS 23.122 clauses 4.4.3.1 and 4.4.3.1.1. Unless otherwise stated these are Rel-15 requirements.

[TS 23.122, clause 4.4.3.1]

If successful registration is achieved, the MS indicates the selected PLMN.

...

NOTE 3: If successful registration is achieved, then the current serving PLMN becomes the registered PLMN and the MS does not store the previous registered PLMN for later use.

[TS 23.122, clause 4.4.3.1.1]

The MS selects and attempts registration on other PLMN/access technology combinations, if available and allowable, in the following order:

- i) either the HPLMN (if the EHPLMN list is not present or is empty) or the highest priority EHPLMN that is available (if the EHPLMN list is present) ;
- ii) each PLMN/access technology combination in the "User Controlled PLMN Selector with Access Technology" data file in the SIM (in priority order);
- iii) each PLMN/access technology combination in the "Operator Controlled PLMN Selector with Access Technology" data file in the SIM (in priority order);
- iv) other PLMN/access technology combinations with received high quality signal in random order;
- v) other PLMN/access technology combinations in order of decreasing signal quality.

6.2.1.1.3 Test description

6.2.1.1.3.1 Pre-test conditions

System Simulator

- 3 NR cells as specified in TS 38.508-1 [4] table 4.4.2-3. System information combination NR-1 as defined in Ts 38.508-1 [4] sub-clause 4.4.3.1.2 is applied to all the NR cells.
- 1 cell belongs to E-UTRA. System information combination 1 as defined in TS 36.508 [7] clause 4.4.3.1 is used.
- PLMN settings are defined in TS 36.523-1 [13] table 6.0.1-1.

Table 6.2.1.1.3.1-1: Cell PLMN identities

Cell	PLMN name
NR Cell 1	PLMN2
NR Cell 12	PLMN13
NR Cell 13	PLMN14
E-UTRA Cell 1	PLMN13

UE

- The UE is in Automatic PLMN selection mode.
- The HPLMN is PLMN1.
- USIM configuration 12 as specified in tables 6.4.1-12 in TS 38.508-1 [4] will be used.

Preamble

- The UE is in state Switched OFF (state 0-A) according to TS 38.508-1 [4].

6.2.1.1.3.2 Test procedure sequence

Table 6.2.1.1.3.2-1 and table 6.2.1.1.3.2-2 illustrate the downlink power levels to be applied for the cells at various time instants of the test execution. Row marked "T0" denotes the initial conditions after preamble, while columns marked "T1" is to be applied subsequently in the Main behaviour. The exact instants on which these values shall be applied are described in the texts in this clause.

Table 6.2.1.1.3.2-1: Cell configuration changes over time for conducted test environment

	Parameter	Unit	NR Cell 1	NR Cell 12	NR Cell 13	E-UTRA Cell 1	Remarks
T0	SS/PBCH SSS EPRE	dBm/SCS	-88	"Off"	-88		Power level "Off" is defined in TS 38.508-1 [4] Table 6.2.2.1-3
	RS EPRE	dBm/15kHz				-85	
T1	SS/PBCH SSS EPRE	dBm/SCS	"Off"	-88	-88		Power level "Off" is defined in TS 38.508-1 [4] Table 6.2.2.1-3
	RS EPRE	dBm/15kHz				-85	

Table 6.2.1.1.3.2-2: Cell configuration changes over time for OTA test environment

	Parameter	Unit	NR Cell 1	NR Cell 12	NR Cell 13	E-UTRA Cell 1	Remarks
T0	SS/PBCH SSS EPRE	dBm/SCS	-82	"Off"	-82		Power level "Off" is defined in TS 38.508-1 [4] Table 6.2.2.1-3
	RS EPRE	dBm/15kHz	-	-	-	-85	
	Qrxlevmin	dBm	-91+ Delta(NRf1)	-	-91+ Delta(NRf3)	-	
T1	SS/PBCH SSS EPRE	dBm/SCS	"Off"	-82	-82		Power level "Off" is defined in TS 38.508-1 [4] Table 6.2.2.1-3
	RS EPRE	dBm/15kHz	-	-	-	-85	
	Qrxlevmin	dBm	-	-91+ Delta(NRf2)	-91+ Delta(NRf1)	-	

Table 6.2.1.1.3.2-3: Main behaviour

St	Procedure	Message Sequence		TP	Verdict
		U – S	Message		
1	The UE is switched on.	-	-	-	-
2	Check: Does the UE send <i>RRCSetupRequest</i> on NR Cell 1?	-->	NR RRC: <i>RRCSetupRequest</i>	1	P
3-20a1	Steps 3-20a1 of the registration procedure described in TS 38.508-1 [4] table 4.5.2.2-2 are performed on NR Cell 1.	-	-	-	-
21	The SS adjusts cell levels according to row T1 of table 6.2.1.1.3.2-1.	-	-	-	-
22-28a1	Check: Does the test result of generic test procedure in TS 38.508-1 [4] table 4.9.7.2.2-1 is performed and the UE is camped on E-UTRAN Cell 1?	-	-	2	P

6.2.1.1.3.3 Specific message contents

None.

6.2.1.2 Inter-RAT PLMN Selection / Selection of correct RAT for UPLMN / Automatic mode

6.2.1.2.1 Test Purpose (TP)

(1)

```
with { UE in Automatic network selection mode and UPLMN and OPLMN cells available on NR and E-UTRAN }
ensure that {
  when { UE is switched on }
  then { UE selects the highest priority UPLMN and RAT combination and UE attempts to register on
the selected cell }
}
```

(2)

```
with { UE in Automatic network selection mode and UPLMN and OPLMN cells available on NR and E-UTRAN }
ensure that {
  when { UE returns to coverage }
```

```

    then { UE selects the highest priority VPLMN and RAT combination and UE attempts to attach on
the selected cell }
    }

```

6.2.1.2.2 Conformance requirements

References: The conformance requirements covered in the present TC are specified in: TS 23.122 clauses 4.4.3.1 and 4.4.3.1.1. Unless otherwise stated these are Rel-15 requirements.

[TS 23.122, clause 4.4.3.1]

If successful registration is achieved, the MS indicates the selected PLMN.

...

NOTE 3: If successful registration is achieved, then the current serving PLMN becomes the registered PLMN and the MS does not store the previous registered PLMN for later use.

[TS 23.122, clause 4.4.3.1.1]

The MS selects and attempts registration on other PLMN/access technology combinations, if available and allowable, in the following order:

- i) either the HPLMN (if the EHPLMN list is not present or is empty) or the highest priority EHPLMN that is available (if the EHPLMN list is present) ;
- ii) each PLMN/access technology combination in the "User Controlled PLMN Selector with Access Technology" data file in the SIM (in priority order);
- iii) each PLMN/access technology combination in the "Operator Controlled PLMN Selector with Access Technology" data file in the SIM (in priority order);
- iv) other PLMN/access technology combinations with received high quality signal in random order;
- v) other PLMN/access technology combinations in order of decreasing signal quality.

6.2.1.2.3 Test description

6.2.1.2.3.1 Pre-test conditions

System Simulator

- NR Cell 1 and NR Cell 12 as specified in TS 38.508-1 [4] table 4.4.2-3 are configured as shown in Table 6.2.1.2.3.2-1. System information combination NR-1 as defined in Ts 38.508-1 [4] sub-clause 4.4.3.1.2 is applied to all the NR cells.
- E-UTRA Cell 1 belongs to E-UTRA (defined in TS 36.508 [7]). System information combination 1 as defined in TS 36.508 [7] clause 4.4.3.1 is used.
- PLMN settings are defined in TS 36.523-1 [13] table 6.0.1-1.

Table 6.2.1.2.3.1-1: Cell PLMN identities

Cell	PLMN name
NR Cell 1	PLMN2
NR Cell 12	PLMN13
E-UTRA Cell 1	PLMN13

UE

- The UE is in Automatic PLMN selection mode.
- The HPLMN is PLMN1.

- USIM configuration 7 as specified in tables 6.4.1-7 in TS 38.508-1 [4] will be used.

Preamble

- The UE is in state Switched OFF (state 0-A) according to TS 38.508-1 [4].

6.2.1.2.3.2 Test procedure sequence

Table 6.2.1.2.3.2-1 and table 6.2.1.2.3.2-2 illustrate the downlink power levels to be applied for the cells at various time instants of the test execution. Row marked "T0" denotes the initial conditions after preamble, while columns marked "T1" is to be applied subsequently in the Main behaviour. The exact instants on which these values shall be applied are described in the texts in this clause.

Table 6.2.1.2.3.2-1: Cell configuration changes over time for conducted test environment

	Parameter	Unit	NR Cell 1	NR Cell 12	E-UTRA Cell 1	Remarks
T0	SS/PBCH SSS EPRE	dBm/SCS	-88	-88	-	
	RS EPRE	dBm/15kHz			-85	
T1	SS/PBCH SSS EPRE	dBm/SCS	-88	"Off"	-	Power level "Off" is defined in TS 38.508-1 [4] Table 6.2.2.1-3
	RS EPRE	dBm/15kHz			-85	

Table 6.2.1.2.3.2-2: Cell configuration changes over time for OTA test environment

	Parameter	Unit	NR Cell 1	NR Cell 12	E-UTRA Cell 1	Remarks
T0	SS/PBCH SSS EPRE	dBm/SCS	-82	-82	-	
	RS EPRE	dBm/15kHz	-	-	-85	
	Qrxlevmin	dBm	-91+ Delta(NRf1)	-91+ Delta(NRf2)	-	
T1	SS/PBCH SSS EPRE	dBm/SCS	-82	"Off"	-	Power level "Off" is defined in TS 38.508-1 [4] Table 6.2.2.1-3
	RS EPRE	dBm/15kHz	-	-	-85	
	Qrxlevmin	dBm	-91+ Delta(NRf1)	-	-	

Table 6.2.1.2.3.2-3: Main behaviour

St	Procedure	Message Sequence		TP	Verdict
		U – S	Message		
1	The UE is switched on.	-	-	-	-
2	Check: Does the UE send <i>RRCSetupRequest</i> on NR Cell 12?	-->	<i>RRCSetupRequest</i>	1	P
3-20a1	Steps 3-20a1 of the registration procedure described in TS 38.508-1 [4] table 4.5.2.2-2 are performed on NR Cell 12.	-	-	-	-
21	The SS adjusts cell levels according to row T1 of table 6.2.1.2.3.2-1/2.	-	-	-	-
22	Check: Does the test result of generic test procedure in TS 38.508-1 [4] table 4.9.7.2.2-1 is performed and the UE is camped on E-UTRAN Cell 1 with condition ' <i>connected without release</i> '?	-	-	2	P
23	At the end of this test procedure sequence,	-	-	-	-

	the UE is in end state E-UTRA connected (E2_T3440) according to TS 36.508 [7].				
--	--	--	--	--	--

6.2.1.2.3.3 Specific message contents

None.

6.2.1.3 Inter-RAT PLMN Selection / Selection of correct PLMN and RAT in shared network environment / Automatic mode

6.2.1.3.1 Test Purpose (TP)

(1)

```
with { UE in Automatic network selection mode and shared OPLMN cells available on NR and E-UTRAN }
ensure that {
  when { UE is switched on }
  then { UE selects the highest priority OPLMN and RAT combination and UE attempts to register on
the selected cell and PLMN }
}
```

(2)

```
with { UE in Automatic network selection mode and shared OPLMN cells available on NR and E-UTRAN }
ensure that {
when { UE returns to coverage }
  then { UE selects the highest priority OPLMN and RAT combination and UE attempts to attach on
the selected cell and PLMN }
}
```

6.2.1.3.2 Conformance requirements

References: The conformance requirements covered in the present TC are specified in: TS 23.122 clauses 4.4.3, 4.4.3.1 and 4.4.3.1.1. Unless otherwise stated these are Rel-15 requirements.

[TS 23.122, clause 4.4.3]

When the MS reselects to a cell in a shared network, and the cell is a suitable cell for multiple PLMN identities received on the BCCH or on the EC-BCCH the AS indicates these multiple PLMN identities to the NAS according to 3GPP TS 44.018 [34], 3GPP TS 44.060 [39], 3GPP TS 25.304 [32] and 3GPP TS 36.304 [43]. The MS shall choose one of these PLMNs. If the registered PLMN is available among these PLMNs, the MS shall not choose a different PLMN.

[TS 23.122, clause 4.4.3.1]

If successful registration is achieved, the MS indicates the selected PLMN.

...

NOTE 3: If successful registration is achieved, then the current serving PLMN becomes the registered PLMN and the MS does not store the previous registered PLMN for later use.

[TS 23.122, clause 4.4.3.1.1]

The MS selects and attempts registration on other PLMN/access technology combinations, if available and allowable, in the following order:

- i) either the HPLMN (if the EHPLMN list is not present or is empty) or the highest priority EHPLMN that is available (if the EHPLMN list is present) ;
- ii) each PLMN/access technology combination in the "User Controlled PLMN Selector with Access Technology" data file in the SIM (in priority order);

- iii) each PLMN/access technology combination in the "Operator Controlled PLMN Selector with Access Technology" data file in the SIM (in priority order);
- iv) other PLMN/access technology combinations with received high quality signal in random order;
- v) other PLMN/access technology combinations in order of decreasing signal quality.

6.2.1.3.3 Test description

6.2.1.3.3.1 Pre-test conditions

System Simulator

- 2 NR cells as specified in TS 38.508-1 [4] table 4.4.2-3 are configured as shown in Table 6.2.1.3.3.2-1. System information combination NR-1 as defined in Ts 38.508-1 [4] sub-clause 4.4.3.1.2 is applied to all the NR cells.
- 1 cell belongs to E-UTRA. System information combination 1 as defined in TS 36.508 [7] clause 4.4.3.1 is used.
- PLMN settings are defined in TS 36.523-1 [13] table 6.0.1-1.

Table 6.2.1.3.3.1-1: Cell PLMN identities

Cell	PLMN name
NR Cell 1	PLMN16
	PLMN15
NR Cell 12	PLMN16
	PLMN17
E-UTRA Cell 1	PLMN17
	PLMN16

UE

- The UE is in Automatic PLMN selection mode.
- The HPLMN is PLMN1.
- USIM configuration 8 as specified in tables 6.4.1-8 in TS 38.508-1 [4] will be used.

Preamble

- The UE is in state Switched OFF (state 0-A) according to TS 38.508-1 [4].

6.2.1.3.3.2 Test procedure sequence

Table 6.2.1.3.3.2-1 and table 6.2.1.3.3.2-2 illustrate the downlink power levels to be applied for the cells at various time instants of the test execution. Row marked "T0" denotes the initial conditions after preamble, while columns marked "T1" is to be applied subsequently in the Main behaviour. The exact instants on which these values shall be applied are described in the texts in this clause.

Table 6.2.1.3.3.2-1: Cell configuration changes over time for conducted test environment

	Parameter	Unit	NR Cell 1	NR Cell 12	E-UTRA Cell 1	Remarks
T0	SS/PBCH SSS EPRE	dBm/SCS	-88	-88		
	RS EPRE	dBm/15kHz			-85	
T1	SS/PBCH SSS EPRE	dBm/SCS	"Off"	-88		Power level "Off" is defined in TS 38.508-1 [4] Table 6.2.2.1-3
	RS EPRE	dBm/15kHz			-85	

Table 6.2.1.3.3.2-2: Cell configuration changes over time for OTA test environment

T0	Parameter	Unit	NR Cell 1	NR Cell 12	E-UTRA Cell 1	Remarks
T0	SS/PBCH SSS EPRE	dBm/SCS	-82	-82		
	RS EPRE	dBm/15kHz	-	-	-85	
	Qrxlevmin	dBm	-91+ Delta(NRf1)	-91+ Delta(NRf2)	-	
T1	SS/PBCH SSS EPRE	dBm/SCS	"Off"	-82	-	Power level "Off" is defined in TS 38.508-1 [4] Table 6.2.2.1-3
	RS EPRE	dBm/15kHz	-	-	-85	
	Qrxlevmin	dBm	-	-91+ Delta(NRf2)	-	

Table 6.2.1.3.3.2-3: Main behaviour

St	Procedure	Message Sequence		TP	Verdict
		U – S	Message		
1	The UE is switched on.	-	-	-	-
2	Check: Does the UE send <i>RRCSetupRequest</i> on NR Cell 1?	-->	NR RRC: <i>RRCSetupRequest</i>	1	P
3-20a1	Steps 3-20a1 of the registration procedure described in TS 38.508-1 [4] Table 4.5.2.2-2 are performed on NR Cell 1.	-	-	-	-
21	The SS adjusts cell levels according to row T1 of table 6.2.1.3.3.2-1/2.	-	-	-	-
22	Check: Does the test result of generic test procedure in TS 38.508-1 [4] table 4.9.7.2.2-1 is performed and the UE is camped on E-UTRAN Cell 1 with condition ' <i>connected without release</i> '?	-	-	2	P
23	At the end of this test procedure sequence, the UE is in end state E-UTRA connected (E2_T3440) according to TS 36.508 [7].	-	-	-	-

6.2.1.3.3.3 Specific message contents

Table 6.2.1.3.3.3-1: SIB1 for NR Cell 1 (all steps, Table 6.2.1.3.3.2-3)

Derivation path: 38.508-1 [4] Table 4.6.1-28			
Information Element	Value/Remark	Comment	Condition
SIB1 ::= SEQUENCE {			
CellAccessRelatedInfo SEQUENCE {			
PLMN-IdentityInfoList SEQUENCE (SIZE (1..maxPLMN)) OF PLMN-IdentityInfo {	1 entry		
PLMN-IdentityInfo[1] SEQUENCE {		entry 1	
plmn-IdentityList SEQUENCE (SIZE (1..maxPLMN)) OF PLMN-Identity {	2 entries		
PLMN-Identity[1] SEQUENCE {		entry 1	
mcc	PLMN16 MCC		
mnc	PLMN16 MNC		
}			
PLMN-Identity[2] SEQUENCE {		entry 2	
mcc	PLMN15 MCC		
mnc	PLMN15 MNC		
}			
}			
}			
}			
}			

}		
---	--	--

Table 6.2.1.3.3.2: SIB1 for NR Cell 12 (all steps, Table 6.2.1.3.3.2-)

Derivation path: 38.508-1 [4] Table 4.6.1-28			
Information Element	Value/Remark	Comment	Condition
SIB1 ::= SEQUENCE {			
CellAccessRelatedInfo SEQUENCE {			
PLMN-IdentityInfoList SEQUENCE (SIZE (1..maxPLMN)) OF PLMN-IdentityInfo {	1 entry		
PLMN-IdentityInfo[1] SEQUENCE {		entry 1	
plmn-IdentityList SEQUENCE (SIZE (1..maxPLMN)) OF PLMN-Identity {	2 entries		
PLMN-Identity[1] SEQUENCE {		entry 1	
mcc	PLMN16 MCC		
mnc	PLMN16 MNC		
}			
}			
}		entry 2	
mcc	PLMN17 MCC		
mnc	PLMN17 MNC		
}			
}			
}			
}			

Table 6.2.1.3.3.3-3: SystemInformationBlockType1 for E-UTRAN Cell 1 (all steps, Table 6.2.1.3.3.2-3)

Derivation path: 36.508[7] Table 4.4.3.2-3			
Information Element	Value/Remark	Comment	Condition
SystemInformationBlockType1 ::= SEQUENCE {			
cellAccessRelatedInfo SEQUENCE {			
plmn-IdentityList SEQUENCE (SIZE (1..6)) OF PLMN-IdentityInfo {	2 entries		
PLMN-IdentityInfo[1] SEQUENCE {		entry 1	
plmn-Identity	PLMN17		
}			
PLMN-IdentityInfo[2] SEQUENCE {		entry 2	
plmn-Identity	PLMN16		
}			
}			
}			
}			

Table 6.2.1.3.3.3-4: RRCSetupComplete (Step 6, Table 6.2.1.3.3.2-3)

Derivation Path: 38.508-1 [4] Table 4.6.1-22			
Information Element	Value/remark	Comment	Condition
RRCSetupComplete ::= SEQUENCE {			
criticalExtensions CHOICE {			
rrcSetupComplete SEQUENCE {			
selectedPLMN-Identity	2	PLMN15	
}			
}			
}			

Table 6.2.1.3.3.3-5: RRCConnectionSetupComplete (Step 22, Table 6.2.1.3.3.2-3)

Derivation Path: 36.331 [11] clause 6.2.2

Information Element	Value/remark	Comment	Condition
RRConnectionSetupComplete ::= SEQUENCE {			
criticalExtensions CHOICE {			
c1 CHOICE {			
rrcConnectionSetupComplete-r8 SEQUENCE {			
selectedPLMN-Identity	1	PLMN17	
}			
}			
}			
}			

6.2.1.4 Inter-RAT PLMN Selection / Selection of correct RAT from the OPLMN list / Manual mode

6.2.1.4.1 Test Purpose (TP)

(1)

```
with { UE in Manual network selection mode and OPLMN cells available on NR and E-UTRA}
ensure that {
  when { the USER selects an OPLMN}
  then { UE selects the highest priority RAT for the OPLMN and UE attempts to attach on the
selected cell and when successfully registered indicates the PLMN to the user }
}
```

(2)

```
with { UE in Manual network selection mode and OPLMN cells available on NR and E-UTRA}
ensure that {
  when { the USER selects an OPLMN and RAT combination}
  then {UE attempts to attach on the selected OPLMN and RAT combination and when successfully
registered indicates the PLMN to the user }
}
```

6.2.1.4.2 Conformance requirements

References: The conformance requirements covered in the present TC are specified in: TS 23.122 clauses 4.4.3.1.2. Unless otherwise stated these are Rel-15 requirements.

[TS 23.122, clause 4.4.3.1.2]

The MS indicates whether there are any PLMNs, which are available using all supported access technologies. This includes PLMNs in the "forbidden PLMNs" list, "forbidden PLMNs for GPRS service" list and PLMNs which only offer services not supported by the MS. An MS which supports GSM COMPACT shall also indicate GSM COMPACT PLMNs (which use PBCCH).

If displayed, PLMNs meeting the criteria above are presented in the following order:

- i)- either the HPLMN (if the EHPLMN list is not present or is empty) or, if one or more of the EHPLMNs are available then based on an optional data field on the SIM either only the highest priority available EHPLMN is to be presented to the user, or all available EHPLMNs are presented to the user in priority order. If the data field is not present on the SIM, then only the highest priority available EHPLMN is presented;
- ii)- PLMN/access technology combinations contained in the " User Controlled PLMN Selector with Access Technology " data file in the SIM (in priority order);
- iii)- PLMN/access technology combinations contained in the "Operator Controlled PLMN Selector with Access Technology" data file in the SIM (in priority order);
- iv)- other PLMN/access technology combinations with received high quality signal in random order;
- v)- other PLMN/access technology combinations in order of decreasing signal quality.

...

The user may select his desired PLMN and the MS then initiates registration on this PLMN using the access technology chosen by the user for that PLMN or using the highest priority available access technology for that PLMN, if the associated access technologies have a priority order. (This may take place at any time during the presentation of PLMNs). For such a registration, the MS shall ignore the contents of the "forbidden location areas for roaming", "forbidden tracking areas for roaming", "5GS forbidden tracking areas for roaming", "forbidden location areas for regional provision of service", "forbidden tracking areas for regional provision of service", "5GS forbidden tracking areas for regional provision of service", "forbidden PLMNs for GPRS service" and "forbidden PLMNs" lists.

NOTE 1: It is an MS implementation option whether to indicate access technologies to the user. If the MS does display access technologies, then the access technology selected by the user is only used for initial registration on the selected PLMN. If the MS does not display access technologies, then the access technology chosen for a particular PLMN should be the highest priority available access technology for that PLMN, if the associated access technologies have a priority order, and is only used for initial registration.

6.2.1.4.3 Test description

6.2.1.4.3.1 Pre-test conditions

System Simulator

- 3 cells are used:
- NR Cell 1 and NR Cell 12 as specified in TS 38.508-1 [4] table 4.4.2-3 are configured as shown in Table 6.2.1.2.3.2-1. System information combination NR-1 as defined in Ts 38.508-1 [4] sub-clause 4.4.3.1.2 is applied to all the NR cells.
- E-UTRA Cell 1 belongs to E-UTRA (defined in TS 36.508 [7]). System information combination 1 as defined in TS 36.508 [7] clause 4.4.3.1 is used.
- PLMN settings are defined in TS 36.523-1 [13] table 6.0.1-1.

Table 6.2.1.4.3.1-1: Cell PLMN identities

Cell	PLMN name
NR Cell 1	PLMN2
NR Cell 12	PLMN13
E-UTRA Cell 1	PLMN2

UE

- The HPLMN is PLMN1.
- USIM configuration 13 as specified in table 6.4.1-13 in TS 38.508-1 [4] will be used.

Preamble

- The UE is attached to PLMN1 and the UE is set to Manual PLMN selection mode before it is in state Switched OFF (state 0N-B) according to TS 38.508-1 [4].

6.2.1.4.3.2 Test procedure sequence

Table 6.2.1.4.3.2-1 and table 6.2.1.4.3.2-2 illustrate the downlink power levels to be applied for the cells at various time instants of the test execution. Row marked "T0" denotes the initial conditions after preamble. Configurations marked "T1" and "T2" are applied at the points indicated in the Main behaviour description in Table 6.2.1.4.3.2-3.

Table 6.2.1.4.3.2-1: Cell configuration changes over time for conducted test environment

	Parameter	Unit	NR Cell 1	NR Cell 12	E-UTRA Cell 1

T0	SS/PBCH SSS EPRE	dBm/SCS	-88	-88	
	RS EPRE	dBm/15kHz			-85
T1	SS/PBCH SSS EPRE	dBm/SCS	OFF	OFF	
	RS EPRE	dBm/15kHz			-85
T2	SS/PBCH SSS EPRE	dBm/SCS	-88	OFF	
	RS EPRE	dBm/15kHz			OFF

Table 6.2.1.4.3.2-2: Cell configuration changes over time for OTA test environment

	Parameter	Unit	NR Cell 1	NR Cell 12	E-UTRA Cell 1
T0	SS/PBCH SSS EPRE	dBm/SCS	-82	-82	-
	RS EPRE	dBm/15kHz	-	-	-85
	Qrxlevmin	dBm	-91+ Delta(NRf1)	-91+ Delta(NRf2)	-
T1	SS/PBCH SSS EPRE	dBm/SCS	OFF	OFF	
	RS EPRE	dBm/15kHz			-85
T2	SS/PBCH SSS EPRE	dBm/SCS	-82	OFF	
	RS EPRE	dBm/15kHz			OFF

Table 6.2.1.4.3.2-3: Main behaviour

St	Procedure	Message Sequence		TP	Verdict
		U – S	Message		
1	The UE is switched on.	-	-	-	-
2	Make the UE display the list of available PLMNs.	-	-	-	-
-	EXCEPTION: Steps 2a1 to 2b5 describe behaviour that depends on UE capabilities; the "lower case letter" identifies a step sequence that takes place if the condition is met.	-	-	-	-
2a1	IF pc_Available_PLMNs_Act_Ind[29] (Support of Access Technology Indication in available PLMNs list) THEN PLMN2 (E-UTRAN) is selected	-	-	-	-
2a2	Check: Does the test result of generic test procedure in TS 38.508-1 [4] table 4.5.2.2-5 is performed and the UE is camped on E-UTRA Cell 1?	-	-	2	
2a3	Check: Is PLMN2 indicated as registered PLMN by the UE?	-	-	2	P
2a4	The SS adjusts the NR Cell power levels according to row "T1" in table 6.2.1.4.3.2-1/2.				
2a5	Set the UE in Automatic PLMN selection mode.				
2b1	ELSE (No Access Technology shown to the User) PLMN2 is selected				
2b2	Check: Does the test result of generic test procedure in TS 38.508-1 [4] table 4.5.2.2-2 is performed and the UE is camped on NR Cell 1?	-		1	
2b3	Check: Is PLMN2 indicated as registered PLMN by the UE?	-	-	1	P
2b4	The SS adjusts the E-UTRA and NR Cell power levels according to row "T2" in table 6.2.1.4.3.2-1/2.				

2b5	Set the UE in Automatic PLMN selection mode.				
3	Wait for 300s to allow the UE to switch to automatic PLMN selection mode.	-	-	-	-

6.2.1.4.3.3 Specific message contents

None.

6.2.1.5 Inter-RAT Background HPLMN Search / Search for correct RAT for HPLMN / Automatic Mode

6.2.1.5.1 Test Purpose (TP)

```

with { UE in Automatic network selection mode is camped on a E-UTRAN VPLMN cell and HPLMN cell
available on NR }
ensure that {
  when { higher priority PLMN search timer T expires }
  then { UE detects NR cell and camps on the NR cell }
}

```

6.2.1.5.2 Conformance requirements

References: The conformance requirements covered in the present TC are specified in: TS 23.122 clauses 4.4.3.3.1. Unless otherwise stated these are Rel-15 requirements.

[TS 23.122, clause 4.4.3.3.1]

If the MS is in a VPLMN, the MS shall periodically attempt to obtain service on its HPLMN (if the EHPLMN list is not present or is empty) or one of its EHPLMNs (if the EHPLMN list is present) or a higher priority PLMN/access technology combinations listed in "user controlled PLMN selector" or "operator controlled PLMN selector" by scanning in accordance with the requirements that are applicable to i), ii) and iii) as defined in the Automatic Network Selection Mode in subclause 4.4.3.1.1. In the case that the mobile has a stored "Equivalent PLMNs" list the mobile shall only select a PLMN if it is of a higher priority than those of the same country as the current serving PLMN which are stored in the "Equivalent PLMNs" list. For this purpose, a value of timer T may be stored in the SIM. The interpretation of the stored value depends on the radio capabilities supported by the MS:

- For an MS that does not support any of the following: EC-GSM-IoT, Category M1 or Category NB1 (as defined in 3GPP TS 36.306 [54]), T is either in the range 6 minutes to 8 hours in 6 minute steps or it indicates that no periodic attempts shall be made. If no value for T is stored in the SIM, a default value of 60 minutes is used for T.
- For an MS that only supports any of the following or a combination of: EC-GSM-IoT, Category M1 or Category NB1 (as defined in 3GPP TS 36.306 [54]), T is either in the range 2 hours to 240 hours, using 2 hour steps from 2 hours to 80 hours and 4 hour steps from 84 hours to 240 hours, or it indicates that no periodic attempts shall be made. If no value for T is stored in the SIM, a default value of 72 hours is used.
- For an MS that supports both:
 - a) any of the following or a combination of: EC-GSM-IoT, Category M1 or Category NB1 (as defined in 3GPP TS 36.306 [54]); and
 - b) any access technology other than the following: EC-GSM-IoT, Category M1 or Category NB1 (as defined in 3GPP TS 36.306 [54]),

then T is interpreted depending on the access technology in use as specified below:

- 1) if the MS is using any of the following at the time of starting timer T: EC-GSM-IoT, Category M1 or Category NB1 (as defined in 3GPP TS 36.306 [54]), T is either in the range 2 hours to 240 hours, using 2 hour steps from 2 hours to 80 hours and 4 hour steps from 84 hours to 240 hours, or it indicates that no periodic attempts shall be made. If no value for T is stored in the SIM, a default value of 72 hours is used; and

- 2) if the MS is not using any of the following at the time of starting timer T: EC-GSM-IoT, Category M1 or Category NB1 (as defined in 3GPP TS 36.306 [54]), T is either in the range 6 minutes to 8 hours in 6 minute steps or it indicates that no periodic attempts shall be made. If no value for T is stored in the SIM, a default value of 60 minutes is used for T.

If the MS is configured with the MinimumPeriodicSearchTimer as specified in 3GPP TS 24.368 [50] or 3GPP TS 31.102 [40], the MS shall not use a value for T that is less than the MinimumPeriodicSearchTimer. If the value stored in the SIM, or the default value for T (when no value is stored in the SIM), is less than the MinimumPeriodicSearchTimer, then T shall be set to the MinimumPeriodicSearchTimer.

The MS does not stop timer T, as described in 3GPP TS 24.008 [23] and 3GPP TS 24.301 [23A], when it activates power saving mode (PSM) (see 3GPP TS 23.682 [27A]).

The MS can be configured for Fast First Higher Priority PLMN search as specified in 3GPP TS 31.102 [40] or 3GPP TS 24.368 [50]. Fast First Higher Priority PLMN search is enabled if the corresponding configuration parameter is present and set to enabled. Otherwise, Fast First Higher Priority PLMN search is disabled.

The attempts to access the HPLMN or an EHPLMN or higher priority PLMN shall be as specified below:

- a) The periodic attempts shall only be performed in automatic mode when the MS is roaming, and not while the MS is attached for emergency bearer services, is registered for emergency services, has a PDU session for emergency services or has a PDN connection for emergency bearer services;
- b) The MS shall make the first attempt after a period of at least 2 minutes and at most T minutes:
 - only after switch on if Fast First Higher Priority PLMN search is disabled; or
 - after switch on or upon selecting a VPLMN if Fast First Higher Priority PLMN search is enabled.
- c) The MS shall make the following attempts if the MS is on the VPLMN at time T after the last attempt;
- d) Periodic attempts shall only be performed by the MS while in idle mode;
- d1) periodic attempts may be postponed while the MS is in power saving mode (PSM) (see 3GPP TS 23.682 [27A]).
- e) If the HPLMN (if the EHPLMN list is not present or is empty) or a EHPLMN (if the list is present) or a higher priority PLMN is not found, the MS shall remain on the VPLMN.
- f) In steps i), ii) and iii) of subclause 4.4.3.1.1 the MS shall limit its attempts to access higher priority PLMN/access technology combinations to PLMN/access technology combinations of the same country as the current serving VPLMN, as defined in Annex B.
- g) Only the priority levels of Equivalent PLMNs of the same country as the current serving VPLMN, as defined in Annex B, shall be taken into account to compare with the priority level of a selected PLMN.
- h) If the PLMN of the highest priority PLMN/access technology combination available is the current VPLMN, or one of the PLMNs in the "Equivalent PLMNs" list, the MS shall remain on the current PLMN/access technology combination.

6.2.1.5.3 Test description

6.2.1.5.3.1 Pre-test conditions

System Simulator

- E-UTRA Cell 1 as specified in TS 36.508 [7]. System information combination 1 as defined in TS 36.508 [7] clause 4.4.3.1 is used.
- NR Cell 1 as specified in TS 38.508-1 [4] table 4.4.2-3. System information combination NR-1 as defined in TS 38.508-1 [4] sub-clause 4.4.3.1.2 is applied to the NR cell.
- PLMN settings are defined in TS 36.523-1 [13] table 6.0.1-1.

Table 6.2.1.5.3.1-1: Cell PLMN identities

Cell	PLMN name
NR Cell 1	PLMN1
E-UTRA Cell 1	PLMN15

UE

- USIM configuration 9 as specified in table 6.4.1-9 in TS 38.508-1 [4] will be used.

Preamble

- With E-UTRA Cell 1 "Serving cell" and NR Cell 1 "Non-suitable "Off" cell" in accordance with TS 38.508-1 [4], Table 6.2.2.1-3, the UE is brought to state RRC_IDLE using generic procedure parameter Connectivity (*E-UTRA/EPC*) and Unrestricted nr PDN (*On*) in accordance with the procedure described in TS 38.508-1 [4], clause 4.5.2. 4G GUTI and eKSI are assigned and security context established.
- the UE is switched-off.
- With E-UTRA Cell 1 "Non-suitable "Off" cell" and NR Cell 1 "Serving cell" in accordance with TS 38.508-1 [4], Table 6.2.2.1-3, the UE is brought to state ON-B, RRC_IDLE Connectivity (NR), in accordance with the procedure described in TS 38.508-1 [4], Table 4.5.5.2-1. 5G-GUTI and ngKSI are assigned and security context established.

6.2.1.5.3.2 Test procedure sequence

Table 6.2.1.3.3.2-1 and table 6.2.1.3.3.2-2 illustrate the downlink power levels to be applied for the cells at various time instants of the test execution. Row marked "T0" denotes the initial conditions after preamble, while columns marked "T1" is to be applied subsequently in the Main behaviour. The exact instants on which these values shall be applied are described in the texts in this clause.

Table 6.2.1.5.3.2-1: Cell configuration changes over time for conducted test environment

	Parameter	Unit	NR Cell 1	E-UTRA Cell 1	Remarks
T0	SS/PBCH SSS EPRE	dBm/SCS	"Off"		Power level "Off" is defined in TS 38.508-1 [4] Table 6.2.2.1-3
	RS EPRE	dBm/15kHz		-85	
T1	SS/PBCH SSS EPRE	dBm/SCS	-88		
	RS EPRE	dBm/15kHz		-85	

Table 6.2.1.5.3.2-2: Cell configuration changes over time for OTA test environment

	Parameter	Unit	NR Cell 1	E-UTRA Cell 1	Remarks
T0	SS/PBCH SSS EPRE	dBm/SCS	"Off"		Power level "Off" is defined in TS 38.508-1 [4] Table 6.2.2.1-3
	RS EPRE	dBm/15kHz	-	-85	
	Qrxlevmin	dBm	-	-	
T1	SS/PBCH SSS EPRE	dBm/SCS	-82		
	RS EPRE	dBm/15kHz	-	-85	
	Qrxlevmin	dBm	-91+ Delta(NRf1)	-	

Table 6.2.1.5.3.2-3: Main behaviour

St	Procedure	Message Sequence		TP	Verdict
		U – S	Message		
1	Power on the UE.	-	-	-	-
2	Void	-	-	-	-
3-12b 8	Steps 1-10b8 of the registration procedure described in TS 38.508-1 [4] table 4.5.2.2-1 take place on E-UTRAN Cell 1.	-	-	-	-
13-18	Void	-	-	-	-
18A	SS starts timer of $t_{min} = 2$ minutes and $t_{max} = 6$ minutes $\cdot (1+10\%$ tolerance) (Note 1)	-	-	-	-
19	The SS adjusts cell levels according to row T1 of table 6.2.1.5.3.2-1.	-	-	-	-
20	Check: Does the UE send an <i>RRCSetupRequest</i> on NR Cell 1 after t_{min} but before t_{max} expires? (Note 1)	-->	NR RRC: <i>RRCSetupRequest</i>	1	P
20A-20B	Steps 3-4 of Table 4.5.2.2-2 of the generic procedure in TS 38.508-1 [4] are performed. (Note 2)				
-	EXCEPTION: Steps 21a1 to 21b10a1 describe behaviours which depend on procedure parameters; the "lower case letter" identifies a step sequence that take place if a procedure parameter has a particular value.	-	-	-	-
21a1-21a16a1	IF 5GS registration type is set as Initial Registration in step 20B, THEN steps 5 to 20a1 of the registration procedure described in TS 38.508-1 [4] Table 4.5.2.2-2 are performed on NR Cell 1.	-	-	-	-
21b1-21b8	ELSE IF 5GS registration type is set as Mobility Registration in step 20B, THEN steps 4 to 11 of the tracking area update procedure described in TS 38.508-1 [4] table 4.9.9.2.2-1 are performed without connection release on NR Cell 1.	-	-	-	-
21b9a1-21b10a1	Steps 19a1-20a1 of the procedure described in TS 38.508-1c [4] table 4.5.2.2-2 are performed with connection release on NR Cell 1.				
22-27a1	Void	-	-	-	-
<p>Note 1: Timers t_{min} and t_{max} in step 12b are derived from the high priority PLMN search timer T defined by EF_{HPPLMN}. The timer t_{max} shall be set to 396s (6 minutes $\cdot (1+10\%$ tolerance)), where the high priority PLMN search timer T is defined in EF_{HPPLMN}.</p> <p>Note 2: The 5GS registration type shall be only set as Mobility Registration for R16 UEs according to TS 24.501 [22] subclause 5.2.3.2.5 specified in Release 16. The EXCEPTION description applies only to R15 UEs.</p>					

6.2.1.5.3.3 Specific message contents

Table 6.2.1.5.3.3-1: REGISTRATION ACCEPT (Step 21b7 of Table 6.2.1.5.3.2-3)

Derivation Path: TS 38.508-1 [4], Table 4.7.1-6.			
Information Element	Value/remark	Comment	Condition
PDU session status	0X 00 00		

6.2.2 Inter-RAT Cell Selection

6.2.2.1 Inter-RAT cell selection / From NR RRC_IDLE to EUTRA_Idle / Serving cell becomes non-suitable

6.2.2.1.1 Test Purpose (TP)

(1)

```
with { UE in NR RRC_IDLE state }
ensure that {
  when { the serving cell becomes non-suitable and there is a suitable E-UTRA neighbour cell }
  then { UE selects the suitable E-UTRA neighbour cell }
}
```

(2)

```
with { UE in NR RRC_IDLE state }
ensure that {
  when { the serving cell becomes barred and there is a suitable E-UTRA neighbour cell }
  then { UE selects the suitable E-UTRA neighbour cell }
}
```

6.2.2.1.2 Conformance requirements

References: The conformance requirements covered in the present TC are specified in: 3GPP TS 38.304, clause 5.2.1, 5.2.3.1, 5.2.3.2 and TS 36.304, clause 5.2.1, 5.2.3.1, 5.2.3.2. Unless otherwise stated these are Rel-15 requirements.

[TS 38.304, clause 5.2.1]

UE shall perform measurements for cell selection and reselection purposes as specified in TS 38.133 [8].

When evaluating S_{rxlev} and S_{qual} of non-serving cells for reselection evaluation purposes, the UE shall use parameters provided by the serving cell and for the final check on cell selection criterion, the UE shall use parameters provided by the target cell for cell reselection.

The NAS can control the RAT(s) in which the cell selection should be performed, for instance by indicating RAT(s) associated with the selected PLMN, and by maintaining a list of forbidden registration area(s) and a list of equivalent PLMNs. The UE shall select a suitable cell based on RRC_IDLE or RRC_INACTIVE state measurements and cell selection criteria.

In order to expedite the cell selection process, stored information for several RATs, if available, may be used by the UE.

When camped on a cell, the UE shall regularly search for a better cell according to the cell reselection criteria. If a better cell is found, that cell is selected. The change of cell may imply a change of RAT. Details on performance requirements for cell reselection can be found in TS 38.133 [8].

The NAS is informed if the cell selection and reselection result in changes in the received system information relevant for NAS.

For normal service, the UE shall camp on a suitable cell, monitor control channel(s) of that cell so that the UE can:

- receive system information from the PLMN or SNPN; and
- receive registration area information from the PLMN or SNPN, e.g., tracking area information; and
- receive other AS and NAS Information; and
- if registered:
 - receive paging and notification messages from the PLMN or SNPN; and
 - initiate transfer to Connected mode.

For cell selection in multi-beam operations, measurement quantity of a cell is up to UE implementation.

For cell reselection in multi-beam operations, including inter-RAT reselection from E-UTRA to NR, the measurement quantity of this cell is derived amongst the beams corresponding to the same cell based on SS/PBCH block as follows:

- if *nrofSS-BlocksToAverage* (*maxRS-IndexCellQual* in E-UTRA) is not configured in *SIB2/SIB4* (*SIB24* in E-UTRA); or
- if *absThreshSS-BlocksConsolidation* (*threshRS-Index* in E-UTRA) is not configured in *SIB2/SIB4* (*SIB24* in E-UTRA); or
- if the highest beam measurement quantity value is below or equal to *absThreshSS-BlocksConsolidation* (*threshRS-Index* in E-UTRA):
 - derive a cell measurement quantity as the highest beam measurement quantity value, where each beam measurement quantity is described in TS 38.215 [11].
- else:
 - derive a cell measurement quantity as the linear average of the power values of up to *nrofSS-BlocksToAverage* (*maxRS-IndexCellQual* in E-UTRA) of highest beam measurement quantity values above *absThreshSS-BlocksConsolidation* (*threshRS-Index* in E-UTRA).

[TS 38.304, clause 5.2.3.1]

Cell selection is performed by one of the following two procedures:

- a) Initial cell selection (no prior knowledge of which RF channels are NR frequencies):
 1. The UE shall scan all RF channels in the NR bands according to its capabilities to find a suitable cell.
 2. On each frequency, the UE need only search for the strongest cell, except for operation with shared spectrum channel access where the UE may search for the next strongest cell(s).
 3. Once a suitable cell is found, this cell shall be selected.
- b) Cell selection by leveraging stored information:
 1. This procedure requires stored information of frequencies and optionally also information on cell parameters from previously received measurement control information elements or from previously detected cells.
 2. Once the UE has found a suitable cell, the UE shall select it.
 3. If no suitable cell is found, the initial cell selection procedure in a) shall be started.

NOTE: Priorities between different frequencies or RATs provided to the UE by system information or dedicated signalling are not used in the cell selection process.

[TS 38.304, clause 5.2.3.2]

The cell selection criterion *S* is fulfilled when:

$$S_{rxlev} > 0 \text{ AND } S_{qual} > 0$$

where:

$$S_{rxlev} = Q_{rxlevmeas} - (Q_{rxlevmin} + Q_{rxlevminoffset}) - P_{compensation} - Q_{offset_{temp}}$$

$$S_{qual} = Q_{qualmeas} - (Q_{qualmin} + Q_{qualminoffset}) - Q_{offset_{temp}}$$

where:

<i>S_{rxlev}</i>	Cell selection RX level value (dB)
<i>S_{qual}</i>	Cell selection quality value (dB)
<i>Q_{offset_{temp}}</i>	Offset temporarily applied to a cell as specified in TS 38.331 [3] (dB)
<i>Q_{rxlevmeas}</i>	Measured cell RX level value (RSRP)
<i>Q_{qualmeas}</i>	Measured cell quality value (RSRQ)
<i>Q_{rxlevmin}</i>	Minimum required RX level in the cell (dBm). If the UE supports SUL frequency for this cell, <i>Q_{rxlevmin}</i> is obtained from <i>q-RxLevMinSUL</i> , if

	present, in <i>SIB1</i> , <i>SIB2</i> and <i>SIB4</i> , additionally, if $Q_{rxlevminoffsetcellSUL}$ is present in <i>SIB3</i> and <i>SIB4</i> for the concerned cell, this cell specific offset is added to the corresponding $Q_{rxlevmin}$ to achieve the required minimum RX level in the concerned cell; else $Q_{rxlevmin}$ is obtained from <i>q-RxLevMin</i> in <i>SIB1</i> , <i>SIB2</i> and <i>SIB4</i> , additionally, if $Q_{rxlevminoffsetcell}$ is present in <i>SIB3</i> and <i>SIB4</i> for the concerned cell, this cell specific offset is added to the corresponding $Q_{rxlevmin}$ to achieve the required minimum RX level in the concerned cell.
$Q_{qualmin}$	Minimum required quality level in the cell (dB). Additionally, if $Q_{qualminoffsetcell}$ is signalled for the concerned cell, this cell specific offset is added to achieve the required minimum quality level in the concerned cell.
$Q_{rxlevminoffset}$	Offset to the signalled $Q_{rxlevmin}$ taken into account in the S_{rxlev} evaluation as a result of a periodic search for a higher priority PLMN while camped normally in a VPLMN, as specified in TS 23.122 [9].
$Q_{qualminoffset}$	Offset to the signalled $Q_{qualmin}$ taken into account in the S_{qual} evaluation as a result of a periodic search for a higher priority PLMN while camped normally in a VPLMN, as specified in TS 23.122 [9].
$P_{compensation}$	For FR1, if the UE supports the additionalPmax in the NR-NS-PmaxList, if present, in <i>SIB1</i> , <i>SIB2</i> and <i>SIB4</i> : $max(P_{EMAX1} - P_{PowerClass}, 0) - (min(P_{EMAX2}, P_{PowerClass}) - min(P_{EMAX1}, P_{PowerClass}))$ (dB); else: $max(P_{EMAX1} - P_{PowerClass}, 0)$ (dB) For FR2, $P_{compensation}$ is set to 0.
P_{EMAX1} , P_{EMAX2}	Maximum TX power level of a UE may use when transmitting on the uplink in the cell (dBm) defined as P_{EMAX} in TS 38.101 [15]. If UE supports SUL frequency for this cell, P_{EMAX1} and P_{EMAX2} are obtained from the <i>p-Max</i> for SUL in <i>SIB1</i> and <i>NR-NS-PmaxList</i> for SUL respectively in <i>SIB1</i> , <i>SIB2</i> and <i>SIB4</i> as specified in TS 38.331 [3], else P_{EMAX1} and P_{EMAX2} are obtained from the <i>p-Max</i> and <i>NR-NS-PmaxList</i> respectively in <i>SIB1</i> , <i>SIB2</i> and <i>SIB4</i> for normal UL as specified in TS 38.331 [3].
$P_{PowerClass}$	Maximum RF output power of the UE (dBm) according to the UE power class as defined in TS 38.101-1 [15].

The signalled values $Q_{rxlevminoffset}$ and $Q_{qualminoffset}$ are only applied when a cell is evaluated for cell selection as a result of a periodic search for a higher priority PLMN while camped normally in a VPLMN (TS 23.122 [9]). During this periodic search for higher priority PLMN, the UE may check the S criteria of a cell using parameter values stored from a different cell of this higher priority PLMN.

[TS 36.304, clause 5.2.1]

UE shall perform measurements for cell selection and reselection purposes as specified in TS 36.133 [10].

The NAS can control the RAT(s) in which the cell selection should be performed, for instance by indicating RAT(s) associated with the selected PLMN, and by maintaining a list of forbidden registration area(s) and a list of equivalent PLMNs. The UE shall select a suitable cell based on idle mode measurements and cell selection criteria.

In order to speed up the cell selection process, stored information for several RATs may be available in the UE.

When camped on a cell, the UE shall regularly search for a better cell according to the cell reselection criteria. If a better cell is found, that cell is selected. The change of cell may imply a change of RAT, or if the current and selected cell are both E-UTRA cells, a change of the CN type. Details on performance requirements for cell reselection can be found in TS 36.133 [10].

The NAS is informed if the cell selection and reselection results in changes in the received system information relevant for NAS.

For normal service, the UE shall camp on a suitable cell, tune to that cell's control channel(s) so that the UE can:

- Receive system information from the PLMN; and
- receive registration area information from the PLMN, e.g., tracking area information; and

- receive other AS and NAS Information; and
- if registered:
 - receive paging and notification messages from the PLMN; and
 - initiate transfer to connected mode.

[TS 36.304, clause 5.2.3.1]

The UE shall use one of the following two cell selection procedures:

a) Initial Cell Selection

This procedure requires no prior knowledge of which RF channels are E-UTRA or NB-IoT carriers. The UE shall scan all RF channels in the E-UTRA bands according to its capabilities to find a suitable cell. On each carrier frequency, the UE need only search for the strongest cell. Once a suitable cell is found this cell shall be selected.

b) Stored Information Cell Selection

This procedure requires stored information of carrier frequencies and optionally also information on cell parameters, from previously received measurement control information elements or from previously detected cells. Once the UE has found a suitable cell the UE shall select it. If no suitable cell is found the Initial Cell Selection procedure shall be started.

NOTE 1: Priorities between different frequencies or RATs provided to the UE by system information or dedicated signalling are not used in the cell selection process.

NOTE 2: If BL UE, UE in enhanced coverage or NB-IoT UE has been provisioned with EARFCN, the UE may use this information during Initial Cell Selection and Stored Information Cell Selection to find a suitable cell.

[TS 36.304, clause 5.2.3.2]

For NB-IoT the cell selection criterion is defined in clause 5.2.3.2a.

The cell selection criterion S in normal coverage is fulfilled when:

$$S_{rxlev} > 0 \text{ AND } S_{qual} > 0$$

where:

$$S_{rxlev} = Q_{rxlevmeas} - (Q_{rxlevmin} + Q_{rxlevminoffset}) - P_{compensation} - Q_{offsettemp}$$

$$S_{qual} = Q_{qualmeas} - (Q_{qualmin} + Q_{qualminoffset}) - Q_{offsettemp}$$

where:

S_{rxlev}	Cell selection RX level value (dB)
S_{qual}	Cell selection quality value (dB)
$Q_{offsettemp}$	Offset temporarily applied to a cell as specified in TS 36.331 [3] (dB)
$Q_{rxlevmeas}$	Measured cell RX level value (RSRP)
$Q_{qualmeas}$	Measured cell quality value (RSRQ)
$Q_{rxlevmin}$	Minimum required RX level in the cell (dBm)
$Q_{qualmin}$	Minimum required quality level in the cell (dB)
$Q_{rxlevminoffset}$	Offset to the signalled $Q_{rxlevmin}$ taken into account in the S_{rxlev} evaluation as a result of a periodic search for a higher priority PLMN while camped normally in a VPLMN TS 23.122 [5]
$Q_{qualminoffset}$	Offset to the signalled $Q_{qualmin}$ taken into account in the S_{qual} evaluation as a result of a periodic search for a higher priority PLMN while camped normally in a VPLMN TS 23.122 [5]
$P_{compensation}$	If the UE supports the <i>additionalPmax</i> in the <i>NS-PmaxList</i> , if present, in SIB1, SIB3 and SIB5: $\max(P_{EMAX1} - P_{PowerClass}, 0) - (\min(P_{EMAX2}, P_{PowerClass}) - \min(P_{EMAX1}, P_{PowerClass}))$ (dB); else: if $P_{PowerClass}$ is 14 dBm:

	$\max(P_{EMAX1} - (P_{PowerClass} - P_{offset}), 0)$ (dB); else: $\max(P_{EMAX1} - P_{PowerClass}, 0)$ (dB)
P_{EMAX1}, P_{EMAX2}	Maximum TX power level an UE may use when transmitting on the uplink in the cell (dBm) defined as P_{EMAX} in TS 36.101 [33]. P_{EMAX1} and P_{EMAX2} are obtained from the <i>p-Max</i> and the <i>NS-PmaxList</i> respectively in SIB1, SIB3 and SIB5 as specified in TS 36.331 [3].
$P_{PowerClass}$	Maximum RF output power of the UE (dBm) according to the UE power class as defined in TS 36.101 [33]

The signalled values $Q_{rxlevminoffset}$ and $Q_{qualminoffset}$ are only applied when a cell is evaluated for cell selection as a result of a periodic search for a higher priority PLMN while camped normally in a VPLMN TS 23.122 [5]. During this periodic search for higher priority PLMN the UE may check the S criteria of a cell using parameter values stored from a different cell of this higher priority PLMN.

If cell selection criterion S in normal coverage is not fulfilled for a cell, UE shall consider itself to be in enhanced coverage if the cell selection criterion S for enhanced coverage is fulfilled, where:

$Q_{rxlevmin}$	UE applies coverage specific value $Q_{rxlevmin_CE}$ (dBm)
$Q_{qualmin}$	UE applies coverage specific value $Q_{qualmin_CE}$ (dB)

If cell selection criteria S in normal coverage is fulfilled for a cell, UE [may] consider itself to be in enhanced coverage if *SystemInformationBlockType1* cannot be acquired but UE is able to acquire *MasterInformationBlock*, *SystemInformationBlockType1-BR* and *SystemInformationBlockType2*.

If cell selection criterion S in normal coverage is not fulfilled for a cell and UE does not consider itself in enhanced coverage based on coverage specific values $Q_{rxlevmin_CE}$ and $Q_{qualmin_CE}$, UE shall consider itself to be in enhanced coverage if UE supports CE Mode B and CE mode B is not restricted by upper layers and the cell selection criterion S for enhanced coverage is fulfilled, where:

$Q_{rxlevmin}$	UE applies coverage specific value $Q_{rxlevmin_CE1}$ (dBm)
$Q_{qualmin}$	UE applies coverage specific value $Q_{qualmin_CE1}$ (dB)

For the UE in enhanced coverage, coverage specific values $Q_{rxlevmin_CE}$ and $Q_{qualmin_CE}$ (or $Q_{rxlevmin_CE1}$ and $Q_{qualmin_CE1}$) are only applied for the suitability check in enhanced coverage (i.e. not used for measurement and reselection thresholds).

6.2.2.1.3 Test description

6.2.2.1.3.1 Pre-test conditions

System Simulator:

- E-UTRA Cell 1, NR Cell 1.
- NR Cell 1 is configured to operate in FR1 bands as defined in TS 38.508-1 [4] clause 6.2.3.
- System information combination 31 as defined in TS 36.508-1 [7] clause 4.4.3.1 is used in E-UTRA Cell.
- System information combination NR-6 as defined in TS 38.508-1 [4] clause 4.4.3.1.3 is used in NR Cell.

UE:

- None.

Preamble:

- With E-UTRA Cell 1 "Serving cell" and NR Cell 1 "Non-suitable "Off" cell" in accordance with TS 38.508-1 [4], Table 6.2.2.1-3, the UE is brought to state RRC_IDLE using generic procedure parameters Connectivity (*E-UTRA/EPC*) and Unrestricted nr PDN (*On*) in accordance with the procedure described in TS 38.508-1 [4], clause 4.5.2. 4G GUTI and eKSI are assigned and security context established.

- the UE is switched-off.
- With E-UTRA Cell 1 "Non-suitable "Off" cell" and NR Cell 1 "Serving cell" in accordance with TS 38.508-1 [4], Table 6.2.2.1-3, the UE is brought to state 1N-A, RRC_IDLE Connectivity (NR), in accordance with the procedure described in TS 38.508-1 [4], Table 4.5.2.2-2. 5G-GUTI and ngKSI are assigned and security context established.

6.2.2.1.3.2 Test procedure sequence

Table 6.2.2.1.3.2-1 illustrates the downlink power levels and other changing parameters to be applied for the cell at various time instants of the test execution. The exact instants on which these values shall be applied are described in the texts in this clause. Row marked "T0" denotes the conditions in the preamble. Configurations marked "T1", "T2" and "T3" are applied at the points indicated in the Main behaviour description in Table 6.2.2.1.3.2-3.

Table 6.2.2.1.3.2-1: Time instances of cell power level and parameter changes for E-UTRA Cell 1 and NR Cell 1 in conducted test environment

	Parameter	Unit	E-UTRA Cell 1	NR Cell 1	Remark
T0	Cell-specific RS EPRE	dBm/15kHz	Off	-	The power level values are assigned to ensure UE registered on NR cell 1
	SS/PBCH SSS EPRE	dBm/SCS	-	-85	
T1	Cell-specific RS EPRE	dBm/15kHz	-85	-	The power level value is such to satisfy $Sr_{xleVNR_{cell\ 1}} < 0$ and ensure UE registered on E-UTRA cell 1
	SS/PBCH SSS EPRE	dBm/SCS	-	-115	
T2	Cell-specific RS EPRE	dBm/15kHz	Off	-	The power level values are assigned to ensure UE registered on NR cell 1
	SS/PBCH SSS EPRE	dBm/SCS	-	-85	
T3	Cell-specific RS EPRE	dBm/15kHz	-85	-	The power level values are assigned to ensure UE registered on E-UTRA cell 1
	SS/PBCH SSS EPRE	dBm/SCS	-	-85	
Note1: Power level "Off" is defined in TS 38.508-1 [4] Table 6.2.2.1-3.					

Table 6.2.2.1.3.2-2: Void

Table 6.2.2.1.3.2-3: Main behaviour

St	Procedure	Message Sequence		TP	Verdict
		U - S	Message		
1	The SS adjusts the E-UTRA and NR Cells power levels according to row "T1" in table 6.2.2.1.3.2-1.	-	-	-	-
2	Check: Does the test result of generic test procedure in TS 38.508-1 [4] Table 4.9.7.2.2-1 indicate that the UE is camped on E-UTRA Cell 1?	-	-	1	P
3	The SS adjusts the E-UTRA and NR Cells power levels according to row "T2" in table 6.2.2.1.3.2-1.	-	-	-	-
4	The test result of generic test procedure in TS 38.508-1 [4] Table 4.9.9.2.2-1 indicate that the UE is camped on NR Cell 1. (NOTE 1)	-	-	-	-
5	The SS changes SIB1 of NR Cell 1 according to table 6.2.2.1.3.3-3 and notifies the UE of change of System Information on NR Cell 1 by sending Short Message on PDCCH using P-RNTI.	<--	PDCCH (DCI 1_0): Short Message	-	-
6	Wait for 2.1* modification period to allow the new system information to take effect.	-	-	-	-

7	The SS adjusts the NR and E-UTRAN Cell power levels according to row "T3" in table 6.2.2.1.3.2-1.	-	-	-	-
8	Check: Does the test result of generic test procedure in TS 38.508-1 [4] Table 4.9.7.2.2-1 indicate that the UE is camped on E-UTRA Cell 1?	-	-	2	P
Note 1: This is the first time in this test case that the UE moves from S1 to N1.					

6.2.2.1.3.3 Specific message contents

Table 6.2.2.1.3.3-1: SIB5 of NR Cell 1(preamble and all steps, Table 6.2.2.1.3.2-3)

Derivation Path: TS 38.508-1 [4], Table 4.6.2-4			
Information Element	Value/remark	Comment	Condition
SIB5 ::= SEQUENCE {			
carrierFreqListEUTRA SEQUENCE (SIZE (1..maxEUTRA-Carrier)) OF CarrierFreqEUTRA {	1 entry		
CarrierFreqEUTRA[1] SEQUENCE {		entry 1	
carrierFreq	Downlink EUTRA ARFCN as E-UTRA Cell 1 used		
}			
}			
}			

Table 6.2.2.1.3.3-2: SystemInformationBlockType24 of EUTRA Cell 1 (preamble and all steps, Table 6.2.2.1.3.2-3)

Derivation path: TS 36.508 [7], Table 4.4.3.3-20			
Information Element	Value/Remark	Comment	Condition
SystemInformationBlockType24-r15 ::= SEQUENCE {			
carrierFreqListNR-r15 SEQUENCE (SIZE (1..maxFreq)) OF CarrierFreqNR-r15 {	1 entry		
CarrierFreqNR-r15[1] SEQUENCE {		entry 1	
carrierFreq-r15	Same downlink SSB ARFCN as used for NR Cell 1		
}			
}			
}			

Table 6.2.2.1.3.3-3: SIB1 for NR Cell 1 (step 5, Table 6.2.2.1.3.2-3)

Derivation Path: TS 38.508-1 [4], Table 4.6.1-28			
Information Element	Value/remark	Comment	Condition
SIB1 ::= SEQUENCE {			
cellAccessRelatedInfo SEQUENCE {			
cellReservedForOtherUse	true	The UE shall treat this cell as if cell status is "barred"	
}			
}			

Table 6.2.2.1.3.3-4: REGISTRATION REQUEST (step 4, Table 6.2.2.1.3.2-3)

Derivation Path: TS 38.508-1 [4], Table 4.9.9.2.3-1.			
Information Element	Value/remark	Comment	Condition
EPS NAS message container	TRACKING AREA UPDATE REQUEST message	See Table 6.2.2.1.3.3-5	

Table 6.2.2.1.3.3-5: TRACKING AREA UPDATE REQUEST (Table 6.2.2.1.3.3-4)

Derivation Path: TS 38.508-1 [4], Table 4.9.9.2.3-2 with condition Mapped EPS security context.

6.2.2.2 Inter-RAT cell selection / From E-UTRA_Idle to NR RRC_IDLE / Serving cell becomes non-suitable

6.2.2.2.1 Test Purpose (TP)

(1)

```
with { UE in E-UTRA RRC_IDLE state }
ensure that {
  when { the serving cell becomes non-suitable and there is a suitable NR neighbour cell }
  then { UE selects the suitable NR neighbour cell }
}
```

(2)

```
with { UE in E-UTRA RRC_IDLE state }
ensure that {
  when { the serving cell becomes barred and there is a suitable NR neighbour cell }
  then { UE selects the suitable NR neighbour cell }
}
```

6.2.2.2.2 Conformance requirements

References: The conformance requirements covered in the present TC are specified in: 3GPP TS 38.304, clause 5.2.1, 5.2.3.1, 5.2.3.2 and TS 36.304, clause 5.2.1, 5.2.3.1, 5.2.3.2. Unless otherwise stated these are Rel-15 requirements.

[TS 38.304, clause 5.2.1]

UE shall perform measurements for cell selection and reselection purposes as specified in TS 38.133 [8].

When evaluating S_{rxlev} and S_{qual} of non-serving cells for reselection evaluation purposes, the UE shall use parameters provided by the serving cell and for the final check on cell selection criterion, the UE shall use parameters provided by the target cell for cell reselection.

The NAS can control the RAT(s) in which the cell selection should be performed, for instance by indicating RAT(s) associated with the selected PLMN, and by maintaining a list of forbidden registration area(s) and a list of equivalent PLMNs. The UE shall select a suitable cell based on RRC_IDLE or RRC_INACTIVE state measurements and cell selection criteria.

In order to expedite the cell selection process, stored information for several RATs, if available, may be used by the UE.

When camped on a cell, the UE shall regularly search for a better cell according to the cell reselection criteria. If a better cell is found, that cell is selected. The change of cell may imply a change of RAT. Details on performance requirements for cell reselection can be found in TS 38.133 [8].

The NAS is informed if the cell selection and reselection result in changes in the received system information relevant for NAS.

For normal service, the UE shall camp on a suitable cell, monitor control channel(s) of that cell so that the UE can:

- receive system information from the PLMN or SNPN; and
- receive registration area information from the PLMN or SNPN, e.g., tracking area information; and
- receive other AS and NAS Information; and
- if registered:
 - receive paging and notification messages from the PLMN or SNPN; and
 - initiate transfer to Connected mode.

For cell selection in multi-beam operations, measurement quantity of a cell is up to UE implementation.

For cell reselection in multi-beam operations, including inter-RAT reselection from E-UTRA to NR, the measurement quantity of this cell is derived amongst the beams corresponding to the same cell based on SS/PBCH block as follows:

- if *nrofSS-BlocksToAverage* (*maxRS-IndexCellQual* in E-UTRA) is not configured in *SIB2/SIB4* (*SIB24* in E-UTRA); or
- if *absThreshSS-BlocksConsolidation* (*threshRS-Index* in E-UTRA) is not configured in *SIB2/SIB4* (*SIB24* in E-UTRA); or
- if the highest beam measurement quantity value is below or equal to *absThreshSS-BlocksConsolidation* (*threshRS-Index* in E-UTRA):
 - derive a cell measurement quantity as the highest beam measurement quantity value, where each beam measurement quantity is described in TS 38.215 [11].
- else:
 - derive a cell measurement quantity as the linear average of the power values of up to *nrofSS-BlocksToAverage* (*maxRS-IndexCellQual* in E-UTRA) of highest beam measurement quantity values above *absThreshSS-BlocksConsolidation* (*threshRS-Index* in E-UTRA).

[TS 38.304, clause 5.2.3.1]

Cell selection is performed by one of the following two procedures:

- a) Initial cell selection (no prior knowledge of which RF channels are NR frequencies):
 1. The UE shall scan all RF channels in the NR bands according to its capabilities to find a suitable cell.
 2. On each frequency, the UE need only search for the strongest cell, except for operation with shared spectrum channel access where the UE may search for the next strongest cell(s).
 3. Once a suitable cell is found, this cell shall be selected.
- b) Cell selection by leveraging stored information:
 1. This procedure requires stored information of frequencies and optionally also information on cell parameters from previously received measurement control information elements or from previously detected cells.
 2. Once the UE has found a suitable cell, the UE shall select it.
 3. If no suitable cell is found, the initial cell selection procedure in a) shall be started.

NOTE: Priorities between different frequencies or RATs provided to the UE by system information or dedicated signalling are not used in the cell selection process.

[TS 38.304, clause 5.2.3.2]

The cell selection criterion *S* is fulfilled when:

$$S_{rxlev} > 0 \text{ AND } S_{qual} > 0$$

where:

$$S_{rxlev} = Q_{rxlevmeas} - (Q_{rxlevmin} + Q_{rxlevminoffset}) - P_{compensation} - Q_{offsettemp}$$

$$S_{qual} = Q_{qualmeas} - (Q_{qualmin} + Q_{qualminoffset}) - Q_{offsettemp}$$

where:

S_{rxlev}	Cell selection RX level value (dB)
S_{qual}	Cell selection quality value (dB)
$Q_{offsettemp}$	Offset temporarily applied to a cell as specified in TS 38.331 [3] (dB)
$Q_{rxlevmeas}$	Measured cell RX level value (RSRP)
$Q_{qualmeas}$	Measured cell quality value (RSRQ)

$Q_{rxlevmin}$	Minimum required RX level in the cell (dBm). If the UE supports SUL frequency for this cell, $Q_{rxlevmin}$ is obtained from $q-RxLevMinSUL$, if present, in <i>SIB1</i> , <i>SIB2</i> and <i>SIB4</i> , additionally, if $Q_{rxlevminoffsetcellSUL}$ is present in <i>SIB3</i> and <i>SIB4</i> for the concerned cell, this cell specific offset is added to the corresponding $Q_{rxlevmin}$ to achieve the required minimum RX level in the concerned cell; else $Q_{rxlevmin}$ is obtained from $q-RxLevMin$ in <i>SIB1</i> , <i>SIB2</i> and <i>SIB4</i> , additionally, if $Q_{rxlevminoffsetcell}$ is present in <i>SIB3</i> and <i>SIB4</i> for the concerned cell, this cell specific offset is added to the corresponding $Q_{rxlevmin}$ to achieve the required minimum RX level in the concerned cell.
$Q_{qualmin}$	Minimum required quality level in the cell (dB). Additionally, if $Q_{qualminoffsetcell}$ is signalled for the concerned cell, this cell specific offset is added to achieve the required minimum quality level in the concerned cell.
$Q_{rxlevminoffset}$	Offset to the signalled $Q_{rxlevmin}$ taken into account in the S_{rxlev} evaluation as a result of a periodic search for a higher priority PLMN while camped normally in a VPLMN, as specified in TS 23.122 [9].
$Q_{qualminoffset}$	Offset to the signalled $Q_{qualmin}$ taken into account in the S_{qual} evaluation as a result of a periodic search for a higher priority PLMN while camped normally in a VPLMN, as specified in TS 23.122 [9].
$P_{compensation}$	For FR1, if the UE supports the additional P_{max} in the NR-NS- $P_{maxList}$, if present, in <i>SIB1</i> , <i>SIB2</i> and <i>SIB4</i> : $max(P_{EMAX1} - P_{PowerClass}, 0) - (min(P_{EMAX2}, P_{PowerClass}) - min(P_{EMAX1}, P_{PowerClass}))$ (dB); else: $max(P_{EMAX1} - P_{PowerClass}, 0)$ (dB) For FR2, $P_{compensation}$ is set to 0.
P_{EMAX1} , P_{EMAX2}	Maximum TX power level of a UE may use when transmitting on the uplink in the cell (dBm) defined as P_{EMAX} in TS 38.101 [15]. If UE supports SUL frequency for this cell, P_{EMAX1} and P_{EMAX2} are obtained from the $p-Max$ for SUL in <i>SIB1</i> and <i>NR-NS-PmaxList</i> for SUL respectively in <i>SIB1</i> , <i>SIB2</i> and <i>SIB4</i> as specified in TS 38.331 [3], else P_{EMAX1} and P_{EMAX2} are obtained from the $p-Max$ and <i>NR-NS-PmaxList</i> respectively in <i>SIB1</i> , <i>SIB2</i> and <i>SIB4</i> for normal UL as specified in TS 38.331 [3].
$P_{PowerClass}$	Maximum RF output power of the UE (dBm) according to the UE power class as defined in TS 38.101-1 [15].

The signalled values $Q_{rxlevminoffset}$ and $Q_{qualminoffset}$ are only applied when a cell is evaluated for cell selection as a result of a periodic search for a higher priority PLMN while camped normally in a VPLMN (TS 23.122 [9]). During this periodic search for higher priority PLMN, the UE may check the S criteria of a cell using parameter values stored from a different cell of this higher priority PLMN.

[TS 36.304, clause 5.2.1]

UE shall perform measurements for cell selection and reselection purposes as specified in TS 36.133 [10].

The NAS can control the RAT(s) in which the cell selection should be performed, for instance by indicating RAT(s) associated with the selected PLMN, and by maintaining a list of forbidden registration area(s) and a list of equivalent PLMNs. The UE shall select a suitable cell based on idle mode measurements and cell selection criteria.

In order to speed up the cell selection process, stored information for several RATs may be available in the UE.

When camped on a cell, the UE shall regularly search for a better cell according to the cell reselection criteria. If a better cell is found, that cell is selected. The change of cell may imply a change of RAT, or if the current and selected cell are both E-UTRA cells, a change of the CN type. Details on performance requirements for cell reselection can be found in TS 36.133 [10].

The NAS is informed if the cell selection and reselection results in changes in the received system information relevant for NAS.

For normal service, the UE shall camp on a suitable cell, tune to that cell's control channel(s) so that the UE can:

- Receive system information from the PLMN; and

- receive registration area information from the PLMN, e.g., tracking area information; and
- receive other AS and NAS Information; and
- if registered:
 - receive paging and notification messages from the PLMN; and
 - initiate transfer to connected mode.

[TS 36.304, clause 5.2.3.1]

The UE shall use one of the following two cell selection procedures:

a) Initial Cell Selection

This procedure requires no prior knowledge of which RF channels are E-UTRA or NB-IoT carriers. The UE shall scan all RF channels in the E-UTRA bands according to its capabilities to find a suitable cell. On each carrier frequency, the UE need only search for the strongest cell. Once a suitable cell is found this cell shall be selected.

b) Stored Information Cell Selection

This procedure requires stored information of carrier frequencies and optionally also information on cell parameters, from previously received measurement control information elements or from previously detected cells. Once the UE has found a suitable cell the UE shall select it. If no suitable cell is found the Initial Cell Selection procedure shall be started.

NOTE 1: Priorities between different frequencies or RATs provided to the UE by system information or dedicated signalling are not used in the cell selection process.

NOTE 2: If BL UE, UE in enhanced coverage or NB-IoT UE has been provisioned with EARFCN, the UE may use this information during Initial Cell Selection and Stored Information Cell Selection to find a suitable cell.

[TS 36.304, clause 5.2.3.2]

For NB-IoT the cell selection criterion is defined in clause 5.2.3.2a.

The cell selection criterion S in normal coverage is fulfilled when:

$$S_{rxlev} > 0 \text{ AND } S_{qual} > 0$$

where:

$$S_{rxlev} = Q_{rxlevmeas} - (Q_{rxlevmin} + Q_{rxlevminoffset}) - P_{compensation} - Q_{offset_{temp}}$$

$$S_{qual} = Q_{qualmeas} - (Q_{qualmin} + Q_{qualminoffset}) - Q_{offset_{temp}}$$

where:

S_{rxlev}	Cell selection RX level value (dB)
S_{qual}	Cell selection quality value (dB)
$Q_{offset_{temp}}$	Offset temporarily applied to a cell as specified in TS 36.331 [3] (dB)
$Q_{rxlevmeas}$	Measured cell RX level value (RSRP)
$Q_{qualmeas}$	Measured cell quality value (RSRQ)
$Q_{rxlevmin}$	Minimum required RX level in the cell (dBm)
$Q_{qualmin}$	Minimum required quality level in the cell (dB)
$Q_{rxlevminoffset}$	Offset to the signalled $Q_{rxlevmin}$ taken into account in the S_{rxlev} evaluation as a result of a periodic search for a higher priority PLMN while camped normally in a VPLMN TS 23.122 [5]
$Q_{qualminoffset}$	Offset to the signalled $Q_{qualmin}$ taken into account in the S_{qual} evaluation as a result of a periodic search for a higher priority PLMN while camped normally in a VPLMN TS 23.122 [5]
$P_{compensation}$	If the UE supports the <i>additionalPmax</i> in the <i>NS-PmaxList</i> , if present, in SIB1, SIB3 and SIB5: $\max(P_{EMAX1} - P_{PowerClass}, 0) - (\min(P_{EMAX2}, P_{PowerClass}) - \min(P_{EMAX1}, P_{PowerClass}))$ (dB);

	else: if $P_{PowerClass}$ is 14 dBm: $\max(P_{EMAX1} - (P_{PowerClass} - P_{offset}), 0)$ (dB); else: $\max(P_{EMAX1} - P_{PowerClass}, 0)$ (dB)
P_{EMAX1}, P_{EMAX2}	Maximum TX power level an UE may use when transmitting on the uplink in the cell (dBm) defined as P_{EMAX} in TS 36.101 [33]. P_{EMAX1} and P_{EMAX2} are obtained from the <i>p-Max</i> and the <i>NS-PmaxList</i> respectively in SIB1, SIB3 and SIB5 as specified in TS 36.331 [3].
$P_{PowerClass}$	Maximum RF output power of the UE (dBm) according to the UE power class as defined in TS 36.101 [33]

The signalled values $Q_{rxlevminoffset}$ and $Q_{qualminoffset}$ are only applied when a cell is evaluated for cell selection as a result of a periodic search for a higher priority PLMN while camped normally in a VPLMN TS 23.122 [5]. During this periodic search for higher priority PLMN the UE may check the S criteria of a cell using parameter values stored from a different cell of this higher priority PLMN.

If cell selection criterion S in normal coverage is not fulfilled for a cell, UE shall consider itself to be in enhanced coverage if the cell selection criterion S for enhanced coverage is fulfilled, where:

$Q_{rxlevmin}$	UE applies coverage specific value $Q_{rxlevmin_CE}$ (dBm)
$Q_{qualmin}$	UE applies coverage specific value $Q_{qualmin_CE}$ (dB)

If cell selection criteria S in normal coverage is fulfilled for a cell, UE [may] consider itself to be in enhanced coverage if *SystemInformationBlockType1* cannot be acquired but UE is able to acquire *MasterInformationBlock*, *SystemInformationBlockType1-BR* and *SystemInformationBlockType2*.

If cell selection criterion S in normal coverage is not fulfilled for a cell and UE does not consider itself in enhanced coverage based on coverage specific values $Q_{rxlevmin_CE}$ and $Q_{qualmin_CE}$, UE shall consider itself to be in enhanced coverage if UE supports CE Mode B and CE mode B is not restricted by upper layers and the cell selection criterion S for enhanced coverage is fulfilled, where:

$Q_{rxlevmin}$	UE applies coverage specific value $Q_{rxlevmin_CE1}$ (dBm)
$Q_{qualmin}$	UE applies coverage specific value $Q_{qualmin_CE1}$ (dB)

For the UE in enhanced coverage, coverage specific values $Q_{rxlevmin_CE}$ and $Q_{qualmin_CE}$ (or $Q_{rxlevmin_CE1}$ and $Q_{qualmin_CE1}$) are only applied for the suitability check in enhanced coverage (i.e. not used for measurement and reselection thresholds).

6.2.2.2.3 Test description

6.2.2.2.3.1 Pre-test conditions

System Simulator:

- E-UTRA Cell 1, NR Cell 1.
- NR Cell 1 is configured to operate in FR1 bands as defined in TS 38.508-1 [4] clause 6.2.3.
- System information combination 31 as defined in TS 36.508-1 [7] clause 4.4.3.1 is used in E-UTRA Cell.
- System information combination NR-6 as defined in TS 38.508-1 [4] clause 4.4.3.1.3 is used in NR Cell.

UE:

- None.

Preamble:

- With E-UTRA Cell 1 "Non-suitable "Off" cell" and NR Cell 1 "Serving cell" in accordance with TS 38.508-1 [4], Table 6.2.2.2-3, the UE is brought to state 1N-A, RRC_IDLE Connectivity (NR), in accordance with the

procedure described in TS 38.508-1 [4], Table 4.5.2.2-2. 5G-GUTI and ngKSI are assigned and security context established.

- The UE is switched-off
- With E-UTRA Cell 1 "Serving cell" and NR Cell 1 "Non-suitable "Off" cell" in accordance with TS 38.508-1 [4], Table 6.2.2.2-3, the UE is brought to state RRC_IDLE using generic procedure parameters Connectivity (E-UTRA/EPC) and Unrestricted nr PDN (*On*) in accordance with the procedure described in TS 38.508-1 [4], clause 4.5.2. 4G GUTI and eKSI are assigned and security context established.

6.2.2.2.3.2 Test procedure sequence

Table 6.2.2.2.3.2-1 illustrates the downlink power levels and other changing parameters to be applied for the cell at various time instants of the test execution. The exact instants on which these values shall be applied are described in the texts in this clause. Row marked "T0" denotes the conditions in the preamble. Configurations marked "T1", "T2" and "T3" are applied at the points indicated in the Main behaviour description in Table 6.2.2.2.3.2-3.

Table 6.2.2.2.3.2-1: Time instances of cell power level and parameter changes for E-UTRA Cell 1 and NR Cell 1 in conducted test environment

	Parameter	Unit	E-UTRA Cell 1	NR Cell 1	Remark
T0	Cell-specific RS EPRE	dBm/15kHz	-85	-	The power level values are assigned to ensure UE registered on E-UTRA cell 1
	SS/PBCH SSS EPRE	dBm/SCS	-	Off	
T1	Cell-specific RS EPRE	dBm/15kHz	-115	-	The power level value is such to satisfy $Srxlev_{E-UTRA\ cell\ 1} < 0$ and ensure UE registered on NR cell 1
	SS/PBCH SSS EPRE	dBm/SCS	-	-85	
T2	Cell-specific RS EPRE	dBm/15kHz	-85	-	The power level values are assigned to ensure UE registered on E-UTRA cell 1
	SS/PBCH SSS EPRE	dBm/SCS	-	Off	
T3	Cell-specific RS EPRE	dBm/15kHz	-85	-	The power level values are assigned to ensure UE registered on NR cell 1
	SS/PBCH SSS EPRE	dBm/SCS	-	-85	
Note1: Power level "Off" is defined in TS 38.508-1 [4] Table 6.2.2.1-3.					

Table 6.2.2.2.3.2-2: Void

Table 6.2.2.2.3.2-3: Main behaviour

St	Procedure	Message Sequence		TP	Verdict
		U - S	Message		
1	The SS adjusts the E-UTRA and NR Cells power levels according to row "T1" in table 6.2.2.2.3.2-1.	-	-	-	-
2	Check: Does the test result of generic test procedure in TS 38.508-1 [4] Table 4.9.9.2.2-1 indicate that the UE is camped on NR Cell 1?. (NOTE 1)	-	-	1	P
3	The SS adjusts the E-UTRA and NR Cells power levels according to row "T2" in table 6.2.2.2.3.2-1.	-	-	-	-
4	The test result of generic test procedure in TS 38.508-1 [4] Table 4.9.7.2.2-1 indicate that the UE is camped on E-UTRA Cell 1.	-	-	-	-
5	The SS changes <i>SystemInformationBlockType1</i> of E-UTRA Cell 1 according to table 6.2.2.2.3.3-3 and notifies the UE of change of System	<--	<i>Paging</i>	-	-

	Information on E-UTRA Cell 1.				
6	The SS adjusts the E-UTRA and NR Cells power levels according to row "T3" in table 6.2.2.2.3.2-1.	-	-	-	-
7	Check: Does the test result of generic test procedure in TS 38.508-1 [4] Table 4.9.9.2.2-1 indicate that the UE is camped on NR Cell 1?	-	-	2	P
Note 1: This is the first time in this test case that the UE moves from S1 to N1.					

6.2.2.2.3.3 Specific message contents

Table 6.2.2.2.3.3-1: SIB5 of NR Cell 1(preamble and all steps, Table 6.2.2.2.3.2-3)

Derivation Path: TS 38.508-1 [4], Table 4.6.2-4			
Information Element	Value/remark	Comment	Condition
SIB5 ::= SEQUENCE {			
carrierFreqListEUTRA SEQUENCE (SIZE (1..maxEUTRA-Carrier)) OF CarrierFreqEUTRA {			
CarrierFreqEUTRA[1] SEQUENCE {		entry 1	
carrierFreq	Downlink EUTRA ARFCN as E-UTRA Cell 1 used		
}			
}			
}			

Table 6.2.2.2.3.3-2: SystemInformationBlockType24 of EUTRA Cell 1 (preamble and all steps, Table 6.2.2.2.3.2-3)

Derivation path: TS 36.508 [7], Table 4.4.3.3-20			
Information Element	Value/Remark	Comment	Condition
SystemInformationBlockType24-r15 ::= SEQUENCE {			
carrierFreqListNR-r15 SEQUENCE (SIZE (1..maxFreq)) OF CarrierFreqNR-r15 {	1 entry		
CarrierFreqNR-r15[1] SEQUENCE {		entry 1	
carrierFreq-r15	Same downlink SSB ARFCN as used for NR Cell 1		
}			
}			
}			

Table 6.2.2.2.3.3-3: SystemInformationBlockType1 for E-UTRA Cell 1 (step 5, Table 6.2.2.2.3.2-3)

Derivation Path: TS 36.508-1 [7], Table 4.4.3.2-3			
Information Element	Value/remark	Comment	Condition
SystemInformationBlockType1 ::= SEQUENCE {			
cellAccessRelatedInfo SEQUENCE {			
cellBarred	barred		
}			
}			

Table 6.2.2.2.3.3-4: REGISTRATION REQUEST (step 4, Table 6.2.2.2.3.2-3)

Derivation Path: TS 38.508-1 [4], Table 4.9.9.2.3-1.			
Information Element	Value/remark	Comment	Condition
EPS NAS message container	TRACKING AREA UPDATE REQUEST message	See Table 6.2.2.2.3.3-5	

Table 6.2.2.3.3-5: TRACKING AREA UPDATE REQUEST (Table 6.2.2.3.3-4)

Derivation Path: TS 38.508-1 [4], Table 4.9.9.2.3-2 with condition Mapped EPS security context.

6.2.3 Inter-RAT Cell Reselection

6.2.3.1 Inter-RAT cell reselection / From E-UTRA_IDLE to NR RRC_IDLE (lower priority & higher priority, Srxlev based)

6.2.3.1.1 Test Purpose (TP)

(1)

```
with { UE in E-UTRA RRC_Idle state }
ensure that {
  when { UE detects the cell re-selection criteria are met for the cell which belongs to the lower
priority inter-RAT NR cell }
  then { UE reselects the cell which belongs to the lower priority inter-RAT NR cell }
}
```

(2)

```
with { UE in E-UTRA RRC_Idle state }
ensure that {
  when { UE detects the cell re-selection criteria are met for the cell which belongs to the higher
priority inter-RAT NR cell }
  then { UE reselects the cell which belongs to the higher priority inter-RAT NR cell }
}
```

6.2.3.1.2 Conformance requirements

References: The conformance requirements covered in the present TC are specified in: 3GPP TS 36.304, clause 5.2.4.1, 5.2.4.2 and 5.2.4.5. Unless otherwise stated these are Rel-15 requirements.

[TS 36.304, clause 5.2.4.1]

Absolute priorities of different E-UTRAN frequencies or inter-RAT frequencies may be provided to the UE in the system information, in the *RRCCConnectionRelease* message, or by inheriting from another RAT at inter-RAT cell (re)selection. In the case of system information, an E-UTRAN frequency or inter-RAT frequency may be listed without providing a priority (i.e. the field *cellReselectionPriority* is absent for that frequency). If priorities are provided in dedicated signalling, the UE shall ignore all the priorities provided in system information. If UE is in *camped on any cell* state, UE shall only apply the priorities provided by system information from current cell, and the UE preserves priorities provided by dedicated signalling and *deprioritisationReq* received in *RRCCConnectionReject* unless specified otherwise. When the UE in *camped normally* state, has only dedicated priorities other than for the current frequency, the UE shall consider the current frequency to be the lowest priority frequency (i.e. lower than any of the network configured values). While the UE is camped on a suitable CSG cell in normal coverage, the UE shall always consider the current frequency to be the highest priority frequency (i.e. higher than any of the network configured values), irrespective of any other priority value allocated to this frequency. When the HSDN capable UE is in High-mobility state, the UE shall always consider the HSDN cells to be the highest priority (i.e. higher than any other network configured priorities). When the HSDN capable UE is not in High-mobility state, the UE shall always consider HSDN cells to be the lowest priority (i.e. lower than network configured priorities). If the UE capable of sidelink communication is configured to perform sidelink communication and can only perform the sidelink communication while camping on a frequency, the UE may consider that frequency to be the highest priority. If the UE capable of V2X sidelink communication is configured to perform V2X sidelink communication and can only perform the V2X sidelink communication while camping on a frequency, the UE may consider that frequency to be the highest priority. If the UE capable of V2X sidelink communication is configured to perform V2X sidelink communication and can only use pre-configuration while not camping on a frequency, the UE may consider the frequency providing inter-carrier V2X sidelink configuration to be the highest priority. If the UE capable of sidelink discovery is configured to perform Public Safety related sidelink discovery and can only perform the Public Safety related sidelink discovery while camping on a frequency, the UE may consider that frequency to be the highest priority.

NOTE 1: The prioritization among the frequencies which UE considers to be the highest priority frequency is left to UE implementation.

If the UE is capable either of MBMS Service Continuity or of SC-PTM reception and is receiving or interested to receive an MBMS service and can only receive this MBMS service while camping on a frequency on which it is provided, the UE may consider that frequency to be the highest priority during the MBMS session TS 36.300 [2] as long as the two following conditions are fulfilled:

1) Either:

- the UE is capable of MBMS service continuity and the reselected cell is broadcasting SIB13; or
- the UE is capable of SC-PTM reception and the reselected cell is broadcasting SIB20;

2) Either:

- SIB15 of the serving cell indicates for that frequency one or more MBMS SAIs included and associated with that frequency in the MBMS User Service Description (USD) TS 26.346 [22] of this service; or
- SIB15 is not broadcast in the serving cell and that frequency is included in the USD of this service.

If the UE is capable either of MBMS Service Continuity or of SC-PTM reception and is receiving or interested to receive an MBMS service provided on a downlink only MBMS frequency, on a frequency used by dedicated MBMS cells, on a frequency used by FeMBMS/Unicast-mixed cells as defined in TS 36.300 [2], or on a frequency belonging to PLMN different from its registered PLMN, the UE may consider cell reselection candidate frequencies at which it can not receive the MBMS service to be of the lowest priority during the MBMS session TS 36.300 [2], as long as the above mentioned condition 1) is fulfilled for the cell on the MBMS frequency which the UE monitors or this cell broadcasts SIB1-MBMS and as long as the above mentioned condition 2) is fulfilled for the serving cell.

NOTE 2: Example scenarios in which the previous down-prioritisation may be needed concerns the cases where camping is not possible, while the UE can only receive this MBMS frequency when camping on a subset of cell reselection candidate frequencies, e.g. the MBMS frequency is a downlink only carrier, the MBMS frequency is used by dedicated MBMS cells, the MBMS frequency is used by FeMBMS/Unicast-mixed cells TS 36.300 [2], or the MBMS frequency belongs to a PLMN different from UE's registered PLMN.

If the UE is not capable of MBMS Service Continuity but has knowledge on which frequency an MBMS service of interest is provided, it may consider that frequency to be the highest priority during the MBMS session TS 36.300 [2] as long as the reselected cell is broadcasting SIB13.

If the UE is not capable of MBMS Service Continuity but has knowledge on which downlink only frequency, on which frequency used by dedicated MBMS cells, on which frequency used by FeMBMS/Unicast-mixed cells as defined in TS 36.300 [2] or on which frequency belonging to PLMN different from its registered PLMN an MBMS service of interest is provided, it may consider cell reselection candidate frequencies at which it can not receive the MBMS service to be of the lowest priority during the MBMS session TS 36.300 [2] as long as the cell on the MBMS frequency which the UE monitors is broadcasting SIB13 or SIB1-MBMS.

NOTE 3: The UE considers that the MBMS session is ongoing using the session start and end times as provided by upper layers in the USD i.e. the UE does not verify if the session is indicated on MCCH.

In case UE receives *RRCConnectionReject* with *deprioritisationReq*, UE shall consider current carrier frequency and stored frequencies due to the previously received *RRCConnectionReject* with *deprioritisationReq* or all the frequencies of EUTRA to be the lowest priority frequency (i.e. lower than any of the network configured values) while T325 is running irrespective of camped RAT. The UE shall delete the stored deprioritisation request(s) when a PLMN selection is performed on request by NAS TS 23.122 [5].

NOTE 4: Connecting to CDMA2000 does not imply PLMN selection.

NOTE 5: UE should search for a higher priority layer for cell reselection as soon as possible after the change of priority. The minimum related performance requirements specified in TS 36.133 [10] are still applicable.

The UE shall delete priorities provided by dedicated signalling when:

- the UE enters a different RRC state; or
- the optional validity time of dedicated priorities (T320) expires; or

- a PLMN selection is performed on request by NAS TS 23.122 [5].

NOTE 6: Equal priorities between RATs are not supported.

The UE shall only perform cell reselection evaluation for E-UTRAN frequencies and inter-RAT frequencies that are given in system information and for which the UE has a priority provided.

The UE shall not consider any black listed cells as candidate for cell reselection.

The UE shall inherit the priorities provided by dedicated signalling and the remaining validity time (i.e., T320 in E-UTRA and NR, T322 in UTRA and T3230 in GERAN), if configured, at inter-RAT cell (re)selection.

NOTE 7: The network may assign dedicated cell reselection priorities for frequencies not configured by system information.

While T360 is running, redistribution target is considered to be the highest priority (i.e. higher than any of the network configured values). UE shall continue to consider the serving frequency as the highest priority until completion of E-UTRAN Inter-frequency Redistribution procedure specified in 5.2.4.10 if triggered on T360 expiry/ stop.

[TS 36.304, clause 5.2.4.2]

For NB-IoT measurement rules for cell re-selection is defined in sub-clause 5.2.4.2.a.

When evaluating S_{rxlev} and S_{qual} of non-serving cells for reselection purposes, the UE shall use parameters provided by the serving cell.

Following rules are used by the UE to limit needed measurements:

- If the serving cell fulfils $S_{rxlev} > S_{IntraSearchP}$ and $S_{qual} > S_{IntraSearchQ}$, the UE may choose not to perform intra-frequency measurements.
- Otherwise, the UE shall perform intra-frequency measurements.
- The UE shall apply the following rules for E-UTRAN inter-frequencies and inter-RAT frequencies which are indicated in system information and for which the UE has priority provided as defined in 5.2.4.1:
 - For an E-UTRAN inter-frequency or inter-RAT frequency with a reselection priority higher than the reselection priority of the current E-UTRA frequency the UE shall perform measurements of higher priority E-UTRAN inter-frequency or inter-RAT frequencies according to TS 36.133 [10].
 - For an E-UTRAN inter-frequency with an equal or lower reselection priority than the reselection priority of the current E-UTRA frequency and for inter-RAT frequency with lower reselection priority than the reselection priority of the current E-UTRAN frequency:
 - If the serving cell fulfils $S_{rxlev} > S_{nonIntraSearchP}$ and $S_{qual} > S_{nonIntraSearchQ}$, the UE may choose not to perform measurements of E-UTRAN inter-frequencies or inter-RAT frequency cells of equal or lower priority unless the UE is triggered to measure an E-UTRAN inter-frequency which is configured with *redistributionInterFreqInfo*.
 - Otherwise, the UE shall perform measurements of E-UTRAN inter-frequencies or inter-RAT frequency cells of equal or lower priority according to TS 36.133 [10].
- If the UE supports relaxed monitoring and *s-SearchDeltaP* is present in *SystemInformationBlockType3*, the UE may further limit the needed measurements, as specified in sub-clause 5.2.4.12.

[TS 36.304, clause 5.2.4.5]

For NB-IoT inter-frequency cell reselection shall be based on ranking as defined in sub-clause 5.2.4.6.

If *threshServingLowQ* is provided in *SystemInformationBlockType3* and more than 1 second has elapsed since the UE camped on the current serving cell, cell reselection to a cell on a higher priority E-UTRAN frequency or inter-RAT frequency than the serving frequency shall be performed if:

- A cell of a higher priority EUTRAN, NR or UTRAN FDD RAT/ frequency fulfils $S_{qual} > Thresh_{X, HighQ}$ during a time interval $T_{reselectionRAT}$; or

- A cell of a higher priority UTRAN TDD, GERAN or CDMA2000 RAT/ frequency fulfils $Srxlev > Thresh_{X, HighP}$ during a time interval $Treselection_{RAT}$.

Otherwise, cell reselection to a cell on a higher priority E-UTRAN frequency or inter-RAT frequency than the serving frequency shall be performed if:

- A cell of a higher priority RAT/ frequency fulfils $Srxlev > Thresh_{X, HighP}$ during a time interval $Treselection_{RAT}$; and
- More than 1 second has elapsed since the UE camped on the current serving cell.

Cell reselection to a cell on an equal priority E-UTRAN frequency shall be based on ranking for Intra-frequency cell reselection as defined in sub-clause 5.2.4.6.

If *threshServingLowQ* is provided in *SystemInformationBlockType3* and more than 1 second has elapsed since the UE camped on the current serving cell, cell reselection to a cell on a lower priority E-UTRAN frequency or inter-RAT frequency than the serving frequency shall be performed if:

- The serving cell fulfils $Squal < Thresh_{Serving, LowQ}$ and a cell of a lower priority EUTRAN, NR or UTRAN FDD RAT/ frequency fulfils $Squal > Thresh_{X, LowQ}$ during a time interval $Treselection_{RAT}$; or
- The serving cell fulfils $Squal < Thresh_{Serving, LowQ}$ and a cell of a lower priority UTRAN TDD, GERAN or CDMA2000 RAT/ frequency fulfils $Srxlev > Thresh_{X, LowP}$ during a time interval $Treselection_{RAT}$.

Otherwise, cell reselection to a cell on a lower priority E-UTRAN frequency or inter-RAT frequency than the serving frequency shall be performed if:

- The serving cell fulfils $Srxlev < Thresh_{Serving, LowP}$ and a cell of a lower priority RAT/ frequency fulfils $Srxlev > Thresh_{X, LowP}$ during a time interval $Treselection_{RAT}$; and
- More than 1 second has elapsed since the UE camped on the current serving cell.

Cell reselection to a higher priority RAT/ frequency shall take precedence over a lower priority RAT/ frequency, if multiple cells of different priorities fulfil the cell reselection criteria.

The UE shall not perform cell reselection to NR or UTRAN FDD cells for which the cell selection criterion S is not fulfilled.

For cdma2000 RATs, $Srxlev$ is equal to $-FLOOR(-2 \times 10 \times \log_{10} Ec/Io)$ in units of 0.5 dB, as defined in [18], with Ec/Io referring to the value measured from the evaluated cell.

For cdma2000 RATs, $Thresh_{X, HighP}$ and $Thresh_{X, LowP}$ are equal to -1 times the values signalled for the corresponding parameters in the system information.

In all the above criteria the value of $Treselection_{RAT}$ is scaled when the UE is in the medium or high mobility state as defined in subclause 5.2.4.3.1. If more than one cell meets the above criteria, the UE shall reselect a cell as follows:

- If the highest-priority frequency is an E-UTRAN frequency, a cell ranked as the best cell among the cells on the highest priority frequency(ies) meeting the criteria according to clause 5.2.4.6;
- If the highest-priority frequency is from another RAT, a cell ranked as the best cell among the cells on the highest priority frequency(ies) meeting the criteria of that RAT.

Cell reselection to another RAT, for which $Squal$ based cell reselection parameters are broadcast in system information, shall be performed based on the $Squal$ criteria if the UE supports $Squal$ (RSRQ) based cell reselection to E-UTRAN from all the other RATs provided by system information which UE supports. Otherwise, cell reselection to another RAT shall be performed based on $Srxlev$ criteria.

Cell reselection to NR, for which a cell reselection parameter, *q-RxLevMinSUL* is broadcast in system information and the UE supports SUL, shall be performed based on $Srxlev$ criteria taking the parameter into account.

6.2.3.1.3 Test description

6.2.3.1.3.1 Pre-test conditions

System Simulator:

- E-UTRA Cell 1, NR Cell 1.
- NR Cell 1 is configured to operate in FR1 bands as defined in TS 38.508-1 [4] clause 6.2.3.
- System information combination 31 as defined in TS 36.508-1 [7] clause 4.4.3.1 is used in E-UTRA Cell.
- System information combination NR-6 as defined in TS 38.508-1 [4] clause 4.4.3.1.3 is used in NR Cell.

UE:

- None.

Preamble:

- With E-UTRA Cell 1 "Non-suitable "Off" cell" and NR Cell 1 "Serving cell" in accordance with TS 38.508-1 [4], Table 6.2.2.1-3, the UE is brought to state 1N-A, RRC_IDLE Connectivity (NR), in accordance with the procedure described in TS 38.508-1 [4], Table 4.5.2.2-2. 5G-GUTI and ngKSI are assigned and security context established.
 - the UE is switched-off
- With E-UTRA Cell 1 "Serving cell" and NR Cell 1 "Non-suitable "Off" cell" in accordance with TS 38.508-1 [4], Table 6.2.2.1-3, the UE is brought to state RRC_IDLE using generic procedure parameters Connectivity (*E-UTRA/EPC*) and Unrestricted nr PDN (*On*) in accordance with the procedure described in TS 38.508-1 [4], clause 4.5.2. 4G GUTI and eKSI are assigned and security context established.

6.2.3.1.3.2 Test procedure sequence

Table 6.2.3.1.3.2-1 illustrates the downlink power levels and other changing parameters to be applied for the cell at various time instants of the test execution. The exact instants on which these values shall be applied are described in the texts in this clause. Row marked "T0" denotes the conditions in the preamble. Configurations marked "T1", "T2" and "T3" are applied at the points indicated in the Main behaviour description in Table 6.2.3.1.3.2-3.

Table 6.2.3.1.3.2-1: Time instances of cell power level and parameter changes for E-UTRA Cell 1 and NR Cell 1 in conducted test environment

	Parameter	Unit	E-UTRA Cell 1	NR Cell 1	Remark
T0	Cell-specific RS EPRE	dBm/15kHz	-85	-	The power level values are assigned to ensure UE registered on E-UTRA cell 1
	SS/PBCH SSS EPRE	dBm/SCS	-	Off	
T1	Cell-specific RS EPRE	dBm/15kHz	-95	-	The power level values are assigned to satisfy both $Sr_{xle}^{VNR \text{ Cell } 1} > \text{Thresh}_{x, \text{low}}$ and $Sr_{xle}^{VE-UTRA \text{ Cell } 1} < \text{Thresh}_{\text{servicing, low}}$
	SS/PBCH SSS EPRE	dBm/SCS	-	-80	
T2	Cell-specific RS EPRE	dBm/15kHz	-80	-	The power level values are assigned to ensure UE registered on E-UTRA cell 1, $Sr_{xle}^{VE-UTRA \text{ Cell } 1} > \text{Thresh}_{x, \text{high}}$
	SS/PBCH SSS EPRE	dBm/SCS	-	-95	
T3	Cell-specific RS EPRE	dBm/15kHz	-95	-	The Priority and power level values are assigned to satisfy $Sr_{xle}^{VNR \text{ Cell } 1} > \text{Thresh}_{x, \text{high}}$
	SS/PBCH SSS EPRE	dBm/SCS	-	-80	
Note1: Power level "Off" is defined in TS 38.508-1 [4] Table 6.2.2.1-3.					

Table 6.2.3.1.3.2-2: Void

Table 6.2.3.1.3.2-3: Main behaviour

St	Procedure	Message Sequence		TP	Verdict
		U - S	Message		
1	The SS adjusts the E-UTRAN and NR Cell power levels according to row "T1" in table 6.2.3.1.3.2-1.	-	-	-	-
2	Wait for 1 second to allow UE to recognise the change.	-	-	-	-
3	Check: Does the test result of generic test procedure in TS 38.508-1 [4] Table 4.9.9.2.2-1 indicate that the UE is camped on NR Cell 1?	-	-	1	P
4	Void.	-	-	-	-
5	The SS adjusts the E-UTRAN and NR Cell power levels according to row "T2" in table 6.2.3.1.3.2-1.	-	-	-	-
6	Wait for 1 second to allow UE to recognise the change.	-	-	-	-
7	The test result of generic test procedure in TS 38.508-1 [4] Table 4.9.7.2.2-1 indicate that the UE is camped on E-UTRAN Cell 1.	-	-	-	-
7A	The SS changes <i>Priority</i> of NR cell 1 in <i>SystemInformationBlockType24</i> . And the <i>systemInfoValueTag</i> in the <i>SystemInformationBlockType1</i> of E-UTRA Cell 1 is increased.	-	-	-	-
8	The SS notifies the UE of change of System Information on E-UTRAN Cell 1.	<--	<i>Paging</i>	-	-
9	Void	-	-	-	-
10	Wait for 6 s for UE to receive system information.	-	-	-	-
11	The SS re-adjusts the E-UTRAN and NR Cell levels according to row "T3" in table 6.2.3.1.3.2-1.	-	-	-	-
12	Check: Does the test result of generic test procedure in TS 38.508-1 [4] Table 4.9.9.2.2-1 indicate that the UE is camped on NR Cell 1?	-	-	2	P
13	Void.	-	-	-	-

6.2.3.1.3.3 Specific message contents

Table 6.2.3.1.3.3-1: *SystemInformationBlockType3* of EUTRA Cell 1 (preamble and all steps, Table 6.2.3.1.3.2-3)

Derivation Path: TS 36.508 [7], Table 4.4.3.3-2			
Information Element	Value/remark	Comment	Condition
<i>SystemInformationBlockType3</i> ::= SEQUENCE {			
<i>cellReselectionServingFreqInfo</i> SEQUENCE {			
<i>threshServingLow</i>	10	20 dB	
}			
}			

Table 6.2.3.1.3.3-2: *SystemInformationBlockType24* of EUTRA Cell 1 (preamble, Table 6.2.3.1.3.2-3)

Derivation path: TS 36.508 [7], Table 4.4.3.3-20			
Information Element	Value/Remark	Comment	Condition
<i>SystemInformationBlockType24-r15</i> ::= SEQUENCE {			
<i>carrierFreqListNR-r15</i> SEQUENCE (SIZE (1.. <i>maxFreq</i>)) OF <i>CarrierFreqNR-r15</i> {	1 entry		
<i>CarrierFreqNR-r15</i> [1] SEQUENCE {		entry 1	

carrierFreq-r15	Downlink NR ARFCN of SSB for NR Cell 1		
cellReselectionPriority-r15	3		
threshX-High-r15	20	40 dB	
threshX-Low-r15	10	20 dB	
}			
}			
t-ReselectionNR-r15	7		
}			

Table 6.2.3.1.3.3-3: SIB2 of NR Cell 1(preamble and all steps, Table 6.2.3.1.3.2-3)

Derivation Path: TS 38.508-1 [4], Table 4.6.2-1			
Information Element	Value/remark	Comment	Condition
SIB2 ::= SEQUENCE {			
cellReselectionServingFreqInfo SEQUENCE {			
threshServingLowP	10	20 dB	
cellReselectionPriority	3		
}			
}			

Table 6.2.3.1.3.3-4: SIB5 of NR Cell 1(preamble and all steps, Table 6.2.3.1.3.2-3)

Derivation Path: TS 38.508-1 [4], Table 4.6.2-4			
Information Element	Value/remark	Comment	Condition
SIB5 ::= SEQUENCE {			
carrierFreqListEUTRA SEQUENCE (SIZE (1..maxEUTRA-Carrier)) OF CarrierFreqEUTRA {	1 entry		
CarrierFreqEUTRA[1] SEQUENCE {		entry 1	
carrierFreq	Downlink EUTRA ARFCN as E-UTRA Cell 1 used		
cellReselectionPriority	5		
threshX-High	10	20 dB	
threshX-Low	20	40 dB	
}			
}			
t-ReselectionEUTRA	7		
}			

Table 6.2.3.1.3.3-5: Paging (step 8, Table 6.2.3.1.3.2-3)

Derivation path: TS 36.508 [7], Table 4.6.1-7			
Information Element	Value/Remark	Comment	Condition
Paging ::= SEQUENCE {			
systemInfoModification	True		
}			

Table 6.2.3.1.3.3-6: SystemInformationBlockType1 of EUTRA Cell 1 (step 7A, Table 6.2.3.1.3.2-3)

Derivation Path: TS 36.508 [7], Table 4.4.3.2-3			
Information Element	Value/remark	Comment	Condition
SystemInformationBlockType1 ::= SEQUENCE {			
systemInfoValueTag	1	Previous value is 0	
}			

Table 6.2.3.1.3.3-7: SystemInformationBlockType24 of EUTRA Cell 1 (step 7A, Table 6.2.3.1.3.2-3)

Derivation path: TS 36.508 [7], Table 4.4.3.3-20			
Information Element	Value/Remark	Comment	Condition

SystemInformationBlockType24-r15 ::= SEQUENCE {			
carrierFreqListNR-r15 SEQUENCE (SIZE (1..maxFreq)) OF CarrierFreqNR-r15 {	1 entry		
CarrierFreqNR-r15[1] SEQUENCE {		entry 1	
carrierFreq-r15	Same downlink SSB ARFCN as used for NR Cell 1		
cellReselectionPriority-r15	5		
threshX-High-r15	10	20 dB	
threshX-Low-r15	20	40 dB	
}			
}			
t-ReselectionNR-r15	7	7 Seconds	
}			

Table 6.2.3.1.3.3-8: TRACKING AREA UPDATE REQUEST (Step 7, Table 6.2.3.1.3.2-3)

Derivation Path: TS 38.508-1 [4], Table 4.9.7.2.3-1			
Information Element	Value/remark	Comment	Condition
EPS update type			
EPS update type Value	'010'B	Combined TA/LA updating	combined_TA_LA
	'000'B	TA updating	TA_only
NOTE: The message shall be integrity protected using the 5GS security context available in the UE.			

Condition	Explanation
TA_only	This condition applies if the UE is configured to initiate EPS attach or if explicitly specified.
combined_TA_LA	This condition applies if the UE is configured to initiate combined EPS/IMS attach or if explicitly specified.

Table 6.2.3.1.3.3-9: REGISTRATION REQUEST (Step 12, Table 6.2.3.1.3.2-3)

Derivation Path: TS 38.508-1 [4], Table 4.7.1-6.			
Information Element	Value/remark	Comment	Condition
EPS NAS message container	TRACKING AREA UPDATE REQUEST message	See Table 6.2.3.1.3.3-10	

Table 6.2.3.1.3.3-10: TRACKING AREA UPDATE REQUEST (Table 6.2.3.1.3.3-9)

Derivation Path: TS 38.508-1 [4], Table 4.9.9.2.3-2 with condition Mapped EPS security context
--

6.2.3.2 Inter-RAT cell reselection / From E-UTRA_IDLE to NR RRC_IDLE (lower priority & higher priority, Squal based)

6.2.3.2.1 Test Purpose (TP)

(1)

```
with { UE in E-UTRA RRC_IDLE state }
ensure that {
  when { UE detects the cell re-selection criteria are met for the cell which belongs to the lower
  priority inter-RAT NR cell }
  then { UE reselects the cell which belongs to the lower priority inter-RAT NR cell }
}
```

(2)

```
with { UE in E-UTRA RRC_IDLE state }
ensure that {
```



```

when { UE detects the cell re-selection criteria are met for the cell which belongs to the higher
priority inter-RAT NR cell}
  then { UE reselects the cell which belongs to the higher priority inter-RAT NR cell }
}

```

6.2.3.2.2 Conformance requirements

References: The conformance requirements covered in the present TC are specified in: 3GPP TS 36.304, clause 5.2.4.1, 5.2.4.2 and 5.2.4.5. Unless otherwise stated these are Rel-15 requirements.

[TS 36.304, clause 5.2.4.1]

Absolute priorities of different E-UTRAN frequencies or inter-RAT frequencies may be provided to the UE in the system information, in the *RRCCConnectionRelease* message, or by inheriting from another RAT at inter-RAT cell (re)selection. In the case of system information, an E-UTRAN frequency or inter-RAT frequency may be listed without providing a priority (i.e. the field *cellReselectionPriority* is absent for that frequency). If priorities are provided in dedicated signalling, the UE shall ignore all the priorities provided in system information. If UE is in *camped on any cell* state, UE shall only apply the priorities provided by system information from current cell, and the UE preserves priorities provided by dedicated signalling and *deprioritisationReq* received in *RRCCConnectionReject* unless specified otherwise. When the UE in *camped normally* state, has only dedicated priorities other than for the current frequency, the UE shall consider the current frequency to be the lowest priority frequency (i.e. lower than any of the network configured values). While the UE is camped on a suitable CSG cell in normal coverage, the UE shall always consider the current frequency to be the highest priority frequency (i.e. higher than any of the network configured values), irrespective of any other priority value allocated to this frequency. When the HSDN capable UE is in High-mobility state, the UE shall always consider the HSDN cells to be the highest priority (i.e. higher than any other network configured priorities). When the HSDN capable UE is not in High-mobility state, the UE shall always consider HSDN cells to be the lowest priority (i.e. lower than network configured priorities). If the UE capable of sidelink communication is configured to perform sidelink communication and can only perform the sidelink communication while camping on a frequency, the UE may consider that frequency to be the highest priority. If the UE capable of V2X sidelink communication is configured to perform V2X sidelink communication and can only perform the V2X sidelink communication while camping on a frequency, the UE may consider that frequency to be the highest priority. If the UE capable of V2X sidelink communication is configured to perform V2X sidelink communication and can only use pre-configuration while not camping on a frequency, the UE may consider the frequency providing inter-carrier V2X sidelink configuration to be the highest priority. If the UE capable of sidelink discovery is configured to perform Public Safety related sidelink discovery and can only perform the Public Safety related sidelink discovery while camping on a frequency, the UE may consider that frequency to be the highest priority.

NOTE 1: The prioritization among the frequencies which UE considers to be the highest priority frequency is left to UE implementation.

If the UE is capable either of MBMS Service Continuity or of SC-PTM reception and is receiving or interested to receive an MBMS service and can only receive this MBMS service while camping on a frequency on which it is provided, the UE may consider that frequency to be the highest priority during the MBMS session TS 36.300 [2] as long as the two following conditions are fulfilled:

1) Either:

- the UE is capable of MBMS service continuity and the reselected cell is broadcasting SIB13; or
- the UE is capable of SC-PTM reception and the reselected cell is broadcasting SIB20;

2) Either:

- SIB15 of the serving cell indicates for that frequency one or more MBMS SAIs included and associated with that frequency in the MBMS User Service Description (USD) TS 26.346 [22] of this service; or
- SIB15 is not broadcast in the serving cell and that frequency is included in the USD of this service.

If the UE is capable either of MBMS Service Continuity or of SC-PTM reception and is receiving or interested to receive an MBMS service provided on a downlink only MBMS frequency, on a frequency used by dedicated MBMS cells, on a frequency used by FeMBMS/Unicast-mixed cells as defined in TS 36.300 [2], or on a frequency belonging to PLMN different from its registered PLMN, the UE may consider cell reselection candidate frequencies at which it can not receive the MBMS service to be of the lowest priority during the MBMS session TS 36.300 [2], as long as the above mentioned condition 1) is fulfilled for the cell on the MBMS frequency which the UE monitors or this cell broadcasts SIB1-MBMS and as long as the above mentioned condition 2) is fulfilled for the serving cell.

NOTE 2: Example scenarios in which the previous down-prioritisation may be needed concerns the cases where camping is not possible, while the UE can only receive this MBMS frequency when camping on a subset of cell reselection candidate frequencies, e.g. the MBMS frequency is a downlink only carrier, the MBMS frequency is used by dedicated MBMS cells, the MBMS frequency is used by FeMBMS/Unicast-mixed cells TS 36.300 [2], or the MBMS frequency belongs to a PLMN different from UE's registered PLMN.

If the UE is not capable of MBMS Service Continuity but has knowledge on which frequency an MBMS service of interest is provided, it may consider that frequency to be the highest priority during the MBMS session TS 36.300 [2] as long as the reselected cell is broadcasting SIB13.

If the UE is not capable of MBMS Service Continuity but has knowledge on which downlink only frequency, on which frequency used by dedicated MBMS cells, on which frequency used by FeMBMS/Unicast-mixed cells as defined in TS 36.300 [2] or on which frequency belonging to PLMN different from its registered PLMN an MBMS service of interest is provided, it may consider cell reselection candidate frequencies at which it can not receive the MBMS service to be of the lowest priority during the MBMS session TS 36.300 [2] as long as the cell on the MBMS frequency which the UE monitors is broadcasting SIB13 or SIB1-MBMS.

NOTE 3: The UE considers that the MBMS session is ongoing using the session start and end times as provided by upper layers in the USD i.e. the UE does not verify if the session is indicated on MCCH.

In case UE receives *RRCConnectionReject* with *deprioritisationReq*, UE shall consider current carrier frequency and stored frequencies due to the previously received *RRCConnectionReject* with *deprioritisationReq* or all the frequencies of EUTRA to be the lowest priority frequency (i.e. lower than any of the network configured values) while T325 is running irrespective of camped RAT. The UE shall delete the stored deprioritisation request(s) when a PLMN selection is performed on request by NAS TS 23.122 [5].

NOTE 4: Connecting to CDMA2000 does not imply PLMN selection.

NOTE 5: UE should search for a higher priority layer for cell reselection as soon as possible after the change of priority. The minimum related performance requirements specified in TS 36.133 [10] are still applicable.

The UE shall delete priorities provided by dedicated signalling when:

- the UE enters a different RRC state; or
- the optional validity time of dedicated priorities (T320) expires; or
- a PLMN selection is performed on request by NAS TS 23.122 [5].

NOTE 6: Equal priorities between RATs are not supported.

The UE shall only perform cell reselection evaluation for E-UTRAN frequencies and inter-RAT frequencies that are given in system information and for which the UE has a priority provided.

The UE shall not consider any black listed cells as candidate for cell reselection.

The UE shall inherit the priorities provided by dedicated signalling and the remaining validity time (i.e., T320 in E-UTRA and NR, T322 in UTRA and T3230 in GERAN), if configured, at inter-RAT cell (re)selection.

NOTE 7: The network may assign dedicated cell reselection priorities for frequencies not configured by system information.

While T360 is running, redistribution target is considered to be the highest priority (i.e. higher than any of the network configured values). UE shall continue to consider the serving frequency as the highest priority until completion of E-UTRAN Inter-frequency Redistribution procedure specified in 5.2.4.10 if triggered on T360 expiry/ stop.

[TS 36.304, clause 5.2.4.2]

Following rules are used by the UE to limit needed measurements:

- If the serving cell fulfils $S_{rxlev} > S_{IntraSearchP}$ and $S_{qual} > S_{IntraSearchQ}$, the UE may choose not to perform intra-frequency measurements.
- Otherwise, the UE shall perform intra-frequency measurements.

- The UE shall apply the following rules for NR inter-frequencies and inter-RAT frequencies which are indicated in system information and for which the UE has priority provided as defined in 5.2.4.1:
 - For a NR inter-frequency or inter-RAT frequency with a reselection priority higher than the reselection priority of the current NR frequency, the UE shall perform measurements of higher priority NR inter-frequency or inter-RAT frequencies according to TS 38.133 [8].
 - For a NR inter-frequency with an equal or lower reselection priority than the reselection priority of the current NR frequency and for inter-RAT frequency with lower reselection priority than the reselection priority of the current NR frequency:
 - If the serving cell fulfils $S_{rxlev} > S_{nonIntraSearchP}$ and $S_{qual} > S_{nonIntraSearchQ}$, the UE may choose not to perform measurements of NR inter-frequencies or inter-RAT frequency cells of equal or lower priority;
 - Otherwise, the UE shall perform measurements of NR inter-frequencies or inter-RAT frequency cells of equal or lower priority according to TS 38.133 [8].

[TS 36.304, clause 5.2.4.5]

For NB-IoT inter-frequency cell reselection shall be based on ranking as defined in sub-clause 5.2.4.6.

If *threshServingLowQ* is provided in *SystemInformationBlockType3* and more than 1 second has elapsed since the UE camped on the current serving cell, cell reselection to a cell on a higher priority E-UTRAN frequency or inter-RAT frequency than the serving frequency shall be performed if:

- A cell of a higher priority EUTRAN, NR or UTRAN FDD RAT/ frequency fulfils $S_{qual} > Thresh_{X, HighQ}$ during a time interval $T_{reselection_{RAT}}$; or
- A cell of a higher priority UTRAN TDD, GERAN or CDMA2000 RAT/ frequency fulfils $S_{rxlev} > Thresh_{X, HighP}$ during a time interval $T_{reselection_{RAT}}$.

Otherwise, cell reselection to a cell on a higher priority E-UTRAN frequency or inter-RAT frequency than the serving frequency shall be performed if:

- A cell of a higher priority RAT/ frequency fulfils $S_{rxlev} > Thresh_{X, HighP}$ during a time interval $T_{reselection_{RAT}}$; and
- More than 1 second has elapsed since the UE camped on the current serving cell.

Cell reselection to a cell on an equal priority E-UTRAN frequency shall be based on ranking for Intra-frequency cell reselection as defined in sub-clause 5.2.4.6.

If *threshServingLowQ* is provided in *SystemInformationBlockType3* and more than 1 second has elapsed since the UE camped on the current serving cell, cell reselection to a cell on a lower priority E-UTRAN frequency or inter-RAT frequency than the serving frequency shall be performed if:

- The serving cell fulfils $S_{qual} < Thresh_{Serving, LowQ}$ and a cell of a lower priority EUTRAN, NR or UTRAN FDD RAT/ frequency fulfils $S_{qual} > Thresh_{X, LowQ}$ during a time interval $T_{reselection_{RAT}}$; or
- The serving cell fulfils $S_{qual} < Thresh_{Serving, LowQ}$ and a cell of a lower priority UTRAN TDD, GERAN or CDMA2000 RAT/ frequency fulfils $S_{rxlev} > Thresh_{X, LowP}$ during a time interval $T_{reselection_{RAT}}$.

Otherwise, cell reselection to a cell on a lower priority E-UTRAN frequency or inter-RAT frequency than the serving frequency shall be performed if:

- The serving cell fulfils $S_{rxlev} < Thresh_{Serving, LowP}$ and a cell of a lower priority RAT/ frequency fulfils $S_{rxlev} > Thresh_{X, LowP}$ during a time interval $T_{reselection_{RAT}}$; and
- More than 1 second has elapsed since the UE camped on the current serving cell.

Cell reselection to a higher priority RAT/ frequency shall take precedence over a lower priority RAT/ frequency, if multiple cells of different priorities fulfil the cell reselection criteria.

The UE shall not perform cell reselection to NR or UTRAN FDD cells for which the cell selection criterion S is not fulfilled.

For cdma2000 RATs, $Srxlev$ is equal to $-FLOOR(-2 \times 10 \times \log_{10} Ec/Io)$ in units of 0.5 dB, as defined in [18], with Ec/Io referring to the value measured from the evaluated cell.

For cdma2000 RATs, $Thresh_{X, HighP}$ and $Thresh_{X, LowP}$ are equal to -1 times the values signalled for the corresponding parameters in the system information.

In all the above criteria the value of $Treselection_{RAT}$ is scaled when the UE is in the medium or high mobility state as defined in subclause 5.2.4.3.1. If more than one cell meets the above criteria, the UE shall reselect a cell as follows:

- If the highest-priority frequency is an E-UTRAN frequency, a cell ranked as the best cell among the cells on the highest priority frequency(ies) meeting the criteria according to clause 5.2.4.6;
- If the highest-priority frequency is from another RAT, a cell ranked as the best cell among the cells on the highest priority frequency(ies) meeting the criteria of that RAT.

Cell reselection to another RAT, for which Squal based cell reselection parameters are broadcast in system information, shall be performed based on the Squal criteria if the UE supports Squal (RSRQ) based cell reselection to E-UTRAN from all the other RATs provided by system information which UE supports. Otherwise, cell reselection to another RAT shall be performed based on $Srxlev$ criteria.

Cell reselection to NR, for which a cell reselection parameter, $q-RxLevMinSUL$ is broadcast in system information and the UE supports SUL, shall be performed based on $Srxlev$ criteria taking the parameter into account.

6.2.3.2.3 Test description

6.2.3.2.3.1 Pre-test conditions

System Simulator:

- E-UTRA Cell 1 and NR Cell 1.
- NR Cell 1 is configured to operate in FR1 bands as defined in TS 38.508-1 [4] clause 6.2.3.
- System information combination 31 as defined in TS 36.508 [7] clause 4.4.3.1, and message contents defined in clause 4.4.3.3 with QBASED condition is used in E-UTRA cell.
- System information combination NR-6 as defined in TS 38.508-1 [4] clause 4.4.3.1.3, and message contents defined in clause 4.6.1 and clause 4.6.2 with QBASED condition is used in NR Cell.

UE:

None.

Preamble:

-

With E-UTRA Cell 1 "Non-suitable "Off" cell" and NR Cell 1 "Serving cell" in accordance with TS 38.508-1 [4], Table 6.2.2.1-3, the UE is brought to state 1N-A, RRC_IDLE Connectivity (NR), in accordance with the procedure described in TS 38.508-1 [4], Table 4.5.2.2-2. 5G-GUTI and ngKSI are assigned and security context established.

The UE is switched-off.

With E-UTRA Cell 1 "Serving cell" and NR Cell 1 "Non-suitable "Off" cell" in accordance with TS 38.508-1 [4], Table 6.2.2.1-3, the UE is brought to state RRC_IDLE using generic procedure parameters Connectivity (E-UTRA/EPC) and Unrestricted nr PDN (*On*) in accordance with the procedure described in TS 38.508-1 [4], clause 4.5.2. 4G-GUTI and eKSI are assigned and security context established.

6.2.3.2.3.2 Test procedure sequence

Table 6.2.3.2.3.2-1 illustrates the downlink power levels and other changing parameters to be applied for the cell at various time instants of the test execution. The exact instants on which these values shall be applied are described in the

texts in this clause. Configurations marked "T1", "T2" and "T3" are applied at the points indicated in the Main behaviour description in Table 6.2.3.2.3.2-3.

Table 6.2.3.2.3.2-1: Time instances of cell power level and parameter changes for E-UTRA Cell and NR Cell in conducted test environment

	Parameter	Unit	E-UTRA Cell 1	NR Cell 1	Remark
T1	Cell-specific RS EPRE	dBm/15kHz	-95	-	The power level values are assignen to ensure UE reselected to NR Cell 1: both $Squal_{\text{ServingCell, E-UTRA Cell1}} < \text{Thresh}_{\text{Serving, LowQ}}$ and $Squal_{\text{nonServingCell, NR Cell1}} > \text{Thresh}_{\text{NR Cell1, LowQ}}$
	SS/PBCH SSS EPRE	dBm/SCS	-	-80	
	RSRQ	dB	-11.46	-11.17	
	Qqualmin	dB	-20	-25	
	No _{CE-UTRA}	dBm/15kHz	-95	-	
	No _{CNR}	dBm/SCS	-	-90	
T2	Cell-specific RS EPRE	dBm/15kHz	-80	-	The power level values are assignen to ensure UE reselected back to E-UTRA Cell 1: $Squal_{\text{nonServingCell, E-UTRA Cell1}} > \text{Thresh}_{\text{E-UTRA Cell1, HighQ}}$
	SS/PBCH SSS EPRE	dBm/SCS	-	-95	
	RSRQ	dB	-3.76	-16.98	
	Qqualmin	dB	-20	-25	
	No _{CE-UTRA}	dBm/15kHz	-95	-	
	No _{CNR}	dBm/SCS	-	-90	
T3	Cell-specific RS EPRE	dBm/15kHz	-95	-	The power level values are assignen to ensure UE reselected to NR Cell 1: $Squal_{\text{nonServingCell, NR Cell1}} > \text{Thresh}_{\text{NR Cell1, HighQ}}$
	SS/PBCH SSS EPRE	dBm/SCS	-	-80	
	RSRQ	dB	-11.46	-11.17	
	Qqualmin	dB	-20	-25	
	No _{CE-UTRA}	dBm/15kHz	-95	-	
	No _{CNR}	dBm/SCS	-	-90	

Table 6.2.3.2.3.2-2: Void

Table 6.2.3.2.3.2-3: Main behaviour

St	Procedure	Message Sequence		TP	Verdict
		U - S	Message		
1	The SS changes Cell-specific RS EPRE level for E-UTRA Cell 1 and SS/PBCH SSS EPRE level for NR Cell 1 according to row "T1" in table 6.2.3.2.3.2-1.	-	-	-	-
2	Check: Does the test result of generic test procedure in TS 38.508-1 [4] Table 4.9.9.2.2-1 indicate that the UE is camped on NR Cell 1? NOTE: This is the first time in this test case that the UE moves from S1 to N1.			1	-
3	The SS transmits an <i>RRCRelease</i> message on NR Cell 1.	<--	NR RRC: <i>RRCRelease</i>		
4	The SS changes Cell-specific RS EPRE level for E-UTRA Cell 1 and SS/PBCH SSS EPRE level for NR Cell 1 according to row "T2" in table 6.2.3.2.3.2-1.	-	-	-	-
5	The UE selects E-UTRAN Cell 1 and performs the generic test procedure in TS 38.508-1 [4] Table 4.9.7.2.2 from steps 1-6.	-	-	-	-
6	The SS transmits an <i>RRCConnectionRelease</i> message to release RRC connection and move to RRC_IDLE on E-UTRAN Cell 1.	<--	E-UTRA RRC: <i>RRCConnectionRelease</i>	-	-
7	The SS changes the NR cell priority broadcast in system information on E-UTRAN Cell 1.	-	-	-	-
8	Notify UE change of System Information on E-	<--	E-UTRA RRC: <i>Paging</i>		

	UTRAN Cell 1.				
9	Wait for 6 s for UE to receive system information.	-	-	-	-
10	The SS changes Cell-specific RS EPRE level for E-UTRA Cell 1 and SS/PBCH SSS EPRE level for NR Cell 1 according to row "T3" in table 6.2.3.2.3.2-1.	-	-	-	-
11	Check: Does the test result of generic test procedure in TS 38.508-1 [4] Table 4.9.9.2.2-1 indicate that the UE is camped on NR Cell 1?	-	-	2	-
12	Void.	-	-	-	-

6.2.3.2.3.3 Specific message contents

Table 6.2.3.2.3.3-1: SystemInformationBlockType1 for E-UTRA Cell 1 (preamble and all steps, Table 6.2.3.2.3.2-3)

Derivation path: TS 36.508-1 [7], Table 4.4.3.2-3				
Information Element	Value/Remark	Comment	Condition	
SystemInformationBlockType1 ::= SEQUENCE {				
nonCriticalExtension SEQUENCE {				
nonCriticalExtension SEQUENCE {				
cellSelectionInfo-v920 SEQUENCE {				
q-QualMin-r9	-20			
}				
}				
}				
}				

Table 6.2.3.2.3.3-2: SystemInformationBlockType3 for E-UTRA Cell 1 (preamble and all steps, Table 6.2.3.2.3.2-3)

Derivation path: TS 36.508 [7], Table 4.4.3.3-2				
Information Element	Value/Remark	Comment	Condition	
SystemInformationBlockType3 ::= SEQUENCE {				
lateNonCriticalExtension {				
q-QualMin-r9	-20			
threshServingLowQ-r9	12			
}				
}				

Table 6.2.3.2.3.3-3: SystemInformationBlockType24 for E-UTRA Cell 1 (preamble, Table 6.2.3.2.3.2-3)

Derivation path: TS 36.508 [7], Table 4.4.3.3-20				
Information Element	Value/remark	Comment	Condition	
SystemInformationBlockType24-r15 ::= SEQUENCE {				
carrierFreqListNR-r15 SEQUENCE (SIZE (1..maxFreq)) OF CarrierFreqNR-r15 {	1 entry			
CarrierFreqNR-r15[1] SEQUENCE {		entry 1		
carrierFreq-r15	Downlink NR ARFCN of SSB for NR Cell 1			
cellReselectionPriority-r15	3			
threshX-Q-r15 SEQUENCE {				
threshX-HighQ-r15	20			
threshX-LowQ-r15	5			
}				
q-QualMin-r15	-25			
}				
}				
t-ReselectionNR-r15	7			

}			
---	--	--	--

Table 6.2.3.2.3.3-4: SIB1 for NR Cell 1 (preamble and all steps, Table 6.2.3.2.3.2-3)

Derivation path: TS 38.508-1 [4], Table 4.6.1-28			
Information Element	Value/Remark	Comment	Condition
SIB1 ::= SEQUENCE {			
cellSelectionInfo SEQUENCE {			
q-QualMin	-25	-25dB	
}			
}			

Table 6.2.3.2.3.3-5: SIB2 for NR Cell 1 (preamble and all steps, Table 6.2.3.2.3.2-3)

Derivation path: TS 38.508-1 [4], Table 4.6.2-1			
Information Element	Value/Remark	Comment	Condition
SIB2 ::= SEQUENCE {			
cellReselectionServingFreqInfo SEQUENCE {			
threshServingLowQ	26		
}			
}			

Table 6.2.3.2.3.3-6: SIB5 for NR Cell 1 (preamble and all steps, Table 6.2.3.2.3.2-3)

Derivation path: TS 38.508-1 [4], Table 4.6.2-4			
Information Element	Value/Remark	Comment	Condition
SIB5 ::= SEQUENCE {			
carrierFreqListEUTRA SEQUENCE (SIZE (1..maxEUTRA-Carrier)) OF CarrierFreqEUTRA {	1 entry		
CarrierFreqEUTRA[1] SEQUENCE {		entry 1	
carrierFreq	Downlink EUTRA ARFCN as E-UTRA Cell 1 used		
cellReselectionPriority	5		
threshX-Q SEQUENCE {			
threshX-HighQ	12		
threshX-LowQ	5		
}			
}			
t-ReselectionEUTRA	7		
}			

Table 6.2.3.2.3.3-7: SystemInformationBlockType24 for E-UTRA Cell 1 (step 7, Table 6.2.3.2.3.2-3)

Derivation path: TS 36.508 [7], Table 4.4.3.3-20			
Information Element	Value/remark	Comment	Condition
SystemInformationBlockType24-r15 ::= SEQUENCE {			
carrierFreqListNR-r15 SEQUENCE (SIZE (1..maxFreq)) OF CarrierFreqNR-r15 {	1 entry		
CarrierFreqNR-r15[1] SEQUENCE {		entry 1	
carrierFreq-r15	Downlink NR ARFCN of SSB for NR Cell 1		
cellReselectionPriority-r15	5		
threshX-Q-r15 SEQUENCE {			
threshX-HighQ-r15	5		
threshX-LowQ-r15	20		
}			
}			

q-QualMin-r15	-25		
}			
}			
t-ReselectionNR-r15	7		
}			

Table 6.2.3.2.3.3-8: Paging for E-UTRA Cell 1 (step 8, Table 6.2.3.2.3.2-3)

Derivation path: TS 36.508 [7], Table 4.6.1-7			
Information Element	Value/Remark	Comment	Condition
Paging ::= SEQUENCE {			
pagingRecordList	Not present		
systemInfoModification	True		
etws-PrimaryNotificationIndication	Not present		
nonCriticalExtension	Not present		
}			

Table 6.2.3.2.3.3-9: SystemInformationBlockType1 for E-UTRA Cell 1 (step 9, Table 6.2.3.2.3.2-3)

Derivation path: TS 36.508-1 [7], Table 4.4.3.2-3			
Information Element	Value/Remark	Comment	Condition
SystemInformationBlockType1 ::= SEQUENCE {			
systemInfoValueTag	1		
}			

Table 6.2.3.2.3.3-10: REGISTRATION REQUEST (Step 11, Table 6.2.3.2.3.2-3)

Derivation Path: TS 38.508-1 [4], Table 4.7.1-6.			
Information Element	Value/remark	Comment	Condition
EPS NAS message container	TRACKING AREA UPDATE REQUEST message	See Table 6.2.3.2.3.3-11	

Table 6.2.3.2.3.3-11: TRACKING AREA UPDATE REQUEST (Table 6.2.3.2.3.3-10)

Derivation Path: TS 38.508-1 [4], Table 4.9.9.2.3-2 with condition Mapped EPS security context
--

6.2.3.3 Inter-RAT cell reselection / From NR RRC_IDLE to E-UTRA_IDLE (lower priority & higher priority, Srxlev based)

6.2.3.3.1 Test Purpose (TP)

(1)

```
with { UE in NR RRC_Idle state }
ensure that {
  when { UE detects the cell re-selection criteria are met for the cell which belongs to the higher
priority E-UTRA frequency }
  then { UE reselects to the E-UTRA cell }
}
```

(2)

```
with { UE in NR RRC_Idle state }
ensure that {
  when { UE detects the cell re-selection criteria are met for the neighbour cell which belongs to
the lower priority E-UTRA frequency }
  then { UE reselects to the E-UTRA cell }
}
```

6.2.3.3.2 Conformance requirements

References: The conformance requirements covered in the present TC are specified in: 3GPP TS 38.304, clause 5.2.4.1, 5.2.4.2 and 5.2.4.5. Unless otherwise stated these are Rel-15 requirements.

[TS 38.304, clause 5.2.4.1]

Absolute priorities of different NR frequencies or inter-RAT frequencies may be provided to the UE in the system information, in the *RRCRelease* message, or by inheriting from another RAT at inter-RAT cell (re)selection. In the case of system information, an NR frequency or inter-RAT frequency may be listed without providing a priority (i.e. the field *cellReselectionPriority* is absent for that frequency). If priorities are provided in dedicated signalling, the UE shall ignore all the priorities provided in system information. If UE is in *camped on any cell* state, UE shall only apply the priorities provided by system information from current cell, and the UE preserves priorities provided by dedicated signalling and *deprioritisationReq* received in *RRCRelease* unless specified otherwise. When the UE in camped normally state, has only dedicated priorities other than for the current frequency, the UE shall consider the current frequency to be the lowest priority frequency (i.e. lower than any of the network configured values).

The UE shall only perform cell reselection evaluation for NR frequencies and inter-RAT frequencies that are given in system information and for which the UE has a priority provided.

In case UE receives *RRCRelease* with *deprioritisationReq*, UE shall consider current frequency and stored frequencies due to the previously received *RRCRelease* with *deprioritisationReq* or all the frequencies of NR to be the lowest priority frequency (i.e. lower than any of the network configured values) while T325 is running irrespective of camped RAT. The UE shall delete the stored deprioritisation request(s) when a PLMN selection is performed on request by NAS (TS 23.122 [9]).

NOTE: UE should search for a higher priority layer for cell reselection as soon as possible after the change of priority. The minimum related performance requirements specified in TS 38.133 [8] are still applicable.

The UE shall delete priorities provided by dedicated signalling when:

- the UE enters a different RRC state; or
- the optional validity time of dedicated priorities (T320) expires; or
- a PLMN selection is performed on request by NAS (TS 23.122 [9]).

NOTE 2: Equal priorities between RATs are not supported.

The UE shall not consider any black listed cells as candidate for cell reselection.

The UE shall inherit the priorities provided by dedicated signalling and the remaining validity time (i.e. T320 in NR and E-UTRA), if configured, at inter-RAT cell (re)selection.

NOTE 3: The network may assign dedicated cell reselection priorities for frequencies not configured by system information.

[TS 38.304, clause 5.2.4.1]

Following rules are used by the UE to limit needed measurements:

- If the serving cell fulfils $S_{rxlev} > S_{IntraSearchP}$ and $S_{qual} > S_{IntraSearchQ}$, the UE may choose not to perform intra-frequency measurements.
- Otherwise, the UE shall perform intra-frequency measurements.
- The UE shall apply the following rules for NR inter-frequencies and inter-RAT frequencies which are indicated in system information and for which the UE has priority provided as defined in 5.2.4.1:
 - For a NR inter-frequency or inter-RAT frequency with a reselection priority higher than the reselection priority of the current NR frequency, the UE shall perform measurements of higher priority NR inter-frequency or inter-RAT frequencies according to TS 38.133 [8].
 - For a NR inter-frequency with an equal or lower reselection priority than the reselection priority of the current NR frequency and for inter-RAT frequency with lower reselection priority than the reselection priority of the current NR frequency:

- If the serving cell fulfils $S_{rxlev} > S_{nonIntraSearchP}$ and $S_{qual} > S_{nonIntraSearchQ}$, the UE may choose not to perform measurements of NR inter-frequencies or inter-RAT frequency cells of equal or lower priority;
- Otherwise, the UE shall perform measurements of NR inter-frequencies or inter-RAT frequency cells of equal or lower priority according to TS 38.133 [8].

[TS 38.304, clause 5.2.4.5]

If *threshServingLowQ* is broadcast in system information and more than 1 second has elapsed since the UE camped on the current serving cell, cell reselection to a cell on a higher priority NR frequency or inter-RAT frequency than the serving frequency shall be performed if:

- A cell of a higher priority NR or EUTRAN RAT/frequency fulfils $S_{qual} > Thresh_{X, HighQ}$ during a time interval $T_{reselection_{RAT}}$

Otherwise, cell reselection to a cell on a higher priority NR frequency or inter-RAT frequency than the serving frequency shall be performed if:

- A cell of a higher priority RAT/ frequency fulfils $S_{rxlev} > Thresh_{X, HighP}$ during a time interval $T_{reselection_{RAT}}$; and
- More than 1 second has elapsed since the UE camped on the current serving cell.

Cell reselection to a cell on an equal priority NR frequency shall be based on ranking for intra-frequency cell reselection as defined in sub-clause 5.2.4.6.

If *threshServingLowQ* is broadcast in system information and more than 1 second has elapsed since the UE camped on the current serving cell, cell reselection to a cell on a lower priority NR frequency or inter-RAT frequency than the serving frequency shall be performed if:

- The serving cell fulfils $S_{qual} < Thresh_{Serving, LowQ}$ and a cell of a lower priority NR or E-UTRAN RAT/ frequency fulfils $S_{qual} > Thresh_{X, LowQ}$ during a time interval $T_{reselection_{RAT}}$.

Otherwise, cell reselection to a cell on a lower priority NR frequency or inter-RAT frequency than the serving frequency shall be performed if:

- The serving cell fulfils $S_{rxlev} < Thresh_{Serving, LowP}$ and a cell of a lower priority RAT/ frequency fulfils $S_{rxlev} > Thresh_{X, LowP}$ during a time interval $T_{reselection_{RAT}}$; and
- More than 1 second has elapsed since the UE camped on the current serving cell.

Cell reselection to a higher priority RAT/frequency shall take precedence over a lower priority RAT/frequency if multiple cells of different priorities fulfil the cell reselection criteria.

If more than one cell meets the above criteria, the UE shall reselect a cell as follows:

- If the highest-priority frequency is an NR frequency, the highest ranked cell among the cells on the highest priority frequency(ies) meeting the criteria according to clause 5.2.4.6;
- If the highest-priority frequency is from another RAT, the highest ranked cell among the cells on the highest priority frequency(ies) meeting the criteria of that RAT.

6.2.3.3.3 Test description

6.2.3.3.3.1 Pre-test conditions

System Simulator:

- NR Cell 1, E-UTRA Cell 1 is different priority inter-RAT Cell.
- NR Cell 1 is configured to operate in FR1 bands as defined in TS 38.508-1 [4] clause 6.2.3.
- System information combination NR-6 as defined in TS 38.508-1 [4] clause 4.4.3.1.3 is used in NR Cell.
- System information combination 31 as defined in TS 36.508-1 [18] clause 4.4.3.1 is used in E-UTRA Cell.

UE:

None.

Preamble:

- With E-UTRA Cell 1 "Serving cell" and NR Cell 1 "Non-suitable "Off" cell" in accordance with TS 38.508-1 [4], Table 6.2.2.1-3, the UE is brought to state RRC_IDLE using generic procedure parameters Connectivity (*E-UTRA/EPC*) and Unrestricted nr PDN (*On*) in accordance with the procedure described in TS 38.508-1 [4], clause 4.5.2. 4G GUTI and eKSI are assigned and security context established.
- the UE is switched-off.
- With E-UTRA Cell 1 "Non-suitable "Off" cell" and NR Cell 1 "Serving cell" in accordance with TS 38.508-1 [4], Table 6.2.2.1-3, the UE is brought to state 1N-A, RRC_IDLE Connectivity (NR), in accordance with the procedure described in TS 38.508-1 [4], Table 4.5.2.2-2. 5G-GUTI and ngKSI are assigned and security context established.

6.2.3.3.3.2 Test procedure sequence

Table 6.2.3.3.3.2-1 illustrates the downlink power levels and other changing parameters to be applied for the cell at various time instants of the test execution. The exact instants on which these values shall be applied are described in the texts in this clause. Row marked "T0" denotes the conditions in the preamble. Configurations marked "T1", "T2" and "T3" are applied at the points indicated in the Main behaviour description in Table 6.2.3.3.3.2-3.

Table 6.2.3.3.3.2-1: Time instances of cell power level and parameter changes for E-UTRA Cell 1 and NR Cell 1 in conducted test environment

	Parameter	Unit	NR Cell 1	E-UTRA Cell 1	Remark
T0	Cell-specific RS EPRE	dBm/15kHz	-	-Off	The power level values are assigned to ensure UE registered on NR Cell 1
	SS/PBCH SSS EPRE	dBm/SCS	-88	-	
T1	Cell-specific RS EPRE	dBm/15kHz	-	-75	The power level values are assigned to satisfy $Srx_{levE-UTRA\ Cell\ 1} > Thresh_{x, high}$
	SS/PBCH SSS EPRE	dBm/SCS	-95	-	
T2	Cell-specific RS EPRE	dBm/15kHz	-	-95	The power level values are assigned to ensure UE reselected back to NR Cell 1: both $Srx_{levE-UTRA\ Cell\ 1} < Thresh_{serving, low}$ and $Srx_{levNR\ Cell\ 1} > Thresh_{x, low}$.
	SS/PBCH SSS EPRE	dBm/SCS	-78	-	
T3	Cell-specific RS EPRE	dBm/15kHz	-	-75	The power level values are assigned to satisfy both $Srx_{levNR\ Cell\ 1} < Thresh_{serving, low}$ and $Srx_{levE-UTRA\ Cell\ 1} > Thresh_{x, low}$.
	SS/PBCH SSS EPRE	dBm/SCS	-95	-	

Table 6.2.3.3.3.2-2: Void

Table 6.2.3.3.3.2-3: Main behaviour

St	Procedure	Message Sequence		TP	Verdict
		U - S	Message		
1	The SS adjusts the NR and E-UTRAN Cell power levels according to row "T1" in table 6.2.3.3.3.2-1.	-	-	-	-
2	Void	-	-	-	-
3	Check: Does the test result of generic test procedure in TS 38.508-1 [4] Table 4.9.7.2.2-1 is performed and the UE is camped on E-UTRAN Cell 1?	-	-	1	-

4	The SS adjusts the NR and E-UTRAN Cell power levels according to row "T2" in table 6.2.3.3.3.2-1.	-	-	-	-
5	Void	-	-	-	-
6	Generic test procedure in TS 38.508-1 [4] Table 4.9.9.2.2-1 take place and UE is camped on NR Cell 1.	-	-	-	-
7	The SS transmits RRCRelease message on NR Cell 1.	<--	NR:RRCRelease	-	-
7A	The SS changes <i>Priority</i> of E-UTRA cell 1 in the <i>SIB5</i> of NR Cell 1, The <i>ValueTag</i> of <i>SIB5</i> in the <i>SIB1</i> is increased on NR Cell 1.	-	-	-	-
8	The SS notifies the UE of change of System Information on NR Cell 1 by send Short Message on PDCCH using P-RNTI.	<--	NR: ShortMessage	-	-
9	Void	-	-	-	-
10	Wait for 2.1* modification period to allow the new system information to take effect.	-	-	-	-
11	The SS adjusts the NR and E-UTRAN Cell power levels according to row "T3" in table 6.2.3.3.3.2-1.	-	-	-	-
12	Void	-	-	-	-
13	Check: Does the test result of generic test procedure in TS 38.508-1 [4] Table 4.9.7.2.2-1 is performed and the UE is camped on E-UTRAN Cell 1?	-	-	2	-

6.2.3.3.3.3 Specific message contents

Table 6.2.3.3.3-1: SIB2 of NR Cell 1(preamble and all steps, Table 6.2.3.3.3.2-3)

Derivation Path: TS 38.508-1 [4], Table 4.6.2-1			
Information Element	Value/remark	Comment	Condition
SIB2 ::= SEQUENCE {			
cellReselectionServingFreqInfo SEQUENCE {			
threshServingLowP	10	20 dB	
}			
}			

Table 6.2.3.3.3-2: SIB5 of NR Cell 1(preamble and all steps, Table 6.2.3.3.3.2-3)

Derivation Path: TS 38.508-1 [4], Table 4.6.2-4			
Information Element	Value/remark	Comment	Condition
SIB5 ::= SEQUENCE {			
carrierFreqListEUTRA SEQUENCE (SIZE (1..maxEUTRA-Carrier)) OF CarrierFreqEUTRA {	1 entry		
CarrierFreqEUTRA[1] SEQUENCE {		entry 1	
carrierFreq	Downlink EUTRA ARFCN as E-UTRA Cell 1 used		
cellReselectionPriority	5		
threshX-High	10	20 dB	
threshX-Low	20	40 dB	
}			
}			
t-ReselectionEUTRA	7	7 Seconds	
}			

Table 6.2.3.3.3-3: SystemInformationBlockType3 of EUTRA Cell 1 (preamble and all steps, Table 6.2.3.3.3.2-3)

Derivation Path: TS 36.508 [7], Table 4.4.3.3-2

Information Element	Value/remark	Comment	Condition
SystemInformationBlockType3 ::= SEQUENCE {			
cellReselectionServingFreqInfo SEQUENCE {			
threshServingLow	10	20 dB	
}			
}			

Table 6.2.3.3.3.3-4: SystemInformationBlockType24 of EUTRA Cell 1 (preamble and all steps, Table 6.2.3.3.3.2-3)

Derivation path: TS 36.508 [7], Table 4.4.3.3-20			
Information Element	Value/Remark	Comment	Condition
SystemInformationBlockType24-r15 ::= SEQUENCE {			
carrierFreqListNR-r15 SEQUENCE (SIZE (1..maxFreq)) OF CarrierFreqNR-r15 {	1 entry		
CarrierFreqNR-r15[1] SEQUENCE {		entry 1	
carrierFreq-r15	Same downlink SSB ARFCN as used for NR Cell 1		
cellReselectionPriority-r15	3		
threshX-High-r15	20	40 dB	
threshX-Low-r15	10	20 dB	
}			
}			
t-ReselectionNR-r15	7	7 Seconds	
}			

Table 6.2.3.3.3.3-5: SIB5 of NR Cell 1(Step 7A, Table 6.2.3.3.3.2-3)

Derivation Path: TS 38.508-1 [4], Table 4.6.2-4			
Information Element	Value/remark	Comment	Condition
SIB5 ::= SEQUENCE {			
carrierFreqListEUTRA SEQUENCE (SIZE (1..maxEUTRA-Carrier)) OF CarrierFreqEUTRA {	1 entry		
CarrierFreqEUTRA[1] SEQUENCE {		entry 1	
carrierFreq	Downlink EUTRA ARFCN as E-UTRA Cell 1 used		
cellReselectionPriority	3		
threshX-High	20	40 dB	
threshX-Low	10	20 dB	
}			
}			
t-ReselectionEUTRA	7	7 Seconds	
}			

Table 6.2.3.3.3.3-6: SIB1 of NR Cell 1 (step 7A, Table 6.2.3.3.3.2-3)

Derivation Path: TS 38.508-1 [4], Table 4.6.128			
Information Element	Value/remark	Comment	Condition
SIB1 ::= SEQUENCE {			
si-SchedulingInfo	SI-SchedulingInfo		
}			

Table 6.2.3.3.3.3-7: SI-SchedulingInfo (si-SchedulingInfo in Table 6.2.3.3.3.3-6)

Derivation Path: TS 38.508-1 [4], Table 4.6.3-173			
Information Element	Value/remark	Comment	Condition
SI-SchedulingInfo ::= SEQUENCE {			
schedulingInfoList SEQUENCE (SIZE(1..maxSI-Message)) OF SchedulingInfo {	1 entry		
}			

SchedulingInfo[1] SEQUENCE {		entry 1	
sib-MappingInfo SEQUENCE (SIZE (1..maxSIB)) OF SIB-TypeInfo {	1 entry		
SIB-TypeInfo[1] SEQUENCE {		entry 1	
type	sibType5		
valueTag	1		
}			
}			
}			

Table 6.2.3.3.3-8: TRACKING AREA UPDATE REQUEST (Step 3, Table 6.2.3.3.3-2-3)

Derivation Path: TS 38.508-1 [4], Table 4.9.7.2.3-1 with condition First-N1-to-S1 = TRUE
--

Table 6.2.3.3.3-9: TRACKING AREA UPDATE REQUEST (Step 13, Table 6.2.3.3.3-2-3)

Derivation Path: TS 38.508-1 [4], Table 4.9.7.2.3-1 with condition First-N1-to-S1 = FALSE

Table 6.2.3.3.3-10: REGISTRATION REQUEST (Step 6, Table 6.2.3.3.3-2-3)

Derivation Path: TS 38.508-1 [4], Table 4.7.1-6.			
Information Element	Value/remark	Comment	Condition
EPS NAS message container	TRACKING AREA UPDATE REQUEST message	See Table 6.2.3.3.3-11	

Table 6.2.3.3.3-11: TRACKING AREA UPDATE REQUEST (Table 6.2.3.3.3-10)

Derivation Path: TS 36.508 [2], Table 4.7.2-27.			
Information Element	Value/remark	Comment	Condition
EPS update type			
EPS update type Value	'000'B	TA updating	
"Active" flag	'0'B	No bearer establishment requested	
NAS key set identifier			
NAS key set identifier	the eKSI value for the current mapped EPS security context		
TSC	'1'B	mapped security context	

6.2.3.4 Inter-RAT cell reselection / From NR RRC_IDLE to E-UTRA_IDLE (lower priority & higher priority, Squal based)

6.2.3.4.1 Test Purpose (TP)

(1)

```

with { UE in NR RRC_Idle state }
ensure that {
  when { UE detects the cell re-selection criteria are met for the cell which belongs to the lower
priority inter-RAT E-UTRA cell }
  then { UE reselects the cell which belongs to the lower priority inter-RAT E-UTRA cell }
}

```

(2)

```

with { UE in NR RRC_Idle state }
ensure that {
  when { UE detects the cell re-selection criteria are met for the cell which belongs to the higher
priority inter-RAT E-UTRA cell }
  then { UE reselects the cell which belongs to the higher priority inter-RAT E-UTRA cell }
}

```

6.2.3.4.2 Conformance requirements

References: The conformance requirements covered in the present TC are specified in: 3GPP TS 38.304, clause 5.2.4.1, 5.2.4.2 and 5.2.4.5. Unless otherwise stated these are Rel-15 requirements.

[TS 38.304, clause 5.2.4.1]

Absolute priorities of different NR frequencies or inter-RAT frequencies may be provided to the UE in the system information, in the *RRCRelease* message, or by inheriting from another RAT at inter-RAT cell (re)selection. In the case of system information, an NR frequency or inter-RAT frequency may be listed without providing a priority (i.e. the field *cellReselectionPriority* is absent for that frequency). If priorities are provided in dedicated signalling, the UE shall ignore all the priorities provided in system information. If UE is in *camped on any cell* state, UE shall only apply the priorities provided by system information from current cell, and the UE preserves priorities provided by dedicated signalling and *deprioritisationReq* received in *RRCRelease* unless specified otherwise. When the UE in camped normally state, has only dedicated priorities other than for the current frequency, the UE shall consider the current frequency to be the lowest priority frequency (i.e. lower than any of the network configured values).

The UE shall only perform cell reselection evaluation for NR frequencies and inter-RAT frequencies that are given in system information and for which the UE has a priority provided.

In case UE receives *RRCRelease* with *deprioritisationReq*, UE shall consider current frequency and stored frequencies due to the previously received *RRCRelease* with *deprioritisationReq* or all the frequencies of NR to be the lowest priority frequency (i.e. lower than any of the network configured values) while T325 is running irrespective of camped RAT. The UE shall delete the stored deprioritisation request(s) when a PLMN selection is performed on request by NAS (TS 23.122 [9]).

NOTE: UE should search for a higher priority layer for cell reselection as soon as possible after the change of priority. The minimum related performance requirements specified in TS 38.133 [8] are still applicable.

The UE shall delete priorities provided by dedicated signalling when:

- the UE enters a different RRC state; or
- the optional validity time of dedicated priorities (T320) expires; or
- a PLMN selection is performed on request by NAS (TS 23.122 [9]).

NOTE 2: Equal priorities between RATs are not supported.

The UE shall not consider any black listed cells as candidate for cell reselection.

The UE shall inherit the priorities provided by dedicated signalling and the remaining validity time (i.e. T320 in NR and E-UTRA), if configured, at inter-RAT cell (re)selection.

NOTE 3: The network may assign dedicated cell reselection priorities for frequencies not configured by system information.

[TS 38.304, clause 5.2.4.1]

Following rules are used by the UE to limit needed measurements:

- If the serving cell fulfils $S_{rxlev} > S_{IntraSearchP}$ and $S_{qual} > S_{IntraSearchQ}$, the UE may choose not to perform intra-frequency measurements.
- Otherwise, the UE shall perform intra-frequency measurements.
- The UE shall apply the following rules for NR inter-frequencies and inter-RAT frequencies which are indicated in system information and for which the UE has priority provided as defined in 5.2.4.1:

- For a NR inter-frequency or inter-RAT frequency with a reselection priority higher than the reselection priority of the current NR frequency, the UE shall perform measurements of higher priority NR inter-frequency or inter-RAT frequencies according to TS 38.133 [8].
- For a NR inter-frequency with an equal or lower reselection priority than the reselection priority of the current NR frequency and for inter-RAT frequency with lower reselection priority than the reselection priority of the current NR frequency:
 - If the serving cell fulfils $S_{rxlev} > S_{nonIntraSearchP}$ and $S_{qual} > S_{nonIntraSearchQ}$, the UE may choose not to perform measurements of NR inter-frequencies or inter-RAT frequency cells of equal or lower priority;
 - Otherwise, the UE shall perform measurements of NR inter-frequencies or inter-RAT frequency cells of equal or lower priority according to TS 38.133 [8].

[TS 38.304, clause 5.2.4.5]

If *threshServingLowQ* is broadcast in system information and more than 1 second has elapsed since the UE camped on the current serving cell, cell reselection to a cell on a higher priority NR frequency or inter-RAT frequency than the serving frequency shall be performed if:

- A cell of a higher priority NR or EUTRAN RAT/frequency fulfils $S_{qual} > Thresh_{X, HighQ}$ during a time interval $T_{reselection_{RAT}}$

Otherwise, cell reselection to a cell on a higher priority NR frequency or inter-RAT frequency than the serving frequency shall be performed if:

- A cell of a higher priority RAT/ frequency fulfils $S_{rxlev} > Thresh_{X, HighP}$ during a time interval $T_{reselection_{RAT}}$; and
- More than 1 second has elapsed since the UE camped on the current serving cell.

Cell reselection to a cell on an equal priority NR frequency shall be based on ranking for intra-frequency cell reselection as defined in sub-clause 5.2.4.6.

If *threshServingLowQ* is broadcast in system information and more than 1 second has elapsed since the UE camped on the current serving cell, cell reselection to a cell on a lower priority NR frequency or inter-RAT frequency than the serving frequency shall be performed if:

- The serving cell fulfils $S_{qual} < Thresh_{Serving, LowQ}$ and a cell of a lower priority NR or E-UTRAN RAT/ frequency fulfils $S_{qual} > Thresh_{X, LowQ}$ during a time interval $T_{reselection_{RAT}}$.

Otherwise, cell reselection to a cell on a lower priority NR frequency or inter-RAT frequency than the serving frequency shall be performed if:

- The serving cell fulfils $S_{rxlev} < Thresh_{Serving, LowP}$ and a cell of a lower priority RAT/ frequency fulfils $S_{rxlev} > Thresh_{X, LowP}$ during a time interval $T_{reselection_{RAT}}$; and
- More than 1 second has elapsed since the UE camped on the current serving cell.

Cell reselection to a higher priority RAT/frequency shall take precedence over a lower priority RAT/frequency if multiple cells of different priorities fulfil the cell reselection criteria.

If more than one cell meets the above criteria, the UE shall reselect a cell as follows:

- If the highest-priority frequency is an NR frequency, the highest ranked cell among the cells on the highest priority frequency(ies) meeting the criteria according to clause 5.2.4.6;
- If the highest-priority frequency is from another RAT, the highest ranked cell among the cells on the highest priority frequency(ies) meeting the criteria of that RAT.

6.2.3.4.3 Test description

6.2.3.4.3.1 Pre-test conditions

System Simulator:

- NR Cell 1 and E-UTRA Cell 1.
- NR Cell 1 is configured to operate in FR1 bands as defined in TS 38.508-1 [4] clause 6.2.3.
- System information combination NR-6 as defined in TS 38.508-1 [7] clause 4.4.3.1, and message contents defined in clause 4.6.1 and clause 4.6.2 with QBASED condition is used in NR cell.
- System information combination 31 as defined in TS 36.508 [7] clause 4.4.3.1, and message contents defined in clause 4.4.3.3 with QBASED condition is used in E-UTRA cell.

UE:

None.

Preamble:

With E-UTRA Cell 1 "Serving cell" and NR Cell 1 "Non-suitable "Off" cell" in accordance with TS 38.508-1 [4], Table 6.2.2.1-3, the UE is brought to state RRC_IDLE using generic procedure parameters Connectivity (E-UTRA/EPC) and Unrestricted nr PDN (*On*) in accordance with the procedure described in TS 38.508-1 [4], clause 4.5.2. 4G-GUTI and eKSI are assigned and security context established.

The UE is switched-off.

With E-UTRA Cell 1 "Non-suitable "Off" cell" and NR Cell 1 "Serving cell" in accordance with TS 38.508-1 [4], Table 6.2.2.1-3, the UE is brought to state 1N-A, RRC_IDLE Connectivity (NR), in accordance with the procedure described in TS 38.508-1 [4], Table 4.5.2.2-2. 5G-GUTI and ngKSI are assigned and security context established.

6.2.3.4.3.2 Test procedure sequence

Table 6.2.3.4.3.2-1 illustrates the downlink power levels and other changing parameters to be applied for the cell at various time instants of the test execution. The exact instants on which these values shall be applied are described in the texts in this clause. Configurations marked "T1", "T2" and "T3" are applied at the points indicated in the Main behaviour description in Table 6.2.3.4.3.2-3.

Table 6.2.3.4.3.2-1: Time instances of cell power level and parameter changes for NR Cell in conducted test environment

	Parameter	Unit	NR Cell 1	E-UTRA Cell 1	Remark
T1	Cell-specific RS EPRE	dBm/15kHz	-	-80	The power level values are assigned to ensure UE reselected to E-UTRA Cell 1: both $S_{qual}^{ServingCell, NR Cell1} < Thresh_{Serving, LowQ}$ and $S_{qual}^{nonServingCell, E-UTRA Cell1} > Thresh_{X, LowQ}$
	SS/PBCH SSS EPRE	dBm/SCS	-95	-	
	RSRQ	dB	-21.20	-3.76	
	Qqualmin	dB	-25	-20	
	NO _{CE-UTRA}	dBm/15kHz	-	-95	
	NO _{CNR}	dBm/SCS	-85	-	
T2	Cell-specific RS EPRE	dBm/15kHz	-	-95	The power level values are assigned to ensure UE reselected back to NR Cell 1: $S_{qual}^{nonServingCell, NR Cell1} > Thresh_{X, HighQ}$
	SS/PBCH SSS EPRE	dBm/SCS	-80	-	
	RSRQ	dB	-11.96	-11.46	
	Qqualmin	dB	-25	-20	
	NO _{CE-UTRA}	dBm/15kHz	-	-95	
	NO _{CNR}	dBm/SCS	-85	-	
T3	Cell-specific RS EPRE	dBm/15kHz	-	-80	The power level values are assigned to ensure UE reselected to E-UTRA Cell 1:

	SS/PBCH SSS EPRE	dBm/SCS	-95	-	Squal _{nonServingCell, E-UTRA Cell1} > ThreshX, HighQ
	RSRQ	dB	-21.20	-3.76	
	Qqualmin	dB	-25	-20	
	NO _{CE-UTRA}	dBm/15kHz	-	-95	
	NO _{CNR}	dBm/SCS	-85	-	

Table 6.2.3.4.3.2-2: Void

Table 6.2.3.4.3.2-3: Main behaviour

St	Procedure	Message Sequence		TP	Verdict
		U - S	Message		
1	The SS changes SS/PBCH SSS EPRE level for NR Cell 1 and Cell-specific RS EPRE level for E-UTRA Cell 1 according to row "T1" in table 6.2.3.4.3.2-1.	-	-	-	-
2	Check: Does the test result of test steps 1 to 6 of generic test procedure in TS 38.508-1 [4] Table 4.9.7.2.2-1 indicate that the UE is camped on E-UTRA Cell 1?	-	-	1	-
3	The SS transmits an <i>RRCConectionRelease</i> message to release RRC connection and move to RRC_IDLE on E-UTRAN Cell 1.	<--	E-UTRA RRC: <i>RRCConectionRelease</i>	-	-
4	The SS changes SS/PBCH SSS EPRE level for NR Cell 1 and Cell-specific RS EPRE level for E-UTRA Cell 1 according to row "T2" in table 6.2.3.4.3.2-1.	-	-	-	-
5	The UE selects NR Cell 1 and performs the generic test procedure in TS 38.508-1 Table 4.9.9.2.2-1 with condition ' <i>connected without release</i> '.	-	-	-	-
6	The SS transmits an <i>RRCRRelease</i> message on NR Cell 1.	<--	NR RRC: <i>RRCRRelease</i>	-	-
7	The SS changes the E-UTRA cell priority broadcast in system information on NR Cell 1.	-	-	-	-
8	Notify UE change of System Information on NR Cell 1.	<--	NR RRC: <i>ShortMessage</i>	-	-
9	Wait for 6 s for UE to receive system information.	-	-	-	-
10	The SS changes SS/PBCH SSS EPRE level for NR Cell 1 and Cell-specific RS EPRE level for E-UTRA Cell 1 according to row "T3" in table 6.2.3.4.3.2-1.	-	-	-	-
11	Check: Does the test result of test steps 1 to 6 of generic test procedure in TS 38.508-1 [4] Table 4.9.7.2.2-1 indicate that the UE is camped on E-UTRA Cell 1?	-	-	2	-
12	The SS transmits an <i>RRCConectionRelease</i> message to release RRC connection and move to RRC_IDLE on E-UTRAN Cell 1.	<--	E-UTRA RRC: <i>RRCConectionRelease</i>	-	-

6.2.3.4.3.3 Specific message contents

Table 6.2.3.4.3.3-1: *SIB1* for NR Cell 1 (preamble and all steps, Table 6.2.3.4.3.2-3)

Derivation path: TS 38.508-1 [4], Table 4.6.1-28			
Information Element	Value/Remark	Comment	Condition
SIB1 ::= SEQUENCE {			
cellSelectionInfo SEQUENCE {			
q-QualMin	-25		
}			

}			
---	--	--	--

Table 6.2.3.4.3.2-2: SIB2 for NR Cell 1 (preamble and all steps, Table 6.2.3.4.3.2-3)

Derivation path: TS 38.508-1 [4], Table 4.6.2-1			
Information Element	Value/Remark	Comment	Condition
SIB2 ::= SEQUENCE {			
cellReselectionServingFreqInfo SEQUENCE {			
threshServingLowQ	9		
}			
}			

Table 6.2.3.4.3.3-3: SIB5 NR Cell 1 (preamble, Table 6.2.3.4.3.2-3)

Derivation path: TS 38.508-1 [4], Table 4.6.2-4			
Information Element	Value/remark	Comment	Condition
SIB5 ::= SEQUENCE {			
carrierFreqListEUTRA SEQUENCE (SIZE (1..maxEUTRA-Carrier)) OF CarrierFreqEUTRA {	1 entry		
CarrierFreqEUTRA[1] SEQUENCE {		entry 1	
carrierFreq	Downlink E-UTRA ARFCN for E-UTRA Cell 1		
}			
}			
threshX-Q SEQUENCE {			
threshX-HighQ	20		
threshX-LowQ	10		
}			
}			
t-ReselectionEUTRA	7		
}			

Table 6.2.3.4.3.3-4: SystemInformationBlockType1 for E-UTRA Cell 1 (preamble and all steps, Table 6.2.3.4.3.2-3)

Derivation path: TS 36.508-1 [7], Table 4.4.3.2-3			
Information Element	Value/Remark	Comment	Condition
SystemInformationBlockType1 ::= SEQUENCE {			
nonCriticalExtension SEQUENCE {			
nonCriticalExtension SEQUENCE {			
cellSelectionInfo-v920 SEQUENCE {			
q-QualMin-r9	-20		
}			
}			
}			
}			

Table 6.2.3.4.3.3-5: SystemInformationBlockType3 for E-UTRA Cell 1 preamble and all steps, Table 6.2.3.4.3.2-3)

Derivation path: TS 36.508 [7], Table 4.4.3.3-2			
Information Element	Value/Remark	Comment	Condition
SystemInformationBlockType3 ::= SEQUENCE {			
lateNonCriticalExtension {			
q-QualMin-r9	-20		
threshServingLowQ-r9	26		
}			
}			

Table 6.2.3.4.3.3-6: SystemInformationBlockType24 for E-UTRA Cell 1 (preamble and all steps, Table 6.2.3.4.3.2-3)

Derivation path: TS 36.508 [7], Table 4.4.3.3-20			
Information Element	Value/remark	Comment	Condition
SystemInformationBlockType24-r15 ::= SEQUENCE {			
carrierFreqListNR-r15 SEQUENCE (SIZE (1..maxFreq)) OF CarrierFreqNR-r15 {	1 entry		
CarrierFreqNR-r15[1] SEQUENCE {		entry 1	
carrierFreq-r15	Downlink NR ARFCN of SSB for NR Cell 1		
cellReselectionPriority-r15	5		
threshX-Q-r15 SEQUENCE {			
threshX-HighQ-r15	10		
threshX-LowQ-r15	20		
}			
q-QualMin-r15	-25		
}			
t-ReselectionNR-r15	7		
}			

Table 6.2.3.4.3.3-7: SIB5 NR Cell 1 (step 7, Table 6.2.3.4.3.2-3)

Derivation path: TS 38.508-1 [4], Table 4.6.2-4			
Information Element	Value/remark	Comment	Condition
SIB5 ::= SEQUENCE {			
carrierFreqListEUTRA SEQUENCE (SIZE (1..maxEUTRA-Carrier)) OF CarrierFreqEUTRA {	1 entry		
CarrierFreqEUTRA[1] SEQUENCE {		entry 1	
carrierFreq	Downlink E-UTRA ARFCN for E-UTRA Cell 1		
cellReselectionPriority	5		
q-QualMin	-20		
threshX-Q SEQUENCE {			
threshX-HighQ	12		
threshX-LowQ	20		
}			
}			
t-ReselectionEUTRA	7		
}			

Table 6.2.3.4.3.3-8: SIB1 of NR Cell 1 (step 9, Table 6.2.3.4.3.2-3)

Derivation Path: TS 38.508-1 [4], Table 4.6.1-28			
Information Element	Value/remark	Comment	Condition
SIB1 ::= SEQUENCE {			
cellSelectionInfo SEQUENCE {			
q-QualMin	-25		
}			
si-SchedulingInfo	SI-SchedulingInfo		
}			

Table 6.2.3.4.3.3-9: SI-SchedulingInfo (si-SchedulingInfo in Table 6.2.3.4.3.3-8)

Derivation Path: TS 38.508-1 [4], Table 4.6.3-173			
Information Element	Value/remark	Comment	Condition
SI-SchedulingInfo ::= SEQUENCE {			

schedulingInfoList SEQUENCE (SIZE(1..maxSI-Message)) OF SchedulingInfo {	1 entry		
SchedulingInfo[1] SEQUENCE {		entry 1	
sib-MappingInfo SEQUENCE (SIZE(1..maxSIB)) OF SIB-TypeInfo {	1 entry		
SIB-TypeInfo[1] SEQUENCE {		entry 1	
type	sibType5		
valueTag	1		
}			
}			
}			
}			

Table 6.2.3.4.3.3-10: REGISTRATION REQUEST (Step 5, Table 6.2.3.4.3.2-3)

Derivation Path: TS 38.508-1 [4], Table 4.7.1-6.			
Information Element	Value/remark	Comment	Condition
EPS NAS message container	TRACKING AREA UPDATE REQUEST message	See Table 6.2.3.4.3.3-11	

Table 6.2.3.4.3.3-11: TRACKING AREA UPDATE REQUEST (Table 6.2.3.4.3.3-10)

Derivation Path: TS 38.508-1 [4], Table 4.9.9.2.3-2 with condition Mapped EPS security context
--

6.2.3.5 Inter-RAT cell reselection / From NR RRC_IDLE to E-UTRA_IDLE according to RAT priority provided by dedicated signalling (RRCRelease)

6.2.3.5.1 Test Purpose (TP)

(1)

```
with { UE in NR RRC_IDLE state having received an RRCRelease message including
cellReselectionPriorities }
ensure that {
  when { UE detects the cell re-selection criteria are met for the cell which belongs to the higher
priority RAT }
  then { UE reselects the cell which belongs to the higher priority RAT }
}
```

(2)

```
with { UE in NR RRC_IDLE state having received an RRCRelease message including a
cellReselectionPriorities }
ensure that {
  when { UE detects the cell re-selection criteria are met for the cell which belongs to the lower
priority RAT }
  then { UE reselects the cell which belongs to the lower priority RAT }
}
```

(3)

```
with { UE in NR RRC_IDLE state having received an RRCRelease message including a
cellReselectionPriorities }
ensure that {
  when { T320 expires }
  then { UE reselects a cell by applying the cellReselectionPriority broadcast in the system
information }
}
```

(4)

```

with { UE in NR RRC_IDLE state and reselection priorities have been provided in dedicated signalling
}
ensure that {
  when { T320 has not expired }
  then { The UE shall ignore all the priorities provided in system information, and not perform
cell reselection evaluation for NR frequencies and E-UTRA frequencies for which the UE doesn't have
a priority provided }
}
}

```

6.2.3.5.2 Conformance requirements

References: The conformance requirements covered in the present TC are specified in: 3GPP TS 38.304: clause 5.2.4.1 and 5.2.4.5, 3GPP TS 38.331: clause 5.3.8.3 and 5.3.8.4. Unless otherwise stated these are Rel-15 requirements.

[TS 38.304, clause 5.2.4.1]

Absolute priorities of different NR frequencies or inter-RAT frequencies may be provided to the UE in the system information, in the *RRCRelease* message, or by inheriting from another RAT at inter-RAT cell (re)selection. In the case of system information, an NR frequency or inter-RAT frequency may be listed without providing a priority (i.e. the field *cellReselectionPriority* is absent for that frequency). If priorities are provided in dedicated signalling, the UE shall ignore all the priorities provided in system information. If UE is in *camped on any cell* state, UE shall only apply the priorities provided by system information from current cell, and the UE preserves priorities provided by dedicated signalling and *deprioritisationReq* received in *RRCRelease* unless specified otherwise. When the UE in *camped normally* state, has only dedicated priorities other than for the current frequency, the UE shall consider the current frequency to be the lowest priority frequency (i.e. lower than any of the network configured values).

The UE shall only perform cell reselection evaluation for NR frequencies and inter-RAT frequencies that are given in system information and for which the UE has a priority provided.

In case UE receives *RRCRelease* with *deprioritisationReq*, UE shall consider current frequency and stored frequencies due to the previously received *RRCRelease* with *deprioritisationReq* or all the frequencies of NR to be the lowest priority frequency (i.e. lower than any of the network configured values) while T325 is running irrespective of *camped* RAT. The UE shall delete the stored *deprioritisationReq* request(s) when a PLMN selection is performed on request by NAS (TS 23.122 [9]).

NOTE: UE should search for a higher priority layer for cell reselection as soon as possible after the change of priority. The minimum related performance requirements specified in TS 38.133 [8] are still applicable.

The UE shall delete priorities provided by dedicated signalling when:

- the UE enters a different RRC state; or
- the optional validity time of dedicated priorities (T320) expires; or
- a PLMN selection is performed on request by NAS (TS 23.122 [9]).

NOTE 2: Equal priorities between RATs are not supported.

The UE shall not consider any black listed cells as candidate for cell reselection.

The UE shall inherit the priorities provided by dedicated signalling and the remaining validity time (i.e. T320 in NR and E-UTRA), if configured, at inter-RAT cell (re)selection.

NOTE 3: The network may assign dedicated cell reselection priorities for frequencies not configured by system information.

[TS 38.304, clause 5.2.4.2]

Following rules are used by the UE to limit needed measurements:

- If the serving cell fulfils $S_{rxlev} > S_{IntraSearchP}$ and $S_{qual} > S_{IntraSearchQ}$, the UE may choose not to perform intra-frequency measurements.
- Otherwise, the UE shall perform intra-frequency measurements.

- The UE shall apply the following rules for NR inter-frequencies and inter-RAT frequencies which are indicated in system information and for which the UE has priority provided as defined in 5.2.4.1:
 - For a NR inter-frequency or inter-RAT frequency with a reselection priority higher than the reselection priority of the current NR frequency, the UE shall perform measurements of higher priority NR inter-frequency or inter-RAT frequencies according to TS 38.133 [8].
 - For a NR inter-frequency with an equal or lower reselection priority than the reselection priority of the current NR frequency and for inter-RAT frequency with lower reselection priority than the reselection priority of the current NR frequency:
 - If the serving cell fulfils $S_{rxlev} > S_{nonIntraSearchP}$ and $S_{qual} > S_{nonIntraSearchQ}$, the UE may choose not to perform measurements of NR inter-frequencies or inter-RAT frequency cells of equal or lower priority;
 - Otherwise, the UE shall perform measurements of NR inter-frequencies or inter-RAT frequency cells of equal or lower priority according to TS 38.133 [8].

[TS 38.331, clause 5.3.8.3]

The UE shall:

- 1> delay the following actions defined in this sub-clause 60 ms from the moment the *RRCRelease* message was received or optionally when lower layers indicate that the receipt of the *RRCRelease* message has been successfully acknowledged, whichever is earlier;
 - 1> stop timer T380, if running;
 - 1> stop timer T320, if running;
 - 1> if T390 is running:
 - 2> stop timer T390 for all access categories;
 - 2> perform the actions as specified in 5.3.14.4;
 - 1> if the AS security is not activated, perform the actions upon going to RRC_IDLE as specified in 5.3.11 with the release cause 'other' upon which the procedure ends;
 - 1> if the *RRCRelease* message includes *redirectedCarrierInfo* indicating redirection to *eutra*:
 - 2> if *cnType* is included:
 - 3> after the cell selection, indicate the available CN Type(s) and the received *cnType* to upper layers;
- NOTE: Handling the case if the E-UTRA cell selected after the redirection does not support the core network type specified by the *cnType*, is up to UE implementation.
- 1> if the *RRCRelease* message includes the *cellReselectionPriorities*:
 - 2> store the cell reselection priority information provided by the *cellReselectionPriorities*;
 - 2> if the *t320* is included:
 - 3> start timer T320, with the timer value set according to the value of *t320*;
 - 1> else:
 - 2> apply the cell reselection priority information broadcast in the system information;
 - 1> if *deprioritisationReq* is included:
 - 2> start or restart timer T325 with the timer value set to the *deprioritisationTimer* signalled;
 - 2> store the *deprioritisationReq* until T325 expiry;
 - 1> if the *RRCRelease* includes *suspendConfig*:
 - 2> apply the received *suspendConfig*;

- 2> reset MAC and release the default MAC Cell Group configuration, if any;
 - 2> re-establish RLC entities for SRB1;
 - 2> if the *RRCRelease* message with *suspendConfig* was received in response to an *RRCResumeRequest* or an *RRCResumeRequest1*:
 - 3> stop the timer T319 if running;
 - 3> in the stored UE Inactive AS context:
 - 4> replace the K_{gNB} and K_{RRCint} keys with the current K_{gNB} and K_{RRCint} keys;
 - 4> replace the C-RNTI with the temporary C-RNTI in the cell the UE has received the *RRCRelease* message;
 - 4> replace the *cellIdentity* with the *cellIdentity* of the cell the UE has received the *RRCRelease* message;
 - 4> replace the physical cell identity with the physical cell identity of the cell the UE has received the *RRCRelease* message;
 - 4> replace the *suspendConfig* with the current *suspendConfig*;
 - 2> else:
 - 3> store in the UE Inactive AS Context the configured *suspendConfig*, the current K_{gNB} and K_{RRCint} keys, the ROHC state, the C-RNTI used in the source PCell, the *cellIdentity* and the physical cell identity of the source PCell, and all other parameters configured except with *ReconfigurationWithSync*;
 - 2> suspend all SRB(s) and DRB(s), except SRB0;
 - 2> indicate PDCP suspend to lower layers of all DRBs;
 - 2> if the *t380* is included:
 - 3> start timer T380, with the timer value set to *t380*;
 - 2> if the *RRCRelease* message is including the *waitTime*:
 - 3> start timer T302 with the value set to the *waitTime*;
 - 3> inform the upper layer that access barring is applicable for all access categories except categories '0' and '2';
 - 2> indicate the suspension of the RRC connection to upper layers;
 - 2> enter RRC_INACTIVE and perform cell selection as specified in TS 38.304 [20];
- 1> else
- 2> perform the actions upon going to RRC_IDLE as specified in 5.3.11, with the release cause 'other'.

[TS 38.331, clause 5.3.8.4]

The UE shall:

- 1> if T320 expires:
 - 2> if stored, discard the cell reselection priority information provided by the *cellReselectionPriorities* or inherited from another RAT;
 - 2> apply the cell reselection priority information broadcast in the system information.

6.2.3.5.3 Test description

6.2.3.5.3.1 Pre-test conditions

System Simulator:

- NR Cell 1, E-UTRA Cell 1 is inter-RAT cell.
- NR Cell 1 is configured to operate in FR1 bands as defined in TS 38.508-1 [4] clause 6.2.3.
- System information combination NR-6 as defined in TS 38.508-1 [4] clause 4.4.3.1.3 is used in NR Cell.
- System information combination 31 as defined in TS 36.508-1 [18] clause 4.4.3.1 is used in E-UTRA Cell.

UE:

None.

Preamble:

- With E-UTRA Cell 1 "Serving cell" and NR Cell 1 "Non-suitable "Off" cell" in accordance with TS 38.508-1 [4], Table 6.2.2.1-3, the UE is brought to state RRC_IDLE using generic procedure parameters Connectivity (E-UTRA/EPC) and Unrestricted nr PDN (*On*) in accordance with the procedure described in TS 38.508-1 [4], clause 4.5.2. 4G GUTI and eKSI are assigned and security context established.
- the UE is switched-off.
- With E-UTRA Cell 1 "Non-suitable "Off" cell" and NR Cell 1 "Serving cell" in accordance with TS 38.508-1 [4], Table 6.2.2.1-3, the UE is brought to state 3N-A, RRC_CONNECTED Connectivity (NR), in accordance with the procedure described in TS 38.508-1 [4], Table 4.5.4.2-3. 5G-GUTI and ngKSI are assigned and security context established.

6.2.3.5.3.2 Test procedure sequence

Table 6.2.3.5.3.2-1 illustrates the downlink power levels and other changing parameters to be applied for the cell at various time instants of the test execution. The exact instants on which these values shall be applied are described in the texts in this clause. Row marked "T0" denotes the conditions in the preamble. Configurations marked "T1", "T2" and so on are applied at the points indicated in the Main behaviour description in Table 6.1.3.5.3.2-3.

Table 6.2.3.5.3.2-1: Time instances of cell power level and parameter changes for E-UTRA cell 1 and NR cell 1 in conducted test environment

	Parameter	Unit	NR Cell 1	E-UTRA Cell 1	Remark
T0	Cell-specific RS EPRE	dBm/15kHz	-	OFF	The power level values are assigned to satisfy $Srxlev_{NR\ Cell\ 1} > 0$ and $Srxlev_{E-UTRA\ Cell\ 1} < 0$. And UE camping on NR Cell 1 is guaranteed.
	SS/PBCH SSS EPRE	dBm/SCS	-88	-	
T1	Cell-specific RS EPRE	dBm/15kHz	-	-70	The power level values are assigned to satisfy $Srxlev_{E-UTRA\ cell\ 1} > Thresh_{x,high}$.
	SS/PBCH SSS EPRE	dBm/SCS	-90	-	
T2	Cell-specific RS EPRE	dBm/15kHz	-	-104	The power level values are such that camping on NR Cell 1 is guaranteed.
	SS/PBCH SSS EPRE	dBm/SCS	-78	-	
T3	Cell-specific RS EPRE	dBm/15kHz	-	-88	The power level values are assigned to satisfy both $Srxlev_{NR\ Cell\ 1} < Thresh_{serving, low}$ and $Srxlev_{E-UTRA\ Cell\ 1} > Thresh_{x, low}$.
	SS/PBCH SSS EPRE	dBm/SCS	-104	-	
T4	Cell-specific RS EPRE	dBm/15kHz	-	-104	The power level values are such that camping on NR Cell 1 is guaranteed.
	SS/PBCH SSS EPRE	dBm/SCS	-78	-	

T5	Cell-specific RS EPRE	dBm/15kHz	-	-70	The power level values are assigned to satisfy $S_{rxlev}^{NMR, cell 1} > Thresh_{serving, low}$ and $S_{rxlev}^{VE-UTRA, cell 1} > Thresh_{x, high}$.
	SS/PBCH SSS EPRE	dBm/SCS	-90	-	

Table 6.2.3.5.3.2-2: Void

Table 6.2.3.5.3.2-3: Main behaviour

St	Procedure	Message Sequence		TP	Verdict
		U - S	Message		
1	The SS transmits RRCRelease message including cellReselectionPriorities on NR Cell 1.	-	NR:RRCRelease	-	-
2	The SS adjusts the NR and E-UTRAN Cell power levels according to row "T1" in table 6.2.3.5.3.2-1.	-	-	-	-
3	Check: Does the UE transmit an RRC CONNECTION REQUEST on E-UTRA Cell 1 within the next 30 Seconds?	-	-	4	F
4	The test steps 1 to 8 of generic test procedure in TS 38.508-1 [4] Table 4.5.4.2-3 are performed on NR Cell 1.	-	-	-	-
5	The SS transmits RRCRelease message including cellReselectionPriorities on NR Cell 1.	<--	NR:RRCRelease	-	-
6	Check: Does the test result of generic test procedure in TS 38.508-1 [4] Table 4.9.7.2.2-1 is performed and the UE is camped on E-UTRAN Cell 1?	-	-	1	-
7	The SS adjusts the NR and E-UTRAN Cell power levels according to row "T2" in table 6.2.3.5.3.2-1.	-	-	-	-
8	Generic test procedure in TS 38.508-1 [4] Table 4.9.9.2.2-1 take place and the UE is camped on NR Cell 1.	-	-	-	-
9	The SS adjusts the NR and E-UTRAN Cell power levels according to row "T3" in table 6.2.3.5.3.2-1.	-	-	-	-
10	The SS transmits RRCRelease message including cellReselectionPriorities on NR Cell 1.	<--	NR:RRCRelease	-	-
11	Check: Does the test result of generic test procedure in TS 38.508-1 [4] Table 4.9.7.2.2-1 is performed and the UE is camped on E-UTRAN Cell 1?	-	-	2	-
12	The SS adjusts the NR and E-UTRAN Cell power levels according to row "T4" in table 6.2.3.5.3.2-1.	-	-	-	-
13	Generic test procedure in TS 38.508-1 [4] Table 4.9.9.2.2-1 take place and the UE is camped on NR Cell 1.	-	-	-	-
14	The SS transmits RRCRelease message including cellReselectionPriorities on NR Cell 1.	<--	NR:RRCRelease	-	-
15	The SS adjusts the NR and E-UTRAN Cell power levels according to row "T5" in table 6.2.3.5.3.2-1.	-	-	-	-
16	Wait for 5 minutes from step 17 to ensure that T320 expires.	-	-	-	-
17	Check: Does the test result of generic test procedure in TS 38.508-1 [4] Table 4.9.7.2.2-1 is performed and the UE is camped on E-UTRAN Cell 1?	-	-	3	-

6.2.3.5.3.3 Specific message contents

Table 6.2.3.5.3.3-1: SIB2 of NR Cell 1(preamble and all steps, Table 6.2.3.5.3.2-3)

Derivation Path: TS 38.508-1 [4], Table 4.6.2-1			
Information Element	Value/remark	Comment	Condition
SIB2 ::= SEQUENCE {			
cellReselectionServingFreqInfo SEQUENCE {			
threshServingLowP	5	10dB	
}			
}			

Table 6.2.3.5.3.3-2: SIB5 of NR Cell 1(preamble and all steps, Table 6.2.3.5.3.2-3)

Derivation Path: TS 38.508-1 [4], Table 4.6.2-4			
Information Element	Value/remark	Comment	Condition
SIB5 ::= SEQUENCE {			
carrierFreqListEUTRA SEQUENCE (SIZE (1..maxEUTRA-Carrier)) OF CarrierFreqEUTRA {	1 entry		
CarrierFreqEUTRA[1] SEQUENCE {		entry 1	
carrierFreq	Downlink EARFCN as E-UTRA Cell 1 used		
cellReselectionPriority	5		
threshX-High	13	26 dB	
threshX-Low	5	10 dB	
}			
}			
t-ReselectionEUTRA	7	7 Seconds	
}			

Table 6.2.3.5.3.3-3: SystemInformationBlockType3 for EUTRA Cell 1 (preamble and all steps, Table 6.2.3.5.3.2-3)

Derivation Path: TS 36.508 [7], Table 4.4.3.2			
Information Element	Value/remark	Comment	Condition
SystemInformationBlockType3 ::= SEQUENCE {			
cellReselectionServingFreqInfo SEQUENCE {			
threshServingLow	5	10dB	
}			
}			

Table 6.2.3.5.3.3-4: SystemInformationBlockType24 for EUTRA Cell 1 (preamble and all steps, Table 6.2.3.5.3.2-3)

Derivation path: TS 36.508 [7], Table 4.4.3.3-20			
Information Element	Value/Remark	Comment	Condition
SystemInformationBlockType24-r15 ::= SEQUENCE {			
carrierFreqListNR-r15 SEQUENCE (SIZE (1..maxFreq)) OF CarrierFreqNR-r15 {	1 entry		
CarrierFreqNR-r15[1] SEQUENCE {		entry 1	
carrierFreq-r15	Same downlink SSB ARFCN as used for NR Cell 1		
cellReselectionPriority-r15	3		
threshX-High-r15	20	40dB	
threshX-Low-r15	10	20dB	
}			
}			
t-ReselectionNR-r15	7	7 Seconds	
}			

Table 6.2.3.5.3.3-5 RRCRelease (step1, Table 6.2.3.5.3.2-3)

Derivation Path: TS 38.508-1 [4], Table 4.6.1-16			
Information Element	Value/remark	Comment	Condition
RRCRelease ::= SEQUENCE {			
criticalExtensions CHOICE {			
rrcRelease SEQUENCE {			
cellReselectionPriorities SEQUENCE {			
freqPriorityListEUTRA	Not present		Step1
freqPriorityListEUTRA SEQUENCE (SIZE (1..maxFreq)) OF FreqPriorityEUTRA {	1 entry		
FreqPriorityListEUTRA[1] SEQUENCE {		entry 1	
carrierFreq	Downlink ARFCN of E-UTRA Cell 1		
cellReselectionPriority	5		Step5
	3		Step10
	3		Step14
}			
}			
freqPriorityListNR SEQUENCE (SIZE (1..maxFreq)) OF FreqPriorityNR {	1 entry		
FreqPriorityNR[1] SEQUENCE {		entry 1	
carrierFreq	Downlink SSB ARFCN of NR Cell 1		
cellReselectionPriority	4		Step1
	4		Step5
	4		Step10
	4		Step14
}			
}			
t320	Not present		Step1
	Not present		Step5
	Not present		Step10
	min5	5 minutes	Step14
}			
}			
}			
}			

Table 6.2.3.5.3.3-6: REGISTRATION REQUEST (Step 8 and Step13, Table 6.2.3.5.3.2-3)

Derivation Path: TS 38.508-1 [4], Table 4.7.1-6.			
Information Element	Value/remark	Comment	Condition
EPS NAS message container	TRACKING AREA UPDATE REQUEST message	See Table 6.2.3.5.3.3-7	

Table 6.2.3.5.3.3-7: TRACKING AREA UPDATE REQUEST (Table 6.2.3.5.3.3-6)

Derivation Path: TS 38.508-1 [4], Table 4.9.9.2.3-2 with condition Mapped EPS security context
--

6.2.3.6 Inter-RAT cell reselection / From E-UTRA_IDLE to NR RRC_IDLE according to RAT priority provided by dedicated signalling (RRCConnRelease)

6.2.3.6.1 Test Purpose (TP)

(1)

```
with { UE in E-UTRA RRC_Idle state having received RRCConnectionRelease including
IdleModeMobilityControlInfo containing cellReselectionPriority for NR cell}
ensure that {
  when { UE detects the cell re-selection criteria are met for the cell which belongs to the lower
priority inter-RAT NR cell based on the configured RAT priority provided by dedicated signaling}
  then { UE reselects the cell which belongs to the lower priority inter-RAT NR cell}
}
```

(2)

```
with { UE in NR RRC_IDLE state having inherit RAT priority provided by dedicated signaling with the
remaining validity time}
ensure that {
  when { UE discard the inherit RAT priority upon connection establishment}
  then { UE reselects a cell by applying the cellReselectionPriority broadcast in the system
information}
```

6.2.3.6.2 Conformance requirements

References: The conformance requirements covered in the present TC are specified in: 3GPP TS 36.304, clause 5.2.4.1, and 3GPP TS 38.304, clause 5.2.4.1. Unless otherwise stated these are Rel-15 requirements.

[TS 36.304, clause 5.2.4.1]

Absolute priorities of different E-UTRAN frequencies or inter-RAT frequencies may be provided to the UE in the system information, in the *RRCConnectionRelease* message, or by inheriting from another RAT at inter-RAT cell (re)selection. In the case of system information, an E-UTRAN frequency or inter-RAT frequency may be listed without providing a priority (i.e. the field *cellReselectionPriority* is absent for that frequency). If priorities are provided in dedicated signalling, the UE shall ignore all the priorities provided in system information. If UE is in *camped on any cell* state, UE shall only apply the priorities provided by system information from current cell, and the UE preserves priorities provided by dedicated signalling and *deprioritisationReq* received in *RRCConnectionReject* unless specified otherwise. When the UE in *camped normally* state, has only dedicated priorities other than for the current frequency, the UE shall consider the current frequency to be the lowest priority frequency (i.e. lower than any of the network configured values). While the UE is camped on a suitable CSG cell in normal coverage, the UE shall always consider the current frequency to be the highest priority frequency (i.e. higher than any of the network configured values), irrespective of any other priority value allocated to this frequency. When the HSDN capable UE is in High-mobility state, the UE shall always consider the HSDN cells to be the highest priority (i.e. higher than any other network configured priorities). When the HSDN capable UE is not in High-mobility state, the UE shall always consider HSDN cells to be the lowest priority (i.e. lower than network configured priorities). If the UE capable of sidelink communication is configured to perform sidelink communication and can only perform the sidelink communication while camping on a frequency, the UE may consider that frequency to be the highest priority. If the UE capable of V2X sidelink communication is configured to perform V2X sidelink communication and can only perform the V2X sidelink communication while camping on a frequency, the UE may consider that frequency to be the highest priority. If the UE capable of V2X sidelink communication is configured to perform V2X sidelink communication and can only use pre-configuration while not camping on a frequency, the UE may consider the frequency providing inter-carrier V2X sidelink configuration to be the highest priority. If the UE capable of sidelink discovery is configured to perform Public Safety related sidelink discovery and can only perform the Public Safety related sidelink discovery while camping on a frequency, the UE may consider that frequency to be the highest priority.

NOTE 1: The prioritization among the frequencies which UE considers to be the highest priority frequency is left to UE implementation.

If the UE is capable either of MBMS Service Continuity or of SC-PTM reception and is receiving or interested to receive an MBMS service and can only receive this MBMS service while camping on a frequency on which it is provided, the UE may consider that frequency to be the highest priority during the MBMS session TS 36.300 [2] as long as the two following conditions are fulfilled:

1) Either:

- the UE is capable of MBMS service continuity and the reselected cell is broadcasting SIB13; or
- the UE is capable of SC-PTM reception and the reselected cell is broadcasting SIB20;

2) Either:

- SIB15 of the serving cell indicates for that frequency one or more MBMS SAIs included and associated with that frequency in the MBMS User Service Description (USD) TS 26.346 [22] of this service; or
- SIB15 is not broadcast in the serving cell and that frequency is included in the USD of this service.

If the UE is capable either of MBMS Service Continuity or of SC-PTM reception and is receiving or interested to receive an MBMS service provided on a downlink only MBMS frequency, on a frequency used by dedicated MBMS cells, on a frequency used by FeMBMS/Unicast-mixed cells as defined in TS 36.300 [2], or on a frequency belonging to PLMN different from its registered PLMN, the UE may consider cell reselection candidate frequencies at which it can not receive the MBMS service to be of the lowest priority during the MBMS session TS 36.300 [2], as long as the above mentioned condition 1) is fulfilled for the cell on the MBMS frequency which the UE monitors or this cell broadcasts SIB1-MBMS and as long as the above mentioned condition 2) is fulfilled for the serving cell.

NOTE 2: Example scenarios in which the previous down-prioritisation may be needed concerns the cases where camping is not possible, while the UE can only receive this MBMS frequency when camping on a subset of cell reselection candidate frequencies, e.g. the MBMS frequency is a downlink only carrier, the MBMS frequency is used by dedicated MBMS cells, the MBMS frequency is used by FeMBMS/Unicast-mixed cells TS 36.300 [2], or the MBMS frequency belongs to a PLMN different from UE's registered PLMN.

If the UE is not capable of MBMS Service Continuity but has knowledge on which frequency an MBMS service of interest is provided, it may consider that frequency to be the highest priority during the MBMS session TS 36.300 [2] as long as the reselected cell is broadcasting SIB13.

If the UE is not capable of MBMS Service Continuity but has knowledge on which downlink only frequency, on which frequency used by dedicated MBMS cells, on which frequency used by FeMBMS/Unicast-mixed cells as defined in TS 36.300 [2] or on which frequency belonging to PLMN different from its registered PLMN an MBMS service of interest is provided, it may consider cell reselection candidate frequencies at which it can not receive the MBMS service to be of the lowest priority during the MBMS session TS 36.300 [2] as long as the cell on the MBMS frequency which the UE monitors is broadcasting SIB13 or SIB1-MBMS.

NOTE 3: The UE considers that the MBMS session is ongoing using the session start and end times as provided by upper layers in the USD i.e. the UE does not verify if the session is indicated on MCCH.

In case UE receives *RRCConnectionReject* with *deprioritisationReq*, UE shall consider current carrier frequency and stored frequencies due to the previously received *RRCConnectionReject* with *deprioritisationReq* or all the frequencies of EUTRA to be the lowest priority frequency (i.e. lower than any of the network configured values) while T325 is running irrespective of camped RAT. The UE shall delete the stored deprioritisation request(s) when a PLMN selection is performed on request by NAS TS 23.122 [5].

NOTE 4: Connecting to CDMA2000 does not imply PLMN selection.

NOTE 5: UE should search for a higher priority layer for cell reselection as soon as possible after the change of priority. The minimum related performance requirements specified in TS 36.133 [10] are still applicable.

The UE shall delete priorities provided by dedicated signalling when:

- the UE enters a different RRC state; or
- the optional validity time of dedicated priorities (T320) expires; or
- a PLMN selection is performed on request by NAS TS 23.122 [5].

NOTE 6: Equal priorities between RATs are not supported.

The UE shall only perform cell reselection evaluation for E-UTRAN frequencies and inter-RAT frequencies that are given in system information and for which the UE has a priority provided.

The UE shall not consider any black listed cells as candidate for cell reselection.

The UE shall inherit the priorities provided by dedicated signalling and the remaining validity time (i.e., T320 in E-UTRA and NR, T322 in UTRA and T3230 in GERAN), if configured, at inter-RAT cell (re)selection.

NOTE 7: The network may assign dedicated cell reselection priorities for frequencies not configured by system information.

While T360 is running, redistribution target is considered to be the highest priority (i.e. higher than any of the network configured values). UE shall continue to consider the serving frequency as the highest priority until completion of E-UTRAN Inter-frequency Redistribution procedure specified in 5.2.4.10 if triggered on T360 expiry/ stop.

[TS 38.304, clause 5.2.4.1]

Absolute priorities of different NR frequencies or inter-RAT frequencies may be provided to the UE in the system information, in the *RRCRelease* message, or by inheriting from another RAT at inter-RAT cell (re)selection. In the case of system information, an NR frequency or inter-RAT frequency may be listed without providing a priority (i.e. the field *cellReselectionPriority* is absent for that frequency). If priorities are provided in dedicated signalling, the UE shall ignore all the priorities provided in system information. If UE is in *camped on any cell* state, UE shall only apply the priorities provided by system information from current cell, and the UE preserves priorities provided by dedicated signalling and *deprioritisationReq* received in *RRCRelease* unless specified otherwise. When the UE in camped normally state, has only dedicated priorities other than for the current frequency, the UE shall consider the current frequency to be the lowest priority frequency (i.e. lower than any of the network configured values).

The UE shall only perform cell reselection evaluation for NR frequencies and inter-RAT frequencies that are given in system information and for which the UE has a priority provided.

In case UE receives *RRCRelease* with *deprioritisationReq*, UE shall consider current frequency and stored frequencies due to the previously received *RRCRelease* with *deprioritisationReq* or all the frequencies of NR to be the lowest priority frequency (i.e. lower than any of the network configured values) while T325 is running irrespective of camped RAT. The UE shall delete the stored deprioritisation request(s) when a PLMN selection is performed on request by NAS (TS 23.122 [9]).

NOTE: UE should search for a higher priority layer for cell reselection as soon as possible after the change of priority. The minimum related performance requirements specified in TS 38.133 [8] are still applicable.

The UE shall delete priorities provided by dedicated signalling when:

- the UE enters a different RRC state; or
- the optional validity time of dedicated priorities (T320) expires; or
- a PLMN selection is performed on request by NAS (TS 23.122 [9]).

NOTE 2: Equal priorities between RATs are not supported.

The UE shall not consider any black listed cells as candidate for cell reselection.

The UE shall inherit the priorities provided by dedicated signalling and the remaining validity time (i.e. T320 in NR and E-UTRA), if configured, at inter-RAT cell (re)selection.

NOTE 3: The network may assign dedicated cell reselection priorities for frequencies not configured by system information.

6.2.3.6.3 Test description

6.2.3.6.3.1 Pre-test conditions

System Simulator:

- E-UTRA Cell 1, NR Cell 1 is different priority inter-RAT NR cell.
- NR Cell 1 is configured to operate in FR1 bands as defined in TS 38.508-1 [4] clause 6.2.3.
- System information combination 31 as defined in TS 36.508-1 [7] clause 4.4.3.1 is used in E-UTRA Cell.
- System information combination NR-6 as defined in TS 38.508-1 [4] clause 4.4.3.1.3 is used in NR Cell.

UE:

- None.

Preamble:

- With E-UTRA Cell 1 "Non-suitable "Off" cell" and NR Cell 1 "Serving cell" in accordance with TS 38.508-1 [4], Table 6.2.2.1-3, the UE is brought to state 1N-A, RRC_IDLE Connectivity (NR), in accordance with the procedure described in TS 38.508-1 [4], Table 4.5.2.2-2. 5G-GUTI and ngKSI are assigned and security context established.
 - the UE is switched-off.
- With E-UTRA Cell 1 "Serving cell" and NR Cell 1 "Non-suitable "Off" cell" in accordance with TS 38.508-1 [4], Table 6.2.2.1-3, the UE is brought to state RRC_CONNECTED using generic procedure parameters Connectivity (*E-UTRA/EPC*) and Unrestricted nr PDN (*On*) in accordance with the procedure described in TS 38.508-1 [4], clause 4.5.4. 4G GUTI and eKSI are assigned and security context established.

6.2.3.6.3.2 Test procedure sequence

Table 6.2.3.6.3.2-1 illustrates the downlink power levels and other changing parameters to be applied for the cell at various time instants of the test execution. The exact instants on which these values shall be applied are described in the texts in this clause. Row marked "T0" denotes the conditions in the preamble. Configurations marked "T1", "T2" and "T3" are applied at the points indicated in the Main behaviour description in Table 6.2.3.6.3.2-3.

Table 6.2.3.6.3.2-1: Time instances of cell power level and parameter changes for E-UTRA Cell 1 and NR Cell 1 in conducted test environment

	Parameter	Unit	E-UTRA Cell 1	NR Cell 1	Remark
T0	Cell-specific RS EPRE	dBm/15kHz	-85	-	The power level values are assigned to ensure UE registered on E-UTRA cell 1
	SS/PBCH SSS EPRE	dBm/SCS	-	Off	
T1	Cell-specific RS EPRE	dBm/15kHz	-95	-	The power level values are assigned to satisfy both $Srxle^{VE-UTRA\ Cell\ 1} < Thresh_{serving, low}$ and $Srxle^{NR\ Cell\ 1} > Thresh_{x, low}$.
	SS/PBCH SSS EPRE	dBm/SCS	-	-80	
T2	Cell-specific RS EPRE	dBm/15kHz	-80	-	The power level values are assigned to satisfy both $Srxle^{NR\ Cell\ 1} < Thresh_{serving, low}$ and $Srxle^{VE-UTRA\ Cell\ 1} > Thresh_{x, low}$
	SS/PBCH SSS EPRE	dBm/SCS	-	-95	

Table 6.2.3.6.3.2-2: Void

Table 6.2.3.6.3.2-3: Main behaviour

St	Procedure	Message Sequence		TP	Verdict
		U - S	Message		
1	The SS transmits <i>RRConnectionRelease</i> message with dedicated priority information and validity timer to the UE on E-UTRA cell 1.	<--	E-UTRA: <i>RRConnectionRelease</i>	-	-
2	The SS adjusts the E-UTRAN and NR Cell power levels according to row "T1" in table 6.2.3.6.3.2-1.	-	-	-	-
3	Check: Does the test result of generic test procedure in TS 38.508-1 [4] Table 4.9.9.2.2-1 indicate that the UE is camped on NR Cell 1? NOTE: This is the first time in this test case that the UE moves from S1 to N1.	-	-	1	-
4	Void.	-	-	-	-
5	The SS adjusts the E-UTRAN and NR Cell	-	-	-	-

	power levels according to row "T2" in table 6.2.3.6.3.2-1.				
6	Check: Does the test result of generic test procedure in TS 38.508-1 [4] Table 4.9.7.2.2-1 is performed and the UE is camped on E-UTRAN Cell 1?	-	-	2	-

6.2.3.6.3.3 Specific message contents

Table 6.2.3.6.3.3-1: SystemInformationBlockType3 of EUTRA Cell 1 (preamble and all steps, Table 6.2.3.6.3.2-3)

Derivation Path: TS 36.508 [7], Table 4.4.3.3-2			
Information Element	Value/remark	Comment	Condition
SystemInformationBlockType3 ::= SEQUENCE {			
cellReselectionServingFreqInfo SEQUENCE {			
threshServingLow	10	20 dB	
}			
}			

Table 6.2.3.6.3.3-2: SystemInformationBlockType24 of EUTRA Cell 1 (preamble and all steps, Table 6.2.3.6.3.2-3)

Derivation path: TS 36.508 [7], Table 4.4.3.3-20			
Information Element	Value/Remark	Comment	Condition
SystemInformationBlockType24-r15 ::= SEQUENCE {			
carrierFreqListNR-r15 SEQUENCE (SIZE (1..maxFreq)) OF CarrierFreqNR-r15 {	1 entry		
CarrierFreqNR-r15[1] SEQUENCE {		entry 1	
carrierFreq-r15	Same downlink SSB ARFCN as used for NR Cell 1		
}			
cellReselectionPriority-r15	5		
threshX-High-r15	20	40 dB	
threshX-Low-r15	10	20 dB	
}			
}			
t-ReselectionNR-r15	7	7 Seconds	
}			

Table 6.2.3.6.3.3-3: SIB2 of NR Cell 1(preamble and all steps, Table 6.2.3.6.3.2-3)

Derivation Path: TS 38.508-1 [4], Table 4.6.2-1			
Information Element	Value/remark	Comment	Condition
SIB2 ::= SEQUENCE {			
cellReselectionServingFreqInfo SEQUENCE {			
threshServingLowP	10	20 dB	
}			
}			

Table 6.2.3.6.3.3-4: SIB5 of NR Cell 1(preamble and all steps, Table 6.2.3.7.3.2-3)

Derivation Path: TS 38.508-1 [4], Table 4.6.2-4			
Information Element	Value/remark	Comment	Condition
SIB5 ::= SEQUENCE {			
carrierFreqListEUTRA SEQUENCE (SIZE (1..maxEUTRA-Carrier)) OF CarrierFreqEUTRA {	1 entry		
CarrierFreqEUTRA[1] SEQUENCE {		entry 1	
carrierFreq	Downlink EUTRA ARFCN as E-UTRA Cell 1 used		
threshX-High	20	40 dB	
}			
}			

threshX-Low	10	20 dB	
}			
}			
t-ReselectionEUTRA	7	7 Seconds	
}			

Table 6.2.3.6.3.3-5: RRCConnectionRelease message for EUTRA Cell 1 (step 1 of Table 6.2.3.6.3.2-3)

Derivation path: TS 36.508 [7], Table 4.6.1-15			
Information Element	Value/Remark	Comment	Condition
RRCConnectionRelease ::= SEQUENCE {			
criticalExtensions CHOICE {			
c1 CHOICE {			
rrcConnectionRelease-r8 SEQUENCE {			
idleModeMobilityControlInfo SEQUENCE {			
freqPriorityListEUTRA SEQUENCE (SIZE (1..maxFreq)) OF FreqPriorityEUTRA {	1 entry		
freqPriorityListEUTRA[1] SEQUENCE {		entry 1	
carrierFreq	DownLink ARFCN-Value of E-UTRA cell 1		
cellReselectionPriority	4		
}			
}			
t320	Not present		
freqPriorityListNR-r15 SEQUENCE (SIZE (1..maxFreq)) OF FreqPriorityNR-r15 {	1 entry		
FreqPriorityNR-r15[1] SEQUENCE {		entry 1	
carrierFreq-r15	Same Downlink SSB ARFCN as used for NR Cell 1		
cellReselectionPriority-r15	3		
}			
}			
}			
}			
}			
}			
}			

6.2.3.7 Inter-RAT cell reselection / From NR RRC_IDLE to E-UTRA RRC_IDLE, Snonintrasearch

6.2.3.7.1 Test Purpose (TP)

(1)

```
with { UE in NR RRC_IDLE state, and the UE is not in high mobility state }
ensure that {
  when { Snonintrasearch is non-zero in system information }
  then { UE perform measurement and reselects to cell which belongs to the high priority E-UTRA cell even if Srxlev > Snonintrasearch }
}
```

6.2.3.7.2 Conformance requirements

References: The conformance requirements covered in the present TC are specified in: 3GPP TS 38.304, clause 5.2.4.1, 5.2.4.2 and 5.2.4.5. Unless otherwise stated these are Rel-15 requirements.

[TS 38.304, clause 5.2.4.1]

Absolute priorities of different NR frequencies or inter-RAT frequencies may be provided to the UE in the system information, in the RRCRelease message, or by inheriting from another RAT at inter-RAT cell (re)selection. In the case of system information, an NR frequency or inter-RAT frequency may be listed without providing a priority (i.e. the

field *cellReselectionPriority* is absent for that frequency). If priorities are provided in dedicated signalling, the UE shall ignore all the priorities provided in system information. If UE is in *camped on any cell* state, UE shall only apply the priorities provided by system information from current cell, and the UE preserves priorities provided by dedicated signalling and *deprioritisationReq* received in *RRCRelease* unless specified otherwise. When the UE in *camped normally* state, has only dedicated priorities other than for the current frequency, the UE shall consider the current frequency to be the lowest priority frequency (i.e. lower than any of the network configured values).

The UE shall only perform cell reselection evaluation for NR frequencies and inter-RAT frequencies that are given in system information and for which the UE has a priority provided.

In case UE receives *RRCRelease* with *deprioritisationReq*, UE shall consider current frequency and stored frequencies due to the previously received *RRCRelease* with *deprioritisationReq* or all the frequencies of NR to be the lowest priority frequency (i.e. lower than any of the network configured values) while T325 is running irrespective of *camped RAT*. The UE shall delete the stored deprioritisation request(s) when a PLMN selection is performed on request by NAS (TS 23.122 [9]).

NOTE: UE should search for a higher priority layer for cell reselection as soon as possible after the change of priority. The minimum related performance requirements specified in TS 38.133 [8] are still applicable.

The UE shall delete priorities provided by dedicated signalling when:

- the UE enters a different RRC state; or
- the optional validity time of dedicated priorities (T320) expires; or
- a PLMN selection is performed on request by NAS (TS 23.122 [9]).

NOTE 2: Equal priorities between RATs are not supported.

The UE shall not consider any black listed cells as candidate for cell reselection.

The UE shall inherit the priorities provided by dedicated signalling and the remaining validity time (i.e. T320 in NR and E-UTRA), if configured, at inter-RAT cell (re)selection.

NOTE 3: The network may assign dedicated cell

[TS 38.304, clause 5.2.4.2]

Following rules are used by the UE to limit needed measurements:

- If the serving cell fulfils $S_{rxlev} > S_{IntraSearchP}$ and $S_{qual} > S_{IntraSearchQ}$, the UE may choose not to perform intra-frequency measurements.
- Otherwise, the UE shall perform intra-frequency measurements.
- The UE shall apply the following rules for NR inter-frequencies and inter-RAT frequencies which are indicated in system information and for which the UE has priority provided as defined in 5.2.4.1:
 - For a NR inter-frequency or inter-RAT frequency with a reselection priority higher than the reselection priority of the current NR frequency, the UE shall perform measurements of higher priority NR inter-frequency or inter-RAT frequencies according to TS 38.133 [8].
 - For a NR inter-frequency with an equal or lower reselection priority than the reselection priority of the current NR frequency and for inter-RAT frequency with lower reselection priority than the reselection priority of the current NR frequency:
 - If the serving cell fulfils $S_{rxlev} > S_{nonIntraSearchP}$ and $S_{qual} > S_{nonIntraSearchQ}$, the UE may choose not to perform measurements of NR inter-frequencies or inter-RAT frequency cells of equal or lower priority;
- Otherwise, the UE shall perform measurements of NR inter-frequencies or inter-RAT frequency cells of equal or lower priority according to TS 38.133 [8].

[TS 38.304, clause 5.2.4.5]

If *threshServingLowQ* is broadcast in system information and more than 1 second has elapsed since the UE camped on the current serving cell, cell reselection to a cell on a higher priority NR frequency or inter-RAT frequency than the serving frequency shall be performed if:

- A cell of a higher priority NR or EUTRAN RAT/frequency fulfils $S_{qual} > \text{Thresh}_{X, \text{HighQ}}$ during a time interval $T_{\text{reselction}_{\text{RAT}}}$

Otherwise, cell reselection to a cell on a higher priority NR frequency or inter-RAT frequency than the serving frequency shall be performed if:

- A cell of a higher priority RAT/ frequency fulfils $S_{rxlev} > \text{Thresh}_{X, \text{HighP}}$ during a time interval $T_{\text{reselction}_{\text{RAT}}}$; and
- More than 1 second has elapsed since the UE camped on the current serving cell.

Cell reselection to a cell on an equal priority NR frequency shall be based on ranking for intra-frequency cell reselection as defined in sub-clause 5.2.4.6.

If *threshServingLowQ* is broadcast in system information and more than 1 second has elapsed since the UE camped on the current serving cell, cell reselection to a cell on a lower priority NR frequency or inter-RAT frequency than the serving frequency shall be performed if:

- The serving cell fulfils $S_{qual} < \text{Thresh}_{\text{Serving, LowQ}}$ and a cell of a lower priority NR or E-UTRAN RAT/ frequency fulfils $S_{qual} > \text{Thresh}_{X, \text{LowQ}}$ during a time interval $T_{\text{reselction}_{\text{RAT}}}$.

Otherwise, cell reselection to a cell on a lower priority NR frequency or inter-RAT frequency than the serving frequency shall be performed if:

- The serving cell fulfils $S_{rxlev} < \text{Thresh}_{\text{Serving, LowP}}$ and a cell of a lower priority RAT/ frequency fulfils $S_{rxlev} > \text{Thresh}_{X, \text{LowP}}$ during a time interval $T_{\text{reselction}_{\text{RAT}}}$; and
- More than 1 second has elapsed since the UE camped on the current serving cell.

Cell reselection to a higher priority RAT/frequency shall take precedence over a lower priority RAT/frequency if multiple cells of different priorities fulfil the cell reselection criteria.

If more than one cell meets the above criteria, the UE shall reselect a cell as follows:

- If the highest-priority frequency is an NR frequency, the highest ranked cell among the cells on the highest priority frequency(ies) meeting the criteria according to clause 5.2.4.6;
- If the highest-priority frequency is from another RAT, the highest ranked cell among the cells on the highest priority frequency(ies) meeting the criteria of that RAT.

6.2.3.7.3 Test description

6.2.3.7.3.1 Pre-test conditions

System Simulator:

- NR Cell 1, E-UTRA Cell 1 is higher priority inter-RAT cell.
- NR Cell 1 is configured to operate in FR1 bands as defined in TS 38.508-1 [4] clause 6.2.3.
- System information combination NR-6 as defined in TS 38.508-1 [4] clause 4.4.3.1.3 is used in NR Cell.
- System information combination 31 as defined in TS 36.508-1 [7] clause 4.4.3.1 is used in E-UTRA Cell.

UE:

None.

Preamble:

- With E-UTRA Cell 1 "Serving cell" and NR Cell 1 "Non-suitable "Off" cell" in accordance with TS 38.508-1 [4], Table 6.2.2.1-3, the UE is brought to state RRC_IDLE using generic procedure parameters Connectivity (*E-UTRA/EPC*) and Unrestricted nr PDN (*On*) in accordance with the procedure described in TS 38.508-1 [4], clause 4.5.2. 4G GUTI and eKSI are assigned and security context established.
- the UE is switched-off.
- With E-UTRA Cell 1 "Non-suitable "Off" cell" and NR Cell 1 "Serving cell" in accordance with TS 38.508-1 [4], Table 6.2.2.1-3, the UE is brought to state 1N-A, RRC_IDLE Connectivity (NR), in accordance with the procedure described in TS 38.508-1 [4], Table 4.5.2.2-2. 5G-GUTI and ngKSI are assigned and security context established.

6.2.3.7.3.2 Test procedure sequence

Table 6.2.3.7.3.2-1 illustrates the downlink power levels and other changing parameters to be applied for the cell at various time instants of the test execution. The exact instants on which these values shall be applied are described in the texts in this clause. Row marked "T0" denotes the conditions in the preamble. Configurations marked "T1" is applied at the points indicated in the Main behaviour description in Table 6.2.3.7.3.2-3.

Table 6.2.3.7.3.2-1: Time instances of cell power level and parameter changes for E-UTRA Cell 1 and NR Cell 1 in conducted test environment

	Parameter	Unit	NR Cell 1	E-UTRA Cell 1	Remark
T0	Cell-specific RS EPRE	dBm/15kHz	-	Off	The power level values are assigned to ensure UE registered on NR Cell 1
	SS/PBCH SSS EPRE	dBm/SCS	-88	-	
T1	Cell-specific RS EPRE	dBm/15kHz	-	-75	The power level values are assigned to satisfy $S_{rxlev}^{NR\ Cell\ 1} > S_{nonintraSearch}$ and $S_{rxlev}^{E-UTRA\ Cell\ 1} > Thresh_{x, high}$.
	SS/PBCH SSS EPRE	dBm/SCS	-90	-	

Table 6.2.3.7.3.2-2: Void

Table 6.2.3.7.3.2-3: Main behaviour

St	Procedure	Message Sequence		TP	Verdict
		U - S	Message		
1	The SS adjusts the NR and E-UTRAN Cell power levels according to row "T1" in table 6.2.3.7.3.2-1.	-	-	-	-
2	Check: Does the test result of generic test procedure in TS 38.508-1 [4] Table 4.9.7.2.2-1 is performed and the UE is camped on E-UTRAN Cell 1?	-	-	1	-

6.2.3.7.3.3 Specific message contents

Table 6.2.3.7.3.3-1: SIB2 of NR Cell 1 (preabmlle and all steps, Table 6.2.3.7.3.2-3)

Derivation Path: TS 38.508-1 [4], Table 4.6.2-1			
Information Element	Value/remark	Comment	Condition
SIB2 ::= SEQUENCE {			
cellReselectionServingFreqInfo			
SEQUENCE {			
s-NonIntraSearchP	3	6 dB	
threshServingLowP	3	6 dB	

}			
}			

Table 6.2.3.7.3.3-2: SIB5 of NR Cell 1(preamble and all steps, Table 6.2.3.7.3.2-3)

Derivation Path: TS 38.508-1 [4], Table 4.6.2-4			
Information Element	Value/remark	Comment	Condition
SIB5 ::= SEQUENCE {			
carrierFreqListEUTRA SEQUENCE (SIZE (1..maxEUTRA-Carrier)) OF CarrierFreqEUTRA {	1 entry		
CarrierFreqEUTRA[1] SEQUENCE {		entry 1	
carrierFreq	Downlink EUTRA ARFCN as E-UTRA Cell 1 used		
cellReselectionPriority	5		
threshX-High	10	20 dB	
threshX-Low	20	40 dB	
}			
}			
t-ReselectionEUTRA	7	7 Seconds	
}			

Table 6.2.3.7.3.3-3: SystemInformationBlockType3 of EUTRA Cell 1 (preamble and all steps, Table 6.2.3.7.3.2-3)

Derivation Path: TS 36.508 [7], Table 4.4.3.3-2			
Information Element	Value/remark	Comment	Condition
SystemInformationBlockType3 ::= SEQUENCE {			
cellReselectionServingFreqInfo SEQUENCE {			
threshServingLow	3	6 dB	
}			
}			

Table 6.2.3.7.3.3-4: SystemInformationBlockType24 for EUTRA Cell 1 (preamble and all steps, Table 6.2.3.7.3.2-3)

Derivation path: TS 36.508 [7], Table 4.4.3.3-20			
Information Element	Value/Remark	Comment	Condition
SystemInformationBlockType24-r15 ::= SEQUENCE {			
carrierFreqListNR-r15 SEQUENCE (SIZE (1..maxFreq)) OF CarrierFreqNR-r15 {	1 entry		
CarrierFreqNR-r15[1] SEQUENCE {		entry 1	
carrierFreq-r15	Same downlink SSB ARFCN as used for NR Cell 1		
cellReselectionPriority-r15	3		
threshX-High-r15	15	30 dB	
threshX-Low-r15	15	30 dB	
}			
t-ReselectionNR-r15	7	7 Seconds	
}			

6.2.3.8 Inter-RAT cell reselection / From E-UTRA RRC_IDLE to NR RRC_IDLE, Snonintrasearch

6.2.3.8.1 Test Purpose (TP)

(1)

with { UE in E-UTRA RRC_Idle state, and the UE is not in high mobility state }
ensure that {

```

when { Snonintrasearch is non-zero in system information }
  then { UE perform measurement and reselects to cell which belongs to the high priority NR cell
even if Srxlev>Snonintrasearch }
}

```

6.2.3.8.2 Conformance requirements

References: The conformance requirements covered in the present TC are specified in: 3GPP TS 36.304, clause 5.2.4.1, 5.2.4.2 and 5.2.4.5. Unless otherwise stated these are Rel-15 requirements.

[TS 36.304, clause 5.2.4.1]

Absolute priorities of different E-UTRAN frequencies or inter-RAT frequencies may be provided to the UE in the system information, in the *RRCCConnectionRelease* message, or by inheriting from another RAT at inter-RAT cell (re)selection. In the case of system information, an E-UTRAN frequency or inter-RAT frequency may be listed without providing a priority (i.e. the field *cellReselectionPriority* is absent for that frequency). If priorities are provided in dedicated signalling, the UE shall ignore all the priorities provided in system information. If UE is in *camped on any cell* state, UE shall only apply the priorities provided by system information from current cell, and the UE preserves priorities provided by dedicated signalling and *deprioritisationReq* received in *RRCCConnectionReject* unless specified otherwise. When the UE in *camped normally* state, has only dedicated priorities other than for the current frequency, the UE shall consider the current frequency to be the lowest priority frequency (i.e. lower than any of the network configured values). While the UE is camped on a suitable CSG cell in normal coverage, the UE shall always consider the current frequency to be the highest priority frequency (i.e. higher than any of the network configured values), irrespective of any other priority value allocated to this frequency. When the HSDN capable UE is in High-mobility state, the UE shall always consider the HSDN cells to be the highest priority (i.e. higher than any other network configured priorities). When the HSDN capable UE is not in High-mobility state, the UE shall always consider HSDN cells to be the lowest priority (i.e. lower than network configured priorities). If the UE capable of sidelink communication is configured to perform sidelink communication and can only perform the sidelink communication while camping on a frequency, the UE may consider that frequency to be the highest priority. If the UE capable of V2X sidelink communication is configured to perform V2X sidelink communication and can only perform the V2X sidelink communication while camping on a frequency, the UE may consider that frequency to be the highest priority. If the UE capable of V2X sidelink communication is configured to perform V2X sidelink communication and can only use pre-configuration while not camping on a frequency, the UE may consider the frequency providing inter-carrier V2X sidelink configuration to be the highest priority. If the UE capable of sidelink discovery is configured to perform Public Safety related sidelink discovery and can only perform the Public Safety related sidelink discovery while camping on a frequency, the UE may consider that frequency to be the highest priority.

NOTE 1: The prioritization among the frequencies which UE considers to be the highest priority frequency is left to UE implementation.

If the UE is capable either of MBMS Service Continuity or of SC-PTM reception and is receiving or interested to receive an MBMS service and can only receive this MBMS service while camping on a frequency on which it is provided, the UE may consider that frequency to be the highest priority during the MBMS session TS 36.300 [2] as long as the two following conditions are fulfilled:

1) Either:

- the UE is capable of MBMS service continuity and the reselected cell is broadcasting SIB13; or
- the UE is capable of SC-PTM reception and the reselected cell is broadcasting SIB20;

2) Either:

- SIB15 of the serving cell indicates for that frequency one or more MBMS SAIs included and associated with that frequency in the MBMS User Service Description (USD) TS 26.346 [22] of this service; or
- SIB15 is not broadcast in the serving cell and that frequency is included in the USD of this service.

If the UE is capable either of MBMS Service Continuity or of SC-PTM reception and is receiving or interested to receive an MBMS service provided on a downlink only MBMS frequency, on a frequency used by dedicated MBMS cells, on a frequency used by FeMBMS/Unicast-mixed cells as defined in TS 36.300 [2], or on a frequency belonging to PLMN different from its registered PLMN, the UE may consider cell reselection candidate frequencies at which it can not receive the MBMS service to be of the lowest priority during the MBMS session TS 36.300 [2], as long as the above mentioned condition 1) is fulfilled for the cell on the MBMS frequency which the UE monitors or this cell broadcasts SIB1-MBMS and as long as the above mentioned condition 2) is fulfilled for the serving cell.

NOTE 2: Example scenarios in which the previous down-prioritisation may be needed concerns the cases where camping is not possible, while the UE can only receive this MBMS frequency when camping on a subset of cell reselection candidate frequencies, e.g. the MBMS frequency is a downlink only carrier, the MBMS frequency is used by dedicated MBMS cells, the MBMS frequency is used by FeMBMS/Unicast-mixed cells TS 36.300 [2], or the MBMS frequency belongs to a PLMN different from UE's registered PLMN.

If the UE is not capable of MBMS Service Continuity but has knowledge on which frequency an MBMS service of interest is provided, it may consider that frequency to be the highest priority during the MBMS session TS 36.300 [2] as long as the reselected cell is broadcasting SIB13.

If the UE is not capable of MBMS Service Continuity but has knowledge on which downlink only frequency, on which frequency used by dedicated MBMS cells, on which frequency used by FeMBMS/Unicast-mixed cells as defined in TS 36.300 [2] or on which frequency belonging to PLMN different from its registered PLMN an MBMS service of interest is provided, it may consider cell reselection candidate frequencies at which it can not receive the MBMS service to be of the lowest priority during the MBMS session TS 36.300 [2] as long as the cell on the MBMS frequency which the UE monitors is broadcasting SIB13 or SIB1-MBMS.

NOTE 3: The UE considers that the MBMS session is ongoing using the session start and end times as provided by upper layers in the USD i.e. the UE does not verify if the session is indicated on MCCH.

In case UE receives *RRCConnectionReject* with *deprioritisationReq*, UE shall consider current carrier frequency and stored frequencies due to the previously received *RRCConnectionReject* with *deprioritisationReq* or all the frequencies of EUTRA to be the lowest priority frequency (i.e. lower than any of the network configured values) while T325 is running irrespective of camped RAT. The UE shall delete the stored deprioritisation request(s) when a PLMN selection is performed on request by NAS TS 23.122 [5].

NOTE 4: Connecting to CDMA2000 does not imply PLMN selection.

NOTE 5: UE should search for a higher priority layer for cell reselection as soon as possible after the change of priority. The minimum related performance requirements specified in TS 36.133 [10] are still applicable.

The UE shall delete priorities provided by dedicated signalling when:

- the UE enters a different RRC state; or
- the optional validity time of dedicated priorities (T320) expires; or
- a PLMN selection is performed on request by NAS TS 23.122 [5].

NOTE 6: Equal priorities between RATs are not supported.

The UE shall only perform cell reselection evaluation for E-UTRAN frequencies and inter-RAT frequencies that are given in system information and for which the UE has a priority provided.

The UE shall not consider any black listed cells as candidate for cell reselection.

The UE shall inherit the priorities provided by dedicated signalling and the remaining validity time (i.e., T320 in E-UTRA and NR, T322 in UTRA and T3230 in GERAN), if configured, at inter-RAT cell (re)selection.

NOTE 7: The network may assign dedicated cell reselection priorities for frequencies not configured by system information.

While T360 is running, redistribution target is considered to be the highest priority (i.e. higher than any of the network configured values). UE shall continue to consider the serving frequency as the highest priority until completion of E-UTRAN Inter-frequency Redistribution procedure specified in 5.2.4.10 if triggered on T360 expiry/ stop.

[TS 36.304, clause 5.2.4.2]

For NB-IoT measurement rules for cell re-selection is defined in sub-clause 5.2.4.2.a.

When evaluating *Srxlev* and *Squal* of non-serving cells for reselection purposes, the UE shall use parameters provided by the serving cell.

Following rules are used by the UE to limit needed measurements:

- If the serving cell fulfils $S_{rxlev} > S_{IntraSearchP}$ and $S_{qual} > S_{IntraSearchQ}$, the UE may choose not to perform intra-frequency measurements.
- Otherwise, the UE shall perform intra-frequency measurements.
- The UE shall apply the following rules for E-UTRAN inter-frequencies and inter-RAT frequencies which are indicated in system information and for which the UE has priority provided as defined in 5.2.4.1:
 - For an E-UTRAN inter-frequency or inter-RAT frequency with a reselection priority higher than the reselection priority of the current E-UTRA frequency the UE shall perform measurements of higher priority E-UTRAN inter-frequency or inter-RAT frequencies according to TS 36.133 [10].
 - For an E-UTRAN inter-frequency with an equal or lower reselection priority than the reselection priority of the current E-UTRA frequency and for inter-RAT frequency with lower reselection priority than the reselection priority of the current E-UTRAN frequency:
 - If the serving cell fulfils $S_{rxlev} > S_{nonIntraSearchP}$ and $S_{qual} > S_{nonIntraSearchQ}$, the UE may choose not to perform measurements of E-UTRAN inter-frequencies or inter-RAT frequency cells of equal or lower priority unless the UE is triggered to measure an E-UTRAN inter-frequency which is configured with *redistributionInterFreqInfo*.
 - Otherwise, the UE shall perform measurements of E-UTRAN inter-frequencies or inter-RAT frequency cells of equal or lower priority according to TS 36.133 [10].
- If the UE supports relaxed monitoring and *s-SearchDeltaP* is present in *SystemInformationBlockType3*, the UE may further limit the needed measurements, as specified in sub-clause 5.2.4.12.

[TS 36.304, clause 5.2.4.5]

For NB-IoT inter-frequency cell reselection shall be based on ranking as defined in sub-clause 5.2.4.6.

If *threshServingLowQ* is provided in *SystemInformationBlockType3* and more than 1 second has elapsed since the UE camped on the current serving cell, cell reselection to a cell on a higher priority E-UTRAN frequency or inter-RAT frequency than the serving frequency shall be performed if:

- A cell of a higher priority EUTRAN, NR or UTRAN FDD RAT/ frequency fulfils $S_{qual} > Thresh_{X, HighQ}$ during a time interval $T_{reselectionRAT}$; or
- A cell of a higher priority UTRAN TDD, GERAN or CDMA2000 RAT/ frequency fulfils $S_{rxlev} > Thresh_{X, HighP}$ during a time interval $T_{reselectionRAT}$.

Otherwise, cell reselection to a cell on a higher priority E-UTRAN frequency or inter-RAT frequency than the serving frequency shall be performed if:

- A cell of a higher priority RAT/ frequency fulfils $S_{rxlev} > Thresh_{X, HighP}$ during a time interval $T_{reselectionRAT}$; and
- More than 1 second has elapsed since the UE camped on the current serving cell.

Cell reselection to a cell on an equal priority E-UTRAN frequency shall be based on ranking for Intra-frequency cell reselection as defined in sub-clause 5.2.4.6.

If *threshServingLowQ* is provided in *SystemInformationBlockType3* and more than 1 second has elapsed since the UE camped on the current serving cell, cell reselection to a cell on a lower priority E-UTRAN frequency or inter-RAT frequency than the serving frequency shall be performed if:

- The serving cell fulfils $S_{qual} < Thresh_{Serving, LowQ}$ and a cell of a lower priority EUTRAN, NR or UTRAN FDD RAT/ frequency fulfils $S_{qual} > Thresh_{X, LowQ}$ during a time interval $T_{reselectionRAT}$; or
- The serving cell fulfils $S_{qual} < Thresh_{Serving, LowQ}$ and a cell of a lower priority UTRAN TDD, GERAN or CDMA2000 RAT/ frequency fulfils $S_{rxlev} > Thresh_{X, LowP}$ during a time interval $T_{reselectionRAT}$.

Otherwise, cell reselection to a cell on a lower priority E-UTRAN frequency or inter-RAT frequency than the serving frequency shall be performed if:

- The serving cell fulfils $Srxlev < Thresh_{Serving, LowP}$ and a cell of a lower priority RAT/ frequency fulfils $Srxlev > Thresh_{X, LowP}$ during a time interval $Treselection_{RAT}$; and
- More than 1 second has elapsed since the UE camped on the current serving cell.

Cell reselection to a higher priority RAT/ frequency shall take precedence over a lower priority RAT/ frequency, if multiple cells of different priorities fulfil the cell reselection criteria.

The UE shall not perform cell reselection to NR or UTRAN FDD cells for which the cell selection criterion S is not fulfilled.

For cdma2000 RATs, $Srxlev$ is equal to $-FLOOR(-2 \times 10 \times \log_{10} Ec/Io)$ in units of 0.5 dB, as defined in [18], with Ec/Io referring to the value measured from the evaluated cell.

For cdma2000 RATs, $Thresh_{X, HighP}$ and $Thresh_{X, LowP}$ are equal to -1 times the values signalled for the corresponding parameters in the system information.

In all the above criteria the value of $Treselection_{RAT}$ is scaled when the UE is in the medium or high mobility state as defined in subclause 5.2.4.3.1. If more than one cell meets the above criteria, the UE shall reselect a cell as follows:

- If the highest-priority frequency is an E-UTRAN frequency, a cell ranked as the best cell among the cells on the highest priority frequency(ies) meeting the criteria according to clause 5.2.4.6;
- If the highest-priority frequency is from another RAT, a cell ranked as the best cell among the cells on the highest priority frequency(ies) meeting the criteria of that RAT.

Cell reselection to another RAT, for which Squal based cell reselection parameters are broadcast in system information, shall be performed based on the Squal criteria if the UE supports Squal (RSRQ) based cell reselection to E-UTRAN from all the other RATs provided by system information which UE supports. Otherwise, cell reselection to another RAT shall be performed based on $Srxlev$ criteria.

Cell reselection to NR, for which a cell reselection parameter, $q-RxLevMinSUL$ is broadcast in system information and the UE supports SUL, shall be performed based on $Srxlev$ criteria taking the parameter into account.

6.2.3.8.3 Test description

6.2.3.8.3.1 Pre-test conditions

System Simulator:

- E-UTRA Cell 1, NR Cell 1 is higher priority inter-RAT NR cell.
- NR Cell 1 is configured to operate in FR1 bands as defined in TS 38.508-1 [4] clause 6.2.3.
- System information combination 31 as defined in TS 36.508-1 [7] clause 4.4.3.1 is used in E-UTRA Cell.
- System information combination NR-6 as defined in TS 38.508-1 [4] clause 4.4.3.1.3 is used in NR Cell.

UE:

- None.

Preamble:

- With E-UTRA Cell 1 "Non-suitable "Off" cell" and NR Cell 1 "Serving cell" in accordance with TS 38.508-1 [4], Table 6.2.2.1-3, the UE is brought to state 1N-A, RRC_IDLE Connectivity (NR), in accordance with the procedure described in TS 38.508-1 [4], Table 4.5.2.2-2. 5G-GUTI and ngKSI are assigned and security context established.
- the UE is switched-off.
- With E-UTRA Cell 1 "Serving cell" and NR Cell 1 "Non-suitable "Off" cell" in accordance with TS 38.508-1 [4], Table 6.2.2.1-3, the UE is brought to state RRC_IDLE using generic procedure parameters Connectivity (E-UTRA/EPC) and Unrestricted nr PDN (*On*) in accordance with the procedure described in TS 38.508-1 [4], clause 4.5.2. 4G GUTI and eKSI are assigned and security context established.

6.2.3.8.3.2 Test procedure sequence

Table 6.2.3.8.3.2-1 illustrates the downlink power levels and other changing parameters to be applied for the cell at various time instants of the test execution. The exact instants on which these values shall be applied are described in the texts in this clause. Row marked "T0" denotes the conditions in the preamble. Configurations marked "T1" is applied at the points indicated in the Main behaviour description in Table 6.2.3.8.3.2-3.

Table 6.2.3.8.3.2-1: Time instances of cell power level and parameter changes for E-UTRA Cell and NR Cell in conducted test environment

	Parameter	Unit	E-UTRA Cell 1	NR Cell 1	Remark
T0	Cell-specific RS EPRE	dBm/15kHz	-85	-	The power level values are assigned to ensure UE registered on E-UTRA Cell 1
	SS/PBCH SSS EPRE	dBm/SCS	-	Off	
T1	Cell-specific RS EPRE	dBm/15kHz	-90	-	The power level values are assigned to satisfy $S_{rxlev} E-UTRA Cell 1 > S_{noninrasearch}$ and and $S_{rxlev} NR Cell 1 > Thresh_{x, high}$.
	SS/PBCH SSS EPRE	dBm/SCS	-	-80	

Table 6.2.3.8.3.2-2: Void

Table 6.2.3.8.3.2-3: Main behaviour

St	Procedure	Message Sequence		TP	Verdict
		U - S	Message		
1	The SS adjusts the E-UTRAN and NR Cell power levels according to row "T1" in table 6.2.3.8.3.2-1.	-	-	-	-
2	Check: Does the test result of generic test procedure in TS 38.508-1 [4] Table 4.9.9.2.2-1 indicate that the UE is camped on NR Cell 1? NOTE: This is the first time in this test case that the UE moves from S1 to N1.	-	-	1	-
3	Void.	-	-	-	-

6.2.3.8.3.3 Specific message contents

Table 6.2.3.8.3.3-1: SystemInformationBlockType3 of EUTRA Cell 1 (preamble and all steps, Table 6.2.3.8.3.2-3)

Derivation Path: TS 36.508 [7], Table 4.4.3.3-2			
Information Element	Value/remark	Comment	Condition
SystemInformationBlockType3 ::= SEQUENCE {			
cellReselectionServingFreqInfo SEQUENCE {			
s-NonIntraSearch	3	6 dB	
threshServingLow	3	6 dB	
}			

Table 6.2.3.8.3.3-2: SystemInformationBlockType24 of EUTRA Cell 1 (preamble and all steps, Table 6.2.3.8.3.2-3)

Derivation path: TS 36.508 [7], Table 4.4.3.3-20			
Information Element	Value/Remark	Comment	Condition
SystemInformationBlockType24-r15 ::= SEQUENCE {			
carrierFreqListNR-r15 SEQUENCE (SIZE (1..maxFreq)) OF CarrierFreqNR-r15 {	1 entry		
CarrierFreqNR-r15[1] SEQUENCE {		entry 1	
carrierFreq-r15	Same downlink SSB ARFCN		

	as used for NR Cell 1		
cellReselectionPriority-r15	5		
threshX-High-r15	10	20 dB	
threshX-Low-r15	20	40 dB	
}			
t-ReselectionNR-r15	7	7 Seconds	
}			

Table 6.2.3.8.3.3-3: SIB2 of NR Cell 1 (preabmle and all steps, Table 6.2.3.8.3.2-3)

Derivation Path: TS 38.508-1 [4], Table 4.6.2-1			
Information Element	Value/remark	Comment	Condition
SIB2 ::= SEQUENCE {			
cellReselectionServingFreqInfo			
SEQUENCE {			
threshServingLowP	3	6 dB	
}			
}			

Table 6.2.3.8.3.3-4: SIB5 of NR Cell 1(preamble and all steps, Table 6.2.3.8.3.2-3)

Derivation Path: TS 38.508 [6], Table 4.6.2-4			
Information Element	Value/remark	Comment	Condition
SIB5 ::= SEQUENCE {			
carrierFreqListEUTRA SEQUENCE (SIZE (1..maxEUTRA-Carrier)) OF CarrierFreqEUTRA {	1 entry		
CarrierFreqEUTRA[1] SEQUENCE {		entry 1	
carrierFreq	Downlink EUTRA ARFCN as E-UTRA Cell 1 used		
}			
}			
cellReselectionPriority	3		
threshX-High	15	30 dB	
threshX-Low	15	30 dB	
}			
}			
t-ReselectionEUTRA	7	7 Seconds	
}			

6.2.3.9 Void

6.2.3.10 Inter-RAT cell reselection / From E-UTRA_IDLE to NR RRC_IDLE / schedulingInfoList-v12j0

6.2.3.10.1 Test Purpose (TP)

(1)

```
with { the UE is in E-UTRA IDLE state and SystemInformationBlockType24 scheduled by optional
extended field schedulingInfoList-v12j0 in SystemInformationBlockType1 is broadcasted }
ensure that {
  when { UE detects the cell re-selection criteria is met for a lower priority NR cell }
  then { UE reselects to the NR cell }
}
```

6.2.3.10.2 Conformance requirements

References: The conformance requirements covered in the current TC are specified in: TS 36.331, clause 5.2.3 and 5.2.3a and TS 36.304, clause 5.2.4.1, 5.2.4.2 and 5.2.4.5. Unless otherwise stated these are Rel-15 requirements.

[TS 36.331, clause 5.2.3]

When acquiring an SI message, the UE shall:

- 1> determine the start of the SI-window for the concerned SI message as follows:
 - 2> if the concerned SI message is configured in the *schedulingInfoList*, *schedulingInfoListExt* (if present) or if the concerned SI message is configured in the *pos-schedulingInfoList* and *si-posOffset* is not configured;
 - 3> for the concerned SI message, determine the number n which corresponds to the order of entry in the concatenated list of SI messages configured by *schedulingInfoList*, *schedulingInfoListExt* (if present) and *posSchedulingInfoList* in *SystemInformationBlockType1*;
 - 3> determine the integer value $x = (n - 1) * w$, where w is the *si-WindowLength*;
 - 3> the SI-window starts at the subframe $\#a$, where $a = x \bmod 10$, in the radio frame for which $\text{SFN} \bmod T = \text{FLOOR}(x/10)$, where T is the *si-Periodicity* of the concerned SI message;
 - 2> else if the concerned SI message is configured by the *posSchedulingInfoList* and *si-posOffset* is configured determine the start of the SI-window for the concerned SI message as follows:
 - 3> determine the number m which corresponds to the number of SI messages with an associated *si-Periodicity* of 8 radio frames (80 ms), configured by *schedulingInfoList* and *schedulingInfoListExt* (if present) in *SystemInformationBlockType1*;
 - 3> for the concerned SI message, determine the number n which corresponds to the order of entry in the list of SI messages configured by *posSchedulingInfoList* in *SystemInformationBlockType1*;
 - 3> determine the integer value $x = m * w + (n - 1) * w$, where w is the *si-WindowLength*
 - 3> the SI-window starts at the subframe $\#a$, where $a = x \bmod 10$, in the radio frame for which $\text{SFN} \bmod T = \text{FLOOR}(x/10) + 8$, where T is the *si-posPeriodicity* of the concerned SI message;

NOTE: E-UTRAN should configure an SI-window of 1 ms only if all SIs are scheduled before subframe #5 in radio frames for which $\text{SFN} \bmod 2 = 0$.

- 1> receive DL-SCH using the SI-RNTI from the start of the SI-window and continue until the end of the SI-window whose absolute length in time is given by *si-WindowLength*, or until the SI message was received, excluding the following subframes:
 - 2> subframe #5 in radio frames for which $\text{SFN} \bmod 2 = 0$;
 - 2> any MBSFN subframes;
 - 2> any uplink subframes in TDD;
- 1> if the SI message was not received by the end of the SI-window, repeat reception at the next SI-window occasion for the concerned SI message;

[TS 36.331, clause 5.2.3a]

When acquiring an SI message, the BL UE or UE in CE or NB-IoT UE shall:

- 1> determine the start of the SI-window for the concerned SI message as follows:
 - 2> if the concerned SI message is configured in the *schedulingInfoList*, *schedulingInfoListExt* (if present) or if the concerned SI message is configured in the *pos-schedulingInfoList* and *si-posOffset* is not configured;
 - 3> for the concerned SI message, determine the number n which corresponds to the order of entry in the concatenated list of SI messages configured by *schedulingInfoList*, *schedulingInfoListExt* (if present) in *SystemInformationBlockType1-BR* (or *SystemInformationBlockType1-NB* in NB-IoT) and *posSchedulingInfoList* in *SystemInformationBlockType1-BR*;
 - 3> determine the integer value $x = (n - 1) * w$, where w is the *si-WindowLength-BR* (or *si-WindowLength* in NB-IoT);
 - 2> else if the concerned SI message is configured by the *posSchedulingInfoList* and *si-posOffset* is configured determine the start of the SI-window for the concerned SI message as follows:

- 3> determine the number m which corresponds to the number of SI messages with an associated *si-Periodicity* of 8 radio frames (80 ms), configured by *schedulingInfoList* and *schedulingInfoListExt* (if present) in *SystemInformationBlockType1-BR*;
 - 3> for the concerned SI message, determine the number n which corresponds to the order of entry in the list of SI messages configured by *posSchedulingInfoList* in *SystemInformationBlockType1-BR*;
 - 3> determine the integer value $x = m*w + (n - 1)*w$, where w is the *si-WindowLength-BR*;
 - 3> the SI-window starts at the subframe $\#a$, where $a = x \bmod 10$, in the radio frame for which $\text{SFN} \bmod T = \text{FLOOR}(x/10) + 8$, where T is the *si-posPeriodicity* of the concerned SI message;
- 2> if the UE is a NB-IoT UE:
- 3> the SI-window starts at the subframe $\#0$ in the radio frame for which $(\text{H-SFN} * 1024 + \text{SFN}) \bmod T = \text{FLOOR}(x/10) + \text{Offset}$, where T is the *si-Periodicity* of the concerned SI message and, *Offset* is the offset of the start of the SI-Window (*si-RadioFrameOffset*);
- 2> else:
- 3> the SI-window starts at the subframe $\#0$ in the radio frame for which $\text{SFN} \bmod T = \text{FLOOR}(x/10)$, where T is the *si-Periodicity* of the concerned SI message;
- 1> if the UE is a NB-IoT UE:
- 2> receive and accumulate SI message transmissions on DL-SCH from the start of the SI-window and continue until the end of the SI-window whose absolute length in time is given by *si-WindowLength*, starting from the radio frames as provided in *si-RepetitionPattern* and in subframes as provided in *downlinkBitmap*, or until successful decoding of the accumulated SI message transmissions excluding the subframes used for transmission of NPSS, NSSS, *MasterInformationBlock-NB/MasterInformationBlock-TDD-NB* and *SystemInformationBlockType1-NB*. If there are not enough subframes for one SI message transmission in the radio frames as provided in *si-RepetitionPattern*, the UE shall continue to receive the SI message transmission in the radio frames following the radio frame indicated in *si-RepetitionPattern*;
- 1> else:
- 2> receive and accumulate SI message transmissions on DL-SCH on narrowband provided by *si-Narrowband*, from the start of the SI-window and continue until the end of the SI-window whose absolute length in time is given by *si-WindowLength-BR*, only in radio frames as provided in *si-RepetitionPattern* and subframes as provided in *fdd-DownlinkOrTddSubframeBitmapBR* in *bandwidthReducedAccessRelatedInfo*, or until successful decoding of the accumulated SI message transmissions;
- 1> if the SI message was not possible to decode from the accumulated SI message transmissions by the end of the SI-window, continue reception and accumulation of SI message transmissions on DL-SCH in the next SI-window occasion for the concerned SI message;

[TS 36.304, clause 5.2.4.1]

Absolute priorities of different E-UTRAN frequencies or inter-RAT frequencies may be provided to the UE in the system information, in the *RRCCConnectionRelease* message, or by inheriting from another RAT at inter-RAT cell (re)selection. In the case of system information, an E-UTRAN frequency or inter-RAT frequency may be listed without providing a priority (i.e. the field *cellReselectionPriority* is absent for that frequency). If priorities are provided in dedicated signalling, the UE shall ignore all the priorities provided in system information. If UE is in *camped on any cell* state, UE shall only apply the priorities provided by system information from current cell, and the UE preserves priorities provided by dedicated signalling and *deprioritisationReq* received in *RRCCConnectionReject* unless specified otherwise. When the UE in *camped normally* state, has only dedicated priorities other than for the current frequency, the UE shall consider the current frequency to be the lowest priority frequency (i.e. lower than any of the network configured values). While the UE is camped on a suitable CSG cell in normal coverage, the UE shall always consider the current frequency to be the highest priority frequency (i.e. higher than any of the network configured values), irrespective of any other priority value allocated to this frequency. When the HSDN capable UE is in High-mobility state, the UE shall always consider the HSDN cells to be the highest priority (i.e. higher than any other network configured priorities). When the HSDN capable UE is not in High-mobility state, the UE shall always consider HSDN cells to be the lowest priority (i.e. lower than network configured priorities). If the UE capable of sidelink communication is configured to perform sidelink communication and can only perform the sidelink communication while camping on a frequency, the UE may consider that frequency to be the highest priority. If the UE capable of V2X

sidelink communication is configured to perform V2X sidelink communication and can only perform the V2X sidelink communication while camping on a frequency, the UE may consider that frequency to be the highest priority. If the UE capable of V2X sidelink communication is configured to perform V2X sidelink communication and can only use pre-configuration while not camping on a frequency, the UE may consider the frequency providing inter-carrier V2X sidelink configuration to be the highest priority. If the UE capable of sidelink discovery is configured to perform Public Safety related sidelink discovery and can only perform the Public Safety related sidelink discovery while camping on a frequency, the UE may consider that frequency to be the highest priority.

NOTE 1: The prioritization among the frequencies which UE considers to be the highest priority frequency is left to UE implementation.

If the UE is capable either of MBMS Service Continuity or of SC-PTM reception and is receiving or interested to receive an MBMS service and can only receive this MBMS service while camping on a frequency on which it is provided, the UE may consider that frequency to be the highest priority during the MBMS session TS 36.300 [2] as long as the two following conditions are fulfilled:

1) Either:

- the UE is capable of MBMS service continuity and the reselected cell is broadcasting SIB13; or
- the UE is capable of SC-PTM reception and the reselected cell is broadcasting SIB20;

2) Either:

- SIB15 of the serving cell indicates for that frequency one or more MBMS SAIs included and associated with that frequency in the MBMS User Service Description (USD) TS 26.346 [22] of this service; or
- SIB15 is not broadcast in the serving cell and that frequency is included in the USD of this service.

If the UE is capable either of MBMS Service Continuity or of SC-PTM reception and is receiving or interested to receive an MBMS service provided on a downlink only MBMS frequency, on a frequency used by dedicated MBMS cells, on a frequency used by FeMBMS/Unicast-mixed cells as defined in TS 36.300 [2], or on a frequency belonging to PLMN different from its registered PLMN, the UE may consider cell reselection candidate frequencies at which it cannot receive the MBMS service to be of the lowest priority during the MBMS session TS 36.300 [2], as long as the above mentioned condition 1) is fulfilled for the cell on the MBMS frequency which the UE monitors or this cell broadcasts SIB1-MBMS and as long as the above mentioned condition 2) is fulfilled for the serving cell.

NOTE 2: Example scenarios in which the previous down-prioritisation may be needed concerns the cases where camping is not possible, while the UE can only receive this MBMS frequency when camping on a subset of cell reselection candidate frequencies, e.g. the MBMS frequency is a downlink only carrier, the MBMS frequency is used by dedicated MBMS cells, the MBMS frequency is used by FeMBMS/Unicast-mixed cells TS 36.300 [2], or the MBMS frequency belongs to a PLMN different from UE's registered PLMN.

If the UE is not capable of MBMS Service Continuity but has knowledge on which frequency an MBMS service of interest is provided, it may consider that frequency to be the highest priority during the MBMS session TS 36.300 [2] as long as the reselected cell is broadcasting SIB13.

If the UE is not capable of MBMS Service Continuity but has knowledge on which downlink only frequency, on which frequency used by dedicated MBMS cells, on which frequency used by FeMBMS/Unicast-mixed cells as defined in TS 36.300 [2] or on which frequency belonging to PLMN different from its registered PLMN an MBMS service of interest is provided, it may consider cell reselection candidate frequencies at which it cannot receive the MBMS service to be of the lowest priority during the MBMS session TS 36.300 [2] as long as the cell on the MBMS frequency which the UE monitors is broadcasting SIB13 or SIB1-MBMS.

NOTE 3: The UE considers that the MBMS session is ongoing using the session start and end times as provided by upper layers in the USD i.e. the UE does not verify if the session is indicated on MCCH.

In case UE receives *RRCConnectionReject* with *deprioritisationReq*, UE shall consider current carrier frequency and stored frequencies due to the previously received *RRCConnectionReject* with *deprioritisationReq* or all the frequencies of EUTRA to be the lowest priority frequency (i.e. lower than any of the network configured values) while T325 is running irrespective of camped RAT. The UE shall delete the stored deprioritisation request(s) when a PLMN selection is performed on request by NAS TS 23.122 [5].

NOTE 4: Connecting to CDMA2000 does not imply PLMN selection.

NOTE 5: UE should search for a higher priority layer for cell reselection as soon as possible after the change of priority. The minimum related performance requirements specified in TS 36.133 [10] are still applicable.

The UE shall delete priorities provided by dedicated signalling when:

- the UE enters a different RRC state; or
- the optional validity time of dedicated priorities (T320) expires; or
- a PLMN selection is performed on request by NAS TS 23.122 [5].

NOTE 6: Equal priorities between RATs are not supported.

The UE shall only perform cell reselection evaluation for E-UTRAN frequencies and inter-RAT frequencies that are given in system information and for which the UE has a priority provided.

The UE shall not consider any black listed cells as candidate for cell reselection.

The UE shall inherit the priorities provided by dedicated signalling and the remaining validity time (i.e., T320 in E-UTRA and NR, T322 in UTRA and T3230 in GERAN), if configured, at inter-RAT cell (re)selection.

NOTE 7: The network may assign dedicated cell reselection priorities for frequencies not configured by system information.

While T360 is running, redistribution target is considered to be the highest priority (i.e. higher than any of the network configured values). UE shall continue to consider the serving frequency as the highest priority until completion of E-UTRAN Inter-frequency Redistribution procedure specified in 5.2.4.10 if triggered on T360 expiry/ stop.

[TS 36.304, clause 5.2.4.2]

For NB-IoT measurement rules for cell re-selection is defined in sub-clause 5.2.4.2.a.

When evaluating S_{rxlev} and S_{qual} of non-serving cells for reselection purposes, the UE shall use parameters provided by the serving cell.

Following rules are used by the UE to limit needed measurements:

- If the serving cell fulfils $S_{rxlev} > S_{IntraSearchP}$ and $S_{qual} > S_{IntraSearchQ}$, the UE may choose not to perform intra-frequency measurements.
- Otherwise, the UE shall perform intra-frequency measurements.
- The UE shall apply the following rules for E-UTRAN inter-frequencies and inter-RAT frequencies which are indicated in system information and for which the UE has priority provided as defined in 5.2.4.1:
 - For an E-UTRAN inter-frequency or inter-RAT frequency with a reselection priority higher than the reselection priority of the current E-UTRA frequency the UE shall perform measurements of higher priority E-UTRAN inter-frequency or inter-RAT frequencies according to TS 36.133 [10].
 - For an E-UTRAN inter-frequency with an equal or lower reselection priority than the reselection priority of the current E-UTRA frequency and for inter-RAT frequency with lower reselection priority than the reselection priority of the current E-UTRAN frequency:
 - If the serving cell fulfils $S_{rxlev} > S_{nonIntraSearchP}$ and $S_{qual} > S_{nonIntraSearchQ}$, the UE may choose not to perform measurements of E-UTRAN inter-frequencies or inter-RAT frequency cells of equal or lower priority unless the UE is triggered to measure an E-UTRAN inter-frequency which is configured with *redistributionInterFreqInfo*.
 - Otherwise, the UE shall perform measurements of E-UTRAN inter-frequencies or inter-RAT frequency cells of equal or lower priority according to TS 36.133 [10].
- If the UE supports relaxed monitoring and *s-SearchDeltaP* is present in *SystemInformationBlockType3*, the UE may further limit the needed measurements, as specified in sub-clause 5.2.4.12.

[TS 36.304, clause 5.2.4.5]

For NB-IoT inter-frequency cell reselection shall be based on ranking as defined in sub-clause 5.2.4.6.

If *threshServingLowQ* is provided in *SystemInformationBlockType3* and more than 1 second has elapsed since the UE camped on the current serving cell, cell reselection to a cell on a higher priority E-UTRAN frequency or inter-RAT frequency than the serving frequency shall be performed if:

- A cell of a higher priority EUTRAN, NR or UTRAN FDD RAT/ frequency fulfils $S_{qual} > Thresh_{X, HighQ}$ during a time interval $T_{reselection_{RAT}}$; or
- A cell of a higher priority UTRAN TDD, GERAN or CDMA2000 RAT/ frequency fulfils $S_{rxlev} > Thresh_{X, HighP}$ during a time interval $T_{reselection_{RAT}}$.

Otherwise, cell reselection to a cell on a higher priority E-UTRAN frequency or inter-RAT frequency than the serving frequency shall be performed if:

- A cell of a higher priority RAT/ frequency fulfils $S_{rxlev} > Thresh_{X, HighP}$ during a time interval $T_{reselection_{RAT}}$; and
- More than 1 second has elapsed since the UE camped on the current serving cell.

Cell reselection to a cell on an equal priority E-UTRAN frequency shall be based on ranking for Intra-frequency cell reselection as defined in sub-clause 5.2.4.6.

If *threshServingLowQ* is provided in *SystemInformationBlockType3* and more than 1 second has elapsed since the UE camped on the current serving cell, cell reselection to a cell on a lower priority E-UTRAN frequency or inter-RAT frequency than the serving frequency shall be performed if:

- The serving cell fulfils $S_{qual} < Thresh_{Serving, LowQ}$ and a cell of a lower priority EUTRAN, NR or UTRAN FDD RAT/ frequency fulfils $S_{qual} > Thresh_{X, LowQ}$ during a time interval $T_{reselection_{RAT}}$; or
- The serving cell fulfils $S_{qual} < Thresh_{Serving, LowQ}$ and a cell of a lower priority UTRAN TDD, GERAN or CDMA2000 RAT/ frequency fulfils $S_{rxlev} > Thresh_{X, LowP}$ during a time interval $T_{reselection_{RAT}}$.

Otherwise, cell reselection to a cell on a lower priority E-UTRAN frequency or inter-RAT frequency than the serving frequency shall be performed if:

- The serving cell fulfils $S_{rxlev} < Thresh_{Serving, LowP}$ and a cell of a lower priority RAT/ frequency fulfils $S_{rxlev} > Thresh_{X, LowP}$ during a time interval $T_{reselection_{RAT}}$; and
- More than 1 second has elapsed since the UE camped on the current serving cell.

Cell reselection to a higher priority RAT/ frequency shall take precedence over a lower priority RAT/ frequency, if multiple cells of different priorities fulfil the cell reselection criteria.

The UE shall not perform cell reselection to NR or UTRAN FDD cells for which the cell selection criterion S is not fulfilled.

For cdma2000 RATs, S_{rxlev} is equal to $-FLOOR(-2 \times 10 \times \log_{10} E_c/I_o)$ in units of 0.5 dB, as defined in [18], with E_c/I_o referring to the value measured from the evaluated cell.

For cdma2000 RATs, $Thresh_{X, HighP}$ and $Thresh_{X, LowP}$ are equal to -1 times the values signalled for the corresponding parameters in the system information.

In all the above criteria the value of $T_{reselection_{RAT}}$ is scaled when the UE is in the medium or high mobility state as defined in subclause 5.2.4.3.1. If more than one cell meets the above criteria, the UE shall reselect a cell as follows:

- If the highest-priority frequency is an E-UTRAN frequency, a cell ranked as the best cell among the cells on the highest priority frequency(ies) meeting the criteria according to clause 5.2.4.6;
- If the highest-priority frequency is from another RAT, a cell ranked as the best cell among the cells on the highest priority frequency(ies) meeting the criteria of that RAT.

Cell reselection to another RAT, for which S_{qual} based cell reselection parameters are broadcast in system information, shall be performed based on the S_{qual} criteria if the UE supports S_{qual} (RSRQ) based cell reselection to E-UTRAN from all the other RATs provided by system information which UE supports. Otherwise, cell reselection to another RAT shall be performed based on S_{rxlev} criteria.

Cell reselection to NR, for which a cell reselection parameter, $q\text{-RxLevMinSUL}$ is broadcast in system information and the UE supports SUL, shall be performed based on $Srxlev$ criteria taking the parameter into account.

6.2.3.10.3 Test description

6.2.3.10.3.1 Pre-test conditions

System Simulator:

- E-UTRA Cell 1, NR Cell 1.
- NR Cell 1 is configured to operate in FR1 bands as defined in TS 38.508-1 [4] clause 6.2.3.
- System information combination 1 as defined in TS 36.508 [7] clause 4.4.3.1 is used in E-UTRA Cell 1. *SystemInformationBlockType1* is broadcasted with extended fields as specified in Table 6.2.3.10.3.3-1. And *SystemInformationBlockType24* is broadcasted according to scheduling information specified in Table 6.2.3.10.3.3-1.
- System information combination NR-1 defined in TS 38.508-1 [4] clause 4.4.3.1.3 is used in NR Cell 1.

UE:

- None.

Preamble:

- With E-UTRA Cell 1 "Non-suitable "Off" cell" and NR Cell 1 "Serving cell" in accordance with TS 38.508-1 [4], Table 6.2.2.1-3, the UE is brought to state RRC_CONNECTED 1N-A, Connectivity (NR), in accordance with the procedure described in TS 38.508-1 [4], Table 4.5.2.2-2. 5G-GUTI and ngKSI are assigned and security context established.
- The UE is switched-off
- With E-UTRA Cell 1 "Serving cell" and NR Cell 1 "Non-suitable "Off" cell" in accordance with TS 38.508-1 [4], Table 6.2.2.1-3, the UE is brought to state RRC_IDLE using generic procedure parameters Connectivity (E-UTRA/EPC) and Unrestricted nr PDN (On) in accordance with the procedure described in TS 38.508-1 [4], clause 4.5. 4. 4G GUTI and eKSI are assigned and security context established.

6.2.3.10.3.2 Test procedure sequence

Table 6.2.3.10.3.2-1 illustrates the downlink power levels and other changing parameters to be applied for the cell at various time instants of the test execution. The exact instants on which these values shall be applied are described in the texts in this clause. Row marked "T0" denotes the conditions in the preamble. Configurations marked "T1", "T2" and "T3" are applied at the points indicated in the Main behaviour description in Table 6.2.3.10.3.2-3.

Table 6.2.3.10.3.2-1: Time instances of cell power level and parameter changes for E-UTRA Cell 1 and NR Cell 1 in conducted test environment

	Parameter	Unit	E-UTRA Cell 1	NR Cell 1	Remark
T0	Cell-specific RS EPRE	dBm/15kHz	-85	-	The power level values are assigned to ensure UE registered on E-UTRA cell 1
	SS/PBCH SSS EPRE	dBm/SCS	-	Off	
T1	Cell-specific RS EPRE	dBm/15kHz	-95	-	The power level values are assigned to satisfy both $Srxlev_{NR\ Cell\ 1} > Thresh_{x, low}$ and $Srxlev_{E-UTRA\ Cell\ 1} < Thresh_{serving, low}$
	SS/PBCH SSS EPRE	dBm/SCS	-	-80	
Note1: Power level "Off" is defined in TS 38.508-1 [4] Table 6.2.2.1-3.					

Table 6.2.3.10.3.2-2: Void

Table 6.2.3.10.3.2-3: Main behaviour

St	Procedure	Message Sequence		TP	Verdict
		U - S	Message		
1	The SS adjusts the E-UTRAN and NR Cell power levels according to row "T1" in table 6.2.3.10.3.2-1.	-	-	-	-
1A	Wait for 1s (Note 2).	-	-	-	-
1B	The SS transmits an <i>RRCConnectionRelease</i> message to release RRC connection and move to E-UTRA RRC_IDLE.	<--	RRC: <i>RRCConnectionRelease</i>	-	-
2	Check: Does the test result of generic test procedure in TS 38.508-1 [4] Table 4.9.9.2.2-1 indicate that the UE is camped on NR Cell 1 within 34s for FR1? (Note 1)	-	-	1	P
Note 1: The wait time for reselection to an newly detected Inter-RAT NR cell is selected to cover $T_{detect,NR}$ (32s for FR1) + T_{SI-NR} (1280 ms system information block type scheduling) = 33.28s rounded up to 34s for FR1 . Note 2: The wait time 1 sec is added to allow the NR cell to be setup before RRC is released on E-UTRAN. This will avoid the UE to miss the $T_{detect,NR}$ window if the NR cell is not up.					

6.2.3.10.3.3 Specific message contents

Table 6.2.3.10.3.3-1: *SystemInformationBlockType1* for cell 1 (preamble and all steps, Table 6.2.3.11.3.2-3)

Derivation Path: TS 36.508 [7], Table 4.4.3.2-3			
Information Element	Value/Remark	Comment	Condition
SystemInformationBlockType1 ::= SEQUENCE {			
nonCriticalExtension SEQUENCE {			
lateNonCriticalExtension SEQUENCE {			
nonCriticalExtension SEQUENCE {			
nonCriticalExtension SEQUENCE {			
nonCriticalExtension SEQUENCE {			
nonCriticalExtension SEQUENCE {			
schedulingInfoList-v12j0 SEQUENCE (SIZE (1..maxSI-Message)) OF SEQUENCE {	2 entries	It includes the same number of entries, and listed in the same order, as in <i>schedulingInfoList</i> (without suffix).	
SchedulingInfo-v12j0[1] SEQUENCE {		entry 1	
SIB-MappingInfo-v12j0	Not present		
SchedulingInfo-v12j0[2] SEQUENCE {		entry 2	
SIB-MappingInfo-v12j0 SEQUENCE (SIZE (1..maxSIB-1)) OF SIB-Type-v12j0 {	1 entry		
SIB-Type-v12j0[1]	sibType24-v1530	entry 2, SIB24 is mapped into the SI message scheduled via the second entry of <i>schedulingInfoList</i> (without suffix)	
}			
}			
}			
}			
}			
}			
}			
}			
}			
}			

}			
}			

Table 6.2.3.10.3.3-2: SystemInformationBlockType3 of EUTRA Cell 1 (preamble and all steps, Table 6.2.3.10.3.2-3)

Derivation Path: TS 36.508 [7], Table 4.4.3.3-2			
Information Element	Value/remark	Comment	Condition
SystemInformationBlockType3 ::= SEQUENCE {			
cellReselectionServingFreqInfo SEQUENCE {			
threshServingLow	10	20 dB	
}			
}			

Table 6.2.3.10.3.3-3: SystemInformationBlockType24 of EUTRA Cell 1 (preamble and all steps, Table 6.2.3.10.3.2-3)

Derivation path: TS 36.508 [7], Table 4.4.3.3-20			
Information Element	Value/Remark	Comment	Condition
SystemInformationBlockType24-r15 ::= SEQUENCE {			
carrierFreqListNR-r15 SEQUENCE (SIZE (1..maxFreq)) OF CarrierFreqNR-r15 {	1 entry		
CarrierFreqNR-r15[1] SEQUENCE {		entry 1	
carrierFreq-r15	Downlink NR ARFCN of SSB for NR Cell 1		
}			
cellReselectionPriority-r15	3		
threshX-Low-r15	10	20 dB	
}			
}			

6.2.3.11 Inter-RAT cell reselection / From E-UTRA_IDLE to NR RRC_IDLE / schedulingInfoListExt-r12

6.2.3.11.1 Test Purpose (TP)

(1)

```
with { the UE is in E-UTRA IDLE state and SystemInformationBlockType24 scheduled by optional
extended field schedulingInfoListExt-r12 in SystemInformationBlockType1 is broadcasted }
ensure that {
  when { UE detects the cell re-selection criteria is met for a lower priority NR cell }
  then { UE reselects to the NR cell }
}
```

6.2.3.11.2 Conformance requirements

References: The conformance requirements covered in the current TC are specified in: TS 36.331, clause 5.2.3 and 5.2.3a and TS 36.304, clause 5.2.4.1, 5.2.4.2 and 5.2.4.5. Unless otherwise stated these are Rel-15 requirements.

[TS 36.331, clause 5.2.3]

When acquiring an SI message, the UE shall:

- 1> determine the start of the SI-window for the concerned SI message as follows:
 - 2> if the concerned SI message is configured in the *schedulingInfoList*, *schedulingInfoListExt* (if present) or if the concerned SI message is configured in the *pos-schedulingInfoList* and *si-posOffset* is not configured;

- 3> for the concerned SI message, determine the number n which corresponds to the order of entry in the concatenated list of SI messages configured by *schedulingInfoList*, *schedulingInfoListExt* (if present) and *posSchedulingInfoList* in *SystemInformationBlockType1*;
 - 3> determine the integer value $x = (n - 1) * w$, where w is the *si-WindowLength*;
 - 3> the SI-window starts at the subframe $\#a$, where $a = x \bmod 10$, in the radio frame for which $\text{SFN} \bmod T = \text{FLOOR}(x/10)$, where T is the *si-Periodicity* of the concerned SI message;
 - 2> else if the concerned SI message is configured by the *posSchedulingInfoList* and *si-posOffset* is configured determine the start of the SI-window for the concerned SI message as follows:
 - 3> determine the number m which corresponds to the number of SI messages with an associated *si-Periodicity* of 8 radio frames (80 ms), configured by *schedulingInfoList* and *schedulingInfoListExt* (if present) in *SystemInformationBlockType1*;
 - 3> for the concerned SI message, determine the number n which corresponds to the order of entry in the list of SI messages configured by *posSchedulingInfoList* in *SystemInformationBlockType1*;
 - 3> determine the integer value $x = m * w + (n - 1) * w$, where w is the *si-WindowLength*
 - 3> the SI-window starts at the subframe $\#a$, where $a = x \bmod 10$, in the radio frame for which $\text{SFN} \bmod T = \text{FLOOR}(x/10) + 8$, where T is the *si-posPeriodicity* of the concerned SI message;
- NOTE: E-UTRAN should configure an SI-window of 1 ms only if all SIs are scheduled before subframe #5 in radio frames for which $\text{SFN} \bmod 2 = 0$.
- 1> receive DL-SCH using the SI-RNTI from the start of the SI-window and continue until the end of the SI-window whose absolute length in time is given by *si-WindowLength*, or until the SI message was received, excluding the following subframes:
 - 2> subframe #5 in radio frames for which $\text{SFN} \bmod 2 = 0$;
 - 2> any MBSFN subframes;
 - 2> any uplink subframes in TDD;
 - 1> if the SI message was not received by the end of the SI-window, repeat reception at the next SI-window occasion for the concerned SI message;

[TS 36.331, clause 5.2.3a]

When acquiring an SI message, the BL UE or UE in CE or NB-IoT UE shall:

- 1> determine the start of the SI-window for the concerned SI message as follows:
 - 2> if the concerned SI message is configured in the *schedulingInfoList*, *schedulingInfoListExt* (if present) or if the concerned SI message is configured in the *pos-schedulingInfoList* and *si-posOffset* is not configured;
 - 3> for the concerned SI message, determine the number n which corresponds to the order of entry in the concatenated list of SI messages configured by *schedulingInfoList*, *schedulingInfoListExt* (if present) in *SystemInformationBlockType1-BR* (or *SystemInformationBlockType1-NB* in NB-IoT) and *posSchedulingInfoList* in *SystemInformationBlockType1-BR*;
 - 3> determine the integer value $x = (n - 1) * w$, where w is the *si-WindowLength-BR* (or *si-WindowLength* in NB-IoT);
- 2> else if the concerned SI message is configured by the *posSchedulingInfoList* and *si-posOffset* is configured determine the start of the SI-window for the concerned SI message as follows:
 - 3> determine the number m which corresponds to the number of SI messages with an associated *si-Periodicity* of 8 radio frames (80 ms), configured by *schedulingInfoList* and *schedulingInfoListExt* (if present) in *SystemInformationBlockType1-BR*;
 - 3> for the concerned SI message, determine the number n which corresponds to the order of entry in the list of SI messages configured by *posSchedulingInfoList* in *SystemInformationBlockType1-BR*;

- 3> determine the integer value $x = m*w + (n - 1)*w$, where w is the *si-WindowLength-BR*;
- 3> the SI-window starts at the subframe # a , where $a = x \bmod 10$, in the radio frame for which $\text{SFN} \bmod T = \text{FLOOR}(x/10) + 8$, where T is the *si-posPeriodicity* of the concerned SI message;
- 2> if the UE is a NB-IoT UE:
 - 3> the SI-window starts at the subframe #0 in the radio frame for which $(\text{H-SFN} * 1024 + \text{SFN}) \bmod T = \text{FLOOR}(x/10) + \text{Offset}$, where T is the *si-Periodicity* of the concerned SI message and, *Offset* is the offset of the start of the SI-Window (*si-RadioFrameOffset*);
- 2> else:
 - 3> the SI-window starts at the subframe #0 in the radio frame for which $\text{SFN} \bmod T = \text{FLOOR}(x/10)$, where T is the *si-Periodicity* of the concerned SI message;
- 1> if the UE is a NB-IoT UE:
 - 2> receive and accumulate SI message transmissions on DL-SCH from the start of the SI-window and continue until the end of the SI-window whose absolute length in time is given by *si-WindowLength*, starting from the radio frames as provided in *si-RepetitionPattern* and in subframes as provided in *downlinkBitmap*, or until successful decoding of the accumulated SI message transmissions excluding the subframes used for transmission of NPSS, NSSS, *MasterInformationBlock-NB/ MasterInformationBlock-TDD-NB* and *SystemInformationBlockType1-NB*. If there are not enough subframes for one SI message transmission in the radio frames as provided in *si-RepetitionPattern*, the UE shall continue to receive the SI message transmission in the radio frames following the radio frame indicated in *si-RepetitionPattern*;
- 1> else:
 - 2> receive and accumulate SI message transmissions on DL-SCH on narrowband provided by *si-Narrowband*, from the start of the SI-window and continue until the end of the SI-window whose absolute length in time is given by *si-WindowLength-BR*, only in radio frames as provided in *si-RepetitionPattern* and subframes as provided in *fdd-DownlinkOrTddSubframeBitmapBR* in *bandwidthReducedAccessRelatedInfo*, or until successful decoding of the accumulated SI message transmissions;
- 1> if the SI message was not possible to decode from the accumulated SI message transmissions by the end of the SI-window, continue reception and accumulation of SI message transmissions on DL-SCH in the next SI-window occasion for the concerned SI message;

[TS 36.304, clause 5.2.4.1]

Absolute priorities of different E-UTRAN frequencies or inter-RAT frequencies may be provided to the UE in the system information, in the *RRConnectionRelease* message, or by inheriting from another RAT at inter-RAT cell (re)selection. In the case of system information, an E-UTRAN frequency or inter-RAT frequency may be listed without providing a priority (i.e. the field *cellReselectionPriority* is absent for that frequency). If priorities are provided in dedicated signalling, the UE shall ignore all the priorities provided in system information. If UE is in *camped on any cell* state, UE shall only apply the priorities provided by system information from current cell, and the UE preserves priorities provided by dedicated signalling and *deprioritisationReq* received in *RRConnectionReject* unless specified otherwise. When the UE in *camped normally* state, has only dedicated priorities other than for the current frequency, the UE shall consider the current frequency to be the lowest priority frequency (i.e. lower than any of the network configured values). While the UE is camped on a suitable CSG cell in normal coverage, the UE shall always consider the current frequency to be the highest priority frequency (i.e. higher than any of the network configured values), irrespective of any other priority value allocated to this frequency. When the HSDN capable UE is in High-mobility state, the UE shall always consider the HSDN cells to be the highest priority (i.e. higher than any other network configured priorities). When the HSDN capable UE is not in High-mobility state, the UE shall always consider HSDN cells to be the lowest priority (i.e. lower than network configured priorities). If the UE capable of sidelink communication is configured to perform sidelink communication and can only perform the sidelink communication while camping on a frequency, the UE may consider that frequency to be the highest priority. If the UE capable of V2X sidelink communication is configured to perform V2X sidelink communication and can only perform the V2X sidelink communication while camping on a frequency, the UE may consider that frequency to be the highest priority. If the UE capable of V2X sidelink communication is configured to perform V2X sidelink communication and can only use pre-configuration while not camping on a frequency, the UE may consider the frequency providing inter-carrier V2X sidelink configuration to be the highest priority. If the UE capable of sidelink discovery is configured to perform Public

Safety related sidelink discovery and can only perform the Public Safety related sidelink discovery while camping on a frequency, the UE may consider that frequency to be the highest priority.

NOTE 1: The prioritization among the frequencies which UE considers to be the highest priority frequency is left to UE implementation.

If the UE is capable either of MBMS Service Continuity or of SC-PTM reception and is receiving or interested to receive an MBMS service and can only receive this MBMS service while camping on a frequency on which it is provided, the UE may consider that frequency to be the highest priority during the MBMS session TS 36.300 [2] as long as the two following conditions are fulfilled:

1) Either:

- the UE is capable of MBMS service continuity and the reselected cell is broadcasting SIB13; or
- the UE is capable of SC-PTM reception and the reselected cell is broadcasting SIB20;

2) Either:

- SIB15 of the serving cell indicates for that frequency one or more MBMS SAIs included and associated with that frequency in the MBMS User Service Description (USD) TS 26.346 [22] of this service; or
- SIB15 is not broadcast in the serving cell and that frequency is included in the USD of this service.

If the UE is capable either of MBMS Service Continuity or of SC-PTM reception and is receiving or interested to receive an MBMS service provided on a downlink only MBMS frequency, on a frequency used by dedicated MBMS cells, on a frequency used by FeMBMS/Unicast-mixed cells as defined in TS 36.300 [2], or on a frequency belonging to PLMN different from its registered PLMN, the UE may consider cell reselection candidate frequencies at which it cannot receive the MBMS service to be of the lowest priority during the MBMS session TS 36.300 [2], as long as the above mentioned condition 1) is fulfilled for the cell on the MBMS frequency which the UE monitors or this cell broadcasts SIB1-MBMS and as long as the above mentioned condition 2) is fulfilled for the serving cell.

NOTE 2: Example scenarios in which the previous down-prioritisation may be needed concerns the cases where camping is not possible, while the UE can only receive this MBMS frequency when camping on a subset of cell reselection candidate frequencies, e.g. the MBMS frequency is a downlink only carrier, the MBMS frequency is used by dedicated MBMS cells, the MBMS frequency is used by FeMBMS/Unicast-mixed cells TS 36.300 [2], or the MBMS frequency belongs to a PLMN different from UE's registered PLMN.

If the UE is not capable of MBMS Service Continuity but has knowledge on which frequency an MBMS service of interest is provided, it may consider that frequency to be the highest priority during the MBMS session TS 36.300 [2] as long as the reselected cell is broadcasting SIB13.

If the UE is not capable of MBMS Service Continuity but has knowledge on which downlink only frequency, on which frequency used by dedicated MBMS cells, on which frequency used by FeMBMS/Unicast-mixed cells as defined in TS 36.300 [2] or on which frequency belonging to PLMN different from its registered PLMN an MBMS service of interest is provided, it may consider cell reselection candidate frequencies at which it cannot receive the MBMS service to be of the lowest priority during the MBMS session TS 36.300 [2] as long as the cell on the MBMS frequency which the UE monitors is broadcasting SIB13 or SIB1-MBMS.

NOTE 3: The UE considers that the MBMS session is ongoing using the session start and end times as provided by upper layers in the USD i.e. the UE does not verify if the session is indicated on MCCH.

In case UE receives *RRCCConnectionReject* with *deprioritisationReq*, UE shall consider current carrier frequency and stored frequencies due to the previously received *RRCCConnectionReject* with *deprioritisationReq* or all the frequencies of EUTRA to be the lowest priority frequency (i.e. lower than any of the network configured values) while T325 is running irrespective of camped RAT. The UE shall delete the stored deprioritisation request(s) when a PLMN selection is performed on request by NAS TS 23.122 [5].

NOTE 4: Connecting to CDMA2000 does not imply PLMN selection.

NOTE 5: UE should search for a higher priority layer for cell reselection as soon as possible after the change of priority. The minimum related performance requirements specified in TS 36.133 [10] are still applicable.

The UE shall delete priorities provided by dedicated signalling when:

- the UE enters a different RRC state; or

- the optional validity time of dedicated priorities (T320) expires; or
- a PLMN selection is performed on request by NAS TS 23.122 [5].

NOTE 6: Equal priorities between RATs are not supported.

The UE shall only perform cell reselection evaluation for E-UTRAN frequencies and inter-RAT frequencies that are given in system information and for which the UE has a priority provided.

The UE shall not consider any black listed cells as candidate for cell reselection.

The UE shall inherit the priorities provided by dedicated signalling and the remaining validity time (i.e., T320 in E-UTRA and NR, T322 in UTRA and T3230 in GERAN), if configured, at inter-RAT cell (re)selection.

NOTE 7: The network may assign dedicated cell reselection priorities for frequencies not configured by system information.

While T360 is running, redistribution target is considered to be the highest priority (i.e. higher than any of the network configured values). UE shall continue to consider the serving frequency as the highest priority until completion of E-UTRAN Inter-frequency Redistribution procedure specified in 5.2.4.10 if triggered on T360 expiry/ stop.

[TS 36.304, clause 5.2.4.2]

For NB-IoT measurement rules for cell re-selection is defined in sub-clause 5.2.4.2.a.

When evaluating S_{rxlev} and S_{qual} of non-serving cells for reselection purposes, the UE shall use parameters provided by the serving cell.

Following rules are used by the UE to limit needed measurements:

- If the serving cell fulfils $S_{rxlev} > S_{IntraSearchP}$ and $S_{qual} > S_{IntraSearchQ}$, the UE may choose not to perform intra-frequency measurements.
- Otherwise, the UE shall perform intra-frequency measurements.
- The UE shall apply the following rules for E-UTRAN inter-frequencies and inter-RAT frequencies which are indicated in system information and for which the UE has priority provided as defined in 5.2.4.1:
 - For an E-UTRAN inter-frequency or inter-RAT frequency with a reselection priority higher than the reselection priority of the current E-UTRA frequency the UE shall perform measurements of higher priority E-UTRAN inter-frequency or inter-RAT frequencies according to TS 36.133 [10].
 - For an E-UTRAN inter-frequency with an equal or lower reselection priority than the reselection priority of the current E-UTRA frequency and for inter-RAT frequency with lower reselection priority than the reselection priority of the current E-UTRAN frequency:
 - If the serving cell fulfils $S_{rxlev} > S_{nonIntraSearchP}$ and $S_{qual} > S_{nonIntraSearchQ}$, the UE may choose not to perform measurements of E-UTRAN inter-frequencies or inter-RAT frequency cells of equal or lower priority unless the UE is triggered to measure an E-UTRAN inter-frequency which is configured with *redistributionInterFreqInfo*.
 - Otherwise, the UE shall perform measurements of E-UTRAN inter-frequencies or inter-RAT frequency cells of equal or lower priority according to TS 36.133 [10].
- If the UE supports relaxed monitoring and *s-SearchDeltaP* is present in *SystemInformationBlockType3*, the UE may further limit the needed measurements, as specified in sub-clause 5.2.4.12.

[TS 36.304, clause 5.2.4.5]

For NB-IoT inter-frequency cell reselection shall be based on ranking as defined in sub-clause 5.2.4.6.

If *threshServingLowQ* is provided in *SystemInformationBlockType3* and more than 1 second has elapsed since the UE camped on the current serving cell, cell reselection to a cell on a higher priority E-UTRAN frequency or inter-RAT frequency than the serving frequency shall be performed if:

- A cell of a higher priority EUTRAN, NR or UTRAN FDD RAT/ frequency fulfils $S_{qual} > Thresh_{X, HighQ}$ during a time interval $T_{reselectionRAT}$; or

- A cell of a higher priority UTRAN TDD, GERAN or CDMA2000 RAT/ frequency fulfils $Srxlev > Thresh_{X, HighP}$ during a time interval $Treselection_{RAT}$.

Otherwise, cell reselection to a cell on a higher priority E-UTRAN frequency or inter-RAT frequency than the serving frequency shall be performed if:

- A cell of a higher priority RAT/ frequency fulfils $Srxlev > Thresh_{X, HighP}$ during a time interval $Treselection_{RAT}$; and
- More than 1 second has elapsed since the UE camped on the current serving cell.

Cell reselection to a cell on an equal priority E-UTRAN frequency shall be based on ranking for Intra-frequency cell reselection as defined in sub-clause 5.2.4.6.

If *threshServingLowQ* is provided in *SystemInformationBlockType3* and more than 1 second has elapsed since the UE camped on the current serving cell, cell reselection to a cell on a lower priority E-UTRAN frequency or inter-RAT frequency than the serving frequency shall be performed if:

- The serving cell fulfils $Squal < Thresh_{Serving, LowQ}$ and a cell of a lower priority EUTRAN, NR or UTRAN FDD RAT/ frequency fulfils $Squal > Thresh_{X, LowQ}$ during a time interval $Treselection_{RAT}$; or
- The serving cell fulfils $Squal < Thresh_{Serving, LowQ}$ and a cell of a lower priority UTRAN TDD, GERAN or CDMA2000 RAT/ frequency fulfils $Srxlev > Thresh_{X, LowP}$ during a time interval $Treselection_{RAT}$.

Otherwise, cell reselection to a cell on a lower priority E-UTRAN frequency or inter-RAT frequency than the serving frequency shall be performed if:

- The serving cell fulfils $Srxlev < Thresh_{Serving, LowP}$ and a cell of a lower priority RAT/ frequency fulfils $Srxlev > Thresh_{X, LowP}$ during a time interval $Treselection_{RAT}$; and
- More than 1 second has elapsed since the UE camped on the current serving cell.

Cell reselection to a higher priority RAT/ frequency shall take precedence over a lower priority RAT/ frequency, if multiple cells of different priorities fulfil the cell reselection criteria.

The UE shall not perform cell reselection to NR or UTRAN FDD cells for which the cell selection criterion S is not fulfilled.

For cdma2000 RATs, $Srxlev$ is equal to $-FLOOR(-2 \times 10 \times \log_{10} Ec/Io)$ in units of 0.5 dB, as defined in [18], with Ec/Io referring to the value measured from the evaluated cell.

For cdma2000 RATs, $Thresh_{X, HighP}$ and $Thresh_{X, LowP}$ are equal to -1 times the values signalled for the corresponding parameters in the system information.

In all the above criteria the value of $Treselection_{RAT}$ is scaled when the UE is in the medium or high mobility state as defined in subclause 5.2.4.3.1. If more than one cell meets the above criteria, the UE shall reselect a cell as follows:

- If the highest-priority frequency is an E-UTRAN frequency, a cell ranked as the best cell among the cells on the highest priority frequency(ies) meeting the criteria according to clause 5.2.4.6;
- If the highest-priority frequency is from another RAT, a cell ranked as the best cell among the cells on the highest priority frequency(ies) meeting the criteria of that RAT.

Cell reselection to another RAT, for which $Squal$ based cell reselection parameters are broadcast in system information, shall be performed based on the $Squal$ criteria if the UE supports $Squal$ (RSRQ) based cell reselection to E-UTRAN from all the other RATs provided by system information which UE supports. Otherwise, cell reselection to another RAT shall be performed based on $Srxlev$ criteria.

Cell reselection to NR, for which a cell reselection parameter, *q-RxLevMinSUL* is broadcast in system information and the UE supports SUL, shall be performed based on $Srxlev$ criteria taking the parameter into account.

6.2.3.11.3 Test description

6.2.3.11.3.1 Pre-test conditions

System Simulator:

- E-UTRA Cell 1, NR Cell 1.
- NR Cell 1 is configured to operate in FR1 bands as defined in TS 38.508-1 [4] clause 6.2.3.
- System information combination 1 as defined in TS 36.508 [7] clause 4.4.3.1 is used in E-UTRA Cell 1. *SystemInformationBlockType1* is broadcasted with extended fields as specified in Table 6.2.3.11.3.3-1. And *SystemInformationBlockType24* is broadcasted according to scheduling information specified in Table 6.2.3.11.3.3-1.
- System information combination NR-1 as defined in TS 38.508-1 [4] clause 4.4.3.1.3 is used in NR Cell 1.

UE:

- None.

Preamble:

- With E-UTRA Cell 1 "Non-suitable "Off" cell" and NR Cell 1 "Serving cell" in accordance with TS 38.508-1 [4], Table 6.2.2.1-3, the UE is brought to state RRC_CONNECTED IN-A, Connectivity (NR), in accordance with the procedure described in TS 38.508-1 [4], Table 4.5.2.2-2. 5G-GUTI and ngKSI are assigned and security context established.
- the UE is switched-off
- With E-UTRA Cell 1 "Serving cell" and NR Cell 1 "Non-suitable "Off" cell" in accordance with TS 38.508-1 [4], Table 6.2.2.1-3, the UE is brought to state RRC_IDLE using generic procedure parameters Connectivity (*E-UTRA/EPC*) and Unrestricted nr PDN (*On*) in accordance with the procedure described in TS 38.508-1 [4], clause 4.5.4. 4G GUTI and eKSI are assigned and security context established.

6.2.3.11.3.2 Test procedure sequence

Table 6.2.3.11.3.2-1 illustrates the downlink power levels and other changing parameters to be applied for the cell at various time instants of the test execution. The exact instants on which these values shall be applied are described in the texts in this clause. Row marked "T0" denotes the conditions in the preamble. Configurations marked "T1", "T2" and "T3" are applied at the points indicated in the Main behaviour description in Table 6.2.3.11.3.2-3.

Table 6.2.3.11.3.2-1: Time instances of cell power level and parameter changes for E-UTRA Cell 1 and NR Cell 1 in conducted test environment

	Parameter	Unit	E-UTRA Cell 1	NR Cell 1	Remark
T0	Cell-specific RS EPRE	dBm/15kHz	-85	-	The power level values are assigned to ensure UE registered on E-UTRA cell 1
	SS/PBCH SSS EPRE	dBm/SCS	-	Off	
T1	Cell-specific RS EPRE	dBm/15kHz	-95	-	The power level values are assigned to satisfy both $Srxle_{VNR, Cell 1} > Thresh_{x, low}$ and $Srxle_{VE-UTRA, Cell 1} < Thresh_{serving, low}$
	SS/PBCH SSS EPRE	dBm/SCS	-	-80	
Note1: Power level "Off" is defined in TS 38.508-1 [4] Table 6.2.2.1-3.					

Table 6.2.3.11.3.2-2: Void

Table 6.2.3.11.3.2-3: Main behaviour

St	Procedure	Message Sequence		TP	Verdict
		U - S	Message		
1	The SS adjusts the E-UTRAN and NR Cell power levels according to row "T1" in table 6.2.3.11.3.2-1.	-	-	-	-
1A	Wait for 1s (Note 2).	-	-	-	-
1B	The SS transmits an <i>RRCConnectionRelease</i> message to release RRC connection and move to E-UTRA RRC_IDLE.	<--	RRC: <i>RRCConnectionRelease</i>	-	-
2	Check: Does the test result of generic test procedure in TS 38.508-1 [4] Table 4.9.9.2.2-1 indicate that the UE is camped on NR Cell 1 within 34s for FR1? (Note 1)	-	-	1	P
Note 1: The wait time for reselection to an newly detected Inter-RAT NR cell is selected to cover $T_{detect,NR}$ (32s for FR1) + T_{SI-NR} (1280 ms system information block type scheduling) = 33.28s rounded up to 34s for FR1. Note 2: The wait time 1 sec is added to allow the NR cell to be setup before RRC is released on E-UTRAN. This will avoid the UE to miss the $T_{detect,NR}$ window if the NR cell is not up.					

6.2.3.11.3.3 Specific message contents

Table 6.2.3.11.3.3-1: SystemInformationBlockType1 for E-UTRA Cell 1 (Preamble and all steps)

Derivation Path: TS 36.508 [7], Table 4.4.3.2-3			
Information Element	Value/Remark	Comment	Condition
SystemInformationBlockType1 ::= SEQUENCE {			
nonCriticalExtension SEQUENCE {			
lateNonCriticalExtension SEQUENCE {			
nonCriticalExtension SEQUENCE {			
nonCriticalExtension SEQUENCE {			
nonCriticalExtension SEQUENCE {			
nonCriticalExtension SEQUENCE {			
schedulingInfoListExt-r12 SEQUENCE (SIZE (1..maxSI-Message)) OF SchedulingInfoExt-r12 {	1 entry		
SchedulingInfoExt-r12[1] SEQUENCE {		entry 1	
si-Periodicity-r12	rf64		
SIB-MappingInfo-v12j0 SEQUENCE (SIZE (1..maxSIB-1)) OF SIB-Type-v12j0 {	1 entry		
SIB-Type-v12j0[1]	sibType24-v1530	entry 1	
}			
}			
}			
}			
}			
}			
}			
}			
}			
}			

Table 6.2.3.11.3.3-2: SystemInformationBlockType3 of E-UTRA Cell 1 (preamble and all steps , Table 6.2.3.11.3.2-3)

Derivation Path: TS 36.508 [7], Table 4.4.3.3-2			
Information Element	Value/remark	Comment	Condition
SystemInformationBlockType3 ::= SEQUENCE {			
cellReselectionServingFreqInfo SEQUENCE {			
threshServingLow	10	20 dB	
}			

}		
---	--	--

Table 6.2.3.11.3.3-3: SystemInformationBlockType24 of E-UTRA Cell 1 (preamble and all steps, Table 6.2.3.11.3.2-3)

Derivation path: TS 36.508 [7], Table 4.4.3.3-20			
Information Element	Value/Remark	Comment	Condition
SystemInformationBlockType24-r15 ::= SEQUENCE {			
carrierFreqListNR-r15 SEQUENCE (SIZE (1..maxFreq)) OF CarrierFreqNR-r15 {	1 entry		
CarrierFreqNR-r15[1] SEQUENCE {		entry 1	
carrierFreq-r15	Downlink NR ARFCN of SSB for NR Cell 1		
cellReselectionPriority-r15	3		
threshX-Low-r15	10	20 dB	
}			
}			
}			

6.3 5GS Steering of Roaming

6.3.1 Steering of Roaming

6.3.1.1 Steering of UE in roaming during registration/security check successful using List Type 1

6.3.1.1.1 Test Purpose (TP)

(1)

with {UE being in automatic PLMN selection mode, current VPLMN not part of "PLMNs where registration was aborted due to SOR" List and not part of "User Controlled PLMN Selector with Access Technology" list and UE's USIM configured with indication that the UE is to receive Steering of Roaming information due to initial registration in a VPLMN}

ensure that {
 when {SOR Transparent container indicates ACK has been requested & List Type indicates PLMN ID and Access technology list in REGISTRATION ACCEPT and security check is successful}

 then {UE sends ACK in REGISTRATION COMPLETE, waits for network release of the NAS signalling connection and selects higher priority PLMN}
}

6.3.1.1.2 Conformance requirements

References: The conformance requirements covered in the present TC are specified in: TS 23.122, clause C.2. Unless otherwise stated these are Rel-15 requirements.

[TS 23.122, clause C.2]

- 6) The VPLMN AMF to the UE: The VPLMN AMF shall transparently send the received steering of roaming information to the UE in the REGISTRATION ACCEPT message;
- 7) If the steering of roaming information is received and the security check is successful, then:
 - a) if the steering of roaming information contains a secured packet (see 3GPP TS 31.115 [67]):
 - if the UDM has not requested an acknowledgement from the UE the UE shall send the REGISTRATION COMPLETE message;
 - the ME shall upload the secured packet to the USIM using procedures in 3GPP TS 31.111 [41].

NOTE 1: How the ME handles UICC responses and failures in communication between the ME and UICC is implementation specific and out of scope of this release of the specification.

- if the UDM has not requested an acknowledgement from the UE and the ME receives a USAT REFRESH command qualifier (3GPP TS 31.111 [41]) of type "Steering of Roaming" it shall perform items a), b) and c) of the procedure for steering of roaming in subclause 4.4.6 and if the UE has a list of available and allowable PLMNs in the area and based on this list the UE determines that there is a higher priority PLMN than the currently camped chosen VPLMN and the UE is in automatic network selection mode, then the UE shall either:
 - i) release the current N1 NAS signalling connection locally and then attempt to obtain service on a higher priority PLMN as specified in subclause 4.4.3.3 by acting as if timer T that controls periodic attempts has expired. In this case, steps 8 to 11 are skipped; or
 - ii) not release the current N1 NAS signalling connection locally and skip steps 8 to 10;
 - b) if the steering of roaming information contains the list of preferred PLMN/access technology combinations, the ME shall replace the highest priority entries in the "Operator Controlled PLMN Selector with Access Technology" list stored in the ME with the received list of preferred PLMN/access technology combinations. Additionally, if the UDM has not requested an acknowledgement from the UE and if the UE has a list of available and allowable PLMNs in the area and based on this list the UE determines that there is a higher priority PLMN than the currently camped chosen VPLMN and the UE is in automatic network selection mode, then the UE shall send the REGISTRATION COMPLETE message to the serving AMF without including an SOR transparent container and then either:
 - i) release the current N1 NAS signalling connection locally and then attempt to obtain service on a higher priority PLMN as specified in subclause 4.4.3.3 by acting as if timer T that controls periodic attempts has expired. In this case, steps 8 to 11 are skipped; or
 - ii) not release the current N1 NAS signalling connection locally and skip steps 8 and 10;
- 8) If:
- a) the UE's USIM is configured with indication that the UE is to receive the steering of roaming information due to initial registration in a VPLMN, but neither the list of preferred PLMN/access technology combinations nor the secured packet nor the HPLMN indication that 'no change of the "Operator Controlled PLMN Selector with Access Technology" list stored in the UE is needed and thus no list of preferred PLMN/access technology combinations is provided' is received in the REGISTRATION ACCEPT message, when the UE performs initial registration in a VPLMN or if the steering of roaming information is received but the security check is not successful; and
 - b) the current chosen VPLMN is not contained in the list of "PLMNs where registration was aborted due to SOR", not part of "User Controlled PLMN Selector with Access Technology" list, the UE is not in manual mode of operation and the PDU session for emergency services is not pending to be activated;

then the UE shall send the REGISTRATION COMPLETE message to the serving AMF without including an SOR transparent container, release the current N1 NAS signalling connection locally, store the PLMN identity in the list of "PLMNs where registration was aborted due to SOR" and attempt to obtain service on a higher priority PLMN as specified in subclause 4.4.3.3 by acting as if timer T that controls periodic attempts has expired, with an exception that the current PLMN is considered as lowest priority, and skip steps 9 to 12;

NOTE 2: When the UE is in the manual mode of operation or the current chosen VPLMN is part of the "User Controlled PLMN Selector with Access Technology" list, the UE stays on the VPLMN.

9) The UE to the VPLMN AMF: If the UDM has requested an acknowledgement from the UE:

the UE verified that the steering of roaming information has been provided by the HPLMN in step 7, the UE sends the REGISTRATION COMPLETE message to the serving AMF with an SOR transparent container including the UE acknowledgement; and

if the steering of roaming information contained a secured packet and the security check was successful, then when the UE receives the USAT REFRESH command qualifier of type "Steering of Roaming", it performs items a), b) and c) of the procedure for steering of roaming in subclause 4.4.6.

10) The AMF to the UDM: If an SOR transparent container is received in the REGISTRATION COMPLETE message, the AMF uses the Nudm_SDM_Info service operation to provide the received SOR transparent container to the UDM. If the HPLMN decided that the UE is to acknowledge the successful security check of the received steering of roaming information in step 4, the UDM verifies that the acknowledgement is provided by the UE as specified in 3GPP TS 33.501 [66];

11) If the UE has a list of available PLMNs in the area and based on this list the UE determines that there is a higher priority PLMN than the currently camped chosen VPLMN and the UE is in automatic network selection mode, then the UE shall attempt to obtain service on a higher priority PLMN as specified in subclause 4.4.3.3 by acting as if timer T that controls periodic attempts has expired after the release of the N1 NAS signalling connection. If the N1 NAS signaling connection is not released after implementation dependent time, the UE may locally release the N1 signaling connection except when the UE is registered for emergency services or the UE has an established emergency PDU session (see 3GPP TS 24.501 [64]); and

12) The UE deletes the list of "PLMNs where registration was aborted due to SOR".

The list of "PLMNs where registration was aborted due to SOR" is deleted when the UE is switched off or the USIM is removed.

6.3.1.1.3 Test Description

6.3.1.1.3.1 Pre-test conditions

System Simulator:

Three inter-frequency multi-PLMN NR Cells as specified in TS 38.508-1 [4] Table 4.4.2-1 are configured broadcasting PLMNs as indicated in Table 6.3.1.1.3.1-1.

The PLMNs are identified in the test by the identifiers in Table 6.3.1.1.3.1-1. The MCC and MNC values corresponding to the PLMN identifier shall be understood as those specified in TS 36.523-1 [42], Table 6.0.1-1.

Table 6.3.1.1.3.1-1: PLMN identifiers

NR Cell	PLMN names
NR Cell 11	PLMN2
NR Cell 12	PLMN13
NR Cell 13	PLMN14

NR Cell 11 is set to "Serving Cell";

NR Cell 12 is set to "Serving Cell";

NR Cell 13 is set to "Serving Cell";

System Information Combination NR-1 as defined in TS 38.508-1 [4] clause 4.4.3.1.3 is used in NR cells.

UE:

- The UE is in Automatic PLMN selection mode.
- USIM configuration as defined in Table 6.4.1-10 in TS 38.508-1 [4] will be used.

Preamble:

- The UE is in Switched OFF (State 0-A) as defined in TS 38.508-1 [4] Table 4.4A.2-0.

6.3.1.1.4 Test procedure sequence

Table 6.3.1.1.4-1: Main behaviour

St	Procedure	Message Sequence	TP	Verdict
----	-----------	------------------	----	---------

		U - S	Message		
1	Power on the UE	-		-	-
2-14	Steps 1 to 13 of the registration procedure described in TS 38.508-1 [4] subclause 4.5.2.2-2 are performed on NR Cell 13	-	-	-	-
15	The SS transmits an <i>DLInformationTransfer</i> message and an REGISTRATION ACCEPT message containing steering of roaming information indicating list of preferred PLMN/access technology combination provided with acknowledgment requested from the UE for successful reception	<--	NR RRC: <i>DLInformationTransfer</i> 5G MM: REGISTRATION ACCEPT	-	-
16	SS starts timer of tmax =(6 minutes + cell selection time) (Note 1, 2 and 3)				
17	The UE transmits an <i>ULInformationTransfer</i> message and REGISTRATION COMPLETE message carrying acknowledgement of successful reception of the steering of roaming information	-->	NR RRC: <i>ULInformationTransfer</i> 5G MM: REGISTRATION COMPLETE	1	P
-	EXCEPTION: Step 18a1 is performed in pc_noOf_PDUsSameConnection > 0.	-	-	-	-
18a1	The generic procedure for UE-requested PDU session establishment, specified in subclause 4.5A.2, takes place performing establishment of UE-requested PDU session(s) with ExpectedNumberOfNewPDUSessions = pc_noOf_PDUsSameConnection.	-	-	-	-
18a2-18a5a1	Void.	-	-	-	-
18A	The SS transmits an <i>RRCRelease</i> message.	<=	NR RRC: <i>RRCRelease</i>		
-	EXCEPTION: Step 18Ba1 is performed if pc_noOf_PDUsNewConnection > 0 and the UE starts PDU session establishment automatically	-	-	-	-
18Ba1	The generic procedure for UE-requested PDU session establishment, specified in subclause 4.5.2.2-4, takes place from step 2 to 9a1 performing establishment of UE-requested PDU session(s) with ExpectedNumberOfNewPDUSessions = pc_noOf_PDUsNewConnection on NR Cell 13 and then release the RRC Connection.	-	-	-	-
19	Check: Does the UE transmits an <i>RRCSetupRequest</i> on NR Cell 11 before tmax expires? (Note 1, 2 and 3)	-->	NR RRC: <i>RRCSetupRequest</i>	1	P
20-21	Steps 3-4 of Table 4.5.2.2-2 of the generic procedure in TS 38.508-1 [4] are performed. (Note 4)	-	-	-	-
-	EXCEPTION: Steps 22a1 to 22b5a1 describe behaviours which depend on procedure parameters; the "lower case letter" identifies a step sequence that take place if a procedure parameter has a particular value.	-	-	-	-
22a1-22a16a1	IF 5GS registration type is set as Initial Registration in step 21, THEN steps 5 to 20a1 of the registration procedure described in TS 38.508-1 [4] Table 4.5.2.2-2 are performed on NR Cell 11.	-	-	-	-
22b1-22b2	Void	-	-	-	-
22b	ELSE IF 5GS registration type is set as	-	-	-	-

3-22b 5a1	Mobility Registration in step 21, THEN steps 4 to 6a1 of the generic test procedure in TS 38.508-1 [4] Table 4.9.5.2.2-1 are performed on NR Cell 11.			
Note 1:	Timer tmax in step 16 and 19 are derived from the high priority PLMN search timer T defined by EFHPPLMN			
Note 2:	Following attempts to access the HPLMN/EHPLMN/higher priority PLMN in VPLMN is operator specific setting (Refer to TS 23.122 Rel-12).Hence, window between 120s to T+Tolerance is being used , where the high priority PLMN search timer T defined by EF _{HP} PLMN			
Note 3:	Tolerance of 5min is added to allow time for the UE to find the proper PLMN			
Note 4:	The 5GS registration type shall be only set as Mobility Registration for R16 UEs according to TS 24.501 [22] subclause 5.2.3.2.5 specified in Release 16. The EXCEPTION description applies only to R15 UEs.			

6.3.1.1.5 Specific message contents

Table 6.3.1.1.5-1: REGISTRATION ACCEPT for NR Cell 13 (step 15, Table 6.3.1.1.4-1)

Derivation Path: 38.508-1 Table 4.7.1-7			
Information Element	Value/remark	Comment	Condition
SOR Transparent Container	Present	The SOR transparent container carries steering of roaming information.	
SoR-MAC-I _{AUS}	Set to match the calculated SoR-MAC-I _{AUS} as the way defined in TS 33.501 A.17		
CounterSOR	Value generated as per TS 33.501 Cl 6.14.2.3		
SOR data type	0	The SOR transparent container carries steering of roaming information.	
List indication value	1	List of preferred PLMN/access technology combinations is provided	
List type	1	The list type is a PLMN ID and access technology list	
Acknowledgement (ACK) value	1	Acknowledgement requested	
PLMN ID 1	PLMN2		
Access Technology Identifier 1	NG-RAN		

Table 6.3.1.1.5-2: Void**Table 6.3.1.1.5-3: REGISTRATION COMPLETE for NR Cell 13 (step 17, Table 6.3.1.1.4-1)**

Derivation Path: 38.508-1 Table 4.7.1-8			
Information Element	Value/remark	Comment	Condition
SOR Transparent Container	Present	The SOR transparent container carries acknowledgement of successful	

		reception of the steering of roaming information.	
SOR data type	1	The SOR transparent container carries acknowledgement of successful reception of the steering of roaming information.	

Table 6.3.1.1.5-4: Void

Table 6.3.1.1.5-5: REGISTRATION ACCEPT for NR Cell 11 (step 22a10, Table 6.3.1.1.4-1)

Derivation Path: 38.508-1 Table 4.7.1-7			
Information Element	Value/remark	Comment	Condition
SOR Transparent Container	Present	The SOR transparent container carries steering of roaming information.	
SoR-MAC-IAUS	Set to match the calculated SoR-MAC-IAUS as the way defined in TS 33.501 A.17		
CounterSOR	Value generated as per TS 33.501 Cl 6.14.2.3		
SOR data type	0	The SOR transparent container carries steering of roaming information.	
List indication value	1	List of preferred PLMN/access technology combinations is provided	
List type	1	The list type is a PLMN ID and access technology list	
Acknowledgement (ACK) value	1	Acknowledgement requested	
PLMN ID 1	PLMN2		
Access Technology Identifier 1	NG-RAN		

Table 6.3.1.1.5-6: REGISTRATION COMPLETE for NR Cell 11 (step 22a11, Table 6.3.1.1.4-1)

Derivation Path: 38.508-1 Table 4.7.1-8			
Information Element	Value/remark	Comment	Condition
SOR Transparent Container	Present	The SOR transparent container carries acknowledgement of successful reception of the	

		steering of roaming information.	
SOR data type	1	The SOR transparent container carries acknowledgement of successful reception of the steering of roaming information.	

6.3.1.2 Steering of UE in roaming during registration/security check successful but SOR Transparent container indicates ACK has been NOT been requested

6.3.1.2.1 Test Purpose (TP)

(1)

with {UE being in automatic PLMN selection mode, current VPLMN not part of "PLMNs where registration was aborted due to SOR" List and not part of "User Controlled PLMN Selector with Access Technology" list and UE's USIM configured with indication that the UE is to receive Steering of Roaming information due to initial registration in a VPLMN}
ensure that {
 when {SOR Transparent container indicates ACK has NOT been requested & List Type indicates PLMN ID and Access technology list in REGISTRATION ACCEPT and security check is successful and if the UE has a list of available and allowable PLMNs in the area and based on this list the UE determines that there is a higher priority PLMN than the currently camped chosen VPLMN}
 then {the UE shall send the REGISTRATION COMPLETE message to the serving AMF without including an SOR transparent container and then either releases N1 NAS Signaling connection locally and then attempt to obtain service on a higher priority PLMN or optionally wait for network release of the NAS signalling connection and then selects higher priority PLMN}
}

6.3.1.2.2 Conformance requirements

References: The conformance requirements covered in the present TC are specified in: TS 23.122, clause C.2, TS 24.501 clause 4.4.4.2 and 5.5.1.2.4. Unless otherwise stated these are Rel-15 requirements.

[TS 23.122, clause C.2]

- 6) The VPLMN AMF to the UE: The VPLMN AMF shall transparently send the received steering of roaming information to the UE in the REGISTRATION ACCEPT message;
- 7) If the steering of roaming information is received and the security check is successful, then:
 - a) if the steering of roaming information contains a secured packet (see 3GPP TS 31.115 [67]):
 - if the UDM has not requested an acknowledgement from the UE the UE shall send the REGISTRATION COMPLETE message;
 - the ME shall upload the secured packet to the USIM using procedures in 3GPP TS 31.111 [41].

NOTE 1: How the ME handles UICC responses and failures in communication between the ME and UICC is implementation specific and out of scope of this release of the specification.

- if the UDM has not requested an acknowledgement from the UE and the ME receives a USAT REFRESH command qualifier (3GPP TS 31.111 [41]) of type "Steering of Roaming" it shall perform items a), b) and c) of the procedure for steering of roaming in subclause 4.4.6 and if the UE has a list of available and allowable PLMNs in the area and based on this list the UE determines that there is a higher priority PLMN than the currently camped chosen VPLMN and the UE is in automatic network selection mode, then the UE shall either:

- i) release the current N1 NAS signalling connection locally and then attempt to obtain service on a higher priority PLMN as specified in subclause 4.4.3.3 by acting as if timer T that controls periodic attempts has expired. In this case, steps 8 to 11 are skipped; or
 - ii) not release the current N1 NAS signalling connection locally and skip steps 8 to 10;
 - b) if the steering of roaming information contains the list of preferred PLMN/access technology combinations, the ME shall replace the highest priority entries in the "Operator Controlled PLMN Selector with Access Technology" list stored in the ME with the received list of preferred PLMN/access technology combinations. Additionally, if the UDM has not requested an acknowledgement from the UE and if the UE has a list of available and allowable PLMNs in the area and based on this list the UE determines that there is a higher priority PLMN than the currently camped chosen VPLMN and the UE is in automatic network selection mode, then the UE shall send the REGISTRATION COMPLETE message to the serving AMF without including an SOR transparent container and then either:
 - i) release the current N1 NAS signalling connection locally and then attempt to obtain service on a higher priority PLMN as specified in subclause 4.4.3.3 by acting as if timer T that controls periodic attempts has expired. In this case, steps 8 to 11 are skipped; or
 - ii) not release the current N1 NAS signalling connection locally and skip steps 8 and 10;
- 8) If:
- a) the UE's USIM is configured with indication that the UE is to receive the steering of roaming information due to initial registration in a VPLMN, but neither the list of preferred PLMN/access technology combinations nor the secured packet nor the HPLMN indication that 'no change of the "Operator Controlled PLMN Selector with Access Technology" list stored in the UE is needed and thus no list of preferred PLMN/access technology combinations is provided' is received in the REGISTRATION ACCEPT message, when the UE performs initial registration in a VPLMN or if the steering of roaming information is received but the security check is not successful; and
 - b) the current chosen VPLMN is not contained in the list of "PLMNs where registration was aborted due to SOR", not part of "User Controlled PLMN Selector with Access Technology" list, the UE is not in manual mode of operation and the PDU session for emergency services is not pending to be activated;
- then the UE shall send the REGISTRATION COMPLETE message to the serving AMF without including an SOR transparent container, release the current N1 NAS signalling connection locally, store the PLMN identity in the list of "PLMNs where registration was aborted due to SOR" and attempt to obtain service on a higher priority PLMN as specified in subclause 4.4.3.3 by acting as if timer T that controls periodic attempts has expired, with an exception that the current PLMN is considered as lowest priority, and skip steps 9 to 12;
- NOTE 2: When the UE is in the manual mode of operation or the current chosen VPLMN is part of the "User Controlled PLMN Selector with Access Technology" list, the UE stays on the VPLMN.
- 9) The UE to the VPLMN AMF: If the UDM has requested an acknowledgement from the UE:
- the UE verified that the steering of roaming information has been provided by the HPLMN in step 7, the UE sends the REGISTRATION COMPLETE message to the serving AMF with an SOR transparent container including the UE acknowledgement; and
- if the steering of roaming information contained a secured packet and the security check was successful, then when the UE receives the USAT REFRESH command qualifier of type "Steering of Roaming", it performs items a), b) and c) of the procedure for steering of roaming in subclause 4.4.6.
- 10) The AMF to the UDM: If an SOR transparent container is received in the REGISTRATION COMPLETE message, the AMF uses the Nudm_SDM_Info service operation to provide the received SOR transparent container to the UDM. If the HPLMN decided that the UE is to acknowledge the successful security check of the received steering of roaming information in step 4, the UDM verifies that the acknowledgement is provided by the UE as specified in 3GPP TS 33.501 [66];
- 11) If the UE has a list of available PLMNs in the area and based on this list the UE determines that there is a higher priority PLMN than the currently camped chosen VPLMN and the UE is in automatic network selection mode, then the UE shall attempt to obtain service on a higher priority PLMN as specified in subclause 4.4.3.3 by acting as if timer T that controls periodic attempts has expired after the release of the N1 NAS signalling connection. If the N1 NAS signaling connection is not released after implementation dependent time, the UE may locally

release the N1 signaling connection except when the UE is registered for emergency services or the UE has an established emergency PDU session (see 3GPP TS 24.501 [64]); and

12) The UE deletes the list of "PLMNs where registration was aborted due to SOR".

The list of "PLMNs where registration was aborted due to SOR" is deleted when the UE is switched off or the USIM is removed.

[TS 24.501 clause 4.4.4.2]

...

The network can provide the SOR transparent container IE during the registration procedure to the UE in the REGISTRATION ACCEPT message. The SOR transparent container IE is integrity protected by the HPLMN as specified in 3GPP TS 33.501 [24].

...

[TS 24.501 clause 5.5.1.2.4]

...

If the REGISTRATION ACCEPT message includes the SOR transparent container IE and the SOR transparent container IE successfully passes the integrity check (see 3GPP TS 33.501 [24]):

- a) the UE shall proceed with the behaviour as specified in 3GPP TS 23.122 [5] annex C; and
- b) if the registration procedure is performed over 3GPP access and the UE attempts obtaining service on another PLMNs as specified in 3GPP TS 23.122 [5] annex C, then the UE may locally release the established N1 NAS signalling connection after sending a REGISTRATION COMPLETE message. Otherwise the UE shall send a REGISTRATION COMPLETE message and not release the current N1 NAS signalling connection locally. If an acknowledgement is requested in the SOR transparent container IE of the REGISTRATION ACCEPT message, the UE acknowledgement is included in the SOR transparent container IE of the REGISTRATION COMPLETE message.

If the SOR transparent container IE successfully passes the integrity check (see 3GPP TS 33.501 [24]), indicates list of preferred PLMN/access technology combinations is provided and the list type indicates:

- a) "PLMN ID and access technology list", then the ME shall replace the highest priority entries in the "Operator Controlled PLMN Selector with Access Technology" list stored in the ME and shall proceed with the behaviour as specified in 3GPP TS 23.122 [5] annex C; or
- b) "secured packet", then the ME shall behave as if a SMS is received with protocol identifier set to SIM data download, data coding scheme set to class 2 message and SMS payload as secured packet contents of SOR transparent container IE. The SMS payload is forwarded to UICC as specified in 3GPP TS 23.040 [4A] and the ME shall proceed with the behaviour as specified in 3GPP TS 23.122 [5] annex C.

...

6.3.1.2.3 Test Description

6.3.1.2.3.1 Pre-test conditions

System Simulator:

- Three inter-frequency multi-PLMN NR Cells as specified in TS 38.508-1 [4] Table 4.4.2-1 are configured broadcasting PLMNs as indicated in Table 6.3.1.2.3.1-1.
- The PLMNs are identified in the test by the identifiers in Table 6.3.1.2.3.1-1. The MCC and MNC values corresponding to the PLMN identifier shall understood as those specified in TS 36.523-1 [42], Table 6.0.1-1.

Table 6.3.1.2.3.1-1: PLMN identifiers

NR Cell	PLMN names
NR Cell 11	PLMN2

NR Cell 12	PLMN13
NR Cell 13	PLMN14

NR Cell 11 is set to "Serving Cell";

NR Cell 12 is set to "Serving Cell";

NR Cell 13 is set to "Serving Cell";

System Information Combination NR-1 as defined in TS38.508-1 [4] clause 4.4.3.1.3 is used in NR cells.

UE:

- The UE is in Automatic PLMN selection mode.
- USIM configuration as defined in Table 6.4.1-10 in TS 38.508-1 [4] will be used.

Preamble:

- The UE is in Switched OFF (State 0-A) as defined in TS 38.508-1 [4] Table 4.4A.2-0.

6.3.1.2.4 Test procedure sequence

Table 6.3.1.2.4-1: Main behaviour

St	Procedure	Message Sequence		TP	Verdict
		U - S	Message		
1	Power on the UE.	-		-	-
2-14	Steps 1 to 13 of the registration procedure described in TS 38.508-1 [4] subclause 4.5.2.2-2 are performed on NR Cell 13.	-	-	-	-
15	The SS transmits an <i>DLInformationTransfer</i> message and a REGISTRATION ACCEPT message containing steering of roaming information indicating that acknowledgment is not requested from the UE for successful reception.	<--	NR RRC: <i>DLInformationTransfer</i> 5G MM: REGISTRATION ACCEPT	-	-
16	The SS also starts timer of tmax = (6 minutes + cell selection time) (Note 1, 2 and 3)	-	-	-	-
17	The UE transmits an <i>ULInformationTransfer</i> message and REGISTRATION COMPLETE message without Steering of Roaming Transparent container.	-->	NR RRC: <i>ULInformationTransfer</i> 5G MM: REGISTRATION COMPLETE	-1	-
-	EXCEPTION: Steps 18a1-18a5 are performed IF pc_SOR_ACKNotReqLocalRel is False, ELSE step 18b1 is performed.	-	-	-	-
-	EXCEPTION: Step 18a1a1 is performed in pc_noOf_PDUsSameConnection > 0.	-	-	-	-
18a1a1	The generic procedure for UE-requested PDU session establishment, specified in subclause 4.5A.2, takes place performing establishment of UE-requested PDU session(s) with ExpectedNumberOfNewPDUSessions = pc_noOf_PDUsSameConnection.	-	-	-	-
18a2	The SS transmits an <i>RRCRelease</i> message.	<==	NR RRC: <i>RRCRelease</i>	-	-
-	EXCEPTION: Step 18a2a1 is performed if pc_noOf_PDUsNewConnection > 0 and the UE starts PDU session establishment automatically	-	-	-	-
18a3a1	The generic procedure for UE-requested PDU session establishment, specified in subclause 4.5.2.2-4, takes place from step 2 to 9a1 performing establishment of UE-requested PDU session(s) with	-	-	-	-

	ExpectedNumberOfNewPDUSessions = pc_noOf_PDUsNewConnection and then release the RRC Connection.				
18a 4- 18a 5a1	Void	-	-	-	-
18b 1	The SS locally releases the RRC connection.	-	-	-	-
19	Void	-	-	-	-
20	Check: Does the UE transmits an <i>RRCSetupRequest</i> message on NR Cell 11 before tmax expires? (Note 1, 2 and 3)	-->	NR RRC: <i>RRCSetupRequest</i>	1	P
21	The SS transmits an <i>RRCSetup</i> message on NR Cell 11.	<--	NR RRC: <i>RRCSetup</i>	-	-
22	The UE transmits an <i>RRCSetupComplete</i> message and a REGISTRATION REQUEST message on NR Cell 11. (Note 4)	-->	NR RRC: <i>RRCSetupComplete</i> 5GMM: REGISTRATION REQUEST	-	-
-	EXCEPTION: Steps 23a1 to 23b5a1 describe behaviours which depend on procedure parameters; the "lower case letter" identifies a step sequence that take place if a procedure parameter has a particular value	-	-	-	-
23a 1- 23a 15a 1	IF 5GS registration type is set as Initial Registration in step 22, THEN steps 5 to 20a1 of the registration procedure described in TS 38.508-1 [4] Table 4.5.2.2-2 are performed on NR Cell 11.	-	-	-	-
23b 1- 23b 2	Void	-	-	-	-
23b 3- 23b 5a1	ELSE IF 5GS registration type is set as Mobility Registration in step 22, THEN steps 4 to 6a1 of the generic test procedure in TS 38.508-1 [4] Table 4.9.5.2.2-1 are performed on NR Cell 11.	-	-	-	-
24- 26	Void	-	-	-	-
<p>Note 1: Timer tmax in step 16 and 20 are derived from the high priority PLMN search timer T defined by EF_{HPPLMN}</p> <p>Note 2: Following attempts to access the HPLMN/EHPLMN/higher priority PLMN in VPLMN is operator specific setting (Refer to TS 23.122 Rel-12). Hence, window between 120s to T+Tolerance is being used, where the high priority PLMN search timer T defined by EF_{HPPLMN}</p> <p>Note 3: Tolerance of 5min is added to allow time for the UE to find the proper PLMN</p> <p>Note 4: The 5GS registration type shall be only set as Mobility Registration for Rel-16 UEs according to TS 24.501 subclause 5.2.3.2.5 specified in Release 16. The EXCEPTION description applies only to Rel-15 UEs.</p>					

6.3.1.2.5 Specific message contents

Table 6.3.1.2.5-1: REGISTRATION ACCEPT for NR Cell 12 (step 15, Table 6.3.1.2.4-1)

Derivation Path: 38.508-1 Table 4.7.1-7			
Information Element	Value/remark	Comment	Condition
SOR Transparent Container	Present	The SOR transparent container carries steering of roaming information.	
SoR-MAC-I _{AUS}	Set to match the calculated SoR-MAC-I _{AUS} as the way defined in TS 33.501 A.17		

CounterSOR	Value generated as per TS 33.501 CI 6.14.2.3		
SOR data type	0	The SOR transparent container carries steering of roaming information.	
List indication value	1	List of preferred PLMN/access technology combinations is provided	
List type	1	The list type is a PLMN ID and access technology list	
Acknowledgement (ACK) value	0	Acknowledgement is NOT requested	
PLMN ID 1	PLMN2		
Access Technology Identifier 1	NG-RAN		
PLMN ID 2	PLMN13		
Access Technology Identifier 2	NG-RAN		
PLMN ID 3	PLMN14		
Access Technology Identifier 3	NG-RAN		

Table 6.3.1.2.5-2: Void

Table 6.3.1.2.5-3: REGISTRATION COMPLETE for NR Cell 13 (step 17, Table 6.3.1.2.4-1)

Derivation Path: 38.508-1 Table 4.7.1-8			
Information Element	Value/remark	Comment	Condition
SOR Transparent Container	Not Present	The SOR transparent container should not be present when ACK is not requested by UDM.	

Table 6.3.1.2.5-4: REGISTRATION ACCEPT for NR Cell 11 (step 23a10, Table 6.3.1.2.4-1)

Derivation Path: 38.508-1 Table 4.7.1-7			
Information Element	Value/remark	Comment	Condition
SOR Transparent Container	Present	The SOR transparent container carries steering of roaming information.	
SoR-MAC-IAUS	Set to match the calculated SoR-MAC-IAUS as the way defined in TS 33.501 A.17		
CounterSOR	Value generated as per TS 33.501 CI 6.14.2.3		
SOR data type	0	The SOR transparent container carries steering of roaming information.	

List indication value	1	List of preferred PLMN/access technology combinations is provided	
List type	1	The list type is a PLMN ID and access technology list	
Acknowledgement (ACK) value	0	Acknowledgement is NOT requested	
PLMN ID 1	PLMN2		
Access Technology Identifier 1	NG-RAN		
PLMN ID 2	PLMN13		
Access Technology Identifier 2	NG-RAN		
PLMN ID 3	PLMN14		
Access Technology Identifier 3	NG-RAN		

6.3.1.3 Steering of UE in roaming during registration/security check unsuccessful/Automatic mode

6.3.1.3.1 Test Purpose (TP)

(1)

with {UE being in automatic PLMN selection mode **and** current VPLMN not part of "PLMNs where registration was aborted due to SOR" List and not part of "User Controlled PLMN Selector with Access Technology" list **and** UE's USIM configured with indication that the UE is to receive Steering of Roaming information due to initial registration in a VPLMN}
ensure that {
 when {Security check on the steering of roaming information SOR Transparent container is unsuccessful}
 then {UE sends REGISTRATION COMPLETE message to the serving AMF without including an SOR transparent container **and** releases the current N1 NAS signalling connection locally and attempts to obtain service on a higher priority PLMN}
}

6.3.1.3.2 Conformance requirements

References: The conformance requirements covered in the present TC are specified in: TS 23.122, clause C.2. Unless otherwise stated these are Rel-15 requirements.

[TS 23.122, clause C.2]

8) If:

- a) the UE's USIM is configured with indication that the UE is to receive the steering of roaming information due to initial registration in a VPLMN, but neither the list of preferred PLMN/access technology combinations nor the secured packet nor the HPLMN indication that 'no change of the "Operator Controlled PLMN Selector with Access Technology" list stored in the UE is needed and thus no list of preferred PLMN/access technology combinations is provided' is received in the REGISTRATION ACCEPT message, when the UE performs initial registration in a VPLMN or if the steering of roaming information is received but the security check is not successful; and
- b) the current chosen VPLMN is not contained in the list of "PLMNs where registration was aborted due to SOR", not part of "User Controlled PLMN Selector with Access Technology" list, the UE is not in manual mode of operation and the PDU session for emergency services is not pending to be activated;

then the UE shall send the REGISTRATION COMPLETE message to the serving AMF without including an SOR transparent container, release the current N1 NAS signalling connection locally, store the PLMN identity in the list of "PLMNs where registration was aborted due to SOR" and attempt to obtain service on a higher priority PLMN as specified in subclause 4.4.3.3 by acting as if timer T that controls periodic attempts has expired, with an exception that the current PLMN is considered as lowest priority, and skip steps 9 to 12;

NOTE 2: When the UE is in the manual mode of operation or the current chosen VPLMN is part of the "User Controlled PLMN Selector with Access Technology" list, the UE stays on the VPLMN.

6.3.1.3.3 Test Description

6.3.1.3.3.1 Pre-test conditions

System Simulator:

- Three inter-frequency multi-PLMN NR Cells as specified in TS 38.508-1 [4] Table 4.4.2-1 are configured broadcasting PLMNs as indicated in Table 6.3.1.3.3.1-1.
- The PLMNs are identified in the test by the identifiers in Table 6.3.1.3.3.1-1. The MCC and MNC values corresponding to the PLMN identifier shall understood as those specified in TS 36.523-1 [42], Table 6.0.1-1.

Table 6.3.1.3.3.1-1: PLMN identifiers

NR Cell	PLMN names
NR Cell 11	PLMN2
NR Cell 12	PLMN13
NR Cell 13	PLMN14

NR Cell 11 is set to "Serving Cell";

NR Cell 12 is set to "Serving Cell";

NR Cell 13 is set to "Serving Cell";

System Information Combination NR-1 as defined in TS 38.508-1 [4] clause 4.4.3.1.3 is used in NR cells.

UE:

- The UE is in Automatic PLMN selection mode.
- USIM configuration as defined in Table 6.4.1-10 of TS 38.508-1 [4] will be used.

Preamble:

- The UE is in Switched OFF (State 0-A) as defined in TS 38.508-1 [4] Table 4.4A.2-0.

6.3.1.3.4 Test procedure sequence

Table 6.3.1.3.4-1: Main behaviour

St	Procedure	Message Sequence		TP	Verdict
		U - S	Message		
1	Power on the UE	-	-	-	-
2-14	Steps 1 to 13 of the registration procedure described in TS 38.508-1 [4] Table 4.5.2.2-2 are performed on NR Cell 13	-	-	-	-
15	The SS transmits a <i>DLInformationTransfer</i> message and a REGISTRATION ACCEPT message containing steering of roaming information, includes unmatched SOR-MAC-I _{AUSF} that will result in unsuccessful security check while on UE reception	<--	NR RRC: <i>DLInformationTransfer</i> 5G MM: REGISTRATION ACCEPT	-	-
16	SS starts timer of t _{max} =(6 minutes + cell selection time) (Note 1, 2 and 3)	-	-	-	-
17	The UE transmits an <i>ULInformationTransfer</i> message and REGISTRATION COMPLETE message without including an SOR transparent container	-->	NR RRC: <i>ULInformationTransfer</i> 5G MM: REGISTRATION COMPLETE	1	P

18-21a1	Void	-	-	-	-
22	The SS locally releases the RRC connection.	-	-	-	-
23	Check: Does the UE transmits an <i>RRCSetupRequest</i> message on NR Cell 12 before tmax expires? (Note 1, 2 and 3)	-->	NR RRC: <i>RRCSetupRequest</i>	1	P
24	The SS transmits an <i>RRCSetup</i> message on NR Cell 12.	<--	NR RRC: <i>RRCSetup</i>	-	-
25	The UE transmits an <i>RRCSetupComplete</i> message and a REGISTRATION REQUEST message on NR Cell 12. (Note 4)	-->	NR RRC: <i>RRCSetupComplete</i> 5GMM: REGISTRATION REQUEST	-	-
25A – 25F	Steps 4 to 9 of the generic test procedure in TS 38.508-1 [4] Table 4.9.8.2.2-1 are performed.	-	-	-	-
26 – 28a1	Void	-	-	-	-
<p>Note 1: Timer tmax in step 16 is derived from the high priority PLMN search timer T defined by EF_{HPPLMN}</p> <p>Note 2: Following attempts to access the HPLMN/EHPLMN/higher priority PLMN in VPLMN is operator specific setting (Refer to TS 23.122 Rel-12). Hence, window between 120s to T+Tolerance is being used , where the high priority PLMN search timer T defined by EF_{HPPLMN}</p> <p>Note 3: Tolerance of 5min is added to allow time for the UE to find the proper PLMN</p> <p>Note 4: The 5GS registration type shall be only set as Mobility Registration for Rel-16 UEs according to TS 24.501 subclause 5.2.3.2.5 specified in Release 16. The EXCEPTION description applies only to Rel-15 UEs.</p>					

6.3.1.3.5 Specific message contents

Table 6.3.1.3.5-1: REGISTRATION ACCEPT for NR Cell 13 (step 15, Table 6.3.1.3.4-1)

Derivation Path: TS 38.508-1 [4] Table 4.7.1-7			
Information Element	Value/remark	Comment	Condition
SOR Transparent Container	Present	The SOR transparent container carries steering of roaming information.	
SoR-MAC-IAUS	Set to mismatch the calculated SoR-MAC-IAUS as the way defined in TS 33.501 A.17		
CounterSOR	Value generated as per TS 33.501 CI 6.14.2.3		
SOR data type	0	The SOR transparent container carries steering of roaming information.	
List indication value	1	List of preferred PLMN/access technology combinations is provided	
List type	1	The list type is a PLMN ID and access technology list	
Acknowledgement (ACK) value	1	Acknowledgement requested	
PLMN ID 1	PLMN2		

Access Technology Identifier 1	NG-RAN		
--------------------------------	--------	--	--

Table 6.3.1.3.5-2: Void

Table 6.3.1.3.5-3: REGISTRATION COMPLETE for NR Cell 13 (step 17, Table 6.3.1.3.4-1)

Derivation Path: TS 38.508-1 [4] Table 4.7.1-8			
Information Element	Value/remark	Comment	Condition
SOR Transparent Container	Not Present	The SOR transparent container is not included in REGISTRATION COMPLETE message	

Table 6.3.1.3.5-4: Void

Table 6.3.1.3.5-5: Void

Table 6.3.1.3.5-6: REGISTRATION REJECT (step 25E, Table 6.3.1.3.4-1)

Derivation Path: TS 38.508-1 [4], Table 4.7.1-9			
Information Element	Value/remark	Comment	Condition
5GMM cause	'00010110'B	Cause #22 (Congestion)	
T3346 Value	'00100001'B	1 minute	

6.3.1.4 Steering of UE in roaming during registration/security check unsuccessful/Manual mode

6.3.1.4.1 Test Purpose (TP)

(1)

```

with {UE being in manual PLMN selection mode and current VPLMN not part of "PLMNs where registration
was aborted due to SOR" List and not part of "User Controlled PLMN Selector with Access Technology"
list and UE's USIM configured with indication that the UE is to receive Steering of Roaming
information due to initial registration in a VPLMN}
ensure that {
  when {Security check on the steering of roaming information SOR Transparent container is
unsuccessful}
  then {UE sends REGISTRATION COMPLETE message to the serving AMF without including an SOR
transparent container and stays on this VPLMN}
}

```

6.3.1.4.2 Conformance requirements

References: The conformance requirements covered in the present TC are specified in: TS 23.122, clause C.2. Unless otherwise stated these are Rel-15 requirements.

[TS 23.122, clause C.2]

- 6) The VPLMN AMF to the UE: The VPLMN AMF shall transparently send the received steering of roaming information to the UE in the REGISTRATION ACCEPT message;

7) If the steering of roaming information is received and the security check is successful, then:

- a) if the steering of roaming information contains a secured packet (see 3GPP TS 31.115 [67]):
 - if the UDM has not requested an acknowledgement from the UE the UE shall send the REGISTRATION COMPLETE message;
 - the ME shall upload the secured packet to the USIM using procedures in 3GPP TS 31.111 [41];

NOTE 1: How the ME handles UICC responses and failures in communication between the ME and UICC is implementation specific and out of scope of this release of the specification.

- if the UDM has not requested an acknowledgement from the UE and the ME receives a USAT REFRESH command qualifier (3GPP TS 31.111 [41]) of type "Steering of Roaming" it shall perform items a), b) and c) of the procedure for steering of roaming in subclause 4.4.6 and if the UE has a list of available and allowable PLMNs in the area and based on this list the UE determines that there is a higher priority PLMN than the currently camped chosen VPLMN and the UE is in automatic network selection mode, then the UE shall either:
 - i) release the current N1 NAS signalling connection locally and then attempt to obtain service on a higher priority PLMN as specified in subclause 4.4.3.3 by acting as if timer T that controls periodic attempts has expired. In this case, steps 8 to 11 are skipped; or
 - ii) not release the current N1 NAS signalling connection locally and skip steps 8 to 10;
- b) if the steering of roaming information contains the list of preferred PLMN/access technology combinations, the ME shall replace the highest priority entries in the "Operator Controlled PLMN Selector with Access Technology" list stored in the ME with the received list of preferred PLMN/access technology combinations. Additionally, if the UDM has not requested an acknowledgement from the UE and if the UE has a list of available and allowable PLMNs in the area and based on this list the UE determines that there is a higher priority PLMN than the currently camped chosen VPLMN and the UE is in automatic network selection mode, then the UE shall send the REGISTRATION COMPLETE message to the serving AMF without including an SOR transparent container and then either:
 - i) release the current N1 NAS signalling connection locally and then attempt to obtain service on a higher priority PLMN as specified in subclause 4.4.3.3 by acting as if timer T that controls periodic attempts has expired. In this case, steps 8 to 11 are skipped; or
 - ii) not release the current N1 NAS signalling connection locally and skip steps 8 to 10;

8) If:

- a) the UE's USIM is configured with indication that the UE is to receive the steering of roaming information due to initial registration in a VPLMN, but neither the list of preferred PLMN/access technology combinations nor the secured packet nor the HPLMN indication that 'no change of the "Operator Controlled PLMN Selector with Access Technology" list stored in the UE is needed and thus no list of preferred PLMN/access technology combinations is provided' is received in the REGISTRATION ACCEPT message, when the UE performs initial registration in a VPLMN or if the steering of roaming information is received but the security check is not successful; and
- b) the current chosen VPLMN is not contained in the list of "PLMNs where registration was aborted due to SOR", not part of "User Controlled PLMN Selector with Access Technology" list, the UE is not in manual mode of operation and the PDU session for emergency services is not pending to be activated;

then the UE shall send the REGISTRATION COMPLETE message to the serving AMF without including an SOR transparent container, release the current N1 NAS signalling connection locally, store the PLMN identity in the list of "PLMNs where registration was aborted due to SOR" and attempt to obtain service on a higher priority PLMN as specified in subclause 4.4.3.3 by acting as if timer T that controls periodic attempts has expired, with an exception that the current PLMN is considered as lowest priority, and skip steps 9 to 12;

NOTE 2: When the UE is in the manual mode of operation or the current chosen VPLMN is part of the "User Controlled PLMN Selector with Access Technology" list, the UE stays on the VPLMN.

9) The UE to the VPLMN AMF: If the UDM has requested an acknowledgement from the UE:

the UE verified that the steering of roaming information has been provided by the HPLMN in step 7, the UE sends the REGISTRATION COMPLETE message to the serving AMF with an SOR transparent container including the UE acknowledgement; and

if the steering of roaming information contained a secured packet and the security check was successful, then when the UE receives the USAT REFRESH command qualifier of type "Steering of Roaming", it performs items a), b) and c) of the procedure for steering of roaming in subclause 4.4.6.

10) The AMF to the UDM: If an SOR transparent container is received in the REGISTRATION COMPLETE message, the AMF uses the Nudm_SDM_Info service operation to provide the received SOR transparent container to the UDM. If the HPLMN decided that the UE is to acknowledge the successful security check of the received steering of roaming information in step 4, the UDM verifies that the acknowledgement is provided by the UE as specified in 3GPP TS 33.501 [66];

11) If the UE has a list of available PLMNs in the area and based on this list the UE determines that there is a higher priority PLMN than the currently camped chosen VPLMN and the UE is in automatic network selection mode, then the UE shall attempt to obtain service on a higher priority PLMN as specified in subclause 4.4.3.3 by acting as if timer T that controls periodic attempts has expired after the release of the N1 NAS signalling connection. If the N1 NAS signalling connection is not released after implementation dependent time, the UE may locally release the N1 signalling connection except when the UE is registered for emergency services or the UE has an established emergency PDU session (see 3GPP TS 24.501 [64]); and

12) The UE deletes the list of "PLMNs where registration was aborted due to SOR".

The list of "PLMNs where registration was aborted due to SOR" is deleted when the UE is switched off or the USIM is removed.

6.3.1.4.3 Test Description

6.3.1.4.3.1 Pre-test conditions

System Simulator:

- Two inter-frequency multi-PLMN NR Cells as specified in TS 38.508-1 [4] Table 4.4.2-1 are configured broadcasting PLMNs as indicated in Table 6.3.1.4.3.1-1.
- The PLMNs are identified in the test by the identifiers in Table 6.3.1.4.3.1-1. The MCC and MNC values corresponding to the PLMN identifier shall be understood as those specified in TS 36.523-1 [42], Table 6.0.1-1.

Table 6.3.1.4.3.1-1: PLMN identifiers

NR Cell	PLMN names
NR Cell 11	PLMN2
NR Cell 12	PLMN13

NR Cell 11 is set to "Serving Cell";

NR Cell 12 is set to "Serving Cell";

System Information Combination NR-1 as defined in TS 38.508 [4] clause 4.4.3.1.3 is used in NR cells.

UE:

- The UE is in Manual PLMN selection mode.
- USIM configuration as defined in Table 6.4.1-10 in TS 38.508-1 [4] will be used.

Preamble:

- The UE is in Switched OFF (State 0-A) as defined in TS 38.508-1 [4] Table 4.4A.2-0

6.3.1.4.4 Test procedure sequence

Table 6.3.1.4.4-1: Main behaviour

St	Procedure	Message Sequence		TP	Verdict
		U - S	Message		
1	Power on the UE	-	-	-	-
2	PLMN13 is manually selected	-	-	-	-
3-15	Steps 1 to 13 of the registration procedure described in TS 38.508-1 [4] Table 4.5.2.2-2 are performed on NR Cell 12	-	-	-	-
16	The SS transmits a <i>DLInformationTransfer</i> message and a REGISTRATION ACCEPT message containing steering of roaming information, includes unmatched SOR-MAC-IAUSF that will result in unsuccessful security check while on UE reception	<--	NR RRC: <i>DLInformationTransfer</i> 5G MM: REGISTRATION ACCEPT	-	-
17	The UE transmits an <i>ULInformationTransfer</i> message and REGISTRATION COMPLETE message without including an SOR transparent container	-->	NR RRC: <i>ULInformationTransfer</i> 5G MM: REGISTRATION COMPLETE	1	P
18-21a1	Steps 16 to 19a1 of the registration procedure described in TS 38.508-1 [4] Table 4.5.2.2-2	-	-	-	-
22	The SS transmits an <i>RRCRelease</i> message	<--	NR RRC: <i>RRCRelease</i>	-	-
23	SS starts timer of 1 minute and waits this timer expires	-	-	-	-
24	Check: Does the UE is in state 5GC RRC_IDLE on NR Cell 12 as specified in TS 38.508-1 [4] Table 4.9.4.2.2-1?	-	-	1	P
25	The SS configures: - NR Cell 11 as a "Non-Suitable "off" cell ".	-	-	-	-
26	The user sets the UE in Automatic PLMN selection mode.	-	-	-	-
27	Wait for 300s to allow the UE to switch to automatic PLMN selection mode.	-	-	-	-

6.3.1.4.5 Specific message contents

Table 6.3.1.4.5-1: REGISTRATION ACCEPT for NR Cell 12 (step 16, Table 6.3.1.4.4-1)

Derivation Path: TS 38.508-1 [4] Table 4.7.1-7			
Information Element	Value/remark	Comment	Condition
SOR Transparent Container	Present	The SOR transparent container carries steering of roaming information.	

Table 6.3.1.4.5-2: SOR Transparent Container in REGISTRATION ACCEPT for NR Cell 12 (step 16, Table 6.3.1.4.4-1)

Derivation Path: TS 24.501 [22] Figure 9.11.3.51.1			
Information Element	Value/remark	Comment	Condition
SoR-MAC-IAUS	Set to mismatch the calculated SoR-MAC-IAUS as the way defined in TS 33.501 A.17		
Counter _{SOR}	Value generated as per TS 33.501 Cl 6.14.2.3		
SOR data type	0	The SOR transparent container carries	

		steering of roaming information.	
List indication value	1	List of preferred PLMN/access technology combinations is provided	
List type	1	The list type is a PLMN ID and access technology list	
Acknowledgement (ACK) value	1	Acknowledgement requested	
PLMN ID 1	PLMN2		
Access Technology Identifier 1	NG-RAN		

Table 6.3.1.4.5-3: REGISTRATION COMPLETE for NR Cell 12 (step 17, Table 6.3.1.4.4-1)

Derivation Path: 38.508-1 [4] Table 4.7.1-8			
Information Element	Value/remark	Comment	Condition
SOR Transparent Container	Not Present	The SOR transparent container is not included in REGISTRATION COMPLETE message	

6.3.1.5 Steering of UE in roaming during registration/UE configured to receive Steering of Roaming information but does not receive Steering of Roaming from Network

6.3.1.5.1 Test Purpose (TP)

(1)

```

with {the UE in Automatic PLMN Selection mode, VPLMN not part of "PLMNs where registration was aborted due to SOR" List and not part of "User Controlled PLMN Selector with Access Technology" & UE's USIM configured with indication that the UE is to receive Steering of Roaming information due to initial registration in a VPLMN and the PDU session for emergency services is not pending to be activated}
ensure that {
  when {neither the list of preferred PLMN/access technology combinations nor the HPLMN indication that "no change of the 'Operator Controlled PLMN Selector with Access Technology' list stored in the UE is needed and thus no list of preferred PLMN/access technology combinations is provided" is received in the REGISTRATION ACCEPT message}
  then {UE releases N1 NAS Signalling connection locally, adds PLMN to "PLMNs where registration was aborted due to SOR" and performs PLMN selection with current VPLMN considered as lowest priority}
}

```

6.3.1.5.2 Conformance requirements

References: The conformance requirements covered in the present TC are specified in: TS 23.122, clauses C.1 and C.2. Unless otherwise stated these are Rel-15 requirements.

[TS 23.122, clause C.1]

If:

- the UE's USIM is configured to indicate that the UE shall expect to receive the steering of roaming information during initial registration procedure but did not receive it or security check on the steering of roaming information fails;

- the current chosen VPLMN is not contained in the list of "PLMNs where registration was aborted due to SOR";
- the current chosen VPLMN is not part of "User Controlled PLMN Selector with Access Technology" list; and
- the UE is not in manual mode of operation;

then the UE will perform PLMN selection with the current VPLMN considered as lowest priority.

[TS 23.122, clause C.2]

- 6) The VPLMN AMF to the UE: The VPLMN AMF shall transparently send the received steering of roaming information to the UE in the REGISTRATION ACCEPT message;
- 7) If the steering of roaming information is received and the security check is successful, then:
 - a) if the steering of roaming information contains a secured packet (see 3GPP TS 31.115 [67]):
 - if the UDM has not requested an acknowledgement from the UE the UE shall send the REGISTRATION COMPLETE message;
 - the ME shall upload the secured packet to the USIM using procedures in 3GPP TS 31.111 [41];

NOTE 1: How the ME handles UICC responses and failures in communication between the ME and UICC is implementation specific and out of scope of this release of the specification.

- if the UDM has not requested an acknowledgement from the UE and the ME receives a USAT REFRESH command qualifier (3GPP TS 31.111 [41]) of type "Steering of Roaming" it shall perform items a), b) and c) of the procedure for steering of roaming in subclause 4.4.6 and if the UE has a list of available and allowable PLMNs in the area and based on this list the UE determines that there is a higher priority PLMN than the currently camped chosen VPLMN and the UE is in automatic network selection mode, then the UE shall either:
 - i) release the current N1 NAS signalling connection locally and then attempt to obtain service on a higher priority PLMN as specified in subclause 4.4.3.3 by acting as if timer T that controls periodic attempts has expired. In this case, steps 8 to 11 are skipped; or
 - ii) not release the current N1 NAS signalling connection locally and skip steps 8 to 10;
 - b) if the steering of roaming information contains the list of preferred PLMN/access technology combinations, the ME shall replace the highest priority entries in the "Operator Controlled PLMN Selector with Access Technology" list stored in the ME with the received list of preferred PLMN/access technology combinations. Additionally, if the UDM has not requested an acknowledgement from the UE and if the UE has a list of available and allowable PLMNs in the area and based on this list the UE determines that there is a higher priority PLMN than the currently camped chosen VPLMN and the UE is in automatic network selection mode, then the UE shall send the REGISTRATION COMPLETE message to the serving AMF without including an SOR transparent container and then either:
 - i) release the current N1 NAS signalling connection locally and then attempt to obtain service on a higher priority PLMN as specified in subclause 4.4.3.3 by acting as if timer T that controls periodic attempts has expired. In this case, steps 8 to 11 are skipped; or
 - ii) not release the current N1 NAS signalling connection locally and skip steps 8 to 10;
- 8) If:
 - a) the UE's USIM is configured with indication that the UE is to receive the steering of roaming information due to initial registration in a VPLMN, but neither the list of preferred PLMN/access technology combinations nor the secured packet nor the HPLMN indication that 'no change of the "Operator Controlled PLMN Selector with Access Technology" list stored in the UE is needed and thus no list of preferred PLMN/access technology combinations is provided' is received in the REGISTRATION ACCEPT message, when the UE performs initial registration in a VPLMN or if the steering of roaming information is received but the security check is not successful; and
 - b) the current chosen VPLMN is not contained in the list of "PLMNs where registration was aborted due to SOR", not part of "User Controlled PLMN Selector with Access Technology" list, the UE is not in manual mode of operation and the PDU session for emergency services is not pending to be activated;

then the UE shall send the REGISTRATION COMPLETE message to the serving AMF without including an SOR transparent container, release the current N1 NAS signalling connection locally, store the PLMN identity in the list of "PLMNs where registration was aborted due to SOR" and attempt to obtain service on a higher priority PLMN as specified in subclause 4.4.3.3 by acting as if timer T that controls periodic attempts has expired, with an exception that the current PLMN is considered as lowest priority, and skip steps 9 to 12;

NOTE 2: When the UE is in the manual mode of operation or the current chosen VPLMN is part of the "User Controlled PLMN Selector with Access Technology" list, the UE stays on the VPLMN.

9) The UE to the VPLMN AMF: If the UDM has requested an acknowledgement from the UE:

the UE verified that the steering of roaming information has been provided by the HPLMN in step 7, the UE sends the REGISTRATION COMPLETE message to the serving AMF with an SOR transparent container including the UE acknowledgement; and

if the steering of roaming information contained a secured packet and the security check was successful, then when the UE receives the USAT REFRESH command qualifier of type "Steering of Roaming", it performs items a), b) and c) of the procedure for steering of roaming in subclause 4.4.6.

10) The AMF to the UDM: If an SOR transparent container is received in the REGISTRATION COMPLETE message, the AMF uses the Nudm_SDM_Info service operation to provide the received SOR transparent container to the UDM. If the HPLMN decided that the UE is to acknowledge the successful security check of the received steering of roaming information in step 4, the UDM verifies that the acknowledgement is provided by the UE as specified in 3GPP TS 33.501 [66];

11) If the UE has a list of available PLMNs in the area and based on this list the UE determines that there is a higher priority PLMN than the currently camped chosen VPLMN and the UE is in automatic network selection mode, then the UE shall attempt to obtain service on a higher priority PLMN as specified in subclause 4.4.3.3 by acting as if timer T that controls periodic attempts has expired after the release of the N1 NAS signalling connection. If the N1 NAS signalling connection is not released after implementation dependent time, the UE may locally release the N1 signalling connection except when the UE is registered for emergency services or the UE has an established emergency PDU session (see 3GPP TS 24.501 [64]); and

12) The UE deletes the list of "PLMNs where registration was aborted due to SOR".

The list of "PLMNs where registration was aborted due to SOR" is deleted when the UE is switched off or the USIM is removed.

6.3.1.5.3 Test Description

6.3.1.5.3.1 Pre-test conditions

System Simulator:

- Three inter-frequency multi-PLMN NR Cells as specified in TS 38.508-1 [4] Table 4.4.2-1 are configured broadcasting PLMNs as indicated in Table 6.3.1.5.3.1-1.
- The PLMNs are identified in the test by the identifiers in Table 6.3.1.5.3.1-1. The MCC and MNC values corresponding to the PLMN identifier shall understood as those specified in TS 36.523-1 [42], Table 6.0.1-1.

Table 6.3.1.5.3.1-1: PLMN identifiers

NR Cell	PLMN names
NR Cell 11	PLMN2
NR Cell 12	PLMN13
NR Cell 13	PLMN14

NR Cell 11 is set to "Serving Cell";

NR Cell 12 is set to "Serving Cell";

NR Cell 13 is set to "Serving Cell";

System Information Combination NR-1 as defined in TS 38.508-1 [4] clause 4.4.3.1.3 is used in NR cells.

UE:

- The UE is in Automatic PLMN selection mode.
- USIM configuration as defined in Table 6.4.1-10 of TS 38.508-1 [4] will be used.

Preamble:

- The UE is in Switched OFF (State 0-A) as defined in TS 38.508-1 [4] Table 4.4A.2-0.

6.3.1.5.4 Test procedure sequence

Table 6.3.1.5.4-1: Main behaviour

St	Procedure	Message Sequence		TP	Verdict
		U - S	Message		
1	Power on the UE	-	-	-	-
2-15	Steps 1 to 14 of the registration procedure described in TS 38.508-1 [4] Table 4.5.2.2-2 are performed on NR Cell 13	-	-	-	-
16	SS starts timer of $t_{max} = (6 \text{ minutes} + \text{cell selection time})$ (Note 1, 2 and 3)	-	-	-	-
17	The UE transmits an <i>ULInformationTransfer</i> message and REGISTRATION COMPLETE message without including an SOR transparent container	-->	NR RRC: <i>ULInformationTransfer</i> 5G MM: REGISTRATION COMPLETE	-	-
18	Void	-	-	-	-
19	Check: Does the UE transmits an <i>RRCSetupRequest</i> message on NR Cell 13 before t_{max} expires? (Note 1, 2 and 3)	-->	NR RRC: <i>RRCSetupRequest</i>	1	F
20	Check: Does the UE transmits an <i>RRCSetupRequest</i> message on NR Cell 12 before t_{max} expires? (Note 1, 2 and 3)	-->	NR RRC: <i>RRCSetupRequest</i>	1	P
21	The SS transmits an <i>RRCSetup</i> message on NR Cell 12.	<--	NR RRC: <i>RRCSetup</i>	-	-
22	The UE transmits an <i>RRCSetupComplete</i> message and a REGISTRATION REQUEST message on NR Cell 12. (Note 4)	-->	NR RRC: <i>RRCSetupComplete</i> 5GMM: REGISTRATION REQUEST	-	-
-	EXCEPTION: Steps 23a1 to 23b7 describe behaviours which depend on procedure parameters; the "lower case letter" identifies a step sequence that take place if a procedure parameter has a particular value	-	-	-	-
23a1-23a15a1	IF 5GS registration type is set as Initial Registration in step 22, THEN steps 5 to 20a1 of the registration procedure described in TS 38.508-1 [4] Table 4.5.2.2-2 are performed on NR Cell 12.	-	-	-	-
23b1-23b2	Void	-	-	-	-
23b3-23b5a1	ELSE IF 5GS registration type is set as Mobility Registration in step 22, THEN steps 4 to 6a1 of the generic test procedure in TS 38.508-1 [4] Table 4.9.5.2.2-1 with ' <i>connected without release</i> ' are performed on NR Cell 12.	-	-	-	-
-	EXCEPTION: Step 23b6a1 describes behaviour depending UE implementation; the "lower case letter" identifies a step sequence	-	-	-	-

	that take place if the UE performs a specific action.				
23b 6a1	The UE performs the generic procedure for UE-requested PDU session(s) establishment, specified in TS 38.508-1 [4] subclause 4.5A.2, performing establishment of UE-requested PDU session(s).	-	-	-	-
23b 6a2	SS Releases RRC Connection	-	-	-	-
-	EXCEPTION: Step 23b6b1 describes behaviour depending UE implementation; the "lower case letter" identifies a step sequence that take place if the UE performs a specific action (pc_noOf_PDUsNewConnection > 0).	-	-	-	-
23b 6b1	SS Releases RRC Connection	-	-	-	-
23b 6b2 – 23b 6b9 a1	The generic procedure for UE-requested PDU session establishment, specified in TS 38.508-1 [4] subclause 4.5.2.2-4, takes place from step 2 to 9a1 performing establishment of UE-requested PDU session(s) with ExpectedNumberOfNewPDUSessions = pc_noOf_PDUsNewConnection and then release the RRC Connection.	-	-	-	-
23b 7	Void	-	-	-	-
<p>Note 1: Timer tmax in step 16, 19 and 20 are derived from the high priority PLMN search timer T defined by EF_{HPPLMN}</p> <p>Note 2: Following attempts to access the HPLMN/EHPLMN/higher priority PLMN in VPLMN is operator specific setting (Refer to TS 23.122 Rel-12). Hence, window between 120s to T+Tolerance is being used , where the high priority PLMN search timer T defined by EF_{HPPLMN}</p> <p>Note 3: Tolerance of 5min is added to allow time for the UE to find the proper PLMN</p> <p>Note 4: The 5GS registration type shall be only set as Mobility Registration for Rel-16 UEs according to TS 24.501 subclause 5.2.3.2.5 specified in Release 16. The EXCEPTION description applies only to Rel-15 UEs.</p>					

6.3.1.5.5 Specific message contents

Table 6.3.1.5.5-1: REGISTRATION COMPLETE for NR Cell 13 (step 17 Table 6.3.1.5.4-1)

Derivation Path: TS 38.508-1 [4] Table 4.7.1-8			
Information Element	Value/remark	Comment	Condition
SOR Transparent Container	Not Present	The SOR transparent container is not included in REGISTRATION COMPLETE message	

Table 6.3.1.5.5-1A: REGISTRATION ACCEPT for NR Cell 13 (step 23a10 Table 6.3.1.5.4-1)

Derivation Path: 38.508-1 Table 4.7.1-7			
Information Element	Value/remark	Comment	Condition
SOR Transparent Container	Present	The SOR transparent container carries steering of roaming information.	
SoR-MAC-IAUS	Set to match the calculated SoR-MAC-IAUS as the way defined in TS 33.501 A.17		
CounterSOR	Value generated as per		

	TS 33.501 CI 6.14.2.3		
SOR data type	0	The SOR transparent container carries steering of roaming information.	
List indication value	1	List of preferred PLMN/access technology combinations is provided	
List type	1	The list type is a PLMN ID and access technology list	
Acknowledgement (ACK) value	0	Acknowledgement is NOT requested	
PLMN ID 1	PLMN13		
Access Technology Identifier 1	NG-RAN		
PLMN ID 2	PLMN14		
Access Technology Identifier 2	NG-RAN		
PLMN ID 3	PLMN2		
Access Technology Identifier 3	NG-RAN		

Table 6.3.1.5.5-2: Void

6.3.1.6 Void

6.3.1.7 Steering of UE in roaming during registration/security check unsuccessful but emergency service pending to be activated

6.3.1.7.1 Test Purpose (TP)

(1)

with {the UE in Automatic PLMN Selection mode **and** current VPLMN not part of "PLMNs where registration was aborted due to SOR" List and not part of "User Controlled PLMN Selector with Access Technology" list **and** UE's USIM configured with indication that the UE is to receive Steering of Roaming information due to initial registration in a VPLMN **and** there is a PDU session for emergency services pending to be activated}
ensure that {
 when {Steering of information is received but security check is unsuccessful}
 then {UE will continue with the registration procedure on the VPLMN so as to be able to establish the emergency PDU session}
}

6.3.1.7.2 Conformance requirements

References: The conformance requirements covered in the present TC are specified in: TS 23.122, clause C.2. Unless otherwise stated these are Rel-15 requirements.

[TS 23.122, clause C.2]

- 6) The VPLMN AMF to the UE: The VPLMN AMF shall transparently send the received steering of roaming information to the UE in the REGISTRATION ACCEPT message;
- 7) If the steering of roaming information is received and the security check is successful, then:
 - a) if the steering of roaming information contains a secured packet (see 3GPP TS 31.115 [67]):
 - if the UDM has not requested an acknowledgement from the UE the UE shall send the REGISTRATION COMPLETE message;

- the ME shall upload the secured packet to the USIM using procedures in 3GPP TS 31.111 [41];

NOTE 1: How the ME handles UICC responses and failures in communication between the ME and UICC is implementation specific and out of scope of this release of the specification.

- if the UDM has not requested an acknowledgement from the UE and the ME receives a USAT REFRESH command qualifier (3GPP TS 31.111 [41]) of type "Steering of Roaming" it shall perform items a), b) and c) of the procedure for steering of roaming in subclause 4.4.6 and if the UE has a list of available and allowable PLMNs in the area and based on this list the UE determines that there is a higher priority PLMN than the currently camped chosen VPLMN and the UE is in automatic network selection mode, then the UE shall either:
 - i) release the current N1 NAS signalling connection locally and then attempt to obtain service on a higher priority PLMN as specified in subclause 4.4.3.3 by acting as if timer T that controls periodic attempts has expired. In this case, steps 8 to 11 are skipped; or
 - ii) not release the current N1 NAS signalling connection locally and skip steps 8 to 10;
 - b) if the steering of roaming information contains the list of preferred PLMN/access technology combinations, the ME shall replace the highest priority entries in the "Operator Controlled PLMN Selector with Access Technology" list stored in the ME with the received list of preferred PLMN/access technology combinations. Additionally, if the UDM has not requested an acknowledgement from the UE and if the UE has a list of available and allowable PLMNs in the area and based on this list the UE determines that there is a higher priority PLMN than the currently camped chosen VPLMN and the UE is in automatic network selection mode, then the UE shall send the REGISTRATION COMPLETE message to the serving AMF without including an SOR transparent container and then either:
 - i) release the current N1 NAS signalling connection locally and then attempt to obtain service on a higher priority PLMN as specified in subclause 4.4.3.3 by acting as if timer T that controls periodic attempts has expired. In this case, steps 8 to 11 are skipped; or
 - ii) not release the current N1 NAS signalling connection locally and skip steps 8 to 10;
- 8) If:
- a) the UE's USIM is configured with indication that the UE is to receive the steering of roaming information due to initial registration in a VPLMN, but neither the list of preferred PLMN/access technology combinations nor the secured packet nor the HPLMN indication that 'no change of the "Operator Controlled PLMN Selector with Access Technology" list stored in the UE is needed and thus no list of preferred PLMN/access technology combinations is provided' is received in the REGISTRATION ACCEPT message, when the UE performs initial registration in a VPLMN or if the steering of roaming information is received but the security check is not successful; and
 - b) the current chosen VPLMN is not contained in the list of "PLMNs where registration was aborted due to SOR", not part of "User Controlled PLMN Selector with Access Technology" list, the UE is not in manual mode of operation and the PDU session for emergency services is not pending to be activated;

then the UE shall send the REGISTRATION COMPLETE message to the serving AMF without including an SOR transparent container, release the current N1 NAS signalling connection locally, store the PLMN identity in the list of "PLMNs where registration was aborted due to SOR" and attempt to obtain service on a higher priority PLMN as specified in subclause 4.4.3.3 by acting as if timer T that controls periodic attempts has expired, with an exception that the current PLMN is considered as lowest priority, and skip steps 9 to 12;

NOTE 2: When the UE is in the manual mode of operation or the current chosen VPLMN is part of the "User Controlled PLMN Selector with Access Technology" list, the UE stays on the VPLMN.

9) The UE to the VPLMN AMF: If the UDM has requested an acknowledgement from the UE:

the UE verified that the steering of roaming information has been provided by the HPLMN in step 7, the UE sends the REGISTRATION COMPLETE message to the serving AMF with an SOR transparent container including the UE acknowledgement; and

if the steering of roaming information contained a secured packet and the security check was successful, then when the UE receives the USAT REFRESH command qualifier of type "Steering of Roaming", it performs items a), b) and c) of the procedure for steering of roaming in subclause 4.4.6.

- 10) The AMF to the UDM: If an SOR transparent container is received in the REGISTRATION COMPLETE message, the AMF uses the Nudm_SDM_Info service operation to provide the received SOR transparent container to the UDM. If the HPLMN decided that the UE is to acknowledge the successful security check of the received steering of roaming information in step 4, the UDM verifies that the acknowledgement is provided by the UE as specified in 3GPP TS 33.501 [66];
- 11) If the UE has a list of available PLMNs in the area and based on this list the UE determines that there is a higher priority PLMN than the currently camped chosen VPLMN and the UE is in automatic network selection mode, then the UE shall attempt to obtain service on a higher priority PLMN as specified in subclause 4.4.3.3 by acting as if timer T that controls periodic attempts has expired after the release of the N1 NAS signalling connection. If the N1 NAS signalling connection is not released after implementation dependent time, the UE may locally release the N1 signalling connection except when the UE is registered for emergency services or the UE has an established emergency PDU session (see 3GPP TS 24.501 [64]); and
- 12) The UE deletes the list of "PLMNs where registration was aborted due to SOR".

The list of "PLMNs where registration was aborted due to SOR" is deleted when the UE is switched off or the USIM is removed.

When the UE performs registration procedure for emergency services (see 3GPP TS 24.501 [64] and 3GPP TS 23.502 [63]) while the UE has a valid USIM and the AMF performs the authentication procedure, then based on HPLMN policy, the SOR procedure described in this subclause may apply.

NOTE 3: The HPLMN/UDM cannot distinguish between "initial registration" and "emergency registration" thus SOR implicitly applies for emergency registration.

6.3.1.7.3 Test Description

6.3.1.7.3.1 Pre-test conditions

System Simulator:

- One inter-frequency multi-PLMN NR Cell as specified in TS 38.508-1 [4] Table 4.4.2-1 are configured broadcasting PLMNs as indicated in Table 6.3.1.7.3.1-1.
- The PLMNs are identified in the test by the identifiers in Table 6.3.1.7.3.1-1. The MCC and MNC values corresponding to the PLMN identifier shall understood as those specified in TS 36.523-1 [42], Table 6.0.1-1.

Table 6.3.1.7.3.1-1: PLMN identifiers

NR Cell	PLMN names
NR Cell 11	PLMN2

NR Cell 11 is set to "Serving Cell";

System Information Combination NR-1 as defined in TS 38.508-1 [4] clause 4.4.3.1.3 is used in NR cells.

UE:

- The UE is in Automatic PLMN selection mode.
- USIM configuration as defined in Table 6.4.1-10 of TS 38.508-1 [4] will be used.

Preamble:

- The UE is in Switched OFF (State 0-A) as defined in TS 38.508-1 [4] Table 4.4A.2-0.

6.3.1.7.4 Test procedure sequence

Table 6.3.1.7.4-1: Main behaviour

St	Procedure	Message Sequence	TP	Verdict
----	-----------	------------------	----	---------

		U - S	Message		
1	Power on the UE	-	-	-	-
1A 1- 1A 13	Steps 1 to 13 of the registration procedure described in TS 38.508-1 [4] Table 4.5.2.2-2 are performed on NR Cell 11.	-	-	-	-
1B	SS transmits a REGISTRATION REJECT message with cause #22 (Congestion) and T3346 set to 3 minutes. (Note 1)	<--	NR RRC: <i>DLInformationTransfer</i> 5GMM: REGISTRATION REJECT	-	-
1C	The SS releases the RRC connection.	-	-	-	-
2	Cause the UE to originate Emergency call. (Note 2)	-	-	-	-
3	The UE transmits an RRCSetupRequest message on NR Cell 11 with establishmentCause set to 'emergency'.	-->	NR RRC: RRCSetupRequest	-	-
4-5	Steps 3 to 4 of the registration procedure described in TS 38.508-1 [4] Table 4.5.2.2-2 are performed.	-	-	-	-
6	The UE transmit a REGISTRATION REQUEST message with IE 5GS registration type set to "Emergency registration" or "Initial registration". (Note 3)	-->	5G MM: REGISTRATION REQUEST	-	-
7- 14	Steps 5 to 13 of the registration procedure described in TS 38.508-1 [4] Table 4.5.2.2-2 are performed on NR Cell 11	-	-	-	-
15	The SS transmits a <i>DLInformationTransfer</i> message and a REGISTRATION ACCEPT message containing steering of roaming information, includes unmatched SOR-MAC-I _{AUSF} that will result in unsuccessful security check while on UE reception	<--	NR RRC: <i>DLInformationTransfer</i> 5G MM: REGISTRATION ACCEPT	-	-
16	The UE transmits an <i>ULInformationTransfer</i> message and REGISTRATION COMPLETE message without including an SOR transparent container	-->	NR RRC: <i>ULInformationTransfer</i> 5G MM: REGISTRATION COMPLETE	-	-
17	Check: Does the UE transmit an UL NAS TRANSPORT message with "Request type" set to "initial emergency request", and a PDU SESSION ESTABLISHMENT REQUEST message on NR Cell 11	-->	5GMM: UL NAS TRANSPORT 5GSM: PDU SESSION ESTABLISHMENT REQUEST	1	P
18- 22	Steps 9 to 13 of the procedure of "IMS Emergency call establishment in 5GC with IMS emergency registration" described in TS 38.508-1 [4] Table 4.9.11.2.2-1 are performed.	-	-	-	-
23	Generic procedure of "Test Procedure for IMS MO Emergency call release" described in TS 38.508-1 [4] Table 4.9.12A.2.2-1 are performed.	-	-	-	-
24	The SS releases the RRC connection.	<--	NR RRC: <i>RRCRelease</i>	-	-
Note 1: T3346 is set to 3 minutes. This is checked for 3 minutes less tolerance.					
Note 2: This can be done by an AT/MMI command.					
Note 3: 5GS registration type can set to either "initial registration" according to TS 24.501 clause 5.2.2.3.3 or "emergency registration" according to TS 24.501 clause 5.5.1.2.					

6.3.1.7.5 Specific message contents

Table 6.3.1.7.5-0: REGISTRATION REJECT for NR Cell 11 (step 1B Table 6.3.1.7.4-1)

Derivation Path: TS 38.508-1 [4], Table 4.7.1-9			
Information Element	Value/remark	Comment	Condition
5GMM cause	'00010110'B	Cause #22 (Congestion)	
T3346 value	'00100011'B	3 minutes	

Table 6.3.1.7.5-1: REGISTRATION REQUEST for NR Cell 11 (step 6 Table 6.3.1.7.4-1)

Derivation Path: TS 38.508-1 [4], Table 4.7.1-6, Condition EMERGENCY or INITIAL.

Table 6.3.1.7.5-2: REGISTRATION ACCEPT for NR Cell 11 11 (step 15, Table 6.3.1.7.4-1)

Derivation Path: TS 38.508-1 [4] Table 4.7.1-7			
Information Element	Value/remark	Comment	Condition
SOR Transparent Container	Present	The SOR transparent container carries steering of roaming information.	

Table 6.3.1.7.5-3: SOR Transparent Container in REGISTRATION ACCEPT for NR Cell 13 (step 15, Table 6.3.1.7.4-1)

Derivation Path: TS 24.501 [22] Figure 9.11.3.51.1			
Information Element	Value/remark	Comment	Condition
SoR-MAC-I _{AUS}	Set to mismatch the calculated SoR-MAC-I _{AUS} as the way defined in TS 33.501 A.17		
Counters _{OR}	Value generated as per TS 33.501 Cl 6.14.2.3		
SOR data type	0	The SOR transparent container carries steering of roaming information.	
List indication value	1	List of preferred PLMN/access technology combinations is provided	
List type	1	The list type is a PLMN ID and access technology list	
Acknowledgement (ACK) value	1	Acknowledgement requested	
PLMN ID 1	PLMN2		
Access Technology Identifier 1	NG-RAN		

Table 6.3.1.7.5-4: REGISTRATION COMPLETE for NR Cell 11 (step 16 Table 6.3.1.7.4-1)

Derivation Path: TS 38.508-1 [4] Table 4.7.1-8			
Information Element	Value/remark	Comment	Condition
SOR Transparent Container	Not Present	The SOR transparent container is not included in REGISTRATION COMPLETE message	

Table 6.3.1.7.5-5: UL NAS TRANSPORT (step 17, Table 6.3.1.7.4-1)

Derivation Path: TS 38.508-1 [4] Table 4.7.1-10, condition INITIAL_PDU_REQUEST.			
Information Element	Value/remark	Comment	Condition
Request type	'011'B	initial emergency request	
S-NSSAI	Not Present		
DNN	Not Present		

Table 6.3.1.7.5-6: PDU SESSION ESTABLISHMENT REQUEST (step 17, Table 6.3.1.7.4-1)

Derivation Path: TS 38.508-1 [4] Table 4.7.2-1.			
Information Element	Value/remark	Comment	Condition
PDU session ID	A value that is not currently being used by another PDU session		
PTI	A value currently not used		
SSC mode	'001'B	SSC mode 1	

6.3.1.8 Steering of UE in roaming after registration/Automatic PLMN selection mode

6.3.1.8.1 Test Purpose (TP)

(1)

```

with {UE being in automatic PLMN selection mode and UE has registered onto a VPLMN}
ensure that {
  when {SOR transparent container included in DL NAS TRANSPORT message contains steering of roaming information and indicates ACK has been requested and security check is successful}
  then {UE sends an SOR transparent container with ACK in UL NAS TRANSPORT message and waits until it moves to idle mode or 5GMM-CONNECTED mode with RRC inactive indication before attempting to obtain service on a higher priority PLMN}
}

```

6.3.1.8.2 Conformance requirements

References: The conformance requirements covered in the present TC are specified in: TS 23.122, clause C.3. Unless otherwise stated these are Rel-15 requirements

[TS 23.122, clause C.3]

- 2) The AMF to the UE: the AMF sends a DL NAS TRANSPORT message to the served UE. The AMF includes in the DL NAS TRANSPORT message the steering of roaming information received from the UDM.
- 3) Upon receiving the steering of roaming information, the UE shall perform a security check on the list of preferred PLMN/access technology combinations included in the DL NAS TRANSPORT message to verify that the list of preferred PLMN/access technology combinations is provided by HPLMN, and:
 - a) if the security check is successful and:
 - if the steering of roaming information contains a secured packet (see 3GPP TS 31.115 [67]), the ME shall upload the secured packet to the USIM using procedures in 3GPP TS 31.111 [41];

NOTE 1: How the ME handles UICC responses and failures in communication between the ME and UICC is implementation specific and out of scope of this release of the specification.

When the ME receives a USAT REFRESH command qualifier (see 3GPP TS 31.111 [41]) of type "Steering of Roaming" it performs the procedure for steering of roaming in subclause 4.4.6 with an exception that if the UE is in automatic network selection mode, then the UE shall wait until it moves to idle mode or 5GMM-CONNECTED mode with RRC inactive indication (see 3GPP TS 24.501 [64]) before attempting to obtain service on a higher priority PLMN (specified in subclause 4.4.6 bullet d);

- otherwise, the ME shall replace the highest priority entries in the "Operator Controlled PLMN Selector with Access Technology" list stored in the ME with the received list of preferred PLMN/access technology combinations. If the UE is in automatic network selection mode, then the UE shall wait until it moves to idle mode or 5GMM-CONNECTED mode with RRC inactive indication (see 3GPP TS 24.501 [64]) before attempting to obtain service on a higher priority PLMN as specified in subclause 4.4.3.3 by acting as if timer T that controls periodic attempts has expired.

If the last established PDU session is an emergency PDU session then the UE shall attempt to perform the PLMN selection after the release of the emergency PDU session and expiration of timer T.

If the UDM has not requested an acknowledgement from the UE then steps 4 and 5 are skipped; and

- b) if the security check is not successful and the UE is in automatic network selection mode, then the UE shall wait until it moves to idle mode or 5GMM-CONNECTED mode with RRC inactive indication (see 3GPP TS 24.501 [64]) before attempting to obtain service on a higher priority PLMN as specified in subclause 4.4.3.3 by acting as if timer T that controls periodic attempts has expired, with an exception that the current PLMN is considered as lowest priority. If the last established PDU session is an emergency PDU session then the UE shall attempt to perform the PLMN selection after the release of the emergency PDU session and expiration of timer T.

If the UDM has not requested an acknowledgement from the UE then steps 4 and 5 are skipped;

NOTE 2: When the UE is in the manual mode of operation or the current chosen VPLMN is part of the "User Controlled PLMN Selector with Access Technology" list, the UE stays on the VPLMN.

- 4) The UE to the AMF: if the UDM has requested an acknowledgement from the UE in the DL NAS TRANSPORT message and the security check in step 2 was successful, the UE sends an UL NAS TRANSPORT message to the serving AMF with an SOR transparent container including the UE acknowledgement;

6.3.1.8.3 Test Description

6.3.1.8.3.1 Pre-test conditions

System Simulator:

- Three inter-frequency multi-PLMN NR Cells as specified in TS 38.508-1 [4] Table 4.4.2-1 are configured broadcasting PLMNs as indicated in Table 6.3.1.8.3.1-1.
- The PLMNs are identified in the test by the identifiers in Table 6.3.1.8.3.1-1. The MCC and MNC values of PLMN identifiers are specified in TS 36.523-1 [13], Table 6.0.1-1.

Table 6.3.1.8.3.1-1: PLMN identifiers

NR Cell	PLMN names
NR Cell 11	PLMN2
NR Cell 12	PLMN13
NR Cell 13	PLMN14

NR Cell 11 is set to "Serving Cell";

NR Cell 12 is set to "Serving Cell";

NR Cell 13 is set to "Serving Cell";

System Information Combination NR-1 as defined in TS 38.508-1 [4] clause 4.4.3.1.3 is used in NR cells.

UE:

- The UE is in Automatic PLMN selection mode.
- USIM configuration as defined in Table 6.4.1-21 of TS 38.508-1 [4] will be used.

Preamble:

- The UE is in Switched OFF (State 0-A) as defined in TS 38.508-1 [4] Table 4.4A.2-0.

6.3.1.8.4 Test procedure sequence

Table 6.3.1.8.4-1: Main behaviour

St	Procedure	Message Sequence		TP	Verdict
		U - S	Message		
1	Power on the UE	-	-	-	-
2	Whole registration procedure described in TS 38.508-1 [4] Table 4.5.2.2-2 are performed on NR Cell 13, with "connected without release"	-	-	-	-
3	The SS transmits an <i>DLInformationTransfer</i> message containing steering of roaming information indicating list of preferred PLMN/access technology combination provided with acknowledgment requested from the UE for successful reception	<--	NR RRC: <i>DLInformationTransfer</i> 5GMM: DL NAS TRANSPORT	-	-
4	SS starts timer of $t_{max} = (6 \text{ minutes} + \text{cell selection time})$ (Note 1, 2 and 3)	-	-	-	-
5	The UE transmits an <i>ULInformationTransfer</i> message carrying acknowledgement of successful reception of the steering of roaming information	-->	NR RRC: <i>ULInformationTransfer</i> 5GMM:UL NAS TRANSPORT	1	P
6	The SS transmits an <i>RRCRelease</i> message	<--	NR RRC: <i>RRCRelease</i>	-	-
7	Check: Does the UE transmits an <i>RRCSetupRequest</i> on NR Cell 11 before t_{max} expires? (Note 1, 2 and 3)	-->	NR RRC: <i>RRCSetupRequest</i>	1	P
8-9	Steps 3-4 of Table 4.5.2.2-2 of the generic procedure in TS 38.508-1 [4] are performed. (Note 4)	-	-	-	-
-	EXCEPTION: Steps 10a1 to 10b5a1 describe behaviours which depend on procedure parameters; the "lower case letter" identifies a step sequence that take place if a procedure parameter has a particular value	-	-	-	-
10a 1- 10a 15a 1	IF 5GS registration type is set as Initial Registration in step 9, THEN steps 5 to 20a1 of the registration procedure described in TS 38.508-1 [4] Table 4.5.2.2-2 are performed on NR Cell 11.	-	-	-	-
10b 1- 10b 2	Void.	-	-	-	-
10b 3- 10b 5a1	ELSE IF 5GS registration type is set as Mobility Registration in step 9, THEN steps 4 to 6a1 of the generic test procedure in TS 38.508-1 [4] Table 4.9.5.2.2-1 are performed on NR Cell 11.	-	-	-	-
11- 12a 1	Void.	-	-	-	-
<p>Note 1: Timer t_{max} in step 4 and 7 are derived from the high priority PLMN search timer T defined by EF_{HPPLMN}</p> <p>Note 2: Following attempts to access the HPLMN/EHPLMN/higher priority PLMN in VPLMN is operator specific setting (Refer to TS 23.122 Rel-12). Hence, window between 120s to T+Tolerance is being used, where the high priority PLMN search timer T defined by EF_{HPPLMN}</p> <p>Note 3: Tolerance of 5min is added to allow time for the UE to find the proper PLMN</p> <p>Note 4: The 5GS registration type shall be only set as Mobility Registration for R16 UEs according to TS 24.501 subclause 5.2.3.2.5 specified in Release 16. The EXCEPTION description applies only to R15 UEs.</p>					

6.3.1.8.5 Specific message contents

Table 6.3.1.8.5-1: DL NAS TRANSPORT Message for NR Cell 13 (step 3, Table 6.3.1.8.4-1)

Derivation Path: TS 38.508-1 [4] Table 4.7.1-11			
Information Element	Value/remark	Comment	Condition
Payload Container	Present	The SOR transparent container in the payload container IE carries steering of roaming information.	
SoR-MAC-IAUS	Set to match the calculated SoR-MAC-IAUS as the way defined in TS 33.501 A.17		
CounterSOR	Value generated as per TS 33.501 CI 6.14.2.3		
SOR data type	0	The SOR transparent container carries steering of roaming information.	
List indication value	1	List of preferred PLMN/access technology combinations is provided	
List type	1	The list type is a PLMN ID and access technology list	
Acknowledgement (ACK) value	1	Acknowledgement requested	
PLMN ID 1	PLMN2		
Access Technology Identifier 1	NG-RAN		

Table 6.3.1.8.5-2: Void**Table 6.3.1.8.5-3: UL NAS TRANSPORT Message for NR Cell 13 (step 5, Table 6.3.1.8.4-1)**

Derivation Path: TS 38.508-1 [4] Table 4.7.1-10			
Information Element	Value/remark	Comment	Condition
Payload Container	Present	The SOR transparent container in the payload container IE carries acknowledgement of successful reception of the steering of roaming information.	
SOR data type	1	The SOR transparent container carries acknowledgement of successful reception of the steering of	

		roaming information.	
--	--	----------------------	--

Table 6.3.1.8.5-4: Void

6.3.1.9 Steering of UE in roaming after registration/Manual PLMN selection mode

6.3.1.9.1 Test Purpose (TP)

(1)

```
with {UE being in manual PLMN selection mode and UE has registered onto a VPLMN}
ensure that {
  when {SOR Transparent container included in DL NAS TRANSPORT message contains steering of roaming information and indicates ACK has been requested and security check is successful}
  then {UE sends an SOR transparent container with ACK in UL NAS TRANSPORT message and stays on the VPLMN}
}
```

6.3.1.9.2 Conformance requirements

References: The conformance requirements covered in the present TC are specified in: TS 23.122, clause C.3. Unless otherwise stated these are Rel-15 requirements.

[TS 23.122, clause C.3]

- 2) The AMF to the UE: the AMF sends a DL NAS TRANSPORT message to the served UE. The AMF includes in the DL NAS TRANSPORT message the steering of roaming information received from the UDM.
- 3) Upon receiving the steering of roaming information, the UE shall perform a security check on the list of preferred PLMN/access technology combinations included in the DL NAS TRANSPORT message to verify that the list of preferred PLMN/access technology combinations is provided by HPLMN, and:
 - a) if the security check is successful and:
 - if the steering of roaming information contains a secured packet (see 3GPP TS 31.115 [67]), the ME shall upload the secured packet to the USIM using procedures in 3GPP TS 31.111 [41];

NOTE 1: How the ME handles UICC responses and failures in communication between the ME and UICC is implementation specific and out of scope of this release of the specification.

When the ME receives a USAT REFRESH command qualifier (see 3GPP TS 31.111 [41]) of type "Steering of Roaming" it performs the procedure for steering of roaming in subclause 4.4.6 with an exception that if the UE is in automatic network selection mode, then the UE shall wait until it moves to idle mode or 5GMM-CONNECTED mode with RRC inactive indication (see 3GPP TS 24.501 [64]) before attempting to obtain service on a higher priority PLMN (specified in subclause 4.4.6 bullet d);

- otherwise, the ME shall replace the highest priority entries in the "Operator Controlled PLMN Selector with Access Technology" list stored in the ME with the received list of preferred PLMN/access technology combinations. If the UE is in automatic network selection mode, then the UE shall wait until it moves to idle mode or 5GMM-CONNECTED mode with RRC inactive indication (see 3GPP TS 24.501 [64]) before attempting to obtain service on a higher priority PLMN as specified in subclause 4.4.3.3 by acting as if timer T that controls periodic attempts has expired.

If the last established PDU session is an emergency PDU session then the UE shall attempt to perform the PLMN selection after the release of the emergency PDU session and expiration of timer T.

If the UDM has not requested an acknowledgement from the UE then steps 4 and 5 are skipped; and

- b) if the security check is not successful and the UE is in automatic network selection mode, then the UE shall wait until it moves to idle mode or 5GMM-CONNECTED mode with RRC inactive indication (see 3GPP TS 24.501 [64]) before attempting to obtain service on a higher priority PLMN as specified in subclause 4.4.3.3 by acting as if timer T that controls periodic attempts has expired, with an exception that the current PLMN is considered as lowest priority. If the last established PDU session is an emergency PDU

session then the UE shall attempt to perform the PLMN selection after the release of the emergency PDU session and expiration of timer T.

If the UDM has not requested an acknowledgement from the UE then steps 4 and 5 are skipped;

NOTE 2: When the UE is in the manual mode of operation or the current chosen VPLMN is part of the "User Controlled PLMN Selector with Access Technology" list, the UE stays on the VPLMN.

- 4) The UE to the AMF: if the UDM has requested an acknowledgement from the UE in the DL NAS TRANSPORT message and the security check in step 2 was successful, the UE sends an UL NAS TRANSPORT message to the serving AMF with an SOR transparent container including the UE acknowledgement;

6.3.1.9.3 Test Description

6.3.1.9.3.1 Pre-test conditions

System Simulator:

- Two inter-frequency multi-PLMN NR Cells as specified in TS 38.508-1 [4] Table 4.4.2-1 are configured broadcasting PLMNs as indicated in Table 6.3.1.9.3.1-1.
- The PLMNs are identified in the test by the identifiers in Table 6.3.1.9.3.1-1. The MCC and MNC values of PLMN identifiers are specified in TS 36.523-1 [13], Table 6.0.1-1.

Table 6.3.1.9.3.1-1: PLMN identifiers

NR Cell	PLMN names
NR Cell 11	PLMN2
NR Cell 12	PLMN13

NR Cell 11 is set to "Serving Cell";

NR Cell 12 is set to "Serving Cell";

System Information Combination NR-1 as defined in TS38.508 clause 4.4.3.1.3 is used in NR cells.

UE:

- The UE is in Manual PLMN selection mode.
- USIM configuration as defined in Table 6.4.1-21 of TS 38.508-1 [4] will be used.

Preamble:

- The UE is in Switched OFF (State 0-A) as defined in TS 38.508-1 [4] Table 4.4A.2-0.

6.3.1.9.4 Test procedure sequence

Table 6.3.1.9.4-1: Main behaviour

St	Procedure	Message Sequence		TP	Verdict
		U - S	Message		
1	Power on the UE.	-	-	-	-
2	PLMN13 is manually selected.	-	-	-	-
3	Whole registration procedure described in TS 38.508-1 [4] Table 4.5.2.2-2 are performed on NR Cell 12, with "connected without release".	-	-	-	-
4	The SS transmits an DLInformationTransfer message containing steering of roaming information indicating list of preferred PLMN/access technology combination	<--	NR RRC: <i>DLInformationTransfer</i> 5GMM: DL NAS TRANSPORT	-	-

	provided with acknowledgment requested from the UE for successful reception.				
5	The UE transmits an <i>ULInformationTransfer</i> message carrying acknowledgement of successful reception of the steering of roaming information.	-->	NR RRC: <i>ULInformationTransfer</i> 5GMM:UL NAS TRANSPORT	1	P
6	The SS transmits an <i>RRCRelease</i> message.	<--	NR RRC: <i>RRCRelease</i>	-	-
7	SS starts timer of 1 minute and waits this timer expires.	-	-	-	-
8	Check: Does the UE is in state 5GC RRC_IDLE on NR Cell 12 as specified in TS 38.508-1 [4] Table 4.9.4.2.2-1?	-	-	1	P
9	The SS configures: - NR Cell 11 as a "Non-Suitable "off" cell ".	-	-	-	-
10	The user sets the UE in Automatic PLMN selection mode.	-	-	-	-
11	Wait for 300s to allow the UE to switch to automatic PLMN selection mode.	-	-	-	-

6.3.1.9.5 Specific message contents

Table 6.3.1.9.5-1: DL NAS TRANSPORT Message for NR Cell 12 (step 4, Table 6.3.1.9.4-1)

Derivation Path: TS 38.508-1 [4] Table 4.7.1-11			
Information Element	Value/remark	Comment	Condition
Payload Container	Present	The SOR transparent container in the payload container IE carries steering of roaming information.	

Table 6.3.1.9.5-2: SOR Transparent Container in Payload Container IE of DL NAS TRANSPORT Message for NR Cell 12 (step 4, Table 6.3.1.9.4-1)

Derivation Path: TS 24.501 [22] Figure 9.11.3.51.1			
Information Element	Value/remark	Comment	Condition
SoR-MAC-IAUS	Set to match the calculated SoR-MAC-IAUS as the way defined in TS 33.501 A.17		
Counter _{SOR}	Value generated as per TS 33.501 CI 6.14.2.3		
SOR data type	0	The SOR transparent container carries steering of roaming information.	
List indication value	1	List of preferred PLMN/access technology combinations is provided	
List type	1	The list type is a PLMN ID and access technology list	
Acknowledgement (ACK) value	1	Acknowledgement requested	
PLMN ID 1	PLMN2		
Access Technology Identifier 1	NG-RAN		

Table 6.3.1.9.5-3: UL NAS TRANSPORT Message for NR Cell 12 (step 5, Table 6.3.1.9.4-1)

Derivation Path: TS 38.508-1 [4] Table 4.7.1-10			
Information Element	Value/remark	Comment	Condition
Payload Container	Present	The SOR transparent container in the payload container IE carries acknowledgement of successful reception of the steering of roaming information.	

Table 6.3.1.9.5-4: SOR Transparent Container in Payload Container IE of UL NAS TRANSPORT Message for NR Cell 12 (step 5, Table 6.3.1.9.4-1)

Derivation Path: TS 24.501 [22] Figure 9.11.3.51.4			
Information Element	Value/remark	Comment	Condition
SOR data type	1	The SOR transparent container carries acknowledgement of successful reception of the steering of roaming information.	

6.3.1.10 Steering of UE in roaming during mobility update registration

6.3.1.10.1 Test Purpose (TP)

(1)

with {UE being in automatic PLMN selection mode , current VPLMN not part of "PLMNs where registration was aborted due to SOR" List and not part of "User Controlled PLMN Selector with Access Technology" list and UE's USIM configured with indication that the UE is to receive Steering of Roaming information due to initial registration in a VPLMN}
ensure that {
 when {UE performs mobility update Registration Procedure to cell belonging to VPLMN **and** chosen VPLMN does not provide Steering of Roaming info}
 then {UE continues to camp on the chosen VPLMN}
}

6.3.1.10.2 Conformance requirements

References: The conformance requirements covered in the present TC are specified in: TS 23.122, clause C.2. Unless otherwise stated these are Rel-15 requirements.

[TS 23.122, clause C.2]

- 2) Upon receiving REGISTRATION REQUEST message, the VPLMN AMF executes the registration procedure as defined in subclause 4.2.2.2.2 of 3GPP TS 23.502 [63]. As part of the registration procedure:
 - a) if the VPLMN AMF does not have subscription data for the UE, the VPLMN AMF invokes Nudm_SDM_Get service operation to the HPLMN UDM to get amongst other information the Access and Mobility Subscription data for the UE (see step 14b in subclause 4.2.2.2.2 of 3GPP TS 23.502 [63]); or
 - b) if the VPLMN AMF already has subscription data for the UE and:

- i) the 5GS registration type IE in the received REGISTRATION REQUEST message indicates "initial registration" and the "SoR Update Indicator for Initial Registration" field in the UE context is set to 'the UDM requests the AMF to retrieve SoR information when the UE performs NAS registration type "initial registration"' as specified in table 5.2.2.2.2-1 of 3GPP TS 23.502 [63]); or
- ii) the 5GS registration type IE in the received REGISTRATION REQUEST message indicates "emergency registration" and the "SoR Update Indicator for Emergency Registration" field in the UE context is set to 'the UDM requests the AMF to retrieve SoR information when the UE performs NAS registration type "emergency registration"' as specified in table 5.2.2.2.2-1 of 3GPP TS 23.502 [63]);

then the VPLMN AMF invokes Nudm_SDM_Get service operation message to the HPLMN UDM to retrieve the steering of roaming information (see step 14b in subclause 4.2.2.2.2 of 3GPP TS 23.502 [63]);

otherwise the VPLMN AMF sends a REGISTRATION ACCEPT message without the steering of roaming information to the UE and steps 3a, 3b, 3c, 3d, 4, 5, 6 are skipped;

...

11) If the UE has a list of available PLMNs in the area and based on this list the UE determines that there is a higher priority PLMN than the selected VPLMN and the UE is in automatic network selection mode, then the UE shall attempt to obtain service on a higher priority PLMN as specified in subclause 4.4.3.3 by acting as if timer T that controls periodic attempts has expired after the release of the N1 NAS signalling connection. If the N1 NAS signalling connection is not released after implementation dependent time, the UE may locally release the N1 signalling connection except when the UE has an established emergency PDU session (see 3GPP TS 24.501 [64]).

6.3.1.10.3 Test Description

6.3.1.10.3.1 Pre-test conditions

System Simulator:

- Three inter-frequency multi-PLMN NR Cells as specified in TS 38.508-1 [4] Table 4.4.2-1 are configured broadcasting PLMNs as indicated in Table 6.3.1.10.3.1-1.
- The PLMNs are identified in the test by the identifiers in Table 6.3.1.10.3.1-1. The MCC and MNC values of PLMN identifiers are specified in TS 36.523-1 [13], Table 6.0.1-1.

Table 6.3.1.10.3.1-1: PLMN identifiers

NR Cell	PLMN names
NR Cell 1	PLMN14
NR Cell 12	PLMN13
NR Cell 11	PLMN14

- NR Cell 1 is set to "Serving Cell";
- NR Cell 12 is set to "Not-Suitable Cell";
- NR Cell 11 is set to "Not-Suitable Cell";
- TAI of NR Cell 11 is set to "TAI-2" and TAI of NR Cell 1 is set to "TAI-1";
- System Information Combination NR-1 as defined in TS 38.508-1 [4] clause 4.4.3.1.3 is used in NR cells.

UE:

- The UE is in Automatic PLMN selection mode.
- USIM configuration as defined in Table 6.4.1-10 of TS 38.508-1 [4] will be used.

Preamble:

- Ensure that the UE has cleared the RPLMN. And the UE is in Switched OFF (State 0-A) as defined in TS 38.508-1 [4] Table 4.4A.2-0.

6.3.1.10.4 Test procedure sequence

Table 6.3.1.10.4-1: Main behaviour

St	Procedure	Message Sequence		TP	Verdict
		U - S	Message		
1	Power on the UE.	-		-	-
2-14	Steps 1 to 13 of the registration procedure described in TS 38.508-1 [4] subclause 4.5.2.2-2 are performed on NR Cell 1.	-		-	-
15	The SS transmits an <i>DLInformationTransfer</i> message and a REGISTRATION ACCEPT message containing steering of roaming information indicating that acknowledgement is not requested from the UE for successful reception.	<--	NR RRC: <i>DLInformationTransfer</i> 5G MM: REGISTRATION ACCEPT	-	-
16	The UE transmits an <i>ULInformationTransfer</i> message and REGISTRATION COMPLETE message without SOR transparent container.	-->	NR RRC: <i>ULInformationTransfer</i> 5G MM: REGISTRATION COMPLETE	-	-
-	EXCEPTION: Step 16Aa1 is performed if <i>pc_noOf_PDUsSameConnection</i> > 0.	-		-	-
16 Aa 1	The generic procedure for UE-requested PDU session establishment, specified in subclause 4.5A.2, takes place performing establishment of UE-requested PDU session(s) with <i>ExpectedNumberOfNewPDUSessions</i> = <i>pc_noOf_PDUsSameConnection</i> .	-		-	-
17	The SS transmits an <i>RRCRelease</i> message.	<--	NR RRC: <i>RRCRelease</i>	-	-
-	EXCEPTION: Step 17Aa1 is performed if <i>pc_noOf_PDUsNewConnection</i> > 0.	-		-	-
17 Aa 1	The generic procedure for UE-requested PDU session establishment, specified in subclause 4.5.2.2-4, takes place performing establishment of UE-requested PDU session(s) with <i>ExpectedNumberOfNewPDUSessions</i> = <i>pc_noOf_PDUsNewConnection</i> and then release the RRC Connection.	-		-	-
18	The SS configures: - NR Cell 11 as "Serving cell" - NR Cell 1 as "Non-Suitable cell" - NR Cell 12 as "Non-Suitable cell".	-		-	-
19	The UE transmits an <i>RRCSetupRequest</i> message on NR Cell 11.	-->	NR RRC: <i>RRCSetupRequest</i>	-	-
20	SS transmits an <i>RRCSetup</i> message on NR Cell 11.	<--	NR RRC: <i>RRCSetup</i>	-	-
21	The UE transmits an <i>RRCSetupComplete</i> message to confirm the successful completion of the connection establishment and a REGISTRATION REQUEST message indicating "mobility registration updating" on NR Cell 11.	-->	NR RRC: <i>RRCSetupComplete</i> 5GMM: REGISTRATION REQUEST	-	-
22	SS sends a REGISTRATION ACCEPT message without including SOR transparent container on NR Cell 11.	<--	NR RRC: <i>DLInformationTransfer</i> 5GMM: REGISTRATION ACCEPT	-	-
23	Check: Does the UE send a REGISTRATION COMPLETE without including SOR transparent container on NR Cell 11?	-->	NR RRC: <i>ULInformationTransfer</i> 5GMM: REGISTRATION COMPLETE	1	P
24	The SS transmits an <i>RRCRelease</i> message on NR Cell 11.	<--	NR RRC: <i>RRCRelease</i>	-	-
25	The SS configures: - NR Cell 11 as "Serving cell"	-		-	-

	- NR Cell 1 as "Non-Suitable cell" - NR Cell 12 as "Serving cell".				
26	Check: Does the UE transmit an <i>RRCSetupRequest</i> message on NR Cell 12 within timer T=6 minutes *(1+10% tolerance)? NOTE: The timer T shall be set to 396s (6 minutes *(1+10% tolerance)), where the high priority PLMN search timer is defined in EF _{HPPLMN} .	-	-	1	F
27	Check: Does the test result of generic test procedure in TS 38.508-1 [4] Table 4.9.4.2.2-1 indicate that the UE is camped on NR Cell 11?	-	-	1	-

6.3.1.10.5 Specific message contents

Table 6.3.1.10.5-1: REGISTRATION ACCEPT for NR Cell 1 (step 15, Table 6.3.1.10.4-1)

Derivation Path: 38.508-1 Table 4.7.1-7			
Information Element	Value/remark	Comment	Condition
SOR Transparent Container	Present	The SOR transparent container carries steering of roaming information.	
SoR-MAC-I _{AUS}	Set to match the calculated SoR-MAC-I _{AUS} as the way defined in TS 33.501 A.17		
CounterSOR	Value generated as per TS 33.501 Cl 6.14.2.3		
SOR data type	0	The SOR transparent container carries steering of roaming information.	
List indication value	1	List of preferred PLMN/access technology combinations is provided	
List type	1	The list type is a PLMN ID and access technology list	
Acknowledgement (ACK) value	0	Acknowledgement is not requested	
PLMN ID 1	PLMN 14		
Access Technology Identifier 1	NG-RAN		
PLMN ID 2	PLMN 13		
Access Technology Identifier 2	NG-RAN		

Table 6.3.1.10.5-2: REGISTRATION COMPLETE for NR Cell 1 (step 16, Table 6.3.1.10.4-1)

Derivation Path: 38.508-1 Table 4.7.1-8			
Information Element	Value/remark	Comment	Condition
SOR Transparent Container	Not Present		

Table 6.3.1.10.5-3: REGISTRATION ACCEPT for NR Cell 11 (step 22, Table 6.3.1.10.4-1)

Derivation Path: 38.508-1 Table 4.7.1-7			
---	--	--	--

Information Element	Value/remark	Comment	Condition
SOR Transparent Container	Not Present		

Table 6.3.1.10.5-4: REGISTRATION COMPLETE for NR Cell 11 (step 23, Table 6.3.1.10.4-1)

Derivation Path: 38.508-1 Table 4.7.1-8			
Information Element	Value/remark	Comment	Condition
SOR Transparent Container	Not Present		

6.4 UE Procedures in RRC_INACTIVE state

6.4.1 NG-RAN Only PLMN Selection in RRC_INACTIVE state

6.4.1.1 PLMN Selection/Higher priority/HPLMN in Automatic PLMN Selection Mode

6.4.1.1.1 Test Purpose (TP)

(1)

```
with { UE in NR RRC_INACTIVE state on an NG-RAN VPLMN cell }
ensure that {
  when { UE performs PLMN Selection to a PLMN that is equivalent PLMN of the registered PLMN }
  then { UE remains in RRC_INACTIVE state after moving to the Equivalent PLMN cell. }
}
```

(2)

```
with { UE in NR RRC_INACTIVE state on an NG-RAN VPLMN cell and cells of a higher priority NG-RAN
PLMN available }
ensure that {
  when { Higher priority PLMN search timer T expires }
  then { UE selects the higher priority PLMN cell, moves to RRC_IDLE and attempts Registration on
the selected cell. }
}
```

6.4.1.1.2 Conformance requirements

References: The conformance requirements covered in the current TC are specified in: TS 23.122 clauses 4.4.3.3, TS 38.304 clauses 4.1 and clauses 4.2 and TS 24.501 clauses 5.3.1.4. Unless otherwise stated these are Rel-15 requirements.

[TS 23.122, clause 4.4.3.3]

If the MS is in a VPLMN, the MS shall periodically attempt to obtain service on its HPLMN (if the EHPLMN list is not present or is empty) or one of its EHPLMNs (if the EHPLMN list is present) or a higher priority PLMN/access technology combinations listed in "user controlled PLMN selector" or "operator controlled PLMN selector" by scanning in accordance with the requirements that are applicable to i), ii) and iii) as defined in the Automatic Network Selection Mode in subclause 4.4.3.1.1. In the case that the mobile has a stored "Equivalent PLMNs" list the mobile shall only select a PLMN if it is of a higher priority than those of the same country as the current serving PLMN which are stored in the "Equivalent PLMNs" list. For this purpose, a value of timer T may be stored in the SIM. The interpretation of the stored value depends on the radio capabilities supported by the MS:

- For an MS that does not support any of the following: EC-GSM-IoT, Category M1 or Category NB1 (as defined in 3GPP TS 36.306 [54]), T is either in the range 6 minutes to 8 hours in 6 minute steps or it indicates that no periodic attempts shall be made. If no value for T is stored in the SIM, a default value of 60 minutes is used for T.
- For an MS that only supports any of the following or a combination of: EC-GSM-IoT, Category M1 or Category NB1 (as defined in 3GPP TS 36.306 [54]), T is either in the range 2 hours to 240 hours, using 2 hour steps from

2 hours to 80 hours and 4 hour steps from 84 hours to 240 hours, or it indicates that no periodic attempts shall be made. If no value for T is stored in the SIM, a default value of 72 hours is used.

- For an MS that supports both:

- a) any of the following or a combination of: EC-GSM-IoT, Category M1 or Category NB1 (as defined in 3GPP TS 36.306 [54]); and
- b) any access technology other than the following: EC-GSM-IoT, Category M1 or Category NB1 (as defined in 3GPP TS 36.306 [54]),

then T is interpreted depending on the access technology in use as specified below:

- 1) if the MS is using any of the following at the time of starting timer T: EC-GSM-IoT, Category M1 or Category NB1 (as defined in 3GPP TS 36.306 [54]), T is either in the range 2 hours to 240 hours, using 2 hour steps from 2 hours to 80 hours and 4 hour steps from 84 hours to 240 hours, or it indicates that no periodic attempts shall be made. If no value for T is stored in the SIM, a default value of 72 hours is used; and
- 2) if the MS is not using any of the following at the time of starting timer T: EC-GSM-IoT, Category M1 or Category NB1 (as defined in 3GPP TS 36.306 [54]), T is either in the range 6 minutes to 8 hours in 6 minute steps or it indicates that no periodic attempts shall be made. If no value for T is stored in the SIM, a default value of 60 minutes is use

for T.

If the MS is configured with the `MinimumPeriodicSearchTimer` as specified in 3GPP TS 24.368 [50] or 3GPP TS 31.102 [40], the MS shall not use a value for T that is less than the `MinimumPeriodicSearchTimer`. If the value stored in the SIM, or the default value for T (when no value is stored in the SIM), is less than the `MinimumPeriodicSearchTimer`, then T shall be set to the `MinimumPeriodicSearchTimer`.

The MS does not stop timer T, as described in 3GPP TS 24.008 [23] and 3GPP TS 24.301 [23A], when it activates power saving mode (PSM) (see 3GPP TS 23.682 [27A]).

The MS can be configured for Fast First Higher Priority PLMN search as specified in 3GPP TS 31.102 [40] or 3GPP TS 24.368 [50]. Fast First Higher Priority PLMN search is enabled if the corresponding configuration parameter is present and set to enabled. Otherwise, Fast First Higher Priority PLMN search is disabled.

The attempts to access the HPLMN or an EHPLMN or higher priority PLMN shall be as specified below:

- a) The periodic attempts shall only be performed in automatic mode when the MS is roaming, and not while the MS is attached for emergency bearer services, is registered for emergency services, has a PDU session for emergency services or has a PDN connection for emergency bearer services;
- b) The MS shall make the first attempt after a period of at least 2 minutes and at most T minutes:
 - only after switch on if Fast First Higher Priority PLMN search is disabled; or
 - after switch on or upon selecting a VPLMN if Fast First Higher Priority PLMN search is enabled.
- c) The MS shall make the following attempts if the MS is on the VPLMN at time T after the last attempt;
- d) Periodic attempts shall only be performed by the MS while in idle mode;
- d1) Periodic attempts may be postponed while the MS is in power saving mode (PSM) (see 3GPP TS 23.682 [27A]).
- d2) Periodic attempts may be postponed while the MS is receiving eMBMS transport service in idle mode (see 3GPP TS 23.246 [68]).
- e) If the HPLMN (if the EHPLMN list is not present or is empty) or a EHPLMN (if the list is present) or a higher priority PLMN is not found, the MS shall remain on the VPLMN.
- f) In steps i), ii) and iii) of subclause 4.4.3.1.1 the MS shall limit its attempts to access higher priority PLMN/access technology combinations to PLMN/access technology combinations of the same country as the current serving VPLMN, as defined in Annex B.

- g) Only the priority levels of Equivalent PLMNs of the same country as the current serving VPLMN, as defined in Annex B, shall be taken into account to compare with the priority level of a selected PLMN.
- h) If the PLMN of the highest priority PLMN/access technology combination available is the current VPLMN, or one of the PLMNs in the "Equivalent PLMNs" list, the MS shall remain on the current PLMN/access technology combination.

[TS 38.304, clause 4.1]

The RRC_IDLE state and RRC_INACTIVE state tasks can be subdivided into three processes:

- PLMN selection;
- Cell selection and reselection;
- Location registration and RNA update.

PLMN selection, cell reselection procedures, and location registration are common for both RRC_IDLE state and RRC_INACTIVE state. RNA update is only applicable for RRC_INACTIVE state. When UE selects a new PLMN, UE transitions from RRC_INACTIVE to RRC_IDLE, as specified in TS 24.501 [14].

When a UE is switched on, a public land mobile network (PLMN) is selected by NAS. For the selected PLMN, associated RAT(s) may be set, as specified in TS 23.122 [9]. The NAS shall provide a list of equivalent PLMNs, if available, that the AS shall use for cell selection and cell reselection.

With cell selection, the UE searches for a suitable cell of the selected PLMN, chooses that cell to provide available services, and monitors its control channel. This procedure is defined as "camping on the cell".

The UE shall, if necessary, then register its presence, by means of a NAS registration procedure, in the tracking area of the chosen cell. As an outcome of a successful Location Registration, the selected PLMN then becomes the registered PLMN, as specified in TS 23.122 [9].

If the UE finds a more suitable cell, according to the cell reselection criteria, it reselects onto that cell and camps on it. If the new cell does not belong to at least one tracking area to which the UE is registered, location registration is performed. In RRC_INACTIVE state, if the new cell does not belong to the configured RNA, an RNA update procedure is performed.

If necessary, the UE shall search for higher priority PLMNs at regular time intervals as described in TS 23.122 [9] and search for a suitable cell if another PLMN has been selected by NAS.

If the UE loses coverage of the registered PLMN, either a new PLMN is selected automatically (automatic mode), or an indication of available PLMNs is given to the user so that a manual selection can be performed (manual mode).

Registration is not performed by UEs only capable of services that need no registration.

The purpose of camping on a cell in RRC_IDLE state and RRC_INACTIVE state is fourfold:

- a) It enables the UE to receive system information from the PLMN.
- b) When registered and if the UE wishes to establish an RRC connection or resume a suspended RRC connection, it can do this by initially accessing the network on the control channel of the cell on which it is camped.
- c) If the network needs to send a message or deliver data to the registered UE, it knows (in most cases) the set of tracking areas (in RRC_IDLE state) or RNA (in RRC_INACTIVE state) in which the UE is camped. It can then send a "paging" message for the UE on the control channels of all the cells in the corresponding set of areas. The UE will then receive the paging message and can respond.
- d) It enables the UE to receive ETWS and CMAS notifications.

When the UE is in RRC_IDLE state, upper layers may deactivate AS layer when MICO mode is activated as specified in TS 24.501 [14]. When MICO mode is activated, the AS configuration (e.g. priorities provided by dedicated signalling) is kept and all running timers continue to run but the UE need not perform any idle mode tasks. If a timer expires while MICO mode is activated it is up to the UE implementation whether it performs the corresponding action immediately or the latest when MICO mode is deactivated. When MICO mode is deactivated, the UE shall perform all idle mode tasks.

[TS 38.304, clause 4.2]

Table 4.2-1 presents the functional division between UE non-access stratum (NAS) and UE access stratum (AS) in RRC_IDLE state and RRC_INACTIVE states. The NAS part is specified in TS 23.122 [9] and the AS part in the present document.

Table 4.2-1: Functional division between AS and NAS in RRC_IDLE state and RRC_INACTIVE state

RRC_IDLE and RRC_INACTIVE state Process	UE Non-Access Stratum	UE Access Stratum
PLMN Selection	<p>Maintain a list of PLMNs in priority order according to TS 23.122 [9]. Select a PLMN using automatic or manual mode as specified in TS 23.122 [9] and request AS to select a cell belonging to this PLMN. For each PLMN, associated RAT(s) may be set.</p> <p>Evaluate reports of available PLMNs from AS for PLMN selection.</p> <p>Maintain a list of equivalent PLMN identities.</p>	<p>Search for available PLMNs.</p> <p>If associated RAT(s) is (are) set for the PLMN, search in this (these) RAT(s) and other RAT(s) for that PLMN as specified in TS 23.122 [9].</p> <p>Perform measurements to support PLMN selection.</p> <p>Synchronise to a broadcast channel to identify found PLMNs.</p> <p>Report available PLMNs with associated RAT(s) to NAS on request from NAS or autonomously.</p>
Cell Selection	<p>Control cell selection for example by indicating RAT(s) associated with the selected PLMN to be used initially in the search of a cell in the cell selection.</p> <p>Maintain a list of "Forbidden Tracking Areas" and provide the list to AS.</p>	<p>Perform measurements needed to support cell selection.</p> <p>Detect and synchronise to a broadcast channel. Receive and handle broadcast information. Forward NAS system information to NAS.</p> <p>Search for a suitable cell. The cells broadcast one or more 'PLMN identity' in the system information. Respond to NAS whether such cell is found or not.</p> <p>If associated RATs is (are) set for the PLMN, perform the search in this (these) RAT(s) and other RATs for that PLMN as specified in TS 23.122 [9].</p> <p>If a cell is found which satisfies cell selection criteria, camp on that cell.</p>
Cell Reselection	<p>Maintain a list of equivalent PLMN identities and provide the list to AS.</p> <p>Maintain a list of "Forbidden Tracking Areas" and provide the list to AS.</p>	<p>Perform measurements needed to support cell reselection.</p> <p>Detect and synchronise to a broadcast channel. Receive and handle broadcast information. Forward NAS system information to NAS.</p> <p>Change cell if a more suitable cell is found.</p>
Location registration	<p>Register the UE as active after power on.</p> <p>Register the UE's presence in a registration area, for instance regularly or when entering a new tracking area.</p> <p>Deregister UE when shutting down.</p> <p>Maintain a list of "Forbidden Tracking Areas".</p>	<p>Report registration area information to NAS.</p>

RRC_IDLE and RRC_INACTIVE state Process	UE Non-Access Stratum	UE Access Stratum
RAN Notification Area Update	Not applicable.	Register the UE's presence in a RAN-based notification area (RNA), periodically or when entering a new RNA.

[TS 24.501, clause 5.3.1.4]

This subclause is only applicable for UE's 5GMM mode over 3GPP access.

The UE is in 5GMM-CONNECTED mode with RRC inactive indication when the UE is in:

- a) 5GMM-CONNECTED mode over 3GPP access at the NAS layer; and
- b) RRC_INACTIVE state at the AS layer (see 3GPP TS 38.300 [27]).

Unless stated otherwise, the UE behaviour in 5GMM-CONNECTED mode with RRC inactive indication follows the UE behaviour in 5GMM-CONNECTED over 3GPP access, except that:

- a) the UE shall apply the mobility restrictions; and
- b) the UE shall perform the PLMN selection procedures as in 5GMM-IDLE mode over 3GPP access.

The UE shall transition from 5GMM-CONNECTED mode over 3GPP access to 5GMM-CONNECTED mode with RRC inactive indication upon receiving an indication from the lower layers that the UE has transitioned to RRC_INACTIVE state.

...

The UE shall trigger a transition from 5GMM-CONNECTED mode with RRC inactive indication to 5GMM-IDLE mode upon selection of a PLMN that is not an equivalent PLMN to the registered PLMN. The UE shall not trigger a transition from 5GMM-CONNECTED mode with RRC inactive indication to 5GMM-IDLE mode upon entering a new PLMN which is in the list of equivalent PLMNs.

6.4.1.1.3 Test description

6.4.1.1.3.1 Pre-test conditions

System Simulator:

- NR Cell 12, NR Cell 13 and NR Cell 1 are configured according to TS 38.508-1 [4], Table 4.4.2-3.
- The PLMNs are identified in the test by the identifiers in Table 6.4.1.1.3.1-1 and the PLMN settings are defined in TS 36.523-1 [13] table 6.0.1-1..

Table 6.4.1.1.3.1–1: PLMN identifiers

NR Cell	PLMN name
12	PLMN15
13	PLMN16
1	PLMN1

- System information combination NR-4 as defined in TS 38.508-1 [4] clause 4.4.3.1.2-1 is used in NR cells.

UE:

- The UE is in Automatic PLMN selection mode.

- USIM configuration as defined in TS 38.508-1 [4] Table 6.4.1-1 will be loaded. The high priority PLMN search timer T defined by EF_{HPPLMN} is 6min.

Preamble:

- The UE is in state Switched OFF (state 0-A) according to TS 38.508-1 [4].

6.4.1.1.3.2 Test procedure sequence

Table 6.4.1.1.3.2-1 for FR1 and Table 6.4.1.1.3.2-2 for FR2 illustrates the downlink power levels and other changing parameters to be applied for the cells at various time instants of the test execution. Row marked "T0" denotes the initial conditions after preamble, while column marked "T1" is to be applied subsequently in the Main behaviour. The exact instants on which these values shall be applied are described in the texts in this clause.

Table 6.4.1.1.3.2-1: Cell configuration changes over time for FR1

	Parameter	Unit	NR Cell 12	NR Cell 13	NR Cell 1	Remarks
T0	SS/PBCH SSS EPRE	dBm/SCS	-88	"Off"	"Off"	Power level "Off" is defined in TS 38.508-1 [4] Table 6.2.2.1-3
T1	SS/PBCH SSS EPRE	dBm/SCS	-115	-78	"Off"	Power level "Off" is defined in TS 38.508-1 [4] Table 6.2.2.1-3
T2	SS/PBCH SSS EPRE	dBm/SCS	"Off"	-88	-88	Power level "Off" is defined in TS 38.508-1 [4] Table 6.2.2.1-3

Table 6.4.1.1.3.2-2: Cell configuration changes over time for FR2

	Parameter	Unit	NR Cell 12	NR Cell 13	NR Cell 1	Remarks
T0	SS/PBCH SSS EPRE	dBm/SCS	-82	"Off"	"Off"	Power level "Off" is defined in TS 38.508-1 [4] Table 6.2.2.2-2
T1	SS/PBCH SSS EPRE	dBm/SCS	FFS	FFS	"Off"	Power level "Off" is defined in TS 38.508-1 [4] Table 6.2.2.2-2
T2	SS/PBCH SSS EPRE	dBm/SCS	"Off"	FFS	FFS	Power level "Off" is defined in TS 38.508-1 [4] Table 6.2.2.2-2

Table 6.4.1.1.3.2-3: Main behaviour

St	Procedure	Message Sequence		TP	Verdict
		U - S	Message		
0A	SS adjusts cell levels according to row T0 of table 6.4.1.1.3.2-1/2.	-	-	-	-
0B	The UE is switched on.	-	-	-	-
0C 1- 0C 19a 1	The steps 1-19a1 specified in generic procedure TS 38.508-1 Table 4.5.3.2-1 are performed.	-	-	-	-
0D	SS starts timers of $t_{min} = 2min$ and $t_{max} = (6 min + 5min)$ (Note 1).	-	-	-	-
0E a1- 0F	The steps 19Aa1-20 specified in generic procedure TS 38.508-1 Table 4.5.3.2-1 are performed.	-	-	-	-
1	SS adjusts cell levels according to row T1 of table 6.4.1.1.3.2-1/2.	-	-	-	-
2	Check: Does the UE transmit an <i>RRCResumeRequest</i> message on NR Cell 13?	-	NR RRC: <i>RRCResumeRequest</i>	1	P
3	The SS transmits an <i>RRCResume</i> message.	<--	NR RRC: <i>RRCResume</i>	-	-
4	The UE transmits an <i>RRCResumeComplete</i> message and a REGISTRATION REQUEST message indicating "mobility registration	-->	NR RRC: <i>RRCResumeComplete</i> 5GMM: REGISTRATION REQUEST	-	-

	updating" is sent to update the registration of NR Cell13.				
4A-4B	Steps 4 to 5 of the generic test procedure in TS 38.508-1 [4] Table 4.9.5.2.2-1 with condition MOBILITY are performed.	-	-	-	-
5	The SS transmits an <i>RRCRelease</i> message with suspend.	<--	NR RRC: <i>RRCRelease</i>	-	-
6	Void	-	-	-	-
7	The SS transmits a <i>Paging</i> message including a matched identity (correct <i>fullI-RNTI</i>) on NR Cell 13.	<--	NR RRC: <i>Paging</i>	-	-
8	Check: Does the UE transmit an <i>RRCResumeRequest</i> message to resume RRC Connection by setting <i>resumelidentity</i> to the stored <i>shortI-RNTI</i> value on NR Cell 13?	-->	NR RRC: <i>RRCResumeRequest</i>	1	P
9	The SS transmits an <i>RRCResume</i> message.	<--	NR RRC: <i>RRCResume</i>	-	-
10	The UE transmits an <i>RRCResumeComplete</i> message.	-->	NR RRC: <i>RRCResumeComplete</i>	-	-
11	The SS transmits an <i>RRCRelease</i> message with suspend.	<--	NR RRC: <i>RRCRelease</i>	-	-
12	SS adjusts cell levels according to row T2 of table 6.4.1.1.3.2-1/2.	-	-	-	-
13	Check: Does the UE send an <i>RRCSetupRequest</i> message on NR Cell 1 after <i>tmin</i> expires but before <i>tmax</i> expires (Note 1)?	-->	NR RRC: <i>RRCSetupRequest</i>	2	P
14	Steps 3-4 of Table 4.5.2.2-2 of the generic procedure in TS 38.508-1 [4] are performed	-	-	2	P
-	EXCEPTION: Steps 14a1 to 14b5a1 describe behaviours which depend on procedure parameters; the "lower case letter" identifies a step sequence that take place if a procedure parameter has a particular value.	-	-	-	-
14a1-14a16a1	IF 5GS registration type is set as Initial Registration in step 14, THEN steps 5 to 20a1 of the registration procedure described in TS 38.508-1 [4] Table 4.5.2.2-2 are performed on NR Cell 1. Note 2	-	-	-	-
14b1-14b5a1	ELSE IF 5GS registration type is set as Mobility Registration in step 14, THEN steps 4 to 6a1 of the generic test procedure in TS 38.508-1 [4] Table 4.9.5.2.2-1 are performed on NR Cell 1. Note 2	-	-	-	-
<p>Note 1: Following attempts to access the HPLMN/EHPLMN/higher priority PLMN in VPLMN is operator specific setting (Refer to TS 23.122 [38] Rel-15).Hence, window between 2min to T+Tolerance is being used, where the high priority PLMN search timer T defined by EF_{HPLMN}. Tolerance of 5min is added to allow time for the UE to find the proper PLMN.</p> <p>Note 2: The 5GS registration type shall be only set as Mobility Registration for R16 UEs according to TS 24.501 [22] subclause 5.2.3.2.5 specified in Release 16. The EXCEPTION description applies only to R15 UEs.</p>					

6.4.1.1.3.3 Specific message contents

Table 6.4.1.1.3.3-1: SIB4 for NR Cell 12 (preamble and all steps, Table 6.4.1.1.3.2-3)

Derivation path: TS 38.508-1 [4], Table 4.6.2-3			
Information Element	Value/Remark	Comment	Condition
SIB4 ::= SEQUENCE {			
interFreqCarrierFreqList SEQUENCE (SIZE (1..maxFreq)) OF InterFreqCarrierFreqInfo {	2 entries		
interFreqCarrierFreqInfo[1] SEQUENCE {		entry 1	
dl-CarrierFreq	Same downlink NR ARFCN as used for NR Cell 13		
cellReselectionPriority	4		

}			
InterFreqCarrierFreqInfo[2] SEQUENCE {		entry 2	
dl-CarrierFreq	Same downlink NR ARFCN as used for NR Cell 1		
cellReselectionPriority	4		
}			
}			
}			

Table 6.4.1.1.3.3-2: SIB4 for NR Cell 13 (preamble and all steps, Table 6.4.1.1.3.2-3)

Derivation path: TS 38.508-1 [4], Table 4.6.2-3			
Information Element	Value/Remark	Comment	Condition
SIB4 ::= SEQUENCE {			
interFreqCarrierFreqList SEQUENCE (SIZE (1..maxFreq)) OF InterFreqCarrierFreqInfo {	2 entries		
InterFreqCarrierFreqInfo[1] SEQUENCE {		entry 1	
dl-CarrierFreq	Same downlink NR ARFCN as used for NR Cell 12		
cellReselectionPriority	4		
}			
InterFreqCarrierFreqInfo[2] SEQUENCE {		entry 2	
dl-CarrierFreq	Same downlink NR ARFCN as used for NR Cell 1		
cellReselectionPriority	4		
}			
}			
}			

Table 6.4.1.1.3.3-3: REGISTRATION ACCEPT for NR Cell 12 (step 0D, Table 6.4.1.1.3.2-3; step 14, TS 38.508-1 [4], Table 4.5.3.2-1)

Derivation path: TS 38.508-1 [4], Table 4.7.1-7			
Information Element	Value/Remark	Comment	Condition
Equivalent PLMNs	PLMN16		

Table 6.4.1.1.3.3-4: RRCResumeRequest (Step 2, Table 6.4.1.1.3.2-3)

Derivation Path: TS 38.508-1 [4], Table 4.6.1-19			
Information Element	Value/remark	Comment	Condition
RRCResumeRequest ::= SEQUENCE {			
rrcResumeRequest SEQUENCE {			
resumeCause	mo-Signalling		
}			
}			

6.4.1.2 Cell reselection of ePLMN in manual mode

6.4.1.2.1 Test Purpose (TP)

(1)

```
with { UE in NR RRC_INACTIVE state on a NR cell in manual PLMN Selection mode and network has
downloaded a list of equivalent PLMNs during the Registration procedure }
ensure that {
  when { Higher ranked cell is a cell of a PLMN in the downloaded equivalent PLMN list }
    then { UE reselects to the equivalent PLMN cell , and attempts Registration with mobility on the
selected cell. }
```

```

    }

```

(2)

```

with { UE in NR RRC_INACTIVE state on a cell and network has downloaded a list of equivalent PLMNs
during Registration procedure for mobility }
ensure that {
  when { Highest ranked cell is a cell of a PLMN not in the downloaded equivalent PLMN list }
  then { UE does not reselect to the cell. }
}

```

6.4.1.2.2 Conformance requirements

References: The conformance requirements covered in the current TC are specified in: TS 23.122 clauses 4.4.3.1.2 and TS 38.304, clauses 4.1 and clauses 4.2. Unless otherwise stated these are Rel-15 requirements.

[TS 23.122, clause 4.4.3.1.2]

The MS indicates whether there are any PLMNs, which are available using all supported access technologies. This includes PLMNs in the "forbidden PLMNs" list, "forbidden PLMNs for GPRS service" list and PLMNs which only offer services not supported by the MS. An MS which supports GSM COMPACT shall also indicate GSM COMPACT PLMNs (which use PBCCH).

If displayed, PLMNs meeting the criteria above are presented in the following order:

- i)- either the HPLMN (if the EHPLMN list is not present or is empty) or, if one or more of the EHPLMNs are available then based on an optional data field on the SIM either only the highest priority available EHPLMN is to be presented to the user or all available EHPLMNs are presented to the user in priority order. If the data field is not present on the SIM, then only the highest priority available EHPLMN is presented;
- ii)- PLMN/access technology combinations contained in the " User Controlled PLMN Selector with Access Technology " data file in the SIM (in priority order);
- iii)- PLMN/access technology combinations contained in the "Operator Controlled PLMN Selector with Access Technology" data file in the SIM (in priority order);
- iv)- other PLMN/access technology combinations with received high quality signal in random order;
- v)- other PLMN/access technology combinations in order of decreasing signal quality.

In ii and iii, an MS using a SIM without access technology information storage (i.e. the "User Controlled PLMN Selector with Access Technology" and the "Operator Controlled PLMN Selector with Access Technology" data files are not present) shall instead present the PLMNs contained in the "PLMN Selector" data file in the SIM (in priority order).

In v, requirement h) in subclause 4.4.3.1.1 applies.

In i to v, requirements j), k) and l) in subclause 4.4.3.1.1 apply.

In GSM COMPACT, the non support of voice services shall be indicated to the user.

The HPLMN may provide on the SIM additional information on the available PLMNs. If this information is provided then the MS shall indicate it to the user. This information, provided as free text may include:

- preferred partner,
- roaming agreement status,
- supported services

Furthermore, the MS may indicate whether the available PLMNs are present on the EHPLMN list, the Forbidden list, the User Controlled PLMN List or the Operator Controlled PLMN List. The MS may also indicate that the PLMN is not present on any of these lists.

The user may select his desired PLMN and the MS then initiates registration on this PLMN using the access technology chosen by the user for that PLMN or using the highest priority available access technology for that PLMN, if the associated access technologies have a priority order. (This may take place at any time during the presentation of PLMNs). For such a registration, the MS shall ignore the contents of the "forbidden location areas for roaming",

"forbidden tracking areas for roaming", "5GS forbidden tracking areas for roaming", "forbidden location areas for regional provision of service", "forbidden tracking areas for regional provision of service", "5GS forbidden tracking areas for regional provision of service", "forbidden PLMNs for GPRS service" and "forbidden PLMNs" lists.

NOTE 1: It is an MS implementation option whether to indicate access technologies to the user. If the MS does display access technologies, then the access technology selected by the user is only used for initial registration on the selected PLMN. If the MS does not display access technologies, then the access technology chosen for a particular PLMN should be the highest priority available access technology for that PLMN, if the associated access technologies have a priority order, and is only used for initial registration.

Once the MS has registered on a PLMN selected by the user, the MS shall not automatically register on a different PLMN unless:

- i) the new PLMN is declared as an equivalent PLMN by the registered PLMN;
- ii) the user selects automatic mode;
- iii) the user initiates an emergency call while the MS is in limited service state and either the network does not broadcast the indication of support of emergency calls in limited service state, the registration request for emergency services is rejected by the network or the attach request for emergency bearer services is rejected by the network; or
- iv) the user initiates access to RLOS, while the MS is in limited service state and either the network does not broadcast the indication of support of RLOS in limited service state, or the EPS attach request for access to RLOS is rejected by the network.

NOTE 2: If case iii) or iv) occurs, the MS can provide an indication to the upper layers that the MS has exited manual network selection mode.

If the user does not select a PLMN, the selected PLMN shall be the one that was selected before the PLMN selection procedure started. If no such PLMN was selected or that PLMN is no longer available, then the MS shall attempt to camp on any acceptable cell and enter the limited service state.

NOTE 3: High quality signal is defined in the appropriate AS specification.

[TS 38.304, clause 4.1]

The RRC_IDLE state and RRC_INACTIVE state tasks can be subdivided into three processes:

- PLMN selection;
- Cell selection and reselection;
- Location registration and RNA update.

PLMN selection, cell reselection procedures, and location registration are common for both RRC_IDLE state and RRC_INACTIVE state. RNA update is only applicable for RRC_INACTIVE state. When UE selects a new PLMN, UE transitions from RRC_INACTIVE to RRC_IDLE, as specified in TS 24.501 [14].

When a UE is switched on, a public land mobile network (PLMN) is selected by NAS. For the selected PLMN, associated RAT(s) may be set, as specified in TS 23.122 [9]. The NAS shall provide a list of equivalent PLMNs, if available, that the AS shall use for cell selection and cell reselection.

With cell selection, the UE searches for a suitable cell of the selected PLMN, chooses that cell to provide available services, and monitors its control channel. This procedure is defined as "camping on the cell".

The UE shall, if necessary, then register its presence, by means of a NAS registration procedure, in the tracking area of the chosen cell. As an outcome of a successful Location Registration, the selected PLMN then becomes the registered PLMN, as specified in TS 23.122 [9].

If the UE finds a more suitable cell, according to the cell reselection criteria, it reselects onto that cell and camps on it. If the new cell does not belong to at least one tracking area to which the UE is registered, location registration is performed. In RRC_INACTIVE state, if the new cell does not belong to the configured RNA, an RNA update procedure is performed.

If necessary, the UE shall search for higher priority PLMNs at regular time intervals as described in TS 23.122 [9] and search for a suitable cell if another PLMN has been selected by NAS.

If the UE loses coverage of the registered PLMN, either a new PLMN is selected automatically (automatic mode), or an indication of available PLMNs is given to the user so that a manual selection can be performed (manual mode).

Registration is not performed by UEs only capable of services that need no registration.

The purpose of camping on a cell in RRC_IDLE state and RRC_INACTIVE state is fourfold:

- a) It enables the UE to receive system information from the PLMN.
- b) When registered and if the UE wishes to establish an RRC connection or resume a suspended RRC connection, it can do this by initially accessing the network on the control channel of the cell on which it is camped.
- c) If the network needs to send a message or deliver data to the registered UE, it knows (in most cases) the set of tracking areas (in RRC_IDLE state) or RNA (in RRC_INACTIVE state) in which the UE is camped. It can then send a "paging" message for the UE on the control channels of all the cells in the corresponding set of areas. The UE will then receive the paging message and can respond.
- d) It enables the UE to receive ETWS and CMAS notifications.

When the UE is in RRC_IDLE state, upper layers may deactivate AS layer when MICO mode is activated as specified in TS 24.501 [14]. When MICO mode is activated, the AS configuration (e.g. priorities provided by dedicated signalling) is kept and all running timers continue to run but the UE need not perform any idle mode tasks. If a timer expires while MICO mode is activated it is up to the UE implementation whether it performs the corresponding action immediately or the latest when MICO mode is deactivated. When MICO mode is deactivated, the UE shall perform all idle mode tasks.

[TS 38.304, clause 4.2]

Table 4.2-1 presents the functional division between UE non-access stratum (NAS) and UE access stratum (AS) in RRC_IDLE state and RRC_INACTIVE states. The NAS part is specified in TS 23.122 [9] and the AS part in the present document.

Table 4.2-1: Functional division between AS and NAS in RRC_IDLE state and RRC_INACTIVE state

RRC_IDLE and RRC_INACTIVE state Process	UE Non-Access Stratum	UE Access Stratum
PLMN Selection	<p>Maintain a list of PLMNs in priority order according to TS 23.122 [9]. Select a PLMN using automatic or manual mode as specified in TS 23.122 [9] and request AS to select a cell belonging to this PLMN. For each PLMN, associated RAT(s) may be set.</p> <p>Evaluate reports of available PLMNs from AS for PLMN selection.</p> <p>Maintain a list of equivalent PLMN identities.</p>	<p>Search for available PLMNs.</p> <p>If associated RAT(s) is (are) set for the PLMN, search in this (these) RAT(s) and other RAT(s) for that PLMN as specified in TS 23.122 [9].</p> <p>Perform measurements to support PLMN selection.</p> <p>Synchronise to a broadcast channel to identify found PLMNs.</p> <p>Report available PLMNs with associated RAT(s) to NAS on request from NAS or autonomously.</p>
Cell Selection	<p>Control cell selection for example by indicating RAT(s) associated with the selected PLMN to be used initially in the search of a cell in the cell selection.</p> <p>Maintain a list of "Forbidden Tracking Areas" and provide the list to AS.</p>	<p>Perform measurements needed to support cell selection.</p> <p>Detect and synchronise to a broadcast channel. Receive and handle broadcast information. Forward NAS system information to NAS.</p> <p>Search for a suitable cell. The cells broadcast one or more 'PLMN identity' in the system information. Respond to NAS</p>

RRC_IDLE and RRC_INACTIVE state Process	UE Non-Access Stratum	UE Access Stratum
		<p>whether such cell is found or not.</p> <p>If associated RATs is (are) set for the PLMN, perform the search in this (these) RAT(s) and other RATs for that PLMN as specified in TS 23.122 [9].</p> <p>If a cell is found which satisfies cell selection criteria, camp on that cell.</p>
Cell Reselection	<p>Maintain a list of equivalent PLMN identities and provide the list to AS.</p> <p>Maintain a list of "Forbidden Tracking Areas" and provide the list to AS.</p>	<p>Perform measurements needed to support cell reselection.</p> <p>Detect and synchronise to a broadcast channel. Receive and handle broadcast information. Forward NAS system information to NAS.</p> <p>Change cell if a more suitable cell is found.</p>
Location registration	<p>Register the UE as active after power on.</p> <p>Register the UE's presence in a registration area, for instance regularly or when entering a new tracking area.</p> <p>Deregister UE when shutting down.</p> <p>Maintain a list of "Forbidden Tracking Areas".</p>	<p>Report registration area information to NAS.</p>
RAN Notification Area Update	Not applicable.	<p>Register the UE's presence in a RAN-based notification area (RNA), periodically or when entering a new RNA.</p>

6.4.1.2.3 Test description

6.4.1.2.3.1 Pre-test conditions

System Simulator:

- NR Cell 1, NR Cell 12 and NR Cell 13 are configured according to TS 38.508-1, Table 4.4.2-3.
- System information combination NR-4 as defined in TS 38.508-1 [4] clause 4.4.3.1.2-1 is used in NR cell 1 and NR cell 12.
- System information combination NR-1 as defined in TS 38.508-1 [4] clause 4.4.3.1.2-1 is used in NR cell 13.

UE:

- The UE is in Manual PLMN selection mode.

Preamble:

- The UE is registered on NR Cell 1 except that the REGISTRATION ACCEPT message indicates the PLMN of NR Cell 12 in the Equivalent PLMN list as described in Table 6.4.1.2.3.3-4.
- The UE is in state 2N-A as defined in TS 38.508-1 [4], Table 4.4A.2-2 on NR Cell 1.

6.4.1.2.3.2 Test procedure sequence

Table 6.4.1.2.3.2-1 for FR1 and Table 6.4.1.2.3.2-2 for FR2 illustrates the downlink power levels and other changing parameters to be applied for the cells at various time instants of the test execution. Row marked "T0" denotes the initial conditions after preamble, while columns marked "T1", "T2" and "T3" are to be applied subsequently in the Main behaviour. The exact instants on which these values shall be applied are described in the texts in this clause.

Table 6.4.1.2.3.2-1: Cell configuration changes over time for FR1

	Parameter	Unit	NR Cell 1	NR Cell 12	NR Cell 13	Remarks
T0	SS/PBCH SSS EPRE	dBm/SCS	-99	-88	-78	
T1	SS/PBCH SSS EPRE	dBm/SCS	"Off"	"Off"	"Off"	Power level "Off" is defined in TS 38.508-1 [4] Table 6.2.2.1-3

Table 6.4.1.2.3.2-2: Cell configuration changes over time for FR2

	Parameter	Unit	NR Cell 1	NR Cell 12	NR Cell 13	Remarks
T0	SS/PBCH SSS EPRE	dBm/SCS	FFS	FFS	FFS	
T1	SS/PBCH SSS EPRE	dBm/SCS	"Off"	"Off"	"Off"	Power level "Off" is defined in TS 38.508-1 [4] Table 6.2.2.2-2

Table 6.4.1.2.3.2-3: Main behaviour

St	Procedure	Message Sequence		TP	Verdict
		U - S	Message		
1	SS adjusts cell levels according to row T0 of table 6.4.1.2.3.2-1/2.	-	-	-	-
2	Check: Does the UE transmit an <i>RRCResumeRequest</i> message on NR Cell 12?	-->	NR RRC: <i>RRCResumeRequest</i>	1	P
3-6	Steps 2 to 5 of the generic test procedure in TS 38.508-1 Table 4.9.5.2.2-1 with condition MOBILITY are performed. (Note 1)	-	-	-	-
6A-6D	Steps 5 to 8 of the generic test procedure in TS 38.508-1 Table 4.5.4.2-3. (Note 3)	-	-	-	-
7	The SS transmits an <i>RRCRelease</i> message with suspend.	-->	NR RRC: <i>RRCRelease</i>	-	-
8	Check: Does the UE send an <i>RRCResumeRequest</i> on NR Cell 13 and NR Cell 1 within 60s?	-->	NR RRC: <i>RRCResumeRequest</i>	2	F
9	SS adjusts cell levels according to row T1 of table 6.4.1.2.3.2-1/2.	-	-	-	-
10	Set UE to Automatic PLMN selection mode. (Note 2)	-	-	-	-

Note 1: The REGISTRATION REQUEST is accepted with the PLMN of NR Cell 1 listed as an Equivalent PLMN.

Note 2: Steps 10 is to ensure UE is set back to automatic PLMN selection mode for the next test case.

Note 3: No SERVICE ACCEPT message should be included in step 6C (corresponding to step 7 of Table 4.5.4.2-3 in TS 38.508-1 [4]).

6.4.1.2.3.3 Specific message contents

Table 6.4.1.2.3.3-1: SIB4 for NR Cell 1 (preamble and all steps, Table 6.4.1.2.3.2-2)

Derivation path: 38.508-1 [4] Table 4.6.2-3			
Information Element	Value/Remark	Comment	Condition
SIB4 ::= SEQUENCE {			
interFreqCarrierFreqList SEQUENCE (SIZE	2 entries		

(1..maxFreq)) OF InterFreqCarrierFreqInfo {			
InterFreqCarrierFreqInfo[1] SEQUENCE {		entry 1	
dl-CarrierFreq	Same downlink NR ARFCN as used for NR Cell 12		
cellReselectionPriority	4		
}			
InterFreqCarrierFreqInfo[2] SEQUENCE {		entry 2	
dl-CarrierFreq	Same downlink NR ARFCN as used for NR Cell 13		
cellReselectionPriority	4		
}			
}			
}			

Table 6.4.1.2.3.3-2: SIB4 for NR Cell 12 (preamble and all steps, Table 6.4.1.2.3.2-2)

Derivation path: 38.508-1 [4] Table 4.6.2-3			
Information Element	Value/Remark	Comment	Condition
SIB4 ::= SEQUENCE {			
interFreqCarrierFreqList SEQUENCE (SIZE (1..maxFreq)) OF InterFreqCarrierFreqInfo {	2 entries		
InterFreqCarrierFreqInfo[1] SEQUENCE {		entry 1	
dl-CarrierFreq	Same downlink NR ARFCN as used for NR Cell 1		
cellReselectionPriority	4		
}			
InterFreqCarrierFreqInfo[2] SEQUENCE {		entry 2	
dl-CarrierFreq	Same downlink NR ARFCN as used for NR Cell 13		
cellReselectionPriority	4		
}			
}			
}			

Table 6.4.1.2.3.3-3: REGISTRATION ACCEPT for NR Cell 1 (preamble)

Derivation path: 38.508-1 [4] Table 4.7.1-7			
Information Element	Value/Remark	Comment	Condition
Equivalent PLMNs	The PLMN of NR Cell 12		

Table 6.4.1.2.3.3-3A: RRCResumeRequest (Step 2, Table 6.4.1.2.3.2-3)

Derivation Path: TS 38.508-1 [4], Table 4.6.1-19			
Information Element	Value/remark	Comment	Condition
RRCResumeRequest ::= SEQUENCE {			
rrcResumeRequest SEQUENCE {			
resumeCause	mo-Signalling		
}			
}			

Table 6.4.1.2.3.3-4: REGISTRATION ACCEPT for NR Cell 12 (step 5, Table 6.4.1.2.3.2-2)

Derivation path: 38.508-1 [4] Table 4.7.1-7			
Information Element	Value/Remark	Comment	Condition
Equivalent PLMNs	The PLMN of NR Cell 1		
Allowed NSSAI			
S-NSSAI			

Length of S-NSSAI contents	'0000 0010'B		
Mapped HPLMN SST	Same as SST		

Table 6.4.1.2.3.3-4A: RRCReconfiguration for NR Cell 12 (step 6C, Table 6.4.1.2.3.2-2)

Derivation path: 38.508-1 [4] Table 4.6.1-13 with condition NR			
Information Element	Value/Remark	Comment	Condition
dedicatedNAS-MessageList	Not Present		

Table 6.4.1.2.3.3-5: RRCRelease (step 7, Table 6.4.1.2.3.2-2)

Derivation Path: 38.508-1 [4], Table 4.6.1-4B			
Information Element	Value/remark	Comment	Condition
RRCRelease ::= SEQUENCE {			
criticalExtensions CHOICE {			
rrcRelease SEQUENCE {			
suspendConfig SEQUENCE {			NR_RRC_I NACTIVE
ran-NotificationAreaInfo CHOICE {			
cellList SEQUENCE {			
plmn-Identity		PLMN ID of NR Cell 12	
ran-AreaCells SEQUENCE {			
cellIdentity	See Table 4.4.2-2 and 4.4.2-3 in TS 38.508-1 [4]	Cell Identity of NR Cell 12	
}			
}			
}			
}			
}			
}			
}			
}			

6.4.2 Cell Selection/Qrxlevmin & Cell Reselection (Intra NR in RRC_INACTIVE state)

6.4.2.1 Cell Selection/Qrxlevmin & Cell Reselection (Intra NR in RRC_INACTIVE state)

6.4.2.1.1 Test Purpose (TP)

(1)

```
with { UE in NR RRC_INACTIVE state }
ensure that {
  when { serving cell fulfils all requirements for a suitable cell except the cell selection
criteria which are not fulfilled (Srxlev<0) }
  then { UE does not consider the cell as suitable , leaves RRC_INACTIVE state and does not remain
camped on that cell }
}
```

(2)

```
with { UE in NR RRC_INACTIVE state }
ensure that {
  when { UE detects a cell ranked as the best cell }
  then { UE reselects to the new cell and continues to remain in RRC_INACTIVE state }
}
```

6.4.2.1.2 Conformance requirements

References: The conformance requirements covered in the present TC are specified in: TS 38.300, clause 9.2.1.1, and TS 38.304, clause 4.1, 4.5, 5.2.1, 5.2.3.1 and 5.2.3.2. Unless otherwise stated these are Rel-15 requirements.

[TS 38.300, clause 9.2.1.1]

The principles of PLMN selection in NR are based on the 3GPP PLMN selection principles. Cell selection is required on transition from RM-DEREGISTERED to RM-REGISTERED, from CM-IDLE to CM-CONNECTED and from CM-CONNECTED to CM-IDLE and is based on the following principles:

- The UE NAS layer identifies a selected PLMN and equivalent PLMNs;
- Cell selection is always based on CD-SSBs located on the synchronization raster (see subclause 5.2.4):
 - The UE searches the NR frequency bands and for each carrier frequency identifies the strongest cell as per the CD-SSB. It then reads cell system information broadcast to identify its PLMN(s):
 - The UE may search each carrier in turn ("initial cell selection") or make use of stored information to shorten the search ("stored information cell selection").
- The UE seeks to identify a suitable cell; if it is not able to identify a suitable cell it seeks to identify an acceptable cell. When a suitable cell is found or if only an acceptable cell is found it camps on that cell and commence the cell reselection procedure:
 - A suitable cell is one for which the measured cell attributes satisfy the cell selection criteria; the cell PLMN is the selected PLMN, registered or an equivalent PLMN; the cell is not barred or reserved and the cell is not part of a tracking area which is in the list of "forbidden tracking areas for roaming";
 - An acceptable cell is one for which the measured cell attributes satisfy the cell selection criteria and the cell is not barred.

Transition to RRC_IDLE:

On transition from RRC_CONNECTED or RRC_INACTIVE to RRC_IDLE, a UE should camp on a cell as result of cell selection according to the frequency be assigned by RRC in the state transition message if any.

Recovery from out of coverage:

The UE should attempt to find a suitable cell in the manner described for stored information or initial cell selection above. If no suitable cell is found on any frequency or RAT, the UE should attempt to find an acceptable cell.

In multi-beam operations, the cell quality is derived amongst the beams corresponding to the same cell (see subclause 9.2.4).

[TS 38.304, clause 4.1]

The RRC_IDLE state and RRC_INACTIVE state tasks can be subdivided into three processes:

- PLMN selection;
- Cell selection and reselection;
- Location registration and RNA update.

PLMN selection, cell reselection procedures, and location registration are common for both RRC_IDLE state and RRC_INACTIVE state. RNA update is only applicable for RRC_INACTIVE state. When UE selects a new PLMN, UE transitions from RRC_INACTIVE to RRC_IDLE, as specified in TS 24.501 [14].

When a UE is switched on, a public land mobile network (PLMN) is selected by NAS. For the selected PLMN, associated RAT(s) may be set, as specified in TS 23.122 [9]. The NAS shall provide a list of equivalent PLMNs, if available, that the AS shall use for cell selection and cell reselection.

With cell selection, the UE searches for a suitable cell of the selected PLMN, chooses that cell to provide available services, and monitors its control channel. This procedure is defined as "camping on the cell".

The UE shall, if necessary, then register its presence, by means of a NAS registration procedure, in the tracking area of the chosen cell. As an outcome of a successful Location Registration, the selected PLMN then becomes the registered PLMN, as specified in TS 23.122 [9].

If the UE finds a more suitable cell, according to the cell reselection criteria, it reselects onto that cell and camps on it. If the new cell does not belong to at least one tracking area to which the UE is registered, location registration is performed. In RRC_INACTIVE state, if the new cell does not belong to the configured RNA, an RNA update procedure is performed.

...

The purpose of camping on a cell in RRC_IDLE state and RRC_INACTIVE state is fourfold:

- a) It enables the UE to receive system information from the PLMN.
- b) When registered and if the UE wishes to establish an RRC connection or resume a suspended RRC connection, it can do this by initially accessing the network on the control channel of the cell on which it is camped.
- c) If the network needs to send a message or deliver data to the registered UE, it knows (in most cases) the set of tracking areas (in RRC_IDLE state) or RNA (in RRC_INACTIVE state) in which the UE is camped. It can then send a "paging" message for the UE on the control channels of all the cells in the corresponding set of areas. The UE will then receive the paging message and can respond.
- d) It enables the UE to receive ETWS and CMAS notifications.

When the UE is in RRC_IDLE state, upper layers may deactivate AS layer when MICO mode is activated as specified in TS 24.501 [14]. When MICO mode is activated, the AS configuration (e.g. priorities provided by dedicated signalling) is kept and all running timers continue to run but the UE need not perform any idle mode tasks. If a timer expires while MICO mode is activated it is up to the UE implementation whether it performs the corresponding action immediately or the latest when MICO mode is deactivated. When MICO mode is deactivated, the UE shall perform all idle mode tasks.

[TS 38.304, clause 4.5]

The cells are categorised according to which services they offer:

acceptable cell:

An "acceptable cell" is a cell on which the UE may camp to obtain limited service (originate emergency calls and receive ETWS and CMAS notifications). Such a cell shall fulfil the following requirements, which is the minimum set of requirements to initiate an emergency call and to receive ETWS and CMAS notification in an NR network:

- The cell is not barred, see subclause 5.3.1;
- The cell selection criteria are fulfilled, see subclause 5.2.3.2.

suitable cell:

A cell is considered as suitable if the following conditions are fulfilled:

- The cell is part of either the selected PLMN or the registered PLMN or PLMN of the Equivalent PLMN list and *trackingAreaCode* is provided for that PLMN;
- The cell selection criteria are fulfilled, see subclause 5.2.3.2.

According to the latest information provided by NAS:

- The cell is not barred, see subclause 5.3.1;
- The cell is part of at least one TA that is not part of the list of "Forbidden Tracking Areas" (TS 22.261 [12]), which belongs to a PLMN that fulfils the first bullet above.

barred cell:

A cell is barred if it is so indicated in the system information, as specified in TS 38.331 [3].

reserved cell:

A cell is reserved if it is so indicated in system information, as specified in TS 38.331 [3].

Following exception to these definitions are applicable for UEs:

- if a UE has an ongoing emergency call, all acceptable cells of that PLMN are treated as suitable for the duration of the emergency call.
- camped on a cell that belongs to a registration area that is forbidden for regional provision of service; a cell that belongs to a registration area that is forbidden for regional provision service (TS 23.122 [9], TS 24.501 [14]) is suitable but provides only limited service.

[TS 38.304, clause 5.2.1]

UE shall perform measurements for cell selection and reselection purposes as specified in TS 38.133 [8].

When evaluating $Srxlev$ and $Squal$ of non-serving cells for reselection evaluation purposes, the UE shall use parameters provided by the serving cell and for the final check on cell selection criterion, the UE shall use parameters provided by the target cell for cell reselection.

The NAS can control the RAT(s) in which the cell selection should be performed, for instance by indicating RAT(s) associated with the selected PLMN, and by maintaining a list of forbidden registration area(s) and a list of equivalent PLMNs. The UE shall select a suitable cell based on RRC_IDLE or RRC_INACTIVE state measurements and cell selection criteria.

In order to expedite the cell selection process, stored information for several RATs, if available, may be used by the UE.

When camped on a cell, the UE shall regularly search for a better cell according to the cell reselection criteria. If a better cell is found, that cell is selected. The change of cell may imply a change of RAT. Details on performance requirements for cell reselection can be found in TS 38.133 [8].

The NAS is informed if the cell selection and reselection result in changes in the received system information relevant for NAS.

For normal service, the UE shall camp on a suitable cell, monitor control channel(s) of that cell so that the UE can:

- receive system information from the PLMN; and
 - receive registration area information from the PLMN, e.g., tracking area information; and
 - receive other AS and NAS Information; and
- if registered:
 - receive paging and notification messages from the PLMN; and
 - initiate transfer to Connected mode.

For cell selection in multi-beam operations, measurement quantity of a cell is up to UE implementation.

For cell reselection in multi-beam operations, the measurement quantity of this cell is derived amongst the beams corresponding to the same cell based on SS/PBCH block as follows:

- if *nrofSS-BlocksToAverage* is not configured in *SIB2/SIB4*; or
- if *absThreshSS-BlocksConsolidation* is not configured in *SIB2/SIB4*; or
- if the highest beam measurement quantity value is below or equal to *absThreshSS-BlocksConsolidation*:
 - derive a cell measurement quantity as the highest beam measurement quantity value, where each beam measurement quantity is described in TS 38.215 [11].
- else:
 - derive a cell measurement quantity as the linear average of the power values of up to *nrofSS-BlocksToAverage* of highest beam measurement quantity values above *absThreshSS-BlocksConsolidation*.

[TS 38.304, clause 5.2.3.1]

Cell selection is performed by one of the following two procedures:

- a) Initial cell selection (no prior knowledge of which RF channels are NR frequencies):
 1. The UE shall scan all RF channels in the NR bands according to its capabilities to find a suitable cell.
 2. On each frequency, the UE need only search for the strongest cell.
 3. Once a suitable cell is found, this cell shall be selected.
- b) Cell selection by leveraging stored information:
 1. This procedure requires stored information of frequencies and optionally also information on cell parameters from previously received measurement control information elements or from previously detected cells.
 2. Once the UE has found a suitable cell, the UE shall select it.
 3. If no suitable cell is found, the initial cell selection procedure in a) shall be started.

NOTE: Priorities between different frequencies or RATs provided to the UE by system information or dedicated signalling are not used in the cell selection process.

[TS 38.304, clause 5.2.3.2]

The cell selection criterion S is fulfilled when:

$$S_{rxlev} > 0 \text{ AND } S_{qual} > 0$$

where:

$$S_{rxlev} = Q_{rxlevmeas} - (Q_{rxlevmin} + Q_{rxlevminoffset}) - P_{compensation} - Q_{offsettemp}$$

$$S_{qual} = Q_{qualmeas} - (Q_{qualmin} + Q_{qualminoffset}) - Q_{offsettemp}$$

where:

S_{rxlev}	Cell selection RX level value (dB)
S_{qual}	Cell selection quality value (dB)
$Q_{offsettemp}$	Offset temporarily applied to a cell as specified in TS 38.331 [3] (dB)
$Q_{rxlevmeas}$	Measured cell RX level value (RSRP)
$Q_{qualmeas}$	Measured cell quality value (RSRQ)
$Q_{rxlevmin}$	Minimum required RX level in the cell (dBm). If the UE supports SUL frequency for this cell, $Q_{rxlevmin}$ is obtained from $q-RxLevMinSUL$, if present, in <i>SIB1</i> , <i>SIB2</i> and <i>SIB4</i> , additionally, if $Q_{rxlevminoffsetcellSUL}$ is present in <i>SIB3</i> and <i>SIB4</i> for the concerned cell, this cell specific offset is added to the corresponding $Q_{rxlevmin}$ to achieve the required minimum RX level in the concerned cell; else $Q_{rxlevmin}$ is obtained from $q-RxLevMin$ in <i>SIB1</i> , <i>SIB2</i> and <i>SIB4</i> , additionally, if $Q_{rxlevminoffsetcell}$ is present in <i>SIB3</i> and <i>SIB4</i> for the concerned cell, this cell specific offset is added to the corresponding $Q_{rxlevmin}$ to achieve the required minimum RX level in the concerned cell.
$Q_{qualmin}$	Minimum required quality level in the cell (dB). Additionally, if $Q_{qualminoffsetcell}$ is signalled for the concerned cell, this cell specific offset is added to achieve the required minimum quality level in the concerned cell.
$Q_{rxlevminoffset}$	Offset to the signalled $Q_{rxlevmin}$ taken into account in the S_{rxlev} evaluation as a result of a periodic search for a higher priority PLMN while camped normally in a VPLMN, as specified in TS 23.122 [9].
$Q_{qualminoffset}$	Offset to the signalled $Q_{qualmin}$ taken into account in the S_{qual} evaluation as a result of a periodic search for a higher priority PLMN while camped normally in a VPLMN, as specified in TS 23.122 [9].
$P_{compensation}$	If the UE supports the additional P_{max} in the NR-NS- P_{max} List, if present, in <i>SIB1</i> , <i>SIB2</i> and <i>SIB4</i> : $\max(P_{EMAX1} - P_{PowerClass}, 0) - (\min(P_{EMAX2}, P_{PowerClass}) - \min(P_{EMAX1}, P_{PowerClass}))$ (dB); else: $\max(P_{EMAX1} - P_{PowerClass}, 0)$ (dB)

P_{EMAX1} , P_{EMAX2}	Maximum TX power level of a UE may use when transmitting on the uplink in the cell (dBm) defined as P_{EMAX} in TS 38.101 [15]. If UE supports SUL frequency for this cell, P_{EMAX1} and P_{EMAX2} are obtained from the p -Max for SUL in <i>SIB1</i> and <i>NR-NS-PmaxList</i> for SUL respectively in <i>SIB1</i> , <i>SIB2</i> and <i>SIB4</i> as specified in TS 38.331 [3], else P_{EMAX1} and P_{EMAX2} are obtained from the p -Max and <i>NR-NS-PmaxList</i> respectively in <i>SIB1</i> , <i>SIB2</i> and <i>SIB4</i> for normal UL as specified in TS 38.331 [3].
$P_{PowerClass}$	Maximum RF output power of the UE (dBm) according to the UE power class as defined in TS 38.101-1 [15].

The signalled values $Q_{rxlevminoffset}$ and $Q_{qualminoffset}$ are only applied when a cell is evaluated for cell selection as a result of a periodic search for a higher priority PLMN while camped normally in a VPLMN (TS 23.122 [9]). During this periodic search for higher priority PLMN, the UE may check the S criteria of a cell using parameter values stored from a different cell of this higher priority PLMN.

6.4.2.1.3 Test description

6.4.2.1.3.1 Pre-test conditions

System Simulator:

- NR Cell 1, NR Cell 2.
- System information combination NR-3 as defined in TS 38.508-1 [4] Table 4.4.3.1.2-1 is used in NR cells.

UE:

None.

Preamble:

- The UE is in state 2N-A on NR Cell 1(serving cell) according to TS 38.508-1 [4] Table 4.4A.2-2.

6.4.2.1.3.2 Test procedure sequence

Table 6.4.2.1.3.2-1/2 illustrates the downlink power levels and other changing parameters to be applied for the NR cells at various time instants of the test execution. The exact instants on which these values shall be applied are described in the texts in this clause. The configuration "T0" indicates the initial conditions. Subsequent configurations marked "T1" and "T2" are applied at the points indicated in the Main behaviour description in Table 6.4.2.1.3.2-3.

Table 6.4.2.1.3.2-1: Time instances of cell power level and parameter changes for FR1

	Parameter	Unit	NR Cell 1	NR Cell 2	Remark
T0	SS/PBCH SSS EPRE	dBm/SCS	-88	Off	The power level values are assigned to ensure the UE registered on NR Cell 1.
T1	SS/PBCH SSS EPRE	dBm/SCS	-115	Off	The power level values are assigned to satisfy S_{rxlev} NR Cell 1 < 0.
T2	SS/PBCH SSS EPRE	dBm/SCS	-88	-78	The power level values are assigned to satisfy $R_{NR\ Cell\ 2}$ > $R_{NR\ Cell\ 1}$.
Note 1: Power level "Off" is defined in TS 38.508-1 [4] Table 6.2.2.1-3.					

Table 6.4.2.1.3.2-2: Time instances of cell power level and parameter changes for FR2

	Parameter	Unit	NR Cell 1	NR Cell 2	Remark
T0	SS/PBCH SSS EPRE	dBm/SCS	FFS	Off	The power level values are assigned to ensure the UE registered on NR Cell 1.
T1	SS/PBCH SSS EPRE	dBm/SCS	FFS	Off	The power level values are assigned to satisfy S_{rxlev} NR Cell 1 < 0.

T2	SS/PBCH SSS EPRE	dBm/SCS	FFS	FFS	The power level values are assigned to satisfy $R_{NR, Cell 2} > R_{NR, Cell 1}$.
Note 1: The uncertain downlink signal level is specified in TS 38.508-1 [4] section FFS.					

Table 6.4.2.1.3.2-3: Main behaviour

St	Procedure	Message Sequence		TP	Verdict
		U - S	Message		
1	The SS changes NR Cell 1 SSS level according to the row "T1" in table 6.4.2.1.3.2-1/2.	-	-	-	-
2	Void	-	-	-	-
2A	Wait 15s. (Note 1)	-	-	-	-
3	The SS transmits a <i>Paging</i> message.	<--	NR RRC: <i>Paging</i>	-	-
4	Check: Does the UE attempt to transmit an uplink message within the next 10s?	-	-	1	F
5	The UE is switched off.	-	-	-	-
6	Void	-	-	-	-
6A	Void	-	-	-	-
6B	The SS changes NR Cell 1 SSS levels according to the row "T0" in table 6.4.2.1.3.2-1/2.	-	-	-	-
6C	The UE is switched on.	-	-	-	-
7	Generic procedure specified in TS 38.508-1 Table 4.5.3.2-1 are performed, in which the RRCRelease message includes the suspendConfig with NR_RRC_INACTIVE condition thereby moving the UE to RRC_INACTIVE.	-	-	-	-
8-15	Void	-	-	-	-
16	The SS changes NR Cell 2 SSS level according to the row "T2" in table 6.4.2.1.3.2-1/2.	-	-	-	-
17	Void	-	-	-	-
18	Check: Does the UE transmit an <i>RRCResumeRequest</i> message on the NR Cell 2?	-->	NR RRC: <i>RRCResumeRequest</i>	2	P
18A	The SS transmits an <i>RRCResume</i> message.	<--	NR RRC: <i>RRCResume</i>	-	-
18B	The UE transmit an <i>RRCResumeComplete</i> message.	-->	NR RRC: <i>RRCResumeComplete</i>	-	-
19	The SS transmits an <i>RRCRelease</i> message including <i>suspendConfig</i> with NR_RRC_INACTIVE condition.	<--	NR RRC: <i>RRCRelease</i>	-	-
Note 1: As specified in TS 38.133 [30] clause 4.2.2.2, UE will wait $DRXCycle * 2$ to evaluate serving cell. If the UE in RRC_IDLE has not found any new suitable cell based on searches and measurements using the intra-frequency, inter-frequency and inter-RAT information indicated in the system information for 10 s, the UE shall initiate cell selection procedures for the selected PLMN. The wait time is selected to cover $DRXCycle * 2 = 1280ms * 2 = 2.56s + 10s = 12.56s$ rounded up to 13s. Therefore, the actual wait time is selected to 15s, in order to be greater than 13s.					

6.4.2.1.3.3 Specific message contents

Table 6.4.2.1.3.3-1: SIB3 of NR Cell 1 (preamble and all steps, Table 6.4.2.1.3.2-3)

Derivation Path: TS 38.508-1 [4], Table 4.6.2-2			
Information Element	Value/remark	Comment	Condition
SIB3 ::= SEQUENCE {			
intraFreqNeighCellList SEQUENCE (SIZE (1.. maxCellIntra)) OF IntraFreqNeighCellInfo {	1 entry		
IntraFreqNeighCellInfo[1] SEQUENCE{		entry 1	
physCellId	Physical cell identity of NR Cell 2		
q-OffsetCell	0		
}			

}			
}			

Table 6.4.2.1.3.3-1A: RRCResumeRequest (Step 18, Table 6.4.2.1.3.2-3)

Derivation Path: TS 38.508-1 [4], Table 4.6.1-19			
Information Element	Value/remark	Comment	Condition
RRCResumeRequest ::= SEQUENCE {			
rrcResumeRequest SEQUENCE {			
resumeCause	rna-Update		
}			
}			

Table 6.4.2.1.3.3-2: RRCResume (step 18A, Table 6.4.2.1.3.2-3)

Derivation Path: TS 38.508-1 [4], Table 4.6.1-17			
Information Element	Value/remark	Comment	Condition
RRCResume ::= SEQUENCE {			
criticalExtensions CHOICE {			
rrcResume SEQUENCE {			
masterCellGroup := SEQUENCE {	CellGroupConfig	Table 6.4.2.1.3.3-3	
}			
}			
}			

Table 6.4.2.1.3.3-3: CellGroupConfig (Table 6.4.2.1.3.3-2)

Derivation Path: 38.508-1 [4], Table 4.6.3-19 with condition RESUME			
Information Element	Value/remark	Comment	Condition
CellGroupConfig ::= SEQUENCE {			
spCellConfigDedicated	ServingCellConfig		
}			

Table 6.4.2.1.3.3-4: ServingCellConfig (Table 6.4.2.1.3.3-3: CellGroupConfig)

Derivation Path: TS 38.508-1 [4], Table 4.6.3-167 with condition RESUME			
Information Element	Value/remark	Comment	Condition
ServingCellConfig ::= SEQUENCE {			
initialDownlinkBWP	BWP-DownlinkDedicated		
}			

Table 6.4.2.1.3.3-5: BWP-DownlinkDedicated (Table 6.4.2.1.3.3-4: ServingCellConfig)

Derivation Path: TS 38.508-1 [4], Table 4.6.3-11			
Information Element	Value/remark	Comment	Condition
BWP-DownlinkDedicated ::= SEQUENCE {			
pdcch-Config	Not present		
pdsch-Config CHOICE {			
setup	PDSCH-Config		
}			
}			

Table 6.4.2.1.3.3-6: PDSCH-Config (Table 6.4.2.1.3.3-5: BWP-DownlinkDedicated)

Derivation Path: TS 38.508-1 [4], Table 4.6.3-100			
Information Element	Value/remark	Comment	Condition
PDSCH-Config ::= SEQUENCE {			
dmrs-DownlinkForPDSCH-MappingTypeA	Not present		

tcI-StatesToAddModList SEQUENCE(SIZE (1..maxNrofTCI-States)) OF TCI-State {	1 entry		
TCI-State[1] SEQUENCE {		entry 1	
tcI-StateId	0		
qcl-type1 SEQUENCE {			
referenceSignal CHOICE {			
ssb	SSB index #n	SSB index of NR Cell 2	
}			
}			
}			
}			
prb-BundlingType	Not present		
}			

6.4.2.2 Inter-frequency cell reselection according to cell reselection priority provided by SIBs in RRC_INACTIVE state

6.4.2.2.1 Test Purpose (TP)

(1)

```
with { UE in NR RRC_INACTIVE state }
ensure that {
  when { UE detects the cell re-selection criteria are met for the cell which belongs to the equal
priority frequency }
  then { UE reselects to the cell which belongs to the equal priority frequency and remains in
RRC_INACTIVE state }
}
```

(2)

```
with { UE in NR RRC_INACTIVE state }
ensure that {
  when { UE detects the cell re-selection criteria are met for the cell which belongs to the higher
priority frequency }
  then { UE reselects to the cell which belongs to the higher priority frequency and remains in
RRC_INACTIVE state }
}
```

(3)

```
with { UE in NR RRC_INACTIVE state }
ensure that {
  when { UE detects the cell re-selection criteria are met for the cell which belongs to the lower
priority frequency }
  then { UE reselects to the cell which belongs to the lower priority frequency and remains in
RRC_INACTIVE state }
}
```

6.4.2.2.2 Conformance requirements

References: The conformance requirements covered in the present TC are specified in TS 38.304: clause 4.1, 5.2.4.1, 5.2.4.2 and 5.2.4.5. Unless otherwise stated these are Rel-15 requirements.

[TS 38.304, clause 4.1]

The RRC_IDLE state and RRC_INACTIVE state tasks can be subdivided into three processes:

- PLMN selection;
- Cell selection and reselection;
- Location registration and RNA update.

PLMN selection, cell reselection procedures, and location registration are common for both RRC_IDLE state and RRC_INACTIVE state. RNA update is only applicable for RRC_INACTIVE state. When UE selects a new PLMN, UE transitions from RRC_INACTIVE to RRC_IDLE, as specified in TS 24.501 [14].

...

If the UE finds a more suitable cell, according to the cell reselection criteria, it reselects onto that cell and camps on it. If the new cell does not belong to at least one tracking area to which the UE is registered, location registration is performed. In RRC_INACTIVE state, if the new cell does not belong to the configured RNA, an RNA update procedure is performed.

If necessary, the UE shall search for higher priority PLMNs at regular time intervals as described in TS 23.122 [9] and search for a suitable cell if another PLMN has been selected by NAS.

If the UE loses coverage of the registered PLMN, either a new PLMN is selected automatically (automatic mode), or an indication of available PLMNs is given to the user so that a manual selection can be performed (manual mode).

Registration is not performed by UEs only capable of services that need no registration.

The purpose of camping on a cell in RRC_IDLE state and RRC_INACTIVE state is fourfold:

- a) It enables the UE to receive system information from the PLMN.
- b) When registered and if the UE wishes to establish an RRC connection or resume a suspended RRC connection, it can do this by initially accessing the network on the control channel of the cell on which it is camped.
- c) If the network needs to send a message or deliver data to the registered UE, it knows (in most cases) the set of tracking areas (in RRC_IDLE state) or RNA (in RRC_INACTIVE state) in which the UE is camped. It can then send a "paging" message for the UE on the control channels of all the cells in the corresponding set of areas. The UE will then receive the paging message and can respond.
- d) It enables the UE to receive ETWS and CMAS notifications.

When the UE is in RRC_IDLE state, upper layers may deactivate AS layer when MICO mode is activated as specified in TS 24.501 [14]. When MICO mode is activated, the AS configuration (e.g. priorities provided by dedicated signalling) is kept and all running timers continue to run but the UE need not perform any idle mode tasks. If a timer expires while MICO mode is activated it is up to the UE implementation whether it performs the corresponding action immediately or the latest when MICO mode is deactivated. When MICO mode is deactivated, the UE shall perform all idle mode tasks.

[TS 38.304, clause 5.2.4.1]

Absolute priorities of different NR frequencies or inter-RAT frequencies may be provided to the UE in the system information, in the *RRCRelease* message, or by inheriting from another RAT at inter-RAT cell (re)selection. In the case of system information, an NR frequency or inter-RAT frequency may be listed without providing a priority (i.e. the field *cellReselectionPriority* is absent for that frequency). If priorities are provided in dedicated signalling, the UE shall ignore all the priorities provided in system information. If UE is in *camped on any cell* state, UE shall only apply the priorities provided by system information from current cell, and the UE preserves priorities provided by dedicated signalling and *deprioritisationReq* received in *RRCRelease* unless specified otherwise. When the UE in camped normally state, has only dedicated priorities other than for the current frequency, the UE shall consider the current frequency to be the lowest priority frequency (i.e. lower than any of the network configured values).

The UE shall only perform cell reselection evaluation for NR frequencies and inter-RAT frequencies that are given in system information and for which the UE has a priority provided.

In case UE receives *RRCRelease* with *deprioritisationReq*, UE shall consider current frequency and stored frequencies due to the previously received *RRCRelease* with *deprioritisationReq* or all the frequencies of NR to be the lowest priority frequency (i.e. lower than any of the network configured values) while T325 is running irrespective of camped RAT. The UE shall delete the stored deprioritisation request(s) when a PLMN selection is performed on request by NAS (3GPP TS 23.122 [9]).

NOTE: UE should search for a higher priority layer for cell reselection as soon as possible after the change of priority. The minimum related performance requirements specified in TS 38.133 [8] are still applicable.

The UE shall delete priorities provided by dedicated signalling when:

- the UE enters a different RRC state; or
- the optional validity time of dedicated priorities (T320) expires; or
- a PLMN selection is performed on request by NAS (3GPP TS 23.122 [9]).

NOTE 2: Equal priorities between RATs are not supported.

The UE shall not consider any black listed cells as candidate for cell reselection.

The UE shall inherit the priorities provided by dedicated signalling and the remaining validity time (i.e. T320 in NR and E-UTRA), if configured, at inter-RAT cell (re)selection.

NOTE 3: The network may assign dedicated cell reselection priorities for frequencies not configured by system information.

[TS 38.304, clause 5.2.4.2]

When evaluating S_{rxlev} and S_{qual} of non-serving cells for reselection purposes, the UE shall use parameters provided by the serving cell.

Following rules are used by the UE to limit needed measurements:

- If the serving cell fulfils $S_{rxlev} > S_{IntraSearchP}$ and $S_{qual} > S_{IntraSearchQ}$, the UE may choose not to perform intra-frequency measurements.
- Otherwise, the UE shall perform intra-frequency measurements.
- The UE shall apply the following rules for NR inter-frequencies and inter-RAT frequencies which are indicated in system information and for which the UE has priority provided as defined in 5.2.4.1:
 - For a NR inter-frequency or inter-RAT frequency with a reselection priority higher than the reselection priority of the current NR frequency, the UE shall perform measurements of higher priority NR inter-frequency or inter-RAT frequencies according to TS 38.133 [8].
 - For a NR inter-frequency with an equal or lower reselection priority than the reselection priority of the current NR frequency and for inter-RAT frequency with lower reselection priority than the reselection priority of the current NR frequency:
 - If the serving cell fulfils $S_{rxlev} > S_{nonIntraSearchP}$ and $S_{qual} > S_{nonIntraSearchQ}$, the UE may choose not to perform measurements of NR inter-frequencies or inter-RAT frequency cells of equal or lower priority;
 - Otherwise, the UE shall perform measurements of NR inter-frequencies or inter-RAT frequency cells of equal or lower priority according to TS 38.133 [8].

[TS 38.304, clause 5.2.4.5]

If *threshServingLowQ* is broadcast in system information and more than 1 second has elapsed since the UE camped on the current serving cell, cell reselection to a cell on a higher priority NR frequency or inter-RAT frequency than the serving frequency shall be performed if:

- A cell of a higher priority NR or EUTRAN RAT/frequency fulfils $S_{qual} > Thresh_{X, HighQ}$ during a time interval $T_{reselectionRAT}$

Otherwise, cell reselection to a cell on a higher priority NR frequency or inter-RAT frequency than the serving frequency shall be performed if:

- A cell of a higher priority RAT/ frequency fulfils $S_{rxlev} > Thresh_{X, HighP}$ during a time interval $T_{reselectionRAT}$; and
- More than 1 second has elapsed since the UE camped on the current serving cell.

Cell reselection to a cell on an equal priority NR frequency shall be based on ranking for intra-frequency cell reselection as defined in sub-clause 5.2.4.6.

If *threshServingLowQ* is broadcast in system information and more than 1 second has elapsed since the UE camped on the current serving cell, cell reselection to a cell on a lower priority NR frequency or inter-RAT frequency than the serving frequency shall be performed if:

- The serving cell fulfils $S_{qual} < \text{Thresh}_{\text{Serving, LowQ}}$ and a cell of a lower priority NR or E-UTRAN RAT/ frequency fulfils $S_{qual} > \text{Thresh}_{X, \text{LowQ}}$ during a time interval $T_{\text{reselectionRAT}}$.

Otherwise, cell reselection to a cell on a lower priority NR frequency or inter-RAT frequency than the serving frequency shall be performed if:

- The serving cell fulfils $S_{rxlev} < \text{Thresh}_{\text{Serving, LowP}}$ and a cell of a lower priority RAT/ frequency fulfils $S_{rxlev} > \text{Thresh}_{X, \text{LowP}}$ during a time interval $T_{\text{reselectionRAT}}$; and
- More than 1 second has elapsed since the UE camped on the current serving cell.

Cell reselection to a higher priority RAT/frequency shall take precedence over a lower priority RAT/frequency if multiple cells of different priorities fulfil the cell reselection criteria.

If more than one cell meets the above criteria, the UE shall reselect a cell as follows:

- If the highest-priority frequency is an NR frequency, a cell ranked as the best cell among the cells on the highest priority frequency(ies) meeting the criteria according to section 5.2.4.6;
- If the highest-priority frequency is from another RAT, a cell ranked as the best cell among the cells on the highest priority frequency(ies) meeting the criteria of that RAT.

6.4.2.2.3 Test description

6.4.2.2.3.1 Pre-test conditions

System Simulator:

- NR Cell 1, NR Cell 3 and NR Cell 6.
- System information combination NR-4 as defined in TS 38.508-1 [4] Table 4.4.3.1.2-1 is used in NR cells.

UE:

- None.

Preamble:

- The UE is in state 2N-A on NR Cell 1(serving cell) according to TS 38.508-1 [4] Table 4.4A.2-2.

6.4.2.2.3.2 Test procedure sequence

Table 6.4.2.2.3.2-1/2 illustrates the downlink power levels and other changing parameters to be applied for the NR cells at various time instants of the test execution. The exact instants on which these values shall be applied are described in the texts in this clause. The configuration "T0" indicates the initial conditions. Subsequent configurations marked "T1", "T2" and "T3" are applied at the points indicated in the Main behaviour description in Table 6.4.2.2.3.2-3.

Table 6.4.2.2.3.2-1: Time instances of cell power level and parameter changes for FR1

	Parameter	Unit	NR Cell 1	NR Cell 3	NR Cell 6	Remark
T0	SS/PBCH SSS EPRE	dBm/SCS	-88	Off	Off	The power level values are assigned to ensure the UE registered on NR Cell 1.
T1	SS/PBCH SSS EPRE	dBm/SCS	-88	-78	Off	The power level values are assigned to satisfy $R_{\text{NR Cell 1}} < R_{\text{NR Cell 3}}$.
T2	SS/PBCH SSS EPRE	dBm/SCS	Off	-78	-78	The power level values are assigned to satisfy $S_{rxlev_{\text{NR Cell 1}}} < 0$ and $S_{rxlev_{\text{NR Cell 6}}} > \text{Thresh}_{\text{NR Cell 6, highP}}$.
T3	SS/PBCH SSS EPRE	dBm/SCS	Off	-78	-98	The power level values are assigned to satisfy $S_{rxlev_{\text{NR Cell 6}}} < \text{Thresh}_{\text{Serving, lowP}}$ and $S_{rxlev_{\text{NR Cell 6}}}$

						$3 > \text{Thresh}_{\text{NR Cell 3, lowP}}, \text{Srxlev}_{\text{NR Cell 1}} < 0$.
Note 1: Power level "Off" is defined in TS 38.508-1 [4] Table 6.2.2.1-3.						

Table 6.4.2.3.2-2: Time instances of cell power level and parameter changes for FR2

	Parameter	Unit	NR Cell 1	NR Cell 3	NR Cell 6	Remark
T0	SS/PBCH SSS EPRE	dBm/SCS	FFS	Off	Off	The power level values are assigned to ensure the UE registered on NR Cell 1.
T1	SS/PBCH SSS EPRE	dBm/SCS	FFS	FFS	Off	The power level values are assigned to satisfy $R_{\text{NR Cell 1}} < R_{\text{NR Cell 3}}$.
T2	SS/PBCH SSS EPRE	dBm/SCS	Off	FFS	FFS	The power level values are assigned to satisfy $\text{Srxlev}_{\text{NR Cell 1}} < 0$ and $\text{Srxlev}_{\text{NR Cell 6}} > \text{Thresh}_{\text{NR Cell 6, highP}}$.
T3	SS/PBCH SSS EPRE	dBm/SCS	Off	FFS	FFS	The power level values are assigned to satisfy $\text{Srxlev}_{\text{NR Cell 6}} < \text{Thresh}_{\text{Serving, lowP}}$ and $\text{Srxlev}_{\text{NR Cell 3}} > \text{Thresh}_{\text{NR Cell 3, lowP}}, \text{Srxlev}_{\text{NR Cell 1}} < 0$.
Note 1: The uncertain downlink signal level is specified in TS 38.508-1 [4] section FFS.						

Table 6.4.2.3.2-3: Main behaviour

St	Procedure	Message Sequence		TP	Verdict
		U - S	Message		
1	The SS changes NR Cell 3 SSS level according to the row "T1" in table 6.4.2.3.2-1/2.	-	-	-	-
2	Void	-	-	-	-
3	Check: Does the UE transmit an <i>RRCResumeRequest</i> message on the cell 3?	-->	NR RRC: <i>RRCResumeRequest</i>	1	P
4	The SS transmits an <i>RRCRelease</i> message including <i>suspendConfig</i> with NR_RRC_INACTIVE condition.	<--	NR RRC: <i>RRCRelease</i>	-	-
5	The SS changes NR Cell 1 and NR Cell 6 SSS levels according to the row "T2" in table 6.4.2.3.2-1/2.	-	-	-	-
6	Void	-	-	-	-
7	Check: Does the UE transmit an <i>RRCResumeRequest</i> message on the cell 6?	-->	NR RRC: <i>RRCResumeRequest</i>	2	P
8	The SS transmits an <i>RRCRelease</i> message including <i>suspendConfig</i> with NR_RRC_INACTIVE condition.	<--	NR RRC: <i>RRCRelease</i>	-	-
9	The SS changes NR Cell 6 SSS level according to the row "T3" in table 6.4.2.3.2-1/2.	-	-	-	-
10	Void	-	-	-	-
11	Check: Does the UE transmit an <i>RRCResumeRequest</i> message on the cell 3?	-->	NR RRC: <i>RRCResumeRequest</i>	3	P
12	The SS transmits an <i>RRCRelease</i> message including <i>suspendConfig</i> with NR_RRC_INACTIVE condition.	<--	NR RRC: <i>RRCRelease</i>	-	-

6.4.2.3.3 Specific message contents

Table 6.4.2.3.3-1: Conditions for specific message contents in Tables below

Condition	Explanation
NR Cell 1	This condition applies to system information transmitted on NR Cell 1.
NR Cell 3	This condition applies to system information transmitted on NR Cell 3.
NR Cell 6	This condition applies to system information transmitted on NR Cell 6.

Table 6.4.2.3.3-2: SIB2 of NR Cell 6 (preamble and all steps, Table 6.4.2.3.2-3)

Derivation Path: TS 38.508-1 [4], Table 4.6.2-1

Information Element	Value/remark	Comment	Condition
SIB2 ::= SEQUENCE {			
cellReselectionServingFreqInfo			
SEQUENCE {			
threshServingLowP	10	20 dB	
cellReselectionPriority	5		
}			
}			

Table 6.4.2.2.3.3-3: SIB4 of NR Cell 1, NR Cell 3 and NR Cell 6 (preamble and all steps, Table 6.4.2.2.3.2-3)

Derivation Path: TS 38.508-1 [4], Table 4.6.2-3			
Information Element	Value/remark	Comment	Condition
SIB4 ::= SEQUENCE {			
interFreqCarrierFreqList SEQUENCE	2 entries		NR Cell 1
SIZE (1..maxFreq) OF SEQUENCE {	1 entry		NR Cell 3 and NR Cell 6
dl-CarrierFreq[1]	Same downlink ARFCN as used for NR Cell 6		NR Cell 1
	Same downlink ARFCN as used for NR Cell 6		NR Cell 3
	Same downlink ARFCN as used for NR Cell 3		NR Cell 6
threshX-HighP[1]	10	20 dB	NR Cell 3
cellReselectionPriority[1]	5		NR Cell 1
	5		NR Cell 3
	4		NR Cell 6
dl-CarrierFreq[2]	Same downlink ARFCN as used for NR Cell 3		NR Cell 1
cellReselectionPriority[2]	4		NR Cell 1
}			
}			

Table 6.4.2.1.3.3-5: RRCResumeRequest (Step 3, 7 and 11, Table 6.4.2.2.3.2-3)

Derivation Path: TS 38.508-1 [4], Table 4.6.1-19			
Information Element	Value/remark	Comment	Condition
RRCResumeRequest ::= SEQUENCE {			
rrcResumeRequest SEQUENCE {			
resumeCause	rna-Update		
}			
}			

6.4.3 Inter-RAT Cell Reselection

6.4.3.1 Inter-RAT cell reselection From NR RRC_INACTIVE to E-UTRA RRC_IDLE (lower priority & higher priority, Srxlev based)

6.4.3.1.1 Test Purpose (TP)

(1)

```
with { UE in NR RRC_INACTIVE state }
ensure that {
  when { UE detects the cell re-selection criteria are met for the neighbour cell which belongs to
the higher priority E-UTRA frequency }
  then { UE reselects to the E-UTRA cell and transitions to E-UTRA RRC_IDLE State }
}
```

(2)

```

with { UE in NR RRC_INACTIVE state }
ensure that {
  when { UE detects the cell re-selection criteria are met for the neighbour cell which belongs to
the lower priority E-UTRA frequency }
  then { UE reselects to the E-UTRA cell and transitions to E-UTRA RRC_IDLE State }
}

```

6.4.3.1.2 Conformance requirements

References: The conformance requirements covered in the present TC are specified in TS 38.304: clause 4.1, 5.2.4.1, 5.2.4.2 and 5.2.4.5. Unless otherwise stated these are Rel-15 requirements.

[TS 38.304, clause 4.1]

The RRC_IDLE state and RRC_INACTIVE state tasks can be subdivided into three processes:

- PLMN selection;
- Cell selection and reselection;
- Location registration and RNA update.

PLMN selection, cell reselection procedures, and location registration are common for both RRC_IDLE state and RRC_INACTIVE state. RNA update is only applicable for RRC_INACTIVE state. When UE selects a new PLMN, UE transitions from RRC_INACTIVE to RRC_IDLE, as specified in TS 24.501 [14].

...

If the UE finds a more suitable cell, according to the cell reselection criteria, it reselects onto that cell and camps on it. If the new cell does not belong to at least one tracking area to which the UE is registered, location registration is performed. In RRC_INACTIVE state, if the new cell does not belong to the configured RNA, an RNA update procedure is performed.

If necessary, the UE shall search for higher priority PLMNs at regular time intervals as described in TS 23.122 [9] and search for a suitable cell if another PLMN has been selected by NAS.

If the UE loses coverage of the registered PLMN, either a new PLMN is selected automatically (automatic mode), or an indication of available PLMNs is given to the user so that a manual selection can be performed (manual mode).

Registration is not performed by UEs only capable of services that need no registration.

The purpose of camping on a cell in RRC_IDLE state and RRC_INACTIVE state is fourfold:

- a) It enables the UE to receive system information from the PLMN.
- b) When registered and if the UE wishes to establish an RRC connection or resume a suspended RRC connection, it can do this by initially accessing the network on the control channel of the cell on which it is camped.
- c) If the network needs to send a message or deliver data to the registered UE, it knows (in most cases) the set of tracking areas (in RRC_IDLE state) or RNA (in RRC_INACTIVE state) in which the UE is camped. It can then send a "paging" message for the UE on the control channels of all the cells in the corresponding set of areas. The UE will then receive the paging message and can respond.
- d) It enables the UE to receive ETWS and CMAS notifications.

When the UE is in RRC_IDLE state, upper layers may deactivate AS layer when MICO mode is activated as specified in TS 24.501 [14]. When MICO mode is activated, the AS configuration (e.g. priorities provided by dedicated signalling) is kept and all running timers continue to run but the UE need not perform any idle mode tasks. If a timer expires while MICO mode is activated it is up to the UE implementation whether it performs the corresponding action immediately or the latest when MICO mode is deactivated. When MICO mode is deactivated, the UE shall perform all idle mode tasks.

[TS 38.304, clause 5.2.4.1]

Absolute priorities of different NR frequencies or inter-RAT frequencies may be provided to the UE in the system information, in the *RRCRelease* message, or by inheriting from another RAT at inter-RAT cell (re)selection. In the case of system information, an NR frequency or inter-RAT frequency may be listed without providing a priority (i.e. the field *cellReselectionPriority* is absent for that frequency). If priorities are provided in dedicated signalling, the UE shall ignore all the priorities provided in system information. If UE is in *camped on any cell* state, UE shall only apply the priorities provided by system information from current cell, and the UE preserves priorities provided by dedicated signalling and *deprioritisationReq* received in *RRCRelease* unless specified otherwise. When the UE in camped normally state, has only dedicated priorities other than for the current frequency, the UE shall consider the current frequency to be the lowest priority frequency (i.e. lower than any of the network configured values).

The UE shall only perform cell reselection evaluation for NR frequencies and inter-RAT frequencies that are given in system information and for which the UE has a priority provided.

In case UE receives *RRCRelease* with *deprioritisationReq*, UE shall consider current frequency and stored frequencies due to the previously received *RRCRelease* with *deprioritisationReq* or all the frequencies of NR to be the lowest priority frequency (i.e. lower than any of the network configured values) while T325 is running irrespective of camped RAT. The UE shall delete the stored deprioritisation request(s) when a PLMN selection is performed on request by NAS (3GPP TS 23.122 [9]).

NOTE: UE should search for a higher priority layer for cell reselection as soon as possible after the change of priority. The minimum related performance requirements specified in TS 38.133 [8] are still applicable.

The UE shall delete priorities provided by dedicated signalling when:

- the UE enters a different RRC state; or
- the optional validity time of dedicated priorities (T320) expires; or
- a PLMN selection is performed on request by NAS (3GPP TS 23.122 [9]).

NOTE 2: Equal priorities between RATs are not supported.

The UE shall not consider any black listed cells as candidate for cell reselection.

The UE shall inherit the priorities provided by dedicated signalling and the remaining validity time (i.e. T320 in NR and E-UTRA), if configured, at inter-RAT cell (re)selection.

NOTE 3: The network may assign dedicated cell reselection priorities for frequencies not configured by system information.

[TS 38.304, clause 5.2.4.2]

When evaluating *Srxlev* and *Squal* of non-serving cells for reselection purposes, the UE shall use parameters provided by the serving cell.

Following rules are used by the UE to limit needed measurements:

- If the serving cell fulfils $S_{rxlev} > S_{IntraSearchP}$ and $S_{qual} > S_{IntraSearchQ}$, the UE may choose not to perform intra-frequency measurements.
- Otherwise, the UE shall perform intra-frequency measurements.
- The UE shall apply the following rules for NR inter-frequencies and inter-RAT frequencies which are indicated in system information and for which the UE has priority provided as defined in 5.2.4.1:
 - For a NR inter-frequency or inter-RAT frequency with a reselection priority higher than the reselection priority of the current NR frequency, the UE shall perform measurements of higher priority NR inter-frequency or inter-RAT frequencies according to TS 38.133 [8].
 - For a NR inter-frequency with an equal or lower reselection priority than the reselection priority of the current NR frequency and for inter-RAT frequency with lower reselection priority than the reselection priority of the current NR frequency:
 - If the serving cell fulfils $S_{rxlev} > S_{nonIntraSearchP}$ and $S_{qual} > S_{nonIntraSearchQ}$, the UE may choose not to perform measurements of NR inter-frequencies or inter-RAT frequency cells of equal or lower priority;

- Otherwise, the UE shall perform measurements of NR inter-frequencies or inter-RAT frequency cells of equal or lower priority according to TS 38.133 [8].

[TS 38.304, clause 5.2.4.5]

If *threshServingLowQ* is broadcast in system information and more than 1 second has elapsed since the UE camped on the current serving cell, cell reselection to a cell on a higher priority NR frequency or inter-RAT frequency than the serving frequency shall be performed if:

- A cell of a higher priority NR or EUTRAN RAT/frequency fulfils $S_{qual} > Thresh_{X, HighQ}$ during a time interval $T_{reselection_{RAT}}$

Otherwise, cell reselection to a cell on a higher priority NR frequency or inter-RAT frequency than the serving frequency shall be performed if:

- A cell of a higher priority RAT/ frequency fulfils $S_{rxlev} > Thresh_{X, HighP}$ during a time interval $T_{reselection_{RAT}}$; and
- More than 1 second has elapsed since the UE camped on the current serving cell.

Cell reselection to a cell on an equal priority NR frequency shall be based on ranking for intra-frequency cell reselection as defined in sub-clause 5.2.4.6.

If *threshServingLowQ* is broadcast in system information and more than 1 second has elapsed since the UE camped on the current serving cell, cell reselection to a cell on a lower priority NR frequency or inter-RAT frequency than the serving frequency shall be performed if:

- The serving cell fulfils $S_{qual} < Thresh_{Serving, LowQ}$ and a cell of a lower priority NR or E-UTRAN RAT/ frequency fulfils $S_{qual} > Thresh_{X, LowQ}$ during a time interval $T_{reselection_{RAT}}$.

Otherwise, cell reselection to a cell on a lower priority NR frequency or inter-RAT frequency than the serving frequency shall be performed if:

- The serving cell fulfils $S_{rxlev} < Thresh_{Serving, LowP}$ and a cell of a lower priority RAT/ frequency fulfils $S_{rxlev} > Thresh_{X, LowP}$ during a time interval $T_{reselection_{RAT}}$; and
- More than 1 second has elapsed since the UE camped on the current serving cell.

Cell reselection to a higher priority RAT/frequency shall take precedence over a lower priority RAT/frequency if multiple cells of different priorities fulfil the cell reselection criteria.

If more than one cell meets the above criteria, the UE shall reselect a cell as follows:

- If the highest-priority frequency is an NR frequency, a cell ranked as the best cell among the cells on the highest priority frequency(ies) meeting the criteria according to section 5.2.4.6;
- If the highest-priority frequency is from another RAT, a cell ranked as the best cell among the cells on the highest priority frequency(ies) meeting the criteria of that RAT.

6.4.3.1.3 Test description

6.4.3.1.3.1 Pre-test conditions

System Simulator:

- NR Cell 1.
- NR Cell 1 is configured to operate in FR1 bands as defined in TS 38.508-1 [4] clause 6.2.3.
- System information combination NR-6 as defined in TS 38.508-1 [4] Table 4.4.3.1.2-1 is used in NR cell.
- E-UTRA Cell 1 and E-UTRA Cell 3.
- System information combination 31 as defined in TS 36.508 [7] Table 4.4.3.1.1-1 is used in E-UTRA cell 1 and E-UTRA cell 3.

UE:

- None.

Preamble:

- With E-UTRA Cell 1 "Serving cell" and NR Cell 1 "Non-suitable "Off" cell" in accordance with TS 38.508-1 [4], Table 6.2.2.1-3, the UE is brought to state RRC_IDLE using generic procedure parameters Connectivity (E-UTRA/EPC) and Unrestricted nr PDN (*On*) in accordance with the procedure described in TS 38.508-1 [4], clause 4.5.2. 4G GUTI and eKSI are assigned and security context established
- the UE is switched-off
- With E-UTRA Cell 1 "Non-suitable "Off" cell" and NR Cell 1 "Serving cell" in accordance with TS 38.508-1 [4], Table 6.2.2.1-3, the UE is brought to state 2N-A, RRC_INACTIVE Connectivity (NR), in accordance with the procedure described in TS 38.508-1 [4], Table 4.5.3.2-1. 5G-GUTI and ngKSI are assigned and security context established.

6.4.3.1.3.2 Test procedure sequence

Table 6.4.3.1.3.2-1 illustrates the downlink power levels and other changing parameters to be applied for the NR cells at various time instants of the test execution. The exact instants on which these values shall be applied are described in the texts in this clause. The configuration "T0" indicates the initial conditions. Subsequent configurations marked "T1" and "T2" are applied at the points indicated in the Main behaviour description in Table 6.4.3.1.3.2-3.

Table 6.4.3.1.3.2-1: Time instances of cell power level and parameter changes for conducted test environment

	Parameter	Unit	NR Cell 1	E-UTRA Cell 1	E-UTRA Cell 3	Remark
T0	Cell-specific RS EPRE	dBm/15kHz	-	Off	Off	The power level values are assigned to ensure the UE registered on NR Cell 1.
	SS/PBCH SSS EPRE	dBm/SCS	-88	-	-	
T1	Cell-specific RS EPRE	dBm/15kHz	-	-78	Off	The power level values are assigned to satisfy $Srxle_{VE-UTRA, Cell 1} > Thresh_{E-UTRA, Cell 1, HighP}$.
	SS/PBCH SSS EPRE	dBm/SCS	-88	-	-	
T2	Cell-specific RS EPRE	dBm/15kHz	-	Off	-76	The power level values are assigned to satisfy $Srxle_{VN, Cell 1} < Thresh_{serving, LowP}$, $Srxle_{VE-UTRA, Cell 3} > Thresh_{E-UTRA, Cell 3, lowP}$, and $Srxle_{VE-UTRA, Cell 1} < 0$.
	SS/PBCH SSS EPRE	dBm/SCS	-98	-	-	
Note 1: Power level "Off" of NR cell is defined in TS 38.508-1 [4] Table 6.2.2.1-3.						
Note 2: Power level "Off" of E-UTRA cell is defined in TS 36.508 [7] Table 6.2.2.1-3.						

Table 6.4.3.1.3.2-2: Void

Table 6.4.3.1.3.2-3: Main behaviour

St	Procedure	Message Sequence		TP	Verdict
		U - S	Message		
1	The SS changes E-UTRA Cell 1 SSS level according to the row "T1" in table 6.4.3.1.3.2-1.	-	-	-	-
2	Void	-	-	-	-
3	Check: Does the test result of generic test procedure in TS 38.508-1 [4] Table 4.9.7.2.2-1 indicate that the UE is camped on E-UTRA Cell 1?	-	-	1	P
4	The SS changes NR Cell 1 SSS levels according to the row "T0" in table 6.4.3.1.3.2-1.	-	-	-	-
5	Void	-	-	-	-

6	Steps of the generic test procedure in TS 38.508-1 [4] Table 4.9.9.2.2-1 are performed on NR Cell 1.	-	-	-	-
7	The SS transmits an <i>RRCRelease</i> message.	<--	NR RRC: <i>RRCRelease</i>	-	-
7A-7H	Steps 1-8 as defined in TS 38.508-1 [4] Table 4.5.4.2-3	-	-	-	-
7I	The SS transmits an <i>RRCRelease</i> message including <i>suspendConfig</i> with NR_RRC_INACTIVE condition.	<--	NR RRC: <i>RRCRelease</i>	-	-
8	The SS changes NR Cell 1, E-UTRA Cell 1 and E-UTRA Cell 3 SSS level according to the row "T2" in table 6.4.3.1.3.2-1.	-	-	-	-
9	Void	-	-	-	-
10	Check: Does the test result of generic test procedure in TS 38.508-1 [4] Table 4.9.7.2.2-1 indicate that the UE is camped on E-UTRA Cell 3 with condition ' <i>connected without release</i> '?	-	-	2	P
11	At the end of this test procedure sequence, the UE is in end state E-UTRA connected (E2_T3440) according to TS 36.508 [7].	-	-	-	-

6.4.3.1.3.3 Specific message contents

Table 6.4.3.1.3.3-1: SIB2 of NR Cell 1 (preamble and all steps, Table 6.4.3.1.3.2-3)

Derivation Path: TS 38.508-1 [4], Table 4.6.2-1			
Information Element	Value/remark	Comment	Condition
SIB2 ::= SEQUENCE {			
cellReselectionServingFreqInfo			
SEQUENCE {			
threshServingLowP	10	20 dB	
cellReselectionPriority	5		
}			
}			

Table 6.4.3.1.3.3-2: SIB5 of NR Cell 1 (preamble and all steps, Table 6.4.3.1.3.2-3)

Derivation Path: TS 38.508-1 [4], Table 4.6.2-4			
Information Element	Value/remark	Comment	Condition
SIB5 ::= SEQUENCE {			
carrierFreqListEUTRA SEQUENCE (SIZE (1..maxEUTRA-Carrier)) OF CarrierFreqEUTRA {	2 entries		
CarrierFreqEUTRA[1] SEQUENCE {		entry 1	
carrierFreq	Same downlink ARFCN as used for E-UTRA Cell 1		
cellReselectionPriority	6		
}			
CarrierFreqEUTRA[2] SEQUENCE {		entry 2	
carrierFreq	Same downlink ARFCN as used for E-UTRA Cell 3		
cellReselectionPriority	4		
}			
}			
}			

Table 6.4.3.1.3.3-3: SystemInformationBlockType24 for E-UTRA Cell 1 (preamble and all steps, Table 6.4.3.1.3.2-3)

Derivation path: 36.508 [7] table 4.4.3.3-20			
Information Element	Value/Remark	Comment	Condition
SystemInformationBlockType24-r15 ::= SEQUENCE {			

carrierFreqListNR-r15 SEQUENCE (SIZE (1..maxFreq)) OF CarrierFreqNR-r15 {	1 entry		
CarrierFreqNR-r15[1] SEQUENCE {		entry 1	
carrierFreq-r15	Same downlink ARFCN as used for NR Cell 1		
cellReselectionPriority-r15	5		
}			
}			
}			

Table 6.4.3.1.3.3-4: TRACKING AREA UPDATE REQUEST (Step 3, Table 6.4.3.1.3.2-3)

Derivation Path: TS 38.508-1 [4], Table 4.9.7.2.3-1			
Information Element	Value/remark	Comment	Condition
EPS update type			
EPS update type Value	'010'B	Combined TA/LA updating with IMSI attach	combined_TA_LA
	'000'B	TA updating	TA_only
NOTE: The message shall be integrity protected using the 5GS security context available in the UE.			

Table 6.4.3.1.3.3-5: TRACKING AREA UPDATE REQUEST (Step 10, Table 6.4.3.1.3.2-3)

Derivation Path: TS 38.508-1 [4], Table 4.9.7.2.3-1			
Information Element	Value/remark	Comment	Condition
EPS update type			
EPS update type Value	'001'B	Combined TA/LA updating	combined_TA_LA
	'000'B	TA updating	TA_only
UE radio capability information update needed	Not Check	UE radio capability information update needed	
NOTE: The message shall be integrity protected using the 5GS security context available in the UE.			

Condition	Explanation
TA_only	This condition applies if the UE is configured to initiate EPS attach or if explicitly specified.
combined_TA_LA	This condition applies if the UE is configured to initiate combined EPS/IMSI attach or if explicitly specified.

Table 6.4.3.1.3.3-6: REGISTRATION REQUEST (Step 6, Table 6.4.3.1.3.2-3)

Derivation Path: TS 38.508-1 [4], Table 4.7.1-6.			
Information Element	Value/remark	Comment	Condition
EPS NAS message container	TRACKING AREA UPDATE REQUEST message	See Table 6.4.3.1.3.3-7	

Table 6.4.3.1.3.3-7: TRACKING AREA UPDATE REQUEST (Table 6.4.3.1.3.3-6)

Derivation Path: TS 38.508-1 [4], Table 4.9.9.2.3-2 with condition Mapped EPS security context
--

Table 6.4.3.1.3.3-8: SystemInformationBlockType24 for E-UTRA Cell 3 (preamble and all steps, Table 6.4.3.1.3.2-3)

Derivation path: 36.508 [7] table 4.4.3.3-20			
Information Element	Value/Remark	Comment	Condition

SystemInformationBlockType24-r15 ::= SEQUENCE {			
carrierFreqListNR-r15 SEQUENCE (SIZE (1..maxFreq)) OF CarrierFreqNR-r15 {	1 entry		
CarrierFreqNR-r15[1] SEQUENCE {		entry 1	
carrierFreq-r15	Same downlink ARFCN as used for NR Cell 1		
threshX-High-r15	10		
}			
}			
}			

6.5 SNPN and CAG Selection

6.5.1 SNPN Only Selection

6.5.1.1 SNPN Selection in Manual Mode

6.5.1.1.1 Test Purpose (TP)

(1)

```
with { UE in Manual network/SNPN selection mode and an SNPN cell is available for which an entry
does not exist in the "list of subscriber data" }
ensure that {
  when { UE is switched on or return to coverage }
  then { UE does not indicate to the user any available SNPNS }
}
```

(2)

```
with { UE in Manual network/SNPN selection mode }
ensure that {
  when { an SNPN cell is available for which an entry exists in the "list of subscriber data" }
  then { UE indicates to the user that an SNPN is available and user selects the SNPN }
}
```

(3)

```
with { UE in Manual network/SNPN selection mode and has registered on an SNPN selected by the user }
ensure that {
  when { an SNPN cell is available for which an entry exists in the "list of subscriber data" }
  then { UE does not automatically register on the SNPN cell until the user selects automatic SNPN
selection mode }
}
```

6.5.1.1.2 Conformance requirements

References: The conformance requirements covered in the current TC are specified in: TS 23.122 clauses 4.9.3.1.0 and 4.9.3.1.2. Unless otherwise stated these are Rel-16 requirements.

[TS 23.122, clause 4.9.3.1.0]

At switch on, or following recovery from lack of coverage, the MS selects the registered SNPN (if it is available) using NG-RAN access technology and if necessary (in the case of recovery from lack of coverage, see subclause 4.5.2) attempts to perform an LR.

NOTE 1: The MS in automatic SNPN selection mode can end the SNPN search procedure once the registered SNPN is found on NG-RAN access technology.

NOTE 2: An MS in automatic SNPN selection mode can use location information to determine which SNPNS can be available in its present location.

If successful registration is achieved, the MS indicates the selected SNPN.

If there is no registered SNPN, or registration is not possible due to the SNPN being unavailable or registration failure, the MS follows the procedure in subclause 4.9.3.1.1 or subclause 4.9.3.1.2 depending on its SNPN selection mode. At switch on, the MS shall use the SNPN selection mode that was used before switching off.

NOTE 3: If successful registration is achieved, then the current serving SNPN becomes the registered SNPN and the MS does not store the previous registered SNPN for later use.

If registration is not possible on recovery from lack of coverage due to the registered SNPN being unavailable, an MS may, optionally, continue looking for the registered SNPN for an implementation dependent time.

NOTE 4: An MS registered to an SNPN should behave as described above only if one or more PDU sessions are currently active.

[TS 23.122, clause 4.9.3.1.2]

The MS indicates to the user one or more SNPNS, which are available and each of them is identified by an SNPN identity in an entry of the "list of subscriber data" in the ME. This includes SNPNS in the list of "permanently forbidden SNPNS", and the list of "temporarily forbidden SNPNS". The MS may indicate to the user whether the available SNPNS are present in the list of "temporarily forbidden SNPNS" or the list of "permanently forbidden SNPNS". The order in which those SNPNS are indicated is MS implementation specific.

For each of the SNPNS indicated to the user, the UE shall forward a human-readable network name along with the SNPN identity to the upper layers if the system information broadcasted for the SNPN includes the human-readable network name for the SNPN.

The MS shall limit its search for the SNPN to the NG-RAN access technology.

The user may select his desired SNPN and the MS then initiates registration on this SNPN using the NG-RAN access technology, the subscriber identifier and the credentials from an entry of the "list of subscriber data", with the SNPN identity matching the selected SNPN (this may take place at any time during the presentation of SNPNS).

Once the MS has registered on an SNPN selected by the user, the MS shall not automatically register on a different SNPN unless the user selects automatic SNPN selection mode.

NOTE: Emergency services are not supported in SNPN access mode.

If the user does not select an SNPN, the selected SNPN shall be the one that was selected either automatically or manually before the SNPN selection procedure started. If no such SNPN was selected or that SNPN is no longer available, then the MS shall attempt to camp on any acceptable cell and enter the limited service state.

6.5.1.1.3 Test description

6.5.1.1.3.1 Pre-test conditions

System Simulator:

- 3 SNPN cells: NR Cell 1, NR Cell 2, and NR Cell 4 are configured broadcasting default SNPN IDs as indicated in TS 38.508-1 [4] Table 4.4.2-4.
- System information combination NR-12 as defined in TS 38.508-1 [4] clause 4.4.3.1.2 is used in NR cells.

UE:

- The UE is in Manual SNPN selection mode.
- The UE is provisioned with a "list of subscriber data" to allow access to SNPN identified by NR Cell 2 and NR Cell 4.

Preamble:

- Ensure that the UE has cleared the Registered SNPN and the UE is in state Switched OFF (state 0-A).

6.5.1.1.3.2 Test procedure sequence

Table 6.5.1.1.3.2-1/2 shows the cell configurations used during the test. Subsequent configurations marked “T1”, “T2” “T3” “T4” etc are applied at the points indicated in the Main behaviour description in Table 6.5.1.1.3.2-3. Cell powers are chosen for a serving cell and a non-suitable “Off” cell as defined in TS 38.508-1 [4] Table 6.2.2.1-3 for FR1 and Table 6.2.2.2-2 for FR2.

Table 6.5.1.1.3.2-1: Time instances of cell power level and parameter changes for FR1

	Parameter	Unit	NR Cell 1	NR Cell 2	NR Cell 4	Remarks
T1	SS/PBCH SSS EPRE	dBm/SCS	-88	“Off”	“Off”	
T2	SS/PBCH SSS EPRE	dBm/SCS	-88	-88	“Off”	
T3	SS/PBCH SSS EPRE	dBm/SCS	-88	-88	-78	
T4	SS/PBCH SSS EPRE	dBm/SCS	-88	“Off”	-78	

Table 6.5.1.1.3.2-2: Time instances of cell power level and parameter changes for FR2

	Parameter	Unit	NR Cell 1	NR Cell 2	NR Cell 4	Remarks
T1	SS/PBCH SSS EPRE	dBm/SCS	FFS	FFS	FFS	
T2	SS/PBCH SSS EPRE	dBm/SCS	FFS	FFS	FFS	
T3	SS/PBCH SSS EPRE	dBm/SCS	FFS	FFS	FFS	
T4	SS/PBCH SSS EPRE	dBm/SCS	FFS	FFS	FFS	

Table 6.5.1.1.3.2-3: Main behaviour

St	Procedure	Message Sequence		TP	Verdict
		U - S	Message		
1	SS adjusts cell levels according to row T1 of table 6.5.1.1.3.2-1/2.	-	-	-	-
2	The UE is Switched ON.	-	-	-	-
3	Manual selection of SNPN identified by NR Cell 1 is performed (NOTE 1).	-	-	-	-
4	Check: Does the UE transmit an <i>RRCSetupRequest</i> on NR Cell 1 within the next 60 s?	-->	<i>RRCSetupRequest</i>	1	F
5	SS adjusts cell levels according to row T2 of table 6.5.1.1.3.2-1/2.	-	-	-	-
6	Manual selection of SNPN identified by NR Cell 2 is performed (NOTE 1).	-	-	-	-
7	Check: Does the UE send a <i>RRCSetupRequest</i> on NR Cell 2?	-->	<i>RRCSetupRequest</i>	2	P
8-25	Steps 3 to 20a1 of Table 4.5.2.2-2 of the generic procedure in TS 38.508-1 are performed on NR Cell 2.	-	-	-	-
26	SS adjusts cell levels according to row T3 of table 6.5.1.1.3.2-1/2.	-	-	-	-
27	Check: Does the UE send a <i>RRCSetupRequest</i> on NR Cell 4 within the next 60 s?	-->	<i>RRCSetupRequest</i>	3	F
28	SS adjusts cell levels according to row T4 of table 6.5.1.1.3.2-1/2	-	-	-	-
29	The user sets the UE in Automatic	-	-	-	-

	SNPN/Network selection mode (NOTE 1).				
30	Check: Does the UE send an <i>RRCSetupRequest</i> on NR Cell 4?	-->	<i>RRCSetupRequest</i>	3	P
31-47	Steps 3 to 20a1 of Table 4.5.2.2-2 of the generic procedure in TS 38.508-1 are performed on NR Cell 4.	-	-	-	-
NOTE 1: This is performed via MMI or AT command.					

6.5.1.1.3.3 Specific message contents

Table 6.5.1.1.3.3-1: REGISTRATION REQUEST (step 9, 32 Table 6.5.1.1.3.2-3)

Derivation path: TS 38.508-1 Table 4.7.1-6			
Information Element	Value/remark	Comment	Condition
5GS registration type value	'001'B	Initial registration	

6.5.1.2 SNPN Selection in Automatic Mode

6.5.1.2.1 Test Purpose (TP)

(1)

```
with { UE in Automatic SNPN selection mode and SNPN cell is available for which an entry does not exist in the "list of subscriber data" }
ensure that {
  when { UE is switched on or return to coverage }
  then { UE does not select the SNPN cell and continues searching for an allowable SNPN Cell }
}
```

(2)

```
with { UE in Automatic SNPN selection mode and a Registered SNPN cell along with another better ranked allowable SNPN cell becomes available }
ensure that {
  when { UE is switched on or return to coverage }
  then { UE selects the Registered SNPN cell and UE attempts a Registration on the selected cell }
}
```

(3)

```
with { UE in Automatic SNPN selection mode and Registration on a SNPN cell is unsuccessful}
ensure that {
  when { UE continues searching for an allowable SNPN Cell and a new allowable SNPN cell becomes available }
  then { the UE registers on the new SNPN cell }
}
```

6.5.1.2.2 Conformance requirements

References: The conformance requirements covered in the current TC are specified in: TS 23.122 clauses 4.9.3.1.0 and 4.9.3.1.1. Unless otherwise stated these are Rel-16 requirements.

[TS 23.122, clause 4.9.3.1.0]

At switch on, or following recovery from lack of coverage, the MS selects the registered SNPN (if it is available) using NG-RAN access technology and if necessary (in the case of recovery from lack of coverage, see subclause 4.5.2) attempts to perform an LR.

NOTE 1: The MS in automatic SNPN selection mode can end the SNPN search procedure once the registered SNPN is found on NG-RAN access technology.

NOTE 2: An MS in automatic SNPN selection mode can use location information to determine which SNPNs can be available in its present location.

If successful registration is achieved, the MS indicates the selected SNPN.

If there is no registered SNPN, or registration is not possible due to the SNPN being unavailable or registration failure, the MS follows the procedure in subclause 4.9.3.1.1 or subclause 4.9.3.1.2 depending on its SNPN selection mode. At switch on, the MS shall use the SNPN selection mode that was used before switching off.

NOTE 3: If successful registration is achieved, then the current serving SNPN becomes the registered SNPN and the MS does not store the previous registered SNPN for later use.

If registration is not possible on recovery from lack of coverage due to the registered SNPN being unavailable, an MS may, optionally, continue looking for the registered SNPN for an implementation dependent time.

NOTE 4: An MS registered to an SNPN should behave as described above only if one or more PDU sessions are currently active.

[TS 23.122, clause 4.9.3.1.0]

The MS selects another SNPN, if available, allowable, and identified by an SNPN identity in an entry of the "list of subscriber data" in the ME. If more than one SNPN are available, allowable, and each of them is identified by an SNPN identity in an entry of the "list of subscriber data" in the ME, how the MS selects one of those SNPNs is MS implementation specific.

The MS shall limit its search for the SNPN to the NG-RAN access technology.

Once the MS selects the SNPN, the MS attempts registrations on the selected SNPN using the NG-RAN access technology, the subscriber identifier and the credentials from an entry of the "list of subscriber data" with the SNPN identity matching the selected SNPN.

If successful registration is achieved, the MS indicates the selected SNPN.

If registration cannot be achieved because no SNPNs are available, allowable, and identified by an SNPN identity in an entry of the "list of subscriber data" in the ME, the MS indicates "no service" to the user, waits until a new SNPN is available, allowable, and identified by an SNPN identity in an entry of the "list of subscriber data" in the ME and then repeats the procedure.

If there were one or more SNPNs which were available, allowable, and identified by an SNPN identity in an entry of the "list of subscriber data" in the ME but an LR failure made registration on those SNPNs unsuccessful, the MS selects one of those SNPNs again and enters a limited service state.

6.5.1.2.3 Test description

6.5.1.2.3.1 Pre-test conditions

System Simulator:

- 3 SNPN cells NR Cell 1, NR cell 2, NR Cell 3 are configured broadcasting default SNPN IDs as indicated in TS 38.508-1 [4] Table 4.4.2-4.
- System information combination NR-12 as defined in TS 38.508-1 [4] clause 4.4.3.1.2 is used in NR cells.

UE:

- The UE is in Automatic SNPN selection mode.
- The UE is provisioned with a "list of subscriber data" to allow access to SNPN identified by NR cell 1 and NR cell 3.

Preamble:

- Ensure that the UE has cleared the Registered SNPN. And the UE is in state Switched OFF (state 0-A).

6.5.1.2.3.2 Test procedure sequence

Table 6.5.1.2.3.2-1/2 shows the cell configurations used during the test. Subsequent configurations marked “T1”, “T2” and “T3” are applied at the points indicated in the Main behaviour description in Table 6.5.1.2.3.2-3. Cell powers are chosen for a serving cell and a non-suitable “Off” cell as defined in TS 38.508-1 [4] Table 6.2.2.1-3 for FR1 and Table 6.2.2.2-2 for FR2.

Table 6.5.1.2.3.2-1: Time instances of cell power level and parameter changes for FR1

	Parameter	Unit	NR Cell 1	NR Cell 2	NR Cell 3	Remarks
T1	SS/PBCH SSS EPRE	dBm/SCS	“Off”	-88	“Off”	Power level “Off” is defined in TS 38.508-1 [4] Table 6.2.2.1-3.
T2	SS/PBCH SSS EPRE	dBm/SCS	-88	-88	“Off”	Power level “Off” is defined in TS 38.508-1 [4] Table 6.2.2.1-3.
T3	SS/PBCH SSS EPRE	dBm/SCS	-88	“Off”	-78	Power level “Off” is defined in TS 38.508-1 [4] Table 6.2.2.1-3.

Table 6.5.1.2.3.2-2: Time instances of cell power level and parameter changes for FR2

	Parameter	Unit	NR Cell 1	NR Cell 2	NR Cell 3	Remarks
T1	SS/PBCH SSS EPRE	dBm/SCS	“Off”	FFS	“Off”	Power level “Off” is defined in TS 38.508-1 [4] Table 6.2.2.1-3.
T2	SS/PBCH SSS EPRE	dBm/SCS	FFS	FFS	“Off”	Power level “Off” is defined in TS 38.508-1 [4] Table 6.2.2.1-3.
T3	SS/PBCH SSS EPRE	dBm/SCS	FFS	“Off”	FFS	Power level “Off” is defined in TS 38.508-1 [4] Table 6.2.2.1-3.

Table 6.5.1.2.3.2-3: Main behaviour

St	Procedure	Message Sequence		TP	Verdict
		U - S	Message		
1	SS adjusts cell levels according to row T1 of table 6.5.1.2.3.2-1/2.	-	-	-	-
2	Power on the UE.	-	-	-	-
3	Check: Does the UE transmit an <i>RRCSetupRequest</i> on NR Cell 2 within the next 60 s?	-->	NR RRC: <i>RRCSetupRequest</i>	1	F
4	SS adjusts cell levels according to row T2 of table 6.5.1.2.3.2-1/2.	-	-	-	-
5	Check: Does the UE send a <i>RRCSetupRequest</i> on NR Cell 1?	-->	NR RRC: <i>RRCSetupRequest</i>	1	P
6-23	Steps 3 to 20a1 of Table 4.5.2.2-2 of the generic procedure in TS 38.508-1 [4] are performed on NR Cell 1 with ‘ <i>connected without release</i> ’.	-	-	-	-
24	The UE is switched off by executing generic procedure in Table 4.9.6.3-1 in TS 38.508-1 [4]	-	-	-	-
25	SS adjusts cell levels according to row T3 of table 6.5.1.2.3.2-1/2.	-	-	-	-
26	The UE is Switched ON.	-	-	-	-
27	Check: Does the UE send a <i>RRCSetupRequest</i> on NR Cell 1?	-->	NR RRC: <i>RRCSetupRequest</i>	2	P
28-34	Steps 3-9 of Table 4.5.2.2-2 in TS38.508-1 [4] are performed on NR Cell 1.	-	-	-	-
35	The SS transmits a REGISTRATION REJECT with cause #75 (Permanently not authorized for this SNPN).	<--	NR RRC: <i>DLInformationTransfer</i> 5GMM: REGISTRATION REJECT	-	-
36	The SS releases the RRC connection	-	-	-	-
37	Check: Does the UE send a <i>RRCSetupRequest</i> on NR Cell 3?	-->	NR RRC: <i>RRCSetupRequest</i>	3	P

38-55	Steps 3 to 20a1 of Table 4.5.2.2-2 of the generic procedure in TS 38.508-1 [4] are performed on NR Cell 3.	-	-	-	-
56	The generic test procedure in TS 38.508-1 Table 4.9.6.1-1 of Switch off procedure in RRC_IDLE are performed.	-	-	-	-
57	The SS configures: - NR Cell 1 as the "Serving cell" - NR Cell 3 as a "Non-Suitable "off" cell".				
58	The UE is brought back to operation or the USIM is inserted. The UE is powered on or switched on.	-	-	-	-
59	The UE is made to perform manual SNPN search and select SNPN identified by NR Cell 1 (Note 1, Note 2).	-	-	-	-
60-78a1	Steps 2 to 20a1 of the registration procedure described in TS 38.508-1 [4] subclause 4.5.2 are performed on NR Cell 1.	-	-	-	-
79	The user sets the UE in Automatic SNPN/Network selection mode (Note 1).	-	-	-	-
Note 1: This is performed via MMI or AT command.					
Note 2: Step 59 is to ensure that UE clears NR Cell 1 from the "permanently forbidden SNPNs" list for the next test case.					

6.5.1.2.3.3 Specific message contents

Table 6.5.1.2.3.3-1: REGISTRATION REJECT for NR Cell 1 (step 35 Table 6.5.1.2.3.2-3)

Derivation Path: TS 38.508-1 [4], Table 4.7.1-9			
Information Element	Value/remark	Comment	Condition
5GMM cause	'01001011'B	#75 (Permanently not authorized for this SNPN).	

Table 6.5.1.2.3.3-2: REGISTRATION REQUEST (step 39, Table 6.5.1.2.3.2-3)

Derivation path: TS 38.508-1 Table 4.7.1-6			
Information Element	Value/remark	Comment	Condition
5GS registration type value	'001'B	Initial registration	

6.5.1.3 SNPN / User Reselection in Automatic Mode

6.5.1.3.1 Test Purpose (TP)

(1)

with { UE in Automatic SNPN selection mode and registered on an SNPN cell for which an entry exists in the "list of subscriber data" and another SNPN cell is made available for which an entry exists in the "list of subscriber data" }

ensure that {
 when { UE is requested to initiate reselection and registration onto an available SNPN }
 then { UE reselects to the SNPN cell }
}

6.5.1.3.2 Conformance requirements

References: The conformance requirements covered in the current TC are specified in: TS 23.122 clauses 4.9.3.2.0 and 4.9.3.2.1. Unless otherwise stated these are Rel-16 requirements.

[TS 23.122, clause 4.9.3.2.0]

At any time the user may request the MS to initiate reselection and registration onto an available SNPN, according to the following procedures, dependent upon the SNPN selection mode of the UE.

[TS 23.122, clause 4.9.3.2.1]

The MS selects an SNPN, if available, allowable, and identified by an SNPN identity in an entry of the "list of subscriber data" in the ME in accordance with the following order:

- i) an SNPN, which is available and identified by an SNPN identity in an entry of the "list of subscriber data" in the ME, excluding the previously selected SNPN. If more than one SNPN different from the previously selected SNPN are available, allowable, and each of them is identified by an SNPN identity in an entry of the "list of subscriber data" in the ME, how the MS selects one of those SNPNs is MS implementation specific.
- ii) the previously selected SNPN.

The MS shall limit its search for the SNPN to the NG-RAN access technology.

The previously selected SNPN is the SNPN which the MS has selected prior to the start of the user reselection procedure.

Once the MS selects an SNPN, if the selected SNPN is other than the previously selected SNPN, the MS attempts registrations on the selected SNPN using the NG-RAN access technology, the subscriber identifier and the credentials from an entry of the "list of subscriber data" with the SNPN identity matching the selected SNPN.

NOTE: If the previously selected SNPN is selected, and registration has not been attempted on any other SNPNs, then the MS is already registered on the SNPN, and so registration is not necessary.

6.5.1.3.3 Test description

6.5.1.3.3.1 Pre-test conditions

System Simulator:

- 2 SNPN cells NR Cell 1, NR Cell 2 are configured broadcasting default SNPN IDs as indicated in TS 38.508-1 [4] Table 4.4.2-4.
- System information combination NR-12 as defined in TS 38.508-1 [4] clause 4.4.3.1.2 is used in NR cells.

UE:

- The UE is in Automatic SNPN selection mode.
- The UE is provisioned with a "list of subscriber data" to allow access to SNPN identified by NR cell 1 and NR cell 2.

Preamble:

- Ensure that the UE has cleared the Registered SNPN. And the UE is in state Switched OFF (state 0-B).

6.5.1.3.3.2 Test procedure sequence

Table 6.5.1.3.3.2-1/2 shows the cell configurations used during the test. Subsequent configurations marked "T1" and "T2" are applied at the points indicated in the Main behaviour description in Table 6.5.1.3.3.2-3. Cell powers are chosen for a serving cell and a non-suitable "Off" cell as defined in TS 38.508-1 [4] Table 6.2.2.1-3 for FR1 and Table 6.2.2.2-2 for FR2.

Table 6.5.1.3.3.2-1: Time instances of cell power level and parameter changes for FR1

	Parameter	Unit	NR Cell 1	NR Cell 2	Remarks
T1	SS/PBCH SSS EPRE	dBm/SCS	-88	"Off"	Power level "Off" is defined in TS 38.508-1 [4] Table 6.2.2.1-3.

T2	SS/PBCH SSS EPRE	dBm/SCS	-88	-88	Power level "Off" is defined in TS 38.508-1 [4] Table 6.2.2.1-3.
-----------	---------------------	---------	-----	-----	---

Table 6.5.1.3.3.2-2: Time instances of cell power level and parameter changes for FR2

	Parameter	Unit	NR Cell 1	NR Cell 2	Remarks
T1	SS/PBCH SSS EPRE	dBm/SCS	FFS	"Off"	Power level "Off" is defined in TS 38.508-1 [4] Table 6.2.2.1-3.
T2	SS/PBCH SSS EPRE	dBm/SCS	FFS	FFS	Power level "Off" is defined in TS 38.508-1 [4] Table 6.2.2.1-3.

Table 6.5.1.3.3.2-3: Main behaviour

St	Procedure	Message Sequence		TP	Verdict
		U - S	Message		
1	SS adjusts cell levels according to row T1 of table 6.5.1.3.3.2-1/2.	-	-	-	-
2	Power on the UE.	-	-	-	-
3-22	Steps 1 to 20a1 of Table 4.5.2.2-2 of the generic procedure in TS 38.508-1 [4] are performed on NR Cell 1 with 'connected without release'.	-	-	-	-
23	SS adjusts cell levels according to row T2 of table 6.5.1.3.3.2-1/2.	-	-	-	-
24	Cause the UE in Automatic network selection mode to initiate user reselection and registration onto an available SNPN identified by NR cell 2. (Note 1)	-	-	-	-
25	Check: Does the UE send a <i>RRCSetupRequest</i> on NR Cell 2?	-->	NR RRC: <i>RRCSetupRequest</i>	1	P
26-44a 1	Steps 2 to 20a1 of the generic test procedure in TS 38.508-1 Table 4.5.2.2-2 are performed on NR Cell 2. (Note 2)	-	-	-	-
Note 1: MMI command "TRIGGER_USER_RESELECTION" to be used. AT command AT+COPS is not suitable to achieve the test purpose.					
Note 2: The 5GS registration type shall be only set as 'Initial Registration' according to TS 24.501 subclause 5.2.3.2.5 specified in Release 16.					

6.5.1.3.3.3 Specific message contents

Table 6.5.1.3.3.3-1: REGISTRATION REQUEST (step 27, Table 6.5.1.3.3.2-3)

Derivation path: TS 38.508-1 Table 4.7.1-6			
Information Element	Value/remark	Comment	Condition
5GS registration type value	'001'B	Initial registration	

6.5.2 CAG (Closed Access Group)

6.5.2.1 CAG Selection in Manual Mode

6.5.2.1.1 Test Purpose (TP)

(1)

with { UE in Manual network selection mode and provided with CAG information list }

```

ensure that {
  when { there exists an entry with the PLMN ID of the PLMN in the "CAG information list" and the
  CAG-ID is included in the "Allowed CAG list" }
    then { UE manually selects the CAG cell }
}

```

(2)

```

with { UE in Manual network selection mode and PLMN ID of the PLMN in the "CAG information list" and
the CAG-ID are not included in the "Allowed CAG list" }
ensure that {
  when { the available CAG cell broadcasts that the PLMN allows a user to manually select the CAG-ID
}
  then { UE manually selects the CAG cell that is outside the UE's Allowed CAG list }
}

```

(3)

```

with { UE in Manual network selection mode }
ensure that {
  when { there exists an entry for the presented PLMN in the "CAG information list" and the entry
includes an "indication that the MS is only allowed to access 5GS via CAG cells" }
    then { UE manually selects the CAG cell }
}

```

6.5.2.1.2 Conformance requirements

References: The conformance requirements covered in the present TC are specified in: TS 23.122, clause 4.4.3.1.2. Unless otherwise stated these are Rel-16 requirements.

[TS 23.122, clause 4.4.3.1.2]

The MS indicates whether there are any PLMNs, which are available using all supported access technologies. This includes PLMNs in the "forbidden PLMNs" list, "forbidden PLMNs for GPRS service" list and PLMNs which only offer services not supported by the MS. An MS which supports GSM COMPACT shall also indicate GSM COMPACT PLMNs (which use PBCCH).

If displayed, PLMNs meeting the criteria above are presented in the following order:

- i)- either the HPLMN (if the EHPLMN list is not present or is empty) or, if one or more of the EHPLMNs are available then based on an optional data field on the SIM either only the highest priority available EHPLMN is to be presented to the user_or all available EHPLMNs are presented to the user in priority order. If the data field is not present on the SIM, then only the highest priority available EHPLMN is presented;
- ii)- PLMN/access technology combinations contained in the " User Controlled PLMN Selector with Access Technology " data file in the SIM (in priority order);
- iii)- PLMN/access technology combinations contained in the "Operator Controlled PLMN Selector with Access Technology" data file in the SIM (in priority order) or stored in the ME (in priority order);
- iv)- other PLMN/access technology combinations with received high quality signal in random order;
- v)- other PLMN/access technology combinations in order of decreasing signal quality.

...

In i to v, if the MS supports CAG, for each PLMN/access technology combination of NG-RAN access technology, the MS shall present to the user:

- a) the PLMN/access technology combination and a list of CAG-IDs composed of one or more CAG-IDs such that for each CAG-ID:
 - 1) there is an available CAG cell which broadcasts the CAG-ID for the PLMN; and
 - 2) the following is true:
 - i) there exists an entry with the PLMN ID of the PLMN in the "CAG information list" and the CAG-ID is included in the "Allowed CAG list" of the entry; or

- ii) the available CAG cell broadcasting the CAG-ID for the PLMN also broadcasts that the PLMN allows a user to manually select the CAG-ID.

For each of the presented CAG-ID, the MS may indicate to the user whether the CAG-ID is present in the "Allowed CAG list" stored in the UE; and

- b) the PLMN/access technology combination without a list of CAG-IDs, if there is an available NG-RAN cell which is not a CAG cell for the PLMN. If there exists an entry for the presented PLMN in the "CAG information list" and the entry includes an "indication that the MS is only allowed to access 5GS via CAG cells", the MS may indicate to the user that the MS is only allowed to access the PLMN via CAG cells.

6.5.2.1.3 Test description

6.5.2.1.3.1 Pre-test conditions

System Simulator:

- NR Cell 1, NR Cell 2 and NR Cell 4.
- NR Cell 2 and NR Cell 4 are CAG cells.
- System information combination NR-2 as defined in TS 38.508-1 [4] clause 4.4.3.1.2 is used for NR Cell 1, NR Cell 2 and NR Cell 4.
- The PLMNs are identified in the test by the identifiers in Table 6.5.2.1.3.1-1 and the PLMN settings are defined in TS 36.523-1 [13] table 6.0.1-1.

Table 6.5.2.1.3.1–1: PLMN and CAG identifiers

NR Cell	PLMN name	CAG IDs
1	PLMN 1	-
2	PLMN 3	1
4	PLMN 2	2

UE:

None.

Preamble:

- The UE is registered on NR Cell 1 using the procedure described in TS 38.508-1 [4] clause 4.5.2.2 except that the REGISTRATION ACCEPT message includes CAG information list with CAG-ID 1.
- The UE is set to Manual PLMN selection mode before it is in state Switched OFF (State 0N-B) as per TS 38.508-1 [4] Table 4.4A.2-0.

6.5.2.1.3.2 Test procedure sequence

Table 6.5.2.1.3.2-1 for FR1 and Table 6.5.2.1.3.2-2 for FR2 illustrate the downlink power to be applied for the cells at various time instants of the test execution. The configuration T0 indicates the initial conditions for preamble. Configurations marked "T1", "T2" and "T3" are applied at the points indicated in the Main behaviour description in Table 6.5.2.1.3.2-3.

Table 6.5.2.1.3.2-1: Time instances of cell power level and parameter changes for FR1

	Parameter	Unit	NR Cell 1	NR Cell 2	NR Cell 4	Remarks
T0	SS/PBCH SSS EPRE	dBm/SCS	-88	"Off"	"Off"	Power level "Off" is defined in TS 38.508-1 [4] Table 6.2.2.1-3
T1	SS/PBCH SSS EPRE	dBm/SCS	"Off"	-88	"Off"	Power level "Off" is defined in TS 38.508-1 [4] Table 6.2.2.1-3
T2	SS/PBCH SSS EPRE	dBm/SCS	"Off"	"Off"	-88	Power level "Off" is defined in TS 38.508-1 [4] Table 6.2.2.1-3

T3	SS/PBCH SSS EPRE	dBm/SCS	"Off"	-88	"Off"	Power level "Off" is defined in TS 38.508-1 [4] Table 6.2.2.1-3
-----------	---------------------	---------	-------	-----	-------	---

Table 6.5.2.1.3.2-2: Time instances of cell power level and parameter changes for FR2

	Parameter	Unit	NR Cell 1	NR Cell 2	NR Cell 4	Remarks
T0	SS/PBCH SSS EPRE	dBm/SCS	FFS	FFS	FFS	
T1	SS/PBCH SSS EPRE	dBm/SCS	FFS	FFS	FFS	
T2	SS/PBCH SSS EPRE	dBm/SCS	FFS	FFS	FFS	
T3	SS/PBCH SSS EPRE	dBm/SCS	FFS	FFS	FFS	

Table 6.5.2.1.3.2-3: Main behaviour

St	Procedure	Message Sequence		TP	Verdict
		U - S	Message		
1	The SS changes cell power levels according to row "T1" in Table 6.5.2.1.3.2-1 for FR1 and Table 6.5.2.1.3.2-2 for FR2.	-	-	-	-
2	The UE is switched on.	-	-	-	-
3	The UE is made to perform manual CAG selection and selects NR Cell 2.	-	-	-	-
4	Check: Does the UE send a <i>RRCSetupRequest</i> on NR Cell 2?	-->	NR RRC: <i>RRCSetupRequest</i>	1	P
5-22	Steps 3-20a1 of Table 4.5.2.2-2 of the generic procedure in TS 38.508-1 [4] are performed on NR Cell 2. Note: The UE performs initial registration procedure with REGISTRATION ACCEPT message including CAG information list with PLMN ID 2 and CAG only indication and the RRC connection is released.	-	-	-	-
23	The SS changes cell power levels according to row "T2" in Table 6.5.2.1.3.2-1 for FR1 and Table 6.5.2.1.3.2-2 for FR2.	-	-	-	-
24	The UE is made to perform manual CAG selection and select NR Cell 4.	-	-	-	-
25	Void	-	-	-	-
26-27 A	Steps 1 to 3 of the test procedure to check that UE is camped on a new cell belonging to a new TA as specified in TS 38.508-1 [4] subclause 4.9.5 are performed on NR Cell 4.	-	-	2	P
28-36	Void	-	-	-	-
37	The SS transmits a <i>DLInformationTransfer</i> message and a REGISTRATION ACCEPT message.	<--	NR RRC: <i>DLInformationTransfer</i> 5G MM: REGISTRATION ACCEPT	-	-
38-39	Steps 5 to 6a1 of the test procedure to check that UE is camped on a new cell belonging to a new TA as specified in TS 38.508-1 [4] subclause 4.9.5 are performed on NR Cell 4.	-	-	-	-
40-43	Void	-	-	-	-
44	Void	-	-	-	-
45	Void	-	-	-	-
46	Void	-	-	-	-
46 A	The SS changes cell power levels according to row "T3" in Table 6.5.2.1.3.2-1 for FR1 and Table 6.5.2.1.3.2-2 for FR2.	-	-	-	-

47	The UE is made to perform manual CAG selection and select NR Cell 2.			-	-
48	Void	-	-	-	-
49-53 A	Steps 1-6a1 of the test procedure to check that UE is camped on a new cell belonging to a new TA as specified in TS 38.508-1 [4] subclause 4.9.5 are performed on NR Cell 2.	-	-	3	P

6.5.2.1.3.3 Specific message contents

Table 6.5.2.1.3.3-1: REGISTRATION REQUEST (Preamble)

Derivation path: TS 38.508-1 [4], Table 4.7.1-6			
Information Element	Value/Remark	Comment	Condition
5GS registration type	'0000 0001'B	Initial registration	
5GMM capability			
CAG	'1'B	CAG supported	

Table 6.5.2.1.3.3-2: REGISTRATION ACCEPT (Preamble)

Derivation path: TS 38.508-1 [4], Table 4.7.1-7			
Information Element	Value/Remark	Comment	Condition
CAG information list		MCC : 003; MNC : 21; CAG only : 0; CAG-ID 1 : 1	
Length of CAG information list contents	0000 0000 '0000 1001'B		
Entry 1			
Length of entry contents	'0000 1000'B		
MCC	MCC of NR Cell 2	See TS 38.508-1 [4] Table 4.4.2-3	
MNC	MNC of NR Cell 2	See TS 38.508-1 [4] Table 4.4.2-3	
CAG only	'0'B		
CAG_ID 1	1	CAG ID is coded as a 32 bit BITSTRING	

Table 6.5.2.1.3.3-3: REGISTRATION ACCEPT (Step 16, Table 6.5.2.1.3.2-3)

Derivation path: TS 38.508-1 [4], Table 4.7.1-7			
Information Element	Value/Remark	Comment	Condition
CAG information list		MCC : 003; MNC : 21; CAG only : 1; CAG-ID 1 : 1	
Length of CAG information list contents	'0000 0000 0000 1001'B		
Entry 1			
Length of entry contents	'0000 1000'B		
MCC	MCC of NR Cell 2	See TS 38.508-1 [4] Table 4.4.2-3	
MNC	MNC of NR Cell 2	See TS 38.508-1 [4] Table 4.4.2-3	
CAG only	'1'B		
CAG_ID 1	1	CAG ID is coded as a 32 bit BITSTRING	

Table 6.5.2.1.3.3-4: SIB1 for NR Cell 4 (all steps in T2, Table 6.5.2.1.3.2-3)

Derivation path: TS 38.508-1 [4], Table 4.6.1-28 with condition SNPN and CAG			
Information Element	Value/Remark	Comment	Condition
SIB1 ::= SEQUENCE {			

}			
}			
}			
}			
}			

6.5.2.2 CAG Selection in Automatic Mode

6.5.2.2.1 Test Purpose (TP)

(1)

```
with { UE in Automatic network selection mode and provisioned with an empty "CAG information list" }
ensure that {
  when { UE is switched on or returned to coverage, and a cell which is not a CAG cell becomes
available }
  then { UE selects the cell }
}
```

(2)

```
with { UE in Automatic network selection mode provisioned with a "CAG information list" }
ensure that {
  when { UE is switched on or returned to coverage, and a CAG cell with a CAG-ID present in the
"Allowed CAG list" becomes available }
  then { UE selects the CAG cell }
}
```

(3)

```
with { UE in Automatic network selection mode provisioned with a "CAG information list" }
ensure that {
  when { UE is switched on and a cell which is not a CAG cell becomes available, and there is an
entry with the PLMN ID of the PLMN in the "CAG information list" but the "indication that the MS is
only allowed to access 5GS via CAG cells" is not included in the entry }
  then { UE selects the cell }
}
```

6.5.2.2.2 Conformance requirements

References: The conformance requirements covered in the present TC are specified in: TS 23.122 clauses 3.8, and 4.4.3.1.1. Unless otherwise stated these are Rel-16 requirements.

[TS 23.122, clause 3.8]

The MS may support CAG.

If the MS supports CAG, the MS can be provisioned with a "CAG information list", consisting of zero or more entries, each containing:

- a) a PLMN ID;
- b) an "Allowed CAG list". The "Allowed CAG list" contains zero or more CAG-IDs; and
- c) an optional "indication that the MS is only allowed to access 5GS via CAG cells".

The "CAG information list" is stored in the ME.

NOTE: When the UE is registering or registered to a PLMN other than the HPLMN or EHPLMN, then the HPLMN will send a "CAG information list" consisting of CAG subscription information related to the serving PLMN only. When the UE is registering or registered to the HPLMN or EHPLMN then the HPLMN or EHPLMN can send CAG subscription information related to any PLMN in the "CAG information list".

If the MS supports CAG and a PLMN is selected as described in subclause 4.4.3.1.1, the automatic CAG selection is performed as part of subclause 4.4.3.1.1.

If the MS supports CAG and a PLMN is selected as described in subclause 4.4.3.1.2, the manual CAG selection is performed as part of subclause 4.4.3.1.2.

The NAS shall provide the AS with a "CAG information list", if available. If the contents of the "CAG information list" have changed, the NAS shall provide an updated "CAG information list" to the AS.

[TS 23.122, clause 4.4.3.1.1]

The MS selects and attempts registration on other PLMN/access technology combinations, if available and allowable, in the following order:

- i) either the HPLMN (if the EHPLMN list is not present or is empty) or the highest priority EHPLMN that is available (if the EHPLMN list is present) ;
- ii) each PLMN/access technology combination in the "User Controlled PLMN Selector with Access Technology" data file in the SIM (in priority order);
- iii) each PLMN/access technology combination in the "Operator Controlled PLMN Selector with Access Technology" data file in the SIM (in priority order) or stored in the ME (in priority order);
- iv) other PLMN/access technology combinations with received high quality signal in random order;
- v) other PLMN/access technology combinations in order of decreasing signal quality.

When following the above procedure the following requirements apply:

...

m) In i to v, if the MS supports CAG and:

1) is provisioned with a non-empty "CAG information list", the MS shall consider a PLMN indicated by an NG-RAN cell only if:

A) the cell is a CAG cell and broadcasts a CAG-ID for the PLMN such that there exists an entry with the PLMN ID of the PLMN in the "CAG information list" and the CAG-ID is included in the "Allowed CAG list" of the entry; or

B) the cell is not a CAG cell and:

- there is no entry with the PLMN ID of the PLMN in the "CAG information list"; or
- there exists an entry with the PLMN ID of the PLMN in the "CAG information list" but the "indication that the MS is only allowed to access 5GS via CAG cells" is not included in the entry; or

2) is provisioned with an empty "CAG information list" or is not provisioned with a "CAG information list", the MS shall consider a PLMN indicated by an NG-RAN cell only if the cell is not a CAG cell.

n) In i to v, if the MS only supports control plane CIoT 5GS optimization (see 3GPP TS 23.501 [62]) and the MS camps on an E-UTRA cell connected to 5GCN, which is not NB-IoT cell (see 3GPP TS 36.304 [43], 3GPP TS 36.331 [22]), the MS shall not consider PLMNs which do not advertise support of 5GS services with control plane CIoT 5GS optimization.

o) In i to v, if the MS supports CIoT 5GS optimizations, the MS shall not consider the PLMN/access technology combinations for which the MS preferred CIoT network behaviour is not advertised as supported by the PLMN/access technology combination (see 3GPP TS 24.501 [64]).

NOTE 7: As an implementation option, the MS supporting CIoT 5GS optimizations that was not able to select any PLMN according to o) can perform a second iteration of i to v with no restriction.

p) In iii, the MS shall use the PLMN/access technology combination in the "Operator Controlled PLMN Selector with Access Technology" stored in the ME, if the last received steering of roaming information contains the "list of preferred PLMN/access technology combinations"(see annex C) and is stored in the ME. Otherwise, the MS shall use the "Operator Controlled PLMN Selector with Access Technology" list retrieved from the SIM.

If successful registration is achieved, the MS indicates the selected PLMN.

If registration cannot be achieved because no PLMNs are available and allowable, and the MS does not support access to RLOS, the MS indicates "no service" to the user, waits until a new PLMN is available and allowable and then repeats the procedure.

If there were one or more PLMNs which were available and allowable, but an LR failure made registration on those PLMNs unsuccessful or an entry in any of the lists "forbidden location areas for roaming", "forbidden tracking areas for roaming", "5GS forbidden tracking areas for roaming", "forbidden location areas for regional provision of service", "forbidden tracking areas for regional provision of service", "5GS forbidden tracking areas for regional provision of service", or "CAG information list" prevented a registration attempt, the MS selects the first such PLMN again and enters a limited service state.

...

6.5.2.2.3 Test description

6.5.2.2.3.1 Pre-test conditions

System Simulator:

- NR Cell 1, NR Cell 2, NR Cell 4 and NR Cell 11.
- NR Cell 2 and NR Cell 4 are CAG cells.
- System information combination NR-2 as defined in TS 38.508-1 [4] clause 4.4.3.1.2 is used for NR Cell 1, NR Cell 2, NR Cell 4 and NR Cell 11.
- The PLMNs are identified in the test by the identifiers in Table 6.5.2.2.3.1-1 and the PLMN settings are defined in TS 36.523-1 [13] table 6.0.1-1.

Table 6.5.2.2.3.1-1: PLMN identifiers

NR Cell	PLMN name	CAG IDs
2	PLMN2	1
4	PLMN3	2
11	PLMN2	-

UE:

- The UE is in Automatic PLMN selection mode.
- There is an empty "CAG information list" provisioned in the UE.

Preamble:

- The UE is registered on NR Cell 1 using the procedure described in TS 38.508-1 [4] clause 4.5.2.2 except that the REGISTRATION ACCEPT message includes an empty CAG information list before it is in state Switched OFF (State ON-B).

6.5.2.2.3.2 Test procedure sequence

Table 6.5.2.2.3.2-1 for FR1 and 6.5.2.2.3.2-2 for FR2 illustrate the downlink power levels to be applied for the cells at various time instants of the test execution. Row marked "T0" denotes the initial conditions after preamble, while columns marked "T1", "T2" and "T3" are to be applied subsequently in the Main behaviour. The exact instants on which these values shall be applied are described in the texts in this clause. Cell powers are chosen for a serving cell and a non-suitable "Off" cell as defined in TS 38.508-1 [4] Table 6.2.2.1-3 for FR1 and Table 6.2.2.2-2 for FR2.

Table 6.5.2.3.2-1: Cell configuration changes over time for FR1

	Parameter	Unit	NR Cell 1	NR Cell 2	NR Cell 4	NR Cell 11	Remarks
T0	SS/PBCH SSS EPRE	dBm/SCS	-88	"Off"	"Off"	"Off"	
T1	SS/PBCH SSS EPRE	dBm/SCS	"Off"	"Off"	-88	"Off"	
T2	SS/PBCH SSS EPRE	dBm/SCS	"Off"	-88	"Off"	"Off"	
T3	SS/PBCH SSS EPRE	dBm/SCS	"Off"	"Off"	"Off"	-88	

Table 6.5.2.3.2-2: Cell configuration changes over time for FR2

	Parameter	Unit	NR Cell 1	NR Cell 2	NR Cell 4	NR Cell 11	Remarks
T0	SS/PBCH SSS EPRE	dBm/SCS	FFS	"Off"	FFS	"Off"	
T1	SS/PBCH SSS EPRE	dBm/SCS	"Off"	"Off"	FFS	"Off"	
T2	SS/PBCH SSS EPRE	dBm/SCS	"Off"	FFS	FFS	"Off"	
T3	SS/PBCH SSS EPRE	dBm/SCS	"Off"	"Off"	"Off"	FFS	

Table 6.5.2.3.2-3: Main behaviour

St	Procedure	Message Sequence		TP	Verdict
		U - S	Message		
1	Power on the UE.	-	-	-	-
2	Check: Does the UE send a <i>RRCSetupRequest</i> on NR Cell 1?	-->	NR RRC: <i>RRCSetupRequest</i>	1	P
3-13	Steps 3 to 13 of the registration procedure described in TS 38.508-1 [4] subclause 4.5.2.2 are performed on NR Cell 1. NOTE: The UE starts registration.	-	-	-	-
14	The SS transmits a <i>DLInformationTransfer</i> message and a REGISTRATION ACCEPT message containing the CAG information list with the CAG ID of NR Cell 2.	<--	NR RRC: <i>DLInformationTransfer</i> 5G MM: REGISTRATION ACCEPT	-	-
15-20a1	Steps 15 to 20a1 of the registration procedure described in TS 38.508-1 [4] subclause 4.5.2.2 are performed on NR Cell 1. NOTE: The UE completes registration and the RRC connection is released.	-	-	-	-
21	The UE is switched off by executing generic procedure in Table 4.9.6.1-1 in TS 38.508-1 [4]	-	-	-	-
22	SS adjusts cell levels according to row T1 of table 6.5.2.3.2-1 for FR1 and table 6.5.2.3.2-2 for FR2.	-	-	-	-
23	Power on the UE.	-	-	-	-
24	Check: Does the UE send a <i>RRCSetupRequest</i> on NR Cell 4 within the next 60 s?	-->	NR RRC: <i>RRCSetupRequest</i>	2	F
25	SS adjusts cell levels according to row T2 of table 6.5.2.3.2-1 for FR1 and table 6.5.2.3.2-2 for FR2.	-	-	-	-
26	Check: Does the UE send a <i>RRCSetupRequest</i> on NR Cell 2?	-->	NR RRC: <i>RRCSetupRequest</i>	2	P
27-44a1	Steps 3 to 20a1 of the registration procedure described in TS 38.508-1 [4] subclause 4.5.2.2 are performed on NR Cell 2.	-	-	-	-

	NOTE: The UE completes registration and the RRC connection is released.				
45	The UE is switched off by executing generic procedure in Table 4.9.6.1-1 in TS 38.508-1 [4]	-	-	-	-
46	SS adjusts cell levels according to row T3 of table 6.5.2.2.3.2-1 for FR1 and table 6.5.2.2.3.2-2 for FR2.	-	-	-	-
47	Power on the UE.	-	-	-	-
48	Check: Does the UE send a <i>RRCSetupRequest</i> on NR Cell 11?	-->	NR RRC: <i>RRCSetupRequest</i>	3	P
49-66a 1	Steps 3 to 20a1 of the registration procedure described in TS 38.508-1 [4] subclause 4.5.2.2 are performed on NR Cell 11. NOTE: The UE performs registration and the RRC connection is released.	-	-	-	-

6.5.2.2.3.3 Specific message contents

Table 6.5.2.2.3.3-1: REGISTRATION ACCEPT (step 14, Table 6.5.2.2.3.2-3)

Derivation path: TS 38.508-1 [4], table 4.7.1-7			
Information Element	Value/Remark	Comment	Condition
CAG information list		MCC : 002; MNC : 11; CAG only : 0; CAG-ID 1 : 1	
Length of CAG information list contents	'0000 0000 0001 0010'B		
Entry 1			
Length of entry contents	'0000 1000'B		
MCC	MCC of NR Cell 2	See Table 6.5.2.2.3.1-1	
MNC	MNC of NR Cell 2	See Table 6.5.2.2.3.1-1	
CAG only	'0'B		
CAG_ID 1	1	CAG ID is coded as a 32 bit BITSTRING	
Entry 1			
Length of entry contents	'0000 1000'B		
MCC	MCC of NR Cell 4	See Table 6.5.2.2.3.1-1	
MNC	MNC of NR Cell 4	See Table 6.5.2.2.3.1-1	
CAG only	'1'B		
CAG_ID 1	4	CAG ID is coded as a 32 bit BITSTRING	
Equivalent PLMNs	PLMN2		

Table 6.5.2.2.3.3-2: REGISTRATION ACCEPT (Preamble)

Derivation path: TS 38.508-1 [4], table 4.7.1-7			
Information Element	Value/Remark	Comment	Condition
CAG information list			
Length of CAG information list contents	'0000 0000'B		
Entry 1	Not present		

Table 6.5.2.2.3.3-3: SIB1 for NR Cell 2 (all steps in Table 6.5.2.2.3.2-3)

Derivation path: TS 38.508-1 [4], Table 4.6.1-28 with condition SNPN and CAG			
Information Element	Value/Remark	Comment	Condition
SIB1 ::= SEQUENCE {			
CellAccessRelatedInfo SEQUENCE {			

}			
}			

6.5.2.3 CAG / Limited Service / No Suitable cell

6.5.2.3.1 Test Purpose (TP)

(1)

```
with { UE in Automatic network selection mode provisioned with a "CAG information list" }
ensure that {
  when { UE is switched on or returned to coverage, and a CAG cell with a CAG-ID not present in the
  "Allowed CAG list" becomes available }
  then { UE does not select the CAG cell }
}
```

(2)

```
with { UE in Automatic network selection mode configured with "indication that the MS is only
allowed to access 5GS via CAG cells" }
ensure that {
  when { UE is switched on and a cell which is not a CAG cell becomes available, and there is an
entry with the PLMN ID of the PLMN in the "CAG information list" but the "indication that the MS is
only allowed to access 5GS via CAG cells" is included in the entry }
  then { UE does not select the CAG cell }
}
```

(3)

```
with { UE in Automatic network selection mode provisioned with an empty "CAG information list" }
ensure that {
  when { UE is switched on or returned to coverage, and a CAG cell with a PLMN ID becomes available
}
  then { UE does not select the CAG cell }
}
```

6.5.2.3.2 Conformance requirements

References: The conformance requirements covered in the present TC are specified in: TS 23.122 clause 3.5. Unless otherwise stated these are Rel-16 requirements.

[TS 23.122, clause 3.5]

There are a number of situations in which the MS is unable to obtain normal service from a PLMN or SNPN. These include:

...

- i) MS supporting CAG is camped on a CAG cell belonging to a PLMN, the CAG-ID of the CAG cell is not manually selected by the user and none of the CAG-ID(s) of the CAG cell are present in the "Allowed CAG list" associated with that PLMN in the "CAG information list";
- j) MS supporting CAG is camped on a non-CAG cell belonging to a PLMN, the PLMN ID of the non-CAG cell without a CAG-ID is not manually selected by the user and the UE is configured with "indication that the MS is only allowed to access 5GS via CAG cells" for that PLMN in the "CAG information list"; and
- k) MS supporting CAG is camped on a CAG cell belonging to a PLMN, the CAG-ID of the CAG cell is not manually selected by the user and the "CAG information list" does not contain an entry for the PLMN (e.g. because the UE is not (pre-)configured with a "CAG information list").

6.5.2.3.3 Test description

6.5.2.3.3.1 Pre-test conditions

System Simulator:

- NR Cell 1, NR Cell 2, NR Cell 4 and NR Cell 11.
- NR Cell 2 and NR Cell 4 are CAG cells.
- System information combination NR-2 as defined in TS 38.508-1 [4] clause 4.4.3.1.2 is used for NR Cell 1, NR Cell 2, NR Cell 4 and NR Cell 11.
- The PLMNs are identified in the test by the identifiers in Table 6.5.2.3.3.1-1 and the PLMN settings are defined in TS 36.523-1 [13] table 6.0.1-1.

Table 6.5.2.3.3.1-1: PLMN identifiers

NR Cell	PLMN name	CAG IDs
1	PLMN1	-
2	PLMN1	1
4	PLMN1	2
11	PLMN1	-

UE:

- The UE is in Automatic PLMN selection mode.
- There is an empty "CAG information list" provisioned in the UE.

Preamble:

- The UE is registered on NR Cell 1 using the procedure described in TS 38.508-1 [4] clause 4.5.2.2 except that the REGISTRATION ACCEPT message includes an empty CAG information list before it is in state Switched OFF (State 0N-B).

6.5.2.3.3.2 Test procedure sequence

Table 6.5.2.3.3.2-1 for FR1 and 6.5.2.3.3.2-2 for FR2 illustrate the downlink power levels to be applied for the cells at various time instants of the test execution. Row marked "T0" denotes the initial conditions after preamble, while columns marked "T1", "T2", "T3" and "T3" are to be applied subsequently in the Main behaviour. The exact instants on which these values shall be applied are described in the texts in this clause. Cell powers are chosen for a serving cell and a non-suitable "Off" cell as defined in TS 38.508-1 [4] Table 6.2.2.1-3 for FR1 and Table 6.2.2.2-2 for FR2.

Table 6.5.2.3.3.2-1: Cell configuration changes over time for FR1

	Parameter	Unit	NR Cell 1	NR Cell 2	NR Cell 4	NR Cell 11	Remarks
T0	SS/PBCH SSS EPRE	dBm/SCS	"Off"	"Off"	-88	"Off"	
T1	SS/PBCH SSS EPRE	dBm/SCS	-88	"Off"	"Off"	"Off"	
T2	SS/PBCH SSS EPRE	dBm/SCS	"Off"	"Off"	-88	"Off"	
T3	SS/PBCH SSS EPRE	dBm/SCS	"Off"	-88	"Off"	"Off"	
T4	SS/PBCH SSS EPRE	dBm/SCS	"Off"	"Off"	"Off"	-88	

Table 6.5.2.3.3.2-2: Cell configuration changes over time for FR2

	Parameter	Unit	NR Cell 1	NR Cell 2	NR Cell 4	NR Cell 11	Remarks
T0	SS/PBCH SSS EPRE	dBm/SCS	"Off"	"Off"	FFS	"Off"	
T1	SS/PBCH SSS EPRE	dBm/SCS	FFS	"Off"	"Off"	"Off"	
T2	SS/PBCH SSS EPRE	dBm/SCS	"Off"	"Off"	FFS	"Off"	
T3	SS/PBCH SSS EPRE	dBm/SCS	"Off"	FFS	"Off"	"Off"	
T4	SS/PBCH SSS EPRE	dBm/SCS	"Off"	"Off"	"Off"	FFS	

Table 6.5.2.3.3.2-3: Main behaviour

St	Procedure	Message Sequence		TP	Verdict
		U - S	Message		
1	Power on the UE.	-	-	-	-
2	Check: Does the UE send a <i>RRCSetupRequest</i> on NR Cell 4 within the next 60 s?	-->	NR RRC: <i>RRCSetupRequest</i>	3	F
3	SS adjusts cell levels according to row T1 of table 6.5.2.3.3.2-1 for FR1 and table 6.5.2.3.3.2-2 for FR2.	-	-	-	-
4-16	Steps 1 to 13 of the registration procedure described in TS 38.508-1 [4] subclause 4.5.2.2 are performed on NR Cell 1. NOTE: The UE starts registration.	-	-	-	-
17	The SS transmits a <i>DLInformationTransfer</i> message and a REGISTRATION ACCEPT message containing the CAG information list with the CAG ID of NR Cell 2.	<--	NR RRC: <i>DLInformationTransfer</i> 5G MM: REGISTRATION ACCEPT	-	-
18-23a 1	Steps 15 to 20a1 of the registration procedure described in TS 38.508-1 [4] subclause 4.5.2.2 are performed on NR Cell 1. NOTE: The UE completes registration and the RRC connection is released.	-	-	-	-
24	The UE is switched off by executing generic procedure in Table 4.9.6.1-1 in TS 38.508-1 [4]	-	-	-	-
25	SS adjusts cell levels according to row T2 of table 6.5.2.3.3.2-1 for FR1 and table 6.5.2.3.3.2-2 for FR2.	-	-	-	-
26	Power on the UE.	-	-	-	-
27	Check: Does the UE send a <i>RRCSetupRequest</i> on NR Cell 4 within the next 60 s?	-->	NR RRC: <i>RRCSetupRequest</i>	1	F
28	SS adjusts cell levels according to row T3 of table 6.5.2.3.3.2-1 for FR1 and table 6.5.2.3.3.2-2 for FR2.	-	-	-	-
29-47a 1	Steps 1 to 20a1 of the registration procedure described in TS 38.508-1 [4] subclause 4.5.2.2 are performed on NR Cell 2. NOTE: The UE completes registration and the RRC connection is released.	-	-	-	-
48	The UE is switched off by executing generic procedure in Table 4.9.6.1-1 in TS 38.508-1 [4]	-	-	-	-
49	SS adjusts cell levels according to row T4 of table 6.5.2.3.3.2-1 for FR1 and table 6.5.2.3.3.2-2 for FR2.	-	-	-	-
50	Power on the UE.	-	-	-	-
51	Check: Does the UE send a <i>RRCSetupRequest</i> on NR Cell 11 within the next 60 s?	-->	NR RRC: <i>RRCSetupRequest</i>	2	F

6.5.2.3.3.3 Specific message contents

Table 6.5.2.3.3.3-1: REGISTRATION REQUEST (Preamble)

Derivation path: TS 38.508-1 [4], Table 4.7.1-6			
Information Element	Value/Remark	Comment	Condition
5GS registration type	'0000 0001'B	Initial registration	
5GMM capability			
CAG	'1'B	CAG supported	

Table 6.5.2.3.3.3-2: REGISTRATION ACCEPT (Preamble)

Derivation path: TS 38.508-1 [4], table 4.7.1-7			
Information Element	Value/Remark	Comment	Condition
CAG information list			
Length of CAG information list contents	'0000 0000 0000 0000'B		
Entry 1	Not present		

Table 6.5.2.3.3.3-3: REGISTRATION ACCEPT (step 17, Table 6.5.2.3.3.2-3)

Derivation path: TS 38.508-1 [4], table 4.7.1-7			
Information Element	Value/Remark	Comment	Condition
CAG information list		MCC : 002; MNC : 11; CAG only : 0; CAG-ID 1 : 1	
Length of CAG information list contents	'0000 0000 0000 1001'B		
Entry 1			
Length of entry contents	'0000 1000'B		
MCC	MCC of NR Cell 2	See Table 6.5.2.3.3.1-1	
MNC	MNC of NR Cell 2	See Table 6.5.2.3.3.1-1	
CAG only	'0'B		
CAG_ID 1	1	CAG ID is coded as a 32 bit BITSTRING	

Table 6.5.2.3.3.3-4: REGISTRATION ACCEPT (step 42, Table 6.5.2.3.3.2-3)

Derivation path: TS 38.508-1 [4], table 4.7.1-7			
Information Element	Value/Remark	Comment	Condition
CAG information list		MCC : 002; MNC : 11; CAG only : 0; CAG-ID 1 : 1	
Length of CAG information list contents	'0000 0000 0000 1001'B		
Entry 1			
Length of entry contents	'0000 1000'B		
MCC	MCC of NR Cell 11	See Table 6.5.2.3.3.1-1	
MNC	MNC of NR Cell 11	See Table 6.5.2.3.3.1-1	
CAG only	'1'B	Indication that the UE is only allowed to access 5GS via CAG cells (CAGonly)	
CAG_ID 1	1	CAG ID is coded as a 32 bit BITSTRING	

}			
}			
trackingAreaCode-r16	TAC of NR Cell 2		
cellIdentity-r16	Cell Identity of NR Cell 2		
cellReservedForOperatorUse-r16	notReserved		
}			
}			
}			
}			
}			

6.5.2.4 CAG / cell reselection / Within allowed CAG / non-CAG cell to CAG cell

6.5.2.4.1 Test Purpose (TP)

(1)

```
with { UE in NR RRC_IDLE state on a non-CAG cell and UE's Allowed CAG list is not empty }
ensure that {
  when { UE detects an allowed CAG cell which becomes highest ranked cell }
  then { UE reselects to the CAG cell }
}
```

(2)

```
with { UE in NR RRC_IDLE state }
ensure that {
  when { UE detects the cell re-selection criteria are met for the CAG cell which belongs to the
  higher priority frequency }
  then { UE reselects the cell which belongs to the higher priority frequency }
}
```

6.5.2.4.2 Conformance requirements

References: The conformance requirements covered in the current TC are specified in: TS 38.304: clauses 5.2.4.2, 5.2.4.5, 5.2.4.6 and 5.2.4.10. Unless otherwise stated these are Rel-16 requirements.

[TS 38.304, clause 5.2.4.2]

Following rules are used by the UE to limit needed measurements:

- If the serving cell fulfils $S_{rxlev} > S_{IntraSearchP}$ and $S_{qual} > S_{IntraSearchQ}$, the UE may choose not to perform intra-frequency measurements.
- Otherwise, the UE shall perform intra-frequency measurements.
- The UE shall apply the following rules for NR inter-frequencies and inter-RAT frequencies which are indicated in system information and for which the UE has priority provided as defined in 5.2.4.1:
 - For a NR inter-frequency or inter-RAT frequency with a reselection priority higher than the reselection priority of the current NR frequency, the UE shall perform measurements of higher priority NR inter-frequency or inter-RAT frequencies according to TS 38.133 [8].
 - For a NR inter-frequency with an equal or lower reselection priority than the reselection priority of the current NR frequency and for inter-RAT frequency with lower reselection priority than the reselection priority of the current NR frequency:
 - If the serving cell fulfils $S_{rxlev} > S_{nonIntraSearchP}$ and $S_{qual} > S_{nonIntraSearchQ}$, the UE may choose not to perform measurements of NR inter-frequency cells of equal or lower priority, or inter-RAT frequency cells of lower priority;
 - Otherwise, the UE shall perform measurements of NR inter-frequency cells of equal or lower priority, or inter-RAT frequency cells of lower priority according to TS 38.133 [8].

- If the UE supports relaxed measurement and *relaxedMeasurement* is present in *SIB2*, the UE may further relax the needed measurements, as specified in clause 5.2.4.9.

[TS 38.304, clause 5.2.4.5]

If *threshServingLowQ* is broadcast in system information and more than 1 second has elapsed since the UE camped on the current serving cell, cell reselection to a cell on a higher priority NR frequency or inter-RAT frequency than the serving frequency shall be performed if:

- A cell of a higher priority NR or EUTRAN RAT/frequency fulfils $S_{qual} > Thresh_{X, HighQ}$ during a time interval $T_{reselection_{RAT}}$

Otherwise, cell reselection to a cell on a higher priority NR frequency or inter-RAT frequency than the serving frequency shall be performed if:

- A cell of a higher priority RAT/ frequency fulfils $S_{rxlev} > Thresh_{X, HighP}$ during a time interval $T_{reselection_{RAT}}$; and
- More than 1 second has elapsed since the UE camped on the current serving cell.

Cell reselection to a cell on an equal priority NR frequency shall be based on ranking for intra-frequency cell reselection as defined in clause 5.2.4.6.

If *threshServingLowQ* is broadcast in system information and more than 1 second has elapsed since the UE camped on the current serving cell, cell reselection to a cell on a lower priority NR frequency or inter-RAT frequency than the serving frequency shall be performed if:

- The serving cell fulfils $S_{qual} < Thresh_{Serving, LowQ}$ and a cell of a lower priority NR or E-UTRAN RAT/ frequency fulfils $S_{qual} > Thresh_{X, LowQ}$ during a time interval $T_{reselection_{RAT}}$.

Otherwise, cell reselection to a cell on a lower priority NR frequency or inter-RAT frequency than the serving frequency shall be performed if:

- The serving cell fulfils $S_{rxlev} < Thresh_{Serving, LowP}$ and a cell of a lower priority RAT/ frequency fulfils $S_{rxlev} > Thresh_{X, LowP}$ during a time interval $T_{reselection_{RAT}}$; and
- More than 1 second has elapsed since the UE camped on the current serving cell.

Cell reselection to a higher priority RAT/frequency shall take precedence over a lower priority RAT/frequency if multiple cells of different priorities fulfil the cell reselection criteria.

If more than one cell meets the above criteria, the UE shall reselect a cell as follows:

- If the highest-priority frequency is an NR frequency, the highest ranked cell among the cells on the highest priority frequency(ies) meeting the criteria according to clause 5.2.4.6;
- If the highest-priority frequency is from another RAT, the strongest cell among the cells on the highest priority frequency(ies) meeting the criteria of that RAT.

[TS 38.304, clause 5.2.4.6]

The cell-ranking criterion R_s for serving cell and R_n for neighbouring cells is defined by:

$$R_s = Q_{meas,s} + Q_{hyst} - Q_{offset_{temp}}$$

$$R_n = Q_{meas,n} - Q_{offset} - Q_{offset_{temp}}$$

where:

Q_{meas}	RSRP measurement quantity used in cell reselections.
Q_{offset}	For intra-frequency: Equals to $Q_{offset_{s,n}}$, if $Q_{offset_{s,n}}$ is valid, otherwise this equals to zero. For inter-frequency: Equals to $Q_{offset_{s,n}}$ plus $Q_{offset_{frequency}}$, if $Q_{offset_{s,n}}$ is valid, otherwise this equals to $Q_{offset_{frequency}}$.
$Q_{offset_{temp}}$	Offset temporarily applied to a cell as specified in TS 38.331 [3].

The UE shall perform ranking of all cells that fulfil the cell selection criterion S, which is defined in 5.2.3.2.

The cells shall be ranked according to the R criteria specified above by deriving $Q_{meas,n}$ and $Q_{meas,s}$ and calculating the R values using averaged RSRP results.

If *rangeToBestCell* is not configured, the UE shall perform cell reselection to the highest ranked cell. If this cell is found to be not-suitable, the UE shall behave according to clause 5.2.4.4.

If *rangeToBestCell* is configured, then the UE shall perform cell reselection to the cell with the highest number of beams above the threshold (i.e. *absThreshSS-BlocksConsolidation*) among the cells whose R value is within *rangeToBestCell* of the R value of the highest ranked cell. If there are multiple such cells, the UE shall perform cell reselection to the highest ranked cell among them. If this cell is found to be not-suitable, the UE shall behave according to clause 5.2.4.4.

In all cases, the UE shall reselect the new cell, only if the following conditions are met:

- the new cell is better than the serving cell according to the cell reselection criteria specified above during a time interval $T_{reselectionRAT}$;
- more than 1 second has elapsed since the UE camped on the current serving cell.

NOTE: If *rangeToBestCell* is configured but *absThreshSS-BlocksConsolidation* is not configured on an NR frequency, the UE considers that there is one beam above the threshold for each cell on that frequency.

[TS 38.304, clause 5.2.4.10]

In addition to normal cell reselection, a UE may optionally use an autonomous search function to detect CAG cells on serving and non-serving frequencies. However UE shall follow the cell reselection criteria based on dedicated frequency priorities and only follow the autonomous cell search result if the result fulfils also the existing cell reselection criteria based on dedicated frequency priorities.

6.5.2.4.3 Test description

6.5.2.4.3.1 Pre-test conditions

System Simulator:

- NR Cell 1, NR Cell 3 and NR Cell 6.
- NR Cell 3 and NR Cell 6 are CAG cells.
- System information combination NR-4 as defined in TS 38.508-1 [4] clause 4.4.3.1.2 is used for NR Cell 1, NR Cell 3 and NR Cell 6.
- The PLMNs are identified in the test by the identifiers in Table 6.5.2.4.3.1-1 and the PLMN settings are defined in TS 36.523-1 [13] table 6.0.1-1.

Table 6.5.2.4.3.1-1: PLMN and CAG identifiers

NR Cell	PLMN name	CAG IDs
1	PLMN 1	-
3	PLMN 2	1
6	PLMN 2	2

UE:

- There is no “CAG information list” provisioned in the UE.

Preamble:

- The UE is registered on NR Cell 1 and is brought to state 1N-A, RRC_IDLE Connectivity (NR), in accordance with the procedure described in TS 38.508-1 [4] Table 4.5.2.2-2, except that the REGISTRATION ACCEPT message includes CAG information list with CAG-ID 1 and CAG-ID 2, and that the REGISTRATION ACCEPT message indicates PLMN2 in the Equivalent PLMN list as described in Table 6.5.2.4.3.3-1.

6.5.2.4.3.2 Test procedure sequence

Table 6.5.2.4.3.2-1/2 shows the cell configurations used during the test. The configuration T0 indicates the initial conditions for preamble. Subsequent configurations marked “T1” and “T2” are applied at the points indicated in the Main behaviour description in Table 6.5.2.4.3.2-3. Cell powers are chosen for a serving cell and a non-suitable “Off” cell as defined in TS 38.508-1 [4] Table 6.2.2.1-3 for FR1 and Table 6.2.2.2-2 for FR2.

Table 6.5.2.4.3.2-1: Time instances of cell power level and parameter changes for FR1

	Parameter	Unit	NR Cell 1	NR Cell 3	NR Cell 6	Remarks
T0	SS/PBCH SSS EPRE	dBm/SCS	-88	"Off"	"Off"	The power level values are assigned to ensure the UE registered on NR Cell 1.
T1	SS/PBCH SSS EPRE	dBm/SCS	-88	-78	"Off"	The power level values are assigned to satisfy $R_{NR Cell 1} < R_{NR Cell 3}$.
T2	SS/PBCH SSS EPRE	dBm/SCS	"Off"	-78	-78	The power level values are assigned to satisfy $Srxlev_{NR Cell 1} < 0$ and $Srxlev_{NR Cell 6} > Thresh_{NR Cell 6, high}$.

Table 6.5.2.4.3.2-2: Time instances of cell power level and parameter changes for FR2

	Parameter	Unit	NR Cell 1	NR Cell 3	NR Cell 6	Remarks
T0	SS/PBCH SSS EPRE	dBm/SCS	FFS	"Off"	"Off"	The power level values are assigned to ensure the UE registered on NR Cell 1.
T1	SS/PBCH SSS EPRE	dBm/SCS	FFS	FFS	"Off"	The power level values are assigned to satisfy $R_{NR Cell 1} < R_{NR Cell 3}$.
T2	SS/PBCH SSS EPRE	dBm/SCS	"Off"	FFS	FFS	The power level values are assigned to satisfy $Srxlev_{NR Cell 1} < 0$ and $Srxlev_{NR Cell 6} > Thresh_{NR Cell 6, high}$.

Table 6.5.2.4.3.2-3: Main behaviour

St	Procedure	Message Sequence		TP	Verdict
		U - S	Message		
1	The SS changes cell power levels according to row "T1" in Table 6.5.2.4.3.2-1 for FR1 and Table 6.5.2.4.3.2-2 for FR2.	-	-	-	-
2	Check: Does the UE transmit an <i>RRCSetupRequest</i> message on NR Cell 3?	-->	NR RRC: <i>RRCSetupRequest</i>	1	P
3-7a1	Steps 2 to 6a1 of the mobility registration updating procedure described in TS 38.508-1 [4] Table 4.9.5.2.2-1 are performed on NR Cell 3.	-	-	-	-
8	SS adjusts cell levels according to row T2 of table 6.5.2.4.3.2-1/2.	-	-	-	-
9	Wait for 34[FR1]/130[FR2] seconds to allow UE to recognise the change.	-	-	-	-
10	Check: Does the test result of generic test procedure in TS 38.508-1 [4] Table 4.9.4.2.2-1 indicate that the UE is camped on NR Cell 6?	-	-	2	-
Note: The wait time at step 9 is $K_{carrier} * T_{detect, NR_Inter}$ (as per TS 38.133 [30], clause 4.2.2.4).					

6.5.2.4.3.3 Specific message contents

Table 6.5.2.4.3.3-1: REGISTRATION ACCEPT for NR Cell 1 (preamble)

Derivation path: TS 38.508-1 [4], table 4.7.1-7			
Information Element	Value/Remark	Comment	Condition
CAG information list		MCC: 002; MNC: 11; CAG only: 0; CAG-ID 1: 1;	

		CAG-ID 2: 2	
Length of CAG information list contents	'0000 0000 0000 1101'B		
Entry 1			
Length of entry contents	'0000 1100'B		
MCC	MCC of PLMN 2	See Table 6.5.2.4.3.1-1	
MNC	MNC of PLMN 2	See Table 6.5.2.4.3.1-1	
CAG only	'0'B		
CAG_ID 1	1	CAG ID is coded as a 32 bit BITSTRING	
Equivalent PLMNs	PLMN2		
CAG_ID 2	2	CAG ID is coded as a 32 bit BITSTRING	

Table 6.5.2.4.3.3-2: SIB2 of NR Cell 6 (preamble and all steps, Table 6.5.2.4.3.2-3)

Derivation Path: TS 38.508-1 [4], Table 4.6.2-1			
Information Element	Value/remark	Comment	Condition
SIB2 ::= SEQUENCE {			
cellReselectionServingFreqInfo SEQUENCE {			
threshServingLowP	10	20 dB	
cellReselectionPriority	5		
}			
}			

Table 6.5.2.4.3.3-3: SIB4 of NR Cell 3 (preamble and all steps, Table 6.5.2.4.3.2-3)

Derivation Path: TS 38.508-1 [4], Table 4.6.2-3			
Information Element	Value/remark	Comment	Condition
SIB4 ::= SEQUENCE {			
interFreqCarrierFreqList SEQUENCE (SIZE (1..maxFreq)) OF InterFreqCarrierFreqInfo {	1 entry		
InterFreqCarrierFreqInfo[1] SEQUENCE {		entry 1	
dl-CarrierFreq	Same downlink ARFCN as used for NR Cell 6		
threshX-HighP	10	20 dB	FR1
	9	18 dB	FR2
cellReselectionPriority	5		
}			
}			
}			

Table 6.5.2.4.3.3-4: SIB4 of NR Cell 1 (preamble and all steps, Table 6.5.2.4.3.2-3)

Derivation Path: TS 38.508-1 [4], Table 4.6.2-3			
Information Element	Value/remark	Comment	Condition
SIB4 ::= SEQUENCE {			
interFreqCarrierFreqList SEQUENCE (SIZE (1..maxFreq)) OF InterFreqCarrierFreqInfo {	2 entries		
InterFreqCarrierFreqInfo[1] SEQUENCE {		entry 1	
dl-CarrierFreq	Same downlink ARFCN as used for NR Cell 6		
cellReselectionPriority	5		
}			
InterFreqCarrierFreqInfo[2] SEQUENCE {		entry 2	
dl-CarrierFreq	Same downlink ARFCN as used for NR Cell 3		
cellReselectionPriority	4		
}			
}			

}			
}			

6.5.2.5 Void

6.5.2.6 CAG / cell reservation

6.5.2.6.1 Test Purpose (TP)

(1)

```
with { UE in Automatic network selection mode and provisioned with "CAG information list }
ensure that {
  when { UE is switched on or returns to coverage, and a cell which is not a CAG cell with cell
status "true" for other use becomes available }
  then { UE does not attempt to reselect to the higher ranked cell }
}
```

(2)

```
with { UE camped normally in state NR RRC_IDLE on a CAG cell and UE's Allowed CAG list is not empty }
ensure that {
  when { a higher ranked CAG cell is found with cell status as "not barred" and "not reserved" for
operator use and "true" for other use, and not "true" for future use }
  then { UE does reselect to the higher ranked cell }
}
```

6.5.2.6.2 Conformance requirements

References: The conformance requirements covered in the current TC are specified in: TS 38.304: clauses 5.2.4.4, 5.2.4.6 and 5.3.1. Unless otherwise stated these are Rel-16 requirements.

[TS 38.304, clause 5.2.4.4]

For the highest ranked cell (including serving cell) according to cell reselection criteria specified in clause 5.2.4.6, for the best cell according to absolute priority reselection criteria specified in clause 5.2.4.5, the UE shall check if the access is restricted according to the rules in clause 5.3.1.

If that cell and other cells have to be excluded from the candidate list, as stated in clause 5.3.1, the UE shall not consider these as candidates for cell reselection. This limitation shall be removed when the highest ranked cell changes.

If the highest ranked cell or best cell according to absolute priority reselection rules is an intra-frequency or inter-frequency cell which is not suitable due to one or more of the following reasons:

- this cell belongs to a PLMN which is not indicated as being equivalent to the registered PLMN, or
- this cell is a CAG cell that belongs to a PLMN which is equivalent to the registered PLMN but with no CAG-ID that is present in the UE's allowed CAG list being broadcasted, or
- this cell is not a CAG cell and the CAG-only indication in the UE is set, or
- this cell does not belong to a SNPN that is equal to the registered or selected SNPN of the UE in SNPN access mode,

the UE shall not consider this cell and, for operation in licensed spectrum, other cells on the same frequency as candidates for reselection for a maximum of 300 seconds.

For operation with shared spectrum channel access, when the highest ranked cell or best cell is not a candidate for reselection per the previous paragraph, the UE should continue to consider other cells on the same frequency for cell reselection, however if the second highest ranked cell on this frequency is also not suitable due to one or more of the above reasons, the UE may consider this frequency to be the lowest priority for a maximum of 300 seconds.

If the highest ranked cell or best cell according to absolute priority reselection rules is an intra-frequency or inter-frequency cell which is not suitable due to being part of the "list of 5GS forbidden TAs for roaming", the UE shall not consider this cell and other cells on the same frequency as candidates for reselection for a maximum of 300 seconds.

If the highest ranked cell or best cell according to absolute priority reselection rules is an inter-RAT cell which is not suitable due to being part of the "list of forbidden TAs for roaming" or belonging to a PLMN which is not indicated as being equivalent to the registered PLMN, the UE shall not consider this cell and other cells on the same frequency, as candidates for reselection for a maximum of 300 seconds.

If the UE enters into state *any cell selection*, any limitation shall be removed. If the UE is redirected under NR control to a frequency for which the timer is running, the limitation(s) on that frequency shall be removed.

[TS 38.304, clause 5.2.4.6]

The cell-ranking criterion R_s for serving cell and R_n for neighbouring cells is defined by:

$$R_s = Q_{\text{meas},s} + Q_{\text{hyst}} - Q_{\text{offset,temp}}$$

$$R_n = Q_{\text{meas},n} - Q_{\text{offset}} - Q_{\text{offset,temp}}$$

where:

Q_{meas}	RSRP measurement quantity used in cell reselections.
Q_{offset}	For intra-frequency: Equals to $Q_{\text{offset},s,n}$, if $Q_{\text{offset},s,n}$ is valid, otherwise this equals to zero. For inter-frequency: Equals to $Q_{\text{offset},s,n}$ plus $Q_{\text{offset,frequency}}$, if $Q_{\text{offset},s,n}$ is valid, otherwise this equals to $Q_{\text{offset,frequency}}$.
$Q_{\text{offset,temp}}$	Offset temporarily applied to a cell as specified in TS 38.331 [3].

The UE shall perform ranking of all cells that fulfil the cell selection criterion S , which is defined in 5.2.3.2.

The cells shall be ranked according to the R criteria specified above by deriving $Q_{\text{meas},n}$ and $Q_{\text{meas},s}$ and calculating the R values using averaged RSRP results.

If *rangeToBestCell* is not configured, the UE shall perform cell reselection to the highest ranked cell. If this cell is found to be not-suitable, the UE shall behave according to subclause 5.2.4.4.

If *rangeToBestCell* is configured, then the UE shall perform cell reselection to the cell with the highest number of beams above the threshold (i.e. *absThreshSS-BlocksConsolidation*) among the cells whose R value is within *rangeToBestCell* of the R value of the highest ranked cell. If there are multiple such cells, the UE shall perform cell reselection to the highest ranked cell among them. If this cell is found to be not-suitable, the UE shall behave according to subclause 5.2.4.4.

In all cases, the UE shall reselect the new cell, only if the following conditions are met:

- the new cell is better than the serving cell according to the cell reselection criteria specified above during a time interval $T_{\text{reselection,RAT}}$;
- more than 1 second has elapsed since the UE camped on the current serving cell.

[TS 38.304, clause 5.3.1]

Cell status and cell reservations are indicated in the *MIB* or *SIB1* message as specified in TS 38.331 [3] by means of following fields:

- *cellBarred* (IE type: "barred" or "not barred")
Indicated in *MIB* message. In case of multiple PLMNs or NPNs indicated in *SIB1*, this field is common for all PLMNs and NPNs
- *cellReservedForOperatorUse* (IE type: "reserved" or "not reserved")
Indicated in *SIB1* message. In case of multiple PLMNs or NPNs indicated in *SIB1*, this field is specified per PLMN or per SNPN.
- *cellReservedForOtherUse* (IE type: "true")
Indicated in *SIB1* message. In case of multiple PLMNs indicated in *SIB1*, this field is common for all PLMNs.

- *cellReservedForFutureUse* (IE type: "true")
Indicated in *SIB1* message. In case of multiple PLMNs or NPNs indicated in *SIB1*, this field is common for all PLMNs and NPNs.

NOTE 0: IAB-MT ignores the *cellBarred*, *cellReservedForOperatorUse*, *cellReservedForFutureUse* and *intraFreqReselection* (i.e. treats *intraFreqReselection* as if it was set to *allowed*) as defined in TS 38.331 [3]. IAB-MT also ignores *cellReservedForOtherUse* for cell barring determination (i.e. NPN capable IAB-MT considers *cellReservedForOtherUse* for determination of an NPN-only cell) as defined in TS 38.331 [3].

- *iab-Support* (IE type: "true")
Indicated in *SIB1* message. In case of multiple PLMNs or NPNs indicated in *SIB1*, this field is specified per PLMN or per SNPN.

When cell status is indicated as "not barred" and "not reserved" for operator use and not "true" for other use and not "true" for future use,

- All UEs shall treat this cell as candidate during the cell selection and cell reselection procedures.

When cell broadcasts any CAG-IDs or NIDs and the cell status is indicated as "not barred" and "not reserved" for operator use and "true" for other use, and not "true" for future use:

- All NPN-capable UEs shall treat this cell as candidate during the cell selection and cell reselection procedures, other UEs shall treat this cell as if cell status is "barred".

When cell status is indicated as "true" for other use, and either cell does not broadcast any CAG-IDs or NIDs or does not broadcast any CAG-IDs and the UE is not operating in SNPN Access Mode,

- The UE shall treat this cell as if cell status is "barred".

When cell status is indicated as "true" for future use,

- The UE shall treat this cell as if cell status is "barred".

When cell status is indicated as "not barred" and "reserved" for operator use for any PLMN/SNPN and not "true" for other use and not "true" for future use,

- UEs assigned to Access Identity 11 or 15 operating in their HPLMN/EHPLMN shall treat this cell as candidate during the cell selection and reselection procedures if the field *cellReservedForOperatorUse* for that PLMN set to "reserved".
- UEs assigned to Access Identity 11 or 15 shall treat this cell as candidate during the cell selection and reselection procedures if the field *cellReservedForOperatorUse* for selected/registered SNPN is set to "reserved".
- UEs assigned to an Access Identity 0, 1, 2 and 12 to 14 shall behave as if the cell status is "barred" in case the cell is "reserved for operator use" for the registered PLMN/SNPN or the selected PLMN/SNPN.

NOTE 1: Access Identities 11, 15 are only valid for use in the HPLMN/ EHPLMN; Access Identities 12, 13, 14 are only valid for use in the home country as specified in TS 22.261 [12].

When cell status "barred" is indicated or to be treated as if the cell status is "barred",

- The UE is not permitted to select/reselect this cell, not even for emergency calls.
- The UE shall select another cell according to the following rule:
- If the cell is to be treated as if the cell status is "barred" due to being unable to acquire the *MIB*:
 - the UE may exclude the barred cell as a candidate for cell selection/reselection for up to 300 seconds.
 - the UE may select another cell on the same frequency if the selection criteria are fulfilled.
- else:
 - If the field *intraFreqReselection* in *MIB* message is set to "allowed":
 - the UE may select another cell on the same frequency if re-selection criteria are fulfilled;

- If the cell is to be treated as if the cell status is "barred" due to being unable to acquire the *SIB1*:
 - the UE may exclude the barred cell as a candidate for cell selection/reselection for up to 300 seconds;
- else:
 - the UE shall exclude the barred cell as a candidate for cell selection/reselection for 300 seconds.
- If the field *intraFreqReselection* in *MIB* message is set to "not allowed":
 - If the cell is to be treated as if the cell status is "barred" due to being unable to acquire the *SIB1*:
 - the UE may exclude the barred cell as a candidate for cell selection/reselection for up to 300 seconds;
 - If the cell operates in licensed spectrum:
 - the UE shall not re-select to another cell on the same frequency as the barred cell and exclude such cell(s) as candidate(s) for cell selection/reselection for 300 seconds;
 - else:
 - the UE may select to another cell on the same frequency if the reselection criteria are fulfilled.
- else:
 - If the cell operates in licensed spectrum, or if this cell belongs to a PLMN which is indicated as being equivalent to the registered PLMN or the selected PLMN of the UE, or if this cell belongs to the registered SNPN or the selected SNPN of the UE:
 - the UE shall not re-select to another cell on the same frequency as the barred cell and exclude such cell(s) as candidate(s) for cell selection/reselection for 300 seconds;
 - else:
 - the UE may select to another cell on the same frequency if the reselection criteria are fulfilled.
 - the UE shall exclude the barred cell as a candidate for cell selection/reselection for 300 seconds.

The cell selection of another cell may also include a change of RAT.

NOTE 2: If barring of a cell is triggered by the condition of *trackingAreaCode* not being provided, as specified in TS 38.331 [3], the barring only applies to this PLMN and the UE can re-evaluate the barring condition again due to selection of another PLMN.

6.5.2.6.3 Test description

6.5.2.6.3.1 Pre-test conditions

System Simulator:

- NR Cell 1, NR Cell 3 and NR Cell 6.
- NR Cell 3 and NR Cell 6 are CAG cells.
- System information combination NR-4 as defined in TS 38.508-1 [4] clause 4.4.3.1.2 is used for NR Cell 1, NR Cell 3 and NR Cell 6.
- The PLMNs are identified in the test by the identifiers in Table 6.5.2.6.3.1-1 and the PLMN settings are defined in TS 38.523-1 [13] table 6.0.1-1.
- NR Cell 6 TAC is set to TAC=2.

Table 6.5.2.6.3.1–1: PLMN and CAG identifiers

NR Cell	PLMN name	CAG IDs
1	PLMN 1	-

3	PLMN 2	1
6	PLMN 2	2

UE:

- There is no “CAG information list” provisioned in the UE.
- The UE is in Automatic PLMN selection mode.

Preamble:

- The UE is registered on NR Cell 1 using the procedure described in TS 38.508-1 [4] Table 4.5.2.2-2, except that the REGISTRATION ACCEPT message includes CAG information list with CAG-ID 1 and CAG-ID 2 before it is in state Switched OFF (State ON-B).

6.5.2.6.3.2 Test procedure sequence

Table 6.5.2.6.3.2-1/2 shows the cell configurations used during the test. The configuration T0 indicates the initial conditions for preamble. Subsequent configurations marked “T1”, “T2” and “T3” are applied at the points indicated in the Main behaviour description in Table 6.5.2.6.3.2-3. Cell powers are chosen for a serving cell and a non-suitable “Off” cell as defined in TS 38.508-1 [4] Table 6.2.2.1-3 for FR1 and Table 6.2.2.2-2 for FR2.

Table 6.5.2.6.3.2-1: Time instances of cell power level and parameter changes for FR1

	Parameter	Unit	NR Cell 1	NR Cell 3	NR Cell 6	Remarks
T0	SS/PBCH SSS EPRE	dBm/SCS	-88	"Off"	"Off"	The power level values are assigned to ensure the UE registered on NR Cell 1.
T1	SS/PBCH SSS EPRE	dBm/SCS	-88	-88	"Off"	
T2	SS/PBCH SSS EPRE	dBm/SCS	"Off"	-88	-78	The power level values are assigned to satisfy $R_{NR \text{ Cell } 3} < R_{NR \text{ Cell } 6}$.
T3	SS/PBCH SSS EPRE	dBm/SCS	"Off"	-88	"Off"	

Table 6.5.2.6.3.2-2: Time instances of cell power level and parameter changes for FR2

	Parameter	Unit	NR Cell 1	NR Cell 3	NR Cell 6	Remarks
T0	SS/PBCH SSS EPRE	dBm/SCS	FFS	"Off"	"Off"	The power level values are assigned to ensure the UE registered on NR Cell 1.
T1	SS/PBCH SSS EPRE	dBm/SCS	FFS	FFS	"Off"	
T2	SS/PBCH SSS EPRE	dBm/SCS	"Off"	FFS	FFS	The power level values are assigned to satisfy $R_{NR \text{ Cell } 3} < R_{NR \text{ Cell } 6}$.
T3	SS/PBCH SSS EPRE	dBm/SCS	"Off"	FFS	"Off"	

Table 6.5.2.6.3.2-3: Main behaviour

St	Procedure	Message Sequence		TP	Verdict
		U - S	Message		
1	The SIB1 for NR cell 1 is updated according to Table 6.5.2.6.3.3-2	-	-	-	-
1A	Wait for 2.1* modification period second for the SS to transmit modified system information (Note 1)	-	-	-	-
2	The UE is switched on.				
3	Check: Does the UE transmit a <i>RRCSetupRequest</i> message on NR Cell 1 within 60s ?	-->	NR RRC: <i>RRCSetupRequest</i>	1	F
4	The SS changes cell power levels according to				

	row "T1" in Table 6.5.2.6.3.2-1 for FR1 and Table 6.5.2.6.3.2-2 for FR2.				
5-22a 1	Steps 2-20a1 of Table 4.5.2.2-2 of the generic procedure in TS 38.508-1 [4] are performed on NR Cell 3.	-	-	-	-
23	SS adjusts cell levels according to row T2 of table 6.5.2.6.3.2-1/2.	-	-	-	-
24	Check: Does the UE transmit a <i>RRCSetupRequest</i> message on NR Cell 6	-->	NR RRC: <i>RRCSetupRequest</i>	2	P
25-29	Steps 2-6a1 of Table 4.9.5.2.2-1 of the generic procedure in TS 38.508-1 [4] are performed on NR Cell 6.	-	-		
30	Void				
31	SS adjusts cell levels according to row T3 of table 6.5.2.6.3.2-1/2.				
32-36	Steps 1 to 5 of the generic test procedure in TS 38.508-1 [4] Table 4.9.5.2.2-1 are performed on NR Cell 3.				
Note 1: The modification period, expressed in number of radio frames = modificationPeriodCoeff * defaultPagingCycle.					

6.5.2.6.3.3 Specific message contents

Table 6.5.2.6.3.3-1: REGISTRATION ACCEPT for NR Cell 1 (preamble)

Derivation path: TS 38.508-1 [4], table 4.7.1-7			
Information Element	Value/Remark	Comment	Condition
CAG information list		MCC : 002; MNC : 11; CAG only : 0; CAG-ID 1 : 1, CAG-ID 2 : 2	
Length of CAG information list contents	'0000 0000 00001101'B		
Entry 1			
Length of entry contents	'0000 1100'B		
MCC	MCC of NR Cell 3	See Table 6.5.2.6.3.1-1	
MNC	MNC of NR Cell 3	See Table 6.5.2.6.3.1-1	
CAG only	'0'B		
CAG_ID 1	1	CAG ID is coded as a 32 bit BITSTRING	
CAG_ID 2	2	CAG ID is coded as a 32 bit BITSTRING	
Equivalent PLMNs	PLMN2		

Table 6.5.2.6.3.3-2: SIB1 for NR Cell 1 (Step 1, Table 6.5.2.6.3.2-3)

Derivation path: TS 38.508-1 [4], Table 4.6.1-28 with condition SNPN and CAG			
Information Element	Value/Remark	Comment	Condition
SIB1 ::= SEQUENCE {			
CellAccessRelatedInfo SEQUENCE {			
cellReservedForOtherUse	true		
}			
}			

Table 6.5.2.6.3.3-3: Void

cellIdentity-r16	Cell Identity of NR Cell 3		
cellReservedForOperatorUse-r16	notReserved		
}			
}			
}			
}			
}			

Table 6.5.2.6.3.3-6: REGISTRATION ACCEPT (Step 17, Table 6.5.2.6.3.2-3)

Derivation path: TS 38.508-1 [4], Table 4.7.1-7			
Information Element	Value/Remark	Comment	Condition
CAG information list		MCC : 002; MNC : 11; CAG only : 1; CAG-ID 1 : 2, CAG ID 2: 1	
Length of CAG information list contents	'0000 0000 0000 1101'B		
Entry 1			
Length of entry contents	'0000 1100'B		
MCC	MCC of NR Cell 6	See Table 6.5.2.6.3.1-1	
MNC	MNC of NR Cell 6	See Table 6.5.2.6.3.1-1	
CAG only	'1'B		
CAG_ID 1	2	CAG ID is coded as a 32 bit BITSTRING	
CAG_ID 2	1	CAG ID is coded as a 32 bit BITSTRING	

Table 6.5.2.6.3.3-7: REGISTRATION ACCEPT (Step 35, Table 6.5.2.6.3.2-3)

Derivation path: TS 38.508-1 [4], table 4.7.1-7			
Information Element	Value/Remark	Comment	Condition
CAG information list			
Length of CAG information list contents	'0000 0000 0000 0000'B		
Entry 1	Not present		

7 Layer 2

7.1 NR Layer 2

7.1.0 Common test case specific values for Layer 2

For all layer 2 test cases, default values for periodicBSR-Timer, retxBSR-Timer and phr-Config shall be taken according to the table 7.1.0-1 unless test case specific values are given in the test case.

Table 7.1.0-1: MAC-CellGroupConfig

Derivation Path: TS 38.308 [6], clause Table 4.6.3-49			
Information Element	Value/remark	Comment	Condition
MAC-CellGroupConfig ::= SEQUENCE {			
bsr-Config SEQUENCE {			
periodicBSR-Timer	infinity		
retxBSR-Timer	sf10240		
}			
phr-Config CHOICE {			
release	NULL		
}			
}			

7.1.1 MAC

7.1.1.0 Default Pre-Test Conditions for all MAC test cases

The following pre-test conditions shall be applied in all MAC test cases until the test case explicitly over writes these conditions

System Simulator:

- The SS configures the test environment in accordance to the execution conditions in Table 7.1.1.0-1.

UE:

- None

Preamble:

- The SS performs the generic procedure in [4] to get UE in state RRC_CONNECTED in accordance to the execution conditions in Table 7.1.1.0-2 and using the message condition UE TEST LOOP MODE A to return one PDCP SDU per DL PDCP SDU.

Table 7.1.1.0-1: Test environment

Execution Condition	Cell configuration	System Information Combination
IF pc_NG_RAN_NR	NR Cell 1	NR: System information Combination NR-1
ELSE IF pc_EN_DC	E-UTRA Cell 1 is PCell, NR Cell 1 is PSCell	EUTRA: System information Combination 1 NR: N/A
ELSE IF pc_NGEN_DC	NG-RAN E-UTRA Cell 1 is PCell, NR Cell 1 is PSCell	EUTRA: System information Combination 1 NR: N/A

ELSE IF pc_NE_DC	NR Cell 1 is PCell, E-UTRA Cell 1 is PSCell	NR: System information Combination NR-1 E-UTRA: N/A
------------------	--	---

Table 7.1.1.0-2: Preamble parameters

Execution Condition	Multi-PDN / Multi-PDU Sessions Condition	Generic Procedure Parameters	Primary DRB used for Data testing
IF pc_NG_RAN_NR	FALSE	Connectivity(NR), Test loop function(On) One DRB	Default DRB of the first PDU session on NR Cell
	TRUE	Connectivity(NR), Test loop function(On) N DRBs ($N \geq 2$)	
ELSE IF pc_EN_DC	FALSE	Connectivity(EN-DC), DC bearer(One MN Terminated MCG bearer and One SN terminated SCG bearer), Test loop function(On)	SN Terminated SCG bearer unless explicitly specified in test case
	TRUE	Connectivity(EN-DC), DC bearer(Two MN Terminated MCG bearer and One SN terminated SCG bearer), Test loop function(On)	
ELSE IF pc_NGEN_DC	FALSE	Connectivity(NGEN-DC), DC bearer(One MN Terminated MCG bearer and One SN terminated SCG bearer), Test loop function(On)	SN Terminated SCG bearer unless explicitly specified in test case
	TRUE	Connectivity(NGEN-DC), DC bearer(Two MN Terminated MCG bearer and One SN terminated SCG bearer), Test loop function(On)	
ELSE IF pc_NE_DC	FALSE	Connectivity(NE-DC), DC bearer(One MN Terminated MCG bearer and One SN terminated SCG bearer), Test loop function(On)	SN Terminated SCG bearer unless explicitly specified in test case
	TRUE	Connectivity(NE-DC), DC bearer($N \geq 2$ MN Terminated MCG bearer and One SN terminated SCG bearer), Test loop function(On)	

Table 7.1.1.0-3: Message conditions

Execution Condition	Message condition exceptions
IF pc_NG_RAN_NR	Message with condition AM is used for step 7 in 4.5.4.2 according to [4]
ELSE IF pc_EN_DC	Message condition MCG_and_SCG with condition AM is used for step 7 in 4.5.4.2 according to [4]
ELSE IF pc_NGEN_DC	Message condition MCG_and_SCG with condition AM is used for step 7 in 4.5.4.2 according to [4]
ELSE IF pc_NE_DC	Message condition MCG_and_SCG with condition AM is used for step 7 in 4.5.4.6 according to [4]

Table 7.1.1.0-4: SDAP Configuration Settings for pc_NG_RAN_NR and pc_NE_DC

Parameter	Value DRB1	Value DRB2	Value DRB3
default DRB	true	false	false

mappedQoS-FlowsToAdd	QFI 1 in Table 4.8.2.3-1 according to TS38.508-1	QFI 2 in Table 4.8.2.3-2 according to TS38.508-1	QFI 3 in Table 4.8.2.3-3 according to TS38.508-1
----------------------	--	--	--

7.1.1.1 Random Access Procedures

7.1.1.1.1 Correct selection of RACH parameters / Random access preamble and PRACH resource explicitly signalled to the UE by RRC / contention free random access procedure

7.1.1.1.1.1 Test Purpose (TP)

(1)

```
with { UE in RRC_Connected }
ensure that {
  when { SS sends an RRCReconfiguration message including RACH-ConfigDedicated information element }
  then { UE sends a prach preamble given in the RACH-ConfigDedicated on the target cell }
}
```

(2)

```
with { UE in RRC_Connected state after transmission of a PRACH preamble on NR SpCell received in RACH-ConfigDedicated on the target cell }
ensure that {
  when { UE does not receive a matching Random Access response in ra-ResponseWindowSize (hence considers RACH attempt as failed) and PREAMBLE_TRANSMISSION_COUNTER is less than PREAMBLE_TRANS_MAX }
  then { UE retransmits a PRACH preamble received in RACH-ConfigDedicated on the target cell }
}
```

7.1.1.1.1.2 Conformance requirements

References: The conformance requirements covered in the present test case are specified in: TS 38.321, clauses 5.1.2, 5.1.4. Unless otherwise stated these are Rel-15 requirements.

[TS 38.321, clause 5.1.2]

The MAC entity shall:

...

1> else if the *ra-PreambleIndex* has been explicitly provided by PDCCH; and

1> if the *ra-PreambleIndex* is not 0b000000:

2> set the *PREAMBLE_INDEX* to the signalled *ra-PreambleIndex*;

2> select the SSB signalled by PDCCH.

1> else if the contention-free Random Access Resources associated with SSBs have been explicitly provided in *rach-ConfigDedicated* and at least one SSB with SS-RSRP above *rsrp-ThresholdSSB* amongst the associated SSBs is available:

2> select an SSB with SS-RSRP above *rsrp-ThresholdSSB* amongst the associated SSBs;

2> set the *PREAMBLE_INDEX* to a *ra-PreambleIndex* corresponding to the selected SSB.

...

1> else if an SSB is selected above:

2> determine the next available PRACH occasion from the PRACH occasions corresponding to the selected SSB permitted by the restrictions given by the *ra-ssb-OccasionMaskIndex* if configured or indicated by

PDCCH (the MAC entity shall select a PRACH occasion randomly with equal probability amongst the consecutive PRACH occasions according to clause 8.1 of TS 38.213 [6], corresponding to the selected SSB; the MAC entity may take into account the possible occurrence of measurement gaps when determining the next available PRACH occasion corresponding to the selected SSB).

1> else if a CSI-RS is selected above:

2> if there is no contention-free Random Access Resource associated with the selected CSI-RS:

3> determine the next available PRACH occasion from the PRACH occasions, permitted by the restrictions given by the *ra-ssb-OccasionMaskIndex* if configured, corresponding to the SSB in *candidateBeamRSList* which is quasi-collocated with the selected CSI-RS as specified in TS 38.214 [7] (the MAC entity shall select a PRACH occasion randomly with equal probability amongst the consecutive PRACH occasions according to clause 8.1 of TS 38.213 [6], corresponding to the SSB which is quasi-collocated with the selected CSI-RS; the MAC entity may take into account the possible occurrence of measurement gaps when determining the next available PRACH occasion corresponding to the SSB which is quasi-collocated with the selected CSI-RS).

2> else:

3> determine the next available PRACH occasion from the PRACH occasions in *ra-OccasionList* corresponding to the selected CSI-RS (the MAC entity shall select a PRACH occasion randomly with equal probability amongst the PRACH occasions occurring simultaneously but on different subcarriers, corresponding to the selected CSI-RS; the MAC entity may take into account the possible occurrence of measurement gaps when determining the next available PRACH occasion corresponding to the selected CSI-RS).

1> perform the Random Access Preamble transmission procedure (see clause 5.1.3).

NOTE: When the UE determines if there is an SSB with SS-RSRP above *rsrp-ThresholdSSB* or a CSI-RS with CSI-RSRP above *rsrp-ThresholdCSI-RS*, the UE uses the latest unfiltered L1-RSRP measurement.

[TS 38.321, clause 5.1.4]

Once the Random Access Preamble is transmitted and regardless of the possible occurrence of a measurement gap, the MAC entity shall:

1> if the contention-free Random Access Preamble for beam failure recovery request was transmitted by the MAC entity:

2> start the *ra-ResponseWindow* configured in *BeamFailureRecoveryConfig* at the first PDCCH occasion as specified in TS 38.213 [6] from the end of the Random Access Preamble transmission;

2> monitor for a PDCCH transmission on the search space indicated by *recoverySearchSpaceId* of the SpCell identified by the C-RNTI while *ra-ResponseWindow* is running.

1> else:

2> start the *ra-ResponseWindow* configured in *RACH-ConfigCommon* at the first PDCCH occasion as specified in TS 38.213 [6] from the end of the Random Access Preamble transmission;

2> monitor the PDCCH of the SpCell for Random Access Response(s) identified by the RA-RNTI while the *ra-ResponseWindow* is running.

1> if notification of a reception of a PDCCH transmission on the search space indicated by *recoverySearchSpaceId* is received from lower layers on the Serving Cell where the preamble was transmitted; and

1> if PDCCH transmission is addressed to the C-RNTI; and

1> if the contention-free Random Access Preamble for beam failure recovery request was transmitted by the MAC entity:

2> consider the Random Access procedure successfully completed.

1> else if a downlink assignment has been received on the PDCCH for the RA-RNTI and the received TB is successfully decoded:

- 2> if the Random Access Response contains a MAC subPDU with Backoff Indicator:
 - 3> set the *PREAMBLE_BACKOFF* to value of the BI field of the MAC subPDU using Table 7.2-1, multiplied with *SCALING_FACTOR_BI*.
- 2> else:
 - 3> set the *PREAMBLE_BACKOFF* to 0 ms.
- 2> if the Random Access Response contains a MAC subPDU with Random Access Preamble identifier corresponding to the transmitted *PREAMBLE_INDEX* (see clause 5.1.3):
 - 3> consider this Random Access Response reception successful.
- 2> if the Random Access Response reception is considered successful:
 - 3> if the Random Access Response includes a MAC subPDU with RAPID only:
 - 4> consider this Random Access procedure successfully completed;
 - 4> indicate the reception of an acknowledgement for SI request to upper layers.
 - 3> else:
 - 4> apply the following actions for the Serving Cell where the Random Access Preamble was transmitted:
 - 5> process the received Timing Advance Command (see clause 5.2);
 - 5> indicate the *preambleReceivedTargetPower* and the amount of power ramping applied to the latest Random Access Preamble transmission to lower layers (i.e. $(PREAMBLE_POWER_RAMPING_COUNTER - 1) \times PREAMBLE_POWER_RAMPING_STEP$);
 - 5> if the Random Access procedure for an SCell is performed on uplink carrier where *pusch-Config* is not configured:
 - 6> ignore the received UL grant.
 - 5> else:
 - 6> process the received UL grant value and indicate it to the lower layers.
 - 4> if the Random Access Preamble was not selected by the MAC entity among the contention-based Random Access Preamble(s):
 - 5> consider the Random Access procedure successfully completed.
 - 4> else:
 - 5> set the *TEMPORARY_C-RNTI* to the value received in the Random Access Response;
 - 5> if this is the first successfully received Random Access Response within this Random Access procedure:
 - 6> if the transmission is not being made for the CCCH logical channel:
 - 7> indicate to the Multiplexing and assembly entity to include a C-RNTI MAC CE in the subsequent uplink transmission.
 - 6> obtain the MAC PDU to transmit from the Multiplexing and assembly entity and store it in the Msg3 buffer.

NOTE: If within a Random Access procedure, an uplink grant provided in the Random Access Response for the same group of contention-based Random Access Preambles has a different size than the first uplink grant allocated during that Random Access procedure, the UE behaviour is not defined.

- 1> if *ra-ResponseWindow* configured in *BeamFailureRecoveryConfig* expires and if a PDCCH transmission on the search space indicated by *recoverySearchSpaceId* addressed to the C-RNTI has not been received on the Serving Cell where the preamble was transmitted; or

- 1> if *ra-ResponseWindow* configured in *RACH-ConfigCommon* expires, and if the Random Access Response containing Random Access Preamble identifiers that matches the transmitted *PREAMBLE_INDEX* has not been received:
 - 2> consider the Random Access Response reception not successful;
 - 2> increment *PREAMBLE_TRANSMISSION_COUNTER* by 1;
 - 2> if *PREAMBLE_TRANSMISSION_COUNTER* = *preambleTransMax* + 1:
 - 3> if the Random Access Preamble is transmitted on the SpCell:
 - 4> indicate a Random Access problem to upper layers;
 - 4> if this Random Access procedure was triggered for SI request:
 - 5> consider the Random Access procedure unsuccessfully completed.
 - 3> else if the Random Access Preamble is transmitted on an SCell:
 - 4> consider the Random Access procedure unsuccessfully completed.
 - 2> if the Random Access procedure is not completed:
 - 3> select a random backoff time according to a uniform distribution between 0 and the *PREAMBLE_BACKOFF*;
 - 3> if the criteria (as defined in clause 5.1.2) to select contention-free Random Access Resources is met during the backoff time:
 - 4> perform the Random Access Resource selection procedure (see clause 5.1.2);
 - 3> else:
 - 4> perform the Random Access Resource selection procedure (see clause 5.1.2) after the backoff time.

The MAC entity may stop *ra-ResponseWindow* (and hence monitoring for Random Access Response(s)) after successful reception of a Random Access Response containing Random Access Preamble identifiers that matches the transmitted *PREAMBLE_INDEX*.

HARQ operation is not applicable to the Random Access Response reception.

7.1.1.1.1.3 Test description

7.1.1.1.1.3.1 Pre-test conditions

Same Pre-test conditions as in clause 7.1.1.0 except the following:

- 2 NR cells (NR Cell 1 and NR Cell 2) are configured.
- Test loop function(*Off*)

7.1.1.1.1.3.2 Test procedure sequence

Table 7.1.1.1.1.3.2-1: Main behaviour

St	Procedure	Message Sequence		TP	Verdict
		U - S	Message		
1	The SS transmits an <i>RRCReconfiguration</i> message to handover NR Cell 1 to target NR Cell 2, including <i>RACH-ConfigDedicated</i> information element (Note 1, Note 3)	<--	<i>RRCReconfiguration</i>	-	-
2	Void				
3	Check: Does the UE transmit Preamble on PRACH corresponding to <i>ra-PreambleIndex</i> in	-->	(PRACH Preamble)	1	P

	step 1 on NR Cell2?				
4	Check: Does the UE re-transmits Preamble on PRACH corresponding to <i>ra-PreambleIndex</i> in step 1 on NR Cell2?	-->	(PRACH Preamble)	2	P
5	The SS transmits Random Access Response on NR cell 2, with RAPID corresponding to <i>ra-PreambleIndex</i> in step 1	<--	Random Access Response	-	-
6	Check: Does the UE transmit an <i>RRCReconfigurationComplete</i> message? (Note 2)	-->	<i>RRCReconfigurationComplete</i>	-	-
<p>Note 1: For EN-DC the NR <i>RRCReconfiguration</i> message is contained in <i>RRCConnectionReconfiguration</i> 36.508 [7], Table 4.6.1-8 using condition EN-DC_PSCell_HO AND RBConfig_NoKeyChange.</p> <p>Note 2: For EN-DC the NR <i>RRCReconfigurationComplete</i> message is contained in <i>RRCConnectionReconfigurationComplete</i>.</p> <p>Note 3: For FR1, PRACH preamble format 0 as per TS 38.211[24] Table 6.3.3.1-1 is configured (real network deployment).</p>					

7.1.1.1.1.3.3 Specific message contents

Table 7.1.1.1.1.3.3-1: Void

Table 7.1.1.1.1.3.3-2: *RRCReconfiguration* for EN-DC (step 1, Table 7.1.1.1.1.3.2-1)

Derivation Path: 38.508-1 [4], Table 4.6.1-13 with condition EN-DC_HO.			
Information Element	Value/remark	Comment	Condition
<i>RRCReconfiguration</i> ::= SEQUENCE {			
criticalExtensions CHOICE {			
<i>rrcReconfiguration</i> ::= SEQUENCE {			
secondaryCellGroup	CellGroupConfig		
}			
}			
}			

Table 7.1.1.1.1.3.3-2A: *RRCReconfiguration* for NR/5GC (step 1, Table 7.1.1.1.1.3.2-1)

Derivation Path: 38.508-1 [4], Table 4.6.1-13			
Information Element	Value/remark	Comment	Condition
<i>RRCReconfiguration</i> ::= SEQUENCE {			
criticalExtensions CHOICE {			
radioBearerConfig	RadioBearerConfig as per TS 38.508-1[4] Table 4.6.3-132 with conditions DRBn and Recover_PDCP	n set to the default DRB of the first PDU session	NR
<i>rrcReconfiguration</i> ::= SEQUENCE {			
nonCriticalExtension SEQUENCE {			
masterCellGroup	CellGroupConfig		
}			
}			
}			
}			

Table 7.1.1.1.1.3.3-3: *CellGroupConfig* for EN-DC (Table 7.1.1.1.1.3.3-2)

Derivation Path: 38.508-1 [4], Table 4.6.3-19 with condition PSCell_change			
Information Element	Value/remark	Comment	Condition
<i>CellGroupConfig</i> ::= SEQUENCE {			
spCellConfig SEQUENCE {			
spCellConfigCommon	ServingCellConfigCommon		

reconfigurationWithSync SEQUENCE {			
rach-ConfigDedicated CHOICE {			
uplink	RACH-ConfigDedicated		
}			
newUE-Identity	UE identity different from NR cell 1 UE identity		
}			
}			
}			
}			

Table 7.1.1.1.1.3.3-3A: CellGroupConfig for NR/5GC (Table 7.1.1.1.1.3.3-2A)

Derivation Path: 38.508-1 [4], Table 4.6.3-19 with condition PCell_change			
Information Element	Value/remark	Comment	Condition
CellGroupConfig ::= SEQUENCE {			
spCellConfig SEQUENCE {			
reconfigurationWithSync SEQUENCE {			
spCellConfigCommon	ServingCellConfigCommon		
rach-ConfigDedicated CHOICE {			
uplink	RACH-ConfigDedicated		
}			
newUE-Identity	UE identity different from NR cell 1 UE identity		
}			
spCellConfigDedicated	ServingCellConfig		
}			
}			
}			

Table 7.1.1.1.1.3.3-4: RACH-ConfigDedicated (Table 7.1.1.1.1.3.3-3 and Table 7.1.1.1.1.3.3-3A)

Derivation Path: TS 38.508-1 [4], Table 4.6.3-129			
Information Element	Value/remark	Comment	Condition
RACH-ConfigDedicated ::= SEQUENCE {			
cfra SEQUENCE {			
occasions SEQUENCE {			
rach-ConfigGeneric	RACH-ConfigGeneric		FR1, PRACH Preamble format 0 used
}			
resources CHOICE {			
ssb SEQUENCE {			
ssb-ResourceList SEQUENCE (SIZE(1..maxRA-SSB-Resources)) OF CFRA-SSB-Resource {	1 entry		
CFRA-SSB-Resource[1] SEQUENCE {		entry 1	
ssb	0		
ra-PreambleIndex	52	Randomly selected	
}			
}			
}			
}			
}			
}			

Table 7.1.1.1.1.3.3-5: RACH-ConfigGeneric (Table 7.1.1.1.1.3.3-4)

Derivation Path: TS 38.508-1 [4], Table 4.6.3-129			
Information Element	Value/remark	Comment	Condition
RACH-ConfigDedicated ::= SEQUENCE {			
prach-ConfigurationIndex	14		FR1

	149		FR2
zeroCorrelationZoneConfig	12		FR1
	15		FR2
}			

Table 7.1.1.1.1.3.3-6: ServingCellConfigCommon (Table 7.1.1.1.1.3.3-3 and Table 7.1.1.1.1.3.3-3A)

Derivation Path: TS 38.508-1 [4], Table 4.6.3-168			
Information Element	Value/remark	Comment	Condition
ServingCellConfigCommon ::= SEQUENCE {			
uplinkConfigCommon SEQUENCE {			
initialUplinkBWP	BWP-UplinkCommon		
}			
tdd-UL-DL-ConfigurationCommon	TDD-UL-DL- ConfigCommon		
}			

Table 7.1.1.1.1.3.3-7: BWP-UplinkCommon (Table 7.1.1.1.1.3.3-6)

Derivation Path: TS 38.508-1 [4], Table 4.6.3-10			
Information Element	Value/remark	Comment	Condition
BWP-UplinkCommon ::= SEQUENCE {			
rach-ConfigCommon CHOICE {			
setup	RACH-ConfigCommon		
}			
}			

Table 7.1.1.1.1.3.3-8: RACH-ConfigCommon (Table 7.1.1.1.1.3.3-7)

Derivation Path: TS 38.508-1 [4], Table 4.6.3-128			
Information Element	Value/remark	Comment	Condition
RACH-ConfigCommon ::= SEQUENCE {			
rach-ConfigGeneric	RACH-ConfigGeneric		
ssb_perRACH_OccasionAndCB_PreamblesPerSSB CHOICE {			
one	n36		
}			
prach-RootSequenceIndex CHOICE {			
l139	Set according to table 4.4.2-2 in TS 38.508-1 [4] for the NR Cell..		
l839	Set according to table 4.4.2-2 in TS 38.508-1 [4] for the NR Cell.	PRACH Preamble format 0 used	FR1,
}			
}			

Table 7.1.1.1.1.3.3-9: TDD-UL-DL-ConfigCommon (Table 7.1.1.1.1.3.3-6)

Derivation Path: TS 38.508-1 [4], Table 4.6.3-192			
Information Element	Value/remark	Comment	Condition
TDD-UL-DL-ConfigCommon ::= SEQUENCE {			
referenceSubcarrierSpacing	SubcarrierSpacing		
pattern1 SEQUENCE {			
dl-UL-TransmissionPeriodicity	ms5		FR1
	ms0p625		FR2
nrofDownlinkSlots	3		FR1 AND SCS30
	1		FR1 AND SCS15
	3		FR2

nrofDownlinkSymbols	6		FR1
	10		FR2
nrofUplinkSlots	2		FR1 AND SCS30
	1		FR1 AND SCS15
nrofUplinkSymbols	1		FR2
	4		FR1
dl-UL-TransmissionPeriodicity-v1530	2		FR2
	ms3		FR1
}			
pattern2	Not present		
pattern2 SEQUENCE {			FR1
dl-UL-TransmissionPeriodicity	ms2		
nrofDownlinkSlots	4		FR1 AND SCS30
	2		FR1 AND SCS15
nrofDownlinkSymbols	0		
nrofUplinkSlots	0		
nrofUplinkSymbols	0		
}			
}			

Table 7.1.1.1.3.3-10: ServingCellConfig (Table 7.1.1.1.3.3-3A)

Derivation Path: TS 38.508-1 [4], Table 4.6.3-167			
Information Element	Value/remark	Comment	Condition
ServingCellConfig ::= SEQUENCE {			
uplinkConfig SEQUENCE {			
initialUplinkBWP	BWP-UplinkDedicated		
}			
}			

Table 7.1.1.1.3.3-11: BWP-UplinkDedicated (Table 7.1.1.1.3.3-10)

Derivation Path: TS 38.508-1 [4], Table 4.6.3-15			
Information Element	Value/remark	Comment	Condition
BWP-UplinkDedicated ::= SEQUENCE {			
pucch-Config CHOICE {			
setup	PUCCH-Config		
}			
}			

Table 7.1.1.1.3.3-12: PUCCH-Config (Table 7.1.1.1.3.3-11)

Derivation Path: TS 38.508-1 [4], Table 4.6.3-112			
Information Element	Value/remark	Comment	Condition
PUCCH-Config ::= SEQUENCE {			
schedulingRequestResourceToAddModList	1 entry		
SEQUENCE (SIZE (1..maxNrofSR-Resources)) OF SchedulingRequestResourceConfig {			
SchedulingRequestResourceConfig	SchedulingRequestResourceConfig	entry 1	
}			
}			

Table 7.1.1.1.3.3-13: SchedulingRequestResourceConfig (Table 7.1.1.1.3.3-12)

Derivation Path: TS 38.508-1 [4], Table 4.6.3-157			
Information Element	Value/remark	Comment	Condition

SchedulingRequestResourceConfig ::= SEQUENCE {			
periodicityAndOffset CHOICE {			
sl10	2	With SCS = kHz15 results in repetition every 10 ms	SCS15
sl20	5	With SCS = kHz30 results in repetition every 10 ms	SCS30
sl80	4	With SCS = kHz120 results in repetition every 10 ms	SCS120
}			
}			

7.1.1.1.1a Correct selection of RACH parameters / Random access preamble and PRACH resource explicitly signalled to the UE by PDCCH Order / contention free random access procedure

7.1.1.1.1a.1 Test Purpose (TP)

(1)

```
with { UE in RRC_Connected }
ensure that {
  when { PDCCH control command is received in NR SpCell providing Random Access Preamble }
  then { UE sends a PRACH preamble given in the PDCCH Order in NR SpCell }
}
```

(2)

```
with { UE in RRC_Connected state after transmission of a PRACH preamble on NR SpCell received in
PDCCH control command on NR SpCell }
ensure that {
  when { UE does not receive a matching Random Access response in ra-ResponseWindowSize (hence
considers RACH attempt as failed) and PREAMBLE_TRANSMISSION_COUNTER is less than PREAMBLE_TRANS_MAX
}
  then { UE retransmits a PRACH preamble received in PDCCH control command on NR SpCell }
}
```

7.1.1.1.1a.2 Conformance requirements

References: The conformance requirements covered in the present test case are specified in: TS 38.321, clauses 5.1.2, 5.1.4 and TS 38.212 clause 7.3.1.2.1. Unless otherwise stated these are Rel-15 requirements.

[TS 38.321, clause 5.1.2]

The MAC entity shall:

...

1> else if the *ra-PreambleIndex* has been explicitly provided by either PDCCH or RRC; and

1> if the *ra-PreambleIndex* is not 0b000000; and

1> if contention-free Random Access Resource associated with SSBs or CSI-RS have not been explicitly provided by RRC:

2> set the *PREAMBLE_INDEX* to the signalled *ra-PreambleIndex*.

...

- 1> if an SSB is selected above and an association between PRACH occasions and SSBs is configured:
 - 2> determine the next available PRACH occasion from the PRACH occasions corresponding to the selected SSB permitted by the restrictions given by the *ra-ssb-OccasionMaskIndex* if configured (the MAC entity may take into account the possible occurrence of measurement gaps when determining the next available PRACH occasion corresponding to the selected SSB).
- 1> else if a CSI-RS is selected above and an association between PRACH occasions and CSI-RSs is configured:
 - 2> determine the next available PRACH occasion from the PRACH occasions in *ra-OccasionList* corresponding to the selected CSI-RS (the MAC entity may take into account the possible occurrence of measurement gaps when determining the next available PRACH occasion corresponding to the selected CSI-RS).
- 1> else:
 - 2> determine the next available PRACH occasion (the MAC entity may take into account the possible occurrence of measurement gaps when determining the next available PRACH occasion).
- 1> perform the Random Access Preamble transmission procedure (see clause 5.1.3).

[TS 38.321, clause 5.1.4]

Once the Random Access Preamble is transmitted and regardless of the possible occurrence of a measurement gap, the MAC entity shall:

...

- 1> else:
 - 2> start the *ra-ResponseWindow* configured in *RACH-ConfigCommon* at the first PDCCH occasion as specified in TS 38.213 [6] from the end of the Random Access Preamble transmission;
 - 2> monitor the PDCCH of the SpCell for Random Access Response(s) identified by the RA-RNTI while the *ra-ResponseWindow* is running.
- 1> if notification of a reception of a PDCCH transmission is received from lower layers; and
- 1> if PDCCH transmission is addressed to the C-RNTI; and
- ...
- 1> else if a downlink assignment has been received on the PDCCH for the RA-RNTI and the received TB is successfully decoded:
 - 2> if the Random Access Response contains a Backoff Indicator subheader:
 - 3> set the *PREAMBLE_BACKOFF* to value of the BI field of the Backoff Indicator subheader using Table 7.2-1.
 - 2> else:
 - 3> set the *PREAMBLE_BACKOFF* to 0 ms.
 - 2> if the Random Access Response contains a Random Access Preamble identifier corresponding to the transmitted *PREAMBLE_INDEX* (see subclause 5.1.3):
 - 3> consider this Random Access Response reception successful.
 - 2> if the Random Access Response reception is considered successful:
 - 3> if the Random Access Response includes RAPID only:
 - 4> consider this Random Access procedure successfully completed;
 - 4> indicate the reception of an acknowledgement for the SI request to upper layers.

- 3> else:
 - 4> apply the following actions for the Serving Cell where the Random Access Preamble was transmitted:
 - 5> process the received Timing Advance Command (see subclause 5.2);
 - 5> indicate the *preambleReceivedTargetPower* and the amount of power ramping applied to the latest Random Access Preamble transmission to lower layers (i.e. $(PREAMBLE_POWER_RAMPING_COUNTER - 1) \times preamblePowerRampingStep$);
 - 5> if the Serving Cell for the Random Access procedure is SRS-only SCell:
 - 6> ignore the received UL grant.
 - 5> else:
 - 6> process the received UL grant value and indicate it to the lower layers.
 - 4> if the Random Access Preamble was not selected by the MAC entity among the contention-based Random Access Preamble(s):
 - 5> consider the Random Access procedure successfully completed.
- ...
- 1> if *ra-ResponseWindow* configured in *RACH-ConfigCommon* expires, and if the Random Access Response containing Random Access Preamble identifiers that matches the transmitted *PREAMBLE_INDEX* has not been received; or:
 - 1> if *ra-ResponseWindow* configured in *BeamFailureRecoveryConfig* expires and if the PDCCH addressed to the C-RNTI has not been received:
 - 2> consider the Random Access Response reception not successful;
 - 2> increment *PREAMBLE_TRANSMISSION_COUNTER* by 1;
 - 2> if $PREAMBLE_TRANSMISSION_COUNTER = preambleTxMax + 1$:
 - 3> if the Random Access Preamble is transmitted on the SpCell:
 - 4> indicate a Random Access problem to upper layers.
 - 3> else if the Random Access Preamble is transmitted on a SCell:
 - 4> consider the Random Access procedure unsuccessfully completed.
 - 2> if in this Random Access procedure, the Random Access Preamble was selected by MAC among the contention-based Random Access Preambles:
 - 3> select a random backoff time according to a uniform distribution between 0 and the *PREAMBLE_BACKOFF*;
 - 3> delay the subsequent Random Access Preamble transmission by the backoff time.
 - 2> perform the Random Access Resource selection procedure (see subclause 5.1.2).

The MAC entity may stop *ra-ResponseWindow* (and hence monitoring for Random Access Response(s)) after successful reception of a Random Access Response containing Random Access Preamble identifiers that matches the transmitted *PREAMBLE_INDEX*.

HARQ operation is not applicable to the Random Access Response transmission.

[TS 38.212, 7.3.1.2.1]

If the CRC of the DCI format 1_0 is scrambled by C-RNTI and the "Frequency domain resource assignment" field are of all ones, the DCI format 1_0 is for random access procedure initiated by a PDCCH order, with all remaining fields set as follows:

- Random Access Preamble index – 6 bits according to *ra-PreambleIndex* in Subclause 5.1.2 of [8, TS38.321]
- UL/SUL indicator – 1 bit. If the value of the "Random Access Preamble index" is not all zeros and if the UE is configured with SUL in the cell, this field indicates which UL carrier in the cell to transmit the PRACH according to Table 7.3.1.1.1-1; otherwise, this field is reserved
- SS/PBCH index – 6 bits. If the value of the "Random Access Preamble index" is not all zeros, this field indicates the SS/PBCH that shall be used to determine the RACH occasion for the PRACH transmission; otherwise, this field is reserved.
- PRACH Mask index – 4 bits. If the value of the "Random Access Preamble index" is not all zeros, this field indicates the RACH occasion associated with the SS/PBCH indicated by "SS/PBCH index" for the PRACH transmission, according to Subclause 5.1.1 of [8, TS38.321]; otherwise, this field is reserved
- Reserved bits – 10 bits

7.1.1.1.1a.3 Test description

7.1.1.1.1a.3.1 Pre-test conditions

Same Pre-test conditions as in clause 7.1.1.0 except that Test loop function(*Off*).

7.1.1.1.1a.3.2 Test procedure sequence

Table 7.1.1.1a.3.2-1: Main behaviour

St	Procedure	Message Sequence		TP	Verdict
		U - S	Message		
0A	SS transmits an RRCReconfiguration message to configure specific parameters. Note 1, Note 3	<--	RRCReconfiguration	-	-
0B	The UE transmits RRCReconfigurationComplete message. Note 2	-->	RRCReconfigurationComplete	-	-
1	The SS transmits a PDCCH order providing Random Access Preamble ID 37 on NR SpCell.	<--	(PDCCH Order)	-	-
2	Check: Does the UE transmit Preamble on PRACH corresponding to <i>ra-PreambleIndex</i> in step 1?	-->	(PRACH Preamble)	1	P
3	Check: Does the UE re-transmits Preamble on PRACH corresponding to <i>ra-PreambleIndex</i> in step 1?	-->	(PRACH Preamble)	2	P
4	Check: Does the UE transmit Preamble on PRACH corresponding to <i>ra-PreambleIndex</i> in step 1?	-->	(PRACH Preamble)	2	P
5	Check: Does the UE re-transmits Preamble on PRACH corresponding to <i>ra-PreambleIndex</i> in step 1?	-->	(PRACH Preamble)	2	P
6	The SS transmits Random Access Response on NR SpCell, with RAPID corresponding to <i>ra-PreambleIndex</i> in step 1	<--	Random Access Response	-	-
Note 1: for EN-DC the NR <i>RRCReconfiguration</i> message is contained in <i>RRCConnectionReconfiguration</i> . Note 2: for EN-DC the NR <i>RRCReconfigurationComplete</i> message is contained in <i>RRCConnectionReconfigurationComplete</i> . Note 3: For FR1, PRACH preamble format 0 as per TS 38.211[24] Table 6.3.3.1-1 is configured in order to provide coverage for PRACH preamble format 0 testing					

7.1.1.1.1a.3.3 Specific message contents

Table 7.1.1.1a.3.3-1: RRCReconfiguration (step 0A, Table7.1.1.1a.3.2-1)

Derivation Path: TS 38.508-1 [4], Table 4.6.1-13
--

Information Element	Value/remark	Comment	Condition
RRCReconfiguration ::= SEQUENCE {			
		TS 38.508-1 [4], 2	
criticalExtensions CHOICE {			
rrcReconfiguration ::= SEQUENCE {			
secondaryCellGroup	CellGroupConfig	OCTET STRING (CONTAINING CellGroupConfig)	EN-DC
nonCriticalExtension SEQUENCE {			NR
masterCellGroup	CellGroupConfig	OCTET STRING (CONTAINING CellGroupConfig)	
}			
}			
}			
}			

Table 7.1.1.1a.3.3-2: CellGroupConfig (Table 7.1.1.1a.3.3-1)

Derivation Path: TS 38.508-1 [4], Table 4.6.3-19			
Information Element	Value/remark	Comment	Condition
CellGroupConfig ::= SEQUENCE {			
spCellConfig SEQUENCE {			
reconfigurationWithSync SEQUENCE {			
spCellConfigCommon	ServingCellConfigCommon		
newUE-Identity	RNTI-Value		
t304	ms2000		
rach-ConfigDedicated	Not Present		
}			
spCellConfigDedicated	ServingCellConfig		
}			
}			

Table 7.1.1.1a.3.3-3: ServingCellConfigCommon (Table 7.1.1.1a.3.3-2)

Derivation Path: TS 38.508-1 [4], Table 4.6.3-168			
Information Element	Value/remark	Comment	Condition
ServingCellConfigCommon ::= SEQUENCE {			
uplinkConfigCommon SEQUENCE {			
initialUplinkBWP	BWP-UplinkCommon		
}			
tdd-UL-DL-ConfigurationCommon	TDD-UL-DL-ConfigurationCommon		
}			

Table 7.1.1.1a.3.3-4: BWP-UplinkCommon (Table 7.1.1.1a.3.3-3)

Derivation Path: TS 38.508-1 [4], Table 4.6.3-10			
Information Element	Value/remark	Comment	Condition
BWP-UplinkCommon ::= SEQUENCE {			
rach-ConfigCommon CHOICE {			
setup	RACH-ConfigCommon		
}			
}			

Table 7.1.1.1a.3.3-5: RACH-ConfigCommon (Table 7.1.1.1a.3.3-4)

Derivation Path: TS 38.508-1 [4], Table 4.6.3-128			
Information Element	Value/remark	Comment	Condition
RACH-ConfigCommon ::= SEQUENCE {			

rach-ConfigGeneric	RACH-ConfigGeneric		
ssb_perRACH_OccasionAndCB_PreamblesPerSSB CHOICE {			
one	n36		
}			
prach-RootSequenceIndex CHOICE {			
1139	Set according to table 4.4.2-2 in TS 38.508-1 [4] for the NR Cell		
1839	Set according to table 4.4.2-2 in TS 38.508-1 [4] for the NR Cell.	PRACH Preamble format 0 used	FR1,
}			
}			

Table 7.1.1.1.1a.3.3-6: RACH-ConfigGeneric (Table 7.1.1.1.1a.3.3-5)

Derivation Path: TS 38.508-1 [4], Table 4.6.3-130			
Information Element	Value/remark	Comment	Condition
RACH-ConfigGeneric ::= SEQUENCE {			
preambleReceivedTargetPower	-104		
preambleTransMax	n4		
prach-ConfigurationIndex	14		FR1
	149		FR2
zeroCorrelationZoneConfig	12		FR1
	15		FR2
}			

Table 7.1.1.1.1a.3.3-7: TDD-UL-DL-ConfigCommon (Table 7.1.1.1.1a.3.3-3)

Derivation Path: TS 38.508-1 [4], Table 4.6.3-192			
Information Element	Value/remark	Comment	Condition
TDD-UL-DL-ConfigCommon ::= SEQUENCE {			
referenceSubcarrierSpacing	SubcarrierSpacing		
pattern1 SEQUENCE {			
dl-UL-TransmissionPeriodicity	ms5		FR1
	ms0p625		FR2
nrofDownlinkSlots	3		FR1 AND SCS30
	1		FR1 AND SCS15
	3		FR2
nrofDownlinkSymbols	6		FR1
	10		FR2
nrofUplinkSlots	2		FR1 AND SCS30
	1		FR1 AND SCS15
	1		FR2
nrofUplinkSymbols	4		
	2		FR2
dl-UL-TransmissionPeriodicity-v1530	ms3		FR1
}			
pattern2	Not present		
pattern2 SEQUENCE {			FR1
dl-UL-TransmissionPeriodicity	ms2		
nrofDownlinkSlots	4		FR1 AND SCS30
	2		FR1 AND SCS15
nrofDownlinkSymbols	0		
nrofUplinkSlots	0		
nrofUplinkSymbols	0		
}			

}			
---	--	--	--

Table 7.1.1.1.1a.3.3-8: ServingCellConfig (Table 7.1.1.1.1a.3.3-2)

Derivation Path: TS 38.508-1 [4], Table 4.6.3-167			
Information Element	Value/remark	Comment	Condition
ServingCellConfig ::= SEQUENCE {			
uplinkConfig SEQUENCE {			
initialUplinkBWP	BWP-UplinkDedicated		
}			
}			

Table 7.1.1.1.1a.3.3-9: BWP-UplinkDedicated (Table 7.1.1.1.1a.3.3-8)

Derivation Path: TS 38.508-1 [4], Table 4.6.3-15			
Information Element	Value/remark	Comment	Condition
BWP-UplinkDedicated ::= SEQUENCE {			
pucch-Config CHOICE {			
setup	PUCCH-Config		
}			
}			

Table 7.1.1.1.1a.3.3-10: PUCCH-Config (Table 7.1.1.1.1a.3.3-9)

Derivation Path: TS 38.508-1 [4], Table 4.6.3-112			
Information Element	Value/remark	Comment	Condition
PUCCH-Config ::= SEQUENCE {			
schedulingRequestResourceToAddModList	1 entry		
SEQUENCE (SIZE (1..maxNrofSR-Resources)) OF			
SchedulingRequestResourceConfig {			
SchedulingRequestResourceConfig	SchedulingRequestResourceConfig	entry 1	
}			
}			

Table 7.1.1.1.1a.3.3-11: SchedulingRequestResourceConfig (Table 7.1.1.1.1a.3.3-10)

Derivation Path: TS 38.508-1 [4], Table 4.6.3-112			
Information Element	Value/remark	Comment	Condition
SchedulingRequestResourceConfig ::= SEQUENCE {			
periodicityAndOffset CHOICE {			
sl10	2	With SCS = kHz15 results in repetition every 10 ms	SCS15
sl20	5	With SCS = kHz30 results in repetition every 10 ms	SCS30
sl80	4	With SCS = kHz120 results in repetition every 10 ms	SCS120
}			
}			

7.1.1.1.2 Random access procedure / Successful / C-RNTI Based / Preamble selected by MAC itself

7.1.1.1.2.1 Test Purpose (TP)

(1)

```
with { UE in RRC_Connected NR SpCell TimeAlignmentTimer expired, and has UL Data to send }
ensure that {
  when { the UL MAC PDU Size is less than messageSizeGroupA }
  then { UE transmits a random access preamble using a preamble in group A of random access
preambles }
}
```

(2)

```
with { UE in RRC_Connected state after transmission of a PRACH preamble on NR SpCell }
ensure that {
  when { SS does not answer with a matching Random Access Response within ra-ResponseWindowSize }
  then { UE retransmits a PRACH preamble from same group }
}
```

(3)

```
with { UE in RRC_Connected state after transmission of a PRACH preamble on NR SpCell }
ensure that {
  when { UE receives while ra-ResponseWindowSizeTimer is running MAC PDU containing multiple RARs
but none of the subheaders contains a RAPID corresponding to the UE }
  then { UE retransmits a PRACH preamble from same group }
}
```

(4)

```
with { UE in RRC_Connected state after transmission of a PRACH preamble on NR SpCell }
ensure that {
  when { SS sends a Random Access Response including a Backoff Indicator and the Random Access
Preamble identifier is different from the value received from the UE }
  then { UE triggers RA preamble after a random time between 0 and the indicated Backoff parameter
from same group }
}
```

(5)

```
with { UE in RRC_Connected state after transmission of a PRACH preamble on NR SpCell }
ensure that {
  when { UE receives while ra-ResponseWindowSizeTimer is running MAC PDU containing multiple RARs
and one of the subheaders contains a RAPID corresponding to the UE and containing Backoff Indicator
}
  then { UE stores Backoff Indicator UE transmits RACH procedure MSG3 }
}
```

(6)

```
with { UE in RRC_Connected state after transmission of Msg3 on NR SpCell without dedicated preamble
}
ensure that {
  when { The SS does not schedule any PDCCH transmission addressed to UE C-RNTI before Contention
resolution timer expiry }
  then { UE transmits a random access preamble using a preamble in the same group of random access
preambles as used for the first transmission of Msg3 }
}
```

(7)

```
with { UE in RRC_Connected state after transmission of Msg3 on NR SpCell without dedicated preamble
}
ensure that {
  when { UE receive PDCCH transmission addressed to its C-RNTI before Contention resolution timer
expiry }
  then { UE considers RACH procedure as complete }
}
```

```

    }

```

(8)

```

with { UE in RRC CONNECTED state and Random Access Preambles group B is configured }
ensure that {
  when { UE has data available for transmission and the MAC PDU Size carrying this data is greater
than ra-Msg3SizeGroupA and TimeAlignmentTimer expires }
  then {UE transmits a random access preamble using a preamble in group B of random access
preambles}
}

```

(9)

```

with { UE in RRC_Connected state and having initiated a random access procedure in NR SpCell }
ensure that {
  when { The SS transmits a Timing Advance Command in a Random Access Response message }
  then {the UE applies the received Timing Advance value in the next transmitted MAC PDU }
}

```

7.1.1.1.2.2 Conformance requirements

References: The conformance requirements covered in the present test case are specified in: TS 38.321, clauses 5.1.2, 5.1.3, 5.1.4, 5.1.5, 5.2, 6.1.3.2, 6.1.5 and 6.2.3. Unless otherwise stated these are Rel-15 requirements.

[TS 38.321, clause 5.1.2]

The MAC entity shall:

...

1> else (i.e. for the contention-based Random Access preamble selection):

2> if at least one of the SSBs with SS-RSRP above *rsrp-ThresholdSSB* is available:

3> select an SSB with SS-RSRP above *rsrp-ThresholdSSB*.

2> else:

3> select any SSB.

2> if Msg3 has not yet been transmitted:

3> if Random Access Preambles group B is configured:

4> if the potential Msg3 size (UL data available for transmission plus MAC header and, where required, MAC CEs) is greater than *ra-Msg3SizeGroupA* and the pathloss is less than *PCMAX* (of the Serving Cell performing the Random Access Procedure) $- preambleReceivedTargetPower - msg3-DeltaPreamble - messagePowerOffsetGroupB$; or

4> if the Random Access procedure was initiated for the CCCH logical channel and the CCCH SDU size plus MAC subheader is greater than *ra-Msg3SizeGroupA*:5> select the Random Access Preambles group B.

4> else:

5> select the Random Access Preambles group A.

3> else:

4> select the Random Access Preambles group A.

2> else (i.e. Msg3 is being retransmitted):

3> select the same group of Random Access Preambles as was used for the Random Access Preamble transmission attempt corresponding to the first transmission of Msg3.

2> if the association between Random Access Preambles and SSBs is configured:

3> select a Random Access Preamble randomly with equal probability from the Random Access Preambles associated with the selected SSB and the selected Random Access Preambles group.

2> else:

3> select a Random Access Preamble randomly with equal probability from the Random Access Preambles within the selected Random Access Preambles group.

2> set the *PREAMBLE_INDEX* to the selected *ra-PreambleIndex*.

...

1> if the Random Access procedure was initiated for SI request (as specified in TS 38.331 [5]); and

1> if *ra-AssociationPeriodIndex* and *si-RequestPeriod* are configured:

2> determine the next available PRACH occasion from the PRACH occasions corresponding to the selected SSB in the association period given by *ra-AssociationPeriodIndex* in the *si-RequestPeriod* permitted by the restrictions given by the *ra-ssb-OccasionMaskIndex* (the MAC entity shall select a PRACH occasion randomly with equal probability amongst the consecutive PRACH occasions according to subclause 8.1 of TS 38.213 [6] corresponding to the selected SSB).

1> else if an SSB is selected above:

2> determine the next available PRACH occasion from the PRACH occasions corresponding to the selected SSB permitted by the restrictions given by the *ra-ssb-OccasionMaskIndex* if configured (the MAC entity shall select a PRACH occasion randomly with equal probability amongst the consecutive PRACH occasions according to subclause 8.1 of TS 38.213 [6], corresponding to the selected SSB; the MAC entity may take into account the possible occurrence of measurement gaps when determining the next available PRACH occasion corresponding to the selected SSB).

1> else if a CSI-RS is selected above:

2> if there is no contention-free Random Access Resource associated with the selected CSI-RS:

3> determine the next available PRACH occasion from the PRACH occasions, permitted by the restrictions given by the *ra-ssb-OccasionMaskIndex* if configured, corresponding to the SSB in *candidateBeamRSList* which is quasi-collocated with the selected CSI-RS as specified in TS 38.214 [7] (the MAC entity may take into account the possible occurrence of measurement gaps when determining the next available PRACH occasion corresponding to the SSB which is quasi-collocated with the selected CSI-RS).

2> else:

3> determine the next available PRACH occasion from the PRACH occasions in *ra-OccasionList* corresponding to the selected CSI-RS (the MAC entity shall select a PRACH occasion randomly with equal probability amongst the PRACH occasions occurring simultaneously but on different subcarriers, corresponding to the selected CSI-RS; the MAC entity may take into account the possible occurrence of measurement gaps when determining the next available PRACH occasion corresponding to the selected CSI-RS).

1> perform the Random Access Preamble transmission procedure (see subclause 5.1.3).

[TS 38.321, clause 5.1.3]

The MAC entity shall, for each Random Access Preamble:

1> if *PREAMBLE_TRANSMISSION_COUNTER* is greater than one; and

1> if the notification of suspending power ramping counter has not been received from lower layers; and

1> if SSB selected is not changed (i.e. same as the previous Random Access Preamble transmission):

2> increment *PREAMBLE_POWER_RAMPING_COUNTER* by 1.

1> select the value of *DELTA_PREAMBLE* according to subclause 7.3;

1> set *PREAMBLE_RECEIVED_TARGET_POWER* to $\text{preambleReceivedTargetPower} + \text{DELTA_PREAMBLE} + (\text{PREAMBLE_POWER_RAMPING_COUNTER} - 1) \times \text{PREAMBLE_POWER_RAMPING_STEP}$;

- 1> except for contention-free Random Access Preamble for beam failure recovery request, compute the RA-RNTI associated with the PRACH occasion in which the Random Access Preamble is transmitted;
- 1> instruct the physical layer to transmit the Random Access Preamble using the selected PRACH, corresponding RA-RNTI (if available), *PREAMBLE_INDEX* and *PREAMBLE_RECEIVED_TARGET_POWER*.

The RA-RNTI associated with the PRACH in which the Random Access Preamble is transmitted, is computed as:

$$\text{RA-RNTI} = 1 + s_id + 14 \times t_id + 14 \times 80 \times f_id + 14 \times 80 \times 8 \times ul_carrier_id$$

where *s_id* is the index of the first OFDM symbol of the specified PRACH ($0 \leq s_id < 14$), *t_id* is the index of the first slot of the specified PRACH in a system frame ($0 \leq t_id < 80$), *f_id* is the index of the specified PRACH in the frequency domain ($0 \leq f_id < 8$), and *ul_carrier_id* is the UL carrier used for Msg1 transmission (0 for NUL carrier, and 1 for SUL carrier).

[TS 38.321, clause 5.1.4]

Once the Random Access Preamble is transmitted and regardless of the possible occurrence of a measurement gap, the MAC entity shall:

...

1> else:

- 2> start the *ra-ResponseWindow* configured in *RACH-ConfigCommon* at the first PDCCH occasion as specified in TS 38.213 [6] from the end of the Random Access Preamble transmission;
- 2> monitor the PDCCH of the SpCell for Random Access Response(s) identified by the RA-RNTI while the *ra-ResponseWindow* is running.
- 1> if notification of a reception of a PDCCH transmission is received from lower layers on the Serving Cell where the preamble was transmitted; and
- 1> if PDCCH transmission is addressed to the C-RNTI; and
- 1> if the contention-free Random Access Preamble for beam failure recovery request was transmitted by the MAC entity:
 - 2> consider the Random Access procedure successfully completed.
- 1> else if a downlink assignment has been received on the PDCCH for the RA-RNTI and the received TB is successfully decoded:
 - 2> if the Random Access Response contains a MAC subPDU with Backoff Indicator:
 - 3> set the *PREAMBLE_BACKOFF* to value of the BI field of the MAC subPDU using Table 7.2-1, multiplied with *SCALING_FACTOR_BI*.
 - 2> else:
 - 3> set the *PREAMBLE_BACKOFF* to 0 ms.
 - 2> if the Random Access Response contains a MAC subPDU with Random Access Preamble identifier corresponding to the transmitted *PREAMBLE_INDEX* (see subclause 5.1.3):
 - 3> consider this Random Access Response reception successful.
 - 2> if the Random Access Response reception is considered successful:
 - 3> if the Random Access Response includes RAPID only:
 - 4> consider this Random Access procedure successfully completed;
 - 4> indicate the reception of an acknowledgement for the SI request to upper layers.
 - 3> else:

- 4> apply the following actions for the Serving Cell where the Random Access Preamble was transmitted:
 - 5> process the received Timing Advance Command (see subclause 5.2);
 - 5> indicate the *preambleReceivedTargetPower* and the amount of power ramping applied to the latest Random Access Preamble transmission to lower layers (i.e. $(PREAMBLE_POWER_RAMPING_COUNTER - 1) \times preamblePowerRampingStep$).
 - 5> if the Serving Cell for the Random Access procedure is SRS-only SCell:
 - 6> ignore the received UL grant.
 - 5> else:
 - 6> process the received UL grant value and indicate it to the lower layers.
- 4> if the Random Access Preamble was not selected by the MAC entity among the contention-based Random Access Preamble(s):
 - 5> consider the Random Access procedure successfully completed.
- 4> else:
 - 5> set the *TEMPORARY_C-RNTI* to the value received in the Random Access Response;
- ...
- 1> if *ra-ResponseWindow* configured in *RACH-ConfigCommon* expires, and if the Random Access Response containing Random Access Preamble identifiers that matches the transmitted *PREAMBLE_INDEX* has not been received; or
- 1> if *ra-ResponseWindow* configured in *BeamFailureRecoveryConfig* expires and if the PDCCH addressed to the C-RNTI has not been received on the Serving Cell where the preamble was transmitted:
 - 2> consider the Random Access Response reception not successful;
 - 2> increment *PREAMBLE_TRANSMISSION_COUNTER* by 1;
 - 2> if *PREAMBLE_TRANSMISSION_COUNTER* = *preambleTxMax* + 1:
 - 3> if the Random Access Preamble is transmitted on the SpCell:
 - 4> indicate a Random Access problem to upper layers.
 - 4> if this Random Access procedure was triggered for SI request:
 - 5> consider the Random Access procedure unsuccessfully completed.
 - > else if the Random Access Preamble is transmitted on a SCell:
 - 4> consider the Random Access procedure unsuccessfully completed.
 - 2> if the Random Access procedure is not completed:
 - 3> select a random backoff time according to a uniform distribution between 0 and the *PREAMBLE_BACKOFF*;
 - 3> if the criteria (as defined in subclause 5.1.2) to select contention-free Random Access Resources is met during the backoff time:
 - 4> perform the Random Access Resource selection procedure (see subclause 5.1.2);
 - 3> else:
 - 4> perform the Random Access Resource selection procedure (see subclause 5.1.2) after the backoff time.

The MAC entity may stop *ra-ResponseWindow* (and hence monitoring for Random Access Response(s)) after successful reception of a Random Access Response containing Random Access Preamble identifiers that matches the transmitted *PREAMBLE_INDEX*.

HARQ operation is not applicable to the Random Access Response transmission.

[TS 38.321, clause 5.1.5]

Once Msg3 is transmitted, the MAC entity shall:

- 1> start the *ra-ContentionResolutionTimer* and restart the *ra-ContentionResolutionTimer* at each HARQ retransmission in the first symbol after the end of the Msg3 transmission;
- 1> monitor the PDCCH while the *ra-ContentionResolutionTimer* is running regardless of the possible occurrence of a measurement gap;
- 1> if notification of a reception of a PDCCH transmission of the SpCell is received from lower layers:
 - 2> if the C-RNTI MAC CE was included in Msg3:
 - 3> if the Random Access procedure was initiated by the MAC sublayer itself or by the RRC sublayer and the PDCCH transmission is addressed to the C-RNTI and contains a UL grant for a new transmission; or
 - 3> if the Random Access procedure was initiated by a PDCCH order and the PDCCH transmission is addressed to the C-RNTI; or
 - 3> if the Random Access procedure was initiated by a beam failure indication from lower layer and the PDCCH transmission is addressed to the C-RNTI:
 - 4> consider this Contention Resolution successful;
 - 4> stop *ra-ContentionResolutionTimer*;
 - 4> discard the *TEMPORARY_C-RNTI*;
 - 4> consider this Random Access procedure successfully completed.

...

- 1> if *ra-ContentionResolutionTimer* expires:
 - 2> discard the *TEMPORARY_C-RNTI*;
 - 2> consider the Contention Resolution not successful.
- 1> if the Contention Resolution is considered not successful:
 - 2> flush the HARQ buffer used for transmission of the MAC PDU in the Msg3 buffer;
 - 2> increment *PREAMBLE_TRANSMISSION_COUNTER* by 1;
 - 2> if *PREAMBLE_TRANSMISSION_COUNTER* = *preambleTxMax* + 1:
 - 3> indicate a Random Access problem to upper layers.
 - 3> if this Random Access procedure was triggered for SI request:
 - 4> consider the Random Access procedure unsuccessfully completed.
 - 2> if the Random Access procedure is not completed:
 - 3> select a random backoff time according to a uniform distribution between 0 and the *PREAMBLE_BACKOFF*;
 - 3> if the criteria (as defined in subclause 5.1.2) to select contention-free Random Access Resources is met during the backoff time:
 - 4> perform the Random Access Resource selection procedure (see subclause 5.1.2);

3> else:

- 4> perform the Random Access Resource selection procedure (see subclause 5.1.2) after the backoff time.

[TS 38.321, clause 5.2]

RRC configures the following parameters for the maintenance of UL time alignment:

- *timeAlignmentTimer* (per TAG) which controls how long the MAC entity considers the Serving Cells belonging to the associated TAG to be uplink time aligned.

The MAC entity shall:

- 1> when a Timing Advance Command MAC CE is received, and if a N_{TA} (as defined in TS 38.211 [8]) has been maintained with the indicated TAG:
 - 2> apply the Timing Advance Command for the indicated TAG;
 - 2> start or restart the *timeAlignmentTimer* associated with the indicated TAG.

...

- 1> when a *timeAlignmentTimer* expires:
 - 2> if the *timeAlignmentTimer* is associated with the pTAG:
 - 3> flush all HARQ buffers for all Serving Cells;
 - 3> notify RRC to release PUCCH for all Serving Cells, if configured;
 - 3> notify RRC to release SRS for all Serving Cells, if configured;
 - 3> clear any configured downlink assignments and configured uplink grants;
 - 3> clear any PUSCH resource for semi-persistent CSI reporting;
 - 3> consider all running *timeAlignmentTimers* as expired;
 - 3> maintain N_{TA} (defined in TS 38.211 [8]) of all TAGs.
 - 2> else if the *timeAlignmentTimer* is associated with an sTAG, then for all Serving Cells belonging to this TAG:
 - 3> flush all HARQ buffers;
 - 3> notify RRC to release PUCCH, if configured;
 - 3> notify RRC to release SRS, if configured;
 - 3> clear any configured downlink assignments and configured uplink grants;
 - 3> clear any PUSCH resource for semi-persistent CSI reporting;
 - 3> maintain N_{TA} (defined in TS 38.211 [8]) of this TAG.

When the MAC entity stops uplink transmissions for an SCell due to the fact that the maximum uplink transmission timing difference between TAGs of the MAC entity or the maximum uplink transmission timing difference between TAGs of any MAC entity of the UE is exceeded, the MAC entity considers the *timeAlignmentTimer* associated with the SCell as expired.

The MAC entity shall not perform any uplink transmission on a Serving Cell except the Random Access Preamble transmission when the *timeAlignmentTimer* associated with the TAG to which this Serving Cell belongs is not running. Furthermore, when the *timeAlignmentTimer* associated with the pTAG is not running, the MAC entity shall not perform any uplink transmission on any Serving Cell except the Random Access Preamble transmission on the SpCell.

[TS 38.321, clause 6.1.3.2]

The C-RNTI MAC CE is identified by MAC PDU subheader with LCID as specified in Table 6.2.1-2.

It has a fixed size and consists of a single field defined as follows (Figure 6.1.3.2-1):

- C-RNTI: This field contains the C-RNTI of the MAC entity. The length of the field is 16 bits.

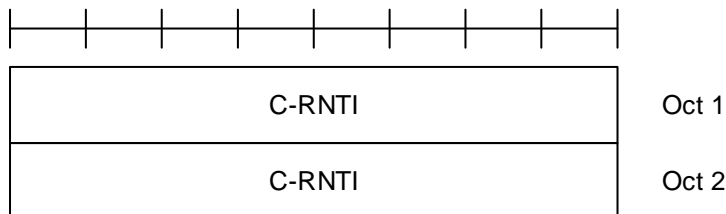

Figure 6.1.3.2-1: C-RNTI MAC CE

[TS 38.321, clause 6.1.5]

A MAC PDU consists of one or more MAC subPDUs and optionally padding. Each MAC subPDU consists one of the following:

- a MAC subheader with Backoff Indicator only;
- a MAC subheader with RAPID only (i.e. acknowledgment for SI request);
- a MAC subheader with RAPID and MAC RAR.

A MAC subheader with Backoff Indicator consists of five header fields E/T/R/R/BI as described in Figure 6.1.5-1. A MAC subPDU with Backoff Indicator only is placed at the beginning of the MAC PDU, if included. 'MAC subPDU(s) with RAPID only' and 'MAC subPDU(s) with RAPID and MAC RAR' can be placed anywhere between MAC subPDU with Backoff Indicator only (if any) and padding (if any).

A MAC subheader with RAPID consists of three header fields E/T/RAPID as described in Figure 6.1.5-2.

Padding is placed at the end of the MAC PDU if present. Presence and length of padding is implicit based on TB size, size of MAC subPDU(s).

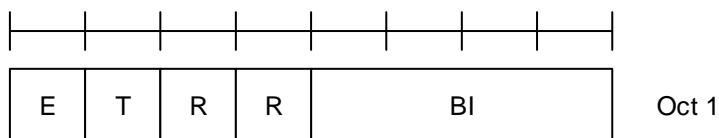

Figure 6.1.5-1: E/T/R/R/BI MAC subheader

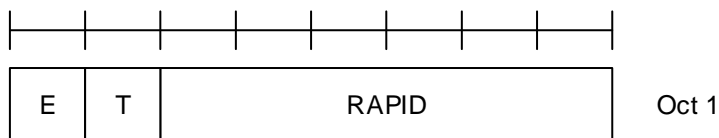

Figure 6.1.5-2: E/T/RAPID MAC subheader

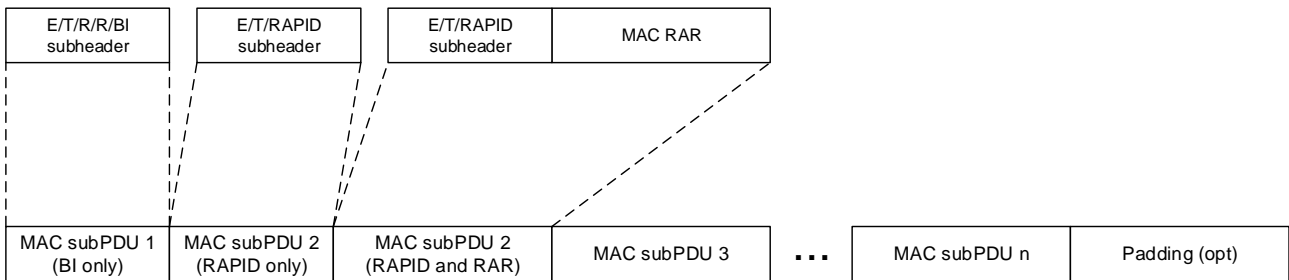

Figure 6.1.5-3: Example of MAC PDU consisting of MAC RARs

[TS 38.321, clause 6.2.3]

The MAC RAR is of fixed size as depicted in Figure 6.2.3-1, and consists of the following fields:

- R: Reserved bit, set to "0";
- Timing Advance Command: The Timing Advance Command field indicates the index value T_A used to control the amount of timing adjustment that the MAC entity has to apply in TS 38.213 [6]. The size of the Timing Advance Command field is 12 bits;
- UL Grant: The Uplink Grant field indicates the resources to be used on the uplink in TS 38.213 [6]. The size of the UL Grant field is 27 bits;
- Temporary C-RNTI: The Temporary C-RNTI field indicates the temporary identity that is used by the MAC entity during Random Access. The size of the Temporary C-RNTI field is 16 bits.

The MAC RAR is octet aligned.

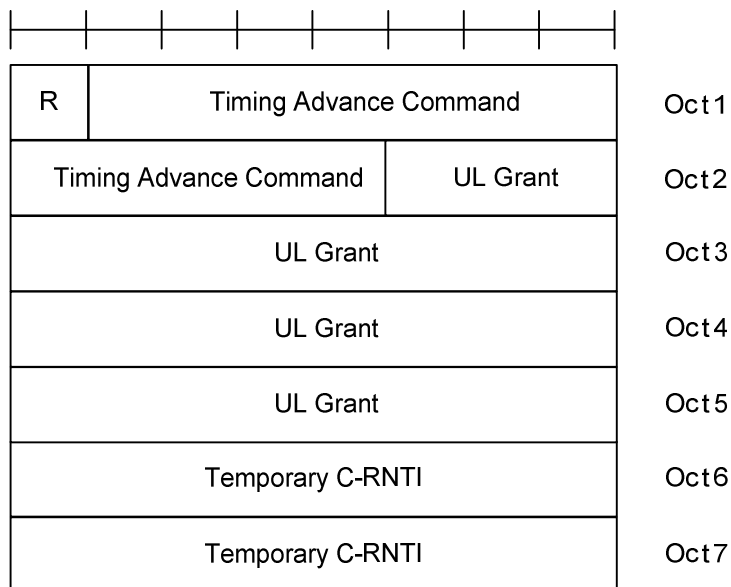

Figure 6.2.3-1: MAC RAR

7.1.1.1.2.3 Test description

7.1.1.1.2.3.1 Pre-test conditions

Same Pre-test conditions as in clause 7.1.1.0 except that Short_DCI condition is applied in NR Serving cell configuration.

7.1.1.1.2.3.2 Test procedure sequence

Table 7.1.1.1.2.3.2-1: Main behaviour

St	Procedure	Message Sequence		TP	Verdict
		U - S	Message		
-	EXCEPTION: Step 0AA is performed IF pc_NG_RAN_NR only.	-	-	-	-
0AA	The SS transmits an updated system information as specified in Table 7.1.1.1.2.3.3-1A.	-	-	-	-
0A	SS transmits an RRCReconfiguration message to configure specific parameters. (Note 1)	<--	RRCReconfiguration	-	-
0B	The UE transmits RRCReconfigurationComplete message. (Note 2)	-->	RRCReconfigurationComplete	-	-
1	SS transmits Timing Advance command to SpCell. SS does not send any subsequent timing alignments. Start Timer_T1 = Time Alignment timer value on SS.	<--	MAC PDU (Timing Advance Command MAC Control Element)	-	-
2	40 to 50 TTI before Timer_T1 expires the SS transmits a MAC PDU containing a PDCP SDU of size 56 bits, less than ra-Msg3SizeGroupA (208 bits) on SpCell. (Note 3)	<--	MAC PDU	-	-
3	The SS ignores scheduling requests and does not allocate any uplink grant.	-	-	-	-
4	Check: Does the UE transmit preamble on PRACH using a preamble in group A defined in CellGroupConfig in RRCReconfiguration (totalNumberOfRA-Preambles, ssb-perRACH-OccasionAndCB-PreamblesPerSSB and numberOfRA-PreamblesGroupA) on SpCell in frame number X meeting condition $n_{SFN} \bmod 8 = 1$, subframe number 2,6,9 (FDD FR1), frame number X meeting condition $n_{SFN} \bmod 2 = 1$, subframe number 8,9 (FR1 TDD) and frame number X meeting condition $n_{SFN} \bmod 4 = 1$ and slot number 8, 9, 18, 19, 28, 29, 38, 39, 48, 49, 58, 59, 68, 69, 78, 79 (FR2 120 kHz)?	-->	PRACH Preamble	1	P
5	Check: Does the UE transmit a preamble on PRACH, in frame number X+8 subframe number 2,6,9 (FDD FR1), in frame number X or X+2 in subframe number 8,9 (FR1 TDD) and frame number X or X+4 and slot number 8, 9, 18, 19, 28, 29, 38, 39, 48, 49, 58, 59, 68, 69, 78, 79 (FR2 120 kHz) using the same group A?	-->	PRACH Preamble	2	P
6	The SS transmits a MAC PDU addressed to UE RA-RNTI, containing multiple RARs but none of the MAC sub headers contains a matching RAPID on SpCell.	<--	Random Access Response	-	-
-	EXCEPTION: In parallel with step 7, parallel behaviour defined in table 7.1.1.1.2.3.2-2 is executed.	-	-	-	-
7	Check: Does the UE re-transmit a preamble on PRACH on SpCell using the same group A?	-->	PRACH Preamble	3	P
8	The SS transmits a Random Access Response with the back off parameter set to value Index field '12' and with the Random Access Preamble identifier different from the value received from the UE in the Random Access Preamble. The SS sets Timer_T2 to the Back off value '960' associated with the Index value '12' and starts Timer_T2.	<--	Random Access Response(BI, RAPID)	-	-

9	Check: Does UE send a Random Access Preamble on SpCell while Timer_T2 is running?	-->	Random Access Preamble	4	P
10	SS sends Random Access Response with an UL Grant of 56-bits, a back off parameter set to value Index field '13' and the Random Access Preamble identifier value set to the same value as received from the UE in the Random Access Preamble. (Note 4)	<--	Random Access Response(BI, RAPID)	-	-
11	Check: Does UE sends a msg3 in the grant associated to the Random Access Response received in step 10 on SpCell?	-->	msg3 (C-RNTI MAC CONTROL ELEMENT)	5	P
12	SS does not schedule any PDCCH transmission for UE C-RNTI. The SS sets Timer_T3 to the Back off value '1920' associated with the Index value '13' plus Contention Resolution Timer and starts Timer_T3.	-	-	-	-
13	Check: Does the UE transmit preamble on PRACH using a preamble belonging to group A for time equal to Timer_T3 on SpCell?	-->	PRACH Preamble	6	P
14	The SS transmits Random Access Response with an UL Grant of 56-bits and RAPID corresponding to the transmitted Preamble in step 13, including T-CRNTI.	<--	Random Access Response	-	-
15	UE sends a msg3 using the grant associated to the Random Access Response received in step 14 on SpCell?	-->	msg3 (C-RNTI MAC CONTROL ELEMENT)	-	-
16	SS schedules PDCCH transmission for UE C_RNTI and allocate uplink grant.	<--	Contention Resolution	-	-
-	EXCEPTION: In parallel with step 17, parallel behaviour defined in table 7.1.1.1.2.3.2-3 is executed.	-	-	-	-
17	Check: Does the UE transmit a MAC PDU with C-RNTI containing looped back PDCP SDU?	-->	MAC PDU	7	P
-	EXCEPTION: Step 17AA is performed IF pc_NG_RAN_NR only.	-	-	-	-
17A	The SS transmits an updated system information as specified in Table 7.1.1.1.2.3.3-1A.	-	-	-	-
17A	The SS transmits an RRCReconfiguration message to configure specific parameters. (Note 1)	<--	NR RRC: RRCReconfiguration	-	-
17B	The UE transmits an RRCReconfigurationComplete message. (Note 2)	-->	NR RRC: RRCReconfigurationComplete	-	-
18	SS transmits Timing Advance command to SpCell. SS does not send any subsequent timing alignments. Start Timer_T4 = Time Alignment timer value on SS.	<--	MAC PDU (Timing Advance Command MAC Control Element)	-	-
19	40 to 50 TTI before Timer_T4 expires the SS transmits a MAC PDU containing a PDCP SDU of size > ra-Msg3SizeGroupA (208 bits).	<--	MAC PDU	-	-
20	The SS ignores scheduling requests and does not allocate any uplink grant.	-	-	-	-
21	Check: Does the UE transmit preamble on PRACH using a preamble in group B defined in CellGroupConfig in RRCReconfiguration (ssb-perRACH-OccasionAndCB-PreamblesPerSSB, numberOfRA-PreamblesGroupA and numberOfRA-Preambles) on SpCell?	-->	PRACH Preamble	8	P
22	The SS transmits Random Access Response with an UL Grant of 56-bits and RAPID corresponding to the transmitted Preamble in step 21, including T-CRNTI.	<--	Random Access Response	-	-

23	UE sends a msg3 using the grant associated to the Random Access Response received in step 22 on SpCell?	-->	msg3 (C-RNTI MAC CONTROL ELEMENT)	-	-
23A	SS schedules PDCCH transmission for UE C_RNTI and allocate uplink grant.	<--	Contention Resolution	-	-
24	Check: Does the UE transmit a MAC PDU with C-RNTI containing looped back PDCP SDU?	-->	MAC PDU	9	P
Note 1: for EN-DC the NR <i>RRCReconfiguration</i> message is contained in <i>RRCConnectionReconfiguration</i> . Note 2: for EN-DC the NR <i>RRCReconfigurationComplete</i> message is contained in <i>RRCConnectionReconfigurationComplete</i> . Note 3: MAC PDU size of 56bits is selected to allow UE send status PDU and still stays below the limit of <i>ra-Msg3SizeGroupA</i> . Note 4: UL grant of 56bits is to make UE not send any loopback data in uplink with msg3.					

Table 7.1.1.1.2.3.2-2: Parallel behaviour

St	Procedure	Message Sequence		TP	Verdict
		U - S	Message		
1	Check: Does the UE transmit msg3 message on SpCell?	-->	msg3 (C-RNTI MAC CONTROL ELEMENT)	-	F

Table 7.1.1.1.2.3.2-3: Parallel behaviour

St	Procedure	Message Sequence		TP	Verdict
		U - S	Message		
1	Check: Does the UE transmit an PRACH preamble on SpCell?	-->	PRACH Preamble	-	F

7.1.1.1.2.3.3 Specific message contents

Table 7.1.1.1.2.3.3-1: MAC-CellGroupConfig (preamble)

Derivation Path: TS 38.508-1 [4], Table 4.6.3-68			
Information Element	Value/remark	Comment	Condition
MAC-CellGroupConfig ::= SEQUENCE {			
tag-Config SEQUENCE {			
tag-ToAddModList SEQUENCE (SIZE (1..maxNrofTAGs)) OF TAG {	1 entry		
TAG[1] SEQUENCE {		entry 1	
timeAlignmentTimer	ms750		
}			
}			
}			
}			

Table 7.1.1.1.2.3.3-1A: SystemInformationBlockType1 (step 0AA and 17AA, Table 7.1.1.1.2.3.2-1)

Derivation path: 38.508-1 [4] table 4.6.1-28			
Information Element	Value/Remark	Comment	Condition
SIB1 ::= SEQUENCE {			
servingCellConfigCommon	ServingCellConfigCommon	Same contents as in Table 7.1.1.1.2.3.3-4	
}			

Table 7.1.1.1.2.3.3-2: RRCReconfiguration (step 0A and step 17A, Table 7.1.1.1.2.3.2-1)

Derivation Path: TS 38.508-1 [4], Table 4.6.1-13			
Information Element	Value/remark	Comment	Condition
RRCReconfiguration ::= SEQUENCE {			

		TS 38.508-1 [4], 2.	
criticalExtensions CHOICE {			
rrcReconfiguration ::= SEQUENCE {			
secondaryCellGroup	CellGroupConfig	OCTET STRING (CONTAINING CellGroupConfig)	EN-DC
nonCriticalExtension SEQUENCE {			NR
masterCellGroup	CellGroupConfig	OCTET STRING (CONTAINING CellGroupConfig)	
}			
}			
}			
}			
}			

Table 7.1.1.1.2.3.3-3: CellGroupConfig (Table 7.1.1.1.2.3.3-2)

Derivation Path: TS 38.508-1 [4], Table 4.6.3-19			
Information Element	Value/remark	Comment	Condition
CellGroupConfig ::= SEQUENCE {			
spCellConfig SEQUENCE {			
reconfigurationWithSync SEQUENCE {			
spCellConfigCommon	ServingCellConfigCommon		
newUE-Identity	RNTI-Value		
t304	ms2000		
rach-ConfigDedicated	Not Present		
}			

Table 7.1.1.1.2.3.3-4: ServingCellConfigCommon (Table 7.1.1.1.2.3.3-3, Table 7.1.1.1.2.3.3-1A)

Derivation Path: TS 38.508-1 [4], Table 4.6.3-168			
Information Element	Value/remark	Comment	Condition
ServingCellConfigCommon ::= SEQUENCE {			
uplinkConfigCommon SEQUENCE {			
initialUplinkBWP	BWP-UplinkCommon		
}			

Table 7.1.1.1.2.3.3-5: BWP-UplinkCommon (Table 7.1.1.1.2.3.3-4)

Derivation Path: TS 38.508-1 [4], Table 4.6.3-10			
Information Element	Value/remark	Comment	Condition
BWP-UplinkCommon ::= SEQUENCE {			
rach-ConfigCommon CHOICE {			
setup	RACH-ConfigCommon		
}			

Table 7.1.1.1.2.3.3-6: RACH-ConfigCommon (Table 7.1.1.1.2.3.3-5)

Derivation Path: TS 38.508-1 [4], Table 4.6.3-128			
Information Element	Value/remark	Comment	Condition
RACH-ConfigCommon ::= SEQUENCE {			
rach-ConfigGeneric	RACH-ConfigGeneric		
totalNumberOfRA-Preambles	42		
ssb-perRACH-OccasionAndCB-PreamblesPerSSB CHOICE {			
One	n32		
}			

groupBconfigured SEQUENCE {			
ra-Msg3SizeGroupA	b208		
messagePowerOffsetGroupB	minusinfinity		
numberOfRA-PreamblesGroupA	28		
}			
ra-ContentionResolutionTimer	sf48		
}			

Table 7.1.1.1.2.3.3-7: RACH-ConfigGeneric (Table 7.1.1.1.2.3.3-6)

Derivation Path: TS 38.508-1 [4], Table 4.6.3-130			
Information Element	Value/remark	Comment	Condition
RACH-ConfigGeneric ::= SEQUENCE {			
prach-ConfigurationIndex	119	As per Table 6.3.3.2-2: of TS 38.211 [24], this results in PRACH preamble transmission in a radio frame meeting $n_{SFN} \bmod 2 = 1$, subframe number 2, 6, 9 and starting symbol 0 using preamble Format A2.	FR1 FDD
prach-ConfigurationIndex	91	As per Table 6.3.3.2-3: of TS 38.211 [24], this results in PRACH preamble transmission in a radio frame meeting $n_{SFN} \bmod 2 = 1$, subframe number 4, 9 and starting symbol 0 using preamble Format A2.	FR1 TDD
prach-ConfigurationIndex	6	As per Table 6.3.3.2-4: of TS 38.211 [24] and clause 5.3.2 of TS 38.211 this results in PRACH preamble transmission in radio frame meeting $n_{SFN} \bmod 4 = 1$, slot number 8, 9, 18, 19, 28, 29, 38, 39, 48, 49, 58, 59, 68, 69, 78, 79 and starting symbol 0 using preamble format A1.	FR2 (120 kHz)
preambleReceivedTargetPower	dBm-104		
preambleTransMax	n10		
powerRampingStep	dB2		
ra-ResponseWindow	sl8		FR1 FDD and FR2 (120 kHz)
	sl20		FR1 TDD
}			

Table 7.1.1.1.2.3.3-8: Void**7.1.1.1.3 Random access procedure / Successful / SI request****7.1.1.1.3.1 Test Purpose (TP)**

(1)

```

with { UE in RRC_Idle State and need for Updated System information }
ensure that {
  when { UE transmitted PRACH preamble and ra-ResponseWindow has expired }
  then { UE retransmits the PRACH Preamble }
}

```

(2)

```

with { UE in RRC_Idle State and transmitted PRACH preamble for System information request }
ensure that {
  when { UE received a RAR message addressed to RA-RNTI and including matching RAPID only }
  then { UE considers the RACH procedure to be successfully completed and informs the upper layer }
}

```

(3)

Void

7.1.1.1.3.2 Conformance requirements

References: The conformance requirements covered in the present TC are specified in: 3GPP TS 38.321, clause 5.1.2, 5.1.3, 5.1.4, and 6.1., 3GPP TS 38.331 clause 5.2.2.2.25. Unless otherwise stated these are Rel-15 requirements.

[TS 38.321, clause 5.1.2]

The MAC entity shall:

- 1> if the Random Access procedure was initiated for beam failure recovery (as specified in subclause 5.17); and
- 1> if the *beamFailureRecoveryTimer* (in subclause 5.17) is either running or not configured; and
- 1> if the contention-free Random Access Resources for beam failure recovery request associated with any of the SSBs and/or CSI-RSs have been explicitly provided by RRC; and
- 1> if at least one of the SSBs with SS-RSRP above *rsrp-ThresholdSSB* amongst the SSBs in *candidateBeamRSList* or the CSI-RSs with CSI-RSRP above *rsrp-ThresholdCSI-RS* amongst the CSI-RSs in *candidateBeamRSList* is available:
 - 2> select an SSB with SS-RSRP above *rsrp-ThresholdSSB* amongst the SSBs in *candidateBeamRSList* or a CSI-RS with CSI-RSRP above *rsrp-ThresholdCSI-RS* amongst the CSI-RSs in *candidateBeamRSList*;
 - 2> if CSI-RS is selected, and there is no *ra-PreambleIndex* associated with the selected CSI-RS:
 - 3> set the *PREAMBLE_INDEX* to a *ra-PreambleIndex* corresponding to the SSB in *candidateBeamRSList* which is quasi-collocated with the selected CSI-RS as specified in TS 38.214 [7].
 - 2> else:
 - 3> set the *PREAMBLE_INDEX* to a *ra-PreambleIndex* corresponding to the selected SSB or CSI-RS from the set of Random Access Preambles for beam failure recovery request.
- 1> else if the *ra-PreambleIndex* has been explicitly provided by either PDCCH or RRC; and

- 1> if the *ra-PreambleIndex* is not 0b000000; and
- 1> if contention-free Random Access Resource associated with SSBs or CSI-RSs have not been explicitly provided by RRC:
 - 2> set the *PREAMBLE_INDEX* to the signalled *ra-PreambleIndex*.
- 1> else if the contention-free Random Access Resources associated with SSBs have been explicitly provided by RRC and at least one SSB with SS-RSRP above *rsrp-ThresholdSSB* amongst the associated SSBs is available:
 - 2> select an SSB with SS-RSRP above *rsrp-ThresholdSSB* amongst the associated SSBs;
 - 2> set the *PREAMBLE_INDEX* to a *ra-PreambleIndex* corresponding to the selected SSB.
- 1> else if the contention-free Random Access Resources associated with CSI-RSs have been explicitly provided by RRC and at least one CSI-RS with CSI-RSRP above *rsrp-ThresholdCSI-RS* amongst the associated CSI-RSs is available:
 - 2> select a CSI-RS with CSI-RSRP above *rsrp-ThresholdCSI-RS* amongst the associated CSI-RSs;
 - 2> set the *PREAMBLE_INDEX* to a *ra-PreambleIndex* corresponding to the selected CSI-RS.
- 1> else:
 - 2> if at least one of the SSBs with SS-RSRP above *rsrp-ThresholdSSB* is available:
 - 3> select an SSB with SS-RSRP above *rsrp-ThresholdSSB*.
 - 2> else:
 - 3> select any SSB.
 - 2> if Msg3 has not yet been transmitted:
 - 3> if Random Access Preambles group B is configured:
 - 4> if the potential Msg3 size (UL data available for transmission plus MAC header and, where required, MAC CEs) is greater than *ra-Msg3SizeGroupA* and the pathloss is less than $PCMAX$ (of the Serving Cell performing the Random Access Procedure) – $preambleReceivedTargetPower - msg3-DeltaPreamble - messagePowerOffsetGroupB$; or
 - 4> if the Random Access procedure was initiated for the CCCH logical channel and the CCCH SDU size plus MAC subheader is greater than *ra-Msg3SizeGroupA*:
 - 5> select the Random Access Preambles group B.
 - 4> else:
 - 5> select the Random Access Preambles group A.
 - 3> else:
 - 4> select the Random Access Preambles group A.
 - 2> else (i.e. Msg3 is being retransmitted):
 - 3> select the same group of Random Access Preambles as was used for the Random Access Preamble transmission attempt corresponding to the first transmission of Msg3.
 - 2> if the association between Random Access Preambles and SSBs is configured:
 - 3> select a *ra-PreambleIndex* randomly with equal probability from the Random Access Preambles associated with the selected SSB and the selected Random Access Preambles group.
 - 2> else:
 - 3> select a *ra-PreambleIndex* randomly with equal probability from the Random Access Preambles within the selected Random Access Preambles group.

- 2> set the *PREAMBLE_INDEX* to the selected *ra-PreambleIndex*.
- 1> if an SSB is selected above and an association between PRACH occasions and SSBs is configured:
- 2> determine the next available PRACH occasion from the PRACH occasions corresponding to the selected SSB permitted by the restrictions given by the *ra-ssb-OccasionMaskIndex* if configured (the MAC entity shall select a PRACH occasion randomly with equal probability amongst the PRACH occasions occurring simultaneously but on different subcarriers, corresponding to the selected SSB; the MAC entity may take into account the possible occurrence of measurement gaps when determining the next available PRACH occasion corresponding to the selected SSB).
- 1> else if a CSI-RS is selected above and an association between PRACH occasions and CSI-RSs is configured:
- 2> determine the next available PRACH occasion from the PRACH occasions in *ra-OccasionList* corresponding to the selected CSI-RS (the MAC entity shall select a PRACH occasion randomly with equal probability amongst the PRACH occasions occurring simultaneously but on different subcarriers, corresponding to the selected CSI-RS; the MAC entity may take into account the possible occurrence of measurement gaps when determining the next available PRACH occasion corresponding to the selected CSI-RS).
- 1> else if Random Access procedure was initiated for beam failure recovery; and
- 1> if a CSI-RS is selected above and there is no contention-free Random Access Resource associated with the selected CSI-RS:
- 2> determine the next available PRACH occasion from the PRACH occasions, permitted by the restrictions given by the *ra-ssb-OccasionMaskIndex* if configured, corresponding to the SSB in *candidateBeamRSList* which is quasi-collocated with the selected CSI-RS as specified in TS 38.214 [7] (the MAC entity may take into account the possible occurrence of measurement gaps when determining the next available PRACH occasion corresponding to the SSB which is quasi-collocated with the selected CSI-RS).
- 1> else:
- 2> determine the next available PRACH occasion (the MAC entity shall select a PRACH occasion randomly with equal probability amongst the PRACH occasions occurring simultaneously but on different subcarriers; the MAC entity may take into account the possible occurrence of measurement gaps when determining the next available PRACH occasion).
- 1> perform the Random Access Preamble transmission procedure (see subclause 5.1.3).

[TS 38.321, clause 5.1.3]

The MAC entity shall, for each Random Access Preamble:

- 1> if *PREAMBLE_TRANSMISSION_COUNTER* is greater than one; and
- 1> if the notification of suspending power ramping counter has not been received from lower layers; and
- 1> if SSB selected is not changed (i.e. same as the previous Random Access Preamble transmission):
- 2> increment *PREAMBLE_POWER_RAMPING_COUNTER* by 1.
- 1> select the value of *DELTA_PREAMBLE* according to subclause 7.3;
- 1> set *PREAMBLE_RECEIVED_TARGET_POWER* to $\text{preambleReceivedTargetPower} + \text{DELTA_PREAMBLE} + (\text{PREAMBLE_POWER_RAMPING_COUNTER} - 1) \times \text{PREAMBLE_POWER_RAMPING_STEP}$;
- 1> except for contention-free Random Access Preamble for beam failure recovery request, compute the RA-RNTI associated with the PRACH occasion in which the Random Access Preamble is transmitted;
- 1> instruct the physical layer to transmit the Random Access Preamble using the selected PRACH, corresponding RA-RNTI (if available), *PREAMBLE_INDEX* and *PREAMBLE_RECEIVED_TARGET_POWER*.

The RA-RNTI associated with the PRACH in which the Random Access Preamble is transmitted, is computed as:

$$\text{RA-RNTI} = 1 + \text{s_id} + 14 \times \text{t_id} + 14 \times 80 \times \text{f_id} + 14 \times 80 \times 8 \times \text{ul_carrier_id}$$

where s_id is the index of the first OFDM symbol of the specified PRACH ($0 \leq s_id < 14$), t_id is the index of the first slot of the specified PRACH in a system frame ($0 \leq t_id < 80$), f_id is the index of the specified PRACH in the frequency domain ($0 \leq f_id < 8$), and $ul_carrier_id$ is the UL carrier used for Msg1 transmission (0 for NUL carrier, and 1 for SUL carrier).

[TS 38.321, clause 5.1.4]

Once the Random Access Preamble is transmitted and regardless of the possible occurrence of a measurement gap, the MAC entity shall:

- 1> if the contention-free Random Access Preamble for beam failure recovery request was transmitted by the MAC entity:
 - 2> start the *ra-ResponseWindow* configured in *BeamFailureRecoveryConfig* at the first PDCCH occasion as specified in TS 38.213 [6] from the end of the Random Access Preamble transmission;
 - 2> monitor the PDCCH of the SpCell for response to beam failure recovery request identified by the C-RNTI while *ra-ResponseWindow* is running.
- 1> else:
 - 2> start the *ra-ResponseWindow* configured in *RACH-ConfigCommon* at the first PDCCH occasion as specified in TS 38.213 [6] from the end of the Random Access Preamble transmission;
 - 2> monitor the PDCCH of the SpCell for Random Access Response(s) identified by the RA-RNTI while the *ra-ResponseWindow* is running.
- 1> if notification of a reception of a PDCCH transmission is received from lower layers; and
- 1> if PDCCH transmission is addressed to the C-RNTI; and
- 1> if the contention-free Random Access Preamble for beam failure recovery request was transmitted by the MAC entity:
 - 2> consider the Random Access procedure successfully completed.
- 1> else if a downlink assignment has been received on the PDCCH for the RA-RNTI and the received TB is successfully decoded:
 - 2> if the Random Access Response contains a MAC subPDU with Backoff Indicator:
 - 3> set the *PREAMBLE_BACKOFF* to value of the BI field of the MAC subPDU using Table 7.2-1, multiplied with *SCALING_FACTOR_BI*.
 - 2> else:
 - 3> set the *PREAMBLE_BACKOFF* to 0 ms.
 - 2> if the Random Access Response contains a MAC subPDU with Random Access Preamble identifier corresponding to the transmitted *PREAMBLE_INDEX* (see subclause 5.1.3):
 - 3> consider this Random Access Response reception successful.
 - 2> if the Random Access Response reception is considered successful:
 - 3> if the Random Access Response includes a MAC subPDU with RAPID only:
 - 4> consider this Random Access procedure successfully completed;
 - 4> indicate the reception of an acknowledgement for SI request to upper layers.
 - 3> else:
 - 4> apply the following actions for the Serving Cell where the Random Access Preamble was transmitted:
 - 5> process the received Timing Advance Command (see subclause 5.2);

- 5> indicate the *preambleReceivedTargetPower* and the amount of power ramping applied to the latest Random Access Preamble transmission to lower layers (i.e. $(PREAMBLE_POWER_RAMPING_COUNTER - 1) \times PREAMBLE_POWER_RAMPING_STEP$);
- 5> if the Serving Cell for the Random Access procedure is SRS-only SCell:
 - 6> ignore the received UL grant.
- 5> else:
 - 6> process the received UL grant value and indicate it to the lower layers.
- 4> if the Random Access Preamble was not selected by the MAC entity among the contention-based Random Access Preamble(s):
 - 5> consider the Random Access procedure successfully completed.
- 4> else:
 - 5> set the *TEMPORARY_C-RNTI* to the value received in the Random Access Response;
 - 5> if this is the first successfully received Random Access Response within this Random Access procedure:
 - 6> if the transmission is not being made for the CCCH logical channel:
 - 7> indicate to the Multiplexing and assembly entity to include a C-RNTI MAC CE in the subsequent uplink transmission.
 - 6> obtain the MAC PDU to transmit from the Multiplexing and assembly entity and store it in the Msg3 buffer.
- 1> if *ra-ResponseWindow* configured in *RACH-ConfigCommon* expires, and if the Random Access Response containing Random Access Preamble identifiers that matches the transmitted *PREAMBLE_INDEX* has not been received; or
- 1> if *ra-ResponseWindow* configured in *BeamFailureRecoveryConfig* expires and if the PDCCH addressed to the C-RNTI has not been received:
 - 2> consider the Random Access Response reception not successful;
 - 2> increment *PREAMBLE_TRANSMISSION_COUNTER* by 1;
 - 2> if *PREAMBLE_TRANSMISSION_COUNTER* = *preambleTransMax* + 1:
 - 3> if the Random Access Preamble is transmitted on the SpCell:
 - 4> indicate a Random Access problem to upper layers;
 - 4> if this Random Access procedure was triggered for SI request:
 - 5> consider the Random Access procedure unsuccessfully completed.
 - 3> else if the Random Access Preamble is transmitted on a SCell:
 - 4> consider the Random Access procedure unsuccessfully completed.
- 2> if the Random Access procedure is not completed:
 - 3> if in this Random Access procedure, the Random Access Preamble was selected by MAC among the contention-based Random Access Preambles:
 - 4> select a random backoff time according to a uniform distribution between 0 and the *PREAMBLE_BACKOFF*;
 - 4> delay the subsequent Random Access Preamble transmission by the backoff time.
 - 3> perform the Random Access Resource selection procedure (see subclause 5.1.2).

The MAC entity may stop *ra-ResponseWindow* (and hence monitoring for Random Access Response(s)) after successful reception of a Random Access Response containing Random Access Preamble identifiers that matches the transmitted *PREAMBLE_INDEX*.

HARQ operation is not applicable to the Random Access Response transmission.

[TS 38.321, clause 6.1.5]

A MAC PDU consists of one or more MAC subPDUs and optionally padding. Each MAC subPDU consists one of the following:

- a MAC subheader with Backoff Indicator only;
- a MAC subheader with RAPID only (i.e. acknowledgment for SI request);
- a MAC subheader with RAPID and MAC RAR.

A MAC subheader with Backoff Indicator consists of five header fields E/T/R/R/BI as described in Figure 6.1.5-1. A MAC subPDU with Backoff Indicator only is placed at the beginning of the MAC PDU, if included. 'MAC subPDU(s) with RAPID only' and 'MAC subPDU(s) with RAPID and MAC RAR' can be placed anywhere between MAC subPDU with Backoff Indicator only (if any) and padding (if any).

A MAC subheader with RAPID consists of three header fields E/T/RAPID as described in Figure 6.1.5-2.

Padding is placed at the end of the MAC PDU if present. Presence and length of padding is implicit based on TB size, size of MAC subPDU(s).

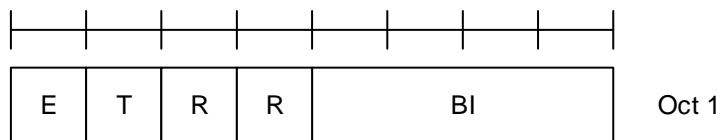

Figure 6.1.5-1: E/T/R/R/BI MAC subheader

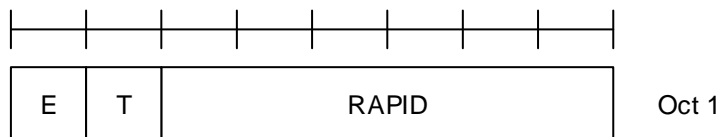

Figure 6.1.5-2: E/T/RAPID MAC subheader

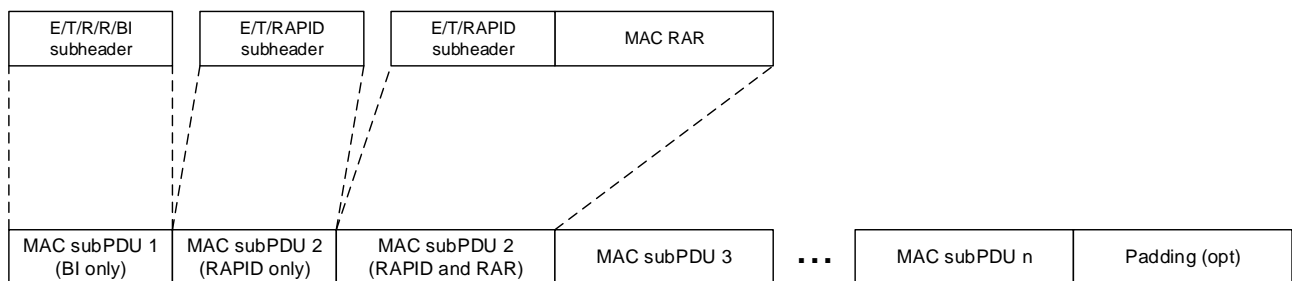

Figure 6.1.5-3: Example of MAC PDU consisting of MAC RARs

[38.331, clause 5.2.2.2.2]

UEs in RRC_IDLE or in RRC_INACTIVE shall monitor for SI change indication in its own paging occasion every DRX cycle. UEs in RRC_CONNECTED shall monitor for SI change indication in any paging occasion at least once per

modification period if the UE is provided with common search space on the active BWP to monitor paging, as specified in TS 38.213 [13], clause 13.

ETWS or CMAS capable UEs in RRC_IDLE or in RRC_INACTIVE shall monitor for indications about PWS notification in its own paging occasion every DRX cycle. ETWS or CMAS capable UEs in RRC_CONNECTED shall monitor for indication about PWS notification in any paging occasion at least once every *defaultPagingCycle* if the UE is provided with common search space on the active BWP to monitor paging.

For Short Message reception in a paging occasion, the UE monitors the PDCCH monitoring occasion(s) for paging as specified in TS 38.304 [20] and TS 38.213 [13].

If the UE receives a Short Message, the UE shall:

- 1> if the UE is ETWS capable or CMAS capable, the *etwsAndCmasIndication* bit of Short Message is set, and the UE is provided with *searchSpaceOtherSystemInformation* on the active BWP:
 - 2> immediately re-acquire the *SIB1*;
 - 2> if the UE is ETWS capable and *si-SchedulingInfo* includes scheduling information for *SIB6*:
 - 3> acquire *SIB6*, as specified in clause 5.2.2.3.2, immediately;
 - 2> if the UE is ETWS capable and *si-SchedulingInfo* includes scheduling information for *SIB7*:
 - 3> acquire *SIB7*, as specified in clause 5.2.2.3.2, immediately;
 - 2> if the UE is CMAS capable and *si-SchedulingInfo* includes scheduling information for *SIB8*:
 - 3> acquire *SIB8*, as specified in sub-clause 5.2.2.3.2, immediately;

1> if the *systemInfoModification* bit of Short Message is set:

2> apply the SI acquisition procedure as defined in sub-clause 5.2.2.3 from the start of the next modification period.

7.1.1.1.3.3 Test description

7.1.1.1.3.3.1 Pre-test conditions

System Simulator:

- NR Cell 1 and NR Cell 11.
- System information combination NR-3 as defined in TS 38.508-1 [4] clause 4.4.3.1.3 is used in NR Cell 1.

UE:

- None.

Preamble:

- The UE is in NR RRC_Idle mode (state 1N-A) on NR Cell 1 according to 38.508-1 [4] Table 4.4A.2-1.

7.1.1.1.3.3.2 Test procedure sequence

Table 7.1.1.1.3.3.2-1/2 illustrate the downlink power levels and other changing parameters to be applied for the cell at various time instants of the test execution. The exact instants on which these values shall be applied are described in the texts in this clause. Configurations marked "T0" is applied for Preamble. Configurations marked "T1" and "T2" are applied at the points indicated in the Main behaviour description in Table 7.1.1.1.3.3.2-3.

Table 7.1.1.1.3.3.2-1: Time instances of cell power level and parameter changes for FR1

	Parameter	Unit	NR Cell 1	NR Cell 11	Remark
T0	SS/PBCH	dBm/SC	-90	Off	The power level is such that $SrXlEV_{NRCell1} > 0$

	SSS EPRE	S			
	Qrxlevmin	dBm	-106	-	
	Qrxlevminoffset	dB	0	-	
	Pcompensation	dB	0	-	
	Qoffset	dB	16	-	
T1	SS/PBCH SSS EPRE	dBm/SC S	-90	-84	The power level values are assigned to satisfy $R_{NRCell\ 1} > R_{NRCell\ 11}$
	Qrxlevmin	dBm	-106	-106	
	Qrxlevminoffset	dB	0	0	
	Pcompensation	dB	0	0	
	Qoffset	dB	16	-	
T2	SS/PBCH SSS EPRE	dBm/SC S	-90	-84	The power level values are assigned to satisfy $R_{NRCell\ 1} < R_{NRCell\ 11}$
	Qrxlevmin	dBm	-106	-106	
	Qrxlevminoffset	dB	0	0	
	Pcompensation	dB	0	0	
	Qoffset	dB	-10	-	
Note: The downlink signal level uncertainty is specified in TS 38.508-1 [4] clause 6.2.2.1.					

Table 7.1.1.1.3.3.2-2: Time instances of cell power level and parameter changes for FR2

	Parameter	Unit	NR Cell 1	NR Cell 11	Remark
T0	SS/PBCH SSS EPRE	dBm/SC S	-91	Off	The power level is such that $S_{rxlevNRCell11} > 0$
	Qrxlevmin	dBm	$2^* \text{ROUND}((-110 + \Delta (NRfs))/2)$	-	
	Qrxlevminoffset	dB	0	-	
	Pcompensation	dB	0	-	
	Qoffset	dB	16	-	
T1	SS/PBCH SSS EPRE	dBm/SC S	-91	-82	The power level values are assigned to satisfy $R_{NRCell\ 1} > R_{NRCell\ 11}$
	Qrxlevmin	dBm	$2^* \text{ROUND}((-110 + \Delta (NRfs))/2)$	$2^* \text{ROUND}((-110 + \Delta (NRfs))/2)$	
	Qrxlevminoffset	dB	0	0	
	Pcompensation	dB	0	0	
	Qoffset	dB	16	-	
T2	SS/PBCH SSS EPRE	dBm/SC S	-91	-82	The power level values are assigned to satisfy $R_{NRCell\ 1} < R_{NRCell\ 11}$
	Qrxlevmin	dBm	$2^* \text{ROUND}((-110 + \Delta (NRfs))/2)$	$2^* \text{ROUND}((-110 + \Delta (NRfs))/2)$	
	Qrxlevminoffset	dB	0	0	
	Pcompensation	dB	0	0	
	Qoffset	dB	-10	-	
Note: The downlink signal level uncertainty is specified in TS 38.508-1 [4] section 6.2.2.2.					

Table 7.1.1.1.3.3.2-3: Main behaviour

St	Procedure	Message Sequence		TP	Verdict
		U - S	Message		
1	The SS changes SS/PBCH EPRE level of NR Cell 11 according to the row "T1" in Table 7.1.1.1.3.3.2-1/2.	-	-	-	-
2	Wait 60s to ensure UE detects NR Cell 11.	-	-	-	-
3	SS transmits Short Message on PDCCH addressed to P-RNTI using Short Message field in DCI format 1_0. Bit 1 of Short Message field is set to 1 to indicate the SI modification.	<--	(Short Message)	-	-

4	The <i>valueTag</i> for SIB3 in the SIB1 message is increased and <i>si-BroadcastStatus</i> for SIB3 is set to ' <i>notBroadcasted</i> ' and SS stops broadcasting SIB3.	<--		-	-
5	Check: Does the UE transmit a preamble on PRACH using the preamble indicated by <i>ra-PreambleStartIndex</i> defined in <i>SI-RequestConfig</i> in <i>SIB1</i> in Table 7.1.1.1.3.3.3-1?	-->	PRACH Preamble	1	P
6	Check: Does the UE re-transmit a preamble on PRACH after <i>ra-ResponseWindow</i> using the preamble indicated by <i>ra-PreambleStartIndex</i> defined in <i>SI-RequestConfig</i> in <i>SIB1</i> in Table 7.1.1.1.3.3.3-1?	-->	PRACH Preamble	1	P
7	Check: Does the UE re-transmit a preamble on PRACH after <i>ra-ResponseWindow</i> using the preamble indicated by <i>ra-PreambleStartIndex</i> defined in <i>SI-RequestConfig</i> in <i>SIB1</i> in Table 7.1.1.1.3.3.3-1?	-->	PRACH Preamble	1	P
8	Check: Does the UE re-transmit a preamble on PRACH after <i>ra-ResponseWindow</i> using the preamble indicated by <i>ra-PreambleStartIndex</i> defined in <i>SI-RequestConfig</i> in <i>SIB1</i> in Table 7.1.1.1.3.3.3-1?	-->	PRACH Preamble	1	P
9	The SS transmits a RAR message addressed to UE RA-RNTI including a MAC subPDU with a matching RAPID only. (Note 1)	<--	Random Access Response	-	-
9A	The SS changes the parameter ' <i>Qoffset</i> ' in SIB3 of NR Cell 1 according to the row "T2" in Table 7.1.1.1.3.3.2-1/2 and starts broadcasting SIB3.				
10	Check: Does UE send Msg3 containing an <i>RRCSetupRequest</i> message in the grant associated to the Random Access Response received in step 9?	-->	<i>RRCSetupRequest</i>	2	F
11	Check: Does the test result of generic test procedure in TS 38.508-1 [4] Table 4.9.5.2.2-1 indicate that the UE is camped on NR Cell 11 belonging to a new TA?	-	-	2	P
Note 1: The UE will indicate the reception of an acknowledgement for SI request to upper layers after UE receives the RAR message including a MAC subPDU with a matching RAPID only, according to TS 38.321 [18] clause 5.1.4.					

7.1.1.1.3.3.3 Specific message contents

Table 7.1.1.1.3.3.3-1: *SIB1* on NR Cell 1 (Step 4, Table 7.1.1.1.3.3.2-3)

Derivation Path: TS 38.508-1 [4], Table 4.6.1-28			
Information Element	Value/remark	Comment	Condition
SIB1 ::= SEQUENCE {			
si-SchedulingInfo SEQUENCE {			
schedulingInfoList SEQUENCE {	2 entries		
si-BroadcastStatus[1]	Broadcasting		
si-Periodicity[1]	rf32		
sib-MappingInfo[1] SEQUENCE {			
type	SibType2		
valueTag	0		
areaScope	Not present		
}			
si-BroadcastStatus[2]	notBroadcasting		
si-Periodicity[2]	rf64		
sib-MappingInfo[2] SEQUENCE {			
type	SibType3		
valueTag	1		
areaScope	Not present		

}			
}			
si-RequestConfig SEQUENCE {			
rach-OccasionsSI SEQUENCE {			
rach-ConfigSI	RACH-ConfigGeneric	TS 38.508-1 [4], Table 4.6.3-130	
ssb-perRACH-Occasion	one		
}			
si-RequestPeriod	two		
si-RequestResources SEQUENCE {	1 entry		
ra-PreambleStartIndex[1]	52		
ra-AssociationPeriodIndex[1]	0		
ra-ssb-OccasionMaskIndex[1]	0		
}			
}			
si-RequestConfigSUL	Not present		
}			
}			

Table 7.1.1.1.3.3.2: SIB3 on NR Cell 1 (Preamble and Step 9A, Table 7.1.1.1.3.3.2-3)

Derivation Path: TS 38.508-1 [4], Table 4.6.2-2			
Information Element	Value/remark	Comment	Condition
SIB3 ::= SEQUENCE {			
intraFreqNeighCellList SEQUENCE {			
physCellId	The cell identity of NR Cell 11 defined in 38.508-1 [4] clause 4.4.2		
q-OffsetCell	16	Preamble	
	-10	Step 9A	
}			
}			

7.1.1.1.4 Random access procedure / Successful / Beam Failure / Preamble selected by MAC itself / Non Contention Free RACH procedure

7.1.1.1.4.1 Test Purpose (TP)

(1)

```
with { UE in RRC_CONNECTED state with no failureDetectionResources configured and RACH procedure due to beam failure is triggered }
ensure that {
  when { contention free random access resources for beam failure recovery request associated with SS blocks are not provided by RRC }
  then { UE selects initiates the non-contention free Random Access Procedure }
}
```

(2)

```
with { UE in RRC_CONNECTED state and RACH procedure due to beam failure is triggered }
ensure that {
  when { contention free random access resources for beam failure recovery request associated with SS blocks are explicitly provided by RRC }
  then { UE selects the PREAMBLE_INDEX to a ra-PreambleIndex corresponding to the selected SS block and initiates the contention free Random Access Procedure }
}
```

(3)

```
with { UE in RRC_CONNECTED state and RACH procedure due to beam failure is triggered }
ensure that {
  when { contention free random access resources for beam failure recovery request associated with CSI-RS are explicitly provided by RRC }
}
```

```

    then { UE selects the PREAMBLE_INDEX to a ra-PreambleIndex corresponding to the selected CSI-RS
and initiates the contention free Random Access Procedure }
    }

```

(4)

```

with { UE in RRC_CONNECTED state with Preamble transmitted for contention free RACH procedure for
beam failure }
ensure that {
  when { ra-ResponseWindowBFR expires and the PDCCH addressed to the C-RNTI has not been received }
  then { UE retransmits the PRACH Preamble }
}

```

(5)

```

with { UE in RRC_CONNECTED state with Preamble transmitted for contention free RACH procedure for
beam failure }
ensure that {
  when { before expiry of ra-ResponseWindowBFR the PDCCH addressed to the C-RNTI is received }
  then { UE considers the RACH procedure to be successfully completed and stops retransmitting
PRACH preambles }
}

```

7.1.1.1.4.2 Conformance requirements

References: The conformance requirements covered in the present test case are specified in: TS 38.321, clause 5.1.2, 5.1.3, 5.1.4 and 5.17. Unless otherwise stated these are Rel-15 requirements.

[TS 38.321, clause 5.1.2]

The MAC entity shall:

- 1> if the Random Access procedure was initiated for beam failure recovery (as specified in subclause 5.17); and
- 1> if the *beamFailureRecoveryTimer* (in subclause 5.17) is either running or not configured; and
- 1> if the contention-free Random Access Resources for beam failure recovery request associated with any of the SSBs and/or CSI-RSs have been explicitly provided by RRC; and
- 1> if at least one of the SSBs with SS-RSRP above *rsrp-ThresholdSSB* amongst the SSBs in *candidateBeamRSList* or the CSI-RSs with CSI-RSRP above *rsrp-ThresholdCSI-RS* amongst the CSI-RSs in *candidateBeamRSList* is available:
 - 2> select an SSB with SS-RSRP above *rsrp-ThresholdSSB* amongst the SSBs in *candidateBeamRSList* or a CSI-RS with CSI-RSRP above *rsrp-ThresholdCSI-RS* amongst the CSI-RSs in *candidateBeamRSList*;
 - 2> if CSI-RS is selected, and there is no *ra-PreambleIndex* associated with the selected CSI-RS:
 - 3> set the *PREAMBLE_INDEX* to a *ra-PreambleIndex* corresponding to the SSB in *candidateBeamRSList* which is quasi-collocated with the selected CSI-RS as specified in TS 38.214 [7].
 - 2> else:
 - 3> set the *PREAMBLE_INDEX* to a *ra-PreambleIndex* corresponding to the selected SSB or CSI-RS from the set of Random Access Preambles for beam failure recovery request.
- 1> else if the *ra-PreambleIndex* has been explicitly provided by PDCCH; and
- 1> if the *ra-PreambleIndex* is not 0b000000:
 - 2> set the *PREAMBLE_INDEX* to the signalled *ra-PreambleIndex*;
 - 2> select the SSB signalled by PDCCH.
- 1> else if the contention-free Random Access Resources associated with SSBs have been explicitly provided by RRC and at least one SSB with SS-RSRP above *rsrp-ThresholdSSB* amongst the associated SSBs is available:
 - 2> select an SSB with SS-RSRP above *rsrp-ThresholdSSB* amongst the associated SSBs;

- 2> set the *PREAMBLE_INDEX* to a *ra-PreambleIndex* corresponding to the selected SSB.
- 1> else if the contention-free Random Access Resources associated with CSI-RSs have been explicitly provided by RRC and at least one CSI-RS with CSI-RSRP above *rsrp-ThresholdCSI-RS* amongst the associated CSI-RSs is available:
 - 2> select a CSI-RS with CSI-RSRP above *rsrp-ThresholdCSI-RS* amongst the associated CSI-RSs;
 - 2> set the *PREAMBLE_INDEX* to a *ra-PreambleIndex* corresponding to the selected CSI-RS.
- 1> else if the Random Access procedure was initiated for SI request (as specified in TS 38.331 [5]); and
- 1> if the Random Access Resources for SI request have been explicitly provided by RRC:
 - 2> if at least one of the SSBs with SS-RSRP above *rsrp-ThresholdSSB* is available:
 - 3> select an SSB with SS-RSRP above *rsrp-ThresholdSSB*.
 - 2> else:
 - 3> select any SSB.
 - 2> select a Random Access Preamble corresponding to the selected SSB, from the Random Access Preamble(s) determined according to *ra-PreambleStartIndex* as specified in TS 38.331 [5];
 - 2> set the *PREAMBLE_INDEX* to selected Random Access Preamble.
- 1> else (i.e. for the contention-based Random Access preamble selection):
 - 2> if at least one of the SSBs with SS-RSRP above *rsrp-ThresholdSSB* is available:
 - 3> select an SSB with SS-RSRP above *rsrp-ThresholdSSB*.
 - 2> else:
 - 3> select any SSB.
 - 2> if Msg3 has not yet been transmitted:
 - 3> if Random Access Preambles group B is configured:
 - 4> if the potential Msg3 size (UL data available for transmission plus MAC header and, where required, MAC CEs) is greater than *ra-Msg3SizeGroupA* and the pathloss is less than $PCMAX$ (of the Serving Cell performing the Random Access Procedure) – *preambleReceivedTargetPower* – *msg3-DeltaPreamble* – *messagePowerOffsetGroupB*; or
 - 4> if the Random Access procedure was initiated for the CCCH logical channel and the CCCH SDU size plus MAC subheader is greater than *ra-Msg3SizeGroupA*:
 - 5> select the Random Access Preambles group B.
 - 4> else:
 - 5> select the Random Access Preambles group A.
 - 3> else:
 - 4> select the Random Access Preambles group A.
- 2> else (i.e. Msg3 is being retransmitted):
 - 3> select the same group of Random Access Preambles as was used for the Random Access Preamble transmission attempt corresponding to the first transmission of Msg3.
- 2> if the association between Random Access Preambles and SSBs is configured:
 - 3> select a Random Access Preamble randomly with equal probability from the Random Access Preambles associated with the selected SSB and the selected Random Access Preambles group.

- 2> else:
 - 3> select a Random Access Preamble randomly with equal probability from the Random Access Preambles within the selected Random Access Preambles group.
 - 2> set the *PREAMBLE_INDEX* to the selected Random Access Preamble.
- 1> if the Random Access procedure was initiated for SI request (as specified in TS 38.331 [5]); and
- 1> if *ra-AssociationPeriodIndex* and *si-RequestPeriod* are configured:
 - 2> determine the next available PRACH occasion from the PRACH occasions corresponding to the selected SSB in the association period given by *ra-AssociationPeriodIndex* in the *si-RequestPeriod* permitted by the restrictions given by the *ra-ssb-OccasionMaskIndex* (the MAC entity shall select a PRACH occasion randomly with equal probability amongst the consecutive PRACH occasions according to subclause 8.1 of TS 38.213 [6] corresponding to the selected SSB).
- 1> else if an SSB is selected above:
 - 2> determine the next available PRACH occasion from the PRACH occasions corresponding to the selected SSB permitted by the restrictions given by the *ra-ssb-OccasionMaskIndex* if configured (the MAC entity shall select a PRACH occasion randomly with equal probability amongst the consecutive PRACH occasions according to subclause 8.1 of TS 38.213 [6], corresponding to the selected SSB; the MAC entity may take into account the possible occurrence of measurement gaps when determining the next available PRACH occasion corresponding to the selected SSB).
- 1> else if a CSI-RS is selected above:
 - 2> if there is no contention-free Random Access Resource associated with the selected CSI-RS:
 - 3> determine the next available PRACH occasion from the PRACH occasions, permitted by the restrictions given by the *ra-ssb-OccasionMaskIndex* if configured, corresponding to the SSB in *candidateBeamRSList* which is quasi-collocated with the selected CSI-RS as specified in TS 38.214 [7] (the MAC entity may take into account the possible occurrence of measurement gaps when determining the next available PRACH occasion corresponding to the SSB which is quasi-collocated with the selected CSI-RS).
 - 2> else:
 - 3> determine the next available PRACH occasion from the PRACH occasions in *ra-OccasionList* corresponding to the selected CSI-RS (the MAC entity shall select a PRACH occasion randomly with equal probability amongst the PRACH occasions occurring simultaneously but on different subcarriers, corresponding to the selected CSI-RS; the MAC entity may take into account the possible occurrence of measurement gaps when determining the next available PRACH occasion corresponding to the selected CSI-RS).
- 1> perform the Random Access Preamble transmission procedure (see subclause 5.1.3).

NOTE: When the UE determines if there is an SSB with SS-RSRP above *rsrp-ThresholdSSB* or a CSI-RS with CSI-RSRP above *rsrp-ThresholdCSI-RS*, the UE uses the latest unfiltered L1-RSRP measurement.

[TS 38.321, clause 5.1.4]

Once the Random Access Preamble is transmitted and regardless of the possible occurrence of a measurement gap, the MAC entity shall:

- 1> if the contention-free Random Access Preamble for beam failure recovery request was transmitted by the MAC entity:
 - 2> start the *ra-ResponseWindow* configured in *BeamFailureRecoveryConfig* at the first PDCCH occasion as specified in TS 38.213 [6] from the end of the Random Access Preamble transmission;
 - 2> monitor the PDCCH of the SpCell for response to beam failure recovery request identified by the C-RNTI while *ra-ResponseWindow* is running.
- 1> else:

- 2> start the *ra-ResponseWindow* configured in *RACH-ConfigCommon* at the first PDCCH occasion as specified in TS 38.213 [6] from the end of the Random Access Preamble transmission;
 - 2> monitor the PDCCH of the SpCell for Random Access Response(s) identified by the RA-RNTI while the *ra-ResponseWindow* is running.
- 1> if notification of a reception of a PDCCH transmission is received from lower layers on the Serving Cell where the preamble was transmitted; and
 - 1> if PDCCH transmission is addressed to the C-RNTI; and
 - 1> if the contention-free Random Access Preamble for beam failure recovery request was transmitted by the MAC entity:
 - 2> consider the Random Access procedure successfully completed.
 - 1> else if a downlink assignment has been received on the PDCCH for the RA-RNTI and the received TB is successfully decoded:
 - 2> if the Random Access Response contains a MAC subPDU with Backoff Indicator:
 - 3> set the *PREAMBLE_BACKOFF* to value of the BI field of the MAC subPDU using Table 7.2-1, multiplied with *SCALING_FACTOR_BI*.
 - 2> else:
 - 3> set the *PREAMBLE_BACKOFF* to 0 ms.
 - 2> if the Random Access Response contains a MAC subPDU with Random Access Preamble identifier corresponding to the transmitted *PREAMBLE_INDEX* (see subclause 5.1.3):
 - 3> consider this Random Access Response reception successful.
 - 2> if the Random Access Response reception is considered successful:
 - 3> if the Random Access Response includes a MAC subPDU with RAPID only:
 - 4> consider this Random Access procedure successfully completed;
 - 4> indicate the reception of an acknowledgement for SI request to upper layers.
 - 3> else:
 - 4> apply the following actions for the Serving Cell where the Random Access Preamble was transmitted:
 - 5> process the received Timing Advance Command (see subclause 5.2);
 - 5> indicate the *preambleReceivedTargetPower* and the amount of power ramping applied to the latest Random Access Preamble transmission to lower layers (i.e. $(PREAMBLE_POWER_RAMPING_COUNTER - 1) \times PREAMBLE_POWER_RAMPING_STEP$);
 - 5> if the Serving Cell for the Random Access procedure is SRS-only SCell:
 - 6> ignore the received UL grant.
 - 5> else:
 - 6> process the received UL grant value and indicate it to the lower layers.
 - 4> if the Random Access Preamble was not selected by the MAC entity among the contention-based Random Access Preamble(s):
 - 5> consider the Random Access procedure successfully completed.
 - 4> else:
 - 5> set the *TEMPORARY_C-RNTI* to the value received in the Random Access Response;

- 5> if this is the first successfully received Random Access Response within this Random Access procedure:
 - 6> if the transmission is not being made for the CCCH logical channel:
 - 7> indicate to the Multiplexing and assembly entity to include a C-RNTI MAC CE in the subsequent uplink transmission.
 - 6> obtain the MAC PDU to transmit from the Multiplexing and assembly entity and store it in the Msg3 buffer.
- 1> if *ra-ResponseWindow* configured in *RACH-ConfigCommon* expires, and if the Random Access Response containing Random Access Preamble identifiers that matches the transmitted *PREAMBLE_INDEX* has not been received; or
- 1> if *ra-ResponseWindow* configured in *BeamFailureRecoveryConfig* expires and if the PDCCH addressed to the C-RNTI has not been received on the Serving Cell where the preamble was transmitted:
 - 2> consider the Random Access Response reception not successful;
 - 2> increment *PREAMBLE_TRANSMISSION_COUNTER* by 1;
 - 2> if *PREAMBLE_TRANSMISSION_COUNTER* = *preambleTransMax* + 1:
 - 3> if the Random Access Preamble is transmitted on the SpCell:
 - 4> indicate a Random Access problem to upper layers;
 - 4> if this Random Access procedure was triggered for SI request:
 - 5> consider the Random Access procedure unsuccessfully completed.
 - 3> else if the Random Access Preamble is transmitted on a SCell:
 - 4> consider the Random Access procedure unsuccessfully completed.
 - 2> if the Random Access procedure is not completed:
 - 3> select a random backoff time according to a uniform distribution between 0 and the *PREAMBLE_BACKOFF*;
 - 3> if the criteria (as defined in subclause 5.1.2) to select contention-free Random Access Resources is met during the backoff time:
 - 4> perform the Random Access Resource selection procedure (see subclause 5.1.2);
 - 3> else:
 - 4> perform the Random Access Resource selection procedure (see subclause 5.1.2) after the backoff time.

The MAC entity may stop *ra-ResponseWindow* (and hence monitoring for Random Access Response(s)) after successful reception of a Random Access Response containing Random Access Preamble identifiers that matches the transmitted *PREAMBLE_INDEX*.

HARQ operation is not applicable to the Random Access Response transmission.

7.1.1.1.4.3 Test description

7.1.1.1.4.3.1 Pre-test conditions

Same Pre-test conditions as in clause 7.1.1.0 except that set to return no data in uplink.

7.1.1.1.4.3.2 Test procedure sequence

Table 7.1.1.1.4.3.2-1/1A illustrates the downlink power levels and other changing parameters to be applied for the cells at various time instants of the test execution. Row marked "T0" denotes the initial conditions after preamble, while columns marked "T1" and "T2" are to be applied subsequently. The exact instants on which these values shall be applied are described in the texts in this clause.

Table 7.1.1.1.4.3.2-1: Time instances of cell power level and parameter changes for FR1

	Parameter	Unit	E-UTRA Cell 1	NR Cell 1	NR Cell 1 Beam index #1	NR Cell 1 Beam index #0	Remark
T0	Cell-specific RS EPRE	dBm/15 kHz	-85	-	-	-	Beam#1 Switch ON and Beam#0 Switch OFF
	Reference Power	dBm/SC S	-	-88	-	-	
	CSI-RS EPRE SS/PBCH SSS EPRE,	dB	-	-	0	-57	
T1	Cell-specific RS EPRE	dBm/15 kHz	-85	-	-	-	Beam#1 Switch OFF and Beam#0 Switch ON
	Reference Power	dBm/SC S	-	-88	-	-	
	CSI-RS EPRE SS/PBCH SSS EPRE,	dB	-	-	-57	0	
T2	Cell-specific RS EPRE	dBm/15 kHz	-85	-	-	-	Beam#1 Switch ON and Beam#0 Switch OFF
	Reference Power	dBm/SC S	-	-88	-	-	
	CSI-RS EPRE SS/PBCH SSS EPRE,	dB	-	-	0	-57	

NOTE: "Beam index #1" refers to transmission of the SS/PBCH block with SSB index #1 (according to the ssb-PositionsInBurst) and CSI-RS with index #1 (according to the CSI-MeasConfig being signalled to the UE at step 1/8/17); "Beam index #0" refers to transmission of the SS/PBCH block with SSB index #0 (according to the ssb-PositionsInBurst) and CSI-RS with index #0 (according to the CSI-MeasConfig being signalled to the UE at step 1/8/17).

Table 7.1.1.1.4.3.2-1A: Time instances of cell power level and parameter changes for FR2

	Parameter	Unit	E-UTRA Cell 1	NR Cell 1	NR Cell 1 Beam index #1	NR Cell 1 Beam index #0	Remark
T0	Cell-specific RS EPRE	dBm/15 kHz	-96	-	-	-	Beam#1 Switch ON and Beam#0 Switch OFF
	Reference Power	dBm/SC S	-	-82	-	-	
	CSI-RS EPRE SS/PBCH SSS EPRE,	dB	-	-	0	-63	
T1	Cell-specific RS EPRE	dBm/15 kHz	-96	-	-	-	Beam#1 Switch OFF and Beam#0 Switch ON
	Reference Power	dBm/SC S	-	-82	-	-	
	CSI-RS EPRE SS/PBCH SSS EPRE,	dBm/SC S	-	-	-63	0	
T2	Cell-specific RS EPRE	dBm/15 kHz	-96	-	-	-	Beam#1 Switch ON and Beam#0 Switch OFF
	Reference Power	dBm/SC S	-	-82	-	-	
	CSI-RS EPRE SS/PBCH	dBm/SC S	-	-	0	-63	

SSS EPRE,						
NOTE: "Beam index #1" refers to transmission of the SS/PBCH block with SSB index #1 (according to the <i>ssb-PositionsInBurst</i>) and CSI-RS with index #1 (according to the <i>CSI-MeasConfig</i> being signalled to the UE at step 1/8/17); "Beam index #0" refers to transmission of the SS/PBCH block with SSB index #0 (according to the <i>ssb-PositionsInBurst</i>) and CSI-RS with index #0 (according to the <i>CSI-MeasConfig</i> being signalled to the UE at step 1/8/17).						

Table 7.1.1.1.4.3.2-2: Main behaviour

St	Procedure	Message Sequence		TP	Verdict
		U - S	Message		
1	The SS transmits an NR <i>RRCReconfiguration</i> message to configure parameters for BFR. Note 1.	<--	NR RRC: <i>RRCReconfiguration</i>	-	-
2	UE responses NR <i>RRCReconfigurationComplete</i> message. Note 2.	-->	NR RRC: <i>RRCReconfigurationComplete</i>	-	-
3	The SS changes NR Cell 1 power level according to the row "T1" in table 7.1.1.1.4.3.2-1/1A.	-	-	-	-
4	Check: Does the UE transmit a preamble on PRACH for the non-contention free Random Access Procedure on NR Cell 1 Beam index #1?	-->	PRACH Preamble	1	P
5	The SS transmits a MAC PDU addressed to UE RA-RNTI, containing multiple RAR's and one of the MAC sub headers contains a matching RAPID on NR Cell 1.	<--	Random Access Response	-	-
6	UE sends a msg3 using the grant associated to the Random Access Response received in Step 5 on NR Cell 1.	-->	msg3 (C-RNTI MAC CONTROL ELEMENT)	-	-
7	SS schedules PDCCH transmission for UE C-RNTI.	<--	Contention Resolution	-	-
8	The SS transmits an NR <i>RRCReconfiguration</i> to establish random access resources for BFR associated with SS blocks explicitly. Note 1.	<--	NR RRC: <i>RRCReconfiguration</i>	-	-
9	UE responses NR <i>RRCReconfigurationComplete</i> message. Note 2.	-->	NR RRC: <i>RRCReconfigurationComplete</i>	-	-
10	The SS changes NR Cell 1 power level according to the row "T2" in table 7.1.1.1.4.3.2-1/1A.	-	-	-	-
11	Check: Does the UE transmit preamble on PRACH using a preamble with <i>PREAMBLE_INDEX</i> to a <i>ra-PreambleIndex</i> corresponding to the selected SS block provided by RRC on NR Cell 1 Beam index #0?	-->	PRACH Preamble	2	P
12	The SS waits for <i>ra-ResponseWindowBFR</i> expire. NOTE: The SS does not transmit Random Access Response to the UE.	-	-	-	-
13	Check: Does the UE retransmit a preamble on PRACH with <i>ra-PreambleIndex</i> same as the Step 11?	-->	PRACH Preamble	4	P
14	The SS transmits a MAC PDU addressed to UE C-RNTI, containing multiple RAR's and one of the MAC sub headers contains a matching RAPID on NR Cell 1.	<--	Random Access Response	-	-
15	The SS waits for <i>ra-ResponseWindowBFR</i> expire.	-	-	-	-
16	Check: Does the UE retransmit a preamble on PRACH?	-	-	5	F
-	EXCEPTION: Steps 17 to 25 describe behaviour that depends on the UE capability.	-	-	-	-

17	IF pc_csi_RS_CFRA_ForHO THEN the SS transmits an NR <i>RRCReconfiguration</i> message to establish random access resources for BFR associated with CSI-RS explicitly. Note 1.	<--	NR RRC: <i>RRCReconfiguration</i>	-	-
18	UE responses NR <i>RRCReconfigurationComplete</i> message. Note 2.	-->	NR RRC: <i>RRCReconfigurationComplete</i>	-	-
19	The SS changes NR Cell 1 power level according to the row "T1" in table 7.1.1.1.4.3.2-1/1A.	-	-	-	-
20	Check: Does the UE transmit preamble on PRACH using a preamble with <i>PREAMBLE_INDEX</i> to a ra-PreambleIndex corresponding to the selected CSI-RS provided by RRC on NR Cell 1 Beam index #1?	-->	PRACH Preamble	3	P
21	The SS waits for ra-ResponseWindowBFR expire. NOTE: The SS does not transmit Random Access Response to the UE.	-	-	-	-
22	Check: Does the UE retransmit a preamble on PRACH with ra-PreambleIndex same as the Step 20?	-->	PRACH Preamble	4	P
23	The SS transmits a MAC PDU addressed to UE C-RNTI, containing multiple RAR's and one of the MAC sub headers contains a matching RAPID on NR Cell 1.	<--	Random Access Response	-	-
24	The SS waits for ra-ResponseWindowBFR expire.	-	-	-	-
25	Check: Does the UE retransmit a preamble on PRACH?	-	-	5	F
Note 1: for EN-DC the NR <i>RRCReconfiguration</i> message is contained in <i>RRCConnectionReconfiguration</i> 36.508 [7], Table 4.6.1-8 using condition EN-DC_EmbedNR_RRCRecon. Note 2: for EN-DC the NR <i>RRCReconfigurationComplete</i> message is contained in <i>RRCConnectionReconfigurationComplete</i> .					

7.1.1.1.4.3.3 Specific message contents

Table 7.1.1.1.4.3.3-1: Void

Table 7.1.1.1.4.3.3-2: Void

Table 7.1.1.1.4.3.3-3: *RRCReconfiguration* (Step 1, Step8, Step17 Table 7.1.1.1.4.3.2-2)

Derivation path: 38.508-1 [4], Table 4.6.1-13			
Information Element	Value/remark	Comment	Condition
<i>RRCReconfiguration</i> ::=SEQUENCE{			
criticalExtensions CHOICE{			
rrcReconfiguration SEQUENCE{			
secondaryCellGroup	CellGroupConfig	OCTET STRING	EN-DC
nonCriticalExtension SEQUENCE {			NR
masterCellGroup	CellGroupConfig	OCTET STRING (CONTAINING CellGroupConfig)	
}			
}			
}			
}			

Table 7.1.1.1.4.3.3-4: CellGroupConfig (Table 7.1.1.1.4.3.3-3: RRCReconfiguration)

Derivation Path: TS 38.508-1 [4], Table 4.6.3-19			
Information Element	Value/remark	Comment	Condition
CellGroupConfig ::= SEQUENCE {			
spCellConfig SEQUENCE {			
spCellConfigDedicated	ServingCellConfig		
}			
}			

Table 7.1.1.1.4.3.3-5: ServingCellConfig (Table 7.1.1.1.4.3.3-4: CellGroupConfig)

Derivation Path: TS 38.508-1 [4], Table 4.6.3-168			
Information Element	Value/remark	Comment	Condition
ServingCellConfig ::= SEQUENCE {			
initialDownlinkBWP	BWP-DownlinkDedicated		
uplinkConfig SEQUENCE {			
initialUplinkBWP	BWP-UplinkDedicated		
}			
csi-MeasConfig CHOICE {			Step 1
setup	CSI-MeasConfig		
}			
}			

Table 7.1.1.1.4.3.3-6: BWP-DownlinkDedicated (Table 7.1.1.1.4.3.3-5: ServingCellConfig)

Derivation Path: TS 38.508-1 [4], Table 4.6.3-11			
Information Element	Value/remark	Comment	Condition
BWP-DownlinkDedicated ::= SEQUENCE {			
pdcch-Config	Not present		Step 17
pdcch-Config CHOICE {			Step 1, Step 8
setup	PDCCH-Config		
}			
pdsch-Config CHOICE {			
setup	PDSCH-Config		
}			
radioLinkMonitoringConfig CHOICE {			
setup	RadioLinkMonitoringConfig		
}			
}			

Table 7.1.1.1.4.3.3-7: RadioLinkMonitoringConfig (Table 7.1.1.1.4.3.3-6: BWP-DownlinkDedicated)

Derivation Path: TS 38.508-1 [4], Table 4.6.3-133			
Information Element	Value/remark	Comment	Condition
RadioLinkMonitoringConfig ::= SEQUENCE {			
failureDetectionResourcesToAddModList SEQUENCE (SIZE(1..maxNrofFailureDetectionResources)) OF RadioLinkMonitoringRS {	2 entries		
RadioLinkMonitoringRS[1] SEQUENCE {		entry 1	
radioLinkMonitoringRS-Id	0		
purpose	rif		Step 1, Step 17
	both		Step 8
detectionResource CHOICE {			
csi-rs	0	NR Cell 1 Beam index #0	
}			
}			

RadioLinkMonitoringRS[2] SEQUENCE {		entry 2	
radioLinkMonitoringRS-Id	1		
purpose	rlf		Step 1, Step 8
	both		Step 17
detectionResource CHOICE {			
csi-rs	1	NR Cell 1 Beam index #1	
}			
}			
}			
beamFailureInstanceMaxCount	n1		
beamFailureDetectionTimer	pbfd1		
}			

Table 7.1.1.1.4.3.3-8: PDSCH-Config (Table 7.1.1.1.4.3.3-6: BWP-DownlinkDedicated)

Derivation Path: TS 38.508-1 [4], Table 4.6.3-100			
Information Element	Value/remark	Comment	Condition
PDSCH-Config ::= SEQUENCE {			
tci-StatesToAddModList SEQUENCE(SIZE (1..maxNrofTCI-States)) OF TCI-State {	3 entries		
TCI-State[1] SEQUENCE {		entry 1	
tci-StateId	0		
qcl-type1 SEQUENCE {			
cell	ServCellIndex of NR SpCell	Cell ID	
bwp-id	0	BWP ID	
referenceSignal CHOICE {			
ssb	1	SSB index #1	
}			
qcl-Type	type C		
}			
qcl-type2	Not present		
qcl-type2 SEQUENCE {			FR2
cell	ServCellIndex of NR SpCell	Cell ID	
bwp-id	0	BWP ID	
referenceSignal CHOICE {			
ssb	1	SSB index #1	
}			
qcl-Type	type D		
}			
}			
TCI-State[2] SEQUENCE {		entry 2	
tci-StateId	1		
qcl-type1 SEQUENCE {			
cell	ServCellIndex of NR SpCell	Cell ID	
bwp-id	0	BWP ID	
referenceSignal CHOICE {			
ssb	0	SSB index #0	
}			
qcl-Type	type C		
}			
qcl-type2	Not present		
qcl-type2 SEQUENCE {			FR2
cell	ServCellIndex of NR SpCell	Cell ID	
bwp-id	0	BWP ID	
referenceSignal CHOICE {			
ssb	0	SSB index #0	
}			
qcl-Type	type D		
}			
}			

}			
TCI-State[3] SEQUENCE {		entry 3	
tci-StateId	2		
qcl-type1 SEQUENCE {			
cell	ServCellIndex of NR SpCell	Cell ID	
bwp-id	0	BWP ID	
referenceSignal CHOICE {			
csi-rs	1	Csi-Rs index #1	
}			
qcl-Type	type A		
}			
qcl-type2	Not present		
qcl-type2 SEQUENCE {			FR2
cell	ServCellIndex of NR SpCell	Cell ID	
bwp-id	0	BWP ID	
referenceSignal CHOICE {			
Csi-rs	1	Csi-Rs index #1	
}			
qcl-Type	type D		
}			
}			
}			
}			
}			

Table 7.1.1.1.4.3.3-9: PDCCH-Config (Table 7.1.1.1.4.3.3-6: BWP-DownlinkDedicated)

Derivation Path: TS 38.508-1 [4], Table 4.6.3-95			
Information Element	Value/remark	Comment	Condition
PDCCH-Config ::= SEQUENCE {			
controlResourceSetToAddModList SEQUENCE(SIZE (1..3)) OF ControlResourceSet {	2 entries		
ControlResourceSet[1]	ControlResourceSetId1	entry 1	
ControlResourceSet[2]	ControlResourceSetId2	entry 2	
}			
searchSpacesToAddModList SEQUENCE(SIZE (1..10)) OF SearchSpace {	2 entries		
SearchSpace[1]	SearchSpace with condition USS	entry 1	
SearchSpace[2]	SearchSpaceBFR	entry 2	
}			
}			

Table 7.1.1.1.4.3.3-10: ControlResourceSetId1 (Table 7.1.1.1.4.3.3-9: PDCCH-Config)

Derivation Path: TS 38.508-1 [4], Table 4.6.3-28			
Information Element	Value/remark	Comment	Condition
ControlResourceSet ::= SEQUENCE {			
controlResourceSetId	1		
tci-StatesPDCCH-ToAddList SEQUENCE (SIZE (1..maxNrofTCI-StatesPDCCH)) OF TCI-StateId {	1 entry		Step 1
TCI-StateId[1]	2	entry 1 TCI-State Id 2	
}			
tci-StatesPDCCH-ToReleaseList SEQUENCE (SIZE (1..maxNrofTCI-StatesPDCCH)) OF TCI-StateId {	1 entry		Step 8
TCI-StateId[1]	2	entry 1 TCI-State Id 2	
}			
}			

Table 7.1.1.1.4.3.3-11: ControlResourceSetId2 (Table 7.1.1.1.4.3.3-9: PDCCH-Config)

Derivation Path: TS 38.508-1 [4], Table 4.6.3-28			
Information Element	Value/remark	Comment	Condition
ControlResourceSet ::= SEQUENCE {			
controlResourceSetId	2		
}			

Table 7.1.1.1.4.3.3-12: SearchSpaceBFR (Table 7.1.1.1.4.3.3-9: PDCCH-Config)

Derivation Path: TS 38.508-1 [4], Table 4.6.3-162			
Information Element	Value/remark	Comment	Condition
SearchSpace ::= SEQUENCE {			
searchSpaceId	4		
controlResourceSetId	2		
searchSpaceType CHOICE {			
ue-Specific SEQUENCE {			
dci-Formats	formats0-0-And-1-0		
}			
}			
}			

Table 7.1.1.1.4.3.3-13: CSI-MeasConfig (Table 7.1.1.1.4.3.3-5: ServingCellConfig)

Derivation Path: TS 38.508-1 [4], Table 4.6.3-38			
Information Element	Value/remark	Comment	Condition
CSI-MeasConfig ::= SEQUENCE {			
nzp-CSI-RS-ResourceToAddModList SEQUENCE {	2 entries		
Nzp-CSI-RS-Resource[1]	Nzp-CSI-RS-ResourceId0		
Nzp-CSI-RS-Resource[2]	Nzp-CSI-RS-ResourceId1		
}			
nzp-CSI-RS-ResourceSetToAddModList SEQUENCE {	1 entry		
Nzp-CSI-RS-ResourceSet[1]	Nzp-CSI-RS-ResourceSetId0		
}			
csi-IM-ResourceToAddModList	Not present		
csi-IM-ResourceSetToAddModList	Not present		
csi-SSB-ResourceSetToAddModList	Not present		
csi-ReportConfigToAddModList	Not present		
reportTriggerSize	Not present		
aperiodicTriggerStateList	Not present		
}			

Table 7.1.1.1.4.3.3-14: NZP-CSI-RS-ResourceId0 (Table 7.1.1.1.4.3.3-13: CSI-MeasConfig)

Derivation Path: TS 38.508-1 [4], Table 4.6.3-85			
Information Element	Value/remark	Comment	Condition
Nzp-CSI-RS-Resource ::= SEQUENCE {			
nzp-CSI-RS-ResourceId	0		
resourceMapping	CSI-RS-ResourceMapping with condition TRS	TS 38.508-1 [4], Table 4.6.3-45	
qcl-InfoPeriodicCSI-RS	0	QCL to SSB #0	
}			

Table 7.1.1.1.4.3.3-15: NZP-CSI-RS-ResourceId1 (Table 7.1.1.1.4.3.3-13: CSI-MeasConfig)

Derivation Path: TS 38.508-1 [4], Table 4.6.3-85			
--	--	--	--

Information Element	Value/remark	Comment	Condition
NZP-CSI-RS-Resource ::= SEQUENCE {			
nzp-CSI-RS-ResourceId	1		
resourceMapping	CSI-RS-ResourceMapping with condition TRS	TS 38.508-1 [4], Table 4.6.3-45	
periodicityAndOffset	CSI-ResourcePeriodicityAndOffset_Id1		
qcl-InfoPeriodicCSI-RS	1	QCL to SSB #1	
}			

Table 7.1.1.1.4.3.3-16: CSI-ResourcePeriodicityAndOffset_Id1 (Table 7.1.1.1.4.3.3-15: NZP-CSI-RS-ResourceId1)

Derivation Path: TS 38.508-1 [4], Table 4.6.3-43			
Information Element	Value/remark	Comment	Condition
CSI-ResourcePeriodicityAndOffset ::= CHOICE {			
slots80	11		FR1
slots320	41		FR2
}			

Table 7.1.1.1.4.3.3-17: NZP-CSI-RS-ResourceSetId0 (Table 7.1.1.1.4.3.3-13: CSI-MeasConfig)

Derivation Path: TS 38.508-1 [4], Table 4.6.3-87			
Information Element	Value/remark	Comment	Condition
NZP-CSI-RS-ResourceSet ::= SEQUENCE {			
nzp-CSI-ResourceSetId	0		
nzp-CSI-RS-Resources SEQUENCE (SIZE (1..maxNrofNZP-CSI-RS-ResourcesPerSet)) OF NZP-CSI-RS-ResourceId {	2 entries		
NZP-CSI-RS-ResourceId[1]	0	entry 1	
NZP-CSI-RS-ResourceId[2]	1	entry 2	
}			
trs-Info	true		
}			

Table 7.1.1.1.4.3.3-18: BWP-UplinkDedicated (Table 7.1.1.1.4.3.3-5: ServingCellConfig)

Derivation Path: TS 38.508-1 [4], Table 4.6.3-15			
Information Element	Value/remark	Comment	Condition
BWP-UplinkDedicated ::= SEQUENCE {			
pucch-Config CHOICE {			
setup	PUCCH-Config		
}			
pusch-Config CHOICE {			
setup	PUSCH-Config		
}			
beamFailureRecoveryConfig	BeamFailureRecoveryConfig_SSB		Step8
	BeamFailureRecoveryConfig_CSIRS		Step17
	Not Present		Step1
}			

Table 7.1.1.1.4.3.3-19: BeamFailureRecoveryConfig_SSB (Table 7.1.1.1.4.3.3-18: BWP-UplinkDedicated)

Derivation Path: TS 38.508-1 [4], Table 4.6.3-6			
---	--	--	--

Information Element	Value/remark	Comment	Condition
BeamFailureRecoveryConfig ::= SEQUENCE {			
rootSequenceIndex-BFR	0	See TS 38.508-1 [4] clause 4.4.2, Table 4.4.2-2	
rach-ConfigBFR	RACH-ConfigGeneric	38.508-1 [4] Table 4.6.3-130	
rsrp-ThresholdSSB	57(-99dBm)		
candidateBeamRSList SEQUENCE (SIZE(1..maxNrofCandidateBeams)) OF PRACH-ResourceDedicatedBFR CHOICE{			
ssb SEQUENCE {			
ssb	1	NR Cell Beam#1	
ra-PreambleIndex	56	(0..63)	
}			
}			
ssb-perRACH-Occasion	one		
ra-ssb-OccasionMaskIndex	0		
recoverySearchSpaceID	4		
ra-Prioritization	Not Present		
beamFailureRecoveryTimer	ms200		
}			

Table 7.1.1.1.4.3.3-20: BeamFailureRecoveryConfig_CSIRS (Table 7.1.1.1.4.3.3-18: BWP-UplinkDedicated)

Derivation Path: TS 38.508-1 [4], Table 4.6.3-6			
Information Element	Value/remark	Comment	Condition
BeamFailureRecoveryConfig ::= SEQUENCE {			
rootSequenceIndex-BFR	0	See TS 38.508-1 [4] clause 4.4.2, Table 4.4.2-2	
rach-ConfigBFR	RACH-ConfigGeneric	38.508-1 [4] Table 4.6.3-130	
rsrp-ThresholdSSB	57(-99dBm)		
candidateBeamRSList SEQUENCE (SIZE(1..maxNrofCandidateBeams)) OF PRACH-ResourceDedicatedBFR CHOICE{			
csi-RS SEQUENCE {			
csi-RS	0		
ra-OccasionList SEQUENCE (SIZE(1..maxRA-OccasionsPerCSIRS)) OF INTEGER (0..maxRA-Occasions-1) {	1 entry		
INTEGER[1]	0	entry 1 NR Cell Beam#0	
}			
ra-PreambleIndex	59		
}			
ssb-perRACH-Occasion	Not Present		
ra-ssb-OccasionMaskIndex	Not Present		
recoverySearchSpaceID	4		
ra-Prioritization	Not Present		
beamFailureRecoveryTimer	ms200		
}			

Table 7.1.1.1.4.3.3-21: PUCCH-Config (Table 7.1.1.1.4.3.3-18: BWP-UplinkDedicated)

Derivation Path: TS 38.508-1 [4], Table 4.6.3-112			
Information Element	Value/remark	Comment	Condition
pucch-Config ::= SEQUENCE {			
pucch-PowerControl SEQUENCE {			
pathlossReferenceRSs SEQUENCE (SIZE (1..maxNrofPUCCH-PathlossReferenceRSs)) OF	1 entry		

PUCCH-PathlossReferenceRS {			
PUCCH-PathlossReferenceRS[1] SEQUENCE {		entry 1	
referenceSignal CHOICE {			
ssb-Index	1		Step1, Step17
	0		Step8
}			
}			
}			

Table 7.1.1.1.4.3.3-22: PUSCH-Config (Table 7.1.1.1.4.3.3-18: BWP-UplinkDedicated)

Derivation Path: TS 38.508-1 [4], Table 4.6.3-118			
Information Element	Value/remark	Comment	Condition
pusch-Config:= SEQUENCE {			
pusch-PowerControl SEQUENCE {			
pathlossReferenceRSToAddModList SEQUENCE (SIZE (1..maxNrofPUSCH-PathlossReferenceRSs)) OF PUSCH-PathlossReferenceRS {	1 entry		
PUSCH-PathlossReferenceRS[1] SEQUENCE {		entry 1	
referenceSignal CHOICE{			
ssb-Index	1		Step1, Step17
	0		Step8
}			
}			
}			
}			
}			

7.1.1.1.5 Random access procedure / Successful / Supplementary Uplink

7.1.1.1.5.1 Test Purpose (TP)

(1)

```
with { UE in RRC_CONNECTED state with supplementary uplink configured and RACH procedure is triggered }
ensure that {
  when { RSRP of the downlink pathloss reference is less than rsrp-ThresholdSSB-SUL }
  then { UE performs the Random Access Procedure on the Supplementary Uplink carrier }
}
```

7.1.1.1.5.2 Conformance requirements

References: The conformance requirements covered in the present TC are specified in TS 38.321: clause 5.1.1 and clause 5.16. Unless otherwise stated these are Rel-15 requirements.

[TS 38.321, clause 5.1.1]

The Random Access procedure described in this clause is initiated by a PDCCH order, by the MAC entity itself, or by RRC for the events in accordance with TS 38.300 [2]. There is only one Random Access procedure ongoing at any point in time in a MAC entity. The Random Access procedure on an SCell shall only be initiated by a PDCCH order with *ra-PreambleIndex* different from 0b000000.

NOTE 1: If a new Random Access procedure is triggered while another is already ongoing in the MAC entity, it is up to UE implementation whether to continue with the ongoing procedure or start with the new procedure (e.g. for SI request).

RRC configures the following parameters for the Random Access procedure:

- *prach-ConfigurationIndex*: the available set of PRACH occasions for the transmission of the Random Access Preamble;
- *preambleReceivedTargetPower*: initial Random Access Preamble power;
- *rsrp-ThresholdSSB*: an RSRP threshold for the selection of the SSB. If the Random Access procedure is initiated for beam failure recovery, *rsrp-ThresholdSSB* used for the selection of the SSB within *candidateBeamRSList* refers to *rsrp-ThresholdSSB* in *BeamFailureRecoveryConfig* IE;
- *rsrp-ThresholdCSI-RS*: an RSRP threshold for the selection of CSI-RS. If the Random Access procedure is initiated for beam failure recovery, *rsrp-ThresholdCSI-RS* is equal to *rsrp-ThresholdSSB* in *BeamFailureRecoveryConfig* IE;
- *rsrp-ThresholdSSB-SUL*: an RSRP threshold for the selection between the NUL carrier and the SUL carrier;
- *candidateBeamRSList*: a list of reference signals (CSI-RS and/or SSB) identifying the candidate beams for recovery and the associated Random Access parameters;
- *recoverySearchSpaceId*: the search space identity for monitoring the response of the beam failure recovery request;
- *powerRampingStep*: the power-ramping factor;
- *powerRampingStepHighPriority*: the power-ramping factor in case of prioritized Random Access procedure;
- *scalingFactorBI*: a scaling factor for prioritized Random Access procedure;
- *ra-PreambleIndex*: Random Access Preamble;
- *ra-ssb-OccasionMaskIndex*: defines PRACH occasion(s) associated with an SSB in which the MAC entity may transmit a Random Access Preamble (see clause 7.4);
- *ra-OccasionList*: defines PRACH occasion(s) associated with a CSI-RS in which the MAC entity may transmit a Random Access Preamble;
- *ra-PreambleStartIndex*: the starting index of Random Access Preamble(s) for on-demand SI request;
- *preambleTransMax*: the maximum number of Random Access Preamble transmission;
- *ssb-perRACH-OccasionAndCB-PreamblesPerSSB*: defines the number of SSBs mapped to each PRACH occasion and the number of contention-based Random Access Preambles mapped to each SSB;
- if *groupBconfigured* is configured, then Random Access Preambles group B is configured.
 - Amongst the contention-based Random Access Preambles associated with an SSB (as defined in TS 38.213 [6]), the first *numberOfRA-PreamblesGroupA* Random Access Preambles belong to Random Access Preambles group A. The remaining Random Access Preambles associated with the SSB belong to Random Access Preambles group B (if configured).

NOTE 2: If Random Access Preambles group B is supported by the cell Random Access Preambles group B is included for each SSB.

- if Random Access Preambles group B is configured:
 - *ra-Msg3SizeGroupA*: the threshold to determine the groups of Random Access Preambles;
 - *msg3-DeltaPreamble*: $\Delta_{\text{PREAMBLE_Msg3}}$ in TS 38.213 [6];
 - *messagePowerOffsetGroupB*: the power offset for preamble selection;
 - *numberOfRA-PreamblesGroupA*: defines the number of Random Access Preambles in Random Access Preamble group A for each SSB.
- the set of Random Access Preambles and/or PRACH occasions for SI request, if any;
- the set of Random Access Preambles and/or PRACH occasions for beam failure recovery request, if any;

- the set of Random Access Preambles and/or PRACH occasions for reconfiguration with sync, if any;
- *ra-ResponseWindow*: the time window to monitor RA response(s) (SpCell only);
- *ra-ContentionResolutionTimer*: the Contention Resolution Timer (SpCell only).

In addition, the following information for related Serving Cell is assumed to be available for UEs:

- if Random Access Preambles group B is configured:
 - if the Serving Cell for the Random Access procedure is configured with supplementary uplink as specified in TS 38.331 [5], and SUL carrier is selected for performing Random Access Procedure:
 - $P_{\text{CMAX},f,c}$ of the SUL carrier as specified in TS 38.101-1 [14], TS 38.101-2 [15], and TS 38.101-3 [16].
 - else:
 - $P_{\text{CMAX},f,c}$ of the NUL carrier as specified in TS 38.101-1 [14], TS 38.101-2 [15], and TS 38.101-3 [16].

The following UE variables are used for the Random Access procedure:

- *PREAMBLE_INDEX*;
- *PREAMBLE_TRANSMISSION_COUNTER*;
- *PREAMBLE_POWER_RAMPING_COUNTER*;
- *PREAMBLE_POWER_RAMPING_STEP*;
- *PREAMBLE_RECEIVED_TARGET_POWER*;
- *PREAMBLE_BACKOFF*;
- *PCMAX*;
- *SCALING_FACTOR_BI*;
- *TEMPORARY_C-RNTI*.

When the Random Access procedure is initiated on a Serving Cell, the MAC entity shall:

- 1> flush the Msg3 buffer;
- 1> set the *PREAMBLE_TRANSMISSION_COUNTER* to 1;
- 1> set the *PREAMBLE_POWER_RAMPING_COUNTER* to 1;
- 1> set the *PREAMBLE_BACKOFF* to 0 ms;
- 1> if the carrier to use for the Random Access procedure is explicitly signalled:
 - 2> select the signalled carrier for performing Random Access procedure;
 - 2> set the *PCMAX* to $P_{\text{CMAX},f,c}$ of the signalled carrier.
- 1> else if the carrier to use for the Random Access procedure is not explicitly signalled; and
- 1> if the Serving Cell for the Random Access procedure is configured with supplementary uplink as specified in TS 38.331 [5]; and
- 1> if the RSRP of the downlink pathloss reference is less than *rsrp-ThresholdSSB-SUL*:
 - 2> select the SUL carrier for performing Random Access procedure;
 - 2> set the *PCMAX* to $P_{\text{CMAX},f,c}$ of the SUL carrier.
- 1> else:
 - 2> select the NUL carrier for performing Random Access procedure;

- 2> set the $PCMAX$ to $P_{CMAX,f,c}$ of the NUL carrier.
- 1> perform the BWP operation as specified in clause 5.15;
- 1> set $PREAMBLE_POWER_RAMPING_STEP$ to $powerRampingStep$; 1> set $SCALING_FACTOR_BI$ to 1;
- 1> if the Random Access procedure was initiated for beam failure recovery (as specified in clause 5.17); and
- 1> if $beamFailureRecoveryConfig$ is configured for the active UL BWP of the selected carrier:
- 2> start the $beamFailureRecoveryTimer$, if configured;
- 2> apply the parameters $powerRampingStep$, $preambleReceivedTargetPower$, and $preambleTransMax$ configured in the $beamFailureRecoveryConfig$;
- 2> if $powerRampingStepHighPriority$ is configured in the $beamFailureRecoveryConfig$:
- 3> set $PREAMBLE_POWER_RAMPING_STEP$ to the $powerRampingStepHighPriority$.
- 2> else:
- 3> set $PREAMBLE_POWER_RAMPING_STEP$ to $powerRampingStep$.
- 2> if $scalingFactorBI$ is configured in the $beamFailureRecoveryConfig$:
- 3> set $SCALING_FACTOR_BI$ to the $scalingFactorBI$.
- 1> else if the Random Access procedure was initiated for handover; and
- 1> if $rach-ConfigDedicated$ is configured for the selected carrier:
- 2> if $powerRampingStepHighPriority$ is configured in the $rach-ConfigDedicated$:
- 3> set $PREAMBLE_POWER_RAMPING_STEP$ to the $powerRampingStepHighPriority$.
- 2> if $scalingFactorBI$ is configured in the $rach-ConfigDedicated$:
- 3> set $SCALING_FACTOR_BI$ to the $scalingFactorBI$.
- 1> perform the Random Access Resource selection procedure (see clause 5.1.2).

[TS 38.321, clause 5.16]

The Supplementary UL (SUL) carrier can be configured as a complement to the normal UL (NUL) carrier. Switching between the NUL carrier and the SUL carrier means that the UL transmissions move from one carrier to the other carrier, which is done by:

- an indication in DCI;
- the Random Access procedure as specified in clause 5.1.1.

If the MAC entity receives a UL grant indicating an SUL switch while a Random Access procedure is ongoing, the MAC entity shall ignore the UL grant.

The Serving Cell configured with *supplementaryUplink* belongs to a single TAG.

7.1.1.1.5.3 Test description

7.1.1.1.5.3.1 Pre-test conditions

Same Pre-test conditions as in clause 7.1.1.0 except that supplementary uplink (SUL) carrier is configured on NR Cell 33.

7.1.1.1.5.3.2 Test procedure sequence

Table 7.1.1.1.5.3.2-1 illustrates the downlink power levels to be applied for the NR cells at various time instants of the test execution. Row marked "T0" denotes the initial conditions, while row marked "T1" are to be applied subsequently. The exact instants on which these values shall be applied are described in the texts in this clause.

Table 7.1.1.1.5.3.2-1: Time instances of cell power level changes

	Parameter	Unit	NR Cell 1 (NUL)	NR Cell 33 (SUL)	Remark
T0	SS/PBCH SSS EPRE	dBm/SCS	-75	N/A	NR Cell1 Power level is higher than <i>rsrp-ThresholdSSB-SUL</i> .
T1	SS/PBCH SSS EPRE	dBm/SCS	-85	N/A	NR Cell1 Power level is lower than <i>rsrp-ThresholdSSB-SUL</i> .

Table 7.1.1.1.5.3.2-2: Main behaviour

St	Procedure	Message Sequence		TP	Verdict
		U - S	Message		
1	The SS ignores scheduling requests and does not allocate any uplink grant		-	-	-
2	The SS transmits a MAC PDU containing a PDCP SDU on NR Cell 1.	<--	MAC PDU	-	-
3	The SS changes NR Cell 1's power level according to the row "T1" in table 7.1.1.1.5.3.2-1. (Note 1)	-	-	-	-
4	Void.	-	-	-	-
5	Check: Does the UE initiate the random access procedure on SUL carrier on NR Cell 33?	-->	PRACH Preamble	1	P
6	The SS transmits Random Access Response with an UL Grant of 56-bits on NR Cell 1 and RAPID corresponding to the transmitted preamble in step 5. (Note 2)	<--	Random Access Response	-	-
7	Check: Does the UE send a msg3 using the grant associated to the Random Access Response received in Step 6 on SUL carrier on NR Cell 33?	-->	Msg3 (C-RNTI MAC CE)	1	P
8	The SS schedules PDCCH transmission on NR Cell 1 for UE C-RNTI with uplink grant's UL/SUL indicator set to 1.	<--	Contention Resolution	-	-
9	Check: Does the UE transmit a MAC PDU with C-RNTI containing looped back PDCP SDU on SUL carrier on NR Cell 33?	-->	MAC PDU	1	P
Note 1:	Reduce the NR Cell 1 SS/PBCH EPRE level to ensure that RSRP of the downlink pathloss reference is lower than <i>rsrp-ThresholdSSB-SUL</i> , while UE is still able to receive msg2 and msg4 correctly.				
Note 2:	UL grant of 56 bits is to make UE not send any loopback data in uplink with msg3, according to TS 38.321 [18] clause 5.4.3.1.				

7.1.1.1.5.3.3 Specific message contents

Table 7.1.1.1.5.3.3-1: SIB1 of NR Cell 1 (preamble and all steps, Table 7.1.1.1.5.3.2-2)

Derivation Path: TS 38.508-1 [4], Table 4.6.1-28			
Information Element	Value/remark	Comment	Condition
SIB1 ::= SEQUENCE {			
servingCellConfigCommon	ServingCellConfigCommonSIB		
}			

Table 7.1.1.1.5.3.3-2: ServingCellConfigCommonSIB (Table 7.1.1.1.5.3.3-1)

Derivation Path: TS 38.508-1 [4], Table 4.6.3-169			
Information Element	Value/remark	Comment	Condition
ServingCellConfigCommonSIB ::= SEQUENCE {			
supplementaryUplink SEQUENCE {			
initialUplinkBWP	BWP-UplinkCommon		
}			
}			

Table 7.1.1.1.5.3.3-3: BWP-UplinkCommon (Table 7.1.1.1.5.3.3-2)

Derivation Path: TS 38.508-1 [4], Table 4.6.3-14			
Information Element	Value/remark	Comment	Condition
BWP-UplinkCommon ::= SEQUENCE {			
rach-ConfigCommon CHOICE {			
setup	RACH-ConfigCommon		
}			
}			

Table 7.1.1.1.5.3.3-4: RACH-ConfigCommon (Table 7.1.1.1.5.3.3-3)

Derivation Path: TS 38.508-1 [4], Table 4.6.3-128			
Information Element	Value/remark	Comment	Condition
RACH-ConfigCommon ::= SEQUENCE {			
rsrp-ThresholdSSB-SUL	76	IE value 76 means -80dBm	SUL
}			

Table 7.1.1.1.5.3.3-5: DCI Format 0-1 (Step 8 of Table 7.1.1.1.5.3.2-2)

Derivation Path: TS 38.508-1 [4], Table 4.3.6.1.1.2-1			
Information Element	Value/remark	Comment	Condition
UL/SUL indicator	1		UE configured with SUL in the cell

7.1.1.1.6 Random access procedure / Successful/ Temporary C-RNTI Based / Preamble selected by MAC itself

7.1.1.1.6.1 Test Purpose (TP)

(1)

```
with { UE in RRC Idle state has UL CCCH PDU to send and Random Access Preambles group B is
configured }
ensure that {
  when { the UL CCCH MAC PDU Size is less than messageSizeGroupA }
  then { UE transmits a random access preamble using a preamble in group A of random access
preambles }
}
```

(2)

```
with { UE in RRC Idle state initiated Random Access procedure to transmit UL CCCH PDU and
transmitted Msg3 }
ensure that {
  when { The SS schedules any PDCCH transmission addressed to UE Temporary C-RNTI before Contention
resolution timer expiry with MAC PDU does not contain a matching UE Contention Resolution Identity
MAC CE }
  then { UE re transmits a random access preamble using a preamble in the same group of random
access preambles as used for the first transmission of Msg3 }
}
```

(3)

```

with { UE in RRC Idle state initiated Random Access procedure to transmit UL CCCH PDU and
transmitted MSG3 }
ensure that {
  when { The SS does not schedule any PDCCH transmission addressed to UE Temporary C-RNTI before
Contention resolution timer expiry }
  then {UE re transmits a random access preamble using a preamble in the same group of random
access preambles as used for the first transmission of Msg3 }
}

```

(4)

```

with { UE in RRC Idle state initiated Random Access procedure to transmit UL CCCH PDU and
transmitted MSG3 }
ensure that {
  when { The SS schedules a PDCCH transmission addressed to UE Temporary C-RNTI before Contention
resolution timer expiry }
  then {UE assumes RACH procedure as complete }
}

```

7.1.1.1.6.2 Conformance requirements

References: The conformance requirements covered in the present TC are specified in: 3GPP TS 38.321, clauses 5.1.2, 5.1.3, 5.1.4, 5.1.5, 5.2, 6.1.3.2, 6.1.5 and 6.2.3. Unless otherwise stated these are Rel-15 requirements.

[TS 38.321, clause 5.1.2]

The MAC entity shall:

- 1> if the Random Access procedure was initiated for beam failure recovery (as specified in subclause 5.17); and
- 1> if the *beamFailureRecoveryTimer* (in subclause 5.17) is either running or not configured; and
- 1> if the contention-free Random Access Resources for beam failure recovery request associated with any of the SSBs and/or CSI-RSs have been explicitly provided by RRC; and
- 1> if at least one of the SSBs with SS-RSRP above *rsrp-ThresholdSSB* amongst the SSBs in *candidateBeamRSList* or the CSI-RSs with CSI-RSRP above *rsrp-ThresholdCSI-RS* amongst the CSI-RSs in *candidateBeamRSList* is available:
 - 2> select an SSB with SS-RSRP above *rsrp-ThresholdSSB* amongst the SSBs in *candidateBeamRSList* or a CSI-RS with CSI-RSRP above *rsrp-ThresholdCSI-RS* amongst the CSI-RSs in *candidateBeamRSList*;
 - 2> if CSI-RS is selected, and there is no *ra-PreambleIndex* associated with the selected CSI-RS:
 - 3> set the *PREAMBLE_INDEX* to a *ra-PreambleIndex* corresponding to the SSB in *candidateBeamRSList* which is quasi-colocated with the selected CSI-RS as specified in TS 38.214 [7].
 - 2> else:
 - 3> set the *PREAMBLE_INDEX* to a *ra-PreambleIndex* corresponding to the selected SSB or CSI-RS from the set of Random Access Preambles for beam failure recovery request.
- 1> else if the *ra-PreambleIndex* has been explicitly provided by PDCCH; and
- 1> if the *ra-PreambleIndex* is not 0b000000:
 - 2> set the *PREAMBLE_INDEX* to the signalled *ra-PreambleIndex*;
 - 2> select the SSB signalled by PDCCH.
- 1> else if the contention-free Random Access Resources associated with SSBs have been explicitly provided in *rach-ConfigDedicated* and at least one SSB with SS-RSRP above *rsrp-ThresholdSSB* amongst the associated SSBs is available:
 - 2> select an SSB with SS-RSRP above *rsrp-ThresholdSSB* amongst the associated SSBs;

- 2> set the *PREAMBLE_INDEX* to a *ra-PreambleIndex* corresponding to the selected SSB.
- 1> else if the contention-free Random Access Resources associated with CSI-RSs have been explicitly provided in *rach-ConfigDedicated* and at least one CSI-RS with CSI-RSRP above *rsrp-ThresholdCSI-RS* amongst the associated CSI-RSs is available:
 - 2> select a CSI-RS with CSI-RSRP above *rsrp-ThresholdCSI-RS* amongst the associated CSI-RSs;
 - 2> set the *PREAMBLE_INDEX* to a *ra-PreambleIndex* corresponding to the selected CSI-RS.
- 1> else if the Random Access procedure was initiated for SI request (as specified in TS 38.331 [5]); and
- 1> if the Random Access Resources for SI request have been explicitly provided by RRC:
 - 2> if at least one of the SSBs with SS-RSRP above *rsrp-ThresholdSSB* is available:
 - 3> select an SSB with SS-RSRP above *rsrp-ThresholdSSB*.
 - 2> else:
 - 3> select any SSB.
 - 2> select a Random Access Preamble corresponding to the selected SSB, from the Random Access Preamble(s) determined according to *ra-PreambleStartIndex* as specified in TS 38.331 [5];
 - 2> set the *PREAMBLE_INDEX* to selected Random Access Preamble.
- 1> else (i.e. for the contention-based Random Access preamble selection):
 - 2> if at least one of the SSBs with SS-RSRP above *rsrp-ThresholdSSB* is available:
 - 3> select an SSB with SS-RSRP above *rsrp-ThresholdSSB*.
 - 2> else:
 - 3> select any SSB.
 - 2> if Msg3 has not yet been transmitted:
 - 3> if Random Access Preambles group B is configured:
 - 4> if the potential Msg3 size (UL data available for transmission plus MAC header and, where required, MAC CEs) is greater than *ra-Msg3SizeGroupA* and the pathloss is less than $PCMAX$ (of the Serving Cell performing the Random Access Procedure) – *preambleReceivedTargetPower* – *msg3-DeltaPreamble* – *messagePowerOffsetGroupB*; or
 - 4> if the Random Access procedure was initiated for the CCCH logical channel and the CCCH SDU size plus MAC subheader is greater than *ra-Msg3SizeGroupA*:
 - 5> select the Random Access Preambles group B.
 - 4> else:
 - 5> select the Random Access Preambles group A.
 - 3> else:
 - 4> select the Random Access Preambles group A.
 - 2> else (i.e. Msg3 is being retransmitted):
 - 3> select the same group of Random Access Preambles as was used for the Random Access Preamble transmission attempt corresponding to the first transmission of Msg3.
 - > select a Random Access Preamble3 randomly with equal probability from the Random Access Preambles associated with the selected SSB and the selected Random Access Preambles group.
 - > else:

- 2> set the *PREAMBLE_INDEX* to the selected Random Access Preamble.
- 11> if the Random Access procedure was initiated for SI request (as specified in TS 38.331 [5]); and
 - 1> if *ra-AssociationPeriodIndex* and *si-RequestPeriod* are configured:
 - 2> determine the next available PRACH occasion from the PRACH occasions corresponding to the selected SSB in the association period given by *ra-AssociationPeriodIndex* in the *si-RequestPeriod* permitted by the restrictions given by the *ra-ssb-OccasionMaskIndex* if configured (the MAC entity shall select a PRACH occasion randomly with equal probability amongst the consecutive PRACH occasions according to subclause 8.1 of TS 38.213 [6] corresponding to the selected SSB).
 - > else if an SSB is selected above:
 - 2> determine the next available PRACH occasion from the PRACH occasions corresponding to the selected SSB permitted by the restrictions given by the *ra-ssb-OccasionMaskIndex* if configured or indicated by PDCCH (the MAC entity shall select a PRACH occasion randomly with equal probability amongst the consecutive PRACH occasions according to subclause 8.1 of TS 38.213 [6], corresponding to the selected SSB; the MAC entity may take into account the possible occurrence of measurement gaps when determining the next available PRACH occasion corresponding to the selected SSB).
- 1> else if a CSI-RS is selected above:
 - 2> if there is no contention-free Random Access Resource associated with the selected CSI-RS:
 - 3> determine the next available PRACH occasion from the PRACH occasions, permitted by the restrictions given by the *ra-ssb-OccasionMaskIndex* if configured, corresponding to the SSB in *candidateBeamRSList* which is quasi-colocated with the selected CSI-RS as specified in TS 38.214 [7] (the MAC entity shall select a PRACH occasion randomly with equal probability amongst the consecutive PRACH occasions according to subclause 8.1 of TS 38.213 [6], corresponding to the SSB which is quasi-colocated with the selected CSI-RS; the MAC entity may take into account the possible occurrence of measurement gaps when determining the next available PRACH occasion corresponding to the SSB which is quasi-colocated with the selected CSI-RS).
 - 2> else:
 - 3> determine the next available PRACH occasion from the PRACH occasions in *ra-OccasionList* corresponding to the selected CSI-RS (the MAC entity shall select a PRACH occasion randomly with equal probability amongst the PRACH occasions occurring simultaneously but on different subcarriers, corresponding to the selected CSI-RS; the MAC entity may take into account the possible occurrence of measurement gaps when determining the next available PRACH occasion corresponding to the selected CSI-RS).
- 1> else if Random Access procedure was initiated for beam failure recovery; and
 - 1> if a CSI-RS is selected above and there is no contention-free Random Access Resource associated with the selected CSI-RS:
 - 2> determine the next available PRACH occasion from the PRACH occasions, permitted by the restrictions given by the *ra-ssb-OccasionMaskIndex* if configured, corresponding to the SSB in *candidateBeamRSList* which is quasi-colocated with the selected CSI-RS as specified in TS 38.214 [7] (the MAC entity may take into account the possible occurrence of measurement gaps when determining the next available PRACH occasion corresponding to the SSB which is quasi-collected with the selected CSI-RS).
 - 1> else:
 - 2> determine the next available PRACH occasion (the MAC entity shall select a PRACH occasion randomly with equal probability amongst the PRACH occasions occurring simultaneously but on different subcarriers; the MAC entity may take into account the possible occurrence of measurement gaps when determining the next available PRACH occasion).
- 1> perform the Random Access Preamble transmission procedure (see subclause 5.1.3).

NOTE: When the UE determines if there is an SSB with SS-RSRP above *rsrp-ThresholdSSB* or a CSI-RS with CSI-RSRP above *rsrp-ThresholdCSI-RS*, the UE uses the latest unfiltered L1-RSRP measurement.

[TS 38.321, clause 5.1.3]

The MAC entity shall, for each Random Access Preamble:

- 1> if *PREAMBLE_TRANSMISSION_COUNTER* is greater than one; and
- 1> if the notification of suspending power ramping counter has not been received from lower layers; and
- 1> if SSB or CSI-RS selected is not changed from the selection in the last Random Access Preamble transmission:
 - 2> increment *PREAMBLE_POWER_RAMPING_COUNTER* by 1.
- 1> select the value of *DELTA_PREAMBLE* according to subclause 7.3;
- 1> set *PREAMBLE_RECEIVED_TARGET_POWER* to $\text{preambleReceivedTargetPower} + \text{DELTA_PREAMBLE} + (\text{PREAMBLE_POWER_RAMPING_COUNTER} - 1) \times \text{PREAMBLE_POWER_RAMPING_STEP}$;
- 1> except for contention-free Random Access Preamble for beam failure recovery request, compute the RA-RNTI associated with the PRACH occasion in which the Random Access Preamble is transmitted;
- 1> instruct the physical layer to transmit the Random Access Preamble using the selected PRACH occasion, corresponding RA-RNTI (if available), *PREAMBLE_INDEX* and *PREAMBLE_RECEIVED_TARGET_POWER*.

The RA-RNTI associated with the PRACH occasion in which the Random Access Preamble is transmitted, is computed as:

$$\text{RA-RNTI} = 1 + \text{s_id} + 14 \times \text{t_id} + 14 \times 80 \times \text{f_id} + 14 \times 80 \times 8 \times \text{ul_carrier_id}$$

where *s_id* is the index of the first OFDM symbol of the PRACH occasion ($0 \leq \text{s_id} < 14$), *t_id* is the index of the first slot of the PRACH occasion in a system frame ($0 \leq \text{t_id} < 80$), *f_id* is the index of the PRACH occasion in the frequency domain ($0 \leq \text{f_id} < 8$), and *ul_carrier_id* is the UL carrier used for Random Access Preamble transmission (0 for NUL carrier, and 1 for SUL carrier).

[TS 38.321, clause 5.1.4]

Once the Random Access Preamble is transmitted and regardless of the possible occurrence of a measurement gap, the MAC entity shall:

- 1> if the contention-free Random Access Preamble for beam failure recovery request was transmitted by the MAC entity:
 - 2> start the *ra-ResponseWindow* configured in *BeamFailureRecoveryConfig* at the first PDCCH occasion as specified in TS 38.213 [6] from the end of the Random Access Preamble transmission;
 - 2> monitor for a PDCCH transmission on the search space indicated by *recoverySearchSpaceId* of the SpCell identified by the C-RNTI while *ra-ResponseWindow* is running.
- 1> else:
 - 2> start the *ra-ResponseWindow* configured in *RACH-ConfigCommon* at the first PDCCH occasion as specified in TS 38.213 [6] from the end of the Random Access Preamble transmission;
 - 2> monitor the PDCCH of the SpCell for Random Access Response(s) identified by the RA-RNTI while the *ra-ResponseWindow* is running.
- 1> if notification of a reception of a PDCCH transmission on the search space indicated by *recoverySearchSpaceId* is received from lower layers on the Serving Cell where the preamble was transmitted; and
- 1> if PDCCH transmission is addressed to the C-RNTI; and
- 1> if the contention-free Random Access Preamble for beam failure recovery request was transmitted by the MAC entity:
 - 2> consider the Random Access procedure successfully completed.
- 1> else if a downlink assignment has been received on the PDCCH for the RA-RNTI and the received TB is successfully decoded:

- 2> if the Random Access Response contains a MAC subPDU with Backoff Indicator:
 - 3> set the *PREAMBLE_BACKOFF* to value of the BI field of the MAC subPDU using Table 7.2-1, multiplied with *SCALING_FACTOR_BI*.
- 2> else:
 - 3> set the *PREAMBLE_BACKOFF* to 0 ms.
- 2> if the Random Access Response contains a MAC subPDU with Random Access Preamble identifier corresponding to the transmitted *PREAMBLE_INDEX* (see subclause 5.1.3):
 - 3> consider this Random Access Response reception successful.
- 2> if the Random Access Response reception is considered successful:
 - 3> if the Random Access Response includes a MAC subPDU with RAPID only:
 - 4> consider this Random Access procedure successfully completed;
 - 4> indicate the reception of an acknowledgement for SI request to upper layers.
 - 3> else:
 - 4> apply the following actions for the Serving Cell where the Random Access Preamble was transmitted:
 - 5> process the received Timing Advance Command (see subclause 5.2);
 - 5> indicate the *preambleReceivedTargetPower* and the amount of power ramping applied to the latest Random Access Preamble transmission to lower layers (i.e. $(PREAMBLE_POWER_RAMPING_COUNTER - 1) \times PREAMBLE_POWER_RAMPING_STEP$);
 - 5> if the Serving Cell for the Random Access procedure is SRS-only SCell:
 - 6> ignore the received UL grant.
 - 5> else:
 - 6> process the received UL grant value and indicate it to the lower layers.
 - 4> if the Random Access Preamble was not selected by the MAC entity among the contention-based Random Access Preamble(s):
 - 5> consider the Random Access procedure successfully completed.
 - 4> else:
 - 5> set the *TEMPORARY_C-RNTI* to the value received in the Random Access Response;
 - 5> if this is the first successfully received Random Access Response within this Random Access procedure:
 - 6> if the transmission is not being made for the CCCH logical channel:
 - 7> indicate to the Multiplexing and assembly entity to include a C-RNTI MAC CE in the subsequent uplink transmission.
 - 6> obtain the MAC PDU to transmit from the Multiplexing and assembly entity and store it in the Msg3 buffer.

NOTE: If within a Random Access procedure, an uplink grant provided in the Random Access Response for the same group of contention-based Random Access Preambles has a different size than the first uplink grant allocated during that Random Access procedure, the UE behavior is not defined.

- 1> if *ra-ResponseWindow* configured in *BeamFailureRecoveryConfig* expires and if a PDCCH transmission on the search space indicated by *recoverySearchSpaceId* addressed to the C-RNTI has not been received on the Serving Cell where the preamble was transmitted; or

- > if *ra-ResponseWindow* configured in *RACH-ConfigCommon* expires, and if the Random Access Response containing Random Access Preamble identifiers that matches the transmitted *PREAMBLE_INDEX* has not been received1:
 - 2> consider the Random Access Response reception not successful;
 - 2> increment *PREAMBLE_TRANSMISSION_COUNTER* by 1;
 - 2> if *PREAMBLE_TRANSMISSION_COUNTER* = *preambleTransMax* + 1:
 - 3> if the Random Access Preamble is transmitted on the SpCell:
 - 4> indicate a Random Access problem to upper layers;
 - 4> if this Random Access procedure was triggered for SI request:
 - 5> consider the Random Access procedure unsuccessfully completed.
 - 3> else if the Random Access Preamble is transmitted on a SCell:
 - 4> consider the Random Access procedure unsuccessfully completed.
 - 2> if the Random Access procedure is not completed:
 - 3> select a random backoff time according to a uniform distribution between 0 and the *PREAMBLE_BACKOFF*;
 - 3> if the criteria (as defined in subclause 5.1.2) to select contention-free Random Access Resources is met during the backoff time:
 - 4> perform the Random Access Resource selection procedure (see subclause 5.1.2);
 - 3> else:
 - 4> perform the Random Access Resource selection procedure (see subclause 5.1.2) after the backoff time.

The MAC entity may stop *ra-ResponseWindow* (and hence monitoring for Random Access Response(s)) after successful reception of a Random Access Response containing Random Access Preamble identifiers that matches the transmitted *PREAMBLE_INDEX*.

HARQ operation is not applicable to the Random Access Response reception.

[TS 38.321, clause 5.1.5]

Once Msg3 is transmitted, the MAC entity shall:

- 1> start the *ra-ContentionResolutionTimer* and restart the *ra-ContentionResolutionTimer* at each HARQ retransmission in the first symbol after the end of the Msg3 transmission;
- 1> monitor the PDCCH while the *ra-ContentionResolutionTimer* is running regardless of the possible occurrence of a measurement gap;
- 1> if notification of a reception of a PDCCH transmission of the SpCell is received from lower layers:
 - 2> if the C-RNTI MAC CE was included in Msg3:
 - 3> if the Random Access procedure was initiated for beam failure recovery (as specified in subclause 5.17) and the PDCCH transmission is addressed to the C-RNTI; or
 - 3> if the Random Access procedure was initiated by the MAC sublayer itself or by the RRC sublayer and the PDCCH transmission is addressed to the C-RNTI and contains a UL grant for a new transmission; or
 - 3> if the Random Access procedure was initiated by a PDCCH order and the PDCCH transmission is addressed to the C-RNTI;

- > if the Random Access procedure was initiated for beam failure recovery (as specified in subclause 5.17) and the PDCCH transmission is addressed to the C-RNTI:
 - 4> consider this Contention Resolution successful;
 - 4> stop *ra-ContentionResolutionTimer*;
 - 4> discard the *TEMPORARY_C-RNTI*;
 - 4> consider this Random Access procedure successfully completed.
- 2> else if the CCCH SDU was included in Msg3 and the PDCCH transmission is addressed to its *TEMPORARY_C-RNTI*:
 - 3> if the MAC PDU is successfully decoded:
 - 4> stop *ra-ContentionResolutionTimer*;
 - 4> if the MAC PDU contains a UE Contention Resolution Identity MAC CE; and
 - 4> if the UE Contention Resolution Identity in the MAC CE matches the CCCH SDU transmitted in Msg3:
 - 5> consider this Contention Resolution successful and finish the disassembly and demultiplexing of the MAC PDU;
 - 5> if this Random Access procedure was initiated for SI request:
 - 6> indicate the reception of an acknowledgement for SI request to upper layers.
 - 5> else:
 - 6> set the C-RNTI to the value of the *TEMPORARY_C-RNTI*;
 - 5> discard the *TEMPORARY_C-RNTI*;
 - 5> consider this Random Access procedure successfully completed.
 - 4> else:
 - 5> discard the *TEMPORARY_C-RNTI*;
 - 5> consider this Contention Resolution not successful and discard the successfully decoded MAC PDU.
- 1> if *ra-ContentionResolutionTimer* expires:
 - 2> discard the *TEMPORARY_C-RNTI*;
 - 2> consider the Contention Resolution not successful.
- 1> if the Contention Resolution is considered not successful:
 - 2> flush the HARQ buffer used for transmission of the MAC PDU in the Msg3 buffer;
 - 2> increment *PREAMBLE_TRANSMISSION_COUNTER* by 1;
 - 2> if *PREAMBLE_TRANSMISSION_COUNTER* = *preambleTransMax* + 1:
 - 3> indicate a Random Access problem to upper layers.
 - 3> if this Random Access procedure was triggered for SI request:
 - 4> consider the Random Access procedure unsuccessfully completed.
 - 2> if the Random Access procedure is not completed:

- 3> select a random backoff time according to a uniform distribution between 0 and the *PREAMBLE_BACKOFF*;
- 3> if the criteria (as defined in subclause 5.1.2) to select contention-free Random Access Resources is met during the backoff time:
- 3> perform the Random Access Resource selection procedure (see subclause 5.1.2).
- 3> else:
 - 4> perform the Random Access Resource selection procedure (see subclause 5.1.2) after the backoff time.

[TS 38.321, clause 5.2]

RRC configures the following parameters for the maintenance of UL time alignment:

- *timeAlignmentTimer* (per TAG) which controls how long the MAC entity considers the Serving Cells belonging to the associated TAG to be uplink time aligned.

The MAC entity shall:

- 1> when a Timing Advance Command MAC CE is received, and if an N_{TA} (as defined in TS 38.211 [8]) has been maintained with the indicated TAG:
 - 2> apply the Timing Advance Command for the indicated TAG;
 - 2> start or restart the *timeAlignmentTimer* associated with the indicated TAG.
- 1> when a Timing Advance Command is received in a Random Access Response message for a Serving Cell belonging to a TAG:
 - 2> if the Random Access Preamble was not selected by the MAC entity among the contention-based Random Access Preamble:
 - 3> apply the Timing Advance Command for this TAG;
 - 3> start or restart the *timeAlignmentTimer* associated with this TAG.
 - 2> else if the *timeAlignmentTimer* associated with this TAG is not running:
 - 3> apply the Timing Advance Command for this TAG;
 - 3> start the *timeAlignmentTimer* associated with this TAG;
 - 3> when the Contention Resolution is considered not successful as described in subclause 5.1.5; or
 - 3> when the Contention Resolution is considered successful for SI request as described in subclause 5.1.5, after transmitting HARQ feedback for MAC PDU including UE Contention Resolution Identity MAC CE:
 - 4> stop *timeAlignmentTimer* associated with this TAG.
 - 2> else:
 - 3> ignore the received Timing Advance Command.
 - 1> when a *timeAlignmentTimer* expires:
 - 2> if the *timeAlignmentTimer* is associated with the PTAG:
 - 3> flush all HARQ buffers for all Serving Cells;
 - 3> notify RRC to release PUCCH for all Serving Cells, if configured;
 - 3> notify RRC to release SRS for all Serving Cells, if configured;
 - 3> clear any configured downlink assignments and configured uplink grants;

- 3> clear any PUSCH resource for semi-persistent CSI reporting;
 - 3> consider all running *timeAlignmentTimers* as expired;
 - 3> maintain N_{TA} (defined in TS 38.211 [8]) of all TAGs.
- 2> else if the *timeAlignmentTimer* is associated with an STAG, then for all Serving Cells belonging to this TAG:
- 3> flush all HARQ buffers;
 - 3> notify RRC to release PUCCH, if configured;
 - 3> notify RRC to release SRS, if configured;
 - 3> clear any configured downlink assignments and configured uplink grants;
 - 3> clear any PUSCH resource for semi-persistent CSI reporting;
 - 3> maintain N_{TA} (defined in TS 38.211 [8]) of this TAG.

When the MAC entity stops uplink transmissions for an SCell due to the fact that the maximum uplink transmission timing difference between TAGs of the MAC entity or the maximum uplink transmission timing difference between TAGs of any MAC entity of the UE is exceeded, the MAC entity considers the *timeAlignmentTimer* associated with the SCell as expired.

The MAC entity shall not perform any uplink transmission on a Serving Cell except the Random Access Preamble transmission when the *timeAlignmentTimer* associated with the TAG to which this Serving Cell belongs is not running. Furthermore, when the *timeAlignmentTimer* associated with the PTAG is not running, the MAC entity shall not perform any uplink transmission on any Serving Cell except the Random Access Preamble transmission on the SpCell.

[TS 38.321, clause 6.1.3.2]

The C-RNTI MAC CE is identified by MAC PDU subheader with LCID as specified in Table 6.2.1-2.

It has a fixed size and consists of a single field defined as follows (Figure 6.1.3.2-1):

- C-RNTI: This field contains the C-RNTI of the MAC entity. The length of the field is 16 bits.

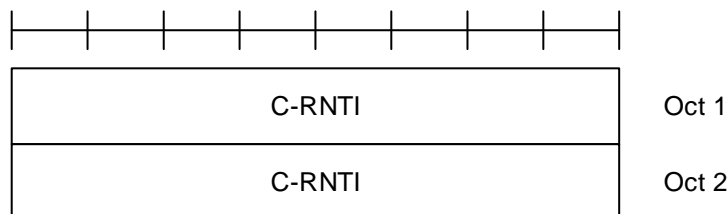

Figure 6.1.3.2-1: C-RNTI MAC CE

[TS 38.321, clause 6.1.5]

A MAC PDU consists of one or more MAC subPDUs and optionally padding. Each MAC subPDU consists one of the following:

- a MAC subheader with Backoff Indicator only;
- a MAC subheader with RAPID only (i.e. acknowledgment for SI request);
- a MAC subheader with RAPID and MAC RAR.

A MAC subheader with Backoff Indicator consists of five header fields E/T/R/R/BI as described in Figure 6.1.5-1. A MAC subPDU with Backoff Indicator only is placed at the beginning of the MAC PDU, if included. 'MAC subPDU(s) with RAPID only' and 'MAC subPDU(s) with RAPID and MAC RAR' can be placed anywhere between MAC subPDU with Backoff Indicator only (if any) and padding (if any).

A MAC subheader with RAPID consists of three header fields E/T/RAPID as described in Figure 6.1.5-2.

Padding is placed at the end of the MAC PDU if present. Presence and length of padding is implicit based on TB size, size of MAC subPDU(s).

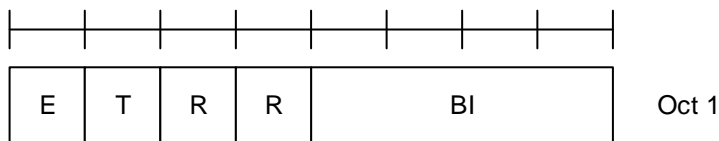

Figure 6.1.5-1: E/T/R/R/BI MAC subheader

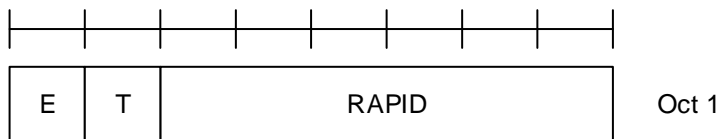

Figure 6.1.5-2: E/T/RAPID MAC subheader

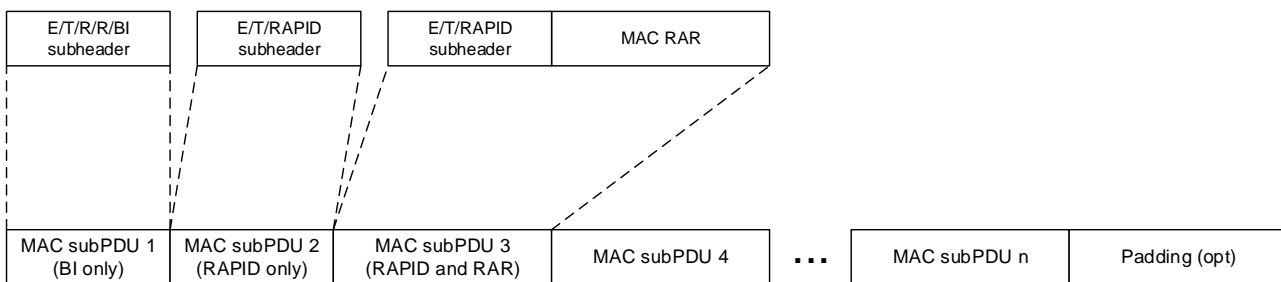

Figure 6.1.5-3: Example of MAC PDU consisting of MAC RARs

[TS 38.321, clause 6.2.3]

The MAC RAR is of fixed size as depicted in Figure 6.2.3-1, and consists of the following fields:

- R: Reserved bit, set to "0";
- Timing Advance Command: The Timing Advance Command field indicates the index value T_A used to control the amount of timing adjustment that the MAC entity has to apply in TS 38.213 [6]. The size of the Timing Advance Command field is 12 bits;
- UL Grant: The Uplink Grant field indicates the resources to be used on the uplink in TS 38.213 [6]. The size of the UL Grant field is 27 bits;
- Temporary C-RNTI: The Temporary C-RNTI field indicates the temporary identity that is used by the MAC entity during Random Access. The size of the Temporary C-RNTI field is 16 bits.

The MAC RAR is octet aligned.

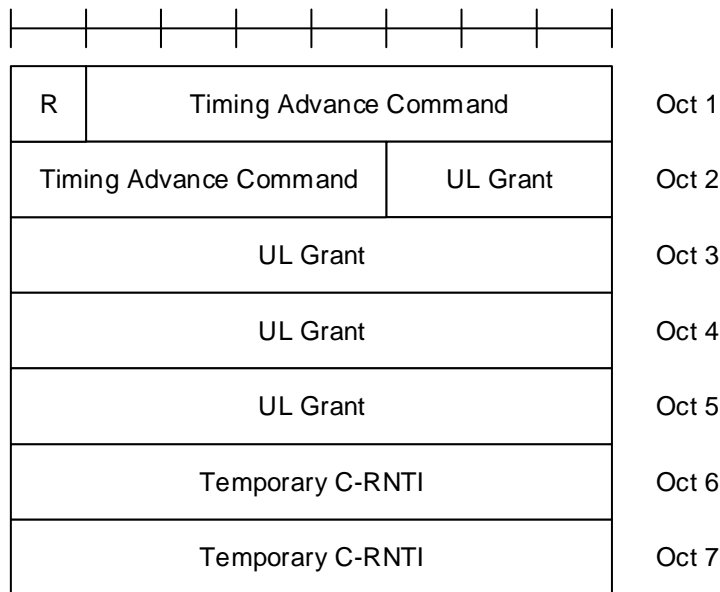

Figure 6.2.3-1: MAC RAR

7.1.1.1.6.3 Test description

7.1.1.1.6.3.1 Pre-test conditions

Same Pre-test conditions as in clause 7.1.1.0 except that Test loop function(Off). 7.1.1.1.6.3.2 Test procedure sequence

Table 7.1.1.1.6.3.2-1: Main behaviour

St	Procedure	Message Sequence		TP	Verdict
		U - S	Message		
1	The SS transmits a Paging message including a matched UE identity.	<--	Paging	-	-
2	Check: Does the UE transmit preamble on PRACH using a preamble in group A defined in <i>servingCellConfigCommon</i> in <i>SIB1</i> (totalNumberOfRA-Preambles, ssb-perRACH-OccasionAndCB-PreamblesPerSSB and numberOfRA-PreamblesGroupA)?	-->	PRACH Preamble	1	P
3	The SS transmits Random Access Response with RAPID corresponding to the transmitted Preamble in step 2, including TC-RNTI and not including Back off Indicator subheader.	<--	Random Access Response	-	-
4	The UE transmits a MAC PDU containing an <i>RRCSetupRequest</i> message. (Note 1)	-->	MAC PDU (<i>RRCSetupRequest</i>)	-	-
5	Before the contention resolution timer expires, the SS does not schedule any PDCCH.				
6	Check: Does the UE re-transmit a preamble on PRACH using a preamble in the same group A?	-->	PRACH Preamble	3	P
7	The SS transmits Random Access Response with RAPID corresponding to the transmitted Preamble in step 6, including TC-RNTI and not including Back off Indicator subheader.	<--	Random Access Response	-	-
8	The UE transmits a MAC PDU containing an <i>RRCSetupRequest</i> message. (Note 1)	-->	MAC PDU (<i>RRCSetupRequest</i>)	-	-
9	The SS schedules PDCCH transmission addressed to TC-RNTI to transmit a valid MAC PDU containing an <i>RRCSetup</i> message, but	<--	MAC PDU (<i>RRCSetup</i>)	-	-

	not including a matching 'UE Contention Resolution Identity' MAC control element.				
-	EXCEPTION: In parallel with step 10, the parallel behaviour in table 7.1.1.1.6.3.2-2 is running.	-	-	-	-
10	Check: Does the UE re-transmit a preamble on PRACH using a preamble in the same group A?	-->	PRACH Preamble	2	P
11	The SS transmits Random Access Response with RAPID corresponding to the transmitted Preamble in step 10, including TC-RNTI and not including Back off Indicator subheader.	<--	Random Access Response	-	
12	The UE transmits a MAC PDU containing an <i>RRCSetupRequest</i> message. (Note 1)	-->	MAC PDU (<i>RRCSetupRequest</i>)	-	-
13	The SS schedules PDCCH transmission addressed to TC-RNTI to transmit a valid MAC PDU containing an <i>RRCSetup</i> message and 'UE Contention Resolution Identity' MAC control element with matched 'Contention Resolution Identity'.	<--	MAC PDU (<i>RRCSetup</i> and UE Contention Resolution Identity MAC CE)	-	-
14	Check: Does UE transmit a MAC PDU containing an <i>RRCSetupComplete</i> message indicating acceptance of <i>RRCSetup</i> message?	-->	MAC PDU (<i>RRCSetupComplete</i>)	4	P
Note 1: Size of <i>RRCSetupRequest</i> message is 45 bits, octet aligned = 48 bits. With 16 bits of MAC Header the minimum size of MAC PDU carrying <i>RRCSetupRequest</i> is 64 bits.					

Table 7.1.1.1.6.3.2-2: Parallel behaviour

St	Procedure	Message Sequence		TP	Verdict
		U - S	Message		
1	Check: UE transmits a MAC PDU containing an <i>RRCSetupComplete</i> message indicating acceptance of <i>RRCSetup</i> message?	-->	MAC PDU (<i>RRCSetupComplete</i>)	2	F

7.1.1.1.6.3.3 Specific message contents

Table 7.1.1.1.6.3.3-1: SIB1 (Preamble, Table 7.1.1.1.6.3.2-1)

Derivation Path: TS 38.508-1 [4], Table 4.6.1-28			
Information Element	Value/remark	Comment	Condition
SIB1 ::= SEQUENCE {			
servingCellConfigCommon SEQUENCE {			
uplinkConfigCommon SEQUENCE {			
initialUplinkBWP	BWP-UplinkCommon		
}			
}			
}			

Table 7.1.1.1.6.3.3-2: BWP-UplinkCommon (Table 7.1.1.1.6.3.3-1)

Derivation Path: TS 38.508-1 [4], Table 4.6.3-10			
Information Element	Value/remark	Comment	Condition
BWP-UplinkCommon ::= SEQUENCE {			
rach-ConfigCommon CHOICE {			
setup	RACH-ConfigCommon		
}			
}			

Table 7.1.1.1.6.3.3-3: RACH-ConfigCommon (Table 7.1.1.1.6.3.3-2)

Derivation Path: TS 38.508-1 [4], Table 4.6.3-128			
---	--	--	--

Information Element	Value/remark	Comment	Condition
RACH-ConfigCommon ::= SEQUENCE {			
rach-ConfigGeneric	RACH-ConfigGeneric		
totalNumberOfRA-Preambles	42		
ssb-perRACH-OccasionAndCB-PreamblesPerSSB			
CHOICE {			
One	n32		
}			
groupBconfigured SEQUENCE {			
ra-Msg3SizeGroupA	b208		
messagePowerOffsetGroupB	minusinfinity		
numberOfRA-PreamblesGroupA	28		
}			
ra-ContentionResolutionTimer	sf48		
}			

7.1.1.1.7 Random access procedure / Successful/ Temporary C-RNTI Based / Preamble selected by MAC itself

7.1.1.1.7.1 Test Purpose (TP)

(1)

```
with { UE in RRC_Connected and NR SpCell TimeAlignmentTimer expired, and has UL Data to send }
ensure that {
  when { the BWP selected for Random Access procedure is configured with both 2-step and 4-step RA
type Random Access Resources and the RSRP of the downlink pathloss reference is above msgA-RSRP-
Threshold }
  then { UE SET RA_TYPE to 2-step AND sends a MSGA on the NR SpCell }
}
```

(2)

```
with { UE in RRC_Connected NR SpCell TimeAlignmentTimer expired, and has UL Data to send }
ensure that {
  when { BWP selected for Random Access procedure is only configured with 2-step RA type Random
Access resources }
  then { UE SET RA_TYPE to 2-step AND sends a MSGA on the NR SpCell }
}
```

7.1.1.1.7.2 Conformance requirements

References: The conformance requirements covered in the present TC are specified in: 3GPP TS 38.321, clause 5.1.1, 5.1.2a and 5.1.3a. Unless otherwise stated these are Rel-16 requirements.

[TS 38.321, clause 5.1.1]

- 1> if the Random Access procedure was initiated for SpCell beam failure recovery (as specified in clause 5.17) and if the contention-free Random Access Resources for beam failure recovery request for 4-step RA type have been explicitly provided by RRC for the BWP selected for Random Access procedure; or
- 1> if the Random Access procedure was initiated for reconfiguration with sync and if the contention-free Random Access Resources for 4-step RA type have been explicitly provided in *rach-ConfigDedicated* for the BWP selected for Random Access procedure:
 - 2> set the *RA_TYPE* to *4-stepRA*.
- 1> else if the BWP selected for Random Access procedure is configured with both 2-step and 4-step RA type Random Access Resources and the RSRP of the downlink pathloss reference is above *msgA-RSRP-Threshold*; or
- 1> if the BWP selected for Random Access procedure is only configured with 2-step RA type Random Access resources (i.e. no 4-step RACH RA type resources configured); or

1> if the Random Access procedure was initiated for reconfiguration with sync and if the contention-free Random Access Resources for 2-step RA type have been explicitly provided in *rach-ConfigDedicated* for the BWP selected for Random Access procedure:

2> set the *RA_TYPE* to *2-stepRA*.

1> else:

2> set the *RA_TYPE* to *4-stepRA*.

1> perform initialization of variables specific to Random Access type as specified in clause 5.1.1a;

1> if *RA_TYPE* is set to *2-stepRA*:

2> perform the Random Access Resource selection procedure for 2-step RA type (see clause 5.1.2a).

1> else:

2> perform the Random Access Resource selection procedure (see clause 5.1.2).

[TS 38.321, clause 5.1.2a]

If the selected *RA_TYPE* is set to *2-stepRA*, the MAC entity shall:

1> if the contention-free 2-step RA type Resources associated with SSBs have been explicitly provided in *rach-ConfigDedicated* and at least one SSB with SS-RSRP above *msgA-RSRP-ThresholdSSB* amongst the associated SSBs is available:

2> select an SSB with SS-RSRP above *msgA-RSRP-ThresholdSSB* amongst the associated SSBs;

2> set the *PREAMBLE_INDEX* to a *ra-PreambleIndex* corresponding to the selected SSB.

1> else (i.e. for the contention-based Random Access Preamble selection):

2> if at least one of the SSBs with SS-RSRP above *msgA-RSRP-ThresholdSSB* is available:

3> select an SSB with SS-RSRP above *msgA-RSRP-ThresholdSSB*.

2> else:

3> select any SSB.

2> if contention-free Random Access Resources for 2-step RA type have not been configured and if Random Access Preambles group has not yet been selected during the current Random Access procedure:

3> if Random Access Preambles group B for 2-step RA type is configured:

4> if the potential MSGA payload size (UL data available for transmission plus MAC subheader and, where required, MAC CEs) is greater than the *ra-MsgA-SizeGroupA* and the pathloss is less than $PCMAX$ (of the Serving Cell performing the Random Access Procedure) – *msgA-PreambleReceivedTargetPower* – *msgA-DeltaPreamble* – *messagePowerOffsetGroupB*; or

4> if the Random Access procedure was initiated for the CCCH logical channel and the CCCH SDU size plus MAC subheader is greater than *ra-MsgA-SizeGroupA*:

5> select the Random Access Preambles group B.

4> else:

5> select the Random Access Preambles group A.

3> else:

4> select the Random Access Preambles group A.

2> else if contention-free Random Access Resources for 2-step RA type have been configured and if Random Access Preambles group has not yet been selected during the current Random Access procedure:

- 3> if Random Access Preambles group B for 2-step RA type is configured; and
- 3> if the transport block size of the MSGA payload configured in the *rach-ConfigDedicated* corresponds to the transport block size of the MSGA payload associated with Random Access Preambles group B:
 - 4> select the Random Access Preambles group B.
- 3> else:
 - 4> select the Random Access Preambles group A.
- 2> else (i.e. Random Access preambles group has been selected during the current Random Access procedure):
 - 3> select the same group of Random Access Preambles as was used for the Random Access Preamble transmission attempt corresponding to the earlier transmission of MSGA.
 - 2> select a Random Access Preamble randomly with equal probability from the 2-step RA type Random Access Preambles associated with the selected SSB and the selected Random Access Preambles group;
 - 2> set the *PREAMBLE_INDEX* to the selected Random Access Preamble.
- 1> determine the next available PRACH occasion from the PRACH occasions corresponding to the selected SSB permitted by the restrictions given by the *msgA-SSB-SharedRO-MaskIndex* if configured and *ra-ssb-OccasionMaskIndex* if configured (the MAC entity shall select a PRACH occasion randomly with equal probability among the consecutive PRACH occasions allocated for 2-step RA type according to clause 8.1 of TS 38.213 [6], corresponding to the selected SSB; the MAC entity may take into account the possible occurrence of measurement gaps when determining the next available PRACH occasion corresponding to the selected SSB);
- 1> if the Random Access Preamble was not selected by the MAC entity among the contention-based Random Access Preamble(s):
 - 2> select a PUSCH occasion from the PUSCH occasions configured in *msgA-CFRA-PUSCH* corresponding to the PRACH slot of the selected PRACH occasion, according to *msgA-PUSCH-resource-Index* corresponding to the selected SSB;
 - 2> determine the UL grant and the associated HARQ information for the MSGA payload in the selected PUSCH occasion;
 - 2> deliver the UL grant and the associated HARQ information to the HARQ entity.
- 1> else:
 - 2> select a PUSCH occasion corresponding to the selected preamble and PRACH occasion according to clause 8.1A of TS 38.213 [6];
 - 2> determine the UL grant for the MSGA payload according to the PUSCH configuration associated with the selected Random Access Preambles group and determine the associated HARQ information;
 - 2> if the selected preamble and PRACH occasion is mapped to a valid PUSCH occasion as specified in clause 8.1A of TS 38.213 [6]:
 - 3> deliver the UL grant and the associated HARQ information to the HARQ entity.
- 1> perform the MSGA transmission procedure (see clause 5.1.3a).

NOTE: To determine if there is an SSB with *SS-RSRP* above *msgA-RSRP-ThresholdSSB*, the UE uses the latest unfiltered *L1-RSRP* measurement.

[TS 38.321, clause 5.1.3a]

The MAC entity shall, for each MSGA:

- 1> if *PREAMBLE_TRANSMISSION_COUNTER* is greater than one; and
- 1> if the notification of suspending power ramping counter has not been received from lower layers; and

- 1> if LBT failure indication was not received from lower layers for the last MSGA Random Access Preamble transmission; and
- 1> if SSB selected is not changed from the selection in the last Random Access Preamble transmission:
 - 2> increment *PREAMBLE_POWER_RAMPING_COUNTER* by 1.
- 1> select the value of *DELTA_PREAMBLE* according to clause 7.3;
- 1> set *PREAMBLE_RECEIVED_TARGET_POWER* to $msgA\text{-}PreambleReceivedTargetPower + DELTA_PREAMBLE + (PREAMBLE_POWER_RAMPING_COUNTER - 1) \times PREAMBLE_POWER_RAMPING_STEP$;
- 1> if this is the first MSGA transmission within this Random Access procedure:
 - 2> if the transmission is not being made for the CCCH logical channel:
 - 3> indicate to the Multiplexing and assembly entity to include a C-RNTI MAC CE in the subsequent uplink transmission.
 - 2> if the Random Access procedure was initiated for SpCell beam failure recovery and *spCell-BFR-CBRA* with value *true* is configured:
 - 3> indicate to the Multiplexing and assembly entity to include a BFR MAC CE or a Truncated BFR MAC CE in the subsequent uplink transmission.
 - 2> obtain the MAC PDU to transmit from the Multiplexing and assembly entity according to the HARQ information determined for the MSGA payload (see clause 5.1.2a) and store it in the MSGA buffer.
- 1> compute the MSGB-RNTI associated with the PRACH occasion in which the Random Access Preamble is transmitted;
- 1> instruct the physical layer to transmit the MSGA using the selected PRACH occasion and the associated PUSCH resource of MSGA (if the selected preamble and PRACH occasion is mapped to a valid PUSCH occasion), using the corresponding RA-RNTI, MSGB-RNTI, *PREAMBLE_INDEX*, *PREAMBLE_RECEIVED_TARGET_POWER*, *msgA-PreambleReceivedTargetPower*, and the amount of power ramping applied to the latest MSGA preamble transmission (i.e. $(PREAMBLE_POWER_RAMPING_COUNTER - 1) \times PREAMBLE_POWER_RAMPING_STEP$);

7.1.1.1.7.3 Test description

7.1.1.1.7.3.1 Pre-test conditions

Same Pre-test conditions as in clause 7.1.1.0.

7.1.1.1.7.3.2 Test procedure sequence

Table 7.1.1.1.7.3.2-1: Main behaviour

St	Procedure	Message Sequence		TP	Verdict
		U - S	Message		
0A	SS transmits an RRCReconfiguration message to configure both 2-Step and 4-Step RA type Random Access Resources. Note 1	<--	RRCReconfiguration	-	-
0B	The UE transmits RRCReconfigurationComplete message. Note 2	-->	RRCReconfigurationComplete	-	-
1	SS transmits Timing Advance command to SpCell. SS does not send any subsequent timing alignments. Start Timer_T1 = Time Alignment timer value on SS.	<--	MAC PDU (Timing Advance Command MAC Control Element)	-	-
2	40 to 50 TTI before Timer_T1 expires the SS transmits a MAC PDU containing a PDCP SDU	<--	MAC PDU	-	-

3	The SS ignores scheduling requests and does not allocate any uplink grant.	-	-	-	-
4	Check: Does the UE MSGA using the selected PRACH occasion and the associated PUSCH resource of MSGA	-->	MAC PDU (including C-RNTI MAC CE)	1	P
5	SS schedules PDCCH transmission for UE C_RNTI and DL MAC PDU containing Absolute Timing Advance Command MAC CE.	<--	MAC PDU(Absolute Timing Advance Command MAC Control Element)	-	-
6	SS transmits an RRCReconfiguration message to configure only 2-Step RA type Random Access Resources. Note 1	<--	RRCReconfiguration	-	-
7	The UE transmits RRCReconfigurationComplete message. Note 2	-->	RRCReconfigurationComplete	-	-
8	SS transmits Timing Advance command to SpCell. SS does not send any subsequent timing alignments. Start Timer_T1 = Time Alignment timer value on SS.	<--	MAC PDU (Timing Advance Command MAC Control Element)	-	-
9	40 to 50 TTI before Timer_T1 expires the SS transmits a MAC PDU containing a PDCP SDU	<--	MAC PDU	-	-
10	The SS ignores scheduling requests and does not allocate any uplink grant.	-	-	-	-
11	Check: Does the UE MSGA using the selected PRACH occasion and the associated PUSCH resource of MSGA	-->	MAC PDU (including C-RNTI MAC CE)	2	P
12	SS schedules PDCCH transmission for UE C_RNTI and DL MAC PDU containing Absolute Timing Advance Command MAC CE.	<--	MAC PDU(Absolute Timing Advance Command MAC Control Element)	-	-
Note 1: for EN-DC the NR <i>RRCReconfiguration</i> message is contained in <i>RRCConnectionReconfiguration</i> . Note 2: for EN-DC the NR <i>RRCReconfigurationComplete</i> message is contained in <i>RRCConnectionReconfigurationComplete</i> .					

7.1.1.1.7.3.3 Specific message contents

Table 7.1.1.1.7.3.3-1: RRCReconfiguration for EN-DC (steps 0A and 6, Table 7.1.1.1.7.3.2-1)

Derivation Path: 38.508-1 [4], Table 4.6.1-13 with condition EN-DC_HO.			
Information Element	Value/remark	Comment	Condition
RRCReconfiguration ::= SEQUENCE {			
criticalExtensions CHOICE {			
rrcReconfiguration ::= SEQUENCE {			
secondaryCellGroup	CellGroupConfig		
}			
}			
}			

Table 7.1.1.1.7.3.3-1A: RRCReconfiguration for NR/5GC (steps 0A and 6, Table 7.1.1.1.7.3.2-1)

Derivation Path: 38.508-1 [4], Table 4.6.1-13			
Information Element	Value/remark	Comment	Condition
RRCReconfiguration ::= SEQUENCE {			
criticalExtensions CHOICE {			
radioBearerConfig	RadioBearerConfig as per TS 38.508-1[4] Table 4.6.3-132 with conditions DRBn and Recover_PDCP	n set to the default DRB of the first PDU session	NR
rrcReconfiguration ::= SEQUENCE {			
nonCriticalExtension SEQUENCE {			
masterCellGroup	CellGroupConfig		
}			
}			
}			

--	--	--

Table 7.1.1.1.7.3.3-2: CellGroupConfig for EN-DC (Table 7.1.1.1.7.3.3-1)

Derivation Path: 38.508-1 [4], Table 4.6.3-19 with condition PSCell_change			
Information Element	Value/remark	Comment	Condition
CellGroupConfig ::= SEQUENCE {			
spCellConfig SEQUENCE {			
spCellConfigCommon	ServingCellConfigCommon		
reconfigurationWithSync SEQUENCE {			
rach-ConfigDedicated CHOICE {			
uplink	Not present		
}			
newUE-Identity	UE identity different from NR cell 1 UE identity		
}			
}			

Table 7.1.1.1.7.3.3-2A: CellGroupConfig for NR/5GC (Table 7.1.1.1.7.3.3-1A)

Derivation Path: 38.508-1 [4], Table 4.6.3-19 with condition PCell_change			
Information Element	Value/remark	Comment	Condition
CellGroupConfig ::= SEQUENCE {			
spCellConfig SEQUENCE {			
reconfigurationWithSync SEQUENCE {			
spCellConfigCommon	ServingCellConfigCommon		
rach-ConfigDedicated CHOICE {			
uplink	Not present		
}			
newUE-Identity	UE identity different from NR cell 1 UE identity		
}			
}			

Table 7.1.1.1.7.3.3-3: ServingCellConfigCommon (Table 7.1.1.1.7.3.3-2 and Table 7.1.1.1.7.3.3-2A)

Derivation Path: TS 38.508-1 [4], Table 4.6.3-168			
Information Element	Value/remark	Comment	Condition
ServingCellConfigCommon ::= SEQUENCE {			
uplinkConfigCommon SEQUENCE {			
initialUplinkBWP	BWP-UplinkCommon		
}			
tdd-UL-DL-ConfigurationCommon	TDD-UL-DL-ConfigCommon		
}			

Table 7.1.1.1.7.3.3-4: BWP-UplinkCommon (Table 7.1.1.1.7.3.3-3)

Derivation Path: TS 38.508-1 [4], Table 4.6.3-10			
Information Element	Value/remark	Comment	Condition
BWP-UplinkCommon ::= SEQUENCE {			
rach-ConfigCommon CHOICE {			
setup	RACH-ConfigCommon		Step 0A
}	Not present		Step 6
}			
msgA-ConfigCommon-r16 CHOICE {			
setup	MsgA-ConfigCommon		

}			
}			

Table 7.1.1.1.7.3.3-5: RACH-ConfigCommon (Table 7.1.1.1.7.3.3-4)

Derivation Path: TS 38.508-1 [4], Table 4.6.3-128			
Information Element	Value/remark	Comment	Condition
RACH-ConfigCommon ::= SEQUENCE {			
rach-ConfigGeneric	RACH-ConfigGeneric		
ssb_perRACH_OccasionAndCB_PreamblesPerSSB CHOICE {			
one	n36		
}			
prach-RootSequenceIndex CHOICE {			
l139	Set according to table 4.4.2-2 in TS 38.508-1 [4] for the NR Cell.		
l839	Set according to table 4.4.2-2 in TS 38.508-1 [4] for the NR Cell.	PRACH Preamble format 0 used	FR1,
}			
}			

Table 7.1.1.1.7.3.3-6: MsgA-ConfigCommon (Table 7.1.1.1.7.3.3-4)

Derivation Path: TS 38.508-1 [4], Table 4.6.3-81A			
Information Element	Value/remark	Comment	Condition
MsgA-ConfigCommonL-r16 ::= SEQUENCE {			
rach-ConfigCommonTwoStepRA-r16	RACH-ConfigCommonTwoStepRA		
msgA-PUSCH-Config-r16	MsgA-PUSCH-Config		
}			

Table 7.1.1.1.7.3.3-7: TDD-UL-DL-ConfigCommon (Table 7.1.1.1.7.3.3-3)

Derivation Path: TS 38.508-1 [4], Table 4.6.3-192			
Information Element	Value/remark	Comment	Condition
TDD-UL-DL-ConfigCommon ::= SEQUENCE {			
referenceSubcarrierSpacing	SubcarrierSpacing		
pattern1 SEQUENCE {			
dl-UL-TransmissionPeriodicity	ms5		FR1 SCS 30
	ms5		FR1 SCS 15
	ms0p625		FR2
nrofDownlinkSlots	3		FR1 SCS 30
	1		FR1 SCS 15
	3		FR2
nrofDownlinkSymbols	6		FR1 SCS 30
	10		FR1 SCS 15
	10		FR2
nrofUplinkSlots	2		FR1 SCS 30
	1		FR1 SCS 15
	1		FR2
nrofUplinkSymbols	4		FR1 SCS 30
	2		FR1 SCS 15
	2		FR2
dl-UL-TransmissionPeriodicity-v1530	ms3		FR1 SCS 30 or FR1 SCS 15
}			
pattern2	Not present		
pattern2 SEQUENCE {			FR1 SCS 30

			or FR1 SCS 15
dl-UL-TransmissionPeriodicity	ms2		
nrofDownlinkSlots	4		FR1 SCS 30
	2		FR1 SCS 15
nrofDownlinkSymbols	0		
nrofUplinkSlots	0		
nrofUplinkSymbols	0		
}			
}			

Table 7.1.1.1.7.3.3-8: RACH-ConfigCommonTwoStepRA (Table 7.1.1.1.7.3.3-4)

Derivation Path: TS 38.508-1 [4], Table 4.6.3-128A			
Information Element	Value/remark	Comment	Condition
RACH-ConfigCommonTwoStepRA-r16 ::= SEQUENCE {			
msgA-RSRP-Threshold-r16	57	-100 dBm	

Table 7.1.1.1.7.3.3-9: MsgA-PUSCH-Config (Table 7.1.1.1.7.3.3-4)

Derivation Path: TS 38.508-1 [4], Table 4.6.3-81B

7.1.1.1.8 Correct selection of RACH parameters / 2-step RACH/MSG A and PRACH resource explicitly signalled to the UE by RRC / contention free random access procedure

7.1.1.1.8.1 Test Purpose (TP)

(1)

```
with { UE in RRC_Connected }
ensure that {
  when { SS sends an RRCReconfiguration message including RACH-ConfigDedicated information element
and the contention-free Random Access Resources for 2-step RA type have been explicitly provided in
rach-ConfigDedicated }
  then { UE SET RA_TYPE to 2-step AND sends a MSG A on the NR PSCell }
}
```

(2)

```
with { UE in RRC_Connected state after transmission of a MSG A on NR SpCell received in RACH-
ConfigDedicated on the target cell }
ensure that {
  when { UE does not receive a matching MSGB in msgB-ResponseWindow and
PREAMBLE_TRANSMISSION_COUNTER is less than msgA-TransMax + 1 }
  then { UE retransmits a MSG A in RACH-ConfigDedicated on the target cell }
}
```

7.1.1.1.8.2 Conformance requirements

References: The conformance requirements covered in the present TC are specified in: 3GPP TS 38.321, clause 5.1.1, 5.1.2a, 5.1.3a and 5.1.4a. Unless otherwise stated these are Rel-16 requirements.

[TS 38.321, clause 5.1.1]

- 1> if the Random Access procedure was initiated for SpCell beam failure recovery (as specified in clause 5.17) and if the contention-free Random Access Resources for beam failure recovery request for 4-step RA type have been explicitly provided by RRC for the BWP selected for Random Access procedure; or

- 1> if the Random Access procedure was initiated for reconfiguration with sync and if the contention-free Random Access Resources for 4-step RA type have been explicitly provided in *rach-ConfigDedicated* for the BWP selected for Random Access procedure:
 - 2> set the *RA_TYPE* to *4-stepRA*.
- 1> else if the BWP selected for Random Access procedure is configured with both 2-step and 4-step RA type Random Access Resources and the RSRP of the downlink pathloss reference is above *msgA-RSRP-Threshold*; or
- 1> if the BWP selected for Random Access procedure is only configured with 2-step RA type Random Access resources (i.e. no 4-step RACH RA type resources configured); or
- 1> if the Random Access procedure was initiated for reconfiguration with sync and if the contention-free Random Access Resources for 2-step RA type have been explicitly provided in *rach-ConfigDedicated* for the BWP selected for Random Access procedure:
 - 2> set the *RA_TYPE* to *2-stepRA*.
- 1> else:
 - 2> set the *RA_TYPE* to *4-stepRA*.
- 1> perform initialization of variables specific to Random Access type as specified in clause 5.1.1a;
- 1> if *RA_TYPE* is set to *2-stepRA*:
 - 2> perform the Random Access Resource selection procedure for 2-step RA type (see clause 5.1.2a).
- 1> else:
 - 2> perform the Random Access Resource selection procedure (see clause 5.1.2).

[TS 38.321, clause 5.1.2a]

If the selected *RA_TYPE* is set to *2-stepRA*, the MAC entity shall:

- 1> if the contention-free 2-step RA type Resources associated with SSBs have been explicitly provided in *rach-ConfigDedicated* and at least one SSB with SS-RSRP above *msgA-RSRP-ThresholdSSB* amongst the associated SSBs is available:
 - 2> select an SSB with SS-RSRP above *msgA-RSRP-ThresholdSSB* amongst the associated SSBs;
 - 2> set the *PREAMBLE_INDEX* to a *ra-PreambleIndex* corresponding to the selected SSB.
- 1> else (i.e. for the contention-based Random Access Preamble selection):
 - 2> if at least one of the SSBs with SS-RSRP above *msgA-RSRP-ThresholdSSB* is available:
 - 3> select an SSB with SS-RSRP above *msgA-RSRP-ThresholdSSB*.
 - 2> else:
 - 3> select any SSB.
- 2> if contention-free Random Access Resources for 2-step RA type have not been configured and if Random Access Preambles group has not yet been selected during the current Random Access procedure:
 - 3> if Random Access Preambles group B for 2-step RA type is configured:
 - 4> if the potential MSGA payload size (UL data available for transmission plus MAC subheader and, where required, MAC CEs) is greater than the *ra-MsgA-SizeGroupA* and the pathloss is less than $PCMAX$ (of the Serving Cell performing the Random Access Procedure) – *msgA-PreambleReceivedTargetPower* – *msgA-DeltaPreamble* – *messagePowerOffsetGroupB*; or
 - 4> if the Random Access procedure was initiated for the CCCH logical channel and the CCCH SDU size plus MAC subheader is greater than *ra-MsgA-SizeGroupA*:

- 5> select the Random Access Preambles group B.
- 4> else:
 - 5> select the Random Access Preambles group A.
- 3> else:
 - 4> select the Random Access Preambles group A.
- 2> else if contention-free Random Access Resources for 2-step RA type have been configured and if Random Access Preambles group has not yet been selected during the current Random Access procedure:
 - 3> if Random Access Preambles group B for 2-step RA type is configured; and
 - 3> if the transport block size of the MSGA payload configured in the *rach-ConfigDedicated* corresponds to the transport block size of the MSGA payload associated with Random Access Preambles group B:
 - 4> select the Random Access Preambles group B.
 - 3> else:
 - 4> select the Random Access Preambles group A.
 - 2> else (i.e. Random Access preambles group has been selected during the current Random Access procedure):
 - 3> select the same group of Random Access Preambles as was used for the Random Access Preamble transmission attempt corresponding to the earlier transmission of MSGA.
 - 2> select a Random Access Preamble randomly with equal probability from the 2-step RA type Random Access Preambles associated with the selected SSB and the selected Random Access Preambles group;
 - 2> set the *PREAMBLE_INDEX* to the selected Random Access Preamble.
- 1> determine the next available PRACH occasion from the PRACH occasions corresponding to the selected SSB permitted by the restrictions given by the *msgA-SSB-SharedRO-MaskIndex* if configured and *ra-ssb-OccasionMaskIndex* if configured (the MAC entity shall select a PRACH occasion randomly with equal probability among the consecutive PRACH occasions allocated for 2-step RA type according to clause 8.1 of TS 38.213 [6], corresponding to the selected SSB; the MAC entity may take into account the possible occurrence of measurement gaps when determining the next available PRACH occasion corresponding to the selected SSB);
- 1> if the Random Access Preamble was not selected by the MAC entity among the contention-based Random Access Preamble(s):
 - 2> select a PUSCH occasion from the PUSCH occasions configured in *msgA-CFRA-PUSCH* corresponding to the PRACH slot of the selected PRACH occasion, according to *msgA-PUSCH-resource-Index* corresponding to the selected SSB;
 - 2> determine the UL grant and the associated HARQ information for the MSGA payload in the selected PUSCH occasion;
 - 2> deliver the UL grant and the associated HARQ information to the HARQ entity.
- 1> else:
 - 2> select a PUSCH occasion corresponding to the selected preamble and PRACH occasion according to clause 8.1A of TS 38.213 [6];
 - 2> determine the UL grant for the MSGA payload according to the PUSCH configuration associated with the selected Random Access Preambles group and determine the associated HARQ information;
 - 2> if the selected preamble and PRACH occasion is mapped to a valid PUSCH occasion as specified in clause 8.1A of TS 38.213 [6]:
 - 3> deliver the UL grant and the associated HARQ information to the HARQ entity.
- 1> perform the MSGA transmission procedure (see clause 5.1.3a).

NOTE: To determine if there is an SSB with *SS-RSRP* above *msgA-RSRP-ThresholdSSB*, the UE uses the latest unfiltered *L1-RSRP* measurement.

[TS 38.321, clause 5.1.3a]

The MAC entity shall, for each MSGA:

- 1> if *PREAMBLE_TRANSMISSION_COUNTER* is greater than one; and
- 1> if the notification of suspending power ramping counter has not been received from lower layers; and
- 1> if LBT failure indication was not received from lower layers for the last MSGA Random Access Preamble transmission; and
- 1> if SSB selected is not changed from the selection in the last Random Access Preamble transmission:
 - 2> increment *PREAMBLE_POWER_RAMPING_COUNTER* by 1.
- 1> select the value of *DELTA_PREAMBLE* according to clause 7.3;
- 1> set *PREAMBLE_RECEIVED_TARGET_POWER* to $msgA-PreambleReceivedTargetPower + DELTA_PREAMBLE + (PREAMBLE_POWER_RAMPING_COUNTER - 1) \times PREAMBLE_POWER_RAMPING_STEP$;
- 1> if this is the first MSGA transmission within this Random Access procedure:
 - 2> if the transmission is not being made for the CCCH logical channel:
 - 3> indicate to the Multiplexing and assembly entity to include a C-RNTI MAC CE in the subsequent uplink transmission.
 - 2> if the Random Access procedure was initiated for SpCell beam failure recovery and *spCell-BFR-CBRA* with value *true* is configured:
 - 3> indicate to the Multiplexing and assembly entity to include a BFR MAC CE or a Truncated BFR MAC CE in the subsequent uplink transmission.
 - 2> obtain the MAC PDU to transmit from the Multiplexing and assembly entity according to the HARQ information determined for the MSGA payload (see clause 5.1.2a) and store it in the MSGA buffer.
- 1> compute the MSGB-RNTI associated with the PRACH occasion in which the Random Access Preamble is transmitted;
- 1> instruct the physical layer to transmit the MSGA using the selected PRACH occasion and the associated PUSCH resource of MSGA (if the selected preamble and PRACH occasion is mapped to a valid PUSCH occasion), using the corresponding RA-RNTI, MSGB-RNTI, *PREAMBLE_INDEX*, *PREAMBLE_RECEIVED_TARGET_POWER*, *msgA-PreambleReceivedTargetPower*, and the amount of power ramping applied to the latest MSGA preamble transmission (i.e. $(PREAMBLE_POWER_RAMPING_COUNTER - 1) \times PREAMBLE_POWER_RAMPING_STEP$);

[TS 38.321, clause 5.1.4a]

Once the MSGA preamble is transmitted, regardless of the possible occurrence of a measurement gap, the MAC entity shall:

- 1> start the *msgB-ResponseWindow* at the PDCCH occasion as specified in TS 38.213 [6], clause 8.2A;
- 1> monitor the PDCCH of the SpCell for a Random Access Response identified by MSGB-RNTI while the *msgB-ResponseWindow* is running;
- 1> if C-RNTI MAC CE was included in the MSGA:
 - 2> monitor the PDCCH of the SpCell for Random Access Response identified by the C-RNTI while the *msgB-ResponseWindow* is running.
- 1> if notification of a reception of a PDCCH transmission of the SpCell is received from lower layers:

- 2> if the C-RNTI MAC CE was included in MSGA:
 - 3> if the Random Access procedure was initiated for SpCell beam failure recovery (as specified in clause 5.17) and the PDCCH transmission is addressed to the C-RNTI:
 - 4> consider this Random Access Response reception successful;
 - 4> stop the *msgB-ResponseWindow*;
 - 4> consider this Random Access procedure successfully completed.
 - 3> else if the *timeAlignmentTimer* associated with the PTAG is running:
 - 4> if the PDCCH transmission is addressed to the C-RNTI and contains a UL grant for a new transmission:
 - 5> consider this Random Access Response reception successful;
 - 5> stop the *msgB-ResponseWindow*;
 - 5> consider this Random Access procedure successfully completed.
 - 3> else:
 - 4> if a downlink assignment has been received on the PDCCH for the C-RNTI and the received TB is successfully decoded:
 - 5> if the MAC PDU contains the Absolute Timing Advance Command MAC CE:
 - 6> process the received Timing Advance Command (see clause 5.2);
 - 6> consider this Random Access Response reception successful;
 - 6> stop the *msgB-ResponseWindow*;
 - 6> consider this Random Access procedure successfully completed and finish the disassembly and demultiplexing of the MAC PDU.
- 2> if a valid (as specified in TS 38.213 [6]) downlink assignment has been received on the PDCCH for the MSGB-RNTI and the received TB is successfully decoded:
 - 3> if the MSGB contains a MAC subPDU with Backoff Indicator:
 - 4> set the *PREAMBLE_BACKOFF* to value of the BI field of the MAC subPDU using Table 7.2-1, multiplied with *SCALING_FACTOR_BI*.
 - 3> else:
 - 4> set the *PREAMBLE_BACKOFF* to 0 ms.
 - 3> if the MSGB contains a fallbackRAR MAC subPDU; and
 - 3> if the Random Access Preamble identifier in the MAC subPDU matches the transmitted *PREAMBLE_INDEX* (see clause 5.1.3a):
 - 4> consider this Random Access Response reception successful;
 - 4> apply the following actions for the SpCell:
 - 5> process the received Timing Advance Command (see clause 5.2);
 - 5> indicate the *msgA-PreambleReceivedTargetPower* and the amount of power ramping applied to the latest Random Access Preamble transmission to lower layers (i.e. $(PREAMBLE_POWER_RAMPING_COUNTER - 1) \times PREAMBLE_POWER_RAMPING_STEP$);
 - 5> if the Random Access Preamble was not selected by the MAC entity among the contention-based Random Access Preamble(s):

- 6> consider the Random Access procedure successfully completed;
- 6> process the received UL grant value and indicate it to the lower layers.
- 5> else:
 - 6> set the *TEMPORARY_C-RNTI* to the value received in the Random Access Response;
 - 6> if the Msg3 buffer is empty:
 - 7> obtain the MAC PDU to transmit from the MSGA buffer and store it in the Msg3 buffer;
 - 6> process the received UL grant value and indicate it to the lower layers and proceed with Msg3 transmission.

NOTE: If within a 2-step RA type procedure, an uplink grant provided in the fallback RAR has a different size than the MSGA payload, the UE behaviour is not defined.

- 3> else if the MSGB contains a successRAR MAC subPDU; and
- 3> if the CCCH SDU was included in the MSGA and the UE Contention Resolution Identity in the MAC subPDU matches the CCCH SDU:
 - 4> stop *msgB-ResponseWindow*;
 - 4> if this Random Access procedure was initiated for SI request:
 - 5> indicate the reception of an acknowledgement for SI request to upper layers.
 - 4> else:
 - 5> set the C-RNTI to the value received in the *successRAR*;
 - 5> apply the following actions for the SpCell:
 - 6> process the received Timing Advance Command (see clause 5.2);
 - 6> indicate the *msgA-PreambleReceivedTargetPower* and the amount of power ramping applied to the latest Random Access Preamble transmission to lower layers (i.e. $(\text{PREAMBLE_POWER_RAMPING_COUNTER} - 1) \times \text{PREAMBLE_POWER_RAMPING_STEP}$).
 - 4> deliver the *TPC*, *PUCCH resource Indicator*, *ChannelAccess-CPext* (if indicated), and *HARQ feedback Timing Indicator* received in successRAR to lower layers.
 - 4> consider this Random Access Response reception successful;
 - 4> consider this Random Access procedure successfully completed;
 - 4> finish the disassembly and demultiplexing of the MAC PDU.
- 1> if *msgB-ResponseWindow* expires, and the Random Access Response Reception has not been considered as successful based on descriptions above:
 - 2> increment *PREAMBLE_TRANSMISSION_COUNTER* by 1;
 - 2> if *PREAMBLE_TRANSMISSION_COUNTER* = *preambleTransMax* + 1:
 - 3> indicate a Random Access problem to upper layers;
 - 3> if this Random Access procedure was triggered for SI request:
 - 4> consider this Random Access procedure unsuccessfully completed.
 - 2> if the Random Access procedure is not completed:
 - 3> if *msgA-TransMax* is applied (see clause 5.1.1a) and *PREAMBLE_TRANSMISSION_COUNTER* = *msgA-TransMax* + 1:

- 4> set the *RA_TYPE* to *4-stepRA*;
- 4> perform initialization of variables specific to Random Access type as specified in clause 5.1.1a;
- 4> if the *Msg3* buffer is empty:
 - 5> obtain the MAC PDU to transmit from the *MSG3* buffer and store it in the *Msg3* buffer;
 - 4> flush HARQ buffer used for the transmission of MAC PDU in the *MSG3* buffer;
 - 4> discard explicitly signalled contention-free 2-step RA type Random Access Resources, if any;
 - 4> perform the Random Access Resource selection procedure as specified in clause 5.1.2.
- 3> else:
 - 4> select a random backoff time according to a uniform distribution between 0 and the *PREAMBLE_BACKOFF*;
 - 4> if the criteria (as defined in clause 5.1.2a) to select contention-free Random Access Resources is met during the backoff time:
 - 5> perform the Random Access Resource selection procedure for 2-step RA type Random Access (see clause 5.1.2a).
 - 4> else:
 - 5> perform the Random Access Resource selection procedure for 2-step RA type Random Access (see clause 5.1.2a) after the backoff time.

Upon receiving a fallbackRAR, the MAC entity may stop *msgB-ResponseWindow* once the Random Access Response reception is considered as successful.

7.1.1.1.8.3 Test description

7.1.1.1.8.3.1 Pre-test conditions

Same Pre-test conditions as in clause 7.1.1.0 except that Test loop function(*Off*).

7.1.1.1.8.3.2 Test procedure sequence

Table 7.1.1.1.8.3.2-1: Main behaviour

St	Procedure	Message Sequence		TP	Verdict
		U - S	Message		
1	SS transmits an RRCReconfiguration message with reconfiguration with sync and contention-free Random Access Resources for 2-step RA type have been explicitly provided in <i>rach-ConfigDedicated</i> . Note 1	<--	RRCReconfiguration	-	-
-	Exception: Steps 2 to 3 are run <i>msgA-TransMax</i> times	-	-	-	-
2	The UE transmits <i>MSG3</i> including RRCReconfigurationComplete message using the Random Access Resources for 2-step RA type explicitly provided. Note 2	-->	MAC PDU (including C-RNTI MAC CE, RRCReconfigurationComplete)	1,2	P
3	SS does not schedule PDCCH transmission for UE C_RNTI until <i>msgB-ResponseWindow</i> expires	-	-	-	-
4	The UE transmits <i>MSG3</i> including RRCReconfigurationComplete message using the Random Access Resources for 2-step RA type explicitly provided. Note 2	-->	MAC PDU (including C-RNTI MAC CE, RRCReconfigurationComplete)	2	P
6	SS schedules PDCCH transmission for UE C_RNTI and DL MAC PDU containing	<--	MAC PDU(Absolute Timing Advance	-	-

	Absolute Timing Advance Command MAC CE.		Command MAC Control Element)		
Note 1:	for EN-DC the NR <i>RRCReconfiguration</i> message is contained in <i>RRCConnectionReconfiguration</i> .				
Note 2:	for EN-DC the NR <i>RRCReconfigurationComplete</i> message is contained in <i>RRCConnectionReconfigurationComplete</i> and sent in E-UTRA cell. In NR Cell a MAC PDU containing C-RNTI MAC CE is sent.				

7.1.1.1.8.3.3 Specific message contents

Table 7.1.1.1.8.3.3-1: *RRCReconfiguration* for EN-DC (steps 1, Table 7.1.1.1.8.3.2-1)

Derivation Path: 38.508-1 [4], Table 4.6.1-13 with condition EN-DC_HO.			
Information Element	Value/remark	Comment	Condition
<i>RRCReconfiguration</i> ::= SEQUENCE {			
<i>criticalExtensions</i> CHOICE {			
<i>rrcReconfiguration</i> ::= SEQUENCE {			
<i>secondaryCellGroup</i>	CellGroupConfig		
}			
}			
}			

Table 7.1.1.1.8.3.3-1A: *RRCReconfiguration* for NR/5GC (steps 0A and 6, Table 7.1.1.1.8.3.2-1)

Derivation Path: 38.508-1 [4], Table 4.6.1-13			
Information Element	Value/remark	Comment	Condition
<i>RRCReconfiguration</i> ::= SEQUENCE {			
<i>criticalExtensions</i> CHOICE {			
<i>radioBearerConfig</i>	RadioBearerConfig as per TS 38.508-1[4] Table 4.6.3-132 with conditions DRBn and Recover_PDCP	n set to the default DRB of the first PDU session	NR
<i>rrcReconfiguration</i> ::= SEQUENCE {			
<i>nonCriticalExtension</i> SEQUENCE {			
<i>masterCellGroup</i>	CellGroupConfig		
}			
}			
}			
}			

Table 7.1.1.1.8.3.3-2: *CellGroupConfig* for EN-DC (Table 7.1.1.1.8.3.3-1)

Derivation Path: 38.508-1 [4], Table 4.6.3-19 with condition PSCell_change			
Information Element	Value/remark	Comment	Condition
<i>CellGroupConfig</i> ::= SEQUENCE {			
<i>spCellConfig</i> SEQUENCE {			
<i>spCellConfigCommon</i>	ServingCellConfigCommon		
<i>reconfigurationWithSync</i> SEQUENCE {			
<i>rach-ConfigDedicated</i> CHOICE {			
<i>uplink</i>	RACH-ConfigDedicated		
}			
<i>newUE-Identity</i>	UE identity different from NR cell 1 UE identity		
}			
}			

Table 7.1.1.1.8.3.3-2A: *CellGroupConfig* for NR/5GC (Table 7.1.1.1.8.3.3-1A)

Derivation Path: 38.508-1 [4], Table 4.6.3-19 with condition PCell_change			
Information Element	Value/remark	Comment	Condition

CellGroupConfig ::= SEQUENCE {			
spCellConfig SEQUENCE {			
reconfigurationWithSync SEQUENCE {			
spCellConfigCommon	ServingCellConfigCommon		
rach-ConfigDedicated CHOICE {			
uplink	RACH-ConfigDedicated		
}			
newUE-Identity	UE identity different from NR cell 1 UE identity		
}			
}			

Table 7.1.1.1.8.3.3-3: RACH-ConfigDedicated (Table 7.1.1.1.8.3.3-2 and Table 7.1.1.1.8.3.3-2A)

Derivation Path: TS 38.508-1 [4], Table 4.6.3-129			
Information Element	Value/remark	Comment	Condition
RACH-ConfigDedicated ::= SEQUENCE {			
cfra-TwoStep-r16 SEQUENCE {			
occasionsTwoStepRA-r16 SEQUENCE {			
rach-ConfigGenericTwoStepRA-r16	RACH-ConfigGenericTwoStepRA		
ssb-PerRACH-OccasionTwoStepRA-r16			
}			
msgA-CFRA-PUSCH-r16	MsgA-PUSCH-Resource		
msgA-TransMax-r16	N10		
resourcesTwoStep-r16 SEQUENCE {			
ssb-ResourceList SEQUENCE (SIZE(1..maxRA-SSB-Resources)) OF CFRA-SSB-Resource {			
ssb	0		
ra-PreambleIndex	52	Randomly selected	
msgA-PUSCH-Resource-Index-r16	Not present		
}			
ra-ssb-OccasionMaskIndex	0		
}			
}			

Table 7.1.1.1.8.3.3-4: RACH-ConfigGeneric (Table 7.1.1.1.8.3.3-3)

Derivation Path: TS 38.508-1 [4], Table 4.6.3-129			
Information Element	Value/remark	Comment	Condition
RACH-ConfigGeneric ::= SEQUENCE {			
prach-ConfigurationIndex	14 149		FR1 FR2
zeroCorrelationZoneConfig	12 15		FR1 FR2
}			

Table 7.1.1.1.8.3.3-5: RACH-ConfigGenericTwoStepRA (Table 7.1.1.1.8.3.3-3 and Table 7.1.1.1.8.3.3-3A)

Derivation Path: TS 38.508-1 [4], Table 4.6.3-130A			
Information Element	Value/remark	Comment	Condition
RACH-ConfigGenericTwoStepRA ::= SEQUENCE {			
msgA-PRACH-ConfigurationIndex-r16	Not present		
msgA-RO-FDM-r16	Not present		
msgA-RO-FrequencyStart-r16	Not present		
msgA-ZeroCorrelationZoneConfig-r16	Not present		

msgA-PreamblePowerRampingStep-r16	Not present		
msgA-PreambleReceivedTargetPower-r16	Not present		
}			

Table 7.1.1.1.8.3.3-6: ServingCellConfigCommon (Table 7.1.1.1.8.3.3-2 and Table 7.1.1.1.8.3.3-2A)

Derivation Path: TS 38.508-1 [4], Table 4.6.3-168			
Information Element	Value/remark	Comment	Condition
ServingCellConfigCommon ::= SEQUENCE {			
uplinkConfigCommon SEQUENCE {			
initialUplinkBWP	BWP-UplinkCommon		
}			
tdd-UL-DL-ConfigurationCommon	TDD-UL-DL- ConfigCommon		
}			

Table 7.1.1.1.8.3.3-7: BWP-UplinkCommon (Table 7.1.1.1.8.3.3-6)

Derivation Path: TS 38.508-1 [4], Table 4.6.3-10			
Information Element	Value/remark	Comment	Condition
BWP-UplinkCommon ::= SEQUENCE {			
rach-ConfigCommon CHOICE {			
setup	RACH-ConfigCommon		
}			
msgA-ConfigCommon-r16 CHOICE {			
setup	MsgA-ConfigCommon		
}			
}			

Table 7.1.1.1.8.3.3-8: RACH-ConfigCommon (Table 7.1.1.1.8.3.3-7)

Derivation Path: TS 38.508-1 [4], Table 4.6.3-128			
Information Element	Value/remark	Comment	Condition
RACH-ConfigCommon ::= SEQUENCE {			
rach-ConfigGeneric	RACH-ConfigGeneric		
ssb_perRACH_OccasionAndCB_PreamblesPerSSB CHOICE {			
one	n36		
}			
prach-RootSequenceIndex CHOICE {			
l139	Set according to table 4.4.2-2 in TS 38.508-1 [4] for the NR Cell.		
l839	Set according to table 4.4.2-2 in TS 38.508-1 [4] for the NR Cell.	PRACH Preamble format 0 used	FR1,
}			
}			

Table 7.1.1.1.8.3.3-9: MsgA-ConfigCommon (Table 7.1.1.1.8.3.3-7)

Derivation Path: TS 38.508-1 [4], Table 4.6.3-81A			
Information Element	Value/remark	Comment	Condition
MsgA-ConfigCommonL-r16 ::= SEQUENCE {			
rach-ConfigCommonTwoStepRA-r16	RACH- ConfigCommonTwoStep RA		
msgA-PUSCH-Config-r16	MsgA-PUSCH-Config		
}			

Table 7.1.1.1.8.3.3-10: TDD-UL-DL-ConfigCommon (Table 7.1.1.1.8.3.3-6)

Derivation Path: TS 38.508-1 [4], Table 4.6.3-192			
Information Element	Value/remark	Comment	Condition
TDD-UL-DL-ConfigCommon ::= SEQUENCE {			
referenceSubcarrierSpacing	SubcarrierSpacing		
pattern1 SEQUENCE {			
dl-UL-TransmissionPeriodicity	ms5		FR1 SCS 30
	ms5		FR1 SCS 15
	ms0p625		FR2
nrofDownlinkSlots	3		FR1 SCS 30
	1		FR1 SCS 15
	3		FR2
nrofDownlinkSymbols	6		FR1 SCS 30
	10		FR1 SCS 15
	10		FR2
nrofUplinkSlots	2		FR1 SCS 30
	1		FR1 SCS 15
	1		FR2
nrofUplinkSymbols	4		FR1 SCS 30
	2		FR1 SCS 15
	2		FR2
dl-UL-TransmissionPeriodicity-v1530	ms3		FR1 SCS 30 or FR1 SCS 15
}			
pattern2	Not present		
pattern2 SEQUENCE {			FR1 SCS 30 or FR1 SCS 15
dl-UL-TransmissionPeriodicity	ms2		
nrofDownlinkSlots	4		FR1 SCS 30
	2		FR1 SCS 15
nrofDownlinkSymbols	0		
nrofUplinkSlots	0		
nrofUplinkSymbols	0		
}			
}			

Table 7.1.1.1.8.3.3-11: RACH-ConfigCommonTwoStepRA (Table 7.1.1.1.8.3.3-7)

Derivation Path: TS 38.508-1 [4], Table 4.6.3-128A			
Information Element	Value/remark	Comment	Condition
RACH-ConfigCommonTwoStepRA-r16 ::= SEQUENCE {			
msgA-RSRP-Threshold-r16	87	-70 dBm	

Table 7.1.1.1.8.3.3-12: MsgA-PUSCH-Config (Table 7.1.1.1.8.3.3-7)

Derivation Path: TS 38.508-1 [4], Table 4.6.3-81B			
---	--	--	--

7.1.1.1.9 Random access procedure / Successful / 2-step RACH/C-RNTI Based / Preamble selected by MAC itself

7.1.1.1.9.1 Test Purpose (TP)

(1)

```
with { UE in RRC_Connected state after NR SpCell TimeAlignmentTimer expired, and has UL Data to send }
ensure that {
  when { the UL MAC PDU Size is less than ra-MsgA-SizeGroupA }
```

```

    then { UE transmits a MSGA using a preamble in group A of random access preambles }
  }

```

(2)

```

with { UE in RRC_Connected state after transmission of a MSGA on NR SpCell }
ensure that {
  when { SS does not answer with a matching MSGB within msgB-ResponseWindow }
  then { UE retransmits a MSGA using a preamble from same group }
}

```

(3)

```

with { UE in RRC_Connected state after transmission of a MSGA on NR SpCell }
ensure that {
  when { SS sends a MSGB including a Backoff Indicator and the Random Access Preamble identifier is
different from the value received from UE }
  then { UE performs the Random Access Resource selection procedure for 2-step RA type Random
Access after a random time between 0 and the indicated Backoff parameter from same group }
}

```

(4)

```

with { UE in RRC_Connected state after NR SpCell TimeAlignmentTimer expired, and has UL Data to send
}
ensure that {
  when { the UL MAC PDU Size is greater than messageSizeGroupA }
  then { UE transmits a MSGA using a preamble in group B of random access preambles }
}

```

(5)

```

with { UE in RRC_Connected state and having initiated a 2-step RA type Random Access procedure in NR
SpCell }
ensure that {
  when { SS transmits a Timing Advance Command in a MSGB message }
  then { UE applies the received Timing Advance value in the next transmitted MAC PDU }
}

```

7.1.1.1.9.2 Conformance requirements

References: The conformance requirements covered in the present TC are specified in: 3GPP TS 38,321, clause 5.1.2a, 5.1.3a, 5.1.4a, 5.1.5 and 5.2. Unless otherwise stated these are Rel-16 requirements.

[TS 38.321, clause 5.1.2a]

If the selected *RA_TYPE* is set to *2-stepRA*, the MAC entity shall:

- 1> if the contention-free 2-step RA type Resources associated with SSBs have been explicitly provided in *rach-ConfigDedicated* and at least one SSB with SS-RSRP above *msgA-RSRP-ThresholdSSB* amongst the associated SSBs is available:
 - 2> select an SSB with SS-RSRP above *msgA-RSRP-ThresholdSSB* amongst the associated SSBs;
 - 2> set the *PREAMBLE_INDEX* to a *ra-PreambleIndex* corresponding to the selected SSB.
- 1> else (i.e. for the contention-based Random Access Preamble selection):
 - 2> if at least one of the SSBs with SS-RSRP above *msgA-RSRP-ThresholdSSB* is available:
 - 3> select an SSB with SS-RSRP above *msgA-RSRP-ThresholdSSB*.
 - 2> else:
 - 3> select any SSB.
 - 2> if contention-free Random Access Resources for 2-step RA type have not been configured and if Random Access Preambles group has not yet been selected during the current Random Access procedure:

- 3> if Random Access Preambles group B for 2-step RA type is configured:
 - 4> if the potential MSGA payload size (UL data available for transmission plus MAC subheader and, where required, MAC CEs) is greater than the *ra-MsgA-SizeGroupA* and the pathloss is less than *PCMAX* (of the Serving Cell performing the Random Access Procedure) – *msgA-PreambleReceivedTargetPower* – *msgA-DeltaPreamble* – *messagePowerOffsetGroupB*; or
 - 4> if the Random Access procedure was initiated for the CCCH logical channel and the CCCH SDU size plus MAC subheader is greater than *ra-MsgA-SizeGroupA*:
 - 5> select the Random Access Preambles group B.
 - 4> else:
 - 5> select the Random Access Preambles group A.
- 3> else:
 - 4> select the Random Access Preambles group A.
- 2> else if contention-free Random Access Resources for 2-step RA type have been configured and if Random Access Preambles group has not yet been selected during the current Random Access procedure:
 - 3> if Random Access Preambles group B for 2-step RA type is configured; and
 - 3> if the transport block size of the MSGA payload configured in the *rach-ConfigDedicated* corresponds to the transport block size of the MSGA payload associated with Random Access Preambles group B:
 - 4> select the Random Access Preambles group B.
 - 3> else:
 - 4> select the Random Access Preambles group A.
- 2> else (i.e. Random Access preambles group has been selected during the current Random Access procedure):
 - 3> select the same group of Random Access Preambles as was used for the Random Access Preamble transmission attempt corresponding to the earlier transmission of MSGA.
 - 2> select a Random Access Preamble randomly with equal probability from the 2-step RA type Random Access Preambles associated with the selected SSB and the selected Random Access Preambles group;
 - 2> set the *PREAMBLE_INDEX* to the selected Random Access Preamble.
- 1> determine the next available PRACH occasion from the PRACH occasions corresponding to the selected SSB permitted by the restrictions given by the *msgA-SSB-SharedRO-MaskIndex* if configured and *ra-ssb-OccasionMaskIndex* if configured (the MAC entity shall select a PRACH occasion randomly with equal probability among the consecutive PRACH occasions allocated for 2-step RA type according to clause 8.1 of TS 38.213 [6], corresponding to the selected SSB; the MAC entity may take into account the possible occurrence of measurement gaps when determining the next available PRACH occasion corresponding to the selected SSB);
- 1> if the Random Access Preamble was not selected by the MAC entity among the contention-based Random Access Preamble(s):
 - 2> select a PUSCH occasion from the PUSCH occasions configured in *msgA-CFRA-PUSCH* corresponding to the PRACH slot of the selected PRACH occasion, according to *msgA-PUSCH-resource-Index* corresponding to the selected SSB;
 - 2> determine the UL grant and the associated HARQ information for the MSGA payload in the selected PUSCH occasion;
 - 2> deliver the UL grant and the associated HARQ information to the HARQ entity.
- 1> else:
 - 2> select a PUSCH occasion corresponding to the selected preamble and PRACH occasion according to clause 8.1A of TS 38.213 [6];

- 2> determine the UL grant for the MSGA payload according to the PUSCH configuration associated with the selected Random Access Preambles group and determine the associated HARQ information;
- 2> if the selected preamble and PRACH occasion is mapped to a valid PUSCH occasion as specified in clause 8.1A of TS 38.213 [6]:
 - 3> deliver the UL grant and the associated HARQ information to the HARQ entity.

1> perform the MSGA transmission procedure (see clause 5.1.3a).

NOTE: To determine if there is an SSB with $SS-RSRP$ above $msgA-RSRP-ThresholdSSB$, the UE uses the latest unfiltered $L1-RSRP$ measurement.

[TS 38.321, clause 5.1.3a]

The MAC entity shall, for each MSGA:

- 1> if $PREAMBLE_TRANSMISSION_COUNTER$ is greater than one; and
- 1> if the notification of suspending power ramping counter has not been received from lower layers; and
- 1> if LBT failure indication was not received from lower layers for the last MSGA Random Access Preamble transmission; and
- 1> if SSB selected is not changed from the selection in the last Random Access Preamble transmission:
 - 2> increment $PREAMBLE_POWER_RAMPING_COUNTER$ by 1.
- 1> select the value of $DELTA_PREAMBLE$ according to clause 7.3;
- 1> set $PREAMBLE_RECEIVED_TARGET_POWER$ to $msgA-PreambleReceivedTargetPower + DELTA_PREAMBLE + (PREAMBLE_POWER_RAMPING_COUNTER - 1) \times PREAMBLE_POWER_RAMPING_STEP$;
- 1> if this is the first MSGA transmission within this Random Access procedure:
 - 2> if the transmission is not being made for the CCCH logical channel:
 - 3> indicate to the Multiplexing and assembly entity to include a C-RNTI MAC CE in the subsequent uplink transmission.
 - 2> if the Random Access procedure was initiated for SpCell beam failure recovery and $spCell-BFR-CBRA$ with value *true* is configured:
 - 3> indicate to the Multiplexing and assembly entity to include a BFR MAC CE or a Truncated BFR MAC CE in the subsequent uplink transmission.
 - 2> obtain the MAC PDU to transmit from the Multiplexing and assembly entity according to the HARQ information determined for the MSGA payload (see clause 5.1.2a) and store it in the MSGA buffer.
- 1> compute the MSGB-RNTI associated with the PRACH occasion in which the Random Access Preamble is transmitted;
- 1> instruct the physical layer to transmit the MSGA using the selected PRACH occasion and the associated PUSCH resource of MSGA (if the selected preamble and PRACH occasion is mapped to a valid PUSCH occasion), using the corresponding RA-RNTI, MSGB-RNTI, $PREAMBLE_INDEX$, $PREAMBLE_RECEIVED_TARGET_POWER$, $msgA-PreambleReceivedTargetPower$, and the amount of power ramping applied to the latest MSGA preamble transmission (i.e. $(PREAMBLE_POWER_RAMPING_COUNTER - 1) \times PREAMBLE_POWER_RAMPING_STEP$);
- 1> if LBT failure indication is received from lower layers for the transmission of this MSGA Random Access Preamble:
 - 2> instruct the physical layer to cancel the transmission of the MSGA payload on the associated PUSCH resource;
 - 2> if $lbt-FailureRecoveryConfig$ is configured:

- 3> perform the Random Access Resource selection procedure for 2-step RA type (see clause 5.1.2a).
- 2> else:
 - 3> increment *PREAMBLE_TRANSMISSION_COUNTER* by 1;
 - 3> if *PREAMBLE_TRANSMISSION_COUNTER* = *preambleTransMax* + 1:
 - 4> indicate a Random Access problem to upper layers;
 - 4> if this Random Access procedure was triggered for SI request:
 - 5> consider this Random Access procedure unsuccessfully completed.
 - 3> if the Random Access procedure is not completed:
 - 4> if *msgA-TransMax* is applied (see clause 5.1.1a) and *PREAMBLE_TRANSMISSION_COUNTER* = *msgA-TransMax* + 1:
 - 5> set the *RA_TYPE* to *4-stepRA*;
 - 5> perform initialization of variables specific to Random Access type as specified in clause 5.1.1a;
 - 5> if the Msg3 buffer is empty:
 - 6> obtain the MAC PDU to transmit from the MSGA buffer and store it in the Msg3 buffer;
 - 5> flush HARQ buffer used for the transmission of MAC PDU in the MSGA buffer;
 - 5> discard explicitly signalled contention-free 2-step RA type Random Access Resources, if any;
 - 5> perform the Random Access Resource selection procedure as specified in clause 5.1.2.
 - 4> else:
 - 5> perform the Random Access Resource selection procedure for 2-step RA type (see clause 5.1.2a).

NOTE: The MSGA transmission includes the transmission of the PRACH Preamble as well as the contents of the MSGA buffer in the PUSCH resource corresponding to the selected PRACH occasion and *PREAMBLE_INDEX* (see TS 38.213 [6])

The MSGB-RNTI associated with the PRACH occasion in which the Random Access Preamble is transmitted, is computed as:

$$\text{MSGB-RNTI} = 1 + s_id + 14 \times t_id + 14 \times 80 \times f_id + 14 \times 80 \times 8 \times ul_carrier_id + 14 \times 80 \times 8 \times 2$$

where *s_id* is the index of the first OFDM symbol of the PRACH occasion ($0 \leq s_id < 14$), *t_id* is the index of the first slot of the PRACH occasion in a system frame ($0 \leq t_id < 80$), where the subcarrier spacing to determine *t_id* is based on the value of μ specified in clause 5.3.2 in TS 38.211 [8], *f_id* is the index of the PRACH occasion in the frequency domain ($0 \leq f_id < 8$), and *ul_carrier_id* is the UL carrier used for Random Access Preamble transmission (0 for NUL carrier, and 1 for SUL carrier). The RA-RNTI is calculated as specified in clause 5.1.3.

[TS 38.321, clause 5.1.4a]

Once the MSGA preamble is transmitted, regardless of the possible occurrence of a measurement gap, the MAC entity shall:

- 1> start the *msgB-ResponseWindow* at the PDCCH occasion as specified in TS 38.213 [6], clause 8.2A;
- 1> monitor the PDCCH of the SpCell for a Random Access Response identified by MSGB-RNTI while the *msgB-ResponseWindow* is running;
- 1> if C-RNTI MAC CE was included in the MSGA:
 - 2> monitor the PDCCH of the SpCell for Random Access Response identified by the C-RNTI while the *msgB-ResponseWindow* is running.
- 1> if notification of a reception of a PDCCH transmission of the SpCell is received from lower layers:

- 2> if the C-RNTI MAC CE was included in MSGA:
 - 3> if the Random Access procedure was initiated for SpCell beam failure recovery (as specified in clause 5.17) and the PDCCH transmission is addressed to the C-RNTI:
 - 4> consider this Random Access Response reception successful;
 - 4> stop the *msgB-ResponseWindow*;
 - 4> consider this Random Access procedure successfully completed.
 - 3> else if the *timeAlignmentTimer* associated with the PTAG is running:
 - 4> if the PDCCH transmission is addressed to the C-RNTI and contains a UL grant for a new transmission:
 - 5> consider this Random Access Response reception successful;
 - 5> stop the *msgB-ResponseWindow*;
 - 5> consider this Random Access procedure successfully completed.
 - 3> else:
 - 4> if a downlink assignment has been received on the PDCCH for the C-RNTI and the received TB is successfully decoded:
 - 5> if the MAC PDU contains the Absolute Timing Advance Command MAC CE:
 - 6> process the received Timing Advance Command (see clause 5.2);
 - 6> consider this Random Access Response reception successful;
 - 6> stop the *msgB-ResponseWindow*;
 - 6> consider this Random Access procedure successfully completed and finish the disassembly and demultiplexing of the MAC PDU.
- 2> if a valid (as specified in TS 38.213 [6]) downlink assignment has been received on the PDCCH for the MSGB-RNTI and the received TB is successfully decoded:
 - 3> if the MSGB contains a MAC subPDU with Backoff Indicator:
 - 4> set the *PREAMBLE_BACKOFF* to value of the BI field of the MAC subPDU using Table 7.2-1, multiplied with *SCALING_FACTOR_BI*.
 - 3> else:
 - 4> set the *PREAMBLE_BACKOFF* to 0 ms.
 - 3> if the MSGB contains a fallbackRAR MAC subPDU; and
 - 3> if the Random Access Preamble identifier in the MAC subPDU matches the transmitted *PREAMBLE_INDEX* (see clause 5.1.3a):
 - 4> consider this Random Access Response reception successful;
 - 4> apply the following actions for the SpCell:
 - 5> process the received Timing Advance Command (see clause 5.2);
 - 5> indicate the *msgA-PreambleReceivedTargetPower* and the amount of power ramping applied to the latest Random Access Preamble transmission to lower layers (i.e. $(PREAMBLE_POWER_RAMPING_COUNTER - 1) \times PREAMBLE_POWER_RAMPING_STEP$);
 - 5> if the Random Access Preamble was not selected by the MAC entity among the contention-based Random Access Preamble(s):

- 6> consider the Random Access procedure successfully completed;
- 6> process the received UL grant value and indicate it to the lower layers.
- 5> else:
 - 6> set the *TEMPORARY_C-RNTI* to the value received in the Random Access Response;
 - 6> if the Msg3 buffer is empty:
 - 7> obtain the MAC PDU to transmit from the MSGA buffer and store it in the Msg3 buffer;
 - 6> process the received UL grant value and indicate it to the lower layers and proceed with Msg3 transmission.

NOTE: If within a 2-step RA type procedure, an uplink grant provided in the fallback RAR has a different size than the MSGA payload, the UE behaviour is not defined.

- 3> else if the MSGB contains a successRAR MAC subPDU; and
- 3> if the CCCH SDU was included in the MSGA and the UE Contention Resolution Identity in the MAC subPDU matches the CCCH SDU:
 - 4> stop *msgB-ResponseWindow*;
 - 4> if this Random Access procedure was initiated for SI request:
 - 5> indicate the reception of an acknowledgement for SI request to upper layers.
 - 4> else:
 - 5> set the C-RNTI to the value received in the *successRAR*;
 - 5> apply the following actions for the SpCell:
 - 6> process the received Timing Advance Command (see clause 5.2);
 - 6> indicate the *msgA-PreambleReceivedTargetPower* and the amount of power ramping applied to the latest Random Access Preamble transmission to lower layers (i.e. $(\text{PREAMBLE_POWER_RAMPING_COUNTER} - 1) \times \text{PREAMBLE_POWER_RAMPING_STEP}$).
 - 4> deliver the *TPC*, *PUCCH resource Indicator*, *ChannelAccess-CPext* (if indicated), and *HARQ feedback Timing Indicator* received in successRAR to lower layers.
 - 4> consider this Random Access Response reception successful;
 - 4> consider this Random Access procedure successfully completed;
 - 4> finish the disassembly and demultiplexing of the MAC PDU.
- 1> if *msgB-ResponseWindow* expires, and the Random Access Response Reception has not been considered as successful based on descriptions above:
 - 2> increment *PREAMBLE_TRANSMISSION_COUNTER* by 1;
 - 2> if *PREAMBLE_TRANSMISSION_COUNTER* = *preambleTransMax* + 1:
 - 3> indicate a Random Access problem to upper layers;
 - 3> if this Random Access procedure was triggered for SI request:
 - 4> consider this Random Access procedure unsuccessfully completed.
 - 2> if the Random Access procedure is not completed:
 - 3> if *msgA-TransMax* is applied (see clause 5.1.1a) and *PREAMBLE_TRANSMISSION_COUNTER* = *msgA-TransMax* + 1:

- 4> set the *RA_TYPE* to *4-stepRA*;
- 4> perform initialization of variables specific to Random Access type as specified in clause 5.1.1a;
- 4> if the *Msg3* buffer is empty:
 - 5> obtain the MAC PDU to transmit from the *MSG3* buffer and store it in the *Msg3* buffer;
 - 4> flush HARQ buffer used for the transmission of MAC PDU in the *MSG3* buffer;
 - 4> discard explicitly signalled contention-free 2-step RA type Random Access Resources, if any;
 - 4> perform the Random Access Resource selection procedure as specified in clause 5.1.2.
- 3> else:
 - 4> select a random backoff time according to a uniform distribution between 0 and the *PREAMBLE_BACKOFF*;
 - 4> if the criteria (as defined in clause 5.1.2a) to select contention-free Random Access Resources is met during the backoff time:
 - 5> perform the Random Access Resource selection procedure for 2-step RA type Random Access (see clause 5.1.2a).
 - 4> else:
 - 5> perform the Random Access Resource selection procedure for 2-step RA type Random Access (see clause 5.1.2a) after the backoff time.

Upon receiving a fallbackRAR, the MAC entity may stop *msgB-ResponseWindow* once the Random Access Response reception is considered as successful.

[TS 38.321, clause 5.1.5]

Once *Msg3* is transmitted the MAC entity shall:

- 1> start the *ra-ContentionResolutionTimer* and restart the *ra-ContentionResolutionTimer* at each HARQ retransmission in the first symbol after the end of the *Msg3* transmission;
- 1> monitor the PDCCH while the *ra-ContentionResolutionTimer* is running regardless of the possible occurrence of a measurement gap;
- 1> if notification of a reception of a PDCCH transmission of the SpCell is received from lower layers:
 - 2> if the C-RNTI MAC CE was included in *Msg3*:
 - 3> if the Random Access procedure was initiated for SpCell beam failure recovery (as specified in clause 5.17) and the PDCCH transmission is addressed to the C-RNTI; or
 - 3> if the Random Access procedure was initiated by a PDCCH order and the PDCCH transmission is addressed to the C-RNTI; or
 - 3> if the Random Access procedure was initiated by the MAC sublayer itself or by the RRC sublayer and the PDCCH transmission is addressed to the C-RNTI and contains a UL grant for a new transmission:
 - 4> consider this Contention Resolution successful;
 - 4> stop *ra-ContentionResolutionTimer*;
 - 4> discard the *TEMPORARY_C-RNTI*;
 - 4> consider this Random Access procedure successfully completed.
 - 2> else if the CCCH SDU was included in *Msg3* and the PDCCH transmission is addressed to its *TEMPORARY_C-RNTI*:
 - 3> if the MAC PDU is successfully decoded:

- 4> stop *ra-ContentionResolutionTimer*;
- 4> if the MAC PDU contains a UE Contention Resolution Identity MAC CE; and
- 4> if the UE Contention Resolution Identity in the MAC CE matches the CCCH SDU transmitted in *Msg3*:
 - 5> consider this Contention Resolution successful and finish the disassembly and demultiplexing of the MAC PDU;
 - 5> if this Random Access procedure was initiated for SI request:
 - 6> indicate the reception of an acknowledgement for SI request to upper layers.
 - 5> else:
 - 6> set the *C-RNTI* to the value of the *TEMPORARY_C-RNTI*;
 - 5> discard the *TEMPORARY_C-RNTI*;
 - 5> consider this Random Access procedure successfully completed.
- 4> else:
 - 5> discard the *TEMPORARY_C-RNTI*;
 - 5> consider this Contention Resolution not successful and discard the successfully decoded MAC PDU.
- 1> if *ra-ContentionResolutionTimer* expires:
 - 2> discard the *TEMPORARY_C-RNTI*;
 - 2> consider the Contention Resolution not successful.
- 1> if the Contention Resolution is considered not successful:
 - 2> flush the HARQ buffer used for transmission of the MAC PDU in the *Msg3* buffer;
 - 2> increment *PREAMBLE_TRANSMISSION_COUNTER* by 1;
 - 2> if $PREAMBLE_TRANSMISSION_COUNTER = preambleTransMax + 1$:
 - 3> indicate a Random Access problem to upper layers.
 - 3> if this Random Access procedure was triggered for SI request:
 - 4> consider the Random Access procedure unsuccessfully completed.
 - 2> if the Random Access procedure is not completed:
 - 3> if the *RA_TYPE* is set to *4-stepRA*:
 - 4> select a random backoff time according to a uniform distribution between 0 and the *PREAMBLE_BACKOFF*;
 - 4> if the criteria (as defined in clause 5.1.2) to select contention-free Random Access Resources is met during the backoff time:
 - 5> perform the Random Access Resource selection procedure (see clause 5.1.2);
 - 4> else:
 - 5> perform the Random Access Resource selection procedure (see clause 5.1.2) after the backoff time.
 - 3> else (i.e. the *RA_TYPE* is set to *2-stepRA*):

- 4> if *msgA-TransMax* is applied (see clause 5.1.1a) and *PREAMBLE_TRANSMISSION_COUNTER* = *msgA-TransMax* + 1:
 - 5> set the *RA_TYPE* to *4-stepRA*;
 - 5> perform initialization of variables specific to Random Access type as specified in clause 5.1.1a;
 - 5> flush HARQ buffer used for the transmission of MAC PDU in the MSGA buffer;
 - 5> discard explicitly signalled contention-free 2-step RA type Random Access Resources, if any;
 - 5> perform the Random Access Resource selection as specified in clause 5.1.2.
- 4> else:
 - 5> select a random backoff time according to a uniform distribution between 0 and the *PREAMBLE_BACKOFF*;
 - 5> if the criteria (as defined in clause 5.1.2a) to select contention-free Random Access Resources is met during the backoff time:
 - 6> perform the Random Access Resource selection procedure for 2-step RA type as specified in clause 5.1.2a.
 - 5> else:
 - 6> perform the Random Access Resource selection for 2-step RA type procedure (see clause 5.1.2a) after the backoff time.

[TS 38.321, clause 5.2]

RRC configures the following parameters for the maintenance of UL time alignment:

- *timeAlignmentTimer* (per TAG) which controls how long the MAC entity considers the Serving Cells belonging to the associated TAG to be uplink time aligned.

The MAC entity shall:

- 1> when a Timing Advance Command MAC CE is received, and if an N_{TA} (as defined in TS 38.211 [8]) has been maintained with the indicated TAG:
 - 2> apply the Timing Advance Command for the indicated TAG;
 - 2> start or restart the *timeAlignmentTimer* associated with the indicated TAG.
- 1> when a Timing Advance Command is received in a Random Access Response message for a Serving Cell belonging to a TAG or in a MSGB for an SpCell:
 - 2> if the Random Access Preamble was not selected by the MAC entity among the contention-based Random Access Preamble:
 - 3> apply the Timing Advance Command for this TAG;
 - 3> start or restart the *timeAlignmentTimer* associated with this TAG.
 - 2> else if the *timeAlignmentTimer* associated with this TAG is not running:
 - 3> apply the Timing Advance Command for this TAG;
 - 3> start the *timeAlignmentTimer* associated with this TAG;
 - 3> when the Contention Resolution is considered not successful as described in clause 5.1.5; or
 - 3> when the Contention Resolution is considered successful for SI request as described in clause 5.1.5, after transmitting HARQ feedback for MAC PDU including UE Contention Resolution Identity MAC CE:
 - 4> stop *timeAlignmentTimer* associated with this TAG.

- 2> else:
 - 3> ignore the received Timing Advance Command.
- 1> when an Absolute Timing Advance Command is received in response to a MSGA transmission including C-RNTI MAC CE as specified in clause 5.1.4a:
 - 2> apply the Timing Advance Command for PTAG;
 - 2> start or restart the *timeAlignmentTimer* associated with PTAG.
- 1> when a *timeAlignmentTimer* expires:
 - 2> if the *timeAlignmentTimer* is associated with the PTAG:
 - 3> flush all HARQ buffers for all Serving Cells;
 - 3> notify RRC to release PUCCH for all Serving Cells, if configured;
 - 3> notify RRC to release SRS for all Serving Cells, if configured;
 - 3> clear any configured downlink assignments and configured uplink grants;
 - 3> clear any PUSCH resource for semi-persistent CSI reporting;
 - 3> consider all running *timeAlignmentTimers* as expired;
 - 3> maintain N_{TA} (defined in TS 38.211 [8]) of all TAGs.
 - 2> else if the *timeAlignmentTimer* is associated with an STAG, then for all Serving Cells belonging to this TAG:
 - 3> flush all HARQ buffers;
 - 3> notify RRC to release PUCCH, if configured;
 - 3> notify RRC to release SRS, if configured;
 - 3> clear any configured downlink assignments and configured uplink grants;
 - 3> clear any PUSCH resource for semi-persistent CSI reporting;
 - 3> maintain N_{TA} (defined in TS 38.211 [8]) of this TAG.

When the MAC entity stops uplink transmissions for an SCell due to the fact that the maximum uplink transmission timing difference between TAGs of the MAC entity or the maximum uplink transmission timing difference between TAGs of any MAC entity of the UE is exceeded, the MAC entity considers the *timeAlignmentTimer* associated with the SCell as expired.

The MAC entity shall not perform any uplink transmission on a Serving Cell except the Random Access Preamble and MSGA transmission when the *timeAlignmentTimer* associated with the TAG to which this Serving Cell belongs is not running. Furthermore, when the *timeAlignmentTimer* associated with the PTAG is not running, the MAC entity shall not perform any uplink transmission on any Serving Cell except the Random Access Preamble and MSGA transmission on the SpCell.

7.1.1.1.9.3 Test description

7.1.1.1.9.3.1 Pre-test conditions

Same Pre-test conditions as in clause 7.1.1.0.

7.1.1.1.9.3.2 Test procedure sequence

Table 7.1.1.1.9.3.2-1: Main behaviour

St	Procedure	Message Sequence	TP	Verdict
----	-----------	------------------	----	---------

		U - S	Message		
-	EXCEPTION: Step 1 is performed IF <i>pc_NG_RAN_NR</i> only.	-	-	-	-
1	The SS transmits an updated system information as specified in Table 7.1.1.1.9.3.3-2.	-	-	-	-
2	SS transmits an RRCReconfiguration message to configure 2-Step and RA type Random Access Resources. (Note 1)	<--	RRCReconfiguration	-	-
3	The UE transmits RRCReconfigurationComplete message. (Note 2)	-->	RRCReconfigurationComplete	-	-
4	SS transmits Timing Advance command to SpCell. SS does not send any subsequent timing alignments. Start Timer_T1 = Time Alignment timer value on SS.	<--	MAC PDU (Timing Advance Command MAC CE)	-	-
5	40 to 50 TTI before Timer_T1 expires the SS transmits a MAC PDU containing a PDCP SDU of size 56 bits, less than <i>ra-MsgA-SizeGroupA</i> (208 bits) on SpCell. (Note 3)	<--	MAC PDU	-	-
6	The SS ignores scheduling requests and does not allocate any uplink grant.	-	-	-	-
7	Check: Does the UE transmit MSGA using preamble on PRACH in group A?	-->	MAC PDU (including C-RNTI MAC CE)	1	P
8	Check: Does the UE re-transmit MSGA using a preamble on PRACH in the same group A after expiry of <i>msgB-ResponseWindow</i> ?	-->	MAC PDU (including C-RNTI MAC CE)	2	P
9	The SS transmits a MSGB with the Backoff parameter set to value Index field '12' and with the RAPID different from the value received from the UE. The SS sets Timer_T2 to the Backoff value '960' associated with the Index value '12' and starts Timer_T2.	<--	MAC PDU(BI, RAPID)	-	-
10	Check: Does UE transmit MSGA using preamble on PRACH in group A while Timer_T2 is running?	-->	MAC PDU (including C-RNTI MAC CE)	3	P
11	The SS schedules PDCCH transmission for UE C_RNTI and DL MAC PDU containing Absolute Timing Advance Command MAC CE.	<--	MAC PDU(Absolute Timing Advance Command MAC CE)	-	-
-	EXCEPTION: Step 12 is performed IF <i>pc_NG_RAN_NR</i> only.	-	-	-	-
12	The SS transmits an updated system information as specified in Table 7.1.1.1.9.3.3-2.	-	-	-	-
13	SS transmits an RRCReconfiguration message to configure 2-Step RA type Random Access Resources. (Note 1)	<--	RRCReconfiguration	-	-
14	The UE transmits RRCReconfigurationComplete message. (Note 2)	-->	RRCReconfigurationComplete	-	-
15	SS transmits Timing Advance command to SpCell. SS does not send any subsequent timing alignments. Start Timer_T3 = Time Alignment timer value on SS.	<--	MAC PDU (Timing Advance Command MAC CE)	-	-
16	40 to 50 TTI before Timer_T3 expires the SS transmits a MAC PDU containing a PDCP SDU of size 256 bits, more than <i>ra-MsgA-SizeGroupA</i> (208 bits) on SpCell. (Note 4)	<--	MAC PDU	-	-
17	The SS ignores scheduling requests and does not allocate any uplink grant.	-	-	-	-
18	Check: Does the UE transmit MSGA using preamble on PRACH in group B?	-->	MAC PDU (including C-RNTI MAC CE)	4	P
19	SS schedules PDCCH transmission for UE C_RNTI and DL MAC PDU containing Timing Advance Command MAC CE.	<--	MAC PDU(Timing Advance Command MAC CE)	-	-

20	Check: Does the UE transmits a MAC PDU with C-RNTI containing looped back PDCP SDU using the new Timing Advance value?	-->	MAC PDU	5	P
<p>Note 1: For EN-DC the NR <i>RRCReconfiguration</i> message is contained in <i>RRCConnectionReconfiguration</i>.</p> <p>Note 2: For EN-DC the NR <i>RRCReconfigurationComplete</i> message is contained in <i>RRCConnectionReconfigurationComplete</i>.</p> <p>Note 3: MAC PDU size of 56bits is selected to allow UE send status PDU and stays below the limit of ra-MsgA-SizeGroupA.</p> <p>Note 4: MAC PDU size of 256bits is selected to allow UE send status PDU and stays above the limit of ra-MsgA-SizeGroupA.</p>					

7.1.1.1.9.3.3 Specific message contents

Table 7.1.1.1.9.3.3-1: MAC-CellGroupConfig (preamble)

Derivation Path: TS 38.508-1 [4], Table 4.6.3-68			
Information Element	Value/remark	Comment	Condition
MAC-CellGroupConfig ::= SEQUENCE {			
tag-Config SEQUENCE {			
tag-ToAddModList SEQUENCE (SIZE (1..maxNrofTAGs)) OF TAG {	1 entry		
TAG[1] SEQUENCE {		entry 1	
timeAlignmentTimer	ms750		
}			
}			
}			
}			

Table 7.1.1.1.9.3.3-2: SIB1S (steps 1 and 12, Table 7.1.1.1.9.3.2-1)

Derivation path: TS 38.508-1 [4] Table 4.6.1-28			
Information Element	Value/Remark	Comment	Condition
SIB1 ::= SEQUENCE {			
servingCellConfigCommon	ServingCellConfigCommon		
}			

Table 7.1.1.1.9.3.3-3: ServingCellConfigCommon (Table 7.1.1.1.9.3.3-2)

Derivation Path: TS 38.508-1 [4], Table 4.6.3-168			
Information Element	Value/remark	Comment	Condition
ServingCellConfigCommon ::= SEQUENCE {			
uplinkConfigCommon SEQUENCE {			
initialUplinkBWP	BWP-UplinkCommon		
}			
}			

Table 7.1.1.1.9.3.3-4: BWP-UplinkCommon (Table 7.1.1.1.9.3.3-3)

Derivation Path: TS 38.508-1 [4], Table 4.6.3-14			
Information Element	Value/remark	Comment	Condition
BWP-UplinkCommon ::= SEQUENCE {			
msgA-ConfigCommon-r16 CHOICE {			
setup	MsgA-ConfigCommon-r16		
}			
}			

Table 7.1.1.1.9.3.3-5: *MsgA-ConfigCommon-r16* (Table 7.1.1.1.9.3.3-4)

Derivation Path: TS 38.508-1 [4], Table 4.6.3-81A			
Information Element	Value/remark	Comment	Condition
MsgA-ConfigCommon-r16 ::= SEQUENCE {			
rach-ConfigCommonTwoStepRA-r16	RACH-ConfigCommonTwoStepRA-r16		
msgA-PUSCH-Config-r16	MsgA-PUSCH-Config-r16		
}			

Table 7.1.1.1.9.3.3-6: *RACH-ConfigCommonTwoStepRA-r16* (Table 7.1.1.1.9.3.3-5)

Derivation Path: TS 38.508-1 [4], Table 4.6.3-128A			
Information Element	Value/remark	Comment	Condition
RACH-ConfigCommonTwoStepRA-r16 ::= SEQUENCE {			
rach-ConfigGenericTwoStepRA-r16	RACH-ConfigGenericTwoStepRA-r16		
msgA-TotalNumberOfRA-Preambles-r16	8		
msgA-SSB-PerRACH-OccasionAndCB-PreamblesPerSSB-r16 CHOICE {			
two	n4		
}			
groupB-ConfiguredTwoStepRA-r16	GroupB-ConfiguredTwoStepRA-r16		
msgA-PRACH-RootSequenceIndex-r16 CHOICE {			
l839	100		
}			
msgA-TransMax-r16	n4		
msgA-RSRP-ThresholdSSB-r16	56		
msgA-RestrictedSetConfig-r16	unrestrictedSet		
ra-PrioritizationForAccessIdentityTwoStep-r16 SEQUENCE {			
ra-Prioritization-r16	RA-Prioritization	TS 38.508-1 [4], Table 4.6.3-131	
ra-PrioritizationForAI-r16	'00'B		
}			
ra-ContentionResolutionTimer-r16	sf32		
}			

Table 7.1.1.1.9.3.3-7: *RACH-ConfigGenericTwoStepRA-r16* (Table 7.1.1.1.9.3.3-6)

Derivation Path: TS 38.508-1 [4], Table 4.6.3-130A			
Information Element	Value/remark	Comment	Condition
RACH-ConfigGenericTwoStepRA-r16 ::= SEQUENCE {			
msgA-PRACH-ConfigurationIndex-r16	0		
msgA-RO-FDM-r16	one		
msgA-RO-FrequencyStart-r16	0		
msgA-ZeroCorrelationZoneConfig-r16	0		
msgA-PreamblePowerRampingStep-r16	dB2		
msgA-PreambleReceivedTargetPower-r16	-200		
msgB-ResponseWindow-r16	sl80		
preambleTransMax-r16	n4		
}			

Table 7.1.1.1.9.3.3-8: *GroupB-ConfiguredTwoStepRA-r16* (Table 7.1.1.1.9.3.3-6)

Derivation Path: TS 38.331 [6], clause 6.3.2			
Information Element	Value/remark	Comment	Condition

GroupB-ConfiguredTwoStepRA-r16 ::= SEQUENCE {			
ra-MsgA-SizeGroupA	b208		
messagePowerOffsetGroupB	minusinfinity		
numberOfRA-PreamblesGroupA	8		
}			

Table 7.1.1.1.9.3.3-9: *MsgA-PUSCH-Config-r16* (Table 7.1.1.1.9.3.3-5)

Derivation Path: TS 38.508-1 [4], Table 4.6.3-81B			
Information Element	Value/remark	Comment	Condition
MsgA-PUSCH-Config-r16 ::= SEQUENCE {			
msgA-PUSCH-ResourceGroupA-r16	MsgA-PUSCH-Resource-r16		
msgA-PUSCH-ResourceGroupB-r16	MsgA-PUSCH-Resource-r16		
}			

Table 7.1.1.1.9.3.3-10: *MsgA-PUSCH-Resource-r16* (Table 7.1.1.1.9.3.3-9)

Derivation Path: TS 38.331 [6], clause 6.3.2			
Information Element	Value/remark	Comment	Condition
MsgA-PUSCH-Resource-r16 ::= SEQUENCE {			
msgA-MCS-r16	0		
nrofSlotsMsgA-PUSCH-r16	1		
nrofMsgA-PO-PerSlot-r16	one		
msgA-PUSCH-TimeDomainOffset-r16	1		
guardBandMsgA-PUSCH-r16	0		
frequencyStartMsgA-PUSCH-r16	0		
nrofPRBs-PerMsgA-PO-r16	24		
nrofMsgA-PO-FDM-r16	one		
msgA-DMRS-Config-r16	MsgA-DMRS-Config-r16		
nrofDMRS-Sequences-r16	1		
}			

Table 7.1.1.1.9.3.3-11: *MsgA-DMRS-Config-r16* (Table 7.1.1.1.9.3.3-10)

Derivation Path: TS 38.331 [6], clause 6.3.2			
Information Element	Value/remark	Comment	Condition
MsgA-DMRS-Config-r16 ::= SEQUENCE {			
msgA-DMRS-AdditionalPosition-r16	pos0		
msgA-MaxLength-r16	len2		
}			

Table 7.1.1.1.9.3.3-12: *RRCReconfiguration* (steps 2 and 13, Table 7.1.1.1.9.3.2-1)

Derivation Path: TS 38.508-1 [4], Table 4.6.1-13			
Information Element	Value/remark	Comment	Condition
RRCReconfiguration ::= SEQUENCE {			
criticalExtensions CHOICE {			
rrcReconfiguration ::= SEQUENCE {			
secondaryCellGroup	CellGroupConfig	OCTET STRING (CONTAINING CellGroupConfig)	EN-DC
nonCriticalExtension SEQUENCE {			NR
masterCellGroup	CellGroupConfig	OCTET STRING (CONTAINING CellGroupConfig)	
}			
}			
}			

Table 7.1.1.1.9.3.3-13: *CellGroupConfig* (Table 7.1.1.1.9.3.3-12)

Derivation Path: TS 38.508-1 [4], Table 4.6.3-19			
Information Element	Value/remark	Comment	Condition
CellGroupConfig ::= SEQUENCE {			
spCellConfig SEQUENCE {			
reconfigurationWithSync SEQUENCE {			
spCellConfigCommon	ServingCellConfigCommon	Same contents as in Table 7.1.1.1.9.3.3-3	
newUE-Identity	RNTI-Value		
t304	ms2000		
rach-ConfigDedicated	Not present		
}			
}			

7.1.1.1.10 Random access procedure / 2-step RACH/not complete/ RA_TYPE to 4-stepRA

7.1.1.1.10.1 Test Purpose (TP)

(1)

```
with { UE in RRC_Connected state after transmission of a MSGA on NR SpCell }
ensure that {
  when { UE does not receive a matching MSGB in msgB-ResponseWindow and
  PREAMBLE_TRANSMISSION_COUNTER is equal to msgA-TransMax+1 }
  then { UE triggers 4-step RACH procedure on NR SpCell }
}
```

7.1.1.1.10.2 Conformance requirements

References: The conformance requirements covered in the current TC are specified in: TS 38.321, clauses 5.1.1, and 5.1.4a.

[TS 38.321, clause5.1.1]

The Random Access procedure described in this clause is initiated by a PDCCH order, by the MAC entity itself, or by RRC for the events in accordance with TS 38.300 [2]. There is only one Random Access procedure ongoing at any point in time in a MAC entity. The Random Access procedure on an SCell shall only be initiated by a PDCCH order with *ra-PreambleIndex* different from 0b000000.

...

- 1> if the Random Access procedure is initiated by PDCCH order and if the *ra-PreambleIndex* explicitly provided by PDCCH is not 0b000000; or
- 1> if the Random Access procedure was initiated for SI request (as specified in TS 38.331 [5]) and the Random Access Resources for SI request have been explicitly provided by RRC; or
- 1> if the Random Access procedure was initiated for SpCell beam failure recovery (as specified in clause 5.17) and if the contention-free Random Access Resources for beam failure recovery request for 4-step RA type have been explicitly provided by RRC for the BWP selected for Random Access procedure; or
- 1> if the Random Access procedure was initiated for reconfiguration with sync and if the contention-free Random Access Resources for 4-step RA type have been explicitly provided in *rach-ConfigDedicated* for the BWP selected for Random Access procedure:
 - 2> set the *RA_TYPE* to 4-stepRA.
- 1> else if the BWP selected for Random Access procedure is configured with both 2-step and 4-step RA type Random Access Resources and the RSRP of the downlink pathloss reference is above *msgA-RSRP-Threshold*; or

- 1> if the BWP selected for Random Access procedure is only configured with 2-step RA type Random Access resources (i.e. no 4-step RACH RA type resources configured); or
- 1> if the Random Access procedure was initiated for reconfiguration with sync and if the contention-free Random Access Resources for 2-step RA type have been explicitly provided in *rach-ConfigDedicated* for the BWP selected for Random Access procedure:
 - 2> set the *RA_TYPE* to *2-stepRA*.
- 1> else:
 - 2> set the *RA_TYPE* to *4-stepRA*.
- 1> perform initialization of variables specific to Random Access type as specified in clause 5.1.1a;
- 1> if *RA_TYPE* is set to *2-stepRA*:
 - 2> perform the Random Access Resource selection procedure for 2-step RA type (see clause 5.1.2a).
- 1> else:
 - 2> perform the Random Access Resource selection procedure (see clause 5.1.2).

[TS 38.321, clause 5.1.4a]

Once the MSGA preamble is transmitted, regardless of the possible occurrence of a measurement gap, the MAC entity shall:

...

- 1> if *msgB-ResponseWindow* expires, and the Random Access Response Reception has not been considered as successful based on descriptions above:
 - 2> increment *PREAMBLE_TRANSMISSION_COUNTER* by 1;
 - 2> if *PREAMBLE_TRANSMISSION_COUNTER* = *preambleTransMax* + 1:
 - 3> indicate a Random Access problem to upper layers;
 - 3> if this Random Access procedure was triggered for SI request:
 - 4> consider this Random Access procedure unsuccessfully completed.
 - 2> if the Random Access procedure is not completed:
 - 3> if *msgA-TransMax* is applied (see clause 5.1.1a) and *PREAMBLE_TRANSMISSION_COUNTER* = *msgA-TransMax* + 1:
 - 4> set the *RA_TYPE* to *4-stepRA*;
 - 4> perform initialization of variables specific to Random Access type as specified in clause 5.1.1a;
 - 4> if the Msg3 buffer is empty:
 - 5> obtain the MAC PDU to transmit from the MSGA buffer and store it in the Msg3 buffer;
 - 4> flush HARQ buffer used for the transmission of MAC PDU in the MSGA buffer;
 - 4> discard explicitly signalled contention-free 2-step RA type Random Access Resources, if any;
 - 4> perform the Random Access Resource selection procedure as specified in clause 5.1.2.
 - 3> else:
 - 4> select a random backoff time according to a uniform distribution between 0 and the *PREAMBLE_BACKOFF*;

4> if the criteria (as defined in clause 5.1.2a) to select contention-free Random Access Resources is met during the backoff time:

5> perform the Random Access Resource selection procedure for 2-step RA type Random Access (see clause 5.1.2a).

4> else:

5> perform the Random Access Resource selection procedure for 2-step RA type Random Access (see clause 5.1.2a) after the backoff time.

Upon receiving a fallbackRAR, the MAC entity may stop *msgB-ResponseWindow* once the Random Access Response reception is considered as successful.

7.1.1.1.10.3 Test description

7.1.1.1.10.3.1 Pre-test conditions

Same Pre-test conditions as in clause 7.1.1.0.

7.1.1.1.10.3.2 Test procedure sequence

Table 7.1.1.1.10.3.2-1: Main behaviour

St	Procedure	Message Sequence		TP	Verdict
		U - S	Message		
1	SS transmits an RRCReconfiguration message to configure both 2-Step and 4-Step RA type Random Access Resources. Note 1	<--	RRCReconfiguration	-	-
2	The UE transmits RRCReconfigurationComplete message. Note 2	-->	RRCReconfigurationComplete	-	-
3	SS transmits Timing Advance command to SpCell. SS does not send any subsequent timing alignments. Start Timer_T1 = Time Alignment timer value on SS.	<--	MAC PDU (Timing Advance Command MAC Control Element)	-	-
4	40 to 50 TTI before Timer_T1 expires the SS transmits a MAC PDU containing a PDCP SDU	<--	MAC PDU	-	-
5	The SS ignores scheduling requests and does not allocate any uplink grant.	-	-	-	-
-	Exception: Step 6 will be repeated preambleTransMax times and SS does not response the MSGA in STEP 6, to make PREAMBLE_TRANSMISSION_COUNTER = msgA-TransMax+1.	-	-	-	-
6	The UE transmits MSGA using the selected PRACH occasion and the associated PUSCH resource of MSGA	-->	MAC PDU (including C-RNTI MAC CE)	-	-
7	Check: Does the UE transmit preamble on PRACH?	-->	PRACH Preamble	1	P
8	The SS transmits Random Access Response and RAPID corresponding to the transmitted Preamble in step 7.	<--	Random Access Response	-	-
9	UE sends a msg3 using the grant associated to the Random Access Response received in step 8	-->	msg3 (C-RNTI MAC CONTROL ELEMENT)	-	-
10	SS schedules PDCCH transmission for UE C_RNTI and allocate uplink grant.	<--	Contention Resolution	-	-
11	The UE transmits a MAC PDU with C-RNTI containing looped back PDCP SDU	-->	MAC PDU	-	-
Note 1:	for EN-DC the NR RRCReconfiguration message is contained in RRCConnectionReconfiguration.				
Note 2:	for EN-DC the NR RRCReconfigurationComplete message is contained in RRCConnectionReconfigurationComplete.				

7.1.1.1.10.3.3 Specific message contents

Table 7.1.1.1.10.3.3-1: RRCReconfiguration for EN-DC (step 1, Table 7.1.1.1.10.3.2-1)

Derivation Path: 38.508-1 [4], Table 4.6.1-13 with condition EN-DC_HO.			
Information Element	Value/remark	Comment	Condition
RRCReconfiguration ::= SEQUENCE {			
criticalExtensions CHOICE {			
rrcReconfiguration ::= SEQUENCE {			
secondaryCellGroup	CellGroupConfig		
}			
}			
}			

Table 7.1.1.1.10.3.3-1A: RRCReconfiguration for NR/5GC (step 1, Table 7.1.1.1.10.3.2-1)

Derivation Path: 38.508-1 [4], Table 4.6.1-13			
Information Element	Value/remark	Comment	Condition
RRCReconfiguration ::= SEQUENCE {			
criticalExtensions CHOICE {			
radioBearerConfig	RadioBearerConfig as per TS 38.508-1[4] Table 4.6.3-132 with conditions DRBn and Recover_PDCP	n set to the default DRB of the first PDU session	NR
rrcReconfiguration ::= SEQUENCE {			
nonCriticalExtension SEQUENCE {			
masterCellGroup	CellGroupConfig		
}			
}			
}			
}			

Table 7.1.1.1.10.3.3-2: CellGroupConfig for EN-DC (Table 7.1.1.1.10.3.3-1)

Derivation Path: 38.508-1 [4], Table 4.6.3-19 with condition PSCell_change			
Information Element	Value/remark	Comment	Condition
CellGroupConfig ::= SEQUENCE {			
spCellConfig SEQUENCE {			
spCellConfigCommon	ServingCellConfigCommon		
reconfigurationWithSync SEQUENCE {			
rach-ConfigDedicated CHOICE {			
uplink	RACH-ConfigDedicated		
}			
newUE-Identity	UE identity different from NR cell 1 UE identity		
}			
}			

Table 7.1.1.1.10.3.3-2A: CellGroupConfig for NR/5GC (Table 7.1.1.1.10.3.3-1A)

Derivation Path: 38.508-1 [4], Table 4.6.3-19 with condition PCell_change			
Information Element	Value/remark	Comment	Condition
CellGroupConfig ::= SEQUENCE {			
spCellConfig SEQUENCE {			
reconfigurationWithSync SEQUENCE {			
spCellConfigCommon	ServingCellConfigCommon		
rach-ConfigDedicated CHOICE {			
uplink	RACH-ConfigDedicated		

}			
newUE-Identity	UE identity different from NR cell 1 UE identity		
}			
}			
}			

Table 7.1.1.1.10.3.3-3: RACH-ConfigDedicated (Table 7.1.1.1.10.3.3-2 and Table 7.1.1.1.10.3.3-2A)

Derivation Path: TS 38.508-1 [4], Table 4.6.3-129			
Information Element	Value/remark	Comment	Condition
RACH-ConfigDedicated ::= SEQUENCE {			
cfra-TwoStep-r16 SEQUENCE {			
occasionsTwoStepRA-r16 SEQUENCE {			
rach-ConfigGenericTwoStepRA-r16	RACH-ConfigGenericTwoStepRA		
ssb-PerRACH-OccasionTwoStepRA-r16			
}			
msgA-CFRA-PUSCH-r16	MsgA-PUSCH-Resource		
msgA-TransMax-r16	N10		
resourcesTwoStep-r16 SEQUENCE {			
ssb-ResourceList SEQUENCE (SIZE(1..maxRA-SSB-Resources)) OF CFRA-SSB-Resource {			
ssb	0		
ra-PreambleIndex	52	Randomly selected	
msgA-PUSCH-Resource-Index-r16	Not present		
}			
ra-ssb-OccasionMaskIndex	0		
}			
}			

Table 7.1.1.1.10.3.3-4: Void

Table 7.1.1.1.10.3.3-5: RACH-ConfigGenericTwoStepRA (Table 7.1.1.1.10.3.3-3)

Derivation Path: TS 38.508-1 [4], Table 4.6.3-130A			
Information Element	Value/remark	Comment	Condition
RACH-ConfigDedicated ::= SEQUENCE {			
msgA-PRACH-ConfigurationIndex-r16	Not present		
msgA-RO-FDM-r16	Not present		
msgA-RO-FrequencyStart-r16	Not present		
msgA-ZeroCorrelationZoneConfig-r16	Not present		
msgA-PreamblePowerRampingStep-r16	Not present		
msgA-PreambleReceivedTargetPower-r16	Not present		
}			

Table 7.1.1.1.10.3.3-6: ServingCellConfigCommon (Table 7.1.1.1.10.3.3-2 and Table 7.1.1.1.10.3.3-2A)

Derivation Path: TS 38.508-1 [4], Table 4.6.3-168			
Information Element	Value/remark	Comment	Condition
ServingCellConfigCommon ::= SEQUENCE {			
uplinkConfigCommon SEQUENCE {			
initialUplinkBWP	BWP-UplinkCommon		
}			
tdd-UL-DL-ConfigurationCommon	TDD-UL-DL-ConfigCommon		
}			

Table 7.1.1.1.10.3.3-7: BWP-UplinkCommon (Table 7.1.1.1.10.3.3-6)

Derivation Path: TS 38.508-1 [4], Table 4.6.3-10			
Information Element	Value/remark	Comment	Condition
BWP-UplinkCommon ::= SEQUENCE {			
rach-ConfigCommon CHOICE {			
setup	RACH-ConfigCommon		
}			
msgA-ConfigCommon-r16 CHOICE {			
setup	MsgA-ConfigCommon		
}			
}			

Table 7.1.1.1.10.3.3-8: RACH-ConfigCommon (Table 7.1.1.1.10.3.3-7)

Derivation Path: TS 38.508-1 [4], Table 4.6.3-128			
Information Element	Value/remark	Comment	Condition
RACH-ConfigCommon ::= SEQUENCE {			
rach-ConfigGeneric	RACH-ConfigGeneric		
ssb_perRACH_OccasionAndCB_PreamblesPerSSB CHOICE {			
one	n36		
}			
prach-RootSequenceIndex CHOICE {			
l139	Set according to table 4.4.2-2 in TS 38.508-1 [4] for the NR Cell.		
l839	Set according to table 4.4.2-2 in TS 38.508-1 [4] for the NR Cell.	PRACH Preamble format 0 used	FR1,
}			
}			

Table 7.1.1.1.10.3.3-9: MsgA-ConfigCommon (Table 7.1.1.1.10.3.3-7)

Derivation Path: TS 38.508-1 [4], Table 4.6.3-81A			
Information Element	Value/remark	Comment	Condition
MsgA-ConfigCommonL-r16 ::= SEQUENCE {			
rach-ConfigCommonTwoStepRA-r16	RACH-ConfigCommonTwoStepRA		
msgA-PUSCH-Config-r16	MsgA-PUSCH-Config		
}			

Table 7.1.1.1.10.3.3-10: TDD-UL-DL-ConfigCommon (Table 7.1.1.1.10.3.3-6)

Derivation Path: TS 38.508-1 [4], Table 4.6.3-192			
Information Element	Value/remark	Comment	Condition
TDD-UL-DL-ConfigCommon ::= SEQUENCE {			
referenceSubcarrierSpacing	SubcarrierSpacing		
pattern1 SEQUENCE {			
dl-UL-TransmissionPeriodicity	ms5		FR1 SCS 30
	ms5		FR1 SCS 15
	ms0p625		FR2
nrofDownlinkSlots	3		FR1 SCS 30
	1		FR1 SCS 15
	3		FR2
nrofDownlinkSymbols	6		FR1 SCS 30
	10		FR1 SCS 15
	10		FR2

nrofUplinkSlots	2		FR1 SCS 30
	1		FR1 SCS 15
	1		FR2
nrofUplinkSymbols	4		FR1 SCS 30
	2		FR1 SCS 15
	2		FR2
dl-UL-TransmissionPeriodicity-v1530	ms3		FR1 SCS 30 or FR1 SCS 15
}			
pattern2	Not present		
pattern2 SEQUENCE {			FR1 SCS 30 or FR1 SCS 15
dl-UL-TransmissionPeriodicity	ms2		
nrofDownlinkSlots	4		FR1 SCS 30
	2		FR1 SCS 15
nrofDownlinkSymbols	0		
nrofUplinkSlots	0		
nrofUplinkSymbols	0		
}			
}			

Table 7.1.1.1.10.3.3-11: RACH-ConfigCommonTwoStepRA (Table 7.1.1.1.10.3.3-7)

Derivation Path: TS 38.508-1 [4], Table 4.6.3-128A			
Information Element	Value/remark	Comment	Condition
RACH-ConfigCommonTwoStepRA-r16 ::= SEQUENCE {			
msgA-RSRP-Threshold-r16	57	-100 dBm	

Table 7.1.1.1.10.3.3-12: MsgA-PUSCH-Config (Table 7.1.1.1.10.3.3-7)

Derivation Path: TS 38.508-1 [4], Table 4.6.3-81B

7.1.1.1.11 to 7.1.1.1.15

7.1.1.1.16 Random access procedure / RedCap UE identification / Msg3-based / CCCH1

7.1.1.1.16.1 Test Purpose (TP)

(1)

```
with { UE supporting RedCap and in NR RRC_Inactive state }
ensure that {
  when { UE starts Random Access procedure }
  then { the UE uses the RedCap specific LCID in Msg3 }
}
```

7.1.1.1.16.2 Conformance requirements

References: The conformance requirements covered in the present test case are specified in: TS 38.321, clause 6.2.1 and TS38.331, clause 5.3.13.3. Unless otherwise stated these are Rel-17 requirements.

[TS 38.321, clause 6.2.1]

Table 6.2.1-2 Values of LCID for UL-SCH

Codepoint/Index	LCID values
0	CCCH of size 64 bits (referred to as "CCCH1" in TS 38.331 [5]), except for a RedCap UE
1–32	Identity of the logical channel of DCCH and DTCH

33	Extended logical channel ID field (two-octet eLCID field)
34	Extended logical channel ID field (one-octet eLCID field)
35	CCCH of size 48 bits (referred to as "CCCH" in TS 38.331 [5]) for a RedCap UE
36	CCCH of size 64 bits (referred to as "CCCH1" in TS 38.331 [5]) for a RedCap UE
37–42	Reserved
43	Truncated Enhanced BFR (one octet C_i)
44	Timing Advance Report
45	Truncated Sidelink BSR
46	Sidelink BSR
47	Reserved
48	LBT failure (four octets)
49	LBT failure (one octet)
50	BFR (one octet C_i)
51	Truncated BFR (one octet C_i)
52	CCCH of size 48 bits (referred to as "CCCH" in TS 38.331 [5]), except for a RedCap UE
53	Recommended bit rate query
54	Multiple Entry PHR (four octets C_i)
55	Configured Grant Confirmation
56	Multiple Entry PHR (one octet C_i)
57	Single Entry PHR
58	C-RNTI
59	Short Truncated BSR
60	Long Truncated BSR
61	Short BSR
62	Long BSR
63	Padding

[TS 38.331, clause 5.3.13.3]

The UE shall set the contents of *RRCResumeRequest* or *RRCResumeRequest1* message as follows:

- 1> if field *useFullResumeID* is signalled in *SIB1*:
 - 2> select *RRCResumeRequest1* as the message to use;
 - 2> set the *resumeIdentity* to the stored *fullI-RNTI* value;

7.1.1.1.16.3 Test description

7.1.1.1.16.3.1 Pre-test conditions

System Simulator:

- NR Cell 1.

UE:

- None

Preamble:

- The UE is in 2N-A state on NR Cell 1 using generic procedure parameter Connectivity (*NR*) and Test loop function(*Off*) according to TS 38.508-1 [4].

7.1.1.1.16.3.2 Test procedure sequence

Table 7.1.1.1.16.3.2-1: Main behaviour

St	Procedure	Message Sequence		TP	Verdict
		U - S	Message		
1	The SS changes the SIB1 of NR Cell 1 to set the <i>useFullResumeID</i> to True.	-	-	-	-

2	The SS transmits a Short message on PDCCH using P-RNTI indicating a <i>systemInfoModification</i> .	<--	PDCCH (DCI 1_0): Short Message	-	-
3	Wait for 2.1* modification period second for the UE to receive new system information. (Note 1)	-	-	-	-
4	The SS transmits a <i>Paging</i> message including a matched identity (correct <i>fullI-RNTI</i>).	<--	NR RRC: <i>Paging</i>	-	-
5	Check: Does the UE transmit an <i>RRCResumeRequest1</i> message by setting LCID to 36?	-->	NR RRC: <i>RRCResumeRequest1</i>	1	P
6	The SS transmits an <i>RRCResume</i> message.	<--	NR RRC: <i>RRCResume</i>	-	-
7	The UE transmits an <i>RRCResumeComplete</i> message.	-->	NR RRC: <i>RRCResumeComplete</i>	-	-
Note 1: The modification period, expressed in number of radio frames = modificationPeriodCoeff * defaultPagingCycle.					

7.1.1.1.16.3.3 Specific message contents

Table 7.1.1.1.16.3.3-1: SIB1 (step 1, Table 7.1.1.1.16.3.2-1)

Derivation Path: TS 38.508-1 [4], Table 4.6.1-28			
Information Element	Value/remark	Comment	Condition
SIB1 ::= SEQUENCE {			
useFullResumeID	true		
}			

Table 7.1.1.1.16.3.3-2: Paging (step 4, Table 7.1.1.1.16.3.2-1)

Derivation Path: TS 38.508-1 [4], Table 4.6.1-9 with condition NR_RRC_RESUME
--

7.1.1.1.17 Random access procedure / RedCap UE identification / Msg1-based

7.1.1.1.17.1 Test Purpose (TP)

(1)

```
with { UE supporting RedCap and in NR RRC_IDLE state }
ensure that {
  when { UE starts Random Access procedure }
  then { the UE uses the RedCap specific random access resource in Msg1 }
}
```

7.1.1.1.17.2 Conformance requirements

References: The conformance requirements covered in the present test case are specified in: TS 38.321, clauses 5.1.1, 5.1.1b, 5.1.1c and 5.1.1d. Unless otherwise stated these are Rel-17 requirements.

[TS 38.321, clause 5.1.1]

...

When a Random Access procedure is initiated, UE selects a set of Random Access resources as specified in clause 5.1.1b and initialises the following parameters for the Random Access procedure according to the values configured by RRC for the selected set of Random Access resources:

...

- *featurePriorities*: priorities for features, such as REDCAP, Slice group(s), etc. (see clause 5.1.1d);

...

- *startPreambleForThisPartition*: the first preamble associated with the set of Random Access Resources applicable to the Random Access procedure;
- ...
- *numberOfPreamblesForThisPartition*: the number of consecutive preambles associated with the set of Random Access Resources applicable to the Random Access procedure;
- ...

When the Random Access procedure is initiated on a Serving Cell, the MAC entity shall:

- ...
- 1> perform the BWP operation as specified in clause 5.15;
- 1> select the set of Random Access resources applicable to the current Random Access procedure according to clause 5.1.1b;
- ...

[TS 38.321, clause 5.1.1b]

The MAC entity shall:

- ...
- 1> if contention-free Random Access Resources have not been provided for this Random Access procedure and one or more of the features including REDCAP and/or a specific slice group(s) and/or SDT and/or MSG3 repetition is applicable for this Random Access procedure:

Editor's Note: FFS if some clarification is needed on how feature applicability is known (e.g. from RRC etc)

- 2> if none of the sets of Random Access resources are available for the current Random Access procedure (as specified in clause 5.1.1c):
 - 3> select the set of Random Access resources that are not associated with any feature indication (as specified in clause 5.1.1c) for this Random Access procedure.
- 2> else if there are one or more set(s) of Random Access resources available (as specified in clause 5.1.1c) and one of these set(s) of Random Access resources can be used for indicating all features triggering this Random Access procedure:
 - 3> select the available set of Random Access resources for this Random Access procedure.

...

[TS 38.321, clause 5.1.1c]

The MAC entity shall for each set of configured Random Access resources for 4-step RA type and for each set of configured Random Access resources for 2-step RA type:

- 1> if REDCAP indication is configured for a set of Random Access resources:
 - 2> consider the set of Random Access resources as not available for a RACH procedure for which REDCAP indication is not applicable.

...

[TS 38.321, clause 5.1.1d]

The MAC entity shall:

- 1> among the available sets of Random Access resources, identify those configured with a feature which has the highest priority assigned in *featurePriorities* among all the features applicable to this Random Access procedure as specified in TS 38.331 [5].

1> if a single set of Random Access resources is identified:

2> select this set of Random Access resources.

...

7.1.1.1.17.3 Test description

7.1.1.1.17.3.1 Pre-test conditions

System Simulator:

- NR Cell 1.

UE:

- None

Preamble:

- The UE is in 1N-A state on NR Cell 1 using generic procedure parameter Connectivity (*NR*) and Test loop function(*Off*) according to TS 38.508-1 [4].

7.1.1.1.17.3.2 Test procedure sequence

Table 7.1.1.1.17.3.2-1: Main behaviour

St	Procedure	Message Sequence		TP	Verdict
		U - S	Message		
1	The SS changes the SIB1 of NR Cell 1 to configure the specific PRACH resource for RedCap.	-	-	-	-
2	The SS transmits a Short message on PDCCH using P-RNTI indicating a <i>systemInfoModification</i> .	<--	PDCCH (DCI 1_0): Short Message	-	-
3	Wait for 2.1* modification period second for the UE to receive new system information. (Note 1)	-	-	-	-
4	The SS transmits a Paging message including a matched identity.	<--	-	-	-
5	Check: Does the UE transmits Preamble on PRACH with <i>ra-PreambleIndex</i> range from 8 to 11 on NR Cell 1?	-->	PRACH Preamble	1	P
6	The SS transmits Random Access Response with RAPID corresponding to the transmitted Preamble in step 5.	<--	Random Access Response	-	-
7	The UE transmits a MAC PDU containing an <i>RRCSetupRequest</i> message.	-->	MAC PDU (<i>RRCSetupRequest</i>)	-	-
8	The SS schedules PDCCH transmission addressed to TC-RNTI to transmit a valid MAC PDU containing an <i>RRCSetup</i> message and 'UE Contention Resolution Identity' MAC control element with matched 'Contention Resolution Identity'.	<--	MAC PDU (<i>RRCSetup</i> and UE Contention Resolution Identity MAC CE)	-	-
9	UE transmit a MAC PDU containing an <i>RRCSetupComplete</i> message indicating acceptance of <i>RRCSetup</i> message	-->	MAC PDU (<i>RRCSetupComplete</i>)	-	-
Note 1: The modification period, expressed in number of radio frames = $\text{modificationPeriodCoeff} * \text{defaultPagingCycle}$.					

7.1.1.1.17.3.3 Specific message contents

Table 7.1.1.1.17.3.3-1: SIB1 (step 1, Table 7.1.1.1.17.3.2-1)

Derivation Path: TS 38.508-1 [4], Table 4.6.1-28			
Information Element	Value/remark	Comment	Condition
SIB1 ::= SEQUENCE {			
servingCellConfigCommon	ServingCellConfigCommonSIB	Table 7.1.1.1.17.3.3-2	
nonCriticalExtension SEQUENCE {			
nonCriticalExtension SEQUENCE {			
nonCriticalExtension SEQUENCE {			
featurePriorities-r17 SEQUENCE {			
redCapPriority-r17	0		
}			
}			
}			
}			

Table 7.1.1.1.17.3.3-2: ServingCellConfigCommonSIB (Table 7.1.1.1.17.3.3-1)

Derivation Path: TS 38.508-1 [4], Table 4.6.3-169			
Information Element	Value/remark	Comment	Condition
ServingCellConfigCommonSIB ::= SEQUENCE {			
uplinkConfigCommon	UplinkConfigCommonSIB	Table 7.1.1.1.17.3.3-3	
}			

Table 7.1.1.1.17.3.3-3: UplinkConfigCommonSIB (Table 7.1.1.1.17.3.3-2)

Derivation Path: TS 38.508-1 [4], Table 4.6.3-202			
Information Element	Value/remark	Comment	Condition
UplinkConfigCommonSIB ::= SEQUENCE {			
initialUplinkBWP	BWP-UplinkCommon	Table 7.1.1.1.17.3.3-4	
}			

Table 7.1.1.1.17.3.3-4: BWP-UplinkCommon (Table 7.1.1.1.17.3.3-3)

Derivation Path: TS 38.508-1 [4], Table 4.6.3-14			
Information Element	Value/remark	Comment	Condition
BWP-UplinkCommon ::= SEQUENCE {			
additionalRACH-ConfigList-r17 CHOICE {			
setup SEQUENCE (SIZE(1..maxAdditionalRACH-r17)) OF AdditionalRACH-ConfigCommon-r17 {	1 entry		
AdditionalRACH-Config-r17[1] SEQUENCE {		entry 1	
rach-ConfigCommon-r17	RACH-ConfigCommon	Table 7.1.1.1.17.3.3-5	
}			
}			
}			

Table 7.1.1.1.17.3.3-5: RACH-ConfigCommon (Table 7.1.1.1.17.3.3-4)

Derivation Path: TS 38.508-1 [4], Table 4.6.3-128			
Information Element	Value/remark	Comment	Condition
RACH-ConfigCommon ::= SEQUENCE {			
ssb-perRACH-OccasionAndCB-PreamblesPerSSB CHOICE {			
one	n16		
}			

featureCombinationPreamblesList-r17 SEQUENCE (SIZE(1..maxFeatureCombPreamblesPerRACHResource-r17)) OF FeatureCombinationPreambles-r17 {	1 entry		
FeatureCombinationPreambles-r17[1] SEQUENCE {		entry 1	
featureCombination-r17 SEQUENCE {			
redCap-r17	True		
}			
startPreambleForThisPartition-r17	8		
numberOfPreamblesPerSSB-ForThisPartition-r17	4		
}			
}			

7.1.1.1.18 Random access procedure / Msg3 repetition indication / Random access resources selection

Editor's note: This clause is incomplete. The following aspects are either missing or not yet determined:

- **Test description part is FFS**

7.1.1.1.18.1 Test Purpose (TP)

(1)

```
with { UE in RRC_IDLE state and supporting MSG3 repetition }
ensure that {
  when { UE is configured both set(s) of Random Access resources with and without MSG3 repetition
indication AND the the RSRP of the downlink pathloss reference is less than the configured threshold
}
  then { UE requests MSG3 repetition via separate RACH resources }
}
```

(2)

```
with { UE in RRC_IDLE state and supporting MSG3 repetition }
ensure that {
  when { UE is only configured Random Access resources with MSG3 repetition indication }
  then { UE requests MSG3 repetition via separate RACH resources }
}
```

7.1.1.1.18.2 Conformance requirements

References: The conformance requirements covered in the present test case are specified in: TS 38.300, clause 19, and TS 38.321 clause 5.1.1b.

[TS 38.300, clause 19]

To improve NR uplink coverage for both FR1 and FR2, the following enhancements on PUSCH, PUCCH and MSG3 PUSCH are supported:

- ...
- Aggregation of multiple slots with TB repetition for MSG3 transmission is supported on both NUL and SUL, applicable to CBRA with 4-step RA type. If configured, the UE requests MSG3 repetition via separate RACH resources when the RSRP of DL path-loss reference is lower than a configured threshold. BWP configured with RACH resources solely for MSG3 repetition is also supported without the need to consider the RSRP of DL path-loss reference by the UE.

[TS 38.321, clause 5.1.1b]

The MAC entity shall:

1> if the BWP selected for Random Access procedure is configured with both set(s) of Random Access resources with MSG3 repetition indication and set(s) of Random Access resources without MSG3 repetition indication and the RSRP of the downlink pathloss reference is less than $rsrp-ThresholdMsg3$; or

1> if the BWP selected for Random Access procedure is only configured with the set(s) of Random Access resources with MSG3 repetition indication;

2> assume MSG3 repetition is applicable for the current Random Access procedure.

1> else:

2> assume MSG3 repetition is not applicable for the current Random Access procedure.

NOTE 1: Void.

1> if contention-free Random Access Resources have not been provided for this Random Access procedure and one or more of the features including RedCap and/or a specific NSAG(s) and/or SDT and/or MSG3 repetition is applicable for this Random Access procedure:

NOTE 2: The applicability of SDT is determined by MAC entity according to clause 5.27. The applicability of specific slice group(s) is determined by upper layers when the Random Access procedure is initiated by the upper layers. The applicability of RedCap is also determined by upper layers when Random Access procedure is initiated and it is applicable to the Random Access procedures initiated by PDCCH orders and any Random Access procedure initiated by the MAC entity.

2> if none of the sets of Random Access resources are available for any feature applicable to the current Random Access procedure (as specified in clause 5.1.1c):

3> select the set(s) of Random Access resources that are not associated with any feature indication (as specified in clause 5.1.1c) for this Random Access procedure.

2> else if there is one set of Random Access resources available which can be used for indicating all features triggering this Random Access procedure:

3> select this set of Random Access resources for this Random Access procedure.

2> else (i.e. there are one or more sets of Random Access resources available that are configured with indication(s) for a subset of all features triggering this Random Access procedure):

3> select a set of Random Access resources from the available set(s) of Random Access resources based on the priority order indicated by upper layers as specified in clause 5.1.1d for this Random Access Procedure.

1> else if contention-free Random Access Resources have been provided for this Random Access procedure and RedCap is applicable for the current Random Access procedure and there is one set of Random Access resources available that is only configured with RedCap indication:

2> select this set of Random Access resources for this Random Access procedure.

1> else:

2> select the set of Random Access resources that are not associated with any feature indication (as specified in clause 5.1.1c) for the current Random Access procedure.

7.1.1.1.18.3 Test description

FFS

7.1.1.2 Downlink Data Transfer

7.1.1.2.1 Correct Handling of DL MAC PDU / Assignment / HARQ process

7.1.1.2.1.1 Test Purpose (TP)

(1)

```
with { UE in RRC_CONNECTED state }
ensure that {
  when { UE receives downlink assignment on the PDCCH for the UE's C-RNTI and receives data in the
associated Slot and UE performs HARQ operation }
  then { UE sends a HARQ feedback on the HARQ process }
}
```

(2)

```
with { UE in RRC_CONNECTED state }
ensure that {
  when { SS transmits downlink assignment on the PDCCH with a C-RNTI unknown by the UE and data is
available in the associated Slot }
  then { UE does not send any HARQ feedback on the HARQ process }
}
```

(3)

```
with { UE in RRC_CONNECTED state }
ensure that {
  when { the UE receives a MAC PDU addressed to its C-RNTI and decode fails in the associated Slot }
  then { the UE transmits a NACK for the corresponding HARQ process }
}
```

(4)

```
with { UE in RRC_CONNECTED state }
ensure that {
  when { the UE receives a MAC PDU retransmission addressed to its C-RNTI, and results in successful
decode in the associated Slot }
  then { the UE transmits an ACK for the corresponding HARQ process and forward to higher layer }
}
```

(5)

```
with { UE in RRC_CONNECTED state }
ensure that {
  when { UE receives a MAC PDU containing multiple MAC sub PDUs each containing a MAC SDU that is
larger than 256 bytes (16 bits L field used) with padding MAC sub PDU at the end }
  then { UE successfully decodes the MAC PDU and forward to higher layer }
}
```

(6)

```
with { UE in RRC_CONNECTED state }
ensure that {
  when { UE receives a MAC PDU containing multiple MAC sub PDUs each containing a MAC SDU that is
smaller than 256 bytes (8 bits L field used) with padding MAC sub PDU at the end }
  then { UE successfully decodes the MAC PDU and forward to higher layer }
}
```

(7)

```
with { UE in RRC_CONNECTED state }
ensure that {
  when { UE receives a MAC PDU containing MAC sub PDU containing a MAC SDU and no padding MAC sub
PDU }
  then { UE successfully decodes the MAC PDU and forward to higher layer }
}
```

(8)

```

with { UE in RRC_CONNECTED state }
ensure that {
  when { UE receives a MAC PDU containing MAC sub PDU containing a MAC SDU that is smaller than 256
bytes (8 bits L field used) plus MAC sub PDU containing a MAC SDU that is greater than 256 bytes (16
bits L field used) and no padding }
  then { UE successfully decodes the MAC PDU and forwards the AMD PDUs to higher layer }
}

```

(9)

```

with { UE in RRC_CONNECTED state and configured with a specific TDD-UL-DL-ConfigCommon including
configuration of pattern2 }
ensure that {
  when { UE receives downlink assignment on the PDCCH associated with pattern2 for the UE's C-RNTI
and receives data in the associated Slot and UE performs HARQ operation }
  then { UE sends a HARQ feedback on the HARQ process }
}

```

7.1.1.2.1.2 Conformance requirements

References: The conformance requirements covered in the present TC are specified in: TS 38.321, clauses 5.3.1, 5.3.2.1, 5.3.2.2 and 6.1.2. Unless otherwise stated these are Rel-15 requirements.

[TS 38.321, clause 5.3.1]

Downlink assignments received on the PDCCH both indicate that there is a transmission on a DL-SCH for a particular MAC entity and provide the relevant HARQ information.

When the MAC entity has a C-RNTI, Temporary C-RNTI, or CS-RNTI, the MAC entity shall for each PDCCH occasion during which it monitors PDCCH and for each Serving Cell:

- 1> if a downlink assignment for this PDCCH occasion and this Serving Cell has been received on the PDCCH for the MAC entity's C-RNTI, or Temporary C-RNTI:
 - 2> if this is the first downlink assignment for this Temporary C-RNTI:
 - 3> consider the NDI to have been toggled.
 - 2> if the downlink assignment is for the MAC entity's C-RNTI, and if the previous downlink assignment indicated to the HARQ entity of the same HARQ process was either a downlink assignment received for the MAC entity's CS-RNTI or a configured downlink assignment:
 - 3> consider the NDI to have been toggled regardless of the value of the NDI.
 - 2> indicate the presence of a downlink assignment and deliver the associated HARQ information to the HARQ entity.
- 1> else if a downlink assignment for this PDCCH occasion has been received for this Serving Cell on the PDCCH for the MAC entity's CS-RNTI:
 - 2> if the NDI in the received HARQ information is 1:
 - 3> consider the NDI for the corresponding HARQ process not to have been toggled;
 - 3> indicate the presence of a downlink assignment for this Serving Cell and deliver the associated HARQ information to the HARQ entity.
 - 2> if the NDI in the received HARQ information is 0:
 - 3> if PDCCH contents indicate SPS deactivation:
 - 4> clear the configured downlink assignment for this Serving Cell (if any);
 - 4> if the timeAlignmentTimer associated with the PTAG is running:
 - 5> indicate a positive acknowledgement for the SPS deactivation to the physical layer.

3> else if PDCCH content indicates SPS activation:

- 4> store the downlink assignment for this Serving Cell and the associated HARQ information as configured downlink assignment;
- 4> initialise or re-initialise the configured downlink assignment for this Serving Cell to start in the associated PDSCH duration and to recur according to rules in subclause 5.8.1;
- 4> set the HARQ Process ID to the HARQ Process ID associated with this PDSCH duration;
- 4> consider the NDI bit for the corresponding HARQ process to have been toggled;
- 4> indicate the presence of a configured downlink assignment for this Serving Cell and deliver the stored HARQ information to the HARQ entity.

For each Serving Cell and each configured downlink assignment, if configured and activated, the MAC entity shall:

- 1> if the PDSCH duration of the configured downlink assignment does not overlap with the PDSCH duration of a downlink assignment received on the PDCCH for this Serving Cell:
 - 2> instruct the physical layer to receive, in this PDSCH duration, transport block on the DL-SCH according to the configured downlink assignment and to deliver it to the HARQ entity;
 - 2> set the HARQ Process ID to the HARQ Process ID associated with this PDSCH duration;
 - 2> consider the NDI bit to have been toggled;
 - 2> indicate the presence of a configured downlink assignment and deliver the stored HARQ information to the HARQ entity.

For configured downlink assignments, the HARQ Process ID associated with the slot where the DL transmission starts is derived from the following equation:

$$\text{HARQ Process ID} = [\text{floor}(\text{CURRENT_slot} \times 10 / (\text{numberOfSlotsPerFrame} \times \text{semiPersistSchedIntervalDL}))] \text{ modulo } \text{nrofHARQ-Processes}$$

where $\text{CURRENT_slot} = [(\text{SFN} \times \text{numberOfSlotsPerFrame}) + \text{slot number in the frame}]$ and *numberOfSlotsPerFrame* refers to the number of consecutive slots per frame as specified in TS 38.211 [8].

When the MAC entity needs to read BCCH, the MAC entity may, based on the scheduling information from RRC:

- 1> if a downlink assignment for this PDCCH occasion has been received on the PDCCH for the SI-RNTI;
- 2> indicate a downlink assignment and redundancy version for the dedicated broadcast HARQ process to the HARQ entity.

[TS 38.321, clause 5.3.2.2]

When a transmission takes place for the HARQ process, one or more (in case of downlink spatial multiplexing) TBs and the associated HARQ information are received from the HARQ entity.

For each received TB and associated HARQ information, the HARQ process shall:

- 1> if the NDI, when provided, has been toggled compared to the value of the previous received transmission corresponding to this TB; or
- 1> if the HARQ process is equal to the broadcast process, and this is the first received transmission for the TB according to the system information schedule indicated by RRC; or
- 1> if this is the very first received transmission for this TB (i.e. there is no previous NDI for this TB):
 - 2> consider this transmission to be a new transmission.
- 1> else:
 - 2> consider this transmission to be a retransmission.

The MAC entity then shall:

- 1> if this is a new transmission:
 - 2> attempt to decode the received data.
- 1> else if this is a retransmission:
 - 2> if the data for this TB has not yet been successfully decoded:
 - 3> instruct the physical layer to combine the received data with the data currently in the soft buffer for this TB and attempt to decode the combined data.
- 1> if the data which the MAC entity attempted to decode was successfully decoded for this TB; or
- 1> if the data for this TB was successfully decoded before:
 - 2> if the HARQ process is equal to the broadcast process:
 - 3> deliver the decoded MAC PDU to upper layers.
 - 2> else if this is the first successful decoding of the data for this TB:
 - 3> deliver the decoded MAC PDU to the disassembly and demultiplexing entity.
- 1> else:
 - 2> instruct the physical layer to replace the data in the soft buffer for this TB with the data which the MAC entity attempted to decode;
- 1> if the HARQ process is associated with a transmission indicated with a Temporary C-RNTI and the Contention Resolution is not yet successful (see subclause 5.1.5); or
- 1> if the HARQ process is equal to the broadcast process; or
- 1> if the *timeAlignmentTimer*, associated with the TAG containing the Serving Cell on which the HARQ feedback is to be transmitted, is stopped or expired:
 - 2> not instruct the physical layer to generate acknowledgement(s) of the data in this TB.
- 1> else:
 - 2> instruct the physical layer to generate acknowledgement(s) of the data in this TB.

The MAC entity shall ignore NDI received in all downlink assignments on PDCCH for its Temporary C-RNTI when determining if NDI on PDCCH for its C-RNTI has been toggled compared to the value in the previous transmission.

[TS 38.321, clause 6.1.2]

A MAC PDU consists of one or more MAC subPDUs. Each MAC subPDU consists of one of the following:

- A MAC subheader only (including padding);
- A MAC subheader and a MAC SDU;
- A MAC subheader and a MAC CE;
- A MAC subheader and padding.

The MAC SDUs are of variable sizes.

Each MAC subheader corresponds to either a MAC SDU, a MAC CE, or padding.

A MAC subheader except for fixed sized MAC CE and padding consists of the four header fields R/F/LCID/L. A MAC subheader for fixed sized MAC CE and padding consists of the two header fields R/LCID.

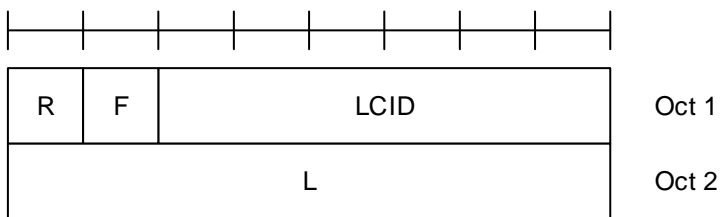

Figure 6.1.2-1: R/F/LCID/L MAC subheader with 8-bit L field

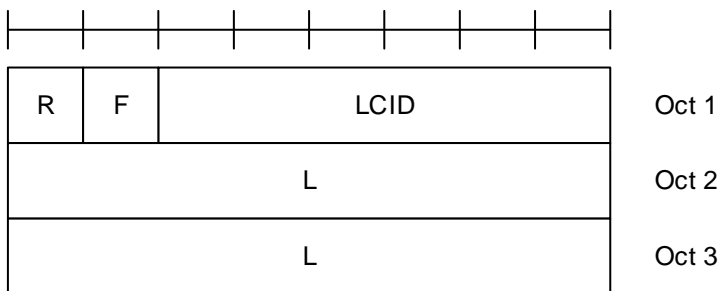

Figure 6.1.2-2: R/F/LCID/L MAC subheader with 16-bit L field

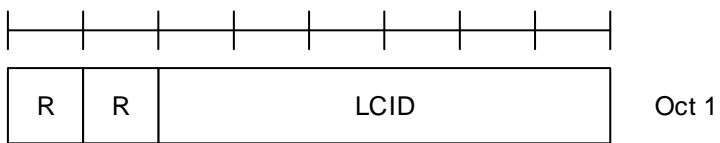

Figure 6.1.2-3: R/LCID MAC subheader

MAC CEs are placed together. DL MAC subPDU(s) with MAC CE(s) is placed before any MAC subPDU with MAC SDU and MAC subPDU with padding as depicted in Figure 6.1.2-4. UL MAC subPDU(s) with MAC CE(s) is placed after all the MAC subPDU(s) with MAC SDU and before the MAC subPDU with padding in the MAC PDU as depicted in Figure 6.1.2-5. The size of padding can be zero.

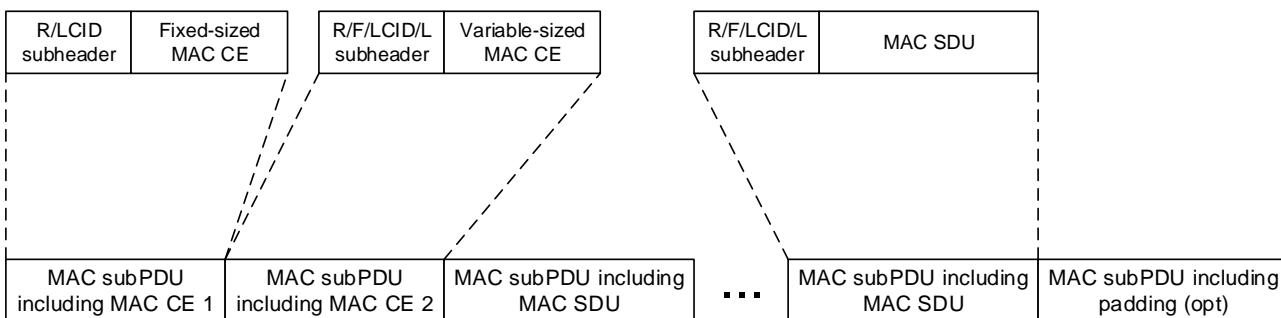

Figure 6.1.2-4: Example of a DL MAC PDU

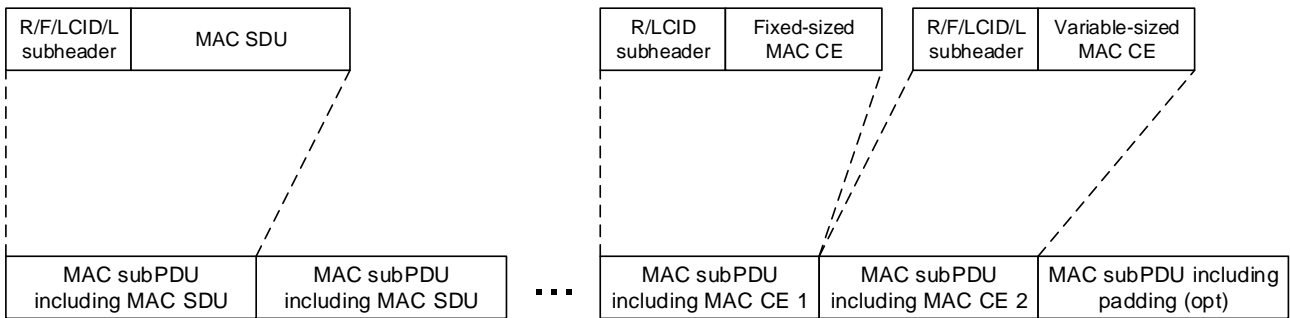

Figure 6.1.2-5: Example of a UL MAC PDU

A maximum of one MAC PDU can be transmitted per TB per MAC entity.

7.1.1.2.1.3 Test description

7.1.1.2.1.3.1 Pre-test conditions

Same Pre-test conditions as in clause 7.1.1.0 except that set to return no data in uplink and parameters as in Table 7.1.1.2.1.3.1-1.

Table 7.1.1.2.1.3.1-1: MAC Parameters

nrofHARQ-ProcessesForPDSCH	n16
----------------------------	-----

7.1.1.2.1.3.2 Test procedure sequence

Table 7.1.1.2.1.3.2-1: Main behaviour

St	Procedure	Message Sequence		TP	Verdict
		U - S	Message		
1	SS transmits a downlink assignment addressed to the C-RNTI assigned to the UE	<--	(PDCCH (C-RNTI))	-	-
2	SS transmits in the indicated downlink assignment a MAC PDU including a RLC PDU with poll bit not set.	<--	MAC PDU	-	-
3	Check: Does the UE transmit an HARQ ACK on PUCCH?	-->	HARQ ACK	1	P
4	SS transmits a downlink assignment to including a C-RNTI different from the assigned to the UE	<--	(PDCCH (unknown C-RNTI))	-	-
5	SS transmits in the indicated downlink assignment a RLC PDU in a MAC PDU including a RLC PDU with poll bit not set.	<--	MAC PDU	-	-
6	Check: Does the UE send any HARQ ACK/NACK on PUCCH?	-->	HARQ ACK/NACK	2	F
-	EXCEPTION: Steps 7 to 10 are run repeated using test parameter values as given for each iteration in table 7.1.1.2.1.3.2.-2.	-	-	-	-
7	The SS indicates a new transmission on PDCCH and transmits a MAC PDU including a RLC PDU with poll bit not set, with content set so that UE could not successfully decode the data from its soft buffer. (Note 1)	<--	MAC PDU	-	-
8	Check: Does the UE transmit a HARQ NACK?	-->	HARQ NACK	3	P
-	EXCEPTION: Step 9 shall be repeated till HARQ ACK is received at step 10 or until HARQ retransmission count = 4 is reached for MAC PDU at step 9 (Note 2).	-	-	-	-
9	The SS indicates a retransmission on PDCCH	<--	MAC PDU	-	-

	and transmits the same MAC PDU like step 7 (Note 1).				
-	EXCEPTION: Up to [3] HARQ NACK from the UE should be allowed at step 10 (Note 2).	-	-	-	-
10	Check: Does the UE send a HARQ ACK?	-->	HARQ ACK	4	P
11	The SS transmits a MAC PDU containing three MAC sub PDUs each containing a MAC SDU(RLC PDU) that is of 260 bytes (16 bits L field used) and a padding MAC sub PDU at the end. The third RLC PDU contained will have poll bit set.	<--	MAC PDU	-	-
12	Check: Does the UE transmit a MAC PDU containing an RLC STATUS PDU acknowledging the reception of all the AMD PDUs in step 11?	-->	MAC PDU (RLC STATUS PDU)	5	P
13	The SS transmits a MAC PDU containing three MAC sub PDUs each containing a MAC SDU(RLC PDU) that is of 128 bytes (8 bits L field used) and a padding MAC sub PDU at the end. The third RLC PDU contained will have poll bit set.	<--	MAC PDU	-	-
14	Check: Does the UE transmit a MAC PDU containing an RLC STATUS PDU acknowledging the reception of all the AMD PDUs in step 13?	-->	MAC PDU (RLC STATUS PDU)	6	P
15	The SS transmits a MAC PDU containing one MAC sub PDU containing a MAC SDU(RLC PDU) that is of [128] bytes (8 bits L field used) and no padding MAC sub PDU at the end. The RLC PDU contained will have poll bit set.	<--	MAC PDU	-	-
16	Check: Does the UE transmit a MAC PDU containing an RLC STATUS PDU acknowledging the reception of the AMD PDU in step 15?	-->	MAC PDU (RLC STATUS PDU)	7	P
17	The SS transmits a MAC PDU containing one MAC sub PDU containing a MAC SDU(RLC PDU) that is of [128] bytes (8 bits L field used), one MAC sub PDU containing a MAC SDU(RLC PDU) that is of [260] bytes (16 bits L field used) and no padding MAC sub PDU at the end. The second RLC PDU contained will have poll bit set.	<--	MAC PDU	-	-
18	Check: Does the UE transmit a MAC PDU containing an RLC STATUS PDU acknowledging the reception of all the AMD PDUs in step 17?	-->	MAC PDU (RLC STATUS PDU)	8	P
-	EXCEPTION : Steps 19a0 to 19a5 are executed for operation on NR TDD band only	-	-	-	-
19a0	The SS transmits an updated system information as specified in Table 7.1.1.3.1.3.3-14. (Note 5)	-	-	-	-
19a1	The SS transmits NR RRCReconfiguration message including <i>TDD-UL-DL-ConfigCommon</i> with <i>pattern1</i> and <i>pattern2</i> specified in Table 7.1.1.2.1.3.3-5 (Note 3)	<--	<i>RRCReconfiguration</i>	-	-
19a2	The UE transmits a NR <i>RRCReconfigurationComplete</i> message. (Note 4)	-->	<i>RRCReconfigurationComplete</i>	-	-
19a3	SS transmits a downlink assignment addressed to the C-RNTI assigned to the UE indicating downlink reception in a symbol in a slot part of <i>pattern2</i> .	<--	(PDCCH (C-RNTI))	-	-
19a4	SS transmits in the indicated downlink assignment a MAC PDU including a RLC PDU with poll bit not set.	<--	MAC PDU	-	-
19a5	Check: Does the UE transmit an HARQ ACK on PUCCH?	-->	HARQ ACK	9	P
Note 1: SS should transmit this PDU so as to ensure at least one NACK.					

Note 2:	The value 4 for the maximum number of HARQ retransmissions has been chosen based on an assumption that, given the radio conditions used in this test case, a UE soft combiner implementation should have sufficient retransmissions to be able to successfully decode the data in its soft buffer.
Note 3:	For EN-DC the NR RRCReconfiguration message is contained in RRCConnectionReconfiguration 36.508 [7], Table 4.6.1-8 using condition EN-DC_EmbedNR_RRCRecon.
Note 4:	For EN-DC the NR RRCReconfigurationComplete message is contained in RRCConnectionReconfigurationComplete.
Note 5:	if pc_NG_RAN_NR only

Table 7.1.1.2.1.3.2-2: Test Parameters

Iteration	DL HARQ process (X)
K=1 to 16	X=K-1

7.1.1.2.1.3.3 Specific message contents

Table 7.1.1.2.1.3.3-1: Void

Table 7.1.1.2.1.3.3-2: RRCReconfiguration (step19a1, Table 7.1.1.2.1.3.2-1)

Derivation Path: 38.508-1 [4], Table 4.6.1-131			
Information Element	Value/remark	Comment	Condition
RRCReconfiguration ::= SEQUENCE {			
criticalExtensions CHOICE {			
rrcReconfiguration ::= SEQUENCE {			
secondaryCellGroup	CellGroupConfig		EN-DC
}			
RRCReconfiguration-v1530-IEs ::= SEQUENCE {			NR
masterCellGroup	CellGroupConfig		
}			
}			
}			

Table 7.1.1.2.1.3.3-3: CellGroupConfig (Table 7.1.1.2.1.3.3-2)

Derivation Path: TS 38.508-1 [4], Table 4.6.3-19			
Information Element	Value/remark	Comment	Condition
CellGroupConfig ::= SEQUENCE {			
spCellConfig SEQUENCE {			
reconfigurationWithSync SEQUENCE {			
spCellConfigCommon	ServingCellConfigCommon		
}			
spCellConfigDedicated	ServingCellConfig		
}			
}			

Table 7.1.1.2.1.3.3-4, 7.1.1.2.1.3.3-13: ServingCellConfigCommon (Table 7.1.1.2.1.3.3-3)

Derivation Path: TS 38.508-1 [4], Table 4.6.3-168			
Information Element	Value/remark	Comment	Condition
ServingCellConfigCommon ::= SEQUENCE {			
uplinkConfigCommon SEQUENCE {			
initialUplinkBWP	BWP-UplinkCommon		
}			
tdd-UL-DL-ConfigurationCommon	TDD-UL-DL-ConfigCommon		
}			

Table 7.1.1.2.1.3.3-5: TDD-UL-DL-ConfigCommon (Table 7.1.1.2.1.3.3-4)

Derivation Path: TS 38.508-1 [4], Table 4.6.3-192			
Information Element	Value/remark	Comment	Condition
TDD-UL-DL-ConfigCommon ::= SEQUENCE {			
referenceSubcarrierSpacing	SubcarrierSpacing		
pattern1 SEQUENCE {			
dl-UL-TransmissionPeriodicity	ms5		FR1
	ms0p625		FR2
nrofDownlinkSlots	3		FR1
	2		FR2
nrofDownlinkSymbols	6		FR1
	6		FR2
nrofUplinkSlots	2		FR1
	2		FR2
nrofUplinkSymbols	4		FR1
	2		FR2
dl-UL-TransmissionPeriodicity-v1530	ms3		FR1
}			
pattern2 SEQUENCE {			
dl-UL-TransmissionPeriodicity	ms2		FR1
	ms0p625		FR2
nrofDownlinkSlots	4		FR1
	3		FR2
nrofDownlinkSymbols	0		FR1
	6		FR2
nrofUplinkSlots	0		FR1
	1		FR2
nrofUplinkSymbols	0		FR1
	2		FR2
}			
}			

Table 7.1.1.2.1.3.3-6: BWP-UplinkCommon (Table 7.1.1.2.1.3.3-4)

Derivation Path: TS 38.508-1 [4], Table 4.6.3-14			
Information Element	Value/remark	Comment	Condition
BWP-UplinkCommon ::= SEQUENCE {			
rach-ConfigCommon CHOICE {			
setup	RACH-ConfigCommon		
}			
}			

Table 7.1.1.2.1.3.3-7: RACH-ConfigCommon (Table 7.1.1.2.1.3.3-6)

Derivation Path: TS 38.508-1 [4], Table 4.6.3-128			
Information Element	Value/remark	Comment	Condition
RACH-ConfigCommon ::= SEQUENCE {			
rach-ConfigGeneric	RACH-ConfigGeneric		
}			

Table 7.1.1.2.1.3.3-8: RACH-ConfigGeneric (Table 7.1.1.2.1.3.3-7)

Derivation Path: TS 38.508-1 [4], Table 4.6.3-130			
Information Element	Value/remark	Comment	Condition
RACH-ConfigGeneric ::= SEQUENCE {			
prach-configurationIndex	156		
}			

Table 7.1.1.2.1.3.3-9: ServingCellConfig (Table 7.1.1.2.1.3.3-3)

Derivation Path: TS 38.508-1 [4], Table 4.6.3-167			
Information Element	Value/remark	Comment	Condition
ServingCellConfig ::= SEQUENCE {			
uplinkConfig SEQUENCE {			
initialUplinkBWP	BWP-UplinkDedicated		
}			
}			

Table 7.1.1.2.1.3.3-10: BWP-UplinkDedicated (Table 7.1.1.2.1.3.3-9)

Derivation Path: TS 38.508-1 [4], Table 4.6.3-15			
Information Element	Value/remark	Comment	Condition
BWP-UplinkDedicated ::= SEQUENCE {			
pucch-Config CHOICE {			
setup	PUCCH-Config		
}			
}			

Table 7.1.1.2.1.3.3-11: PUCCH-Config (Table 7.1.1.2.1.3.3-10)

Derivation Path: TS 38.508-1 [4], Table 4.6.3-112			
Information Element	Value/remark	Comment	Condition
PUCCH-Config ::= SEQUENCE {			
schedulingRequestResourceToAddModList	1 entry		
SEQUENCE (SIZE (1..maxNrofSR-Resources)) OF			
SchedulingRequestResourceConfig {			
SchedulingRequestResourceConfig[1]	SchedulingRequestResourceConfig	entry 1	
}			
}			

Table 7.1.1.2.1.3.3-12: SchedulingRequestResourceConfig (Table 7.1.1.2.1.3.3-11)

Derivation Path: TS 38.508-1 [4], Table 4.6.3-112			
Information Element	Value/remark	Comment	Condition
SchedulingRequestResourceConfig ::= SEQUENCE {			
periodicityAndOffset CHOICE {			
sl10	5	With SCS = kHz15 results in repetition every 10 ms	SCS_15kHz
sl20	5	With SCS = kHz30 results in repetition every 10 ms	SCS_30kHz
sl80	5	With SCS = kHz120 results in repetition every 10 ms	SCS_120kHz
}			
}			

Table 7.1.1.2.1.3.3-13: SystemInformationBlockType1 (step 19a0, Table 7.1.1.2.1.3.2-1)

Derivation path: 38.508-1 [4] table 4.6.1-28			
Information Element	Value/Remark	Comment	Condition
SIB1 ::= SEQUENCE {			
servingCellConfigCommon	ServingCellConfigCommon	Same contents as in Table 7.1.1.2.1.3.3-5	

}		
---	--	--

7.1.1.2.2 Correct Handling of DL HARQ process PDSCH Aggregation

7.1.1.2.2.1 Test Purpose (TP)

(1)

```
with { UE in RRC_CONNECTED state and pdsch-AggregationFactor > 1 }
ensure that {
  when { UE receives downlink assignment on the PDCCH for the UE's C-RNTI and receives data in the
associated slot and successive pdsch-AggregationFactor - 1 HARQ retransmissions within a bundle and
UE performs HARQ operation }
  then { UE sends a HARQ feedback on the HARQ process }
}
```

7.1.1.2.2.2 Conformance requirements

References: The conformance requirements covered in the current TC are specified in: TS 38.321, clauses 5.3.1, 5.3.2.1 and 5.3.2.2, TS 38.214, clause 5.1.2.1.

[TS 38.321, clause 5.3.1]

Downlink assignments received on the PDCCH both indicate that there is a transmission on a DL-SCH for a particular MAC entity and provide the relevant HARQ information.

When the MAC entity has a C-RNTI, Temporary C-RNTI, or CS-RNTI, the MAC entity shall for each PDCCH occasion during which it monitors PDCCH and for each Serving Cell:

- 1> if a downlink assignment for this PDCCH occasion and this Serving Cell has been received on the PDCCH for the MAC entity's C-RNTI, or Temporary C-RNTI:
 - 2> if this is the first downlink assignment for this Temporary C-RNTI:
 - 3> consider the NDI to have been toggled.
 - 2> if the downlink assignment is for the MAC entity's C-RNTI, and if the previous downlink assignment indicated to the HARQ entity of the same HARQ process was either a downlink assignment received for the MAC entity's CS-RNTI or a configured downlink assignment:
 - 3> consider the NDI to have been toggled regardless of the value of the NDI.
 - 2> indicate the presence of a downlink assignment and deliver the associated HARQ information to the HARQ entity.
- 1> else if a downlink assignment for this PDCCH occasion has been received for this Serving Cell on the PDCCH for the MAC entity's CS-RNTI:
 - 2> if the NDI in the received HARQ information is 1:
 - 3> consider the NDI for the corresponding HARQ process not to have been toggled;
 - 3> indicate the presence of a downlink assignment for this Serving Cell and deliver the associated HARQ information to the HARQ entity.
 - 2> if the NDI in the received HARQ information is 0:
 - 3> if PDCCH contents indicate SPS deactivation:
 - 4> clear the configured downlink assignment for this Serving Cell (if any);
 - 4> if the timeAlignmentTimer associated with the PTAG is running:
 - 5> indicate a positive acknowledgement for the SPS deactivation to the physical layer.

3> else if PDCCH content indicates SPS activation:

- 4> store the downlink assignment for this Serving Cell and the associated HARQ information as configured downlink assignment;
- 4> initialise or re-initialise the configured downlink assignment for this Serving Cell to start in the associated PDSCH duration and to recur according to rules in subclause 5.8.1;
- 4> set the HARQ Process ID to the HARQ Process ID associated with this PDSCH duration;
- 4> consider the NDI bit for the corresponding HARQ process to have been toggled;
- 4> indicate the presence of a configured downlink assignment for this Serving Cell and deliver the stored HARQ information to the HARQ entity.

For each Serving Cell and each configured downlink assignment, if configured and activated, the MAC entity shall:

- 1> if the PDSCH duration of the configured downlink assignment does not overlap with the PDSCH duration of a downlink assignment received on the PDCCH for this Serving Cell:
 - 2> instruct the physical layer to receive, in this PDSCH duration, transport block on the DL-SCH according to the configured downlink assignment and to deliver it to the HARQ entity;
 - 2> set the HARQ Process ID to the HARQ Process ID associated with this PDSCH duration;
 - 2> consider the NDI bit to have been toggled;
 - 2> indicate the presence of a configured downlink assignment and deliver the stored HARQ information to the HARQ entity.

For configured downlink assignments, the HARQ Process ID associated with the slot where the DL transmission starts is derived from the following equation:

$$\text{HARQ Process ID} = [\text{floor}(\text{CURRENT_slot} \times 10 / (\text{numberOfSlotsPerFrame} \times \text{periodicity}))] \text{ modulo } n_{\text{rofHARQ-Processes}}$$

where $\text{CURRENT_slot} = [(\text{SFN} \times \text{numberOfSlotsPerFrame}) + \text{slot number in the frame}]$ and *numberOfSlotsPerFrame* refers to the number of consecutive slots per frame as specified in TS 38.211 [8].

When the MAC entity needs to read BCCH, the MAC entity may, based on the scheduling information from RRC:

- 1> if a downlink assignment for this PDCCH occasion has been received on the PDCCH for the SI-RNTI;
 - 2> indicate a downlink assignment and redundancy version for the dedicated broadcast HARQ process to the HARQ entity.

[TS 38.321, clause 5.3.2.1]

The MAC entity includes a HARQ entity for each Serving Cell, which maintains a number of parallel HARQ processes. Each HARQ process is associated with a HARQ process identifier. The HARQ entity directs HARQ information and associated TBs received on the DL-SCH to the corresponding HARQ processes (see subclause 5.3.2.2).

The number of parallel DL HARQ processes per HARQ entity is specified in TS 38.214 [7]. The dedicated broadcast HARQ process is used for BCCH.

The HARQ process supports one TB when the physical layer is not configured for downlink spatial multiplexing. The HARQ process supports one or two TBs when the physical layer is configured for downlink spatial multiplexing.

When the MAC entity is configured with *pdsch-AggregationFactor* > 1, the parameter *pdsch-AggregationFactor* provides the number of transmissions of a TB within a bundle of the dynamic downlink assignment. Bundling operation relies on the HARQ entity for invoking the same HARQ process for each transmission that is part of the same bundle. After the initial transmission, *pdsch-AggregationFactor* – 1 HARQ retransmissions follow within a bundle.

The MAC entity shall:

- 1> if a downlink assignment has been indicated:

2> allocate the TB(s) received from the physical layer and the associated HARQ information to the HARQ process indicated by the associated HARQ information.

1> if a downlink assignment has been indicated for the broadcast HARQ process:

2> allocate the received TB to the broadcast HARQ process.

[TS 38.321, clause 5.3.2.2]

When a transmission takes place for the HARQ process, one or two (in case of downlink spatial multiplexing) TBs and the associated HARQ information are received from the HARQ entity.

For each received TB and associated HARQ information, the HARQ process shall:

1> if the NDI, when provided, has been toggled compared to the value of the previous received transmission corresponding to this TB; or

1> if the HARQ process is equal to the broadcast process, and this is the first received transmission for the TB according to the system information schedule indicated by RRC; or

1> if this is the very first received transmission for this TB (i.e. there is no previous NDI for this TB):

2> consider this transmission to be a new transmission.

1> else:

2> consider this transmission to be a retransmission.

The MAC entity then shall:

1> if this is a new transmission:

2> attempt to decode the received data.

1> else if this is a retransmission:

2> if the data for this TB has not yet been successfully decoded:

3> instruct the physical layer to combine the received data with the data currently in the soft buffer for this TB and attempt to decode the combined data.

1> if the data which the MAC entity attempted to decode was successfully decoded for this TB; or

1> if the data for this TB was successfully decoded before:

2> if the HARQ process is equal to the broadcast process:

3> deliver the decoded MAC PDU to upper layers.

2> else if this is the first successful decoding of the data for this TB:

3> deliver the decoded MAC PDU to the disassembly and demultiplexing entity.

1> else:

2> instruct the physical layer to replace the data in the soft buffer for this TB with the data which the MAC entity attempted to decode.

1> if the HARQ process is associated with a transmission indicated with a Temporary C-RNTI and the Contention Resolution is not yet successful (see subclause 5.1.5); or

1> if the HARQ process is equal to the broadcast process; or

1> if the *timeAlignmentTimer*, associated with the TAG containing the Serving Cell on which the HARQ feedback is to be transmitted, is stopped or expired:

2> not instruct the physical layer to generate acknowledgement(s) of the data in this TB.

1> else:

2> instruct the physical layer to generate acknowledgement(s) of the data in this TB.

The MAC entity shall ignore NDI received in all downlink assignments on PDCCH for its Temporary C-RNTI when determining if NDI on PDCCH for its C-RNTI has been toggled compared to the value in the previous transmission.

[TS 38.214, clause 5.1.2.1]

When the UE is scheduled to receive PDSCH by a DCI, the *Time domain resource assignment* field value m of the DCI provides a row index $m + 1$ to an allocation table. The determination of the used resource allocation table is defined in sub-clause 5.1.2.1.1. The indexed row defines the slot offset K_0 , the start and length indicator $SLIV$, or directly the start symbol S and the allocation length L , and the PDSCH mapping type to be assumed in the PDSCH reception.

Given the parameter values of the indexed row:

- The slot allocated for the PDSCH is $\left\lfloor n \cdot \frac{2^{\mu_{\text{PDSCH}}}}{2^{\mu_{\text{PDCCH}}}} \right\rfloor + K_0$, where n is the slot with the scheduling DCI, and K_0 is

based on the numerology of PDSCH, and μ_{PDSCH} and μ_{PDCCH} are the subcarrier spacing configurations for PDSCH and PDCCH, respectively, and

- The starting symbol S relative to the start of the slot, and the number of consecutive symbols L counting from the symbol S allocated for the PDSCH are determined from the start and length indicator $SLIV$:

if $(L-1) \leq 7$ then

$$SLIV = 14 \cdot (L-1) + S$$

else

$$SLIV = 14 \cdot (14 - L + 1) + (14 - 1 - S)$$

where $0 < L \leq 14 - S$, and

- The PDSCH mapping type is set to Type A or Type B as defined in sub-clause 7.4.1.1.2 of [4, TS 38.211].

The UE shall consider the S and L combinations defined in table 5.1.2.1-1 as valid PDSCH allocations:

Table 5.1.2.1-1: Valid S and L combinations

PDSCH mapping type	Normal cyclic prefix			Extended cyclic prefix		
	S	L	$S+L$	S	L	$S+L$
Type A	{0,1,2,3} (Note 1)	{3,...,14}	{3,...,14}	{0,1,2,3} (Note 1)	{3,...,12}	{3,...,12}
Type B	{0,...,12}	{2,4,7}	{2,...,14}	{0,...,10}	{2,4,6}	{2,...,12}

Note 1: $S = 3$ is applicable only if $d_{\text{mrs-TypeA-Position}} = 3$

When the UE is configured with $\text{aggregationFactorDL} > 1$, the same symbol allocation is applied across the $\text{aggregationFactorDL}$ consecutive slots. The UE may expect that the TB is repeated within each symbol allocation among each of the $\text{aggregationFactorDL}$ consecutive slots and the PDSCH is limited to a single transmission layer. The redundancy version to be applied on the n^{th} transmission occasion of the TB is determined according to table 5.1.2.1-2.

Table 5.1.2.1-2: Applied redundancy version when $\text{aggregationFactorDL} > 1$

rv_{id} indicated by the DCI scheduling the PDSCH	rv_{id} to be applied to n^{th} transmission occasion			
	$n \bmod 4 = 0$	$n \bmod 4 = 1$	$n \bmod 4 = 2$	$n \bmod 4 = 3$
0	0	2	3	1
2	2	3	1	0
3	3	1	0	2
1	1	0	2	3

If the UE procedure for determining slot configuration as defined in Subclause 11.1 of [6, TS 38.213] determines symbol of a slot allocated for PDSCH as uplink symbols, the transmission on that slot is omitted for multi-slot PDSCH transmission.

The UE is not expected to receive a PDSCH with mapping type A in a slot, if the PDCCH scheduling the PDSCH was received in the same slot and was not contained within the first three symbols of the slot.

The UE is not expected to receive a PDSCH with mapping type B in a slot, if the first symbol of the PDCCH scheduling the PDSCH was received in a later symbol than the first symbol indicated in the PDSCH time domain resource allocation.

7.1.1.2.2.3 Test description

7.1.1.2.2.3.1 Pre-test conditions

Same Pre-test conditions as in clause 7.1.1.0 except that set to return no data in uplink and parameters as in Table 7.1.1.2.2.3.1-1.

Table 7.1.1.2.2.3.1-1: Void

7.1.1.2.2.3.2 Test procedure sequence

Table 7.1.1.2.2.3.2-1: Main behaviour

St	Procedure	Message Sequence		TP	Verdict
		U - S	Message		
1	SS transmits in the indicated downlink assignment an NR RRCReconfiguration. (Note 1)	<--	-	-	-
2	UE transmits NR RRCReconfigurationComplete message to the SS. (Note 2)	-->	-	-	-
3	The SS transmits a downlink assignment addressed to the C-RNTI assigned to the UE, the rv_idx is 0.	<--	-	-	-
4	The SS transmits in the indicated downlink assignment a MAC PDU including a RLC PDU, The CRC is calculated in such a way, it will result in CRC error on UE side.	<--	MAC PDU	-	-
5	In the following 3 consecutive slots, the SS transmits on the same downlink assignment a MAC PDU including a RLC PDU, The CRC is calculated in such a way, it will result in CRC error on UE side. (Note3)	<--	MAC PDU	-	-
5A	Void	-	-	-	-
6	Check: Does the UE transmit a HARQ NACK on slot n3+k1? (Note 4)	-->	HARQ NACK	1	P
7	The SS transmits a downlink assignment addressed to the C-RNTI assigned to the UE, the rv_idx is 0.	<--	-	-	-
8	The SS transmits in the indicated downlink assignment a MAC PDU including a RLC PDU, The CRC is calculated in such a way, it will result in CRC pass on UE side.	<--	MAC PDU	-	-
9	In the following 3 consecutive slots, the SS transmits on the same downlink assignment a MAC PDU including a RLC PDU, The CRC is calculated in such a way, it will result in CRC pass on UE side. (Note3)	<--	MAC PDU	-	-
10	Check: Does the UE transmit a HARQ ACK on slot n3+k1? (Note 4)	-->	HARQ ACK	1	P
Note 1: For EN-DC the NR RRCReconfiguration message is contained in RRCConnectionReconfiguration 36.508 [7], Table 4.6.1-8 using condition EN-DC_EmbedNR_RRCRecon.					

Note 2:	For EN-DC the NR RRCReconfigurationComplete message is contained in RRCConnectionReconfigurationComplete.
Note 3:	For <i>aggregationFactorDL</i> =4, the PDSCH will repeat in following 4-1=3 slots with same resource allocation but different redundancy version, if the slot can be used for downlink transmission.
Note 4:	n0 is the index of slot when 1 st transmission of MAC PDU in step 4/8 happens, n1, n2, n3 are indices of slots when 2 nd , 3 rd , 4 th transmission of MAC PDU in step 5/9 may happen, k1 is obtained from "PDSCH-to-HARQ_feedback timing indicator" of downlink assignment in step 3/7.

7.1.1.2.2.3.3 Specific message contents

Table 7.1.1.2.2.3.3-1: RRCReconfiguration (step 1, Table 7.1.1.2.2.3.2-1)

Derivation Path: 38.508-1 [4], Table 4.6.1-13			
Information Element	Value/remark	Comment	Condition
RRCReconfiguration ::= SEQUENCE {			
criticalExtensions CHOICE {			
rrcReconfiguration SEQUENCE {			
secondaryCellGroup	CellGroupConfig	OCTET STRING (CONTAINING CellGroupConfig)	EN-DC
}			
RRCReconfiguration-v1530-IEs ::= SEQUENCE {			NR
masterCellGroup	CellGroupConfig		
}			
}			

Table 7.1.1.2.2.3.3-2: cellGroupConfig (Table 7.1.1.2.2.3.3-1: RRCReconfiguration)

Derivation Path: 38.508-1 [4], Table 4.6.3-19			
Information Element	Value/remark	Comment	Condition
cellGroupConfig ::= SEQUENCE {			
cellGroupId	0		
	1		EN-DC
spCellConfig SEQUENCE {			
spCellConfigDedicated SEQUENCE {			
servingCellConfig SEQUENCE {			
initialDownlinkBWP SEQUENCE {			
pdsch-Config SEQUENCE {			
pdsch-AggregationFactor	n4		
}			
}			
}			
}			
}			

Table 7.1.1.2.2.3.3-3: Physical layer parameters for DCI format 1_1 (Steps 3, 7, Table 7.1.1.2.2.3.2-1)

Derivation Path: TS 38.508-1 [4], Table 4.3.6.1.2.2-1			
Parameter	Value	Value in binary	Condition
PDSCH-to-HARQ_feedback timing indicator	Corresponding to K1=5 slots as per dl-DataToUL-ACK in Table 4.6.3-112 TS 38.508-1 [4].	"011"B	

7.1.1.2.3 Correct HARQ process handling / CCCH

7.1.1.2.3.1 Test Purpose (TP)

(1)

```
with { UE in RRC_IDLE state with RRC connection establishment procedure initiated }
ensure that {
  when { UE receives a MAC PDU addressed to RA-RNTI }
  then { UE does not transmit the HARQ feedback for the corresponding HARQ process }
}
```

(2)

```
with { UE in RRC_IDLE state with RRC connection establishment procedure initiated }
ensure that {
  when { UE receives a MAC PDU addressed to T-CRNTI without UE Contention Resolution Identity
  corresponding the transmitted RRCSetupRequest message }
  then { UE does not transmit the HARQ feedback for the corresponding HARQ process }
}
```

(3)

```
with { UE in RRC_IDLE state with RRC connection establishment procedure initiated }
ensure that {
  when { UE receives a MAC PDU addressed to T-CRNTI and cannot decode properly }
  then { UE does not transmit the HARQ feedback for the corresponding HARQ process }
}
```

(4)

```
with { UE in RRC_IDLE state with RRC connection establishment procedure initiated }
ensure that {
  when { UE receives a MAC PDU addressed to T-CRNTI with UE Contention Resolution Identity
  corresponding the transmitted RRCSetupRequest message }
  then { UE transmits the HARQ ACK for the corresponding HARQ process }
}
```

7.1.1.2.3.2 Conformance requirements

References: The conformance requirements covered in the current TC are specified in: TS 38.321, clauses 5.3.2.1 and 5.3.2.2.

[TS 38.321, clause 5.3.2.1]

The MAC entity includes a HARQ entity for each Serving Cell, which maintains a number of parallel HARQ processes. Each HARQ process is associated with a HARQ process identifier. The HARQ entity directs HARQ information and associated TBs received on the DL-SCH to the corresponding HARQ processes (see subclause 5.3.2.2).

The number of parallel DL HARQ processes per HARQ entity is specified in TS 38.214 [7]. The dedicated broadcast HARQ process is used for BCCH.

The HARQ process supports one TB when the physical layer is not configured for downlink spatial multiplexing. The HARQ process supports one or two TBs when the physical layer is configured for downlink spatial multiplexing.

When the MAC entity is configured with *pdsch-AggregationFactor* > 1, the parameter *pdsch-AggregationFactor* provides the number of transmissions of a TB within a bundle of the dynamic downlink assignment. Bundling operation relies on the HARQ entity for invoking the same HARQ process for each transmission that is part of the same bundle. After the initial transmission, *pdsch-AggregationFactor* – 1 HARQ retransmissions follow within a bundle.

The MAC entity shall:

- 1> if a downlink assignment has been indicated:
 - 2> allocate the TB(s) received from the physical layer and the associated HARQ information to the HARQ process indicated by the associated HARQ information.

- 1> if a downlink assignment has been indicated for the broadcast HARQ process:
 - 2> allocate the received TB to the broadcast HARQ process.

[TS 38.321, clause 5.3.2.2]

When a transmission takes place for the HARQ process, one or two (in case of downlink spatial multiplexing) TBs and the associated HARQ information are received from the HARQ entity.

For each received TB and associated HARQ information, the HARQ process shall:

- 1> if the NDI, when provided, has been toggled compared to the value of the previous received transmission corresponding to this TB; or
- 1> if the HARQ process is equal to the broadcast process, and this is the first received transmission for the TB according to the system information schedule indicated by RRC; or
- 1> if this is the very first received transmission for this TB (i.e. there is no previous NDI for this TB):
 - 2> consider this transmission to be a new transmission.
- 1> else:
 - 2> consider this transmission to be a retransmission.

The MAC entity then shall:

- 1> if this is a new transmission:
 - 2> attempt to decode the received data.
- 1> else if this is a retransmission:
 - 2> if the data for this TB has not yet been successfully decoded:
 - 3> instruct the physical layer to combine the received data with the data currently in the soft buffer for this TB and attempt to decode the combined data.
- 1> if the data which the MAC entity attempted to decode was successfully decoded for this TB; or
- 1> if the data for this TB was successfully decoded before:
 - 2> if the HARQ process is equal to the broadcast process:
 - 3> deliver the decoded MAC PDU to upper layers.
 - 2> else if this is the first successful decoding of the data for this TB:
 - 3> deliver the decoded MAC PDU to the disassembly and demultiplexing entity.
- 1> else:
 - 2> instruct the physical layer to replace the data in the soft buffer for this TB with the data which the MAC entity attempted to decode.
- 1> if the HARQ process is associated with a transmission indicated with a Temporary C-RNTI and the Contention Resolution is not yet successful (see subclause 5.1.5); or
- 1> if the HARQ process is equal to the broadcast process; or
- 1> if the *timeAlignmentTimer*, associated with the TAG containing the Serving Cell on which the HARQ feedback is to be transmitted, is stopped or expired:
 - 2> not instruct the physical layer to generate acknowledgement(s) of the data in this TB.
- 1> else:
 - 2> instruct the physical layer to generate acknowledgement(s) of the data in this TB.

The MAC entity shall ignore NDI received in all downlink assignments on PDCCH for its Temporary C-RNTI when determining if NDI on PDCCH for its C-RNTI has been toggled compared to the value in the previous transmission.

NOTE: If the MAC entity receives a retransmission with a TB size different from the last TB size signalled for this TB, the UE behavior is left up to UE implementation.

7.1.1.2.3.3 Test description

7.1.1.2.3.3.1 Pre-test conditions

System Simulator:

- NR Cell 1.

UE:

- None

Preamble:

- The UE is in 1N-A state on NR Cell 1 using generic procedure parameter Connectivity (*NR*) according to TS 38.508-1 [4].

7.1.1.2.3.3.2 Test procedure sequence

Table 7.1.1.2.3.3.2-1: Main behaviour

St	Procedure	Message Sequence		TP	Verdict
		U - S	Message		
1	The SS transmits a Paging message including a matched identity.	<--	-	-	-
2	The UE transmits Preamble on PRACH.	-->	PRACH Preamble	-	-
3	The SS transmits Random Access Response with matching RA-RNTI and including Temporary C-RNTI. The CRC is calculated in such a way, it will result in CRC error on UE side.	<--	Random Access Response	-	-
4	Check: does the UE transmit a HARQ ACK/NACK?	-->	HARQ ACK/NACK	1	F
5	The UE transmits Preamble on PRACH.	-->	PRACH Preamble	-	-
6	The SS transmits Random Access Response with matching RA-RNTI and including Temporary C-RNTI. The CRC is calculated in such a way, it will result in CRC pass on UE side.	<--	Random Access Response	-	-
7	Check: does the UE transmit a HARQ ACK/NACK?	-->	HARQ ACK/NACK	1	F
8	The UE transmits a MAC PDU containing an <i>RRCSetupRequest</i> message.	-->	MAC PDU	-	-
9	The SS transmits a valid MAC PDU containing <i>RRCSetup</i> , and including 'UE Contention Resolution Identity' MAC control element with not matching 'Contention Resolution Identity'.	<--	MAC PDU	-	-
10	Check: does the UE transmit a HARQ ACK/NACK?	-->	HARQ ACK/NACK	2	F
11	The UE transmits Preamble on PRACH.	-->	PRACH Preamble	-	-
12	The SS transmits Random Access Response with matching RA-RNTI and including Temporary C-RNTI.	<--	Random Access Response	-	-
13	The UE transmits a MAC PDU containing an <i>RRCSetupRequest</i> message.	-->	MAC PDU	-	-
14	The SS transmits a valid MAC PDU containing <i>RRCSetup</i> , and including 'UE Contention Resolution Identity' MAC control element with	<--	MAC PDU	-	-

	matching 'Contention Resolution Identity'. The CRC is calculated in such a way that it will result in CRC error on UE side.				
15	Check: Does UE transmit a HARQ ACK/NACK?	-->	HARQ ACK/NACK	3	F
16	The UE transmits Preamble on PRACH.	-->	PRACH Preamble	-	-
17	The SS transmits Random Access Response with matching RA-RNTI and including Temporary C-RNTI.	<--	Random Access Response	-	-
18	The UE transmits a MAC PDU containing an <i>RRCSetupRequest</i> message.	-->	MAC PDU	-	-
19	The SS transmits a valid MAC PDU containing <i>RRCSetup</i> , and including 'UE Contention Resolution Identity' MAC control element with matching 'Contention Resolution Identity'. The CRC is calculated in such a way that it will result in CRC pass on UE side.	<--	MAC PDU	-	-
20	Check: does the UE transmit a HARQ ACK?	-->	HARQ ACK	4	P
21	The UE transmits a MAC PDU containing an <i>RRCSetupComplete</i> message including SERVICE REQUEST message indicating acceptance of <i>RRCSetup</i> message	-->	MAC PDU	-	-
22-25	Steps 5 to 8 of the generic radio bearer establishment procedure (TS 38.508 table 4.5.4.2-3) are executed to successfully complete the service request procedure.	-	-	-	-

7.1.1.2.3.3.3 Specific message contents

None.

7.1.1.2.4 Correct HARQ process handling / BCCH

7.1.1.2.4.1 Test Purpose (TP)

(1)

```
with { UE in RRC_CONNECTED state }
ensure that {
  when { UE receives a MAC PDU addressed to SI-RNTI on the broadcast HARQ process }
  then { UE does not transmit the HARQ feedback for the broadcast HARQ process }
}
```

7.1.1.2.4.2 Conformance requirements

References: The conformance requirements covered in the current TC are specified in: TS 38.321, clauses 5.3.2.1 and 5.3.2.2.

[TS 38.321, clause 5.3.2.1]

The MAC entity includes a HARQ entity for each Serving Cell, which maintains a number of parallel HARQ processes. Each HARQ process is associated with a HARQ process identifier. The HARQ entity directs HARQ information and associated TBs received on the DL-SCH to the corresponding HARQ processes (see subclause 5.3.2.2).

The number of parallel DL HARQ processes per HARQ entity is specified in TS 38.214 [7]. The dedicated broadcast HARQ process is used for BCCH.

The HARQ process supports one TB when the physical layer is not configured for downlink spatial multiplexing. The HARQ process supports one or two TBs when the physical layer is configured for downlink spatial multiplexing.

When the MAC entity is configured with *pdsch-AggregationFactor* > 1, the parameter *pdsch-AggregationFactor* provides the number of transmissions of a TB within a bundle of the dynamic downlink assignment. Bundling operation relies on the HARQ entity for invoking the same HARQ process for each transmission that is part of the same bundle. After the initial transmission, *pdsch-AggregationFactor* – 1 HARQ retransmissions follow within a bundle.

The MAC entity shall:

- 1> if a downlink assignment has been indicated:
 - 2> allocate the TB(s) received from the physical layer and the associated HARQ information to the HARQ process indicated by the associated HARQ information.
- 1> if a downlink assignment has been indicated for the broadcast HARQ process:
 - 2> allocate the received TB to the broadcast HARQ process.

[TS 38.321, clause 5.3.2.2]

When a transmission takes place for the HARQ process, one or two (in case of downlink spatial multiplexing) TBs and the associated HARQ information are received from the HARQ entity.

For each received TB and associated HARQ information, the HARQ process shall:

- 1> if the NDI, when provided, has been toggled compared to the value of the previous received transmission corresponding to this TB; or
- 1> if the HARQ process is equal to the broadcast process, and this is the first received transmission for the TB according to the system information schedule indicated by RRC; or
- 1> if this is the very first received transmission for this TB (i.e. there is no previous NDI for this TB):
 - 2> consider this transmission to be a new transmission.
- 1> else:
 - 2> consider this transmission to be a retransmission.

The MAC entity then shall:

- 1> if this is a new transmission:
 - 2> attempt to decode the received data.
- 1> else if this is a retransmission:
 - 2> if the data for this TB has not yet been successfully decoded:
 - 3> instruct the physical layer to combine the received data with the data currently in the soft buffer for this TB and attempt to decode the combined data.
 - 1> if the data which the MAC entity attempted to decode was successfully decoded for this TB; or
 - 1> if the data for this TB was successfully decoded before:
 - 2> if the HARQ process is equal to the broadcast process:
 - 3> deliver the decoded MAC PDU to upper layers.
 - 2> else if this is the first successful decoding of the data for this TB:
 - 3> deliver the decoded MAC PDU to the disassembly and demultiplexing entity.
 - 1> else:
 - 2> instruct the physical layer to replace the data in the soft buffer for this TB with the data which the MAC entity attempted to decode.
 - 1> if the HARQ process is associated with a transmission indicated with a Temporary C-RNTI and the Contention Resolution is not yet successful (see subclause 5.1.5); or
 - 1> if the HARQ process is equal to the broadcast process; or

- 1> if the *timeAlignmentTimer*, associated with the TAG containing the Serving Cell on which the HARQ feedback is to be transmitted, is stopped or expired:
- 2> not instruct the physical layer to generate acknowledgement(s) of the data in this TB.
- 1> else:
- 2> instruct the physical layer to generate acknowledgement(s) of the data in this TB.

The MAC entity shall ignore NDI received in all downlink assignments on PDCCH for its Temporary C-RNTI when determining if NDI on PDCCH for its C-RNTI has been toggled compared to the value in the previous transmission.

NOTE: If the MAC entity receives a retransmission with a TB size different from the last TB size signalled for this TB, the UE behaviour is left up to UE implementation.

7.1.1.2.4.3 Test description

7.1.1.2.4.3.1 Pre-test conditions

Same Pre-test conditions as in clause 7.1.1.0 except that Short_DCI condition is applied in NR Serving cell configuration.

7.1.1.2.4.3.2 Test procedure sequence

Table 7.1.1.2.4.3.2-1: Main behaviour

St	Procedure	Message Sequence		TP	Verdict
		U - S	Message		
1	The SS transmits a Short message on PDCCH using P-RNTI indicating a <i>systemInfoModification</i> . (Note 1)	<--	PDCCH (DCI 1_0): Short Message	-	-
2	At the start of the modification period, the SS transmits an updated system information with SI-RNTI addressed in L1/L2 header. CRC is calculated in such a way, it will result in CRC fail on UE side. Dedicated HARQ process for broadcast is used. (Note 5)	<--	-	-	-
3	Check: Does the UE transmit a HARQ ACK/NACK? (Note 2 and 3)	-->	HARQ ACK/NACK	1	F
4	After 400ms of step 2, the SS transmits an updated system information contents same as in step 2 with SI-RNTI addressed in L1/L2 header. CRC is calculated in such a way, it will result in CRC pass on UE side. Dedicated HARQ process for broadcast is used.	<--	-	-	-
5	Check: Does the UE transmit a HARQ ACK/NACK? (Note 2 and 4)	->	HARQ ACK/NACK	1	F
6	After 100 ms of Step 4, SS is configured to not allocate UL Grants on Scheduling Request.	-	-	-	-
7	The SS transmits MAC PDU containing an RLC PDU.	<--	MAC PDU	-	-
8	The UE transmits a HARQ ACK.	-->	HARQ ACK	-	-
9	Check: Does the UE transmit PRACH Preamble, using PRACH resources as in new SI?	-->	PRACH Preamble	1	P
10	The SS transmits Random Access Response	<--	Random Access Response	-	-
11	The UE transmits a MAC PDU with C-RNTI containing loop backed RLC PDU.	-->	MAC PDU	-	-
12	SS sends PDCCH transmission for UE C-RNTI to complete contention resolution.	<--	-	-	-
<p>Note 1: The Short Message was transmitted in <i>controlResourceSetZero</i> as Configured in SIB1, need to guarantee that the UE will receive at least one Paging in the Modification Period preceding the SysInfo change, SS should send the Paging message in every eligible PO in this Modification Period.</p> <p>Note 2: When requested to check HARQ feedback for the dedicated broadcast HARQ process, the SS</p>					

	shall assume the same PUCCH reception requirement as specified in TS 38.213 section 9 for a normal HARQ process.
Note 3:	For duration of 400ms, the SS shall check HARQ ACK/NACK for all broadcast SIBs. This duration is sufficient to ensure that SS transmits few times SIBs with CRC corruption.
Note 4:	For duration of 100 ms, The SS shall check for HARQ ACK/NACK for all broadcast SIBs. This duration is sufficient to ensure that SS transmits few times SIBs after CRC corruption is removed.
Note 5:	The modification period boundaries are defined by SFN values for which SFN mod m = 0, where m is the number of radio frames comprising the modification period. Value of m is calculated based on the parameters specified in TS 38.508-1 [4] i.e $m = (\text{modificationPeriodCoeff}=4) * (\text{defaultPagingCycle}=128)$

7.1.1.2.4.3.3 Specific message contents

Table 7.1.1.2.4.3.3-1: SystemInformationBlockType1 (steps 2 and 4 of table 7.1.1.2.4.3.2-1)

Derivation path: 38.508-1 [4] table 4.6.1-28			
Information Element	Value/Remark	Comment	Condition
SIB1 ::= SEQUENCE {			
servingCellConfigCommon SEQUENCE {			
uplinkConfigCommon SEQUENCE {			
initialUplinkBWP SEQUENCE {			
rach-ConfigCommon SEQUENCE {			
prach-RootSequenceIndex CHOICE {			
I139	20		FDD
I139	2		TDD
}			
}			
}			
}			
}			
}			

7.1.1.2.5 Correct HARQ process handling / DL grant prioritization

Editor’s Note: Does the test coverage need to be provided for simultaneous 2 HARQ transmission or can be tested with 2 transmissions in two different time slots? The first option requires additional mechanism to make sure HARQ feedback is with right priority by enforcing different HARQ feedbacks for 2 PDSCH simultaneous transmissions. The test sequence currently is for second option.

7.1.1.2.5.1 Test Purpose (TP)

(1)

```
with { UE in RRC_CONNECTED state and is configured with two PUCCH-config each corresponds to a PHY
priority }
ensure that {
  when { UE receives DL MAC PDU's with DL grant indicating different priorities }
  then { UE transmit the HARQ feedback using correct PUCCH resource as per priority }
}
```

7.1.1.2.5.2 Conformance requirements

References: The conformance requirements covered in the present TC are specified in: TS 38.213 clause 9, 9.2.4. Unless otherwise stated these are Rel-16 requirements.

[TS 38.213, clause 9]

A PUSCH or a PUCCH transmission, including repetitions if any, can be of priority index 0 or of priority index 1. For a configured grant PUSCH transmission, a UE determines a priority index from *phy-PriorityIndex*, if provided. For a PUCCH transmission with HARQ-ACK information corresponding to a SPS PDSCH reception or a SPS PDSCH release, a UE determines a priority index from *harq-CodebookID*, if provided. For a PUCCH transmission with SR, a UE determines the corresponding priority as described in Clause 9.2.4. For a PUSCH transmission with semi-persistent CSI report, a UE determines a priority index from a priority indicator field, if provided, in a DCI format that activates

the semi-persistent CSI report. If a priority index is not provided to a UE for a PUSCH or a PUCCH transmission, the priority index is 0.

[TS 38.213, clause 9.1]

If a UE is provided *pdsch-HARQ-ACK-CodebookList*, the UE can be indicated by *pdsch-HARQ-ACK-CodebookList* to generate one or two HARQ-ACK codebooks. If the UE is indicated to generate one HARQ-ACK codebook, the HARQ-ACK codebook is associated with a PUCCH of priority index 0. If a UE is provided *pdsch-HARQ-ACK-CodebookList*, the UE multiplexes in a same HARQ-ACK codebook only HARQ-ACK information associated with a same priority index. If the UE is indicated to generate two HARQ-ACK codebooks

- a first HARQ-ACK codebook is associated with a PUCCH of priority index 0 and a second HARQ-ACK codebook is associated with a PUCCH of priority index 1

[TS 38.213, clause 9.2.4]

A UE can be configured by *SchedulingRequestResourceConfig* a set of configurations for SR in a PUCCH transmission using either PUCCH format 0 or PUCCH format 1. A UE can be configured by *schedulingRequestID-BFR-SCell* a configuration for LRR in a PUCCH transmission using either PUCCH format 0 or PUCCH format 1. The UE can be provided, by *phy-PriorityIndex* in *SchedulingRequestResourceConfig*, a priority index 0 or a priority index 1 for the SR. If the UE is not provided a priority index for SR, the priority index is 0.

7.1.1.2.5.3 Test description

7.1.1.2.5.3.1 Pre-test conditions

Same Pre-test conditions as in clause 7.1.1.0 except that set to return no data in uplink and parameters as in Table 7.1.1.2.5.3.1-1.

Table 7.1.1.2.5.3.1-1: MAC Parameters

Parameter	Value	Comment
pdsch-HARQ-ACK-Codebook	Not Present	It is assumed this will force the UE to use pdsch-HARQ-ACK-CodebookList-r16
pdsch-HARQ-ACK-CodebookList-r16	dynamic, semiStatic	2 entries

7.1.1.2.5.3.2 Test procedure sequence

Table 7.1.1.2.5.3.2-1: Main behaviour

St	Procedure	Message Sequence		TP	Verdict
		U - S	Message		
1	SS transmits a downlink assignment addressed to the C-RNTI assigned to the UE with priority indicator =0	<--	(PDCCH (C-RNTI) priority Ind =0) (PDCCH (C-RNTI))	-	-
2	SS transmits in the indicated downlink assignment a MAC PDU including a RLC PDU with poll bit not set.	<--	MAC PDU	-	-
3	Check: Does the UE transmit an HARQ ACK on PUCCH associated with priority indicator 0?	-->	HARQ ACK	1	P
4	SS transmits a downlink assignment addressed to the C-RNTI assigned to the UE with priority indicator =1	<--	(PDCCH (C-RNTI) priority Ind =1) (PDCCH (C-RNTI))	-	-
5	SS transmits in the indicated downlink assignment a MAC PDU including a RLC PDU with poll bit not set.	<--	MAC PDU	-	-
6	Check: Does the UE transmit an HARQ ACK on PUCCH associated with priority indicator 1?	-->	HARQ ACK	1	P

7.1.1.2.5.3.3 Specific message contents

None

7.1.1.3 Uplink Data Transfer

7.1.1.3.1 Correct Handling of UL MAC PDU / Assignment / HARQ process

7.1.1.3.1.1 Test Purpose (TP)

(1)

```
with { UE in RRC_CONNECTED state }
ensure that {
  when { UE receives for a Slot an uplink grant with valid C-RNTI }
  then { UE transmits data and associated HARQ information to the HARQ entity for this Slot }
}
```

(2)

```
with { UE in RRC_CONNECTED state }
ensure that {
  when { SS transmits for a Slot an uplink grant with not allocated C-RNTI }
  then { UE does not transmits data and associated HARQ information to the HARQ entity for this Slot }
}
```

(3)

```
with { UE in RRC_CONNECTED state }
ensure that {
  when { UE receives an UL Grant with toggled NDI and has data available for transmission }
  then { UE transmits a new MAC PDU }
}
```

(4)

```
with { UE in RRC_CONNECTED state and having transmitted a MAC PDU on a HARQ process }
ensure that {
  when { UE receives an uplink grant on PDCCH for the next Slot corresponding to the HARQ process with old NDI not toggled }
  then { UE performs an adaptive retransmission of the MAC PDU with redundancy version as received on PDCCH }
}
```

(5)

```
with { UE in E-UTRA RRC_CONNECTED state }
ensure that {
  when { UE receives an uplink grant on PDCCH for the next Slot corresponding to the HARQ process with toggled NDI, and data is not available for transmission }
  then { UE transmits any MAC Padding PDU }
}
```

(6)

```
with { UE in RRC_CONNECTED state }
ensure that {
  when { UE has a MAC SDU to be transmitted that is smaller or equal to 256 bytes }
  then { UE sets F field to 0 and includes 8 bit L field in the MAC sub PDU }
}
```

(7)

```
with { UE in RRC_CONNECTED state }
ensure that {
  when { UE has a MAC SDU to be transmitted that is larger than 256 bytes }
  then { UE sets F field to 1 and includes 16 bit L field in the MAC sub PDU }
}
```

```

    }

```

(8)

```

with { UE in E-UTRA RRC_CONNECTED state }
ensure that {
  when { UE has to insert padding in a MAC PDU }
  then { UE inserts the last MAC sub PDU as a padding sub PDU }
}

```

(9)

```

with { UE in RRC_CONNECTED state and configured with a specific TDD-UL-DL-ConfigCommon including
configuration of pattern2 }
ensure that {
  when { UE receives for a Slot an uplink grant associated with pattern2 with valid C-RNTI }
  then { UE transmits data and associated HARQ information to the HARQ entity for this Slot }
}

```

7.1.1.3.1.2 Conformance requirements

References: The conformance requirements covered in the present TC are specified in: TS 38.321, clauses 5.4.1, 5.4.2.1, 5.4.2.2 and 6.1.2. Unless otherwise stated these are Rel-15 requirements.

[TS 38.321, clause 5.4.1]

Uplink grant is either received dynamically on the PDCCH, in a Random Access Response, or configured semi-persistently by RRC. The MAC entity shall have an uplink grant to transmit on the UL-SCH. To perform the requested transmissions, the MAC layer receives HARQ information from lower layers.

If the MAC entity has a C-RNTI, a Temporary C-RNTI or CS-RNTI, the MAC entity shall for each PDCCH occasion and for each Serving Cell belonging to a TAG that has a running *timeAlignmentTimer* and for each grant received for this PDCCH occasion:

- 1> if an uplink grant for this Serving Cell has been received on the PDCCH for the MAC entity's C-RNTI or Temporary C-RNTI; or
- 1> if an uplink grant has been received in a Random Access Response:
 - 2> if the uplink grant is for MAC entity's C-RNTI and if the previous uplink grant delivered to the HARQ entity for the same HARQ process was either an uplink grant received for the MAC entity's CS-RNTI or a configured uplink grant:
 - 3> consider the NDI to have been toggled for the corresponding HARQ process regardless of the value of the NDI.
 - 2> deliver the uplink grant and the associated HARQ information to the HARQ entity.
- 1> else if an uplink grant for this PDCCH occasion has been received for this serving cell on the PDCCH for the MAC entity's CS-RNTI:
 - 2> if the NDI in the received HARQ information is 1:
 - 3> consider the NDI for the corresponding HARQ process not to have been toggled;
 - 3> stop the *ConfiguredGrantTimer* for the corresponding HARQ process, if running;
 - 3> deliver the uplink grant and the associated HARQ information to the HARQ entity.
 - 2> else if the NDI in the received HARQ information is 0:
 - 3> if PDCCH contents indicate configured grant Type 2 deactivation:
 - 4> trigger configured grant confirmation.
 - 3> else if PDCCH contents indicate configured grant Type 2 activation:
 - 4> trigger configured grant confirmation;

- 4> store the uplink grant for this serving cell and the associated HARQ information as configured uplink grant;
- 4> initialise or re-initialise the configured uplink grant for this serving cell to start in the associated PUSCH duration and to recur according to rules in subclause 5.8.2;
- 4> set the HARQ Process ID to the HARQ Process ID associated with this PUSCH duration;
- 4> consider the NDI bit for the corresponding HARQ process to have been toggled;
- 4> stop the *ConfiguredGrantTimer* for the corresponding HARQ process, if running;
- 4> deliver the configured uplink grant and the associated HARQ information to the HARQ entity.

For each Serving Cell and each configured uplink grant, if configured and activated, the MAC entity shall:

- 1> set the HARQ Process ID to the HARQ Process ID associated with this PUSCH duration;
- 1> if the *ConfiguredGrantTimer* for the corresponding HARQ process is not running:
 - 2> consider the NDI bit for the corresponding HARQ process to have been toggled;
 - 2> deliver the configured uplink grant and the associated HARQ information to the HARQ entity.

NOTE 1: For the same serving cell, an uplink grant addressed to C-RNTI shall override a configured uplink grant in case of overlap in time domain.

For configured uplink grants, the HARQ Process ID associated with this symbol is derived from the following equation:

$$\text{HARQ Process ID} = [\text{floor}(\text{CURRENT_symbol}/\text{periodicity})] \text{ modulo } \text{numberOfConfGrant-Processes}$$

where $\text{CURRENT_symbol} = (\text{SFN} * \text{numberOfSlotsPerFrame} * \text{numberOfSymbolsPerSlot} + \text{slot number in the frame} * \text{numberOfSymbolsPerSlot} + \text{symbol number in the slot})$, and *numberOfSlotsPerFrame* and *numberOfSymbolsPerSlot* refer to the number of consecutive slots per frame and the number of consecutive symbols per slot, respectively as specified in TS 38.211 [8].

NOTE 2: *CURRENT_symbol* refers to the symbol index of the first transmission of a repetition bundle that takes place. [TS 36.322, clause 5.4.2.1]

The MAC entity includes a HARQ entity for each Serving Cell with configured uplink (including the case when it is configured with *supplementaryUplink*), which maintains a number of parallel HARQ processes.

The number of parallel UL HARQ processes per HARQ entity is specified in TS 38.214 [7].

Each HARQ process supports one TB.

Each HARQ process is associated with a HARQ process identifier. For UL transmission with UL grant in RA Response, HARQ process identifier 0 is used.

When repetition is configured with $\text{repK} > 1$, the parameter *repK* provides the number of repetitions of a TB within a bundle. Repetition operation relies on the HARQ entity for invoking the same HARQ process for each transmission that is part of the same bundle. Within a bundle HARQ retransmissions are non-adaptive and triggered without waiting for feedback from previous transmissions according to *repK*.

For each uplink grant, the HARQ entity shall:

- 1> identify the HARQ process(es) associated with this grant, and for each identified HARQ process:
 - 2> if the received grant was not addressed to a Temporary C-RNTI on PDCCH, and the NDI provided in the associated HARQ information has been toggled compared to the value in the previous transmission of this TB of this HARQ process; or
 - 2> if the uplink grant was received on PDCCH for the C-RNTI and the HARQ buffer of the identified process is empty; or
 - 2> if the uplink grant was received in a Random Access Response:

- 3> if there is a MAC PDU in the Msg3 buffer and the uplink grant was received in a Random Access Response:
 - 4> obtain the MAC PDU to transmit from the Msg3 buffer.
- 3> else:
 - 4> obtain the MAC PDU to transmit from the "Multiplexing and assembly" entity, if any;
- 3> if a MAC PDU to transmit has been obtained:
 - 4> deliver the MAC PDU and the uplink grant and the HARQ information of the TB to the identified HARQ process;
 - 4> instruct the identified HARQ process to trigger a new transmission.
 - 4> if the uplink grant is addressed to CS-RNTI or the uplink grant is a configured uplink grant:
 - 5> start or restart the *ConfiguredGrantTimer*, if configured, for the corresponding HARQ process when the transmission is performed.
- 2> else:
 - 3> if the uplink grant received on PDCCH was addressed to CS-RNTI and if the HARQ buffer of the identified process is empty:
 - 4> ignore the uplink grant.
 - 3> else:
 - 4> deliver the uplink grant and the HARQ information (redundancy version) of the TB to the identified HARQ process;
 - 4> instruct the identified HARQ process to trigger a retransmission;
 - 4> if the uplink grant is addressed to CS-RNTI or the uplink grant is a configured uplink grant:
 - 5> start or restart the *ConfiguredGrantTimer*, if configured, for the corresponding HARQ process when the transmission is performed.

When determining if NDI has been toggled compared to the value in the previous transmission the MAC entity shall ignore NDI received in all uplink grants on PDCCH for its Temporary C-RNTI.

[TS 38.321, clause 5.4.2.2]

Each HARQ process is associated with a HARQ buffer.

New transmissions are performed on the resource and with the MCS indicated on either PDCCH, Random Access Response, or RRC. Retransmissions are performed on the resource and, if provided, with the MCS indicated on PDCCH.

If the HARQ entity requests a new transmission for a TB, the HARQ process shall:

- 1> store the MAC PDU in the associated HARQ buffer;
- 1> store the uplink grant received from the HARQ entity;
- 1> generate a transmission as described below.

If the HARQ entity requests a retransmission for a TB, the HARQ process shall:

- 1> store the uplink grant received from the HARQ entity;
- 1> generate a transmission as described below.

To generate a transmission for a TB, the HARQ process shall:

- 1> if the MAC PDU was obtained from the Msg3 buffer; or

- 1> if there is no measurement gap at the time of the transmission and, in case of retransmission, the retransmission does not collide with a transmission for a MAC PDU obtained from the Msg3 buffer:
- 2> instruct the physical layer to generate a transmission according to the stored uplink grant.

[TS 38.321, clause 6.1.2]

A MAC PDU consists of one or more MAC subPDUs. Each MAC subPDU consists of one of the following:

- A MAC subheader only (including padding);
- A MAC subheader and a MAC SDU;
- A MAC subheader and a MAC CE;
- A MAC subheader and padding.

The MAC SDUs are of variable sizes.

Each MAC subheader corresponds to either a MAC SDU, a MAC CE, or padding.

A MAC subheader except for fixed sized MAC CE and padding consists of the four header fields R/F/LCID/L. A MAC subheader for fixed sized MAC CE and padding consists of the two header fields R/LCID.

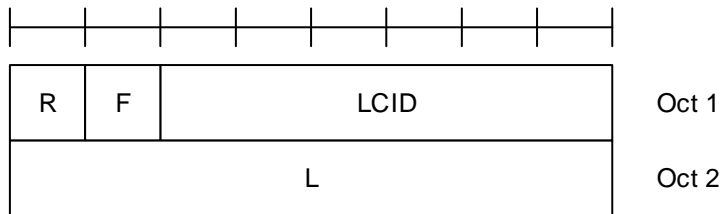

Figure 6.1.2-1: R/F/LCID/L MAC subheader with 8-bit L field

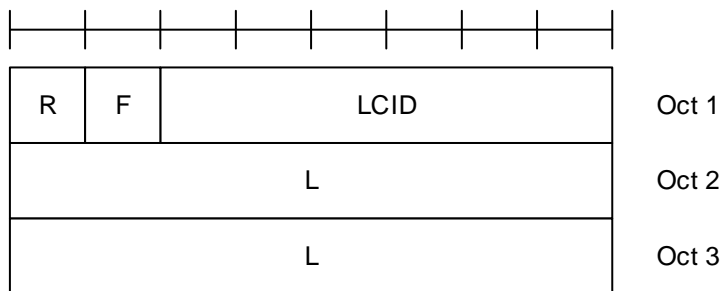

Figure 6.1.2-2: R/F/LCID/L MAC subheader with 16-bit L field

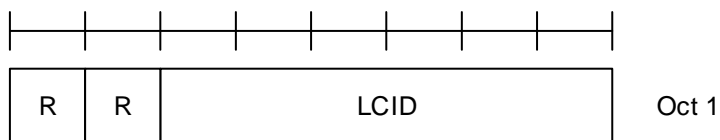

Figure 6.1.2-3: R/LCID MAC subheader

MAC CEs are placed together. DL MAC subPDU(s) with MAC CE(s) is placed before any MAC subPDU with MAC SDU and MAC subPDU with padding as depicted in Figure 6.1.2-4. UL MAC subPDU(s) with MAC CE(s) is placed after all the MAC subPDU(s) with MAC SDU and before the MAC subPDU with padding in the MAC PDU as depicted in Figure 6.1.2-5. The size of padding can be zero.

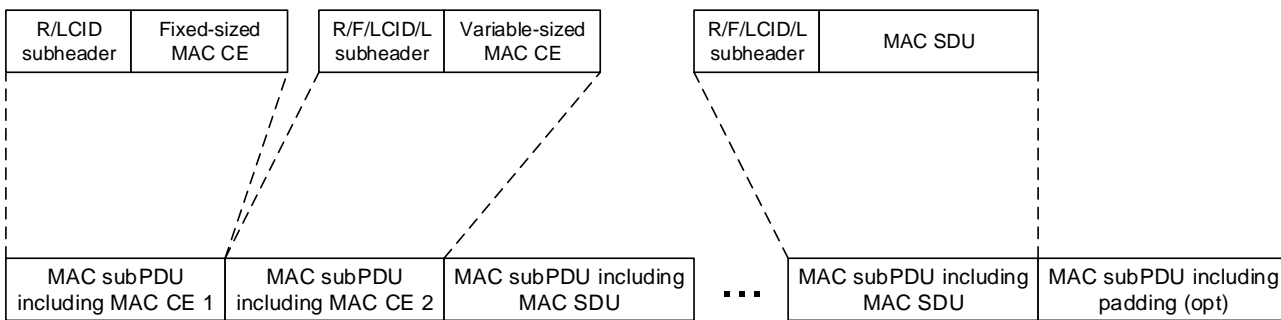

Figure 6.1.2-4: Example of a DL MAC PDU

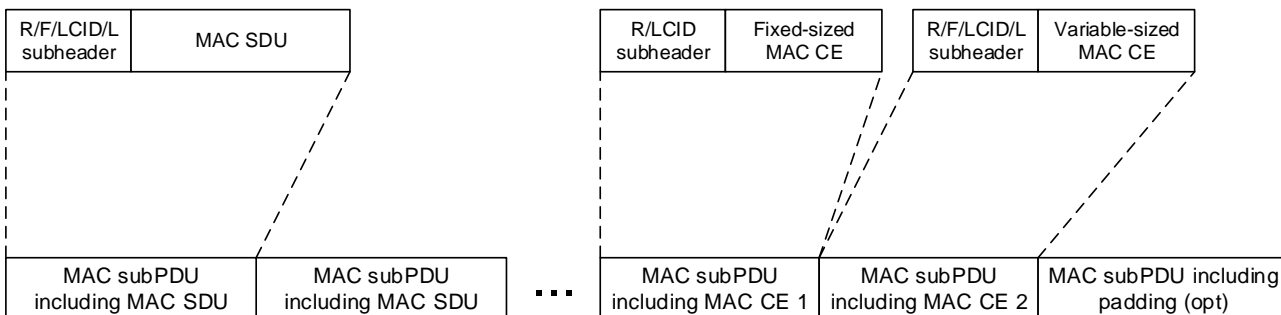

Figure 6.1.2-5: Example of a UL MAC PDU

A maximum of one MAC PDU can be transmitted per TB per MAC entity.

7.1.1.3.1.3 Test description

7.1.1.3.1.3.1 Pre-test conditions

Same Pre-test conditions as in clause 7.1.1.0.

7.1.1.3.1.3.2 Test procedure sequence

Table 7.1.1.3.1.3.2-1: Main behaviour

St	Procedure	Message Sequence		TP	Verdict
		U - S	Message		
1	The SS ignores scheduling requests and does not allocate any uplink grant.	-	-	-	-
2	SS transmits a MAC PDU including a RLC SDU	<--	MAC PDU	-	-
-	EXCEPTION: Step 3 runs in parallel with behaviour in table 7.1.1.3.1.3.2-2	-	-	-	-
3	For 100 ms SS transmits an UL Grant every 10 ms , allowing the UE to return the RLC SDU as received in step 2, on PDCCH, but with the C-RNTI different from the C-RNTI assigned to the UE.	<--	(UL Grant (unknown C-RNTI))	-	-
4	Check: Does the UE transmit a MAC PDU corresponding to grant in step 3?	-->	MAC PDU	2	F
5	SS transmits an UL Grant, allowing the UE to return the RLC SDU as received in step 2, on PDCCH with the C-RNTI assigned to the UE.	<--	(UL Grant (C-RNTI))	-	-
6	Check: Does the UE transmit a MAC PDU corresponding to grant in step 6?	-->	MAC PDU	1	P
6A	SS transmits a MAC PDU containing an RLC STATUS PDU acknowledging the reception of the AMD PDUs in step 6.	<--	MAC PDU (RLC STATUS PDU)	-	-

7	The SS Transmits a valid MAC PDU containing RLC PDU	<--	MAC PDU	-	-
8	The SS allocates an UL Grant for one HARQ process X, sufficient for one RLC SDU to be looped back in a Slot, and NDI indicates new transmission redundancy version to be used as 0	<--	Uplink Grant	-	-
9	Check: Does the UE transmit a MAC PDU including one RLC SDU, in HARQ process X?	-->	MAC PDU	3	P
10	The SS transmits an UL grant corresponding to slot for HARQ process X, with NDI not toggled and redundancy version to be used as 1	<--	Uplink Grant	-	-
11	Check: Does the UE retransmit the MAC PDU in for HARQ process X, using redundancy version1?	-->	MAC PDU	4	P
11A	SS transmits a MAC PDU containing an RLC STATUS PDU acknowledging the reception of the AMD PDUs in step 11.	<--	MAC PDU (RLC STATUS PDU)	-	-
12	The SS transmits an UL grant corresponding to SLOT for HARQ process X, with NDI toggled and redundancy version to be used as 0	<--	Uplink Grant	-	-
13	Check: Does the UE retransmit the MAC PDU containing padding for HARQ process X, using redundancy version 0?	-->	MAC PDU	5	P
14	SS transmits a MAC PDU including a RLC PDU of size 128 bytes	<--	MAC PDU	-	-
15	The SS transmits an UL Grant, allowing the UE to return the RLC SDU as received in step 14 and padding.	<--	(UL Grant (C-RNTI))	-	-
16	Check: Does the UE transmit a MAC PDU corresponding to grant in step 14 with F field set to 0 and includes 8 bit L field in the MAC sub PDU and includes a padding sub PDU at end?	-->	MAC PDU	6,8	P
16A	SS transmits a MAC PDU containing an RLC STATUS PDU acknowledging the reception of the AMD PDUs in step 16.	<--	MAC PDU (RLC STATUS PDU)	-	-
17	SS transmits a MAC PDU including a RLC PDU of size 512 bytes	<--	MAC PDU	-	-
18	The SS transmits an UL Grant, allowing the UE to return the RLC SDU as received in step 17 and padding.	<--	(UL Grant (C-RNTI))	-	-
19	Check: Does the UE transmit a MAC PDU corresponding to grant in step 17 with F field set to 1 and includes 16 bit L field in the MAC sub PDU and includes a padding sub PDU at end?	-->	MAC PDU	7,8	P
19A	SS transmits a MAC PDU containing an RLC STATUS PDU acknowledging the reception of the AMD PDUs in step 19.	<--	MAC PDU (RLC STATUS PDU)	-	-
-	EXCEPTION : Steps 20a0 to 20a6 are executed for operation on NR TDD band only	-	-	-	-
20a0	The SS transmits an updated system information as specified in Table 7.1.1.3.1.3.3-14.				
20a1	The SS transmits a NR RRCReconfiguration message including <i>TDD-UL-DL-ConfigCommon</i> with <i>pattern1</i> and <i>pattern 2</i> specified in Table 7.1.1.3.1.3.3-5 (Note 1)	<--	<i>RRCReconfiguration</i>	-	-
20a2	The UE transmit a NR <i>RRCReconfigurationComplete</i> message. (Note 2)	-->	<i>RRCReconfigurationComplete</i>	-	-
20a3	SS transmits a MAC PDU including a RLC SDU	<--	MAC PDU	-	-
20a4	SS transmits an UL Grant, allowing the UE to	<--	(UL Grant (C-RNTI))	-	-

	return the RLC SDU as received in step 20a3, on PDCCH with the C-RNTI assigned to the UE.				
20a5	Check: Does the UE transmit a MAC PDU corresponding to grant in step 20a4?	-->	MAC PDU	9	P
20a6	SS transmits a MAC PDU containing an RLC STATUS PDU acknowledging the reception of the AMD PDUs in step 20a5.	<--	MAC PDU (RLC STATUS PDU)	-	-
Note 1:	For EN-DC the NR RRCReconfiguration message is contained in RRCConnectionReconfiguration 36.508 [7], Table 4.6.1-8 using condition EN-DC_EmbedNR_RRCRecon.				
Note 2:	For EN-DC the NR RRCReconfigurationComplete message is contained in RRCConnectionReconfigurationComplete.				

Table 7.1.1.3.1.3.2-2: Parallel behaviour

St	Procedure	Message Sequence		TP	Verdict
		U - S	Message		
1	UE transmits a Scheduling Request.	-->	(SR)	-	-

7.1.1.3.1.3.3 Specific message contents

Table 7.1.1.3.1.3.3-1: Void

Table 7.1.1.3.1.3.3-2: Void

Table 7.1.1.3.1.3.3-3: RRCReconfiguration (step20a1, Table 7.1.1.3.1.3.2-1)

Derivation Path: 38.508-1 [4], Table 4.6.1-13			
Information Element	Value/remark	Comment	Condition
RRCReconfiguration ::= SEQUENCE {			
criticalExtensions CHOICE {			
rrcReconfiguration ::= SEQUENCE {			
secondaryCellGroup	CellGroupConfig		EN-DC
}			
RRCReconfiguration-v1530-IEs ::= SEQUENCE {			NR
masterCellGroup	CellGroupConfig		
}			
}			
}			

Table 7.1.1.3.1.3.3-4: CellGroupConfig (Table 7.1.1.3.1.3.3-3)

Derivation Path: TS 38.508-1 [4], Table 4.6.3-19			
Information Element	Value/remark	Comment	Condition
CellGroupConfig ::= SEQUENCE {			
spCellConfig SEQUENCE {			
reconfigurationWithSync SEQUENCE {			
spCellConfigCommon	ServingCellConfigCommon		
}			
spCellConfigDedicated	ServingCellConfig		
}			
}			

Table 7.1.1.3.1.3.3-5: ServingCellConfigCommon (Table 7.1.1.3.1.3.3-4, Table 7.1.1.3.1.3.3-14)

Derivation Path: TS 38.508-1 [4], Table 4.6.3-168			
Information Element	Value/remark	Comment	Condition
ServingCellConfigCommon ::= SEQUENCE {			
uplinkConfigCommon SEQUENCE {			
initialUplinkBWP	BWP-UplinkCommon		

}			
tdd-UL-DL-ConfigurationCommon	TDD-UL-DL-ConfigCommon		
}			

Table 7.1.1.3.1.3.3-6: TDD-UL-DL-ConfigCommon (Table 7.1.1.3.1.3.3-5)

Derivation Path: TS 38.508-1 [4], Table 4.6.3-192			
Information Element	Value/remark	Comment	Condition
TDD-UL-DL-ConfigCommon ::= SEQUENCE {			
referenceSubcarrierSpacing	SubcarrierSpacing		
pattern1 SEQUENCE {			
dl-UL-TransmissionPeriodicity	ms5		FR1
	ms0p625		FR2
nrofDownlinkSlots	3		FR1
	2		FR2
nrofDownlinkSymbols	6		FR1
	6		FR2
nrofUplinkSlots	2		FR1
	2		FR2
nrofUplinkSymbols	4		FR1
	2		FR2
dl-UL-TransmissionPeriodicity-v1530	ms3		FR1
}			
pattern2 SEQUENCE {			
dl-UL-TransmissionPeriodicity	ms2		FR1
	ms0p625		FR2
nrofDownlinkSlots	4		FR1
	3		FR2
nrofDownlinkSymbols	0		FR1
	6		FR2
nrofUplinkSlots	0		FR1
	1		FR2
nrofUplinkSymbols	0		FR1
	2		FR2
}			
}			

Table 7.1.1.3.1.3.3-7: BWP-UplinkCommon (Table 7.1.1.3.1.3.3-5)

Derivation Path: TS 38.508-1 [4], Table 4.6.3-14			
Information Element	Value/remark	Comment	Condition
BWP-UplinkCommon ::= SEQUENCE {			
rach-ConfigCommon CHOICE {			
setup	RACH-ConfigCommon		
}			
}			

Table 7.1.1.3.1.3.3-8: RACH-ConfigCommon (Table 7.1.1.3.1.3.3-7)

Derivation Path: TS 38.508-1 [4], Table 4.6.3-128			
Information Element	Value/remark	Comment	Condition
RACH-ConfigCommon ::= SEQUENCE {			
rach-ConfigGeneric	RACH-ConfigGeneric		
}			

Table 7.1.1.3.1.3.3-9: RACH-ConfigGeneric (Table 7.1.1.3.1.3.3-8)

Derivation Path: TS 38.508-1 [4], Table 4.6.3-130			
Information Element	Value/remark	Comment	Condition
RACH-ConfigGeneric ::= SEQUENCE {			

prach-configurationIndex	156		
}			

Table 7.1.1.3.1.3.3-10: ServingCellConfig (Table 7.1.1.3.1.3.3-4)

Derivation Path: TS 38.508-1 [4], Table 4.6.3-167			
Information Element	Value/remark	Comment	Condition
ServingCellConfig ::= SEQUENCE {			
uplinkConfig SEQUENCE {			
initialUplinkBWP	BWP-UplinkDedicated		
}			
}			

Table 7.1.1.3.1.3.3-11: BWP-UplinkDedicated (Table 7.1.1.3.1.3.3-10)

Derivation Path: TS 38.508-1 [4], Table 4.6.3-15			
Information Element	Value/remark	Comment	Condition
BWP-UplinkDedicated ::= SEQUENCE {			
pucch-Config CHOICE {			
setup	PUCCH-Config		
}			
}			

Table 7.1.1.3.1.3.3-12: PUCCH-Config (Table 7.1.1.3.1.3.3-11)

Derivation Path: TS 38.508-1 [4], Table 4.6.3-112			
Information Element	Value/remark	Comment	Condition
PUCCH-Config ::= SEQUENCE {			
schedulingRequestResourceToAddModList	1 entry		
SEQUENCE (SIZE (1..maxNrofSR-Resources)) OF			
SchedulingRequestResourceConfig {			
SchedulingRequestResourceConfig[1]	SchedulingRequestResourceConfig	entry 1	
}			
}			

Table 7.1.1.3.1.3.3-13: SchedulingRequestResourceConfig (Table 7.1.1.3.1.3.3-12)

Derivation Path: TS 38.508-1 [4], Table 4.6.3-112			
Information Element	Value/remark	Comment	Condition
SchedulingRequestResourceConfig ::= SEQUENCE {			
periodicityAndOffset CHOICE {			
sl10	5	With SCS = kHz15 results in repetition every 10 ms	SCS_15kHz
sl20	5	With SCS = kHz30 results in repetition every 10 ms	SCS_30kHz
sl80	4	With SCS = kHz120 results in repetition every 10 ms	SCS_120kHz
}			
}			

Table 7.1.1.3.1.3.3-14: SystemInformationBlockType1 (step 20a0, Table 7.1.1.3.1.3.2-1)

Derivation path: 38.508-1 [4] table 4.6.1-28
--

Information Element	Value/Remark	Comment	Condition
SIB1 ::= SEQUENCE {			
servingCellConfigCommon	ServingCellConfigCommon	Same contents as in Table 7.1.1.3.1.3.3-5	
}			

7.1.1.3.2 Logical channel prioritization handling

7.1.1.3.2.1 Test Purpose (TP)

(1)

```
with {UE in RRC_CONNECTED state}
ensure that {
  when { UE is sending data on the uplink }
  then { UE serves the logical channels according to their priority and configured PBR }
}
```

7.1.1.3.1.2 Conformance requirements

References: The conformance requirements covered in the present TC are specified in: TS 38.321, clause 5.4.3.1.1, 5.4.3.1.2, 5.4.3.1.3. Unless otherwise stated these are Rel-15 requirements.

[TS 38.321, clause 5.4.3.1.1]

The Logical Channel Prioritization procedure is applied whenever a new transmission is performed.

RRC controls the scheduling of uplink data by signalling for each logical channel per MAC entity:

- *priority* where an increasing priority value indicates a lower priority level;
- *prioritisedBitRate* which sets the Prioritized Bit Rate (PBR);
- *bucketSizeDuration* which sets the Bucket Size Duration (BSD).

RRC additionally controls the LCP procedure by configuring mapping restrictions for each logical channel:

- *allowedSCS-List* which sets the allowed Subcarrier Spacing(s) for transmission;
- *maxPUSCH-Duration* which sets the maximum PUSCH duration allowed for transmission;
- *configuredGrantType1Allowed* which sets whether a Configured Grant Type 1 can be used for transmission;
- *allowedServingCells* which sets the allowed cell(s) for transmission.

The following UE variable is used for the Logical channel prioritization procedure:

- B_j which is maintained for each logical channel j .

The MAC entity shall initialize B_j of the logical channel to zero when the logical channel is established.

For each logical channel j , the MAC entity shall:

- 1> increment B_j by the product $PBR \times T$ before every instance of the LCP procedure, where T is the time elapsed since B_j was last updated;
- 1> if the value of B_j is greater than the bucket size (i.e. $PBR \times BSD$):
 - 2> set B_j to the bucket size.

NOTE: The exact moment(s) when the UE updates B_j between LCP procedures is up to UE implementation, as long as B_j is up to date at the time when a grant is processed by LCP.

[TS 38.321, clause 5.4.3.1.2]

The MAC entity shall, when a new transmission is performed:

- 1> select the logical channels for each UL grant that satisfy all the following conditions:
 - 2> the set of allowed Subcarrier Spacing index values in *allowedSCS-List*, if configured, includes the Subcarrier Spacing index associated to the UL grant; and
 - 2> *maxPUSCH-Duration*, if configured, is larger than or equal to the PUSCH transmission duration associated to the UL grant; and
 - 2> *configuredGrantType1Allowed*, if configured, is set to TRUE in case the UL grant is a Configured Grant Type 1; and
 - 2> *allowedServingCells*, if configured, includes the Cell information associated to the UL grant.

NOTE: The Subcarrier Spacing index, PUSCH transmission duration and Cell information are included in Uplink transmission information received from lower layers for the corresponding scheduled uplink transmission.

[TS 38.321, clause 5.4.3.1.3]

The MAC entity shall, when a new transmission is performed:

- 1> allocate resources to the logical channels as follows:
 - 2> logical channels selected in subclause 5.4.3.1.2 for the UL grant with $B_j > 0$ are allocated resources in a decreasing priority order. If the PBR of a logical channel is set to "infinity", the MAC entity shall allocate resources for all the data that is available for transmission on the logical channel before meeting the PBR of the lower priority logical channel(s);
 - 2> decrement B_j by the total size of MAC SDUs served to logical channel j above;

NOTE: The value of B_j can be negative.

- 2> if any resources remain, all the logical channels selected in subclause 5.4.3.1.2 are served in a strict decreasing priority order (regardless of the value of B_j) until either the data for that logical channel or the UL grant is exhausted, whichever comes first. Logical channels configured with equal priority should be served equally.

The UE shall also follow the rules below during the scheduling procedures above:

- the UE should not segment an RLC SDU (or partially transmitted SDU or retransmitted RLC PDU) if the whole SDU (or partially transmitted SDU or retransmitted RLC PDU) fits into the remaining resources of the associated MAC entity;
- if the UE segments an RLC SDU from the logical channel, it shall maximize the size of the segment to fill the grant of the associated MAC entity as much as possible;
- the UE should maximise the transmission of data;
- if the MAC entity is given an UL grant size that is equal to or larger than 8 bytes while having data available for transmission, the MAC entity shall not transmit only padding BSR and/or padding.

The MAC entity shall not generate a MAC PDU for the HARQ entity if the following conditions are satisfied:

- the MAC entity is configured with *skipUplinkTxDynamic* and the grant indicated to the HARQ entity was addressed to a C-RNTI, or the grant indicated to the HARQ entity is a configured uplink grant; and
- the MAC PDU includes zero MAC SDUs; and
- the MAC PDU includes only the periodic BSR and there is no data available for any LCG, or the MAC PDU includes only the padding BSR.

Logical channels shall be prioritised in accordance with the following order (highest priority listed first):

- MAC CE for C-RNTI or data from UL-CCCH;
- MAC CE for SPS confirmation;

- MAC CE for BSR, with exception of BSR included for padding;
- MAC CE for single entry PHR or multiple entry PHR;
- data from any Logical Channel, except data from UL-CCCH;
- MAC CE for BSR included for padding.

7.1.1.3.2.3 Test description

7.1.1.3.2.3.1 Pre-test conditions

Same Pre-test conditions as in clause 7.1.1.0 with the exception of 3 UM SN terminated SCG bearers configured according to Table 7.1.1.3.2.3.1-1.

Table 7.1.1.3.2.3.1-1: Priority, PBR and Bucket Delay settings

DRB	priority	prioritizedBitRate (kbytes/s)	bucketSizeDuration (ms)
DRB1	6	8	100
DRB2	7	16	100
DRB3	8	32	100

Table 7.1.1.3.2.3.1-2: PDCP Settings

Parameter	Value
Discard_Timer	ms1500

7.1.1.3.2.3.2 Test procedure sequence

Table 7.1.1.3.2.3.2-1: Main behaviour

St	Procedure	Message Sequence		TP	Verdict
		U - S	Message		
-	EXCEPTION: Steps 1 to 3 are run 4 times using the parameters specified for each run in table 7.1.1.3.2.3.2-3.	-	-	-	-
1	The SS transmits N1 320-octet RLC SDUs on DRB1, N2 320-octet RLC SDUs on DRB2, and N3 320-octet RLC SDUs on DRB3.	<--	(RLC SDUs)	-	-
1A	Start WatchDog_Timer set to 5 seconds	-	-	-	-
-	EXCEPTION: In parallel to the event described in step 2 the events specified in Table 7.1.1.3.2.3.2-2 shall take place.	-	-	-	-
2	The SS is configured for Uplink Grant Allocation Type 2 as defined in TS 38.523-3 [3]. 150 ms after Step 1 (Note1), for a duration of T2, the SS transmits an UL grant of D octets every T1.	<--	(UL grants)	-	-
3	Check: Are the total number of octets of the UL RLC SDUs received at the SS for each DRB as follows: - total number of octets received for DRB1 is D1 octets +/- 10% - total number of octets received for DRB2 is D2 octets +/- 10% - total number of octets received for DRB3 is D3 octets +/- 10% ?	-	-	1	P
4	Wait for WatchDog_Timer expiry(Note2)	-	-	-	-
Note 1: This wait time will ensure that a) all octets have been completely received by the UE on all 3 DRBs before the first UL grant is received and b) the Bjs for each logical channel have reached their maximum value i.e. the bucket size of the corresponding logical channel before the first UL grant is received.					
Note 2: Several PDUs on DRB3 after second run and on DRB2 after third run and on DRB1 after fourth run would					

be awaiting on PDCP Tx Buffer. Timer 5 seconds ensures the PDCP Data PDUs are discarded after expiry of Discard_timer(1500ms).

Table 7.1.1.3.2.3.2-2: Parallel behaviour

St	Procedure	Message Sequence		TP	Verdict
		U - S	Message		
1	Check: Does the UE transmit the RLC SDUs back to the SS?	-->	-	1	P

Table 7.1.1.3.2.3.2-3: Test parameter values

Parameter	First run	Second run	Third run	Fourth run
N1 (SDUs)	13	13	7	104
N2 (SDUs)	25	25	50	25
N3 (SDUs)	50	50	50	50
D (octets)	1153	576	1153	1153
T1 (ms)	20	20	20	10
T2 (ms)	500	700	500	500
D1 (octets)	4160	4160	2240	33350 (Note 1)
D2 (octets)	8000	8000	10435 (Note 1)	8000
D3 (octets)	16000	7790 (Note 1)	16000	16000

Note 1: Calculated using the following equation for the case of the least header size:
 $(D1 + D2 + D3) = (D - 6) * T2 / T1$

NOTE: The Test parameter values above and the test procedure assume that the UE has a loopback buffer of at least 57280 octets.

7.1.1.3.2.3.3 Specific message contents

Table 7.1.1.3.2.3.3-1: SchedulingRequest-Config (Preamble)

Derivation Path: 38.508-1 [4], Table 4.6.3-155			
Information Element	Value/remark	Comment	Condition
sr-TransMax	n64		

7.1.1.3.2b Logical channel prioritization handling with Mapping restrictions

7.1.1.3.2b.1 Test Purpose (TP)

(1)

```
with {UE in RRC_CONNECTED state with allowedSCS-List configured }
ensure that {
  when { UE is sending data on the uplink }
  then { UE serves the logical channels according to their priority and configured PBR and
respecting allowedSCS-List }
}
```

(2)

```
with {UE in RRC_CONNECTED state with maxPUSCH-Duration configured }
ensure that {
  when { UE is sending data on the uplink }
  then { UE serves the logical channels according to their priority and configured PBR and
respecting maxPUSCH-Duration }
}
```

(3)

```

with { UE in RRC_CONNECTED state with configuredGrantType1Allowed configured and supporting Type 1
PUSCH transmissions with configured grant }
ensure that {
  when { UE is sending data on the uplink }
  then { UE serves the logical channels according to their priority and configured PBR and
respecting configuredGrantType1Allowed }
}

```

7.1.1.3.2b.2 Conformance requirements

References: The conformance requirements covered in the present TC are specified in: TS 38.321, clause 5.4.3.1.1, 5.4.3.1.2, 5.4.3.1.3. Unless otherwise stated these are Rel-15 requirements.

[TS 38.321, clause 5.4.3.1.1]

The Logical Channel Prioritization (LCP) procedure is applied whenever a new transmission is performed.

RRC controls the scheduling of uplink data by signalling for each logical channel per MAC entity:

- *priority* where an increasing priority value indicates a lower priority level;
- *prioritisedBitRate* which sets the Prioritized Bit Rate (PBR);
- *bucketSizeDuration* which sets the Bucket Size Duration (BSD).

RRC additionally controls the LCP procedure by configuring mapping restrictions for each logical channel:

- *allowedSCS-List* which sets the allowed Subcarrier Spacing(s) for transmission;
- *maxPUSCH-Duration* which sets the maximum PUSCH duration allowed for transmission;
- *configuredGrantType1Allowed* which sets whether a configured grant Type 1 can be used for transmission;
- *allowedServingCells* which sets the allowed cell(s) for transmission.

The following UE variable is used for the Logical channel prioritization procedure:

- *B_j* which is maintained for each logical channel *j*.

The MAC entity shall initialize *B_j* of the logical channel to zero when the logical channel is established.

For each logical channel *j*, the MAC entity shall:

- 1> increment *B_j* by the product $PBR \times T$ before every instance of the LCP procedure, where *T* is the time elapsed since *B_j* was last incremented;
- 1> if the value of *B_j* is greater than the bucket size (i.e. $PBR \times BSD$):
 - 2> set *B_j* to the bucket size.

NOTE: The exact moment(s) when the UE updates *B_j* between LCP procedures is up to UE implementation, as long as *B_j* is up to date at the time when a grant is processed by LCP.

[TS 38.321, clause 5.4.3.1.2]

The MAC entity shall, when a new transmission is performed:

- 1> select the logical channels for each UL grant that satisfy all the following conditions:
 - 2> the set of allowed Subcarrier Spacing index values in *allowedSCS-List*, if configured, includes the Subcarrier Spacing index associated to the UL grant; and
 - 2> *maxPUSCH-Duration*, if configured, is larger than or equal to the PUSCH transmission duration associated to the UL grant; and
 - 2> *configuredGrantType1Allowed*, if configured, is set to *true* in case the UL grant is a Configured Grant Type 1; and

- 2> *allowedServingCells*, if configured, includes the Cell information associated to the UL grant. Does not apply to logical channels associated with a DRB configured with PDCP duplication within the same MAC entity (i.e. CA duplication) for which PDCP duplication is deactivated.

NOTE: The Subcarrier Spacing index, PUSCH transmission duration and Cell information are included in Uplink transmission information received from lower layers for the corresponding scheduled uplink transmission.

[TS 38.321, clause 5.4.3.1.3]

The MAC entity shall, when a new transmission is performed:

- 1> allocate resources to the logical channels as follows:
 - 2> logical channels selected in subclause 5.4.3.1.2 for the UL grant with $B_j > 0$ are allocated resources in a decreasing priority order. If the PBR of a logical channel is set to *infinity*, the MAC entity shall allocate resources for all the data that is available for transmission on the logical channel before meeting the PBR of the lower priority logical channel(s);
 - 2> decrement B_j by the total size of MAC SDUs served to logical channel j above;
 - 2> if any resources remain, all the logical channels selected in subclause 5.4.3.1.2 are served in a strict decreasing priority order (regardless of the value of B_j) until either the data for that logical channel or the UL grant is exhausted, whichever comes first. Logical channels configured with equal priority should be served equally.

NOTE: The value of B_j can be negative.

If the MAC entity is requested to simultaneously transmit multiple MAC PDUs, or if the MAC entity receives the multiple UL grants within one or more coinciding PDCCH occasions (i.e. on different Serving Cells), it is up to UE implementation in which order the grants are processed.

The UE shall also follow the rules below during the scheduling procedures above:

- the UE should not segment an RLC SDU (or partially transmitted SDU or retransmitted RLC PDU) if the whole SDU (or partially transmitted SDU or retransmitted RLC PDU) fits into the remaining resources of the associated MAC entity;
- if the UE segments an RLC SDU from the logical channel, it shall maximize the size of the segment to fill the grant of the associated MAC entity as much as possible;
- the UE should maximise the transmission of data;
- if the MAC entity is given a UL grant size that is equal to or larger than 8 bytes while having data available and allowed (according to subclause 5.4.3.1) for transmission, the MAC entity shall not transmit only padding BSR and/or padding.

The MAC entity shall not generate a MAC PDU for the HARQ entity if the following conditions are satisfied:

- the MAC entity is configured with *skipUplinkTxDynamic* with value *true* and the grant indicated to the HARQ entity was addressed to a C-RNTI, or the grant indicated to the HARQ entity is a configured uplink grant; and
- there is no aperiodic CSI requested for this PUSCH transmission as specified in TS 38.212 [9]; and
- the MAC PDU includes zero MAC SDUs; and
- the MAC PDU includes only the periodic BSR and there is no data available for any LCG, or the MAC PDU includes only the padding BSR.

Logical channels shall be prioritised in accordance with the following order (highest priority listed first):

- C-RNTI MAC CE or data from UL-CCCH;
- Configured Grant Confirmation MAC CE;
- MAC CE for BSR, with exception of BSR included for padding;
- Single Entry PHR MAC CE or Multiple Entry PHR MAC CE;

- data from any Logical Channel, except data from UL-CCCH;
- MAC CE for Recommended bit rate query;
- MAC CE for BSR included for padding.

7.1.1.3.2b.3 Test description

7.1.1.3.2b.3.1 Pre-test conditions

Same Pre-test conditions as in clause 7.1.1.0 with the exception of 3 UM NR DRBs configured according to Table 7.1.1.3.2b.3.1-1.

Table 7.1.1.3.2b.3.1-1: Priority, PBR, Bucket Delay allowed-SCSList settings

DRB	priority	prioritizedBitRate (kbytes/s)	bucketSize Duration (ms)	allowed-SCSList	
				FR1	FR2
DRB1	6	8	100	{15KHz, 30KHz}	{60KHz, 120KHz}
DRB2	7	16	100	{60KHz}	{60KHz}
DRB3	8	32	100	{15KHz, 30KHz, 60KHz}	{120KHz}

Table 7.1.1.3.2b.3.1-2: allowed-SCSList and maxPUSCH-Duration settings

DRB	allowed-SCSList	maxPUSCH-Duration
DRB1	Not Present	ms0p02
DRB2	Not Present	ms0p5
DRB3	Not Present	ms0p5

Table 7.1.1.3.2b.3.1-2a: PUSCH-TimeDomainResourceAllocationList

Derivation Path: TS 38.508-1 [4], table 4.6.3-122			
Information Element	Value/remark	Comment	Condition
PUSCH-TimeDomainResourceAllocationList ::= SEQUENCE (SIZE(1..maxNrofUL-Allocations)) OF PUSCH-TimeDomainResourceAllocation {	2 entry		
PUSCH-TimeDomainResourceAllocation[1]		entry 1	
SEQUENCE {			
k2	2		FR1
	4		FR2
mappingType	typeB		
startSymbolAndLength	52	Start symbol(S)=10, Length(L)=4	FR1
startSymbolAndLength	42	Start symbol(S)=0, Length(L)=4	FR2
}			
PUSCH-TimeDomainResourceAllocation[2]		entry 2	
SEQUENCE {			
k2	2		FR1
	4		FR2
mappingType	typeB		
startSymbolAndLength	27	Start symbol(S)=0, Length(L)=14	
}			
}			

Table 7.1.1.3.2b.3.1-3: maxPUSCH-Duration and configuredGrantType1Allowed settings

DRB	maxPUSCH-Duration	configuredGrantType1Allowed
DRB1	Not Present	true
DRB2	Not Present	false
DRB3	Not Present	true

Table 7.1.1.3.2b.3.1-4: PDCP Settings

Parameter	Value
Discard_Timer	ms1500

7.1.1.3.2b.3.2 Test procedure sequence

Table 7.1.1.3.2b.3.2-1: Main behaviour

St	Procedure	Message Sequence		TP	Verdict
		U - S	Message		
-	EXCEPTION: Steps 1 to 3 are run using the parameters specified for first run in table 7.1.1.3.2b.3.2-3.	-	-	-	-
1	The SS transmits N1 320-octet RLC SDUs on DRB1, N2 320-octet RLC SDUs on DRB2, and N3 320-octet RLC SDUs on DRB3.	<--	(RLC SDUs)	-	-
-	EXCEPTION: In parallel to the event described in step 2 the events specified in Table 7.1.1.3.2b.3.2-2 shall take place.	-	-	-	-
2	The SS is configured for Uplink Grant Allocation Type 2 as defined in TS 38.523-3 [3]. 150 ms after Step 1 (Note1), for a duration of T2, the SS transmits an UL grant of D octets every T1.	<--	(UL grants)	-	-
3	Check: Are the total number of octets of the UL RLC SDUs received at the SS for each DRB as follows: - total number of octets received for DRB1 is D1 octets +/- 10% - total number of octets received for DRB2 is 0 - total number of octets received for DRB3 is D3 octets +/- 10% otherwise?	-	-	1	P
4	SS transmits NR <i>RRCReconfiguration</i> message to configure allowed-SCSList and maxPUSCH-Duration as per Table 7.1.1.3.2b.3.1-2. (Note 2)	<--	(NR RRC: <i>RRCReconfiguration</i>)	-	-
-	EXCEPTION: In parallel to the event described in step 5 the events specified in Table 7.1.1.3.2b.3.2-2a shall take place on DRB2	-	-	-	-
5	The UE transmits NR <i>RRCReconfigurationComplete</i> message. (Note 3)	-->	(NR RRC: <i>RRCReconfigurationComplete</i>)	-	-
-	EXCEPTION: Steps 6 to 8 are run using the parameters specified for second run in table 7.1.1.3.2b.3.1-2.	-	-	-	-
6	The SS transmits N1 320-octet RLC SDUs on DRB1, N2 320-octet RLC SDUs on DRB2, and N3 320-octet RLC SDUs on DRB3.	<--	(RLC SDUs)	-	-
-	EXCEPTION: In parallel to the event described in step 7 the events specified in Table 7.1.1.3.2b.3.2-2 shall take place.	-	-	-	-
7	The SS is configured for Uplink Grant Allocation Type 2 as defined in TS 38.523-3 [3]. 150 ms after Step 1 (Note1), for a duration	<--	(UL grants)	-	-

	of T2, the SS transmits an UL grant of D octets every T1.				
8	Check: Are the total number of octets of the UL RLC SDUs received at the SS for each DRB as follows: - total number of octets received for DRB1 are 0 - total number of octets received for DRB2 are D2 octets +/- 10% - total number of octets received for DRB3 are D3 octets +/- 10%?	-	-	2	P
-	EXCEPTION: Steps 9 to 14 describe behaviour that depends on the UE capability.	-	-	-	-
9	IF <i>pc_configuredUL_GrantType1</i> the SS transmits NR <i>RRCReconfiguration</i> message to configure UL configured grant type 1 with UL grant configured 150 ms after Step 11 (Note1), for a duration of T2 and an UL grant of D octets every T1. It also configures <i>maxPUSCH-Duration</i> and <i>configuredGrantType1Allowed</i> as per Table 7.1.1.3.2b.3.1-3 (Note 2)	<--	(NR RRC: <i>RRCReconfiguration</i>)	-	-
-	EXCEPTION: In parallel to the event described in step 10 the events specified in Table 7.1.1.3.2b.3.2-2a shall take place on DRB1	-	-	-	-
10	The UE transmits NR <i>RRCReconfigurationComplete</i> message. (Note 3)	-->	(NR RRC: <i>RRCReconfigurationComplete</i>)	-	-
-	EXCEPTION: Steps 11 to 13 are run using the parameters specified for third run in table 7.1.1.3.2b.3.1-1.	-	-	-	-
11	The SS transmits N1 320-octet RLC SDUs on DRB1, N2 320-octet RLC SDUs on DRB2, and N3 320-octet RLC SDUs on DRB3.	<--	(RLC SDUs)	-	-
-	EXCEPTION: In parallel to the event described in step 9 the events specified in Table 7.1.1.3.2b.3.2-2 shall take place.	-	-	-	-
12	Check: Are the total number of octets of the UL RLC SDUs received at the SS for each DRB as follows: - total number of octets received for DRB1 are D1 octets +/- 10% - total number of octets received for DRB2 are 0 - total number of octets received for DRB3 are D3 octets +/- 10%?	-	-	3	P
13	The SS sends one Uplink Grant to send loop back PDU on DRB 2.	<--	(UL grants)	-	-
14	The UE transmits the RLC SDU back to the SS.	-->	-	-	-
<p>Note 1: This wait time will ensure that a) all octets have been completely received by the UE on all 3 DRBs before the first UL grant is received and b) the Bj's for each logical channel have reached their maximum value i.e. the bucket size of the corresponding logical channel before the first UL grant is received.</p> <p>Note 2: For EN-DC the NR <i>RRCReconfiguration</i> message is contained in <i>RRCCConnectionReconfiguration</i> 36.508 [7], Table 4.6.1-8 using condition EN-DC_EMBEDNR_RRCRecon.</p> <p>Note 3: For EN-DC the NR <i>RRCReconfigurationComplete</i> message is contained in <i>RRCCConnectionReconfigurationComplete</i></p>					

Table 7.1.1.3.2b.3.2-2: Parallel behaviour

St	Procedure	Message Sequence		TP	Verdict
		U – S	Message		
1	Check: Does the UE transmit the RLC SDUs back to the SS?	-->	-	1,2,3	P

Table 7.1.1.3.2b.3.2-2a: Parallel behaviour

St	Procedure	Message Sequence		TP	Verdict
		U – S	Message		
1	The UE may transmit the RLC SDU back to the SS within one second.	-->	-	-	-

Table 7.1.1.3.2b.3.2-3: Test parameter values

Parameter	First run	Second run	Third run
N1 (SDUs)	13	1	13
N2 (SDUs)	1	25	1
N3 (SDUs)	50	50	50
D (octets)	1153	576	1153
T1 (ms)	20	20	20
T2 (ms)	360	860	360
D1 (octets)	4160	0	4160
D2 (octets)	0	8000	0
D3 (octets)	16000	16000	16000

Note 1: Calculated using the following equation for the case of the least header size: $(D1 + D2 + D3) = (D - 6) * T2 / T1$.

7.1.1.3.2b.3.3 Specific message contents

Table 7.1.1.3.2b.3.3-1: SchedulingRequest-Config (Preamble)

Derivation Path: 36.508 [7], Table 4.6.3-20			
Information Element	Value/remark	Comment	Condition
sr-TransMax	n64		

Table 7.1.1.3.2b.3.3-2: RRCReconfiguration (step 9, Table 7.1.1.3.2b.3.2-1)

Derivation path: 38.508-1 [4], Table 4.6.1-13			
Information Element	Value/remark	Comment	Condition
RRCReconfiguration ::= SEQUENCE {			
criticalExtensions CHOICE {			
rrcReconfiguration SEQUENCE {			
radioBearerConfig	Not present		
secondaryCellGroup	CellGroupConfig	OCTET STRING (CONTAINING CellGroupConfig)	EN-DC
nonCriticalExtension ::= SEQUENCE {}	Not present		EN-DC
nonCriticalExtension ::= SEQUENCE{			NR
masterCellGroup	CellGroupConfig	OCTET STRING (CONTAINING CellGroupConfig)	
dedicatedNAS-MessageList SEQUENCE (SIZE(1..maxDRB)) OF DedicatedNAS-Message {}	Not present		
}			
}			
}			
}			

Table 7.1.1.3.2b.3.3-3: CellGroupConfig (Table 7.1.1.3.2b.3.3-2: RRCReconfiguration)

Derivation path: 38.508-1 [4], Table 4.6.3-19			
Information Element	Value/remark	Comment	Condition
CellGroupConfig ::= SEQUENCE {			
rlc-BearerToAddModList	Not present		
mac-CellGroupConfig	Not present		
physicalCellGroupConfig SEQUENCE {			

cs-RNTI CHOICE {			
setup SEQUENCE{			
RNTI-Value	'FFE0'H		
}			
}			
spCellConfig SEQUENCE{			
servCellIndex	Not present		NR
	1		EN-DC
reconfigurationWithSync	Not present		
spCellConfigDedicated SEQUENCE{			
uplinkConfig SEQUENCE {			
initialUplinkBWP SEQUENCE {			
pucch-Config CHOICE {			
setup SEQUENCE {			
schedulingRequestResourceToAddModList {			
schedulingRequestResourceId	1		
schedulingRequestID	0		
periodicityAndOffset CHOICE {			
sl20	10		
}			
}			
}			
}			
}			
}			
configuredGrantConfig CHOICE {			
setup SEQUENCE {			
cg-DMRS-Configuration	DMRS-UplinkConfig	Reference TS 38.508-1[4], Table 4.6.3-51	
}			
uci-OnPUSCH CHOICE {			
setup SEQUENCE {			
semiStatic SEQUENCE {	BetaOffsets		
betaOffsetACK-Index1	9		
betaOffsetACK-Index2	9		
betaOffsetACK-Index3	9		
betaOffsetCSI-Part1-Index1	6		
betaOffsetCSI-Part1-Index2	6		
betaOffsetCSI-Part2-Index1	6		
betaOffsetCSI-Part2-Index2	6		
}			
}			
}			
resourceAllocation	ResourceAllocationType 1		
powerControlLoopToUse	n0		
p0-PUSCH-Alpha	1		
nrofHARQ-Processes	16		
repK	n1		
periodicity	Sym20x14		15kHz
periodicity	Sym40x14		30kHz
periodicity	Sym80x14		60kHz
periodicity	Sym160x14		120kHz
rrc-ConfiguredUplinkGrant SEQUENCE{			
timeDomainOffset	0		
timeDomainAllocation	0	Reference TS 38.508-1 [4], Table 4.6.3-122	
frequencyDomainAllocation	BIT STRING (SIZE(18))	BIT STRING (SIZE(18), Equal to NBWPsize * (LRB- 1) + RBstart), where LRB = 23 PRB, RBstart = 0, NBWPsize is the size [PRBs] of the	

		active carrier bandwidth part and ontained in TS.38.508-1 [4] clause 4.3.1.1.	
antennaPort	0		
precodingAndNumberOfLayers	0		
srs-ResourceIndicator	Not present		
mcsAndTBS	16		
pathlossReferenceIndex	0		
}			
}			
}			

7.1.1.3.3 Correct handling of MAC control information / Scheduling requests

7.1.1.3.3.1 Test Purpose (TP)

(1)

```
with { UE in RRC_CONNECTED state with SR resource on PUCCH is configured }
ensure that {
  when { UE has UL data available for transmission and UE has no UL-SCH resources available and
SR_COUNTER is less than sr-TransMax }
  then { the UE transmits a SR on every available PUCCH until resources are granted }
}
```

(2)

```
with { UE in RRC_CONNECTED state with SR resource on PUCCH is configured }
ensure that {
  when { UE receives an UL grant for a new transmission }
  then { UE cancels all pending SR(s) }
}
```

(3)

```
with { UE in RRC_CONNECTED state with SR resource on PUCCH is configured }
ensure that {
  when { UE has UL data available for transmission and UE has no UL-SCH resources available and
SR_COUNTER becomes equal to sr-TransMax }
  then { the UE transmits a PRACH Preamble to initiate a Random Access procedure }
}
```

(4)

```
with { UE in RRC_CONNECTED state with SR resource on PUCCH is configured and logicalChannelSR-
DelayTimer is configured }
ensure that {
  when { UE has UL data available for transmission on LCH for which logicalChannelSR-DelayTimer is
configured and UE has no UL-SCH resources available and SR_COUNTER is less than sr-TransMax }
  then { the UE delays transmission of SR until logicalChannelSR-DelayTimer expires }
}
```

(5)

```
with { UE in RRC_CONNECTED state with SR resource on PUCCH is configured }
ensure that {
  when { UE has UL data available for transmission on LCH for which logicalChannelSR-DelayTimer is
not configured and UE has no UL-SCH resources available and SR_COUNTER is less than sr-TransMax }
  then { the UE transmits a SR on every available PUCCH until resources are granted }
}
```

7.1.1.3.3.2 Conformance requirements

References: The conformance requirements covered in the present TC are specified in: TS 38.321, clauses 5.4.4 and 5.4.5. Unless otherwise stated these are Rel-15 requirements.

[TS 38.321, clause 5.4.4]

The Scheduling Request (SR) is used for requesting UL-SCH resources for new transmission.

The MAC entity may be configured with zero, one, or more SR configurations. An SR configuration consists of a set of PUCCH resources for SR across different BWPs and cells. For a logical channel, at most one PUCCH resource for SR is configured per BWP.

Each SR configuration corresponds to one or more logical channels. Each logical channel may be mapped to zero or one SR configuration, which is configured by RRC. The SR configuration of the LCH that triggered the BSR (subclause 5.4.5) (if such a configuration exists) is considered as corresponding SR configuration for the triggered SR. For BSR triggered by *retxBSR-Timer* expiry, the corresponding SR configuration for the triggered SR is that of the highest priority LCH (if such a configuration exists) that has data available for transmission at the time the BSR is triggered.

RRC configures the following parameters for the scheduling request procedure:

- *sr-ProhibitTimer* (per SR configuration);
- *sr-TransMax* (per SR configuration);
- *sr-ConfigIndex*.

The following UE variables are used for the scheduling request procedure:

- *SR_COUNTER* (per SR configuration).

If an SR is triggered and there are no other SRs pending corresponding to the same SR configuration, the MAC entity shall set the *SR_COUNTER* of the corresponding SR configuration to 0.

When an SR is triggered, it shall be considered as pending until it is cancelled. All pending SR(s) shall be cancelled and each respective *sr-ProhibitTimer* shall be stopped when a MAC PDU is assembled and this PDU includes a BSR which contains buffer status up to (and including) the last event that triggered a BSR (see subclause 5.4.5), or when the UL grant(s) can accommodate all pending data available for transmission.

Only PUCCH resources on a BWP which is active at the time of SR transmission occasion are considered valid.

As long as at least one SR is pending, the MAC entity shall for each pending SR:

- 1> if the MAC entity has no valid PUCCH resource configured for the pending SR:
 - 2> initiate a Random Access procedure (see subclause 5.1) on the SpCell and cancel the pending SR.
- 1> else, for the SR configuration corresponding to the pending SR:
 - 2> when the MAC entity has an SR transmission occasion on the valid PUCCH resource for SR configured; and
 - 2> if *sr-ProhibitTimer* is not running at the time of the SR transmission occasion; and
 - 2> if the PUCCH resource for the SR transmission occasion does not overlap with a measurement gap; and
 - 2> if the PUCCH resource for the SR transmission occasion does not overlap with a UL-SCH resource:
 - 3> if *SR_COUNTER* < *sr-TransMax*:
 - 4> increment *SR_COUNTER* by 1;
 - 4> instruct the physical layer to signal the SR on one valid PUCCH resource for SR;
 - 4> start the *sr-ProhibitTimer*.
 - 3> else:
 - 4> notify RRC to release PUCCH for all serving cells;
 - 4> notify RRC to release SRS for all serving cells;
 - 4> clear any configured downlink assignments and uplink grants;

4> initiate a Random Access procedure (see subclause 5.1) on the SpCell and cancel all pending SRs.

NOTE: The selection of which valid PUCCH resource for SR to signal SR on when the MAC entity has more than one overlapping valid PUCCH resource for the SR transmission occasion is left to UE implementation.

[TS 38.321, clause 5.4.5]

For Regular BSR, the MAC entity shall:

- 1> if the BSR is triggered for a logical channel for which *logicalChannelSR-Delay* is configured by upper layers:
 - 2> start or restart the *logicalChannelSR-DelayTimer*.
- 1> else:
 - 2> if running, stop the *logicalChannelSR-DelayTimer*.

...

The MAC entity shall:

- 1> if the Buffer Status reporting procedure determines that at least one BSR has been triggered and not cancelled:
 - 2> if UL-SCH resources are available for a new immediate transmission:
 - 3> instruct the Multiplexing and Assembly procedure to generate the BSR MAC CE(s);
 - 3> start or restart *periodicBSR-Timer* except when all the generated BSRs are long or short Truncated BSRs;
 - 3> start or restart *retxBSR-Timer*.
 - 2> else if a Regular BSR has been triggered and *logicalChannelSR-DelayTimer* is not running:
 - 3> if an uplink grant is not a configured grant; or
 - 3> if the Regular BSR was not triggered for a logical channel for which logical channel SR masking (*logicalChannelSR-Mask*) is setup by upper layers:
 - 4> trigger a Scheduling Request.

7.1.1.3.3.3 Test description

7.1.1.3.3.3.1 Pre-test conditions

Same Pre-test conditions as in clause 7.1.1.0 with the exception of 2 AM DRBs configured according to Table 7.1.1.3.3.3.1-1 and Table 7.1.1.3.3.3.1-2 and with MAC-CellGroupConfig configured according to Table 7.1.1.3.3.3.1-3 and Short_DCI condition is applied in NR Serving cell configuration.

Table 7.1.1.3.3.3.1-1: Logical Channel Configuration Settings

Parameter	DRB1	DRB2
LogicalChannelIdentity	LCH4(DRB-Identity +3)	LCH5(DRB-Identity +3)
Priority	7	6
prioritizedBitRate	0kbs	0kbs
logicalChannelGroup	2 (LCG ID#2)	1 (LCG ID#1)
logicalChannelSR-DelayTimerApplied	False	True
logicalChannelSR-DelayTimer	Not Present	sf512

Table 7.1.1.3.3.3.1-2: RLC parameters

<i>t-PollRetransmit</i>	ms80
-------------------------	------

Table 7.1.1.3.3.3.1-3: MAC-CellGroupConfig

Derivation Path: TS 38.308 [6], clause Table 4.6.3-49			
Information Element	Value/remark	Comment	Condition
MAC-CellGroupConfig ::= SEQUENCE {			
bsr-Config SEQUENCE {			
periodicBSR-Timer	infinity		
retxBSR-Timer	sf2560		
}			
phr-Config CHOICE {			
release	NULL		
}			
}			

7.1.1.3.3.3.2 Test procedure sequence

Table 7.1.1.3.3.3.2-1: Main behaviour

St	Procedure	Message Sequence		TP	Verdict
		U - S	Message		
1	The SS transmits a MAC PDU containing A MAC Sub PDU containing a RLC SDU on LCH 5	<--	MAC PDU (containing 1 MAC sub PDU)	-	-
2	Check: Does the UE transmit Scheduling Requests for logicalChannelSR-DelayTimer (sf512) from step 1?	-->	(SR)	4	F
3	Check: Does the UE transmit [x] Scheduling Requests separately on [x] consecutively available PUCCHs after logicalChannelSR-DelayTimer expiry? (Note 1)	-->	(SR)	1,4	P
4	The SS transmits an UL grant to allocate UL-SCH resources that are enough to transmit looped back PDU	<--	(UL Grant)	-	-
5	Check: Does the UE transmit a MAC PDU containing MAC Sub PDU containing a RLC SDU on LCH5?	-->	MAC PDU (containing 1 MAC sub PDU containing RLC SDU)	1	P
6	The SS transmits a MAC PDU containing A MAC Sub PDU containing a RLC SDU on LCH 4	<--	MAC PDU (containing 1 MAC sub PDU)	-	-
7	Check: Does the UE transmit Scheduling Requests separately on [x] consecutively available PUCCHs? (Note 1)	-->	(SR)	1,5	P
8	The SS transmits an UL grant to allocate UL-SCH resources that are enough to transmit looped back PDU	<--	(UL Grant)	-	-
9	Check: Does the UE transmit a MAC PDU containing MAC Sub PDU containing a RLC SDU on LCH4?	-->	MAC PDU (containing 1 MAC sub PDU containing RLC SDU)	1	P
10	Check: For 1 second, does the UE transmit a Scheduling Request?	-->	(SR)	1,2	F
11	The SS transmits a MAC PDU containing a Timing Advance Command MAC Control Element, but does not send any subsequent alignments.	<--	MAC PDU (Timing Advance Command)	-	-
12	The SS transmits a MAC PDU containing a MAC SDU on LCH 4	<--	MAC PDU (MAC SDU)	-	-
-	EXCEPTION: Step 13 is repeated less than sr-TransMax times	-	-	-	-
13	The UE may transmit Scheduling Requests before time alignment timer expires. The SS shall not respond to the Scheduling Requests in this step. (Note 2)	-->	(SR)	-	-
14	Check: does the UE transmit a preamble on PRACH?	-->	(PRACH Preamble)	3	P

15	The SS transmits a Random Access Response including an UL grant to enable UE to transmit C-RNTI MAC Control Element and the MAC SDU as received in step 14.	<--	Random Access Response	-	-
16	The UE transmit a MAC PDU including a C-RNTI MAC Control Element and a MAC SDU. (Note 3)	-->	MAC PDU (MAC Sub PDU containing C-RNTI control element, MAC sub PDU containing MAC SDU)	-	-
17	The SS sends PDCCH transmission for UE C-RNTI	<--	-	-	-
<p>Note 1: The UE repeats the scheduling requests on every available PUCCH as long as SR_COUNTER < dsr-TransMax and there is UL data available for transmission and there are no resources available to transmit it. At the reception of first Scheduling Request from the UE, SS will be scheduled to transmit a grant after 100ms. Hence SS will receive 10 Scheduling Requests.</p> <p>Note 2: In step 8, SR repetition of [63] times (<i>sr-TransMax</i> (64)) will take at least [63*10 = 630] ms which is smaller than TA timer [infinity].</p> <p>Note 3: The UE transmission of the MAC PDU ensures that the random access procedure was successful.</p>					

7.1.1.3.3.3 Specific message contents

Table 7.1.1.3.3.3-1: SchedulingRequestConfig (Preamble)

Derivation Path: TS 38.508-1 [4], Table 4.6.3-155			
Information Element	Value/remark	Comment	Condition
SchedulingRequestConfig ::= SEQUENCE { schedulingRequestToAddModList (SIZE(1..maxNrofSR-ConfigPerCellGroup)) OF SSchedulingRequestToAddMod {	1 entry		
SchedulingRequestToAddMod[1] SEQUENCE {		entry 1	
sr-TransMax	n64	MAX Value	
}			
}			

7.1.1.3.4 Correct handling of MAC control information / Buffer status / UL data arrive in the UE Tx buffer / Regular BSR

7.1.1.3.4.1 Test Purpose (TP)

(1)

```
with { UE in RRC_CONNECTED state }
ensure that {
  when { UL data arrives in the UE transmission buffer and the data belongs to a logical channel
with higher priority than those for which data is already available for transmission and the new
logical channel and the existing logical channels belongs to the different LCG }
  then { UE Reports a Long Buffer Status Reporting (BSR) }
}
```

(2)

```
with { UE in RRC_CONNECTED state }
ensure that {
  when { UL data arrives in the UE transmission buffer and there is no data available for
transmission for any of the logical channels which belong to a LCG }
  then { UE Reports a Short Buffer Status Reporting (BSR) }
}
```

(3)

```
with { UE in RRC_CONNECTED state }
ensure that {
  when { UL data arrives in the UE transmission buffer and the data belongs to a logical channel
with higher priority than those for which data is already available for transmission and the new
logical channel and existing logical channels belong to the same LCG }
  then { UE Reports a Short Buffer Status Reporting (BSR) }
}
```

```
    }
```

(4)

```
with { UE in RRC_CONNECTED state }
ensure that {
  when { retxBSR-Timer expires and only one LCG has data available for transmission }
  then { UE triggers a regular BSR and Reports a Short Buffer Status Reporting (BSR) }
}
```

(5)

```
with { UE in RRC_CONNECTED state }
ensure that {
  when { a Regular BSR has been triggered and UE has pending data for transmission and UE has only
  resources to send either BSR report or data }
  then { UE transmits the BSR report }
}
```

(6)

```
with { UE in E-UTRA RRC_CONNECTED state }
ensure that {
  when { UE determines that a BSR has been triggered since the last transmission of a BSR and UE has
  no UL resources allocated for new transmission for this TTI }
  then { UE transmits a scheduling request }
}
```

(7)

Void.

(8)

```
with { UE in RRC_CONNECTED state }
ensure that {
  when { a Regular BSR has been triggered and UE has pending data on several logical channels for
  transmission and UE has UL resources to send all pending data including BSR }
  then { UE transmits the UL data and reports buffer status reporting (BSR) that indicates there
  is no more data in the buffer }
}
```

7.1.1.3.4.2 Conformance requirements

References: The conformance requirements covered in the present TC are specified in: TS 38.321, clauses 5.4.5, 6.1.3.1, 6.2.1 and TS 38.323 clause 5.6. Unless otherwise stated these are Rel-15 requirements.

[TS 38.321, clause 5.4.3.1.3]

Logical channels shall be prioritised in accordance with the following order (highest priority listed first):

- C-RNTI MAC CE or data from UL-CCCH;
- Configured Grant Confirmation MAC CE;
- MAC CE for BSR, with exception of BSR included for padding;
- Single Entry PHR MAC CE or Multiple Entry PHR MAC CE;
- data from any Logical Channel, except data from UL-CCCH;
- MAC CE for Recommended bit rate query;
- MAC CE for BSR included for padding.

[TS 38.321, clause 5.4.5]

The Buffer Status reporting (BSR) procedure is used to provide the serving gNB with information about UL data volume in the MAC entity.

RRC configures the following parameters to control the BSR:

- *periodicBSR-Timer*;
- *retxBSR-Timer*;
- *logicalChannelSR-Delay*;
- *logicalChannelSR-DelayTimer*;
- *logicalChannelGroup*.

Each logical channel may be allocated to an LCG using the *logicalChannelGroup*. The maximum number of LCGs is eight.

The MAC entity determines the amount of UL data available for a logical channel according to the data volume calculation procedure in TSs 38.322 and 38.323 [3] [4].

A BSR shall be triggered if any of the following events occur:

- the MAC entity has new UL data available for a logical channel which belongs to an LCG; and either
 - the new UL data belongs to a logical channel with higher priority than the priority of any logical channel containing available UL data which belong to any LCG; or
 - none of the logical channels which belong to an LCG contains any available UL data.

in which case the BSR is referred below to as 'Regular BSR';

- UL resources are allocated and number of padding bits is equal to or larger than the size of the Buffer Status Report MAC CE plus its subheader, in which case the BSR is referred below to as 'Padding BSR';
- *retxBSR-Timer* expires, and at least one of the logical channels which belong to an LCG contains UL data, in which case the BSR is referred below to as 'Regular BSR';
- *periodicBSR-Timer* expires, in which case the BSR is referred below to as 'Periodic BSR'.

For Regular BSR, the MAC entity shall:

- 1> if the BSR is triggered for a logical channel for which *logicalChannelSR-Delay* is configured by upper layers:
 - 2> start or restart the *logicalChannelSR-DelayTimer*.
- 1> else:
 - 2> if running, stop the *logicalChannelSR-DelayTimer*.

For Regular and Periodic BSR, the MAC entity shall:

- 1> if more than one LCG has data available for transmission when the BSR is to be transmitted:
 - 2> report Long BSR for all LCGs which have data available for transmission.
- 1> else:
 - 2> report Short BSR.

For Padding BSR:

- 1> if the number of padding bits is equal to or larger than the size of the Short BSR plus its subheader but smaller than the size of the Long BSR plus its subheader:
 - 2> if more than one LCG has data available for transmission when the BSR is to be transmitted:
 - 3> if the number of padding bits is equal to the size of the Short BSR plus its subheader:
 - 4> report Short Truncated BSR of the LCG with the highest priority logical channel with data available for transmission.

3> else:

4> report Long Truncated BSR of the LCG(s) with the logical channels having data available for transmission following a decreasing order of priority, and in case of equal priority, in increasing order of LCGID.

2> else:

3> report Short BSR;

1> else if the number of padding bits is equal to or larger than the size of the Long BSR plus its subheader:

2> report Long BSR for all LCGs which have data available for transmission.

The MAC entity shall:

1> if the Buffer Status reporting procedure determines that at least one BSR has been triggered and not cancelled:

2> if UL-SCH resources are available for a new immediate transmission:

3> instruct the Multiplexing and Assembly procedure to generate the BSR MAC CE(s);

3> start or restart *periodicBSR-Timer* except when all the generated BSRs are long or short Truncated BSRs;

3> start or restart *retxBSR-Timer*.

2> else if a Regular BSR has been triggered and *logicalChannelSR-DelayTimer* is not running:

3> if an uplink grant is not a configured grant; or

3> if the Regular BSR was not triggered for a logical channel for which logical channel SR masking (*logicalChannelSR-Mask*) is setup by upper layers:

4> trigger a Scheduling Request.

A MAC PDU shall contain at most one BSR MAC CE, even when multiple events have triggered a BSR by the time. The Regular BSR and the Periodic BSR shall have precedence over the padding BSR.

The MAC entity shall restart *retxBSR-Timer* upon reception of a grant for transmission of new data on any UL-SCH.

All triggered BSRs may be cancelled when the UL grant(s) can accommodate all pending data available for transmission but is not sufficient to additionally accommodate the BSR MAC control element plus its subheader. All triggered BSRs shall be cancelled when a BSR is included in a MAC PDU for transmission.

The MAC entity shall transmit at most one BSR in one MAC PDU. Padding BSR shall not be included when the MAC PDU contains a Regular or Periodic BSR.

[TS 38.321, clause 6.1.3.1]

Buffer Status Report (BSR) MAC CEs consist of either:

- Short BSR format (fixed size); or
- Long BSR format (variable size); or
- Short Truncated BSR format (fixed size); or
- Long Truncated BSR format (variable size).

The BSR formats are identified by MAC PDU subheaders with LCIDs as specified in Table 6.2.1-2.

The fields in the BSR MAC CE are defined as follows:

- LCG ID: The Logical Channel Group ID field identifies the group of logical channel(s) whose buffer status is being reported. The length of the field is 3 bits;
- LCG_i: For the Long BSR format, this field indicates the presence of the Buffer Size field for the logical channel group i. The LCG_i field set to "1" indicates that the Buffer Size field for the logical channel group i is reported.

The LCG_i field set to "0" indicates that the Buffer Size field for the logical channel group i is not reported. For the Long Truncated BSR format, this field indicates whether logical channel group i has data available. The LCG_i field set to "1" indicates that logical channel group i has data available. The LCG_i field set to "0" indicates that logical channel group i does not have data available;

- Buffer Size: The Buffer Size field identifies the total amount of data available according to the data volume calculation procedure in TSs 38.322 and 38.323 [3] [4] across all logical channels of a logical channel group after the MAC PDU has been built (i.e. after the logical channel prioritization procedure, which may result the value of the Buffer Size field to zero). The amount of data is indicated in number of bytes. The size of the RLC and MAC headers are not considered in the buffer size computation. The length of this field for the Short BSR format and the Short Truncated BSR format is 5 bits. The length of this field for the Long BSR format and the Long Truncated BSR format is 8 bits. The values for the 5-bit and 8-bit Buffer Size fields are shown in Tables 6.1.3.1-1 and 6.1.3.1-2, respectively. For the Long BSR format and the Long Truncated BSR format, the Buffer Size fields are included in ascending order based on the LCG_i . For the Long Truncated BSR format the number of Buffer Size fields included is maximised, while not exceeding the number of padding bits.

NOTE: The number of the Buffer Size fields in the Long Truncated BSR format can be zero.

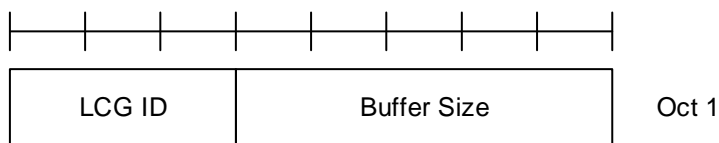

Figure 6.1.3.1-1: Short BSR and Short Truncated BSR MAC CE

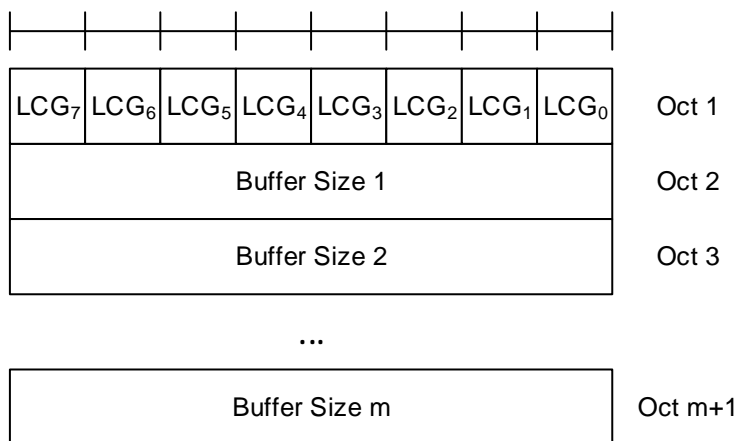

Figure 6.1.3.1-2: Long BSR and Long Truncated BSR MAC CE

Table 6.1.3.1-1: Buffer size levels (in bytes) for 5-bit Buffer Size field

Index	BS value	Index	BS value	Index	BS value	Index	BS value
0	0	8	≤ 102	16	≤ 1446	24	≤ 20516
1	≤ 10	9	≤ 142	17	≤ 2014	25	≤ 28581
2	≤ 14	10	≤ 198	18	≤ 2806	26	≤ 39818
3	≤ 20	11	≤ 276	19	≤ 3909	27	≤ 55474
4	≤ 28	12	≤ 384	20	≤ 5446	28	≤ 77284
5	≤ 38	13	≤ 535	21	≤ 7587	29	≤ 107669
6	≤ 53	14	≤ 745	22	≤ 10570	30	≤ 150000
7	≤ 74	15	≤ 1038	23	≤ 14726	31	> 150000

Table 6.1.3.1-2: Buffer size levels (in bytes) for 8-bit Buffer Size field

Index	BS value	Index	BS value	Index	BS value	Index	BS value
0	0	64	≤ 560	128	≤ 31342	192	≤ 1754595
1	≤ 10	65	≤ 597	129	≤ 33376	193	≤ 1868488

2	≤ 11	66	≤ 635	130	≤ 35543	194	≤ 1989774
3	≤ 12	67	≤ 677	131	≤ 37850	195	≤ 2118933
4	≤ 13	68	≤ 720	132	≤ 40307	196	≤ 2256475
5	≤ 14	69	≤ 767	133	≤ 42923	197	≤ 2402946
6	≤ 15	70	≤ 817	134	≤ 45709	198	≤ 2558924
7	≤ 16	71	≤ 870	135	≤ 48676	199	≤ 2725027
8	≤ 17	72	≤ 926	136	≤ 51836	200	≤ 2901912
9	≤ 18	73	≤ 987	137	≤ 55200	201	≤ 3090279
10	≤ 19	74	≤ 1051	138	≤ 58784	202	≤ 3290873
11	≤ 20	75	≤ 1119	139	≤ 62599	203	≤ 3504487
12	≤ 22	76	≤ 1191	140	≤ 66663	204	≤ 3731968
13	≤ 23	77	≤ 1269	141	≤ 70990	205	≤ 3974215
14	≤ 25	78	≤ 1351	142	≤ 75598	206	≤ 4232186
15	≤ 26	79	≤ 1439	143	≤ 80505	207	≤ 4506902
16	≤ 28	80	≤ 1532	144	≤ 85730	208	≤ 4799451
17	≤ 30	81	≤ 1631	145	≤ 91295	209	≤ 5110989
18	≤ 32	82	≤ 1737	146	≤ 97221	210	≤ 5442750
19	≤ 34	83	≤ 1850	147	≤ 103532	211	≤ 5796046
20	≤ 36	84	≤ 1970	148	≤ 110252	212	≤ 6172275
21	≤ 38	85	≤ 2098	149	≤ 117409	213	≤ 6572925
22	≤ 40	86	≤ 2234	150	≤ 125030	214	≤ 6999582
23	≤ 43	87	≤ 2379	151	≤ 133146	215	≤ 7453933
24	≤ 46	88	≤ 2533	152	≤ 141789	216	≤ 7937777
25	≤ 49	89	≤ 2698	153	≤ 150992	217	≤ 8453028
26	≤ 52	90	≤ 2873	154	≤ 160793	218	≤ 9001725
27	≤ 55	91	≤ 3059	155	≤ 171231	219	≤ 9586039
28	≤ 59	92	≤ 3258	156	≤ 182345	220	≤ 10208280
29	≤ 62	93	≤ 3469	157	≤ 194182	221	≤ 10870913
30	≤ 66	94	≤ 3694	158	≤ 206786	222	≤ 11576557
31	≤ 71	95	≤ 3934	159	≤ 220209	223	≤ 12328006
32	≤ 75	96	≤ 4189	160	≤ 234503	224	≤ 13128233
33	≤ 80	97	≤ 4461	161	≤ 249725	225	≤ 13980403
34	≤ 85	98	≤ 4751	162	≤ 265935	226	≤ 14887889
35	≤ 91	99	≤ 5059	163	≤ 283197	227	≤ 15854280
36	≤ 97	100	≤ 5387	164	≤ 301579	228	≤ 16883401
37	≤ 103	101	≤ 5737	165	≤ 321155	229	≤ 17979324
38	≤ 110	102	≤ 6109	166	≤ 342002	230	≤ 19146385
39	≤ 117	103	≤ 6506	167	≤ 364202	231	≤ 20389201
40	≤ 124	104	≤ 6928	168	≤ 387842	232	≤ 21712690
41	≤ 132	105	≤ 7378	169	≤ 413018	233	≤ 23122088
42	≤ 141	106	≤ 7857	170	≤ 439827	234	≤ 24622972
43	≤ 150	107	≤ 8367	171	≤ 468377	235	≤ 26221280
44	≤ 160	108	≤ 8910	172	≤ 498780	236	≤ 27923336
45	≤ 170	109	≤ 9488	173	≤ 531156	237	≤ 29735875
46	≤ 181	110	≤ 10104	174	≤ 565634	238	≤ 31666069
47	≤ 193	111	≤ 10760	175	≤ 602350	239	≤ 33721553
48	≤ 205	112	≤ 11458	176	≤ 641449	240	≤ 35910462
49	≤ 218	113	≤ 12202	177	≤ 683087	241	≤ 38241455
50	≤ 233	114	≤ 12994	178	≤ 727427	242	≤ 40723756
51	≤ 248	115	≤ 13838	179	≤ 774645	243	≤ 43367187
52	≤ 264	116	≤ 14736	180	≤ 824928	244	≤ 46182206
53	≤ 281	117	≤ 15692	181	≤ 878475	245	≤ 49179951
54	≤ 299	118	≤ 16711	182	≤ 935498	246	≤ 52372284
55	≤ 318	119	≤ 17795	183	≤ 996222	247	≤ 55771835
56	≤ 339	120	≤ 18951	184	≤ 1060888	248	≤ 59392055
57	≤ 361	121	≤ 20181	185	≤ 1129752	249	≤ 63247269
58	≤ 384	122	≤ 21491	186	≤ 1203085	250	≤ 67352729
59	≤ 409	123	≤ 22885	187	≤ 1281179	251	≤ 71724679
60	≤ 436	124	≤ 24371	188	≤ 1364342	252	≤ 76380419
61	≤ 464	125	≤ 25953	189	≤ 1452903	253	≤ 81338368
62	≤ 494	126	≤ 27638	190	≤ 1547213	254	> 81338368
63	≤ 526	127	≤ 29431	191	≤ 1647644	255	Reserved

[TS 38.321, clause 6.2.1]

Table 6.2.1-2 Values of LCID for UL-SCH

Index	LCID values
000000	CCCH
000001–100000	Identity of the logical channel
100001–110110	Reserved
110111	Configured Grant Confirmation
111000	Multiple Entry PHR
111001	Single Entry PHR
111010	C-RNTI
111011	Short Truncated BSR
111100	Long Truncated BSR
111101	Short BSR
111110	Long BSR
111111	Padding

[TS 38.323, clause 5.6]

For the purpose of MAC buffer status reporting, the transmitting PDCP entity shall consider the following as PDCP data volume:

- the PDCP SDUs for which no PDCP Data PDUs have been constructed;
- the PDCP Data PDUs that have not been submitted to lower layers;
- the PDCP Control PDUs;
- for AM DRBs, the PDCP SDUs to be retransmitted according to subclause 5.1.2;
- for AM DRBs, the PDCP Data PDUs to be retransmitted according to subclause 5.5.

[TS 38.322, clause 5.5] For the purpose of MAC buffer status reporting, the UE shall consider the following as RLC data volume:

- RLC SDUs and RLC SDU segments that have not yet been included in an RLC data PDU;
- RLC data PDUs that are pending for initial transmission;
- RLC data PDUs that are pending for retransmission (RLC AM).

In addition, if a STATUS PDU has been triggered and *t-StatusProhibit* is not running or has expired, the UE shall estimate the size of the STATUS PDU that will be transmitted in the next transmission opportunity, and consider this as part of RLC data volume.

7.1.1.3.4.3 Test description

7.1.1.3.4.3.1 Pre-test conditions

Same Pre-test conditions as in clause 7.1.1.0 with the exception of 3 AM DRBs on NR cell configured according to Table 7.1.1.3.4.3.1-1.

Table 7.1.1.3.4.3.1-1: Logical Channel Configuration Settings

Parameter	Value DRB1	Value DRB2	Value DRB3
LogicalChannelIdentity	LCH4((DRB-Identity +3)	LCH5(DRB-Identity +3)	LCH6(DRB-Identity +3)
Priority	8	7	6
prioritizedBitRate	0 kB/s	0 kB/s	0 kB/s
logicalChannelGroup	2 (LCG ID#2)	2 (LCG ID#2)	1 (LCG ID#1)

7.1.1.3.4.3.2 Test procedure sequence

Table 7.1.1.3.4.3.2-1: Main behaviour

St	Procedure	Message Sequence		TP	Verdict
		U - S	Message		
1	The SS ignores scheduling requests and does not allocate any uplink grant.	-	-	-	-
2	The SS transmits a MAC PDU containing two RLC SDUs of size 12 bytes on LCH4	<--	MAC PDU (2 RLC SDUs on LCH4)	-	-
3	SS allocates an UL Grant of 40 bits. (Note 1)	<--	(UL Grant, 40 bits)	-	-
4	Check: Does the UE transmit a Short BSR with 'LCG ID' field set to '2' and 'Buffer size' field set to value '4' or bigger? (Note 2)	-->	MAC PDU (MAC Short BSR (LCG ID='2', Buffer Size='4' or bigger))	2,5	P
5	Wait for retxBSR-Timer expiry on UE side.	-	-	-	-
6	Check: Does the UE transmit a scheduling request?	-->	(SR)	6	P
7	The SS responds to the scheduling request in step 6 by an UL Grant of 40 bits. (Note 1)	<--	(UL Grant, 40 bits)	-	-
8	Check: Does the UE transmit a Short BSR with 'LCG ID' field set to '2' and 'Buffer size' field set to value '4' or bigger? (Note 2)	-->	MAC PDU (MAC Short BSR (LCG ID='2', Buffer Size='4' or bigger))	4,5	P
9	The SS transmits a MAC PDU containing one RLC SDU of size 12 bytes on LCH5	<--	MAC PDU (1 RLC SDU on LCH5)	-	-
10	Check: Does the UE transmit a scheduling request?	-->	(SR)	6	P
11	The SS respond to the scheduling request in step 10 by an UL Grant of 40 bits. (Note 1)	<--	(UL Grant, 40 bits)	-	-
12	Check: Does the UE transmit a Short BSR with 'LCG ID' field set to '2' and 'Buffer size#1' field set to value '5' or bigger? (Note 2)	-->	MAC PDU (MAC Short BSR (LCG ID='2', Buffer Size='5' or bigger))	3,5	P
13	The SS transmits a MAC PDU containing two RLC SDUs of size 5 bytes on LCH6	<--	MAC PDU (2 RLC SDUs on LCH6)	-	-
14	Check: Does the UE transmit a scheduling request?	-->	(SR)	6	P
15	The SS responds to the scheduling request in step 14 by one UL Grant of 40 bits. (Note 1)	<--	(UL Grant, 40 bits)	-	-
16	Check: Does the UE transmit a Long BSR with 'Buffer size#1' field set to value '1', 'Buffer size#2' field set to value '20' or bigger? (Note 3)	-->	MAC PDU (MAC Long BSR (Buffer size#1='1' or bigger, Buffer size#2='20' or bigger))	1,5	P
17	Wait for retxBSR-Timer expiry on the UE side.	-	-	-	-
18	Check: Does the UE transmit a scheduling request?	-->	(SR)	6	P
19	SS allocates an UL Grant of 608 bits. (Note 4)	<--	(UL Grant, 608 bits)	-	-
20	Check: Does the UE transmit a MAC PDU including five RLC SDUs and BSR? (Note 5)	-->	MAC PDU (17-Byte 2 MAC sub PDUs from LCH4, 17-Byte 1 MAC sub PDU from LCH5 and 10-Byte 2 MAC Sub PDUs from LCH6)	-	-
21	SS transmits an RLC STATUS PDU to acknowledge correctly received data(LCID='000100')	<--	RLC STATUS PDU (ACK_SN=2)	-	-
22	SS transmits an RLC STATUS PDU to acknowledge correctly received data(LCID='000101')	<--	RLC STATUS PDU (ACK_SN=1)	-	-
23	SS transmits an RLC STATUS PDU to acknowledge correctly received data(LCID='000110')	<--	RLC STATUS PDU (ACK_SN=2)	-	-
24	The SS transmits a MAC PDU containing two MAC SDUs, the first containing a 8 byte RLC SDU with LCID set to LCH4 and the second containing a 7 byte RLC SDU with LCID set to LCH6.	<--	MAC PDU	-	-
25	The UE sends Scheduling Request	-->	(SR)	-	-
26	The SS transmits an uplink grant of size 256 bits. (Note 6)	<--	(UL grant, 256 bits)	-	-

27	Check: Does the UE return a MAC PDU of length 256 bits including RLC SDUs, Padding and Short BSR or LongBSR with Buffer size(s) set to '0'? (Note 5)	-->	MAC PDU (13-Byte MAC Sub PDU from LC 4 and 12-Byte MAC Sub PDU from LCH6 and 5-Byte MAC Sub PDU containing Long BSR and 2-Byte MAC Sub PDU containing Padding) Or MAC PDU (13-Byte MAC Sub PDU from LCH4 and 12-Byte MAC Sub PDU from LCH6 and 2-Byte MAC Sub PDU containing short BSR and 5-Byte MAC Sub PDU containing Padding)	8	P
28	SS transmits an RLC STATUS PDU to acknowledge correctly received data(LCID=LCH4)	<--	RLC STATUS PDU (ACK_SN=3)	-	-
29	SS transmits an RLC STATUS PDU to acknowledge correctly received data(LCID=LCH6)	<--	RLC STATUS PDU (ACK_SN=3)	-	-
<p>Note 1: 40 bits enables UE to transmit a MAC PDU with a 1 byte MAC BSR header and a Short BSR (1 byte) or a 2 bytes MAC BSR header and a Long BSR (3 bytes with 2 LCG configured).</p> <p>Note 2: UE triggers a Short BSR of type "Regular BSR" to report buffer status for one LCG for that TTI. The UE should not send any of the received RLC SDUs (segmented) due to Regular BSR has higher priority than U-plane logical channels.</p> <p>Note 3: UE triggers and transmit a Long BSR of type "Regular BSR". The UL grant would be enough for UE to transmit one RLC SDU as received in step 8, but Regular BSR has higher priority than U-plane logical channels.</p> <p>Note 4: The UE has 46 bytes of RLC SDU data (received in steps 2, 9 and 13) in the transmission buffer.608 bits enables UE to transmit user data in MAC PDU 2 RLC SDUs of 12 bytes on LCH4, each 3 Bytes RLC Header and 2 Bytes MAC Header resulting in 2 MAC Sub PDUs of 17 Bytes Each. Similarly one 17 Bytes MAC Sub PDU for 12 Bytes RLC SDU on LCH5. Two 5 Bytes RLC SDUs on LCH6 with 3 Bytes RLC header each and 2 Bytes MAC header each, will result in 2 MAC sub PDUs of 10 bytes each. Total comes to 17+17+10+10 +3 B LongBSR(2 Bytes LongBSR header + 1 Byte LongBSR) + 2 B padding =76 Bytes.</p> <p>Note 5: The MAC SDUs for the different logical channels may be in any order in the MAC PDU.</p> <p>Note 6: UL grant of 256 bits (L_{RBs} & I_{MCS} as per 38.523-3[3] annex B) is chosen to enable UE to transmit two MAC SDUs of size 11 and 10 bytes in a MAC PDU (8 bytes RLC SDU + 3 bytes AMD PDU header +2 Bytes MAC sub Header + 7 bytes RLC SDU+ 3 bytes AMD PDU header+2 Bytes MAC sub Header + 2 Bytes Long BSR MAC Sub Header + 3 Bytes Long BSR + 2 Bytes MAC Padding Sub PDU) or (8 bytes RLC SDU + 3 bytes AMD PDU header +2 Bytes MAC sub Header + 7 bytes RLC SDU+ 3 bytes AMD PDU header+2 Bytes MAC sub Header + 1 Byte Short BSR MAC Sub Header + 1 Byte Short BSR + 7 Bytes MAC Padding Sub PDU) = 32 Bytes</p>					

7.1.1.3.4.3.3 Specific message contents

Table 7.1.1.3.4.3.3: MAC-CellGroupConfig (preamble)

Derivation Path: TS 38.508-1 [4], clause Table 4.6.3-68			
Information Element	Value/remark	Comment	Condition
MAC-CellGroupConfig ::= SEQUENCE {			
bsr-Config SEQUENCE {			
periodicBSR-Timer	infinity		
retxBSR-Timer	sf320		
}			
phr-Config CHOICE {			
release	NULL		
}			
}			

7.1.1.3.5 Correct handling of MAC control information / Buffer Status / UL resources are allocated / Padding BSR

7.1.1.3.5.1 Test Purpose (TP)

(1)

```
with { UE in RRC_CONNECTED state }
ensure that {
  when { UE transmits a MAC PDU and the number of padding bits is equal to the size of a Short BSR
plus its subheader and the UE has available data for transmission from more than one LCG in the TTI
where the BSR is transmitted }
  then { UE reports a Truncated short BSR of the LCG with the highest priority logical channel
with data available for transmission }
}
```

(2)

```
with { UE in E-UTRA RRC_CONNECTED state }
ensure that {
  when { UE transmits a MAC PDU and the number of padding bits is larger than the size of a Short
BSR plus its subheader but smaller than the size of a Long BSR plus its subheader and the UE has
available data for transmission from more than one LCG in the TTI where the BSR is transmitted }
  then { UE reports a Truncated long BSR }
}
```

(3)

```
with { UE in RRC_CONNECTED state }
ensure that {
  when { UE transmits a MAC PDU and the number of padding bits is equal to or larger than the size
of a Short BSR plus its subheader but smaller than the size of a Long BSR plus its subheader and the
UE has available data for transmission from only one LCG in the TTI where the BSR is transmitted }
  then { UE reports a Short BSR }
}
```

(4)

```
with { UE in RRC_CONNECTED state }
ensure that {
  when { UE transmits a MAC PDU and the number of padding bits is equal to or larger than the size
of a Long BSR plus its subheader }
  then { UE reports a long BSR }
}
```

7.1.1.3.5.2 Conformance requirements

References: The conformance requirements covered in the present TC are specified in: TS 38.321, clauses 5.4.5, 6.1.3.1 and 6.2.1. Unless otherwise stated these are Rel-15 requirements.

[TS 38.321, clause 5.4.5]

The Buffer Status reporting (BSR) procedure is used to provide the serving gNB with information about UL data volume in the MAC entity.

RRC configures the following parameters to control the BSR:

- *periodicBSR-Timer*;
- *retxBSR-Timer*;
- *logicalChannelSR-Delay*;
- *logicalChannelSR-DelayTimer*;
- *logicalChannelGroup*.

Each logical channel may be allocated to an LCG using the *logicalChannelGroup*. The maximum number of LCGs is eight.

The MAC entity determines the amount of UL data available for a logical channel according to the data volume calculation procedure in TSs 38.322 and 38.323 [3] [4].

A BSR shall be triggered if any of the following events occur:

- the MAC entity has new UL data available for a logical channel which belongs to an LCG; and either
 - the new UL data belongs to a logical channel with higher priority than the priority of any logical channel containing available UL data which belong to any LCG; or
 - none of the logical channels which belong to an LCG contains any available UL data.

in which case the BSR is referred below to as 'Regular BSR';

- UL resources are allocated and number of padding bits is equal to or larger than the size of the Buffer Status Report MAC CE plus its subheader, in which case the BSR is referred below to as 'Padding BSR';
- *retxBSR-Timer* expires, and at least one of the logical channels which belong to an LCG contains UL data, in which case the BSR is referred below to as 'Regular BSR';
- *periodicBSR-Timer* expires, in which case the BSR is referred below to as 'Periodic BSR'.

For Regular BSR, the MAC entity shall:

- 1> if the BSR is triggered for a logical channel for which *logicalChannelSR-Delay* is configured by upper layers:
 - 2> start or restart the *logicalChannelSR-DelayTimer*.
- 1> else:
 - 2> if running, stop the *logicalChannelSR-DelayTimer*.

For Regular and Periodic BSR, the MAC entity shall:

- 1> if more than one LCG has data available for transmission when the BSR is to be transmitted:
 - 2> report Long BSR for all LCGs which have data available for transmission.
- 1> else:
 - 2> report Short BSR.

For Padding BSR:

- 1> if the number of padding bits is equal to or larger than the size of the Short BSR plus its subheader but smaller than the size of the Long BSR plus its subheader:
 - 2> if more than one LCG has data available for transmission when the BSR is to be transmitted:
 - 3> if the number of padding bits is equal to the size of the Short BSR plus its subheader:
 - 4> report Short Truncated BSR of the LCG with the highest priority logical channel with data available for transmission.
 - 3> else:
 - 4> report Long Truncated BSR of the LCG(s) with the logical channels having data available for transmission following a decreasing order of priority, and in case of equal priority, in increasing order of LCGID.
 - 2> else:
 - 3> report Short BSR;
- 1> else if the number of padding bits is equal to or larger than the size of the Long BSR plus its subheader:
 - 2> report Long BSR for all LCGs which have data available for transmission.

The MAC entity shall:

- 1> if the Buffer Status reporting procedure determines that at least one BSR has been triggered and not cancelled:
 - 2> if UL-SCH resources are available for a new immediate transmission:
 - 3> instruct the Multiplexing and Assembly procedure to generate the BSR MAC CE(s);
 - 3> start or restart *periodicBSR-Timer* except when all the generated BSRs are long or short Truncated BSRs;
 - 3> start or restart *retxBSR-Timer*.
 - 2> else if a Regular BSR has been triggered and *logicalChannelSR-DelayTimer* is not running:
 - 3> if an uplink grant is not a configured grant; or
 - 3> if the Regular BSR was not triggered for a logical channel for which logical channel SR masking (*logicalChannelSR-Mask*) is setup by upper layers:
 - 4> trigger a Scheduling Request.

A MAC PDU shall contain at most one BSR MAC CE, even when multiple events have triggered a BSR by the time. The Regular BSR and the Periodic BSR shall have precedence over the padding BSR.

The MAC entity shall restart *retxBSR-Timer* upon reception of a grant for transmission of new data on any UL-SCH.

All triggered BSRs may be cancelled when the UL grant(s) can accommodate all pending data available for transmission but is not sufficient to additionally accommodate the BSR MAC control element plus its subheader. All triggered BSRs shall be cancelled when a BSR is included in a MAC PDU for transmission.

The MAC entity shall transmit at most one BSR in one MAC PDU. Padding BSR shall not be included when the MAC PDU contains a Regular or Periodic BSR.

[TS 38.321, clause 6.1.3.1]

Buffer Status Report (BSR) MAC CEs consist of either:

- Short BSR format (fixed size); or
- Long BSR format (variable size); or
- Short Truncated BSR format (fixed size); or
- Long Truncated BSR format (variable size).

The BSR formats are identified by MAC PDU subheaders with LCIDs as specified in Table 6.2.1-2.

The fields in the BSR MAC CE are defined as follows:

- LCG ID: The Logical Channel Group ID field identifies the group of logical channel(s) whose buffer status is being reported. The length of the field is 3 bits;
- LCG_i: For the Long BSR format, this field indicates the presence of the Buffer Size field for the logical channel group *i*. The LCG_i field set to "1" indicates that the Buffer Size field for the logical channel group *i* is reported. The LCG_i field set to "0" indicates that the Buffer Size field for the logical channel group *i* is not reported. For the Long Truncated BSR format, this field indicates whether logical channel group *i* has data available. The LCG_i field set to "1" indicates that logical channel group *i* has data available. The LCG_i field set to "0" indicates that logical channel group *i* does not have data available;
- Buffer Size: The Buffer Size field identifies the total amount of data available according to the data volume calculation procedure in TSs 38.322 and 38.323 [3] [4] across all logical channels of a logical channel group after the MAC PDU has been built (i.e. after the logical channel prioritization procedure, which may result the value of the Buffer Size field to zero). The amount of data is indicated in number of bytes. The size of the RLC and MAC headers are not considered in the buffer size computation. The length of this field for the Short BSR format and the Short Truncated BSR format is 5 bits. The length of this field for the Long BSR format and the Long Truncated BSR format is 8 bits. The values for the 5-bit and 8-bit Buffer Size fields are shown in Tables 6.1.3.1-1 and 6.1.3.1-2, respectively. For the Long BSR format and the Long Truncated BSR format, the Buffer

Size fields are included in ascending order based on the LCG_i. For the Long Truncated BSR format the number of Buffer Size fields included is maximised, while not exceeding the number of padding bits.

NOTE: The number of the Buffer Size fields in the Long Truncated BSR format can be zero.

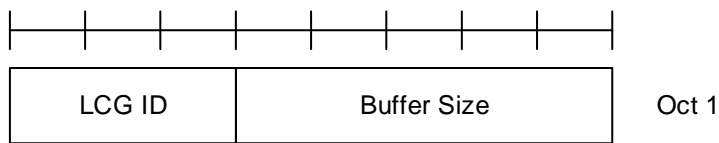

Figure 6.1.3.1-1: Short BSR and Short Truncated BSR MAC CE

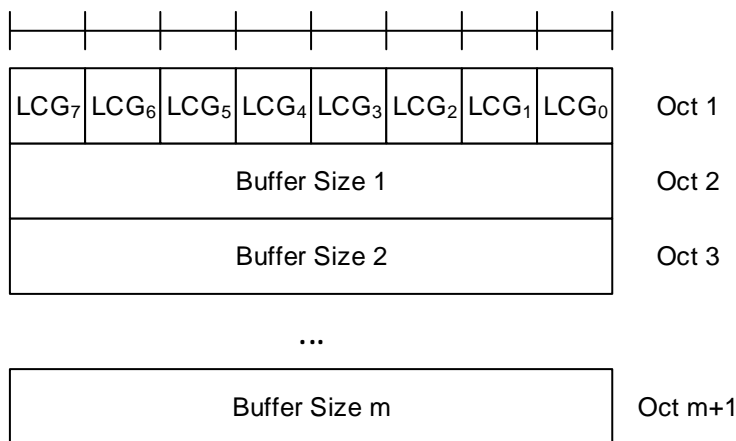

Figure 6.1.3.1-2: Long BSR and Long Truncated BSR MAC CE

Table 6.1.3.1-1: Buffer size levels (in bytes) for 5-bit Buffer Size field

Index	BS value	Index	BS value	Index	BS value	Index	BS value
0	0	8	≤ 102	16	≤ 1446	24	≤ 20516
1	≤ 10	9	≤ 142	17	≤ 2014	25	≤ 28581
2	≤ 14	10	≤ 198	18	≤ 2806	26	≤ 39818
3	≤ 20	11	≤ 276	19	≤ 3909	27	≤ 55474
4	≤ 28	12	≤ 384	20	≤ 5446	28	≤ 77284
5	≤ 38	13	≤ 535	21	≤ 7587	29	≤ 107669
6	≤ 53	14	≤ 745	22	≤ 10570	30	≤ 150000
7	≤ 74	15	≤ 1038	23	≤ 14726	31	> 150000

Table 6.1.3.1-2: Buffer size levels (in bytes) for 8-bit Buffer Size field

Index	BS value	Index	BS value	Index	BS value	Index	BS value
0	0	64	≤ 560	128	≤ 31342	192	≤ 1754595
1	≤ 10	65	≤ 597	129	≤ 33376	193	≤ 1868488
2	≤ 11	66	≤ 635	130	≤ 35543	194	≤ 1989774
3	≤ 12	67	≤ 677	131	≤ 37850	195	≤ 2118933
4	≤ 13	68	≤ 720	132	≤ 40307	196	≤ 2256475
5	≤ 14	69	≤ 767	133	≤ 42923	197	≤ 2402946
6	≤ 15	70	≤ 817	134	≤ 45709	198	≤ 2558924
7	≤ 16	71	≤ 870	135	≤ 48676	199	≤ 2725027
8	≤ 17	72	≤ 926	136	≤ 51836	200	≤ 2901912
9	≤ 18	73	≤ 987	137	≤ 55200	201	≤ 3090279
10	≤ 19	74	≤ 1051	138	≤ 58784	202	≤ 3290873
11	≤ 20	75	≤ 1119	139	≤ 62599	203	≤ 3504487
12	≤ 22	76	≤ 1191	140	≤ 66663	204	≤ 3731968
13	≤ 23	77	≤ 1269	141	≤ 70990	205	≤ 3974215

14	≤ 25	78	≤ 1351	142	≤ 75598	206	≤ 4232186
15	≤ 26	79	≤ 1439	143	≤ 80505	207	≤ 4506902
16	≤ 28	80	≤ 1532	144	≤ 85730	208	≤ 4799451
17	≤ 30	81	≤ 1631	145	≤ 91295	209	≤ 5110989
18	≤ 32	82	≤ 1737	146	≤ 97221	210	≤ 5442750
19	≤ 34	83	≤ 1850	147	≤ 103532	211	≤ 5796046
20	≤ 36	84	≤ 1970	148	≤ 110252	212	≤ 6172275
21	≤ 38	85	≤ 2098	149	≤ 117409	213	≤ 6572925
22	≤ 40	86	≤ 2234	150	≤ 125030	214	≤ 6999582
23	≤ 43	87	≤ 2379	151	≤ 133146	215	≤ 7453933
24	≤ 46	88	≤ 2533	152	≤ 141789	216	≤ 7937777
25	≤ 49	89	≤ 2698	153	≤ 150992	217	≤ 8453028
26	≤ 52	90	≤ 2873	154	≤ 160793	218	≤ 9001725
27	≤ 55	91	≤ 3059	155	≤ 171231	219	≤ 9586039
28	≤ 59	92	≤ 3258	156	≤ 182345	220	≤ 10208280
29	≤ 62	93	≤ 3469	157	≤ 194182	221	≤ 10870913
30	≤ 66	94	≤ 3694	158	≤ 206786	222	≤ 11576557
31	≤ 71	95	≤ 3934	159	≤ 220209	223	≤ 12328006
32	≤ 75	96	≤ 4189	160	≤ 234503	224	≤ 13128233
33	≤ 80	97	≤ 4461	161	≤ 249725	225	≤ 13980403
34	≤ 85	98	≤ 4751	162	≤ 265935	226	≤ 14887889
35	≤ 91	99	≤ 5059	163	≤ 283197	227	≤ 15854280
36	≤ 97	100	≤ 5387	164	≤ 301579	228	≤ 16883401
37	≤ 103	101	≤ 5737	165	≤ 321155	229	≤ 17979324
38	≤ 110	102	≤ 6109	166	≤ 342002	230	≤ 19146385
39	≤ 117	103	≤ 6506	167	≤ 364202	231	≤ 20389201
40	≤ 124	104	≤ 6928	168	≤ 387842	232	≤ 21712690
41	≤ 132	105	≤ 7378	169	≤ 413018	233	≤ 23122088
42	≤ 141	106	≤ 7857	170	≤ 439827	234	≤ 24622972
43	≤ 150	107	≤ 8367	171	≤ 468377	235	≤ 26221280
44	≤ 160	108	≤ 8910	172	≤ 498780	236	≤ 27923336
45	≤ 170	109	≤ 9488	173	≤ 531156	237	≤ 29735875
46	≤ 181	110	≤ 10104	174	≤ 565634	238	≤ 31666069
47	≤ 193	111	≤ 10760	175	≤ 602350	239	≤ 33721553
48	≤ 205	112	≤ 11458	176	≤ 641449	240	≤ 35910462
49	≤ 218	113	≤ 12202	177	≤ 683087	241	≤ 38241455
50	≤ 233	114	≤ 12994	178	≤ 727427	242	≤ 40723756
51	≤ 248	115	≤ 13838	179	≤ 774645	243	≤ 43367187
52	≤ 264	116	≤ 14736	180	≤ 824928	244	≤ 46182206
53	≤ 281	117	≤ 15692	181	≤ 878475	245	≤ 49179951
54	≤ 299	118	≤ 16711	182	≤ 935498	246	≤ 52372284
55	≤ 318	119	≤ 17795	183	≤ 996222	247	≤ 55771835
56	≤ 339	120	≤ 18951	184	≤ 1060888	248	≤ 59392055
57	≤ 361	121	≤ 20181	185	≤ 1129752	249	≤ 63247269
58	≤ 384	122	≤ 21491	186	≤ 1203085	250	≤ 67352729
59	≤ 409	123	≤ 22885	187	≤ 1281179	251	≤ 71724679
60	≤ 436	124	≤ 24371	188	≤ 1364342	252	≤ 76380419
61	≤ 464	125	≤ 25953	189	≤ 1452903	253	≤ 81338368
62	≤ 494	126	≤ 27638	190	≤ 1547213	254	> 81338368
63	≤ 526	127	≤ 29431	191	≤ 1647644	255	Reserved

[TS 38.321, clause 6.2.1]

Table 6.2.1-2: Values of LCID for UL-SCH

Index	LCID values
000000	CCCH
000001–100000	Identity of the logical channel
100001–110110	Reserved
110111	Configured Grant Confirmation
111000	Multiple Entry PHR
111001	Single Entry PHR
111010	C-RNTI
111011	Short Truncated BSR

111100	Long Truncated BSR
111101	Short BSR
111110	Long BSR
111111	Padding

7.1.1.3.5.3 Test description

7.1.1.3.5.3.1 Pre-test conditions

Same Pre-test conditions as in clause 7.1.1.0 with the exception of 2 AM DRBs on NR cell configured according to Table 7.1.1.3.5.3.1-1.

Table 7.1.1.3.5.3.1-1: Logical Channel Configuration Settings

Parameter	DRB1	DRB2
LogicalChannelIdentity	LCH4(DRB-Identity +3)	LCH5(DRB-Identity +3)
Priority	7	6
prioritizedBitRate	0kbs	0kbs
logicalChannelGroup	2 (LCG ID#2)	1 (LCG ID#1)

7.1.1.3.5.3.2 Test procedure sequence

Table 7.1.1.3.5.3.2-1: Main behaviour

St	Procedure	Message Sequence		TP	Verdict
		U - S	Message		
1	The SS ignores scheduling requests and does not allocate any uplink grant.	-	-	-	-
-	EXCEPTION: Step 2 shall be repeated for 3 times	-	-	-	-
2	The SS transmits a MAC PDU including an RLC PDU of size 13 bytes on LCH5.	<--	MAC PDU (RLC SDU on LCH5)	-	-
3	The SS transmits a MAC PDU including an RLC PDU of size 12 bytes on LCH4.	<--	MAC PDU (RLC SDU on LCH4)	-	-
4	UE transmits a Scheduling Request on PUCCH.	-->	(SR)	-	-
5	The SS sends an uplink grant of size 40 bits. (Note 1)	<--	(UL grant)	-	-
6	The UE transmit a Long BSR report.	-->	MAC PDU (Long BSR header (LCID='111110'), Long BSR)	-	-
7	The SS sends an uplink grant of size 136 bits. (Note 2)	<--	(UL grant)	-	-
8	Check: Does UE transmit a MAC PDU containing an RLC SDU and a short truncated BSR indicating pending data ('Buffer size' field > '0') for logicalChannelGroup 1 ('LCG ID' field set to '01')?	-->	MAC PDU (MAC sub PDU header for RLC PDU, RLC PDU, short truncated BSR header (LCID='111011'), short truncatedBSR(LCG ID ='01', Buffer size>'0'))	1	P
9	The SS sends an uplink grant of size 152 bits. (Note 3)	<--	(UL grant)	-	-
10	Check: Does UE transmit a MAC PDU containing an RLC SDU and a long truncated BSR indicating pending data available for LCG ₁ and LCG ₂ and 'Buffer size' field > '0' for logicalChannelGroup 1?	-->	MAC PDU (MAC sub PDU header for RLC PDU, RLC PDU, long truncated BSR header (LCID='111100'), long truncatedBSR(LCG ₁ =1, LCG ₂ =1, Buffer size1>'0'))	2	P
11	The SS sends an uplink grant of size 136 bits. (Note 4)	<--	(UL grant)	-	-
12	Check: Does UE transmit a MAC PDU containing an RLC SDU and with a Short BSR indicating pending data ('Buffer size' field > '0') for logicalChannelGroup 2 ('LCG ID' field	-->	MAC PDU (MAC sub PDU header for RLC PDU, RLC PDU, Short BSR header(LCID='11101'), Short BSR(LCG ID ='10',Buffer	3	P

	= '10')?		size>'0'))		
12 A	SS transmits an RLC STATUS PDU to acknowledge correctly received data (LCID=LCH5)	<--	RLC STATUS PDU (ACK_SN=3)	-	-
13	The SS sends an uplink grant of size 160 bits. (Note 5)	<--	(UL grant)	-	-
14	Check: Does UE transmit a MAC PDU containing a RLC SDU and a Long BSR?	-->	MAC PDU (MAC sub PDU header for RLC PDU, RLC PDU, Long BSR header (LCID='11110'), Long BSR)	4	P
15	SS transmits an RLC STATUS PDU to acknowledge correctly received data (LCID=LCH4)	<--	RLC STATUS PDU (ACK_SN=1)	-	-
<p>Note 1: 40 bits (LRBs & IMCS as per 38.523-3[3] annex B) enables UE to transmit a MAC PDU with a MAC BSR header (1 byte) and a Short BSR (1 byte) or a MAC BSR header (2 bytes) a Long BSR (3 bytes when 2 LCG configured).</p> <p>Note 2: UE triggers a truncated Short BSR of type "Padding BSR" to report buffer status for one LCG for that TTI. (2 Bytes MAC Data sub PDU header + 13 Bytes MAC SDU + 1 Byte Short truncated BSR sub header + 1 Byte Short truncated BSR = 17 bytes)</p> <p>Note 3: UE triggers a truncated Long BSR of type "Padding BSR" to report buffer status for one LCG for that TTI. (2 Bytes MAC Data sub PDU header + 13 Bytes MAC SDU + 2 Bytes Long truncated BSR sub header + 2 Bytes Long truncated BSR = 19 bytes)</p> <p>Note 4: UE triggers a Short BSR of type "Padding BSR" to report buffer status for one LCG for that TTI. (2 Bytes MAC Data sub PDU header + 13 Bytes MAC SDU + 1 Byte Short BSR sub header + 1 Byte short BSR = 17 bytes)</p> <p>Note 5: UE triggers a long BSR of type "Padding BSR" to report buffer status for one LCG for that TTI. (2 Bytes MAC Data sub PDU header + 12 Bytes MAC SDU + 2 Bytes long BSR sub header + 1 Byte long BSR + 1 byte Padding sub header + 2 bytes Padding = 20 bytes)</p>					

7.1.1.3.5.3.3 Specific message contents

None

7.1.1.3.6 Correct handling of MAC control information / Buffer status / Periodic BSR timer expires

7.1.1.3.6.1 Test Purpose (TP)

(1)

```
with { UE in RRC_CONNECTED state }
ensure that {
  when { periodicBSR-Timer expires and more than one LCG has buffered data }
  then { UE triggers a Periodic BSR and reports Long BSR and restarts the periodicBSR-Timer }
}
```

(2)

```
with { UE in E-UTRA RRC_CONNECTED state }
ensure that {
  when { periodicBSR-Timer expires and one LCG has buffered data }
  then { UE triggers a Periodic BSR and reports Short BSR and restarts the periodicBSR-Timer }
}
```

7.1.1.3.6.2 Conformance requirements

References: The conformance requirements covered in the present TC are specified in: TS 38.321, clauses 5.4.5, 6.1.3.1 and 6.2.1. Unless otherwise stated these are Rel-15 requirements.

[TS 38.321, clause 5.4.5]

The Buffer Status reporting (BSR) procedure is used to provide the serving gNB with information about UL data volume in the MAC entity.

RRC configures the following parameters to control the BSR:

- *periodicBSR-Timer*;
- *retxBSR-Timer*;
- *logicalChannelSR-Delay*;
- *logicalChannelSR-DelayTimer*;
- *logicalChannelGroup*.

Each logical channel may be allocated to an LCG using the *logicalChannelGroup*. The maximum number of LCGs is eight.

The MAC entity determines the amount of UL data available for a logical channel according to the data volume calculation procedure in TSs 38.322 and 38.323 [3] [4].

A BSR shall be triggered if any of the following events occur:

- the MAC entity has new UL data available for a logical channel which belongs to an LCG; and either
 - the new UL data belongs to a logical channel with higher priority than the priority of any logical channel containing available UL data which belong to any LCG; or
 - none of the logical channels which belong to an LCG contains any available UL data.

in which case the BSR is referred below to as 'Regular BSR';

- UL resources are allocated and number of padding bits is equal to or larger than the size of the Buffer Status Report MAC CE plus its subheader, in which case the BSR is referred below to as 'Padding BSR';
- *retxBSR-Timer* expires, and at least one of the logical channels which belong to an LCG contains UL data, in which case the BSR is referred below to as 'Regular BSR';
- *periodicBSR-Timer* expires, in which case the BSR is referred below to as 'Periodic BSR'.

For Regular BSR, the MAC entity shall:

- 1> if the BSR is triggered for a logical channel for which *logicalChannelSR-Delay* is configured by upper layers:
 - 2> start or restart the *logicalChannelSR-DelayTimer*.
- 1> else:
 - 2> if running, stop the *logicalChannelSR-DelayTimer*.

For Regular and Periodic BSR, the MAC entity shall:

- 1> if more than one LCG has data available for transmission when the BSR is to be transmitted:
 - 2> report Long BSR for all LCGs which have data available for transmission.
- 1> else:
 - 2> report Short BSR.

For Padding BSR:

- 1> if the number of padding bits is equal to or larger than the size of the Short BSR plus its subheader but smaller than the size of the Long BSR plus its subheader:
 - 2> if more than one LCG has data available for transmission when the BSR is to be transmitted:
 - 3> if the number of padding bits is equal to the size of the Short BSR plus its subheader:
 - 4> report Short Truncated BSR of the LCG with the highest priority logical channel with data available for transmission.
 - 3> else:

4> report Long Truncated BSR of the LCG(s) with the logical channels having data available for transmission following a decreasing order of priority, and in case of equal priority, in increasing order of LCGID.

2> else:

3> report Short BSR;

1> else if the number of padding bits is equal to or larger than the size of the Long BSR plus its subheader:

2> report Long BSR for all LCGs which have data available for transmission.

The MAC entity shall:

1> if the Buffer Status reporting procedure determines that at least one BSR has been triggered and not cancelled:

2> if UL-SCH resources are available for a new immediate transmission:

3> instruct the Multiplexing and Assembly procedure to generate the BSR MAC CE(s);

3> start or restart *periodicBSR-Timer* except when all the generated BSRs are long or short Truncated BSRs;

3> start or restart *retxBSR-Timer*.

2> else if a Regular BSR has been triggered and *logicalChannelSR-DelayTimer* is not running:

3> if an uplink grant is not a configured grant; or

3> if the Regular BSR was not triggered for a logical channel for which logical channel SR masking (*logicalChannelSR-Mask*) is setup by upper layers:

4> trigger a Scheduling Request.

A MAC PDU shall contain at most one BSR MAC CE, even when multiple events have triggered a BSR by the time. The Regular BSR and the Periodic BSR shall have precedence over the padding BSR.

The MAC entity shall restart *retxBSR-Timer* upon reception of a grant for transmission of new data on any UL-SCH.

All triggered BSRs may be cancelled when the UL grant(s) can accommodate all pending data available for transmission but is not sufficient to additionally accommodate the BSR MAC control element plus its subheader. All triggered BSRs shall be cancelled when a BSR is included in a MAC PDU for transmission.

The MAC entity shall transmit at most one BSR in one MAC PDU. Padding BSR shall not be included when the MAC PDU contains a Regular or Periodic BSR.

[TS 38.321, clause 6.1.3.1]

Buffer Status Report (BSR) MAC CEs consist of either:

- Short BSR format (fixed size); or
- Long BSR format (variable size); or
- Short Truncated BSR format (fixed size); or
- Long Truncated BSR format (variable size).

The BSR formats are identified by MAC PDU subheaders with LCIDs as specified in Table 6.2.1-2.

The fields in the BSR MAC CE are defined as follows:

- LCG ID: The Logical Channel Group ID field identifies the group of logical channel(s) whose buffer status is being reported. The length of the field is 3 bits;
- LCG_i: For the Long BSR format, this field indicates the presence of the Buffer Size field for the logical channel group *i*. The LCG_i field set to "1" indicates that the Buffer Size field for the logical channel group *i* is reported. The LCG_i field set to "0" indicates that the Buffer Size field for the logical channel group *i* is not reported. For the Long Truncated BSR format, this field indicates whether logical channel group *i* has data available. The

LCG_i field set to "1" indicates that logical channel group i has data available. The LCG_i field set to "0" indicates that logical channel group i does not have data available;

- Buffer Size: The Buffer Size field identifies the total amount of data available according to the data volume calculation procedure in TSs 38.322 and 38.323 [3] [4] across all logical channels of a logical channel group after the MAC PDU has been built (i.e. after the logical channel prioritization procedure, which may result the value of the Buffer Size field to zero). The amount of data is indicated in number of bytes. The size of the RLC and MAC headers are not considered in the buffer size computation. The length of this field for the Short BSR format and the Short Truncated BSR format is 5 bits. The length of this field for the Long BSR format and the Long Truncated BSR format is 8 bits. The values for the 5-bit and 8-bit Buffer Size fields are shown in Tables 6.1.3.1-1 and 6.1.3.1-2, respectively. For the Long BSR format and the Long Truncated BSR format, the Buffer Size fields are included in ascending order based on the LCG_i. For the Long Truncated BSR format the number of Buffer Size fields included is maximised, while not exceeding the number of padding bits.

NOTE: The number of the Buffer Size fields in the Long Truncated BSR format can be zero.

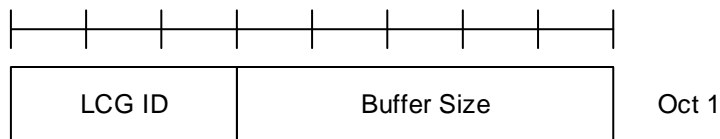

Figure 6.1.3.1-1: Short BSR and Short Truncated BSR MAC CE

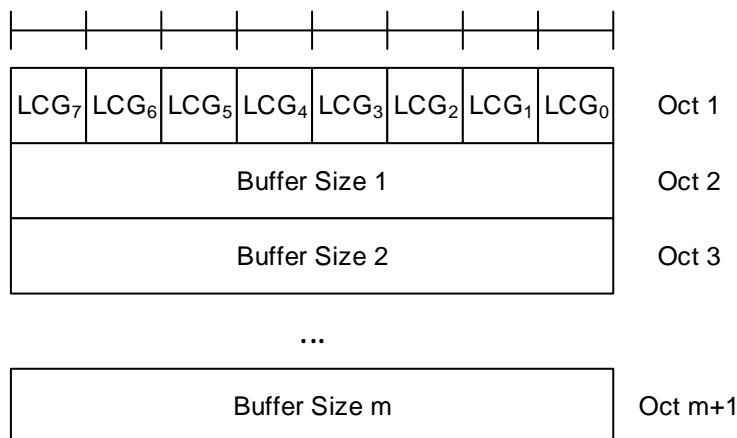

Figure 6.1.3.1-2: Long BSR and Long Truncated BSR MAC CE

Table 6.1.3.1-1: Buffer size levels (in bytes) for 5-bit Buffer Size field

Index	BS value	Index	BS value	Index	BS value	Index	BS value
0	0	8	≤ 102	16	≤ 1446	24	≤ 20516
1	≤ 10	9	≤ 142	17	≤ 2014	25	≤ 28581
2	≤ 14	10	≤ 198	18	≤ 2806	26	≤ 39818
3	≤ 20	11	≤ 276	19	≤ 3909	27	≤ 55474
4	≤ 28	12	≤ 384	20	≤ 5446	28	≤ 77284
5	≤ 38	13	≤ 535	21	≤ 7587	29	≤ 107669
6	≤ 53	14	≤ 745	22	≤ 10570	30	≤ 150000
7	≤ 74	15	≤ 1038	23	≤ 14726	31	> 150000

Table 6.1.3.1-2: Buffer size levels (in bytes) for 8-bit Buffer Size field

Index	BS value	Index	BS value	Index	BS value	Index	BS value
0	0	64	≤ 526	128	≤ 29431	192	≤ 1647644
1	≤ 10	65	≤ 560	129	≤ 31342	193	≤ 1754595
2	≤ 11	66	≤ 597	130	≤ 33376	194	≤ 1868488

3	≤ 12	67	≤ 635	131	≤ 35543	195	≤ 1989774
4	≤ 13	68	≤ 677	132	≤ 37850	196	≤ 2118933
5	≤ 13	69	≤ 720	133	≤ 40307	197	≤ 2256475
6	≤ 14	70	≤ 767	134	≤ 42923	198	≤ 2402946
7	≤ 15	71	≤ 817	135	≤ 45709	199	≤ 2558924
8	≤ 16	72	≤ 870	136	≤ 48676	200	≤ 2725027
9	≤ 17	73	≤ 926	137	≤ 51836	201	≤ 2901912
10	≤ 18	74	≤ 987	138	≤ 55200	202	≤ 3090279
11	≤ 19	75	≤ 1051	139	≤ 58784	203	≤ 3290873
12	≤ 20	76	≤ 1119	140	≤ 62599	204	≤ 3504487
13	≤ 22	77	≤ 1191	141	≤ 66663	205	≤ 3731968
14	≤ 23	78	≤ 1269	142	≤ 70990	206	≤ 3974215
15	≤ 25	79	≤ 1351	143	≤ 75598	207	≤ 4232186
16	≤ 26	80	≤ 1439	144	≤ 80505	208	≤ 4506902
17	≤ 28	81	≤ 1532	145	≤ 85730	209	≤ 4799451
18	≤ 30	82	≤ 1631	146	≤ 91295	210	≤ 5110989
19	≤ 32	83	≤ 1737	147	≤ 97221	211	≤ 5442750
20	≤ 34	84	≤ 1850	148	≤ 103532	212	≤ 5796046
21	≤ 36	85	≤ 1970	149	≤ 110252	213	≤ 6172275
22	≤ 38	86	≤ 2098	150	≤ 117409	214	≤ 6572925
23	≤ 40	87	≤ 2234	151	≤ 125030	215	≤ 6999582
24	≤ 43	88	≤ 2379	152	≤ 133146	216	≤ 7453933
25	≤ 46	89	≤ 2533	153	≤ 141789	217	≤ 7937777
26	≤ 49	90	≤ 2698	154	≤ 150992	218	≤ 8453028
27	≤ 52	91	≤ 2873	155	≤ 160793	219	≤ 9001725
28	≤ 55	92	≤ 3059	156	≤ 171231	220	≤ 9586039
29	≤ 59	93	≤ 3258	157	≤ 182345	221	≤ 10208280
30	≤ 62	94	≤ 3469	158	≤ 194182	222	≤ 10870913
31	≤ 66	95	≤ 3694	159	≤ 206786	223	≤ 11576557
32	≤ 71	96	≤ 3934	160	≤ 220209	224	≤ 12328006
33	≤ 75	97	≤ 4189	161	≤ 234503	225	≤ 13128233
34	≤ 80	98	≤ 4461	162	≤ 249725	226	≤ 13980403
35	≤ 85	99	≤ 4751	163	≤ 265935	227	≤ 14887889
36	≤ 91	100	≤ 5059	164	≤ 283197	228	≤ 15854280
37	≤ 97	101	≤ 5387	165	≤ 301579	229	≤ 16883401
38	≤ 103	102	≤ 5737	166	≤ 321155	230	≤ 17979324
39	≤ 110	103	≤ 6109	167	≤ 342002	231	≤ 19146385
40	≤ 117	104	≤ 6506	168	≤ 364202	232	≤ 20389201
41	≤ 124	105	≤ 6928	169	≤ 387842	233	≤ 21712690
42	≤ 132	106	≤ 7378	170	≤ 413018	234	≤ 23122088
43	≤ 141	107	≤ 7857	171	≤ 439827	235	≤ 24622972
44	≤ 150	108	≤ 8367	172	≤ 468377	236	≤ 26221280
45	≤ 160	109	≤ 8910	173	≤ 498780	237	≤ 27923336
46	≤ 170	110	≤ 9488	174	≤ 531156	238	≤ 29735875
47	≤ 181	111	≤ 10104	175	≤ 565634	239	≤ 31666069
48	≤ 193	112	≤ 10760	176	≤ 602350	240	≤ 33721553
49	≤ 205	113	≤ 11458	177	≤ 641449	241	≤ 35910462
50	≤ 218	114	≤ 12202	178	≤ 683087	242	≤ 38241455
51	≤ 233	115	≤ 12994	179	≤ 727427	243	≤ 40723756
52	≤ 248	116	≤ 13838	180	≤ 774645	244	≤ 43367187
53	≤ 264	117	≤ 14736	181	≤ 824928	245	≤ 46182206
54	≤ 281	118	≤ 15692	182	≤ 878475	246	≤ 49179951
55	≤ 299	119	≤ 16711	183	≤ 935498	247	≤ 52372284
56	≤ 318	120	≤ 17795	184	≤ 996222	248	≤ 55771835
57	≤ 339	121	≤ 18951	185	≤ 1060888	249	≤ 59392055
58	≤ 361	122	≤ 20181	186	≤ 1129752	250	≤ 63247269
59	≤ 384	123	≤ 21491	187	≤ 1203085	251	≤ 67352729
60	≤ 409	124	≤ 22885	188	≤ 1281179	252	≤ 71724679
61	≤ 436	125	≤ 24371	189	≤ 1364342	253	≤ 76380419
62	≤ 464	126	≤ 25953	190	≤ 1452903	254	≤ 81338368
63	≤ 494	127	≤ 27638	191	≤ 1547213	255	> 81338368

[TS 38.321, clause 6.2.1]

Table 6.2.1-2: Values of LCID for UL-SCH

Index	LCID values
000000	CCCH
000001–100000	Identity of the logical channel
100001–110110	Reserved
110111	Configured Grant Confirmation
111000	Multiple Entry PHR
111001	Single Entry PHR
111010	C-RNTI
111011	Short Truncated BSR
111100	Long Truncated BSR
111101	Short BSR
111110	Long BSR
111111	Padding

7.1.1.3.6.3 Test description

7.1.1.3.6.3.1 Pre-test conditions

Same Pre-test conditions as in clause 7.1.1.0 with the exception of 2 SN terminated SCG bearers configured according to Table 7.1.1.3.6.3.1-1.

Table 7.1.1.3.6.3.1-1: Logical Channel Configuration Settings

Parameter	DRB1	DRB2
LogicalChannelIdentity	LCH4(DRB-Identity +3)	LCH5(DRB-Identity +3)
Priority	7	6
prioritizedBitRate	0kbs	0kbs
logicalChannelGroup	2 (LCG ID#2)	1 (LCG ID#1)

7.1.1.3.6.3.2 Test procedure sequence

Table 7.1.1.3.6.3.2-1: Main behaviour

St	Procedure	Message Sequence		TP	Verdict
		U - S	Message		
1	The SS ignores scheduling requests and does not allocate any uplink grant.	-	-	-	-
2	The SS transmits a MAC PDU containing an RLC PDU on LCH4 (LCG ID 2), which contains 1 RLC SDU of size 14 bytes.	<--	MAC PDU (RLC PDU)		
3	The SS sends an uplink grant of size 32 bits. (Note 1)	<--	(UL grant)	-	-
4	The UE transmits a short BSR report and restarts <i>periodicBSR-Timer</i>	-->	MAC PDU ((LCID='111101', LCG ID='10', Buffer size index > 0)	-	-
-	EXCEPTION: Steps 5 to 7 shall be repeated two times (Note 2)	-	-	-	-
5	Wait for <i>periodicBSR-Timer</i> expiry.	-	-	-	-
6	The SS sends an uplink grant of size 32 bits	-	-	-	-
7	Check: Does UE transmit a MAC PDU containing a Short BSR with 'LCG ID' field set to '10' (logicalChannelGroup 2) and Buffer Size Index > 0?	-->	MAC PDU (LCID='111101', LCG ID='10', Buffer Size index > 0)	2	P
8	The SS transmits a MAC PDU containing an RLC PDU on LCH5 (LCG ID 1), which contains 1 RLC SDU of size 14 bytes.	<--	MAC PDU (RLC PDU)	-	-
9	The SS sends an uplink grant of size 40 bits (Note 3)	<--	(UL grant)	-	-
10	The UE transmits a long BSR report with 'Buffer size#1' (LCG ID=1) and 'Buffer size#2' (LCG ID=2) fields set to value > '0'	-->	MAC PDU (('Buffer size#1 index' > 0, 'Buffer size#2 index=' >0')	-	-

-	EXCEPTION: Step 11 to 13 shall be repeated twice. (Note 4)	-	-	-	-
11	Wait for periodicBSR-Timer expiry.	-	-	-	-
12	The SS sends an uplink grant of size 40 bits	-	-	-	-
13	Check: Does UE transmit a MAC PDU containing a Long BSR with 'Buffer size#1' (LCG ID=1) and 'Buffer size#2' (LCG ID=2) fields set to value > '0'?	-->	MAC PDU	1	P
14	The SS transmits 1 UL grant of size 320 bits to enable the UE to loopback RLC SDU on LCH4 and LCH5.			-	-
15	The UE transmits MAC PDU containing the remaining RLC SDUs as sent by the SS in steps 2 and 8.	-->	MAC PDU	-	-
<p>Note 1: SS transmits an UL grant of 32 bits(L_{RBS} & I_{MCS} as per 38.523-3[3] annex B) to allow UE to transmit a Regular BSR triggered by the new data received logicalChannelGroup 1 in step 2.</p> <p>Note 2: One short BSR due to first expiry of <i>periodicBSR-Timer</i> and one short BSR due to second expiry of <i>periodicBSR-Timer</i>.</p> <p>Note 3: SS transmits an UL grant of 40 bits(L_{RBS} & I_{MCS} as per 38.523-3[3] annex B) to allow UE to transmit a Regular BSR triggered by the new data received on higher priority logicalChannelGroup 1 in step 8.</p> <p>Note 4: One long BSR due to expiry of <i>periodicBSR-Timer</i> and one long BSR due to second expiry of <i>periodicBSR-Timer</i>.</p>					

7.1.1.3.6.3.3 Specific message contents

Table 7.1.1.3.6.3.3: MAC-CellGroupConfig (preamble)

Derivation Path: TS 38.308 [6], clause Table 4.6.3-49			
Information Element	Value/remark	Comment	Condition
MAC-CellGroupConfig ::= SEQUENCE {			
bsr-Config SEQUENCE {			
periodicBSR-Timer	sf160		
retxBSR-Timer	sf10240		
}			
phr-Config CHOICE {			
release	NULL		
}			
}			

7.1.1.3.7 UE power headroom reporting / Periodic reporting / DL pathloss change reporting

7.1.1.3.7.1 Test Purpose (TP)

(1)

```
with { UE in RRC_CONNECTED state }
ensure that {
  when { phr-PeriodicTimer is configured in UE }
  then { UE transmits a MAC PDU containing Power Headroom MAC Control Element }
}
```

(2)

```
with { UE in RRC_CONNECTED state with periodic power headroom reporting configured }
ensure that {
  when { phr-PeriodicTimer expires and UL resources allocated for new transmission }
  then { UE transmits a MAC PDU containing Power Headroom MAC Control Element }
}
```

(3)

```
with { UE in RRC_CONNECTED state with periodic power headroom reporting configured }
ensure that {
  when { power headroom reporting is disabled }
```

```

    then { UE stops transmitting Power Headroom MAC Control Element }
  }

```

(4)

```

with { UE in RRC_Connected state with Power headroom reporting for phr-Tx-PowerFactorChange
configured }
ensure that {
  when { the DL Pathloss has changed more than phr-Tx-PowerFactorChange dB and phr-ProhibitTimer is
running }
  then { UE does not transmit a MAC PDU containing Power Headroom MAC Control Element }
}

```

(5)

```

with { UE in RRC_Connected state with Power headroom reporting for phr-Tx-PowerFactorChange
configured }
ensure that {
  when { phr-ProhibitTimer expires and power headroom report is triggered due to DL Pathloss change
}
  then { UE transmits a MAC PDU containing Power Headroom MAC Control Element }
}

```

7.1.1.3.7.2 Conformance requirements

References: The conformance requirements covered in the current TC are specified in: TS 38.321 clause 5.4.6 and 6.1.3.8. Unless otherwise stated these are Rel-15 requirements.

[TS 38.321, clause 5.4.6]

The Power Headroom reporting procedure is used to provide the serving gNB with the following information:

- Type 1 power headroom: the difference between the nominal UE maximum transmit power and the estimated power for UL-SCH transmission per activated Serving Cell;
- Type 2 power headroom: the difference between the nominal UE maximum transmit power and the estimated power for UL-SCH and PUCCH transmission on SpCell of the other MAC entity (i.e. E-UTRA MAC entity in EN-DC case only);
- Type 3 power headroom: the difference between the nominal UE maximum transmit power and the estimated power for SRS transmission per activated Serving Cell.

RRC controls Power Headroom reporting by configuring the following parameters:

- *phr-PeriodicTimer*;
- *phr-ProhibitTimer*;
- *phr-Tx-PowerFactorChange*;
- *phr-Type2PCell*;
- *phr-Type2OtherCell*;
- *phr-ModeOtherCG*;
- *multiplePHR*.

A Power Headroom Report (PHR) shall be triggered if any of the following events occur:

- *phr-ProhibitTimer* expires or has expired and the path loss has changed more than *phr-Tx-PowerFactorChange* dB for at least one activated Serving Cell of any MAC entity which is used as a pathloss reference since the last transmission of a PHR in this MAC entity when the MAC entity has UL resources for new transmission;

NOTE 1: The path loss variation for one cell assessed above is between the pathloss measured at present time on the current pathloss reference and the pathloss measured at the transmission time of the last transmission of PHR on the pathloss reference in use at that time, irrespective of whether the pathloss reference has changed in between.

- *phr-PeriodicTimer* expires;
- upon configuration or reconfiguration of the power headroom reporting functionality by upper layers, which is not used to disable the function;
- activation of an SCell of any MAC entity with configured uplink;
- addition of the PSCell (i.e. PSCell is newly added or changed);
- *phr-ProhibitTimer* expires or has expired, when the MAC entity has UL resources for new transmission, and the following is true for any of the activated Serving Cells of any MAC entity with configured uplink:
 - there are UL resources allocated for transmission or there is a PUCCH transmission on this cell, and the required power backoff due to power management (as allowed by $P\text{-MPR}_c$ as specified in TS 38.101-1 [14], TS 38.101-2 [15], and TS 38.101-3 [16]) for this cell has changed more than *phr-Tx-PowerFactorChange* dB since the last transmission of a PHR when the MAC entity had UL resources allocated for transmission or PUCCH transmission on this cell.

NOTE 2: The MAC entity should avoid triggering a PHR when the required power backoff due to power management decreases only temporarily (e.g. for up to a few tens of milliseconds) and it should avoid reflecting such temporary decrease in the values of $P_{\text{CMAX},f,c}/\text{PH}$ when a PHR is triggered by other triggering conditions.

If the MAC entity has UL resources allocated for a new transmission the MAC entity shall:

- 1> if it is the first UL resource allocated for a new transmission since the last MAC reset:
 - 2> start *phr-PeriodicTimer*;
- 1> if the Power Headroom reporting procedure determines that at least one PHR has been triggered and not cancelled; and
- 1> if the allocated UL resources can accommodate the MAC CE for PHR which the MAC entity is configured to transmit, plus its subheader, as a result of LCP as defined in subclause 5.4.3.1:
 - 2> if *multiplePHR* is configured:
 - 3> for each activated Serving Cell with configured uplink associated with any MAC entity:
 - 4> obtain the value of the Type 1 or Type 3 power headroom for the corresponding uplink carrier as specified in subclause 7.7 of TS 38.213 [6];
 - 4> if this MAC entity has UL resources allocated for transmission on this Serving Cell; or
 - 4> if the other MAC entity, if configured, has UL resources allocated for transmission on this Serving Cell and *phr-ModeOtherCG* is set to real by upper layers:
 - 5> obtain the value for the corresponding $P_{\text{CMAX},f,c}$ field from the physical layer.
 - 3> if *phr-Type2OtherCell* is configured:
 - 4> if the other MAC entity is E-UTRA MAC entity:
 - 5> obtain the value of the Type 2 power headroom for the SpCell of the other MAC entity (i.e. E-UTRA MAC entity);
 - 5> if *phr-ModeOtherCG* is set to real by upper layers:
 - 6> obtain the value for the corresponding $P_{\text{CMAX},f,c}$ field for the SpCell of the other MAC entity (i.e. E-UTRA MAC entity) from the physical layer.
 - 3> instruct the Multiplexing and Assembly procedure to generate and transmit the Multiple Entry PHR MAC CE as defined in subclause 6.1.3.9 based on the values reported by the physical layer.
 - 2> else (i.e. Single Entry PHR format is used):

- 3> obtain the value of the Type 1 power headroom from the physical layer for the corresponding uplink carrier of the PCell;
- 3> obtain the value for the corresponding $P_{\text{CMAX},f,c}$ field from the physical layer;
- 3> instruct the Multiplexing and Assembly procedure to generate and transmit the Single Entry PHR MAC CE as defined in subclause 6.1.3.8 based on the values reported by the physical layer.
- 2> start or restart *phr-PeriodicTimer*;
- 2> start or restart *phr-ProhibitTimer*;
- 2> cancel all triggered PHR(s).

[TS 38.321, clause 6.1.3.8]

The Single Entry PHR MAC CE is identified by a MAC PDU subheader with LCID as specified in Table 6.2.1-2.

It has a fixed size and consists of two octet defined as follows (figure 6.1.3.8-1):

- R: Reserved bit, set to "0";
- Power Headroom (PH): This field indicates the power headroom level. The length of the field is 6 bits. The reported PH and the corresponding power headroom levels are shown in Table 6.1.3.8-1 below (the corresponding measured values in dB are specified in TS 38.133 [11]);
- $P_{\text{CMAX},f,c}$: This field indicates the $P_{\text{CMAX},f,c}$ (as specified in TS 38.213 [6]) used for calculation of the preceding PH field. The reported $P_{\text{CMAX},f,c}$ and the corresponding nominal UE transmit power levels are shown in Table 6.1.3.8-2 (the corresponding measured values in dBm are specified in TS 38.133 [11]).

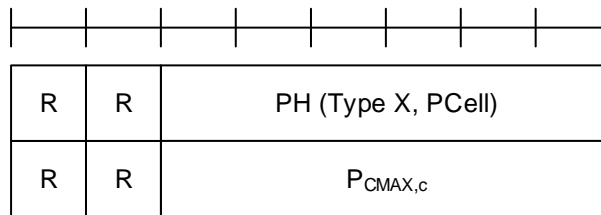

Figure 6.1.3.8-1: Single Entry PHR MAC CE

Table 6.1.3.8-1: Power Headroom levels for PHR

PH	Power Headroom Level
0	POWER_HEADROOM_0
1	POWER_HEADROOM_1
2	POWER_HEADROOM_2
3	POWER_HEADROOM_3
...	...
60	POWER_HEADROOM_60
61	POWER_HEADROOM_61
62	POWER_HEADROOM_62
63	POWER_HEADROOM_63

Table 6.1.3.8-2: Nominal UE transmit power level for PHR

$P_{\text{CMAX},f,c}$	Nominal UE transmit power level
0	PCMAX_C_00
1	PCMAX_C_01
2	PCMAX_C_02
...	...

61	PCMAX_C_61
62	PCMAX_C_62
63	PCMAX_C_63

7.1.1.3.7.3 Test description

7.1.1.3.7.3.1 Pre-test conditions

Same Pre-test conditions as in clause 7.1.1.0 except that set to return no data in uplink.

7.1.1.3.7.3.2 Test procedure sequence

Table 7.1.1.3.7.3.2-1: Main behaviour

St	Procedure	Message Sequence		TP	Verdict
		U - S	Message		
1	The SS transmits UL grant to the UE at every 10ms in PDCCH occasion.	<--	-	-	-
2	SS transmits NR <i>RRCReconfiguration</i> message to configure specific Power Headroom parameters for NR Cell.(Note 1).	<--	(<i>RRCReconfiguration</i>)	-	-
3	Check: does the UE transmit a MAC PDU containing Power Headroom MAC Control Element? (Note 2, 5)	-->	MAC PDU	1	P
4	The UE transmits an NR <i>RRCReconfigurationComplete</i> message to confirm the setup of Power Headroom parameters. (Note 2,3)	-->	(<i>RRCReconfigurationComplete</i>)	-	-
5	Check: does the UE transmit a MAC PDU containing Power Headroom MAC Control Element 500ms after step 3? (Note 5)	-->	MAC PDU	2	P
6	The SS transmits an NR <i>RRCReconfiguration</i> message to disable Power Headroom reporting.(Note 1)	<--	(<i>RRCReconfiguration</i>)	-	-
7	The UE transmits an NR <i>RRCReconfigurationComplete</i> message to confirm the disabling of Power Headroom parameters.(Note 3)	-->	(<i>RRCReconfigurationComplete</i>)	-	-
8	Check: for 2 seconds, does the UE transmit a MAC PDU containing Power Headroom MAC Control Element? (Note 5)	-->	MAC PDU	3	F
9	SS transmits NR <i>RRCReconfiguration</i> message to configure specific Power Headroom parameters for NR Cell.(Note 1)	<--	(<i>RRCReconfiguration</i>)	-	-
10	Check: does the UE transmit a MAC PDU containing Power Headroom MAC Control Element? (Note 4, 5)	-->	MAC PDU	1	P
11	The UE transmits an NR <i>RRCReconfigurationComplete</i> message to confirm the setup of Power Headroom parameters. (Note 3,4)	-->	(<i>RRCReconfigurationComplete</i>)	-	-
12	Wait for T1= 20% of <i>prohibitPHR-Timer</i> .	-	-	-	-
13	Reduce SS power level for NR Cell so as to cause a DL_Pathloss change at UE by 5dB.	-	-	-	-
14	Check: for 80% of <i>prohibitPHR-Timer</i> since step 10, does the UE transmit a MAC PDU containing Power Headroom MAC Control Element? (Note 5)	-->	MAC PDU	4	F

15	Check: after <i>prohibitPHR-Timer</i> after step 10, does the UE transmit a MAC PDU containing Power Headroom MAC Control Element? (Note 5)	-->	MAC PDU	5	P
16	Increase SS power level for NR Cell so as to cause a DL_Pathloss change at UE by 5dB.	-	-	-	-
17	Check: for 80% of <i>prohibitPHR-Timer</i> since step 15, does the UE transmit a MAC PDU containing Power Headroom MAC Control Element? (Note 5)	-->	MAC PDU	4	F
18	Check: after <i>prohibitPHR-Timer</i> after step 15, does the UE transmit a MAC PDU containing Power Headroom MAC Control Element? (Note 5)	-->	MAC PDU	5	P
19	The SS transmits an NR <i>RRCReconfiguration</i> message to disable Power Headroom reporting.(Note 1)	<--	(<i>RRCReconfiguration</i>)	-	-
20	The UE transmits an NR <i>RRCReconfigurationComplete</i> message to confirm the disabling of Power Headroom parameters.(Note 3)	-->	(<i>RRCReconfigurationComplete</i>)	-	-
<p>Note 1: for EN-DC the NR <i>RRCReconfiguration</i> message is contained in <i>RRCConnectionReconfiguration</i> 36.508 [7], Table 4.6.1-8 using condition EN-DC_EmbedNR_RRCRecon.</p> <p>Note 2: Steps 3 and 4 can happen in any order.</p> <p>Note 3: for EN-DC the NR <i>RRCReconfigurationComplete</i> message is contained in <i>RRCConnectionReconfigurationComplete</i>.</p> <p>Note 4: Steps 10 and 11 can happen in any order.</p> <p>Note 5: For NR5GC the received MAC PDU will contain Single-entry PHR MAC CE. For EN-DC/NE-DC the received MAC PDU will contain Multiple-Entry PHR MAC CE.</p>					

7.1.1.3.7.3.3 Specific message contents

Table 7.1.1.3.7.3.3-1: RRCReconfiguration (step 2 Table 7.1.1.3.7.3.2-1)

Derivation Path: 38.508-1 [4], Table 4.6.1-13			
Information Element	Value/remark	Comment	Condition
RRCReconfiguration ::= SEQUENCE {			
criticalExtensions CHOICE {			
rrcReconfiguration SEQUENCE {			
secondaryCellGroup	CellGroupConfig	OCTET STRING (CONTAINING CellGroupConfig)	EN-DC
nonCriticalExtension SEQUENCE {			NR NE-DC
masterCellGroup	CellGroupConfig	OCTET STRING (CONTAINING CellGroupConfig)	
}			
}			
}			
}			

Table 7.1.1.3.7.3.3-2: CellGroupConfig (Table 7.1.1.3.7.3.3-1)

Derivation Path: 38.508-1 [4], Table 4.6.3-19			
Information Element	Value/remark	Comment	Condition
cellGroupConfig ::= SEQUENCE {			
mac-CellGroupConfig SEQUENCE {			
phr-Config CHOICE {			
setup SEQUENCE {			
phr-PeriodicTimer	sf500		
phr-ProhibitTimer	sf1000		
phr-Tx-PowerFactorChange	infinity		
multiplePHR	false		

multiplePHR	true		EN-DC NE-DC
phr-Type2PCell	false		
phr-Type2OtherCell	false		
phr-ModeOtherCG	real		
}			
}			
}			
}			

Table 7.1.1.3.7.3.3-3: RRCReconfiguration (step 6,19 Table 7.1.1.3.7.3.2-1)

Derivation Path: 38.508-1 [4], Table 4.6.1-13			
Information Element	Value/remark	Comment	Condition
RRCReconfiguration ::= SEQUENCE {			
criticalExtensions CHOICE {			
rrcReconfiguration SEQUENCE {			
secondaryCellGroup	CellGroupConfig	OCTET STRING (CONTAINING CellGroupConfig)	EN-DC
nonCriticalExtension SEQUENCE {			NR NE-DC
masterCellGroup	CellGroupConfig	OCTET STRING (CONTAINING CellGroupConfig)	
}			
}			
}			
}			

Table 7.1.1.3.7.3.3-4: CellGroupConfig (Table 7.1.1.3.7.3.3-3)

Derivation Path: 38.508-1 [4], Table 4.6.3-19			
Information Element	Value/remark	Comment	Condition
cellGroupConfig ::= SEQUENCE {			
mac-CellGroupConfig SEQUENCE {			
phr-Config CHOICE {			
release	NULL		
}			
}			
}			

Table 7.1.1.3.7.3.3-5: RRCReconfiguration (step 9 Table 7.1.1.3.7.3.2-1)

Derivation Path: 38.508-1 [4], Table 4.6.1-13			
Information Element	Value/remark	Comment	Condition
RRCReconfiguration ::= SEQUENCE {			
criticalExtensions CHOICE {			
rrcReconfiguration SEQUENCE {			
secondaryCellGroup	CellGroupConfig	OCTET STRING (CONTAINING CellGroupConfig)	EN-DC
nonCriticalExtension SEQUENCE {			NR NE-DC
masterCellGroup	CellGroupConfig	OCTET STRING (CONTAINING CellGroupConfig)	
}			
}			
}			
}			

Table 7.1.1.3.7.3.3-6: CellGroupConfig (Table 7.1.1.3.7.3.3-5)

Derivation Path: 38.508-1 [4], Table 4.6.3-19			
Information Element	Value/remark	Comment	Condition
cellGroupConfig ::= SEQUENCE {			
mac-CellGroupConfig SEQUENCE {			
phr-Config CHOICE {			
setup SEQUENCE {			
phr-PeriodicTimer	infinity		
phr-ProhibitTimer	sf1000		
phr-Tx-PowerFactorChange	3dB		
multiplePHR	false		
multiplePHR	true		EN-DC NE-DC
phr-Type2PCell	false		
phr-Type2OtherCell	false		
phr-ModeOtherCG	real		
}			
}			
}			
}			

7.1.1.3.8 UE power headroom reporting / SCell activation / DL pathloss change reporting

7.1.1.3.8.1 UE power headroom reporting / SCell activation / DL pathloss change reporting/ Intra-band Contiguous CA

7.1.1.3.8.1.1 Test Purpose (TP)

(1)

```
with { UE in RRC_Connected state with multiple Power headroom reporting and an SCell with uplink is
configured }
ensure that {
  when { UE receives an Activation MAC Control Element activating the SCell }
    then { UE transmits a MAC PDU containing Power Headroom Report MAC Control Element including PH
type1 for SpCell and SCell }
}
```

(2)

```
with { UE in RRC_Connected state with multiple Power headroom reporting for phr-dl-PathlossChange
configured }
ensure that {
  when { the DL Pathloss changes and phr-ProhibitTimer is running }
    then { UE does not transmit a MAC PDU containing Power Headroom Report MAC Control Element
including PH type1 for SpCell and SCell }
}
```

(3)

```
with { UE in RRC_Connected state with Power headroom reporting for phr-dl-PathlossChange configured
}
ensure that {
  when { phr-ProhibitTimer expires and power headroom report is triggered due to DL Pathloss change
}
    then { UE transmits a MAC PDU containing Power Headroom Report MAC Control Element including PH
type1 for SpCell and SCell }
}
```

7.1.1.3.8.1.2 Conformance requirements

References: The conformance requirements covered in the current TC are specified in: TS 38.321 clause 5.4.6 and 6.1.3.8. Unless otherwise stated these are Rel-15 requirements.

[TS 38.321, clause 5.4.6]

The Power Headroom reporting procedure is used to provide the serving gNB with the following information:

- Type 1 power headroom: the difference between the nominal UE maximum transmit power and the estimated power for UL-SCH transmission per activated Serving Cell;
- Type 2 power headroom: the difference between the nominal UE maximum transmit power and the estimated power for UL-SCH and PUCCH transmission on SpCell of the other MAC entity (i.e. E-UTRA MAC entity in EN-DC, NE-DC, and NGEN-DC cases);
- Type 3 power headroom: the difference between the nominal UE maximum transmit power and the estimated power for SRS transmission per activated Serving Cell.

RRC controls Power Headroom reporting by configuring the following parameters:

- *phr-PeriodicTimer*;
- *phr-ProhibitTimer*;
- *phr-Tx-PowerFactorChange*;
- *phr-Type2OtherCell*;
- *phr-ModeOtherCG*;
- *multiplePHR*.

A Power Headroom Report (PHR) shall be triggered if any of the following events occur:

- *phr-ProhibitTimer* expires or has expired and the path loss has changed more than *phr-Tx-PowerFactorChange* dB for at least one activated Serving Cell of any MAC entity which is used as a pathloss reference since the last transmission of a PHR in this MAC entity when the MAC entity has UL resources for new transmission;

NOTE 1: The path loss variation for one cell assessed above is between the pathloss measured at present time on the current pathloss reference and the pathloss measured at the transmission time of the last transmission of PHR on the pathloss reference in use at that time, irrespective of whether the pathloss reference has changed in between.

- *phr-PeriodicTimer* expires;
- upon configuration or reconfiguration of the power headroom reporting functionality by upper layers, which is not used to disable the function;
- activation of an SCell of any MAC entity with configured uplink;
- addition of the PSCell (i.e. PSCell is newly added or changed);
- *phr-ProhibitTimer* expires or has expired, when the MAC entity has UL resources for new transmission, and the following is true for any of the activated Serving Cells of any MAC entity with configured uplink:
 - there are UL resources allocated for transmission or there is a PUCCH transmission on this cell, and the required power backoff due to power management (as allowed by $P-MPR_c$ as specified in TS 38.101-1 [14], TS 38.101-2 [15], and TS 38.101-3 [16]) for this cell has changed more than *phr-Tx-PowerFactorChange* dB since the last transmission of a PHR when the MAC entity had UL resources allocated for transmission or PUCCH transmission on this cell.

NOTE 2: The MAC entity should avoid triggering a PHR when the required power backoff due to power management decreases only temporarily (e.g. for up to a few tens of milliseconds) and it should avoid reflecting such temporary decrease in the values of $P_{CMAX,f,c}/PH$ when a PHR is triggered by other triggering conditions.

If the MAC entity has UL resources allocated for a new transmission the MAC entity shall:

- 1> if it is the first UL resource allocated for a new transmission since the last MAC reset:
 - 2> start *phr-PeriodicTimer*;

- 1> if the Power Headroom reporting procedure determines that at least one PHR has been triggered and not cancelled; and
- 1> if the allocated UL resources can accommodate the MAC CE for PHR which the MAC entity is configured to transmit, plus its subheader, as a result of LCP as defined in clause 5.4.3.1:
 - 2> if *multiplePHR* with value *true* is configured:
 - 3> for each activated Serving Cell with configured uplink associated with any MAC entity:
 - 4> obtain the value of the Type 1 or Type 3 power headroom for the corresponding uplink carrier as specified in clause 7.7 of TS 38.213 [6] for NR Serving Cell and clause 5.1.1.2 of TS 36.213 [17] for E-UTRA Serving Cell;
 - 4> if this MAC entity has UL resources allocated for transmission on this Serving Cell; or
 - 4> if the other MAC entity, if configured, has UL resources allocated for transmission on this Serving Cell and *phr-ModeOtherCG* is set to *real* by upper layers:
 - 5> obtain the value for the corresponding $P_{\text{CMAX},f,c}$ field from the physical layer.
 - 3> if *phr-Type2OtherCell* with value *true* is configured:
 - 4> if the other MAC entity is E-UTRA MAC entity:
 - 5> obtain the value of the Type 2 power headroom for the SpCell of the other MAC entity (i.e. E-UTRA MAC entity);
 - 5> if *phr-ModeOtherCG* is set to *real* by upper layers:
 - 6> obtain the value for the corresponding $P_{\text{CMAX},f,c}$ field for the SpCell of the other MAC entity (i.e. E-UTRA MAC entity) from the physical layer.
 - 3> instruct the Multiplexing and Assembly procedure to generate and transmit the Multiple Entry PHR MAC CE as defined in clause 6.1.3.9 based on the values reported by the physical layer.
 - 2> else (i.e. Single Entry PHR format is used):
 - 3> obtain the value of the Type 1 power headroom from the physical layer for the corresponding uplink carrier of the PCell;
 - 3> obtain the value for the corresponding $P_{\text{CMAX},f,c}$ field from the physical layer;
 - 3> instruct the Multiplexing and Assembly procedure to generate and transmit the Single Entry PHR MAC CE as defined in clause 6.1.3.8 based on the values reported by the physical layer.
 - 2> start or restart *phr-PeriodicTimer*;
 - 2> start or restart *phr-ProhibitTimer*;
 - 2> cancel all triggered PHR(s).

[TS 38.321, clause 6.1.3.9]

The Multiple Entry PHR MAC CE is identified by a MAC subheader with LCID as specified in Table 6.2.1-2.

It has a variable size, and includes the bitmap, a Type 2 PH field and an octet containing the associated $P_{\text{CMAX},f,c}$ field (if reported) for SpCell of the other MAC entity, a Type 1 PH field and an octet containing the associated $P_{\text{CMAX},f,c}$ field (if reported) for the PCell. It further includes, in ascending order based on the *ServCellIndex*, one or multiple of Type X PH fields and octets containing the associated $P_{\text{CMAX},f,c}$ fields (if reported) for Serving Cells other than PCell indicated in the bitmap. X is either 1 or 3 according to TS 38.213 [6] and TS 36.213 [17].

The presence of Type 2 PH field for SpCell of the other MAC entity is configured by *phr-Type2OtherCell* with value *true*.

A single octet bitmap is used for indicating the presence of PH per Serving Cell when the highest *ServCellIndex* of Serving Cell with configured uplink is less than 8, otherwise four octets are used.

The MAC entity determines whether PH value for an activated Serving Cell is based on real transmission or a reference format by considering the configured grant(s) and downlink control information which has been received until and including the PDCCH occasion in which the first UL grant for a new transmission that can accommodate the MAC CE for PHR as a result of LCP as defined in clause 5.4.3.1 is received since a PHR has been triggered if the PHR MAC CE is reported on an uplink grant received on the PDCCH or until the first uplink symbol of PUSCH transmission minus PUSCH preparation time as defined in clause 7.7 of TS 38.213 [6] if the PHR MAC CE is reported on a configured grant.

For a band combination in which the UE does not support dynamic power sharing, the UE may omit the octets containing Power Headroom field and $P_{\text{CMAX},f,c}$ field for Serving Cells in the other MAC entity except for the PCell in the other MAC entity and the reported values of Power Headroom and $P_{\text{CMAX},f,c}$ for the PCell are up to UE implementation.

The PHR MAC CEs are defined as follows:

- C_i : This field indicates the presence of a PH field for the Serving Cell with *ServCellIndex* i as specified in TS 38.331 [5]. The C_i field set to 1 indicates that a PH field for the Serving Cell with *ServCellIndex* i is reported. The C_i field set to 0 indicates that a PH field for the Serving Cell with *ServCellIndex* i is not reported;
- R: Reserved bit, set to 0;
- V: This field indicates if the PH value is based on a real transmission or a reference format. For Type 1 PH, the V field set to 0 indicates real transmission on PUSCH and the V field set to 1 indicates that a PUSCH reference format is used. For Type 2 PH, the V field set to 0 indicates real transmission on PUCCH and the V field set to 1 indicates that a PUCCH reference format is used. For Type 3 PH, the V field set to 0 indicates real transmission on SRS and the V field set to 1 indicates that an SRS reference format is used. Furthermore, for Type 1, Type 2, and Type 3 PH, the V field set to 0 indicates the presence of the octet containing the associated $P_{\text{CMAX},f,c}$ field, and the V field set to 1 indicates that the octet containing the associated $P_{\text{CMAX},f,c}$ field is omitted;
- Power Headroom (PH): This field indicates the power headroom level. The length of the field is 6 bits. The reported PH and the corresponding power headroom levels are shown in Table 6.1.3.8-1 (the corresponding measured values in dB for the NR Serving Cell are specified in TS 38.133 [11] while the corresponding measured values in dB for the E-UTRA Serving Cell are specified in TS 36.133 [12]);
- P: This field indicates whether the MAC entity applies power backoff due to power management (as allowed by $P\text{-MPR}_c$ as specified in TS 38.101-1 [14], TS 38.101-2 [15], and TS 38.101-3 [16]). The MAC entity shall set the P field to 1 if the corresponding $P_{\text{CMAX},f,c}$ field would have had a different value if no power backoff due to power management had been applied;
- $P_{\text{CMAX},f,c}$: If present, this field indicates the $P_{\text{CMAX},f,c}$ (as specified in TS 38.213 [6]) for the NR Serving Cell and the $P_{\text{CMAX},c}$ or $\tilde{P}_{\text{CMAX},c}$ (as specified in TS 36.213 [17]) for the E-UTRA Serving Cell used for calculation of the preceding PH field. The reported $P_{\text{CMAX},f,c}$ and the corresponding nominal UE transmit power levels are shown in Table 6.1.3.8-2 (the corresponding measured values in dBm for the NR Serving Cell are specified in TS 38.133 [11] while the corresponding measured values in dBm for the E-UTRA Serving Cell are specified in TS 36.133 [12]).

C ₇	C ₆	C ₅	C ₄	C ₃	C ₂	C ₁	R
P	V	PH (Type 2, SpCell of the other MAC entity)					
R	R	P _{C_{MAX,f,c} 1}					
P	V	PH (Type 1, PCell)					
R	R	P _{C_{MAX,f,c} 2}					
P	V	PH (Type X, Serving Cell 1)					
R	R	P _{C_{MAX,f,c} 3}					
...							
P	V	PH (Type X, Serving Cell n)					
R	R	P _{C_{MAX,f,c} m}					

Figure 6.1.3.9-1: Multiple Entry PHR MAC CE with the highest *ServCellIndex* of Serving Cell with configured uplink is less than 8

7.1.1.3.8.1.3 Test description

7.1.1.3.8.1.3.1 Pre-test conditions

Same Pre-test conditions as in clause 7.1.1.0 except that Test loop function(*Off*) System information combination NR-4 and in addition NR Cell 3 is configured as NR Active Scell.

7.1.1.3.8.1.3.2 Test procedure sequence

Table 7.1.1.3.8.1.3.2-0: Cell configuration power level changes over time for conducted test environment

T	Parameter	Unit	NR Cell 1	NR Cell 3	Remarks
T0	Cell-specific RS EPRE	dBm/SC S	-88	-88	
T1	Cell-specific RS EPRE	dBm/SC S	-99	-88	
T2	Cell-specific RS EPRE	dBm/SC S	-88	-88	
T3	Cell-specific RS EPRE	dBm/SC S	-88	-99	
T4	Cell-specific RS EPRE	dBm/SC S	-88	-88	

Table 7.1.1.3.8.1.3.2-0A: Cell configuration power level changes over time for OTA test environment

	Parameter	Unit	NR Cell 1	NR Cell 3	Remarks
T0	Cell-specific RS EPRE	dBm/SC S	-82	-82	
T1	Cell-specific RS EPRE	dBm/SC S	-91	-82	
T2	Cell-specific RS EPRE	dBm/SC S	-82	-82	
T3	Cell-specific RS EPRE	dBm/SC S	-82	-91	
T4	Cell-specific RS EPRE	dBm/SC S	-82	-82	

Table 7.1.1.3.8.1.3.2-1: Main behaviour

St	Procedure	Message Sequence		TP	Verdict
		U - S	Message		
1	SS transmits an RRCReconfiguration message to configure SCell (NR Cell 3). Note 1	<--	RRCReconfiguration	-	-
2	The UE transmits RRCReconfigurationComplete message. Note 2	-->	RRCReconfigurationComplete	-	-
3	The SS is configured for Uplink Grant Allocation Type 2. SS is configured to transmit UL grant for UE at every 10 ms.	-	-	-	-
4	SS transmits an RRCReconfiguration message to provide Power Headroom parameters. Note 1	<--	RRCReconfiguration	-	-
	EXCEPTION: In parallel with step 5, UE executes parallel behaviour defined in Table 7.1.1.3.8.1.3.2-2	-	-	-	-
5	The UE transmits RRCReconfigurationComplete message to confirm the setup of Power Headroom parameters. Note 2	-->	RRCReconfigurationComplete	-	-
6	The SS transmits an Activation MAC control element to activate SCell.	<--	MAC PDU (SCell Activation/Deactivation MAC CE of one octet (C ₁ =1))	-	-
7	Check: Does the UE transmit a MAC PDU containing Multiple Entry PHR MAC CE containing Type 1 PH of NR SpCell and Scell? Note 3	-->	MAC PDU	1	P
8	Void	-	-	-	-
9	SS adjusts cell levels according to row T1 of Table 7.1.1.3.8.3.1.2-0/0A.	-	-	-	-
10	Check: For 80% of <i>prohibitPHR-Timer</i> since step 7, does the UE transmit a MAC PDU containing Multiple Entry PHR MAC CE?	-->	MAC PDU	2	F
11	Check: After <i>prohibitPHR-Timer</i> after step 7, does the UE transmit a MAC PDU containing Multiple Entry PHR MAC CE containing Type 1 PH of NR SpCell and Scell? Note 3	-->	MAC PDU	3	P
12	SS adjusts cell levels according to row T2 of Table 7.1.1.3.8.1.3.2-0/0A.	-	-	-	-
13	Check: For 80% of <i>prohibitPHR-Timer</i> since step 11, does the UE transmit a MAC PDU containing Multiple Entry PHR MAC CE ?	-->	MAC PDU	2	F
14	Check: After <i>prohibitPHR-Timer</i> after step 11, does the UE transmit a MAC PDU containing Multiple Entry PHR MAC CE containing Type	-->	MAC PDU	3	P

	1PH of NR SpCell and Scell? Note 3				
15	SS adjusts cell levels according to row T3 of Table 7.1.1.3.8.1.3.2-0/0A.	-	-	-	-
16	Check: For 80% of <i>prohibitPHR-Timer</i> since step 14, does the UE transmit a MAC PDU containing Multiple Entry PHR MAC CE containing?	-->	MAC PDU	2	F
17	Check: After <i>prohibitPHR-Timer</i> after step 14, does the UE transmit a MAC PDU containing Multiple Entry PHR MAC CE containing Type 1 PH of NR SpCell and Scell? Note 3	-->	MAC PDU	3	P
18	SS adjusts cell levels according to row T4 of Table 7.1.1.3.8.1.3.2-0/0A.	-	-	-	-
19	Check: For 80% of <i>prohibitPHR-Timer</i> since step 17, does the UE transmit a MAC PDU containing Multiple Entry PHR MAC CE?	-->	MAC PDU	2	F
20	Check: After <i>prohibitPHR-Timer</i> after step 17, does the UE transmit a MAC PDU containing Multiple Entry PHR MAC CE containing Type 1 PH of NR SpCell and Scell? Note 3	-->	MAC PDU	3	P
21	The SS transmits an NR <i>RRCReconfiguration</i> message to disable Power Headroom reporting.(Note 1)	<--	(<i>RRCReconfiguration</i>)	-	-
22	The UE transmits an NR <i>RRCReconfigurationComplete</i> message to confirm the disabling of Power Headroom parameters.(Note 3)	-->	(<i>RRCReconfigurationComplete</i>)	-	-
Note 1: For EN-DC the NR <i>RRCReconfiguration</i> message is contained in <i>RRCConnectionReconfiguration</i> .					
Note 2: For EN-DC the NR <i>RRCReconfigurationComplete</i> message is contained in <i>RRCConnectionReconfigurationComplete</i> .					
Note 3: For EN-DC the Type 1 PHR report for EUTRA Pcell is also included.					

Table 7.1.1.3.8.1.3.2-2: Parallel behaviour

St	Procedure	Message Sequence		TP	Verdict
		U - S	Message		
1	The UE transmits a MAC PDU containing Multiple Entry PHR MAC CE containing Type 1 PH of NR SpCell.	-->	MAC PDU	-	-

7.1.1.3.8.1.3.3 Specific message contents

Table 7.1.1.3.8.1.3.3-1: *RRCReconfiguration* (step 1, Table 7.1.1.3.8.1.3.2-1)

Derivation Path: TS 38.508-1 [4], Table 4.6.1-13.			
Information Element	Value/remark	Comment	Condition
<i>RRCReconfiguration</i> ::= SEQUENCE {			
criticalExtensions CHOICE {			
c1 CHOICE {			
rrcReconfiguration ::= SEQUENCE {			
secondaryCellGroup	CellGroupConfig	OCTET STRING (CONTAINING CellGroupConfig)	EN-DC
nonCriticalExtension SEQUENCE {			NR
masterCellGroup	CellGroupConfig	OCTET STRING (CONTAINING CellGroupConfig)	
}			
}			
}			
}			
}			

Table 7.1.1.3.8.1.3.3-2: CellGroupConfig (Table 7.1.1.3.8.1.3.3-1)

Derivation Path: TS 38.508-1 [4], Table 4.6.3-19.			
Information Element	Value/remark	Comment	Condition
CellGroupConfig ::= SEQUENCE {			
sCellToAddModList SEQUENCE (SIZE (1..maxMeasId)) OF SCellConfig {	1 entry		
SCellConfig[1] SEQUENCE {		entry 1	
sCellIndex	SCellIndex as per TS 38.508-1 [4] table 4.6.3-154		
sCellConfigCommon	ServingCellConfigCommon		
sCellConfigDedicated	ServingCellConfig		
}			
}			
}			

Table 7.1.1.3.8.1.3.3-3: ServingCellConfigCommon (Table 7.1.1.3.8.1.3.3-2)

Derivation Path: TS 38.508-1 [4], Table 4.6.3-168.			
Information Element	Value/remark	Comment	Condition
ServingCellConfigCommon ::= SEQUENCE {			
physCellId	Physical Cell Identity of NR Cell 3		
}			

Table 7.1.1.3.8.1.3.3-3A: Void**Table 7.1.1.3.8.1.3.3-4: RRCReconfiguration (Step 4, Table 7.1.1.3.8.1.3.2-1)**

Derivation Path: 38.508-1 [4], Table 4.6.1-13			
Information Element	Value/remark	Comment	Condition
RRCReconfiguration ::= SEQUENCE {			
criticalExtensions CHOICE {			
rrcReconfiguration SEQUENCE {			
secondaryCellGroup	CellGroupConfig	OCTET STRING (CONTAINING CellGroupConfig)	EN-DC
nonCriticalExtension SEQUENCE {			NR
masterCellGroup	CellGroupConfig	OCTET STRING (CONTAINING CellGroupConfig)	
}			
}			
}			
}			

Table 7.1.1.3.8.1.3.3-5: CellGroupConfig (Table 7.1.1.3.8.1.3.3-4)

Derivation Path: 38.508-1 [4], Table 4.6.3-19			
Information Element	Value/remark	Comment	Condition
CellGroupConfig ::= SEQUENCE {			
cellGroupId	CellGroupId as per TS 38.508-1 [4] table 4.6.3-20		
mac-CellGroupConfig SEQUENCE {			
phr-Config CHOICE {			
setup SEQUENCE {			
phr-PeriodicTimer	infinity		
phr-ProhibitTimer	sf1000		
phr-Tx-PowerFactorChange	3db		
}			
}			

multiplePHR	true		
dummy	true		
phr-Type2OtherCell	false		
phr-ModeOtherCG	real		
}			
}			
}			

Table 7.1.1.3.8.1.3.3-6: ServingCellConfig (Table 7.1.1.3.8.1.3.3-2)

Derivation Path: TS 38.508-1 [4], Table 4.6.3-167.			
Information Element	Value/remark	Comment	Condition
ServingCellConfig ::= SEQUENCE {			
uplinkConfig SEQUENCE {			
initialUplinkBWP	BWP-UplinkDedicated		
}			
}			

Table 7.1.1.3.8.1.3.3-7: BWP-UplinkDedicated (Table 7.1.1.3.8.1.3.3-6)

Derivation Path: TS 38.508-1 [4], Table 4.6.3-15			
Information Element	Value/remark	Comment	Condition
BWP-UplinkDedicated ::= SEQUENCE {			
pucch-Config	Not present		
}			

Table 7.1.1.3.8.1.3.3-8: ServingCellConfigCommon (Table 7.1.1.3.8.1.3.3-2)

Derivation Path: TS 38.508-1 [4], Table 4.6.3-168.			
Information Element	Value/remark	Comment	Condition
ServingCellConfigCommon ::= SEQUENCE {			
physCellId	Physical Cell Identity of NR Cell 3		
uplinkConfigCommon	UplinkConfigCommon		
}			

Table 7.1.1.3.8.1.3.3-9: UplinkConfigCommon (Table 7.1.1.3.8.1.3.3-8)

Derivation Path: TS 38.331 [6], clause 6.3.2			
Information Element	Value/remark	Comment	Condition
UplinkConfigCommon ::= SEQUENCE {			
initialUplinkBWP	BWP-UplinkCommon		
}			

Table 7.1.1.3.8.1.3.3-10: BWP-UplinkCommon (Table 7.1.1.3.8.1.3.3-9)

Derivation Path: TS 38.331 [6], clause 6.3.2			
Information Element	Value/remark	Comment	Condition
BWP-UplinkCommon ::= SEQUENCE {			
pucch-ConfigCommon	Not present		
}			

7.1.1.3.8.2 UE power headroom reporting / SCell activation / DL pathloss change reporting / Inter-band CA

The scope and description of the present TC is the same as test case 7.1.1.3.8.1 with the following differences:

- CA configuration: Inter-band CA replaces Intra-band Contiguous CA
- Cells configuration: NR Cell 10 replaces NR Cell 3

7.1.1.3.8.3 UE power headroom reporting / SCell activation / DL pathloss change reporting / Intra-band non-Contiguous CA

The scope and description of the present TC is the same as test case 7.1.1.3.8.1 with the following differences:

- CA configuration: Intra-band non-Contiguous CA replaces Intra-band Contiguous CA.

7.1.1.3.9 Correct Handling of UL HARQ process / PUSCH Repetition Type A / PUSCH Aggregation

7.1.1.3.9.1 Test Purpose (TP)

(1)

```
with { UE in RRC_CONNECTED state and PUSCH Aggregation > 1 }
ensure that {
  when { UE receives an UL Grant with toggled NDI and has data available for transmission }
  then { UE transmits a new MAC PDU and repeats the MAC PDU pusch-AggregationFactor-1 times after
first transmission and selects the redundancy version correctly }
}
```

7.1.1.3.9.2 Conformance requirements

References: The conformance requirements covered in the present TC are specified in: TS 38.214 clauses 6.1.2.1 and 6.1.4, TS 38.321 clauses 5.4.1, 5.4.2.1 and 5.4.2.2. Unless otherwise stated these are Rel-15 requirements.

[TS 38.214, clause 6.1.2.1]

When the UE is scheduled to transmit a transport block and no CSI report, or the UE is scheduled to transmit a transport block and a CSI report on PUSCH by a DCI, the *Time domain resource assignment* field value m of the DCI provides a row index $m + 1$ to an allocated table. The determination of the used resource allocation table is defined in sub-clause 6.1.2.1.1. The indexed row defines the slot offset K_2 , the start and length indicator *SLIV*, or directly the start symbol S and the allocation length L , and the PUSCH mapping type to be applied in the PUSCH transmission.

When the UE is scheduled to transmit a PUSCH with no transport block and with a CSI report by a *CSI request* field on a DCI, the *Time-domain resource assignment* field value m of the DCI provides a row index $m + 1$ to an allocated table. The determination of the applied resource allocation table is defined in sub-clause 6.1.2.1.1. The indexed row defines the start and length indicator *SLIV*, or directly the start symbol S and the allocation length L , and the PUSCH mapping type to be applied in the PUSCH transmission and K_2 is determined based on the corresponding list entries $Y_j, j = 0, \dots, N_{\text{Rep}} - 1$ of the higher layer parameter *reportSlotConfig* in *CSI-ReportConfig* for the N_{Rep} triggered CSI Reporting Settings. The i th codepoint of K_2 is determined as $K_2 = \max_j Y_j(i)$ where $Y_j(i)$ is the i th codepoint of Y_j .

- The slot where the UE shall transmit the PUSCH is determined by K_2 as $\left\lceil n \cdot \frac{2^{\mu_{\text{PUSCH}}}}{2^{\mu_{\text{PDCCH}}}} \right\rceil + K_2$ where n is the slot with the scheduling DCI, K_2 is based on the numerology of PUSCH, and μ_{PUSCH} and μ_{PDCCH} are the subcarrier spacing configurations for PUSCH and PDCCH, respectively, and
- The starting symbol S relative to the start of the slot, and the number of consecutive symbols L counting from the symbol S allocated for the PUSCH are determined from the start and length indicator *SLIV* of the indexed row:

if $(L-1) \leq 7$ then

$$SLIV = 14 \cdot (L-1) + S$$

else

$$SLIV = 14 \cdot (14 - L + 1) + (14 - 1 - S)$$

where $0 < L \leq 14 - S$, and

- The PUSCH mapping type is set to Type A or Type B as defined in Subclause 6.4.1.1.3 of [4, TS 38.211] as given by the indexed row.

The UE shall consider the S and L combinations defined in table 6.1.2.1-1 as valid PUSCH allocations

Table 6.1.2.1-1: Valid S and L combinations

PUSCH mapping type	Normal cyclic prefix			Extended cyclic prefix		
	S	L	$S+L$	S	L	$S+L$
Type A	0	{4,...,14}	{4,...,14}	0	{4,...,12}	{4,...,12}
Type B	{0,...,13}	{1,...,14}	{1,...,14}	{0,...,12}	{1,...,12}	{1,...,12}

When the UE is configured with $aggregationFactorUL > 1$, the same symbol allocation is applied across the $aggregationFactorUL$ consecutive slots and the PUSCH is limited to a single transmission layer. The UE shall repeat the TB across the $aggregationFactorUL$ consecutive slots applying the same symbol allocation in each slot. The redundancy version to be applied on the n^{th} transmission occasion of the TB is determined according to table 6.1.2.1-2.

Table 6.1.2.1-2: Redundancy version when $aggregationFactorUL > 1$

r_{vid} indicated by the DCI scheduling the PUSCH	r_{vid} to be applied to n^{th} transmission occasion			
	$n \bmod 4 = 0$	$n \bmod 4 = 1$	$n \bmod 4 = 2$	$n \bmod 4 = 3$
0	0	2	3	1
2	2	3	1	0
3	3	1	0	2
1	1	0	2	3

If the UE procedure for determining slot configuration, as defined in subclause 11.1 of [6, TS 38.213], determines symbols of a slot allocated for PUSCH as downlink symbols, the transmission on that slot is omitted for multi-slot PUSCH transmission.

[TS 38.214, clause 6.1.4]

To determine the modulation order, target code rate, redundancy version and transport block size for the physical uplink shared channel, the UE shall first

- read the 5-bit modulation and coding scheme field (I_{MCS}) in the DCI to determine the modulation order (O_m) and target code rate (R) based on the procedure defined in Subclause 6.1.4.1
- read redundancy version field (rv) in the DCI to determine the redundancy version, and
- [check the "CSI request" bit field]

and second

- the UE shall use the number of layers (ν), the total number of allocated PRBs (n_{PRB}) to determine the transport block size based on the procedure defined in Subclause 6.1.4.2.

[TS 38.321, clause 5.4.1]

Uplink grant is either received dynamically on the PDCCH, in a Random Access Response, or configured semi-persistently by RRC. The MAC entity shall have an uplink grant to transmit on the UL-SCH. To perform the requested transmissions, the MAC layer receives HARQ information from lower layers.

If the MAC entity has a C-RNTI, a Temporary C-RNTI, or CS-RNTI, the MAC entity shall for each PDCCH occasion and for each Serving Cell belonging to a TAG that has a running *timeAlignmentTimer* and for each grant received for this PDCCH occasion:

- 1> if an uplink grant for this Serving Cell has been received on the PDCCH for the MAC entity's C-RNTI or Temporary C-RNTI; or
- 1> if an uplink grant has been received in a Random Access Response:
 - 2> if the uplink grant is for MAC entity's C-RNTI and if the previous uplink grant delivered to the HARQ entity for the same HARQ process was either an uplink grant received for the MAC entity's CS-RNTI or a configured uplink grant:
 - 3> consider the NDI to have been toggled for the corresponding HARQ process regardless of the value of the NDI.
 - 2> if the uplink grant is for MAC entity's C-RNTI, and the identified HARQ process is configured for a configured uplink grant:
 - 3> start or restart the *configuredGrantTimer* for the corresponding HARQ process, if configured.
 - 2> deliver the uplink grant and the associated HARQ information to the HARQ entity.
- 1> else if an uplink grant for this PDCCH occasion has been received for this Serving Cell on the PDCCH for the MAC entity's CS-RNTI:
 - 2> if the NDI in the received HARQ information is 1:
 - 3> consider the NDI for the corresponding HARQ process not to have been toggled;
 - 3> start or restart the *configuredGrantTimer* for the corresponding HARQ process, if configured;
 - 3> deliver the uplink grant and the associated HARQ information to the HARQ entity.
 - 2> else if the NDI in the received HARQ information is 0:
 - 3> if PDCCH contents indicate configured grant Type 2 deactivation:
 - 4> trigger configured uplink grant confirmation.
 - 3> else if PDCCH contents indicate configured grant Type 2 activation:
 - 4> trigger configured uplink grant confirmation;
 - 4> store the uplink grant for this Serving Cell and the associated HARQ information as configured uplink grant;
 - 4> initialise or re-initialise the configured uplink grant for this Serving Cell to start in the associated PUSCH duration and to recur according to rules in subclause 5.8.2;
 - 4> set the HARQ Process ID to the HARQ Process ID associated with this PUSCH duration;
 - 4> consider the NDI bit for the corresponding HARQ process to have been toggled;
 - 4> stop the *configuredGrantTimer* for the corresponding HARQ process, if running;
 - 4> deliver the configured uplink grant and the associated HARQ information to the HARQ entity.

For each Serving Cell and each configured uplink grant, if configured and activated, the MAC entity shall:

- 1> if the PUSCH duration of the configured uplink grant does not overlap with the PUSCH duration of an uplink grant received on the PDCCH for this Serving Cell:
 - 2> set the HARQ Process ID to the HARQ Process ID associated with this PUSCH duration;
- 2> if the *configuredGrantTimer* for the corresponding HARQ process is not running:
 - 3> consider the NDI bit for the corresponding HARQ process to have been toggled;
 - 3> deliver the configured uplink grant and the associated HARQ information to the HARQ entity.

For configured uplink grants, the HARQ Process ID associated with the first symbol of a UL transmission is derived from the following equation:

$$\text{HARQ Process ID} = [\text{floor}(\text{CURRENT_symbol}/\text{periodicity})] \text{ modulo } n\text{rofHARQ-Processes}$$

where $\text{CURRENT_symbol} = (\text{SFN} \times \text{numberOfSlotsPerFrame} \times \text{numberOfSymbolsPerSlot} + \text{slot number in the frame} \times \text{numberOfSymbolsPerSlot} + \text{symbol number in the slot})$, and $\text{numberOfSlotsPerFrame}$ and $\text{numberOfSymbolsPerSlot}$ refer to the number of consecutive slots per frame and the number of consecutive symbols per slot, respectively as specified in TS 38.211 [8].

NOTE 1: CURRENT_symbol refers to the symbol index of the first transmission occasion of a repetition bundle that takes place.

NOTE 2: A HARQ process is configured for a configured uplink grant if the configured uplink grant is activated and the associated HARQ process ID is less than $n\text{rofHARQ-Processes}$.

[TS 38.321, clause 5.4.2.1]

The MAC entity includes a HARQ entity for each Serving Cell with configured uplink (including the case when it is configured with *supplementaryUplink*), which maintains a number of parallel HARQ processes.

The number of parallel UL HARQ processes per HARQ entity is specified in TS 38.214 [7].

Each HARQ process supports one TB.

Each HARQ process is associated with a HARQ process identifier. For UL transmission with UL grant in RA Response, HARQ process identifier 0 is used.

When the MAC entity is configured with $\text{pusch-AggregationFactor} > 1$, the parameter $\text{pusch-AggregationFactor}$ provides the number of transmissions of a TB within a bundle of the dynamic grant. After the initial transmission, $\text{pusch-AggregationFactor} - 1$ HARQ retransmissions follow within a bundle. When the MAC entity is configured with $\text{repK} > 1$, the parameter repK provides the number of transmissions of a TB within a bundle of the configured uplink grant. After the initial transmission, HARQ retransmissions follow within a bundle. For both dynamic grant and configured uplink grant, bundling operation relies on the HARQ entity for invoking the same HARQ process for each transmission that is part of the same bundle. Within a bundle, HARQ retransmissions are triggered without waiting for feedback from previous transmission according to $\text{pusch-AggregationFactor}$ for a dynamic grant and repK for a configured uplink grant, respectively. Each transmission within a bundle is a separate uplink grant after the initial uplink grant within a bundle is delivered to the HARQ entity.

For each transmission within a bundle of the dynamic grant, the sequence of redundancy versions is determined according to subclause 6.1.4 of TS 38.214 [7]. For each transmission within a bundle of the configured uplink grant, the sequence of redundancy versions is determined according to subclause 6.1.2.3 of TS 38.214 [7].

For each uplink grant, the HARQ entity shall:

- 1> identify the HARQ process associated with this grant, and for each identified HARQ process:
 - 2> if the received grant was not addressed to a Temporary C-RNTI on PDCCH, and the NDI provided in the associated HARQ information has been toggled compared to the value in the previous transmission of this TB of this HARQ process; or
 - 2> if the uplink grant was received on PDCCH for the C-RNTI and the HARQ buffer of the identified process is empty; or
 - 2> if the uplink grant was received in a Random Access Response; or
 - 2> if the uplink grant is part of a bundle of the configured uplink grant, and may be used for initial transmission according to subclause 6.1.2.3 of TS 38.214 [7], and if no MAC PDU has been obtained for this bundle:
 - 3> if there is a MAC PDU in the Msg3 buffer and the uplink grant was received in a Random Access Response:
 - 4> obtain the MAC PDU to transmit from the Msg3 buffer.
 - 3> else:

- 4> obtain the MAC PDU to transmit from the Multiplexing and assembly entity, if any;
- 3> if a MAC PDU to transmit has been obtained:
 - 4> deliver the MAC PDU and the uplink grant and the HARQ information of the TB to the identified HARQ process;
 - 4> instruct the identified HARQ process to trigger a new transmission;
 - 4> if the uplink grant is addressed to CS-RNTI; or
 - 4> if the uplink grant is a configured uplink grant; or
 - 4> if the uplink grant is addressed to C-RNTI, and the identified HARQ process is configured for a configured uplink grant:
 - 5> start or restart the *configuredGrantTimer*, if configured, for the corresponding HARQ process when the transmission is performed.
- 3> else:
 - 4> flush the HARQ buffer of the identified HARQ process.
- 2> else (i.e. retransmission):
 - 3> if the uplink grant received on PDCCH was addressed to CS-RNTI and if the HARQ buffer of the identified process is empty; or
 - 3> if the uplink grant is part of a bundle and if no MAC PDU has been obtained for this bundle; or
 - 3> if the uplink grant is part of a bundle of the configured uplink grant, and the PUSCH of the uplink grant overlaps with a PUSCH of another uplink grant received on the PDCCH for this Serving Cell:
 - 4> ignore the uplink grant.
 - 3> else:
 - 4> deliver the uplink grant and the HARQ information (redundancy version) of the TB to the identified HARQ process;
 - 4> instruct the identified HARQ process to trigger a retransmission;
 - 4> if the uplink grant is addressed to CS-RNTI; or
 - 4> if the uplink grant is addressed to C-RNTI, and the identified HARQ process is configured for a configured uplink grant:
 - 5> start or restart the *configuredGrantTimer*, if configured, for the corresponding HARQ process when the transmission is performed.

When determining if NDI has been toggled compared to the value in the previous transmission the MAC entity shall ignore NDI received in all uplink grants on PDCCH for its Temporary C-RNTI.

[TS 38.321, clause 5.4.2.2]

Each HARQ process is associated with a HARQ buffer.

New transmissions are performed on the resource and with the MCS indicated on either PDCCH, Random Access Response, or RRC. Retransmissions are performed on the resource and, if provided, with the MCS indicated on PDCCH, or on the same resource and with the same MCS as was used for last made transmission attempt within a bundle.

If the HARQ entity requests a new transmission for a TB, the HARQ process shall:

- 1> store the MAC PDU in the associated HARQ buffer;
- 1> store the uplink grant received from the HARQ entity;

1> generate a transmission as described below.

If the HARQ entity requests a retransmission for a TB, the HARQ process shall:

1> store the uplink grant received from the HARQ entity;

1> generate a transmission as described below.

To generate a transmission for a TB, the HARQ process shall:

1> if the MAC PDU was obtained from the Msg3 buffer; or

1> if there is no measurement gap at the time of the transmission and, in case of retransmission, the retransmission does not collide with a transmission for a MAC PDU obtained from the Msg3 buffer:

2> instruct the physical layer to generate a transmission according to the stored uplink grant.

7.1.1.3.9.3 Test description

7.1.1.3.9.3.1 Pre-test conditions

Same Pre-test conditions as in clause 7.1.1.0 except that DRB is configured in RLC AM mode according to Table 7.1.1.3.9.3.1-1.

Table 7.1.1.3.9.3.1-1: RLC parameters

<i>t-PollRetransmit</i>	ms80
-------------------------	------

7.1.1.3.9.3.2 Test procedure sequence

Table 7.1.1.3.9.3.2-1: Main behaviour

St	Procedure	Message Sequence		TP	Verdict
		U - S	Message		
0A	SS transmits in the indicated downlink assignment an NR RRCReconfiguration. (Note 1)	<---	-	-	-
0B	UE transmits NR RRCReconfigurationComplete message to the SS. (Note 2)	-->	-	-	-
1	The SS transmits a valid MAC PDU containing one RLC PDU.	<---	MAC PDU	-	-
2	The UE transmits a Scheduling Request.	-->	(SR)	-	-
3	The SS allocates an UL Grant for HARQ process 1, sufficient for one RLC SDU to be looped back in a slot n, and NDI indicates new transmission and DCI scheduling the PUSCH indicates $rv^{ID} = 0$.	<--	UL Grant	-	-
4	Check: Does the UE transmit a MAC PDU including one RLC SDU, in HARQ process 1 and in slot n+4 and repeats in following pusch-AggregationFactor-1 slots with same resource allocation but different redundancy version (Note 3), if the slot can be used for uplink transmission (Note 4)	-->	MAC PDU	1	P
5	SS transmits a MAC PDU containing an RLC STATUS PDU acknowledging the reception of the AMD PDU in step 4.	<--	MAC PDU (RLC STATUS PDU)	-	-

Note 1: For EN-DC the NR RRCReconfiguration message is contained in RRCConnectionReconfiguration 36.508 [7], Table 4.6.1-8 using condition EN-DC_EmbedNR_RRCRecon.

Note 2: For EN-DC the NR RRCReconfigurationComplete message is contained in RRCConnectionReconfigurationComplete.

Note 3: The redundancy version for the first transmission and all possible repetitions are set in the following order {0, 2, 3, 1} according to TS 38.214 [15] Table 6.1.2.1-2, first row.

Note 4: Usage of correct redundancy version is implicitly checked upon correct decoding by the SS of the UE UL

repetitions.

7.1.1.3.9.3.3 Specific message contents

Table 7.1.1.3.9.3.3-0A: RRCReconfiguration (step 0A, Table 7.1.1.3.9.3.2-1)

Derivation Path: 38.508-1 [4], Table 4.6.1-13			
Information Element	Value/remark	Comment	Condition
RRCReconfiguration ::= SEQUENCE {			
criticalExtensions CHOICE {			
rrcReconfiguration SEQUENCE {			
secondaryCellGroup	CellGroupConfig	OCTET STRING (CONTAINING CellGroupConfig)	EN-DC
}			
RRCReconfiguration-v1530-IEs ::= SEQUENCE {			NR
masterCellGroup	CellGroupConfig		
}			
}			
}			

Table 7.1.1.3.9.3.3-0B: CellGroupConfig (Table 7.1.1.3.9.3.3-0A: RRCReconfiguration)

Derivation Path: 38.508-1 [4], Table 4.6.3-19			
Information Element	Value/remark	Comment	Condition
cellGroupConfig ::= SEQUENCE {			
cellGroupId	0		
	1		EN-DC
spCellConfig SEQUENCE {			
spCellConfigDedicated SEQUENCE {			
servingCellConfig	ServingCellConfig		
}			
}			
}			

Table 7.1.1.3.9.3.3-1: ServingCellConfig (Table 7.1.1.3.9.3.3-0B: CellGroupConfig)

Derivation Path: TS 38.508-1 [4], Table 4.6.3-167			
Information Element	Value/remark	Comment	Condition
ServingCellConfig ::= SEQUENCE {			
uplinkConfig SEQUENCE {			
initialUplinkBWP	BWP-UplinkDedicated		
}			
}			

Table 7.1.1.3.9.3.3-2: BWP-UplinkDedicated (Table 7.1.1.3.9.3.3-1)

Derivation Path: TS 38.508-1 [4], Table 4.6.3-11			
Information Element	Value/remark	Comment	Condition
BWP-UplinkDedicated ::= SEQUENCE {			
pusch-Config CHOICE {	Not present		
Setup	PUSCH-Config		
}			
}			

Table 7.1.1.3.9.3.3-3: PUSCH-Config (Table 7.1.1.3.9.3.3-2)

Derivation Path: TS 38.508-1 [4], Table 4.6.3-118			
Information Element	Value/remark	Comment	Condition

PUSCH-Config ::= SEQUENCE {			
pusch-AggregationFactor	n4		
	n8		(TDD AND SCS15) OR FR2
}			

7.1.1.3.10 Correct Handling of HARQ process / Multiple CORESETPoolIndex

7.1.1.3.10.1. Test Purpose (TP)

(1)

```
with { UE in RRC_CONNECTED state and is configured with PDCCH-Config that contains two different values of CORESETPoolIndex in ControlResourceSet }
ensure that {
  when { UE receives PDCCHs that schedule two non-overlapping in time domain PUSCHs are associated to different ControlResourceSets having different values of CORESETPoolIndex }
  then { UE sends PUSCHs following the scheduling information of PDCCHs }
}
```

(2)

```
with(UE in RRC_CONNECTED state and is configured with PDCCH-Config that contains two different values of CORESETPoolIndex in ControlResourceSet)
ensure that {
  when{ UE receives PDCCHs that schedule two overlapping in time domain PDSCHs are associated to different ControlResourceSets having different values of CORESETPoolIndex }
  then { UE Receives PDSCHs following the scheduling information of PDCCHs }
}
```

7.1.1.3.10.2 Conformance requirements

References: The conformance requirements covered in the present TC are specified in: TS 38.214, clauses 5.18.10 and 6.1.20. Unless otherwise stated these are Rel-16 requirements.

[TS 38.214, clause 5.11]

If a UE is configured by higher layer parameter *PDCCH-Config* that contains two different values of *CORESETPoolIndex* in *ControlResourceSet*, the UE may expect to receive multiple PDCCHs scheduling fully/partially/non-overlapped PDSCHs in time and frequency domain. The UE may expect the reception of full/partially-overlapped PDSCHs in time only when PDCCHs that schedule two PDSCHs are associated to different *ControlResourceSets* having different values of *CORESETPoolIndex*. For a *ControlResourceSet* without *CORESETPoolIndex*, the UE may assume that the *ControlResourceSet* is assigned with *CORESETPoolIndex* as 0. When the UE is scheduled with full/partially/non-overlapped PDSCHs in time and frequency domain, the full scheduling information for receiving a PDSCH is indicated and carried only by the corresponding PDCCH, the UE is expected to be scheduled with the same active BWP and the same SCS. When the UE is scheduled with full/partially-overlapped PDSCHs in time and frequency domain, the UE can be scheduled with at most two codewords simultaneously. When PDCCHs that schedule two PDSCHs are associated to different *ControlResourceSets* having different values of *CORESETPoolIndex*, the following operations are allowed:

- For any two HARQ process IDs in a given scheduled cell, if the UE is scheduled to start receiving a first PDSCH starting in symbol j by a PDCCH associated with a value of *CORESETPoolIndex* ending in symbol i , the UE can be scheduled to receive a PDSCH starting earlier than the end of the first PDSCH with a PDCCH associated with a different value of *CORESETPoolIndex* that ends later than symbol i .
- In a given scheduled cell, the UE can receive a first PDSCH in slot i , with the corresponding HARQ-ACK assigned to be transmitted in slot j , and a second PDSCH associated with a value of *CORESETPoolIndex* different from that of the first PDSCH starting later than the first PDSCH with its corresponding HARQ-ACK assigned to be transmitted in a slot before slot j .

If PDCCHs that schedule corresponding PDSCHs are associated to the same or different *ControlResourceSets* having the same value of *CORESETPoolIndex*, the UE procedure for receiving the PDSCH upon detection of a PDCCH follows Clause 5.1.

[TS 38.214, clause 6.1]

If a UE is configured by higher layer parameter *PDCCH-Config* that contains two different values of *CORESETPoolIndex* in *ControlResourceSet* for the active BWP of a serving cell and PDCCHs that schedule two non-overlapping in time domain PUSCHs are associated to different *ControlResourceSets* having different values of *CORESETPoolIndex*, for any two HARQ process IDs in a given scheduled cell, if the UE is scheduled to start a first PUSCH transmission starting in symbol *j* by a PDCCH associated with a value of *CORESETPoolIndex* ending in symbol *i*, the UE can be scheduled to transmit a PUSCH starting earlier than the end of the first PUSCH by a PDCCH associated with a different value of *CORESETPoolIndex* that ends later than symbol *i*.

7.1.1.3.10.3 Test description

7.1.1.3.10.3.1 Pre-test conditions

Same Pre-test conditions as in clause 7.1.1.0.

7.1.1.3.10.3.2 Test procedure sequence

Table 7.1.1.3.10.3.2-2: Main behaviour

St	Procedure	Message Sequence		TP	Verdict
		U - S	Message		
1	SS transmits NR <i>RRCReconfiguration</i> message to configure two different values of <i>CORESETPoolIndex</i> in <i>ControlResourceSet</i> , (Note1)	<--	-	-	-
2	The UE transmit NR <i>RRCReconfigurationComplete</i> messages (Note 2)	-->	-	-	-
3	The SS transmits 2 MAC PDU's on overlapping PDSCH's scheduled by two different values of <i>CORESETPoolIndex</i> in <i>ControlResourceSet</i>	<--	MAC PDU 1, MAC PDU 2	-	-
4	100 ms after step 4, the SS transmits a two UL grants scheduling two non-overlapping in time domain PUSCHs associated to different <i>ControlResourceSets</i> having different values of <i>CORESETPoolIndex</i>	<--	(UL Grant 1, UL Grant 2)	-	-
5	Check: The UE transmits 2 MAC PDU's loop backed PDU's from step 4	-->	MAC PDU 1, MAC PDU 2	1,2	P
Note 1: For EN-DC the NR <i>RRCReconfiguration</i> message is contained in <i>RRCConnectionReconfiguration</i> 36.508 [7], Table 4.6.1-8 using condition EN-DC_EmbedNR_RRCRecon.					
Note 2: For EN-DC the NR <i>RRCReconfigurationComplete</i> message is contained in <i>RRCConnectionReconfigurationComplete</i> .					

7.1.1.3.10.3.3 Specific message contents

Table 7.1.1.3.10.3.3-1: PDCCH-Config (Preamble)

Derivation Path: TS 38.508-1 [4], Table 4.6.3-95			
Information Element	Value/remark	Comment	Condition
PDCCH-Config ::= SEQUENCE {			
controlResourceSetToAddModList	2 entries		
SEQUENCE (SIZE (1..3)) OF			
ControlResourceSet {			
ControlResourceSet[1]	ControlResourceSetid1	entry 1	
ControlResourceSet[2]	ControlResourceSetid2	entry 2	
}			
}			

Table 7.1.1.3.10.3.3-2: ControlResourceSetId1 (Table 7.1.1.3.10.3.3-1: PDCCH-Config)

Derivation Path: TS 38.508-1 [4], Table 4.6.3-28			
Information Element	Value/remark	Comment	Condition
ControlResourceSet ::= SEQUENCE {			
controlResourceSetId	1		
coresetPoolIndex-r16	0		
}			

Table 7.1.1.3.10.3.3-3: ControlResourceSetId2 (Table 7.1.1.3.10.3.3-1: PDCCH-Config)

Derivation Path: TS 38.508-1 [4], Table 4.6.3-28			
Information Element	Value/remark	Comment	Condition
ControlResourceSet ::= SEQUENCE {			
controlResourceSetId	2		
coresetPoolIndex-r16	1		
}			

7.1.1.3.11 Correct handling of UL grant prioritization

7.1.1.3.11.1 Test Purpose (TP)

(1)

```
with { UE in RRC_CONNECTED and configured with lch-basedPrioritization, and a resource conflict
happened when the UE is sending data based on a UL grant which is addressed to CS-RNTI with NDI = 1
or C-RNTI }
ensure that {
  when { the data causes the resource conflict is based on a configured UL grant whose priority is
lower than or equal to the UL grant's }
    then { UE determines the UL grant to be prioritized and sends the corresponding MAC PDU.}
}
```

(2)

```
with { UE in RRC_CONNECTED and configured with lch-basedPrioritization, a resource conflict happened
when the UE is sending data based on a UL grant which is addressed to CS-RNTI with NDI = 1 or C-
RNTI, and UE determines the UL grant to be prioritized }
ensure that {
  when { UE sends out the MAC PDU associated with the prioritized grant }
    then { autonomously re-transmit the MAC PDU associated with the de-prioritized grant.}
}
```

7.1.1.3.11.2 Conformance requirements

References: The conformance requirements covered in the present TC are specified in: TS 38.321, clauses 5.4.1 and 5.4.2.1. Unless otherwise stated these are Rel-16 requirements.

[TS 38.321, clause 5.4.1]

...

For the MAC entity configured with *lch-basedPrioritization*, priority of an uplink grant is determined by the highest priority among priorities of the logical channels with data available that are multiplexed or can be multiplexed in the MAC PDU, according to the mapping restrictions as described in clause 5.4.3.1.2. The priority of an uplink grant for which no data for logical channels is multiplexed or can be multiplexed in the MAC PDU is lower than either the priority of an uplink grant for which data for any logical channels is multiplexed or can be multiplexed in the MAC PDU or the priority of the logical channel triggering an SR.

If the corresponding PUSCH transmission of a configured uplink grant is cancelled by CI-RNTI as specified in clause 11.2A of TS 38.213 [6] or cancelled by a high PHY-priority PUCCH transmission as specified in clause 9 of TS 38.213 [6], this uplink grant is considered as a de-prioritized uplink grant.

When the MAC entity is configured with *lch-basedPrioritization*, for each uplink grant whose associated PUSCH can be transmitted by lower layers, the MAC entity shall:

- 1> if this uplink grant is addressed to CS-RNTI with NDI = 1 or C-RNTI:
 - 2> if there is no overlapping PUSCH duration of a configured uplink grant which was not already de-prioritized, in the same BWP whose priority is higher than the priority of the uplink grant; and
 - 2> if there is no overlapping PUCCH resource with an SR transmission which was not already de-prioritized and the priority of the logical channel that triggered the SR is higher than the priority of the uplink grant:
 - 3> consider this uplink grant as a prioritized uplink grant;
 - 3> consider the other overlapping uplink grant(s), if any, as a de-prioritized uplink grant(s);
 - 3> consider the other overlapping SR transmission(s), if any, as a de-prioritized SR transmission(s).
- 1> else if this uplink grant is a configured uplink grant:
 - 2> if there is no overlapping PUSCH duration of another configured uplink grant which was not already de-prioritized, in the same BWP, whose priority is higher than the priority of the uplink grant; and
 - 2> if there is no overlapping PUSCH duration of an uplink grant addressed to CS-RNTI with NDI = 1 or C-RNTI which was not already de-prioritized, in the same BWP, whose priority is higher than or equal to the priority of the uplink grant; and
 - 2> if there is no overlapping PUCCH resource with an SR transmission which was not already de-prioritized and the priority of the logical channel that triggered the SR is higher than the priority of the uplink grant:
 - 3> consider this uplink grant as a prioritized uplink grant;
 - 3> consider the other overlapping uplink grant(s), if any, as a de-prioritized uplink grant(s);
 - 3> consider the other overlapping SR transmission(s), if any, as a de-prioritized SR transmission(s).

NOTE 6: If the MAC entity is configured with *lch-basedPrioritization* and if there is overlapping PUSCH duration of at least two configured uplink grants whose priorities are equal, the prioritized uplink grant is determined by UE implementation.

NOTE 7: If the MAC entity is not configured with *lch-basedPrioritization* and if there is overlapping PUSCH duration of at least two configured uplink grants, it is up to UE implementation to choose one of the configured uplink grants.

[TS 38.321, clause 5.4.2.1]

The MAC entity includes a HARQ entity for each Serving Cell with configured uplink (including the case when it is configured with *supplementaryUplink*), which maintains a number of parallel HARQ processes.

The number of parallel UL HARQ processes per HARQ entity is specified in TS 38.214 [7].

Each HARQ process supports one TB.

Each HARQ process is associated with a HARQ process identifier. For UL transmission with UL grant in RA Response or for UL transmission for MSGA payload, HARQ process identifier 0 is used.

NOTE: When a single DCI is used to schedule multiple PUSCH, the UE is allowed to map generated TB(s) internally to different HARQ processes in case of LBT failure(s), i.e. UE may transmit a new TB on any HARQ process in the grants that have the same TBS, the same RV and the NDIs indicate new transmission.

The number of transmissions of a TB within a bundle of the dynamic grant or configured grant is given by *REPETITION_NUMBER* as follows:

- For a dynamic grant, *REPETITION_NUMBER* is set to a value provided by lower layers, as specified in clause 6.1.2.1 of TS 38.214 [7];

- For a configured grant, *REPETITION_NUMBER* is set to a value provided by lower layers, as specified in clause 6.1.2.3 of TS 38.214 [7].

If *REPETITION_NUMBER* > 1, after the first transmission within a bundle, *REPETITION_NUMBER* – 1 HARQ retransmissions follow within the bundle. For both dynamic grant and configured uplink grant, bundling operation relies on the HARQ entity for invoking the same HARQ process for each transmission that is part of the same bundle. Within a bundle, HARQ retransmissions are triggered without waiting for feedback from previous transmission according to *REPETITION_NUMBER* for a dynamic grant or configured uplink grant. Each transmission within a bundle is a separate uplink grant delivered to the HARQ entity.

For each transmission within a bundle of the dynamic grant, the sequence of redundancy versions is determined according to clause 6.1.2.1 of TS 38.214 [7]. For each transmission within a bundle of the configured uplink grant, the sequence of redundancy versions is determined according to clause 6.1.2.3 of TS 38.214 [7].

For each uplink grant, the HARQ entity shall:

- 1> identify the HARQ process associated with this grant, and for each identified HARQ process:
 - 2> if the received grant was not addressed to a Temporary C-RNTI on PDCCH, and the NDI provided in the associated HARQ information has been toggled compared to the value in the previous transmission of this TB of this HARQ process; or
 - 2> if the uplink grant was received on PDCCH for the C-RNTI and the HARQ buffer of the identified process is empty; or
 - 2> if the uplink grant was received in a Random Access Response (i.e. in a MAC RAR or a fallback RAR); or
 - 2> if the uplink grant was determined as specified in clause 5.1.2a for the transmission of the MSGA payload; or
 - 2> if the uplink grant was received on PDCCH for the C-RNTI in *ra-ResponseWindow* and this PDCCH successfully completed the Random Access procedure initiated for beam failure recovery; or
 - 2> if the uplink grant is part of a bundle of the configured uplink grant, and may be used for initial transmission according to clause 6.1.2.3 of TS 38.214 [7], and if no MAC PDU has been obtained for this bundle:
 - 3> if there is a MAC PDU in the MSGA buffer and the uplink grant determined as specified in clause 5.1.2a for the transmission of the MSGA payload was selected; or
 - 3> if there is a MAC PDU in the MSGA buffer and the uplink grant was received in a fallbackRAR and this fallbackRAR successfully completed the Random Access procedure:
 - 4> obtain the MAC PDU to transmit from the MSGA buffer.
 - 3> else if there is a MAC PDU in the Msg3 buffer and the uplink grant was received in a fallbackRAR:
 - 4> obtain the MAC PDU to transmit from the Msg3 buffer.
 - 3> else if there is a MAC PDU in the Msg3 buffer and the uplink grant was received in a MAC RAR; or:
 - 3> if there is a MAC PDU in the Msg3 buffer and the uplink grant was received on PDCCH for the C-RNTI in *ra-ResponseWindow* and this PDCCH successfully completed the Random Access procedure initiated for beam failure recovery:
 - 4> obtain the MAC PDU to transmit from the Msg3 buffer.
 - 4> if the uplink grant size does not match with size of the obtained MAC PDU; and
 - 4> if the Random Access procedure was successfully completed upon receiving the uplink grant:
 - 5> indicate to the Multiplexing and assembly entity to include MAC subPDU(s) carrying MAC SDU from the obtained MAC PDU in the subsequent uplink transmission;
 - 5> obtain the MAC PDU to transmit from the Multiplexing and assembly entity.
 - 3> else if this uplink grant is a configured grant configured with *autonomousTx*; and
 - 3> if the previous configured uplink grant, in the BWP, for this HARQ process was not prioritized; and

- 3> if a MAC PDU had already been obtained for this HARQ process; and
- 3> if the uplink grant size matches with size of the obtained MAC PDU; and
- 3> if a transmission of the obtained MAC PDU has not been performed:
 - 4> consider the MAC PDU has been obtained.
- 3> else if the MAC entity is not configured with *lch-basedPrioritization*; or
- 3> if this uplink grant is a prioritized uplink grant:
 - 4> obtain the MAC PDU to transmit from the Multiplexing and assembly entity, if any;
- 3> if a MAC PDU to transmit has been obtained:
 - 4> if the uplink grant is not a configured grant configured with *autonomousTx*; or
 - 4> if the uplink grant is a prioritized uplink grant:
 - 5> deliver the MAC PDU and the uplink grant and the HARQ information of the TB to the identified HARQ process;
 - 5> instruct the identified HARQ process to trigger a new transmission;
 - 5> if the uplink grant is a configured uplink grant:
 - 6> start or restart the *configuredGrantTimer*, if configured, for the corresponding HARQ process when the transmission is performed if LBT failure indication is not received from lower layers;
 - 6> start or restart the *cg-RetransmissionTimer*, if configured, for the corresponding HARQ process when the transmission is performed if LBT failure indication is not received from lower layers.
 - 5> if the uplink grant is addressed to C-RNTI, and the identified HARQ process is configured for a configured uplink grant:
 - 6> start or restart the *configuredGrantTimer*, if configured, for the corresponding HARQ process when the transmission is performed if LBT failure indication is not received from lower layers.
 - 5> if *cg-RetransmissionTimer* is configured for the identified HARQ process; and
 - 5> if the transmission is performed and LBT failure indication is received from lower layers:
 - 6> consider the identified HARQ process as pending.
- 3> else:
 - 4> flush the HARQ buffer of the identified HARQ process.
- 2> else (i.e. retransmission):
 - 3> if the uplink grant received on PDCCH was addressed to CS-RNTI and if the HARQ buffer of the identified process is empty; or
 - 3> if the uplink grant is part of a bundle and if no MAC PDU has been obtained for this bundle; or
 - 3> if the uplink grant is part of a bundle of the configured uplink grant, and the PUSCH duration of the uplink grant overlaps with a PUSCH duration of another uplink grant received on the PDCCH or an uplink grant received in a Random Access Response (i.e. MAC RAR or fallbackRAR) or an uplink grant determined as specified in clause 5.1.2a for MSGA payload for this Serving Cell; or
 - 3> if the MAC entity is configured with *lch-basedPrioritization* and this uplink grant is not a prioritized uplink grant:
 - 4> ignore the uplink grant.
- 3> else:

- 4> deliver the uplink grant and the HARQ information (redundancy version) of the TB to the identified HARQ process;
- 4> instruct the identified HARQ process to trigger a retransmission;
- 4> if the uplink grant is addressed to CS-RNTI; or
- 4> if the uplink grant is addressed to C-RNTI, and the identified HARQ process is configured for a configured uplink grant:
 - 5> start or restart the *configuredGrantTimer*, if configured, for the corresponding HARQ process when the transmission is performed if LBT failure indication is not received from lower layers.
- 4> if the uplink grant is a configured uplink grant:
 - 5> if the identified HARQ process is pending:
 - 6> start or restart the *configuredGrantTimer*, if configured, for the corresponding HARQ process when the transmission is performed if LBT failure indication is not received from lower layers;
 - 5> start or restart the *cg-RetransmissionTimer*, if configured, for the corresponding HARQ process when the transmission is performed if LBT failure indication is not received from lower layers.
- 4> if the identified HARQ process is pending and the transmission is performed and LBT failure indication is not received from lower layers:
 - 5> consider the identified HARQ process as not pending.

When determining if NDI has been toggled compared to the value in the previous transmission the MAC entity shall ignore NDI received in all uplink grants on PDCCH for its Temporary C-RNTI.

When *configuredGrantTimer* or *cg-RetransmissionTimer* is started or restarted by a PUSCH transmission, it shall be started at the beginning of the first symbol of the PUSCH transmission.

7.1.1.3.11.3 Test description

7.1.1.3.11.3.1 Pre-test conditions

Same Pre-test conditions as in clause 7.1.1.0 except that the UM DRB is configured and the logical channels are configured according to 7.1.1.3.11.3.1-1.

Table 7.1.1.3.11.3.1-2: Logical Channel Configuration Settings

Parameter	DRB1	DRB2
LogicalChannelIdentity	LCH4(DRB-Identity +3)	LCH5(DRB-Identity +3)
Priority	6	7
logicalChannelGroup	2 (LCG ID#2)	1 (LCG ID#1)

7.1.1.3.11.3.2 Test procedure sequence

Table 7.1.1.3.11.3.2-1: Main behaviour

St	Procedure	Message Sequence		TP	Verdict
		U - S	Message		
1	SS transmits NR RRCReconfiguration message to configure type 2 configured uplink grant.	<--	RRCReconfiguration	-	-
2	The UE transmits NR RRCReconfigurationComplete.	-->	RRCReconfigurationComplete	-	-
3	The SS ignores scheduling requests and does not allocate any uplink grant.	-	-	-	-
4	SS transmits a MAC PDU including a RLC SDU-1 on LCH 4.	<--	MAC PDU (1 RLC SDU of 40 bytes on DRB)	-	-

5	The SS allocates an UL Grant (with size 384 bits that only sufficient for one RLC SDU to be looped back in a Slot) for one HARQ process X and NDI indicates new transmission redundancy version to be used as 0.	<--	(UL Grant (C-RNTI))	-	-
6	The UE transmit a MAC PDU including the RLC SDU-1, in HARQ process X.	-->	MAC PDU	-	-
7	SS transmits a MAC PDU including a RLC SDU-2 on LCH 5.	<--	MAC PDU (1 RLC SDU of 40 bytes on DRB)	-	-
8	SS transmits a configured UL Grant (with size 384 bits that only sufficient for one RLC SDU to be looped back in a Slot), on PDCCH with the CS-RNTI assigned to the UE, allowing the UE to return the RLC SDU-2 (as received in step 5) in Slot P.	<--	(UL Grant (CS-RNTI))	-	-
9	The SS transmits an UL grant corresponding to slot for HARQ process X, with NDI not toggled and redundancy version to be used as 1. (Note 3)	<--	(UL Grant (C-RNTI))	-	-
10	Check: Does the UE retransmit the MAC PDU including RLC SDU-1 in slot P?	-->	MAC PDU	1	P
11	Check: Does the UE transmit the MAC PDU including RLC SDU-2 after slot P?	-->	MAC PDU	2	P
12	The SS transmits a PDCCH [for UL configured grant type 2 explicit release] using UE's CS-RNTI in Symbol 'S' of slot 'p' with NDI=0. Where $(z+5x < p < z+6x)$.	<--	PDCCH [for UL configured grant type 2 explicit release]	-	-
Note 1: Void. Note 2: Void. Note 3: The UL grant slot is equal to the configured slot in step 8.					

7.1.1.3.11.3.3 Specific message contents

Table 7.1.1.3.11.3.3-1: RRCReconfiguration (step 1, Table 7.1.1.3.11.3.2-1)

Derivation path: 38.508-1 [4], Table 4.6.1-13			
Information Element	Value/remark	Comment	Condition
RRCReconfiguration ::= SEQUENCE {			
criticalExtensions CHOICE {			
rrcReconfiguration SEQUENCE {			
nonCriticalExtension := SEQUENCE{			NR
masterCellGroup	CellGroupConfig	OCTET STRING (CONTAINING CellGroupConfig)	
}			
}			
}			
}			

Table 7.1.1.3.11.3.3-2: CellGroupConfig (Table 7.1.1.3.11.3.3-1)

Derivation path: 38.508-1 [4], Table 4.6.3-19			
Information Element	Value/remark	Comment	Condition
CellGroupConfig ::= SEQUENCE {			
mac-CellGroupConfig	MAC-CellGroupConfig	Table 7.1.1.3.11.3.3-3	
physicalCellGroupConfig	PhysicalCellGroupConfig	Table 7.1.1.3.11.3.3-4	
spCellConfig SEQUENCE{			
spCellConfigDedicated SEQUENCE{			
uplinkConfig SEQUENCE {			
initialUplinkBWP SEQUENCE {			
pucch-Config CHOICE {			
setup SEQUENCE {			

schedulingRequestResourceToAddModList {			
schedulingRequestResourceId	1		
schedulingRequestID	0		
periodicityAndOffset CHOICE {			
sl20	10		
}			
}			
}			
configuredGrantConfig CHOICE {			
setup SEQUENCE {			
cg-DMRS-Configuration	DMRS-UplinkConfig	Reference TS 38.508-1 [4], Table 4.6.3-51	
uci-OnPUSCH CHOICE {			
setup SEQUENCE {			
semiStatic SEQUENCE {	BetaOffsets		
betaOffsetACK-Index1	9		
betaOffsetACK-Index2	9		
betaOffsetACK-Index3	9		
betaOffsetCSI-Part1-Index1	6		
betaOffsetCSI-Part1-Index2	6		
betaOffsetCSI-Part2-Index1	6		
betaOffsetCSI-Part2-Index2	6		
}			
}			
resourceAllocation	ResourceAllocationType 1		
powerControlLoopToUse	n0		
p0-PUSCH-Alpha	1		
nrofHARQ-Processes	16		
repK	n1		
periodicity	Sym80x14		15kHz
periodicity	Sym160x14		30kHz
periodicity	Sym320x14		60kHz
periodicity	Sym640x14		120kHz
autonomousTx-r16	enabled		
}			
}			
pusch-Config CHOICE {			
setup SEQUENCE {			
PUSCH-TimeDomainResourceAllocationList SEQUENCE {			
k2	n8		FR1 and FR2
mappingType	typeB		
startSymbolAndLength	0011011		FR1
startSymbolAndLength	0001110		FR2
}			
}			
}			
}			
}			
}			
}			

Table 7.1.1.3.11.3.3-3: MAC-CellGroupConfig (Table 7.1.1.3.11.3.3-2)

Derivation Path: TS 38.508-1 [4], Table 4.6.3-68			
Information Element	Value/remark	Comment	Condition
MAC-CellGroupConfig ::= SEQUENCE {			
lch-BasedPrioritization-r16	enabled		
}			

Table 7.1.1.3.11.3.3-4: PhysicalCellGroupConfig (Table 7.1.1.3.11.3.3-2)

Derivation Path: TS 38.508-1 [4], Table 4.6.3-106			
Information Element	Value/remark	Comment	Condition
PhysicalCellGroupConfig ::= SEQUENCE {			
cs-RNTI	'FFE0'H		
}			

7.1.1.3.12 Correct Handling of UL HARQ process / PUSCH Repetition Type B

7.1.1.3.12.1 Test Purpose (TP)

(1)

```
with { UE in RRC_CONNECTED state and is configured with PUSCH repetition type B }
ensure that {
  when { UE receives an UL Grant with toggled NDI and has data available for transmission }
  then { UE transmits a new MAC PDU and repeats the MAC PDU in proper actual transmission times
        after first transmission and selects the redundancy version correctly }
}
```

7.1.1.3.12.2 Conformance requirements

References: The conformance requirements covered in the present TC are specified in: TS 38.214 clauses 6.1.2.1 and 6.1.4, TS 38.321 clause 5.4.2.1. Unless otherwise stated these are Rel-16 requirements.

[TS 38.214, clause 6.1.2.1]

- for PUSCH scheduled by DCI format 0_1, if *pusch-RepTypeIndicatorDCI-0-1* is set to 'pusch-RepTypeB', the UE applies PUSCH repetition Type B procedure when determining the time domain resource allocation. For PUSCH scheduled by DCI format 0_2, if *pusch-RepTypeIndicatorDCI-0-2* is set to 'pusch-RepTypeB', the UE applies PUSCH repetition Type B procedure when determining the time domain resource allocation. Otherwise, the UE applies PUSCH repetition Type A procedure when determining the time domain resource allocation for PUSCH scheduled by PDCCH.
- For PUSCH repetition Type A, the starting symbol S relative to the start of the slot, and the number of consecutive symbols L counting from the symbol S allocated for the PUSCH are determined from the start and length indicator $SLIV$ of the indexed row:

if $(L-1) \leq 7$ then

$$SLIV = 14 \cdot (L-1) + S$$

else

$$SLIV = 14 \cdot (14 - L + 1) + (14 - 1 - S)$$

where $0 < L \leq 14 - S$, and

- For PUSCH repetition Type B, the starting symbol S relative to the start of the slot, and the number of consecutive symbols L counting from the symbol S allocated for the PUSCH are provided by *startSymbol* and *length* of the indexed row of the resource allocation table, respectively.
- For PUSCH repetition Type A, the PUSCH mapping type is set to Type A or Type B as defined in Clause 6.4.1.1.3 of [4, TS 38.211] as given by the indexed row.
- For PUSCH repetition Type B, the PUSCH mapping type is set to Type B.

The UE shall consider the S and L combinations defined in table 6.1.2.1-1 as valid PUSCH allocations

Table 6.1.2.1-1: Valid S and L combinations

PUSCH mapping type	Normal cyclic prefix			Extended cyclic prefix		
	S	L	$S+L$	S	L	$S+L$
Type A (repetition Type A only)	0	{4,...,14}	{4,...,14}	0	{4,...,12}	{4,...,12}
Type B	{0,...,13}	{1,...,14}	{1,...,14} for repetition Type A, {1,...,27} for repetition Type B	{0,..., 11}	{1,...,12}	{1,...,12} for repetition Type A, {1,...,23} for repetition Type B

For PUSCH repetition Type A, when transmitting PUSCH scheduled by DCI format 0_1 or 0_2 in PDCCH with CRC scrambled with C-RNTI, MCS-C-RNTI, or CS-RNTI with NDI=1, the number of repetitions K is determined as

- if *numberOfRepetitions* is present in the resource allocation table, the number of repetitions K is equal to *numberOfRepetitions*;
- elseif the UE is configured with *pusch-AggregationFactor*, the number of repetitions K is equal to *pusch-AggregationFactor*;
- otherwise $K=1$.

If a UE is configured with higher layer parameter *pusch-TimeDomainAllocationListForMultiPUSCH*, the UE does not expect to be configured with *pusch-AggregationFactor*.

For PUSCH repetition Type A, in case $K>1$, the same symbol allocation is applied across the K consecutive slots and the PUSCH is limited to a single transmission layer. The UE shall repeat the TB across the K consecutive slots applying the same symbol allocation in each slot. The redundancy version to be applied on the n th transmission occasion of the TB, where $n = 0, 1, \dots, K-1$, is determined according to table 6.1.2.1-2.

Table 6.1.2.1-2: Redundancy version for PUSCH transmission

rv_{id} indicated by the DCI scheduling the PUSCH	rv_{id} to be applied to n^{th} transmission occasion (repetition Type A) or n^{th} actual repetition (repetition Type B)			
	$n \bmod 4 = 0$	$n \bmod 4 = 1$	$n \bmod 4 = 2$	$n \bmod 4 = 3$
0	0	2	3	1
2	2	3	1	0
3	3	1	0	2
1	1	0	2	3

When transmitting MsgA PUSCH on a non-initial UL BWP, if the UE is configured with *startSymbolAndLengthMsgA-PO*, the UE shall determine the S and L from *startSymbolAndLengthMsgA-PO*.

When transmitting MsgA PUSCH, if the UE is not configured with *startSymbolAndLengthMsgA-PO*, and if the TDRA list *PUSCH-TimeDomainResourceAllocationList* is provided in *PUSCH-ConfigCommon*, the UE shall use *msgA-PUSCH-TimeDomainAllocation* to indicate which values are used in the list. If *PUSCH-TimeDomainResourceAllocationList* is not provided in *PUSCH-ConfigCommon*, the UE shall use parameters S and L from table 6.1.2.1.1-2 or table 6.1.2.1.1-3 where *msgA-PUSCH-TimeDomainAllocation* indicates which values are used in the list. The time offset for PUSCH transmission is described in [6, TS38.213].

For PUSCH repetition Type A, a PUSCH transmission in a slot of a multi-slot PUSCH transmission is omitted according to the conditions in Clause 9, Clause 11.1 and Clause 11.2A of [6, TS38.213].

For PUSCH repetition Type B, except for PUSCH transmitting CSI report(s) with no transport block, the number of nominal repetitions is given by *numberOfRepetitions*. For the n -th nominal repetition, $n = 0, \dots, \text{numberOfRepetitions} - 1$,

- The slot where the nominal repetition starts is given by $K_s + \left\lfloor \frac{S+n \cdot L}{N_{\text{symbol}}^{\text{slot}}} \right\rfloor$, and the starting symbol relative to the start of the slot is given by $\text{mod}(S+n \cdot L, N_{\text{symbol}}^{\text{slot}})$.
- The slot where the nominal repetition ends is given by $K_s + \left\lfloor \frac{S+(n+1) \cdot L-1}{N_{\text{symbol}}^{\text{slot}}} \right\rfloor$, and the ending symbol relative to the start of the slot is given by $\text{mod}(S+(n+1) \cdot L-1, N_{\text{symbol}}^{\text{slot}})$.

Here K_s is the slot where the PUSCH transmission starts, and $N_{\text{symbol}}^{\text{slot}}$ is the number of symbols per slot as defined in Clause 4.3.2 of [4, TS38.211].

For PUSCH repetition Type B, the UE determines invalid symbol(s) for PUSCH repetition Type B transmission as follows:

- A symbol that is indicated as downlink by *tdd-UL-DL-ConfigurationCommon* or *tdd-UL-DL-ConfigurationDedicated* is considered as an invalid symbol for PUSCH repetition Type B transmission.
- For operation in unpaired spectrum, symbols indicated by *ssb-PositionsInBurst* in SIB1 or *ssb-PositionsInBurst* in *ServingCellConfigCommon* for reception of SS/PBCH blocks are considered as invalid symbols for PUSCH repetition Type B transmission.
- For operation in unpaired spectrum, symbol(s) indicated by *pdccch-ConfigSIB1* in MIB for a CORESET for Type0-PDCCH CSS set are considered as invalid symbol(s) for PUSCH repetition Type B transmission.
- For operation in unpaired spectrum, if *numberOfInvalidSymbolsForDL-UL-Switching* is configured, *numberOfInvalidSymbolsForDL-UL-Switching* symbol(s) after the last symbol that is indicated as downlink in each consecutive set of all symbols that are indicated as downlink by *tdd-UL-DL-ConfigurationCommon* or *tdd-UL-DL-ConfigurationDedicated* are considered as invalid symbol(s) for PUSCH repetition Type B transmission. The symbol(s) given by *numberOfInvalidSymbolsForDL-UL-Switching* are defined using the reference SCS configuration *referenceSubcarrierSpacing* provided in *tdd-UL-DL-ConfigurationCommon*.
- The UE may be configured with the higher layer parameter *invalidSymbolPattern*, which provides a symbol level bitmap spanning one or two slots (higher layer parameter *symbols* given by *invalidSymbolPattern*). A bit value equal to 1 in the symbol level bitmap *symbols* indicates that the corresponding symbol is an invalid symbol for PUSCH repetition Type B transmission. The UE may be additionally configured with a time-domain pattern (higher layer parameter *periodicityAndPattern* given by *invalidSymbolPattern*), where each bit of *periodicityAndPattern* corresponds to a unit equal to a duration of the symbol level bitmap *symbols*, and a bit value equal to 1 indicates that the symbol level bitmap *symbols* is present in the unit. The *periodicityAndPattern* can be {1, 2, 4, 5, 8, 10, 20 or 40} units long, but maximum of 40 msec. The first symbol of *periodicityAndPattern* every 40 msec/P periods is a first symbol in frame $n_f \bmod 4 = 0$, where P is the duration of *periodicityAndPattern-r16* in units of msec. When *periodicityAndPattern* is not configured, for a symbol level bitmap spanning two slots, the bits of the first and second slots correspond respectively to even and odd slots of a radio frame, and for a symbol level bitmap spanning one slot, the bits of the slot correspond to every slot of a radio frame. If *invalidSymbolPattern* is configured, when the UE applies the invalid symbol pattern is determined as follows:
 - if the PUSCH is scheduled by DCI format 0_1, or corresponds to a Type 2 configured grant activated by DCI format 0_1, and if *invalidSymbolPatternIndicatorDCI-0-1* is configured,
 - if invalid symbol pattern indicator field is set 1, the UE applies the invalid symbol pattern;
 - otherwise, the UE does not apply the invalid symbol pattern;
 - if the PUSCH is scheduled by DCI format 0_2, or corresponds to a Type 2 configured grant activated by DCI format 0_2, and if *invalidSymbolPatternIndicatorDCI-0-2* is configured,
 - if invalid symbol pattern indicator field is set 1, the UE applies the invalid symbol pattern;
 - otherwise, the UE does not apply the invalid symbol pattern;

- otherwise, the UE applies the invalid symbol pattern.
- If the UE
 - is configured with multiple serving cells and is provided *half-duplex-behavior* = 'enable', and
 - is not capable of simultaneous transmission and reception on any of the multiple serving cells, and
 - indicates support of capability for half-duplex operation in CA with unpaired spectrum, and
 - is not configured to monitor PDCCH for detection of DCI format 2-0 on any of the multiple serving cells,
- a symbol is considered as an invalid symbol in any of the multiple serving cells for PUSCH repetition Type B transmission if the symbol is indicated to the UE for reception of SS/PBCH blocks in any of the multiple serving cells by *ssb-PositionsInBurst* in *SIB1* or *ssb-PositionsInBurst* in *ServingCellConfigCommon*, and

a symbol is considered as an invalid symbol in any of the multiple serving cells for PUSCH repetition Type B transmission with Type 1 or Type 2 configured grant except for the first Type 2 PUSCH transmission (including all repetitions) after activation if the symbol is indicated as downlink by *tdd-UL-DL-ConfigurationCommon* or *tdd-UL-DL-ConfigurationDedicated* on the reference cell, or the UE is configured by higher layers to receive PDCCH, PDSCH, or CSI-RS on the reference cell in the symbol.

For PUSCH repetition Type B, after determining the invalid symbol(s) for PUSCH repetition type B transmission for each of the K nominal repetitions, the remaining symbols are considered as potentially valid symbols for PUSCH repetition Type B transmission. If the number of potentially valid symbols for PUSCH repetition type B transmission is greater than zero for a nominal repetition, the nominal repetition consists of one or more actual repetitions, where each actual repetition consists of a consecutive set of all potentially valid symbols that can be used for PUSCH repetition Type B transmission within a slot. An actual repetition with a single symbol is omitted except for the case of $L=1$. An actual repetition is omitted according to the conditions in Clause 9, Clause 11.1 and Clause 11.2A of [6, TS38.213]. The redundancy version to be applied on the n th actual repetition (with the counting including the actual repetitions that are omitted) is determined according to table 6.1.2.1-2.

For PUSCH repetition Type B, when a UE receives a DCI that schedules aperiodic CSI report(s) or activates semi-persistent CSI report(s) on PUSCH with no transport block by a '*CSI request*' field on a DCI, the number of nominal repetitions is always assumed to be 1, regardless of the value of *numberOfRepetitions*. When the UE is scheduled to transmit a PUSCH repetition Type B with no transport block and with aperiodic or semi-persistent CSI report(s) by a '*CSI request*' field on a DCI, the first nominal repetition is expected to be the same as the first actual repetition. For PUSCH repetition Type B carrying semi-persistent CSI report(s) without a corresponding PDCCH after being activated on PUSCH by a '*CSI request*' field on a DCI, if the first nominal repetition is not the same as the first actual repetition, the first nominal repetition is omitted; otherwise, the first nominal repetition is omitted according to the conditions in Clause 9, Clause 11.1 and Clause 11.2A of [6, TS38.213].

For PUSCH repetition Type B, when a UE is scheduled to transmit a transport block and aperiodic CSI report(s) on PUSCH by a '*CSI request*' field on a DCI, the CSI report(s) is multiplexed only on the first actual repetition. The UE does not expect that the first actual repetition has a single symbol duration.

[TS 38.214, clause 6.1.4]

To determine the modulation order, target code rate, redundancy version and transport block size for the physical uplink shared channel, the UE shall first

- read the 5-bit modulation and coding scheme field (I_{MCS}) in the DCI scheduling PUSCH or provided in a DCI activating a configured grant Type 2 PUSCH, or as provided by *mcsAndTBS* as described in Clause 6.1.2.3 for a configured grant Type 1 PUSCH to determine the modulation order (O_m) and target code rate (R) based on the procedure defined in Clause 6.1.4.1
- read redundancy version field (rv) in the DCI to determine the redundancy version for PUSCH scheduled by DCI, or determine the redundancy version according to Clause 6.1.2.3.1 for configured grant Type 1 and Type 2 PUSCH,

and second

- use the number of layers (ν), the total number of allocated PRBs (n_{PRB}) to determine the transport block size based on the procedure defined in Clause 6.1.4.2.

When the UE is scheduled with multiple PUSCHs by a DCI, as described in clause 6.1.2.1, the bits of rv field and NDI field, respectively, in the DCI are one to one mapped to the scheduled PUSCH(s) with the corresponding transport block(s) in the scheduled order where the LSB bits of the rv field and NDI field, respectively, correspond to the last scheduled PUSCH.

Within a cell group, a UE is not required to handle PUSCH(s) transmissions in slot s_j in serving cell- j , and for $j = 0, 1, 2, \dots, J-1$, slot s_j overlapping with any given point in time, if the following condition is not satisfied at that point in time:

$$\sum_{j=0}^{J-1} \frac{\sum_{m=0}^{M-1} V_{j,m}}{T_{slot}^{\mu(j)}} \leq \text{DataRate},$$

where

- J is the number of configured serving cells belong to a frequency range
- for the j -th serving cell,
 - M is the number of TB(s) transmitted in slot- s_j . For PUSCH repetition Type B, each actual repetition is counted separately.
 - $T_{slot}^{\mu(j)} = 10^{-3}/2^{\mu(j)}$, where $\mu(j)$ is the numerology for PUSCH(s) in slot s_j of the j -th serving cell.
 - for the m -th TB, $V_{j,m} = C^t \cdot \left\lfloor \frac{A}{C} \right\rfloor$
 - A is the number of bits in the transport block as defined in Clause 6.2.1 [5, TS 38.212]
 - C is the total number of code blocks for the transport block defined in Clause 5.2.2 [5, TS 38.212].
 - C^t is the number of scheduled code blocks for the transport block as defined in Clause 5.4.2.1 [5, TS 38.212]
- **DataRate** [Mbps] is computed as the maximum data rate summed over all the carriers in the frequency range for any signalled band combination and feature set consistent with the configured serving cells, where the data rate value is given by the formula in Clause 4.1.2 in [13, TS 38.306], including the scaling factor $f(i)$.

For a j -th serving cell, if higher layer parameter *processingType2Enabled* of *PUSCH-ServingCellConfig* is configured for the serving cell and set to 'enable', or if at least one $I_{MCS} > W$ for a PUSCH, where $W = 28$ for MCS tables 5.1.3.1-1 and 5.1.3.1-3, and $W = 27$ for MCS tables 5.1.3.1-2, 6.1.4.1-1, and 6.1.4.1-2, or if it is an actual repetition for PUSCH repetition Type B, the UE is not required to handle PUSCH transmissions, if the following condition is not satisfied:

$$\frac{\sum_{m=0}^{M-1} V_{j,m}}{L \times T_s^{\mu}} \leq \text{DataRateCC}$$

where

- L is the number of symbols assigned to the PUSCH
- M is the number of TB in the PUSCH
- $T_s^{\mu} = \frac{10^{-3}}{2^{\mu \cdot N_{\text{slot}}^{\text{symb}}}}$ where μ is the numerology of the PUSCH
- for the m -th TB, $V_{j,m} = C^t \cdot \left\lfloor \frac{A}{C} \right\rfloor$
 - A is the number of bits in the transport block as defined in Clause 6.2.1 [5, TS 38.212]
 - C is the total number of code blocks for the transport block defined in Clause 5.2.2 [5, TS 38.212]
 - C^t is the number of scheduled code blocks for the transport block as defined in Clause 5.4.2.1 [5, TS 38.212]
- **DataRateCC** [Mbps] is computed as the maximum data rate for a carrier in the frequency band of the serving cell for any signalled band combination and feature set consistent with the serving cell, where the data rate value is given by the formula in Clause 4.1.2 in [13, TS 38.306], including the scaling factor $f(i)$
- each actual repetition for PUSCH repetition type B is treated as one PUSCH.

[TS 38.321, clause 5.4.2.1]

The MAC entity includes a HARQ entity for each Serving Cell with configured uplink (including the case when it is configured with *supplementaryUplink*), which maintains a number of parallel HARQ processes.

The number of parallel UL HARQ processes per HARQ entity is specified in TS 38.214 [7].

Each HARQ process supports one TB.

Each HARQ process is associated with a HARQ process identifier. For UL transmission with UL grant in RA Response or for UL transmission for MSGA payload, HARQ process identifier 0 is used.

NOTE: When a single DCI is used to schedule multiple PUSCH, the UE is allowed to map generated TB(s) internally to different HARQ processes in case of LBT failure(s), i.e. UE may transmit a new TB on any HARQ process in the grants that have the same TBS, the same RV and the NDIs indicate new transmission.

The maximum number of transmissions of a TB within a bundle of the dynamic grant or configured grant is given by *REPETITION_NUMBER* as follows:

- For a dynamic grant, *REPETITION_NUMBER* is set to a value provided by lower layers, as specified in clause 6.1.2.1 of TS 38.214 [7];
- For a configured grant, *REPETITION_NUMBER* is set to a value provided by lower layers, as specified in clause 6.1.2.3 of TS 38.214 [7].

If *REPETITION_NUMBER* > 1, after the first transmission within a bundle, at most *REPETITION_NUMBER* – 1 HARQ retransmissions follow within the bundle. For both dynamic grant and configured uplink grant, bundling operation relies on the HARQ entity for invoking the same HARQ process for each transmission that is part of the same bundle. Within a bundle, HARQ retransmissions are triggered without waiting for feedback from previous transmission according to *REPETITION_NUMBER* for a dynamic grant or configured uplink grant unless they are terminated as specified in clause 6.1 of TS 38.214 [7]. Each transmission within a bundle is a separate uplink grant delivered to the HARQ entity.

For each transmission within a bundle of the dynamic grant, the sequence of redundancy versions is determined according to clause 6.1.2.1 of TS 38.214 [7]. For each transmission within a bundle of the configured uplink grant, the sequence of redundancy versions is determined according to clause 6.1.2.3 of TS 38.214 [7].

For each uplink grant, the HARQ entity shall:

- 1> identify the HARQ process associated with this grant, and for each identified HARQ process:
 - 2> if the received grant was not addressed to a Temporary C-RNTI on PDCCH, and the NDI provided in the associated HARQ information has been toggled compared to the value in the previous transmission of this TB of this HARQ process; or
 - 2> if the uplink grant was received on PDCCH for the C-RNTI and the HARQ buffer of the identified process is empty; or
 - 2> if the uplink grant was received in a Random Access Response (i.e. in a MAC RAR or a fallback RAR); or
 - 2> if the uplink grant was determined as specified in clause 5.1.2a for the transmission of the MSGA payload; or
 - 2> if the uplink grant was received on PDCCH for the C-RNTI in *ra-ResponseWindow* and this PDCCH successfully completed the Random Access procedure initiated for beam failure recovery; or
 - 2> if the uplink grant is part of a bundle of the configured uplink grant, and may be used for initial transmission according to clause 6.1.2.3 of TS 38.214 [7], and if no MAC PDU has been obtained for this bundle:
 - 3> if there is a MAC PDU in the MSGA buffer and the uplink grant determined as specified in clause 5.1.2a for the transmission of the MSGA payload was selected; or
 - 3> if there is a MAC PDU in the MSGA buffer and the uplink grant was received in a fallbackRAR and this fallbackRAR successfully completed the Random Access procedure:
 - 4> obtain the MAC PDU to transmit from the MSGA buffer.

- 3> else if there is a MAC PDU in the Msg3 buffer and the uplink grant was received in a fallbackRAR:
 - 4> obtain the MAC PDU to transmit from the Msg3 buffer.
- 3> else if there is a MAC PDU in the Msg3 buffer and the uplink grant was received in a MAC RAR; or:
- 3> if there is a MAC PDU in the Msg3 buffer and the uplink grant was received on PDCCH for the C-RNTI in *ra-ResponseWindow* and this PDCCH successfully completed the Random Access procedure initiated for beam failure recovery:
 - 4> obtain the MAC PDU to transmit from the Msg3 buffer.
 - 4> if the uplink grant size does not match with size of the obtained MAC PDU; and
 - 4> if the Random Access procedure was successfully completed upon receiving the uplink grant:
 - 5> indicate to the Multiplexing and assembly entity to include MAC subPDU(s) carrying MAC SDU from the obtained MAC PDU in the subsequent uplink transmission;
 - 5> obtain the MAC PDU to transmit from the Multiplexing and assembly entity.
- 3> else if this uplink grant is a configured grant configured with *autonomousTx*; and
- 3> if the previous configured uplink grant, in the BWP, for this HARQ process was not prioritized; and
- 3> if a MAC PDU had already been obtained for this HARQ process; and
- 3> if the uplink grant size matches with size of the obtained MAC PDU; and
- 3> if none of PUSCH transmission(s) of the obtained MAC PDU has been completely performed:
 - 4> consider the MAC PDU has been obtained.
- 3> else if the MAC entity is not configured with *lch-basedPrioritization*; or
- 3> if this uplink grant is a prioritized uplink grant:
 - 4> obtain the MAC PDU to transmit from the Multiplexing and assembly entity, if any;
- 3> if a MAC PDU to transmit has been obtained:
 - 4> if the uplink grant is not a configured grant configured with *autonomousTx*; or
 - 4> if the uplink grant is a prioritized uplink grant:
 - 5> deliver the MAC PDU and the uplink grant and the HARQ information of the TB to the identified HARQ process;
 - 5> instruct the identified HARQ process to trigger a new transmission;
 - 5> if the uplink grant is a configured uplink grant:
 - 6> start or restart the *configuredGrantTimer*, if configured, for the corresponding HARQ process when the transmission is performed if LBT failure indication is not received from lower layers;
 - 6> start or restart the *cg-RetransmissionTimer*, if configured, for the corresponding HARQ process when the transmission is performed if LBT failure indication is not received from lower layers.
 - 5> if the uplink grant is addressed to C-RNTI, and the identified HARQ process is configured for a configured uplink grant:
 - 6> start or restart the *configuredGrantTimer*, if configured, for the corresponding HARQ process when the transmission is performed if LBT failure indication is not received from lower layers.
 - 5> if *cg-RetransmissionTimer* is configured for the identified HARQ process; and
 - 5> if the transmission is performed and LBT failure indication is received from lower layers:

- 6> consider the identified HARQ process as pending.
- 3> else:
 - 4> flush the HARQ buffer of the identified HARQ process.
- 2> else (i.e. retransmission):
 - 3> if the uplink grant received on PDCCH was addressed to CS-RNTI and if the HARQ buffer of the identified process is empty; or
 - 3> if the uplink grant is part of a bundle and if no MAC PDU has been obtained for this bundle; or
 - 3> if the uplink grant is part of a bundle of the configured uplink grant, and the PUSCH duration of the uplink grant overlaps with a PUSCH duration of another uplink grant received on the PDCCH or an uplink grant received in a Random Access Response (i.e. MAC RAR or fallbackRAR) or an uplink grant determined as specified in clause 5.1.2a for MSGA payload for this Serving Cell; or
 - 3> if the MAC entity is configured with *lch-basedPrioritization* and this uplink grant is not a prioritized uplink grant:
 - 4> ignore the uplink grant.
 - 3> else:
 - 4> deliver the uplink grant and the HARQ information (redundancy version) of the TB to the identified HARQ process;
 - 4> instruct the identified HARQ process to trigger a retransmission;
 - 4> if the uplink grant is addressed to CS-RNTI; or
 - 4> if the uplink grant is addressed to C-RNTI, and the identified HARQ process is configured for a configured uplink grant:
 - 5> start or restart the *configuredGrantTimer*, if configured, for the corresponding HARQ process when the transmission is performed if LBT failure indication is not received from lower layers.
 - 4> if the uplink grant is a configured uplink grant:
 - 5> if the identified HARQ process is pending:
 - 6> start or restart the *configuredGrantTimer*, if configured, for the corresponding HARQ process when the transmission is performed if LBT failure indication is not received from lower layers;
 - 5> start or restart the *cg-RetransmissionTimer*, if configured, for the corresponding HARQ process when the transmission is performed if LBT failure indication is not received from lower layers.
 - 4> if the identified HARQ process is pending and the transmission is performed and LBT failure indication is not received from lower layers:
 - 5> consider the identified HARQ process as not pending.

When determining if NDI has been toggled compared to the value in the previous transmission the MAC entity shall ignore NDI received in all uplink grants on PDCCH for its Temporary C-RNTI.

When *configuredGrantTimer* or *cg-RetransmissionTimer* is started or restarted by a PUSCH transmission, it shall be started at the beginning of the first symbol of the PUSCH transmission.

7.1.1.3.12.3 Test description

7.1.1.3.12.3.1 Pre-test conditions

Same Pre-test conditions as in clause 7.1.1.0.

7.1.1.3.12.3.2 Test procedure sequence

Table 7.1.1.3.12.3.2-1: Main behaviour

St	Procedure	Message Sequence		TP	Verdict
		U - S	Message		
0A	SS transmits in the indicated downlink assignment an NR RRCReconfiguration. (Note 1)	<---	-	-	-
0B	UE transmits NR RRCReconfigurationComplete message to the SS. (Note 2)	-->	-	-	-
1	The SS transmits a valid MAC PDU containing one RLC PDU.	<---	MAC PDU	-	-
2	The UE transmits a Scheduling Request.	-->	(SR)	-	-
3	The SS allocates an UL Grant for HARQ process 1, sufficient for one RLC SDU to be looped back in a slot n, NDI indicates new transmission, DCI scheduling the PUSCH indicates $rv^{ID} = 0$ and invalid symbol pattern indicator set to 1. The slot n is selected such that slot n+4 is the first UL slot in subframe m satisfying $(m \bmod 20) = 9$ for SCS=15kHz and SCS=120kHz and $(m \bmod 20) = 8$ for SCS=30kHz. (Note 5)	<--	UL Grant	-	-
4	Check: Does the UE transmit a MAC PDU including one RLC SDU, in HARQ process 1 and in slot n+4 and repeats in actual repetitions according to Table 7.1.1.3.12.3.2-2 with same resource allocation but different redundancy version (Note 3), if the slot can be used for uplink transmission (Note 4)	-->	MAC PDU	1	P
5	SS transmits a MAC PDU containing an RLC STATUS PDU acknowledging the reception of the AMD PDU in step 4.	<--	MAC PDU (RLC STATUS PDU)	-	
<p>Note 1: For EN-DC the NR RRCReconfiguration message is contained in RRCConnectionReconfiguration 36.508 [7], Table 4.6.1-8 using condition EN-DC_EmbedNR_RRCRecon.</p> <p>Note 2: For EN-DC the NR RRCReconfigurationComplete message is contained in RRCConnectionReconfigurationComplete.</p> <p>Note 3: The redundancy version for the first transmission and all possible actual repetitions (including skipped ones) are set in the following order {0, 2, 3, 1} according to TS 38.214 [15] Table 6.1.2.1-2, first row.</p> <p>Note 4: Usage of correct redundancy version is implicitly checked upon correct decoding by the SS of the UE UL repetitions.</p> <p>Note 5: The UL grant is set to 384 bits: $L_{RBs} = 24$ & $I_{MCS} = 2$ (with PUSCH-duration=4 and PUSCH mapping Type B).</p>					

Table 7.1.1.3.12.3.2-2: Transmitted actual repetition in each nominal repetition

	Nominal repetition 0 (NOTE 1)	Nominal repetition 1 (NOTE 1)	Nominal repetition 2 (NOTE 2)	Nominal repetition 3 (NOTE 3)
FR1 TDD SCS=15kHz	Actual repetition 0	Actual repetition 0	N/A (NOTE 4, 5)	N/A (NOTE 6)

FR1 FDD SCS=15kHz	Actual repetition 0	Actual repetition 0	Actual repetition 1 (NOTE 4, 7)	Actual repetition 0
FR1 TDD SCS=30kHz	Actual repetition 0	Actual repetition 0	Actual repetition 1 (NOTE 4)	Actual repetition 0
FR2 SCS=120kHz	Actual repetition 0	Actual repetition 0	N/A (NOTE 4, 5)	N/A (NOTE 6)
NOTE 1: The nominal repetition is in slot n+4 and only one actual repetition expected. NOTE 2: The nominal repetition is split into two actual repetitions in slot n+4 and n+5 respectively. NOTE 3: The nominal repetition is in slot n+5 and only one actual repetition expected. NOTE 4: The actual repetition 0 is skipped due to only 1 valid symbol left according to invalidSymbolPattern-r16. NOTE 5: The actual repetition 1 is skipped due to being located in DL symbols NOTE 6: The actual repetition 0 is skipped due to being located in DL symbols NOTE 7: The SS may not be able to decode the MAC PDU and may only detect a CRC error as there are less symbols available for transmission of the TBS				

7.1.1.3.12.3.3 Specific message contents

Table 7.1.1.3.12.3.3-0A: RRCReconfiguration (step 0A, Table 7.1.1.3.12.3.2-1)

Derivation Path: 38.508-1 [4], Table 4.6.1-13			
Information Element	Value/remark	Comment	Condition
RRCReconfiguration ::= SEQUENCE {			
criticalExtensions CHOICE {			
rrcReconfiguration SEQUENCE {			
secondaryCellGroup	CellGroupConfig	OCTET STRING (CONTAINING CellGroupConfig)	EN-DC
}			
RRCReconfiguration-v1530-IEs ::= SEQUENCE {			NR
masterCellGroup	CellGroupConfig		
}			
}			
}			

Table 7.1.1.3.12.3.3-0B: CellGroupConfig (Table 7.1.1.3.12.3.3-0A: RRCReconfiguration)

Derivation Path: 38.508-1 [4], Table 4.6.3-19			
Information Element	Value/remark	Comment	Condition
CellGroupConfig ::= SEQUENCE {			
cellGroupId	0 1		EN-DC
spCellConfig SEQUENCE {			
spCellConfigDedicated SEQUENCE {			
servingCellConfig	ServingCellConfig		
}			
}			
}			

Table 7.1.1.3.12.3.3-1: ServingCellConfig (Table 7.1.1.3.12.3.3-0B: CellGroupConfig)

Derivation Path: TS 38.508-1 [4], Table 4.6.3-167			
Information Element	Value/remark	Comment	Condition
ServingCellConfig ::= SEQUENCE {			
uplinkConfig SEQUENCE {			
initialUplinkBWP	BWP-UplinkDedicated		
}			
}			

Table 7.1.1.3.12.3.3-2: BWP-UplinkDedicated (Table 7.1.1.3.12.3.3-1)

Derivation Path: TS 38.508-1 [4], Table 4.6.3-11			
Information Element	Value/remark	Comment	Condition
BWP-UplinkDedicated ::= SEQUENCE {			
pusch-Config CHOICE {			
setup	PUSCH-Config		
}			
}			

Table 7.1.1.3.12.3.3-3: PUSCH-Config (Table 7.1.1.3.12.3.3-2)

Derivation Path: TS 38.508-1 [4], Table 4.6.3-118			
Information Element	Value/remark	Comment	Condition
PUSCH-Config ::= SEQUENCE {			
dmrs-UplinkForPUSCH-MappingTypeB CHOICE {			
setup	DMRS-UplinkConfig		
}			
pusch-TimeDomainAllocationListDCI-0-1-r16 CHOICE {			
setup SEQUENCE (SIZE(1..maxNrofUL-Allocations-r16)) OF SEQUENCE {	1 entry		
k2-r16[1]	4		
puschAllocationList-r16[1] SEQUENCE (SIZE(1..maxNrofMultiplePUSCHs-r16)) OF SEQUENCE {	1 entry		
mappingType-r16[1]	Not present		
startSymbolAndLength-r16[1]	Not present		
startSymbol-r16[1]	4		
length-r16[1]	4		
numberOfRepetitions-r16[1]	n4		
}			
}			
invalidSymbolPatternIndicatorDCI-0-1-r16	enabled		
pusch-RepTypeIndicatorDCI-0-1-r16	pusch-RepTypeB		
invalidSymbolPattern-r16 SEQUENCE {			
symbols-r16 CHOICE {			
oneSlot	00000000000001		
}			
periodicityAndPattern-r16	Not present		
}			
}			

Table 7.1.1.3.12.3.3-4: DMRS-UplinkConfig

Derivation Path: TS 38.508-1 [4], Table 4.6.3-51
--

7.1.1.3.13 Logical channel prioritization handling with Mapping restrictions / physical layer priority

7.1.1.3.13.1 Test Purpose (TP)

(1)

```
with {UE in RRC_CONNECTED state with allowedPHY-PriorityIndex configured}
ensure that {
  when { UE is scheduled by DCI including priority indicator}
  then { UE serves the logical channels according to their priority and configured PHY priority}
}
```

7.1.1.3.1.2 Conformance requirements

References: The conformance requirements covered in the present TC are specified in: TS 38.331, clause 6.3.2, TS 38.321, clause 5.4.3.1.2, 5.4.3.1.3, TS 38.213 clause 9, TS 38.212 clause 7.3.1.1.3. Unless otherwise stated these are Rel-16 requirements.

[TS 38.331, clause 6.3.2]

allowedPHY-PriorityIndex

This restriction applies only when the UL grant is a dynamic grant. If the field is present and the dynamic grant has a PHY-priority index, UL MAC SDUs from this logical channel can only be mapped to the dynamic grants indicating PHY-priority index equal to the values configured by this field. If the field is present and the dynamic grant does not have a PHY-priority index, UL MAC SDUs from this logical channel can only be mapped to this dynamic grant if the value of the field is $p0$, see TS 38.213 [13], clause 9. If the field is not present, UL MAC SDUs from this logical channel can be mapped to any dynamic grants. Corresponds to "allowedPHY-PriorityIndex" as specified in TS 38.321 [3].

[TS 38.321, clause 5.4.3.1.2]

The MAC entity shall, when a new transmission is performed:

- 1> select the logical channels for each UL grant that satisfy all the following conditions:
 - 2> the set of allowed Subcarrier Spacing index values in *allowedSCS-List*, if configured, includes the Subcarrier Spacing index associated to the UL grant; and
 - 2> *maxPUSCH-Duration*, if configured, is larger than or equal to the PUSCH transmission duration associated to the UL grant; and
 - 2> *configuredGrantType1Allowed*, if configured, is set to *true* in case the UL grant is a Configured Grant Type 1; and
 - 2> *allowedServingCells*, if configured, includes the Cell information associated to the UL grant. Does not apply to logical channels associated with a DRB configured with PDCP duplication within the same MAC entity (i.e. CA duplication) when CA duplication is deactivated for this DRB in this MAC entity; and
 - 2> *allowedCG-List*, if configured, includes the configured grant index associated to the UL grant; and
 - 2> *allowedPHY-PriorityIndex*, if configured, includes the priority index (as specified in clause 9 of TS 38.213 [6]) associated to the dynamic UL grant.

NOTE: The Subcarrier Spacing index, PUSCH transmission duration, Cell information, and priority index are included in Uplink transmission information received from lower layers for the corresponding scheduled uplink transmission.

[TS 38.321, clause 5.4.3.1.3]

Before the successful completion of the Random Access procedure initiated for DAPS handover, the target MAC entity shall not select the logical channel(s) corresponding to non-DAPS DRB(s) for the uplink grant received in a Random Access Response or the uplink grant for the transmission of the MSGA payload.

The MAC entity shall, when a new transmission is performed:

- 1> allocate resources to the logical channels as follows:
 - 2> logical channels selected in clause 5.4.3.1.2 for the UL grant with $B_j > 0$ are allocated resources in a decreasing priority order. If the PBR of a logical channel is set to *infinity*, the MAC entity shall allocate resources for all the data that is available for transmission on the logical channel before meeting the PBR of the lower priority logical channel(s);
 - 2> decrement B_j by the total size of MAC SDUs served to logical channel j above;

- 2> if any resources remain, all the logical channels selected in clause 5.4.3.1.2 are served in a strict decreasing priority order (regardless of the value of B_j) until either the data for that logical channel or the UL grant is exhausted, whichever comes first. Logical channels configured with equal priority should be served equally.

NOTE 1: The value of B_j can be negative.

If the MAC entity is requested to simultaneously transmit multiple MAC PDUs, or if the MAC entity receives the multiple UL grants within one or more coinciding PDCCH occasions (i.e. on different Serving Cells), it is up to UE implementation in which order the grants are processed.

The UE shall also follow the rules below during the scheduling procedures above:

- the UE should not segment an RLC SDU (or partially transmitted SDU or retransmitted RLC PDU) if the whole SDU (or partially transmitted SDU or retransmitted RLC PDU) fits into the remaining resources of the associated MAC entity;
- if the UE segments an RLC SDU from the logical channel, it shall maximize the size of the segment to fill the grant of the associated MAC entity as much as possible;
- the UE should maximise the transmission of data;
- if the MAC entity is given a UL grant size that is equal to or larger than 8 bytes while having data available and allowed (according to clause 5.4.3.1) for transmission, the MAC entity shall not transmit only padding BSR and/or padding.

The MAC entity shall:

- 1> if the MAC entity is configured with *enhancedSkipUplinkTxDynamic* with value *true* and the grant indicated to the HARQ entity was addressed to a C-RNTI, or if the MAC entity is configured with *enhancedSkipUplinkTxConfigured* with value *true* and the grant indicated to the HARQ entity is a configured uplink grant; and
- 1> if the MAC entity is not configured with *lch-basedPrioritization*; and
- 1> if there is no UCI to be multiplexed on this PUSCH transmission as specified in TS 38.213 [6]; and
- 1> if there is no aperiodic CSI requested for this PUSCH transmission as specified in TS 38.212 [9]; and
- 1> if the MAC PDU includes zero MAC SDUs; and
- 1> if the MAC PDU includes only the periodic BSR and there is no data available for any LCG, or the MAC PDU includes only the padding BSR:
 - 2> not generate a MAC PDU for the HARQ entity.
- 1> else if the MAC entity is configured with *skipUplinkTxDynamic* with value *true* and the grant indicated to the HARQ entity was addressed to a C-RNTI, or the grant indicated to the HARQ entity is a configured uplink grant; and
- 1> if there is no aperiodic CSI requested for this PUSCH transmission as specified in TS 38.212 [9]; and
- 1> if the MAC PDU includes zero MAC SDUs; and
- 1> if the MAC PDU includes only the periodic BSR and there is no data available for any LCG, or the MAC PDU includes only the padding BSR:
 - 2> not generate a MAC PDU for the HARQ entity.

Logical channels shall be prioritised in accordance with the following order (highest priority listed first):

- C-RNTI MAC CE or data from UL-CCCH;
- Configured Grant Confirmation MAC CE or BFR MAC CE or Multiple Entry Configured Grant Confirmation MAC CE;
- Sidelink Configured Grant Confirmation MAC CE;

- LBT failure MAC CE;
- MAC CE for SL-BSR prioritized according to clause 5.22.1.6;
- MAC CE for BSR, with exception of BSR included for padding;
- Single Entry PHR MAC CE or Multiple Entry PHR MAC CE;
- MAC CE for the number of Desired Guard Symbols;
- MAC CE for Pre-emptive BSR;
- MAC CE for SL-BSR, with exception of SL-BSR prioritized according to clause 5.22.1.6 and SL-BSR included for padding;
- data from any Logical Channel, except data from UL-CCCH;
- MAC CE for Recommended bit rate query;
- MAC CE for BSR included for padding;
- MAC CE for SL-BSR included for padding.

NOTE 2: Prioritization among Configured Grant Confirmation MAC CE, Multiple Entry Configured Grant Confirmation MAC CE, and BFR MAC CE is up to UE implementation.

The MAC entity shall prioritize any MAC CE listed in a higher order than 'data from any Logical Channel, except data from UL-CCCH' over transmission of NR sidelink communication.

[TS 38.213, clause 9]

A PUSCH or a PUCCH transmission, including repetitions if any, can be of priority index 0 or of priority index 1. For a configured grant PUSCH transmission, a UE determines a priority index from *phy-PriorityIndex*, if provided. For a PUCCH transmission with HARQ-ACK information corresponding to a SPS PDSCH reception or a SPS PDSCH release, a UE determines a priority index from *harq-CodebookID*, if provided. For a PUCCH transmission with SR, a UE determines the corresponding priority as described in Clause 9.2.4. For a PUSCH transmission with semi-persistent CSI report, a UE determines a priority index from a priority indicator field, if provided, in a DCI format that activates the semi-persistent CSI report. If a priority index is not provided to a UE for a PUSCH or a PUCCH transmission, the priority index is 0.

7.1.1.3.13.3 Test description

7.1.1.3.13.3.1 Pre-test conditions

Same Pre-test conditions as in clause 7.1.1.0 with the exception of 3 UM bearers configured according to Table 7.1.1.3.13.3.1-1.

Table 7.1.1.3.13.3.1-1: Priority, PBR and Bucket Delay settings

DRB	priority	prioritisedBitRate (kbytes/s)	bucketSizeDuration (ms)	allowedPHY-PriorityIndex-r16
DRB1	6	infinity	100	p0
DRB2	7	infinity	100	p1
DRB3	8	infinity	100	p1

7.1.1.3.13.3.2 Test procedure sequence

Table 7.1.1.3.13.3.2-1: Main behaviour

St	Procedure	Message Sequence		TP	Verdict
		U - S	Message		
1	The SS transmits 2 equal size RLC SDUs each on DRB1, DRB2, DRB3.	<--	(RLC SDUs)	-	-

2	The SS is configured for Uplink Grant Allocation Type 2 as defined in TS 38.523-3 [3]. 100 ms after Step 1 (Note1), the SS transmits 4 UL grant of suitable size to receive one loop back RLC SDU on one logical channel every 20 ms with Priority indicator =1	<--	(UL grants)	-	-
3	Check: Does the UE transmit a MAC PDU containing MAC Sub PDU containing a RLC SDU on DRB2?	-->	MAC PDU (containing 1 MAC sub PDU containing RLC SDU)	1	P
4	Check: Does the UE transmit a MAC PDU containing MAC Sub PDU containing a RLC SDU on DRB2?	-->	MAC PDU (containing 1 MAC sub PDU containing RLC SDU)	1	P
5	Check: Does the UE transmit a MAC PDU containing MAC Sub PDU containing a RLC SDU on DRB1?	-->	MAC PDU (containing 1 MAC sub PDU containing RLC SDU)	1	P
6	Check: Does the UE transmit a MAC PDU containing MAC Sub PDU containing a RLC SDU on DRB1?	-->	MAC PDU (containing 1 MAC sub PDU containing RLC SDU)	1	P
7	The SS is configured for Uplink Grant Allocation Type 2 as defined in TS 38.523-3 [3]. 100 ms after Step 1 (Note1), the SS transmits 2 UL grant of suitable size to receive one loop back RLC SDU on one logical channel every 20 ms with Priority indicator=0	<--	(UL grants)	-	-
8	Check: Does the UE transmit a MAC PDU containing MAC Sub PDU containing a RLC SDU on DRB1?	-->	MAC PDU (containing 1 MAC sub PDU containing RLC SDU)	1	P
9	Check: Does the UE transmit a MAC PDU containing MAC Sub PDU containing a RLC SDU on DRB1?	-->	MAC PDU (containing 1 MAC sub PDU containing RLC SDU)	1	P
Note 1: This wait time will ensure that a) all octets have been completely received by the UE on all 3 DRBs before the first UL grant is received and b) the Bj's for each logical channel have reached their maximum value i.e. the bucket size of the corresponding logical channel before the first UL grant is received.					

7.1.1.3.13.3.3 Specific message contents

Table 7.1.1.3.13.3.3-1: SchedulingRequest-Config (Preamble)

Derivation Path: 38.508-1 [4], Table 4.6.3-155			
Information Element	Value/remark	Comment	Condition
sr-TransMax	n64		

7.1.1.4 Transport Size Selection

7.1.1.4.1 DL-SCH Transport Block Size Selection

7.1.1.4.1.0 Common parameters for DL-SCH Transport Block Size Selection

Table 7.1.1.4.1.0-1: PDSCH-TimeDomainResourceAllocationList

Derivation Path: TS 38.508-1 [4], Table 4.6.3-103			
Information Element	Value/remark	Comment	Condition
PDSCH-TimeDomainResourceAllocationList ::= SEQUENCE(SIZE(1..maxNrofDL-Allocations)) OF SEQUENCE(SIZE(1..maxNrofDL-Allocations)) OF PDSCH-TimeDomainResourceAllocation {	2 entries		
PDSCH-TimeDomainResourceAllocation[1]		entry 1	
SEQUENCE {			
k0	Not present		
mappingType	typeA		
startSymbolAndLength	53	S=2, L=12	
}			

PDSCH-TimeDomainResourceAllocation[2] SEQUENCE {		entry 2	
k0	Not present		
mappingType	typeA		
startSymbolAndLength	86	S=2, L=7	
}			
}			

7.1.1.4.1.1 DL-SCH Transport Block Size selection / DCI format 1_0

7.1.1.4.1.1.1 Test Purpose (TP)

(1)

```
with { UE in RRC_CONNECTED state }
ensure that {
  when { UE on PDCCH receives DCI format 1_0 indicating a resource block assignment correspondent to
physical resource blocks , Time domain resource assignment and a modulation and coding }
  then { UE decodes the received transport block of size correspondent as per Modulation Coding
scheme, time domain resource allocation and PRB's and forwards it to higher layers }
}
```

7.1.1.4.1.1.2 Conformance requirements

References: The conformance requirements covered in the present TC are specified in: TS 38.212 clause 7.3.1.2.1, TS 38.214 clause 5.1.2.1, 5.1.2.2, 5.1.2.2.2, 5.1.3, 5.1.3.1 and 5.1.3.2. Unless otherwise stated these are Rel-15 requirements.

[TS 38.212, clause 7.3.1.2.1]

DCI format 1_0 is used for the scheduling of PDSCH in one DL cell.

The following information is transmitted by means of the DCI format 1_0 with CRC scrambled by C-RNTI or CS-RNTI or new-RNTI:

- Identifier for DCI formats – 1 bits
- The value of this bit field is always set to 1, indicating a DL DCI format
- Frequency domain resource assignment – $\lceil \log_2(N_{RB}^{DL,BWP}(N_{RB}^{DL,BWP} + 1)/2) \rceil$ bits
 - $N_{RB}^{DL,BWP}$ is the size of the active DL bandwidth part in case DCI format 1_0 is monitored in the UE specific search space and satisfying
 - the total number of different DCI sizes monitored per slot is no more than 4 for the cell, and
 - the total number of different DCI sizes with C-RNTI monitored per slot is no more than 3 for the cell
 - otherwise, $N_{RB}^{DL,BWP}$ is the size of the initial DL bandwidth part.

If the CRC of the DCI format 1_0 is scrambled by C-RNTI and the "Frequency domain resource assignment" field are of all ones, the DCI format 1_0 is for random access procedure initiated by a PDCCH order, with all remaining fields set as follows:

- Random Access Preamble index – 6 bits according to *ra-PreambleIndex* in Subclause 5.1.2 of [8, TS38.321]
- UL/SUL indicator – 1 bit. If the value of the "Random Access Preamble index" is not all zeros and if the UE is configured with SUL in the cell, this field indicates which UL carrier in the cell to transmit the PRACH according to Table 7.3.1.1.1-1; otherwise, this field is reserved
- SS/PBCH index – 6 bits. If the value of the "Random Access Preamble index" is not all zeros, this field indicates the SS/PBCH that shall be used to determine the RACH occasion for the PRACH transmission; otherwise, this field is reserved.

- PRACH Mask index – 4 bits. If the value of the “Random Access Preamble index” is not all zeros, this field indicates the RACH occasion associated with the SS/PBCH indicated by “SS/PBCH index” for the PRACH transmission, according to Subclause 5.1.1 of [8, TS38.321]; otherwise, this field is reserved
- Reserved bits – 10 bits

Otherwise, all remaining fields are set as follows:

- Time domain resource assignment – 4 bits as defined in Subclause 5.1.2.1 of [6, TS38.214]
- VRB-to-PRB mapping – 1 bit according to Table 7.3.1.1.2-33
- Modulation and coding scheme – 5 bits as defined in Subclause 5.1.3 of [6, TS38.214]
- New data indicator – 1 bit
- Redundancy version – 2 bits as defined in Table 7.3.1.1.1-2
- HARQ process number – 4 bits
- Downlink assignment index – 2 bits as defined in Subclause 9.1.3 of [5, TS38.213], as counter DAI
- TPC command for scheduled PUCCH – 2 bits as defined in Subclause 7.2.1 of [5, TS38.213]
- PUCCH resource indicator – 3 bits as defined in Subclause 9.2.3 of [5, TS38.213]
- PDSCH-to-HARQ_feedback timing indicator – 3 bits as defined in Subclause 9.2.3 of [5, TS38.213]

[TS 38.214, clause 5.1.2.1]

When the UE is scheduled to receive PDSCH by a DCI, the *Time domain resource assignment* field value m of the DCI provides a row index $m + 1$ to an allocation table. The determination of the used resource allocation table is defined in sub-clause 5.1.2.1.1. The indexed row defines the slot offset K_0 , the start and length indicator $SLIV$, or directly the start symbol S and the allocation length L , and the PDSCH mapping type to be assumed in the PDSCH reception.

Given the parameter values of the indexed row:

- The slot allocated for the PDSCH is $\left\lfloor n \cdot \frac{2^{\mu_{\text{PDSCH}}}}{2^{\mu_{\text{PDCCH}}}} \right\rfloor + K_0$, where n is the slot with the scheduling DCI, and K_0 is based on the numerology of PDSCH, and μ_{PDSCH} and μ_{PDCCH} are the subcarrier spacing configurations for PDSCH and PDCCH, respectively, and
- The starting symbol S relative to the start of the slot, and the number of consecutive symbols L counting from the symbol S allocated for the PDSCH are determined from the start and length indicator $SLIV$:
 - if $(L-1) \leq 7$ then

$$SLIV = 14 \cdot (L-1) + S$$
 - else

$$SLIV = 14 \cdot (14-L+1) + (14-1-S)$$
 - where $0 < L \leq 14 - S$, and
- The PDSCH mapping type is set to Type A or Type B as defined in sub-clause 7.4.1.1.2 of [4, TS 38.211].

The UE shall consider the S and L combinations defined in table 5.1.2.1-1 as valid PDSCH allocations:

Table 5.1.2.1-1: Valid S and L combinations

PDSCH mapping type	Normal cyclic prefix			Extended cyclic prefix		
	S	L	$S+L$	S	L	$S+L$
Type A	{0,1,2,3} (Note 1)	{3,...,14}	{3,...,14}	{0,1,2,3} (Note 1)	{3,...,12}	{3,...,12}

Type B	{0,...,12}	{2,4,7}	{2,...,14}	{0,...,10}	{2,4,6}	{2,...,12}
--------	------------	---------	------------	------------	---------	------------

[38.214 clause 5.1.2.2]

Two downlink resource allocation schemes, type 0 and type 1, are supported. The UE shall assume that when the scheduling grant is received with DCI format 1_0, then downlink resource allocation type 1 is used.

[38.214 clause 5.1.2.2.2]

In downlink resource allocation of type 1, the resource block assignment information indicates to a scheduled UE a set of contiguously allocated non-interleaved or interleaved virtual resource blocks within the active bandwidth part of size N_{BWP}^{size} PRBs except for the case when DCI format 1_0 is decoded in any common search space in CORESET 0 in which case the initial bandwidth part of size $N_{BWP,0}^{size}$ shall be used.

A downlink type 1 resource allocation field consists of a resource indication value (RIV) corresponding to a starting virtual resource block (RB_{start}) and a length in terms of contiguously allocated resource blocks L_{RBs} . The resource indication value is defined by

if $(L_{RBs} - 1) \leq \lfloor N_{BWP}^{size} / 2 \rfloor$ then

$$RIV = N_{BWP}^{size} (L_{RBs} - 1) + RB_{start}$$

else

$$RIV = N_{BWP}^{size} (N_{BWP}^{size} - L_{RBs} + 1) + (N_{BWP}^{size} - 1 - RB_{start})$$

where $L_{RBs} \geq 1$ and shall not exceed $N_{BWP}^{size} - RB_{start}$.

[TS 38.214, clause 5.1.3]

To determine the modulation order, target code rate, and transport block size(s) in the physical downlink shared channel, the UE shall first

- read the 5-bit *modulation and coding scheme* field (I_{MCS}) in the DCI to determine the modulation order (Q_m) and target code rate (R) based on the procedure defined in Subclause 5.1.3.1, and
- read *redundancy version* field (rv) in the DCI to determine the redundancy version.

and second

- the UE shall use the number of layers (v), the total number of allocated PRBs before rate matching (n_{PRB}) to determine to the transport block size based on the procedure defined in Subclause 5.1.3.2.

The UE may skip decoding a transport block in an initial transmission if the effective channel code rate is higher than 0.95, where the effective channel code rate is defined as the number of downlink information bits (including CRC bits) divided by the number of physical channel bits on PDSCH. If the UE skips decoding, the physical layer indicates to higher layer that the transport block is not successfully decoded.

[TS 38.214, clause 5.1.3.1]

For the PDSCH scheduled by a PDCCH with DCI format 1_0 or format 1_1 with CRC scrambled by C-RNTI, new-RNTI, TC-RNTI, CS-RNTI, SI-RNTI, RA-RNTI, or P-RNTI,

if the higher layer parameter *mcs-Table* given by *PDSCH-Config* is set to 'qam256', and the PDSCH is scheduled by a PDCCH with a DCI format 1_1 and the CRC is scrambled by C-RNTI or CS-RNTI

- the UE shall use I_{MCS} and Table 5.1.3.1-2 to determine the modulation order (Q_m) and Target code rate (R) used in the physical downlink shared channel.

elseif the UE is not configured with new-RNTI, the higher layer parameter *mcs-Table* given by *PDSCH-Config* is set to 'qam64LowSE', and the PDSCH is scheduled with C-RNTI, and the PDSCH is assigned by a PDCCH in a UE-specific search space

- the UE shall use I_{MCS} and Table 5.1.3.1-3 to determine the modulation order (Q_m) and Target code rate (R) used in the physical downlink shared channel.

elseif the UE is configured with new-RNTI, and the PDSCH is scheduled with new-RNTI

- the UE shall use I_{MCS} and Table 5.1.3.1-3 to determine the modulation order (Q_m) and Target code rate (R) used in the physical downlink shared channel.

elseif the UE is not configured with the higher layer parameter *mcs-Table* given by *SPS-config*, the higher layer parameter *mcs-Table* given by *PDSCH-Config* is set to 'qam256', the PDSCH is scheduled with CS-RNTI, and the PDSCH is assigned by a PDCCH with DCI format 1_1

- the UE shall use I_{MCS} and Table 5.1.3.1-2 to determine the modulation order (Q_m) and Target code rate (R) used in the physical downlink shared channel.

elseif the UE is configured with the higher layer parameter *mcs-Table* given by *SPS-config* set to 'qam64LowSE', and the PDSCH is scheduled with CS-RNTI

- the UE shall use I_{MCS} and Table 5.1.3.1-3 to determine the modulation order (Q_m) and Target code rate (R) used in the physical downlink shared channel.

else

- the UE shall use I_{MCS} and Table 5.1.3.1-1 to determine the modulation order (Q_m) and Target code rate (R) used in the physical downlink shared channel.

End

The UE is not expected to decode a PDSCH scheduled with P-RNTI, RA-RNTI, SI-RNTI and $Q_m > 2$

Table 5.1.3.1-1: MCS index table 1 for PDSCH

MCS Index I_{MCS}	Modulation Order Q_m	Target code Rate $R \times [1024]$	Spectral efficiency
0	2	120	0.2344
1	2	157	0.3066
2	2	193	0.3770
3	2	251	0.4902
4	2	308	0.6016
5	2	379	0.7402
6	2	449	0.8770
7	2	526	1.0273
8	2	602	1.1758
9	2	679	1.3262
10	4	340	1.3281
11	4	378	1.4766
12	4	434	1.6953
13	4	490	1.9141
14	4	553	2.1602
15	4	616	2.4063
16	4	658	2.5703
17	6	438	2.5664
18	6	466	2.7305
19	6	517	3.0293
20	6	567	3.3223
21	6	616	3.6094
22	6	666	3.9023
23	6	719	4.2129
24	6	772	4.5234
25	6	822	4.8164
26	6	873	5.1152
27	6	910	5.3320
28	6	948	5.5547
29	2	reserved	
30	4	reserved	
31	6	reserved	

[TS 38.214, clause 5.1.3.2]

In case the higher layer parameter *maxNrofCodeWordsScheduledByDCI* indicates that two codeword transmission is enabled, then a transport block is disabled by DCI format 1_1 if $I_{MCS} = 26$ and if $rv_{id} = 1$ for the corresponding transport block, otherwise the transport block is enabled. If both transport blocks are enabled, transport block 1 and 2 are mapped to codeword 0 and 1 respectively. If only one transport block is enabled, then the enabled transport block is always mapped to the first codeword.

For the PDSCH assigned by a PDCCH with DCI format 1_0 or format 1_1 with CRC scrambled by C-RNTI, new-RNTI, TC-RNTI, CS-RNTI, or SI-RNTI, if Table 5.1.3.1-2 is used and $0 \leq I_{MCS} \leq 27$, or a table other than Table 5.1.3.1-2 is used and $0 \leq I_{MCS} \leq 28$, the UE shall, except if the transport block is disabled in DCI format 1_1, first determine the TBS as specified below:

- 1) The UE shall first determine the number of REs (N_{RE}) within the slot.
 - A UE first determines the number of REs allocated for PDSCH within a PRB (N'_{RE}) by $N'_{RE} = N_{sc}^{RB} \cdot N_{symp}^{sh} - N_{DMRS}^{PRB} - N_{oh}^{PRB}$, where $N_{sc}^{RB} = 12$ is the number of subcarriers in a physical resource block, N_{symp}^{sh} is the number of symbols of the PDSCH allocation within the slot, N_{DMRS}^{PRB} is the number of REs for DM-RS per PRB in the scheduled duration including the overhead of the DM-RS CDM groups without data, as indicated by DCI format 1_1 or as described for format 1_0 in Subclause 5.1.6.2, and N_{oh}^{PRB} is the overhead configured by higher layer parameter *xOverhead* in *PDSCH-ServingCellConfig*. If the *xOverhead* in *PDSCH-ServingCellconfig* is not configured (a value from 0, 6, 12, or 18), the N_{oh}^{PRB} is set to 0. If the PDSCH is scheduled by PDCCH with a CRC scrambled by SI-RNTI, RA-RNTI or P-RNTI, N_{oh}^{PRB} is assumed to be 0.
 - A UE determines the total number of REs allocated for PDSCH (N_{RE}) by $N_{RE} = \min(156, N'_{RE}) \cdot n_{PRB}$, where n_{PRB} is the total number of allocated PRBs for the UE.

- 2) Intermediate number of information bits (N_{info}) is obtained by $N_{info} = N_{RE} \cdot R \cdot Q_m \cdot v$.

If $N_{info} \leq 3824$

Use step 3 as the next step of the TBS determination

else

Use step 4 as the next step of the TBS determination

end if

- 3) When $N_{info} \leq 3824$, TBS is determined as follows

- quantized intermediate number of information bits $N'_{info} = \max\left(24, 2^n \cdot \left\lfloor \frac{N_{info}}{2^n} \right\rfloor\right)$, where $n = \max(3, \lfloor \log_2(N_{info}) \rfloor - 6)$.
- use Table 5.1.3.2-2 find the closest TBS that is not less than N'_{info} .

Table 5.1.3.2-2: TBS for $N_{info} \leq 3824$

Index	TBS	Index	TBS	Index	TBS	Index	TBS
1	24	31	336	61	1288	91	3624
2	32	32	352	62	1320	92	3752
3	40	33	368	63	1352	93	3824

4	48	34	384	64	1416		
5	56	35	408	65	1480		
6	64	36	432	66	1544		
7	72	37	456	67	1608		
8	80	38	480	68	1672		
9	88	39	504	69	1736		
10	96	40	528	70	1800		
11	104	41	552	71	1864		
12	112	42	576	72	1928		
13	120	43	608	73	2024		
14	128	44	640	74	2088		
15	136	45	672	75	2152		
16	144	46	704	76	2216		
17	152	47	736	77	2280		
18	160	48	768	78	2408		
19	168	49	808	79	2472		
20	176	50	848	80	2536		
21	184	51	888	81	2600		
22	192	52	928	82	2664		
23	208	53	984	83	2728		
24	224	54	1032	84	2792		
25	240	55	1064	85	2856		
26	256	56	1128	86	2976		
27	272	57	1160	87	3104		
28	288	58	1192	88	3240		
29	304	59	1224	89	3368		
30	320	60	1256	90	3496		

4) When $N_{info} > 3824$, TBS is determined as follows.

- quantized intermediate number of information bits $N'_{info} = \max\left(3840, 2^n \times \text{round}\left(\frac{N_{info} - 24}{2^n}\right)\right)$, where $n = \lfloor \log_2(N_{info} - 24) \rfloor - 5$ and ties in the round function are broken towards the next largest integer.
- if $R \leq 1/4$

$$TBS = 8 \cdot C \cdot \left\lceil \frac{N'_{info} + 24}{8 \cdot C} \right\rceil - 24, \text{ where } C = \left\lceil \frac{N'_{info} + 24}{3816} \right\rceil$$

else

if $N'_{info} > 8424$

$$TBS = 8 \cdot C \cdot \left\lceil \frac{N'_{info} + 24}{8 \cdot C} \right\rceil - 24, \text{ where } C = \left\lceil \frac{N'_{info} + 24}{8424} \right\rceil$$

else

$$TBS = 8 \cdot \left\lceil \frac{N'_{info} + 24}{8} \right\rceil - 24$$

end if

end if

7.1.1.4.1.1.3 Test description

7.1.1.4.1.1.3.1 Pre-test conditions

Same Pre-test conditions as in clause 7.1.1.0 except set the NR Cell bandwidth and applicable BWP to maximum for the NR Band under test as specified in Table 5.3.5-1 in TS 38.101-1 [16] / TS 38.101-2 [17] (to enable testing of n_{PRB} up to maximum value) and Short_DCI condition is applied in NR Serving cell configuration.

Test frequency NRf1 is as specified in TS 38.508-1 [4] clause 4.3.1 using the common highest mandatory UL and DL channel bandwidth and using the default subcarrier spacing specified in TS 38.508-1 [4] clause 6.2.3.1.

7.1.1.4.1.1.3.2 Test procedure sequence

Table 7.1.1.4.1.1.3.2-1: Maximum TBS for different UE categories

UE Category	Maximum number of bits of a UL-SCH transport block received within a TTI
TS 38.306 [23] clause 4.1.2 require UE without <i>ue-CategoryDL</i> and <i>ue-CategoryUL</i> , to support Max TBS achievable based on max bandwidth of the Band under test.	

Table 7.1.1.4.1.1.3.2-2: Number of downlink PDCP SDUs and PDCP SDU size used as test data

TBS [bits]	Number of PDCP SDUs	PDCP SDU size [bits] (Note 1)
$136 \leq TBS \leq 12128$ note 2	1	$8 * \text{FLOOR}((TBS - 128) / 8)$
$12129 \leq TBS \leq 24200$	2	$8 * \text{FLOOR}((TBS - 200) / 16)$
$24201 \leq TBS \leq 36272$	3	$8 * \text{FLOOR}((TBS - 272) / 24)$
$36273 \leq TBS \leq 48344$	4	$8 * \text{FLOOR}((TBS - 344) / 32)$
$48345 \leq TBS \leq 60416$	5	$8 * \text{FLOOR}((TBS - 416) / 40)$
$60417 \leq TBS \leq 72488$	6	$8 * \text{FLOOR}((TBS - 488) / 48)$
$72489 \leq TBS \leq 84560$	7	$8 * \text{FLOOR}((TBS - 560) / 56)$
$84561 \leq TBS \leq 96632$	8	$8 * \text{FLOOR}((TBS - 632) / 64)$
$96633 < TBS \leq 108704$	9	$8 * \text{FLOOR}((TBS - 704) / 72)$
$10705 \leq TBS \leq 120776$	10	$8 * \text{FLOOR}((TBS - 776) / 80)$
$120777 \leq TBS \leq 132848$	11	$8 * \text{FLOOR}((TBS - 848) / 88)$
$132849 \leq TBS \leq 144920$	12	$8 * \text{FLOOR}((TBS - 920) / 96)$
$144921 \leq TBS \leq 156992$	13	$8 * \text{FLOOR}((TBS - 992) / 104)$
$156993 \leq TBS \leq 169064$	14	$8 * \text{FLOOR}((TBS - 1064) / 112)$
$169065 \leq TBS \leq 181136$	15	$8 * \text{FLOOR}((TBS - 1136) / 120)$
$181137 \leq TBS \leq 193208$	16	$8 * \text{FLOOR}((TBS - 1208) / 128)$
$193209 \leq TBS \leq 205280$	17	$8 * \text{FLOOR}((TBS - 1280) / 136)$
$205281 \leq TBS \leq 217352$	18	$8 * \text{FLOOR}((TBS - 1352) / 144)$
$217353 \leq TBS \leq 229424$	19	$8 * \text{FLOOR}((TBS - 1424) / 152)$
$TBS > 229424$	20	$8 * \text{FLOOR}((TBS - 1496) / 160)$

Note 1: Each PDCP SDU is limited to 1500 octets (to keep below maximum SDU size of ESM as specified in TS 24.301 [21] clause 9.9.4.12).

The PDCP SDU size of each PDCP SDU is

$$\text{PDCP SDU size} = (TBS - N * \text{PDCP header size} - N * \text{AMD PDU header size} - N * \text{MAC header size} - \text{Size of Timing Advance} - \text{RLC Status PDU size} - \text{MAC header for RLC Status PDU}) / N, \text{ where}$$

PDCP header size is 24 bits for the RLC AM and 18-bit SN case;
AMD PDU header size is 24 bits with 18 bit SN;

MAC header size for AMD PDU = 16 or 24 bits depending on L=8 or 16 bits. Worst case 24 is taken.

Size of Timing Advance MAC CE with header is 16 bits (if no Timing Advance and/or RLC status needs to be sent, padding will occur instead).

RLC Status PDU size = 24 bits with 1 ACK_SN, With a MAC header of 16 bits.

This gives:

$PDCP\ SDU\ size = 8 * FLOOR((TBS - N * 24 - N * 24 - N * 24 - 56) / (8 * N))\ bits.$

Note 2: According to the final PDCP SDU size formula in Note 1, the smallest TBS that can be tested is 136 bits.

Table 7.1.1.4.1.1.3.2-3: Specific Parameters

Parameter	Value	Comment
number of layers (v)	1	
mcs-Table	qam64	
xoh-PDSCH	Not Present	Results in value 0(xoh0)

Table 7.1.1.4.1.1.3.2-4: Main behaviour

St	Procedure	Message Sequence		TP	Verdict
		U - S	Message		
-	EXCEPTION: Steps 1 to 5 are repeated for allowed values of N_{PRB} 1 to $N_{RB}^{DL,BWP}$ in BWP, time domain resource as per table 7.1.1.4.1.0-1 and I_{MCS} from 0 to 28. NOTE: Skip the execution of steps for which the TBS size results in coding rate exceeding 0.95.	-	-	-	-
1	The SS calculates or looks up TBS in TS 38.214 [15] based on the value of S, L, I_{MCS} and n_{PRB} .	-	-	-	-
-	EXCEPTION: Steps 2 to 5 are performed if TBS is less than or equal to UE capability "Maximum number of DL-SCH transport block bits received within a TTI" as specified in Table 7.1.1.4.1.1.3.2-1 and larger than or equal to 132 bits as specified in Table 7.1.1.4.1.1.3.2-2	-	-	-	-
2	The SS creates one or more PDCP SDUs, depending on TBS, in accordance with Table 7.1.1.4.1.1.3.2-2.	-	-	-	-
3	The SS transmits the PDCP SDUs concatenated into a MAC PDU and indicates on PDCCH DCI Format 1_0 and values of S, L, I_{MCS} and n_{PRB} .	<--	MAC PDU (NxPDCP SDUs) DCI: (DCI Format 1_0, S, L, I_{MCS} and n_{PRB})	-	-
4	At the reception of scheduling request the SS transmits UL Grant for transmitting loop back PDCP SDUs.	<--	(UL Grant)	-	-
5	CHECK: Does UE return the same number of PDCP SDUs with same content as transmitted by the SS in step 3?	-->	(NxPDCP SDUs)	1	P

7.1.1.4.1.1.3.3 Specific message contents

None.

- 7.1.1.4.1.2 Void
- 7.1.1.4.1.3 DL-SCH transport block size selection / DCI format 1_1 / RA type 0/RA Type 1 / 2 Codewords enabled

7.1.1.4.1.3.1 Test Purpose (TP)

(1)

```
with { UE in RRC_CONNECTED state and maxNrofCodeWordsScheduledByDCI set to 'n2' }
ensure that {
  when { UE on PDCCH receives DCI format 1_1 indicating resource allocation type 0 a resource block
assignment correspondent to physical resource blocks , Time domain resource assignment and a
modulation and coding }
  then { UE decodes the received transport block of size correspondent as per Modulation Coding
scheme, time domain resource allocation and PRB's and forwards it to higher layers }
}
```

(2)

```
with { UE in RRC_CONNECTED state and maxNrofCodeWordsScheduledByDCI set to 'n2' }
ensure that {
  when { UE on PDCCH receives DCI format 1_1 indicating resource allocation type 1 a resource block
assignment correspondent to physical resource blocks , Time domain resource assignment and a
modulation and coding }
  then { UE decodes the received transport block of size correspondent as per Modulation Coding
scheme, time domain resource allocation and PRB's and forwards it to higher layers }
}
```

7.1.1.4.1.3.2 Conformance requirements

References: The conformance requirements covered in the present TC are specified in: TS 38.212 clause 7.3.1.2.2, TS 38.214 clause 5.1.2.1, 5.1.2.2.1, 5.1.2.2.2, 5.1.3, 5.1.3.1 and 5.1.3.2. Unless otherwise stated these are Rel-15 requirements.

[TS 38.212, clause 7.3.1.2.2]

DCI format 1_1 is used for the scheduling of PDSCH in one cell.

The following information is transmitted by means of the DCI format 1_1 with CRC scrambled by C-RNTI or CS-RNTI or new-RNTI:

- Identifier for DCI formats – 1 bits
- The value of this bit field is always set to 1, indicating a DL DCI format
 - Carrier indicator – 0 or 3 bits as defined in Subclause 10.1 of [5, TS38.213].
 - Bandwidth part indicator – 0, 1 or 2 bits as determined by the number of DL BWPs $n_{\text{BWP,RRC}}$ configured by higher layers, excluding the initial DL bandwidth part. The bit width for this field is determined as $\lceil \log_2(n_{\text{BWP}}) \rceil$ bits, where
 - $n_{\text{BWP}} = n_{\text{BWP,RRC}} + 1$ if $n_{\text{BWP,RRC}} \leq 3$, in which case the bandwidth part indicator is equivalent to the higher layer parameter *BWP-Id*;
 - otherwise $n_{\text{BWP}} = n_{\text{BWP,RRC}}$, in which case the bandwidth part indicator is defined in Table 7.3.1.1.2-1;

If a UE does not support active BWP change via DCI, the UE ignores this bit field.

- Frequency domain resource assignment – number of bits determined by the following, where $N_{\text{RB}}^{\text{DL,BWP}}$ is the size of the active DL bandwidth part:
 - N_{RBG} bits if only resource allocation type 0 is configured, where N_{RBG} is defined in Subclause 5.1.2.2.1 of [6, TS38.214],

- $\lceil \log_2(N_{RB}^{DL,BWP}(N_{RB}^{DL,BWP} + 1)/2) \rceil$ bits if only resource allocation type 1 is configured, or
 - $\max(\lceil \log_2(N_{RB}^{DL,BWP}(N_{RB}^{DL,BWP} + 1)/2) \rceil, N_{RBG}) + 1$ bits if both resource allocation type 0 and 1 are configured.
 - If both resource allocation type 0 and 1 are configured, the MSB bit is used to indicate resource allocation type 0 or resource allocation type 1, where the bit value of 0 indicates resource allocation type 0 and the bit value of 1 indicates resource allocation type 1.
 - For resource allocation type 0, the N_{RBG} LSBs provide the resource allocation as defined in Subclause 5.1.2.2.1 of [6, TS38.214].
 - For resource allocation type 1, the $\lceil \log_2(N_{RB}^{DL,BWP}(N_{RB}^{DL,BWP} + 1)/2) \rceil$ LSBs provide the resource allocation as defined in Subclause 5.1.2.2.2 of [6, TS38.214]
- If “Bandwidth part indicator” field indicates a bandwidth part other than the active bandwidth part and if both resource allocation type 0 and 1 are configured for the indicated bandwidth part, the UE assumes resource allocation type 0 for the indicated bandwidth part if the bit width of the “Frequency domain resource assignment” field of the active bandwidth part is smaller than the bit width of the “Frequency domain resource assignment” field of the indicated bandwidth part.
- Time domain resource assignment – 0, 1, 2, 3, or 4 bits as defined in Subclause 5.1.2.1 of [6, TS38.214]. The bit width for this field is determined as $\lceil \log_2(I) \rceil$ bits, where I is the number of entries in the higher layer parameter *pusch-AllocationList*.
 - VRB-to-PRB mapping – 0 or 1 bit
 - 0 bit if only resource allocation type 0 is configured;
 - 1 bit according to Table 7.3.1.1.2-33 otherwise, only applicable to resource allocation type 1, as defined in Subclause 7.3.1.6 of [4, TS38.211].
 - PRB bundling size indicator – 0 bit if the higher layer parameter *prb-BundlingType* is not configured or is set to ‘static’, or 1 bit if the higher layer parameter *prb-BundlingType* is set to ‘dynamic’, according to Subclause 5.1.2.3 of [6, TS38.214].
 - Rate matching indicator – 0, 1, or 2 bits according to higher layer parameter *rateMatchPattern*.
 - ZP CSI-RS trigger – 0, 1, or 2 bits as defined in Subclause 5.1.4.2 of [6, TS38.214]. The bit width for this field is determined as $\lceil \log_2(n_{ZP} + 1) \rceil$ bits, where n_{ZP} is the number of ZP CSI-RS resource sets in the higher layer parameter *zp-CSI-RS-Resource*.

For transport block 1:

- Modulation and coding scheme – 5 bits as defined in Subclause 5.1.3.1 of [6, TS38.214]
- New data indicator – 1 bit
- Redundancy version – 2 bits as defined in Table 7.3.1.1.1-2

For transport block 2 (only present if *maxNrofCodeWordsScheduledByDCI* equals 2

- Modulation and coding scheme – 5 bits as defined in Subclause 5.1.3.1 of [6, TS38.214]
- New data indicator – 1 bit
- Redundancy version – 2 bits as defined in Table 7.3.1.1.1-2

If “Bandwidth part indicator” field indicates a bandwidth part other than the active bandwidth part and the value of *maxNrofCodeWordsScheduledByDCI* for the indicated bandwidth part equals 2 and the value of *maxNrofCodeWordsScheduledByDCI* for the active bandwidth part equals 1, the UE assumes zeros are padded when interpreting the “Modulation and coding scheme”, “New data indicator”, and “Redundancy version” fields of transport block 2 according to Subclause 12 of [5, TS38.213], and the UE ignores the “Modulation and coding

scheme”, “New data indicator”, and “Redundancy version” fields of transport block 2 for the indicated bandwidth part.

- HARQ process number – 4 bits
- Downlink assignment index – number of bits as defined in the following
 - 4 bits if more than one serving cell are configured in the DL and the higher layer parameter *pdsch-HARQ-ACK-Codebook=dynamic*, where the 2 MSB bits are the counter DAI and the 2 LSB bits are the total DAI;
 - 2 bits if only one serving cell is configured in the DL and the higher layer parameter *pdsch-HARQ-ACK-Codebook=dynamic*, where the 2 bits are the counter DAI;
 - 0 bits otherwise.
- TPC command for scheduled PUCCH – 2 bits as defined in Subclause 7.2.1 of [5, TS38.213]
- PUCCH resource indicator – 3 bits as defined in Subclause 9.2.3 of [5, TS38.213]
- PDSCH-to-HARQ_feedback timing indicator – 3 0, 1, 2, or bits as defined in Subclause 9.2.3 of [5, TS38.213]. The bit width for this field is determined as $\lceil \log_2(I) \rceil$ bits, where I is the number of entries in the higher layer parameter *dl-DataToUL-ACK*.
- Antenna port(s) – 4, 5, or 6 bits as defined by Tables 7.3.1.2.2-1/2/3/4, where the number of CDM groups without data of values 1, 2, and 3 refers to CDM groups {0}, {0,1}, and {0, 1,2} respectively. The antenna ports $\{p_0, \dots, p_{v-1}\}$ shall be determined according to the ordering of DMRS port(s) given by Tables 7.3.1.2.2-1/2/3/4.

If a UE is configured with both *dmrs-DownlinkForPDSCH-MappingTypeA* and *dmrs-DownlinkForPDSCH-MappingTypeB*, the bit width of this field equals $\max\{x_A, x_B\}$, where x_A is the “Antenna ports” bit width derived according to *dmrs-DownlinkForPDSCH-MappingTypeA* and x_B is the “Antenna ports” bit width derived according to *dmrs-DownlinkForPDSCH-MappingTypeB*. A number of $|x_A - x_B|$ zeros are padded in the MSB of this field, if the mapping type of the PDSCH corresponds to the smaller value of x_A and x_B .

- Transmission configuration indication – 0 bit if higher layer parameter *tci-PresentInDCI* is not enabled; otherwise 3 bits as defined in Subclause 5.1.5 of [6, TS38.214].

If “Bandwidth part indicator” field indicates a bandwidth part other than the active bandwidth part and the “Transmission configuration indication” field is not present in the DCI format 1_1, the UE assumes *tci-PresentInDCI* is not enabled for the indicated bandwidth part.

- SRS request – 2 bits as defined by Table 7.3.1.1.2-24 for UEs not configured with SUL in the cell; 3 bits for UEs configured SUL in the cell where the first bit is the non-SUL/SUL indicator as defined in Table 7.3.1.1.1-1 and the second and third bits are defined by Table 7.3.1.1.2-24. This bit field may also indicate the associated CSI-RS according to Subclause 6.1.1.2 of [6, TS 38.214].
- CBG transmission information (CBGTI) – 0, 2, 4, 6, or 8 bits as defined in Subclause 5.1.7 of [6, TS38.214], determined by the higher layer parameters *maxCodeBlockGroupsPerTransportBlock* and *Number-MCS-HARQ-DL-DCI* for the PDSCH.
- CBG flushing out information (CBGFI) – 0 or 1 bit as defined in Subclause 5.1.7 of [6, TS38.214], determined by higher layer parameter *codeBlockGroupFlushIndicator*.
- DMRS sequence initialization – 1 bit if both *scramblingID0* and *scramblingID1* are configured in *DMRS-DownlinkConfig* for n_{SCID} selection defined in Subclause 7.4.1.1.1 of [4, TS38.211]; 0 bit otherwise.

[TS 38.214, clause 5.1.2.1]

When the UE is scheduled to receive PDSCH by a DCI, the *Time domain resource assignment* field value m of the DCI provides a row index $m + 1$ to an allocation table. The determination of the used resource allocation table is defined in sub-clause 5.1.2.1.1. The indexed row defines the slot offset K_0 , the start and length indicator *SLIV*, or directly the start symbol S and the allocation length L , and the PDSCH mapping type to be assumed in the PDSCH reception.

Given the parameter values of the indexed row:

- The slot allocated for the PDSCH is $\left\lfloor n \cdot \frac{2^{\mu_{\text{PDSCH}}}}{2^{\mu_{\text{PDCCH}}}} \right\rfloor + K_0$, where n is the slot with the scheduling DCI, and K_0 is based on the numerology of PDSCH, and μ_{PDSCH} and μ_{PDCCH} are the subcarrier spacing configurations for PDSCH and PDCCH, respectively, and
- The starting symbol S relative to the start of the slot, and the number of consecutive symbols L counting from the symbol S allocated for the PDSCH are determined from the start and length indicator $SLIV$:
 - if $(L-1) \leq 7$ then

$$SLIV = 14 \cdot (L-1) + S$$
 - else

$$SLIV = 14 \cdot (14 - L + 1) + (14 - 1 - S)$$
 - where $0 < L \leq 14 - S$, and
- The PDSCH mapping type is set to Type A or Type B as defined in sub-clause 7.4.1.1.2 of [4, TS 38.211].

The UE shall consider the S and L combinations defined in table 5.1.2.1-1 as valid PDSCH allocations:

Table 5.1.2.1-1: Valid S and L combinations

PDSCH mapping type	Normal cyclic prefix			Extended cyclic prefix		
	S	L	$S+L$	S	L	$S+L$
Type A	{0,1,2,3} (Note 1)	{3,...,14}	{3,...,14}	{0,1,2,3} (Note 1)	{3,...,12}	{3,...,12}
Type B	{0,...,12}	{2,4,7}	{2,...,14}	{0,...,10}	{2,4,6}	{2,...,12}
Note 1: $S = 3$ is applicable only if $dmrs\text{-}TypeA\text{-}Position = 3$						

[TS 38.214, clause 5.1.2.2.1]

In downlink resource allocation of type 0, the resource block assignment information includes a bitmap indicating the Resource Block Groups (RBGs) that are allocated to the scheduled UE where a RBG is a set of consecutive virtual resource blocks defined by higher layer parameter $rbg\text{-}Size$ configured for PDSCH and the size of the carrier bandwidth part as defined in Table 5.1.2.2.1-1.

Table 5.1.2.2.1-1: Nominal RBG size P

Bandwidth Part Size	Configuration 1	Configuration 2
1 – 36	2	4
37 – 72	4	8
73 – 144	8	16
145 – 275	16	16

The total number of RBGs (N_{RBG}) for a downlink carrier bandwidth part i of size $N_{\text{BWP},i}^{\text{size}}$ PRBs is given by

$$N_{\text{RBG}} = \left\lfloor \left(N_{\text{BWP},i}^{\text{size}} + \left(N_{\text{BWP},i}^{\text{start}} \bmod P \right) \right) / P \right\rfloor, \text{ where}$$

- the size of the first RBG is $RBG_0^{\text{size}} = P - N_{\text{BWP},i}^{\text{start}} \bmod P$,
- the size of last RBG is $RBG_{\text{last}}^{\text{size}} = \left(N_{\text{BWP},i}^{\text{start}} + N_{\text{BWP},i}^{\text{size}} \right) \bmod P$ if $\left(N_{\text{BWP},i}^{\text{start}} + N_{\text{BWP},i}^{\text{size}} \right) \bmod P > 0$ and P otherwise,
- the size of all other RBGs is P .

The bitmap is of size N_{RBG} bits with one bitmap bit per RBG such that each RBG is addressable. The RBGs shall be indexed in the order of increasing frequency and starting at the lowest frequency of the carrier bandwidth part. The order of RBG bitmap is such that RBG 0 to RBG $N_{\text{RBG}} - 1$ are mapped from MSB to LSB. The RBG is allocated to the UE if the corresponding bit value in the bitmap is 1, the RBG is not allocated to the UE otherwise.

[TS 38.214, clause 5.1.2.2.2]

In downlink resource allocation of type 1, the resource block assignment information indicates to a scheduled UE a set of contiguously allocated localized or distributed virtual resource blocks within the active carrier bandwidth part of size $N_{\text{BWP}}^{\text{size}}$ PRBs except for the case when DCI format 1_0 is decoded in the common search space in CORESET 0 in which case the initial bandwidth part of size $N_{\text{BWP}}^{\text{size}}$ shall be used.

A downlink type 1 resource allocation field consists of a resource indication value (RIV) corresponding to a starting virtual resource block (RB_{start}) and a length in terms of contiguously allocated resource blocks L_{RBs} . The resource indication value is defined by

if $(L_{\text{RBs}} - 1) \leq \lfloor N_{\text{BWP}}^{\text{size}} / 2 \rfloor$ then

$$RIV = N_{\text{BWP}}^{\text{size}} (L_{\text{RBs}} - 1) + RB_{\text{start}}$$

else

$$RIV = N_{\text{BWP}}^{\text{size}} (N_{\text{BWP}}^{\text{size}} - L_{\text{RBs}} + 1) + (N_{\text{BWP}}^{\text{size}} - 1 - RB_{\text{start}})$$

where $L_{\text{RBs}} \geq 1$ and shall not exceed $N_{\text{BWP}}^{\text{size}} - RB_{\text{start}}$.

[TS 38.214, clause 5.1.3]

To determine the modulation order, target code rate, and transport block size(s) in the physical downlink shared channel, the UE shall first

- read the 5-bit *modulation and coding scheme* field (I_{MCS}) in the DCI to determine the modulation order (Q_m) and target code rate (R) based on the procedure defined in Subclause 5.1.3.1, and
- read *redundancy version* field (rv) in the DCI to determine the redundancy version.

and second

- the UE shall use the number of layers (v), the total number of allocated PRBs before rate matching (n_{PRB}) to determine to the transport block size based on the procedure defined in Subclause 5.1.3.2.

The UE may skip decoding a transport block in an initial transmission if the effective channel code rate is higher than 0.95, where the effective channel code rate is defined as the number of downlink information bits (including CRC bits) divided by the number of physical channel bits on PDSCH. If the UE skips decoding, the physical layer indicates to higher layer that the transport block is not successfully decoded.

[TS 38.214, clause 5.1.3.1]

For the PDSCH scheduled by a PDCCH with DCI format 1_0 or format 1_1 with CRC scrambled by C-RNTI, new-RNTI, TC-RNTI, CS-RNTI, SI-RNTI, RA-RNTI, or P-RNTI,

if the higher layer parameter *mcs-Table* given by *PDSCH-Config* is set to 'qam256', and the PDSCH is scheduled by a PDCCH with a DCI format 1_1 and the CRC is scrambled by C-RNTI or CS-RNTI

- the UE shall use I_{MCS} and Table 5.1.3.1-2 to determine the modulation order (Q_m) and Target code rate (R) used in the physical downlink shared channel.

elseif the UE is not configured with new-RNTI, the higher layer parameter *mcs-Table* given by *PDSCH-Config* is set to 'qam64LowSE', and the PDSCH is scheduled with C-RNTI, and the PDSCH is assigned by a PDCCH in a UE-specific search space

- the UE shall use I_{MCS} and Table 5.1.3.1-3 to determine the modulation order (Q_m) and Target code rate (R) used in the physical downlink shared channel.

elseif the UE is configured with new-RNTI, and the PDSCH is scheduled with new-RNTI

- the UE shall use I_{MCS} and Table 5.1.3.1-3 to determine the modulation order (Q_m) and Target code rate (R) used in the physical downlink shared channel.

elseif the UE is not configured with the higher layer parameter *mcs-Table* given by *SPS-config*, the higher layer parameter *mcs-Table* given by *PDSCH-Config* is set to 'qam256', the PDSCH is scheduled with CS-RNTI, and the PDSCH is assigned by a PDCCH with DCI format 1_1

- the UE shall use I_{MCS} and Table 5.1.3.1-2 to determine the modulation order (Q_m) and Target code rate (R) used in the physical downlink shared channel.

elseif the UE is configured with the higher layer parameter *mcs-Table* given by *SPS-config* set to 'qam64LowSE', and the PDSCH is scheduled with CS-RNTI

- the UE shall use I_{MCS} and Table 5.1.3.1-3 to determine the modulation order (Q_m) and Target code rate (R) used in the physical downlink shared channel.

else

- the UE shall use I_{MCS} and Table 5.1.3.1-1 to determine the modulation order (Q_m) and Target code rate (R) used in the physical downlink shared channel.

End

The UE is not expected to decode a PDSCH scheduled with P-RNTI, RA-RNTI, SI-RNTI and $Q_m > 2$

Table 5.1.3.1-1: MCS index table 1 for PDSCH

MCS Index I_{MCS}	Modulation Order Q_m	Target code Rate $R \times [1024]$	Spectral efficiency
0	2	120	0.2344
1	2	157	0.3066
2	2	193	0.3770
3	2	251	0.4902
4	2	308	0.6016
5	2	379	0.7402
6	2	449	0.8770
7	2	526	1.0273
8	2	602	1.1758
9	2	679	1.3262
10	4	340	1.3281
11	4	378	1.4766
12	4	434	1.6953
13	4	490	1.9141
14	4	553	2.1602
15	4	616	2.4063
16	4	658	2.5703
17	6	438	2.5664
18	6	466	2.7305
19	6	517	3.0293
20	6	567	3.3223
21	6	616	3.6094
22	6	666	3.9023
23	6	719	4.2129
24	6	772	4.5234
25	6	822	4.8164
26	6	873	5.1152
27	6	910	5.3320
28	6	948	5.5547
29	2	reserved	
30	4	reserved	
31	6	reserved	

[TS 38.214, clause 5.1.3.2]

In case the higher layer parameter *maxNrofCodeWordsScheduledByDCI* indicates that two codeword transmission is enabled, then a transport block is disabled by DCI format 1_1 if $I_{MCS} = 26$ and if $rv_{id} = 1$ for the corresponding transport block, otherwise the transport block is enabled. If both transport blocks are enabled, transport block 1 and 2 are mapped to codeword 0 and 1 respectively. If only one transport block is enabled, then the enabled transport block is always mapped to the first codeword.

For the PDSCH assigned by a PDCCH with DCI format 1_0 or format 1_1 with CRC scrambled by C-RNTI, new-RNTI, TC-RNTI, CS-RNTI, or SI-RNTI, if Table 5.1.3.1-2 is used and $0 \leq I_{MCS} \leq 27$, or a table other than Table 5.1.3.1-2 is used and $0 \leq I_{MCS} \leq 28$, the UE shall, except if the transport block is disabled in DCI format 1_1, first determine the TBS as specified below:

1) The UE shall first determine the number of REs (N_{RE}) within the slot.

- A UE first determines the number of REs allocated for PDSCH within a PRB (N'_{RE}) by

$N'_{RE} = N_{sc}^{RB} \cdot N_{symp}^{sh} - N_{DMRS}^{PRB} - N_{oh}^{PRB}$, where $N_{sc}^{RB} = 12$ is the number of subcarriers in a physical resource block, N_{symp}^{sh} is the number of symbols of the PDSCH allocation within the slot, N_{DMRS}^{PRB} is the number of REs for DM-RS per PRB in the scheduled duration including the overhead of the DM-RS CDM groups without data, as indicated by DCI format 1_1 or as described for format 1_0 in Subclause 5.1.6.2, and N_{oh}^{PRB} is the overhead configured by higher layer parameter *xOverhead* in *PDSCH-ServingCellConfig*. If the *xOverhead* in *PDSCH-ServingCellconfig* is not configured (a value from 0, 6, 12, or 18), the N_{oh}^{PRB} is set to 0. If the PDSCH is scheduled by PDCCH with a CRC scrambled by SI-RNTI, RA-RNTI or P-RNTI, N_{oh}^{PRB} is assumed to be 0.

- A UE determines the total number of REs allocated for PDSCH (N_{RE}) by $N_{RE} = \min(156, N'_{RE}) \cdot n_{PRB}$, where n_{PRB} is the total number of allocated PRBs for the UE.

2) Intermediate number of information bits (N_{info}) is obtained by $N_{info} = N_{RE} \cdot R \cdot Q_m \cdot v$.

If $N_{info} \leq 3824$

Use step 3 as the next step of the TBS determination

else

Use step 4 as the next step of the TBS determination

end if

3) When $N_{info} \leq 3824$, TBS is determined as follows

- quantized intermediate number of information bits $N'_{info} = \max\left(24, 2^n \cdot \left\lfloor \frac{N_{info}}{2^n} \right\rfloor\right)$, where

$$n = \max(3, \lfloor \log_2(N_{info}) \rfloor - 6).$$

- use Table 5.1.3.2-2 find the closest TBS that is not less than N'_{info} .

Table 5.1.3.2-2: TBS for $N_{info} \leq 3824$

Index	TBS	Index	TBS	Index	TBS	Index	TBS
1	24	31	336	61	1288	91	3624
2	32	32	352	62	1320	92	3752
3	40	33	368	63	1352	93	3824

4	48	34	384	64	1416		
5	56	35	408	65	1480		
6	64	36	432	66	1544		
7	72	37	456	67	1608		
8	80	38	480	68	1672		
9	88	39	504	69	1736		
10	96	40	528	70	1800		
11	104	41	552	71	1864		
12	112	42	576	72	1928		
13	120	43	608	73	2024		
14	128	44	640	74	2088		
15	136	45	672	75	2152		
16	144	46	704	76	2216		
17	152	47	736	77	2280		
18	160	48	768	78	2408		
19	168	49	808	79	2472		
20	176	50	848	80	2536		
21	184	51	888	81	2600		
22	192	52	928	82	2664		
23	208	53	984	83	2728		
24	224	54	1032	84	2792		
25	240	55	1064	85	2856		
26	256	56	1128	86	2976		
27	272	57	1160	87	3104		
28	288	58	1192	88	3240		
29	304	59	1224	89	3368		
30	320	60	1256	90	3496		

4) When $N_{info} > 3824$, TBS is determined as follows.

- quantized intermediate number of information bits $N'_{info} = \max\left(3840, 2^n \times \text{round}\left(\frac{N_{info} - 24}{2^n}\right)\right)$, where $n = \lfloor \log_2(N_{info} - 24) \rfloor - 5$ and ties in the round function are broken towards the next largest integer.
- if $R \leq 1/4$

$$TBS = 8 \cdot C \cdot \left\lceil \frac{N'_{info} + 24}{8 \cdot C} \right\rceil - 24, \text{ where } C = \left\lceil \frac{N'_{info} + 24}{3816} \right\rceil$$

else

if $N'_{info} > 8424$

$$TBS = 8 \cdot C \cdot \left\lceil \frac{N'_{info} + 24}{8 \cdot C} \right\rceil - 24, \text{ where } C = \left\lceil \frac{N'_{info} + 24}{8424} \right\rceil$$

else

$$TBS = 8 \cdot \left\lceil \frac{N'_{info} + 24}{8} \right\rceil - 24$$

end if

end if

7.1.1.4.1.3.3 Test description

7.1.1.4.1.3.3.1 Pre-test conditions

Same Pre-test conditions as in clause 7.1.1.0 except set the NR Cell bandwidth and applicable BWP to maximum for the NR Band under test as specified in Table 5.3.5-1 in TS 38.101-1 [16] / TS 38.101-2 [17] (to enable testing of n_{PRB} up to maximum value).

Test frequency NRf1 is as specified in TS 38.508-1 [4] clause 4.3.1 using the common highest mandatory UL and DL channel bandwidth and using the default subcarrier spacing specified in TS 38.508-1 [4] clause 6.2.3.1.

7.1.1.4.1.3.3.2 Test procedure sequence

Table 7.1.1.4.1.3.3.2-1: Maximum TBS for different UE categories

UE Category	Maximum number of bits of a UL-SCH transport block received within a TTI
TS 38.306 [23] clause 4.1.2 require UE without <i>ue-CategoryDL</i> and <i>ue-CategoryUL</i> , to support Max TBS achievable based on max bandwidth of the Band under test.	

Table 7.1.1.4.1.3.3.2-2: Number of downlink PDCP SDUs and PDCP SDU size used as test data

TBS [bits]	Number of PDCP SDUs	PDCP SDU size [bits] (Note 1)
$192 \leq TBS \leq 12184$ note 2	1	$8 * \text{FLOOR}((TBS - 184)/8)$
$12185 \leq TBS \leq 24256$	2	$8 * \text{FLOOR}((TBS - 256)/16)$
$24257 \leq TBS \leq 36328$	3	$8 * \text{FLOOR}((TBS - 328)/24)$
$36329 \leq TBS \leq 48400$	4	$8 * \text{FLOOR}((TBS - 400)/32)$
$48401 \leq TBS \leq 60472$	5	$8 * \text{FLOOR}((TBS - 472)/40)$
$60473 \leq TBS \leq 72544$	6	$8 * \text{FLOOR}((TBS - 544)/48)$
$72545 \leq TBS \leq 84616$	7	$8 * \text{FLOOR}((TBS - 616)/56)$
$84617 \leq TBS \leq 96688$	8	$8 * \text{FLOOR}((TBS - 688)/64)$
$96689 < TBS \leq 108760$	9	$8 * \text{FLOOR}((TBS - 760)/72)$
$108761 \leq TBS \leq 120832$	10	$8 * \text{FLOOR}((TBS - 832)/80)$
$120833 \leq TBS \leq 132904$	11	$8 * \text{FLOOR}((TBS - 904)/88)$
$132905 \leq TBS \leq 144976$	12	$8 * \text{FLOOR}((TBS - 976)/96)$
$TBS > 144976$	13	$8 * \text{FLOOR}((TBS - 1048)/104)$

Note 1: Each PDCP SDU is limited to 1500 octets (to keep below maximum SDU size of ESM as specified in TS 24.301 [21] clause 9.9.4.12).

The PDCP SDU size of each PDCP SDU is

$$\text{PDCP SDU size} = (TBS - N * \text{PDCP header size} - N * \text{AMD PDU header size} - N * \text{MAC header size} - \text{Size of Timing Advance} - \text{RLC Status PDU size} - \text{MAC header for RLC Status PDU} - 32 \text{ bit Additional RLC header with SO if one RLC SDU gets split in 2 TBS and } 24 \text{ bit MAC header for this additional PDU}) / N,$$

where

PDCP header size is 24 bits for the RLC AM and 18-bit SN case;
AMD PDU header size is 24 bits with 18 bit SN;

MAC header size for AMD PDU = 16 or 24 bits depending on L=8 or 16 bits. Worst case 24 is taken.

Size of Timing Advance MAC CE with header is 16 bits (if no Timing Advance and/or RLC status needs to be sent, padding will occur instead).
IF RLC SDU does not get split the 32 bits additional padding gets added instead

RLC Status PDU size = 24 bits with 1 ACK_SN, With a MAC header of 16 bits.

This gives:

$$\text{PDCP SDU size} = 8 * \text{FLOOR}((TBS - N * 24 - N * 24 - N * 24 - 112) / (8 * N)) \text{ bits.}$$

Note 2: According to the final PDCP SDU size formula in Note 1, the smallest TBS that can be tested is 192 bits.

Table 7.1.1.4.1.3.3.2-2A: Bandwidth part Dependent Parameters for Resource allocation 0 with start of BWP assumed as 0

$N_{RB}^{DL,BWP}$ $N_{BWP,i}^{size}$	Nominal RBG size P (Configuration1)	Size of last RBG	Allowed N_{PRB} Values
11	2	1	All 1...11
18	2	2	2,4,6,8,10,12,16,18
24	2	2	2,4,6,8,10,12,16,18,20,22,24
25	2	1	All 1...25
31	2	1	All 1...31
32	2	2	2,4,6,8,10,12,16,18,20,22,24,26,28,30,32
38	4	2	2,4,6,8,10,12,16,18,20,22,24,26,28,30,32,34,36,38
51	4	3	3,4,7,8,11,12,15,16,19,20,23,24,27,28,31,32,35,36,39,40,43,44,47,48,51
52	4	4	4,8,12,16,20,24,28,32,36,40,44,48,52
65	4	1	1,4,5,8,9,12,13,16,17,20,21,24,25,28,29,32,33,36,37,40,41,44,45,48,49,52,53,56,57,60,61,64,65
66	4	2	2,4,6,8,10,12,16,18,20,22,24,26,28,30,32,34,36,38,40,42,44,46,48,50,52,54,56,58,60,62,64,66
79	8	7	7,8,15,16,23,24,31,32,39,40,47,48,55,56,63,64,71,72,79
106	8	2	2,8,10,16,18,24,26,32,34,40,42,48,50,56,58,64,66,72,74,80,82,88,90,96,92,104,106
107	8	3	3,8,11,16,19,24,27,32,35,40,43,48,51,56,59,64,67,72,75,80,83,88,91,96,99,104,107
132	8	4	4,8,12,16,20,24,28,32,36,40,44,48,52,56,60,64,68,72,76,80,84,88,92,96,100,104,108,112,116,120,124,128,132
133	8	5	5,8,13,16,21,24,29,32,37,40,45,48,53,56,61,64,69,72,77,80,85,88,93,96,101,104,109,112,117,120,125,128,133
135	8	7	7,8,15,16,23,24,31,32,39,40,47,48,55,56,63,64,71,72,79,80,87,88,95,96,103,104,111,112,119,120,127,128,135
160	16	16	16,32,48,64,80,96,112,128,144,160
216	16	8	8,16,24,32,40,48,56,64,72,80,88,96,104,112,120,128,136,144,152,160,168,176,184,192,200,208,216
217	16	9	9,16,25,32,41,48,57,64,73,80,89,96,105,112,121,128,137,144,153,160,169,176,185,192,201,208,217
264	16	8	8,16,24,32,40,48,56,64,72,80,88,96,104,112,120,128,136,144,160,168,176,184,192,200,208,216,224,232,240,248,256,264
270	16	14	14,16,30,32,46,44,62,64,78,80,94,96,110,112,126,128,142,144,158,160,174,176,190,192,206,208,222,224,238,240,254,256,270
273	16	1	1,16,17,32,33,48,49,64,65,80,81,96,97,112,113,128,129,144,145,160,161,176,171,192,193,208,209,224,225,240,241,256,257,272,273

Table 7.1.1.4.1.3.3.2-3: Specific Parameter

Parameter	Value	Comments	Condition
number of layers (v)	1		
mcs-Table	qam64		
resourceAllocation	dynamicSwitch		pc_dynamicSwitchRA_Type0_1_PDSCH
	resourceAllocationType0		NOT pc_dynamicSwitchRA_Type0_1_PDSCH AND Steps 1-5
	resourceAllocationType1		NOT pc_dynamicSwitchRA_Type0_1_PDSCH AND Steps 6-10
maxNrofCodeWordsScheduledByDCI	n2	both codewords enabled	
N_{BWP}^{start}	0		

Table 7.1.1.4.1.3.3.2-4: Main behaviour

St	Procedure	Message Sequence		TP	Verdict
		U - S	Message		

-	EXCEPTION: Steps 1 to 5 are repeated for allowed values of N_{PRB} as per table 7.1.1.4.1.3.3.2-2A in BWP, time domain resource as per table 7.1.1.4.1.0-1 and I_{MCS} from 0 to 28. NOTE: Skip the execution of steps for which the TBS size results in coding rate exceeding 0.95.	-	-	-	-
1	SS calculates or looks up TBS in TS 38.214 [15] based on the value of S, L, I_{MCS} and n_{PRB} . The SS uses the same I_{MCS} and TBS for both transport blocks: $I_{MCS\#1} = I_{MCS\#2} = I_{MCS}$ TBS 1= TBS 2= TBS	-	-	-	-
-	EXCEPTION: Steps 2 to 5 are performed if TBS1 + TBS2 is less than or equal to UE capability "Maximum number of DL-SCH transport block bits received within a TTI" as specified in Table 7.1.1.4.1.3.3.2-1 and larger than or equal to 192 bits as specified in Table 7.1.1.4.1.3.3.2-2.	-	-	-	-
2	SS creates one or more PDCP SDUs for transport block 1 and 2 depending on TBS1, and TBS2 in accordance with Table 7.1.1.4.1.3.3.2-2.	-	-	-	-
3	SS transmits the PDCP SDUs concatenated into a MAC PDU and indicates on PDCCH DCI Format 1_1 resource allocation 0 and values of S, L, $I_{MCS\#1}$, $I_{MCS\#2}$ and n_{PRB} .	<--	Transport block 1: MAC PDU Transport block 2: MAC PDU DCI: (DCI Format 1_1, S, L, $I_{MCS\#1}$, $I_{MCS\#2}$ and n_{PRB} .)	-	-
4	At the reception of scheduling request the SS transmits UL Grant for transmitting loop back PDCP SDUs.	<--	(UL Grant)	-	-
5	CHECK: Does UE return the same number of PDCP SDUs with same content as transmitted by the SS in step 3?	-->	(NxPDCP SDUs)	1	P
-	EXCEPTION : Steps 5Aa1 to 5Aa2 are executed if NOT <code>pc_dynamicSwitchRA_Type0_1_PDSCH</code>	-	-	-	-
5A a1	The SS transmits a NR RRCReconfiguration message including <i>PDSCH-Config</i> with IE <code>resourceAllocation</code> set to <code>resourceAllocationType1</code> (Note 1)	<--	<i>RRCReconfiguration</i>	-	-
5A a2	The UE transmit a NR <i>RRCReconfigurationComplete</i> message. (Note 2)	-->	<i>RRCReconfigurationComplete</i>	-	-
-	EXCEPTION: Steps 6 to 10 are repeated for allowed values of N_{PRB} 1 to $N_{RB}^{DL,BWP}$ in BWP, time domain resource as per table 7.1.1.4.1.0-1 and I_{MCS} from 0 to 28.	-	-	-	-

6	SS calculates or looks up TBS in TS 38.214 [15] based on the value of S, L, I_{MCS} and n_{PRB} . The SS uses the same I_{MCS} and TBS for both transport blocks: $I_{MCS\#1} = I_{MCS\#2} = I_{MCS}$ TBS 1= TBS 2= TBS	-	-	-	-
-	EXCEPTION: Steps 7 to 10 are performed if TBS1 + TBS2 is less than or equal to UE capability "Maximum number of DL-SCH transport block bits received within a TTI" as specified in Table 7.1.1.4.1.3.3.2-1 and larger than or equal to 192 bits as specified in Table 7.1.1.4.1.3.3.2-2.	-	-	-	-
7	SS creates one or more PDCP SDUs for transport block 1 and 2 depending on TBS1, and TBS2 in accordance with Table 7.1.1.4.1.3.3.2-2.	-	-	-	-
8	SS transmits the PDCP SDUs concatenated into a MAC PDU and indicates on PDCCH DCI Format 1_1 resource allocation 1 and values of S, L, $I_{MCS\#1}$, $I_{MCS\#2}$ and n_{PRB} .	<--	Transport block 1: MAC PDU Transport block 2: MAC PDU DCI: (DCI Format 1_1, S, L, $I_{MCS\#1}$, $I_{MCS\#2}$ and n_{PRB} .)	-	-
9	At the reception of scheduling request the SS transmits UL Grant for transmitting loop back PDCP SDUs.	<--	(UL Grant)	-	-
10	CHECK: Does UE return the same number of PDCP SDUs with same content as transmitted by the SS in step 3?	-->	(NxPDCP SDUs)	2	P
Note 1: For EN-DC the NR RRCReconfiguration message is contained in RRCConnectionReconfiguration 36.508 [7], Table 4.6.1-8 using condition EN-DC_EmbedNR_RRCRecon. Note 2: For EN-DC the NR RRCReconfigurationComplete message is contained in RRCConnectionReconfigurationComplete.					

7.1.1.4.1.3.3.3 Specific message contents

None.

7.1.1.4.1.4 DL-SCH transport block size selection / DCI format 1_1 / RA type 0/RA Type 1 / 2 Codewords enabled / 256QAM

7.1.1.4.1.4.1 Test Purpose (TP)

(1)

```
with { UE in RRC_CONNECTED state, maxNrofCodeWordsScheduledByDCI set to 'n2' and mcs-Table is set as 'qam256' }
ensure that {
  when { UE on PDCCH receives DCI format 1_1 indicating resource allocation type 0 a resource block assignment correspondent to physical resource blocks, Time domain resource assignment and a modulation and coding }
  then { UE decodes the received transport block of size correspondent as per Modulation Coding scheme, time domain resource allocation and PRB's and forwards it to higher layers }
}
```

(2)

```
with { UE in RRC_CONNECTED state, maxNrofCodeWordsScheduledByDCI set to 'n2' and mcs-Table is set as 'qam256' }
ensure that {
```

```

when { UE on PDCCH receives DCI format 1_1 indicating resource allocation type 1 a resource block
assignment correspondent to physical resource blocks , Time domain resource assignment and a
modulation and coding }
  then { UE decodes the received transport block of size correspondent as per Modulation Coding
scheme, time domain resource allocation and PRB's and forwards it to higher layers }
}

```

7.1.1.4.1.4.2 Conformance requirements

References: The conformance requirements covered in the present TC are specified in: TS 38.212 clause 7.3.1.2.2, TS 38.214 clauses 5.1.2.1, 5.1.2.2.1, 5.1.2.2.2, 5.1.3, 5.1.3.1 and 5.1.3.2. Unless otherwise stated these are Rel-15 requirements.

[TS 38.212, clause 7.3.1.2.2]

DCI format 1_1 is used for the scheduling of PDSCH in one cell.

The following information is transmitted by means of the DCI format 1_1 with CRC scrambled by C-RNTI or CS-RNTI or new-RNTI:

- Identifier for DCI formats – 1 bits
- The value of this bit field is always set to 1, indicating a DL DCI format
- Carrier indicator – 0 or 3 bits as defined in Subclause 10.1 of [5, TS38.213].
- Bandwidth part indicator – 0, 1 or 2 bits as determined by the number of DL BWPs $n_{\text{BWP,RRC}}$ configured by higher layers, excluding the initial DL bandwidth part. The bit width for this field is determined as $\lceil \log_2(n_{\text{BWP}}) \rceil$ bits, where
 - $n_{\text{BWP}} = n_{\text{BWP,RRC}} + 1$ if $n_{\text{BWP,RRC}} \leq 3$, in which case the bandwidth part indicator is equivalent to the higher layer parameter *BWP-Id*;
 - otherwise $n_{\text{BWP}} = n_{\text{BWP,RRC}}$, in which case the bandwidth part indicator is defined in Table 7.3.1.1.2-1;

If a UE does not support active BWP change via DCI, the UE ignores this bit field.

- Frequency domain resource assignment – number of bits determined by the following, where $N_{\text{RB}}^{\text{DL,BWP}}$ is the size of the active DL bandwidth part:
 - N_{RBG} bits if only resource allocation type 0 is configured, where N_{RBG} is defined in Subclause 5.1.2.2.1 of [6, TS38.214],
 - $\lceil \log_2(N_{\text{RB}}^{\text{DL,BWP}}(N_{\text{RB}}^{\text{DL,BWP}} + 1)/2) \rceil$ bits if only resource allocation type 1 is configured, or
 - $\max(\lceil \log_2(N_{\text{RB}}^{\text{DL,BWP}}(N_{\text{RB}}^{\text{DL,BWP}} + 1)/2) \rceil, N_{\text{RBG}}) + 1$ bits if both resource allocation type 0 and 1 are configured.
 - If both resource allocation type 0 and 1 are configured, the MSB bit is used to indicate resource allocation type 0 or resource allocation type 1, where the bit value of 0 indicates resource allocation type 0 and the bit value of 1 indicates resource allocation type 1.
 - For resource allocation type 0, the N_{RBG} LSBs provide the resource allocation as defined in Subclause 5.1.2.2.1 of [6, TS38.214].
 - For resource allocation type 1, the $\lceil \log_2(N_{\text{RB}}^{\text{DL,BWP}}(N_{\text{RB}}^{\text{DL,BWP}} + 1)/2) \rceil$ LSBs provide the resource allocation as defined in Subclause 5.1.2.2.2 of [6, TS38.214]

If “Bandwidth part indicator” field indicates a bandwidth part other than the active bandwidth part and if both resource allocation type 0 and 1 are configured for the indicated bandwidth part, the UE assumes resource allocation type 0 for the indicated bandwidth part if the bit width of the “Frequency domain resource

assignment” field of the active bandwidth part is smaller than the bit width of the “Frequency domain resource assignment” field of the indicated bandwidth part.

- Time domain resource assignment – 0, 1, 2, 3, or 4 bits as defined in Subclause 5.1.2.1 of [6, TS38.214]. The bit width for this field is determined as $\lceil \log_2(I) \rceil$ bits, where I is the number of entries in the higher layer parameter *pusch-AllocationList*.
- VRB-to-PRB mapping – 0 or 1 bit
 - 0 bit if only resource allocation type 0 is configured;
 - 1 bit according to Table 7.3.1.1.2-33 otherwise, only applicable to resource allocation type 1, as defined in Subclause 7.3.1.6 of [4, TS38.211].
- PRB bundling size indicator – 0 bit if the higher layer parameter *prb-BundlingType* is not configured or is set to ‘static’, or 1 bit if the higher layer parameter *prb-BundlingType* is set to ‘dynamic’, according to Subclause 5.1.2.3 of [6, TS38.214].
- Rate matching indicator – 0, 1, or 2 bits according to higher layer parameter *rateMatchPattern*.
- ZP CSI-RS trigger – 0, 1, or 2 bits as defined in Subclause 5.1.4.2 of [6, TS38.214]. The bit width for this field is determined as $\lceil \log_2(n_{ZP} + 1) \rceil$ bits, where n_{ZP} is the number of ZP CSI-RS resource sets in the higher layer parameter *zp-CSI-RS-Resource*.

For transport block 1:

- Modulation and coding scheme – 5 bits as defined in Subclause 5.1.3.1 of [6, TS38.214]
- New data indicator – 1 bit
- Redundancy version – 2 bits as defined in Table 7.3.1.1.1-2

For transport block 2 (only present if *maxNrofCodeWordsScheduledByDCI* equals 2

- Modulation and coding scheme – 5 bits as defined in Subclause 5.1.3.1 of [6, TS38.214]
- New data indicator – 1 bit
- Redundancy version – 2 bits as defined in Table 7.3.1.1.1-2

If “Bandwidth part indicator” field indicates a bandwidth part other than the active bandwidth part and the value of *maxNrofCodeWordsScheduledByDCI* for the indicated bandwidth part equals 2 and the value of *maxNrofCodeWordsScheduledByDCI* for the active bandwidth part equals 1, the UE assumes zeros are padded when interpreting the “Modulation and coding scheme”, “New data indicator”, and “Redundancy version” fields of transport block 2 according to Subclause 12 of [5, TS38.213], and the UE ignores the “Modulation and coding scheme”, “New data indicator”, and “Redundancy version” fields of transport block 2 for the indicated bandwidth part.

- HARQ process number – 4 bits
- Downlink assignment index – number of bits as defined in the following
 - 4 bits if more than one serving cell are configured in the DL and the higher layer parameter *pdsch-HARQ-ACK-Codebook=dynamic*, where the 2 MSB bits are the counter DAI and the 2 LSB bits are the total DAI;
 - 2 bits if only one serving cell is configured in the DL and the higher layer parameter *pdsch-HARQ-ACK-Codebook=dynamic*, where the 2 bits are the counter DAI;
 - 0 bits otherwise.
- TPC command for scheduled PUCCH – 2 bits as defined in Subclause 7.2.1 of [5, TS38.213]
- PUCCH resource indicator – 3 bits as defined in Subclause 9.2.3 of [5, TS38.213]

- PDSCH-to-HARQ_feedback timing indicator – 0, 1, 2, or 3 bits as defined in Subclause 9.2.3 of [5, TS38.213]. The bit width for this field is determined as $\lceil \log_2(I) \rceil$ bits, where I is the number of entries in the higher layer parameter *dl-DataToUL-ACK*.
- Antenna port(s) – 4, 5, or 6 bits as defined by Tables 7.3.1.2.2-1/2/3/4, where the number of CDM groups without data of values 1, 2, and 3 refers to CDM groups {0}, {0,1}, and {0, 1,2} respectively. The antenna ports $\{p_0, \dots, p_{v-1}\}$ shall be determined according to the ordering of DMRS port(s) given by Tables 7.3.1.2.2-1/2/3/4.

If a UE is configured with both *dmrs-DownlinkForPDSCH-MappingTypeA* and *dmrs-DownlinkForPDSCH-MappingTypeB*, the bit width of this field equals $\max\{x_A, x_B\}$, where x_A is the “Antenna ports” bit width derived according to *dmrs-DownlinkForPDSCH-MappingTypeA* and x_B is the “Antenna ports” bit width derived according to *dmrs-DownlinkForPDSCH-MappingTypeB*. A number of $|x_A - x_B|$ zeros are padded in the MSB of this field, if the mapping type of the PDSCH corresponds to the smaller value of x_A and x_B .

- Transmission configuration indication – 0 bit if higher layer parameter *tci-PresentInDCI* is not enabled; otherwise 3 bits as defined in Subclause 5.1.5 of [6, TS38.214].

If “Bandwidth part indicator” field indicates a bandwidth part other than the active bandwidth part and the “Transmission configuration indication” field is not present in the DCI format 1_1, the UE assumes *tci-PresentInDCI* is not enabled for the indicated bandwidth part.

- SRS request – 2 bits as defined by Table 7.3.1.1.2-24 for UEs not configured with SUL in the cell; 3 bits for UEs configured SUL in the cell where the first bit is the non-SUL/SUL indicator as defined in Table 7.3.1.1.1-1 and the second and third bits are defined by Table 7.3.1.1.2-24. This bit field may also indicate the associated CSI-RS according to Subclause 6.1.1.2 of [6, TS 38.214].
- CBG transmission information (CBGTI) – 0, 2, 4, 6, or 8 bits as defined in Subclause 5.1.7 of [6, TS38.214], determined by the higher layer parameters *maxCodeBlockGroupsPerTransportBlock* and *Number-MCS-HARQ-DL-DCI* for the PDSCH.
- CBG flushing out information (CBGFI) – 0 or 1 bit as defined in Subclause 5.1.7 of [6, TS38.214], determined by higher layer parameter *codeBlockGroupFlushIndicator*.
- DMRS sequence initialization – 1 bit if both *scramblingID0* and *scramblingID1* are configured in *DMRS-DownlinkConfig* for n_{SCID} selection defined in Subclause 7.4.1.1.1 of [4, TS38.211]; 0 bit otherwise.

[TS 38.214, clause 5.1.2.1]

When the UE is scheduled to receive PDSCH by a DCI, the *Time domain resource assignment* field value m of the DCI provides a row index $m + 1$ to an allocation table. The determination of the used resource allocation table is defined in sub-clause 5.1.2.1.1. The indexed row defines the slot offset K_0 , the start and length indicator *SLIV*, or directly the start symbol S and the allocation length L , and the PDSCH mapping type to be assumed in the PDSCH reception.

Given the parameter values of the indexed row:

- The slot allocated for the PDSCH is $\left\lfloor n \cdot \frac{2^{\mu_{\text{PDSCH}}}}{2^{\mu_{\text{PDCCH}}}} \right\rfloor + K_0$, where n is the slot with the scheduling DCI, and K_0 is based on the numerology of PDSCH, and μ_{PDSCH} and μ_{PDCCH} are the subcarrier spacing configurations for PDSCH and PDCCH, respectively, and
- The starting symbol S relative to the start of the slot, and the number of consecutive symbols L counting from the symbol S allocated for the PDSCH are determined from the start and length indicator *SLIV*:

if $(L-1) \leq 7$ then

$$SLIV = 14 \cdot (L-1) + S$$

else

$$SLIV = 14 \cdot (14 - L + 1) + (14 - 1 - S)$$

where $0 < L \leq 14 - S$, and

- The PDSCH mapping type is set to Type A or Type B as defined in sub-clause 7.4.1.1.2 of [4, TS 38.211].

The UE shall consider the S and L combinations defined in table 5.1.2.1-1 as valid PDSCH allocations:

Table 5.1.2.1-1: Valid S and L combinations

PDSCH mapping type	Normal cyclic prefix			Extended cyclic prefix		
	S	L	$S+L$	S	L	$S+L$
Type A	{0,1,2,3 (Note 1)}	{3,...,14}	{3,...,14}	{0,1,2,3 (Note 1)}	{3,...,12}	{3,...,12}
Type B	{0,...,12}	{2,4,7}	{2,...,14}	{0,...,10}	{2,4,6}	{2,...,12}
Note 1: $S = 3$ is applicable only if $dmrs\text{-}TypeA\text{-}Position = 3$						

[TS 38.214, clause 5.1.2.2.1]

In downlink resource allocation of type 0, the resource block assignment information includes a bitmap indicating the Resource Block Groups (RBGs) that are allocated to the scheduled UE where a RBG is a set of consecutive virtual resource blocks defined by higher layer parameter $rbg\text{-}Size$ configured for PDSCH and the size of the carrier bandwidth part as defined in Table 5.1.2.2.1-1.

Table 5.1.2.2.1-1: Nominal RBG size P

Bandwidth Part Size	Configuration 1	Configuration 2
1 – 36	2	4
37 – 72	4	8
73 – 144	8	16
145 – 275	16	16

The total number of RBGs (N_{RBG}) for a downlink carrier bandwidth part i of size $N_{BWP,i}^{size}$ PRBs is given by

$$N_{RBG} = \left\lfloor \left(N_{BWP,i}^{size} + \left(N_{BWP,i}^{start} \bmod P \right) \right) / P \right\rfloor, \text{ where}$$

- the size of the first RBG is $RBG_0^{size} = P - N_{BWP,i}^{start} \bmod P$,
- the size of last RBG is $RBG_{last}^{size} = \left(N_{BWP,i}^{start} + N_{BWP,i}^{size} \right) \bmod P$ if $\left(N_{BWP,i}^{start} + N_{BWP,i}^{size} \right) \bmod P > 0$ and P otherwise,
- the size of all other RBGs is P .

The bitmap is of size N_{RBG} bits with one bitmap bit per RBG such that each RBG is addressable. The RBGs shall be indexed in the order of increasing frequency and starting at the lowest frequency of the carrier bandwidth part. The order of RBG bitmap is such that RBG 0 to RBG $N_{RBG} - 1$ are mapped from MSB to LSB. The RBG is allocated to the UE if the corresponding bit value in the bitmap is 1, the RBG is not allocated to the UE otherwise.

[TS 38.214, clause 5.1.2.2.2]

In downlink resource allocation of type 1, the resource block assignment information indicates to a scheduled UE a set of contiguously allocated localized or distributed virtual resource blocks within the active carrier bandwidth part of size N_{BWP}^{size} PRBs except for the case when DCI format 1_0 is decoded in the common search space in CORESET 0 in which case the initial bandwidth part of size N_{BWP}^{size} shall be used.

A downlink type 1 resource allocation field consists of a resource indication value (RIV) corresponding to a starting virtual resource block (RB_{start}) and a length in terms of contiguously allocated resource blocks L_{RBs} . The resource indication value is defined by

$$\text{if } (L_{RBs} - 1) \leq \left\lfloor N_{BWP}^{size} / 2 \right\rfloor \text{ then}$$

$$RIV = N_{BWP}^{size} (L_{RBs} - 1) + RB_{start}$$

else

$$RIV = N_{BWP}^{size} (N_{BWP}^{size} - L_{RBs} + 1) + (N_{BWP}^{size} - 1 - RB_{start})$$

where $L_{RBs} \geq 1$ and shall not exceed $N_{BWP}^{size} - RB_{start}$.

[TS 38.214, clause 5.1.3]

To determine the modulation order, target code rate, and transport block size(s) in the physical downlink shared channel, the UE shall first

- read the 5-bit *modulation and coding scheme* field (I_{MCS}) in the DCI to determine the modulation order (Q_m) and target code rate (R) based on the procedure defined in Subclause 5.1.3.1, and
- read *redundancy version* field (rv) in the DCI to determine the redundancy version.

and second

- the UE shall use the number of layers (v), the total number of allocated PRBs before rate matching (n_{PRB}) to determine the transport block size based on the procedure defined in Subclause 5.1.3.2.

The UE may skip decoding a transport block in an initial transmission if the effective channel code rate is higher than 0.95, where the effective channel code rate is defined as the number of downlink information bits (including CRC bits) divided by the number of physical channel bits on PDSCH. If the UE skips decoding, the physical layer indicates to higher layer that the transport block is not successfully decoded.

[TS 38.214, clause 5.1.3.1]

For the PDSCH scheduled by a PDCCH with DCI format 1_0 or format 1_1 with CRC scrambled by C-RNTI, new-RNTI, TC-RNTI, CS-RNTI, SI-RNTI, RA-RNTI, or P-RNTI,

if the higher layer parameter *mcs-Table* given by *PDSCH-Config* is set to 'qam256', and the PDSCH is scheduled by a PDCCH with a DCI format 1_1 and the CRC is scrambled by C-RNTI or CS-RNTI

- the UE shall use I_{MCS} and Table 5.1.3.1-2 to determine the modulation order (Q_m) and Target code rate (R) used in the physical downlink shared channel.

elseif the UE is not configured with new-RNTI, the higher layer parameter *mcs-Table* given by *PDSCH-Config* is set to 'qam64LowSE', and the PDSCH is scheduled with C-RNTI, and the PDSCH is assigned by a PDCCH in a UE-specific search space

- the UE shall use I_{MCS} and Table 5.1.3.1-3 to determine the modulation order (Q_m) and Target code rate (R) used in the physical downlink shared channel.

elseif the UE is configured with new-RNTI, and the PDSCH is scheduled with new-RNTI

- the UE shall use I_{MCS} and Table 5.1.3.1-3 to determine the modulation order (Q_m) and Target code rate (R) used in the physical downlink shared channel.

elseif the UE is not configured with the higher layer parameter *mcs-Table* given by *SPS-config*, the higher layer parameter *mcs-Table* given by *PDSCH-Config* is set to 'qam256', the PDSCH is scheduled with CS-RNTI, and the PDSCH is assigned by a PDCCH with DCI format 1_1

- the UE shall use I_{MCS} and Table 5.1.3.1-2 to determine the modulation order (Q_m) and Target code rate (R) used in the physical downlink shared channel.

elseif the UE is configured with the higher layer parameter *mcs-Table* given by *SPS-config* set to 'qam64LowSE', and the PDSCH is scheduled with CS-RNTI

- the UE shall use I_{MCS} and Table 5.1.3.1-3 to determine the modulation order (Q_m) and Target code rate (R) used in the physical downlink shared channel.

else

- the UE shall use I_{MCS} and Table 5.1.3.1-1 to determine the modulation order (Q_m) and Target code rate (R) used in the physical downlink shared channel.

End

The UE is not expected to decode a PDSCH scheduled with P-RNTI, RA-RNTI, SI-RNTI and $Q_m > 2$

...

Table 5.1.3.1-2: MCS index table 2 for PDSCH

MCS Index I_{MCS}	Modulation Order Q_m	Target code Rate $R \times [1024]$	Spectral efficiency
0	2	120	0.2344
1	2	193	0.3770
2	2	308	0.6016
3	2	449	0.8770
4	2	602	1.1758
5	4	378	1.4766
6	4	434	1.6953
7	4	490	1.9141
8	4	553	2.1602
9	4	616	2.4063
10	4	658	2.5703
11	6	466	2.7305
12	6	517	3.0293
13	6	567	3.3223
14	6	616	3.6094
15	6	666	3.9023
16	6	719	4.2129
17	6	772	4.5234
18	6	822	4.8164
19	6	873	5.1152
20	8	682.5	5.3320
21	8	711	5.5547
22	8	754	5.8906
23	8	797	6.2266
24	8	841	6.5703
25	8	885	6.9141
26	8	916.5	7.1602
27	8	948	7.4063
28	2	reserved	
29	4	reserved	
30	6	reserved	
31	8	reserved	

[TS 38.214, clause 5.1.3.2]

In case the higher layer parameter *maxNrofCodeWordsScheduledByDCI* indicates that two codeword transmission is enabled, then a transport block is disabled by DCI format 1_1 if $I_{MCS} = 26$ and if $rv_{id} = 1$ for the corresponding transport block, otherwise the transport block is enabled. If both transport blocks are enabled, transport block 1 and 2 are mapped to codeword 0 and 1 respectively. If only one transport block is enabled, then the enabled transport block is always mapped to the first codeword.

For the PDSCH assigned by a PDCCH with DCI format 1_0 or format 1_1 with CRC scrambled by C-RNTI, new-RNTI, TC-RNTI, CS-RNTI, or SI-RNTI, if Table 5.1.3.1-2 is used and $0 \leq I_{MCS} \leq 27$, or a table other than Table 5.1.3.1-2 is used and $0 \leq I_{MCS} \leq 28$, the UE shall, except if the transport block is disabled in DCI format 1_1, first determine the TBS as specified below:

- 1) The UE shall first determine the number of REs (N_{RE}) within the slot.

- A UE first determines the number of REs allocated for PDSCH within a PRB (N'_{RE}) by

$$N'_{RE} = N_{sc}^{RB} \cdot N_{sym}^{sh} - N_{DMRS}^{PRB} - N_{oh}^{PRB}, \text{ where } N_{sc}^{RB} = 12 \text{ is the number of subcarriers in a physical resource}$$

block, N_{symp}^{sh} is the number of symbols of the PDSCH allocation within the slot, N_{DMRS}^{PRB} is the number of REs for DM-RS per PRB in the scheduled duration including the overhead of the DM-RS CDM groups without data, as indicated by DCI format 1_1 or as described for format 1_0 in Subclause 5.1.6.2, and N_{oh}^{PRB} is the overhead configured by higher layer parameter $xOverhead$ in *PDSCH-ServingCellConfig*. If the $xOverhead$ in *PDSCH-ServingCellConfig* is not configured (a value from 0, 6, 12, or 18), the N_{oh}^{PRB} is set to 0. If the PDSCH is scheduled by PDCCH with a CRC scrambled by SI-RNTI, RA-RNTI or P-RNTI, N_{oh}^{PRB} is assumed to be 0.

- A UE determines the total number of REs allocated for PDSCH (N_{RE}) by $N_{RE} = \min(156, N_{RE}') \cdot n_{PRB}$, where n_{PRB} is the total number of allocated PRBs for the UE.

2) Intermediate number of information bits (N_{info}) is obtained by $N_{info} = N_{RE} \cdot R \cdot Q_m \cdot \nu$.

If $N_{info} \leq 3824$

Use step 3 as the next step of the TBS determination

else

Use step 4 as the next step of the TBS determination

end if

3) When $N_{info} \leq 3824$, TBS is determined as follows

- quantized intermediate number of information bits $N_{info}' = \max\left(24, 2^n \cdot \left\lfloor \frac{N_{info}}{2^n} \right\rfloor\right)$, where $n = \max(3, \lfloor \log_2(N_{info}) \rfloor - 6)$.
- use Table 5.1.3.2-2 find the closest TBS that is not less than N_{info}' .

Table 5.1.3.2-2: TBS for $N_{info} \leq 3824$

Index	TBS	Index	TBS	Index	TBS	Index	TBS
1	24	31	336	61	1288	91	3624
2	32	32	352	62	1320	92	3752
3	40	33	368	63	1352	93	3824
4	48	34	384	64	1416		
5	56	35	408	65	1480		
6	64	36	432	66	1544		
7	72	37	456	67	1608		
8	80	38	480	68	1672		
9	88	39	504	69	1736		
10	96	40	528	70	1800		
11	104	41	552	71	1864		
12	112	42	576	72	1928		
13	120	43	608	73	2024		
14	128	44	640	74	2088		
15	136	45	672	75	2152		
16	144	46	704	76	2216		
17	152	47	736	77	2280		
18	160	48	768	78	2408		
19	168	49	808	79	2472		
20	176	50	848	80	2536		
21	184	51	888	81	2600		
22	192	52	928	82	2664		
23	208	53	984	83	2728		
24	224	54	1032	84	2792		

25	240	55	1064	85	2856		
26	256	56	1128	86	2976		
27	272	57	1160	87	3104		
28	288	58	1192	88	3240		
29	304	59	1224	89	3368		
30	320	60	1256	90	3496		

4) When $N_{info} > 3824$, TBS is determined as follows.

- quantized intermediate number of information bits $N'_{info} = \max\left(3840, 2^n \times \text{round}\left(\frac{N_{info} - 24}{2^n}\right)\right)$, where $n = \lfloor \log_2(N_{info} - 24) \rfloor - 5$ and ties in the round function are broken towards the next largest integer.

- if $R \leq 1/4$

$$TBS = 8 \cdot C \cdot \left\lceil \frac{N'_{info} + 24}{8 \cdot C} \right\rceil - 24, \text{ where } C = \left\lceil \frac{N'_{info} + 24}{3816} \right\rceil$$

else

if $N'_{info} > 8424$

$$TBS = 8 \cdot C \cdot \left\lceil \frac{N'_{info} + 24}{8 \cdot C} \right\rceil - 24, \text{ where } C = \left\lceil \frac{N'_{info} + 24}{8424} \right\rceil$$

else

$$TBS = 8 \cdot \left\lceil \frac{N'_{info} + 24}{8} \right\rceil - 24$$

end if

end if

7.1.1.4.1.4.3 Test description

7.1.1.4.1.4.3.1 Pre-test conditions

Same Pre-test conditions as in clause 7.1.1.0 except set the NR Cell bandwidth and applicable BWP to maximum for the NR Band under test as specified in Table 5.3.5-1 in TS 38.101-1 [16] / TS 38.101-2 [17] (to enable testing of n_{PRB} up to maximum value).

Test frequency NRf1 is as specified in TS 38.508-1[4] clause 4.3.1 using the common highest UL and DL channel bandwidth and using the default subcarrier spacing specified in TS 38.508-1[4] clause 6.2.3.1.

7.1.1.4.1.4.3.2 Test procedure sequence

Table 7.1.1.4.1.4.3.2-1: Maximum TBS for different UE categories

UE Category	Maximum number of bits of a UL-SCH transport block received within a TTI
TS 38.306 [23] clause 4.1.2 require UE without ue-CategoryDL and ue-CategoryUL, to support Max TBS achievable based on max bandwidth of the Band under test.	

Table 7.1.1.4.1.4.3.2-2: Number of downlink PDCP SDUs and PDCP SDU size used as test data

TBS [bits]	Number of PDCP SDUs	PDCP SDU size [bits] (Note 1)
192 ≤ TBS ≤ 12184 note 2	1	8*FLOOR((TBS – 184)/8)
12185 ≤ TBS ≤ 24256	2	8*FLOOR((TBS – 256)/16)
24257 ≤ TBS ≤ 36328	3	8*FLOOR((TBS – 328)/24)
36329 ≤ TBS ≤ 48400	4	8*FLOOR((TBS – 400)/32)
48401 ≤ TBS ≤ 60472	5	8*FLOOR((TBS – 472)/40)
60473 ≤ TBS ≤ 72544	6	8*FLOOR((TBS – 544)/48)
72545 ≤ TBS ≤ 84616	7	8*FLOOR((TBS – 616)/56)
84617 ≤ TBS ≤ 96688	8	8*FLOOR((TBS – 688)/64)
96689 < TBS ≤ 108760	9	8*FLOOR((TBS – 760)/72)
108761 ≤ TBS ≤ 120832	10	8*FLOOR((TBS – 832)/80)
120833 ≤ TBS ≤ 132904	11	8*FLOOR((TBS – 904)/88)
132905 ≤ TBS ≤ 144976	12	8*FLOOR((TBS – 976)/96)
144785 ≤ TBS ≤ 157048	13	8*FLOOR((TBS – 1048)/104)
157049 ≤ TBS ≤ 169120	14	8*FLOOR((TBS – 1120)/112)
169121 < TBS ≤ 181192	15	8*FLOOR((TBS – 1192)/120)
181193 ≤ TBS ≤ 193264	16	8*FLOOR((TBS – 1264)/128)
193337 ≤ TBS ≤ 205336	17	8*FLOOR((TBS – 1336)/136)
205409 ≤ TBS ≤ 217408	18	8*FLOOR((TBS – 1408)/144)
TBS > 217408	19	8*FLOOR((TBS – 1480)/152)

Note 1: Each PDCP SDU is limited to 1500 octets (to keep below maximum SDU size of ESM as specified in TS 24.301 [21] clause 9.9.4.12).

The PDCP SDU size of each PDCP SDU is

PDCP SDU size = (TBS – N*PDCP header size – N*AMD PDU header size – N*MAC header size – Size of Timing Advance – RLC Status PDU size- MAC header for RLC Status PDU – 32 bit Additional RLC header with SO if one RLC SDU gets split in 2 TBS and 24 bit MAC header for this additional PDU) / N, where

PDCP header size is 24 bits for the RLC AM and 18-bit SN case;
AMD PDU header size is 24 bits with 18 bit SN;

MAC header size for AMD PDU = 16 or 24 bits depending on L=8 or 16 bits. Worst case 24 is taken.

Size of Timing Advance MAC CE with header is 16 bits (if no Timing Advance and/or RLC status needs to be sent, padding will occur instead).
IF RLC SDU does not get split the 32 bits additional padding gets added instead

RLC Status PDU size = 24 bits with 1 ACK_SN, With a MAC header of 16 bits.

This gives:

PDCP SDU size = 8*FLOOR((TBS – N*24- N*24- N*24 -112)/(8*N)) bits.

Note 2: According to the final PDCP SDU size formula in Note 1, the smallest TBS that can be tested is 192 bits.

Table 7.1.1.4.1.4.3.2-2A: Bandwidth part Dependent Parameters for Resource allocation 0 with start of BWP assumed as 0

$N_{RB}^{DL,BWP} = N_{BWP,i}^{size}$	Nominal RBG size P (Configuration1)	Size of last RBG	Allowed N_{PRB} Values
11	2	1	All 1...11
18	2	2	2,4,6,8,10,12,16,18
24	2	2	2,4,6,8,10,12,16,18,20,22,24
25	2	1	All 1...25
31	2	1	All 1...31
32	2	2	2,4,6,8,10,12,16,18,20,22,24,26,28,30,32
38	4	2	2,4,6,8,10,12,16,18,20,22,24,26,28,30,32,34,36,38
51	4	3	3,4,7,8,11,12,15,16,19,20,23,24,27,28,31,32,35,36,39,40,43,44,47,48,51

52	4	4	4,8,12,16,20,24,28,32,36,40,44,48,52
65	4	1	1,4,5,8,9,12,13,16,17,20,21,24,25,28,29,32,33,36,37,40,41,44,45,48,49,52,53,56,57,60,61,64,65
66	4	2	2,4,6,8,10,12,16,18,20,22,24,26,28,30,32,34,36,38,40,42,44,46,48,50,52,54,56,58,60,62,64,66
79	8	7	7,8,15,16,23,24,31,32,39,40,47,48,55,56,63,64,71,72,79
106	8	2	2,8,10,16,18,24,26,32,34,40,42,48,50,56,58,64,66,72,74,80,82,88,90,96,92,104,106
107	8	3	3,8,11,16,19,24,27,32,35,40,43,48,51,56,59,64,67,72,75,80,83,88,91,96,99,104,107
132	8	4	4,8,12,16,20,24,28,32,36,40,44,48,52,56,60,64,68,72,76,80,84,88,92,96,100,104,108,112,116,120,124,128,132
133	8	5	5,8,13,16,21,24,29,32,37,40,45,48,53,56,61,64,69,72,77,80,85,88,93,96,101,104,109,112,117,120,125,128,133
135	8	7	7,8,15,16,23,24,31,32,39,40,47,48,55,56,63,64,71,72,79,80,87,88,95,96,103,104,111,112,119,120,127,128,135
160	16	16	16,32,48,64,80,96,112,128,144,160
216	16	8	8,16,24,32,40,48,56,64,72,80,88,96,104,112,120,128,136,144,152,160,168,176,184,192,200,208,216
217	16	9	9,16,25,32,41,48,57,64,73,80,89,96,105,112,121,128,137,144,153,160,169,176,185,192,201,208,217
264	16	8	8,16,24,32,40,48,56,64,72,80,88,96,104,112,120,128,136,144,160,168,176,184,192,200,208,216,224,232,240,248,256,264
270	16	14	14,16,30,32,46,44,62,64,78,80,94,96,110,112,126,128,142,144,158,160,174,176,190,192,206,208,222,224,238,240,254,256,270
273	16	1	1,16,17,32,33,48,49,64,65,80,81,96,97,112,113,128,129,144,145,160,161,176,171,192,193,208,209,224,225,240,241,256,257,272,273

Table 7.1.1.4.1.4.3.2-3: Specific Parameter

Parameter	Value	Comments	Condition
PDSCH mappingType	typeA		
starting symbol S	0 Or 3 to avoid clash with PDCCH symbols		
number of consecutive symbols L	3..14-S		
≤ 0	0 or 1 (if S=0)		
number of layers (v)	1		
qcs-Table	qam256		
xoh-PDSCH	Not present	Results in value 0(xoh0)	
dmrs-AdditionalPosition	pos0	Results in 1 DMRS symbol per two carrier (N_{DMRS}^{PDSCH}) for Duration in symbols ≥ 3 (TS 38.211 [24], table 7.4.1.1.2-3)	
resourceAllocation	dynamicSwitch		pc_dynamicSwitchRA_Type0_1_PDSC
	resourceAllocationType0		NOT pc_dynamicSwitchRA_Type0_1_PDSC AND Steps 1-5
	resourceAllocationType1		NOT pc_dynamicSwitchRA_Type0_1_PDSC AND Steps 6-10
maxNrofCodeWordsScheduledByDCI	n2	both codewords enabled	
rbg-Size	Not present	configuration 1 applicable	
N_{start}^{BWP}	0		

Table 7.1.1.4.1.4.3.2-4: Main behaviour

St	Procedure	Message Sequence		TP	Verdict
		U - S	Message		

-	EXCEPTION: Steps 1 to 5 are repeated for allowed values of N_{PRB} as per Table 7.1.1.4.1.4.3.2-2A in BWP, time domain resource as per table 7.1.1.4.1.0-1 and I_{MCS} from 0 to 27. NOTE: Skip the execution of steps for which the TBS size results in coding rate exceeding 0.95.	-	-	-	-
1	SS calculates or looks up TBS in TS 38.214 [15] based on the value of S, L, I_{MCS} and n_{PRB} . The SS uses the same I_{MCS} and TBS for both transport blocks: $I_{MCS\#1} = I_{MCS\#2} = I_{MCS}$ TBS 1= TBS 2= TBS	-	-	-	-
-	EXCEPTION: Steps 2 to 5 are performed if TBS1 + TBS2 is less than or equal to UE capability "Maximum number of DL-SCH transport block bits received within a TTI" as specified in Table 7.1.1.4.1.4.3.2-1 and larger than or equal to 192 bits as specified in Table 7.1.1.4.1.4.3.2-2.	-	-	-	-
2	SS creates one or more PDCP SDUs for transport block 1 and 2 depending on TBS1, and TBS2 in accordance with Table 7.1.1.4.1.4.3.2-2.	-	-	-	-
3	SS transmits the PDCP SDUs concatenated into a MAC PDU and indicates on PDCCH DCI Format 1_1 resource allocation 0 and values of S, L, $I_{MCS\#1}$, $I_{MCS\#2}$ and n_{PRB} .	<--	Transport block 1: MAC PDU Transport block 2: MAC PDU DCI: (DCI Format 1_1, S, $I_{MCS\#1}$, $I_{MCS\#2}$ and n_{PRB} .)	-	-
4	At the reception of scheduling request the SS transmits UL Grant for transmitting loop back PDCP SDUs.	<--	(UL Grant)	-	-
5	CHECK: Does UE return the same number of PDCP SDUs with same content as transmitted by the SS in step 3?	-->	(NxPDCP SDUs)	1	P
-	EXCEPTION : Steps 5Aa1 to 5Aa2 are executed if NOT $pc_dynamicSwitchRA_Type0_1_PDSCH$	-	-	-	-
5A a1	The SS transmits a NR RRCReconfiguration message including <i>PDSCH-Config</i> with IE resourceAllocation set to resourceAllocationType1 (Note 1)	<--	<i>RRCReconfiguration</i>	-	-
5A a2	The UE transmit a NR <i>RRCReconfigurationComplete</i> message. (Note 2)	-->	<i>RRCReconfigurationComplete</i>	-	-
-	EXCEPTION: Steps 6 to 10 are repeated for allowed values of N_{PRB} 1 to $N_{RB}^{DL,BWP}$ in BWP, time domain resource length L 3 to 14- S and I_{MCS} from 0 to 27.	-	-	-	-
6	SS calculates or looks up TBS in TS 38.214 [15] based on the value of S, L, I_{MCS} and n_{PRB} . The SS uses the same I_{MCS} and TBS for both transport blocks: $I_{MCS\#1} = I_{MCS\#2} = I_{MCS}$ TBS 1= TBS 2= TBS	-	-	-	-

-	EXCEPTION: Steps 7 to 10 are performed if TBS1 + TBS2 is less than or equal to UE capability "Maximum number of DL-SCH transport block bits received within a TTI" as specified in Table 7.1.1.4.1.4.3.2-1 and larger than or equal to 192 bits as specified in Table 7.1.1.4.1.4.3.2-2	-	-	-	-
7	SS creates one or more PDCP SDUs for transport block 1 and 2 depending on TBS1, and TBS2 in accordance with Table 7.1.1.4.1.4.3.2-2.	-	-	-	-
8	SS transmits the PDCP SDUs concatenated into a MAC PDU and indicates on PDCCH DCI Format 1_1 resource allocation 1 and values of S, L, $I_{MCS\#1}$, $I_{MCS\#2}$ and n_{PRB} .	<--	Transport block 1: MAC PDU Transport block 2: MAC PDU DCI: (DCI Format 1_1, S, $I_{MCS\#1}$, $I_{MCS\#2}$ and n_{PRB} .)	-	-
9	At the reception of scheduling request the SS transmits UL Grant for transmitting loop back PDCP SDUs.	<--	(UL Grant)	-	-
10	CHECK: Does UE return the same number of PDCP SDUs with same content as transmitted by the SS in step 3?	-->	(NxPDCP SDUs)	2	P
Note 1: For EN-DC the NR RRCReconfiguration message is contained in RRCConnectionReconfiguration 36.508 [7], Table 4.6.1-8 using condition EN-DC_EmbedNR_RRCRecon.					
Note 2: For EN-DC the NR RRCReconfigurationComplete message is contained in RRCConnectionReconfigurationComplete.					

7.1.1.4.1.4.3.3 Specific message contents

None.

7.1.1.4.1.5 DL-SCH transport block size selection / DCI format 1_2

7.1.1.4.1.5.1 Test Purpose (TP)

(1)

```
with { UE in RRC_CONNECTED state }
ensure that {
  when { UE on PDCCH receives DCI format 1_2 indicating a resource block assignment correspondent to
physical resource blocks , Time domain resource assignment and a modulation and coding }
  then { UE decodes the received transport block of size correspondent as per Modulation Coding
scheme, time domain resource allocation and PRB's and forwards it to higher layers }
}
```

7.1.1.4.1.5.2 Conformance requirements

References: The conformance requirements covered in the present TC are specified in: TS 38.212 clause 7.3.1.2.3, TS 38.214 clause 5.1.2.1, 5.1.2.2, 5.1.2.2.1, 5.1.2.2.2, 5.1.3, 5.1.3.1 and 5.1.3.2. Unless otherwise stated these are Rel-16 requirements.

[TS 38.212, clause 7.3.1.2.3]

DCI format 1_2 is used for the scheduling of PDSCH in one cell.

The following information is transmitted by means of the DCI format 1_2 with CRC scrambled by C-RNTI or CS-RNTI or MCS-C-RNTI:

- Identifier for DCI formats – 1 bits
- The value of this bit field is always set to 1, indicating a DL DCI format.
- Carrier indicator – 0, 1, 2 or 3 bits determined by higher layer parameter *carrierIndicatorSizeDCI-1-2*, as defined in Clause 10.1 of [5, TS38.213].

- Bandwidth part indicator – 0, 1 or 2 bits as determined by the number of DL BWPs $n_{BWP,RRC}$ configured by higher layers, excluding the initial DL bandwidth part. The bitwidth for this field is determined as $\lceil \log_2(n_{BWP}) \rceil$ bits, where
 - $n_{BWP} = n_{BWP,RRC} + 1$ if $n_{BWP,RRC} \leq 3$, in which case the bandwidth part indicator is equivalent to the ascending order of the higher layer parameter *BWP-Id*;
 - otherwise $n_{BWP} = n_{BWP,RRC}$, in which case the bandwidth part indicator is defined in Table 7.3.1.1.2-1;

If a UE does not support active BWP change via DCI, the UE ignores this bit field.

- Frequency domain resource assignment – number of bits determined by the following:
 - N_{RBG} bits if only resource allocation type 0 is configured, where N_{RBG} is defined in Clause 5.1.2.2.1 of [6, TS 38.214];
 - $\lceil \log_2(N_{RBG,K2}(N_{RBG,K2} + 1)/2) \rceil$ bits if only resource allocation type 1 is configured, or $\max(\lceil \log_2(N_{RBG,K2}(N_{RBG,K2} + 1)/2) \rceil, N_{RBG}) + 1$ bits if *resourceAllocationDCI-1-2-r16* is configured as 'dynamicSwitch', where $N_{RBG,K2} = \lceil (N_{RB}^{DL,BWP} + (N_{DL,BWP}^{start} \bmod K2)) / K2 \rceil$, $N_{RB}^{DL,BWP}$ is the size of the active DL bandwidth part, $N_{DL,BWP}^{start}$ is defined as in clause 4.4.4.4 of [4, TS 38.211] and $K2$ is determined by higher layer parameter *resourceAllocationType1GranularityDCI-1-2*. If the higher layer parameter *resourceAllocationType1GranularityDCI-1-2* is not configured, $K2$ is equal to 1.
 - If *resourceAllocationDCI-1-2-r16* is configured as 'dynamicSwitch', the MSB bit is used to indicate resource allocation type 0 or resource allocation type 1, where the bit value of 0 indicates resource allocation type 0 and the bit value of 1 indicates resource allocation type 1.
 - For resource allocation type 0, the N_{RBG} LSBs provide the resource allocation as defined in Clause 5.1.2.2.1 of [6, TS 38.214].
 - For resource allocation type 1, the $\lceil \log_2(N_{RBG,K2}(N_{RBG,K2} + 1)/2) \rceil$ LSBs provide the resource allocation as defined in Clause 5.1.2.2.2 of [6, TS 38.214]

If "Bandwidth part indicator" field indicates a bandwidth part other than the active bandwidth part and if *resourceAllocationDCI-1-2-r16* is configured as 'dynamicSwitch' for the indicated bandwidth part, the UE assumes resource allocation type 0 for the indicated bandwidth part if the bitwidth of the "Frequency domain resource assignment" field of the active bandwidth part is smaller than the bitwidth of the "Frequency domain resource assignment" field of the indicated bandwidth part.

- Time domain resource assignment – 0, 1, 2, 3, or 4 bits as defined in Clause 5.1.2.1 of [6, TS 38.214]. The bitwidth for this field is determined as $\lceil \log_2(I) \rceil$ bits, where I is the number of entries in the higher layer parameter *pdsch-TimeDomainAllocationListDCI-1-2* if the higher layer parameter is configured, or I is the number of entries in the higher layer parameter *pdsch-TimeDomainAllocationList* if the higher layer parameter *pdsch-TimeDomainAllocationListDCI-1-2* is not configured; otherwise I is the number of entries in the default table.
- VRB-to-PRB mapping – 0 or 1 bit:
 - 0 bit if the higher layer parameter *vrB-ToPRB-InterleaverDCI-1-2* is not configured;
 - 1 bit according to Table 7.3.1.2.2-5 otherwise, only applicable to resource allocation type 1, as defined in Clause 7.3.1.6 of [4, TS 38.211].
- PRB bundling size indicator – 0 bit if the higher layer parameter *prB-BundlingTypeDCI-1-2* is not configured or is set to 'static', or 1 bit if the higher layer parameter *prB-BundlingTypeDCI-1-2* is set to 'dynamic' according to Clause 5.1.2.3 of [6, TS 38.214].
- Rate matching indicator – 0, 1, or 2 bits according to higher layer parameters *rateMatchPatternGroup1DCI-1-2* and *rateMatchPatternGroup2DCI-1-2*, where the MSB is used to indicate *rateMatchPatternGroup1DCI-1-2* and the LSB is used to indicate *rateMatchPatternGroup2DCI-1-2* when there are two groups.
- ZP CSI-RS trigger – 0, 1, or 2 bits as defined in Clause 5.1.4.2 of [6, TS 38.214]. The bitwidth for this field is determined as $\lceil \log_2(n_{ZF} + 1) \rceil$ bits, where n_{ZF} is the number of aperiodic ZP CSI-RS resource sets configured by higher layer parameter *aperiodicZP-CSI-RS-ResourceSetsToAddModListDCI-1-2*.

- Modulation and coding scheme – 5 bits as defined in Clause 5.1.3.1 of [6, TS 38.214]
- New data indicator – 1 bit
- Redundancy version – 0, 1 or 2 bits determined by higher layer parameter *numberOfBitsForRV-DCI-1-2*
 - If 0 bit is configured, *rv_{id}* to be applied is 0;
 - 1 bit according to Table 7.3.1.2.3-1;
 - 2 bits according to Table 7.3.1.1.1-2.
- HARQ process number – 0, 1, 2, 3 or 4 bits determined by higher layer parameter *harq-ProcessNumberSizeDCI-1-2*
- Downlink assignment index – 0, 1, 2 or 4 bits
 - 0 bit if the higher layer parameter *downlinkAssignmentIndexDCI-1-2* is not configured;
 - 1, 2 or 4 bits determined by higher layer parameter *downlinkAssignmentIndexDCI-1-2* otherwise,
 - 4 bits if more than one serving cell are configured in the DL and the higher layer parameter *pdsch-HARQ-ACK-Codebook=dynamic*, where the 2 MSB bits are the counter DAI and the 2 LSB bits are the total DAI
 - 4 bits if one serving cell are configured in the DL and the higher layer parameter *pdsch-HARQ-ACK-Codebook=dynamic*, and the UE is not provided *coresetPoolIndex* or is provided *coresetPoolIndex* with value 0 for one or more first CORESETs and is provided *coresetPoolIndex* with value 1 for one or more second CORESETs, and is provided *ackNackFeedbackMode = joint*, where the 2 MSB bits are the counter DAI and the 2 LSB bits are the total DAI.
 - 1 or 2 bits if only one serving cell is configured in the DL and the higher layer parameter *pdsch-HARQ-ACK-Codebook=dynamic*, when the UE is not configured with *coresetPoolIndex* or the value of *coresetPoolIndex* is the same for all CORESETs if *coresetPoolIndex* is provided or the UE is not configured with *ackNackFeedbackMode = joint*, where the 1 bit or 2 bits are the counter DAI.

If higher layer parameter *priorityIndicatorDCI-1-2* is configured, if the bit width of the Downlink assignment index in DCI format 1_2 for one HARQ-ACK codebook is not equal to that of the Downlink assignment index in DCI format 1_2 for the other HARQ-ACK codebook, a number of most significant bits with value set to '0' are inserted to smaller Downlink assignment index until the bit width of the Downlink assignment index in DCI format 1_2 for the two HARQ-ACK codebooks are the same.

- TPC command for scheduled PUCCH – 2 bits as defined in Clause 7.2.1 of [5, TS 38.213]
- PUCCH resource indicator – 0 or 1 or 2 or 3 bits determined by higher layer parameter *numberOfBitsForPUCCH-ResourceIndicatorDCI-1-2*
- PDSCH-to-HARQ_feedback timing indicator – 0, 1, 2, or 3 bits as defined in Clause 9.2.3 of [5, TS 38.213]. The bitwidth for this field is determined as $\lceil \log_2(I) \rceil$ bits, where *I* is the number of entries in the higher layer parameter *DL-DataToUL-ACK-DCI-1-2*.

If higher layer parameter *priorityIndicatorDCI-1-2* is configured, if the bit width of the PDSCH-to-HARQ_feedback timing indicator in DCI format 1_2 for one HARQ-ACK codebook is not equal to that of the PDSCH-to-HARQ_feedback timing indicator in DCI format 1_2 for the other HARQ-ACK codebook, a number of most significant bits with value set to '0' are inserted to smaller PDSCH-to-HARQ_feedback timing indicator until the bit width of the PDSCH-to-HARQ_feedback timing indicator in DCI format 1_2 for the two HARQ-ACK codebooks are the same.

- Antenna port(s) – 0, 4, 5, or 6 bits
 - 0 bit if higher layer parameter *antennaPortsFieldPresenceDCI-1-2* is not configured;
 - Otherwise 4, 5 or 6 bits as defined by Tables 7.3.1.2.2-1/2/3/4, where the number of CDM groups without data of values 1, 2, and 3 refers to CDM groups {0}, {0,1}, and {0, 1,2} respectively. The antenna ports $\{p_0, \dots, p_{V-1}\}$ shall be determined according to the ordering of DMRS port(s) given by Tables 7.3.1.2.2-1/2/3/4. If a UE is configured with both *dmrs-DownlinkForPDSCH-MappingTypeA-DCI-1-2* and *dmrs-*

DownlinkForPDSCH-MappingTypeB-DCI-1-2 and is configured with higher layer parameter *antennaPortsFieldPresenceDCI-1-2*, the bitwidth of this field equals $\max\{x_A, x_B\}$, where x_A is the "Antenna ports" bitwidth derived according to *dmrs-DownlinkForPDSCH-MappingTypeA-DCI-1-2* and x_B is the "Antenna ports" bitwidth derived according to *dmrs-DownlinkForPDSCH-MappingTypeB-DCI-1-2*. A number of $|x_A - x_B|$ zeros are padded in the MSB of this field, if the mapping type of the PDSCH corresponds to the smaller value of x_A and x_B .

If a UE is not configured with higher layer parameter *antennaPortsFieldPresenceDCI-1-2*, antenna port(s) are defined assuming bit field index value 0 in Tables 7.3.1.2.2-1/2/3/4.

- Transmission configuration indication – 0 bit if higher layer parameter *tci-PresentDCI-1-2* is not configured; otherwise 1 or 2 or 3 bits determined by higher layer parameter *tci-PresentDCI-1-2* as defined in Clause 5.1.5 of [6, TS38.214].

If "Bandwidth part indicator" field indicates a bandwidth part other than the active bandwidth part,

- if the higher layer parameter *tci-PresentDCI-1-2* is not configured for the CORESET used for the PDCCH carrying the DCI format 1_2,
 - the UE assumes *tci-PresentDCI-1-2* is not configured for all CORESETs in the indicated bandwidth part;
- otherwise,
 - the UE assumes *tci-PresentDCI-1-2* is configured for all CORESETs in the indicated bandwidth part with the same value configured for the CORESET used for the PDCCH carrying the DCI format 1_2.
- SRS request – 0, 1, 2 or 3 bits
 - 0 bit if the higher layer parameter *srs-RequestDCI-1-2* is not configured;
 - 1 bit as defined by Table 7.3.1.1.3-1 if the higher layer parameter *srs-RequestDCI-1-2* = 1 and for UEs not configured with *supplementaryUplink* in *ServingCellConfig* in the cell;
 - 2 bits if the higher layer parameter *srs-RequestDCI-1-2* = 1 and for UEs configured with *supplementaryUplink* in *ServingCellConfig* in the cell, where the first bit is the non-SUL/SUL indicator as defined in Table 7.3.1.1.1-1 and the second bit is defined by Table 7.3.1.1.3-1;
 - 2 bits as defined by Table 7.3.1.1.2-24 if the higher layer parameter *srs-RequestDCI-1-2* = 2 and for UEs not configured with *supplementaryUplink* in *ServingCellConfig* in the cell;
 - 3 bits if the higher layer parameter *srs-RequestDCI-1-2* = 2 and for UEs configured with *supplementaryUplink* in *ServingCellConfig* in the cell, where the first bit is the non-SUL/SUL indicator as defined in Table 7.3.1.1.1-1 and the second and third bits are defined by Table 7.3.1.1.2-24;
- DMRS sequence initialization – 0 or 1 bit
 - 0 bit if the higher layer parameter *dmrs-SequenceInitializationDCI-1-2* is not configured;
 - 1 bit otherwise.
- Priority indicator – 0 bit if higher layer parameter *priorityIndicatorDCI-1-2* is not configured; otherwise 1 bit as defined in Clause 9 in [5, TS 38.213].

If DCI formats 1_2 are monitored in multiple search spaces associated with multiple CORESETs in a BWP for scheduling the same serving cell, zeros shall be appended until the payload size of the DCI formats 1_2 monitored in the multiple search spaces equal to the maximum payload size of the DCI format 1_2 monitored in the multiple search spaces.

Table 7.3.1.2.3-1: Redundancy version

Value of the Redundancy version field	Value of rv_{id} to be applied
0	0
1	3

[TS 38.214, clause 5.1.2.1]

When the UE is scheduled to receive PDSCH by a DCI, the *Time domain resource assignment* field value m of the DCI provides a row index $m + 1$ to an allocation table. The determination of the used resource allocation table is defined in Clause 5.1.2.1.1. The indexed row defines the slot offset K_0 , the start and length indicator $SLIV$, or directly the start symbol S and the allocation length L , and the PDSCH mapping type to be assumed in the PDSCH reception.

Given the parameter values of the indexed row:

- The slot allocated for the PDSCH is K_s , where

$$K_s = \left\lfloor n \cdot \frac{2^{\mu_{\text{PDSCH}}}}{2^{\mu_{\text{PDCCH}}}} \right\rfloor + K_0 + \left\lfloor \left(\frac{N_{\text{slot,offset,PDCCH}}^{\text{CA}}}{2^{\mu_{\text{offset,PDCCH}}}} - \frac{N_{\text{slot,offset,PDSCH}}^{\text{CA}}}{2^{\mu_{\text{offset,PDSCH}}}} \right) \cdot 2^{\mu_{\text{PDSCH}}} \right\rfloor, \text{ if UE is configured with } ca-$$

$$\text{SlotOffset for at least one of the scheduled and scheduling cell, and } K_s = \left\lfloor n \cdot \frac{2^{\mu_{\text{PDSCH}}}}{2^{\mu_{\text{PDCCH}}}} \right\rfloor + K_0, \text{ otherwise, and}$$

where n is the slot with the scheduling DCI, and K_0 is based on the numerology of PDSCH, and μ_{PDSCH} and μ_{PDCCH} are the subcarrier spacing configurations for PDSCH and PDCCH, respectively, and

- $N_{\text{slot,offset,PDCCH}}^{\text{CA}}$ and $\mu_{\text{offset,PDCCH}}$ are the $N_{\text{slot,offset}}^{\text{CA}}$ and the μ_{offset} , respectively, which are determined by higher-layer configured $ca\text{-SlotOffset}$, for the cell receiving the PDCCH respectively, $N_{\text{slot,offset,PDSCH}}^{\text{CA}}$ and $\mu_{\text{offset,PDSCH}}$ are the $N_{\text{slot,offset}}^{\text{CA}}$ and the μ_{offset} , respectively, which are determined by higher-layer configured $ca\text{-SlotOffset}$ for the cell receiving the PDSCH, as defined in clause 4.5 of [4, TS 38.211].
- The reference point S_0 for starting symbol S is defined as:
 - if configured with *referenceOfSLIVDCI-1-2*, and when receiving PDSCH scheduled by DCI format 1_2 with CRC scrambled by C-RNTI, MCS-C-RNTI, CS-RNTI with $K_0=0$, and PDSCH mapping Type B, the starting symbol S is relative to the starting symbol S_0 of the PDCCH monitoring occasion where DCI format 1_2 is detected;
 - otherwise, the starting symbol S is relative to the start of the slot using $S_0=0$.
- The number of consecutive symbols L counting from the starting symbol S allocated for the PDSCH are determined from the start and length indicator $SLIV$:

if $(L-1) \leq 7$ then

$$SLIV = 14 \cdot (L-1) + S$$

else

$$SLIV = 14 \cdot (14-L+1) + (14-1-S)$$

where $0 < L \leq 14-S$, and

- the PDSCH mapping type is set to Type A or Type B as defined in Clause 7.4.1.1.2 of [4, TS 38.211].

The UE shall consider the S and L combinations defined in table 5.1.2.1-1 satisfying $S_0 + S + L \leq 14$ for normal cyclic prefix and $S_0 + S + L \leq 12$ for extended cyclic prefix as valid PDSCH allocations:

Table 5.1.2.1-1: Valid S and L combinations

PDSCH mapping type	Normal cyclic prefix			Extended cyclic prefix		
	S	L	$S+L$	S	L	$S+L$
Type A	{0,1,2,3} (Note 1)	{3,...,14}	{3,...,14}	{0,1,2,3} (Note 1)	{3,...,12}	{3,...,12}
Type B	{0,...,12}	{2,...,13}	{2,...,14}	{0,...,10}	{2,4,6}	{2,...,12}

Note 1: $S = 3$ is applicable only if $dmrs\text{-TypeA-Position} = 3$

[38.214 clause 5.1.2.2]

Two downlink resource allocation schemes, type 0 and type 1, are supported. The UE shall assume that when the scheduling grant is received with DCI format 1_0, then downlink resource allocation type 1 is used.

If the scheduling DCI is configured to indicate the downlink resource allocation type as part of the '*Frequency domain resource assignment*' field by setting a higher layer parameter *resourceAllocation* in *PDSCH-Config* to 'dynamicSwitch', for DCI format 1_1 or setting a higher layer parameter *resourceAllocationDCI-1-2* in *PDSCH-Config* to 'dynamicSwitch' for DCI format 1_2, the UE shall use downlink resource allocation type 0 or type 1 as defined by this DCI field. Otherwise the UE shall use the downlink frequency resource allocation type as defined by the higher layer parameter *resourceAllocation* for DCI format 1_1 or by the higher layer parameter *resourceAllocationDCI-1-2* for DCI format 1_2.

[38.214 clause 5.1.2.2.1]

In downlink resource allocation of type 0, the resource block assignment information includes a bitmap indicating the Resource Block Groups (RBGs) that are allocated to the scheduled UE where a RBG is a set of consecutive virtual resource blocks defined by higher layer parameter *rbg-Size* configured by *PDSCH-Config* and the size of the bandwidth part as defined in Table 5.1.2.2.1-1.

Table 5.1.2.2.1-1: Nominal RBG size *P*

Bandwidth Part Size	Configuration 1	Configuration 2
1 – 36	2	4
37 – 72	4	8
73 – 144	8	16
145 – 275	16	16

[38.214 clause 5.1.2.2.2]

When the scheduling grant is received with DCI format 1_2, a downlink type 1 resource allocation field consists of a resource indication value (*RIV*) corresponding to a starting resource block group $RBG_{start}=0, 1, \dots, N_{RBG}-1$ and a length in terms of virtually contiguously allocated resource block groups $L_{RBGs}=1, \dots, N_{RBG}$, where the resource block groups are defined as in 5.1.2.2.1 with *P* defined by *resourceAllocationType1GranularityDCI-1-2* if the UE is configured with higher layer parameter *resourceAllocationType1GranularityDCI-1-2*, and $P=1$ otherwise. The resource indication value is defined by

if $(L_{RBGs} - 1) \leq \lfloor N_{RBG} / 2 \rfloor$ then

$$RIV = N_{RBG} (L_{RBGs} - 1) + RBG_{start}$$

else

$$RIV = N_{RBG} (N_{RBG} - L_{RBGs} + 1) + (N_{RBG} - 1 - RBG_{start})$$

where $L_{RBGs} \geq 1$ and shall not exceed $N_{RBG} - RBG_{start}$.

[TS 38.214, clause 5.1.3]

To determine the modulation order, target code rate, and transport block size(s) in the physical downlink shared channel, the UE shall first

- read the 5-bit *modulation and coding scheme* field (I_{MCS}) in the DCI to determine the modulation order (Q_m) and target code rate (R) based on the procedure defined in Subclause 5.1.3.1, and
- read *redundancy version* field (rv) in the DCI to determine the redundancy version.

and second

- the UE shall use the number of layers (v), the total number of allocated PRBs before rate matching (n_{PRB}) to determine to the transport block size based on the procedure defined in Subclause 5.1.3.2.

The UE may skip decoding a transport block in an initial transmission if the effective channel code rate is higher than 0.95, where the effective channel code rate is defined as the number of downlink information bits (including CRC bits) divided by the number of physical channel bits on PDSCH. If the UE skips decoding, the physical layer indicates to higher layer that the transport block is not successfully decoded.

[TS 38.214, clause 5.1.3.1]

For the PDSCH scheduled by a PDCCH with DCI format 1_0, format 1_1 or format 1_2 with CRC scrambled by C-RNTI, MCS-C-RNTI, TC-RNTI, CS-RNTI, SI-RNTI, RA-RNTI, MSGB-RNTI, or P-RNTI, or for the PDSCH scheduled without corresponding PDCCH transmissions using the higher-layer-provided PDSCH configuration *SPS-Config*,

if the higher layer parameter *mcs-TableDCI-1-2* given by *PDSCH-Config* is set to 'qam256', and the PDSCH is scheduled by a PDCCH with DCI format 1_2 with CRC scrambled by C-RNTI

- the UE shall use I_{MCS} and Table 5.1.3.1-2 to determine the modulation order (Q_m) and Target code rate (R) used in the physical downlink shared channel.

elseif the UE is not configured with MCS-C-RNTI, the higher layer parameter *mcs-TableDCI-1-2* given by *PDSCH-Config* is set to 'qam64LowSE', and the PDSCH is scheduled by a PDCCH with DCI format 1_2 scrambled by C-RNTI

- the UE shall use I_{MCS} and Table 5.1.3.1-3 to determine the modulation order (Q_m) and Target code rate (R) used in the physical downlink shared channel.

...

Table 5.1.3.1-3: MCS index table 3 for PDSCH

MCS Index I_{MCS}	Modulation Order Q_m	Target code Rate $R \times [1024]$	Spectral efficiency
0	2	30	0.0586
1	2	40	0.0781
2	2	50	0.0977
3	2	64	0.1250
4	2	78	0.1523
5	2	99	0.1934
6	2	120	0.2344
7	2	157	0.3066
8	2	193	0.3770
9	2	251	0.4902
10	2	308	0.6016
11	2	379	0.7402
12	2	449	0.8770
13	2	526	1.0273
14	2	602	1.1758
15	4	340	1.3281
16	4	378	1.4766
17	4	434	1.6953
18	4	490	1.9141
19	4	553	2.1602
20	4	616	2.4063
21	6	438	2.5664
22	6	466	2.7305
23	6	517	3.0293
24	6	567	3.3223
25	6	616	3.6094
26	6	666	3.9023
27	6	719	4.2129
28	6	772	4.5234
29	2	reserved	
30	4	reserved	
31	6	reserved	

[TS 38.214, clause 5.1.3.2]

In case the higher layer parameter *maxNrofCodeWordsScheduledByDCI* indicates that two codeword transmission is enabled, then one of the two transport blocks is disabled by DCI format 1_1 if $I_{MCS} = 26$ and if $r_{vid} = 1$ for the corresponding transport block. If both transport blocks are enabled, transport block 1 and 2 are mapped to codeword 0

and 1 respectively. If only one transport block is enabled, then the enabled transport block is always mapped to the first codeword.

For the PDSCH assigned by a PDCCH with DCI format 1_0, format 1_1 or format 1_2 with CRC scrambled by C-RNTI, MCS-C-RNTI, TC-RNTI, CS-RNTI, or SI-RNTI, if Table 5.1.3.1-2 is used and $0 \leq I_{MCS} \leq 27$, or a table other than Table 5.1.3.1-2 is used and $0 \leq I_{MCS} \leq 28$, the UE shall, except if the transport block is disabled in DCI format 1_1, first determine the TBS as specified below:

1) The UE shall first determine the number of REs (N_{RE}) within the slot.

- A UE first determines the number of REs allocated for PDSCH within a PRB (N'_{RE}) by

$$N'_{RE} = N_{sc}^{RB} \cdot N_{symp}^{sh} - N_{DMRS}^{PRB} - N_{oh}^{PRB}$$

where $N_{sc}^{RB} = 12$ is the number of subcarriers in a physical resource block, N_{symp}^{sh} is the number of symbols of the PDSCH allocation within the slot, N_{DMRS}^{PRB} is the number of REs for DM-RS per PRB in the scheduled duration including the overhead of the DM-RS CDM groups without data, as indicated by DCI format 1_1 or format 1_2 or as described for format 1_0 in Clause 5.1.6.2, and N_{oh}^{PRB} is the overhead configured by higher layer parameter $xOverhead$ in *PDSCH-ServingCellConfig*.

If the $xOverhead$ in *PDSCH-ServingCellConfig* is not configured (a value from 6, 12, or 18), the N_{oh}^{PRB} is set to 0. If the PDSCH is scheduled by PDCCH with a CRC scrambled by SI-RNTI, RA-RNTI, MSGB-RNTI or P-RNTI, N_{oh}^{PRB} is assumed to be 0.

- A UE determines the total number of REs allocated for PDSCH (N_{RE}) by $N_{RE} = \min(156, N'_{RE}) \cdot n_{PRB}$, where n_{PRB} is the total number of allocated PRBs for the UE.

2) Unquantized intermediate variable (N_{info}) is obtained by $N_{info} = N_{RE} \cdot R \cdot Q_m \cdot v$.

If $N_{info} \leq 3824$

Use step 3 as the next step of the TBS determination

else

Use step 4 as the next step of the TBS determination

end if

3) When $N_{info} > 3824$, TBS is determined as follows

- quantized intermediate number of information bits $N'_{info} = \max\left(24, 2^n \cdot \left\lfloor \frac{N_{info}}{2^n} \right\rfloor\right)$, where $n = \max(3, \lfloor \log_2(N_{info}) \rfloor - 6)$.
- use Table 5.1.3.2-1 find the closest TBS that is not less than N'_{info} .

Table 5.1.3.2-1: TBS for $N_{info} \leq 3824$

Index	TBS	Index	TBS	Index	TBS	Index	TBS
1	24	31	336	61	1288	91	3624
2	32	32	352	62	1320	92	3752
3	40	33	368	63	1352	93	3824
4	48	34	384	64	1416		
5	56	35	408	65	1480		
6	64	36	432	66	1544		
7	72	37	456	67	1608		
8	80	38	480	68	1672		
9	88	39	504	69	1736		
10	96	40	528	70	1800		

11	104	41	552	71	1864		
12	112	42	576	72	1928		
13	120	43	608	73	2024		
14	128	44	640	74	2088		
15	136	45	672	75	2152		
16	144	46	704	76	2216		
17	152	47	736	77	2280		
18	160	48	768	78	2408		
19	168	49	808	79	2472		
20	176	50	848	80	2536		
21	184	51	888	81	2600		
22	192	52	928	82	2664		
23	208	53	984	83	2728		
24	224	54	1032	84	2792		
25	240	55	1064	85	2856		
26	256	56	1128	86	2976		
27	272	57	1160	87	3104		
28	288	58	1192	88	3240		
29	304	59	1224	89	3368		
30	320	60	1256	90	3496		

4) When $N_{info} > 3824$, TBS is determined as follows.

- quantized intermediate number of information bits $N'_{info} = \max\left(3840, 2^n \times \text{round}\left(\frac{N_{info} - 24}{2^n}\right)\right)$, where $n = \lfloor \log_2(N_{info} - 24) \rfloor - 5$ and ties in the round function are broken towards the next largest integer.
- if $R \leq 1/4$

$$TBS = 8 \cdot C \cdot \left\lceil \frac{N'_{info} + 24}{8 \cdot C} \right\rceil - 24, \text{ where } C = \left\lceil \frac{N'_{info} + 24}{3816} \right\rceil$$

else

if $N'_{info} > 8424$

$$TBS = 8 \cdot C \cdot \left\lceil \frac{N'_{info} + 24}{8 \cdot C} \right\rceil - 24, \text{ where } C = \left\lceil \frac{N'_{info} + 24}{8424} \right\rceil$$

else

$$TBS = 8 \cdot \left\lceil \frac{N'_{info} + 24}{8} \right\rceil - 24$$

end if

end if

7.1.1.4.1.5.3 Test description

7.1.1.4.1.5.3.1 Pre-test conditions

Same Pre-test conditions as in clause 7.1.1.0 except set the NR Cell bandwidth and applicable BWP to maximum for the NR Band under test as specified in Table 5.3.5-1 in TS 38.101-1 [16] / TS 38.101-2 [17] (to enable testing of n_{PRB} up to maximum value) is applied in NR Serving cell configuration.

Test frequency NRf1 is as specified in TS 38.508-1 [4] clause 4.3.1 using the common highest UL and DL channel bandwidth and using the default subcarrier spacing specified in TS 38.508-1 [4] clause 6.2.3.1.

7.1.1.4.1.5.3.2 Test procedure sequence

Table 7.1.1.4.1.5.3.2-1: Maximum TBS for different UE categories

UE Category	Maximum number of bits of a UL-SCH transport block received within a TTI
TS 38.306 [23] clause 4.1.2 require UE without ue-CategoryDL and ue-CategoryUL, to support Max TBS achievable based on max bandwidth of the Band under test.	

Table 7.1.1.4.1.5.3.2-2: Number of downlink PDCP SDUs and PDCP SDU size used as test data

TBS [bits]	Number of PDCP SDUs	PDCP SDU size [bits] (Note 1)
$136 \leq \text{TBS} \leq 12128$ note 2	1	$8 * \text{FLOOR}((\text{TBS} - 128)/8)$
$12129 \leq \text{TBS} \leq 24200$	2	$8 * \text{FLOOR}((\text{TBS} - 200)/16)$
$24201 \leq \text{TBS} \leq 36272$	3	$8 * \text{FLOOR}((\text{TBS} - 272)/24)$
$36273 \leq \text{TBS} \leq 48344$	4	$8 * \text{FLOOR}((\text{TBS} - 344)/32)$
$48345 \leq \text{TBS} \leq 60416$	5	$8 * \text{FLOOR}((\text{TBS} - 416)/40)$
$60417 \leq \text{TBS} \leq 72488$	6	$8 * \text{FLOOR}((\text{TBS} - 488)/48)$
$72489 \leq \text{TBS} \leq 84560$	7	$8 * \text{FLOOR}((\text{TBS} - 560)/56)$
$84561 \leq \text{TBS} \leq 96632$	8	$8 * \text{FLOOR}((\text{TBS} - 632)/64)$
$96633 < \text{TBS} \leq 108704$	9	$8 * \text{FLOOR}((\text{TBS} - 704)/72)$
$10705 \leq \text{TBS} \leq 120776$	10	$8 * \text{FLOOR}((\text{TBS} - 776)/80)$
$120777 \leq \text{TBS} \leq 132848$	11	$8 * \text{FLOOR}((\text{TBS} - 848)/88)$
$132849 \leq \text{TBS} \leq 144920$	12	$8 * \text{FLOOR}((\text{TBS} - 920)/96)$
$\text{TBS} > 144920$	13	$8 * \text{FLOOR}((\text{TBS} - 992)/104)$

Note 1: Each PDCP SDU is limited to 1500 octets (to keep below maximum SDU size of ESM as specified in TS 24.301 [21] clause 9.9.4.12).

The PDCP SDU size of each PDCP SDU is

$\text{PDCP SDU size} = (\text{TBS} - N * \text{PDCP header size} - N * \text{AMD PDU header size} - N * \text{MAC header size} - \text{Size of Timing Advance} - \text{RLC Status PDU size} - \text{MAC header for RLC Status PDU}) / N$, where

PDCP header size is 24 bits for the RLC AM and 18-bit SN case;
AMD PDU header size is 24 bits with 18 bit SN;

MAC header size for AMD PDU = 16 or 24 bits depending on L=8 or 16 bits. Worst case 24 is taken.

Size of Timing Advance MAC CE with header is 16 bits (if no Timing Advance and/or RLC status needs to be sent, padding will occur instead).

RLC Status PDU size = 24 bits with 1 ACK_SN, With a MAC header of 16 bits.

This gives:

$\text{PDCP SDU size} = 8 * \text{FLOOR}((\text{TBS} - N * 24 - N * 24 - N * 24 - 56) / (8 * N))$ bits.

Note 2: According to the final PDCP SDU size formula in Note 1, the smallest TBS that can be tested is 136 bits.

Table 7.1.1.4.1.5.3.2-2A: Void**Table 7.1.1.4.1.5.3.2-3: Specific Parameters**

Parameter	Value	Comment
resourceAllocationType1GranularityDCI-1-2-r16	Not Present	granularity 'P' is 1 PRB
mcs-TableDCI-1-2-r16	Not present	qam64 per default

Table 7.1.1.4.1.5.3.2-4: Main behaviour

St	Procedure	Message Sequence		TP	Verdict
		U - S	Message		
-	EXCEPTION: EXCEPTION: Steps 1 to 5 are repeated for allowed values of N_{PRB} in BWP, time domain resource as per table 7.1.1.4.1.5.3.2-1 and I_{MCS} from 0 to 28. NOTE: Skip the execution of steps for which the TBS size results in coding rate exceeding 0.95.	-	-	-	-
1	The SS calculates or looks up TBS in TS 38.214 [15] based on the value of S, L, I_{MCS} and n_{PRB} .	-	-	-	-
-	EXCEPTION: Steps 2 to 5 are performed if TBS is less than or equal to UE capability "Maximum number of DL-SCH transport block bits received within a TTI" as specified in Table 7.1.1.4.1.5.3.2-1 and larger than or equal to 132 bits as specified in Table 7.1.1.4.1.5.3.2-2	-	-	-	-
2	The SS creates one or more PDCP SDUs, depending on TBS, in accordance with Table 7.1.1.4.1.5.3.2-2.	-	-	-	-
3	The SS transmits the PDCP SDUs concatenated into a MAC PDU and indicates on PDCCH DCI Format 1_2 and values of S, L, I_{MCS} and n_{PRB} .	<--	MAC PDU (NxPDCP SDUs) DCI: (DCI Format 1_2, S, L, I_{MCS} and n_{PRB})	-	-
4	At the reception of scheduling request the SS transmits UL Grant for transmitting loop back PDCP SDUs.	<--	(UL Grant)	-	-
5	CHECK: Does UE return the same number of PDCP SDUs with same content as transmitted by the SS in step 3?	-->	(NxPDCP SDUs)	1	P

7.1.1.4.1.5.3.3 Specific message contents

Table 7.1.1.4.1.5.3.3-1: PDSCH-Config

Derivation Path: TS 38.508-1 [4], table 4.6.3-100			
Information Element	Value/remark	Comment	Condition
PDSCH-Config ::= SEQUENCE {			
dmrs-DownlinkForPDSCH-MappingTypeA-DCI-1-2-r16 CHOICE {			
setup	DMRS-DownlinkConfig		
}			
harq-ProcessNumberSizeDCI-1-2-r16	3	nrofHARQ-ProcessesForPDSCH is 8	
numberOfBitsForRV-DCI-1-2-r16	2		
prb-BundlingTypeDCI-1-2-r16			
staticBundling SEQUENCE {			
bundleSize	wideband		
}			
}			

resourceAllocationDCI-1-2-r16	resourceAllocationType1		
}			

Table 7.1.1.4.1.5.3.3-2: PhysicalCellGroupConfig

Derivation Path: TS 38.508-1 [4], Table 4.6.3-106			
Information Element	Value/remark	Comment	Condition
PhysicalCellGroupConfig ::= SEQUENCE {			
downlinkAssignmentIndexDCI-1-2-r16	2	pdsch-HARQ-ACK-Codebook=dynamic ackNackFeedbackMode = Not present	
}			

Table 7.1.1.4.1.5.3.3-3: PUCCH-Config

Derivation Path: TS 38.508-1 [4], Table 4.6.3-112			
Information Element	Value/remark	Comment	Condition
PUCCH-Config ::= SEQUENCE {			
numberOfBitsForPUCCH-ResourceIndicatorDCI-1-2-r16	3		
}			

7.1.1.4.2 UL-SCH Transport Block Size Selection

7.1.1.4.2.0 Common parameters for UL-SCH Transport Block Size Selection

Table 7.1.1.4.2.0-1: PUSCH-TimeDomainResourceAllocationList

Derivation Path: TS 38.508-1 [4], table 4.6.3-122			
Information Element	Value/remark	Comment	Condition
PUSCH-TimeDomainResourceAllocationList ::= SEQUENCE (SIZE(1..maxNrofUL-Allocations)) OF PUSCH-TimeDomainResourceAllocation {	2 entry		
PUSCH-TimeDomainResourceAllocation[1]		entry 1	FR1
SEQUENCE {			
k2	2		FR1
	4		FR2
mappingType	typeB		
startSymbolAndLength	52	Start symbol(S)=10, Length(L)=4	FR1
startSymbolAndLength	42	Start symbol(S)=0, Length(L)=4	FR2
}			
PUSCH-TimeDomainResourceAllocation[2]		entry 2	FR1
SEQUENCE {			
k2	2		FR1
	4		FR2
mappingType	typeB		
startSymbolAndLength	27	Start symbol(S)=0, Length(L)=14	
}			
}			

Table 7.1.1.4.2.0-2: *PUSCH-Config*

Derivation Path: TS 38.508-1 [4], Table 4.6.3-118			
Information Element	Value/remark	Comment	Condition
PUSCH-Config ::= SEQUENCE {			
dmrs-UplinkForPUSCH-MappingTypeB CHOICE {			
setup	DMRS-UplinkConfig	See Table 7.1.1.4.2.0-3	
}			
}			

Table 7.1.1.4.2.0-3: *DMRS-UplinkConfig*

Derivation Path: TS 38.508-1 [4], Table 4.6.3-51
--

Table 7.1.1.4.2.0-4: *SchedulingRequestResourceConfig*

Derivation Path: TS 38.508 [4], Table 4.6.3-157			
Information Element	Value/remark	Comment	Condition
SchedulingRequestResourceConfig ::= SEQUENCE {			
schedulingRequestResourceId	SchedulingRequestResourceId		
schedulingRequestID	SchedulingRequestID		
periodicityAndOffset CHOICE {			
sl40	9	With SCS = kHz15 results in repetition every 40 ms	SCS15
sl80	9	With SCS = kHz30 results in repetition every 40 ms	SCS30
sl320	9	With SCS = kHz120 results in repetition every 40 ms	SCS120
}			
resource	6	ID of the PUCCH resource as configured by PUCCH-Config (Table 4.6.3-84)	
}			

Table 7.1.1.4.2.0-5: *PDSCH-TimeDomainResourceAllocationList*

Derivation Path: TS 38.508-1 [4], Table 4.6.3-103			
Information Element	Value/remark	Comment	Condition
PDSCH-TimeDomainResourceAllocationList ::= SEQUENCE(SIZE(1..maxNrofDL-Allocations)) OF SEQUENCE(SIZE(1..maxNrofDL-Allocations)) OF PDSCH-TimeDomainResourceAllocation {	2 entries		
PDSCH-TimeDomainResourceAllocation[1] SEQUENCE {		entry 1	
k0	Not present		
mappingType	typeA		
startSymbolAndLength	53	S=2, L=12	
}			
PDSCH-TimeDomainResourceAllocation[2] SEQUENCE {		entry 2	
k0	1		
mappingType	typeA		

startSymbolAndLength	27	S=0, L=14	
}			
}			

7.1.1.4.2.1 UL-SCH Transport Block Size selection / DCI format 0_0 / Transform precoding disabled

7.1.1.4.2.1.1 Test Purpose (TP)

(1)

```

with { UE in RRC_CONNECTED state }
ensure that {
  when { UE has pending data for transmission and receives on PDCCH DCI format 0_0 indicating a
resource block assignment correspondent to physical resource blocks , Time domain resource
assignment and modulation and coding }
  then { UE transmits MAC PDU on PUSCH as per Modulation Coding scheme, time domain resource
allocation and PRB's }
}

```

7.1.1.4.2.1.2 Conformance requirements

References: The conformance requirements covered in the present TC are specified in: TS 38.212 clause 7.3.1.1.1, TS 38.214 clause 6.1.2.1, 6.1.2.2, 6.1.2.2.2, 6.1.4.1, 5.1.3.1, 6.1.4.2 and 5.1.3.2. Unless otherwise stated these are Rel-15 requirements.

[TS 38.212, clause 7.3.1.1.1]

DCI format 0_0 is used for the scheduling of PUSCH in one cell.

The following information is transmitted by means of the DCI format 0_0 with CRC scrambled by C-RNTI or CS-RNTI or new-RNTI:

- Identifier for DCI formats – 1 bit
 - The value of this bit field is always set to 0, indicating an UL DCI format
- Frequency domain resource assignment – $\lceil \log_2(N_{RB}^{UL,BWP}(N_{RB}^{UL,BWP} + 1)/2) \rceil$ bits where
 - $N_{RB}^{UL,BWP}$ is the size of the active UL bandwidth part in case DCI format 0_0 is monitored in the UE specific search space and satisfying
 - the total number of different DCI sizes monitored per slot is no more than 4 for the cell, and
 - the total number of different DCI sizes with C-RNTI monitored per slot is no more than 3 for the cell
 - otherwise, $N_{RB}^{UL,BWP}$ is the size of the initial UL bandwidth part.
- For PUSCH hopping with resource allocation type 1:
 - N_{UL_hop} MSB bits are used to indicate the frequency offset according to Subclause 6.3 of [6, TS 38.214], where $N_{UL_hop} = 1$ if the higher layer parameter *frequencyHoppingOffsetLists* contains two offset values and $N_{UL_hop} = 2$ if the higher layer parameter *frequencyHoppingOffsetLists* contains four offset values
 - $\lceil \log_2(N_{RB}^{UL,BWP}(N_{RB}^{UL,BWP} + 1)/2) \rceil - N_{UL_hop}$ bits provides the frequency domain resource allocation according to Subclause 6.1.2.2.2 of [6, TS 38.214]
- For non-PUSCH hopping with resource allocation type 1:
 - $\lceil \log_2(N_{RB}^{UL,BWP}(N_{RB}^{UL,BWP} + 1)/2) \rceil$ bits provides the frequency domain resource allocation according to Subclause 6.1.2.2.2 of [6, TS 38.214]

- Time domain resource assignment – 4 bits as defined in Subclause 6.1.2.1 of [6, TS 38.214]
- Frequency hopping flag – 1 bit.
- Modulation and coding scheme – 5 bits as defined in Subclause 6.1.3 of [6, TS 38.214]
- New data indicator – 1 bit
- Redundancy version – 2 bits as defined in Table 7.3.1.1.1-2
- HARQ process number – 4 bits
- TPC command for scheduled PUSCH – 2 bits as defined in Subclause 7.1.1 of [5, TS 38.213]
- Padding bits, if required.
- UL/SUL indicator – 1 bit for UEs configured with SUL in the cell as defined in Table 7.3.1.1.1-1 and the number of bits for DCI format 1_0 before padding is larger than the number of bits for DCI format 0_0 before padding; 0 bit otherwise. The UL/SUL indicator, if present, locates in the last bit position of DCI format 0_0, after the padding bit(s).
 - If the UL/SUL indicator is present in DCI format 0_0 and the higher layer parameter *pusch-Config* is not configured on both UL and SUL the UE ignores the UL/SUL indicator field in DCI format 0_0, and the corresponding PUSCH scheduled by the DCI format 0_0 is for the UL or SUL for which high layer parameter *pucch-Config* is configured;
 - If the UL/SUL indicator is not present in DCI format 0_0, the corresponding PUSCH scheduled by the DCI format 0_0 is for the UL or SUL for which high layer parameter *pucch-Config* is configured.

The following information is transmitted by means of the DCI format 0_0 with CRC scrambled by TC-RNTI:

- Identifier for DCI formats – 1 bit
 - The value of this bit field is always set to 0, indicating an UL DCI format
- Frequency domain resource assignment – $\lceil \log_2(N_{RB}^{UL,BWP}(N_{RB}^{UL,BWP} + 1)/2) \rceil$ bits where
 - $N_{RB}^{UL,BWP}$ is the size of the initial UL bandwidth part.
 - For PUSCH hopping with resource allocation type 1:
 - N_{UL_hop} MSB bits are used to indicate the frequency offset according to Subclause 6.3 of [6, TS 38.214], where $N_{UL_hop} = 1$ if $N_{RB}^{UL,BWP} < 50$ and $N_{UL_hop} = 2$ otherwise
 - $\lceil \log_2(N_{RB}^{UL,BWP}(N_{RB}^{UL,BWP} + 1)/2) \rceil - N_{UL_hop}$ bits provides the frequency domain resource allocation according to Subclause 6.1.2.2.2 of [6, TS 38.214]
 - For non-PUSCH hopping with resource allocation type 1:
 - $\lceil \log_2(N_{RB}^{UL,BWP}(N_{RB}^{UL,BWP} + 1)/2) \rceil$ bits provides the frequency domain resource allocation according to Subclause 6.1.2.2.2 of [6, TS 38.214]
- Time domain resource assignment – 4 bits as defined in Subclause 6.1.2.1 of [6, TS 38.214]
- Frequency hopping flag – 1 bit.
- Modulation and coding scheme – 5 bits as defined in Subclause 6.1.3 of [6, TS 38.214], using Table 5.1.3.1-1
- New data indicator – 1 bit, reserved
- Redundancy version – 2 bits as defined in Table 7.3.1.1.1-2
- HARQ process number – 4 bits, reserved

- TPC command for scheduled PUSCH – 2 bits as defined in Subclause 7.1.1 of [5, TS 38.213]
- Padding bits, if required.
- UL/SUL indicator – 1 bit if the cell has two ULs and the number of bits for DCI format 1_0 before padding is larger than the number of bits for DCI format 0_0 before padding; 0 bit otherwise. The UL/SUL indicator, if present, locates in the last bit position of DCI format 0_0, after the padding bit(s).
- If 1 bit, reserved, and the corresponding PUSCH is always on the same UL carrier as the previous transmission of the same TB

If DCI format 0_0 is monitored in common search space and if the number of information bits in the DCI format 0_0 prior to padding is less than the payload size of the DCI format 1_0 monitored in common search space for scheduling the same serving cell, zeros shall be appended to the DCI format 0_0 until the payload size equals that of the DCI format 1_0.

If DCI format 0_0 is monitored in common search space and if the number of information bits in the DCI format 0_0 prior to padding is larger than the payload size of the DCI format 1_0 monitored in common search space for scheduling the same serving cell, the bit width of the frequency domain resource allocation field in the DCI format 0_0 is reduced by truncating the first few most significant bits such that the size of DCI format 0_0 equals to the size of the DCI format 1_0.

If DCI format 0_0 is monitored in UE specific search space but does not satisfy at least one of the following

- the total number of different DCI sizes monitored per slot is no more than 4 for the cell, and
- the total number of different DCI sizes with C-RNTI monitored per slot is no more than 3 for the cell

and if the number of information bits in the DCI format 0_0 prior to padding is less than the payload size of the DCI format 1_0 monitored in common search space for scheduling the same serving cell, zeros shall be appended to the DCI format 0_0 until the payload size equals that of the DCI format 1_0.

If DCI format 0_0 is monitored in UE specific search space but does not satisfy at least one of the following

- the total number of different DCI sizes monitored per slot is no more than 4 for the cell, and
- the total number of different DCI sizes with C-RNTI monitored per slot is no more than 3 for the cell

and if the number of information bits in the DCI format 0_0 prior to padding is larger than the payload size of the DCI format 1_0 monitored in common search space for scheduling the same serving cell, the bit width of the frequency domain resource allocation field in the DCI format 0_0 is reduced by truncating the first few most significant bits such that the size of DCI format 0_0 equals to the size of the DCI format 1_0.

If DCI format 0_0 is monitored in UE specific search space and satisfies both of the following

- the total number of different DCI sizes monitored per slot is no more than 4 for the cell, and
- the total number of different DCI sizes with C-RNTI monitored per slot is no more than 3 for the cell

and if the number of information bits in the DCI format 0_0 prior to padding is less than the payload size of the DCI format 1_0 monitored in UE specific search space for scheduling the same serving cell, zeros shall be appended to the DCI format 0_0 until the payload size equals that of the DCI format 1_0.

[TS 38.214, clause 6.1.2.1]

When the UE is scheduled to transmit a transport block and no CSI report, or the UE is scheduled to transmit a transport block and a CSI report on PUSCH by a DCI, the *Time domain resource assignment* field value m of the DCI provides a row index $m + 1$ to an allocated table. The determination of the used resource allocation table is defined in sub-clause 6.1.2.1.1. The indexed row defines the slot offset K_2 , the start and length indicator *SLIV*, or directly the start symbol S and the allocation length L , and the PUSCH mapping type to be applied in the PUSCH transmission.

When the UE is scheduled to transmit a PUSCH with no transport block and with a CSI report by a *CSI request* field on a DCI, the *Time-domain resource assignment* field value m of the DCI provides a row index $m + 1$ to an allocated table. The determination of the applied resource allocation table is defined in sub-clause 6.1.2.1.1. The indexed row defines the start and length indicator *SLIV*, or directly the start symbol S and the allocation length L , and the PUSCH mapping type to be applied in the PUSCH transmission and K_2 is determined based on the corresponding list entries

$Y_j, j = 0, \dots, N_{\text{Rep}} - 1$ of the higher layer parameter *reportSlotConfig* in *CSI-ReportConfig* for the N_{Rep} triggered CSI Reporting Settings. The i th codepoint of K_2 is determined as $K_2 = \max_j Y_j(i)$ where $Y_j(i)$ is the i th codepoint of Y_j .

- The slot where the UE shall transmit the PUSCH is determined by K_2 as $\left\lfloor n \cdot \frac{2^{\mu_{\text{PUSCH}}}}{2^{\mu_{\text{PDCCH}}}} \right\rfloor + K_2$ where n is the slot with the scheduling DCI, K_2 is based on the numerology of PUSCH, and μ_{PUSCH} and μ_{PDCCH} are the subcarrier spacing configurations for PUSCH and PDCCH, respectively, and
- The starting symbol S relative to the start of the slot, and the number of consecutive symbols L counting from the symbol S allocated for the PUSCH are determined from the start and length indicator $SLIV$ of the indexed row:
 - if $(L-1) \leq 7$ then

$$SLIV = 14 \cdot (L-1) + S$$
 - else

$$SLIV = 14 \cdot (14 - L + 1) + (14 - 1 - S)$$
 where $0 < L \leq 14 - S$, and
- The PUSCH mapping type is set to Type A or Type B as defined in Subclause 6.4.1.1.3 of [4, TS 38.211] as given by the indexed row.

The UE shall consider the S and L combinations defined in table 6.1.2.1-1 as valid PUSCH allocations

Table 6.1.2.1-1: Valid S and L combinations

PUSCH mapping type	Normal cyclic prefix			Extended cyclic prefix		
	S	L	$S+L$	S	L	$S+L$
Type A	0	{4,...,14}	{4,...,14}	0	{4,...,12}	{4,...,12}
Type B	{0,...,13}	{1,...,14}	{1,...,14}	{0,...,12}	{1,...,12}	{1,...,12}

When the UE is configured with *aggregationFactorUL* > 1, the same symbol allocation is applied across the *aggregationFactorUL* consecutive slots and the PUSCH is limited to a single transmission layer. The UE shall repeat the TB across the *aggregationFactorUL* consecutive slots applying the same symbol allocation in each slot. The redundancy version to be applied on the n^{th} transmission occasion of the TB is determined according to table 6.1.2.1-2.

Table 6.1.2.1-2: Redundancy version when *aggregationFactorUL* > 1

r_{vid} indicated by the DCI scheduling the PUSCH	r_{vid} to be applied to n^{th} transmission occasion			
	$n \bmod 4 = 0$	$n \bmod 4 = 1$	$n \bmod 4 = 2$	$n \bmod 4 = 3$
0	0	2	3	1
2	2	3	1	0
3	3	1	0	2
1	1	0	2	3

If the UE procedure for determining slot configuration, as defined in subclause 11.1 of [6, TS 38.213], determines symbols of a slot allocated for PUSCH as downlink symbols, the transmission on that slot is omitted for multi-slot PUSCH transmission.

[38.214 clause 6.1.2.2]

The UE shall determine the resource block assignment in frequency domain using the resource allocation field in the detected PDCCH DCI. Two uplink resource allocation schemes type 0 and type 1 are supported. Uplink resource allocation scheme type 0 is supported for PUSCH only when transform precoding is disabled. Uplink resource allocation scheme type 1 is supported for PUSCH for both cases when transform precoding is enabled or disabled.

If the scheduling DCI is configured to indicate the uplink resource allocation type as part of the *Frequency domain resource* assignment field by setting a higher layer parameter *resourceAllocation* in *pusch-Config* to 'dynamicswitch', the UE shall use uplink resource allocation type 0 or type 1 as defined by this DCI field. Otherwise the UE shall use the uplink frequency resource allocation type as defined by the higher layer parameter *resourceAllocation*.

The UE shall assume that when the scheduling PDCCH is received with DCI format 0_0, then uplink resource allocation type 1 is used.

If a bandwidth part indicator field is not configured in the scheduling DCI, the RB indexing for uplink type 0 and type 1 resource allocation is determined within the UE's active bandwidth part. If a bandwidth part indicator field is configured in the scheduling DCI, the RB indexing for uplink type 0 and type 1 resource allocation is determined within the UE's bandwidth part indicated by bandwidth part indicator field value in the DCI, except for the case when DCI format 0_0 is decoded in any PDCCH common search space in CORESET 0 in which case the initial bandwidth part shall be used. The UE shall upon detection of PDCCH intended for the UE determine first the uplink bandwidth part and then the resource allocation within the bandwidth part.

[38.214 clause 6.1.2.2.2]

In uplink resource allocation of type 1, the resource block assignment information indicates to a scheduled UE a set of contiguously allocated non-interleaved virtual resource blocks within the active carrier bandwidth part of size N_{BWP}^{size} PRBs except for the case when DCI format 0_0 is decoded in the Type0-PDCCH common search space in CORESET 0 in which case the initial bandwidth part of size N_{BWP}^{size} shall be used.

An uplink type 1 resource allocation field consists of a resource indication value (*RIV*) corresponding to a starting virtual resource block (RB_{start}) and a length in terms of contiguously allocated resource blocks L_{RBs} . The resource indication value is defined by

if $(L_{RBs} - 1) \leq \lfloor N_{BWP}^{size} / 2 \rfloor$ then

$$RIV = N_{BWP}^{size} (L_{RBs} - 1) + RB_{start}$$

else

$$RIV = N_{BWP}^{size} (N_{BWP}^{size} - L_{RBs} + 1) + (N_{BWP}^{size} - 1 - RB_{start})$$

where $L_{RBs} \geq 1$ and shall not exceed $N_{BWP}^{size} - RB_{start}$.

[TS 38.214, clause 6.1.4.1]

For the PUSCH assigned by a DCI format 0_0/0_1 with CRC scrambled by C-RNTI, new-RNTI, TC-RNTI, or SP-CSI-RNTI, the transform precoding is enabled if *transformPrecoder* in *PUSCH-Config* is set to 'enabled', or if *transformPrecoder* in *PUSCH-Config* is not configured and *msg3-transformPrecoding* in *rach-ConfigCommon* is set to 'enabled'; otherwise the transform precoding is disabled.

For the PUSCH assigned by a DCI format 0_0/0_1 with CRC scrambled by CS-RNTI, or the PUSCH with configured grant using CS-RNTI, the transform precoding is enabled if *transformPrecoder* in *ConfiguredGrantConfig* is set to 'enabled'; otherwise the transform precoding is disabled.

For a PUSCH scheduled by RAR UL grant or for a PUSCH scheduled by a DCI format 0_0/0_1 with CRC scrambled by C-RNTI, TC-RNTI, or CS-RNTI, or SP-CSI-RNTI, or for a PUSCH with configured grant using CS-RNTI,

if *transformPrecoder* is disabled for this PUSCH transmission

- if *mcs-Table* in *PUSCH-Config* is set to 'qam256', and PUSCH is scheduled with C-RNTI or SP-CSI-RNTI, and PUSCH is assigned by DCI format 0_1,
- the UE shall use I_{MCS} and Table 5.1.3.1-2 to determine the modulation order (Q_m) and Target code rate (R) used in the physical uplink shared channel.

- elseif the UE is not configured with new-RNTI, *mcs-Table* in *PUSCH-Config* is set to 'qam64LowSE', the PUSCH is scheduled with C-RNTI, or SP-CSI-RNTI, and the PUSCH is assigned by a PDCCH in a UE-specific search space,
 - the UE shall use I_{MCS} and Table 5.1.3.1-3 to determine the modulation order (Q_m) and Target code rate (R) used in the physical uplink shared channel.
- elseif the UE is configured with new-RNTI, and the PUSCH is scheduled with new-RNTI,
 - the UE shall use I_{MCS} and Table 5.1.3.1-3 to determine the modulation order (Q_m) and Target code rate (R) used in the physical uplink shared channel.
- elseif *mcs-Table* in *ConfiguredGrantConfig* is set to 'qam256', and PUSCH is scheduled with CS-RNTI,
 - the UE shall use I_{MCS} and Table 5.1.3.1-2 to determine the modulation order (Q_m) and Target code rate (R) used in the physical uplink shared channel.
- elseif *mcs-Table* in *ConfiguredGrantConfig* is set to 'qam64LowSE', and PUSCH is scheduled with CS-RNTI,
 - the UE shall use I_{MCS} and Table 5.1.3.1-3 to determine the modulation order (Q_m) and Target code rate (R) used in the physical uplink shared channel.
- else
 - the UE shall use I_{MCS} and Table 5.1.3.1-1 to determine the modulation order (Q_m) and Target code rate (R) used in the physical uplink shared channel.

[TS 38.214, clause 5.1.3.1]

Table 5.1.3.1-1: MCS index table 1 for PDSCH

MCS Index I_{MCS}	Modulation Order Q_m	Target code Rate $R \times [1024]$	Spectral efficiency
0	2	120	0.2344
1	2	157	0.3066
2	2	193	0.3770
3	2	251	0.4902
4	2	308	0.6016
5	2	379	0.7402
6	2	449	0.8770
7	2	526	1.0273
8	2	602	1.1758
9	2	679	1.3262
10	4	340	1.3281
11	4	378	1.4766
12	4	434	1.6953
13	4	490	1.9141
14	4	553	2.1602
15	4	616	2.4063
16	4	658	2.5703
17	6	438	2.5664
18	6	466	2.7305
19	6	517	3.0293
20	6	567	3.3223
21	6	616	3.6094
22	6	666	3.9023
23	6	719	4.2129
24	6	772	4.5234
25	6	822	4.8164
26	6	873	5.1152
27	6	910	5.3320
28	6	948	5.5547
29	2	reserved	
30	4	reserved	
31	6	reserved	

[TS 38.214, clause 6.1.4.2]

For a PUSCH scheduled by RAR UL grant or for a PUSCH scheduled by a DCI format 0_0/0_1 with CRC scrambled by C-RNTI, new-RNTI, TC-RNTI, CS-RNTI, or SP-CSI-RNTI.

if

- $0 \leq I_{MCS} \leq 27$ and transform precoding is disabled and Table 5.1.3.1-2 is used, or
- $0 \leq I_{MCS} \leq 28$ and transform precoding is disabled and a table other than Table 5.1.3.1-2 is used, or
- $0 \leq I_{MCS} \leq 27$ and transform precoding is enabled and , the UE shall first determine the TBS as specified below:

The UE shall first determine the number of REs (N_{RE}) within the slot:

- A UE first determines the number of REs allocated for PUSCH within a PRB (N'_{RE}) by
- $N'_{RE} = N_{sc}^{RB} * N_{symp}^{sh} - N_{DMRS}^{PRB} - N_{oh}^{PRB}$, where $N_{sc}^{RB} = 12$ is the number of subcarriers in the frequency domain in a physical resource block, N_{symp}^{sh} is the number of symbols of the PUSCH allocation within the slot, N_{DMRS}^{PRB} is the number of REs for DM-RS per PRB in the scheduled duration including the overhead of the DM-RS CDM groups without data, as indicated by DCI format 0_1 or as described for DCI format 0_0 in Subclause 6.2.2, and N_{oh}^{PRB} is the overhead configured by higher layer parameter $xOverhead$ in *PUSCH-ServingCellConfig*. If the N_{oh}^{PRB} is not configured (a value from 0, 6, 12, or 18), the N_{oh}^{PRB} is assumed to be 0. For MSG3 transmission the N_{oh}^{PRB} is always set to 0.
- A UE determines the total number of REs allocated for PUSCH (N_{RE}) by

$$N_{RE} = \min(156, N'_{RE}) \cdot n_{PRB}$$
where n_{PRB} is the total number of allocated PRBs for the UE.
- Next, proceed with steps 2-5 as defined in Subclause 5.1.3.2

else if

- $28 \leq I_{MCS} \leq 31$ and transform precoding is disabled and Table 5.1.3.1-2 is used, or
- $28 \leq I_{MCS} \leq 31$ and transform precoding is enabled,
- the TBS is assumed to be as determined from the DCI transported in the latest PDCCH for the same transport block using $0 \leq I_{MCS} \leq 27$. If there is no PDCCH for the same transport block using $0 \leq I_{MCS} \leq 27$, and if the initial PUSCH for the same transport block is transmitted with configured grant, the TBS shall be determined from the most recent configured scheduling PDCCH.

else

- the TBS is assumed to be as determined from the DCI transported in the latest PDCCH for the same transport block using $0 \leq I_{MCS} \leq 28$. If there is no PDCCH for the same transport block using $0 \leq I_{MCS} \leq 28$, and if the initial PUSCH for the same transport block is transmitted with configured grant, the TBS shall be determined from the most recent configured scheduling PDCCH.

[TS 38.214, clause 5.1.3.2]

- 2 Intermediate number of information bits (N_{info}) is obtained by $N_{info} = N_{RE} \cdot R \cdot Q_m \cdot v$.

If $N_{info} \leq 3824$

Use step 3 as the next step of the TBS determination

else

Use step 4 as the next step of the TBS determination

end if

3) When $N_{info} \leq 3824$, TBS is determined as follows

- quantized intermediate number of information bits $N'_{info} = \max\left(24, 2^n \cdot \left\lfloor \frac{N_{info}}{2^n} \right\rfloor\right)$, where
 $n = \max(3, \lfloor \log_2(N_{info}) \rfloor - 6)$.
- use Table 5.1.3.2-2 find the closest TBS that is not less than N'_{info} .

Table 5.1.3.2-2: TBS for $N_{info} \leq 3824$

Index	TBS	Index	TBS	Index	TBS	Index	TBS
1	24	31	336	61	1288	91	3624
2	32	32	352	62	1320	92	3752
3	40	33	368	63	1352	93	3824
4	48	34	384	64	1416		
5	56	35	408	65	1480		
6	64	36	432	66	1544		
7	72	37	456	67	1608		
8	80	38	480	68	1672		
9	88	39	504	69	1736		
10	96	40	528	70	1800		
11	104	41	552	71	1864		
12	112	42	576	72	1928		
13	120	43	608	73	2024		
14	128	44	640	74	2088		
15	136	45	672	75	2152		
16	144	46	704	76	2216		
17	152	47	736	77	2280		
18	160	48	768	78	2408		
19	168	49	808	79	2472		
20	176	50	848	80	2536		
21	184	51	888	81	2600		
22	192	52	928	82	2664		
23	208	53	984	83	2728		
24	224	54	1032	84	2792		
25	240	55	1064	85	2856		
26	256	56	1128	86	2976		
27	272	57	1160	87	3104		
28	288	58	1192	88	3240		
29	304	59	1224	89	3368		
30	320	60	1256	90	3496		

4) When $N_{info} > 3824$, TBS is determined as follows.

- quantized intermediate number of information bits $N'_{info} = \max\left(3840, 2^n \times \text{round}\left(\frac{N_{info} - 24}{2^n}\right)\right)$, where
 $n = \lfloor \log_2(N_{info} - 24) \rfloor - 5$ and ties in the round function are broken towards the next largest integer.
- if $R \leq 1/4$

$$TBS = 8 \cdot C \cdot \left\lfloor \frac{N'_{info} + 24}{8 \cdot C} \right\rfloor - 24, \text{ where } C = \left\lfloor \frac{N'_{info} + 24}{3816} \right\rfloor$$

else

if $N'_{info} > 8424$

$$TBS = 8 \cdot C \cdot \left\lceil \frac{N'_{info} + 24}{8 \cdot C} \right\rceil - 24, \text{ where } C = \left\lceil \frac{N'_{info} + 24}{8424} \right\rceil$$

else

$$TBS = 8 \cdot \left\lceil \frac{N'_{info} + 24}{8} \right\rceil - 24$$

end if

end if

7.1.1.4.2.1.3 Test description

7.1.1.4.2.1.3.1 Pre-test conditions

Same Pre-test conditions as in clause 7.1.1.0 except set the NR Cell bandwidth and applicable BWP to maximum for the NR Band under test as specified in Table 5.3.5-1 in TS 38.101-1 [16] / TS 38.101-2 [17] (to enable testing of n_{PRB} up to maximum value) and Short_DCI condition is applied in NR Serving cell configuration.

Test frequency NRf1 is as specified in TS 38.508-1 [4] clause 4.3.1 using the common highest mandatory UL and DL channel bandwidth and using the default subcarrier spacing specified in TS 38.508-1 [4] clause 6.2.3.1.

7.1.1.4.2.1.3.2 Test procedure sequence

Table 7.1.1.4.2.1.3.2-1: Maximum TBS for different UE categories

UE Category	Maximum number of bits of a UL-SCH transport block received within a TTI
TS 38.306 [23] clause 4.1.2 require UE without <i>ue-CategoryDL</i> and <i>ue-CategoryUL</i> , to support Max TBS achievable based on max bandwidth of the Band under test.	

Table 7.1.1.4.2.1.3.2-2: Number of uplink PDCP SDUs and PDCP SDU size used as test data

TBS [bits]	Number of PDCP SDUs	PDCP SDU size [bits] (Note 1)
$136 \leq TBS \leq 12128$ note 2	1	$8 \cdot \text{FLOOR}((TBS - 128)/8)$
$12129 \leq TBS \leq 24200$	2	$8 \cdot \text{FLOOR}((TBS - 200)/16)$
$24201 \leq TBS \leq 36272$	3	$8 \cdot \text{FLOOR}((TBS - 272)/24)$
$36273 \leq TBS \leq 48344$	4	$8 \cdot \text{FLOOR}((TBS - 344)/32)$
$48345 \leq TBS \leq 60416$	5	$8 \cdot \text{FLOOR}((TBS - 416)/40)$
$60417 \leq TBS \leq 72488$	6	$8 \cdot \text{FLOOR}((TBS - 488)/48)$
$72489 \leq TBS \leq 84560$	7	$8 \cdot \text{FLOOR}((TBS - 560)/56)$
$84561 \leq TBS \leq 96632$	8	$8 \cdot \text{FLOOR}((TBS - 632)/64)$
$96633 < TBS \leq 108704$	9	$8 \cdot \text{FLOOR}((TBS - 704)/72)$
$10705 \leq TBS \leq 120776$	10	$8 \cdot \text{FLOOR}((TBS - 776)/80)$
$120777 \leq TBS \leq 132848$	11	$8 \cdot \text{FLOOR}((TBS - 848)/88)$
$132849 \leq TBS \leq 144920$	12	$8 \cdot \text{FLOOR}((TBS - 920)/96)$
$144921 \leq TBS \leq 156992$	13	$8 \cdot \text{FLOOR}((TBS - 992)/104)$
$156993 \leq TBS \leq 169064$	14	$8 \cdot \text{FLOOR}((TBS - 1064)/112)$
$169065 \leq TBS \leq 181136$	15	$8 \cdot \text{FLOOR}((TBS - 1136)/120)$
$181137 \leq TBS \leq 193208$	16	$8 \cdot \text{FLOOR}((TBS - 1208)/128)$
$193209 \leq TBS \leq 205280$	17	$8 \cdot \text{FLOOR}((TBS - 1280)/136)$
$205281 \leq TBS \leq 217352$	18	$8 \cdot \text{FLOOR}((TBS - 1352)/144)$
$217353 \leq TBS \leq 229424$	19	$8 \cdot \text{FLOOR}((TBS - 1424)/152)$
$TBS > 229424$	20	$8 \cdot \text{FLOOR}((TBS - 1496)/160)$
Note 1: Each PDCP SDU is limited to 1500 octets (to keep below maximum SDU size of ESM as specified in TS 24.301 [21] clause 9.9.4.12).		

The PDCP SDU size of each PDCP SDU is

PDCP SDU size = (TBS – N*PDCP header size – N*AMD PDU header size - N*MAC header size – Size of Timing Advance – RLC Status PDU size- MAC header for RLC Status PDU) / N, where

PDCP header size is 24 bits for the RLC AM and 18-bit SN case;
AMD PDU header size is 24 bits with 18 bit SN;

MAC header size for AMD PDU = 16 or 24 bits depending on L=8 or 16 bits. Worst case 24 is taken.

Size of Timing Advance MAC CE with header is 16 bits (if no Timing Advance and/or RLC status needs to be sent, padding will occur instead).

RLC Status PDU size = 24 bits with 1 ACK_SN, With a MAC header of 16 bits.

This gives:

PDCP SDU size = $8 * \text{FLOOR}((\text{TBS} - N * 24 - N * 24 - N * 24 - 56) / (8 * N))$ bits.

Note 2: According to the final PDCP SDU size formula in Note 1, the smallest TBS that can be tested is 136 bits.

Table 7.1.1.4.2.1.3.2-3: Specific Parameters

Parameter	Value	Comment
number of layers (v)	1	
mcs-Table	qam64	

Table 7.1.1.4.2.1.3.2-4: Main behaviour

St	Procedure	Message Sequence		TP	Verdict
		U - S	Message		
-	EXCEPTION: Steps 1 to 5 are repeated for allowed values of N_{PRB} 1 to $N_{RB}^{UL,BWP}$ in BWP, time domain resource as per Table 7.1.1.4.2.0-1 and I_{MCS} from 0 to 28.	-	-	-	-
1	The SS calculates or looks up TBS in TS 38.214 [15] based on the value of S, L, I_{MCS} and n_{PRB} .	-	-	-	-
-	EXCEPTION: Steps 2 to 5 are performed if TBS is less than or equal to UE capability "Maximum number of UL-SCH transport block bits received within a TTI" as specified in Table 7.1.1.4.2.1.3.2-1 and larger than or equal to 136 bits as specified in Table 7.1.1.4.2.1.3.2-2. Skip the execution of steps 2 to 5 for which the TBS size equal to 3824 or 3840. (Note 2) Skip the execution of steps for $I_{MCS} > 27$ and $N_{PRB} < 5$. (Note 1)	-	-	-	-
2	The SS creates one or more PDCP SDUs, depending on TBS, in accordance with Table 7.1.1.4.2.1.3.2-2.	-	-	-	-
3	The SS transmits all PDCP SDUs (N_{SDUs}) as created in step 2 in a MAC PDU.	<--	MAC PDU ($N \times$ PDCP SDUs)	-	-
4	After the reception of 2 Scheduling Request, SS transmits UL Grant DCI 0_0, and values of S, L, I_{MCS} and n_{PRB} .	<--	(UL Grant) (DCI Format 0_0, S, L, I_{MCS} and n_{PRB})	-	-
5	CHECK: Does UE return the same number of PDCP SDUs with same content as transmitted by the SS in step 3 using Time, frequency Resources and modulation and coding scheme as configured by the SS in step 4?	-->	MAC PDU ($N \times$ PDCP SDU)	1	P
<p>Note 1: For $I_{MCS} > 27$ and $N_{PRB} < 5$, the combination results in higher coding rate and therefore leading to CRC errors in decoding UL data.</p> <p>Note 2: There is ambiguity of TBS calculation when $3824.0 < N_{info} < 3825.0$ in clause 5.1.3.2 of TS 38.214 [15].</p>					

7.1.1.4.2.1.3.3 Specific message contents

None.

7.1.1.4.2.2 Void

7.1.1.4.2.3 UL-SCH transport block size selection / DCI format 0_1 / RA type 0/RA Type 1 / Transform precoding disabled

7.1.1.4.2.3.1 Test Purpose (TP)

(1)

```
with { UE in RRC_CONNECTED state }
ensure that {
  when { UE has pending data for transmission and receives DCI format 0_1 indicating resource
allocation type 0 a resource block assignment correspondent to physical resource blocks , Time
domain resource assignment and a modulation and coding }
  then { UE transmits MAC PDU's on PUSCH as per Modulation Coding scheme, time domain resource
allocation and PRB's }
}
```

(2)

```
with { UE in RRC_CONNECTED state }
ensure that {
  when { UE has pending data for transmission and receives DCI format 0_1 indicating resource
allocation type 1 a resource block assignment correspondent to physical resource blocks , Time
domain resource assignment and a modulation and coding }
  then { UE transmits MAC PDU's on PUSCH as per Modulation Coding scheme, time domain resource
allocation and PRB's }
}
```

7.1.1.4.2.3.2 Conformance requirements

References: The conformance requirements covered in the present TC are specified in: TS 38.212 clause 7.3.1.1.1, TS 38.214 clause 6.1.2.1, 6.1.2.2, 6.1.2.2.1, 6.1.2.2.2, 6.1.4.1, 5.1.3.1, 6.1.4.2 and 5.1.3.2. Unless otherwise stated these are Rel-15 requirements.

[TS 38.212, clause 7.3.1.1.2]

DCI format 0_1 is used for the scheduling of PUSCH in one cell.

The following information is transmitted by means of the DCI format 0_1 with CRC scrambled by C-RNTI or CS-RNTI or SP-CSI-RNTI or new-RNTI:

- Identifier for DCI formats – 1 bit
- The value of this bit field is always set to 0, indicating an UL DCI format
- Carrier indicator – 0 or 3 bits, as defined in Subclause 10.1 of [5, TS38.213].
- UL/SUL indicator – 0 bit for UEs not configured with SUL in the cell or UEs configured with SUL in the cell but only PUCCH carrier in the cell is configured for PUSCH transmission; 1 bit for UEs configured with SUL in the cell as defined in Table 7.3.1.1.1-1.
- Bandwidth part indicator – 0, 1 or 2 bits as determined by the number of UL BWPs $n_{\text{BWP,RRC}}$ configured by higher layers, excluding the initial UL bandwidth part. The bit width for this field is determined as $\lceil \log_2(n_{\text{BWP}}) \rceil$ bits, where
 - $n_{\text{BWP}} = n_{\text{BWP,RRC}} + 1$ if , in which case the bandwidth part indicator is equivalent to the higher layer parameter *BWP-Id*;
 - otherwise $n_{\text{BWP}} = n_{\text{BWP,RRC}}$, in which case the bandwidth part indicator is defined in Table 7.3.1.1.2-1;

If a UE does not support active BWP change via DCI, the UE ignores this bit field.

- Frequency domain resource assignment – number of bits determined by the following, where $N_{\text{RB}}^{\text{UL,BWP}}$ is the size of the active UL bandwidth part:

- N_{RBG} bits if only resource allocation type 0 is configured, where N_{RBG} is defined in Subclause 6.1.2.2.1 of [6, TS 38.214],
- $\lceil \log_2(N_{\text{RB}}^{\text{UL,BWP}}(N_{\text{RB}}^{\text{UL,BWP}} + 1)/2) \rceil$ bits if only resource allocation type 1 is configured, or $\max(\lceil \log_2(N_{\text{RB}}^{\text{UL,BWP}}(N_{\text{RB}}^{\text{UL,BWP}} + 1)/2) \rceil, N_{\text{RBG}}) + 1$ bits if both resource allocation type 0 and 1 are configured.
- If both resource allocation type 0 and 1 are configured, the MSB bit is used to indicate resource allocation type 0 or resource allocation type 1, where the bit value of 0 indicates resource allocation type 0 and the bit value of 1 indicates resource allocation type 1.
- For resource allocation type 0, the N_{RBG} LSBs provide the resource allocation as defined in Subclause 6.1.2.2.1 of [6, TS 38.214].
- For resource allocation type 1, the $\lceil \log_2(N_{\text{RB}}^{\text{UL,BWP}}(N_{\text{RB}}^{\text{UL,BWP}} + 1)/2) \rceil$ LSBs provide the resource allocation as follows:
 - For PUSCH hopping with resource allocation type 1:
 - $N_{\text{UL_hop}}$ MSB bits are used to indicate the frequency offset according to Subclause 6.3 of [6, TS 38.214], where $N_{\text{UL_hop}} = 1$ if the higher layer parameter *frequencyHoppingOffsetLists* contains two offset values and $N_{\text{UL_hop}} = 2$ if the higher layer parameter *frequencyHoppingOffsetLists* contains four offset values
 - $\lceil \log_2(N_{\text{RB}}^{\text{UL,BWP}}(N_{\text{RB}}^{\text{UL,BWP}} + 1)/2) \rceil - N_{\text{UL_hop}}$ bits provides the frequency domain resource allocation according to Subclause 6.1.2.2.2 of [6, TS 38.214]

If "Bandwidth part indicator" field indicates a bandwidth part other than the active bandwidth part and if both resource allocation type 0 and 1 are configured for the indicated bandwidth part, the UE assumes resource allocation type 0 for the indicated bandwidth part if the bit width of the "Frequency domain resource assignment" field of the active bandwidth part is smaller than the bit width of the "Frequency domain resource assignment" field of the indicated bandwidth part.

- For non-PUSCH hopping with resource allocation type 1:
 - $\lceil \log_2(N_{\text{RB}}^{\text{UL,BWP}}(N_{\text{RB}}^{\text{UL,BWP}} + 1)/2) \rceil$ bits provides the frequency domain resource allocation according to Subclause 6.1.2.2.2 of [6, TS 38.214]
- Time domain resource assignment – 0, 1, 2, 3, or 4 bits as defined in Subclause 6.1.2.1 of [6, TS38.214]. The bit width for this field is determined as $\lceil \log_2(I) \rceil$ bits, where I the number of entries in the higher layer parameter *pusch-AllocationList*.
- Frequency hopping flag – 0 or 1 bit:
 - 0 bit if only resource allocation type 0 is configured or if the higher layer parameter *frequencyHopping* is not configured;
 - 1 bit according to Table 7.3.1.1.2-34 otherwise, only applicable to resource allocation type 1, as defined in Subclause 6.3 of [6, TS 38.214].
- Modulation and coding scheme – 5 bits as defined in Subclause 6.1.4.1 of [6, TS 38.214]
- New data indicator – 1 bit
- Redundancy version – 2 bits as defined in Table 7.3.1.1.1-2
- HARQ process number – 4 bits
- 1st downlink assignment index – 1 or 2 bits:

- 1 bit for semi-static HARQ-ACK codebook;
- 2 bits for dynamic HARQ-ACK codebook.
- 2nd downlink assignment index – 0 or 2 bits:
 - 2 bits for dynamic HARQ-ACK codebook with two HARQ-ACK sub-codebooks;
 - 0 bit otherwise.
- TPC command for scheduled PUSCH – 2 bits as defined in Subclause 7.1.1 of [5, TS38.213]
- SRS resource indicator – $\left\lceil \log_2 \left(\sum_{k=1}^{\min\{L_{\max}^{\text{PUSCH}}, N_{\text{SRS}}\}} \binom{N_{\text{SRS}}}{k} \right) \right\rceil$ or $\lceil \log_2(N_{\text{SRS}}) \rceil$ bits, where N_{SRS} is the number of configured SRS resources in the SRS resource set associated with the higher layer parameter *usage* of value '*codeBook*' or '*nonCodeBook*', and L_{\max}^{PUSCH} is the maximum number of supported layers for the PUSCH.
 - $\left\lceil \log_2 \left(\sum_{k=1}^{\min\{L_{\max}^{\text{PUSCH}}, N_{\text{SRS}}\}} \binom{N_{\text{SRS}}}{k} \right) \right\rceil$ bits according to Tables 7.3.1.1.2-28/29/30/31 if the higher layer parameter *txConfig* = *nonCodebook*, where N_{SRS} is the number of configured SRS resources in the SRS resource set associated with the higher layer parameter *usage* of value '*nonCodeBook*';
 - $\lceil \log_2(N_{\text{SRS}}) \rceil$ bits according to Tables 7.3.1.1.2-32 if the higher layer parameter *txConfig* = *codebook*, where N_{SRS} is the number of configured SRS resources in the SRS resource set associated with the higher layer parameter *usage* of value '*codeBook*'.
- Precoding information and number of layers – number of bits determined by the following:
 - 0 bits if the higher layer parameter *txConfig* = *nonCodeBook*;
 - 0 bits for 1 antenna port and if the higher layer parameter *txConfig* = *codebook*;
 - 4, 5, or 6 bits according to Table 7.3.1.1.2-2 for 4 antenna ports, if *txConfig* = *codebook*, and according to the values of higher layer parameters *transformPrecoder*, *maxRank*, and *codebookSubset*;
 - 2, 4, or 5 bits according to Table 7.3.1.1.2-3 for 4 antenna ports, if *txConfig* = *codebook*, and according to the values of higher layer parameters *transformPrecoder*, *maxRank*, and *codebookSubset*;
 - 2 or 4 bits according to Table 7.3.1.1.2-4 for 2 antenna ports, if *txConfig* = *codebook*, and according to the values of higher layer parameters *maxRank* and *codebookSubset*;
 - 1 or 3 bits according to Table 7.3.1.1.2-5 for 2 antenna ports, if *txConfig* = *codebook* *maxRank* and *codebookSubset*, and according to the values of higher layer parameters.
- Antenna ports – number of bits determined by the following
 - 2 bits as defined by Tables 7.3.1.1.2-6, if *transformPrecoder*=*enabled*, *dmrs-Type*=1, and *maxLength*=1;
 - 4 bits as defined by Tables 7.3.1.1.2-7, if *transformPrecoder*=*enabled*, *dmrs-Type*=1, and *maxLength*=2;
 - 3 bits as defined by Tables 7.3.1.1.2-8/9/10/11, if *transformPrecoder*=*disabled*, *dmrs-Type*=1, and *maxLength*=1, and the value of rank is determined according to the SRS resource indicator field if the higher layer parameter *txConfig* = *nonCodebook* and according to the Precoding information and number of layers field if the higher layer parameter *txConfig* = *codebook*;
 - 4 bits as defined by Tables 7.3.1.1.2-12/13/14/15, if *transformPrecoder*=*disabled*, *dmrs-Type*=1, and *maxLength*=2, and the value of rank is determined according to the SRS resource indicator field if the higher layer parameter *txConfig* = *nonCodebook* and according to the Precoding information and number of layers field if the higher layer parameter *txConfig* = *codebook*;

- 4 bits as defined by Tables 7.3.1.1.2-16/17/18/19, if *transformPrecoder=disabled*, *dmrs-Type=2*, and *maxLength=1*, and the value of rank is determined according to the SRS resource indicator field if the higher layer parameter *txConfig = nonCodebook* and according to the Precoding information and number of layers field if the higher layer parameter *txConfig = codebook*;
- 5 bits as defined by Tables 7.3.1.1.2-20/21/22/23, if *transformPrecoder=disabled*, *dmrs-Type=2*, and *maxLength=2*, and the value of rank is determined according to the SRS resource indicator field if the higher layer parameter *txConfig = nonCodebook* and according to the Precoding information and number of layers field if the higher layer parameter *txConfig = codebook*.

where the number of CDM groups without data of values 1, 2, and 3 in Tables 7.3.1.1.2-6 to 7.3.1.1.2-23 refers to CDM groups {0}, {0,1}, and {0, 1,2} respectively.

If a UE is configured with both *dmrs-UplinkForPUSCH-MappingTypeA* and *dmrs-UplinkForPUSCH-MappingTypeB*, the bit width of this field equals $\max\{x_A, x_B\}$, where x_A is the “Antenna ports” bit width derived according to *dmrs-UplinkForPUSCH-MappingTypeA* and x_B is the “Antenna ports” bit width derived according to *dmrs-UplinkForPUSCH-MappingTypeB*. A number of $|x_A - x_B|$ zeros are padded in the MSB of this field, if the mapping type of the PUSCH corresponds to the smaller value of x_A and x_B .

- SRS request – 2 bits as defined by Table 7.3.1.1.2-24 for UEs not configured with SUL in the cell; 3 bits for UEs configured SUL in the cell where the first bit is the non-SUL/SUL indicator as defined in Table 7.3.1.1.1-1 and the second and third bits are defined by Table 7.3.1.1.2-24. This bit field may also indicate the associated CSI-RS according to Subclause 6.1.1.2 of [6, TS 38.214].
- CSI request – 0, 1, 2, 3, 4, 5, or 6 bits determined by higher layer parameter *reportTriggerSize*.
- CBG transmission information (CBGTI) – 0, 2, 4, 6, or 8 bits determined by higher layer parameter *maxCodeBlockGroupsPerTransportBlock* for PUSCH.
- PTRS-DMRS association – number of bits determined as follows
 - 0 bit if *PTRS-UplinkConfig* is not configured and *transformPrecoder=disabled*, or if *transformPrecoder=enabled*, or if *maxRank=1*;
 - 2 bits otherwise, where Table 7.3.1.1.2-25 and 7.3.1.1.2-26 are used to indicate the association between PTRS port(s) and DMRS port(s) for transmission of one PT-RS port and two PT-RS ports respectively, and the DMRS ports are indicated by the Antenna ports field.

If “Bandwidth part indicator” field indicates a bandwidth part other than the active bandwidth part and the “PTRS-DMRS association” field is present for the indicated bandwidth part but not present for the active bandwidth part, the UE assumes the “PTRS-DMRS association” field is not present for the indicated bandwidth part. *betaOffsets = semiStatic*

- *beta_offset* indicator – 0 if the higher layer parameter ; otherwise 2 bits as defined by Table 9.3-3 in [5, TS 38.213].
- DMRS sequence initialization – 0 if the higher layer parameter *transformPrecoder=enabled*; 1 bit if the higher layer parameter *transformPrecoder=disabled* and both *scramblingID0* and *scramblingID1* are configured in *DMRS-UplinkConfig*, for n_{SCID} selection defined in Subclause 6.4.1.1.1.1 of [4, TS 38.211].
- UL-SCH indicator – 1 bit. A value of “1” indicates UL-SCH shall be transmitted on the PUSCH and a value of “0” indicates UL-SCH shall not be transmitted on the PUSCH.

For a UE configured with SUL in a cell, if PUSCH is configured to be transmitted on both the SUL and the non-SUL of the cell and if the number of information bits in format 0_1 for the SUL is not equal to the number of information bits in format 0_1 for the non-SUL, zeros shall be appended to smaller format 0_1 until the payload size equals that of the larger format 0_1.

Table 7.3.1.1.2-1: Bandwidth part indicator

Value of BWP indicator field 2 bits	Bandwidth part
--	----------------

00	First bandwidth part configured by higher layers
01	Second bandwidth part configured by higher layers
10	Third bandwidth part configured by higher layers
11	Fourth bandwidth part configured by higher layers

Table 7.3.1.1.2-2: Precoding information and number of layers, for 4 antenna ports, if *transformPrecoder=disabled* and *maxRank* = 2 or 3 or 4

Bit field mapped to index	<i>codebookSubset</i> = <i>fullyAndPartialAndNonCoherent</i>	Bit field mapped to index	<i>codebookSubset</i> = <i>partialAndNonCoherent</i>	Bit field mapped to index	<i>codebookSubset</i> = <i>nonCoherent</i>
0	1 layer: TPMI=0	0	1 layer: TPMI=0	0	1 layer: TPMI=0
1	1 layer: TPMI=1	1	1 layer: TPMI=1	1	1 layer: TPMI=1
...
3	1 layer: TPMI=3	3	1 layer: TPMI=3	3	1 layer: TPMI=3
4	2 layers: TPMI=0	4	2 layers: TPMI=0	4	2 layers: TPMI=0
...
9	2 layers: TPMI=5	9	2 layers: TPMI=5	9	2 layers: TPMI=5
10	3 layers: TPMI=0	10	3 layers: TPMI=0	10	3 layers: TPMI=0
11	4 layers: TPMI=0	11	4 layers: TPMI=0	11	4 layers: TPMI=0
12	1 layer: TPMI=4	12	1 layer: TPMI=4	12-15	reserved
...
19	1 layer: TPMI=11	19	1 layer: TPMI=11		
20	2 layers: TPMI=6	20	2 layers: TPMI=6		
...		
27	2 layers: TPMI=13	27	2 layers: TPMI=13		
28	3 layers: TPMI=1	28	3 layers: TPMI=1		
29	3 layers: TPMI=2	29	3 layers: TPMI=2		
30	4 layers: TPMI=1	30	4 layers: TPMI=1		
31	4 layers: TPMI=2	31	4 layers: TPMI=2		
32	1 layers: TPMI=12				
...	...				
47	1 layers: TPMI=27				
48	2 layers: TPMI=14				
...	...				
55	2 layers: TPMI=21				
56	3 layers: TPMI=3				
...	...				
59	3 layers: TPMI=6				
60	4 layers: TPMI=3				
61	4 layers: TPMI=4				
62-63	reserved				

Table 7.3.1.1.2-3: Precoding information and number of layers for 4 antenna ports, if *transformPrecoder=enabled*, or if *transformPrecoder=disabled* and *maxRank* = 1

Bit field mapped to index	<i>codebookSubset</i> = <i>fullyAndPartialAndNonCoherent</i>	Bit field mapped to index	<i>codebookSubset</i> = <i>partialAndNonCoherent</i>	Bit field mapped to index	<i>codebookSubset</i> = <i>nonCoherent</i>
0	1 layer: TPMI=0	0	1 layer: TPMI=0	0	1 layer: TPMI=0
1	1 layer: TPMI=1	1	1 layer: TPMI=1	1	1 layer: TPMI=1
...
3	1 layer: TPMI=3	3	1 layer: TPMI=3	3	1 layer: TPMI=3
4	1 layer: TPMI=4	4	1 layer: TPMI=4		
...		
11	1 layer: TPMI=11	11	1 layer: TPMI=11		
12	1 layers: TPMI=12	12-15	reserved		
...	...				
27	1 layers: TPMI=27				
28-31	reserved				

Table 7.3.1.1.2-4: Precoding information and number of layers, for 2 antenna ports, if $transformPrecoder=disabled$ and $maxRank = 2$

Bit field mapped to index	<i>codebookSubset = fullyAndPartialAndNonCoherent</i>	Bit field mapped to index	<i>codebookSubset = nonCoherent</i>
0	1 layer: TPMI=0	0	1 layer: TPMI=0
1	1 layer: TPMI=1	1	1 layer: TPMI=1
2	2 layers: TPMI=0	2	2 layers: TPMI=0
3	1 layer: TPMI=2	3	reserved
4	1 layer: TPMI=3		
5	1 layer: TPMI=4		
6	1 layer: TPMI=5		
7	2 layers: TPMI=1		
8	2 layers: TPMI=2		
9-15	reserved		

Table 7.3.1.1.2-5: Precoding information and number of layers, for 2 antenna ports, if $transformPrecoder=enabled$, or if $transformPrecoder=disabled$ and $maxRank = 1$

Bit field mapped to index	<i>codebookSubset = fullyAndPartialAndNonCoherent</i>	Bit field mapped to index	<i>codebookSubset = nonCoherent</i>
0	1 layer: TPMI=0	0	1 layer: TPMI=0
1	1 layer: TPMI=1	1	1 layer: TPMI=1
2	1 layer: TPMI=2		
3	1 layer: TPMI=3		
4	1 layer: TPMI=4		
5	1 layer: TPMI=5		
6-7	reserved		

...

Table 7.3.1.1.2-33: VRB-to-PRB mapping

Bit field mapped to index	VRB-to-PRB mapping
0	Non-interleaved
1	Interleaved

[TS 38.214, clause 6.1.2.1]

When the UE is scheduled to transmit a transport block and no CSI report, or the UE is scheduled to transmit a transport block and a CSI report on PUSCH by a DCI, the *Time domain resource assignment* field value m of the DCI provides a row index $m + 1$ to an allocated table. The determination of the used resource allocation table is defined in sub-clause 6.1.2.1.1. The indexed row defines the slot offset K_2 , the start and length indicator $SLIV$, or directly the start symbol S and the allocation length L , and the PUSCH mapping type to be applied in the PUSCH transmission.

When the UE is scheduled to transmit a PUSCH with no transport block and with a CSI report by a *CSI request* field on a DCI, the *Time-domain resource assignment* field value m of the DCI provides a row index $m + 1$ to an allocated table. The determination of the applied resource allocation table is defined in sub-clause 6.1.2.1.1. The indexed row defines the start and length indicator $SLIV$, or directly the start symbol S and the allocation length L , and the PUSCH mapping type to be applied in the PUSCH transmission and K_2 is determined based on the corresponding list entries $Y_j, j = 0, \dots, N_{Rep} - 1$ of the higher layer parameter *reportSlotConfig* in *CSI-ReportConfig* for the N_{Rep} triggered CSI Reporting Settings. The i th codepoint of K_2 is determined as $K_2 = \max_j Y_j(i)$ where $Y_j(i)$ is the i th codepoint of Y_j .

- The slot where the UE shall transmit the PUSCH is determined by K_2 as $\left\lfloor n \cdot \frac{2^{\mu_{\text{PUSCH}}}}{2^{\mu_{\text{PDCCH}}}} \right\rfloor + K_2$ where n is the slot with the scheduling DCI, K_2 is based on the numerology of PUSCH, and μ_{PUSCH} and μ_{PDCCH} are the subcarrier spacing configurations for PUSCH and PDCCH, respectively, and
- The starting symbol S relative to the start of the slot, and the number of consecutive symbols L counting from the symbol S allocated for the PUSCH are determined from the start and length indicator $SLIV$ of the indexed row:

if $(L-1) \leq 7$ then

$$SLIV = 14 \cdot (L-1) + S$$

else

$$SLIV = 14 \cdot (14-L+1) + (14-1-S)$$

where $0 < L \leq 14 - S$, and

- The PUSCH mapping type is set to Type A or Type B as defined in Subclause 6.4.1.1.3 of [4, TS 38.211] as given by the indexed row.

The UE shall consider the S and L combinations defined in table 6.1.2.1-1 as valid PUSCH allocations

Table 6.1.2.1-1: Valid S and L combinations

PUSCH mapping type	Normal cyclic prefix			Extended cyclic prefix		
	S	L	$S+L$	S	L	$S+L$
Type A	0	{4,...,14}	{4,...,14}	0	{4,...,12}	{4,...,12}
Type B	{0,...,13}	{1,...,14}	{1,...,14}	{0,...,12}	{1,...,12}	{1,...,12}

When the UE is configured with $aggregationFactorUL > 1$, the same symbol allocation is applied across the $aggregationFactorUL$ consecutive slots and the PUSCH is limited to a single transmission layer. The UE shall repeat the TB across the $aggregationFactorUL$ consecutive slots applying the same symbol allocation in each slot. The redundancy version to be applied on the n^{th} transmission occasion of the TB is determined according to table 6.1.2.1-2.

Table 6.1.2.1-2: Redundancy version when $aggregationFactorUL > 1$

$rvid$ indicated by the DCI scheduling the PUSCH	$rvid$ to be applied to n^{th} transmission occasion			
	$n \bmod 4 = 0$	$n \bmod 4 = 1$	$n \bmod 4 = 2$	$n \bmod 4 = 3$
0	0	2	3	1
2	2	3	1	0
3	3	1	0	2
1	1	0	2	3

If the UE procedure for determining slot configuration, as defined in subclause 11.1 of [6, TS 38.213], determines symbols of a slot allocated for PUSCH as downlink symbols, the transmission on that slot is omitted for multi-slot PUSCH transmission.

[38.214 clause 6.1.2.2]

The UE shall determine the resource block assignment in frequency domain using the resource allocation field in the detected PDCCH DCI. Two uplink resource allocation schemes type 0 and type 1 are supported. Uplink resource allocation scheme type 0 is supported for PUSCH only when transform precoding is disabled. Uplink resource allocation scheme type 1 is supported for PUSCH for both cases when transform precoding is enabled or disabled.

If the scheduling DCI is configured to indicate the uplink resource allocation type as part of the *Frequency domain resource* assignment field by setting a higher layer parameter *resourceAllocation* in *pusch-Config* to ‘dynamicswitch’, the UE shall use uplink resource allocation type 0 or type 1 as defined by this DCI field. Otherwise the UE shall use the uplink frequency resource allocation type as defined by the higher layer parameter *resourceAllocation*.

The UE shall assume that when the scheduling PDCCH is received with DCI format 0_0, then uplink resource allocation type 1 is used.

If a bandwidth part indicator field is not configured in the scheduling DCI, the RB indexing for uplink type 0 and type 1 resource allocation is determined within the UE's active bandwidth part. If a bandwidth part indicator field is configured in the scheduling DCI, the RB indexing for uplink type 0 and type 1 resource allocation is determined within the UE's bandwidth part indicated by bandwidth part indicator field value in the DCI, except for the case when DCI format 0_0 is decoded in any PDCCH common search space in CORESET 0 in which case the initial bandwidth part shall be used. The UE shall upon detection of PDCCH intended for the UE determine first the uplink bandwidth part and then the resource allocation within the bandwidth part.

[38.214 clause 6.1.2.2.1]

In uplink resource allocation of type 0, the resource block assignment information includes a bitmap indicating the Resource Block Groups (RBGs) that are allocated to the scheduled UE where a RBG is a set of consecutive virtual resource blocks defined by higher layer parameter *rbg-Size* configured for PUSCH and the size of the carrier bandwidth part as defined in Table 6.1.2.2.1-1.

Table 6.1.2.2.1-1: Nominal RBG size P

Carrier Bandwidth Part Size	Configuration 1	Configuration 2
1 – 36	2	4
37 – 72	4	8
73 – 144	8	16
145 – 275	16	16

The total number of RBGs (N_{RBG}) for a uplink carrier bandwidth part i of size $N_{\text{BWP},i}^{\text{size}}$ PRBs is given by

$$N_{\text{RBG}} = \left\lfloor \left(N_{\text{BWP},i}^{\text{size}} + \left(N_{\text{BWP},i}^{\text{start}} \bmod P \right) \right) / P \right\rfloor \text{ where}$$

- the size of the first RBG is $\text{RBG}_0^{\text{size}} = P - N_{\text{BWP},i}^{\text{start}} \bmod P$,
- the size of the last RBG is $\text{RBG}_{\text{last}}^{\text{size}} = \left(N_{\text{BWP},i}^{\text{start}} + N_{\text{BWP},i}^{\text{size}} \right) \bmod P$ if $\left(N_{\text{BWP},i}^{\text{start}} + N_{\text{BWP},i}^{\text{size}} \right) \bmod P > 0$ and P otherwise.
- the size of all other RBG is P .

The bitmap is of size N_{RBG} bits with one bitmap bit per RBG such that each RBG is addressable. The RBGs shall be indexed in the order of increasing frequency of the carrier bandwidth part and starting at the lowest frequency. The order of RBG bitmap is such that RBG 0 to RBG $N_{\text{RBG}} - 1$ are mapped from MSB to LSB of the bitmap. The RBG is allocated to the UE if the corresponding bit value in the bitmap is 1, the RBG is not allocated to the UE otherwise.

[38.214 clause 6.1.2.2.2]

In uplink resource allocation of type 1, the resource block assignment information indicates to a scheduled UE a set of contiguously allocated non-interleaved virtual resource blocks within the active carrier bandwidth part of size $N_{\text{BWP}}^{\text{size}}$ PRBs except for the case when DCI format 0_0 is decoded in the Type0-PDCCH common search space in CORESET 0 in which case the initial bandwidth part of size $N_{\text{BWP}}^{\text{size}}$ shall be used.

An uplink type 1 resource allocation field consists of a resource indication value (RIV) corresponding to a starting virtual resource block (RB_{start}) and a length in terms of contiguously allocated resource blocks L_{RBs} . The resource indication value is defined by

$$\text{if } (L_{\text{RBs}} - 1) \leq \left\lfloor N_{\text{BWP}}^{\text{size}} / 2 \right\rfloor \text{ then}$$

$$RIV = N_{\text{BWP}}^{\text{size}} (L_{\text{RBs}} - 1) + RB_{\text{start}}$$

else

$$RIV = N_{BWP}^{size} (N_{BWP}^{size} - L_{RB_s} + 1) + (N_{BWP}^{size} - 1 - RB_{start})$$

where $L_{RB_s} \geq 1$ and shall not exceed $N_{BWP}^{size} - RB_{start}$.

[TS 38.214, clause 6.1.4.1]

For the PUSCH assigned by a DCI format 0_0/0_1 with CRC scrambled by C-RNTI, new-RNTI, TC-RNTI, or SP-CSI-RNTI, the transform precoding is enabled if *transformPrecoder* in *PUSCH-Config* is set to 'enabled', or if *transformPrecoder* in *PUSCH-Config* is not configured and *msg3-transformPrecoding* in *rach-ConfigCommon* is set to 'enabled'; otherwise the transform precoding is disabled.

For the PUSCH assigned by a DCI format 0_0/0_1 with CRC scrambled by CS-RNTI, or the PUSCH with configured grant using CS-RNTI, the transform precoding is enabled if *transformPrecoder* in *ConfiguredGrantConfig* is set to 'enabled'; otherwise the transform precoding is disabled.

For a PUSCH scheduled by RAR UL grant or for a PUSCH scheduled by a DCI format 0_0/0_1 with CRC scrambled by C-RNTI, TC-RNTI, or CS-RNTI, or SP-CSI-RNTI, or for a PUSCH with configured grant using CS-RNTI,

if *transformPrecoder* is disabled for this PUSCH transmission

- if *mcs-Table* in *PUSCH-Config* is set to 'qam256', and PUSCH is scheduled with C-RNTI or SP-CSI-RNTI, and PUSCH is assigned by DCI format 0_1,
 - the UE shall use I_{MCS} and Table 5.1.3.1-2 to determine the modulation order (Q_m) and Target code rate (R) used in the physical uplink shared channel.
- elseif the UE is not configured with new-RNTI, *mcs-Table* in *PUSCH-Config* is set to 'qam64LowSE', the PUSCH is scheduled with C-RNTI, or SP-CSI-RNTI, and the PUSCH is assigned by a PDCCH in a UE-specific search space,
 - the UE shall use I_{MCS} and Table 5.1.3.1-3 to determine the modulation order (Q_m) and Target code rate (R) used in the physical uplink shared channel.
- elseif the UE is configured with new-RNTI, and the PUSCH is scheduled with new-RNTI,
 - the UE shall use I_{MCS} and Table 5.1.3.1-3 to determine the modulation order (Q_m) and Target code rate (R) used in the physical uplink shared channel.
- elseif *mcs-Table* in *ConfiguredGrantConfig* is set to 'qam256', and PUSCH is scheduled with CS-RNTI,
 - the UE shall use I_{MCS} and Table 5.1.3.1-2 to determine the modulation order (Q_m) and Target code rate (R) used in the physical uplink shared channel.
- elseif *mcs-Table* in *ConfiguredGrantConfig* is set to 'qam64LowSE', and PUSCH is scheduled with CS-RNTI,
 - the UE shall use I_{MCS} and Table 5.1.3.1-3 to determine the modulation order (Q_m) and Target code rate (R) used in the physical uplink shared channel.
- else
 - the UE shall use I_{MCS} and Table 5.1.3.1-1 to determine the modulation order (Q_m) and Target code rate (R) used in the physical uplink shared channel.

[TS 38.214, clause 5.1.3.1]

Table 5.1.3.1-1: MCS index table 1 for PDSCH

MCS Index I_{Mcs}	Modulation Order Q_m	Target code Rate $R \times [1024]$	Spectral efficiency
0	2	120	0.2344
1	2	157	0.3066
2	2	193	0.3770
3	2	251	0.4902
4	2	308	0.6016
5	2	379	0.7402

6	2	449	0.8770
7	2	526	1.0273
8	2	602	1.1758
9	2	679	1.3262
10	4	340	1.3281
11	4	378	1.4766
12	4	434	1.6953
13	4	490	1.9141
14	4	553	2.1602
15	4	616	2.4063
16	4	658	2.5703
17	6	438	2.5664
18	6	466	2.7305
19	6	517	3.0293
20	6	567	3.3223
21	6	616	3.6094
22	6	666	3.9023
23	6	719	4.2129
24	6	772	4.5234
25	6	822	4.8164
26	6	873	5.1152
27	6	910	5.3320
28	6	948	5.5547
29	2	reserved	
30	4	reserved	
31	6	reserved	

[TS 38.214, clause 6.1.4.2]

For a PUSCH scheduled by RAR UL grant or for a PUSCH scheduled by a DCI format 0_0/0_1 with CRC scrambled by C-RNTI, new-RNTI, TC-RNTI, CS-RNTI, or SP-CSI-RNTI.

if

- $0 \leq I_{MCS} \leq 27$ and transform precoding is disabled and Table 5.1.3.1-2 is used, or
- $0 \leq I_{MCS} \leq 28$ and transform precoding is disabled and a table other than Table 5.1.3.1-2 is used, or
- $0 \leq I_{MCS} \leq 27$ and transform precoding is enabled, the UE shall first determine the TBS as specified below:

The UE shall first determine the number of REs (N_{RE}) within the slot:

- A UE first determines the number of REs allocated for PUSCH within a PRB (N'_{RE}) by
- $N'_{RE} = N_{sc}^{RB} * N_{symp}^{sh} - N_{DMRS}^{PRB} - N_{oh}^{PRB}$, where $N_{sc}^{RB} = 12$ is the number of subcarriers in the frequency domain in a physical resource block, N_{symp}^{sh} is the number of symbols of the PUSCH allocation within the slot, N_{DMRS}^{PRB} is the number of REs for DM-RS per PRB in the scheduled duration including the overhead of the DM-RS CDM groups without data, as indicated by DCI format 0_1 or as described for DCI format 0_0 in Subclause 6.2.2, and N_{oh}^{PRB} is the overhead configured by higher layer parameter $xOverhead$ in *PUSCH-ServingCellConfig*. If the N_{oh}^{PRB} is not configured (a value from 0, 6, 12, or 18), the N_{oh}^{PRB} is assumed to be 0. For MSG3 transmission the N_{oh}^{PRB} is always set to 0.
- A UE determines the total number of REs allocated for PUSCH (N_{RE}) by $N_{RE} = \min(156, N'_{RE}) \cdot n_{PRB}$ where n_{PRB} is the total number of allocated PRBs for the UE.
- Next, proceed with steps 2-4 as defined in Subclause 5.1.3.2

else if

- $28 \leq I_{MCS} \leq 31$ and transform precoding is disabled and Table 5.1.3.1-2 is used, or
- $28 \leq I_{MCS} \leq 31$ and transform precoding is enabled,
- the TBS is assumed to be as determined from the DCI transported in the latest PDCCH for the same transport block using $0 \leq I_{MCS} \leq 27$. If there is no PDCCH for the same transport block using $0 \leq I_{MCS} \leq 27$, and if the initial PUSCH for the same transport block is transmitted with configured grant, the TBS shall be determined from the most recent configured scheduling PDCCH.

else

- the TBS is assumed to be as determined from the DCI transported in the latest PDCCH for the same transport block using $0 \leq I_{MCS} \leq 28$. If there is no PDCCH for the same transport block using $0 \leq I_{MCS} \leq 28$, and if the initial PUSCH for the same transport block is transmitted with configured grant, the TBS shall be determined from the most recent configured scheduling PDCCH.

[TS 38.214, clause 5.1.3.2]

- 2) Intermediate number of information bits (N_{info}) is obtained by $N_{info} = N_{RE} \cdot R \cdot Q_m \cdot \nu$.

If $N_{info} \leq 3824$

Use step 3 as the next step of the TBS determination

else

Use step 4 as the next step of the TBS determination

end if

- 3) When $N_{info} \leq 3824$, TBS is determined as follows

- quantized intermediate number of information bits $N'_{info} = \max\left(24, 2^n \cdot \left\lfloor \frac{N_{info}}{2^n} \right\rfloor\right)$, where
 $n = \max(3, \lfloor \log_2(N_{info}) \rfloor - 6)$.
- use Table 5.1.3.2-2 find the closest TBS that is not less than N'_{info} .

Table 5.1.3.2-2: TBS for $N_{info} \leq 3824$

Index	TBS	Index	TBS	Index	TBS	Index	TBS
1	24	31	336	61	1288	91	3624
2	32	32	352	62	1320	92	3752
3	40	33	368	63	1352	93	3824
4	48	34	384	64	1416		
5	56	35	408	65	1480		
6	64	36	432	66	1544		
7	72	37	456	67	1608		
8	80	38	480	68	1672		
9	88	39	504	69	1736		
10	96	40	528	70	1800		
11	104	41	552	71	1864		
12	112	42	576	72	1928		
13	120	43	608	73	2024		
14	128	44	640	74	2088		
15	136	45	672	75	2152		
16	144	46	704	76	2216		
17	152	47	736	77	2280		
18	160	48	768	78	2408		

19	168	49	808	79	2472		
20	176	50	848	80	2536		
21	184	51	888	81	2600		
22	192	52	928	82	2664		
23	208	53	984	83	2728		
24	224	54	1032	84	2792		
25	240	55	1064	85	2856		
26	256	56	1128	86	2976		
27	272	57	1160	87	3104		
28	288	58	1192	88	3240		
29	304	59	1224	89	3368		
30	320	60	1256	90	3496		

4) When $N_{info} > 3824$, TBS is determined as follows.

- quantized intermediate number of information bits $N'_{info} = \max\left(3840, 2^n \times \text{round}\left(\frac{N_{info} - 24}{2^n}\right)\right)$, where $n = \lfloor \log_2(N_{info} - 24) \rfloor - 5$ and ties in the round function are broken towards the next largest integer.
- if $R \leq 1/4$

$$TBS = 8 \cdot C \cdot \left\lceil \frac{N'_{info} + 24}{8 \cdot C} \right\rceil - 24, \text{ where } C = \left\lceil \frac{N'_{info} + 24}{3816} \right\rceil$$

else

if $N'_{info} > 8424$

$$TBS = 8 \cdot C \cdot \left\lceil \frac{N'_{info} + 24}{8 \cdot C} \right\rceil - 24, \text{ where } C = \left\lceil \frac{N'_{info} + 24}{8424} \right\rceil$$

else

$$TBS = 8 \cdot \left\lceil \frac{N'_{info} + 24}{8} \right\rceil - 24$$

end if

end if

7.1.1.4.2.3.3 Test description

7.1.1.4.2.3.3.1 Pre-test conditions

Same Pre-test conditions as in clause 7.1.1.0 except set the NR Cell bandwidth and applicable BWP to maximum for the NR Band under test as specified in Table 5.3.5-1 in TS 38.101-1 [16] / TS 38.101-2 [17] (to enable testing of n_{PRB} up to maximum value).

Test frequency NRf1 is as specified in TS 38.508-1 [4] clause 4.3.1 using the common highest mandatory UL and DL channel bandwidth and using the default subcarrier spacing specified in TS 38.508-1 [4] clause 6.2.3.1.

7.1.1.4.2.3.3.2 Test procedure sequence

Table 7.1.1.4.2.3.3.2-1: Maximum TBS for different UE categories

UE Category	Maximum number of bits of a UL-SCH transport block received within a TTI
TS 38.306 [23] clause 4.1.2 require UE without ue-CategoryDL and ue-CategoryUL, to	

support Max TBS achievable based on max bandwidth of the Band under test.

Table 7.1.1.4.2.3.3.2-2: Number of downlink PDCP SDUs and PDCP SDU size used as test data

TBS [bits]	Number of PDCP SDUs	PDCP SDU size [bits] (Note 1)
$136 \leq \text{TBS} \leq 12128$ note 2	1	$8 * \text{FLOOR}((\text{TBS} - 128) / 8)$
$12129 \leq \text{TBS} \leq 24200$	2	$8 * \text{FLOOR}((\text{TBS} - 200) / 16)$
$24201 \leq \text{TBS} \leq 36272$	3	$8 * \text{FLOOR}((\text{TBS} - 272) / 24)$
$36273 \leq \text{TBS} \leq 48344$	4	$8 * \text{FLOOR}((\text{TBS} - 344) / 32)$
$48345 \leq \text{TBS} \leq 60416$	5	$8 * \text{FLOOR}((\text{TBS} - 416) / 40)$
$60417 \leq \text{TBS} \leq 72488$	6	$8 * \text{FLOOR}((\text{TBS} - 488) / 48)$
$72489 \leq \text{TBS} \leq 84560$	7	$8 * \text{FLOOR}((\text{TBS} - 560) / 56)$
$84561 \leq \text{TBS} \leq 96632$	8	$8 * \text{FLOOR}((\text{TBS} - 632) / 64)$
$96633 < \text{TBS} \leq 108704$	9	$8 * \text{FLOOR}((\text{TBS} - 704) / 72)$
$10705 \leq \text{TBS} \leq 120776$	10	$8 * \text{FLOOR}((\text{TBS} - 776) / 80)$
$120777 \leq \text{TBS} \leq 132848$	11	$8 * \text{FLOOR}((\text{TBS} - 848) / 88)$
$132849 \leq \text{TBS} \leq 144920$	12	$8 * \text{FLOOR}((\text{TBS} - 920) / 96)$
$144921 \leq \text{TBS} \leq 156992$	13	$8 * \text{FLOOR}((\text{TBS} - 992) / 104)$
$156993 \leq \text{TBS} \leq 169064$	14	$8 * \text{FLOOR}((\text{TBS} - 1064) / 112)$
$169065 \leq \text{TBS} \leq 181136$	15	$8 * \text{FLOOR}((\text{TBS} - 1136) / 120)$
$181137 \leq \text{TBS} \leq 193208$	16	$8 * \text{FLOOR}((\text{TBS} - 1208) / 128)$
$193209 \leq \text{TBS} \leq 205280$	17	$8 * \text{FLOOR}((\text{TBS} - 1280) / 136)$
$205281 \leq \text{TBS} \leq 217352$	18	$8 * \text{FLOOR}((\text{TBS} - 1352) / 144)$
$217353 \leq \text{TBS} \leq 229424$	19	$8 * \text{FLOOR}((\text{TBS} - 1424) / 152)$
$\text{TBS} > 229424$	20	$8 * \text{FLOOR}((\text{TBS} - 1496) / 160)$

Note 1: Each PDCP SDU is limited to 1500 octets (to keep below maximum SDU size of ESM as specified in TS 24.301 [21] clause 9.9.4.12).

The PDCP SDU size of each PDCP SDU is

PDCP SDU size = (TBS – N*PDCP header size – N*AMD PDU header size – N*MAC header size – Size of Timing Advance – RLC Status PDU size- MAC header for RLC Status PDU) / N, where

PDCP header size is 24 bits for the RLC AM and 18-bit SN case;
AMD PDU header size is 24 bits with 18 bit SN;

MAC header size for AMD PDU = 16 or 24 bits depending on L=8 or 16 bits. Worst case 24 is taken.

Size of Timing Advance MAC CE with header is 16 bits (if no Timing Advance and/or RLC status needs to be sent, padding will occur instead).

RLC Status PDU size = 24 bits with 1 ACK_SN, With a MAC header of 16 bits.

This gives:

PDCP SDU size = $8 * \text{FLOOR}((\text{TBS} - N * 24 - N * 24 - N * 24 - 56) / (8 * N))$ bits.

Note 2: According to the final PDCP SDU size formula in Note 1, the smallest TBS that can be tested is 136 bits.

Table 7.1.1.4.2.3.3.2-2A: Bandwidth part Dependent Parameters for Resource allocation 0 with start of BWP assumed as 0

$N_{RB}^{DL,BWP} = N_{BWP,i}^{size}$	Nominal RBG size P (Configuration1)	Size of last RBG	Allowed N_{PRB} Values
11	2	1	All 1...11
18	2	2	2,4,6,8,10,12,16,18
24	2	2	2,4,6,8,10,12,16,18,20,22,24
25	2	1	All 1...25
31	2	1	All 1...31
32	2	2	2,4,6,8,10,12,16,18,20,22,24,26,28,30,32

38	4	2	2,4,6,8,10,12,16,18,20,22,24,26,28,30,32,34,36,38
51	4	3	3,4,7,8,11,12,15,16,19,20,23,24,27,28,31,32,35,36,39,40,43,44,47,48,51
52	4	4	4,8,12,16,20,24,28,32,36,40,44,48,52
65	4	1	1,4,5,8,9,12,13,16,17,20,21,24,25,28,29,32,33,36,37,40,41,44,45,48,49,52,53,56,57,60,61,64,65
66	4	2	2,4,6,8,10,12,16,18,20,22,24,26,28,30,32,34,36,38,40,42,44,46,48,50,52,54,56,58,60,62,64,66
79	8	7	7,8,15,16,23,24,31,32,39,40,47,48,55,56,63,64,71,72,79
106	8	2	2,8,10,16,18,24,26,32,34,40,42,48,50,56,58,64,66,72,74,80,82,88,90,96,92,104,106
107	8	3	3,8,11,16,19,24,27,32,35,40,43,48,51,56,59,64,67,72,75,80,83,88,91,96,99,104,107
132	8	4	4,8,12,16,20,24,28,32,36,40,44,48,52,56,60,64,68,72,76,80,84,88,92,96,100,104,108,112,116,120,124,128,132
133	8	5	5,8,13,16,21,24,29,32,37,40,45,48,53,56,61,64,69,72,77,80,85,88,93,96,101,104,109,112,117,120,125,128,133
135	8	7	7,8,15,16,23,24,31,32,39,40,47,48,55,56,63,64,71,72,79,80,87,88,95,96,103,104,111,112,119,120,127,128,135
160	16	16	16,32,48,64,80,96,112,128,144,160
216	16	8	8,16,24,32,40,48,56,64,72,80,88,96,104,112,120,128,136,144,152,160,168,176,184,192,200,208,216
217	16	9	9,16,25,32,41,48,57,64,73,80,89,96,105,112,121,128,137,144,153,160,169,176,185,192,201,208,217
264	16	8	8,16,24,32,40,48,56,64,72,80,88,96,104,112,120,128,136,144,160,168,176,184,192,200,208,216,224,232,240,248,256,264
270	16	14	14,16,30,32,46,44,62,64,78,80,94,96,110,112,126,128,142,144,158,160,174,176,190,192,206,208,222,224,238,240,254,256,270
273	16	1	1,16,17,32,33,48,49,64,65,80,81,96,97,112,113,128,129,144,145,160,161,176,171,192,193,208,209,224,225,240,241,256,257,272,273

Table 7.1.1.4.2.3.3.2-3: Specific Parameter

Parameter	Value	Comment	Condition
mcs-Table	qam64		
resourceAllocation	dynamicSwitch		pc_dynamicSwitchRA_Type0_1_PUSCH
	resourceAllocationType1		NOT pc_dynamicSwitchRA_Type0_1_PUSCH AND Steps 1-5
	resourceAllocationType0		NOT pc_dynamicSwitchRA_Type0_1_PUSCH AND pc_ra_Type0_PUSCH AND Steps 6-10
rbg-Size	Not present	configuration 1 applicable	
N_{BWP}^{start}	0		

Table 7.1.1.4.2.3.3.2-4: Main behaviour

		U - S	Message		
3GPP	EXCEPTION: Steps 1 to 5 are repeated for allowed values of N_{PRB} 1 to $N_{PRB}^{UL,BWP}$ in BWP, time domain resource as per Table 7.1.1.4.2.0-1 and I_{MCS} from 0 to 28.	-	-	-	-
TS 38.523-1	version 17.0.0 Release 17	693	ETSI TS 138 523-1 V17.0.0 (2022-10)		
1	SS calculates or looks up TBS in TS 38.214 [15] based on the value of S, L, I_{MCS} and n_{PRB} .	-	-	-	-
-	EXCEPTION: Steps 2 to 5 are performed if TBS is less than or equal to UE capability "Maximum number of UL-SCH transport block bits received within a TTI" as specified in Table 7.1.1.4.2.3.3.2-1 and larger than or equal to 136 bits as specified in Table 7.1.1.4.2.3.3.2-2. Skip the execution of steps 2 to 5 for which the value of N_{info} satisfies the condition $3824 < N_{info} < 3825$. (Note 4) Skip the execution of steps 1 to 5 for $I_{MCS} > 27$ and $N_{PRB} < 5$. (Note3)	-	-	-	-
2	SS creates one or more PDCP SDUs depending on TBS in accordance with Table 7.1.1.4.2.3.3.2-2.	-	-	-	-
3	The SS transmits all PDCP SDUs (N_{SDUs}) as created in step 2 in a MAC PDU.	<--	MAC PDU (NxPDCP SDUs)	-	-
4	After the reception of 2 Scheduling Request, SS transmits UL Grant DCI 0_1, and values of S, L, I_{MCS} and n_{PRB}	<--	(UL Grant) (DCI: (DCI Format 0_1, S, L, I_{MCS} and n_{PRB}))	-	-
5	CHECK: Does UE return the same number of PDCP SDUs with same content as transmitted by the SS in step 3 using Time, frequency Resources and modulation and coding scheme as configured by the SS in step 4?	-->	(NxPDCP SDUs)	2	P
-	EXCEPTION : Steps 5Aa1 to 10 are executed if $pc_ra_Type0_PUSCH$	-	-	-	-
-	EXCEPTION : Steps 5Aa1 to 5Aa2 are executed if NOT $pc_dynamicSwitchRA_Type0_1_PUSCH$	-	-	-	-
5A a1	The SS transmits a NR RRCReconfiguration message including <i>PUSCH-Config</i> with IE resourceAllocation set to resourceAllocationType0 (Note 1)	<--	<i>RRCReconfiguration</i>	-	-
5A a2	The UE transmit a NR <i>RRCReconfigurationComplete</i> message.(Note 2)	-->	<i>RRCReconfigurationComplete</i>	-	-
-	EXCEPTION: Steps 6 to 10 are repeated for allowed values of N_{PRB} as per table 7.1.1.4.2.3.3.2-2A in BWP, time domain resource length L 3 to 14-S and I_{MCS} from 0 to 28.	-	-	-	-
6	SS calculates or looks up TBS in TS 38.214 [15] based on the value of S, L, I_{MCS} and n_{PRB} .	-	-	-	-
-	EXCEPTION: Steps 7 to 10 are performed if TBS1 + TBS2 is less than or equal to UE capability "Maximum number of UL-SCH transport block bits received within a TTI" as specified in Table 7.1.1.4.2.3.3.2-1 and larger than or equal to 136 bits as specified in Table 7.1.1.4.2.3.3.2-2. Skip the execution of steps 7 to 10 for which the value of N_{info} satisfies the condition $3824 < N_{info} < 3825$. (Note 4) Skip the execution of steps 6 to 10 for $I_{MCS} > 27$ and $N_{PRB} < 5$. (Note 3)	-	-	-	-
7	SS creates one or more PDCP SDUs depending on TBS in accordance with Table	ETSI	-	-	-

7.1.1.4.2.3.3.3 Specific message contents

None.

7.1.1.4.2.4 UL-SCH transport block size selection / DCI format 0_1 / RA type 0/RA Type 1 / 256QAM / Transform precoding disabled

7.1.1.4.2.4.1 Test Purpose (TP)

(1)

```
with { UE in RRC_CONNECTED state and mcs-Table is set as 'qam256' }
ensure that {
  when { UE has pending data for transmission and receives DCI format 0_1 indicating resource
allocation type 0 a resource block assignment correspondent to physical resource blocks , Time
domain resource assignment and a modulation and coding }
  then { UE transmits MAC PDU's on PUSCH as per Modulation Coding scheme, time domain resource
allocation and PRB's }
}
```

(2)

```
with { UE in RRC_CONNECTED state and mcs-Table is set as 'qam256' }
ensure that {
  when { UE has pending data for transmission and receives DCI format 0_1 indicating resource
allocation type 1 a resource block assignment correspondent to physical resource blocks , Time
domain resource assignment and a modulation and coding }
  then { UE transmits MAC PDU's on PUSCH as per Modulation Coding scheme, time domain resource
allocation and PRB's }
}
```

7.1.1.4.2.4.2 Conformance requirements

References: The conformance requirements covered in the present TC are specified in: TS 38.212 clause 7.3.1.1.1, TS 38.214 clause 6.1.2.1, 6.1.2.2, 6.1.2.2.1, 6.1.2.2.2, 6.1.4.1, 5.1.3.1, 6.1.4.2 and 5.1.3.2. Unless otherwise stated these are Rel-15 requirements.

[TS 38.212, clause 7.3.1.1.2]

DCI format 0_1 is used for the scheduling of PUSCH in one cell.

The following information is transmitted by means of the DCI format 0_1 with CRC scrambled by C-RNTI or CS-RNTI or SP-CSI-RNTI or new-RNTI:

- Identifier for DCI formats – 1 bit
- The value of this bit field is always set to 0, indicating an UL DCI format
 - Carrier indicator – 0 or 3 bits, as defined in Subclause 10.1 of [5, TS38.213].
 - UL/SUL indicator – 0 bit for UEs not configured with SUL in the cell or UEs configured with SUL in the cell but only PUCCH carrier in the cell is configured for PUSCH transmission; 1 bit for UEs configured with SUL in the cell as defined in Table 7.3.1.1.1-1.
 - Bandwidth part indicator – 0, 1 or 2 bits as determined by the number of UL BWPs $n_{\text{BWP,RRC}}$ configured by higher layers, excluding the initial UL bandwidth part. The bit width for this field is determined as $\lceil \log_2(n_{\text{BWP}}) \rceil$ bits, where
 - $n_{\text{BWP}} = n_{\text{BWP,RRC}} + 1$ if $n_{\text{BWP,RRC}} \leq 3$, in which case the bandwidth part indicator is equivalent to the higher layer parameter *BWP-Id*;
 - otherwise $n_{\text{BWP}} = n_{\text{BWP,RRC}}$, in which case the bandwidth part indicator is defined in Table 7.3.1.1.2-1;

If a UE does not support active BWP change via DCI, the UE ignores this bit field.

- Frequency domain resource assignment – number of bits determined by the following, where $N_{RB}^{UL,BWP}$ is the size of the active UL bandwidth part:
 - N_{RBG} bits if only resource allocation type 0 is configured, where N_{RBG} is defined in Subclause 6.1.2.2.1 of [6, TS 38.214],
 - $\lceil \log_2(N_{RB}^{UL,BWP}(N_{RB}^{UL,BWP} + 1)/2) \rceil$ bits if only resource allocation type 1 is configured, or $\max(\lceil \log_2(N_{RB}^{UL,BWP}(N_{RB}^{UL,BWP} + 1)/2) \rceil, N_{RBG}) + 1$ bits if both resource allocation type 0 and 1 are configured.
- If both resource allocation type 0 and 1 are configured, the MSB bit is used to indicate resource allocation type 0 or resource allocation type 1, where the bit value of 0 indicates resource allocation type 0 and the bit value of 1 indicates resource allocation type 1.
- For resource allocation type 0, the N_{RBG} LSBs provide the resource allocation as defined in Subclause 6.1.2.2.1 of [6, TS 38.214].
- For resource allocation type 1, the $\lceil \log_2(N_{RB}^{UL,BWP}(N_{RB}^{UL,BWP} + 1)/2) \rceil$ LSBs provide the resource allocation as follows:
 - For PUSCH hopping with resource allocation type 1:
 - N_{UL_hop} MSB bits are used to indicate the frequency offset according to Subclause 6.3 of [6, TS 38.214], where $N_{UL_hop} = 1$ if the higher layer parameter *frequencyHoppingOffsetLists* contains two offset values and $N_{UL_hop} = 2$ if the higher layer parameter *frequencyHoppingOffsetLists* contains four offset values
 - $\lceil \log_2(N_{RB}^{UL,BWP}(N_{RB}^{UL,BWP} + 1)/2) \rceil - N_{UL_hop}$ bits provides the frequency domain resource allocation according to Subclause 6.1.2.2.2 of [6, TS 38.214]
 - For non-PUSCH hopping with resource allocation type 1:
 - $\lceil \log_2(N_{RB}^{UL,BWP}(N_{RB}^{UL,BWP} + 1)/2) \rceil$ bits provides the frequency domain resource allocation according to Subclause 6.1.2.2.2 of [6, TS 38.214]

If "Bandwidth part indicator" field indicates a bandwidth part other than the active bandwidth part and if both resource allocation type 0 and 1 are configured for the indicated bandwidth part, the UE assumes resource allocation type 0 for the indicated bandwidth part if the bit width of the "Frequency domain resource assignment" field of the active bandwidth part is smaller than the bit width of the "Frequency domain resource assignment" field of the indicated bandwidth part.

- Time domain resource assignment – 0, 1, 2, 3, or 4 bits as defined in Subclause 6.1.2.1 of [6, TS38.214]. The bit width for this field is determined as $\lceil \log_2(I) \rceil$ bits, where I the number of entries in the higher layer parameter *pusch-AllocationList*.
- Frequency hopping flag – 0 or 1 bit:
 - 0 bit if only resource allocation type 0 is configured or if the higher layer parameter *frequencyHopping* is not configured;
 - 1 bit according to Table 7.3.1.1.2-34 otherwise, only applicable to resource allocation type 1, as defined in Subclause 6.3 of [6, TS 38.214].
- Modulation and coding scheme – 5 bits as defined in Subclause 6.1.4.1 of [6, TS 38.214]
- New data indicator – 1 bit
- Redundancy version – 2 bits as defined in Table 7.3.1.1.1-2

- HARQ process number – 4 bits
- 1st downlink assignment index – 1 or 2 bits:
 - 1 bit for semi-static HARQ-ACK codebook;
 - 2 bits for dynamic HARQ-ACK codebook.
- 2nd downlink assignment index – 0 or 2 bits:
 - 2 bits for dynamic HARQ-ACK codebook with two HARQ-ACK sub-codebooks;
 - 0 bit otherwise.
- TPC command for scheduled PUSCH – 2 bits as defined in Subclause 7.1.1 of [5, TS38.213]
- SRS resource indicator – $\left\lceil \log_2 \left(\sum_{k=1}^{\min\{L_{\max}^{\text{PUSCH}}, N_{\text{SRS}}\}} \binom{N_{\text{SRS}}}{k} \right) \right\rceil$ or $\lceil \log_2(N_{\text{SRS}}) \rceil$ bits, where N_{SRS} is the number of configured SRS resources in the SRS resource set associated with the higher layer parameter *usage* of value 'codeBook' or 'nonCodeBook', and L_{\max}^{PUSCH} is the maximum number of supported layers for the PUSCH.
 - $\left\lceil \log_2 \left(\sum_{k=1}^{\min\{L_{\max}^{\text{PUSCH}}, N_{\text{SRS}}\}} \binom{N_{\text{SRS}}}{k} \right) \right\rceil$ bits according to Tables 7.3.1.1.2-28/29/30/31 if the higher layer parameter *txConfig* = *nonCodebook*, where N_{SRS} is the number of configured SRS resources in the SRS resource set associated with the higher layer parameter *usage* of value 'nonCodeBook';
 - $\lceil \log_2(N_{\text{SRS}}) \rceil$ bits according to Tables 7.3.1.1.2-32 if the higher layer parameter *txConfig* = *codebook*, where N_{SRS} is the number of configured SRS resources in the SRS resource set associated with the higher layer parameter *usage* of value 'codeBook'.
- Precoding information and number of layers – number of bits determined by the following:
 - 0 bits if the higher layer parameter *txConfig* = *nonCodeBook*;
 - 0 bits for 1 antenna port and if the higher layer parameter *txConfig* = *codebook*;
 - 4, 5, or 6 bits according to Table 7.3.1.1.2-2 for 4 antenna ports, if *txConfig* = *codebook*, and according to the values of higher layer parameters *transformPrecoder*, *maxRank*, and *codebookSubset*;
 - 2, 4, or 5 bits according to Table 7.3.1.1.2-3 for 4 antenna ports, if *txConfig* = *codebook*, and according to the values of higher layer parameters *transformPrecoder*, *maxRank*, and *codebookSubset*;
 - 2 or 4 bits according to Table 7.3.1.1.2-4 for 2 antenna ports, if *txConfig* = *codebook*, and according to the values of higher layer parameters *maxRank* and *codebookSubset*;
 - 1 or 3 bits according to Table 7.3.1.1.2-5 for 2 antenna ports, if *txConfig* = *codebook*, and according to the values of higher layer parameters *maxRank* and *codebookSubset*.
- Antenna ports – number of bits determined by the following
 - 2 bits as defined by Tables 7.3.1.1.2-6, if *transformPrecoder*=*enabled*, *dmrs-Type*=1, and *maxLength*=1;
 - 4 bits as defined by Tables 7.3.1.1.2-7, if *transformPrecoder*=*enabled*, *dmrs-Type*=1, and *maxLength*=2;
 - 3 bits as defined by Tables 7.3.1.1.2-8/9/10/11, if *transformPrecoder*=*disabled*, *dmrs-Type*=1, and *maxLength*=1, and the value of rank is determined according to the SRS resource indicator field if the higher layer parameter *txConfig* = *nonCodebook* and according to the Precoding information and number of layers field if the higher layer parameter *txConfig* = *codebook*;
 - 4 bits as defined by Tables 7.3.1.1.2-12/13/14/15, if *transformPrecoder*=*disabled*, *dmrs-Type*=1, and *maxLength*=2, and the value of rank is determined according to the SRS resource indicator field if the higher

layer parameter *txConfig = nonCodebook* and according to the Precoding information and number of layers field if the higher layer parameter *txConfig = codebook*;

- 4 bits as defined by Tables 7.3.1.1.2-16/17/18/19, if *transformPrecoder=disabled*, *dmrs-Type=2*, and *maxLength=1*, and the value of rank is determined according to the SRS resource indicator field if the higher layer parameter *txConfig = nonCodebook* and according to the Precoding information and number of layers field if the higher layer parameter *txConfig = codebook*;
- 5 bits as defined by Tables 7.3.1.1.2-20/21/22/23, if *transformPrecoder=disabled*, *dmrs-Type=2*, and *maxLength=2*, and the value of rank is determined according to the SRS resource indicator field if the higher layer parameter *txConfig = nonCodebook* and according to the Precoding information and number of layers field if the higher layer parameter *txConfig = codebook*.

where the number of CDM groups without data of values 1, 2, and 3 in Tables 7.3.1.1.2-6 to 7.3.1.1.2-23 refers to CDM groups {0}, {0,1}, and {0, 1,2} respectively.

If a UE is configured with both *dmrs-UplinkForPUSCH-MappingTypeA* and *dmrs-UplinkForPUSCH-MappingTypeB*, the bit width of this field equals $\max\{x_A, x_B\}$, where x_A is the “Antenna ports” bit width derived according to *dmrs-UplinkForPUSCH-MappingTypeA* and x_B is the “Antenna ports” bit width derived according to *dmrs-UplinkForPUSCH-MappingTypeB*. A number of $|x_A - x_B|$ zeros are padded in the MSB of this field, if the mapping type of the PUSCH corresponds to the smaller value of x_A and x_B .

- SRS request – 2 bits as defined by Table 7.3.1.1.2-24 for UEs not configured with SUL in the cell; 3 bits for UEs configured SUL in the cell where the first bit is the non-SUL/SUL indicator as defined in Table 7.3.1.1.1-1 and the second and third bits are defined by Table 7.3.1.1.2-24. This bit field may also indicate the associated CSI-RS according to Subclause 6.1.1.2 of [6, TS 38.214].
- CSI request – 0, 1, 2, 3, 4, 5, or 6 bits determined by higher layer parameter *reportTriggerSize*.
- CBG transmission information (CBGTI) – 0, 2, 4, 6, or 8 bits determined by higher layer parameter *maxCodeBlockGroupsPerTransportBlock* for PUSCH.
- PTRS-DMRS association – number of bits determined as follows
 - 0 bit if *PTRS-UplinkConfig* is not configured and *transformPrecoder=disabled*, or if *transformPrecoder=enabled*, or if *maxRank=1*;
 - 2 bits otherwise, where Table 7.3.1.1.2-25 and 7.3.1.1.2-26 are used to indicate the association between PTRS port(s) and DMRS port(s) for transmission of one PT-RS port and two PT-RS ports respectively, and the DMRS ports are indicated by the Antenna ports field.

If “Bandwidth part indicator” field indicates a bandwidth part other than the active bandwidth part and the “PTRS-DMRS association” field is present for the indicated bandwidth part but not present for the active bandwidth part, the UE assumes the “PTRS-DMRS association” field is not present for the indicated bandwidth part.

- beta_offset indicator – 0 if the higher layer parameter *betaOffsets = semiStatic*; otherwise 2 bits as defined by Table 9.3-3 in [5, TS 38.213].
- DMRS sequence initialization – 0 if the higher layer parameter *transformPrecoder=enabled*; 1 bit if the higher layer parameter *transformPrecoder=disabled* and both *scramblingID0* and *scramblingID1* are configured in *DMRS-UplinkConfig*, for n_{SCID} selection defined in Subclause 6.4.1.1.1.1 of [4, TS 38.211].
- UL-SCH indicator – 1 bit. A value of “1” indicates UL-SCH shall be transmitted on the PUSCH and a value of “0” indicates UL-SCH shall not be transmitted on the PUSCH.

For a UE configured with SUL in a cell, if PUSCH is configured to be transmitted on both the SUL and the non-SUL of the cell and if the number of information bits in format 0_1 for the SUL is not equal to the number of information bits in format 0_1 for the non-SUL, zeros shall be appended to smaller format 0_1 until the payload size equals that of the larger format 0_1.

Table 7.3.1.1.2-1: Bandwidth part indicator

Value of BWP indicator field 2 bits	Bandwidth part
00	First bandwidth part configured by higher layers
01	Second bandwidth part configured by higher layers
10	Third bandwidth part configured by higher layers
11	Fourth bandwidth part configured by higher layers

Table 7.3.1.1.2-2: Precoding information and number of layers, for 4 antenna ports, if *transformPrecoder=disabled* and *maxRank = 2 or 3 or 4*

Bit field mapped to index	<i>codebookSubset = fullyAndPartialAndNonCoherent</i>	Bit field mapped to index	<i>codebookSubset = partialAndNonCoherent</i>	Bit field mapped to index	<i>codebookSubset= nonCoherent</i>
0	1 layer: TPMI=0	0	1 layer: TPMI=0	0	1 layer: TPMI=0
1	1 layer: TPMI=1	1	1 layer: TPMI=1	1	1 layer: TPMI=1
...
3	1 layer: TPMI=3	3	1 layer: TPMI=3	3	1 layer: TPMI=3
4	2 layers: TPMI=0	4	2 layers: TPMI=0	4	2 layers: TPMI=0
...
9	2 layers: TPMI=5	9	2 layers: TPMI=5	9	2 layers: TPMI=5
10	3 layers: TPMI=0	10	3 layers: TPMI=0	10	3 layers: TPMI=0
11	4 layers: TPMI=0	11	4 layers: TPMI=0	11	4 layers: TPMI=0
12	1 layer: TPMI=4	12	1 layer: TPMI=4	12-15	reserved
...		
19	1 layer: TPMI=11	19	1 layer: TPMI=11		
20	2 layers: TPMI=6	20	2 layers: TPMI=6		
...		
27	2 layers: TPMI=13	27	2 layers: TPMI=13		
28	3 layers: TPMI=1	28	3 layers: TPMI=1		
29	3 layers: TPMI=2	29	3 layers: TPMI=2		
30	4 layers: TPMI=1	30	4 layers: TPMI=1		
31	4 layers: TPMI=2	31	4 layers: TPMI=2		
32	1 layers: TPMI=12				
...	...				
47	1 layers: TPMI=27				
48	2 layers: TPMI=14				
...	...				
55	2 layers: TPMI=21				
56	3 layers: TPMI=3				
...	...				
59	3 layers: TPMI=6				
60	4 layers: TPMI=3				
61	4 layers: TPMI=4				
62-63	reserved				

Table 7.3.1.1.2-3: Precoding information and number of layers for 4 antenna ports, if *transformPrecoder= enabled*, or if *transformPrecoder=disabled* and *maxRank = 1*

Bit field mapped to index	<i>codebookSubset = fullyAndPartialAndNonCoherent</i>	Bit field mapped to index	<i>codebookSubset= partialAndNonCoherent</i>	Bit field mapped to index	<i>codebookSubset= nonCoherent</i>
0	1 layer: TPMI=0	0	1 layer: TPMI=0	0	1 layer: TPMI=0
1	1 layer: TPMI=1	1	1 layer: TPMI=1	1	1 layer: TPMI=1
...
3	1 layer: TPMI=3	3	1 layer: TPMI=3	3	1 layer: TPMI=3
4	1 layer: TPMI=4	4	1 layer: TPMI=4		
...		
11	1 layer: TPMI=11	11	1 layer: TPMI=11		
12	1 layers: TPMI=12	12-15	reserved		
...	...				
27	1 layers: TPMI=27				

28-31	reserved				
-------	----------	--	--	--	--

Table 7.3.1.1.2-4: Precoding information and number of layers, for 2 antenna ports, if *transformPrecoder=disabled* and *maxRank = 2*

Bit field mapped to index	<i>codebookSubset = fullyAndPartialAndNonCoherent</i>	Bit field mapped to index	<i>codebookSubset = nonCoherent</i>
0	1 layer: TPMI=0	0	1 layer: TPMI=0
1	1 layer: TPMI=1	1	1 layer: TPMI=1
2	2 layers: TPMI=0	2	2 layers: TPMI=0
3	1 layer: TPMI=2	3	reserved
4	1 layer: TPMI=3		
5	1 layer: TPMI=4		
6	1 layer: TPMI=5		
7	2 layers: TPMI=1		
8	2 layers: TPMI=2		
9-15	reserved		

Table 7.3.1.1.2-5: Precoding information and number of layers, for 2 antenna ports, if *transformPrecoder= enabled*, or if *transformPrecoder= disabled* and *maxRank = 1*

Bit field mapped to index	<i>codebookSubset = fullyAndPartialAndNonCoherent</i>	Bit field mapped to index	<i>codebookSubset = nonCoherent</i>
0	1 layer: TPMI=0	0	1 layer: TPMI=0
1	1 layer: TPMI=1	1	1 layer: TPMI=1
2	1 layer: TPMI=2		
3	1 layer: TPMI=3		
4	1 layer: TPMI=4		
5	1 layer: TPMI=5		
6-7	reserved		

...

Table 7.3.1.1.2-33: VRB-to-PRB mapping

Bit field mapped to index	VRB-to-PRB mapping
0	Non-interleaved
1	Interleaved

[TS 38.214, clause 6.1.2.1]

When the UE is scheduled to transmit a transport block and no CSI report, or the UE is scheduled to transmit a transport block and a CSI report on PUSCH by a DCI, the *Time domain resource assignment* field value md of the DCI provides a row index $m + 1$ to an allocated table. The determination of the used resource allocation table is defined in sub-clause 6.1.2.1.1. The indexed row defines the slot offset K_2 , the start and length indicator $SLIV$, or directly the start symbol S and the allocation length L , and the PUSCH mapping type to be applied in the PUSCH transmission.

When the UE is scheduled to transmit a PUSCH with no transport block and with a CSI report by a *CSI request* field on a DCI, the *Time-domain resource assignment* field value m of the DCI provides a row index $m + 1$ to an allocated table. The determination of the applied resource allocation table is defined in sub-clause 6.1.2.1.1. The indexed row defines the start and length indicator $SLIV$, or directly the start symbol S and the allocation length L , and the PUSCH mapping type to be applied in the PUSCH transmission and K_2 is determined based on the corresponding list entries $Y_j, j = 0, \dots, N_{Rep} - 1$ of the higher layer parameter *reportSlotConfig* in *CSI-ReportConfig* for the N_{Rep} triggered CSI Reporting Settings. The i th codepoint of K_2 is determined as $K_2 = \max_j Y_j(i)$ where $Y_j(i)$ is the i th codepoint of Y_j .

- The slot where the UE shall transmit the PUSCH is determined by K_2 as $\left\lfloor n \cdot \frac{2^{\mu_{\text{PUSCH}}}}{2^{\mu_{\text{PDCCH}}}} \right\rfloor + K_2$ where n is the slot with the scheduling DCI, K_2 is based on the numerology of PUSCH, and μ_{PUSCH} and μ_{PDCCH} are the subcarrier spacing configurations for PUSCH and PDCCH, respectively, and
- The starting symbol S relative to the start of the slot, and the number of consecutive symbols L counting from the symbol S allocated for the PUSCH are determined from the start and length indicator $SLIV$ of the indexed row:

if $(L-1) \leq 7$ then

$$SLIV = 14 \cdot (L-1) + S$$

else

$$SLIV = 14 \cdot (14-L+1) + (14-1-S)$$

where $0 < L \leq 14 - S$, and

- The PUSCH mapping type is set to Type A or Type B as defined in Subclause 6.4.1.1.3 of [4, TS 38.211] as given by the indexed row.

The UE shall consider the S and L combinations defined in table 6.1.2.1-1 as valid PUSCH allocations

Table 6.1.2.1-1: Valid S and L combinations

PUSCH mapping type	Normal cyclic prefix			Extended cyclic prefix		
	S	L	$S+L$	S	L	$S+L$
Type A	0	{4,...,14}	{4,...,14}	0	{4,...,12}	{4,...,12}
Type B	{0,...,13}	{1,...,14}	{1,...,14}	{0,...,12}	{1,...,12}	{1,...,12}

When the UE is configured with $aggregationFactorUL > 1$, the same symbol allocation is applied across the $aggregationFactorUL$ consecutive slots and the PUSCH is limited to a single transmission layer. The UE shall repeat the TB across the $aggregationFactorUL$ consecutive slots applying the same symbol allocation in each slot. The redundancy version to be applied on the n^{th} transmission occasion of the TB is determined according to table 6.1.2.1-2.

Table 6.1.2.1-2: Redundancy version when $aggregationFactorUL > 1$

$rvid$ indicated by the DCI scheduling the PUSCH	$rvid$ to be applied to n^{th} transmission occasion			
	$n \bmod 4 = 0$	$n \bmod 4 = 1$	$n \bmod 4 = 2$	$n \bmod 4 = 3$
0	0	2	3	1
2	2	3	1	0
3	3	1	0	2
1	1	0	2	3

If the UE procedure for determining slot configuration, as defined in subclause 11.1 of [6, TS 38.213], determines symbols of a slot allocated for PUSCH as downlink symbols, the transmission on that slot is omitted for multi-slot PUSCH transmission.

[38.214 clause 6.1.2.2]

The UE shall determine the resource block assignment in frequency domain using the resource allocation field in the detected PDCCH DCI. Two uplink resource allocation schemes type 0 and type 1 are supported. Uplink resource allocation scheme type 0 is supported for PUSCH only when transform precoding is disabled. Uplink resource allocation scheme type 1 is supported for PUSCH for both cases when transform precoding is enabled or disabled.

If the scheduling DCI is configured to indicate the uplink resource allocation type as part of the *Frequency domain resource* assignment field by setting a higher layer parameter *resourceAllocation* in *pusch-Config* to ‘dynamicswitch’, the UE shall use uplink resource allocation type 0 or type 1 as defined by this DCI field. Otherwise the UE shall use the uplink frequency resource allocation type as defined by the higher layer parameter *resourceAllocation*.

The UE shall assume that when the scheduling PDCCH is received with DCI format 0_0, then uplink resource allocation type 1 is used.

If a bandwidth part indicator field is not configured in the scheduling DCI, the RB indexing for uplink type 0 and type 1 resource allocation is determined within the UE's active bandwidth part. If a bandwidth part indicator field is configured in the scheduling DCI, the RB indexing for uplink type 0 and type 1 resource allocation is determined within the UE's bandwidth part indicated by bandwidth part indicator field value in the DCI, except for the case when DCI format 0_0 is decoded in any PDCCH common search space in CORESET 0 in which case the initial bandwidth part shall be used. The UE shall upon detection of PDCCH intended for the UE determine first the uplink bandwidth part and then the resource allocation within the bandwidth part.

[38.214 clause 6.1.2.2.1]

In uplink resource allocation of type 0, the resource block assignment information includes a bitmap indicating the Resource Block Groups (RBGs) that are allocated to the scheduled UE where a RBG is a set of consecutive virtual resource blocks defined by higher layer parameter *rbg-Size* configured for PUSCH and the size of the carrier bandwidth part as defined in Table 6.1.2.2.1-1.

Table 6.1.2.2.1-1: Nominal RBG size P

Carrier Bandwidth Part Size	Configuration 1	Configuration 2
1 – 36	2	4
37 – 72	4	8
73 – 144	8	16
145 – 275	16	16

The total number of RBGs (N_{RBG}) for a uplink carrier bandwidth part i of size $N_{\text{BWP},i}^{\text{size}}$ PRBs is given by

$$N_{\text{RBG}} = \left\lfloor \left(N_{\text{BWP},i}^{\text{size}} + \left(N_{\text{BWP},i}^{\text{start}} \bmod P \right) \right) / P \right\rfloor \text{ where}$$

- the size of the first RBG is $\text{RBG}_0^{\text{size}} = P - N_{\text{BWP},i}^{\text{start}} \bmod P$,
- the size of the last RBG is $\text{RBG}_{\text{last}}^{\text{size}} = \left(N_{\text{BWP},i}^{\text{start}} + N_{\text{BWP},i}^{\text{size}} \right) \bmod P$ if $\left(N_{\text{BWP},i}^{\text{start}} + N_{\text{BWP},i}^{\text{size}} \right) \bmod P > 0$ and P otherwise.
- the size of all other RBG is P .

The bitmap is of size N_{RBG} bits with one bitmap bit per RBG such that each RBG is addressable. The RBGs shall be indexed in the order of increasing frequency of the carrier bandwidth part and starting at the lowest frequency. The order of RBG bitmap is such that RBG 0 to RBG $N_{\text{RBG}} - 1$ are mapped from MSB to LSB of the bitmap. The RBG is allocated to the UE if the corresponding bit value in the bitmap is 1, the RBG is not allocated to the UE otherwise.

[38.214 clause 6.1.2.2.2]

In uplink resource allocation of type 1, the resource block assignment information indicates to a scheduled UE a set of contiguously allocated non-interleaved virtual resource blocks within the active carrier bandwidth part of size $N_{\text{BWP}}^{\text{size}}$ PRBs except for the case when DCI format 0_0 is decoded in the Type0-PDCCH common search space in CORESET 0 in which case the initial bandwidth part of size $N_{\text{BWP}}^{\text{size}}$ shall be used.

An uplink type 1 resource allocation field consists of a resource indication value (RIV) corresponding to a starting virtual resource block (RB_{start}) and a length in terms of contiguously allocated resource blocks L_{RBs} . The resource indication value is defined by

$$\text{if } (L_{\text{RBs}} - 1) \leq \left\lfloor N_{\text{BWP}}^{\text{size}} / 2 \right\rfloor \text{ then}$$

$$RIV = N_{\text{BWP}}^{\text{size}} (L_{\text{RBs}} - 1) + RB_{\text{start}}$$

else

$$RIV = N_{BWP}^{size} (N_{BWP}^{size} - L_{RBs} + 1) + (N_{BWP}^{size} - 1 - RB_{start})$$

where $L_{RBs} \geq 1$ and shall not exceed $N_{BWP}^{size} - RB_{start}$.

[TS 38.214, clause 6.1.4.1]

For the PUSCH assigned by a DCI format 0_0/0_1 with CRC scrambled by C-RNTI, new-RNTI, TC-RNTI, or SP-CSI-RNTI, the transform precoding is enabled if *transformPrecoder* in *PUSCH-Config* is set to 'enabled', or if *transformPrecoder* in *PUSCH-Config* is not configured and *msg3-transformPrecoding* in *rach-ConfigCommon* is set to 'enabled'; otherwise the transform precoding is disabled.

For the PUSCH assigned by a DCI format 0_0/0_1 with CRC scrambled by CS-RNTI, or the PUSCH with configured grant using CS-RNTI, the transform precoding is enabled if *transformPrecoder* in *ConfiguredGrantConfig* is set to 'enabled'; otherwise the transform precoding is disabled.

For a PUSCH scheduled by RAR UL grant or for a PUSCH scheduled by a DCI format 0_0/0_1 with CRC scrambled by C-RNTI, TC-RNTI, or CS-RNTI, or SP-CSI-RNTI, or for a PUSCH with configured grant using CS-RNTI,

if *transformPrecoder* is disabled for this PUSCH transmission

- if *mcs-Table* in *PUSCH-Config* is set to 'qam256', and PUSCH is scheduled with C-RNTI or SP-CSI-RNTI, and PUSCH is assigned by DCI format 0_1,
 - the UE shall use I_{MCS} and Table 5.1.3.1-2 to determine the modulation order (Q_m) and Target code rate (R) used in the physical uplink shared channel.
- elseif the UE is not configured with new-RNTI, *mcs-Table* in *PUSCH-Config* is set to 'qam64LowSE', the PUSCH is scheduled with C-RNTI, or SP-CSI-RNTI, and the PUSCH is assigned by a PDCCH in a UE-specific search space,
 - the UE shall use I_{MCS} and Table 5.1.3.1-3 to determine the modulation order (Q_m) and Target code rate (R) used in the physical uplink shared channel.
- elseif the UE is configured with new-RNTI, and the PUSCH is scheduled with new-RNTI,
 - the UE shall use I_{MCS} and Table 5.1.3.1-3 to determine the modulation order (Q_m) and Target code rate (R) used in the physical uplink shared channel.
- elseif *mcs-Table* in *ConfiguredGrantConfig* is set to 'qam256', and PUSCH is scheduled with CS-RNTI,
 - the UE shall use I_{MCS} and Table 5.1.3.1-2 to determine the modulation order (Q_m) and Target code rate (R) used in the physical uplink shared channel.
- elseif *mcs-Table* in *ConfiguredGrantConfig* is set to 'qam64LowSE', and PUSCH is scheduled with CS-RNTI,
 - the UE shall use I_{MCS} and Table 5.1.3.1-3 to determine the modulation order (Q_m) and Target code rate (R) used in the physical uplink shared channel.
- else
 - the UE shall use I_{MCS} and Table 5.1.3.1-1 to determine the modulation order (Q_m) and Target code rate (R) used in the physical uplink shared channel.

[TS 38.214, clause 5.1.3.1]

Table 5.1.3.1-2: MCS index table 2 for PDSCH

MCS Index I_{MCS}	Modulation Order Q_m	Target code Rate $R \times [1024]$	Spectral efficiency
0	2	120	0.2344
1	2	193	0.3770
2	2	308	0.6016
3	2	449	0.8770
4	2	602	1.1758
5	4	378	1.4766

6	4	434	1.6953
7	4	490	1.9141
8	4	553	2.1602
9	4	616	2.4063
10	4	658	2.5703
11	6	466	2.7305
12	6	517	3.0293
13	6	567	3.3223
14	6	616	3.6094
15	6	666	3.9023
16	6	719	4.2129
17	6	772	4.5234
18	6	822	4.8164
19	6	873	5.1152
20	8	682.5	5.3320
21	8	711	5.5547
22	8	754	5.8906
23	8	797	6.2266
24	8	841	6.5703
25	8	885	6.9141
26	8	916.5	7.1602
27	8	948	7.4063
28	2	reserved	
29	4	reserved	
30	6	reserved	
31	8	reserved	

[TS 38.214, clause 6.1.4.2]

For a PUSCH scheduled by RAR UL grant or for a PUSCH scheduled by a DCI format 0_0/0_1 with CRC scrambled by C-RNTI, new-RNTI, TC-RNTI, CS-RNTI, or SP-CSI-RNTI.

if

- $0 \leq I_{MCS} \leq 27$ and transform precoding is disabled and Table 5.1.3.1-2 is used, or
- $0 \leq I_{MCS} \leq 28$ and transform precoding is disabled and a table other than Table 5.1.3.1-2 is used, or
- $0 \leq I_{MCS} \leq 27$ and transform precoding is enabled, the UE shall first determine the TBS as specified below:

The UE shall first determine the number of REs (N_{RE}) within the slot:

- A UE first determines the number of REs allocated for PUSCH within a PRB (N'_{RE}) by
- $N'_{RE} = N_{sc}^{RB} * N_{symp}^{sh} - N_{DMRS}^{PRB} - N_{oh}^{PRB}$, where $N_{sc}^{RB} = 12$ is the number of subcarriers in the frequency domain in a physical resource block, N_{symp}^{sh} is the number of symbols of the PUSCH allocation within the slot, N_{DMRS}^{PRB} is the number of REs for DM-RS per PRB in the scheduled duration including the overhead of the DM-RS CDM groups without data, as indicated by DCI format 0_1 or as described for DCI format 0_0 in Subclause 6.2.2, and N_{oh}^{PRB} is the overhead configured by higher layer parameter $xOverhead$ in *PUSCH-ServingCellConfig*. If the N_{oh}^{PRB} is not configured (a value from 0, 6, 12, or 18), the N_{oh}^{PRB} is assumed to be 0. For MSG3 transmission the N_{oh}^{PRB} is always set to 0.
- A UE determines the total number of REs allocated for PUSCH (N_{RE}) by $N_{RE} = \min(156, N'_{RE}) \cdot n_{PRB}$ where n_{PRB} is the total number of allocated PRBs for the UE.
- Next, proceed with steps 2-4 as defined in Subclause 5.1.3.2

else if

- $28 \leq I_{MCS} \leq 31$ and transform precoding is disabled and Table 5.1.3.1-2 is used, or
- $28 \leq I_{MCS} \leq 31$ and transform precoding is enabled,
- the TBS is assumed to be as determined from the DCI transported in the latest PDCCH for the same transport block using $0 \leq I_{MCS} \leq 27$. If there is no PDCCH for the same transport block using $0 \leq I_{MCS} \leq 27$, and if the initial PUSCH for the same transport block is transmitted with configured grant, the TBS shall be determined from the most recent configured scheduling PDCCH.

else

- the TBS is assumed to be as determined from the DCI transported in the latest PDCCH for the same transport block using $0 \leq I_{MCS} \leq 28$. If there is no PDCCH for the same transport block using $0 \leq I_{MCS} \leq 28$, and if the initial PUSCH for the same transport block is transmitted with configured grant, the TBS shall be determined from the most recent configured scheduling PDCCH.

[TS 38.214, clause 5.1.3.2]

- 2) Intermediate number of information bits (N_{info}) is obtained by $N_{info} = N_{RE} \cdot R \cdot Q_m \cdot \nu$.

If $N_{info} \leq 3824$

Use step 3 as the next step of the TBS determination

else

Use step 4 as the next step of the TBS determination

end if

- 3) When $N_{info} \leq 3824$, TBS is determined as follows

- quantized intermediate number of information bits $N'_{info} = \max\left(24, 2^n \cdot \left\lfloor \frac{N_{info}}{2^n} \right\rfloor\right)$, where
 $n = \max(3, \lfloor \log_2(N_{info}) \rfloor - 6)$.
- use Table 5.1.3.2-2 find the closest TBS that is not less than N'_{info} .

Table 5.1.3.2-2: TBS for $N_{info} \leq 3824$

Index	TBS	Index	TBS	Index	TBS	Index	TBS
1	24	31	336	61	1288	91	3624
2	32	32	352	62	1320	92	3752
3	40	33	368	63	1352	93	3824
4	48	34	384	64	1416		
5	56	35	408	65	1480		
6	64	36	432	66	1544		
7	72	37	456	67	1608		
8	80	38	480	68	1672		
9	88	39	504	69	1736		
10	96	40	528	70	1800		
11	104	41	552	71	1864		
12	112	42	576	72	1928		
13	120	43	608	73	2024		
14	128	44	640	74	2088		
15	136	45	672	75	2152		
16	144	46	704	76	2216		
17	152	47	736	77	2280		
18	160	48	768	78	2408		

19	168	49	808	79	2472		
20	176	50	848	80	2536		
21	184	51	888	81	2600		
22	192	52	928	82	2664		
23	208	53	984	83	2728		
24	224	54	1032	84	2792		
25	240	55	1064	85	2856		
26	256	56	1128	86	2976		
27	272	57	1160	87	3104		
28	288	58	1192	88	3240		
29	304	59	1224	89	3368		
30	320	60	1256	90	3496		

4) When $N_{info} > 3824$, TBS is determined as follows.

- quantized intermediate number of information bits $N'_{info} = \max\left(3840, 2^n \times \text{round}\left(\frac{N_{info} - 24}{2^n}\right)\right)$, where $n = \lfloor \log_2(N_{info} - 24) \rfloor - 5$ and ties in the round function are broken towards the next largest integer.
- if $R \leq 1/4$

$$TBS = 8 \cdot C \cdot \left\lceil \frac{N'_{info} + 24}{8 \cdot C} \right\rceil - 24, \text{ where } C = \left\lceil \frac{N'_{info} + 24}{3816} \right\rceil$$

else

if $N'_{info} > 8424$

$$TBS = 8 \cdot C \cdot \left\lceil \frac{N'_{info} + 24}{8 \cdot C} \right\rceil - 24, \text{ where } C = \left\lceil \frac{N'_{info} + 24}{8424} \right\rceil$$

else

$$TBS = 8 \cdot \left\lceil \frac{N'_{info} + 24}{8} \right\rceil - 24$$

end if

end if

7.1.1.4.2.4.3 Test description

7.1.1.4.2.4.3.1 Pre-test conditions

Same Pre-test conditions as in clause 7.1.1.0 except set the NR Cell bandwidth and applicable BWP to maximum for the NR Band under test as specified in Table 5.3.5-1 in TS 38.101-1 [16] / TS 38.101-2 [17] (to enable testing of n_{PRB} up to maximum value).

Test frequency NRf1 is as specified in TS 38.508-1 [4] clause 4.3.1 using the common highest mandatory UL and DL channel bandwidth and using the default subcarrier spacing specified in TS 38.508-1 [4] clause 6.2.3.1.

7.1.1.4.2.4.3.2 Test procedure sequence

Table 7.1.1.4.2.4.3.2-1: Maximum TBS for different UE categories

UE Category	Maximum number of bits of a UL-SCH transport block received within a TTI
TS 38.306 [23] clause 4.1.2 require UE without ue-CategoryDL and ue-CategoryUL, to	

support Max TBS achievable based on max bandwidth of the Band under test.

Table 7.1.1.4.2.4.3.2-2: Number of downlink PDCP SDUs and PDCP SDU size used as test data

TBS [bits]	Number of PDCP SDUs	PDCP SDU size [bits] (Note 1)
$136 \leq TBS \leq 12128$ note 2	1	$8 * \text{FLOOR}((TBS - 128) / 8)$
$12129 \leq TBS \leq 24200$	2	$8 * \text{FLOOR}((TBS - 200) / 16)$
$24201 \leq TBS \leq 36272$	3	$8 * \text{FLOOR}((TBS - 272) / 24)$
$36273 \leq TBS \leq 48344$	4	$8 * \text{FLOOR}((TBS - 344) / 32)$
$48345 \leq TBS \leq 60416$	5	$8 * \text{FLOOR}((TBS - 416) / 40)$
$60417 \leq TBS \leq 72488$	6	$8 * \text{FLOOR}((TBS - 488) / 48)$
$72489 \leq TBS \leq 84560$	7	$8 * \text{FLOOR}((TBS - 560) / 56)$
$84561 \leq TBS \leq 96632$	8	$8 * \text{FLOOR}((TBS - 632) / 64)$
$96633 < TBS \leq 108704$	9	$8 * \text{FLOOR}((TBS - 704) / 72)$
$10705 \leq TBS \leq 120776$	10	$8 * \text{FLOOR}((TBS - 776) / 80)$
$120777 \leq TBS \leq 132848$	11	$8 * \text{FLOOR}((TBS - 848) / 88)$
$132849 \leq TBS \leq 144920$	12	$8 * \text{FLOOR}((TBS - 920) / 96)$
$TBS > 144920$	13	$8 * \text{FLOOR}((TBS - 992) / 104)$

Note 1: Each PDCP SDU is limited to 1500 octets (to keep below maximum SDU size of ESM as specified in TS 24.301 [21] clause 9.9.4.12).

The PDCP SDU size of each PDCP SDU is

PDCP SDU size = (TBS – N*PDCP header size – N*AMD PDU header size - N*MAC header size – Size of Timing Advance – RLC Status PDU size- MAC header for RLC Status PDU) / N, where

PDCP header size is 24 bits for the RLC AM and 18-bit SN case;
 AMD PDU header size is 24 bits with 18 bit SN;

MAC header size for AMD PDU = 16 or 24 bits depending on L=8 or 16 bits. Worst case 24 is taken.

Size of Timing Advance MAC CE with header is 16 bits (if no Timing Advance and/or RLC status needs to be sent, padding will occur instead).

RLC Status PDU size = 24 bits with 1 ACK_SN, With a MAC header of 16 bits.

This gives:

PDCP SDU size = $8 * \text{FLOOR}((TBS - N * 24 - N * 24 - N * 24 - 56) / (8 * N))$ bits.

Note 2: According to the final PDCP SDU size formula in Note 1, the smallest TBS that can be tested is 136 bits.

Table 7.1.1.4.2.4.3.2-2A: Bandwidth part Dependent Parameters for Resource allocation 0 with start of BWP assumed as 0

$N_{RB}^{DL,BWP} = N_{BWP,i}^{size}$	Nominal RBG size P (Configuration1)	Size of last RBG	Allowed N_{PRB} Values
11	2	1	All 1...11
18	2	2	2,4,6,8,10,12,16,18
24	2	2	2,4,6,8,10,12,16,18,20,22,24
25	2	1	All 1...25
31	2	1	All 1...31
32	2	2	2,4,6,8,10,12,16,18,20,22,24,26,28,30,32
38	4	2	2,4,6,8,10,12,16,18,20,22,24,26,28,30,32,34,36,38
51	4	3	3,4,7,8,11,12,15,16,19,20,23,24,27,28,31,32,35,36,39,40,43,44,47,48,51
52	4	4	4,8,12,16,20,24,28,32,36,40,44,48,52
65	4	1	1,4,5,8,9,12,13,16,17,20,21,24,25,28,29,32,33,36,37,40,41,44,45,48,49,52,53,56,57,60,61,64,65
66	4	2	2,4,6,8,10,12,16,18,20,22,24,26,28,30,32,34,36,38,40,42,44,46,48,50,52,54,56,58,60,62,64,66

79	8	7	7,8,15,16,23,24,31,32,39,40,47,48,55,56,63,64,71,72,79
106	8	2	2,8,10,16,18,24,26,32,34,40,42,48,50,56,58,64,66,72,74,80,82,88,90,96,92,104,106
107	8	3	3,8,11,16,19,24,27,32,35,40,43,48,51,56,59,64,67,72,75,80,83,88,91,96,99,104,107
132	8	4	4,8,12,16,20,24,28,32,36,40,44,48,52,56,60,64,68,72,76,80,84,88,92,96,100,104,108,112,116,120,124,128,132
133	8	5	5,8,13,16,21,24,29,32,37,40,45,48,53,56,61,64,69,72,77,80,85,88,93,96,101,104,109,112,117,120,125,128,133
135	8	7	7,8,15,16,23,24,31,32,39,40,47,48,55,56,63,64,71,72,79,80,87,88,95,96,103,104,111,112,119,120,127,128,135
160	16	16	16,32,48,64,80,96,112,128,144,160
216	16	8	8,16,24,32,40,48,56,64,72,80,88,96,104,112,120,128,136,144,152,160,168,176,184,192,200,208,216
217	16	9	9,16,25,32,41,48,57,64,73,80,89,96,105,112,121,128,137,144,153,160,169,176,185,192,201,208,217
264	16	8	8,16,24,32,40,48,56,64,72,80,88,96,104,112,120,128,136,144,160,168,176,184,192,200,208,216,224,232,240,248,256,264
270	16	14	14,16,30,32,46,44,62,64,78,80,94,96,110,112,126,128,142,144,158,160,174,176,190,192,206,208,222,224,238,240,254,256,270
273	16	1	1,16,17,32,33,48,49,64,65,80,81,96,97,112,113,128,129,144,145,160,161,176,171,192,193,208,209,224,225,240,241,256,257,272,273

Table 7.1.1.4.2.4.3.2-3: Specific Parameter

Parameter	Value	Comment	Condition
number of layers (v)	1		
mcs-Table	qam256		
resourceAllocation	dynamicSwitch		pc_dynamicSwitchRA_Type0_1_PUSCH
	resourceAllocationType1		NOT pc_dynamicSwitchRA_Type0_1_PUSCH AND Steps 1-5
	resourceAllocationType0		NOT pc_dynamicSwitchRA_Type0_1_PUSCH AND pc_ra_Type0_PUSCH AND Steps 6-10
rbg-Size	Not present	configuration 1 applicable	
$N_{\text{BWP}}^{\text{start}}$	0		

Table 7.1.1.4.2.4.3.2-4: Main behaviour

St	Procedure	Message Sequence		TP	Verdict
		U - S	Message		
-	EXCEPTION: Steps 1 to 5 are repeated for allowed values of N_{PRB} 1 to $N_{\text{RB}}^{\text{DL,BWP}}$ in BWP, time domain resource as per Table 7.1.1.4.2.0-1 and I_{MCS} from 0 to 27.	-	-	-	-
1	SS calculates or looks up TBS in TS 38.214 [15] based on the value of S, L, I_{MCS} and n_{PRB} .	-	-	-	-
-	EXCEPTION: Steps 2 to 5 are performed if TBS is less than or equal to UE capability "Maximum number of UL-SCH transport block bits received within a TTI" as specified in Table 7.1.1.4.2.4.3.2-1 and larger than or equal to 136 bits as specified in Table 7.1.1.4.2.4.3.2-2. Skip the execution of steps 2 to 5 for which the TBS size equal to 3824 or 3840. (Note 3)	-	-	-	-
2	SS creates one or more PDCP SDUs depending on TBS in accordance with Table 7.1.1.4.2.4.3.2-2.	-	-	-	-

3	After 300ms, the SS transmits all PDCP SDUs (N_{SDUs}) as created in step 2 in a MAC PDU.	<--	MAC PDU (NxDPCP SDUs)	-	-
4	After 60ms of step 3 SS transmits UL Grant DCI 0_1, and values of S, L, I_{MCS} and n_{PRB} .	<--	(UL Grant) (DCI: (DCI Format 0_1, S, L, I_{MCS} and n_{PRB} .)	-	-
5	CHECK: Does UE return the same number of PDCP SDUs with same content as transmitted by the SS in step 3 using Time, frequency Resources and modulation and coding scheme as configured by the SS in step 4?	-->	(NxDPCP SDUs)	2	P
-	EXCEPTION : Steps 5Aa1 to 10 are executed if $pc_ra_Type0_PUSCH$	-	-	-	-
-	EXCEPTION : Steps 5Aa1 to 5Aa2 are executed if NOT $pc_dynamicSwitchRA_Type0_1_PUSCH$	-	-	-	-
5A a1	The SS transmits a NR RRCReconfiguration message including <i>PUSCH-Config</i> with IE resourceAllocation set to resourceAllocationType1 (Note 1)	<--	<i>RRCReconfiguration</i>	-	-
5A a2	The UE transmit a NR <i>RRCReconfigurationComplete</i> message. (Note 2)	-->	<i>RRCReconfigurationComplete</i>	-	-
-	EXCEPTION: Steps 6 to 10 are repeated for allowed values of N_{PRB} as per Table 7.1.1.4.2.4.3.2-2A in BWP, time domain resource length L 3 to 14-S and I_{MCS} from 0 to 27.	-	-	-	-
6	SS calculates or looks up TBS in TS 38.214 [15] based on the value of S, L, I_{MCS} and n_{PRB} .	-	-	-	-
-	EXCEPTION: Steps 7 to 10 are performed if TBS is less than or equal to UE capability "Maximum number of UL-SCH transport block bits received within a TTI" as specified in Table 7.1.1.4.2.4.3.2-1 and larger than or equal to 136 bits as specified in Table 7.1.1.4.2.4.3.2-2. Skip the execution of steps 7 to 10 for which the TBS size equal to 3824 or 3840. (Note 3)	-	-	-	-
7	SS creates one or more PDCP SDUs depending on TBS in accordance with Table 7.1.1.4.2.4.3.2-2.	-	-	-	-
8	After 300ms, the SS transmits all PDCP SDUs (N_{SDUs}) as created in step 7 in a MAC PDU.	<--	MAC PDU (NxDPCP SDUs)	-	-
9	After 60ms of step 8 SS transmits UL Grant DCI 0_1, and values of S, L, I_{MCS} and n_{PRB} .	<--	(UL Grant) (DCI: (DCI Format 0_1, S, L, I_{MCS} and n_{PRB} .)	-	-
10	CHECK: Does UE return the same number of PDCP SDUs with same content as transmitted by the SS in step 8 using Time, frequency Resources and modulation and coding scheme as configured by the SS in step 4?	-->	(NxDPCP SDUs)	1	P
<p>Note 1: For EN-DC the NR RRCReconfiguration message is contained in RRCConnectionReconfiguration 36.508 [7], Table 4.6.1-8 using condition EN-DC_EmbedNR_RRCRecon.</p> <p>Note 2: For EN-DC the NR RRCReconfigurationComplete message is contained in RRCConnectionReconfigurationComplete.</p> <p>Note 3: There is ambiguity of TBS calculation when $3824.0 < N_{info} < 3825.0$ in clause 5.1.3.2 of TS 38.214 [15].</p>					

7.1.1.4.2.4.3.3 Specific message contents

[None].

7.1.1.4.2.5 UL-SCH Transport Block Size selection / DCI format 0_0 / Transform precoding and 64QAM

7.1.1.4.2.5.1 Test Purpose (TP)

(1)

```
with { UE in RRC_CONNECTED state and transform precoding enabled}
ensure that {
  when { UE has pending data for transmission and receives on PDCCH DCI format 0_0 indicating a
resource block assignment correspondent to physical resource blocks , Time domain resource
assignment and modulation and coding }
  then { UE transmits MAC PDU on PUSCH as per Modulation Coding scheme, time domain resource
allocation and PRB's }
}
```

7.1.1.4.2.5.2 Conformance requirements

References: The conformance requirements covered in the present TC are specified in: TS 38.212 clause 7.3.1.1.1, TS 38.214 clause 6.1.2.1, 6.1.2.2, 6.1.2.2.2, 6.1.4.1, 5.1.3.1, 6.1.4.2 and 5.1.3.2. Unless otherwise stated these are Rel-15 requirements.

[TS 38.212, clause 7.3.1.1.1]

DCI format 0_0 is used for the scheduling of PUSCH in one cell.

The following information is transmitted by means of the DCI format 0_0 with CRC scrambled by C-RNTI or CS-RNTI or new-RNTI:

- Identifier for DCI formats – 1 bit
 - The value of this bit field is always set to 0, indicating an UL DCI format
- Frequency domain resource assignment – $\lceil \log_2(N_{RB}^{UL,BWP}(N_{RB}^{UL,BWP} + 1)/2) \rceil$ bits where
 - $N_{RB}^{UL,BWP}$ is the size of the active UL bandwidth part in case DCI format 0_0 is monitored in the UE specific search space and satisfying
 - the total number of different DCI sizes monitored per slot is no more than 4 for the cell, and
 - the total number of different DCI sizes with C-RNTI monitored per slot is no more than 3 for the cell
 - otherwise, $N_{RB}^{UL,BWP}$ is the size of the initial UL bandwidth part.
- For PUSCH hopping with resource allocation type 1:
 - N_{UL_hop} MSB bits are used to indicate the frequency offset according to Subclause 6.3 of [6, TS 38.214], where $N_{UL_hop} = 1$ if the higher layer parameter *frequencyHoppingOffsetLists* contains two offset values and $N_{UL_hop} = 2$ if the higher layer parameter *frequencyHoppingOffsetLists* contains four offset values
 - $\lceil \log_2(N_{RB}^{UL,BWP}(N_{RB}^{UL,BWP} + 1)/2) \rceil - N_{UL_hop}$ bits provides the frequency domain resource allocation according to Subclause 6.1.2.2.2 of [6, TS 38.214]
- For non-PUSCH hopping with resource allocation type 1:
 - $\lceil \log_2(N_{RB}^{UL,BWP}(N_{RB}^{UL,BWP} + 1)/2) \rceil$ bits provides the frequency domain resource allocation according to Subclause 6.1.2.2.2 of [6, TS 38.214]
- Time domain resource assignment – 4 bits as defined in Subclause 6.1.2.1 of [6, TS 38.214]

- Frequency hopping flag – 1 bit.
- Modulation and coding scheme – 5 bits as defined in Subclause 6.1.3 of [6, TS 38.214]
- New data indicator – 1 bit
- Redundancy version – 2 bits as defined in Table 7.3.1.1.1-2
- HARQ process number – 4 bits
- TPC command for scheduled PUSCH – 2 bits as defined in Subclause 7.1.1 of [5, TS 38.213]
- Padding bits, if required.
- UL/SUL indicator – 1 bit for UEs configured with SUL in the cell as defined in Table 7.3.1.1.1-1 and the number of bits for DCI format 1_0 before padding is larger than the number of bits for DCI format 0_0 before padding; 0 bit otherwise. The UL/SUL indicator, if present, locates in the last bit position of DCI format 0_0, after the padding bit(s).
 - If the UL/SUL indicator is present in DCI format 0_0 and the higher layer parameter *pusch-Config* is not configured on both UL and SUL the UE ignores the UL/SUL indicator field in DCI format 0_0, and the corresponding PUSCH scheduled by the DCI format 0_0 is for the UL or SUL for which high layer parameter *pucch-Config* is configured;
 - If the UL/SUL indicator is not present in DCI format 0_0, the corresponding PUSCH scheduled by the DCI format 0_0 is for the UL or SUL for which high layer parameter *pucch-Config* is configured.

The following information is transmitted by means of the DCI format 0_0 with CRC scrambled by TC-RNTI:

- Identifier for DCI formats – 1 bit
 - The value of this bit field is always set to 0, indicating an UL DCI format
- Frequency domain resource assignment – $\lceil \log_2(N_{RB}^{UL,BWP}(N_{RB}^{UL,BWP} + 1)/2) \rceil$ bits where
 - $N_{RB}^{UL,BWP}$ is the size of the initial UL bandwidth part.
 - For PUSCH hopping with resource allocation type 1:
 - N_{UL_hop} MSB bits are used to indicate the frequency offset according to Subclause 6.3 of [6, TS 38.214], where $N_{UL_hop} = 1$ if $N_{RB}^{UL,BWP} < 50$ and $N_{UL_hop} = 2$ otherwise
 - $\lceil \log_2(N_{RB}^{UL,BWP}(N_{RB}^{UL,BWP} + 1)/2) \rceil - N_{UL_hop}$ bits provides the frequency domain resource allocation according to Subclause 6.1.2.2.2 of [6, TS 38.214]
 - For non-PUSCH hopping with resource allocation type 1:
 - $\lceil \log_2(N_{RB}^{UL,BWP}(N_{RB}^{UL,BWP} + 1)/2) \rceil$ bits provides the frequency domain resource allocation according to Subclause 6.1.2.2.2 of [6, TS 38.214]
- Time domain resource assignment – 4 bits as defined in Subclause 6.1.2.1 of [6, TS 38.214]
- Frequency hopping flag – 1 bit.
- Modulation and coding scheme – 5 bits as defined in Subclause 6.1.3 of [6, TS 38.214], using Table 5.1.3.1-1
- New data indicator – 1 bit, reserved
- Redundancy version – 2 bits as defined in Table 7.3.1.1.1-2
- HARQ process number – 4 bits, reserved
- TPC command for scheduled PUSCH – 2 bits as defined in Subclause 7.1.1 of [5, TS 38.213]
- Padding bits, if required.

- UL/SUL indicator – 1 bit if the cell has two ULs and the number of bits for DCI format 1_0 before padding is larger than the number of bits for DCI format 0_0 before padding; 0 bit otherwise. The UL/SUL indicator, if present, locates in the last bit position of DCI format 0_0, after the padding bit(s).
- If 1 bit, reserved, and the corresponding PUSCH is always on the same UL carrier as the previous transmission of the same TB

If DCI format 0_0 is monitored in common search space and if the number of information bits in the DCI format 0_0 prior to padding is less than the payload size of the DCI format 1_0 monitored in common search space for scheduling the same serving cell, zeros shall be appended to the DCI format 0_0 until the payload size equals that of the DCI format 1_0.

If DCI format 0_0 is monitored in common search space and if the number of information bits in the DCI format 0_0 prior to padding is larger than the payload size of the DCI format 1_0 monitored in common search space for scheduling the same serving cell, the bit width of the frequency domain resource allocation field in the DCI format 0_0 is reduced by truncating the first few most significant bits such that the size of DCI format 0_0 equals to the size of the DCI format 1_0.

If DCI format 0_0 is monitored in UE specific search space but does not satisfy at least one of the following

- the total number of different DCI sizes monitored per slot is no more than 4 for the cell, and
- the total number of different DCI sizes with C-RNTI monitored per slot is no more than 3 for the cell

and if the number of information bits in the DCI format 0_0 prior to padding is less than the payload size of the DCI format 1_0 monitored in common search space for scheduling the same serving cell, zeros shall be appended to the DCI format 0_0 until the payload size equals that of the DCI format 1_0.

If DCI format 0_0 is monitored in UE specific search space but does not satisfy at least one of the following

- the total number of different DCI sizes monitored per slot is no more than 4 for the cell, and
- the total number of different DCI sizes with C-RNTI monitored per slot is no more than 3 for the cell

and if the number of information bits in the DCI format 0_0 prior to padding is larger than the payload size of the DCI format 1_0 monitored in common search space for scheduling the same serving cell, the bit width of the frequency domain resource allocation field in the DCI format 0_0 is reduced by truncating the first few most significant bits such that the size of DCI format 0_0 equals to the size of the DCI format 1_0.

If DCI format 0_0 is monitored in UE specific search space and satisfies both of the following

- the total number of different DCI sizes monitored per slot is no more than 4 for the cell, and
- the total number of different DCI sizes with C-RNTI monitored per slot is no more than 3 for the cell

and if the number of information bits in the DCI format 0_0 prior to padding is less than the payload size of the DCI format 1_0 monitored in UE specific search space for scheduling the same serving cell, zeros shall be appended to the DCI format 0_0 until the payload size equals that of the DCI format 1_0.

[TS 38.214, clause 6.1.2.1]

When the UE is scheduled to transmit a transport block and no CSI report, or the UE is scheduled to transmit a transport block and a CSI report on PUSCH by a DCI, the *Time domain resource assignment* field value m of the DCI provides a row index $m + 1$ to an allocated table. The determination of the used resource allocation table is defined in sub-clause 6.1.2.1.1. The indexed row defines the slot offset K_2 , the start and length indicator *SLIV*, or directly the start symbol S and the allocation length L , and the PUSCH mapping type to be applied in the PUSCH transmission.

When the UE is scheduled to transmit a PUSCH with no transport block and with a CSI report by a *CSI request* field on a DCI, the *Time-domain resource assignment* field value m of the DCI provides a row index $m + 1$ to an allocated table. The determination of the applied resource allocation table is defined in sub-clause 6.1.2.1.1. The indexed row defines the start and length indicator *SLIV*, or directly the start symbol S and the allocation length L , and the PUSCH mapping type to be applied in the PUSCH transmission and K_2 is determined based on the corresponding list entries $Y_j, j = 0, \dots, N_{\text{Rep}} - 1$ of the higher layer parameter *reportSlotConfig* in *CSI-ReportConfig* for the N_{Rep} triggered CSI Reporting Settings. The i th codepoint of K_2 is determined as $K_2 = \max_j Y_j(i)$ where $Y_j(i)$ is the i th codepoint of Y_j .

- The slot where the UE shall transmit the PUSCH is determined by K_2 as $\left\lfloor n \cdot \frac{2^{\mu_{\text{PUSCH}}}}{2^{\mu_{\text{PDCCH}}}} \right\rfloor + K_2$ where n is the slot with the scheduling DCI, K_2 is based on the numerology of PUSCH, and μ_{PUSCH} and μ_{PDCCH} are the subcarrier spacing configurations for PUSCH and PDCCH, respectively, and
- The starting symbol S relative to the start of the slot, and the number of consecutive symbols L counting from the symbol S allocated for the PUSCH are determined from the start and length indicator $SLIV$ of the indexed row:

if $(L-1) \leq 7$ then

$$SLIV = 14 \cdot (L-1) + S$$

else

$$SLIV = 14 \cdot (14 - L + 1) + (14 - 1 - S)$$

where $0 < L \leq 14 - S$, and
- The PUSCH mapping type is set to Type A or Type B as defined in Subclause 6.4.1.1.3 of [4, TS 38.211] as given by the indexed row.

The UE shall consider the S and L combinations defined in table 6.1.2.1-1 as valid PUSCH allocations

Table 6.1.2.1-1: Valid S and L combinations

PUSCH mapping type	Normal cyclic prefix			Extended cyclic prefix		
	S	L	$S+L$	S	L	$S+L$
Type A	0	{4,...,14}	{4,...,14}	0	{4,...,12}	{4,...,12}
Type B	{0,...,13}	{1,...,14}	{1,...,14}	{0,...,12}	{1,...,12}	{1,...,12}

When the UE is configured with $aggregationFactorUL > 1$, the same symbol allocation is applied across the $aggregationFactorUL$ consecutive slots and the PUSCH is limited to a single transmission layer. The UE shall repeat the TB across the $aggregationFactorUL$ consecutive slots applying the same symbol allocation in each slot. The redundancy version to be applied on the n^{th} transmission occasion of the TB is determined according to table 6.1.2.1-2.

Table 6.1.2.1-2: Redundancy version when $aggregationFactorUL > 1$

rv_{id} indicated by the DCI scheduling the PUSCH	rv_{id} to be applied to n^{th} transmission occasion			
	$n \bmod 4 = 0$	$n \bmod 4 = 1$	$n \bmod 4 = 2$	$n \bmod 4 = 3$
0	0	2	3	1
2	2	3	1	0
3	3	1	0	2
1	1	0	2	3

If the UE procedure for determining slot configuration, as defined in subclause 11.1 of [6, TS 38.213], determines symbols of a slot allocated for PUSCH as downlink symbols, the transmission on that slot is omitted for multi-slot PUSCH transmission.

[38.214 clause 6.1.2.2]

The UE shall determine the resource block assignment in frequency domain using the resource allocation field in the detected PDCCH DCI. Two uplink resource allocation schemes type 0 and type 1 are supported. Uplink resource allocation scheme type 0 is supported for PUSCH only when transform precoding is disabled. Uplink resource allocation scheme type 1 is supported for PUSCH for both cases when transform precoding is enabled or disabled.

If the scheduling DCI is configured to indicate the uplink resource allocation type as part of the *Frequency domain resource* assignment field by setting a higher layer parameter *resourceAllocation* in *pusch-Config* to 'dynamicswitch', the UE shall use uplink resource allocation type 0 or type 1 as defined by this DCI field. Otherwise the UE shall use the uplink frequency resource allocation type as defined by the higher layer parameter *resourceAllocation*.

The UE shall assume that when the scheduling PDCCH is received with DCI format 0_0, then uplink resource allocation type 1 is used.

If a bandwidth part indicator field is not configured in the scheduling DCI, the RB indexing for uplink type 0 and type 1 resource allocation is determined within the UE's active bandwidth part. If a bandwidth part indicator field is configured in the scheduling DCI, the RB indexing for uplink type 0 and type 1 resource allocation is determined within the UE's bandwidth part indicated by bandwidth part indicator field value in the DCI, except for the case when DCI format 0_0 is decoded in any PDCCH common search space in CORESET 0 in which case the initial bandwidth part shall be used. The UE shall upon detection of PDCCH intended for the UE determine first the uplink bandwidth part and then the resource allocation within the bandwidth part.

[38.214 clause 6.1.2.2.2]

n uplink resource allocation of type 1, the resource block assignment information indicates to a scheduled UE a set of contiguously allocated non-interleaved virtual resource blocks within the active carrier bandwidth part of size N_{BWP}^{size} PRBs except for the case when DCI format 0_0 is decoded in the Type0-PDCCH common search space in CORESET 0 in which case the initial bandwidth part of size N_{BWP}^{size} shall be used.

An uplink type 1 resource allocation field consists of a resource indication value (RIV) corresponding to a starting virtual resource block (RB_{start}) and a length in terms of contiguously allocated resource blocks L_{RBs} . The resource indication value is defined by

if $(L_{RBs} - 1) \leq \lfloor N_{BWP}^{size} / 2 \rfloor$ then

$$RIV = N_{BWP}^{size} (L_{RBs} - 1) + RB_{start}$$

else

$$RIV = N_{BWP}^{size} (N_{BWP}^{size} - L_{RBs} + 1) + (N_{BWP}^{size} - 1 - RB_{start})$$

where $L_{RBs} \geq 1$ and shall not exceed $N_{BWP}^{size} - RB_{start}$.

[TS 38.214, clause 6.1.4.1]

For the PUSCH assigned by a DCI format 0_0/0_1 with CRC scrambled by C-RNTI, new-RNTI, TC-RNTI, or SP-CSI-RNTI, the transform precoding is enabled if *transformPrecoder* in *PUSCH-Config* is set to 'enabled', or if *transformPrecoder* in *PUSCH-Config* is not configured and *msg3-transformPrecoding* in *rach-ConfigCommon* is set to 'enabled'; otherwise the transform precoding is disabled.

For the PUSCH assigned by a DCI format 0_0/0_1 with CRC scrambled by CS-RNTI, or the PUSCH with configured grant using CS-RNTI, the transform precoding is enabled if *transformPrecoder* in *ConfiguredGrantConfig* is set to 'enabled'; otherwise the transform precoding is disabled.

For a PUSCH scheduled by RAR UL grant or for a PUSCH scheduled by a DCI format 0_0/0_1 with CRC scrambled by C-RNTI, TC-RNTI, or CS-RNTI, or for a PUSCH with configured grant using CS-RNTI,

if *transformPrecoder* is disabled for this PUSCH transmission

...

else

- if *mcs-TableTransformPrecoder* in *PUSCH-Config* is set to 'qam256', and the PUSCH is scheduled with C-RNTI or SP-CSI-RNTI, and PUSCH is assigned by DCI format 0_1,
- the UE shall use I_{MCS} and Table 5.1.3.1.-2 to determine the modulation order (Q_m) and Target code rate (R) used in the physical uplink shared channel.
- elseif the UE is not configured with new-RNTI, *mcs-TableTransformPrecoder* in *PUSCH-Config* is set to 'qam64LowSE', and the PUSCH is scheduled with C-RNTI, or SP-CSI-RNTI, and the PUSCH is assigned by a PDCCH in a UE-specific search space,

- the UE shall use I_{MCS} and Table 6.1.4.1-2 to determine the modulation order (Q_m) and Target code rate (R) used in the physical uplink shared channel.
- elseif the UE is configured with new-RNTI, and the PUSCH is scheduled with new-RNTI,
 - the UE shall use I_{MCS} and Table 6.1.4.1-2 to determine the modulation order (Q_m) and Target code rate (R) used in the physical uplink shared channel.
- elseif *mcs-TableTransformPrecoder* in *ConfiguredGrantConfig* is set to 'qam256', and PUSCH is scheduled with CS-RNTI,
 - the UE shall use I_{MCS} and Table 5.1.3.1-2 to determine the modulation order (Q_m) and Target code rate (R) used in the physical uplink shared channel.
- elseif *mcs-TableTransformPrecoder* in *ConfiguredGrantConfig* is set to 'qam64LowSE', and PUSCH is scheduled with CS-RNTI,
 - the UE shall use I_{MCS} and Table 6.1.4.1-2 to determine the modulation order (Q_m) and Target code rate (R) used in the physical uplink shared channel.
- else
 - the UE shall use I_{MCS} and Table 6.1.4.1-1 to determine the modulation order (Q_m) and Target code rate (R) used in the physical uplink shared channel.

end

For Table 6.1.4.1-1 and Table 6.1.4.1-2, if higher layer parameter *PUSCH-tp-pi2BPSK* is configured, $q = 1$ otherwise $q=2$.

Table 6.1.4.1-1: MCS index table for PUSCH with transform precoding and 64QAM

MCS Index I_{MCS}	Modulation Order Q_m	Target code Rate R x 1024	Spectral efficiency
0	q	240/ q	0.2344
1	q	314/ q	0.3066
2	2	193	0.3770
3	2	251	0.4902
4	2	308	0.6016
5	2	379	0.7402
6	2	449	0.8770
7	2	526	1.0273
8	2	602	1.1758
9	2	679	1.3262
10	4	340	1.3281
11	4	378	1.4766
12	4	434	1.6953
13	4	490	1.9141
14	4	553	2.1602
15	4	616	2.4063
16	4	658	2.5703
17	6	466	2.7305
18	6	517	3.0293
19	6	567	3.3223
20	6	616	3.6094
21	6	666	3.9023
22	6	719	4.2129
23	6	772	4.5234
24	6	822	4.8164
25	6	873	5.1152
26	6	910	5.3320
27	6	948	5.5547
28	q	reserved	
29	2	reserved	

30	4	reserved
31	6	reserved

[TS 38.214, clause 6.1.4.2]

For a PUSCH scheduled by RAR UL grant or for a PUSCH scheduled by a DCI format 0_0/0_1 with CRC scrambled by C-RNTI, new-RNTI, TC-RNTI, CS-RNTI, or SP-CSI-RNTI.

if

- $0 \leq I_{MCS} \leq 27$ and transform precoding is disabled and Table 5.1.3.1-2 is used, or
- $0 \leq I_{MCS} \leq 28$ and transform precoding is disabled and a table other than Table 5.1.3.1-2 is used, or
- $0 \leq I_{MCS} \leq 27$ and transform precoding is enabled, the UE shall first determine the TBS as specified below:

The UE shall first determine the number of REs (N_{RE}) within the slot:

- A UE first determines the number of REs allocated for PUSCH within a PRB (N'_{RE}) by
- $N'_{RE} = N_{sc}^{RB} * N_{symp}^{sh} - N_{DMRS}^{PRB} - N_{oh}^{PRB}$, where $N_{sc}^{RB} = 12$ is the number of subcarriers in the frequency domain in a physical resource block, N_{symp}^{sh} is the number of symbols of the PUSCH allocation within the slot, N_{DMRS}^{PRB} is the number of REs for DM-RS per PRB in the scheduled duration including the overhead of the DM-RS CDM groups without data, as indicated by DCI format 0_1 or as described for DCI format 0_0 in Subclause 6.2.2, and N_{oh}^{PRB} is the overhead configured by higher layer parameter $xOverhead$ in *PUSCH-ServingCellConfig*. If the N_{oh}^{PRB} is not configured (a value from 0, 6, 12, or 18), the N_{oh}^{PRB} is assumed to be 0. For MSG3 transmission the N_{oh}^{PRB} is always set to 0.
- A UE determines the total number of REs allocated for PUSCH (N_{RE}) by

$$N_{RE} = \min(156, N'_{RE}) \cdot n_{PRB}$$
where n_{PRB} is the total number of allocated PRBs for the UE.
- Next, proceed with steps 2-4 as defined in Subclause 5.1.3.2

else if

- $28 \leq I_{MCS} \leq 31$ and transform precoding is disabled and Table 5.1.3.1-2 is used, or
- $28 \leq I_{MCS} \leq 31$ and transform precoding is enabled,
- the TBS is assumed to be as determined from the DCI transported in the latest PDCCH for the same transport block using $0 \leq I_{MCS} \leq 27$. If there is no PDCCH for the same transport block using $0 \leq I_{MCS} \leq 27$, and if the initial PUSCH for the same transport block is transmitted with configured grant, the TBS shall be determined from the most recent configured scheduling PDCCH.

else

- the TBS is assumed to be as determined from the DCI transported in the latest PDCCH for the same transport block using $0 \leq I_{MCS} \leq 28$. If there is no PDCCH for the same transport block using $0 \leq I_{MCS} \leq 28$, and if the initial PUSCH for the same transport block is transmitted with configured grant, the TBS shall be determined from the most recent configured scheduling PDCCH.

[TS 38.214, clause 5.1.3.2]

- 2) Intermediate number of information bits (N_{info}) is obtained by $N_{info} = N_{RE} \cdot R \cdot Q_m \cdot \nu$.

If $N_{info} \leq 3824$

Use step 3 as the next step of the TBS determination

else

Use step 4 as the next step of the TBS determination

end if

3) When $N_{info} \leq 3824$, TBS is determined as follows

- quantized intermediate number of information bits $N'_{info} = \max\left(24, 2^n \cdot \left\lfloor \frac{N_{info}}{2^n} \right\rfloor\right)$, where
 $n = \max(3, \lfloor \log_2(N_{info}) \rfloor - 6)$.
- use Table 5.1.3.2-2 find the closest TBS that is not less than N'_{info} .

Table 5.1.3.2-2: TBS for $N_{info} \leq 3824$

Index	TBS	Index	TBS	Index	TBS	Index	TBS
1	24	31	336	61	1288	91	3624
2	32	32	352	62	1320	92	3752
3	40	33	368	63	1352	93	3824
4	48	34	384	64	1416		
5	56	35	408	65	1480		
6	64	36	432	66	1544		
7	72	37	456	67	1608		
8	80	38	480	68	1672		
9	88	39	504	69	1736		
10	96	40	528	70	1800		
11	104	41	552	71	1864		
12	112	42	576	72	1928		
13	120	43	608	73	2024		
14	128	44	640	74	2088		
15	136	45	672	75	2152		
16	144	46	704	76	2216		
17	152	47	736	77	2280		
18	160	48	768	78	2408		
19	168	49	808	79	2472		
20	176	50	848	80	2536		
21	184	51	888	81	2600		
22	192	52	928	82	2664		
23	208	53	984	83	2728		
24	224	54	1032	84	2792		
25	240	55	1064	85	2856		
26	256	56	1128	86	2976		
27	272	57	1160	87	3104		
28	288	58	1192	88	3240		
29	304	59	1224	89	3368		
30	320	60	1256	90	3496		

4) When $N_{info} > 3824$, TBS is determined as follows.

- quantized intermediate number of information bits $N'_{info} = \max\left(3840, 2^n \times \text{round}\left(\frac{N_{info} - 24}{2^n}\right)\right)$, where
 $n = \lfloor \log_2(N_{info} - 24) \rfloor - 5$ and ties in the round function are broken towards the next largest integer.
- if $R \leq 1/4$

$$TBS = 8 \cdot C \cdot \left\lceil \frac{N'_{info} + 24}{8 \cdot C} \right\rceil - 24, \text{ where } C = \left\lceil \frac{N'_{info} + 24}{3816} \right\rceil$$

else

if $N'_{info} > 8424$

$$TBS = 8 \cdot C \cdot \left\lceil \frac{N'_{info} + 24}{8 \cdot C} \right\rceil - 24, \text{ where } C = \left\lceil \frac{N'_{info} + 24}{8424} \right\rceil$$

else

$$TBS = 8 \cdot \left\lceil \frac{N'_{info} + 24}{8} \right\rceil - 24$$

end if

end if

7.1.1.4.2.5.3 Test description

7.1.1.4.2.5.3.1 Pre-test conditions

Same Pre-test conditions as in clause 7.1.1.0 except set the NR Cell bandwidth and applicable BWP to maximum for the NR Band under test as specified in Table 5.3.5-1 in TS 38.101-1 [16] / TS 38.101-2 [17] (to enable testing of n_{PRB} up to maximum value) and Short_DCI condition is applied in NR Serving cell configuration.

Test frequency NRf1 is as specified in TS 38.508-1 [4] clause 4.3.1 using the common highest mandatory UL and DL channel bandwidth and using the default subcarrier spacing specified in TS 38.508-1 [4] clause 6.2.3.1.

7.1.1.4.2.5.3.2 Test procedure sequence

Table 7.1.1.4.2.5.3.2-1: Maximum TBS for different UE categories

UE Category	Maximum number of bits of a UL-SCH transport block received within a TTI
TS 38.306 [23] clause 4.1.2 require UE without <i>ue-CategoryDL</i> and <i>ue-CategoryUL</i> , to support Max TBS achievable based on max bandwidth of the Band under test.	

Table 7.1.1.4.2.5.3.2-2: Number of uplink PDCP SDUs and PDCP SDU size used as test data

TBS [bits]	Number of PDCP SDUs	PDCP SDU size [bits] (Note 1)
$136 \leq TBS \leq 12128$ note 2	1	$8 * \text{FLOOR}((TBS - 128) / 8)$
$12129 \leq TBS \leq 24200$	2	$8 * \text{FLOOR}((TBS - 200) / 16)$
$24201 \leq TBS \leq 36272$	3	$8 * \text{FLOOR}((TBS - 272) / 24)$
$36273 \leq TBS \leq 48344$	4	$8 * \text{FLOOR}((TBS - 344) / 32)$
$48345 \leq TBS \leq 60416$	5	$8 * \text{FLOOR}((TBS - 416) / 40)$
$60417 \leq TBS \leq 72488$	6	$8 * \text{FLOOR}((TBS - 488) / 48)$
$72489 \leq TBS \leq 84560$	7	$8 * \text{FLOOR}((TBS - 560) / 56)$
$84561 \leq TBS \leq 96632$	8	$8 * \text{FLOOR}((TBS - 632) / 64)$
$96633 < TBS \leq 108704$	9	$8 * \text{FLOOR}((TBS - 704) / 72)$
$10705 \leq TBS \leq 120776$	10	$8 * \text{FLOOR}((TBS - 776) / 80)$
$120777 \leq TBS \leq 132848$	11	$8 * \text{FLOOR}((TBS - 848) / 88)$
$132849 \leq TBS \leq 144920$	12	$8 * \text{FLOOR}((TBS - 920) / 96)$
$144921 \leq TBS \leq 156992$	13	$8 * \text{FLOOR}((TBS - 992) / 104)$
$156993 \leq TBS \leq 169064$	14	$8 * \text{FLOOR}((TBS - 1064) / 112)$
$169065 \leq TBS \leq 181136$	15	$8 * \text{FLOOR}((TBS - 1136) / 120)$
$181137 \leq TBS \leq 193208$	16	$8 * \text{FLOOR}((TBS - 1208) / 128)$

$193209 \leq TBS \leq 205280$	17	$8 * \text{FLOOR}((TBS - 1280) / 136)$
$205281 \leq TBS \leq 217352$	18	$8 * \text{FLOOR}((TBS - 1352) / 144)$
$217353 \leq TBS \leq 229424$	19	$8 * \text{FLOOR}((TBS - 1424) / 152)$
$TBS > 229424$	20	$8 * \text{FLOOR}((TBS - 1496) / 160)$

Note 1: Each PDCP SDU is limited to 1500 octets (to keep below maximum SDU size of ESM as specified in TS 24.301 [21] clause 9.9.4.12).

The PDCP SDU size of each PDCP SDU is

PDCP SDU size = (TBS – N*PDCP header size – N*AMD PDU header size - N*MAC header size – Size of Timing Advance – RLC Status PDU size- MAC header for RLC Status PDU) / N, where

PDCP header size is 24 bits for the RLC AM and 18-bit SN case;
AMD PDU header size is 24 bits with 18 bit SN;

MAC header size for AMD PDU = 16 or 24 bits depending on L=8 or 16 bits. Worst case 24 is taken.

Size of Timing Advance MAC CE with header is 16 bits (if no Timing Advance and/or RLC status needs to be sent, padding will occur instead).

RLC Status PDU size = 24 bits with 1 ACK_SN, With a MAC header of 16 bits.

This gives:

PDCP SDU size = $8 * \text{FLOOR}((TBS - N * 24 - N * 24 - N * 24 - 56) / (8 * N))$ bits.

Note 2: According to the final PDCP SDU size formula in Note 1, the smallest TBS that can be tested is 136 bits.

Table 7.1.1.4.2.5.3.2-3: Specific Parameters

Parameter	Value	Comment
number of layers (v)	1	
<i>transformPrecoder</i>	enabled	

Table 7.1.1.4.2.5.3.2-4: Main behaviour

St	Procedure	Message Sequence		TP	Verdict
		U - S	Message		
-	EXCEPTION: Steps 1 to 5 are repeated for allowed values of N_{PRB} 1 to $N_{RB}^{UL,BWP}$ in BWP, time domain resource as per Table 7.1.1.4.2.0-1 and I_{MCS} from 0 to 27.	-	-	-	-
1	The SS calculates or looks up TBS in TS 38.214 [15] based on the value of S, L, I_{MCS} and n_{PRB} .	-	-	-	-
-	EXCEPTION: Steps 2 to 5 are performed if TBS is less than or equal to UE capability "Maximum number of UL-SCH transport block bits received within a TTI" as specified in Table 7.1.1.4.2.5.3.2-1 and larger than or equal to 136 bits as specified in Table 7.1.1.4.2.5.3.2-2 Skip the execution of steps 2 to 5 for which the TBS size equal to 3824 or 3840. (Note 1) Skip the execution of steps 1 to 5 for $I_{MCS} > 27$ and $N_{PRB} < 5$. (Note2)	-	-	-	-
2	The SS creates one or more PDCP SDUs, depending on TBS, in accordance with Table 7.1.1.4.2.5.3.2-2.	-	-	-	-
3	The SS transmits all PDCP SDUs (N_{SDUs}) as created in step 2 in a MAC PDU.	<--	MAC PDU ($N \times$ PDCP SDUs)	-	-
4	After the reception of 2 Scheduling Request, SS transmits UL Grant DCI 0_0, and values of S, L, I_{MCS} and n_{PRB} .	<--	(UL Grant) (DCI Format 0_0, S, L, I_{MCS} and n_{PRB})	-	-
5	CHECK: Does UE return the same number of PDCP SDUs with same content as transmitted by the SS in step 3 using Time, frequency Resources and modulation and coding scheme as configured by the SS in step 4?	-->	MAC PDU ($N \times$ PDCP SDU)	1	P
Note 1: There is ambiguity of TBS calculation when $3824.0 < N_{info} < 3825.0$ in clause 5.1.3.2 of TS 38.214 [15].					
Note 2: For $I_{MCS} > 27$ and $N_{PRB} < 5$, the resulting TBS is very small leading to CRC errors in decoding UL data.					

7.1.1.4.2.5.3.3 Specific message contents

None.

7.1.1.4.2.6 UL-SCH Transport Block Size selection / DCI format 0_2

7.1.1.4.2.6.1 Test Purpose (TP)

(1)

```

with { UE in RRC_CONNECTED state }
ensure that {
  when { UE has pending data for transmission and receives on PDCCH DCI format 0_2 indicating a
resource block assignment correspondent to physical resource blocks , Time domain resource
assignment and modulation and coding}
  then { UE transmits MAC PDU on PUSCH as per Modulation Coding scheme, time domain resource
allocation and PRB's }
}

```

7.1.1.4.2.6.2 Conformance requirements

References: The conformance requirements covered in the present TC are specified in: TS 38.212 clause 7.3.1.1.3, TS 38.214 clause 6.1.2.1, 6.1.2.2, 6.1.2.2.1, 6.1.2.2.2, 6.1.4.1, 5.1.3.1, 6.1.4.2 and 5.1.3.2. Unless otherwise stated these are Rel-16 requirements.

[TS 38.212, clause 7.3.1.1.3]

DCI format 0_2 is used for the scheduling of PUSCH in one cell.

The following information is transmitted by means of the DCI format 0_2 with CRC scrambled by C-RNTI or CS-RNTI or SP-CSI-RNTI or MCS-C-RNTI:

- Identifier for DCI formats – 1 bit
 - The value of this bit field is always set to 0, indicating an UL DCI format
- Carrier indicator – 0, 1, 2 or 3 bits determined by higher layer parameter *carrierIndicatorSizeDCI-0-2*, as defined in Clause 10.1 of [5, TS38.213].
- UL/SUL indicator – 0 bit for UEs not configured with *supplementaryUplink* in *ServingCellConfig* in the cell or UEs configured with *supplementaryUplink* in *ServingCellConfig* in the cell but only one carrier in the cell is configured for PUSCH transmission; otherwise, 1 bit as defined in Table 7.3.1.1.1-1.
- Bandwidth part indicator – 0, 1 or 2 bits as determined by the number of UL BWPs $n_{BWP,RRC}$ configured by higher layers, excluding the initial UL bandwidth part. The bitwidth for this field is determined as $\lceil \log_2(n_{BWP}) \rceil$ bits, where
 - $n_{BWP} = n_{BWP,RRC} + 1$ if $n_{BWP,RRC} \leq 3$, in which case the bandwidth part indicator is equivalent to the ascending order of the higher layer parameter *BWP-Id*;
 - otherwise $n_{BWP} = n_{BWP,RRC}$, in which case the bandwidth part indicator is defined in Table 7.3.1.1.2-1;

If a UE does not support active BWP change via DCI, the UE ignores this bit field.

- Frequency domain resource assignment – number of bits determined by the following:
 - N_{RBG} bits if only resource allocation type 0 is configured, where N_{RBG} is defined in Clause 6.1.2.2.1 of [6, TS 38.214]
 - $\lceil \log_2(N_{RBG,K1}(N_{RBG,K1} + 1)/2) \rceil$ bits if only resource allocation type 1 is configured, or $\max(\lceil \log_2(N_{RBG,K1}(N_{RBG,K1} + 1)/2) \rceil, N_{RBG}) + 1$ bits if *resourceAllocationDCI-0-2-r16* is configured as 'dynamicSwitch', where $N_{RBG,K1} = \lceil (N_{RB}^{UL,BWP} + (N_{UL,BWP}^{start} \bmod K1)) / K1 \rceil$, $N_{RB}^{UL,BWP}$ is the size of the active UL bandwidth part, $N_{UL,BWP}^{start}$ is defined as in clause 4.4.4.4 of [4, TS 38.211] and $K1$ is given by higher layer parameter *resourceAllocationType1GranularityDCI-0-2*. If the higher layer parameter *resourceAllocationType1GranularityDCI-0-2* is not configured, $K1$ is equal to 1.
 - If *resourceAllocationDCI-0-2-r16* is configured as 'dynamicSwitch', the MSB bit is used to indicate resource allocation type 0 or resource allocation type 1, where the bit value of 0 indicates resource allocation type 0 and the bit value of 1 indicates resource allocation type 1.

- For resource allocation type 0, the N_{RBG} LSBs provide the resource allocation as defined in Clause 6.1.2.2.1 of [6, TS 38.214].
- For resource allocation type 1, the $\lceil \log_2(N_{RBG,K1}(N_{RBG,K1} + 1)/2) \rceil$ LSBs provide the resource allocation as follows:
 - For PUSCH hopping with resource allocation type 1:
 - N_{UL_hop} MSB bits are used to indicate the frequency offset according to Clause 6.3 of [6, TS 38.214], where $N_{UL_hop} = 1$ if the higher layer parameter *frequencyHoppingOffsetListsDCI-0-2* contains two offset values and $N_{UL_hop} = 2$ if the higher layer parameter *frequencyHoppingOffsetListsDCI-0-2* contains four offset values
 - $\lceil \log_2(N_{RBG,K1}(N_{RBG,K1} + 1)/2) \rceil - N_{UL_hop}$ bits provide the frequency domain resource allocation according to Clause 6.1.2.2.2 of [6, TS 38.214]
 - For non-PUSCH hopping with resource allocation type 1:
 - $\lceil \log_2(N_{RBG,K1}(N_{RBG,K1} + 1)/2) \rceil$ bits provide the frequency domain resource allocation according to Clause 6.1.2.2.2 of [6, TS 38.214]

If "Bandwidth part indicator" field indicates a bandwidth part other than the active bandwidth part and if *resourceAllocationDCI-0-2-r16* is configured as 'dynamicSwitch' for the indicated bandwidth part, the UE assumes resource allocation type 0 for the indicated bandwidth part if the bitwidth of the "Frequency domain resource assignment" field of the active bandwidth part is smaller than the bitwidth of the "Frequency domain resource assignment" field of the indicated bandwidth part.

- Time domain resource assignment – 0, 1, 2, 3, 4, 5 or 6 bits as defined in Clause 6.1.2.1 of [6, TS38.214]. The bitwidth for this field is determined as $\lceil \log_2(I) \rceil$ bits, where I is the number of entries in the higher layer parameter *pusch-TimeDomainAllocationListDCI-0-2* if the higher layer parameter is configured, or I is the number of entries in the higher layer parameter *PUSCH-TimeDomainResourceAllocationList* if the higher layer parameter *PUSCH-TimeDomainResourceAllocationList* is configured and the higher layer parameter *pusch-TimeDomainAllocationListDCI-0-2* is not configured; otherwise I is the number of entries in the default table.
- Frequency hopping flag – 0 or 1 bit:
 - 0 bit if the higher layer parameter *frequencyHoppingDCI-0-2* is not configured;
 - 1 bit according to Table 7.3.1.1.1-3 otherwise, only applicable to resource allocation type 1, as defined in Clause 6.3 of [6, TS 38.214].
- Modulation and coding scheme – 5 bits as defined in Clause 6.1.4.1 of [6, TS 38.214]
- New data indicator – 1 bit
- Redundancy version – 0, 1 or 2 bits determined by higher layer parameter *numberOfBitsForRV-DCI-0-2*
 - If 0 bit is configured, r_{vid} to be applied is 0;
 - 1 bit according to Table 7.3.1.2.3-1;
 - 2 bits according to Table 7.3.1.1.1-2.
- HARQ process number – 0, 1, 2, 3 or 4 bits determined by higher layer parameter *harq-ProcessNumberSizeDCI-0-2*
- Downlink assignment index – 0, 1, 2 or 4 bits
 - 0 bit if the higher layer parameter *downlinkAssignmentIndexDCI-0-2* is not configured;
 - 1, 2 or 4 bits otherwise,
 - 1st downlink assignment index – 1 or 2 bits:
 - 1 bit for semi-static HARQ-ACK codebook;

- 2 bits for dynamic HARQ-ACK codebook.
- 2nd downlink assignment index – 0 or 2 bits
- 2 bits for dynamic HARQ-ACK codebook with two HARQ-ACK sub-codebooks;
- 0 bit otherwise.

When two HARQ-ACK codebooks are configured for the same serving cell and if higher layer parameter *priorityIndicatorDCI-0-2* is configured, if the bit width of the Downlink assignment index in DCI format 0_2 for one HARQ-ACK codebook is not equal to that of the Downlink assignment index in DCI format 0_2 for the other HARQ-ACK codebook, a number of most significant bits with value set to '0' are inserted to smaller Downlink assignment index until the bit width of the Downlink assignment index in DCI format 0_2 for the two HARQ-ACK codebooks are the same.

- TPC command for scheduled PUSCH – 2 bits as defined in Clause 7.1.1 of [5, TS38.213]

- SRS resource indicator – $\left\lceil \log_2 \left(\sum_{k=1}^{\min\{L_{max}, N_{SRS}\}} \binom{N_{SRS}}{k} \right) \right\rceil$ or $\lceil \log_2 N_{SRS} \rceil$ bits, where N_{SRS} is the number of

configured SRS resources in the SRS resource set configured by higher layer parameter *srs-ResourceSetToAddModListDCI-0-2*, and associated with the higher layer parameter *usage* of value 'codeBook' or 'nonCodeBook',

- $\left\lceil \log_2 \left(\sum_{k=1}^{\min\{L_{max}, N_{SRS}\}} \binom{N_{SRS}}{k} \right) \right\rceil$ bits according to Tables 7.3.1.1.2-28/29/30/31 if the higher layer parameter

txConfig = nonCodebook, where N_{SRS} is the number of configured SRS resources in the SRS resource set configured by higher layer parameter *srs-ResourceSetToAddModListDCI-0-2*, and associated with the higher layer parameter *usage* of value 'nonCodeBook' and

- if UE supports operation with *maxMIMO-LayersDCI-0-2* and the higher layer parameter *maxMIMO-LayersDCI-0-2* of *PUSCH-ServingCellConfig* of the serving cell is configured, L_{max} is given by that parameter
- otherwise, L_{max} is given by the maximum number of layers for PUSCH supported by the UE for the serving cell for non-codebook based operation.
- $\lceil \log_2 N_{SRS} \rceil$ bits according to Tables 7.3.1.1.2-32 if the higher layer parameter *txConfig = codebook*, where N_{SRS} is the number of configured SRS resources in the SRS resource set configured by higher layer parameter *srs-ResourceSetToAddModListDCI-0-2*, and associated with the higher layer parameter *usage* of value 'codeBook'.
- Precoding information and number of layers – number of bits determined by the following:
 - 0 bits if the higher layer parameter *txConfig = nonCodeBook*;
 - 0 bits for 1 antenna port and if the higher layer parameter *txConfig = codebook*;
 - 4, 5, or 6 bits according to Table 7.3.1.1.2-2 for 4 antenna ports, if *txConfig = codebook*, *ul-FullPowerTransmission* is not configured or configured to *fullpowerMode2* or configured to *fullpower*, and according to whether transform precoder is enabled or disabled, and the values of higher layer parameters *maxRankDCI-0-2*, and *codebookSubsetDCI-0-2*;
 - 4 or 5 bits according to Table 7.3.1.1.2-2A for 4 antenna ports, if *txConfig = codebook*, *ul-FullPowerTransmission = fullpowerMode1*, the values of higher layer parameters *maxRankDCI-0-2=2*, transform precoder is disabled, and according to the value of higher layer parameter *codebookSubsetDCI-0-2*;
 - 4 or 6 bits according to Table 7.3.1.1.2-2B for 4 antenna ports, if *txConfig = codebook*, *ul-FullPowerTransmission = fullpowerMode1*, the values of higher layer parameters *maxRankDCI-0-2=3 or 4*, transform precoder is disabled, and according to the value of higher layer parameter *codebookSubsetDCI-0-2*;
 - 2, 4, or 5 bits according to Table 7.3.1.1.2-3 for 4 antenna ports, if *txConfig = codebook*, *ul-FullPowerTransmission* is not configured or configured to *fullpowerMode2* or configured to *fullpower*, and

according to whether transform precoder is enabled or disabled, and the values of higher layer parameters *maxRankDCI-0-2* and *codebookSubsetDCI-0-2*;

- 3 or 4 bits according to Table 7.3.1.1.2-3A for 4 antenna ports, if *txConfig = codebook*, *ul-FullPowerTransmission = fullpowerMode1*, *maxRankDCI-0-2=1*, and according to whether transform precoder is enabled or disabled, and the value of higher layer parameter *codebookSubsetDCI-0-2*;
- 2 or 4 bits according to Table 7.3.1.1.2-4 for 2 antenna ports, if *txConfig = codebook*, *ul-FullPowerTransmission* is not configured or configured to *fullpowerMode2* or configured to *fullpower*, and according to whether transform precoder is enabled or disabled, and the values of higher layer parameters *maxRankDCI-0-2* and *codebookSubsetDCI-0-2*;
- 2 bits according to Table 7.3.1.1.2-4A for 2 antenna ports, if *txConfig = codebook*, *ul-FullPowerTransmission = fullpowerMode1*, transform precoder is disabled, the *maxRankDCI-0-2=2*, and *codebookSubsetDCI-0-2=nonCoherent*;
- 1 or 3 bits according to Table 7.3.1.1.2-5 for 2 antenna ports, if *txConfig = codebook*, *ul-FullPowerTransmission* is not configured or configured to *fullpowerMode2* or configured to *fullpower*, and according to whether transform precoder is enabled or disabled, and the values of higher layer parameters *maxRankDCI-0-2* and *codebookSubsetDCI-0-2*;
- 2 bits according to Table 7.3.1.1.2-5A for 2 antenna ports, if *txConfig = codebook*, *ul-FullPowerTransmission = fullpowerMode1*, *maxRankDCI-0-2=1*, and according to whether transform precoder is enabled or disabled, and the value of higher layer parameter *codebookSubsetDCI-0-2*.

For the higher layer parameter *txConfig=codebook*, if *ul-FullPowerTransmission* is configured to *fullpowerMode2*, the values of higher layer parameters *maxRankDCI-0-2* is configured to be larger than 2, and at least one SRS resource with 4 antenna ports is configured in an SRS resource set with usage set to 'codebook' and an SRS resource with 2 antenna ports is indicated via SRI in the same SRS resource set, then Table 7.3.1.1.2-4 is used.

For the higher layer parameter *txConfig = codebook*, if different SRS resources with different number of antenna ports are configured, the bitwidth is determined according to the maximum number of ports in an SRS resource among the configured SRS resources in an SRS resource set with usage set to 'codebook'. If the number of ports for a configured SRS resource in the set is less than the maximum number of ports in an SRS resource among the configured SRS resources, a number of most significant bits with value set to '0' are inserted to the field.

- Antenna ports – number of bits determined by the following:
 - 0 bit if higher layer parameter *antennaPortsFieldPresenceDCI-0-2* is not configured;
 - 2, 3, 4, or 5 bits otherwise,
 - 2 bits as defined by Tables 7.3.1.1.2-6, if transform precoder is enabled, *dmrs-Type=1*, and *maxLength=1*, except that *dmrs-UplinkTransformPrecoding* and *tp-pi2BPSK* are both configured and $\pi/2$ BPSK modulation is used;
 - 2 bits as defined by 7.3.1.1.2-6A, if transform precoder is enabled, and *dmrs-UplinkTransformPrecoding* and *tp-pi2BPSK* are both configured, $\pi/2$ BPSK modulation is used, *dmrs-Type=1*, and *maxLength=1*, where n_{SCID} is the scrambling identity for antenna ports defined in Clause 6.4.1.1.1.2, in [4, TS38.211];
 - 4 bits as defined by Tables 7.3.1.1.2-7, if transform precoder is enabled, *dmrs-Type=1*, and *maxLength=2*, except that *dmrs-UplinkTransformPrecoding* and *tp-pi2BPSK* are both configured and $\pi/2$ BPSK modulation is used;
 - 4 bits as defined by Tables 7.3.1.1.2-7A, if transform precoder is enabled, and *dmrs-UplinkTransformPrecoding* and *tp-pi2BPSK* are both configured, $\pi/2$ BPSK modulation is used, *dmrs-Type=1*, and *maxLength=2*, where n_{SCID} is the scrambling identity for antenna ports defined in Clause 6.4.1.1.1.2, in [4, TS38.211];
 - 3 bits as defined by Tables 7.3.1.1.2-8/9/10/11, if transform precoder is disabled, *dmrs-Type=1*, and *maxLength=1*, and the value of rank is determined according to the SRS resource indicator field if the higher layer parameter *txConfig = nonCodebook* and according to the Precoding information and number of layers field if the higher layer parameter *txConfig = codebook*;

- 4 bits as defined by Tables 7.3.1.1.2-12/13/14/15, if transform precoder is disabled, *dmrs-Type*=1, and *maxLength*=2, and the value of rank is determined according to the SRS resource indicator field if the higher layer parameter *txConfig* = *nonCodebook* and according to the Precoding information and number of layers field if the higher layer parameter *txConfig* = *codebook*;
- 4 bits as defined by Tables 7.3.1.1.2-16/17/18/19, if transform precoder is disabled, *dmrs-Type*=2, and *maxLength*=1, and the value of rank is determined according to the SRS resource indicator field if the higher layer parameter *txConfig* = *nonCodebook* and according to the Precoding information and number of layers field if the higher layer parameter *txConfig* = *codebook*;
- 5 bits as defined by Tables 7.3.1.1.2-20/21/22/23, if transform precoder is disabled, *dmrs-Type*=2, and *maxLength*=2, and the value of rank is determined according to the SRS resource indicator field if the higher layer parameter *txConfig* = *nonCodebook* and according to the Precoding information and number of layers field if the higher layer parameter *txConfig* = *codebook*.

where the number of CDM groups without data of values 1, 2, and 3 in Tables 7.3.1.1.2-6 to 7.3.1.1.2-23 refers to CDM groups {0}, {0,1}, and {0, 1,2} respectively.

If a UE is configured with both *dmrs-UplinkForPUSCH-MappingTypeA-DCI-0-2* and *dmrs-UplinkForPUSCH-MappingTypeB-DCI-0-2* and is configured with *antennaPortsFieldPresenceDCI-0-2*, the bitwidth of this field equals $\max\{x_A, x_B\}$, where x_A is the "Antenna ports" bitwidth derived according to *dmrs-UplinkForPUSCH-MappingTypeA-DCI-0-2* and x_B is the "Antenna ports" bitwidth derived according to *dmrs-UplinkForPUSCH-MappingTypeB-DCI-0-2*. A number of $|x_A - x_B|$ zeros are padded in the MSB of this field, if the mapping type of the PUSCH corresponds to the smaller value of x_A and x_B .

If a UE is not configured with higher layer parameter *antennaPortsFieldPresenceDCI-0-2*, antenna port(s) are defined assuming bit field index value 0 in Tables 7.3.1.1.2-6 to 7.3.1.1.2-23.

- SRS request – 0, 1, 2 or 3 bits
 - 0 bit if the higher layer parameter *srs-RequestDCI-0-2* is not configured;
 - 1 bit as defined by Table 7.3.1.1.3-1 if higher layer parameter *srs-RequestDCI-0-2* = 1 and for UEs not configured with *supplementaryUplink* in *ServingCellConfig* in the cell;
 - 2 bits if higher layer parameter *srs-RequestDCI-0-2* = 1 and for UEs configured with *supplementaryUplink* in *ServingCellConfig* in the cell, where the first bit is the non-SUL/SUL indicator as defined in Table 7.3.1.1.1-1 and the second bit is defined by Table 7.3.1.1.3-1;
 - 2 bits as defined by Table 7.3.1.1.2-24 if higher layer parameter *srs-RequestDCI-0-2* = 2 and for UEs not configured with *supplementaryUplink* in *ServingCellConfig* in the cell;
 - 3 bits if higher layer parameter *srs-RequestDCI-0-2* = 2 and for UEs configured with *supplementaryUplink* in *ServingCellConfig* in the cell, where the first bit is the non-SUL/SUL indicator as defined in Table 7.3.1.1.1-1 and the second and third bits are defined by Table 7.3.1.1.2-24;
- CSI request – 0, 1, 2, 3, 4, 5, or 6 bits determined by higher layer parameter *reportTriggerSizeDCI-0-2*.
- PTRS-DMRS association – number of bits determined as follows
 - 0 bit if *PTRS-UplinkConfig* is not configured in either *dmrs-UplinkForPUSCH-MappingTypeA* or *dmrs-UplinkForPUSCH-MappingTypeB* and transform precoder is disabled, or if transform precoder is enabled, or if *maxRankDCI-0-2*=1;
 - 2 bits otherwise, where Table 7.3.1.1.2-25 and 7.3.1.1.2-26 are used to indicate the association between PTRS port(s) and DMRS port(s) when one PT-RS port and two PT-RS ports are configured by *maxNrofPorts* in *PTRS-UplinkConfig* respectively, and the DMRS ports are indicated by the Antenna ports field.

If "Bandwidth part indicator" field indicates a bandwidth part other than the active bandwidth part and the "PTRS-DMRS association" field is present for the indicated bandwidth part but not present for the active bandwidth part, the UE assumes the "PTRS-DMRS association" field is not present for the indicated bandwidth part.

- *beta_offset* indicator – 0 bit if the higher layer parameter *betaOffsets* = *semiStatic*; otherwise 1 bit if 2 offset indexes are configured by higher layer parameter *dynamicDCI-0-2* as defined by Table 9.3-3A in [5, TS 38.213], and 2 bits if 4 offset indexes are configured by higher layer parameter *dynamicDCI-0-2* as defined by Table 9.3-3 in [5, TS 38.213].

When two HARQ-ACK codebooks are configured for the same serving cell and if higher layer parameter *priorityIndicatorDCI-0-2* is configured, if the bit width of the *beta_offset* indicator in DCI format 0_2 for one HARQ-ACK codebook is not equal to that of the *beta_offset* indicator in DCI format 0_2 for the other HARQ-ACK codebook, a number of most significant bits with value set to '0' are inserted to smaller *beta_offset* indicator until the bit width of the *beta_offset* indicator in DCI format 0_2 for the two HARQ-ACK codebooks are the same.

- DMRS sequence initialization – 0 or 1 bit
 - 0 bit if the higher layer parameter *dmrs-SequenceInitializationDCI-0-2* is not configured or if transform precoder is enabled;
 - 1 bit if transform precoder is disabled and the higher layer parameter *dmrs-SequenceInitializationDCI-0-2* is configured.
- UL-SCH indicator – 1 bit. A value of "1" indicates UL-SCH shall be transmitted on the PUSCH and a value of "0" indicates UL-SCH shall not be transmitted on the PUSCH. Except for DCI format 0_2 with CRC scrambled by SP-CSI-RNTI, a UE is not expected to receive a DCI format 0_2 with UL-SCH indicator of "0" and CSI request of all zero(s).
- Open-loop power control parameter set indication – 0 or 1 or 2 bits.
 - 0 bit if the higher layer parameter *p0-PUSCH-SetList* is not configured;
 - 1 or 2 bits otherwise,
 - 1 bit if SRS resource indicator is present in the DCI format 0_2;
 - 1 or 2 bits as determined by higher layer parameter *olpc-ParameterSetDCI-0-2* if SRS resource indicator is not present in the DCI format 0_2;
- Priority indicator – 0 bit if higher layer parameter *priorityIndicatorDCI-0-2* is not configured; otherwise 1 bit as defined in Clause 9 in [5, TS 38.213].
- Invalid symbol pattern indicator – 0 bit if higher layer parameter *invalidSymbolPatternIndicatorDCI-0-2* is not configured; otherwise 1 bit as defined in Clause 6.1.2.1 in [6, TS 38.214].

A UE does not expect that the bit width of a field in DCI format 0_2 with CRC scrambled by CS-RNTI is larger than corresponding bit width of same field in DCI format 0_2 with CRC scrambled by C-RNTI for the same serving cell. If the bit width of a field in the DCI format 0_2 with CRC scrambled by CS-RNTI is not equal to that of the corresponding field in the DCI format 0_2 with CRC scrambled by C-RNTI for the same serving cell, a number of most significant bits with value set to '0' are inserted to the field in DCI format 0_2 with CRC scrambled by CS-RNTI until the bit width equals that of the corresponding field in the DCI format 0_2 with CRC scrambled by C-RNTI for the same serving cell.

Table 7.3.1.1.3-1: 1 bit SRS request in DCI format 0_2 and DCI format 1_2

Value of SRS request field	Triggered aperiodic SRS resource set(s) for DCI format 0_2 and 1_2
0	No aperiodic SRS resource set triggered
1	SRS resource set(s) configured with higher layer parameter <i>aperiodicSRS-ResourceTrigger</i> set to 1 or an entry in <i>aperiodicSRS-ResourceTriggerList</i> set to 1

[TS 38.214, clause 6.1.2.1]

When the UE is scheduled to transmit a transport block and no CSI report, or the UE is scheduled to transmit a transport block and a CSI report(s) on PUSCH by a DCI, the 'Time domain resource assignment' field value m of the DCI provides a row index $m + 1$ to an allocated table. The determination of the used resource allocation table is defined in Clause 6.1.2.1.1. The indexed row defines the slot offset K_2 , the start and length indicator $SLIV$, or directly the start symbol S and the allocation length L , the PUSCH mapping type, and the number of repetitions (if *numberOfRepetitions* is present in the resource allocation table) to be applied in the PUSCH transmission.

When the UE is scheduled to transmit a PUSCH with no transport block and with a CSI report(s) by a 'CSI request' field on a DCI, the 'Time domain resource assignment' field value m of the DCI provides a row index $m + 1$ to the allocated table as defined in Clause 6.1.2.1.1. The indexed row defines the start and length indicator $SLIV$, or directly the start symbol S and the allocation length L , and the PUSCH mapping type to be applied in the PUSCH transmission and the K_2 value is determined as $K_2 = \max_j Y_j(m+1)$, where $Y_j, j = 0, \dots, N_{\text{Rep}} - 1$ are the corresponding list entries of the higher layer parameter

- *reportSlotOffsetListDCI-0-2*, if PUSCH is scheduled by DCI format 0_2 and *reportSlotOffsetListDCI-0-2* is configured;
- *reportSlotOffsetListDCI-0-1*, if PUSCH is scheduled by DCI format 0_1 and *reportSlotOffsetListDCI-0-1* is configured;
- *reportSlotOffsetList*, otherwise;

in *CSI-ReportConfig* for the N_{Rep} triggered CSI Reporting Settings and $Y_j(m+1)$ is the $(m+1)$ th entry of Y_j .

- The slot K_s where the UE shall transmit the PUSCH is determined by K_2 as K_s

$$= \left\lfloor n \cdot \frac{2^{\mu_{\text{PUSCH}}}}{2^{\mu_{\text{PDCCH}}}} \right\rfloor + K_2 + \left\lfloor \left(\frac{N_{\text{slot,offset,PDCCH}}^{\text{CA}}}{2^{\mu_{\text{offset,PDCCH}}}} - \frac{N_{\text{slot,offset,PUSCH}}^{\text{CA}}}{2^{\mu_{\text{offset,PUSCH}}}} \right) \cdot 2^{\mu_{\text{PUSCH}}} \right\rfloor$$
, if UE is configured with *ca-SlotOffset* for at least one of the scheduled and scheduling cell, $K_s = \left\lfloor n \cdot \frac{2^{\mu_{\text{PUSCH}}}}{2^{\mu_{\text{PDCCH}}}} \right\rfloor + K_2$, otherwise, and where n is the slot with the scheduling DCI, K_2 is based on the numerology of PUSCH, and μ_{PUSCH} and μ_{PDCCH} are the subcarrier spacing configurations for PUSCH and PDCCH, respectively,
 - $N_{\text{slot,offset,PDCCH}}^{\text{CA}}$ and $\mu_{\text{offset,PDCCH}}$ are the $N_{\text{slot,offset}}^{\text{CA}}$ and the μ_{offset} , respectively, which are determined by higher-layer configured *ca-SlotOffset* for the cell receiving the PDCCH, $N_{\text{slot,offset,PUSCH}}^{\text{CA}}$ and $\mu_{\text{offset,PUSCH}}$ are the $N_{\text{slot,offset}}^{\text{CA}}$ and the μ_{offset} , respectively, which are determined by higher-layer configured *ca-SlotOffset* for the cell transmitting the PUSCH, as defined in clause 4.5 of [4, TS 38.211], and
 - for PUSCH scheduled by DCI format 0_1, if *pusch-RepTypeIndicatorDCI-0-1* is set to 'pusch-RepTypeB', the UE applies PUSCH repetition Type B procedure when determining the time domain resource allocation. For PUSCH scheduled by DCI format 0_2, if *pusch-RepTypeIndicatorDCI-0-2* is set to 'pusch-RepTypeB', the UE applies PUSCH repetition Type B procedure when determining the time domain resource allocation. Otherwise, the UE applies PUSCH repetition Type A procedure when determining the time domain resource allocation for PUSCH scheduled by PDCCH.
 - For PUSCH repetition Type A, the starting symbol S relative to the start of the slot, and the number of consecutive symbols L counting from the symbol S allocated for the PUSCH are determined from the start and length indicator $SLIV$ of the indexed row:
 - if $(L-1) \leq 7$ then
$$SLIV = 14 \cdot (L-1) + S$$
 - else
$$SLIV = 14 \cdot (14 - L + 1) + (14 - 1 - S)$$

if $(L-1) \leq 7$ then

$$SLIV = 14 \cdot (L-1) + S$$

else

$$SLIV = 14 \cdot (14 - L + 1) + (14 - 1 - S)$$

where $0 < L \leq 14 - S$, and

- For PUSCH repetition Type B, the starting symbol S relative to the start of the slot, and the number of consecutive symbols L counting from the symbol S allocated for the PUSCH are provided by *startSymbol* and *length* of the indexed row of the resource allocation table, respectively.
- For PUSCH repetition Type A, the PUSCH mapping type is set to Type A or Type B as defined in Clause 6.4.1.1.3 of [4, TS 38.211] as given by the indexed row.
- For PUSCH repetition Type B, the PUSCH mapping type is set to Type B.

The UE shall consider the S and L combinations defined in table 6.1.2.1-1 as valid PUSCH allocations

Table 6.1.2.1-1: Valid S and L combinations

PUSCH mapping type	Normal cyclic prefix			Extended cyclic prefix		
	S	L	$S+L$	S	L	$S+L$
Type A (repetition Type A only)	0	{4,...,14}	{4,...,14}	0	{4,...,12}	{4,...,12}
Type B	{0,...,13}	{1,...,14}	{1,...,14} for repetition Type A, {1,...,27} for repetition Type B	{0,..., 11}	{1,...,12}	{1,...,12} for repetition Type A, {1,...,23} for repetition Type B

For PUSCH repetition Type A, when transmitting PUSCH scheduled by DCI format 0_1 or 0_2 in PDCCH with CRC scrambled with C-RNTI, MCS-C-RNTI, or CS-RNTI with NDI=1, the number of repetitions K is determined as

- if *numberOfRepetitions* is present in the resource allocation table, the number of repetitions K is equal to *numberOfRepetitions*;
- elseif the UE is configured with *pusch-AggregationFactor*, the number of repetitions K is equal to *pusch-AggregationFactor*;
- otherwise $K=1$.

If a UE is configured with higher layer parameter *pusch-TimeDomainAllocationListForMultiPUSCH*, the UE does not expect to be configured with *pusch-AggregationFactor*.

For PUSCH repetition Type A, in case $K>1$, the same symbol allocation is applied across the K consecutive slots and the PUSCH is limited to a single transmission layer. The UE shall repeat the TB across the K consecutive slots applying the same symbol allocation in each slot. The redundancy version to be applied on the n th transmission occasion of the TB, where $n = 0, 1, \dots, K-1$, is determined according to table 6.1.2.1-2.

Table 6.1.2.1-2: Redundancy version for PUSCH transmission

rv_{id} indicated by the DCI scheduling the PUSCH	rv_{id} to be applied to n^{th} transmission occasion (repetition Type A) or n^{th} actual repetition (repetition Type B)			
	$n \bmod 4 = 0$	$n \bmod 4 = 1$	$n \bmod 4 = 2$	$n \bmod 4 = 3$
0	0	2	3	1
2	2	3	1	0
3	3	1	0	2
1	1	0	2	3

[38.214 clause 6.1.2.2]

The UE shall determine the resource block assignment in frequency domain using the resource allocation field in the detected PDCCH DCI except for a PUSCH transmission scheduled by a RAR UL grant or fallbackRAR UL grant, in which case the frequency domain resource allocation is determined according to clause 8.3 of [6, 38.213] or a MsgA PUSCH transmission with frequency domain resource allocation determined according to clause 8.1A of [6, 38.213]. Three uplink resource allocation schemes type 0, type 1 and type 2 are supported. Uplink resource allocation scheme

type 0 is supported for PUSCH only when transform precoding is disabled. Uplink resource allocation scheme type 1 and type 2 are supported for PUSCH for both cases when transform precoding is enabled or disabled.

If the scheduling DCI is configured to indicate the uplink resource allocation type as part of the 'Frequency domain resource' assignment field by setting a higher layer parameter *resourceAllocation* in *pusch-Config* to 'dynamicSwitch', for DCI format 0_1 or setting a higher layer parameter *resourceAllocationDCI-0-2* in *pusch-Config* to 'dynamicSwitch' for DCI format 0_2, the UE shall use uplink resource allocation type 0 or type 1 as defined by this DCI field. Otherwise the UE shall use the uplink frequency resource allocation type as defined by the higher layer parameter *resourceAllocation* for DCI format 0_1 or the higher layer parameter *resourceAllocationDCI-0-2* for DCI format 0_2. The UE shall assume that when the scheduling PDCCH is received with DCI format 0_1 and *useInterlacePUCCH-PUSCH* in *BWP-UplinkDedicated* is configured, uplink type 2 resource allocation is used.

The UE shall assume that when the scheduling PDCCH is received with DCI format 0_0, then uplink resource allocation type 1 is used, except when any of the higher layer parameters *useInterlacePUCCH-PUSCH* in *BWP-UplinkCommon* and *useInterlacePUCCH-PUSCH* in *BWP-UplinkDedicated* is configured in which case uplink resource allocation type 2 is used.

The UE expects that either none or both of *useInterlacePUCCH-PUSCH* in *BWP-UplinkCommon* and *useInterlacePUCCH-PUSCH* in *BWP-UplinkDedicated* is configured.

If a bandwidth part indicator field is not configured in the scheduling DCI or the UE does not support active bandwidth part change via DCI, the RB indexing for uplink type 0, type 1 and type 2 resource allocation is determined within the UE's active bandwidth part. If a bandwidth part indicator field is configured in the scheduling DCI and the UE supports active bandwidth part change via DCI, the RB indexing for uplink type 0, type 1, type 2 resource allocation is determined within the UE's bandwidth part indicated by bandwidth part indicator field value in the DCI. The UE shall upon detection of PDCCH intended for the UE determine first the uplink bandwidth part and then the resource allocation within the bandwidth part. RB numbering starts from the lowest RB in the determined uplink bandwidth part.

[38.214 clause 6.1.2.2.1]

In uplink resource allocation of type 0, the resource block assignment information includes a bitmap indicating the Resource Block Groups (RBGs) that are allocated to the scheduled UE where a RBG is a set of consecutive virtual resource blocks defined by higher layer parameter *rbg-Size* configured in *pusch-Config* and the size of the bandwidth part as defined in Table 6.1.2.2.1-1.

Table 6.1.2.2.1-1: Nominal RBG size *P*

Bandwidth Part Size	Configuration 1	Configuration 2
1 – 36	2	4
37 – 72	4	8
73 – 144	8	16
145 – 275	16	16

[38.214 clause 6.1.2.2.2]

In uplink resource allocation of type 1, the resource block assignment information indicates to a scheduled UE a set of contiguously allocated non-interleaved virtual resource blocks within the active bandwidth part of size N_{BWP}^{size} PRBs except for the case when DCI format 0_0 is decoded in any common search space in which case the size of the initial UL bandwidth part $N_{BWP,0}^{size}$ shall be used.

An uplink type 1 resource allocation field consists of a resource indication value (*RIV*) corresponding to a starting virtual resource block (RB_{start}) and a length in terms of contiguously allocated resource blocks L_{RBs} . The resource indication value is defined by

if $(L_{RBs} - 1) \leq \lfloor N_{BWP}^{size} / 2 \rfloor$ then

$$RIV = N_{BWP}^{size} (L_{RBs} - 1) + RB_{start}$$

else

$$RIV = N_{BWP}^{size} (N_{BWP}^{size} - L_{RBs} + 1) + (N_{BWP}^{size} - 1 - RB_{start})$$

where $L_{RBs} \geq 1$ and shall not exceed $N_{BWP}^{size} - RB_{start}$.

When the DCI size for DCI format 0_0 in USS is derived from the initial UL BWP with size $N_{BWP}^{initial}$ but applied to another active BWP with size of N_{BWP}^{active} , an uplink type 1 resource block assignment field consists of a resource indication value (RIV) corresponding to a starting resource block $RB_{start} = 0, K, 2 \cdot K, \dots, (N_{BWP}^{initial} - 1) \cdot K$ and a length in terms of virtually contiguously allocated resource blocks $L_{RBs} = K, 2 \cdot K, \dots, N_{BWP}^{initial} \cdot K$.

The resource indication value is defined by

if $(L'_{RBs} - 1) \leq \lfloor N_{BWP}^{initial} / 2 \rfloor$ then

$$RIV = N_{BWP}^{initial} (L'_{RBs} - 1) + RB'_{start}$$

else

$$RIV = N_{BWP}^{initial} (N_{BWP}^{initial} - L'_{RBs} + 1) + (N_{BWP}^{initial} - 1 - RB'_{start})$$

where $L'_{RBs} = L_{RBs} / K$, $RB'_{start} = RB_{start} / K$ and where L'_{RBs} shall not exceed $N_{BWP}^{initial} - RB'_{start}$.

If $N_{BWP}^{active} > N_{BWP}^{initial}$, K is the maximum value from set $\{1, 2, 4, 8\}$ which satisfies $K \leq \lfloor N_{BWP}^{active} / N_{BWP}^{initial} \rfloor$; otherwise $K = 1$.

When the scheduling grant is received with DCI format 0_2, an uplink type 1 resource allocation field consists of a resource indication value (RIV) corresponding to a starting resource block group $RBG_{start} = 0, 1, \dots, N_{RBG} - 1$ and a length in terms of virtually contiguously allocated resource block groups $L_{RBGs} = 1, \dots, N_{RBG}$, where the resource block groups are defined as in 6.1.2.2.1 with P defined by *resourceAllocationType1GranularityDCI-0-2* if the UE is configured with higher layer parameter *resourceAllocationType1GranularityDCI-0-2*, and $P=1$ otherwise. The resource indication value is defined by

if $(L_{RBGs} - 1) \leq \lfloor N_{RBG} / 2 \rfloor$ then

$$RIV = N_{RBG} (L_{RBGs} - 1) + RBG_{start}$$

else

$$RIV = N_{RBG} (N_{RBG} - L_{RBGs} + 1) + (N_{RBG} - 1 - RBG_{start})$$

where $L_{RBGs} \geq 1$ and shall not exceed $N_{RBG} - RBG_{start}$.

[TS 38.214, clause 6.1.4.1]

For a PUSCH scheduled by RAR UL grant or

for a PUSCH scheduled by a fallbackRAR UL grant or

for a MsgA PUSCH transmission, or

for a PUSCH scheduled by a DCI format 0_0 with CRC scrambled by C-RNTI, MCS-C-RNTI, TC-RNTI, CS-RNTI, or

for a PUSCH scheduled by a DCI format 0_1 or DCI format 0_2 with CRC scrambled by C-RNTI, MCS-C-RNTI, CS-RNTI, SP-CSI-RNTI, or

for a PUSCH with configured grant using CS-RNTI, and

if transform precoding is disabled for this PUSCH transmission according to Clause 6.1.3

- if *mcs-TableDCI-0-2* in *pusch-Config* is set to 'qam256', and PUSCH is scheduled by a PDCCH with DCI format 0_2 with CRC scrambled by C-RNTI or SP-CSI-RNTI,

- the UE shall use I_{MCS} and Table 5.1.3.1-2 to determine the modulation order (Q_m) and Target code rate (R) used in the physical uplink shared channel;
- elseif the UE is not configured with MCS-C-RNTI, $mcs\text{-}TableDCI\text{-}0\text{-}2$ in $pusch\text{-}Config$ is set to 'qam64LowSE', and the PUSCH is scheduled by a PDCCH by a PDCCH with DCI format 0_2 with CRC scrambled by C-RNTI or SP-CSI-RNTI,
- the UE shall use I_{MCS} and Table 5.1.3.1-3 to determine the modulation order (Q_m) and Target code rate (R) used in the physical uplink shared channel.

[TS 38.214, clause 5.1.3.1]

Table 5.1.3.1-3: MCS index table 3 for PDSCH

MCS Index I_{MCS}	Modulation Order Q_m	Target code Rate $R \times [1024]$	Spectral efficiency
0	2	30	0.0586
1	2	40	0.0781
2	2	50	0.0977
3	2	64	0.1250
4	2	78	0.1523
5	2	99	0.1934
6	2	120	0.2344
7	2	157	0.3066
8	2	193	0.3770
9	2	251	0.4902
10	2	308	0.6016
11	2	379	0.7402
12	2	449	0.8770
13	2	526	1.0273
14	2	602	1.1758
15	4	340	1.3281
16	4	378	1.4766
17	4	434	1.6953
18	4	490	1.9141
19	4	553	2.1602
20	4	616	2.4063
21	6	438	2.5664
22	6	466	2.7305
23	6	517	3.0293
24	6	567	3.3223
25	6	616	3.6094
26	6	666	3.9023
27	6	719	4.2129
28	6	772	4.5234
29	2	reserved	
30	4	reserved	
31	6	reserved	

[TS 38.214, clause 6.1.4.2]

For a PUSCH scheduled by RAR UL grant or

for a PUSCH scheduled by fallbackRAR UL grant or

for a PUSCH scheduled by a DCI format 0_0 with CRC scrambled by C-RNTI, MCS-C-RNTI, TC-RNTI, CS-RNTI, or

for a PUSCH scheduled by a DCI format 0_1 or DCI format 0_2 with CRC scrambled by C-RNTI, MCS-C-RNTI, CS-RNTI, or

for a PUSCH transmission with configured grant, or

for a MsgA PUSCH transmission,

if

- $0 \leq I_{MCS} \leq 27$ and transform precoding is disabled and Table 5.1.3.1-2 is used, or
- $0 \leq I_{MCS} \leq 28$ and transform precoding is disabled and a table other than Table 5.1.3.1-2 is used, or
- $0 \leq I_{MCS} \leq 27$ and transform precoding is enabled, the UE shall first determine the TBS as specified below:

The UE shall first determine the number of REs (N_{RE}) within the slot:

- A UE first determines the number of REs allocated for PUSCH within a PRB (N'_{RE}) by
 - $N'_{RE} = N_{sc}^{RB} \cdot N_{symbol}^{sh} - N_{DMRS}^{PRB} - N_{oh}^{PRB}$, where $N_{sc}^{RB} = 12$ is the number of subcarriers in the frequency domain in a physical resource block, N_{symbol}^{sh} is the number of symbols L of the PUSCH allocation according to Clause 6.1.2.1 for scheduled PUSCH or Clause 6.1.2.3 for configured PUSCH, N_{DMRS}^{PRB} is the number of REs for DM-RS per PRB in the allocated duration including the overhead of the DM-RS CDM groups without data, as described for PUSCH with a configured grant in Clause 6.1.2.3 or as indicated by DCI format 0_1 or DCI format 0_2 or as described for DCI format 0_0 in Clause 6.2.2, and N_{oh}^{PRB} is the overhead configured by higher layer parameter $xOverhead$ in *PUSCH-ServingCellConfig*. If the N_{oh}^{PRB} is not configured (a value from 6, 12, or 18), the N_{oh}^{PRB} is assumed to be 0. For Msg3 or MsgA PUSCH transmission the N_{oh}^{PRB} is always set to 0. In case of PUSCH repetition Type B, N_{DMRS}^{PRB} is determined assuming a nominal repetition with the duration of L symbols without segmentation.
 - A UE determines the total number of REs allocated for PUSCH (N_{RE}) by
- $$N_{RE} = \min(156, N'_{RE}) \cdot n_{PRB}$$
- where n_{PRB} is the total number of allocated PRBs for the UE.
- Next, proceed with steps 2-4 as defined in Clause 5.1.3.2
 - For a PUSCH scheduled by fallbackRAR UL grant, UE assumes the TB size determined by the UL grant in the fallbackRAR shall be the same as the TB size used in the corresponding MsgA PUSCH transmission.

else if

- $28 \leq I_{MCS} \leq 31$ and transform precoding is disabled and Table 5.1.3.1-2 is used, or
- $28 \leq I_{MCS} \leq 31$ and transform precoding is enabled,
- the TBS is assumed to be as determined from the DCI transported in the latest PDCCH for the same transport block using $0 \leq I_{MCS} \leq 27$. If there is no PDCCH for the same transport block using $0 \leq I_{MCS} \leq 27$, and if the initial PUSCH for the same transport block is transmitted with configured grant,
 - the TBS shall be determined from *configuredGrantConfig* for a configured grant Type 1 PUSCH.
 - the TBS shall be determined from the most recent PDCCH scheduling a configured grant Type 2 PUSCH.

else

- the TBS is assumed to be as determined from the DCI transported in the latest PDCCH for the same transport block using $0 \leq I_{MCS} \leq 28$. If there is no PDCCH for the same transport block using $0 \leq I_{MCS} \leq 28$, and if the initial PUSCH for the same transport block is transmitted with configured grant,
 - the TBS shall be determined from *configuredGrantConfig* for a configured grant Type 1 PUSCH.
 - the TBS shall be determined from the most recent PDCCH scheduling a configured grant Type 2 PUSCH.

[TS 38.214, clause 5.1.3.2]

- 2) Unquantized intermediate variable (N_{info}) is obtained by $N_{info} = N_{RE} \cdot R \cdot Q_m \cdot v$.

If $N_{info} \leq 3824$

Use step 3 as the next step of the TBS determination

else

Use step 4 as the next step of the TBS determination

end if

3) When $N_{info} \leq 3824$, TBS is determined as follows

- quantized intermediate number of information bits $N'_{info} = \max\left(24, 2^n \cdot \left\lfloor \frac{N_{info}}{2^n} \right\rfloor\right)$, where
 $n = \max(3, \lfloor \log_2(N_{info}) \rfloor - 6)$.
- use Table 5.1.3.2-1 find the closest TBS that is not less than N'_{info} .

Table 5.1.3.2-1: TBS for $N_{info} \leq 3824$

Index	TBS	Index	TBS	Index	TBS	Index	TBS
1	24	31	336	61	1288	91	3624
2	32	32	352	62	1320	92	3752
3	40	33	368	63	1352	93	3824
4	48	34	384	64	1416		
5	56	35	408	65	1480		
6	64	36	432	66	1544		
7	72	37	456	67	1608		
8	80	38	480	68	1672		
9	88	39	504	69	1736		
10	96	40	528	70	1800		
11	104	41	552	71	1864		
12	112	42	576	72	1928		
13	120	43	608	73	2024		
14	128	44	640	74	2088		
15	136	45	672	75	2152		
16	144	46	704	76	2216		
17	152	47	736	77	2280		
18	160	48	768	78	2408		
19	168	49	808	79	2472		
20	176	50	848	80	2536		
21	184	51	888	81	2600		
22	192	52	928	82	2664		
23	208	53	984	83	2728		
24	224	54	1032	84	2792		
25	240	55	1064	85	2856		
26	256	56	1128	86	2976		
27	272	57	1160	87	3104		
28	288	58	1192	88	3240		
29	304	59	1224	89	3368		
30	320	60	1256	90	3496		

4) When $N_{info} > 3824$, TBS is determined as follows.

- quantized intermediate number of information bits $N'_{info} = \max\left(3840, 2^n \times \text{round}\left(\frac{N_{info} - 24}{2^n}\right)\right)$, where
 $n = \lfloor \log_2(N_{info} - 24) \rfloor - 5$ and ties in the round function are broken towards the next largest integer.
- if $R \leq 1/4$

$$TBS = 8 \cdot C \cdot \left\lceil \frac{N'_{info} + 24}{8 \cdot C} \right\rceil - 24, \text{ where } C = \left\lceil \frac{N'_{info} + 24}{3816} \right\rceil$$

else

if $N'_{info} > 8424$

$$TBS = 8 \cdot C \cdot \left\lceil \frac{N'_{info} + 24}{8 \cdot C} \right\rceil - 24, \text{ where } C = \left\lceil \frac{N'_{info} + 24}{8424} \right\rceil$$

else

$$TBS = 8 \cdot \left\lceil \frac{N'_{info} + 24}{8} \right\rceil - 24$$

end if

end if

7.1.1.4.2.6.3 Test description

7.1.1.4.2.6.3.1 Pre-test conditions

Same Pre-test conditions as in clause 7.1.1.0 except set the NR Cell bandwidth and applicable BWP to maximum for the NR Band under test as specified in Table 5.3.5-1 in TS 38.101-1 [16] / TS 38.101-2 [17] (to enable testing of n_{PRB} up to maximum value) and Short_DCI condition is applied in NR Serving cell configuration.

Test frequency NRf1 is as specified in TS 38.508-1 [4] clause 4.3.1 using the common highest UL and DL channel bandwidth and using the default subcarrier spacing specified in TS 38.508-1 [4] clause 6.2.3.1.

7.1.1.4.2.6.3.2 Test procedure sequence

Table 7.1.1.4.2.6.3.2-1: Maximum TBS for different UE categories

UE Category	Maximum number of bits of a UL-SCH transport block received within a TTI
TS 38.306 [23] clause 4.1.2 require UE without <i>ue-CategoryDL</i> and <i>ue-CategoryUL</i> , to support Max TBS achievable based on max bandwidth of the Band under test.	

Table 7.1.1.4.2.6.3.2-2: Number of uplink PDCP SDUs and PDCP SDU size used as test data

TBS [bits]	Number of PDCP SDUs	PDCP SDU size [bits] (Note 1)
$136 \leq TBS \leq 12128$ note 2	1	$8 \cdot \text{FLOOR}((TBS - 128)/8)$
$12129 \leq TBS \leq 24200$	2	$8 \cdot \text{FLOOR}((TBS - 200)/16)$
$24201 \leq TBS \leq 36272$	3	$8 \cdot \text{FLOOR}((TBS - 272)/24)$
$36273 \leq TBS \leq 48344$	4	$8 \cdot \text{FLOOR}((TBS - 344)/32)$
$48345 \leq TBS \leq 60416$	5	$8 \cdot \text{FLOOR}((TBS - 416)/40)$
$60417 \leq TBS \leq 72488$	6	$8 \cdot \text{FLOOR}((TBS - 488)/48)$
$72489 \leq TBS \leq 84560$	7	$8 \cdot \text{FLOOR}((TBS - 560)/56)$
$84561 \leq TBS \leq 96632$	8	$8 \cdot \text{FLOOR}((TBS - 632)/64)$
$96633 < TBS \leq 108704$	9	$8 \cdot \text{FLOOR}((TBS - 704)/72)$
$10705 \leq TBS \leq 120776$	10	$8 \cdot \text{FLOOR}((TBS - 776)/80)$
$120777 \leq TBS \leq 132848$	11	$8 \cdot \text{FLOOR}((TBS - 848)/88)$
$132849 \leq TBS \leq 144920$	12	$8 \cdot \text{FLOOR}((TBS - 920)/96)$
$TBS > 144920$	13	$8 \cdot \text{FLOOR}((TBS - 992)/104)$
Note 1: Each PDCP SDU is limited to 1500 octets (to keep below maximum SDU size of ESM as specified in TS 24.301 [21] clause 9.9.4.12).		

The PDCP SDU size of each PDCP SDU is

PDCP SDU size = (TBS – N*PDCP header size – N*AMD PDU header size - N*MAC header size – Size of Timing Advance – RLC Status PDU size- MAC header for RLC Status PDU) / N, where

PDCP header size is 24 bits for the RLC AM and 18-bit SN case;
AMD PDU header size is 24 bits with 18 bit SN;

MAC header size for AMD PDU = 16 or 24 bits depending on L=8 or 16 bits. Worst case 24 is taken.

Size of Timing Advance MAC CE with header is 16 bits (if no Timing Advance and/or RLC status needs to be sent, padding will occur instead).

RLC Status PDU size = 24 bits with 1 ACK_SN, With a MAC header of 16 bits.

This gives:

PDCP SDU size = $8 * \text{FLOOR}((\text{TBS} - N * 24 - N * 24 - N * 24 - 56) / (8 * N))$ bits.

Note 2: According to the final PDCP SDU size formula in Note 1, the smallest TBS that can be tested is 136 bits.

Table 7.1.1.4.2.6.3.2-2A: Void

Table 7.1.1.4.2.6.3.2-3: Specific Parameter

Parameter	Value	Comment	Condition
<i>mcs-TableDCI-0-2-r16</i>	Not Present	qam64 per default	
<i>rbg-Size</i>	Not present	configuration 1 applicable	
$N_{\text{BWP}}^{\text{start}}$	0		

Table 7.1.1.4.2.6.3.2-4: Main behaviour

St	Procedure	Message Sequence		TP	Verdict
		U - S	Message		
-	EXCEPTION: Steps 1 to 5 are repeated for allowed values of N_{PRB} 1 to $N_{RB}^{UL,BWP}$ in BWP, time domain resource as per Table 7.1.1.4.2.0-1 and I_{MCS} from 0 to 28. Skip the execution of steps for $I_{MCS} = 28$ and $N_{PRB} < 4$. (Note 1)	-	-	-	-
1	The SS calculates or looks up TBS in TS 38.214 [15] based on the value of S, L, I_{MCS} and n_{PRB} .	-	-	-	-
-	EXCEPTION: Steps 2 to 5 are performed if TBS is less than or equal to UE capability "Maximum number of UL-SCH transport block bits received within a TTI" as specified in Table 7.1.1.4.2.6.3.2-1 and larger than or equal to 136 bits as specified in Table 7.1.1.4.2.6.3.2-2. Skip the execution of steps 2 to 5 for which the TBS size equal to 3824 or 3840. (Note 2)	-	-	-	-
2	The SS creates one or more PDCP SDUs, depending on TBS, in accordance with Table 7.1.1.4.2.6.3.2-2.	-	-	-	-
3	After 300ms, the SS transmits all PDCP SDUs (N_{SDUs}) as created in step 2 in a MAC PDU.	<--	MAC PDU (N x PDCP SDUs)	-	-
4	After 60ms of step 3, SS transmits UL Grant DCI 0_2, and values of S, L, I_{MCS} and n_{PRB} .	<--	(UL Grant) (DCI Format 0_2, S, L, I_{MCS} and n_{PRB})	-	-
5	CHECK: Does UE return the same number of PDCP SDUs with same content as transmitted by the SS in step 3 using Time, frequency Resources and modulation and coding scheme as configured by the SS in step 4?	-->	MAC PDU (N x PDCP SDU)	1	P
<p>Note 1: For $I_{MCS} = 28$ and $N_{PRB} < 4$, the resulting TBS is very small leading to CRC errors in decoding UL data.</p> <p>Note 2: There is ambiguity of TBS calculation when $3824.0 < N_{info} < 3825.0$ in clause 5.1.3.2 of TS 38.214 [15].</p>					

7.1.1.4.2.6.3.3 Specific message contents

Table 7.1.1.4.2.6.3.3-1: PUSCH-Config

Derivation Path: TS 38.508-1 [4], table 4.6.3-118			
Information Element	Value/remark	Comment	Condition
PUSCH-Config ::= SEQUENCE {			
dmrs-UplinkForPUSCH-MappingTypeA-DCI-0-2-r16CHOICE {			
setup	DMRS-UplinkConfig		
}			

dmrs-UplinkForPUSCH-MappingTypeB-DCI-0-2-r16CHOICE {			
setup	DMRS-UplinkConfig		
}			
harq-ProcessNumberSizeDCI-0-2-r16	4	nrofHARQ-ProcessesForPUSCH is 16	
numberOfBitsForRV-DCI-0-2-r16	2		
resourceAllocationDCI-0-2-r16	resourceAllocationType1		
}			

7.1.1.5 Discontinuous reception

7.1.1.5.0 DRX Common Definitions

FirstSlot is the First DL Slot in the subframe, which is 0 for both FDD and TDD as per default configuration in 38.5081-1[4] TDD-UL-DL-Config Table 4.6.3-192

LastDLSlot is the Last DL Slot in a frame; for FDD numerology =0 it is slot 9, numerology=1 it is slot 19, numerology=2 it is slot 39. For TDD as per default configuration in 38.5081-1[4] TDD-UL-DL-Config Table 4.6.3-192, for numerology =0, it is slot 7, numerology=1 it is slot 16, numerology=3 it is slot 77

LastULSlot is the Last UL Slot in a frame; for FDD/TDD numerology =0 it is slot 9, numerology=1 it is slot 18(Second Last as 2 Consecutive UL Slots), numerology=3 it is slot 79; the PDCCH for UL grant is sent K2= 4 Slot earlier.

7.1.1.5.1 DRX operation / Short cycle not configured / Parameters configured by RRC

(1)

```
with { UE in RRC_CONNECTED state }
ensure that {
  when { Long DRX cycle is configured and [(SFN * 10) + subframe number] modulo (drx-LongCycle) =
drx-StartOffset }
  then { UE starts the OnDurationTimer and monitors the PDCCH for OnDurationTimer PDCCH-Occasions }
}
```

(2)

```
with { UE in RRC_CONNECTED state }
ensure that {
  when { Long DRX cycle is configured and a new DL transmission is indicated on the PDCCH during
Active Time }
  then { UE starts or restarts the Drx-InactivityTimer and monitors the PDCCH for Drx-
InactivityTimer PDCCH occasions starting from the next PDCCH occasion of the PDCCH occasion where
the DL new transmission was indicated }
}
```

(3)

```
with { UE in RRC_CONNECTED state }
ensure that {
  when { Long DRX cycle is configured and if a HARQ RTT Timer expires in this PDCCH Occasion and the
data in the soft buffer of the corresponding HARQ process was not successfully decoded }
  then { UE starts the drx-RetransmissionTimer-DL for the corresponding HARQ process and monitors
the PDCCH for drx-RetransmissionTimer consecutive PDCCH Occasion }
}
```

(4)

```
with { UE in RRC_CONNECTED state }
ensure that {
  when { Long DRX cycle is configured and an uplink grant for a pending HARQ retransmission can
occur in this PDCCH occasion }
  then { UE monitors the PDCCH in this PDCCH occasion }
}
```

7.1.1.5.1.2 Conformance requirements

References: The conformance requirements covered in the present TC are specified in: TS 38.321, clause 5.7. Unless otherwise stated these are Rel-15 requirements.

[TS 38.321, clause 5.7]

The MAC entity may be configured by RRC with a DRX functionality that controls the UE's PDCCH monitoring activity for the MAC entity's C-RNTI, CS-RNTI, INT-RNTI, SFI-RNTI, SP-CSI-RNTI, TPC-PUCCH-RNTI, TPC-PUSCH-RNTI, and TPC-SRS-RNTI. When using DRX operation, the MAC entity shall also monitor PDCCH according to requirements found in other subclauses of this specification. When in RRC_CONNECTED, if DRX is configured, the MAC entity may monitor the PDCCH discontinuously using the DRX operation specified in this subclause; otherwise the MAC entity shall monitor the PDCCH continuously.

RRC controls DRX operation by configuring the following timers:

- *drx-onDurationTimer*: the duration at the beginning of a DRX Cycle;
- *drx-SlotOffset*: the delay before starting the *drx-onDurationTimer*;
- *drx-InactivityTimer*: the duration after the PDCCH occasion in which a PDCCH indicates a new UL or DL transmission for the MAC entity;
- *drx-RetransmissionTimerDL* (per DL HARQ process): the maximum duration until a DL retransmission is received;
- *drx-RetransmissionTimerUL* (per UL HARQ process): the maximum duration until a grant for UL retransmission is received;
- *drx-LongCycle StartOffset*: the Long DRX cycle and *drx-StartOffset* which defines the subframe where the Long and Short DRX Cycle starts;
- *drx-ShortCycle* (optional): the Short DRX cycle;
- *drx-ShortCycleTimer* (optional): the duration the UE shall follow the Short DRX cycle;
- *drx-HARQ-RTT-TimerDL* (per DL HARQ process): the minimum duration before a DL assignment for HARQ retransmission is expected by the MAC entity;
- *drx-HARQ-RTT-TimerUL* (per UL HARQ process): the minimum duration before a UL HARQ retransmission grant is expected by the MAC entity.

When a DRX cycle is configured, the Active Time includes the time while:

- *drx-onDurationTimer* or *drx-InactivityTimer* or *drx-RetransmissionTimerDL* or *drx-RetransmissionTimerUL* or *ra-ContentionResolutionTimer* (as described in subclause 5.1.5) is running; or
- a Scheduling Request is sent on PUCCH and is pending (as described in subclause 5.4.4); or
- a PDCCH indicating a new transmission addressed to the C-RNTI of the MAC entity has not been received after successful reception of a Random Access Response for the random access preamble not selected by the MAC entity among the contention-based Random Access Preamble (as described in subclause 5.1.4).

When DRX is configured, the MAC entity shall:

- 1> if a MAC PDU is received in a configured downlink assignment:
 - 2> start the *drx-HARQ-RTT-TimerDL* for the corresponding HARQ process in the first symbol after the end of the corresponding transmission carrying the DL HARQ feedback;
 - 2> stop the *drx-RetransmissionTimerDL* for the corresponding HARQ process.
- 1> if a MAC PDU is transmitted in a configured uplink grant:
 - 2> start the *drx-HARQ-RTT-TimerUL* for the corresponding HARQ process in the first symbol after the end of the first repetition of the corresponding PUSCH transmission;

- 2> stop the *drx-RetransmissionTimerUL* for the corresponding HARQ process.
- 1> if a *drx-HARQ-RTT-TimerDL* expires:
 - 2> if the data of the corresponding HARQ process was not successfully decoded:
 - 3> start the *drx-RetransmissionTimerDL* for the corresponding HARQ process.
- 1> if an *drx-HARQ-RTT-TimerUL* expires:
 - 2> start the *drx-RetransmissionTimerUL* for the corresponding HARQ process.
- 1> if a DRX Command MAC CE or a Long DRX Command MAC CE is received:
 - 2> stop *drx-onDurationTimer*;
 - 2> stop *drx-InactivityTimer*.
- 1> if *drx-InactivityTimer* expires or a DRX Command MAC CE is received:
 - 2> if the Short DRX cycle is configured:
 - 3> start or restart *drx-ShortCycleTimer* in the first symbol after the expiry of *drx-HARQ-RTT-TimerDL*;
 - 3> use the Short DRX Cycle.
 - 2> else:
 - 3> use the Long DRX cycle.
- 1> if *drx-ShortCycleTimer* expires:
 - 2> use the Long DRX cycle.
- 1> if a Long DRX Command MAC CE is received:
 - 2> stop *drx-ShortCycleTimer*;
 - 2> use the Long DRX cycle.
- 1> if the Short DRX Cycle is used, and $[(\text{SFN} \times 10) + \text{subframe number}] \bmod (\text{drx-ShortCycle}) = (\text{drx-StartOffset}) \bmod (\text{drx-ShortCycle})$; or
- 1> if the Long DRX Cycle is used, and $[(\text{SFN} \times 10) + \text{subframe number}] \bmod (\text{drx-LongCycle}) = \text{drx-StartOffset}$:
 - 2> if *drx-SlotOffset* is configured:
 - 3> start *drx-onDurationTimer* after *drx-SlotOffset* from the beginning of the subframe.
 - 2> else:
 - 3> start *drx-onDurationTimer*.
- 1> if the MAC entity is in Active Time:
 - 2> monitor the PDCCH;
 - 2> if the PDCCH indicates a DL transmission or if a DL assignment has been configured:
 - 3> start the *drx-HARQ-RTT-TimerDL* for the corresponding HARQ process immediately after the corresponding PUCCH transmission;
 - 3> stop the *drx-RetransmissionTimerDL* for the corresponding HARQ process.
 - 2> if the PDCCH indicates a UL transmission or if a UL grant has been configured:
 - 3> start the *drx-HARQ-RTT-TimerUL* for the corresponding HARQ process immediately after the first repetition of the corresponding PUSCH transmission;

- 3> stop the *drx-RetransmissionTimerUL* for the corresponding HARQ process.
- 2> if the PDCCH indicates a new transmission (DL or UL):
- 3> start or restart *drx-InactivityTimer*.
- 1> else (i.e. not part of the Active Time):
- 2> not report CQI/PMI/RI on PUCCH.

7.1.1.5.1.3 Test description

7.1.1.5.1.3.1 Pre-test conditions

Same Pre-test conditions as in clause 7.1.1.0 except that set to return no data in uplink.

7.1.1.5.1.3.2 Test procedure sequence

Table 7.1.1.5.1.3.2-1: Main behaviour

St	Procedure	Message Sequence		TP	Verdict
		U - S	Message		
1	SS transmits RRCReconfiguration to configure specific DRX parameters. (Note 6)	<--	-	-	-
2	The UE transmits RRCReconfigurationComplete. (Note 7)	-->	-	-	-
3	In the first PDCCH occasion when the <i>Drx-onDurationTimer</i> is running, the SS indicates the transmission of a DL MAC PDU on the PDCCH.	<--	MAC PDU	-	-
4	Check: Does the UE transmit a HARQ ACK for the DL MAC PDU in Step 3?	-->	HARQ ACK	1	P
5	At least <i>drx-InactivityTimer</i> PDCCH occasions after the transmission of the MAC PDU in Step 3 has been indicated (This means the next DRX cycle or later after Step 2) in the last PDCCH occasion while the <i>drx-onDurationTimer</i> is still running, the SS indicates the transmission a DL MAC PDU on the PDCCH. (Note 4).	<--	MAC PDU	-	-
6	Check: Does the UE transmit a HARQ ACK for the DL MAC PDU in Step 5?	-->	HARQ ACK	1	P
7	<i>drx-InactivityTimer</i> PDCCH-occasions after the transmission of the MAC PDU transmitted in step 5 was indicated on the PDCCH, the SS indicates the transmission of a DL MAC PDU on the PDCCH. (Note 4)	<--	MAC PDU	-	-
8	Check: Does the UE transmit a HARQ ACK for the DL MAC PDU in Step 7?	-->	HARQ ACK	2	P
9	At least <i>drx-InactivityTimer</i> PDCCH occasions after the transmission of the MAC PDU in Step 7 has been indicated (This means the next DRX cycle or later after Step 5) and in the last PDCCH occasion before the <i>Drx-onDurationTimer</i> expires, the SS indicates the transmission of a DL MAC PDU on the PDCCH. The DL MAC PDU transmitted is invalid. (Note 1, Note 4)	<--	Invalid MAC PDU	-	-
10	Check: Does the UE transmit a HARQ NACK for the DL MAC PDU in Step 9?	-->	HARQ NACK	1	P
11	In the first PDCCH occasion when the <i>Drx-RetransmissionTimerDL</i> for the MAC PDU in Step 9 is started (i.e. after expiry of <i>drx-HARQ-RTT-TimerDL</i> after step 9), the SS indicates the transmission of a DL MAC PDU on the PDCCH.	<--	MAC PDU	-	-

12	Check: Does the UE transmit a HARQ ACK for the DL MAC PDU in Step 11?	-->	HARQ ACK	3	P
13	At least drx-InactivityTimer PDCCH occasions after the transmission of the DL MAC PDU in Step 11 has been indicated (This means the next DRX cycle or later after Step 11) and last PDCCH occasion before the <i>Drx-onDurationTimer</i> expires, the SS indicates the transmission of DL MAC PDU on the PDCCH. The DL MAC PDU transmitted is invalid. (Note 1, Note 4)	<--	Invalid MAC PDU	-	-
14	Check: Does the UE transmit a HARQ NACK for the DL MAC PDU in Step 13?	-->	HARQ NACK	1	P
15	In the last PDCCH occasion when the drx-RetransmissionTimerDL for MAC PDU in Step 13 is still running, the SS indicates the transmission of a DL MAC PDU on the PDCCH.	<--	MAC PDU	-	-
16	Check: Does the UE transmit a HARQ ACK for the DL MAC PDU in Step 15?	-->	HARQ ACK	3	P
17	The SS is configured for Uplink Grant Allocation Type [0]. At least drx-InactivityTimer PDCCH subframes after the transmission of the DL MAC PDU in Step 15 has been indicated in the last PDCCH occasion when the onDurationTimer is still running (This means the next DRX cycle or later after Step 9), the SS indicates an UL grant to the UE on the PDCCH. (Note 4)	<--	UL grant on PDCCH	-	-
18	Check: Does the UE transmit a Buffer Status Report on the UL indicating an empty buffer?	-->	Buffer Status Report MAC control element	1	P
19	In the last PDCCH occasion when the drx-RetransmissionTimer-UL for MAC PDU from Step 17 is still running, the SS indicates the transmission of a DL MAC PDU on the PDCCH.	<--	MAC PDU	-	-
20	Check: Does the UE transmit a HARQ ACK for the DL MAC PDU in Step 19?	-->	HARQ ACK	4	P
<p>Note 1: Invalid MAC PDU is a MAC PDU that fails the CRC check.</p> <p>Note 2: All the DL MAC PDU are transmitted with the NDI set on the PDCCH.</p> <p>Note 3: Timer tolerances for the MAC DRX related timers measured in PDCCH occasions is 0. These timers are: drx-InactivityTimer, drx-RetransmissionTimerDL, drx-RetransmissionTimerUL, drx-HARQ-RTT-TimerDL and drx-HARQ-RTT-TimerUL.</p> <p>Note 4: The drx-InactivityTimer is started in the next PDCCH occasion of the PDCCH occasion where DL new transmission is indicated.</p> <p>Note 5: The timer values expressed in number of slots.</p> <p>Note 6: For EN-DC the NR RRCReconfiguration message is contained in RRCConnectionReconfiguration 36.508 [7], Table 4.6.1-8 using condition EN-DC_EmbedNR_RRCRecon.</p> <p>Note 7: For EN-DC the NR <i>RRCReconfigurationComplete</i> message is contained in <i>RRCConnectionReconfigurationComplete</i>.</p>					

7.1.1.5.1.3.3 Specific message contents

Table 7.1.1.5.1.3.3-1: RRCReconfiguration (step 1, Table 7.1.1.5.1.3.2-1)

Derivation Path: 38.508-1 [4], Table 4.6.1-13			
Information Element	Value/remark	Comment	Condition
RRCReconfiguration ::= SEQUENCE {			
criticalExtensions CHOICE {			
rrcReconfiguration ::= SEQUENCE {			
radioBearerConfig	RadioBearerConfig		NR
secondaryCellGroup	CellGroupConfig		EN-DC
}			
nonCriticalExtension ::= SEQUENCE {			
masterCellGroup	CellGroupConfig		NR
}			

}			
}			

Table 7.1.1.5.1.3.3-2: CellGroupConfig (Table 7.1.1.5.1.3.3-1)

Derivation Path: 38.508-1 [4], Table 4.6.3-19			
Information Element	Value/remark	Comment	Condition
cellGroupConfig ::= SEQUENCE {			
mac-CellGroupConfig SEQUENCE {			
drx-Config CHOICE {			
setup SEQUENCE {			
drx-onDurationTimer	ms20		
drx-InactivityTimer	ms10		
drx-HARQ-RTT-TimerDL	56	Number of slots=4 due to number of symbol per slot=14	$\mu = 0,1,2,3,4$ (2 with normal CP)
	48	Number of slots=4 due to number of symbol per slot=12	$\mu = 2$ with external CP
drx-HARQ-RTT-TimerUL	56	Number of slots=4 due to number of symbol per slot=14	$\mu = 0,1,2,3,4$ (2 with normal CP)
	48	Number of slots=4 due to number of symbol per slot=12	$\mu = 2$ with external CP
drx-RetransmissionTimerDL	s18		
drx-RetransmissionTimerUL	s18		
drx-LongCycleStartOffset CHOICE {			
ms640	7		
}			
shortDRX	Not present		
drx-SlotOffset	ms0		
}			
}			
}			

7.1.1.5.2 DRX operation / Short cycle not configured / Long DRX command MAC control element reception

7.1.1.5.2.1 Test Purpose (TP)

(1)

```
with { UE in CONNECTED mode }
ensure that {
  when { long DRX cycle is configured and a DRX Command MAC control element is received }
  then { UE successfully decodes the MAC control PDU }
}
```

(2)

```
with { UE in CONNECTED mode }
ensure that {
  when { long DRX cycle is configured and the HARQ RTT Timer is running and a DRX Command MAC control element is received }
  then { UE continues running the HARQ RTT timer }
}
```

(3)

```

with { UE in CONNECTED mode }
ensure that {
  when { long DRX cycle is configured and the drx-RetransmissionTimer is running and a DRX Command
  MAC control element is received }
  then { UE continues running the drx-RetransmissionTimer and monitors the PDCCH }
}

```

7.1.1.5.2.2 Conformance requirements

References: The conformance requirements covered in the present TC are specified in: TS 38.321, clause 5.7. Unless otherwise stated these are Rel-15 requirements.

[TS 38.321, clause 5.7]

The MAC entity may be configured by RRC with a DRX functionality that controls the UE's PDCCH monitoring. Activity for the MAC entity's C-RNTI, CS-RNTI, INT-RNTI, SFI-RNTI, SP-CSI-RNTI, TPC-PUCCH-RNTI, TPC-PUSCH-RNTI, and TPC-SRS-RNTI. When using DRX operation, the MAC entity shall also monitor PDCCH according to requirements found in other subclauses of this specification. When in RRC_CONNECTED, if DRX is configured, the MAC entity may monitor the PDCCH discontinuously using the DRX operation specified in this subclause; otherwise the MAC entity shall monitor the PDCCH continuously.

RRC controls DRX operation by configuring the following timers:

- *drx-onDurationTimer*: the duration at the beginning of a DRX Cycle;
- *drx-SlotOffset*: the delay before starting the *drx-onDurationTimer*;
- *drx-InactivityTimer*: the duration after the PDCCH occasion in which a PDCCH indicates a new UL or DL transmission for the MAC entity;
- *drx-RetransmissionTimerDL* (per DL HARQ process): the maximum duration until a DL retransmission is received;
- *drx-RetransmissionTimerUL* (per UL HARQ process): the maximum duration until a grant for UL retransmission is received;
- *drx-LongCycle StartOffset*: the Long DRX cycle and *drx-StartOffset* which defines the subframe where the Long and Short DRX Cycle starts;
- *drx-ShortCycle* (optional): the Short DRX cycle;
- *drx-ShortCycleTimer* (optional): the duration the UE shall follow the Short DRX cycle;
- *drx-HARQ-RTT-TimerDL* (per DL HARQ process): the minimum duration before a DL assignment for HARQ retransmission is expected by the MAC entity;
- *drx-HARQ-RTT-TimerUL* (per UL HARQ process): the minimum duration before a UL HARQ retransmission grant is expected by the MAC entity.

When a DRX cycle is configured, the Active Time includes the time while:

- *drx-onDurationTimer* or *drx-InactivityTimer* or *drx-RetransmissionTimerDL* or *drx-RetransmissionTimerUL* or *ra-ContentionResolutionTimer* (as described in subclause 5.1.5) is running; or
- a Scheduling Request is sent on PUCCH and is pending (as described in subclause 5.4.4); or
- a PDCCH indicating a new transmission addressed to the C-RNTI of the MAC entity has not been received after successful reception of a Random Access Response for the random access preamble not selected by the MAC entity among the contention-based Random Access Preamble (as described in subclause 5.1.4).

When DRX is configured, the MAC entity shall:

- 1> if a MAC PDU is received in a configured downlink assignment:

- 2> start the *drx-HARQ-RTT-TimerDL* for the corresponding HARQ process in the first symbol after the end of the corresponding transmission carrying the DL HARQ feedback;
- 2> stop the *drx-RetransmissionTimerDL* for the corresponding HARQ process.
- 1> if a MAC PDU is transmitted in a configured uplink grant:
 - 2> start the *drx-HARQ-RTT-TimerUL* for the corresponding HARQ process in the first symbol after the end of the first repetition of the corresponding PUSCH transmission;
 - 2> stop the *drx-RetransmissionTimerUL* for the corresponding HARQ process.
- 1> if a *drx-HARQ-RTT-TimerDL* expires:
 - 2> if the data of the corresponding HARQ process was not successfully decoded:
 - 3> start the *drx-RetransmissionTimerDL* for the corresponding HARQ process.
- 1> if an *drx-HARQ-RTT-TimerUL* expires:
 - 2> start the *drx-RetransmissionTimerUL* for the corresponding HARQ process.
- 1> if a DRX Command MAC CE or a Long DRX Command MAC CE is received:
 - 2> stop *drx-onDurationTimer*;
 - 2> stop *drx-InactivityTimer*.
- 1> if *drx-InactivityTimer* expires or a DRX Command MAC CE is received:
 - 2> if the Short DRX cycle is configured:
 - 3> start or restart *drx-ShortCycleTimer* in the first symbol after the expiry of *drx-HARQ-RTT-TimerDL*;
 - 3> use the Short DRX Cycle.
 - 2> else:
 - 3> use the Long DRX cycle.
- 1> if *drx-ShortCycleTimer* expires:
 - 2> use the Long DRX cycle.
- 1> if a Long DRX Command MAC CE is received:
 - 2> stop *drx-ShortCycleTimer*;
 - 2> use the Long DRX cycle.
- 1> if the Short DRX Cycle is used, and $[(\text{SFN} \times 10) + \text{subframe number}] \bmod (\text{drx-ShortCycle}) = (\text{drx-StartOffset}) \bmod (\text{drx-ShortCycle})$; or
- 1> if the Long DRX Cycle is used, and $[(\text{SFN} \times 10) + \text{subframe number}] \bmod (\text{drx-LongCycle}) = \text{drx-StartOffset}$:
 - 2> if *drx-SlotOffset* is configured:
 - 3> start *drx-onDurationTimer* after *drx-SlotOffset* from the beginning of the subframe.
 - 2> else:
 - 3> start *drx-onDurationTimer*.
- 1> if the MAC entity is in Active Time:
 - 2> monitor the PDCCH;
 - 2> if the PDCCH indicates a DL transmission or if a DL assignment has been configured:

- 3> start the *drx-HARQ-RTT-TimerDL* for the corresponding HARQ process immediately after the corresponding PUCCH transmission;
- 3> stop the *drx-RetransmissionTimerDL* for the corresponding HARQ process.
- 2> if the PDCCH indicates a UL transmission or if a UL grant has been configured:
 - 3> start the *drx-HARQ-RTT-TimerUL* for the corresponding HARQ process immediately after the first repetition of the corresponding PUSCH transmission;
 - 3> stop the *drx-RetransmissionTimerUL* for the corresponding HARQ process.
- 2> if the PDCCH indicates a new transmission (DL or UL):
 - 3> start or restart *drx-InactivityTimer*.
- 1> else (i.e. not part of the Active Time):
 - 2> not report CQI/PMI/RI on PUCCH.

7.1.1.5.2.3 Test description

7.1.1.5.2.3.1 Pre-test conditions

Same Pre-test conditions as in clause 7.1.1.0 except that set to return no data in uplink.

7.1.1.5.2.3.2 Test procedure sequence

For FDD, *NormalSLT*(current SFN,current sub-frame, current slot,y)=y; For TDD, *NormalSLT*(current SFN, current slot,y) counts the minimum number of normal slots needed to cover y number of PDCCH-occasions(slots) until next PDCCH-occasion(slot) available, starting from current slot on current SFN.

Table 7.1.1.5.2.3.2-1: Main behaviour

St	Procedure	Message Sequence		TP	Verdict
		U - S	Message		
1	SS transmits RRCReconfiguration to configure specific DRX parameters. (Note 5)	<--	-	-	-
2	The UE transmits RRCReconfigurationComplete. (Note 6)	-->	-	-	-
3	In a PDCCH occasion which is X PDCCH sub frames before the PDCCH occasion in which the <i>onDurationTimer</i> expires, with $X < \text{drx-onDurationTimer}$, the SS indicates the transmission of a DL MAC PDU on the PDCCH. The SS transmits an MAC PDU.	<--	MAC PDU	-	-
4	Check: Does the UE transmit a HARQ ACK for the DL MAC PDU in Step 3?	-->	HARQ ACK	1	P
5	In a PDCCH occasion before the <i>drx-onDurationTimer</i> expires, the SS indicates the transmission of a DL MAC PDU on the PDCCH. The SS transmits a DL MAC PDU with DRX MAC Control element. UE successfully decodes the MAC PDU and starts the long DRX cycle.	<--	MAC PDU(DRX MAC Control element)	-	-
6	Check: Does the UE transmit a HARQ ACK?	-->	HARQ ACK	1	P
6A	In a PDCCH occasion before the Long DRX cycle ends, the SS indicates the transmission of a DL MAC PDU on the PDCCH. The SS transmits a DL MAC PDU	<--	MAC PDU		
6B	Check: Does the UE transmit a HARQ ACK?	-->	HARQ ACK	1	F
7	On the next or later DRX cycle than the one used for Step 3 and on a PDCCH occasion which is X PDCCH sub frames before the PDCCH occasion in which the <i>onDurationTimer</i> expires, with $X < \text{drx-}$	<--	MAC PDU	-	-

	onDurationTimer,the SS indicates the transmission of a DL MAC PDU. The SS transmits an invalid MAC PDU. (Note 1)				
8	Check: Does the UE transmit a HARQ NACK?	-->	HARQ NACK	-	P
8A	In a PDCCH occasion before the <i>Drx-HARQ-RTT-TimerDL</i> for the MAC PDU indicated in Step 7 expires, the SS indicates the transmission of a DL MAC PDU on the PDCCH. The SS transmits a DL MAC PDU with DRX MAC Control element.	<--	MAC PDU(DRX MAC Control element)	-	-
8B	Check: Does the UE transmit a HARQ ACK?	-->	HARQ ACK	2,3	P
9	In a PDCCH occasion when the <i>drx-RetransmissionTimer</i> for the MAC PDU indicated in Step 7 is still running,, the SS indicates the transmission of a DL MAC PDU. The SS transmits a DL MAC PDU with DRX MAC Control element.	<--	MAC PDU(DRX MAC Control element)	-	-
10	Check: Does the UE transmit a HARQ ACK?	-->	HARQ ACK	2,3	P
11	In the last sub frame when the <i>Drx-RetransmissionTimer</i> for the DL MAC PDU indicated on the PDCCH in Step 7 is still running, the SS indicates the transmission of a DL MAC PDU.	<--	MAC PDU	-	-
12	Check: Does the UE transmit a HARQ ACK?	-->	HARQ ACK	2,3	P
<p>Note 1: Invalid MAC PDU is a MAC PDU that fails the CRC check. Note 2: All DL MAC PDUs are transmitted with the NDI set on the PDCCH. Note 3: Timer tolerances for the MAC DRX related timers measured in PDCCH occasions(slots). These timers are: <i>drx-InactivityTimer</i>, <i>drx-RetransmissionTimer</i>, <i>Drx-HARQ-RTT-TimerDL</i>. Note 5: For EN-DC the NR <i>RRCReconfiguration</i> message is contained in <i>RRCConnectionReconfiguration</i> 36.508 [7], Table 4.6.1-8 using condition EN-DC_EmbedNR_RRCRecon. Note 6: For EN-DC the NR <i>RRCReconfigurationComplete</i> message is contained in <i>RRCConnectionReconfigurationComplete</i></p>					

7.1.1.5.2.3.3 Specific message contents

Table 7.1.1.5.2.3.3-1: RRCReconfiguration (step 1, Table 7.1.1.5.2.3.2-1)

Derivation Path: 38.508-1 [4], Table 4.6.1-13			
Information Element	Value/remark	Comment	Condition
RRCReconfiguration ::= SEQUENCE {			
criticalExtensions CHOICE {			
rrcReconfiguration ::= SEQUENCE {			
radioBearerConfig	RadioBearerConfig		NR
secondaryCellGroup	CellGroupConfig		EN-DC
}			
nonCriticalExtension ::= SEQUENCE {			NR
masterCellGroup	CellGroupConfig		
}			
}			
}			

Table 7.1.1.5.2.3.3-2: CellGroupConfig (Table 7.1.1.5.2.3.3-1)

Derivation Path: 38.508-1 [4], Table 4.6.3-19			
Information Element	Value/remark	Comment	Condition
cellGroupConfig ::= SEQUENCE {			
mac-CellGroupConfig SEQUENCE {			
drx-Config CHOICE {			
setup SEQUENCE {			
drx-onDurationTimer	ms40		
drx-InactivityTimer	ms10		
drx-HARQ-RTT-TimerDL	56	Number of slots=4 due to number of symbol per	$\mu =0,1,2,3,4$ (2 with

		slot=14	normal CP)
	48	Number of slots=4 due to number of symbol per slot=12	$\mu = 2$ with external CP
drx-HARQ-RTT-TimerUL	56	Number of slots=4 due to number of symbol per slot=14	$\mu = 0,1,2,3,4$ (2 with normal CP)
	48	Number of slots=4 due to number of symbol per slot=12	$\mu = 2$ with external CP
drx-RetransmissionTimerDL	sl80		
drx-RetransmissionTimerUL	sl80		
drx-LongCycleStartOffset CHOICE {			
ms640	7		
}			
shortDRX	Not present		
drx-SlotOffset	ms0		
}			
}			
}			
}			

7.1.1.5.3 DRX operation / Short cycle configured / Parameters configured by RRC

7.1.1.5.3.1 Test Purpose (TP)

(1)

```
with { UE in RRC_CONNECTED state }
ensure that {
  when { Short DRX cycle and drx-SlotOffset is configured and [(SFN * 10) + subframe number] modulo
drx-ShortCycle) = (drx-StartOffset) modulo (drx-ShortCycle) }
  then { UE starts the OnDurationTimer after drx-SlotOffset and monitors the PDCCH for
OnDurationTimer PDCCH-subframes }
}
```

(2)

```
with { UE in RRC_CONNECTED state }
ensure that {
  when { drxShortCycleTimer is expired and [(SFN * 10) + subframe number] modulo (drx-LongCycle) =
drx-StartOffset: }
  then { UE starts the OnDurationTimer after drx-SlotOffset and monitors the PDCCH for
OnDurationTimer PDCCH-subframes }
}
```

7.1.1.5.3.2 Conformance requirements

Editor's Note: The conformance requirements are based on running RAN2 CR

References: The conformance requirements covered in the present test case are specified in: TS 38.321, clause 5.7. Unless otherwise stated these are Rel-15 requirements.

[TS 38.321, clause 5.7]

The MAC entity may be configured by RRC with a DRX functionality that controls the UE's PDCCH monitoring activity for the MAC entity's C-RNTI, CS-RNTI, INT-RNTI, SFI-RNTI, SP-CSI-RNTI, TPC-PUCCH-RNTI, TPC-PUSCH-RNTI, and TPC-SRS-RNTI. When using DRX operation, the MAC entity shall also monitor PDCCH according to requirements found in other subclauses of this specification. When in RRC_CONNECTED, if DRX is configured, the MAC entity may monitor the PDCCH discontinuously using the DRX operation specified in this subclause; otherwise the MAC entity shall monitor the PDCCH continuously.

RRC controls DRX operation by configuring the following parameters:

- *drx-onDurationTimer*: the duration at the beginning of a DRX Cycle;
- *drx-SlotOffset*: the delay before starting the *drx-onDurationTimer*;
- *drx-InactivityTimer*: the duration after the PDCCH occasion in which a PDCCH indicates a new UL or DL transmission for the MAC entity;
- *drx-RetransmissionTimerDL* (per DL HARQ process): the maximum duration until a DL retransmission is received;
- *drx-RetransmissionTimerUL* (per UL HARQ process): the maximum duration until a grant for UL retransmission is received;
- *drx-LongCycleStartOffset*: the Long DRX cycle and *drx-StartOffset* which defines the subframe where the Long and Short DRX Cycle starts;
- *drx-ShortCycle* (optional): the Short DRX cycle;
- *drx-ShortCycleTimer* (optional): the duration the UE shall follow the Short DRX cycle;
- *drx-HARQ-RTT-TimerDL* (per DL HARQ process): the minimum duration before a DL assignment for HARQ retransmission is expected by the MAC entity;
- *drx-HARQ-RTT-TimerUL* (per UL HARQ process): the minimum duration before a UL HARQ retransmission grant is expected by the MAC entity.

When a DRX cycle is configured, the Active Time includes the time while:

- *drx-onDurationTimer* or *drx-InactivityTimer* or *drx-RetransmissionTimerDL* or *drx-RetransmissionTimerUL* or *ra-ContentionResolutionTimer* (as described in subclause 5.1.5) is running; or
- a Scheduling Request is sent on PUCCH and is pending (as described in subclause 5.4.4); or
- a PDCCH indicating a new transmission addressed to the C-RNTI of the MAC entity has not been received after successful reception of a Random Access Response for the Random Access Preamble not selected by the MAC entity among the contention-based Random Access Preamble (as described in subclause 5.1.4).

...

1> if *drx-InactivityTimer* expires or a DRX Command MAC CE is received:

2> if the Short DRX cycle is configured:

3> start or restart *drx-ShortCycleTimer* in the first symbol after the expiry of *drx-InactivityTimer* or in the first symbol after the end of DRX Command MAC CE reception;

3> use the Short DRX Cycle.

2> else:

3> use the Long DRX cycle.

1> if *drx-ShortCycleTimer* expires:

2> use the Long DRX cycle.

1> if a Long DRX Command MAC CE is received:

2> stop *drx-ShortCycleTimer*;

2> use the Long DRX cycle.

1> if the Short DRX Cycle is used, and $[(\text{SFN} \times 10) + \text{subframe number}] \bmod (\text{drx-ShortCycle}) = (\text{drx-StartOffset}) \bmod (\text{drx-ShortCycle})$; or

1> if the Long DRX Cycle is used, and $[(SFN \times 10) + \text{subframe number}] \bmod (drx\text{-}LongCycle) = drx\text{-}StartOffset$:

2> start *drx-onDurationTimer* after *drx-SlotOffset* from the beginning of the subframe.

7.1.1.5.3.3 Test description

7.1.1.5.3.3.1 Pre-test conditions

Same Pre-test conditions as in clause 7.1.1.0 except that set to return no data in uplink.

7.1.1.5.3.3.2 Test procedure sequence

For FDD, *NormalSLT* (current SFN, current sub-frame, current slot, y) = y; For TDD, *NormalSLT* (current SFN, current slot, y) counts the minimum number of normal slots needed to cover y number of PDCCH-occasions(slots) until next PDCCH-occasion(slot) available, starting from current slot on current Subframe.

Table 7.1.1.5.3.3.2-1: Main behaviour

St	Procedure	Message Sequence		TP	Verdict
		U – S	Message		
1	SS transmits NR <i>RRCReconfiguration</i> message to configure specific DRX parameters for SpCell (Note1)	<--	-	-	-
2	The UE transmit NR <i>RRCReconfigurationComplete</i> messages (Note 2)	-->	-	-	-
3	In the first PDCCH occasion, after the <i>drx-SlotOffset</i> when the <i>drx-onDurationTimer</i> is running, the SS indicates the transmission of a DL MAC PDU on the PDCCH. (Note 3)(Note 4)(Note 5)	<--	MAC PDU	-	-
4	Check: Does the UE transmit a HARQ ACK for the DL MAC PDU in Step 3?	-->	HARQ ACK	-	-
5	At least <i>drx-InactivityTimer</i> after the transmission of the MAC PDU in Step 3 has been indicated (This means the next DRX cycle or later after Step 1) in the last PDCCH occasion while the <i>drx-onDurationTimer</i> is still running according to $[(SFN * 10) + \text{subframe number}] \bmod (drx\text{-}ShortCycle) = (drx\text{-}StartOffset) \bmod (drx\text{-}ShortCycle)$, the SS indicates the transmission a DL MAC PDU on the PDDCH.	<--	MAC PDU	-	-
6	Check: Does the UE transmit a HARQ ACK for the DL MAC PDU in Step 5?	-->	HARQ ACK	1	P
7	SS waits for <i>drx-ShortCycleTimer</i> to expire.	-	-	-	-
8	In the first PDCCH occasion after the <i>drx-SlotOffset</i> when the <i>drx-onDurationTimer</i> of <i>drx-LongCycle</i> is running, the SS indicates the transmission of a DL MAC PDU on the PDCCH.	<--	MAC PDU	-	-
9	Check: Does the UE transmit a HARQ ACK for the DL MAC PDU in Step 8?	-->	HARQ ACK	2	P
Note 1:	For EN-DC the NR <i>RRCReconfiguration</i> message is contained in <i>RRCConnectionReconfiguration</i> 36.508 [7], Table 4.6.1-8 using condition EN-DC_EmbedNR_RRCRecon.				
Note 2:	For EN-DC the NR <i>RRCReconfigurationComplete</i> message is contained in <i>RRCConnectionReconfigurationComplete</i> .				
Note 3:	The <i>drx-InactivityTimer</i> is started in the first symbol after the end of the PDCCH reception where DL new transmission is indicated.				
Note 4:	When the <i>drx-InactivityTimer</i> expires, UE starts <i>drx-ShortCycleTimer</i> in the first symbol after the expiry of <i>drx-InactivityTimer</i> .				
Note 5:	The SS assumes that the UE starts in long DRX after configuration.				

7.1.1.5.3.3.3 Specific message contents

Table 7.1.1.5.3.3.3-1: RRCReconfiguration (step 1, Table 7.1.1.5.3.3.2-1)

Derivation Path: 38.508-1 [4], Table 4.6.1-13			
Information Element	Value/remark	Comment	Condition
RRCReconfiguration ::= SEQUENCE {			
criticalExtensions CHOICE {			
rrcReconfiguration ::= SEQUENCE {			
radioBearerConfig	RadioBearerConfig		NR
secondaryCellGroup	CellGroupConfig		EN-DC
}			
nonCriticalExtension ::= SEQUENCE {			NR
masterCellGroup	CellGroupConfig		
}			
}			
}			

Table 7.1.1.5.3.3.3-2: CellGroupConfig (Table 7.1.1.5.3.3.3-1)

Derivation Path: 38.508-1 [4], Table 4.6.3-19			
Information Element	Value/remark	Comment	Condition
cellGroupConfig ::= SEQUENCE {			
mac-CellGroupConfig SEQUENCE {			
drx-Config CHOICE {			
setup SEQUENCE {			
drx-onDurationTimer	ms20		
drx-InactivityTimer	Ms10		
drx-HARQ-RTT-TimerDL	56		
drx-HARQ-RTT-TimerUL	56		
drx-RetransmissionTimerDL	sl80		
drx-RetransmissionTimerUL	sl80		
drx-LongCycleStartOffset CHOICE {			
ms640	7		
}			
shortDRX SEQUENCE {			
drx-ShortCycle	Ms80		
drx-ShortCycleTimer	7		
}			
drx-SlotOffset	ms0		
}			
}			

7.1.1.5.4 DRX operation / Short cycle configured / DRX command MAC control element reception

7.1.1.5.4.1 Test Purpose (TP)

(1)

```
with { UE in RRC_CONNECTED state }
ensure that {
  when { Short DRX cycle is configured and a DRX Command MAC control element is received }
  then { UE successfully decodes the MAC control PDU }
}
```

(2)

```
with { UE in RRC_CONNECTED state }
ensure that {
```

```

when { Short DRX cycle is configured and the HARQ RTT Timer is running and a DRX Command MAC
control element is received }
  then { UE continues running the HARQ RTT timer }
}

```

(3)

```

with { UE in RRC_CONNECTED state }
ensure that {
  when { Short DRX cycle is configured and the drx-RetransmissionTimer-DL is running and a DRX
Command MAC control element is received }
    then { UE continues running the drx-RetransmissionTimer-DL and monitors the PDCCH }
}

```

7.1.1.5.4.2 Conformance requirements

References: The conformance requirements covered in the present TC are specified in: TS 38.321, clause 5.7. Unless otherwise stated these are Rel-15 requirements.

[TS 38.321, clause 5.7]

The MAC entity may be configured by RRC with a DRX functionality that controls the UE's PDCCH monitoring activity for the MAC entity's C-RNTI, CS-RNTI, INT-RNTI, SFI-RNTI, SP-CSI-RNTI, TPC-PUCCH-RNTI, TPC-PUSCH-RNTI, and TPC-SRS-RNTI. When using DRX operation, the MAC entity shall also monitor PDCCH according to requirements found in other subclauses of this specification. When in RRC_CONNECTED, if DRX is configured, for all the activated Serving Cells, the MAC entity may monitor the PDCCH discontinuously using the DRX operation specified in this subclause; otherwise the MAC entity shall monitor the PDCCH continuously.

RRC controls DRX operation by configuring the following parameters:

- *drx-onDurationTimer*: the duration at the beginning of a DRX Cycle;
- *drx-SlotOffset*: the delay before starting the *drx-onDurationTimer*;
- *drx-InactivityTimer*: the duration after the PDCCH occasion in which a PDCCH indicates a new UL or DL transmission for the MAC entity;
- *drx-RetransmissionTimerDL* (per DL HARQ process except for the broadcast process): the maximum duration until a DL retransmission is received;
- *drx-RetransmissionTimerUL* (per UL HARQ process): the maximum duration until a grant for UL retransmission is received;
- *drx-LongCycleStartOffset*: the Long DRX cycle and *drx-StartOffset* which defines the subframe where the Long and Short DRX Cycle starts;
- *drx-ShortCycle* (optional): the Short DRX cycle;
- *drx-ShortCycleTimer* (optional): the duration the UE shall follow the Short DRX cycle;
- *drx-HARQ-RTT-TimerDL* (per DL HARQ process except for the broadcast process): the minimum duration before a DL assignment for HARQ retransmission is expected by the MAC entity;
- *drx-HARQ-RTT-TimerUL* (per UL HARQ process): the minimum duration before a UL HARQ retransmission grant is expected by the MAC entity.

When a DRX cycle is configured, the Active Time includes the time while:

- *drx-onDurationTimer* or *drx-InactivityTimer* or *drx-RetransmissionTimerDL* or *drx-RetransmissionTimerUL* or *ra-ContentionResolutionTimer* (as described in subclause 5.1.5) is running; or
- a Scheduling Request is sent on PUCCH and is pending (as described in subclause 5.4.4); or
- a PDCCH indicating a new transmission addressed to the C-RNTI of the MAC entity has not been received after successful reception of a Random Access Response for the Random Access Preamble not selected by the MAC entity among the contention-based Random Access Preamble (as described in subclause 5.1.4).

When DRX is configured, the MAC entity shall:

- 1> if a MAC PDU is received in a configured downlink assignment:
 - 2> start the *drx-HARQ-RTT-TimerDL* for the corresponding HARQ process in the first symbol after the end of the corresponding transmission carrying the DL HARQ feedback;
 - 2> stop the *drx-RetransmissionTimerDL* for the corresponding HARQ process.
- 1> if a MAC PDU is transmitted in a configured uplink grant:
 - 2> start the *drx-HARQ-RTT-TimerUL* for the corresponding HARQ process in the first symbol after the end of the first repetition of the corresponding PUSCH transmission;
 - 2> stop the *drx-RetransmissionTimerUL* for the corresponding HARQ process.
- 1> if a *drx-HARQ-RTT-TimerDL* expires:
 - 2> if the data of the corresponding HARQ process was not successfully decoded:
 - 3> start the *drx-RetransmissionTimerDL* for the corresponding HARQ process in the first symbol after the expiry of *drx-HARQ-RTT-TimerDL*.
- 1> if a *drx-HARQ-RTT-TimerUL* expires:
 - 2> start the *drx-RetransmissionTimerUL* for the corresponding HARQ process in the first symbol after the expiry of *drx-HARQ-RTT-TimerUL*.
- 1> if a DRX Command MAC CE or a Long DRX Command MAC CE is received:
 - 2> stop *drx-onDurationTimer*;
 - 2> stop *drx-InactivityTimer*.
- 1> if *drx-InactivityTimer* expires or a DRX Command MAC CE is received:
 - 2> if the Short DRX cycle is configured:
 - 3> start or restart *drx-ShortCycleTimer* in the first symbol after the expiry of *drx-InactivityTimer* or in the first symbol after the end of DRX Command MAC CE reception;
 - 3> use the Short DRX Cycle.
 - 2> else:
 - 3> use the Long DRX cycle.
- 1> if *drx-ShortCycleTimer* expires:
 - 2> use the Long DRX cycle.
- 1> if a Long DRX Command MAC CE is received:
 - 2> stop *drx-ShortCycleTimer*;
 - 2> use the Long DRX cycle.
- 1> if the Short DRX Cycle is used, and $[(\text{SFN} \times 10) + \text{subframe number}] \bmod (\text{drx-ShortCycle}) = (\text{drx-StartOffset}) \bmod (\text{drx-ShortCycle})$; or
- 1> if the Long DRX Cycle is used, and $[(\text{SFN} \times 10) + \text{subframe number}] \bmod (\text{drx-LongCycle}) = \text{drx-StartOffset}$:
 - 2> start *drx-onDurationTimer* after *drx-SlotOffset* from the beginning of the subframe.
- 1> if the MAC entity is in Active Time:
 - 2> monitor the PDCCH;

- 2> if the PDCCH indicates a DL transmission:
 - 3> start the *drx-HARQ-RTT-TimerDL* for the corresponding HARQ process in the first symbol after the end of the corresponding transmission carrying the DL HARQ feedback;
 - 3> stop the *drx-RetransmissionTimerDL* for the corresponding HARQ process.
- 2> if the PDCCH indicates a UL transmission:
 - 3> start the *drx-HARQ-RTT-TimerUL* for the corresponding HARQ process in the first symbol after the end of the first repetition of the corresponding PUSCH transmission;
 - 3> stop the *drx-RetransmissionTimerUL* for the corresponding HARQ process.
- 2> if the PDCCH indicates a new transmission (DL or UL):
 - 3> start or restart *drx-InactivityTimer* in the first symbol after the end of the PDCCH reception.
- 1> in current symbol n, if the MAC entity would not be in Active Time considering grants/assignments/DRX Command MAC CE/Long DRX Command MAC CE received and Scheduling Request sent 4 ms prior to symbol n when evaluating all DRX Active Time conditions as specified in this subclause:
 - 2> not transmit periodic SRS and semi-persistent SRS defined in TS 38.214 [7].
- 1> if CSI masking (*csi-Mask*) is setup by upper layers:
 - 2> in current symbol n, if *onDurationTimer* would not be running considering grants/assignments/DRX Command MAC CE/Long DRX Command MAC CE received 4 ms prior to symbol n when evaluating all DRX Active Time conditions as specified in this subclause:
 - 3> not report CSI on PUCCH.
- 1> else:
 - 2> in current symbol n, if the MAC entity would not be in Active Time considering grants/assignments/DRX Command MAC CE/Long DRX Command MAC CE received and Scheduling Request sent 4 ms prior to symbol n when evaluating all DRX Active Time conditions as specified in this subclause:
 - 3> not report CSI on PUCCH and semi-persistent CSI on PUSCH.

Regardless of whether the MAC entity is monitoring PDCCH or not, the MAC entity transmits HARQ feedback, aperiodic CSI on PUSCH, and aperiodic SRS defined in TS 38.214 [7] when such is expected.

The MAC entity needs not to monitor the PDCCH if it is not a complete PDCCH occasion (e.g. the Active Time starts or ends in the middle of a PDCCH occasion).

7.1.1.5.4.3 Test description

7.1.1.5.4.3.1 Pre-test conditions

Same Pre-test conditions as in clause 7.1.1.0 except that set to return no data in uplink.

7.1.1.5.4.3.2 Test procedure sequence

For FDD, *NormalSLT*(current SFN, current subframe, current slot, y)=y; For TDD, *NormalSLT*(current SFN, current subframe, current slot, y) counts the minimum number of normal slots needed to cover y number of PDCCH-occasions (slots) until next PDCCH-occasion (slot) available, starting from current slot on current SFN.

Table 7.1.1.5.4.3.2-1: Main behaviour

St	Procedure	Message Sequence		TP	Verdict
		U - S	Message		
1	SS transmits NR RRCReconfigurationmessage to configure specific DRX parameters for NR Cell. (Note	<--	NR RRC: <i>RRCReconfiguration</i>	-	-

	1)				
2	The UE transmits NR RRCReconfigurationComplete message. (Note 2)	-->	NR RRC: <i>RRCReconfigurationComplete</i>	-	-
3	In a PDCCH occasion which is X subframes before the PDCCH occasion in which the <i>drx-onDurationTimer</i> expires, with $X < drx-onDurationTimer-1$, the SS indicates the transmission of a DL MAC PDU on the PDCCH. (Note 7)	<--	MAC PDU	-	-
4	Check: Does the UE transmit a HARQ ACK for the DL MAC PDU in Step 3?	-->	HARQ ACK	1	P
5	In a PDCCH occasion before the <i>drx-onDurationTimer</i> expires, the SS indicates the transmission of a DL MAC PDU on the PDCCH. The SS transmits a DL MAC PDU with DRX MAC Control element. UE successfully decodes the MAC PDU.	<--	MAC PDU (DRX MAC Control element)	-	-
6	Check: Does the UE transmit a HARQ ACK for the DL MAC PDU in Step 5?	-->	HARQ ACK	1	P
6 A	In a PDCCH occasion before the short DRX cycle ends, the SS indicates the transmission of a DL MAC PDU on the PDCCH. The SS transmits a DL MAC PDU	<--	MAC PDU		
6 B	Check: Does the UE transmit a HARQ ACK in step 6B?	-->	HARQ ACK	1	F
7	On the next or later DRX cycle than the one used for Step 3 and on a PDCCH occasion which is X PDCCH sub frames before the PDCCH occasion in which the <i>onDurationTimer</i> expires, with $X < drx-onDurationTimer$, the SS indicates the transmission of a DL MAC PDU. The SS transmits an invalid MAC PDU. (Note 3)	<--	MAC PDU	-	-
8	Check: Does the UE transmit a HARQ NACK for the DL MAC PDU in Step 7?	-->	HARQ NACK	2,3	P
8 A	In a PDCCH occasion before the <i>Drx-HARQ-RTT-TimerDL</i> for the MAC PDU indicated in Step 7 expires, the SS indicates the transmission of a DL MAC PDU on the PDCCH. The SS transmits a DL MAC PDU with DRX MAC Control element.	<--	MAC PDU(DRX MAC Control element)		
8 B	Check: Does the UE transmit a HARQ ACK?	-->	HARQ ACK	2,3	P
9	In a PDCCH occasion which is Z slots before the slot in which the <i>drx-RetransmissionTimerDL</i> for the DL MAC PDU in Step 7 expires, with $1 < Z < drx-RetransmissionTimerDL$, the SS indicates the transmission of a DL MAC PDU. The SS transmits a DL MAC PDU with DRX MAC Control element.	<--	MAC PDU(DRX MAC Control element)	-	-
10	Check: Does the UE transmit a HARQ ACK for the DL MAC PDU in Step 9?	-->	HARQ ACK	2,3,1	P
11	In the last PDCCH occasion when the <i>drx-RetransmissionTimerDL</i> for the DL MAC PDU indicated on the PDCCH in Step 7 is still running, the SS indicates the transmission of a DL MAC PDU.	<--	MAC PDU	-	-
12	Check: Does the UE transmit a HARQ ACK for the DL MAC PDU in Step 11?	-->	HARQ ACK	2,3	P
<p>Note 1: For EN-DC the NR <i>RRCReconfiguration</i> message is contained in <i>RRCConnectionReconfiguration</i>.</p> <p>Note 2: For EN-DC the NR <i>RRCReconfigurationComplete</i> message is contained in <i>RRCConnectionReconfigurationComplete</i>.</p> <p>Note 3: Invalid MAC PDU is a MAC PDU that fails the CRC check.</p> <p>Note 4: All DL MAC PDUs are transmitted with the NDI set on the PDCCH.</p> <p>Note 5: Timer tolerances for the MAC DRX related timers measured in PDCCH occasions (slots). These timers are: <i>drx-InactivityTimer</i>, <i>drx-RetransmissionTimer</i>, <i>Drx-HARQ-RTT-TimerDL</i>.</p>					

Note 6: K is the time for given PDSCH to HARQ feedback of PUCCH and shall be shorter than drx-InactivityTimer. In this TC, the DCI format should be configured to not include the PDSCH-to-HARQ-timing-indicator field. When the UE schedules a PDSCH reception over a number of symbols where the last symbol is within slot n-k, the UE shall provide corresponding HARQ-ACK information in a PUCCH transmission within slot n-k+4 according to TS 38.321 clause 9.2.3. Thus, the maximum value of K is 4 slots in this test case.

Note 7: The SS assumes that the UE starts in long DRX after configuration.

7.1.1.5.4.3.3 Specific message contents

Table 7.1.1.5.4.3.3-1: RRCReconfiguration (Step 1, Table 7.1.1.5.4.3.2-1)

Derivation Path: 38.508-1 [4], Table 4.6.1-13			
Information Element	Value/remark	Comment	Condition
RRCReconfiguration ::= SEQUENCE {			
criticalExtensions CHOICE {			
rrcReconfiguration SEQUENCE {			
radioBearerConfig	Not present		
secondaryCellGroup	CellGroupConfig	OCTET STRING (CONTAINING CellGroupConfig)	EN-DC
nonCriticalExtension ::= SEQUENCE {}	Not present		EN-DC
nonCriticalExtension ::= SEQUENCE{			NR
masterCellGroup	CellGroupConfig	OCTET STRING (CONTAINING CellGroupConfig)	
dedicatedNAS-MessageList SEQUENCE (SIZE(1..maxDRB)) OF DedicatedNAS-Message {}	Not present		
}			
}			
}			
}			

Table 7.1.1.5.4.3.3-2: CellGroupConfig (Table 7.1.1.5.4.3.3-1)

Derivation Path: 38.508-1 [4], Table 4.6.3-n			
Information Element	Value/remark	Comment	Condition
cellGroupConfig ::= SEQUENCE {			
mac-CellGroupConfig SEQUENCE {			
drx-Config CHOICE {			
setup SEQUENCE {			
drx-onDurationTimer	ms40		
drx-InactivityTimer	Ms10		
drx-HARQ-RTT-TimerDL	56		
drx-HARQ-RTT-TimerUL	56		
drx-RetransmissionTimerDL	SI80		
drx-RetransmissionTimerUL	SI80		
drx-LongCycleStartOffset CHOICE {			
ms640	7		
}			
shortDRX SEQUENCE {			
drx-ShortCycle	ms80		
drx-ShortCycleTimer	7		
}			
drx-SlotOffset	ms0		
}			
}			
}			
}			

7.1.1.5.5 DRX operation / Short cycle configured / Long DRX command MAC control element reception

7.1.1.5.5.1 Test Purpose (TP)

(1)

```
with { UE in RRC_CONNECTED state }
ensure that {
  when { short DRX cycle is configured and a long DRX Command MAC control element is received }
  then { UE successfully decodes the MAC control PDU }
}
```

(2)

```
with { UE in RRC_CONNECTED state }
ensure that {
  when { Long DRX cycle and drx-SlotOffset is configured and [(SFN * 10) + subframe number] modulo
drx-LongCycle} = drxStartOffset }
  then { UE starts the OnDurationTimer after drx-SlotOffset and monitors PDCCH for OnDurationTimer
PDCCH-subframes }
}
```

7.1.1.5.5.2 Conformance requirements

References: The conformance requirements covered in the present TC are specified in: TS 38.321, clause 5.7. Unless otherwise stated these are Rel-15 requirements.

[TS 38.321, clause 5.7]

The MAC entity may be configured by RRC with a DRX functionality that controls the UE's PDCCH monitoring activity for the MAC entity's C-RNTI, CS-RNTI, INT-RNTI, SFI-RNTI, SP-CSI-RNTI, TPC-PUCCH-RNTI, TPC-PUSCH-RNTI, and TPC-SRS-RNTI. When using DRX operation, the MAC entity shall also monitor PDCCH according to requirements found in other clauses of this specification. When in RRC_CONNECTED, if DRX is configured, for all the activated Serving Cells, the MAC entity may monitor the PDCCH discontinuously using the DRX operation specified in this clause; otherwise the MAC entity shall monitor the PDCCH as specified in TS 38.213 [6].

RRC controls DRX operation by configuring the following parameters:

- *drx-onDurationTimer*: the duration at the beginning of a DRX Cycle;
- *drx-SlotOffset*: the delay before starting the *drx-onDurationTimer*;
- *drx-InactivityTimer*: the duration after the PDCCH occasion in which a PDCCH indicates a new UL or DL transmission for the MAC entity;
- *drx-RetransmissionTimerDL* (per DL HARQ process except for the broadcast process): the maximum duration until a DL retransmission is received;
- *drx-RetransmissionTimerUL* (per UL HARQ process): the maximum duration until a grant for UL retransmission is received;
- *drx-LongCycleStartOffset*: the Long DRX cycle and *drx-StartOffset* which defines the subframe where the Long and Short DRX Cycle starts;
- *drx-ShortCycle* (optional): the Short DRX cycle;
- *drx-ShortCycleTimer* (optional): the duration the UE shall follow the Short DRX cycle;
- *drx-HARQ-RTT-TimerDL* (per DL HARQ process except for the broadcast process): the minimum duration before a DL assignment for HARQ retransmission is expected by the MAC entity;
- *drx-HARQ-RTT-TimerUL* (per UL HARQ process): the minimum duration before a UL HARQ retransmission grant is expected by the MAC entity.

When a DRX cycle is configured, the Active Time includes the time while:

- *drx-onDurationTimer* or *drx-InactivityTimer* or *drx-RetransmissionTimerDL* or *drx-RetransmissionTimerUL* or *ra-ContentionResolutionTimer* (as described in clause 5.1.5) is running; or
- a Scheduling Request is sent on PUCCH and is pending (as described in clause 5.4.4); or
- a PDCCH indicating a new transmission addressed to the C-RNTI of the MAC entity has not been received after successful reception of a Random Access Response for the Random Access Preamble not selected by the MAC entity among the contention-based Random Access Preamble (as described in clause 5.1.4).

When DRX is configured, the MAC entity shall:

- 1> if a MAC PDU is received in a configured downlink assignment:
 - 2> start the *drx-HARQ-RTT-TimerDL* for the corresponding HARQ process in the first symbol after the end of the corresponding transmission carrying the DL HARQ feedback;
 - 2> stop the *drx-RetransmissionTimerDL* for the corresponding HARQ process.
- 1> if a MAC PDU is transmitted in a configured uplink grant:
 - 2> start the *drx-HARQ-RTT-TimerUL* for the corresponding HARQ process in the first symbol after the end of the first repetition of the corresponding PUSCH transmission;
 - 2> stop the *drx-RetransmissionTimerUL* for the corresponding HARQ process.
- 1> if a *drx-HARQ-RTT-TimerDL* expires:
 - 2> if the data of the corresponding HARQ process was not successfully decoded:
 - 3> start the *drx-RetransmissionTimerDL* for the corresponding HARQ process in the first symbol after the expiry of *drx-HARQ-RTT-TimerDL*.
- 1> if a *drx-HARQ-RTT-TimerUL* expires:
 - 2> start the *drx-RetransmissionTimerUL* for the corresponding HARQ process in the first symbol after the expiry of *drx-HARQ-RTT-TimerUL*.
- 1> if a DRX Command MAC CE or a Long DRX Command MAC CE is received:
 - 2> stop *drx-onDurationTimer*;
 - 2> stop *drx-InactivityTimer*.
- 1> if *drx-InactivityTimer* expires or a DRX Command MAC CE is received:
 - 2> if the Short DRX cycle is configured:
 - 3> start or restart *drx-ShortCycleTimer* in the first symbol after the expiry of *drx-InactivityTimer* or in the first symbol after the end of DRX Command MAC CE reception;
 - 3> use the Short DRX Cycle.
 - 2> else:
 - 3> use the Long DRX cycle.
- 1> if *drx-ShortCycleTimer* expires:
 - 2> use the Long DRX cycle.
- 1> if a Long DRX Command MAC CE is received:
 - 2> stop *drx-ShortCycleTimer*;
 - 2> use the Long DRX cycle.

- 1> if the Short DRX Cycle is used, and $[(SFN \times 10) + \text{subframe number}] \bmod (drx-ShortCycle) = (drx-StartOffset) \bmod (drx-ShortCycle)$; or
- 1> if the Long DRX Cycle is used, and $[(SFN \times 10) + \text{subframe number}] \bmod (drx-LongCycle) = drx-StartOffset$:
 - 2> start *drx-onDurationTimer* after *drx-SlotOffset* from the beginning of the subframe.
- 1> if the MAC entity is in Active Time:
 - 2> monitor the PDCCH as specified in TS 38.213 [6];
 - 2> if the PDCCH indicates a DL transmission:
 - 3> start the *drx-HARQ-RTT-TimerDL* for the corresponding HARQ process in the first symbol after the end of the corresponding transmission carrying the DL HARQ feedback;
 - 3> stop the *drx-RetransmissionTimerDL* for the corresponding HARQ process.
 - 2> if the PDCCH indicates a UL transmission:
 - 3> start the *drx-HARQ-RTT-TimerUL* for the corresponding HARQ process in the first symbol after the end of the first repetition of the corresponding PUSCH transmission;
 - 3> stop the *drx-RetransmissionTimerUL* for the corresponding HARQ process.
 - 2> if the PDCCH indicates a new transmission (DL or UL):
 - 3> start or restart *drx-InactivityTimer* in the first symbol after the end of the PDCCH reception.
- 1> in current symbol *n*, if the MAC entity would not be in Active Time considering grants/assignments/DRX Command MAC CE/Long DRX Command MAC CE received and Scheduling Request sent until 4 ms prior to symbol *n* when evaluating all DRX Active Time conditions as specified in this clause:
 - 2> not transmit periodic SRS and semi-persistent SRS defined in TS 38.214 [7];
 - 2> not report CSI on PUCCH and semi-persistent CSI configured on PUSCH.
- 1> if CSI masking (*csi-Mask*) is setup by upper layers:
 - 2> in current symbol *n*, if *drx-onDurationTimer* would not be running considering grants/assignments/DRX Command MAC CE/Long DRX Command MAC CE received until 4 ms prior to symbol *n* when evaluating all DRX Active Time conditions as specified in this clause:
 - 3> not report CSI on PUCCH.

NOTE: If a UE multiplexes a CSI configured on PUCCH with other overlapping UCI(s) according to the procedure specified in TS 38.213 [6] subclause 9.2.5 and this CSI multiplexed with other UCI(s) would be reported on a PUCCH resource outside DRX Active Time, it is up to UE implementation whether to report this CSI multiplexed with other UCI(s).

Regardless of whether the MAC entity is monitoring PDCCH or not, the MAC entity transmits HARQ feedback, aperiodic CSI on PUSCH, and aperiodic SRS defined in TS 38.214 [7] when such is expected.

The MAC entity needs not to monitor the PDCCH if it is not a complete PDCCH occasion (e.g. the Active Time starts or ends in the middle of a PDCCH occasion).

7.1.1.5.5.3 Test Description

7.1.1.5.5.3.1 Pre-test conditions

Same Pre-test conditions as in clause 7.1.1.0 except that set to return no data in uplink.

7.1.1.5.5.3.2 Test procedure sequence

For FDD, $NormalSLT = (\text{current SFN}, \text{current sub-frame}, \text{current slot}, y) = y$; For TDD, $NormalSLT(\text{current SFN}, \text{current slot}, y)$ counts the minimum number of normal slots needed to cover y number of PDCCH-occasions (slots) until next PDCCH-occasion(slot) available, starting from current slot on current SFN.

Table 7.1.1.5.5.3.2-1: Main behaviour

St	Procedure	Message Sequence		TP	Verdict
		U - S	Message		
1	SS transmits NR RRCReconfiguration message to configure specific DRX parameters for NR Cell. (Note 1)	<--	NR RRC: <i>RRCReconfiguration</i>	-	-
2	The UE transmits NR RRCReconfigurationComplete message. (Note 2)	-->	NR RRC: <i>RRCReconfigurationComplete</i>	-	-
3	In a PDCCH occasion when the <i>drx-onDurationTimer</i> is running, the SS indicates the transmission of a DL MAC PDU on the PDCCH. The SS transmits a valid MAC PDU. (Note 3)	<--	MAC PDU	-	-
4	Check: Does the UE transmit a HARQ ACK for the DL MAC PDU in Step 3?	-->	HARQ ACK	1	P
4 A	Wait for the expiry of <i>drx-InactivityTimer</i> to ensure that UE starts the Short DRX Cycle.	-	-	-	-
5	In a PDCCH occasion before the <i>drx-onDurationTimer</i> expires, the SS indicates the transmission of a DL MAC PDU on the PDCCH. The SS transmits a DL MAC PDU with Long DRX MAC Control element. UE successfully decodes the MAC PDU.	<--	MAC PDU (Long DRX MAC Control element)	-	-
6	Check: Does the UE transmit a HARQ ACK for the DL MAC PDU in Step 5?	-->	HARQ ACK	1	P
7	In the first PDCCH occasion, after the <i>drx-SlotOffset</i> when the <i>drx-onDurationTimer</i> is running according to $[(\text{SFN} * 10) + \text{subframe number}] \bmod \text{drx-LongCycle} = (\text{drx-StartOffset}) \bmod (\text{drx-LongCycle})$, the SS indicates the transmission of a DL MAC PDU on the PDCCH.	<--	MAC PDU	-	-
8	Check: Does the UE transmit a HARQ ACK for the DL MAC PDU in Step 7?	-->	HARQ ACK	2	P
9	At least <i>drx-InactivityTimer</i> PDCCH occasions after the transmission of the MAC PDU in Step 7 has been indicated (This means the next DRX cycle or later after Step 7) in the last PDCCH occasion while the <i>drx-onDurationTimer</i> is still running, the SS indicates the transmission a DL MAC PDU on the PDDCH. (Note 7)	<--	MAC PDU	-	-
10	Check: Does the UE transmit a HARQ ACK for the DL MAC PDU in Step 9?	-->	HARQ ACK	2	P
Note 1: For EN-DC the NR RRCReconfiguration message is contained in RRCConnectionReconfiguration 36.508 [7], Table 4.6.1-8 using condition EN-DC_EmbedNR_RRCRecon.					
Note 2: For EN-DC the NR RRCReconfigurationComplete message is contained in RRCConnectionReconfigurationComplete.					
Note 3: The SS assumes that the UE starts in long DRX after configuration.					
Note 4: All DL MAC PDUs are transmitted with the NDI set on the PDCCH.					
Note 5: Timer tolerances for the MAC DRX related timers measured in PDCCH occasions (slots). These timers are: <i>drx-InactivityTimer</i> , <i>drx-RetransmissionTimer</i> , <i>Drx-HARQ-RTT-TimerDL</i> .					
Note 6: Void					
Note 7: The <i>drx-InactivityTimer</i> is started in the next PDCCH occasion of the PDCCH occasion where DL new transmission is indicated.					

7.1.1.5.5.3.3 Specific message contents

Table 7.1.1.5.5.3.3-1: RRCReconfiguration (Step 1, Table 7.1.1.5.5.3.2-1)

Derivation Path: 38.508-1 [4], Table 4.6.1-13			
Information Element	Value/remark	Comment	Condition
RRCReconfiguration ::= SEQUENCE {			
criticalExtensions CHOICE {			
rrcReconfiguration ::= SEQUENCE {			
radioBearerConfig	RadioBearerConfig with conditions SRB2 and DRB1		NR
secondaryCellGroup	CellGroupConfig		EN-DC
}			
nonCriticalExtension ::= SEQUENCE {			NR
masterCellGroup	CellGroupConfig with condition SRB2_DRB1		NR
}			
}			
}			
}			

Table 7.1.1.5.5.3.3-2: CellGroupConfig (Table 7.1.1.5.5.3.3-1)

Derivation Path: 38.508-1 [4], Table 4.6.3-19			
Information Element	Value/remark	Comment	Condition
cellGroupConfig ::= SEQUENCE {			
mac-CellGroupConfig SEQUENCE {			
drx-Config CHOICE {			
setup SEQUENCE {			
drx-onDurationTimer	ms40		
drx-InactivityTimer	ms10		
drx-HARQ-RTT-TimerDL	56		
drx-HARQ-RTT-TimerUL	56		
drx-RetransmissionTimerDL	s180		
drx-RetransmissionTimerUL	s180		
drx-LongCycleStartOffset CHOICE {			
ms640	7		
}			
shortDRX SEQUENCE {			
drx-ShortCycle	ms80		
drx-ShortCycleTimer	7		
}			
drx-SlotOffset	ms0		
}			
}			
}			
}			
}			

7.1.1.6 Semi-Persistent Scheduling

7.1.1.6.1 Correct handling of DL assignment / Semi-persistent case

7.1.1.6.1.1 Test Purpose (TP)

(1)

```

with { UE in RRC_Connected state with DRB established and sps-Configuration in DL is enabled }
ensure that {
  when { UE receives a DL assignment addressed to its stored CS-RNTI in slot y and with NDI set as 0
and PDCCH content indicates activation }
  then {UE starts receiving DL MAC PDU in slots y+n*[semiPersistSchedIntervalDL] where 'n' is
positive integer starting at zero }

```



```

    }

```

(2)

```

with { UE in RRC_Connected state with DRB established and stored DL SPS assignment to receive MAC
PDU in slot  $y+n \cdot [\text{semiPersistSchedIntervalDL}]$  }
ensure that {
  when { UE receives a DL assignment addressed to its CS-RNTI in slot  $p$  and with NDI set as 0, where
 $p \neq y+n \cdot [\text{semiPersistSchedIntervalDL}]$  }
  then { UE starts receiving DL MAC PDU in slots  $p+n \cdot [\text{semiPersistSchedIntervalDL}]$  and stops
receiving DL MAC PDU at slots  $y+n \cdot [\text{semiPersistSchedIntervalDL}]$  where 'n' is positive integer starting
at zero }
}

```

(3)

```

with { UE in RRC_Connected state with DRB established and stored DL SPS assignment to receive MAC
PDU at slot  $p+n \cdot [\text{semiPersistSchedIntervalDL}]$  }
ensure that {
  when { UE receives a DL assignment [for retransmission] addressed to its CS-RNTI in Slot  $z$  and
with NDI set as 1, where  $z \neq p+n \cdot [\text{semiPersistSchedIntervalDL}]$  }
  then { UE receives MAC PDU as per the retransmission grant for CS-RNTI }
}

```

(4)

```

with { UE in RRC_Connected state with DRB established and stored DL SPS assignment to receive MAC
PDU at slot  $y+n \cdot [\text{semiPersistSchedIntervalDL}]$  }
ensure that {
  when { UE receives a DL assignment addressed to its C-RNTI in Slot  $p$ , such that  $p =
y+n \cdot [\text{semiPersistSchedIntervalDL}]$  }
  then { UE receives MAC PDU as per assignment addressed to its C-RNTI }
}

```

(5)

```

with { UE in RRC_Connected state with DRB established and stored DL SPS grant to receive MAC PDU at
slot  $z+n \cdot [\text{semiPersistSchedIntervalDL}]$  }
ensure that {
  when { UE receives a RRC Message including sps-Configuration with sps-ConfigurationDL set as
'disable' and hence resulting in DL SPS grant deactivation }
  then { UE deletes the stored sps-Configuration DL parameters and stops receiving DL MAC PDU's as
per stored SPS assignment in slot  $z+n \cdot [\text{semiPersistSchedIntervalDL}]$  }
}

```

(6)

```

with { UE in RRC_Connected state with DRB established and sps-Configuration in DL is enabled }
ensure that {
  when { UE receives a DL assignment addressed to its stored CS-RNTI in slot  $p$  and with NDI set as 0
and PDCCH content indicates deactivation }
  then { UE stops receiving DL MAC PDU's as per stored SPS assignment }
}

```

7.1.1.6.1.2 Conformance requirements

References: The conformance requirements covered in the present TC are specified in TS 38.321, clause 5.3.1, 5.8.1 TS 38.300, clause 10.2 and TS 38.213 clause 102. Unless otherwise stated these are Rel-15 requirements.

[TS 38.321, clause 5.3.1]

Downlink assignments received on the PDCCH both indicate that there is a transmission on a DL-SCH for a particular MAC entity and provide the relevant HARQ information.

When the MAC entity has a C-RNTI, Temporary C-RNTI, or CS-RNTI, the MAC entity shall for each PDCCH occasion during which it monitors PDCCH and for each Serving Cell:

- 1> if a downlink assignment for this PDCCH occasion and this Serving Cell has been received on the PDCCH for the MAC entity's C-RNTI, or Temporary C-RNTI:

- 2> if this is the first downlink assignment for this Temporary C-RNTI:
 - 3> consider the NDI to have been toggled.
- 2> if the downlink assignment is for the MAC entity's C-RNTI, and if the previous downlink assignment indicated to the HARQ entity of the same HARQ process was either a downlink assignment received for the MAC entity's CS-RNTI or a configured downlink assignment:
 - 3> consider the NDI to have been toggled regardless of the value of the NDI.
- 2> indicate the presence of a downlink assignment and deliver the associated HARQ information to the HARQ entity.
- 1> else if a downlink assignment for this PDCCH occasion has been received for this Serving Cell on the PDCCH for the MAC entity's CS-RNTI:
 - 2> if the NDI in the received HARQ information is 1:
 - 3> consider the NDI for the corresponding HARQ process not to have been toggled;
 - 3> indicate the presence of a downlink assignment for this Serving Cell and deliver the associated HARQ information to the HARQ entity.
 - 2> if the NDI in the received HARQ information is 0:
 - 3> if PDCCH contents indicate SPS deactivation:
 - 4> clear the configured downlink assignment for this Serving Cell (if any);
 - 4> if the timeAlignmentTimer, associated with the TAG containing the Serving Cell on which the HARQ feedback is to be transmitted, is running:
 - 5> indicate a positive acknowledgement for the SPS deactivation to the physical layer.
 - 3> else if PDCCH content indicates SPS activation:
 - 4> store the downlink assignment for this Serving Cell and the associated HARQ information as configured downlink assignment;
 - 4> initialise or re-initialise the configured downlink assignment for this Serving Cell to start in the associated PDSCH duration and to recur according to rules in subclause 5.8.1;

For each Serving Cell and each configured downlink assignment, if configured and activated, the MAC entity shall:

- 1> if the PDSCH duration of the configured downlink assignment does not overlap with the PDSCH duration of a downlink assignment received on the PDCCH for this Serving Cell:
 - 2> instruct the physical layer to receive, in this PDSCH duration, transport block on the DL-SCH according to the configured downlink assignment and to deliver it to the HARQ entity;
 - 2> set the HARQ Process ID to the HARQ Process ID associated with this PDSCH duration;
 - 2> consider the NDI bit for the corresponding HARQ process to have been toggled;
 - 2> indicate the presence of a configured downlink assignment and deliver the stored HARQ information to the HARQ entity.

For configured downlink assignments, the HARQ Process ID associated with the slot where the DL transmission starts is derived from the following equation:

$$\text{HARQ Process ID} = [\text{floor}(\text{CURRENT_slot} \times 10 / (\text{numberOfSlotsPerFrame} \times \text{periodicity}))] \text{ modulo } \text{nrofHARQ-Processes}$$

where $\text{CURRENT_slot} = [(\text{SFN} \times \text{numberOfSlotsPerFrame}) + \text{slot number in the frame}]$ and $\text{numberOfSlotsPerFrame}$ refers to the number of consecutive slots per frame as specified in TS 38.211 [8].

When the MAC entity needs to read BCCH, the MAC entity may, based on the scheduling information from RRC:

- 1> if a downlink assignment for this PDCCH occasion has been received on the PDCCH for the SI-RNTI;
- 2> indicate a downlink assignment and redundancy version for the dedicated broadcast HARQ process to the HARQ entity.

[TS 38.321, clause 5.8.1]

Semi-Persistent Scheduling (SPS) is configured by RRC per Serving Cell and per BWP. Activation and deactivation of the DL SPS are independent among the Serving Cells.

For the DL SPS, a DL assignment is provided by PDCCH, and stored or cleared based on L1 signalling indicating SPS activation or deactivation.

RRC configures the following parameters when SPS is configured:

- *cs-RNTI*: CS-RNTI for activation, deactivation, and retransmission;
- *nrofHARQ-Processes*: the number of configured HARQ processes for SPS;
- *periodicity*: periodicity of configured downlink assignment for SPS.

When SPS is released by upper layers, all the corresponding configurations shall be released.

After a downlink assignment is configured for SPS, the MAC entity shall consider sequentially that the Nth downlink assignment occurs in the slot for which:

$$\frac{(numberOfSlotsPerFrame \times SFN + slot\ number\ in\ the\ frame) = [(numberOfSlotsPerFrame \times SFN_{start\ time} + slot_{start\ time}) + N \times periodicity \times numberOfSlotsPerFrame / 10] \bmod (1024 \times numberOfSlotsPerFrame)}{\times numberOfSlotsPerFrame}$$

where $SFN_{start\ time}$ and $slot_{start\ time}$ are the SFN and slot, respectively, of the first transmission of PDSCH where the configured downlink assignment was (re-)initialised.

[TS 38.300, clause 10.2]

In the downlink, the gNB can dynamically allocate resources to UEs via the C-RNTI on PDCCH(s). A UE always monitors the PDCCH(s) in order to find possible assignments when its downlink reception is enabled (activity governed by DRX when configured). When CA is configured, the same C-RNTI applies to all serving cells.

The gNB may pre-empt an ongoing PDSCH transmission to one UE with a latency-critical transmission to another UE. The gNB can configure UEs to monitor interrupted transmission indications using INT-RNTI on a PDCCH. If a UE receives the interrupted transmission indication, the UE may assume that no useful information to that UE was carried by the resource elements included in the indication, even if some of those resource elements were already scheduled to this UE.

In addition, with Semi-Persistent Scheduling (SPS), the gNB can allocate downlink resources for the initial HARQ transmissions to UEs: RRC defines the periodicity of the configured downlink assignments while PDCCH addressed to CS-RNTI can either signal and activate the configured downlink assignment, or deactivate it; i.e. a PDCCH addressed to CS-RNTI indicates that the downlink assignment can be implicitly reused according to the periodicity defined by RRC, until deactivated.

NOTE: when required, retransmissions are explicitly scheduled on PDCCH(s).

The dynamically allocated downlink reception overrides the configured downlink assignment in the same serving cell, if they overlap in time. Otherwise a downlink reception according to the configured downlink assignment is assumed, if activated.

When CA is configured, at most one configured downlink assignment can be signalled per serving cell. When BA is configured, at most one configured downlink assignment can be signalled per BWP. On each serving cell, there can be only one configured downlink assignment active at a time, and multiple configured downlink assignment can be simultaneously active on different serving cells only. Activation and deactivation of configured downlink assignments are independent among the serving cells.

[TS 38.213, clause 10.2]

A UE validates, for scheduling activation or scheduling release, a DL SPS assignment PDCCH or configured UL grant Type 2 PDCCH if

- the CRC of a corresponding DCI format is scrambled with a CS-RNTI provided by *cs-RNTI*, and
- the new data indicator field for the enabled transport block is set to '0'.

Validation of the DCI format is achieved if all fields for the DCI format are set according to Table 10.2-1 or Table 10.2-2.

If validation is achieved, the UE considers the information in the DCI format as a valid activation or valid release of DL SPS or configured UL grant Type 2. If validation is not achieved, the UE discards all the information in the DCI format.

Table 10.2-1: Special fields for DL SPS and UL grant Type 2 scheduling activation PDCCH validation

	DCI format 0_0/0_1	DCI format 1_0	DCI format 1_1
HARQ process number	set to all '0's	set to all '0's	set to all '0's
Redundancy version	set to '00'	set to '00'	For the enabled transport block: set to '00'

Table 10.2-2: Special fields for DL SPS and UL grant Type 2 scheduling release PDCCH validation

	DCI format 0_0	DCI format 1_0
HARQ process number	set to all '0's	set to all '0's
Redundancy version	set to '00'	set to '00'
Modulation and coding scheme	set to all '1's	set to all '1's
Frequency domain resource assignment	set to all '1's	set to all '1's

A UE is expected to provide HARQ-ACK information in response to a SPS PDSCH release after {} symbols from the last symbol of a PDCCH providing the SPS PDSCH release. If *processingType2Enabled* of *PDSCH-ServingCellConfig* is set to *enable* for the serving cell with the PDCCH providing the SPS PDSCH release, $N=5$ for $\mu = 0$, $N=5.5$ for $\mu = 1$, and $N=11$ for $\mu = 2$, otherwise, $N=10$ for $\mu = 0$, $N=12$ for $\mu = 1$, $N=22$ for $\mu = 2$, and $N=25$ for $\mu = 3$, wherein μ corresponds to the smallest SCS configuration between the SCS configuration of the PDCCH providing the SPS PDSCH release and the SCS configuration of a PUCCH carrying the HARQ-ACK information in response to a SPS PDSCH release.

7.1.1.6.1.3 Test description

7.1.1.6.1.3.1 Pre-test conditions

Same Pre-test conditions as in clause 7.1.1.0 except that set to return no data in uplink.

7.1.1.6.1.3.2 Test procedure sequence

Table 7.1.1.6.1.3.2-1: Main behaviour

St	Procedure	Message Sequence		TP	Verdict
		U - S	Message		
1	The SS transmits a DL assignment using UE's CS-RNTI in Slot 'Y', NDI=0.	<--	(DL SPS Grant)	-	-
2	The SS transmits in Slot 'Y', a DL MAC PDU containing a RLC PDU (DL-SQN=0) on UM DRB.	<--	MAC PDU	-	-
3	Check: Does the UE transmit a HARQ ACK?	-->	HARQ ACK	1	P
4	The SS transmits in Slot 'Y+X', a DL MAC PDU containing a RLC PDU (DL-SQN=1) on DRB. (Note 1)	<--	MAC PDU	-	-
5	Check: Does the UE transmit a HARQ ACK?	-->	HARQ ACK	1	P

6	The SS transmits a DL assignment using UE's CS-RNTI in Slot 'P', NDI=0; (Where $Y+X < P < Y+2X$)	<--	(DL SPS Grant)	-	-
7	The SS transmits in Slot 'P', a DL MAC PDU containing a RLC PDU (DL-SQN=2) on UM DRB.	<--	MAC PDU	-	-
8	Check: Does the UE transmit a HARQ ACK?	-->	HARQ ACK	2	P
9	The SS transmits in Slot 'Y+2X', a DL MAC PDU containing a RLC PDU (DL-SQN=3) on UM DRB.	<--	MAC PDU	-	-
10	Check: Does the UE transmit a HARQ Feedback?	-->	HARQ ACK/NACK	2	F
11	The SS transmits a DL assignment using UE's C-RNTI in Slot 'P+X', NDI=0.	<--	(DL Grant)	-	-
12	The SS transmits in Slot 'P+X', a DL MAC PDU containing a RLC PDU (DL-SQN=3) on UM DRB.(Note2)	<--	MAC PDU	-	-
13	Check: Does the UE transmit a HARQ ACK?	-->	HARQ ACK	4	P
14	The SS transmits in Slot 'P+2X', a DL MAC PDU containing a RLC PDU (DL-SQN=4) on UM DRB.	<--	MAC PDU	-	-
15	Check: Does the UE transmit a HARQ ACK?	-->	HARQ ACK	1	P
16	The SS transmits a DL assignment using UE's CS-RNTI in Slot 'P+3X', NDI=0.	<--	(DL SPS Grant)	-	-
17	The SS transmits in Slot 'P+3X', a DL MAC PDU containing 1 RLC PDU's (DL-SQN=5) on UM DRB; CRC is calculated in such a way will result in CRC error in UE.	<--	MAC PDU	-	-
18	Check: Does the UE transmit a HARQ NACK?	-->	HARQ NACK	-	-
-	EXCEPTION: Step 19 and 20 shall be repeated until HARQ retransmission count = 3 is reached for MAC PDU at step 17.(Note 3)	-	-	-	-
19	The SS transmits a DL assignment using UE's CS-RNTI in Slot 'Z', NDI=1; Where $(P+3X < Z < P+4X)$; The DL HARQ process is same as in step 18.	<--	(DL SPS Grant)	-	-
20	The SS re-transmits in Slot 'Z', a DL MAC PDU containing a RLC PDU (DL-SQN=5) on UM DRB.	<--	MAC PDU	-	-
-	EXCEPTION: Up to 3 HARQ NACK from the UE should be allowed at step 21(Note 3).	-	-	-	-
21	Check: Does the UE transmit a HARQ ACK?	-->	HARQ ACK	3	P
22	The SS Transmits a PDCCH [for DL SPS deactivation] using UE's CS-RNTI in slot 'Q', NDI=0; Where $(P+3X < Q < P+4X)$.	<--	PDCCH [for DL SPS explicit release]	-	-
23	Check: Does the UE transmit a HARQ ACK?	-->	HARQ ACK	6	P
24	The SS transmits in Slot 'P+5X', a DL MAC PDU containing 1 RLC PDU's (DL-SQN=6) on UM DRB;	<--	MAC PDU	-	-
25	Check: Does the UE transmit a HARQ Feedback?	-->	HARQ ACK/NACK	6	F
26	The SS Transmits a DL assignment using UE's CS-RNTI in SF-Num 'P+6X', NDI=0	<--	(DL SPS Grant)	-	-
27	The SS transmits in SF-Num 'P+6X', a DL MAC PDU containing a RLC PDU (DL-SQN=6) on UM DRB	<--	MAC PDU	-	-
28	Check: Does the UE transmit a HARQ ACK?	-->	HARQ ACK	1	P
29	SS transmits NR RRCReconfiguration to disable SPS-ConfigurationDL.(Note 4)	<--	RRCReconfiguration	-	-
30	The UE transmits NR RRCReconfigurationComplete.(Note5)	-->	RRCReconfigurationComplete	-	-
31	The SS transmits in Slot 'P+5X', a DL MAC PDU containing 1 RLC PDU's (DL-SQN=7) on UM DRB;	<--	MAC PDU	-	-
32	Check: Does the UE transmit a HARQ Feedback?	-->	HARQ ACK/NACK	5	F

Note 1:	X is equal to semiPersistSchedIntervalDL in this document.
Note 2:	The DL assignment for C-RNTI and hence the size of MAC PDU is different in size than stored CS-RNTI DL assignment in step 6. This assures UE is receiving DSCH data as per DL assignment for C-RNTI and not as per stored grant for CS-RNTI.
Note 3:	The value 4 for the maximum number of HARQ retransmissions has been chosen based on an assumption that, given the radio conditions used in this test case, a UE soft combiner implementation should have sufficient retransmissions to be able to successfully decode the data in its soft buffer.
Note 4:	For EN-DC the NR RRCReconfiguration message is contained in RRCConnectionReconfiguration 36.508 [7], Table 4.6.1-8 using condition EN-DC_EmbedNR_RRCRecon.
Note 5:	For EN-DC the NR RRCReconfigurationComplete message is contained in RRCConnectionReconfigurationComplete.
Note 6:	As per TS 38.508-1[4], the default value for PDSCH slot offset (K_0) is 0, hence the DL MAC PDU's associated with DL SPS grant in Slot X are sent in same slot X.

7.1.1.6.1.3.3 Specific message contents

Table 7.1.1.6.1.3.3-1: RRCReconfiguration (Preamble)

Derivation path: 38.508-1 [4], Table 4.6.1-13			
Information Element	Value/remark	Comment	Condition
RRCReconfiguration ::= SEQUENCE {			
criticalExtensions CHOICE {			
rrcReconfiguration SEQUENCE {			
secondaryCellGroup	CellGroupConfig	OCTET STRING (CONTAINING CellGroupConfig)	EN-DC
	Not present		NR
nonCriticalExtension ::= SEQUENCE{}	Not present		EN-DC
nonCriticalExtension ::= SEQUENCE{			NR
masterCellGroup	CellGroupConfig	OCTET STRING (CONTAINING CellGroupConfig)	
}			
}			
}			
}			

Table 7.1.1.6.1.3.3-2: CellGroupConfig (Table 7.1.1.6.1.3.3-2)

Derivation path: 38.508-1 [4], Table 4.6.3-19			
Information Element	Value/remark	Comment	Condition
CellGroupConfig ::= SEQUENCE {			
spCellConfig SEQUENCE {			
servCellIndex	1		
	Not present		NR
spCellConfigDedicated SEQUENCE {			
initialDownlinkBWP SEQUENCE {			
sps-Config CHOICE {			
setup SEQUENCE {			
periodicity	ms40		
nrofHARQ-Processes	8		
n1PUCCH-AN SEQUENCE{			
pucch-ResourceId	0		
}			
}			
}			
}			
physicalCellGroupConfig SEQUENCE {			
cs-RNTI CHOICE {			
setup SEQUENCE{			
RNTI-Value	'FFE0'H		
}			

}			
}			
}			

Table 7.1.1.6.1.3.3-3: RRCReconfiguration (step 29 of Table 7.1.1.6.1.3.2-1)

Derivation path: 38.508-1 [4], Table 4.6.1-13			
Information Element	Value/remark	Comment	Condition
RRCReconfiguration ::= SEQUENCE {			
criticalExtensions CHOICE {			
rrcReconfiguration SEQUENCE {			
secondaryCellGroup	CellGroupConfig	OCTET STRING (CONTAINING CellGroupConfig)	EN-DC
	Not present		NR
nonCriticalExtension := SEQUENCE{}	Not present		EN-DC
nonCriticalExtension := SEQUENCE{			NR
masterCellGroup	CellGroupConfig	OCTET STRING (CONTAINING CellGroupConfig)	
}			
}			
}			
}			

Table 7.1.1.6.1.3.3-4: CellGroupConfig (Table 7.1.1.6.1.3.3-3)

Derivation path: 38.508-1 [4], Table 4.6.3-19			
Information Element	Value/remark	Comment	Condition
CellGroupConfig ::= SEQUENCE {			
spCellConfig SEQUENCE {			
servCellIndex	1		
	Not present		NR
spCellConfigDedicated SEQUENCE {			
initialDownlinkBWP SEQUENCE {			
sps-Config CHOICE {			
release	Null		
}			
}			
}			
}			
}			

7.1.1.6.2 Correct handling of UL grant / configured grant Type 1

7.1.1.6.2.1 Test Purpose (TP)

(1)

```

with { UE in RRC_Connected state with DRB established and sps-Configuration in UL is enabled with
Configured grant type 1 }
ensure that {
  when { The symbol in which equation  $[(SFN \times \text{numberOfSlotsPerFrame} \times \text{numberOfSymbolsPerSlot}) +
(\text{slot number in the frame} \times \text{numberOfSymbolsPerSlot}) + \text{symbol number in the slot}] =
(\text{timeDomainOffset} \times \text{numberOfSymbolsPerSlot} + S + N \times \text{periodicity}) \text{ modulo } (1024 \times
\text{numberOfSlotsPerFrame} \times \text{numberOfSymbolsPerSlot})$  is satisfied }
  then { UE starts transmitting UL MAC PDU periodically in the symbol associated with the new re-
configured grant }
}

```

(2)

```

with { UE in RRC_Connected state with DRB established and configured UL grant type 1 }
ensure that {
  when { UE receives a new UL grant type 1 in an RRC message }
  then { UE starts transmitting UL MAC PDU periodically in the symbol associated with the new re-
configured grant }
}

```

(3)

```

with { UE in RRC_Connected state with DRB established and configured UL grant type 1 }
ensure that {
  when { UE receives a RRC message including sps-Configuration with rrcConfiguredUplinkGrant set as
'release' }
  then { UE deletes the stored configured UL Grant type 1 parameters and stops transmitting UL MAC
PDU's as per configured UL grant type 1 }
}

```

(4)

```

with { UE in RRC_Connected state with DRB established and configured UL grant type 1 }
ensure that {
  when { UE receives a UL grant addressed to its CS-RNTI with NDI set as 1 for retransmission }
  then { UE re-transmits MAC PDU as per the new grant }
}

```

(5)

```

with { UE in RRC_Connected state with DRB established and configured UL grant type 1 }
ensure that {
  when { UE receives a UL grant addressed to its C-RNTI resulting in UL transmission overlap in time
domain as configured grante type 1 }
  then { UE transmits MAC PDU as per grant addressed to its C-RNTI }
}

```

7.1.1.6.2.2 Conformance requirements

References: The conformance requirements covered in the present TC are specified in: 3GPP TS 38.321 clauses 5.4.1 and 5.8.2, 3GPP TS 38.300 clause 10.3. Unless otherwise stated these are Rel-15 requirements.

[TS 38.321, clause 5.4.1]

Uplink grant is either received dynamically on the PDCCH, in a Random Access Response, or configured semi-persistently by RRC. The MAC entity shall have an uplink grant to transmit on the UL-SCH. To perform the requested transmissions, the MAC layer receives HARQ information from lower layers.

If the MAC entity has a C-RNTI, a Temporary C-RNTI, or CS-RNTI, the MAC entity shall for each PDCCH occasion and for each Serving Cell belonging to a TAG that has a running *timeAlignmentTimer* and for each grant received for this PDCCH occasion:

- 1> if an uplink grant for this Serving Cell has been received on the PDCCH for the MAC entity's C-RNTI or Temporary C-RNTI; or
- 1> if an uplink grant has been received in a Random Access Response:
 - 2> if the uplink grant is for MAC entity's C-RNTI and if the previous uplink grant delivered to the HARQ entity for the same HARQ process was either an uplink grant received for the MAC entity's CS-RNTI or a configured uplink grant:
 - 3> consider the NDI to have been toggled for the corresponding HARQ process regardless of the value of the NDI.
 - 2> if the uplink grant is for MAC entity's C-RNTI, and the identified HARQ process is configured for a configured uplink grant:
 - 3> start or restart the *configuredGrantTimer* for the corresponding HARQ process, if configured.
- 2> deliver the uplink grant and the associated HARQ information to the HARQ entity.

- 1> else if an uplink grant for this PDCCH occasion has been received for this Serving Cell on the PDCCH for the MAC entity's CS-RNTI:
 - 2> if the NDI in the received HARQ information is 1:
 - 3> consider the NDI for the corresponding HARQ process not to have been toggled;
 - 3> start or restart the *configuredGrantTimer* for the corresponding HARQ process, if configured;
 - 3> deliver the uplink grant and the associated HARQ information to the HARQ entity.
 - 2> else if the NDI in the received HARQ information is 0:
 - 3> if PDCCH contents indicate configured grant Type 2 deactivation:
 - 4> trigger configured uplink grant confirmation.
 - 3> else if PDCCH contents indicate configured grant Type 2 activation:
 - 4> trigger configured uplink grant confirmation;
 - 4> store the uplink grant for this Serving Cell and the associated HARQ information as configured uplink grant;
 - 4> initialise or re-initialise the configured uplink grant for this Serving Cell to start in the associated PUSCH duration and to recur according to rules in subclause 5.8.2;
 - 4> stop the *configuredGrantTimer* for the corresponding HARQ process, if running;

For each Serving Cell and each configured uplink grant, if configured and activated, the MAC entity shall:

- 1> if the PUSCH duration of the configured uplink grant does not overlap with the PUSCH duration of an uplink grant received on the PDCCH or in a Random Access Response for this Serving Cell:
 - 2> set the HARQ Process ID to the HARQ Process ID associated with this PUSCH duration;
- 2> if the *configuredGrantTimer* for the corresponding HARQ process is not running:
 - 3> consider the NDI bit for the corresponding HARQ process to have been toggled;
 - 3> deliver the configured uplink grant and the associated HARQ information to the HARQ entity.

For configured uplink grants, the HARQ Process ID associated with the first symbol of a UL transmission is derived from the following equation:

$$\text{HARQ Process ID} = [\text{floor}(\text{CURRENT_symbol}/\text{periodicity})] \text{ modulo } nrof\text{HARQ-Processes}$$

where $\text{CURRENT_symbol} = (\text{SFN} \times \text{numberOfSlotsPerFrame} \times \text{numberOfSymbolsPerSlot} + \text{slot number in the frame} \times \text{numberOfSymbolsPerSlot} + \text{symbol number in the slot})$, and *numberOfSlotsPerFrame* and *numberOfSymbolsPerSlot* refer to the number of consecutive slots per frame and the number of consecutive symbols per slot, respectively as specified in TS 38.211 [8].

NOTE 1: *CURRENT_symbol* refers to the symbol index of the first transmission occasion of a repetition bundle that takes place.

NOTE 2: A HARQ process is configured for a configured uplink grant if the configured uplink grant is activated and the associated HARQ process ID is less than *nrofHARQ-Processes*.

NOTE 3: If the MAC entity receives both a grant in a Random Access Response and an overlapping grant for its C-RNTI or CS-RNTI, requiring concurrent transmissions on the SpCell, the MAC entity may choose to continue with either the grant for its RA-RNTI or the grant for its C-RNTI or CS-RNTI.

[TS 38.321, clause 5.8.2]

There are two types of transmission without dynamic grant:

- configured grant Type 1 where an uplink grant is provided by RRC, and stored as configured uplink grant;

- configured grant Type 2 where an uplink grant is provided by PDCCH, and stored or cleared as configured uplink grant based on L1 signalling indicating configured uplink grant activation or deactivation.

Type 1 and Type 2 are configured by RRC per Serving Cell and per BWP. Multiple configurations can be active simultaneously only on different Serving Cells. For Type 2, activation and deactivation are independent among the Serving Cells. For the same Serving Cell, the MAC entity is configured with either Type 1 or Type 2.

RRC configures the following parameters when the configured grant Type 1 is configured:

- *cs-RNTI*: CS-RNTI for retransmission;
- *periodicity*: periodicity of the configured grant Type 1;
- *timeDomainOffset*: Offset of a resource with respect to SFN=0 in time domain;
- *timeDomainAllocation*: Allocation of configured uplink grant in time domain which contains *startSymbolAndLength* (i.e. *SLIV* in TS 38.214 [7]);
- *nrofHARQ-Processes*: the number of HARQ processes for configured grant.

RRC configures the following parameters when the configured grant Type 2 is configured:

- *cs-RNTI*: CS-RNTI for activation, deactivation, and retransmission;
- *periodicity*: periodicity of the configured grant Type 2;
- *nrofHARQ-Processes*: the number of HARQ processes for configured grant.

Upon configuration of a configured grant Type 1 for a Serving Cell by upper layers, the MAC entity shall:

- 1> store the uplink grant provided by upper layers as a configured uplink grant for the indicated Serving Cell;
- 1> initialise or re-initialise the configured uplink grant to start in the symbol according to *timeDomainOffset* and *S* (derived from *SLIV* as specified in TS 38.214 [7]), and to reoccur with *periodicity*.

After an uplink grant is configured for a configured grant Type 1, the MAC entity shall consider that the uplink grant recurs associated with each symbol for which:

$$[(SFN \times \text{numberOfSlotsPerFrame} \times \text{numberOfSymbolsPerSlot}) + (\text{slot number in the frame} \times \text{numberOfSymbolsPerSlot}) + \text{symbol number in the slot}] = (\text{timeDomainOffset} \times \text{numberOfSymbolsPerSlot} + S + N \times \text{periodicity}) \text{ modulo } (1024 \times \text{numberOfSlotsPerFrame} \times \text{numberOfSymbolsPerSlot}), \text{ for all } N \geq 0.$$

After an uplink grant is configured for a configured grant Type 2, the MAC entity shall consider that the uplink grant recurs associated with each symbol for which:

$$[(SFN \times \text{numberOfSlotsPerFrame} \times \text{numberOfSymbolsPerSlot}) + (\text{slot number in the frame} \times \text{numberOfSymbolsPerSlot}) + \text{symbol number in the slot}] = [(SFN_{\text{start time}} \times \text{numberOfSlotsPerFrame} \times \text{numberOfSymbolsPerSlot} + \text{slot}_{\text{start time}} \times \text{numberOfSymbolsPerSlot} + \text{symbol}_{\text{start time}}) + N \times \text{periodicity}] \text{ modulo } (1024 \times \text{numberOfSlotsPerFrame} \times \text{numberOfSymbolsPerSlot}), \text{ for all } N \geq 0.$$

where $SFN_{\text{start time}}$, $\text{slot}_{\text{start time}}$, and $\text{symbol}_{\text{start time}}$ are the SFN, slot, and symbol, respectively, of the first transmission opportunity of PUSCH where the configured uplink grant was (re-)initialised.

When a configured uplink grant is released by upper layers, all the corresponding configurations shall be released and all corresponding uplink grants shall be cleared.

The MAC entity shall:

- 1> if the configured uplink grant confirmation has been triggered and not cancelled; and
- 1> if the MAC entity has UL resources allocated for new transmission:
 - 2> instruct the Multiplexing and Assembly procedure to generate an Configured Grant Confirmation MAC CE as defined in subclause 6.1.3.7;

2> cancel the triggered configured uplink grant confirmation.

For a configured grant Type 2, the MAC entity shall clear the configured uplink grant immediately after first transmission of Configured Grant Confirmation MAC CE triggered by the configured uplink grant deactivation.

Retransmissions except for repetition of configured uplink grants use uplink grants addressed to CS-RNTI.

[TS 38.300, clause 10.3]

In the uplink, the gNB can dynamically allocate resources to UEs via the C-RNTI on PDCCH(s). A UE always monitors the PDCCH(s) in order to find possible grants for uplink transmission when its downlink reception is enabled (activity governed by DRX when configured). When CA is configured, the same C-RNTI applies to all serving cells.

In addition, with Configured Grants, the gNB can allocate uplink resources for the initial HARQ transmissions to UEs. Two types of configured uplink grants are defined:

- With Type 1, RRC directly provides the configured uplink grant (including the periodicity).
- With Type 2, RRC defines the periodicity of the configured uplink grant while PDCCH addressed to CS-RNTI can either signal and activate the configured uplink grant, or deactivate it; i.e. a PDCCH addressed to CS-RNTI indicates that the uplink grant can be implicitly reused according to the periodicity defined by RRC, until deactivated.

The dynamically allocated uplink transmission overrides the configured uplink grant in the same serving cell, if they overlap in time. Otherwise an uplink transmission according to the configured uplink grant is assumed, if activated.

Retransmissions other than repetitions are explicitly allocated via PDCCH(s).

When CA is configured, at most one configured uplink grant can be signalled per serving cell. When BA is configured, at most one configured uplink grant can be signalled per BWP. On each serving cell, there can be only one configured uplink grant active at a time. A configured uplink grant for one serving cell can either be of Type 1 or Type 2. For Type 2, activation and deactivation of configured uplink grants are independent among the serving cells. When SUL is configured, a configured uplink grant can only be signalled for one of the 2 ULs of the cell.

7.1.1.6.2.3 Test description

7.1.1.6.2.3.1 Pre-test conditions

Same Pre-test conditions as in clause 7.1.1.0 and UM DRB should be established on NR Cell 1.

7.1.1.6.2.3.2 Test procedure sequence

Table 7.1.1.6.2.3.2-1: Main behaviour

St	Procedure	Message Sequence		TP	Verdict
		U - S	Message		
1	SS transmits NR <i>RRCReconfiguration</i> message to configure UL configured grant type 1 in SFN 900, <i>timeDomainOffset</i> is set to 5. (Note 1)	<--	(NR RRC: <i>RRCReconfiguration</i>)	-	-
2	The UE transmits NR <i>RRCReconfigurationComplete</i> message. (Note 2)	-->	(NR RRC: <i>RRCReconfigurationComplete</i>)	-	-
3	SS transmits a DL MAC PDU containing 4 RLC SDUs of size 96 bytes in SFN 1022 on UM DRB. (Note 3)	<--	MAC PDU (nine RLC SDUs)	-	-
4	Check: Does the UE transmit a MAC PDU containing first RLC SDU in Symbol 'x0', Slot y0', SFN 'z0' after the SFN in step 3 wraps around? Where [(z0 × <i>numberOfSlotsPerFrame</i> × <i>numberOfSymbolsPerSlot</i>) + (y0 × <i>numberOfSymbolsPerSlot</i>) + x0] = (5 × <i>numberOfSymbolsPerSlot</i> + S + 0 ×	-->	MAC PDU (one RLC SDU)	1	P

	$periodicity) \bmod (1024 \times numberOfSlotsPerFrame \times numberOfSymbolsPerSlot)$. (Note 4)				
5	Check: Does the UE transmit a MAC PDU containing second RLC SDU in Symbol 'x1', Slot y1', SFN 'z1'? Where $[(z1 \times numberOfSlotsPerFrame \times numberOfSymbolsPerSlot) + (y1 \times numberOfSymbolsPerSlot) + x1] = (5 \times numberOfSymbolsPerSlot + S + 1 \times periodicity) \bmod (1024 \times numberOfSlotsPerFrame \times numberOfSymbolsPerSlot)$.	-->	MAC PDU (one RLC SDU)	1	P
6	SS transmits NR <i>RRCReconfiguration</i> message to configure UL configured grant type 1 in SFN 'z1 + 1', <i>timeDomainOffset</i> is set to 35.	<--	(NR RRC: <i>RRCReconfiguration</i>)	-	-
7	The UE transmits NR <i>RRCReconfigurationComplete</i> . message	-->	(NR RRC: <i>RRCReconfigurationComplete</i>)	-	-
8	Check: Does the UE transmit a MAC PDU containing third RLC SDU received in step 4 in Symbol 'x2', Slot y2', SFN 'z2'? Where $[(z2 \times numberOfSlotsPerFrame \times numberOfSymbolsPerSlot) + (y2 \times numberOfSymbolsPerSlot) + x2] = (5 \times numberOfSymbolsPerSlot + S + N \times periodicity) \bmod (1024 \times numberOfSlotsPerFrame \times numberOfSymbolsPerSlot)$, $N \geq 2$.	-->	MAC PDU (one RLC SDU)	2	F
9	Check: Does the UE transmit a MAC PDU containing fourth RLC SDU in Symbol 'x3', Slot y3', SFN 'z3' after the SFN in step 8 wraps around? Where $[(z3 \times numberOfSlotsPerFrame \times numberOfSymbolsPerSlot) + (y3 \times numberOfSymbolsPerSlot) + x3] = (35 \times numberOfSymbolsPerSlot + S + 0 \times periodicity) \bmod (1024 \times numberOfSlotsPerFrame \times numberOfSymbolsPerSlot)$.	-->	MAC PDU (one RLC SDU)	2	P
10	Check: Does the UE transmit a MAC PDU containing fifth RLC SDU in Symbol 'x4', Slot y4', SFN 'z4'? Where $[(z4 \times numberOfSlotsPerFrame \times numberOfSymbolsPerSlot) + (y4 \times numberOfSymbolsPerSlot) + x4] = (35 \times numberOfSymbolsPerSlot + S + 1 \times periodicity) \bmod (1024 \times numberOfSlotsPerFrame \times numberOfSymbolsPerSlot)$.	-->	MAC PDU (one RLC SDU)	2	P
11	SS transmits a UL grant addressed to UE's stored CS-RNTI with NDI set as 1 in Slot 'p0' of PDCCH ($p0 = \text{floor}((y4 + 2) \times (PDCCH_{scs} / PUSCH_{scs}))$), allowing the UE to retransmit one loop back SDU.	<--	(UL Grant)	-	-
12	Check: Does the UE retransmit the MAC PDU containing the same fifth RLC SDU as in step 10 in Symbol 'S' of Slot 'q' of PUSCH? i.e., in the PUSCH slot $q = \text{floor}(p0 \times (PUSCH_{scs} / PDCCH_{scs})) + K_2$. (Note 5)	-->	MAC PDU (one RLC SDU)	4	P
13	Check: Does the UE transmit a MAC PDU containing sixth RLC SDU in Symbol 'x5', Slot y5', SFN 'z5'?	-->	MAC PDU (one RLC SDU)	1	P

	Where $[(z5 \times \text{numberOfSlotsPerFrame} \times \text{numberOfSymbolsPerSlot}) + (y5 \times \text{numberOfSymbolsPerSlot}) + x5] = (35 \times \text{numberOfSymbolsPerSlot} + S + 2 \times \text{periodicity}) \text{ modulo } (1024 \times \text{numberOfSlotsPerFrame} \times \text{numberOfSymbolsPerSlot}).$				
14	SS transmits a UL Grant using UE's C-RNTI in in Slot 'p1' of PDCCH allowing UE to transmit a MAC PDU containing two RLC SDU, where $p1 = \text{floor}((z6 \times \text{numberOfSlotsPerFrame} - K_2) * (\text{PDCCH}_{\text{scs}} / \text{PUSCH}_{\text{scs}}))$. (Note 6) Where $[(z6 \times \text{numberOfSlotsPerFrame} \times \text{numberOfSymbolsPerSlot}) + (y6 \times \text{numberOfSymbolsPerSlot}) + x6] = (35 \times \text{numberOfSymbolsPerSlot} + S + 3 \times \text{periodicity}) \text{ modulo } (1024 \times \text{numberOfSlotsPerFrame} \times \text{numberOfSymbolsPerSlot}).$	<--	(UL Grant)	-	-
15	Check: Does the UE transmit a MAC PDU containing seventh and eight RLC SDU's in Symbol 'x6', Slot 'y6', SFN 'z6'?	-->	MAC PDU (two RLC SDU's)	5	P
16	Check: Does the UE transmit a MAC PDU containing one RLC SDU in Symbol 'x7', Slot 'y7', SFN 'z7'? Where $[(z7 \times \text{numberOfSlotsPerFrame} \times \text{numberOfSymbolsPerSlot}) + (y7 \times \text{numberOfSymbolsPerSlot}) + x7] = (35 \times \text{numberOfSymbolsPerSlot} + S + 4 \times \text{periodicity}) \text{ modulo } (1024 \times \text{numberOfSlotsPerFrame} \times \text{numberOfSymbolsPerSlot}).$	-->	MAC PDU (one RLC SDU)	1	P
17	After step 16, SS transmits NR <i>RRCReconfiguration</i> message to release UL configured grant type 1 in SFN 'z4 + 1'.	<--	(NR RRC: <i>RRCReconfiguration</i>)	-	-
18	The UE transmits NR <i>RRCReconfigurationComplete</i> message.	-->	(NR RRC: <i>RRCReconfigurationComplete</i>)	-	-
19	SS transmits a DL MAC PDU containing one RLC SDU of size 96 bytes in SFN 'z7 + 10'.	<--	MAC PDU (one RLC SDU)		
20	Check: Does the UE transmit a MAC PDU containing one RLC SDU in Symbol 'x8', Slot 'y8', SFN 'z8'? Where $[(z8 \times \text{numberOfSlotsPerFrame} \times \text{numberOfSymbolsPerSlot}) + (y8 \times \text{numberOfSymbolsPerSlot}) + x8] = (35 \times \text{numberOfSymbolsPerSlot} + S + 8 \times \text{periodicity}) \text{ modulo } (1024 \times \text{numberOfSlotsPerFrame} \times \text{numberOfSymbolsPerSlot}).$	-->	MAC PDU (one RLC SDU)	3	F
Note 1: For EN-DC the NR <i>RRCReconfiguration</i> message is contained in <i>RRCConnectionReconfiguration</i> . Note 2: For EN-DC the NR <i>RRCReconfigurationComplete</i> message is contained in <i>RRCConnectionReconfigurationComplete</i> . Note 3: According to the setting parameters in Table 7.1.1.6.2.3.3-2, TB size for configured grant type 1 is 808 bits, which is enough to allow the UE to transmit one PDU at a time (96 bytes RLC SDU + 1 byte UM RLC Header + 2 bytes MAC Sub PDU header + 2 bytes for short BSR or padding). Note 4: S is the starting symbol relative to the slot of the first PUSCH transmission for new configured grant type 1. The value of S can be obtained from TS 38.508-1 [4], Table 4.6.3-122. Note 5: q is the slot where the UE shall transmit the PUSCH and is determined by K_2 as $\left\lceil n \cdot \frac{2^{\mu_{\text{PUSCH}}}}{2^{\mu_{\text{PDCCH}}}} \right\rceil + K_2$ where n is the slot with the scheduling DCI, K_2 is based on the numerology of PUSCH. S is the starting symbol related to the start of the slot q according to TS 38.214 clause 6.1.2.1.					

Note 6: The UL grant addressed to C-RNTI should result in UL transmission overlap in time domain as configured grant type 1.

7.1.1.6.2.3.3 Specific message contents

Table 7.1.1.6.2.3.3-1: RRCReconfiguration (step 1 and step 6, Table 7.1.1.6.2.3.2-1)

Derivation path: 38.508-1 [4], Table 4.6.1-13			
Information Element	Value/remark	Comment	Condition
RRCReconfiguration ::= SEQUENCE {			
criticalExtensions CHOICE {			
rrcReconfiguration SEQUENCE {			
radioBearerConfig	Not present		
secondaryCellGroup	CellGroupConfig	OCTET STRING (CONTAINING CellGroupConfig)	EN-DC
	Not Present		NR
nonCriticalExtension := SEQUENCE {}	Not present		EN-DC
nonCriticalExtension := SEQUENCE{			NR
masterCellGroup	CellGroupConfig	OCTET STRING (CONTAINING CellGroupConfig)	
dedicatedNAS-MessageList SEQUENCE (SIZE(1..maxDRB)) OF DedicatedNAS-Message {}	Not present		
}			
}			
}			

Table 7.1.1.6.2.3.3-2: CellGroupConfig (Table 7.1.1.6.2.3.3-2: RRCReconfiguration)

Derivation path: 38.508-1 [4], Table 4.6.3-19			
Information Element	Value/remark	Comment	Condition
CellGroupConfig ::= SEQUENCE {			
rlc-BearerToAddModList	Not present		
mac-CellGroupConfig	Not present		
physicalCellGroupConfig SEQUENCE {			
cs-RNTI CHOICE {			
setup SEQUENCE{			
RNTI-Value	'FFE0'H		
}			
}			
}			
spCellConfig SEQUENCE{			
servCellIndex	Not present		NR
	1		EN-DC
reconfigurationWithSync	Not present		
spCellConfigDedicated SEQUENCE{			
uplinkConfig SEQUENCE {			
initialUplink SEQUENCE {			
pucch-Config CHOICE {			
setup SEQUENCE {			
schedulingRequestResourceToAddModList {			
schedulingRequestResourceId	1		
schedulingRequestID	0		
periodicityAndOffset CHOICE {			
sl20	10		
}			
}			
}			
}			
}			
configuredGrantConfig CHOICE {			
setup SEQUENCE {			

cg-DMRS-Configuration	DMRS-UplinkConfig	Reference TS 38.508-1[4], Table 4.6.3-51	
uci-OnPUSCH CHOICE {			
setup SEQUENCE {			
semiStatic SEQUENCE {	BetaOffsets		
betaOffsetACK-Index1	9		
betaOffsetACK-Index2	9		
betaOffsetACK-Index3	9		
betaOffsetCSI-Part1-Index1	6		
betaOffsetCSI-Part1-Index2	6		
betaOffsetCSI-Part2-Index1	6		
betaOffsetCSI-Part2-Index2	6		
}			
}			
}			
resourceAllocation	ResourceAllocationType 1		
powerControlLoopToUse	n0		
p0-PUSCH-Alpha	1		
nrofHARQ-Processes	16		
repK	n1		
periodicity	Sym40x14		15kHz
periodicity	Sym80x14		30kHz
periodicity	Sym160x14		60kHz
periodicity	Sym320x14		120kHz
rrc-ConfiguredUplinkGrant SEQUENCE{			
timeDomainOffset	5 35		For Step 1 For Step 6
timeDomainAllocation	0	Reference TS 38.508-1 [4], Table 4.6.3-122	
frequencyDomainAllocation	BIT STRING (SIZE(18))	BIT STRING (SIZE(18), Equal to NBWPsize * (LRB- 1) + RBstart), where LRB = 2 PRB, RBstart = 0, NBWPsize is the size [PRBs] of the active carrier bandwidth part and ontained in TS.38.508-1 [4] clause 4.3.1.1.	FR1_FDD, FR1_TDD
frequencyDomainAllocation	BIT STRING (SIZE(18))	BIT STRING (SIZE(18), Equal to NBWPsize * (LRB- 1) + RBstart), where LRB=9 PRB, RBstart = 0and NBWPsize is the size [PRBs] of the active carrier bandwidth part and ontained in TS.38.508-1 [4] clause 4.3.1.2.	FR2_TDD
antennaPort	0		
precodingAndNumberOfLayers	0		
srs-ResourceIndicator	Not present		

mcsAndTBS	18		FR1_FDD, FR1_TDD
	25		FR2_TDD
pathlossReferenceIndex	0		
}			
}			
pusch-Config CHOICE {			
setup SEQUENCE {			
PUSCH-TimeDomainResourceAllocationList			
SEQUENCE {			
k2	n8		FR1 and FR2
mappingType	typeB		
startSymbolAndLength	0011011	Start symbol(S)=0, Length(L)=14	FR1
startSymbolAndLength	0001110	S=0, L=2	FR2
}			
}			
}			
}			
}			
}			
}			
}			
}			
}			
}			

Table 7.1.1.6.2.3.3-3: RRCReconfiguration (step 11, Table 7.1.1.6.2.3.2-1)

Derivation path: 38.508-1 [4], Table 4.6.1-13			
Information Element	Value/remark	Comment	Condition
RRCReconfiguration ::= SEQUENCE {			
criticalExtensions CHOICE {			
rrcReconfiguration SEQUENCE {			
radioBearerConfig	Not present		
secondaryCellGroup	CellGroupConfig	OCTET STRING (CONTAINING CellGroupConfig)	EN-DC
	Not present		NR
nonCriticalExtension := SEQUENCE {}	Not present		EN-DC
nonCriticalExtension := SEQUENCE {}			NR
masterCellGroup	CellGroupConfig	OCTET STRING (CONTAINING CellGroupConfig)	
dedicatedNAS-MessageList SEQUENCE (SIZE(1..maxDRB)) OF DedicatedNAS-Message {}	Not present		
}			
}			
}			
}			

Table 7.1.1.6.2.3.3-4: CellGroupConfig (Table 7.1.1.6.2.3.3-3: RRCReconfiguration)

Derivation path: 38.508-1 [4], Table 4.6.3-19			
Information Element	Value/remark	Comment	Condition
CellGroupConfig ::= SEQUENCE {			
spCellConfig SEQUENCE {			
spCellConfigDedicated SEQUENCE {			
uplinkConfig SEQUENCE {			
initialUplink SEQUENCE {			
configuredGrantConfig CHOICE {			
release	Null		
}			
}			
}			
}			

}			
}			
}			
}			

7.1.1.6.3 Correct handling of UL grant / configured grant Type 2

7.1.1.6.3.1 Test Purpose (TP)

(1)

```
with { UE in RRC_Connected state with DRB established and sps-Configuration in UL is enabled }
ensure that {
  when { UE receives an UL configured grant type 2 addressed to its stored CS-RNTI with NDI set as 0
and PDCCH content indicates SPS activation }
  then { UE starts transmitting UL MAC PDU periodically in the symbol associated with the
configured grant }
}
```

(2)

```
with { UE in RRC_Connected state with DRB established and configured UL grant type 2 }
ensure that {
  when { UE receives a UL grant addressed to its CS-RNTI with NDI set as 0 }
  then { UE starts transmitting UL MAC PDU periodically in the symbol associated with the new re-
configured grant }
}
```

(3)

```
with { UE in RRC_Connected state with DRB established and configured UL grant type 2 }
ensure that {
  when { UE receives a UL grant addressed to its CS-RNTI with NDI set as 1 for retransmission }
  then { UE re-transmits MAC PDU as per the new grant }
}
```

(4)

```
with{ UE in RRC_Connected state with DRB established and configured UL grant type 2 }
ensure that {
  when { UE receives a UL grant addressed to its C-RNTI resulting in UL transmission overlap in time
domain as configured grante type 2 }
  then { UE transmits MAC PDU as per grant addressed to its C-RNTI }
}
```

(5)

```
with { UE in RRC_Connected state with DRB established and configured UL grant type 2 }
ensure that {
  when { UE receives a RRC message including sps-Configuration with sps-ConfigurationUL set as
'disable' and hence resulting in UL SPS grant deactivation }
  then { UE deletes the stored sps-Configuration UL parameters and stops transmitting UL MAC PDU's
as per configured UL grant type 2 }
}
```

(6)

```
with{ UE in RRC_Connected state with DRB established and configured UL grant type 2 }
ensure that {
  when{ If in the symbol in which UL Configured Grant type 2 is available but the HARQ buffer is
empty (no data for transmission) }
  then{ UE ignores the UL configured grant type 2 and does not send any MAC PDU }
}
```

(7)

```
with { UE in RRC_Connected state with DRB established and sps-Configuration in UL is enabled }
ensure that {
```

```

when { UE receives UL configured grant type 2 addressed to its stored CS-RNTI in slot p and with
      NDI set as 0 and PDCCH content indicates SPS deactivation }
  then { UE transmits configured Grant Confirmation MAC CE confirming the deactivation and stops
        transmitting UL MAC PDU's as per configured UL grant type 2 }
}

```

7.1.1.6.3.2 Conformance requirements

References: The conformance requirements covered in the present TC are specified in: 3GPP TS 38.321 clauses 5.4.1 and 5.8.2, 3GPP TS 38.300 clauses 10.3 and TS 38.213 clause 102. Unless otherwise stated these are Rel-15 requirements.

[TS 38.321, clause 5.4.1]

Uplink grant is either received dynamically on the PDCCH, in a Random Access Response, or configured semi-persistently by RRC. The MAC entity shall have an uplink grant to transmit on the UL-SCH. To perform the requested transmissions, the MAC layer receives HARQ information from lower layers.

If the MAC entity has a C-RNTI, a Temporary C-RNTI, or CS-RNTI, the MAC entity shall for each PDCCH occasion and for each Serving Cell belonging to a TAG that has a running *timeAlignmentTimer* and for each grant received for this PDCCH occasion:

- 1> if an uplink grant for this Serving Cell has been received on the PDCCH for the MAC entity's C-RNTI or Temporary C-RNTI; or
- 1> if an uplink grant has been received in a Random Access Response:
 - 2> if the uplink grant is for MAC entity's C-RNTI and if the previous uplink grant delivered to the HARQ entity for the same HARQ process was either an uplink grant received for the MAC entity's CS-RNTI or a configured uplink grant:
 - 3> consider the NDI to have been toggled for the corresponding HARQ process regardless of the value of the NDI.
 - 2> if the uplink grant is for MAC entity's C-RNTI, and the identified HARQ process is configured for a configured uplink grant:
 - 3> start or restart the *configuredGrantTimer* for the corresponding HARQ process, if configured.
 - 2> deliver the uplink grant and the associated HARQ information to the HARQ entity.
- 1> else if an uplink grant for this PDCCH occasion has been received for this Serving Cell on the PDCCH for the MAC entity's CS-RNTI:
 - 2> if the NDI in the received HARQ information is 1:
 - 3> consider the NDI for the corresponding HARQ process not to have been toggled;
 - 3> start or restart the *configuredGrantTimer* for the corresponding HARQ process, if configured;
 - 3> deliver the uplink grant and the associated HARQ information to the HARQ entity.
 - 2> else if the NDI in the received HARQ information is 0:
 - 3> if PDCCH contents indicate configured grant Type 2 deactivation:
 - 4> trigger configured uplink grant confirmation.
 - 3> else if PDCCH contents indicate configured grant Type 2 activation:
 - 4> trigger configured uplink grant confirmation;
 - 4> store the uplink grant for this Serving Cell and the associated HARQ information as configured uplink grant;
 - 4> initialise or re-initialise the configured uplink grant for this Serving Cell to start in the associated PUSCH duration and to recur according to rules in subclause 5.8.2;

4> stop the *configuredGrantTimer* for the corresponding HARQ process, if running;

For each Serving Cell and each configured uplink grant, if configured and activated, the MAC entity shall:

- 1> if the PUSCH duration of the configured uplink grant does not overlap with the PUSCH duration of an uplink grant received on the PDCCH or in a Random Access Response for this Serving Cell:
 - 2> set the HARQ Process ID to the HARQ Process ID associated with this PUSCH duration;
- 2> if the *configuredGrantTimer* for the corresponding HARQ process is not running:
 - 3> consider the NDI bit for the corresponding HARQ process to have been toggled;
 - 3> deliver the configured uplink grant and the associated HARQ information to the HARQ entity.

For configured uplink grants, the HARQ Process ID associated with the first symbol of a UL transmission is derived from the following equation:

$$\text{HARQ Process ID} = [\text{floor}(\text{CURRENT_symbol}/\text{periodicity})] \text{ modulo } n\text{rofHARQ-Processes}$$

where $\text{CURRENT_symbol} = (\text{SFN} \times \text{numberOfSlotsPerFrame} \times \text{numberOfSymbolsPerSlot} + \text{slot number in the frame} \times \text{numberOfSymbolsPerSlot} + \text{symbol number in the slot})$, and *numberOfSlotsPerFrame* and *numberOfSymbolsPerSlot* refer to the number of consecutive slots per frame and the number of consecutive symbols per slot, respectively as specified in TS 38.211 [8].

NOTE 1: *CURRENT_symbol* refers to the symbol index of the first transmission occasion of a repetition bundle that takes place.

NOTE 2: A HARQ process is configured for a configured uplink grant if the configured uplink grant is activated and the associated HARQ process ID is less than *nrofHARQ-Processes*.

NOTE 3: If the MAC entity receives both a grant in a Random Access Response and an overlapping grant for its C-RNTI or CS-RNTI, requiring concurrent transmissions on the SpCell, the MAC entity may choose to continue with either the grant for its RA-RNTI or the grant for its C-RNTI or CS-RNTI.

[TS 38.321, clause 5.8.2]

There are two types of transmission without dynamic grant:

- configured grant Type 1 where an uplink grant is provided by RRC, and stored as configured uplink grant;
- configured grant Type 2 where an uplink grant is provided by PDCCH, and stored or cleared as configured uplink grant based on L1 signalling indicating configured uplink grant activation or deactivation.

Type 1 and Type 2 are configured by RRC per Serving Cell and per BWP. Multiple configurations can be active simultaneously only on different Serving Cells. For Type 2, activation and deactivation are independent among the Serving Cells. For the same Serving Cell, the MAC entity is configured with either Type 1 or Type 2.

RRC configures the following parameters when the configured grant Type 1 is configured:

- *cs-RNTI*: CS-RNTI for retransmission;
- *periodicity*: periodicity of the configured grant Type 1;
- *timeDomainOffset*: Offset of a resource with respect to SFN=0 in time domain;
- *timeDomainAllocation*: Allocation of configured uplink grant in time domain which contains *startSymbolAndLength* (i.e. *SLIV* in TS 38.214 [7]);
- *nrofHARQ-Processes*: the number of HARQ processes for configured grant.

RRC configures the following parameters when the configured grant Type 2 is configured:

- *cs-RNTI*: CS-RNTI for activation, deactivation, and retransmission;
- *periodicity*: periodicity of the configured grant Type 2;

- *nrofHARQ-Processes*: the number of HARQ processes for configured grant.

Upon configuration of a configured grant Type 1 for a Serving Cell by upper layers, the MAC entity shall:

- 1> store the uplink grant provided by upper layers as a configured uplink grant for the indicated Serving Cell;
- 1> initialise or re-initialise the configured uplink grant to start in the symbol according to *timeDomainOffset* and *S* (derived from *SLIV* as specified in TS 38.214 [7]), and to reoccur with *periodicity*.

After an uplink grant is configured for a configured grant Type 1, the MAC entity shall consider that the uplink grant recurs associated with each symbol for which:

$$[(SFN \times \text{numberOfSlotsPerFrame} \times \text{numberOfSymbolsPerSlot}) + (\text{slot number in the frame} \times \text{numberOfSymbolsPerSlot}) + \text{symbol number in the slot}] = (\text{timeDomainOffset} \times \text{numberOfSymbolsPerSlot} + S + N \times \text{periodicity}) \text{ modulo } (1024 \times \text{numberOfSlotsPerFrame} \times \text{numberOfSymbolsPerSlot}), \text{ for all } N \geq 0.$$

After an uplink grant is configured for a configured grant Type 2, the MAC entity shall consider that the uplink grant recurs associated with each symbol for which:

$$[(SFN \times \text{numberOfSlotsPerFrame} \times \text{numberOfSymbolsPerSlot}) + (\text{slot number in the frame} \times \text{numberOfSymbolsPerSlot}) + \text{symbol number in the slot}] = [(SFN_{\text{start time}} \times \text{numberOfSlotsPerFrame} \times \text{numberOfSymbolsPerSlot} + \text{slot}_{\text{start time}} \times \text{numberOfSymbolsPerSlot} + \text{symbol}_{\text{start time}}) + N \times \text{periodicity}] \text{ modulo } (1024 \times \text{numberOfSlotsPerFrame} \times \text{numberOfSymbolsPerSlot}), \text{ for all } N \geq 0.$$

where $SFN_{\text{start time}}$, $\text{slot}_{\text{start time}}$, and $\text{symbol}_{\text{start time}}$ are the SFN, slot, and symbol, respectively, of the first transmission opportunity of PUSCH where the configured uplink grant was (re-)initialised.

When a configured uplink grant is released by upper layers, all the corresponding configurations shall be released and all corresponding uplink grants shall be cleared.

The MAC entity shall:

- 1> if the configured uplink grant confirmation has been triggered and not cancelled; and
- 1> if the MAC entity has UL resources allocated for new transmission:
 - 2> instruct the Multiplexing and Assembly procedure to generate an Configured Grant Confirmation MAC CE as defined in subclause 6.1.3.7;
 - 2> cancel the triggered configured uplink grant confirmation.

For a configured grant Type 2, the MAC entity shall clear the configured uplink grant immediately after first transmission of Configured Grant Confirmation MAC CE triggered by the configured uplink grant deactivation.

Retransmissions except for repetition of configured uplink grants use uplink grants addressed to CS-RNTI.

[TS 38.300, clause 10.3]

In the uplink, the gNB can dynamically allocate resources to UEs via the C-RNTI on PDCCH(s). A UE always monitors the PDCCH(s) in order to find possible grants for uplink transmission when its downlink reception is enabled (activity governed by DRX when configured). When CA is configured, the same C-RNTI applies to all serving cells.

In addition, with Configured Grants, the gNB can allocate uplink resources for the initial HARQ transmissions to UEs. Two types of configured uplink grants are defined:

- With Type 1, RRC directly provides the configured uplink grant (including the periodicity).
- With Type 2, RRC defines the periodicity of the configured uplink grant while PDCCH addressed to CS-RNTI can either signal and activate the configured uplink grant, or deactivate it; i.e. a PDCCH addressed to CS-RNTI indicates that the uplink grant can be implicitly reused according to the periodicity defined by RRC, until deactivated.

The dynamically allocated uplink transmission overrides the configured uplink grant in the same serving cell, if they overlap in time. Otherwise an uplink transmission according to the configured uplink grant is assumed, if activated.

Retransmissions other than repetitions are explicitly allocated via PDCCH(s).

When CA is configured, at most one configured uplink grant can be signalled per serving cell. When BA is configured, at most one configured uplink grant can be signalled per BWP. On each serving cell, there can be only one configured uplink grant active at a time. A configured uplink grant for one serving cell can either be of Type 1 or Type 2. For Type 2, activation and deactivation of configured uplink grants are independent among the serving cells. When SUL is configured, a configured uplink grant can only be signalled for one of the 2 ULs of the cell.

[TS 38.213, clause 10.2]

A UE validates, for scheduling activation or scheduling release, a DL SPS assignment PDCCH or configured UL grant Type 2 PDCCH if

- the CRC of a corresponding DCI format is scrambled with a CS-RNTI provided by *cs-RNTI*, and
- the new data indicator field for the enabled transport block is set to '0'.

Validation of the DCI format is achieved if all fields for the DCI format are set according to Table 10.2-1 or Table 10.2-2.

If validation is achieved, the UE considers the information in the DCI format as a valid activation or valid release of DL SPS or configured UL grant Type 2. If validation is not achieved, the UE discards all the information in the DCI format.

Table 10.2-1: Special fields for DL SPS and UL grant Type 2 scheduling activation PDCCH validation

	DCI format 0_0/0_1	DCI format 1_0	DCI format 1_1
HARQ process number	set to all '0's	set to all '0's	set to all '0's
Redundancy version	set to '00'	set to '00'	For the enabled transport block: set to '00'

Table 10.2-2: Special fields for DL SPS and UL grant Type 2 scheduling release PDCCH validation

	DCI format 0_0	DCI format 1_0
HARQ process number	set to all '0's	set to all '0's
Redundancy version	set to '00'	set to '00'
Modulation and coding scheme	set to all '1's	set to all '1's
Frequency domain resource assignment	set to all '1's	set to all '1's

A UE is expected to provide HARQ-ACK information in response to a SPS PDSCH release after N symbols from the last symbol of a PDCCH providing the SPS PDSCH release. If *processingType2Enabled* of *PDSCH-ServingCellConfig* is set to *enable* for the serving cell with the PDCCH providing the SPS PDSCH release, $N=5$ for $\mu = 0$, $N=5.5$ for $\mu = 1$, and $N=11$ for $\mu = 2$, otherwise, $N=10$ for $\mu = 0$, $N=12$ for $\mu = 1$, $N=22$ for $\mu = 2$, and $N=25$ for $\mu = 3$, wherein μ corresponds to the smallest SCS configuration between the SCS configuration of the PDCCH providing the SPS PDSCH release and the SCS configuration of a PUCCH carrying the HARQ-ACK information in response to a SPS PDSCH release.

7.1.1.6.3.3 Test description

7.1.1.6.3.3.1 Pre-test conditions

Same Pre-test conditions as in clause 7.1.1.0 and UM DRB should be established on NR Cell 1. The loop back size is set to accommodate one RLC SDU in UL of same size as one RLC SDU in DL and 1 byte MAC subheader for Configured Grant Confirmation MAC CE.

7.1.1.6.3.3.2 Test procedure sequence

Table 7.1.1.6.3.3.2-1: Main behaviour

St	Procedure	Message Sequence		TP	Verdict
		U - S	Message		

1	SS transmits NR <i>RRCReconfiguration</i> message to configure UL configured grant type 2. (Note 1)	<--	(NR RRC: <i>RRCReconfiguration</i>)	-	-
2	The UE transmits NR <i>RRCReconfigurationComplete</i> message. (Note 2)	-->	(NR RRC: <i>RRCReconfigurationComplete</i>)	-	-
3	SS transmits a DL MAC PDU containing 6 RLC SDUs on UM DRB.	<--	MAC PDU	-	-
4	The UE transmits a Scheduling Request, indicating that loop back SDUs are ready for transmission in UL RLC.	-->	(SR)	-	-
5	SS transmits a UL configured grant type 2 addressed to UE's stored CS-RNTI in Slot 'n' of PDCCH, NDI=0, allowing the UE to transmit one loop back SDU and 1 byte MAC subheader for Configured Grant Confirmation MAC CE.	<--	(UL configured Grant type 2)	-	-
6	Check: Does the UE transmit a MAC PDU containing one RLC SDU and a Configured Grant Confirmation MAC CE in Symbol 'S' of Slot 'y' of PUSCH as per grant in step 5? i.e., in the PUSCH slot $y = \text{floor}(n * (\text{PUSCH}_{\text{scs}} / \text{PDCCH}_{\text{scs}})) + K_2$. (Note 3)	-->	MAC PDU	1	P
7	Check: Does the UE transmit a MAC PDU containing one RLC SDU in Symbol 'S' of Slot 'y + x' of PUSCH as per grant in step 5? (Note 4)	-->	MAC PDU	1	P
8	SS transmits a UL configured grant type 2 addressed to UE's stored CS-RNTI in Slot 'p' of PDCCH ($p = \text{floor}(p_0 * (\text{PDCCH}_{\text{scs}} / \text{PUSCH}_{\text{scs}}))$), NDI = 0, allowing the UE to transmit one loop back SDU and 1 byte MAC subheader for Configured Grant Confirmation MAC CE, Where p_0 is the slot of PUSCH with $y + x < p_0 < y + 2x - K_2$.	<--	(UL configured Grant type 2)	-	-
9	Check: Does the UE transmit a MAC PDU containing one RLC SDU and 1 byte MAC subheader for Configured Grant Confirmation MAC CE in Symbol 'S' of Slot 'z' of PUSCH as per grant in step 8? i.e., in the PUSCH slot $z = \text{floor}(p * (\text{PUSCH}_{\text{scs}} / \text{PDCCH}_{\text{scs}})) + K_2$. (Note 3)	-->	MAC PDU	2	P
10	Check: Does the UE transmit a MAC PDU containing one RLC SDU in Symbol 'S' of Slot 'y + 2x' as per grant in step 5?	-->	MAC PDU	2	F
11	Check: Does the UE transmit a MAC PDU containing one RLC SDU in Symbol 'S' of Slot 'z + x' of PUSCH as per grant in step 8?	-->	MAC PDU	2	P
12	SS transmits a UL configured grant type 2 addressed to UE's stored CS-RNTI in Slot 'q' of PDCCH ($q = \text{floor}(q_0 * (\text{PDCCH}_{\text{scs}} / \text{PUSCH}_{\text{scs}}))$), NDI = 1; allowing the UE to transmit one loop back SDU. The UL HARQ process is the same as in step 11, Where q_0 is the slot of PUSCH with $z + x < q_0 < z + 2x - K_2$.	<--	(UL configured Grant type 2)	-	-
13	Check: Does the UE transmit a MAC PDU containing the same RLC SDU as in step 11 in Symbol 'S' of Slot 'w' of PUSCH? i.e., in the PUSCH slot $w = \text{floor}(q * (\text{PUSCH}_{\text{scs}} / \text{PDCCH}_{\text{scs}})) + K_2$. (Note 3)	-->	MAC PDU	3	P
14	Check: Does the UE transmit a MAC PDU containing one RLC SDU in Symbol 'S' of Slot 'z + 2x' of PUSCH as per grant in step 8?	-->	MAC PDU	1	P

15	SS transmits a UL Grant using UE's C-RNTI in in Slot 'r' of PDCCH allowing UE to transmit a MAC PDU containing one RLC SDU, where $r = \text{floor}((z + 3x - K_2) * (\text{PDCCH}_{\text{SCS}} / \text{PUSCH}_{\text{SCS}}))$.	<--	(UL Grant)	-	-
16	Check: Does the UE transmit a MAC PDU containing one RLC SDU in Symbol 'S' of Slot 'z + 3x' of PUSCH as per grant in step 8?	-->	MAC PDU	4	P
17	Check: Does the UE transmit a MAC PDU in Slot 'z + 4x' as per grant in containing zero MAC SDU? (Note 5)	-->	MAC PDU	6	F
18	SS transmits a DL MAC PDU containing 3 RLC SDUs on UM DRB after step 17.	<--	MAC PDU		
19	Check: Does the UE transmit a MAC PDU containing one RLC SDU in Symbol 'S' of Slot 'z + 5x' of PUSCH as per grant in step 8?	-->	MAC PDU	1	P
20	The SS transmits a PDCCH [for UL configured grant type 2 explicit release] using UE's CS-RNTI in Symbol 'S' of slot 'p' with NDI=0. Where $(z+5x < p < z+6x)$.	<--	PDCCH [for UL configured grant type 2 explicit release]	-	-
21	Check: Does the UE transmit a MAC PDU containing a Configured Grant Confirmation MAC CE and one RLC SDU in 'S' of Slot 'z + 6x' of PUSCH as per grant in step 8?	-->	MAC PDU	7	P
21 A	Check: Does the UE transmit a MAC PDU containing one RLC SDU in 'S' of Slot 'z + 7x' of PUSCH as per grant in step 8?	-->	MAC PDU	7	F
22	SS transmits a UL configured grant type 2 addressed to UE's stored CS-RNTI in Slot 'j' of PDCCH, NDI=0, allowing the UE to transmit one loop back SDU and 1 byte MAC subheader for Configured Grant Confirmation MAC CE.	<--	(UL configured grant type 2)	-	-
23	Check: Does the UE transmit a MAC PDU containing one RLC SDU and a Configured Grant Confirmation MAC CE in Symbol 'S' of Slot 'y' of PUSCH as per grant in step 22? i.e., in the PUSCH slot $y = \text{floor}(n * (\text{PUSCH}_{\text{SCS}} / \text{PDCCH}_{\text{SCS}})) + K_2$. (Note 3)	-->	MAC PDU	1	P
24	SS transmits <i>RRCReconfiguration</i> to disable UL configured grant type 2.	<--	NR RRC: <i>RRCReconfiguration</i>	-	-
25	The UE transmits <i>RRCReconfigurationComplete</i> .	-->	NR RRC: <i>RRCReconfigurationComplete</i>	-	-
26	SS transmits a DL MAC PDU containing 1 RLC SDU.	<--	MAC PDU	-	-
27	Check: Does the UE transmit a MAC PDU in Symbol 'S' of Slot 'y + 10x' of PUSCH as per grant in step 22.	-->	MAC PDU	5	F
<p>Note 1: For EN-DC the NR <i>RRCReconfiguration</i> message is contained in <i>RRCConnectionReconfiguration</i>.</p> <p>Note 2: For EN-DC the NR <i>RRCReconfigurationComplete</i> message is contained in <i>RRCConnectionReconfigurationComplete</i>.</p> <p>Note 3: y is the slot where the UE shall transmit the PUSCH and is determined by K_2 as $K_2 = \left\lceil n \cdot \frac{2^{\mu_{\text{PUSCH}}}}{2^{\mu_{\text{PDCCH}}}} \right\rceil + K_2$ where n is the slot with the scheduling DCI, K_2 is based on the numerology of PUSCH. S is the starting symbol related to the start of the slot y according to TS 38.214 clause 6.1.2.1.</p> <p>Note 4: x is equal to <i>periodicity</i> / 14 in this test case.</p> <p>Note 5: If the MAC entity does not generate a MAC PDU, one of the conditions which shall be satisfied is that there is no aperiodic CSI requested for this PUSCH transmission as specified in TS 38.321 clause 5.4.3.1.3.</p>					

7.1.1.6.3.3.3 Specific message contents

Table 7.1.1.6.3.3.3-1: RRCReconfiguration (step 1, Table 7.1.1.6.3.3.2-1)

Derivation path: 38.508-1 [4], Table 4.6.1-13			
Information Element	Value/remark	Comment	Condition
RRCReconfiguration ::= SEQUENCE {			
criticalExtensions CHOICE {			
rrcReconfiguration SEQUENCE {			
radioBearerConfig	Not present		
secondaryCellGroup	CellGroupConfig	OCTET STRING (CONTAINING CellGroupConfig)	EN-DC
	Not present		NR
nonCriticalExtension := SEQUENCE {}	Not present		EN-DC
nonCriticalExtension := SEQUENCE{			NR
masterCellGroup	CellGroupConfig	OCTET STRING (CONTAINING CellGroupConfig)	
dedicatedNAS-MessageList SEQUENCE (SIZE(1..maxDRB)) OF DedicatedNAS-Message {}	Not present		
}			
}			
}			
}			

Table 7.1.1.6.3.3.3-2: CellGroupConfig (Table 7.1.1.6.3.3.3-1: RRCReconfiguration)

Derivation path: 38.508-1 [4], Table 4.6.3-19			
Information Element	Value/remark	Comment	Condition
CellGroupConfig ::= SEQUENCE {			
rlc-BearerToAddModList	Not present		
mac-CellGroupConfig	Not present		
physicalCellGroupConfig SEQUENCE {			
cs-RNTI CHOICE {			
setup SEQUENCE{			
RNTI-Value	'FFEO'H		
}			
}			
}			
spCellConfig SEQUENCE{			
spCellConfigDedicated SEQUENCE{			
uplinkConfig SEQUENCE {			
initialUplinkBWP SEQUENCE {			
pucch-Config CHOICE {			
setup SEQUENCE {			
schedulingRequestResourceToAddModList {			
schedulingRequestResourceId	1		
schedulingRequestID	0		
periodicityAndOffset CHOICE {			
sl20	9		
}			
}			
}			
configuredGrantConfig CHOICE {			
setup SEQUENCE {			
cg-DMRS-Configuration	DMRS-UplinkConfig	Reference TS 38.508-1 [4], Table 4.6.3-51	
uci-OnPUSCH CHOICE {			
setup SEQUENCE {			
semiStatic SEQUENCE {	BetaOffsets		
betaOffsetACK-Index1	9		

betaOffsetACK-Index2	9		
betaOffsetACK-Index3	9		
betaOffsetCSI-Part1-Index1	6		
betaOffsetCSI-Part1-Index2	6		
betaOffsetCSI-Part2-Index1	6		
betaOffsetCSI-Part2-Index2	6		
}			
}			
}			
resourceAllocation	ResourceAllocationType1		
powerControlLoopToUse	n0		
p0-PUSCH-Alpha	0		
nrofHARQ-Processes	16		
repK	n1		
periodicity	Sym40x14		15kHz
periodicity	Sym80x14		30kHz
periodicity	Sym160x14		60kHz
periodicity	Sym320x14		120kHz
}			
}			
pusch-Config CHOICE {			
setup SEQUENCE {			
PUSCH-TimeDomainResourceAllocationList			
SEQUENCE {			
k2	4		FR1
	8		FR2
mappingType	typeB		
startSymbolAndLength	0011011		FR1
startSymbolAndLength	0001110		FR2
}			
}			
}			
}			
}			
}			
}			
}			

Table 7.1.1.6.3.3.3-3: RRCReconfiguration (step 24 of Table 7.1.1.6.3.3.2-1)

Derivation path: 38.508-1 [4], Table 4.6.1-13			
Information Element	Value/remark	Comment	Condition
RRCReconfiguration ::= SEQUENCE {			
criticalExtensions CHOICE {			
rrcReconfiguration SEQUENCE {			
radioBearerConfig	Not present		
secondaryCellGroup	CellGroupConfig	OCTET STRING (CONTAINING CellGroupConfig)	EN-DC
	Not present		NR
nonCriticalExtension ::= SEQUENCE {}	Not present		EN-DC
nonCriticalExtension ::= SEQUENCE{			NR
masterCellGroup	CellGroupConfig	OCTET STRING (CONTAINING CellGroupConfig)	
dedicatedNAS-MessageList SEQUENCE (SIZE(1..maxDRB)) OF DedicatedNAS-Message {}	Not present		
}			
}			
}			

Table 7.1.1.6.3.3.3-4: CellGroupConfig (Table 7.1.1.6.3.3.3-3: RRCReconfiguration)

Derivation path: 38.508-1 [4], Table 4.6.3-19			
Information Element	Value/remark	Comment	Condition
CellGroupConfig ::= SEQUENCE {			
cellGroupId	1		
spCellConfig SEQUENCE{			
spCellConfigDedicated SEQUENCE{			
uplinkConfig SEQUENCE {			
initialUplink SEQUENCE {			
configuredGrantConfig CHOICE {			
release	Null		
}			
}			
}			
}			
}			
}			

7.1.1.6.4 Correct handling of DL assignment / Multi Semi-persistent configuration

7.1.1.6.4.1 Test Purpose (TP)

(1)

```
with { UE in RRC_Connected state with DRB established and sps-Configuration in DL is enabled }
ensure that {
  when { UE receives a DL assignment addressed to its stored CS-RNTI in slot y and with NDI set as 0
with sps-ConfigIndex=0}
  then {UE starts receiving DL MAC PDU in slots y+n*[semiPersistSchedIntervalDL] where 'n' is
positive integer starting at zero }
}
```

(2)

```
with { UE in RRC_Connected state with DRB established and stored DL SPS assignment to receive MAC
PDU in slot y+n*[semiPersistSchedIntervalDL] }
ensure that {
  when { UE receives another DL assignment addressed to its CS-RNTI in slot p and with NDI set as 0
associated with sps-ConfigIndex=1, where p!= y+n*[semiPersistSchedIntervalDL] }
  then { UE starts receiving DL MAC PDU in slots p+n*[semiPersistSchedIntervalDL] and continue
receiving DL MAC PDU at slots y+n*[semiPersistSchedIntervalDL]where 'n' is positive integer starting
at zero }
}
```

7.1.1.6.4.2 Conformance requirements

References: The conformance requirements covered in the present TC are specified in TS 38.321, clause 5.3.1, 5.8.1 TS 38.300, clause 10.2, and TS 38.213, clause 10.2. Unless otherwise stated these are Rel-16 requirements.

[TS 38.321, clause 5.3.1]

Downlink assignments received on the PDCCH both indicate that there is a transmission on a DL-SCH for a particular MAC entity and provide the relevant HARQ information.

When the MAC entity has a C-RNTI, Temporary C-RNTI, or CS-RNTI, the MAC entity shall for each PDCCH occasion during which it monitors PDCCH and for each Serving Cell:

- 1> if a downlink assignment for this PDCCH occasion and this Serving Cell has been received on the PDCCH for the MAC entity's C-RNTI, or Temporary C-RNTI:
- 2> if this is the first downlink assignment for this Temporary C-RNTI:
- 3> consider the NDI to have been toggled.

- 2> if the downlink assignment is for the MAC entity's C-RNTI, and if the previous downlink assignment indicated to the HARQ entity of the same HARQ process was either a downlink assignment received for the MAC entity's CS-RNTI or a configured downlink assignment:
 - 3> consider the NDI to have been toggled regardless of the value of the NDI.
- 2> indicate the presence of a downlink assignment and deliver the associated HARQ information to the HARQ entity.
- 1> else if a downlink assignment for this PDCCH occasion has been received for this Serving Cell on the PDCCH for the MAC entity's CS-RNTI:
 - 2> if the NDI in the received HARQ information is 1:
 - 3> consider the NDI for the corresponding HARQ process not to have been toggled;
 - 3> indicate the presence of a downlink assignment for this Serving Cell and deliver the associated HARQ information to the HARQ entity.
 - 2> if the NDI in the received HARQ information is 0:
 - 3> if PDCCH contents indicate SPS deactivation:
 - 4> clear the configured downlink assignment for this Serving Cell (if any);
 - 4> if the *timeAlignmentTimer*, associated with the TAG containing the Serving Cell on which the HARQ feedback is to be transmitted, is running:
 - 5> indicate a positive acknowledgement for the SPS deactivation to the physical layer.
 - 3> else if PDCCH content indicates SPS activation:
 - 4> store the downlink assignment for this Serving Cell and the associated HARQ information as configured downlink assignment;
 - 4> initialise or re-initialise the configured downlink assignment for this Serving Cell to start in the associated PDSCH duration and to recur according to rules in clause 5.8.1;

For each Serving Cell and each configured downlink assignment, if configured and activated, the MAC entity shall:

- 1> if the PDSCH duration of the configured downlink assignment does not overlap with the PDSCH duration of a downlink assignment received on the PDCCH for this Serving Cell:
 - 2> instruct the physical layer to receive, in this PDSCH duration, transport block on the DL-SCH according to the configured downlink assignment and to deliver it to the HARQ entity;
 - 2> set the HARQ Process ID to the HARQ Process ID associated with this PDSCH duration;
 - 2> consider the NDI bit for the corresponding HARQ process to have been toggled;
 - 2> indicate the presence of a configured downlink assignment and deliver the stored HARQ information to the HARQ entity.

For configured downlink assignments without *harq-ProcID-Offset*, the HARQ Process ID associated with the slot where the DL transmission starts is derived from the following equation:

$$\text{HARQ Process ID} = [\text{floor}(\text{CURRENT_slot} \times 10 / (\text{numberOfSlotsPerFrame} \times \text{periodicity}))] \text{ modulo } n_{\text{rofHARQ-Processes}}$$

where $\text{CURRENT_slot} = [(\text{SFN} \times \text{numberOfSlotsPerFrame}) + \text{slot number in the frame}]$ and *numberOfSlotsPerFrame* refers to the number of consecutive slots per frame as specified in TS 38.211 [8].

NOTE 1: In case of unaligned SFN across carriers in a cell group, the SFN of the concerned Serving Cell is used to calculate the HARQ Process ID used for configured downlink assignments.

For configured downlink assignments with *harq-ProcID-Offset*, the HARQ Process ID associated with the slot where the DL transmission starts is derived from the following equation:

$$\text{HARQ Process ID} = [\text{floor}(\text{CURRENT_slot} \times 10 / (\text{numberOfSlotsPerFrame} \times \text{periodicity}))] \text{ modulo } \text{nrofHARQ-Processes} + \text{harq-ProcID-Offset}$$

where $\text{CURRENT_slot} = [(\text{SFN} \times \text{numberOfSlotsPerFrame}) + \text{slot number in the frame}]$ and $\text{numberOfSlotsPerFrame}$ refers to the number of consecutive slots per frame as specified in TS 38.211 [8].

NOTE 2: CURRENT_slot refers to the slot index of the first transmission occasion of a bundle of configured downlink assignment.

When the MAC entity needs to read BCCH, the MAC entity may, based on the scheduling information from RRC:

- 1> if a downlink assignment for this PDCCH occasion has been received on the PDCCH for the SI-RNTI;
- 2> indicate a downlink assignment and redundancy version for the dedicated broadcast HARQ process to the HARQ entity.

[TS 38.321, clause 5.8.1]

Semi-Persistent Scheduling (SPS) is configured by RRC per Serving Cell and per BWP. Multiple assignments can be active simultaneously in the same BWP. Activation and deactivation of the DL SPS are independent among the Serving Cells.

For the DL SPS, a DL assignment is provided by PDCCH, and stored or cleared based on L1 signalling indicating SPS activation or deactivation.

RRC configures the following parameters when the SPS is configured:

- $cs\text{-RNTI}$: CS-RNTI for activation, deactivation, and retransmission;
- $nrofHARQ\text{-Processes}$: the number of configured HARQ processes for SPS;
- $harq\text{-ProcID-Offset}$: Offset of HARQ process for SPS;
- $periodicity$: periodicity of configured downlink assignment for SPS.

When the SPS is released by upper layers, all the corresponding configurations shall be released.

After a downlink assignment is configured for SPS, the MAC entity shall consider sequentially that the N^{th} downlink assignment occurs in the slot for which:

$$(\text{numberOfSlotsPerFrame} \times \text{SFN} + \text{slot number in the frame}) = [(\text{numberOfSlotsPerFrame} \times \text{SFN}_{\text{start time}} + \text{slot}_{\text{start time}}) + N \times \text{periodicity} \times \text{numberOfSlotsPerFrame} / 10] \text{ modulo } (1024 \times \text{numberOfSlotsPerFrame})$$

where $\text{SFN}_{\text{start time}}$ and $\text{slot}_{\text{start time}}$ are the SFN and slot, respectively, of the first transmission of PDSCH where the configured downlink assignment was (re-)initialised.

NOTE: In case of unaligned SFN across carriers in a cell group, the SFN of the concerned Serving Cell is used to calculate the occurrences of configured downlink assignments.

[TS 38.300, clause 10.2]

In the downlink, the gNB can dynamically allocate resources to UEs via the C-RNTI on PDCCH(s). A UE always monitors the PDCCH(s) in order to find possible assignments when its downlink reception is enabled (activity governed by DRX when configured). When CA is configured, the same C-RNTI applies to all serving cells.

The gNB may pre-empt an ongoing PDSCH transmission to one UE with a latency-critical transmission to another UE. The gNB can configure UEs to monitor interrupted transmission indications using INT-RNTI on a PDCCH. If a UE receives the interrupted transmission indication, the UE may assume that no useful information to that UE was carried by the resource elements included in the indication, even if some of those resource elements were already scheduled to this UE.

In addition, with Semi-Persistent Scheduling (SPS), the gNB can allocate downlink resources for the initial HARQ transmissions to UEs: RRC defines the periodicity of the configured downlink assignments while PDCCH addressed to CS-RNTI can either signal and activate the configured downlink assignment, or deactivate it; i.e. a PDCCH addressed

to CS-RNTI indicates that the downlink assignment can be implicitly reused according to the periodicity defined by RRC, until deactivated.

NOTE: When required, retransmissions are explicitly scheduled on PDCCH(s).

The dynamically allocated downlink reception overrides the configured downlink assignment in the same serving cell, if they overlap in time. Otherwise a downlink reception according to the configured downlink assignment is assumed, if activated.

The UE may be configured with up to 8 active configured downlink assignments for a given BWP of a serving cell. When more than one is configured:

- The network decides which of these configured downlink assignments are active at a time (including all of them); and
- Each configured downlink assignment is activated separately using a DCI command and deactivation of configured downlink assignments is done using a DCI command, which can either deactivate a single configured downlink assignment or multiple configured downlink assignments jointly.

[TS 38.213, clause 10.2]

A UE validates, for scheduling activation or scheduling release, a DL SPS assignment PDCCH or a configured UL grant Type 2 PDCCH if

- the CRC of a corresponding DCI format is scrambled with a CS-RNTI provided by *cs-RNTI*, and
- the new data indicator field in the DCI format for the enabled transport block is set to '0', and
- the DFI flag field, if present, in the DCI format is set to '0', and
- if validation is for scheduling activation and if the PDSCH-to-HARQ_feedback timing indicator field in the DCI format is present, the PDSCH-to-HARQ_feedback timing indicator field does not provide an inapplicable value from *dl-DataToUL-ACK-r16*.

If a UE is provided a single configuration for UL grant Type 2 PUSCH or for SPS PDSCH, validation of the DCI format is achieved if all fields for the DCI format are set according to Table 10.2-1 or Table 10.2-2.

If a UE is provided more than one configurations for UL grant Type 2 PUSCH or for SPS PDSCH, a value of the HARQ process number field in a DCI format indicates an activation for a corresponding UL grant Type 2 PUSCH or for a SPS PDSCH configuration with a same value as provided by *ConfiguredGrantConfigIndex* or by *sps-ConfigIndex*, respectively. Validation of the DCI format is achieved if the RV field for the DCI format is set as in Table 10.2-3.

If a UE is provided more than one configuration for UL grant Type 2 PUSCH or for SPS PDSCH

- if the UE is provided *ConfiguredGrantConfigType2DeactivationStateList* or *sps-ConfigDeactivationStateList*, a value of the HARQ process number field in a DCI format indicates a corresponding entry for scheduling release of one or more UL grant Type 2 PUSCH or SPS PDSCH configurations
- if the UE is not provided *ConfiguredGrantConfigType2DeactivationStateList* or *sps-ConfigDeactivationStateList*, a value of the HARQ process number field in a DCI format indicates a release for a corresponding UL grant Type 2 PUSCH or for a SPS PDSCH configuration with a same value as provided by *ConfiguredGrantConfigIndex* or by *sps-ConfigIndex*, respectively.

Validation of the DCI format is achieved if all fields for the DCI format are set according to Table 10.2-4.

If validation is achieved, the UE considers the information in the DCI format as a valid activation or valid release of DL SPS or configured UL grant Type 2. If validation is not achieved, the UE discards all the information in the DCI format.

Table 10.2-1: Special fields for single DL SPS or single UL grant Type 2 scheduling activation PDCCH validation when a UE is provided a single SPS PDSCH or UL grant Type 2 configuration in the active DL/UL BWP of the scheduled cell

	DCI format 0_0/0_1/0_2	DCI format 1_0/1_2	DCI format 1_1
HARQ process number	set to all '0's	set to all '0's	set to all '0's
Redundancy version	set to all '0's	set to all '0's	For the enabled transport block: set to all '0's

Table 10.2-2: Special fields for single DL SPS or single UL grant Type 2 scheduling release PDCCH validation when a UE is provided a single SPS PDSCH or UL grant Type 2 configuration in the active DL/UL BWP of the scheduled cell

	DCI format 0_0/0_1/0_2	DCI format 1_0/1_1/1_2
HARQ process number	set to all '0's	set to all '0's
Redundancy version	set to all '0's	set to all '0's
Modulation and coding scheme	set to all '1's	set to all '1's
Frequency domain resource assignment	set to all '0's for FDRA Type 2 with $\mu = 1$ set to all '1's, otherwise	set to all '0's for FDRA Type 0 or for <i>dynamicSwitch</i> set to all '1's for FDRA Type 1

Table 10.2-3: Special fields for a single DL SPS or single UL grant Type 2 scheduling activation PDCCH validation when a UE is provided multiple DL SPS or UL grant Type 2 configurations in the active DL/UL BWP of the scheduled cell

	DCI format 0_0/0_1/0_2	DCI format 1_0/1_2	DCI format 1_1
Redundancy version	set to all '0's	set to all '0's	For the enabled transport block: set to all '0's

Table 10.2-4: Special fields for a single or multiple DL SPS and UL grant Type 2 scheduling release PDCCH validation when a UE is provided multiple DL SPS or UL grant Type 2 configurations in the active DL/UL BWP of the scheduled cell

	DCI format 0_0/0_1/0_2	DCI format 1_0/1_1/1_2
Redundancy version	set to all '0's	set to all '0's
Modulation and coding scheme	set to all '1's	set to all '1's
Frequency domain resource assignment	set to all '0's for FDRA Type 2 with $\mu = 1$ set to all '1's, otherwise	set to all '0's for FDRA Type 0 or for <i>dynamicSwitch</i> set to all '1's for FDRA Type 1

A UE is expected to provide HARQ-ACK information in response to a SPS PDSCH release after N symbols from the last symbol of a PDCCH providing the SPS PDSCH release. If *processingType2Enabled* of *PDSCH-ServingCellConfig* is set to *enable* for the serving cell with the PDCCH providing the SPS PDSCH release, $N = 5$ for $\mu = 0$, $N = 5.5$ for $\mu = 1$, and $N = 11$ for $\mu = 2$, otherwise, $N = 10$ for $\mu = 0$, $N = 12$ for $\mu = 1$, $N = 22$ for $\mu = 2$, and $N = 25$ for $\mu = 3$, wherein μ corresponds to the smallest SCS configuration between the SCS configuration of the PDCCH providing the SPS PDSCH release and the SCS configuration of a PUCCH carrying the HARQ-ACK information in response to a SPS PDSCH release.

7.1.1.6.4.3 Test description

7.1.1.6.4.3.1 Pre-test conditions

Same Pre-test conditions as in clause 7.1.1.0 except that set to return no data in uplink and that the UM DRB is configured according to Table 7.1.1.6.4.3.1-1.

Table 7.1.1.6.4.3.1-1: RLC parameters

Uplink UM RLC sn-FieldLength	IF (pc_um_WithShortSN) size6 ELSE size12
Downlink UM RLC sn-FieldLength	F (pc_um_WithShortSN) size6 ELSE size12

7.1.1.6.4.3.2 Test procedure sequence

Table 7.1.1.6.4.3.2-1: Main behaviour

St	Procedure	Message Sequence		TP	Verdict
		U - S	Message		
1	SS transmits NR RRCReconfiguration to config SPS-ConfigurationDL.(Note 2)	<--	RRCReconfiguration	-	-
2	The UE transmits NR RRCReconfigurationComplete.(Note 3)	-->	RRCReconfigurationComplete	-	-
3	The SS transmits a DL assignment using UE's CS-RNTI associated with <i>sps-ConfigIndex</i> =0 in Slot 'Y', NDI=0	<--	(DL SPS Grant)	-	-
4	The SS transmits in Slot 'Y', a DL MAC PDU containing a RLC PDU on UM DRB.	<--	MAC PDU	-	-
5	Check: does the UE transmit a HARQ ACK?	-->	HARQ ACK	1	P
6	The SS transmits in Slot 'Y+X', a DL MAC PDU containing a RLC PDU on DRB. (Note 1)	<--	MAC PDU	-	-
7	Check: Does the UE transmit a HARQ ACK?	-->	HARQ ACK	1	P
8	SS transmits NR RRCReconfiguration to add another SPS-ConfigurationDL.(Note 2)	<--	RRCReconfiguration	-	-
9	The UE transmits NR RRCReconfigurationComplete.(Note 3)	-->	RRCReconfigurationComplete	-	-
10	The SS transmits a DL assignment using UE's CS-RNTI associated with <i>sps-ConfigIndex</i> =1 in Slot 'P', NDI=0; (Where $Y+X < P < Y+2X$)	<--	(DL SPS Grant)	-	-
11	The SS transmits in Slot 'P', a DL MAC PDU containing a RLC PDU on UM DRB.	<--	MAC PDU	-	-
12	Check: Does the UE transmit a HARQ ACK?	-->	HARQ ACK	2	P
13	The SS transmits in Slot 'Y+2X', a DL MAC PDU containing a RLC PDU on UM DRB.	<--	MAC PDU	-	-
14	Check: Does the UE transmit a HARQ Feedback?	-->	HARQ ACK	2	P
15	The SS transmits in Slot 'P+X', a DL MAC PDU containing a RLC PDU (DL-SQN=1) on UM DRB.	<--	MAC PDU	-	-
16	Check: Does the UE transmit a HARQ Feedback?	-->	HARQ ACK	2	P
17	SS transmits NR RRCReconfiguration to disable SPS-ConfigurationDL.(Note 2)	<--	RRCReconfiguration	-	-
18	The UE transmits NR RRCReconfigurationComplete.(Note 3)	-->	RRCReconfigurationComplete	-	-
Note 1: X is equal to semiPersistSchedIntervalDL in this document.					
Note 2: For EN-DC the NR RRCReconfiguration message is contained in RRCConnectionReconfiguration 36.508 [7], Table 4.6.1-8 using condition EN-DC_EmbedNR_RRCRecon.					
Note 3: For EN-DC the NR RRCReconfigurationComplete message is contained in RRCConnectionReconfigurationComplete.					
Note 4: As per TS 38.508-1[4], the default value for PDSCH slot offset (K_0) is 0, hence the DL MAC PDU's associated with DL SPS grant in Slot X are sent in same slot X.					

7.1.1.6.4.3.3 Specific message contents

Table 7.1.1.6.4.3.3-1: RRCReconfiguration (step 1/8, Table 7.1.1.6.4.3.2-1)

Derivation path: 38.508-1 [4], Table 4.6.1-13			
Information Element	Value/remark	Comment	Condition
RRCReconfiguration ::= SEQUENCE {			
criticalExtensions CHOICE {			
rrcReconfiguration SEQUENCE {			
secondaryCellGroup	CellGroupConfig	OCTET STRING (CONTAINING CellGroupConfig)	EN-DC

	Not present		NR
nonCriticalExtension	Not present		EN-DC
nonCriticalExtension := SEQUENCE{			NR
masterCellGroup	CellGroupConfig	OCTET STRING (CONTAINING CellGroupConfig)	
}			
}			
}			
}			

Table 7.1.1.6.4.3.3-2: CellGroupConfig (in Table 7.1.1.6.4.3.3-1)

Derivation path: 38.508-1 [4], Table 4.6.3-19			
Information Element	Value/remark	Comment	Condition
CellGroupConfig ::= SEQUENCE {			
physicalCellGroupConfig	PhysicalCellGroupConfig	Table 7.1.1.6.4.3.3-3	
spCellConfig SEQUENCE {			
servCellIndex	1		EN-DC
}	Not present		NR
spCellConfigDedicated SEQUENCE {			
initialDownlinkBWP SEQUENCE {			
sps-ConfigToAddModList-r16 ::= SEQUENCE (SIZE (1..maxNrofSPS-Config-r16)) OF SPS- Config {			
SPS-Config ::= SEQUENCE [1] {		The first SPS configuration entry	STEP 1
setup SEQUENCE {			
periodicity	ms160		
nrofHARQ-Processes	8		
sps-ConfigIndex-r16	0		
harq-ProclD-Offset-r16	0		
sps-ConfigIndex-r16	0		
}			
}		The second SPS configuration entry	STEP 8
}			
}			
}			
}			

Table 7.1.1.6.4.3.3-3: PhysicalCellGroupConfig (Table 7.1.1.6.4.3.3-2)

Derivation Path: TS 38.508-1 [4], Table 4.6.3-106			
Information Element	Value/remark	Comment	Condition
PhysicalCellGroupConfig ::= SEQUENCE {			
cs-RNTI	'FFE0'H		
}			

Table 7.1.1.6.4.3.3-4: RRCReconfiguration (step 17 of Table 7.1.1.6.4.3.2-1)

Derivation path: 38.508-1 [4], Table 4.6.1-13			
---	--	--	--

Information Element	Value/remark	Comment	Condition
RRCReconfiguration ::= SEQUENCE {			
criticalExtensions CHOICE {			
rrcReconfiguration SEQUENCE {			
secondaryCellGroup	CellGroupConfig	OCTET STRING (CONTAINING CellGroupConfig)	EN-DC
	Not present		NR
nonCriticalExtension	Not present		EN-DC
nonCriticalExtension := SEQUENCE{			NR
masterCellGroup	CellGroupConfig	OCTET STRING (CONTAINING CellGroupConfig)	
}			
}			
}			
}			

Table 7.1.1.6.4.3.3-5: CellGroupConfig (Table 7.1.1.6.4.3.3-4)

Derivation path: 38.508-1 [4], Table 4.6.3-19			
Information Element	Value/remark	Comment	Condition
CellGroupConfig ::= SEQUENCE {			
spCellConfig SEQUENCE {			
servCellIndex	1		
	Not present		NR
spCellConfigDedicated SEQUENCE {			
initialDownlinkBWP SEQUENCE {			
sps-ConfigToReleaseList-r16 SEQUENCE (SIZE (1..maxNrofSPS-Config-r16)) OF SPS-ConfigIndex-r16 {	2 entries	Release all the SPS entries configured previously	
SPS-ConfigIndex-r16[1]	0		
SPS-ConfigIndex-r16[2]	1		
}			
}			
}			
}			
}			

7.1.1.6.5 Correct handling of UL grant / Multi configured uplink grants

7.1.1.6.5.1 Test Purpose (TP)(1)

```

with { UE in RRC_Connected state with DRB established and sps-Configuration in UL is enabled with Configured grant type 1 }
ensure that {
  when { The symbol in which equation  $[(SFN \times \text{numberOfSlotsPerFrame} \times \text{numberOfSymbolsPerSlot}) + (\text{slot number in the frame} \times \text{numberOfSymbolsPerSlot}) + \text{symbol number in the slot}] = (\text{timeDomainOffset} \times \text{numberOfSymbolsPerSlot} + S + N \times \text{periodicity}) \text{ modulo } (1024 \times \text{numberOfSlotsPerFrame} \times \text{numberOfSymbolsPerSlot})$  is satisfied }
  then { UE starts transmitting UL MAC PDU periodically in the symbol associated with the new re-configured grant }
}

```

(2)

```

with { UE in RRC_Connected state with DRB established and configured UL grant type 1 }
ensure that {
  when { UE receives another UL grant type 1 in an RRC message with timeDomainOffset 15 }
  then { UE starts transmitting UL MAC PDU in symbol with timeDomainOffset 15 and continue transmitting UL MAC PDU in symbol with timeDomainOffset 5 }
}

```

7.1.1.6.5.2 Conformance requirements

References: The conformance requirements covered in the present TC are specified in TS 38.321, clause 5.4.1, 5.8.2 TS 38.300, clause 10.3. Unless otherwise stated these are Rel-16 requirements.

[TS 38.321, clause 5.4.1]

Uplink grant is either received dynamically on the PDCCH, in a Random Access Response, configured semi-persistently by RRC or determined to be associated with the PUSCH resource of MSGA as specified in clause 5.1.2a. The MAC entity shall have an uplink grant to transmit on the UL-SCH. To perform the requested transmissions, the MAC layer receives HARQ information from lower layers. An uplink grant addressed to CS-RNTI with NDI = 0 is considered as a configured uplink grant. An uplink grant addressed to CS-RNTI with NDI = 1 is considered as a dynamic uplink grant.

If the MAC entity has a C-RNTI, a Temporary C-RNTI, or CS-RNTI, the MAC entity shall for each PDCCH occasion and for each Serving Cell belonging to a TAG that has a running *timeAlignmentTimer* and for each grant received for this PDCCH occasion:

- 1> if an uplink grant for this Serving Cell has been received on the PDCCH for the MAC entity's C-RNTI or Temporary C-RNTI; or
- 1> if an uplink grant has been received in a Random Access Response:
 - 2> if the uplink grant is for MAC entity's C-RNTI and if the previous uplink grant delivered to the HARQ entity for the same HARQ process was either an uplink grant received for the MAC entity's CS-RNTI or a configured uplink grant:
 - 3> consider the NDI to have been toggled for the corresponding HARQ process regardless of the value of the NDI.
 - 2> if the uplink grant is for MAC entity's C-RNTI, and the identified HARQ process is configured for a configured uplink grant:
 - 3> start or restart the *configuredGrantTimer* for the corresponding HARQ process, if configured.
 - 3> stop the *cg-RetransmissionTimer* for the corresponding HARQ process, if running.
 - 2> deliver the uplink grant and the associated HARQ information to the HARQ entity.
- 1> else if an uplink grant for this PDCCH occasion has been received for this Serving Cell on the PDCCH for the MAC entity's CS-RNTI:
 - 2> if the NDI in the received HARQ information is 1:
 - 3> consider the NDI for the corresponding HARQ process not to have been toggled;
 - 3> start or restart the *configuredGrantTimer* for the corresponding HARQ process, if configured;
 - 3> stop the *cg-RetransmissionTimer* for the corresponding HARQ process, if running;
 - 3> deliver the uplink grant and the associated HARQ information to the HARQ entity.
 - 2> else if the NDI in the received HARQ information is 0:
 - 3> if PDCCH contents indicate configured grant Type 2 deactivation:
 - 4> trigger configured uplink grant confirmation.
 - 3> else if PDCCH contents indicate configured grant Type 2 activation:
 - 4> trigger configured uplink grant confirmation;
 - 4> store the uplink grant for this Serving Cell and the associated HARQ information as configured uplink grant;
 - 4> initialise or re-initialise the configured uplink grant for this Serving Cell to start in the associated PUSCH duration and to recur according to rules in clause 5.8.2;

- 4> stop the *configuredGrantTimer* for the corresponding HARQ process, if running;
- 4> stop the *cg-RetransmissionTimer* for the corresponding HARQ process, if running.

For each Serving Cell and each configured uplink grant, if configured and activated, the MAC entity shall:

- 1> if the MAC entity is configured with *lch-basedPrioritization*, and the PUSCH duration of the configured uplink grant does not overlap with the PUSCH duration of an uplink grant received in a Random Access Response or with the PUSCH duration of an uplink grant addressed to Temporary C-RNTI or the PUSCH duration of a MSGA payload for this Serving Cell; or
- 1> if the MAC entity is not configured with *lch-basedPrioritization*, and the PUSCH duration of the configured uplink grant does not overlap with the PUSCH duration of an uplink grant received on the PDCCH or in a Random Access Response or the PUSCH duration of a MSGA payload for this Serving Cell:
 - 2> set the HARQ Process ID to the HARQ Process ID associated with this PUSCH duration;
 - 2> if, for the corresponding HARQ process, the *configuredGrantTimer* is not running and *cg-RetransmissionTimer* is not configured (i.e. new transmission):
 - 3> consider the NDI bit for the corresponding HARQ process to have been toggled;
 - 3> deliver the configured uplink grant and the associated HARQ information to the HARQ entity.
 - 2> else if the *cg-RetransmissionTimer* for the corresponding HARQ process is configured and not running, then for the corresponding HARQ process:
 - 3> if the *configuredGrantTimer* is not running, and the HARQ process is not pending (i.e. new transmission):
 - 4> consider the NDI bit to have been toggled;
 - 4> deliver the configured uplink grant and the associated HARQ information to the HARQ entity.
 - 3> else if the previous uplink grant delivered to the HARQ entity for the same HARQ process was a configured uplink grant (i.e. retransmission on configured grant):
 - 4> deliver the configured uplink grant and the associated HARQ information to the HARQ entity.

For configured uplink grants neither configured with *harq-ProcID-Offset2* nor with *cg-RetransmissionTimer*, the HARQ Process ID associated with the first symbol of a UL transmission is derived from the following equation:

$$\text{HARQ Process ID} = [\text{floor}(\text{CURRENT_symbol} / \text{periodicity})] \text{ modulo } n_{\text{rofHARQ-Processes}}$$

For configured uplink grants with *harq-ProcID-Offset2*, the HARQ Process ID associated with the first symbol of a UL transmission is derived from the following equation:

$$\text{HARQ Process ID} = [\text{floor}(\text{CURRENT_symbol} / \text{periodicity})] \text{ modulo } n_{\text{rofHARQ-Processes}} + \text{harq-ProcID-Offset2}$$

where $\text{CURRENT_symbol} = (\text{SFN} \times \text{numberOfSlotsPerFrame} \times \text{numberOfSymbolsPerSlot} + \text{slot number in the frame} \times \text{numberOfSymbolsPerSlot} + \text{symbol number in the slot})$, and *numberOfSlotsPerFrame* and *numberOfSymbolsPerSlot* refer to the number of consecutive slots per frame and the number of consecutive symbols per slot, respectively as specified in TS 38.211 [8].

[TS 38.321, clause 5.8.2] There are two types of transmission without dynamic grant:

- configured grant Type 1 where an uplink grant is provided by RRC, and stored as configured uplink grant;
- configured grant Type 2 where an uplink grant is provided by PDCCH, and stored or cleared as configured uplink grant based on L1 signalling indicating configured uplink grant activation or deactivation.

Type 1 and Type 2 are configured by RRC for a Serving Cell per BWP. Multiple configurations can be active simultaneously in the same BWP. For Type 2, activation and deactivation are independent among the Serving Cells. For the same BWP, the MAC entity can be configured with both Type 1 and Type 2.

RRC configures the following parameters when the configured grant Type 1 is configured:

- *cs-RNTI*: CS-RNTI for retransmission;
- *periodicity*: periodicity of the configured grant Type 1;
- *timeDomainOffset*: Offset of a resource with respect to $SFN = timeReferenceSFN$ in time domain;
- *timeDomainAllocation*: Allocation of configured uplink grant in time domain which contains *startSymbolAndLength* (i.e. *SLIV* in TS 38.214 [7]) or *startSymbol* (i.e. *S* in TS 38.214 [7]);
- *nrofHARQ-Processes*: the number of HARQ processes for configured grant;
- *harq-ProcID-Offset*: offset of HARQ process for configured grant for operation with shared spectrum channel access;
- *harq-ProcID-Offset2*: offset of HARQ process for configured grant;
- *timeReferenceSFN*: SFN used for determination of the offset of a resource in time domain. The UE uses the closest SFN with the indicated number preceding the reception of the configured grant configuration.

RRC configures the following parameters when the configured grant Type 2 is configured:

- *cs-RNTI*: CS-RNTI for activation, deactivation, and retransmission;
- *periodicity*: periodicity of the configured grant Type 2;
- *nrofHARQ-Processes*: the number of HARQ processes for configured grant;
- *harq-ProcID-Offset*: offset of HARQ process for configured grant for operation with shared spectrum channel access;
- *harq-ProcID-Offset2*: offset of HARQ process for configured grant.

RRC configures the following parameters when retransmissions on configured uplink grant is configured:

- *cg-RetransmissionTimer*: the duration after a configured grant (re)transmission of a HARQ process when the UE shall not autonomously retransmit that HARQ process.

Upon configuration of a configured grant Type 1 for a BWP of a Serving Cell by upper layers, the MAC entity shall:

- 1> store the uplink grant provided by upper layers as a configured uplink grant for the indicated BWP of the Serving Cell;
- 1> initialise or re-initialise the configured uplink grant to start in the symbol according to *timeDomainOffset*, *timeReferenceSFN*, and *S* (derived from *SLIV* or provided by *startSymbol* as specified in TS 38.214 [7]), and to reoccur with *periodicity*.

After an uplink grant is configured for a configured grant Type 1, the MAC entity shall consider sequentially that the N^{th} ($N \geq 0$) uplink grant occurs in the symbol for which:

$$[(SFN \times numberOfSlotsPerFrame \times numberOfSymbolsPerSlot) + (\text{slot number in the frame} \times numberOfSymbolsPerSlot) + \text{symbol number in the slot}] = (timeReferenceSFN \times numberOfSlotsPerFrame \times numberOfSymbolsPerSlot + timeDomainOffset \times numberOfSymbolsPerSlot + S + N \times periodicity) \text{ modulo } (1024 \times numberOfSlotsPerFrame \times numberOfSymbolsPerSlot).$$

After an uplink grant is configured for a configured grant Type 2, the MAC entity shall consider sequentially that the N^{th} ($N \geq 0$) uplink grant occurs in the symbol for which:

$$[(SFN \times numberOfSlotsPerFrame \times numberOfSymbolsPerSlot) + (\text{slot number in the frame} \times numberOfSymbolsPerSlot) + \text{symbol number in the slot}] = [(SFN_{\text{start time}} \times numberOfSlotsPerFrame \times numberOfSymbolsPerSlot + \text{slot}_{\text{start time}} \times numberOfSymbolsPerSlot + \text{symbol}_{\text{start time}}) + N \times periodicity] \text{ modulo } (1024 \times numberOfSlotsPerFrame \times numberOfSymbolsPerSlot).$$

where $SFN_{\text{start time}}$, $\text{slot}_{\text{start time}}$, and $\text{symbol}_{\text{start time}}$ are the SFN, slot, and symbol, respectively, of the first transmission opportunity of PUSCH where the configured uplink grant was (re-)initialised.

If *cg-nrofPUSCH-InSlot* or *cg-nrofSlots* is configured for a configured grant Type 1 or Type 2, the MAC entity shall consider the uplink grants occur in those additional PUSCH allocations as specified in clause 6.1.2.3 of TS 38.214 [7].

NOTE: In case of unaligned SFN across carriers in a cell group, the SFN of the concerned Serving Cell is used to calculate the occurrences of configured uplink grants.

When the configured uplink grant is released by upper layers, all the corresponding configurations shall be released and all corresponding uplink grants shall be cleared.

The MAC entity shall:

- 1> if at least one configured uplink grant confirmation has been triggered and not cancelled; and
- 1> if the MAC entity has UL resources allocated for new transmission:
 - 2> if, in this MAC entity, at least one configured uplink grant is configured by *configuredGrantConfigToAddModList*:
 - 3> instruct the Multiplexing and Assembly procedure to generate a Multiple Entry Configured Grant Confirmation MAC CE as defined in clause 6.1.3.31.
 - 2> else:
 - 3> instruct the Multiplexing and Assembly procedure to generate a Configured Grant Confirmation MAC CE as defined in clause 6.1.3.7.
- 2> cancel all triggered configured uplink grant confirmation(s).

For a configured grant Type 2, the MAC entity shall clear the configured uplink grant(s) immediately after first transmission of Configured Grant Confirmation MAC CE or Multiple Entry Configured Grant Confirmation MAC CE which confirms the configured uplink grant deactivation.

Retransmissions use:

- repetition of configured uplink grants; or
- received uplink grants addressed to CS-RNTI; or
- configured uplink grants with *cg-RetransmissionTimer* configured.

[TS 38.300, clause 10.3]

In the uplink, the gNB can dynamically allocate resources to UEs via the C-RNTI on PDCCH(s). A UE always monitors the PDCCH(s) in order to find possible grants for uplink transmission when its downlink reception is enabled (activity governed by DRX when configured). When CA is configured, the same C-RNTI applies to all serving cells.

The gNB may cancel a PUSCH transmission, or a repetition of a PUSCH transmission, or an SRS transmission of a UE for another UE with a latency-critical transmission. The gNB can configure UEs to monitor cancelled transmission indications using CI-RNTI on a PDCCH. If a UE receives the cancelled transmission indication, the UE shall cancel the PUSCH transmission from the earliest symbol overlapped with the resource or the SRS transmission overlapped with the resource indicated by cancellation (see clause 11.2A of TS 38.213 [38]).

In addition, with Configured Grants, the gNB can allocate uplink resources for the initial HARQ transmissions and HARQ retransmissions to UEs. Two types of configured uplink grants are defined:

- With Type 1, RRC directly provides the configured uplink grant (including the periodicity).
- With Type 2, RRC defines the periodicity of the configured uplink grant while PDCCH addressed to CS-RNTI can either signal and activate the configured uplink grant, or deactivate it; i.e. a PDCCH addressed to CS-RNTI indicates that the uplink grant can be implicitly reused according to the periodicity defined by RRC, until deactivated.

If the UE is not configured with enhanced intra-UE overlapping resources prioritization, the dynamically allocated uplink transmission overrides the configured uplink grant in the same serving cell, if they overlap in time. Otherwise an uplink transmission according to the configured uplink grant is assumed, if activated.

If the UE is configured with enhanced intra-UE overlapping resources prioritization, in case a configured uplink grant transmission overlaps in time with dynamically allocated uplink transmission or with another configured uplink grant transmission in the same serving cell, the UE prioritizes the transmission based on the comparison between the highest priority of the logical channels that have data to be transmitted and which are multiplexed or can be multiplexed in MAC PDUs associated with the overlapping resources. Similarly, in case a configured uplink grant transmissions or a dynamically allocated uplink transmission overlaps in time with a scheduling request transmission, the UE prioritizes the transmission based on the comparison between the priority of the logical channel which triggered the scheduling request and the highest priority of the logical channels that have data to be transmitted and which are multiplexed or can be multiplexed in MAC PDU associated with the overlapping resource. In case the MAC PDU associated with a deprioritized transmission has already been generated, the UE keeps it stored to allow the gNB to schedule a retransmission. The UE may also be configured by the gNB to transmit the stored MAC PDU as a new transmission using a subsequent resource of the same configured uplink grant configuration when an explicit retransmission grant is not provided by the gNB.

Retransmissions other than repetitions are explicitly allocated via PDCCH(s) or via configuration of a retransmission timer.

The UE may be configured with up to 12 active configured uplink grants for a given BWP of a serving cell. When more than one is configured, the network decides which of these configured uplink grants are active at a time (including all of them). Each configured uplink grant can either be of Type 1 or Type 2. For Type 2, activation and deactivation of configured uplink grants are independent among the serving cells. When more than one Type 2 configured grant is configured, each configured grant is activated separately using a DCI command and deactivation of Type 2 configured grants is done using a DCI command, which can either deactivate a single configured grant configuration or multiple configured grant configurations jointly.

When SUL is configured, the network should ensure that an active configured uplink grant on SUL does not overlap in time with another active configured uplink grant on the other UL configuration.

For both dynamic grant and configured grant, for a transport block, two or more repetitions can be in one slot, or across slot boundary in consecutive available slots with each repetition in one slot. For both dynamic grant and configured grant Type 2, the number of repetitions can be also dynamically indicated in the L1 signalling. The dynamically indicated number of repetitions shall override the RRC configured number of repetitions, if both are present.

7.1.1.6.5.3 Test description

7.1.1.6.5.3.1 Pre-test conditions

Same Pre-test conditions as in clause 7.1.1.0 and UM DRB should be established on NR Cell 1.

7.1.1.6.5.3.2 Test procedure sequence

Table 7.1.1.6.5.3.2-1: Main behaviour

St	Procedure	Message Sequence		TP	Verdict
		U - S	Message		
1	SS transmits NR <i>RRCReconfiguration</i> message to configure UL configured grant type 1 in SFN 900, <i>timeDomainOffset</i> is set to 5.	<--	(NR RRC: <i>RRCReconfiguration</i>)	-	-
2	The UE transmits NR <i>RRCReconfigurationComplete</i> message.	-->	(NR RRC: <i>RRCReconfigurationComplete</i>)	-	-
3	SS transmits a DL MAC PDU containing 4 RLC SDUs of size 96 bytes in SFN 1022 on UM DRB. (Note 1)	<--	MAC PDU (nine RLC SDUs)	-	-
4	Check: Does the UE transmit a MAC PDU containing first RLC SDU in Symbol 'x0', Slot y0', SFN 'z0' after the SFN in step 3 wraps around? Where $[(z0 \times \text{numberOfSlotsPerFrame} \times \text{numberOfSymbolsPerSlot}) + (y0 \times \text{numberOfSymbolsPerSlot}) + x0] = (5 \times \text{numberOfSymbolsPerSlot} + S + 0 \times \text{periodicity}) \text{ modulo } (1024 \times \text{numberOfSlotsPerFrame} \times$	-->	MAC PDU (one RLC SDU)	1	P

	<i>numberOfSymbolsPerSlot</i>). (Note 2)				
5	Check: Does the UE transmit a MAC PDU containing second RLC SDU in Symbol 'x1', Slot y1', SFN 'z1'? Where $[(z1 \times \text{numberOfSlotsPerFrame} \times \text{numberOfSymbolsPerSlot}) + (y1 \times \text{numberOfSymbolsPerSlot}) + x1] = (5 \times \text{numberOfSymbolsPerSlot} + S + 1 \times \text{periodicity}) \text{ modulo } (1024 \times \text{numberOfSlotsPerFrame} \times \text{numberOfSymbolsPerSlot})$.	-->	MAC PDU (one RLC SDU)	1	P
6	SS transmits NR <i>RRCReconfiguration</i> message to add another configure UL configured grant type 1 in SFN 'z1 + 1', <i>timeDomainOffset</i> is set to 15.	<--	(NR RRC: <i>RRCReconfiguration</i>)	-	-
7	The UE transmits NR <i>RRCReconfigurationComplete</i> message	-->	(NR RRC: <i>RRCReconfigurationComplete</i>)	-	-
8	Check: Does the UE transmit a MAC PDU containing third RLC SDU in Symbol 'x0', Slot y0', SFN 'z2' after the SFN in step 6 wraps around? Where $[(z2 \times \text{numberOfSlotsPerFrame} \times \text{numberOfSymbolsPerSlot}) + (y0 \times \text{numberOfSymbolsPerSlot}) + x0] = (5 \times \text{numberOfSymbolsPerSlot} + S + 0 \times \text{periodicity}) \text{ modulo } (1024 \times \text{numberOfSlotsPerFrame} \times \text{numberOfSymbolsPerSlot})$.	-->	MAC PDU (one RLC SDU)	2	P
9	Check: Does the UE transmit a MAC PDU containing fourth RLC SDU in Symbol 'x2', Slot y2', SFN 'z2'? Where $[(z2 \times \text{numberOfSlotsPerFrame} \times \text{numberOfSymbolsPerSlot}) + (y2 \times \text{numberOfSymbolsPerSlot}) + x2] = (15 \times \text{numberOfSymbolsPerSlot} + S + 0 \times \text{periodicity}) \text{ modulo } (1024 \times \text{numberOfSlotsPerFrame} \times \text{numberOfSymbolsPerSlot})$.	-->	MAC PDU (one RLC SDU)	2	P
10	Check: Does the UE transmit a MAC PDU containing fifth RLC SDU in Symbol 'x1', Slot y1', SFN 'z3' after the SFN in step 8 wraps around? Where $[(z3 \times \text{numberOfSlotsPerFrame} \times \text{numberOfSymbolsPerSlot}) + (y3 \times \text{numberOfSymbolsPerSlot}) + x3] = (5 \times \text{numberOfSymbolsPerSlot} + S + 1 \times \text{periodicity}) \text{ modulo } (1024 \times \text{numberOfSlotsPerFrame} \times \text{numberOfSymbolsPerSlot})$.	-->	MAC PDU (one RLC SDU)	2	P
11	Check: Does the UE transmit a MAC PDU containing sixth RLC SDU in Symbol 'x3', Slot y3', SFN 'z3'? Where $[(z3 \times \text{numberOfSlotsPerFrame} \times \text{numberOfSymbolsPerSlot}) + (y3 \times \text{numberOfSymbolsPerSlot}) + x3] = (15 \times \text{numberOfSymbolsPerSlot} + S + 1 \times \text{periodicity}) \text{ modulo } (1024 \times \text{numberOfSlotsPerFrame} \times \text{numberOfSymbolsPerSlot})$.	-->	MAC PDU (one RLC SDU)	2	P
Note 1: According to the setting parameters in Table 7.1.1.6.2.3.3-2, TB size for configured grant type 1 is 808 bits, which is enough to allow the UE to transmit one PDU at a time (96 bytes RLC SDU + 1 byte UM RLC Header + 2 bytes MAC Sub PDU header + 2 bytes for short BSR or padding).					
Note 2: S is the starting symbol relative to the slot of the first PUSCH transmission for new configured grant type 1.					

The value of S can be obtained from TS 38.508-1 [4], Table 4.6.3-122.

Note 3: q is the slot where the UE shall transmit the PUSCH and is determined by K_2 as
$$\left\lceil n \cdot \frac{2^{u_{\text{PUSCH}}}}{2^{u_{\text{PDCCH}}}} \right\rceil + K_2$$

where n is the slot with the scheduling DCI, K_2 is based on the numerology of PUSCH. S is the starting symbol relative to the start of the slot q according to TS 38.214 clause 6.1.2.1.

Note 4: The UL grant addressed to C-RNTI should result in UL transmission overlap in time domain as configured grant type 1.

7.1.1.6.5.3.3 Specific message contents

Table 7.1.1.6.5.3.3-1: RRCReconfiguration (step 1 and step 6, Table 7.1.1.6.5.3.2-1)

Derivation path: 38.508-1 [4], Table 4.6.1-13			
Information Element	Value/remark	Comment	Condition
RRCReconfiguration ::= SEQUENCE {			
criticalExtensions CHOICE {			
rrcReconfiguration SEQUENCE {			
radioBearerConfig	Not present		
secondaryCellGroup	Not Present		
nonCriticalExtension := SEQUENCE{			
masterCellGroup	CellGroupConfig	OCTET STRING (CONTAINING CellGroupConfig)	
dedicatedNAS-MessageList SEQUENCE (SIZE(1..maxDRB)) OF DedicatedNAS-Message {}	Not present		
}			
}			
}			
}			

Table 7.1.1.6.5.3.3-2: CellGroupConfig (Table 7.1.1.6.5.3.3-1: RRCReconfiguration)

Derivation path: 38.508-1 [4], Table 4.6.3-19			
Information Element	Value/remark	Comment	Condition
CellGroupConfig ::= SEQUENCE {			
rlc-BearerToAddModList	Not present		
mac-CellGroupConfig	Not present		
physicalCellGroupConfig SEQUENCE {			
cs-RNTI CHOICE {			
setup SEQUENCE{			
RNTI-Value	'FFE0'H		
}			
}			
}			
spCellConfig SEQUENCE{			
servCellIndex	Not present		
reconfigurationWithSync	Not present		
spCellConfigDedicated SEQUENCE{			
uplinkConfig SEQUENCE {			
initialUplinkBWP SEQUENCE {			
pucch-Config CHOICE {			
setup SEQUENCE {			
schedulingRequestResourceToAddModList {			
schedulingRequestResourceId	1		
schedulingRequestID	0		
periodicityAndOffset CHOICE {			
sl20	10		
}			
}			
}			

}			
configuredGrantConfigToAddModList-r16 SEQUENCE (SIZE (1..maxNrofConfiguredGrantConfig-r16)) OF ConfiguredGrantConfig {	2 entries		
configuredGrantConfig[1] SEQUENCE {		The first UL Grant configuration entry	Step1
cg-DMRS-Configuration	DMRS-UplinkConfig	Reference TS 38.508-1[4], Table 4.6.3-51	
uci-OnPUSCH CHOICE {			
setup SEQUENCE {			
semiStatic SEQUENCE {	BetaOffsets		
betaOffsetACK-Index1	9		
betaOffsetACK-Index2	9		
betaOffsetACK-Index3	9		
betaOffsetCSI-Part1-Index1	6		
betaOffsetCSI-Part1-Index2	6		
betaOffsetCSI-Part2-Index1	6		
betaOffsetCSI-Part2-Index2	6		
}			
}			
resourceAllocation	ResourceAllocationType 1		
powerControlLoopToUse	n0		
p0-PUSCH-Alpha	1		
nrofHARQ-Processes	16		
repK	n1		
periodicity	Sym40x14		15kHz
periodicity	Sym80x14		30kHz
periodicity	Sym160x14		60kHz
periodicity	Sym320x14		120kHz
rrc-ConfiguredUplinkGrant SEQUENCE{			
timeDomainOffset	5		
timeDomainAllocation	0	Reference TS 38.508-1 [4], Table 4.6.3-122	
frequencyDomainAllocation	BIT STRING (SIZE(18))	BIT STRING (SIZE(18), Equal to NBWPsize * (LRB-1) + RBstart), where LRB = 2 PRB, RBstart = 0, NBWPsize is the size [PRBs] of the active carrier bandwidth part and contained in TS.38.508-1 [4] clause 4.3.1.1.	FR1_FDD, FR1_TDD
frequencyDomainAllocation	BIT STRING (SIZE(18))	BIT STRING (SIZE(18), Equal to NBWPsize * (LRB-1) + RBstart), where LRB=9 PRB, RBstart = 0 and NBWPsize is the size [PRBs] of the active carrier bandwidth part and contained in TS.38.508-1 [4] clause 4.3.1.2.	FR2_TDD
antennaPort	0		

precodingAndNumberOfLayers	0		
srs-ResourceIndicator	Not present		
mcsAndTBS	18		FR1_FDD, FR1_TDD
	25		FR2_TDD
pathlossReferenceIndex	0		
}			
}			
configuredGrantConfig[2] SEQUENCE {		The second UL Grant configuration entry	Step6
cg-DMRS-Configuration	DMRS-UplinkConfig	Reference TS 38.508-1[4], Table 4.6.3-51	
uci-OnPUSCH CHOICE {			
setup SEQUENCE {			
semiStatic SEQUENCE {	BetaOffsets		
betaOffsetACK-Index1	9		
betaOffsetACK-Index2	9		
betaOffsetACK-Index3	9		
betaOffsetCSI-Part1-Index1	6		
betaOffsetCSI-Part1-Index2	6		
betaOffsetCSI-Part2-Index1	6		
betaOffsetCSI-Part2-Index2	6		
}			
}			
}			
resourceAllocation	ResourceAllocationType 1		
powerControlLoopToUse	n0		
p0-PUSCH-Alpha	1		
nrofHARQ-Processes	16		
repK	n1		
periodicity	Sym40x14		15kHz
periodicity	Sym80x14		30kHz
periodicity	Sym160x14		60kHz
periodicity	Sym320x14		120kHz
rrc-ConfiguredUplinkGrant SEQUENCE{			
timeDomainOffset	15		
timeDomainAllocation	0	Reference TS 38.508-1 [4], Table 4.6.3-122	
frequencyDomainAllocation	BIT STRING (SIZE(18))	BIT STRING (SIZE(18), Equal to NBWPsize * (LRB-1) + RBstart), where LRB = 2 PRB, RBstart = 0, NBWPsize is the size [PRBs] of the active carrier bandwidth part and contained in TS.38.508-1 [4] clause 4.3.1.1.	FR1_FDD, FR1_TDD
frequencyDomainAllocation	BIT STRING (SIZE(18))	BIT STRING (SIZE(18), Equal to NBWPsize * (LRB-1) + RBstart), where LRB=9 PRB, RBstart = 0and NBWPsize is the size [PRBs] of the active carrier bandwidth part and	FR2_TDD

		contained in TS.38.508-1 [4] clause 4.3.1.2.	
antennaPort	0		
precodingAndNumberOfLayers	0		
srs-ResourceIndicator	Not present		
mcsAndTBS	18		FR1_FDD, FR1_TDD
	25		FR2_TDD
pathlossReferenceIndex	0		
}			
}			
}			
pusch-Config CHOICE {			
setup SEQUENCE {			
PUSCH-TimeDomainResourceAllocationList			
SEQUENCE {			
k2	n8		FR1 and FR2
mappingType	typeB		
startSymbolAndLength	0011011	Start symbol(S)=0, Length(L)=14	FR1
startSymbolAndLength	0001110	S=0, L=2	FR2
}			
}			
}			
}			
}			
}			
}			
}			
}			
}			

7.1.1.7 Activation/Deactivation of SCells

7.1.1.7.1 Activation/Deactivation of SCells / Activation/Deactivation MAC control element reception / sCellDeactivationTimer

7.1.1.7.1.1 Activation/Deactivation of SCells / Activation/Deactivation MAC control element reception / sCellDeactivationTimer / Intra-band Contiguous CA

7.1.1.7.1.1.1 Test Purpose (TP)

(1)

```
with { UE in RRC_CONNECTED state with SCell configured }
ensure that {
  when { UE receives an SCell Activation/Deactivation MAC CE activating the SCell }
  then { UE starts monitoring PDCCH on activated SCell }
}
```

(2)

```
with(UE in RRC_CONNECTED state with SCell activated )
ensure that {
  when{ UE receives a DL assignment on SCell PDCCH }
  then { UE restarts the sCellDeactivationTimer }
}
```

(3)

```
with ( UE in RRC_CONNECTED state with SCell activated )
ensure that {
  when{ UE sCellDeactivationTimer expires }
  then { UE deactivates the SCell and stops monitoring PDCCH on SCell }
}
```

```

    }

```

(4)

```

with ( UE in RRC_CONNECTED state with SCell activated )
ensure that {
  when { UE receives a SCell Activation/Deactivation MAC CE deactivating the SCell }
  then { UE deactivates the SCell and stops monitoring PDCCH on SCell }
}

```

(5)

```

with ( UE in RRC_CONNECTED state with SCell activated and UL CA is supported )
ensure that {
  when { UE receives a UL assignment on SCell and has data available for transmission }
  then { UE transmits the UL MAC PDU }
}

```

7.1.1.7.1.1.2 Conformance requirements

References: The conformance requirements covered in the present TC are specified in: TS 38.321, clauses 5.9 and TS 38.331 clause 5.3.5.5.2. Unless otherwise stated these are Rel-15 requirements.

[TS 38.321, clause 5.9]

If the MAC entity is configured with one or more SCells, the network may activate and deactivate the configured SCells. Upon configuration of an SCell, the SCell is deactivated.

The configured SCell(s) is activated and deactivated by:

- receiving the SCell Activation/Deactivation MAC CE described in subclause 6.1.3.10;
- configuring *sCellDeactivationTimer* timer per configured SCell (except the SCell configured with PUCCH, if any): the associated SCell is deactivated upon its expiry.

The MAC entity shall for each configured SCell:

- 1> if an SCell Activation/Deactivation MAC CE is received activating the SCell:
 - 2> activate the SCell according to the timing defined in TS 38.213 [6]; i.e. apply normal SCell operation including:
 - 3> SRS transmissions on the SCell;
 - 3> CSI reporting for the SCell;
 - 3> PDCCH monitoring on the SCell;
 - 3> PDCCH monitoring for the SCell;
 - 3> PUCCH transmissions on the SCell, if configured.
 - 2> start or restart the *sCellDeactivationTimer* associated with the SCell in the slot when the SCell Activation/Deactivation MAC CE was received;
 - 2> (re-)initialize any suspended configured uplink grants of configured grant Type 1 associated with this SCell according to the stored configuration, if any, and to start in the symbol according to rules in subclause 5.8.2;
 - 2> trigger PHR according to subclause 5.4.6.
- 1> else if an SCell Activation/Deactivation MAC CE is received deactivating the SCell; or
- 1> if the *sCellDeactivationTimer* associated with the activated SCell expires:
 - 2> deactivate the SCell according to the timing defined in TS 38.213 [6];
 - 2> stop the *sCellDeactivationTimer* associated with the SCell;

- 2> stop the *bwp-InactivityTimer* associated with the SCell;
 - 2> clear any configured downlink assignment and any configured uplink grant Type 2 associated with the SCell respectively;
 - 2> suspend any configured uplink grant Type 1 associated with the SCell;
 - 2> flush all HARQ buffers associated with the SCell.
- 1> if PDCCH on the activated SCell indicates an uplink grant or downlink assignment; or
- 1> if PDCCH on the Serving Cell scheduling the activated SCell indicates an uplink grant or a downlink assignment for the activated SCell; or
- 1> if a MAC PDU is transmitted in a configured uplink grant or received in a configured downlink assignment:
- 2> restart the *sCellDeactivationTimer* associated with the SCell.
- 1> if the SCell is deactivated:
- 2> not transmit SRS on the SCell;
 - 2> not report CSI for the SCell;
 - 2> not transmit on UL-SCH on the SCell;
 - 2> not transmit on RACH on the SCell;
 - 2> not monitor the PDCCH on the SCell;
 - 2> not monitor the PDCCH for the SCell;
 - 2> not transmit PUCCH on the SCell.

HARQ feedback for the MAC PDU containing SCell Activation/Deactivation MAC CE shall not be impacted by PCell, PSCell and PUCCH SCell interruptions due to SCell activation/deactivation in TS 38.133 [11].

When SCell is deactivated, the ongoing Random Access procedure on the SCell, if any, is aborted.

[TS 38.321, clause 6.1.3.10]

The SCell Activation/Deactivation MAC CE of one octet is identified by a MAC PDU subheader with LCID as specified in Table 6.2.1-1. It has a fixed size and consists of a single octet containing seven C-fields and one R-field. The SCell Activation/Deactivation MAC CE with one octet is defined as follows (Figure 6.1.3.10-1).

The SCell Activation/Deactivation MAC CE of four octets is identified by a MAC PDU subheader with LCID as specified in Table 6.2.1-1. It has a fixed size and consists of four octets containing 31 C-fields and one R-field. The SCell Activation/Deactivation MAC CE of four octets is defined as follows (Figure 6.1.3.10-2).

For the case with no Serving Cell with a *ServCellIndex* as specified in TS 38.331 [8] larger than 7, SCell Activation/Deactivation MAC CE of one octet is applied, otherwise SCell Activation/Deactivation MAC CE of four octets is applied.

- C_i : If there is an SCell configured for the MAC entity with *SCellIndex* i as specified in TS 38.331 [8], this field indicates the activation/deactivation status of the SCell with *SCellIndex* i , else the MAC entity shall ignore the C_i field. The C_i field is set to "1" to indicate that the SCell with *SCellIndex* i shall be activated. The C_i field is set to "0" to indicate that the SCell with *SCellIndex* i shall be deactivated;
- R: Reserved bit, set to "0".

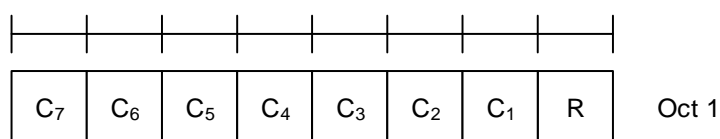

Figure 6.1.3.10-1: SCell Activation/Deactivation MAC CE of one octet

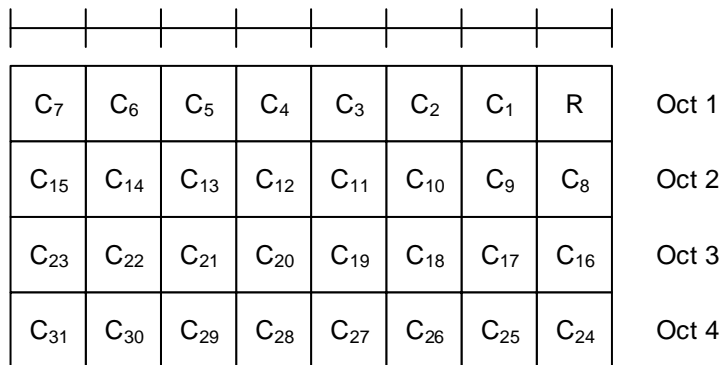

Figure 6.1.3.10-2: SCell Activation/Deactivation MAC CE of four octets

7.1.1.7.1.1.3 Test description

7.1.1.7.1.1.3.1 Pre-test conditions

Same Pre-test conditions as in clause 7.1.1.0 except that DRB is configured in RLC AM mode according to Table 7.1.1.7.1.1.3.1-1 and in addition NR Cell 3 is configured as NR Active SCell.

Table 7.1.1.7.1.1.3.1-1: RLC parameters

<i>t-PollRetransmit</i>	ms80
-------------------------	------

7.1.1.7.1.1.3.2 Test procedure sequence

Table 7.1.1.7.1.1.3.2-1: Time instances of cell power level and parameter changes

	Parameter	Unit	NR Cell 1	NR Cell 3
T0	SS/PBCH SSS EPRE	dBm/SC S	-85	-85

Table 7.1.1.7.1.1.3.2-2: Main behaviour

St	Procedure	Message Sequence		TP	Verdict
		U - S	Message		
1	SS transmits an RRCReconfiguration message to configure NR SCell(NR Cell 3). Note 1	<--	(RRCReconfiguration)	-	-
2	The UE transmits RRCReconfigurationComplete message. Note 2	-->	(RRCReconfigurationComplete)	-	-
3	The SS transmits Activation MAC control element to activate NR SCell on NR SpCell.	<--	MAC PDU (SCell Activation/Deactivation MAC CE of one octet (C ₁ =1))	-	-
4	200 ms after step 3, the SS indicates a new transmission on PDCCH of SCell and transmits a MAC PDU (containing an RLC PDU)	<--	MAC PDU	-	-
5	Check: Does the UE transmit a Scheduling Request on PUCCH?	-->	(SR)	1	P
6	The SS sends an UL grant suitable for transmitting loop back PDU on NR SpCell.	<--	(UL Grant)	-	-
7	The UE transmits a MAC PDU containing the loop back PDU corresponding to step 4.	-->	MAC PDU	-	-
8	The SS transmits a MAC PDU containing RLC	<--	MAC PDU	-	-

	status PDU acknowledging reception of RLC PDU in step 7 on NR SpCell				
9	400 ms(sCellDeactivationTimer = 320 ms) after step 4, the SS indicates a new transmission on PDCCH of NR SCell and transmits a MAC PDU (containing an RLC PDU)	<--	MAC PDU	-	-
10	Check: Does the UE transmit a Scheduling Request on PUCCH in next 1 second?	-->	(SR)	2	F
11	The SS transmits Activation MAC control element to activate SCell on NR SpCell.	<--	MAC PDU ((SCell Activation/Deactivation MAC CE of one octet (C ₁ =1))	-	-
12	200 ms after step 11 The SS indicates a new transmission on PDCCH of NR SCell and transmits a MAC PDU (containing just padding or RLC status PDU, but no RLC data PDU)	<--	MAC PDU	-	-
13	400 ms after step 11 the SS indicates a new transmission on PDCCH of NR SCell and transmits a MAC PDU (containing an RLC PDU)	<--	MAC PDU	-	-
14	Check: Does the UE transmit a Scheduling Request on PUCCH?	-->	(SR)	1,3	P
15	The SS sends an UL grant suitable for transmitting loop back PDU IF pc_UL_NR_CA_2CC on NR SCell ELSE on NR SpCell.	<--	(UL Grant)	-	-
16	The UE transmits a MAC PDU containing the loop back PDU corresponding to step 14	-->	MAC PDU	5	P
17	The SS transmits a MAC PDU containing RLC status PDU acknowledging reception of RLC PDU in step 16	<--	MAC PDU	-	-
18	The SS transmits Deactivation MAC control element to de-activate SCell on NR SpCell.	<--	MAC PDU (SCell Activation/Deactivation MAC CE of one octet (C ₁ =0))	-	-
19	The SS indicates a new transmission on PDCCH of NR SCell and transmits a MAC PDU (containing an RLC PDU)	<--	MAC PDU	-	-
20	Check: Does the UE transmit a Scheduling Request on PUCCH in the next 1 second?	-->	(SR)	4	F
<p>Note 1: For EN-DC the NR <i>RRCReconfiguration</i> message is contained in <i>RRCConnectionReconfiguration</i>. Note 2: For EN-DC the NR <i>RRCReconfigurationComplete</i> message is contained in <i>RRCConnectionReconfigurationComplete</i>.</p>					

7.1.1.7.1.1.3.3 Specific message contents

Table 7.1.1.7.1.1.3.3-1: *RRCReconfiguration* (step 1, Table 7.1.1.7.1.1.3.2-2)

Derivation Path: TS 38.508-1 [4], Table 4.6.1-13			
Information Element	Value/remark	Comment	Condition
<i>RRCReconfiguration</i> ::= SEQUENCE {			
criticalExtensions CHOICE {			
c1 CHOICE {			
rrcReconfiguration SEQUENCE {			
secondaryCellGroup	CellGroupConfig		EN-DC
nonCriticalExtension SEQUENCE {			NR
masterCellGroup	CellGroupConfig	OCTET STRING (CONTAINING CellGroupConfig)	
}			
}			
}			
}			
}			

Table 7.1.1.7.1.1.3.3-2: CellGroupConfig (Table 7.1.1.7.1.1.3.3-1)

Derivation Path: TS 38.508-1 [4], Table 4.6.3-19			
Information Element	Value/remark	Comment	Condition
CellGroupConfig ::= SEQUENCE {			
sCellToAddModList SEQUENCE (SIZE (1..maxMeasId)) OF SCellConfig {	1 entry		
SCellConfig[1] SEQUENCE {		entry 1	
sCellIndex	SCellIndex as per TS 38.508-1 [4] table 4.6.3-154		
sCellConfigCommon	ServingCellConfigCommon		
sCellConfigDedicated	ServingCellConfig		
}			
}			
}			

Table 7.1.1.7.1.1.3.3-3: ServingCellConfigCommon (Table 7.1.1.7.1.1.3.3-2)

Derivation Path: TS 38.508-1 [4], Table 4.6.3-168			
Information Element	Value/remark	Comment	Condition
ServingCellConfigCommon ::= SEQUENCE {			
physCellId	Physical Cell Identity of NR Cell 3		
uplinkConfigCommon	Not present		Not pc_UL_NR_CA_2CC
}			

Table 7.1.1.7.1.1.3.3-4: ServingCellConfig (Table 7.1.1.7.1.1.3.3-2)

Derivation Path: TS 38.508-1 [4], Table 4.6.3-167			
Information Element	Value/remark	Comment	Condition
ServingCellConfig ::= SEQUENCE {			
uplinkConfig	Not present		Not pc_UL_NR_CA_2CC
uplinkConfig SEQUENCE {			pc_UL_NR_CA_2CC
initialUplinkBWP	BWP-UplinkDedicated		
}			
sCellDeactivationTimer	ms320		
}			

Table 7.1.1.7.1.1.3.3-5: BWP-UplinkDedicated (Table 7.1.1.7.1.1.3.3-4)

Derivation Path: TS 38.508-1 [4], Table 4.6.3-15			
Information Element	Value/remark	Comment	Condition
BWP-UplinkDedicated ::= SEQUENCE {			
pucch-Config	Not present		
}			

7.1.1.7.1.2 Activation/Deactivation of SCells / Activation/Deactivation MAC control element reception / sCellDeactivationTimer / Inter-Band CA

The scope and description of the present TC is the same as test case 7.1.1.7.1.1 with the following differences:

- CA configuration: Inter-band CA replaces Intra-band Contiguous CA
- Cells configuration: NR Cell 10 replaces NR Cell 3

7.1.1.7.1.3 Activation/Deactivation of SCells / Activation/Deactivation MAC control element reception / sCellDeactivationTimer / Intra-band non-Contiguous CA

The scope and description of the present TC is the same as test case 7.1.1.7.1.1 with the following differences:

- CA configuration: Intra-band non-Contiguous CA replaces Intra-band Contiguous CA

7.1.1.8 Bandwidth Part (BWP) operation

7.1.1.8.1 Bandwidth Part (BWP) operation UL/DL

7.1.1.8.1.1 Test Purpose (TP)

(1)

```
with { UE in RRC_CONNECTED state }
ensure that {
  when { UE receives BandwidthPart-Config IE included in RRC Message received on SpCell (i.e. PSCell
in case of EN-DC or PCell in case of SA) }
    then { UE starts normal MAC operation in the FirstActive UL and DL Bandwidth part }
}
```

(2)

```
with { UE in RRC_CONNECTED state }
ensure that {
  when { UE receives a DL DCI format 1_1 assigning a BWP different than the previously configured
BWP }
    then { UE starts normal MAC operation in the received new BWP }
}
```

(3)

```
with { UE in RRC_CONNECTED }
ensure that {
  when { UE receives a UL DCI format 0_1 assigning a BWP different than the previously configured
BWP }
    then { UE starts normal MAC operation in the received new BWP }
}
```

(4)

```
with { UE in RRC_CONNECTED state }
ensure that {
  when { UE determines that a RACH Procedure is triggered in SpCell (i.e. PSCell in case of EN-DC or
PCell in case of SA) and PRACH occasions are not configured }
    then { UE initiates the PRACH procedure in the initial BWP }
}
```

(5)

```
with { UE in RRC_Connected State with defaultDownlinkBWP configured }
ensure that {
  when { UE bwp-InactivityTimer expires }
    then { UE performs BWP switching to a BWP indicated by the defaultDownlinkBWP }
}
```

(6)

```
with { UE in RRC_Connected State with defaultDownlinkBWP configured and Active BWP is different than
defaultDownlinkBWP and bwp-InactivityTimer is running }
ensure that {
  when { UE receives UL assignment or DL grant addressed to its C-RNTI }
    then { UE restarts the bwp-InactivityTimer }
}
```

7.1.1.8.1.2 Conformance requirements

References: The conformance requirements covered in the present TC are specified in: TS 38.211 clause 4.4.5, TS 38.212 clause 7.3.1.1.2 and 7.3.1.2.2, TS 38.321 clause 5.15 and TS 38.331 clause 5.3.5.3. Unless otherwise stated these are Rel-15 requirements.

[TS 38.211, clause 4.4.5]

A bandwidth part is a subset of contiguous common resource blocks defined in subclause 4.4.4.3 for a given numerology μ_i in bandwidth part i on a given carrier. The starting position $N_{\text{BWP},i}^{\text{start},\mu}$ and the number of resource blocks $N_{\text{BWP},i}^{\text{size},\mu}$ in a bandwidth part shall fulfil $N_{\text{grid},x}^{\text{start},\mu} \leq N_{\text{BWP},i}^{\text{start},\mu} < N_{\text{grid},x}^{\text{start},\mu} + N_{\text{grid},x}^{\text{size},\mu}$ and $N_{\text{grid},x}^{\text{start},\mu} < N_{\text{BWP},i}^{\text{size},\mu} + N_{\text{BWP},i}^{\text{start},\mu} \leq N_{\text{grid},x}^{\text{start},\mu} + N_{\text{grid},x}^{\text{size},\mu}$, respectively. Configuration of a bandwidth part is described in clause 12 of [5, TS 38.213].

A UE can be configured with up to four bandwidth parts in the downlink with a single downlink bandwidth part being active at a given time. The UE is not expected to receive PDSCH, PDCCH, or CSI-RS (except for RRM) outside an active bandwidth part.

A UE can be configured with up to four bandwidth parts in the uplink with a single uplink bandwidth part being active at a given time. If a UE is configured with a supplementary uplink, the UE can in addition be configured with up to four bandwidth parts in the supplementary uplink with a single supplementary uplink bandwidth part being active at a given time. The UE shall not transmit PUSCH or PUCCH outside an active bandwidth part. For an active cell, the UE shall not transmit SRS outside an active bandwidth part.

Unless otherwise noted, the description in this specification applies to each of the bandwidth parts. When there is no risk of confusion, the index μ may be dropped from $N_{\text{BWP},i}^{\text{start},\mu}$, $N_{\text{BWP},i}^{\text{size},\mu}$, $N_{\text{grid},x}^{\text{start},\mu}$, and $N_{\text{grid},x}^{\text{size},\mu}$.

[TS 38.212, clause 7.3.1.1.2]

DCI format 0_1 is used for the scheduling of PUSCH in one cell.

The following information is transmitted by means of the DCI format 0_1 with CRC scrambled by C-RNTI or CS-RNTI or SP-CSI-RNTI or MCS-C-RNTI:

- Identifier for DCI formats – 1 bit
 - The value of this bit field is always set to 0, indicating an UL DCI format
- Carrier indicator – 0 or 3 bits, as defined in Subclause 10.1 of [5, TS 38.213].
- UL/SUL indicator – 0 bit for UEs not configured with SUL in the cell or UEs configured with SUL in the cell but only PUCCH carrier in the cell is configured for PUSCH transmission; 1 bit for UEs configured with SUL in the cell as defined in Table 7.3.1.1.1-1.
- Bandwidth part indicator – 0, 1 or 2 bits as determined by the number of UL BWPs $n_{\text{BWP,RRC}}$ configured by higher layers, excluding the initial UL bandwidth part. The bitwidth for this field is determined as $\lceil \log_2(n_{\text{BWP}}) \rceil$ bits, where
 - $n_{\text{BWP}} = n_{\text{BWP,RRC}} + 1$ if $n_{\text{BWP,RRC}} \leq 3$, in which case the bandwidth part indicator is equivalent to the ascending order of the higher layer parameter *BWP-Id*;
 - otherwise $n_{\text{BWP}} = n_{\text{BWP,RRC}}$, in which case the bandwidth part indicator is defined in Table 7.3.1.1.2-1;

If a UE does not support active BWP change via DCI, the UE ignores this bit field.

[TS 38.212, clause 7.3.1.2.2]

DCI format 1_1 is used for the scheduling of PDSCH in one cell.

The following information is transmitted by means of the DCI format 1_1 with CRC scrambled by C-RNTI or CS-RNTI or MCS-C-RNTI:

- Identifier for DCI formats – 1 bits

- The value of this bit field is always set to 1, indicating a DL DCI format
- Carrier indicator – 0 or 3 bits as defined in Subclause 10.1 of [5, TS 38.213].
- Bandwidth part indicator – 0, 1 or 2 bits as determined by the number of DL BWPs $n_{\text{BWP,RRC}}$ configured by higher layers, excluding the initial DL bandwidth part. The bitwidth for this field is determined as $\lceil \log_2(n_{\text{BWP}}) \rceil$ bits, where
 - $n_{\text{BWP}} = n_{\text{BWP,RRC}} + 1$ if $n_{\text{BWP,RRC}} \leq 3$, in which case the bandwidth part indicator is equivalent to the higher layer parameter *BWP-Id*;
 - otherwise $n_{\text{BWP}} = n_{\text{BWP,RRC}}$, in which case the bandwidth part indicator is defined in Table 7.3.1.1.2-1;

If a UE does not support active BWP change via DCI, the UE ignores this bit field.

[TS 38.321, clause 5.15]

In addition to clause 12 of TS 38.213 [6], this subclause specifies requirements on BWP operation.

A Serving Cell may be configured with one or multiple BWPs, and the maximum number of BWP per Serving Cell is specified in TS 38.213 [6].

The BWP switching for a Serving Cell is used to activate an inactive BWP and deactivate an active BWP at a time. The BWP switching is controlled by the PDCCH indicating a downlink assignment or an uplink grant, by the *bwp-InactivityTimer*, by RRC signalling, or by the MAC entity itself upon initiation of Random Access procedure. Upon RRC (re-)configuration of *firstActiveDownlinkBWP-Id* and/or *firstActiveUplinkBWP-Id* for SpCell or activation of an SCell, the DL BWP and/or UL BWP indicated by *firstActiveDownlinkBWP-Id* and/or *firstActiveUplinkBWP-Id* respectively (as specified in TS 38.331 [5]) is active without receiving PDCCH indicating a downlink assignment or an uplink grant. The active BWP for a Serving Cell is indicated by either RRC or PDCCH (as specified in TS 38.213 [6]). For unpaired spectrum, a DL BWP is paired with a UL BWP, and BWP switching is common for both UL and DL.

For each activated Serving Cell configured with a BWP, the MAC entity shall:

- 1> if a BWP is activated:
 - 2> transmit on UL-SCH on the BWP;
 - 2> transmit on RACH on the BWP, if PRACH occasions are configured;
 - 2> monitor the PDCCH on the BWP;
 - 2> transmit PUCCH on the BWP, if configured;
 - 2> report CSI for the BWP;
 - 2> transmit SRS on the BWP, if configured;
 - 2> receive DL-SCH on the BWP;
 - 2> (re-)initialize any suspended configured uplink grants of configured grant Type 1 on the active BWP according to the stored configuration, if any, and to start in the symbol according to rules in subclause 5.8.2.
- 1> if a BWP is deactivated:
 - 2> not transmit on UL-SCH on the BWP;
 - 2> not transmit on RACH on the BWP;
 - 2> not monitor the PDCCH on the BWP;
 - 2> not transmit PUCCH on the BWP;
 - 2> not report CSI for the BWP;
 - 2> not transmit SRS on the BWP;

- 2> not receive DL-SCH on the BWP;
- 2> clear any configured downlink assignment and configured uplink grant of configured grant Type 2 on the BWP;
- 2> suspend any configured uplink grant of configured grant Type 1 on the inactive BWP.

Upon initiation of the Random Access procedure on a Serving Cell, after the selection of carrier for performing Random Access procedure as specified in subclause 5.1.1, the MAC entity shall for the selected carrier of this Serving Cell:

- 1> if PRACH occasions are not configured for the active UL BWP:
 - 2> switch the active UL BWP to BWP indicated by *initialUplinkBWP*;
 - 2> if the Serving Cell is a SpCell:
 - 3> switch the active DL BWP to BWP indicated by *initialDownlinkBWP*.
- 1> else:
 - 2> if the Serving Cell is a SpCell:
 - 3> if the active DL BWP does not have the same *bwp-Id* as the active UL BWP:
 - 4> switch the active DL BWP to the DL BWP with the same *bwp-Id* as the active UL BWP.
- 1> stop the *bwp-InactivityTimer* associated with the active DL BWP of this Serving Cell, if running.
- 1> if the Serving Cell is SCell:
 - 2> stop the *bwp-InactivityTimer* associated with the active DL BWP of SpCell, if running.
- 1> perform the Random Access procedure on the active DL BWP of SpCell and active UL BWP of this Serving Cell.

If the MAC entity receives a PDCCH for BWP switching of a Serving Cell, the MAC entity shall:

- 1> if there is no ongoing Random Access procedure associated with this Serving Cell; or
- 1> if the ongoing Random Access procedure associated with this Serving Cell is successfully completed upon reception of this PDCCH addressed to C-RNTI (as specified in subclauses 5.1.4 and 5.1.5):
 - 2> perform BWP switching to a BWP indicated by the PDCCH.

If the MAC entity receives a PDCCH for BWP switching for a Serving Cell while a Random Access procedure associated with that Serving Cell is ongoing in the MAC entity, it is up to UE implementation whether to switch BWP or ignore the PDCCH for BWP switching, except for the PDCCH reception for BWP switching addressed to the C-RNTI for successful Random Access procedure completion (as specified in subclauses 5.1.4 and 5.1.5) in which case the UE shall perform BWP switching to a BWP indicated by the PDCCH. Upon reception of the PDCCH for BWP switching other than successful contention resolution, if the MAC entity decides to perform BWP switching, the MAC entity shall stop the ongoing Random Access procedure and initiate a Random Access procedure after performing the BWP switching; if the MAC decides to ignore the PDCCH for BWP switching, the MAC entity shall continue with the ongoing Random Access procedure on the Serving Cell.

Upon reception of RRC (re-)configuration for BWP switching for a Serving Cell while a Random Access procedure associated with that Serving Cell is ongoing in the MAC entity, the MAC entity shall stop the ongoing Random Access procedure and initiate a Random Access procedure after performing the BWP switching.

The MAC entity shall for each activated Serving Cell configured with *bwp-InactivityTimer*:

- 1> if the *defaultDownlinkBWP-Id* is configured, and the active DL BWP is not the BWP indicated by the *defaultDownlinkBWP-Id*; or
- 1> if the *defaultDownlinkBWP-Id* is not configured, and the active DL BWP is not the *initialDownlinkBWP*:
 - 2> if a PDCCH addressed to C-RNTI or CS-RNTI indicating downlink assignment or uplink grant is received on the active BWP; or

- 2> if a PDCCH addressed to C-RNTI or CS-RNTI indicating downlink assignment or uplink grant is received for the active BWP; or
- 2> if a MAC PDU is transmitted in a configured uplink grant or received in a configured downlink assignment:
 - 3> if there is no ongoing random access procedure associated with this Serving Cell; or
 - 3> if the ongoing Random Access procedure associated with this Serving Cell is successfully completed upon reception of this PDCCH addressed to C-RNTI (as specified in subclauses 5.1.4 and 5.1.5):
 - 4> start or restart the *bwp-InactivityTimer* associated with the active DL BWP.
- 2> if the *bwp-InactivityTimer* associated with the active DL BWP expires:
 - 3> if the *defaultDownlinkBWP-Id* is configured:
 - 4> perform BWP switching to a BWP indicated by the *defaultDownlinkBWP-Id*.
 - 3> else:
 - 4> perform BWP switching to the *initialDownlinkBWP*.

NOTE: If a Random Access procedure is initiated on an SCell, both this SCell and the SpCell are associated with this Random Access procedure.

- 1> if a PDCCH for BWP switching is received, and the MAC entity switches the active DL BWP:
 - 2> if the *defaultDownlinkBWP-Id* is configured, and the MAC entity switches to the DL BWP which is not indicated by the *defaultDownlinkBWP-Id*; or
 - 2> if the *defaultDownlinkBWP-Id* is not configured, and the MAC entity switches to the DL BWP which is not the *initialDownlinkBWP*:
 - 3> start or restart the *bwp-InactivityTimer* associated with the active DL BWP.

[TS 38.331, clause 5.2.1]

System Information (SI) is divided into the *MIB* and a number of SIBs where:

- ...
- For a UE in RRC_CONNECTED, the network can provide system information through dedicated signalling using the *RRCReconfiguration* message, e.g. if the UE has an active BWP with no common search space configured to monitor system information or paging.
- For PSCell and SCells, the network provides the required SI by dedicated signalling, i.e. within an *RRCReconfiguration* message. Nevertheless, the UE shall acquire MIB of the PSCell to get SFN timing of the SCG (which may be different from MCG). Upon change of relevant SI for SCell, RAN releases and adds the concerned SCell. For PSCell, SI can only be changed with Reconfiguration with Sync.

NOTE: The physical layer imposes a limit to the maximum size a SIB can take. The maximum *SIB1* or *SI message* size is 2976 bits.

[TS 38.331, clause 5.3.5.3]

The UE shall perform the following actions upon reception of the *RRCReconfiguration*:

...

- 1> if the UE is configured with E-UTRA *nr-SecondaryCellGroupConfig* (MCG is E-UTRA):
 - 2> if *RRCReconfiguration* was received via SRB1:
 - 3> submit the *RRCReconfigurationComplete* via the EUTRA MCG embedded in E-UTRA RRC message *RRCConnectionReconfigurationComplete* as specified in TS 36.331 [10];
 - 3> if *reconfigurationWithSync* was included in *spCellConfig* of an SCG:

4> initiate the random access procedure on the SpCell, as specified in TS 38.321 [3];

...

NOTE: For EN-DC, in the case *RRCReconfiguration* is received via SRB1, the random access is triggered by RRC layer itself as there is not necessarily other UL transmission. In the case *RRCReconfiguration* is received via SRB3, the random access is triggered by the MAC layer due to arrival of *RRCReconfigurationComplete*.

7.1.1.8.1.3 Test description

7.1.1.8.1.3.1 Pre-test conditions

Same Pre-test conditions as in clause 7.1.1.0.

7.1.1.8.1.3.2 Test procedure sequence

Table 7.1.1.8.1.3.2-1: Main behaviour

St	Procedure	Message Sequence		TP	Verdict
		U - S	Message		
0	The SS transmits RRCReconfiguration to configure the dedicated BWPs incl. the FirstActive BWP. (Note 1) (Note 4).	<--	(RRCReconfiguration)	-	-
-	EXCEPTION: Steps 0Aa1 to 0Ab2 describe behaviour which depends on procedure parameters; the "lower case letter" identifies a step sequence that take place if a procedure parameter has a particular value.	-	-	-	-
0Aa1	IF <i>Connectivity</i> is EN-DC or NGEN-DC, the UE sends RRCReconfigurationComplete (Note 2).	-->	(RRCReconfigurationComplete)	-	-
0Ab1	IF <i>Connectivity</i> is NR, the SS allocates (transmitted in FirstActiveDownlinkBWP) an UL Grant with DCI format 0_1 indicating FirstActiveUplinkBWP (BWP#1).	<--	UL Grant	-	-
0Ab2	Check: Does the UE send RRCReconfigurationComplete in the FirstActive BWP configured? (Note 2) (Note 3) (Note 5)	-->	(RRCReconfigurationComplete)	1	P
1	The SS transmits a valid MAC PDU containing RLC PDU in the configured FirstActive Downlink BWP configured.	<--	MAC PDU	-	-
2	After 100ms from step 1, the SS allocates (transmitted in FirstActiveDownlinkBWP) an UL Grant.	<--	UL Grant	-	-
3	Check: Does the UE transmit a MAC PDU including one RLC SDU in the FirstActive BWP configured? (Note 5)	-->	MAC PDU	1	P
4	Void	-	-	-	-

5	The SS indicates on PDCCH (transmitted in Downlink BWP#1) DL DCI format 1_1 with new BWP Id (= BWP #2) and transmits a MAC PDU containing RLC PDU on the newly configured BWP (i.e. Downlink BWP#2).	<--	MAC PDU	-	-
6	After 100ms from step5, the SS allocates (transmitted in Downlink BWP#2) an UL Grant (with DCI indicating BWP#2), sufficient for loopback of the RLC SDU from step 5 in a Slot. (Note 3)	<--	UL Grant	-	-
7	Check: Does the UE transmit a MAC PDU including one RLC SDU in the configured BWP (i.e. Uplink BWP#2)? (Note 5)	-->	MAC PDU	2	P
8	Void	-	-	-	-
9	The SS transmits a valid MAC PDU containing RLC PDU in the configured BWP (i.e. Downlink BWP#2).	<--	MAC PDU	-	-
10	After 100ms from step 9 the SS indicates on PDCCH (transmitted in Downlink BWP#2) UL DCI format 0_1 with new BWP Id (=IF pc_bwp_sameNumerology_upto4, THEN BWP #3 ELSE BWP #1) and allocates an UL Grant, sufficient for loopback of the RLC SDU from step 9 in a Slot.	<--	UL Grant	-	-
11	Check: Does the UE transmit a MAC PDU including one RLC SDU in the configured BWP (i.e. (IF pc_bwp_sameNumerology_upto4, THEN BWP #3 ELSE BWP #1, for FDD and for TDD)? (Note 5)	-->	MAC PDU	3	P
11 A	The SS transmits a valid MAC PDU containing RLC PDU in the configured BWP (i.e. Downlink BWP#2 for FDD) or (IF pc_bwp_sameNumerology_upto4, THEN BWP #3 ELSE BWP #1 for TDD).	<--	MAC PDU	-	-
12	After 100ms from step 11A the SS indicates PDCCH order on CSS for contention-based random access (transmitted in Downlink BWP#2 for FDD OR (IF pc_bwp_sameNumerology_upto4, THEN BWP #3 ELSE BWP #1 for TDD).	<--	PDCCH Order (ra-PreambleIndex = '000000'B)	-	-
13	Check: Does the UE send PRACH Preamble in the initial BWP (UL BWP#0)?	-->	PRACH Preamble	4	P
13 A	The SS transmits (in Downlink BWP #0) a MAC PDU addressed to UE RA-RNTI, containing RAR with matching RAPID in MAC sub header.	<--	Random Access Response	-	-
13 B	The UE sends (in UL BWP#0) a msg3 in the grant associated to the received Random Access Response.	-->	msg3 (C-RNTI MAC CONTROL ELEMENT)	-	-

13 C	SS schedules (in Downlink BWP#0) PDCCH transmission for UE C-RNTI and allocates UL grant sufficient for the UE to loop back the data received at step 11a.	<--	Contention Resolution	-	-
13 D	Check: Does the UE transmit a MAC PDU including one RLC SDU in the initial BWP (i.e. Uplink BWP#0)? (Note 5)	-->	MAC PDU	4	P
14- 15	Void	-	-	-	-
16	The SS indicates on PDCCH (transmitted in Downlink BWP#0) DL DCI format 1_1 with BWP Id (= BWP #1) and transmits a MAC PDU containing RLC PDU on the configured BWP (i.e. Downlink BWP#1).	<--	MAC PDU	-	-
17	After 400 ms from step 16, the SS transmits another valid MAC PDU containing RLC PDU in the active BWP (i.e. Downlink BWP#1).	<--	MAC PDU	-	-
18	After 400 ms from step 17, the SS allocates (transmitted in Downlink BWP#1) an UL Grant (with DCI indicating BWP#1), sufficient for loopback of a MAC PDU containing both RLC SDUs from steps 16 and 17 in a Slot. (Note 3)	<--	UL Grant	-	-
19	Check: Does the UE transmit a MAC PDU containing both RLC SDUs in the active BWP (i.e. Uplink BWP#1)? (Note 5)	-->	MAC PDU	5	P
20	The SS waits 1000 ms from step 18 to ensure that the bwp-InactivityTimer expired and then transmits a valid MAC PDU containing RLC PDU in the BWP with defaultDownlinkBWP-Id (= Downlink BWP#2).	<--	MAC PDU	-	-
21	The SS allocates (transmitted in the defaultDownlinkBWP, i.e. Downlink BWP#2) an UL Grant (with DCI indicating BWP#2), sufficient for loopback of the RLC SDU from step 20 in a Slot. (Note 3)	<--	UL Grant	-	-
22	Check: Does the UE transmit a MAC PDU in Uplink BWP#2 (= BWP Id of the defaultDownlinkBWP)? (Note 5)	-->	MAC PDU	6	P
<p>Note 1: For EN-DC the NR <i>RRCReconfiguration</i> message is contained in <i>RRCConnectionReconfiguration</i>.</p> <p>Note 2: For EN-DC the NR <i>RRCReconfigurationComplete</i> message is contained in <i>RRCConnectionReconfigurationComplete</i>.</p> <p>Note 3: In paired spectrum (= FDD), the switching of Downlink BWP and Uplink BWP can happen independently. Whereas in TDD, the switching of BWP for Downlink and Uplink is always at the same time instance. Currently, the scope of the Test Purposes (TP) is considered to <u>not</u> cover checking of a BWP deviation which results from non-synchronized Downlink and Uplink BWP switching in FDD.</p> <p>Note 4: After the preamble the UE is in RRC_CONNECTED, therefore SRBs and DRBs are already established. The <i>RRCReconfiguration</i> message in step 1 and step 14 shall not contain any elements like e.g. "rlc-BearerToAddModList" whose value(s) remain unchanged since the preamble. The sole purpose of the <i>RRCReconfiguration</i> message in step 1 and 14 is to configure BWPs and related fields for switching of BWPs.</p> <p>Note 5: When the UE does not use the expected BWP for the UL transmission the SS shall not receive the data what implicitly fails the test case.</p>					

7.1.1.8.1.3.3 Specific message contents

Table 7.1.1.8.1.3.3-0: Conditions for specific message contents

Condition	Explanation
BWP#1	Bandwidth part 1
BWP#2	Bandwidth part 2
BWP#3	Bandwidth part 3

Table 7.1.1.8.1.3.3-1: RRCReconfiguration (step 0)

Derivation Path: TS 38.508-1 [4], Table 4.6.1-13 (see also Note 4 in Table 7.1.1.8.1.3.2-1)			
Information Element	Value/remark	Comment	Condition
RRCReconfiguration ::= SEQUENCE {			
criticalExtensions CHOICE {			
rrcReconfiguration SEQUENCE {			
secondaryCellGroup	CellGroupConfig		EN-DC
nonCriticalExtension SEQUENCE {			NR
masterCellGroup	CellGroupConfig		
}			
}			
}			
}			

Table 7.1.1.8.1.3.3-1A: CellGroupConfig (Table 7.1.1.8.1.3.3-1)

Derivation Path: TS 38.508-1 [4], Table 4.6.3-19			
Information Element	Value/remark	Comment	Condition
CellGroupConfig ::= SEQUENCE {			
mac-CellGroupConfig	Not present		
physicalCellGroupConfig	Not present		
spCellConfig SEQUENCE {			
servCellIndex	Not present ServCellIndex		EN-DC
spCellConfigCommon	Not present		
rfl-TimersAndConstants	Not present		
spCellConfigDedicated	ServingCellConfig-Dedicated	Table 7.1.1.8.1.3.3-2	
}			
reportUplinkTxDirectCurrent-v1530	true		
}			

Table 7.1.1.8.1.3.3-2: ServingCellConfig-Dedicated (Table 7.1.1.8.1.3.3-1A)

Derivation Path: TS 38.508-1 [4] Table 4.6.3-167			
Information Element	Value/remark	Comment	Condition
ServingCellConfig ::= SEQUENCE {			
tdd-UL-DL-ConfigurationDedicated	Not present TDD-UL-DL- ConfigDedicated		TDD
..initialDownlinkBWP ::= SEQUENCE {			
pdccch-Config CHOICE {			
release	NULL		
}			
pdsch-Config CHOICE {			
release	NULL		
}			
downlinkBWP-ToAddModList SEQUENCE (SIZE (1..maxNrofBWPs)) BWP-Downlink {	3 entries		
BWP-Downlink[1]	BWP-Downlink-BWP-N with condition BWP#1	entry 1	

BWP-Downlink[2]	BWP-Downlink-BWP-N with condition BWP#2	entry 2	
BWP-Downlink[3]	BWP-Downlink-BWP-N with condition BWP#3	entry 3	pc_bwp_sameNumerology_upto4
}			
firstActiveDownlinkBWP-Id	1		
bwp-InactivityTimer	ms750		
defaultDownlinkBWP-Id	2		
uplinkConfig SEQUENCE {			
initialUplinkBWP ::= SEQUENCE {			
pucch-Config CHOICE {			
release	NULL		
}			
pusch-Config CHOICE {			
release	NULL		
}			
srs-Config CHOICE {			
release	NULL		
}			
}			
uplinkBWP-ToReleaseList	Not present		
uplinkBWP-ToAddModList SEQUENCE (SIZE (1..maxNrofBWPs)) OF BWP-Uplink {	3 entries		
BWP-Uplink[1]	BWP-Uplink-BWP-N with condition BWP#1	entry 1	
BWP-Uplink[2]	BWP-Uplink-BWP-N with condition BWP#2	entry 2	
BWP-Uplink[3]	BWP-Uplink-BWP-N with condition BWP#3	entry 3	pc_bwp_sameNumerology_upto4
}			
firstActiveUplinkBWP-Id	1		
pusch-ServingCellConfig	Not present		
}			
pdccch-ServingCellConfig	Not present		
pdsch-ServingCellConfig	Not present		
csi-MeasConfig	CSI-MeasConfig for TRS		pc_bwp-WithoutRestriction = True
}			

Table 7.1.1.8.1.3.3-2A: BWP-Downlink-BWP-N (Table 7.1.1.8.1.3.3-2 and Table 7.1.1.8.1.3.3-4)

Derivation Path: TS 38.508-1 [4], Table 4.6.3-9			
Information Element	Value/remark	Comment	Condition
BWP-Downlink ::= SEQUENCE {			
bwp-Id	1		BWP#1
	2		BWP#2
	3		BWP#3
bwp-Common SEQUENCE {			
genericParameters SEQUENCE {			
locationAndBandwidth	1381	Note 1	BWP#1 and pc_bwp-WithoutRestriction = True
	1387	Note 1	BWP#2 and pc_bwp-WithoutRestriction = True
	1393	Note 1	BWP#3 and pc_bwp-

		WithoutRestriction = True
6600	Note 2	BWP#1,2,3 and pc_bwp-WithoutRestriction = False and 5MHz
7975	Note 3	BWP#1 and pc_bwp-WithoutRestriction = False
9625	Note 3	BWP#2 and pc_bwp-WithoutRestriction = False
11275	Note 3	BWP#3 and pc_bwp-WithoutRestriction = False
12925	Note 4	BWP#1and pc_bwp-WithoutRestriction = False and 100MHz
14575	Note 4	BWP#2and pc_bwp-WithoutRestriction = False and 100MHz
16225	Note 4	BWP#3 and pc_bwp-WithoutRestriction = False and 100MHz
}		
pdcch-ConfigCommon	Not present	no cell specific configuration for dedicated BWP
pdsch-ConfigCommon	Not present	no cell specific configuration for dedicated BWP
}		
bwp-Dedicated SEQUENCE {		
pdcch-Config CHOICE {		
setup	PDCCH-Config-BWP-N	
}		
pdsch-Config CHOICE {		
setup	PDSCH-Config-BWP-N	
}		
}		
}		
}		
<p>Note 1: According to TS 38.214 [21] clause 5.1.2.2.2 with $N_{BWI}^{size}=275$, $L_{RBs}=6$ and $RB_{Start}=6,12,18$ for BWP#1,2,3</p> <p>Note 2: According to TS 38.214 [21] clause 5.1.2.2.2 with $N_{BWI}^{size}=275$, $L_{RBs}=25$ and $RB_{Start}=0$ for BWP#1,2,3</p> <p>Note 3: According to TS 38.214 [21] clause 5.1.2.2.2 with $N_{BWI}^{size}=275$, $L_{RBs}=30,36,42$ and $RB_{Start}=0$ for BWP#1,2,3</p>		

Note 4: According to TS 38.214 [21] clause 5.1.2.2.2 with $N_{\text{BWP}}^{\text{size}}=275$, $L_{\text{RBs}}=48,54,60$ and $\text{RB}_{\text{Start}}=0$ for BWP#1,2,3

Table 7.1.1.8.1.3.3-2B: PDCCH-Config-BWP-N (Table 7.1.1.8.1.3.3-2A)

Derivation Path: TS 38.508-1 [4], Table 4.6.3-95			
Information Element	Value/remark	Comment	Condition
PDCCH-Config ::= SEQUENCE {			
controlResourceSetToAddModList SEQUENCE (SIZE (1..3)) OF ControlResourceSet {	2 entries		
ControlResourceSet[1]	ControlResourceSet-BWP-N with condition BWP#N	entry 1	
}			
searchSpacesToAddModList SEQUENCE (SIZE (1..10)) OF SearchSpace {	1 entry		
SearchSpace[1]	SearchSpace-BWP-N with condition BWP#N	entry 1	
SearchSpace[2]	SearchSpace-CSS-BWP-N with condition BWP#N	entry 2	
}			
}			

Table 7.1.1.8.1.3.3-2C: PDSCH-Config (Table 7.1.1.8.1.3.3-2A)

Derivation Path: TS 38.508-1 [4], Table 4.6.3-100			
Information Element	Value/remark	Comment	Condition
PDSCH-Config ::= SEQUENCE {			
tci-StatesToAddModList SEQUENCE (SIZE (1..maxNrofTCI-States)) OF TCI-State {	2 entries		pc_bwp-WithoutRestriction = True
TCI-State[1] SEQUENCE {		entry 1	
tci-StateId	0		
qcl-type1 SEQUENCE {			
cell	ServCellIndex	As per 38.508-1 Table 4.6.3-166	
bwp-id	Not present		
referenceSignal CHOICE {			
ssb	1		
}			
qcl-Type	type C		
}			
qcl-type2	Not present		
qcl-type2 SEQUENCE {			FR2
cell	ServCellIndex	As per 38.508-1 Table 4.6.3-166	
bwp-id	Not present	BWP ID	
referenceSignal CHOICE {			
ssb	1		
}			
qcl-Type	type D		
}			
}			
TCI-State[2] SEQUENCE {		entry 2	
tci-StateId	1		
qcl-type1 SEQUENCE {			
cell	ServCellIndex	As per 38.508-1 Table 4.6.3-166	
bwp-id	1	BWP#1	
	2	BWP#2	
	3	BWP#3	
referenceSignal CHOICE {			
csi-rs	1		

}			
qcl-Type	type A		
}			
qcl-type2	Not present		
qcl-type2 SEQUENCE {			FR2
cell	ServCellIndex	As per 38.508-1 Table 4.6.3-166	
bwp-id	1	BWP#1	
	2	BWP#2	
	3	BWP#3	
referenceSignal CHOICE {			
csi-rs	1		
}			
qcl-Type	type D		
}			
}			
PDSCH-TimeDomainAllocationList::= SEQUENCE {	PDSCH- TimeDomainResourceAll ocationList		
}			

Table 7.1.1.8.1.3.3-2CA: PDSCH-TimeDomainResourceAllocationList (Table 7.1.1.8.1.3.3-2C)

Derivation Path: TS 38.331 [6], clause 6.3.2			
Information Element	Value/remark	Comment	Condition
PDSCH-TimeDomainAllocationList::= SEQUENCE {			
PDSCH-TimeDomainResourceAllocation[1]		entry 1	
SEQUENCE {			
k0	1		pc_bwp-SwitchingDelay_Type1 AND SCS_15KHz
	3		pc_bwp_SwitchingDelay_Type2 AND SCS_15KHz
	2		pc_bwp-SwitchingDelay_Type1 AND SCS_30KHz
	5		pc_bwp_SwitchingDelay_Type2 AND SCS_30KHz
	3		pc_bwp-SwitchingDelay_Type1 AND SCS_60KHz
	9		pc_bwp_SwitchingDelay_Type2 AND SCS_60KHz
	6		pc_bwp-SwitchingDelay_Type1 AND SCS_120KHz
	18		pc_bwp_Swi

			tchingDelay _Type2 AND SCS_120KH z
mappingType	typeA		
startSymbolAndLength	53	Start symbol(S)=2, Length(L)=12	
}			
}			

Table 7.1.1.8.1.3.3-2D: ControlResourceSet-BWP-N (Table 7.1.1.8.1.3.3-2B)

Derivation Path: TS 38.508-1 [4], Table 4.6.3-28			
Information Element	Value/remark	Comment	Condition
ControlResourceSet ::= SEQUENCE {			
controlResourceSetId	9		BWP#1
	10		BWP#2
	11		BWP#3
frequencyDomainResources	10000000 00000000 00000000 00000000 00000000 000000	CORESET to use the least significant 6 RBs of each BWP	
duration	2	SearchSpace duration of 2 symbols	
tci-StatesPDCCH-ToAddList SEQUENCE(SIZE (1..maxNrofTCI-StatesPDCCH)) OF TCI-StateId {	1 entry		pc_bwp- WithoutRest riktion = True
TCI-StateId[1]	1	TRS	
}			
}			

Table 7.1.1.8.1.3.3-2E: SearchSpace-BWP-N (Table 7.1.1.8.1.3.3-2B)

Derivation Path: TS 38.508-1 [4], Table 4.6.3-162 with condition USS			
Information Element	Value/remark	Comment	Condition
SearchSpace ::= SEQUENCE {			
searchSpaceId	37		BWP#1
	38		BWP#2
	39		BWP#3
controlResourceSetId	9		BWP#1
	10		BWP#2
	11		BWP#3
nrofCandidates SEQUENCE {			
aggregationLevel1	n0		
aggregationLevel2	n1		
aggregationLevel4	n0		
aggregationLevel8	n0		
aggregationLevel16	n0		
}			
}			

Table 7.1.1.8.1.3.3-2F: *BWP-Uplink-BWP-N* (Table 7.1.1.8.1.3.3-2 and Table 7.1.1.8.1.3.3-4)

Information Element	Value/remark	Comment	Condition
BWP-Uplink ::= SEQUENCE {			
bwp-Id	1		BWP#1
3GPP TS 38.523-1 version 17.0.0 Release 17	2 823	ETSI TS 138 523-1 V17	0.0 (2022-10)
	3		BWP#3
bwp-Common SEQUENCE {			
genericParameters SEQUENCE {			
locationAndBandwidth	1381	Note 1	BWP#1 and pc_bwp-WithoutRestriction = True
	1387	Note 1	BWP#2 and pc_bwp-WithoutRestriction = True
	1393	Note 1	BWP#3 and pc_bwp-WithoutRestriction = True
	6600	Note 2	BWP#1,2,3 and pc_bwp-WithoutRestriction = False and 5MHz
	7975	Note 3	BWP#1 and pc_bwp-WithoutRestriction = False
	9625	Note 3	BWP#2and pc_bwp-WithoutRestriction = False
	11275	Note 3	BWP#3 and pc_bwp-WithoutRestriction = False
	12925	Note 4	BWP#1 and pc_bwp-WithoutRestriction = False and 100MHz
	14575	Note 4	BWP#2and pc_bwp-WithoutRestriction = False and 100MHz
	16225	Note 4	BWP#3 and pc_bwp-WithoutRestriction = False and 100MHz
}			
rach-ConfigCommon	Not present	No cell specific configuration for dedicated BWP	
pusch-ConfigCommon	Not present	no cell specific configuration for dedicated BWP	
pucch-ConfigCommon	<i>PUCCH-ConfigCommon-BWP-N</i>		
}			
bwp-Dedicated SEQUENCE {			
pucch-Config CHOICE {			
setup	PUCCH-Config-BWP-N		
}			
pusch-Config CHOICE {			
setup	ETSI PUSCH-Config-BWP-N		

Condition	Explanation
BWP#1	Bandwidth part 1
BWP#2	Bandwidth part 2
BWP#3	Bandwidth part 3
5MHz	According to TS 38.508-1 [4] clause 6.2.3.1 with CBW=5Mhz
100MHz	According to TS 38.508-1 [4] clause 6.2.3.1 with CBW=100Mhz

Table 7.1.1.8.1.3.3-2G: PUCCH-Config-BWP-N (Table 7.1.1.8.1.3.3-2F)

Derivation Path: TS 38.508-1 [4], Table 4.6.3-112			
Information Element	Value/remark	Comment	Condition
PUCCH-Config ::= SEQUENCE {			
resourceSetToAddModList SEQUENCE (SIZE (1..4)) OF PUCCH-ResourceSet {	1 entry		
PUCCH-ResourceSet[1] SEQUENCE {		entry 1	
pucch-ResourceSetId	0		
resourceList SEQUENCE (SIZE (1..32)) OF PUCCH-ResourceId {	1 entry		
PUCCH-ResourceId[1]	0	entry 1	
}			
maxPayloadSize	256		
}			
resourceToAddModList SEQUENCE (SIZE (1..128)) OF PUCCH-Resource {	1 entry		
PUCCH-Resource[1] SEQUENCE {		entry 1	
pucch-ResourceId	0		
startingPRB	0		BWP#1
	0		BWP#2
	0		BWP#3
intraSlotFrequencyHopping	disabled		
secondHopPRB	Not Present		
format CHOICE {			
format0 SEQUENCE {			
initialCyclicShift	0		
nrofSymbols	2		
startingSymbolIndex	0		
}			
}			
}			
}			

Condition	Explanation
BWP#1	Bandwidth part 1
BWP#2	Bandwidth part 2
BWP#3	Bandwidth part 3

Table 7.1.1.8.1.3.3-2H: PUSCH-Config-BWP-N (Table 7.1.1.8.1.3.3-2F)

Derivation Path: TS 38.508-1 [4], Table 4.6.3-118			
Information Element	Value/remark	Comment	Condition
PUSCH-Config ::= SEQUENCE {			
pusch-TimeDomainAllocationList	PUSCH-TimeDomainResourceAllocationList	TS 38.508-1 [4] Table 4.6.3-122	
}			

Table 7.1.1.8.1.3.3-3: PUCCH-ConfigCommon-BWP-N (Table 7.1.1.8.1.3.3-2F)

Derivation Path: TS 38.508-1 [4], Table 4.6.3-113			
Information Element	Value/remark	Comment	Condition
PUCCH-ConfigCommon ::= SEQUENCE {			
pucch-ResourceCommon	Not Present		
pucch-GroupHopping	enable		
hoppingId	Not present		
p0-nominal	Not Present		
}			

Table 7.1.1.8.1.3.3-4: SearchSpace-CSS-BWP-N (Table 7.1.1.8.1.3.3-2B)

Derivation Path: TS 38.508-1[4], Table 4.6.3-162 with condition CSS			
Information Element	Value/remark	Comment	Condition
SearchSpace ::= SEQUENCE {			
searchSpaceId	30		BWP#1
	31		BWP#2
	32		BWP#3
controlResourceSetId	9		BWP#1
	10		BWP#2
	11		BWP#3
nrofCandidates SEQUENCE {			
aggregationLevel1	n0		
aggregationLevel2	n1		
aggregationLevel4	n0		
aggregationLevel8	n0		
aggregationLevel16	n0		
}			
}			

Table 7.1.1.8.1.3.3-5: CSI-MeasConfig for TRS (Table 7.1.1.8.1.3.3-2)

Derivation Path: TS 38.508-1[4] Table 4.6.3-38			
Information Element	Value/remark	Comment	Condition
CSI-MeasConfig ::= SEQUENCE {			
nzp-CSI-RS-ResourceToAddModList SEQUENCE (SIZE (1..maxNrofNzp-CSI-RS-Resources)) OF NZP-CSI-RS-Resource {	2 entries in case of FR2 4 entries in case of FR1	2 entries in case of FR2 4 entries in case of FR1	
NZP-CSI-RS-Resource[1]	NZP-CSI-RS-Resource for TRS (1)	entry 1 CSI-RS resource 1	
NZP-CSI-RS-Resource[2]	NZP-CSI-RS-Resource for TRS (2)	entry 2 CSI-RS resource 2	
NZP-CSI-RS-Resource[3]	NZP-CSI-RS-Resource for TRS (3)	entry 3 CSI-RS resource 3	FR1
NZP-CSI-RS-Resource[4]	NZP-CSI-RS-Resource for TRS (4)	entry 4 CSI-RS resource 4	FR1
}			
nzp-CSI-RS-ResourceSetToAddModList SEQUENCE (SIZE (1..maxNrofNzp-CSI-RS-ResourceSets)) OF NZP-CSI-RS-ResourceSet {	1 entry		
NZP-CSI-RS-ResourceSet[1]	NZP-CSI-RS-ResourceSet for TRS	entry 1	
}			
csi-IM-ResourceToAddModList	Not present		
csi-IM-ResourceSetToAddModList	Not present		
csi-SSB-ResourceSetToAddModList	Not present		
csi-ResourceConfigToAddModList SEQUENCE	1 entry		

(SIZE (1..maxNrofCSI-ResourceConfigurations)) OF CSI-ResourceConfig {			
CSI-ResourceConfig[1]	CSI-ResourceConfig for TRS	entry 1	
}			
reportTriggerSize	Not present		
aperiodicTriggerStateList SetupRelease	Not present		
}			

Table 7.1.1.8.1.3.3-6: NZP-CSI-RS-ResourceSet for TRS (Table 7.1.1.8.1.3.3-5)

Derivation Path: TS 38.508-1[4] Table 4.6.3-87			
Information Element	Value/remark	Comment	Condition
NZP-CSI-RS-ResourceSet ::= SEQUENCE {			
nzp_CSI_ResourceSetId	0		
nzp-CSI-RS-Resources SEQUENCE (SIZE (1..maxNrofNZP-CSI-RS-ResourcesPerSet)) OF NZP-CSI-RS-ResourceId {	2 entries in case of FR2 4 entries in case of FR1		
NZP-CSI-RS-ResourceId[1]	0	entry 1 CSI-RS resource 1	
NZP-CSI-RS-ResourceId[2]	1	entry 2 CSI-RS resource 2	
NZP-CSI-RS-ResourceId[3]	2	entry 3 CSI-RS resource 3	FR1
NZP-CSI-RS-ResourceId[4]	3	entry 4 CSI-RS resource 4	FR1
}			
repetition	off		
aperiodicTriggeringOffset	Not present		
trs_Info	true		
}			

Table 7.1.1.8.1.3.3-7: CSI-ResourceConfig for TRS (Table 7.1.1.8.1.3.3-5)

Derivation Path: TS 38.508-1[4] Table 4.6.3-41			
Information Element	Value/remark	Comment	Condition
CSI-ResourceConfig ::= SEQUENCE {			
csi-ResourceConfigId	0		
csi-RS-ResourceSetList CHOICE {			
nzp-CSI-RS-SSB SEQUENCE {			
nzp-CSI-RS-ResourceSetList SEQUENCE (SIZE (1..maxNrofNZP-CSI-RS-ResourceSetsPerConfig)) OF NZP-CSI-RS-ResourceSetId {	1 entry		
NZP-CSI-RS-ResourceSetId[1]	0	entry 1	
}			
csi-SSB-ResourceSetList	Not present		
}			
}			
bwp-Id	BWP-Id		
resourceType	periodic		
}			

Table 7.1.1.8.1.3.3-8: NZP-CSI-RS-Resource for TRS (Table 7.1.1.8.1.3.3-5)

Derivation Path: TS 38.508-1[4] Table 4.6.3-85			
Information Element	Value/remark	Comment	Condition
NZP-CSI-RS-Resource ::= SEQUENCE {			
nzp-CSI-RS-ResourceId	0	CSI-RS resource 1	
	1	CSI-RS resource 2	
	2	CSI-RS resource 3	
	3	CSI-RS resource 4	
resourceMapping	CSI-RS-		

	ResourceMapping for TRS		
powerControlOffset	0		
periodicityAndOffset	CSI-ResourcePeriodicityAndOffset for TRS		
qcl-InfoPeriodicCSI-RS	TCI-StateId 0		

7.1.1.8.2

7.1.1.8.3 Separate BWP / IDLE / RedCap

7.1.1.8.3.1 Test Purpose (TP)

(1)

```
with { UE supporting RedCap and in NR RRC_IDLE state }
ensure that {
  when { initialDownlinkBWP-RedCap is configured }
  then { the UE shall monitor the PDCCH on the BWP configured by initialDownlinkBWP-RedCap }
}
```

(2)

```
with { UE supporting RedCap and in NR RRC_IDLE state }
ensure that {
  when { initialUplinkBWP-RedCap is configured and the UE needs to perform the Random Access procedure }
  then { the UE shall perform the Random Access procedure by using the BWP configured by initialUplinkBWP-RedCap }
}
```

7.1.1.8.3.2 Conformance requirements

References: The conformance requirements covered in the present test case are specified in: TS 38.321, clause 5.15.1. Unless otherwise stated these are Rel-17 requirements.

[TS 38.321, clause 5.15.1]

A RedCap UE may be configured with a RedCap-specific initial UL BWP in *initialUplinkBWP-RedCap*, as specified in TS 38.331 [5].

Upon initiation of the Random Access procedure on a Serving Cell, after the selection of carrier for performing Random Access procedure as specified in clause 5.1.1, the MAC entity shall for the selected carrier of this Serving Cell:

- 1> if PRACH occasions are not configured for the active UL BWP:
 - 2> if the UE is a RedCap UE; and
 - 2> if *initialUplinkBWP-RedCap* is configured:
 - 3> switch the active UL BWP to BWP configured by *initialUplinkBWP-RedCap*.
 - 2> else:
 - 3> switch the active UL BWP to BWP indicated by *initialUplinkBWP*.
- 2> if the Serving Cell is an SpCell:
 - 3> if the UE is a RedCap UE; and
 - 3> if *initialDownlinkBWP-RedCap* is configured:
 - 4> switch the active DL BWP to BWP configured by *initialDownlinkBWP-RedCap*.

3> else:

4> switch the active DL BWP to BWP indicated by *initialDownlinkBWP*.

1> else:

2> if the Serving Cell is an SpCell:

3> if the active DL BWP does not have the same *bwp-Id* as the active UL BWP:

4> switch the active DL BWP to the DL BWP with the same *bwp-Id* as the active UL BWP.

1> stop the *bwp-InactivityTimer* associated with the active DL BWP of this Serving Cell, if running.

1> if the Serving Cell is SCell:

2> stop the *bwp-InactivityTimer* associated with the active DL BWP of SpCell, if running.

1> perform the Random Access procedure on the active DL BWP of SpCell and active UL BWP of this Serving Cell.

If the MAC entity receives a PDCCH for BWP switching of a Serving Cell, the MAC entity shall:

1> if there is no ongoing Random Access procedure associated with this Serving Cell; or

1> if the ongoing Random Access procedure associated with this Serving Cell is successfully completed upon reception of this PDCCH addressed to C-RNTI (as specified in clauses 5.1.4, 5.1.4a, and 5.1.5):

2> cancel, if any, triggered consistent LBT failure for this Serving Cell;

2> perform BWP switching to a BWP indicated by the PDCCH.

...

Upon reception of RRC (re-)configuration for BWP switching for a Serving Cell, cancel any triggered LBT failure in this Serving Cell.

The MAC entity shall for each activated Serving Cell configured with *bwp-InactivityTimer*:

1> if the *defaultDownlinkBWP-Id* is configured, and the active DL BWP is not the BWP indicated by the *defaultDownlinkBWP-Id*, and the active DL BWP is not the BWP indicated by the *dormantBWP-Id* if configured; or

1> if the *defaultDownlinkBWP-Id* is not configured, and if the UE is not a RedCap UE, and the active DL BWP is not the *initialDownlinkBWP*, and the active DL BWP is not the BWP indicated by the *dormantBWP-Id* if configured; or

1> if the *defaultDownlinkBWP-Id* is not configured and if the UE is a RedCap UE, and *initialDownlinkBWP-RedCap* is not configured, and the active DL BWP is not the *initialDownlinkBWP*, and the active DL BWP is not the BWP indicated by the *dormantBWP-Id* if configured; or

1> if the *defaultDownlinkBWP-Id* is not configured and if the UE is a RedCap UE, and *initialDownlinkBWP-RedCap* is configured, the active DL BWP is not the *initialDownlinkBWP-RedCap*, and the active DL BWP is not the BWP indicated by the *dormantBWP-Id* if configured:

2> if a PDCCH addressed to C-RNTI or CS-RNTI indicating downlink assignment or uplink grant is received on the active BWP; or

2> if a PDCCH addressed to G-RNTI or G-CS-RNTI configured for multicast indicating downlink assignment is received on the active BWP; or

2> if a PDCCH addressed to C-RNTI or CS-RNTI indicating downlink assignment or uplink grant is received for the active BWP; or

2> if a MAC PDU is transmitted in a configured uplink grant and LBT failure indication is not received from lower layers; or

- 2> if a MAC PDU is received in a configured downlink assignment for unicast or MBS multicast:
 - 3> if there is no ongoing Random Access procedure associated with this Serving Cell; or
 - 3> if the ongoing Random Access procedure associated with this Serving Cell is successfully completed upon reception of this PDCCH addressed to C-RNTI (as specified in clauses 5.1.4, 5.1.4a and 5.1.5):
 - 4> start or restart the *bwp-InactivityTimer* associated with the active DL BWP.
- 2> if the *bwp-InactivityTimer* associated with the active DL BWP expires:
 - 3> if the *defaultDownlinkBWP-Id* is configured:
 - 4> perform BWP switching to a BWP indicated by the *defaultDownlinkBWP-Id*.
 - 3> else:
 - 4> if the UE is a RedCap UE; and
 - 4> if *initialDownlinkBWP-RedCap* is configured:
 - 5> perform BWP switching to the *initialDownlinkBWP-RedCap*.
 - 4> else:
 - 5> perform BWP switching to the *initialDownlinkBWP*.

NOTE: If a Random Access procedure is initiated on an SCell, both this SCell and the SpCell are associated with this Random Access procedure.

- 1> if a PDCCH for BWP switching is received, and the MAC entity switches the active DL BWP:
 - 2> if the *defaultDownlinkBWP-Id* is configured, and the MAC entity switches to the DL BWP which is not indicated by the *defaultDownlinkBWP-Id* and is not indicated by the *dormantBWP-Id* if configured; or
 - 2> if the *defaultDownlinkBWP-Id* is not configured, and the MAC entity switches to the DL BWP which is not the *initialDownlinkBWP* and is not indicated by the *dormantBWP-Id* if configured:
 - 3> start or restart the *bwp-InactivityTimer* associated with the active DL BWP.

Upon initiation of the Random Access procedure, after selection of the carrier for performing Random Access procedure as specified in clause 5.1.1, if the UE is a RedCap UE in RRC_IDLE or RRC_INACTIVE mode, the MAC entity shall:

- 1> if *initialUplinkBWP-RedCap* is configured:
 - 2> perform the Random Access procedure as specified in clause 5.1 by using the BWP configured by *initialUplinkBWP-RedCap*.
- 1> else:
 - 2> perform the Random Access procedure as specified in clause 5.1 by using the BWP configured by *initialUplinkBWP*.
- 1> if *initialDownlinkBWP-RedCap* is configured:
 - 2> monitor the PDCCH on the BWP configured by *initialDownlinkBWP-RedCap*.
- 1> else:
 - 2> monitor the PDCCH on the BWP configured by *initialDownlinkBWP*.

7.1.1.8.3.3 Test description

7.1.1.8.3.3.1 Pre-test conditions

System Simulator:

- NR Cell 2.

UE:

- None

Preamble:

- The UE is in NR RRC_Idle mode (state 1N-A) on NR Cell 1 according to 38.508-1 [4] Table 4.4A.2-1.

7.1.1.8.3.3.2 Test procedure sequence

Table 7.1.1.8.3.3.2-1: Main behaviour

St	Procedure	Message Sequence		TP	Verdict
		U - S	Message		
1	The SS changes the SIB1 of NR Cell 1 to configure <i>initialDownlinkBWP-RedCap</i> and <i>initialUplinkBWP-RedCap</i> .	-	-	-	--
2	The SS transmits a Short message on PDCCH using P-RNTI indicating a <i>systemInfoModification</i> .	<--	PDCCH (DCI 1_0): Short Message	-	-
3	Wait for 2.1* modification period second for the UE to receive new system information. (Note 1)	-	-	-	-
4	The SS transmits a <i>Paging</i> message within the BWP configured by <i>initialDownlinkBWP-RedCap</i> .	<--	NR RRC: <i>Paging</i>	-	-
5	Check: Does the UE transmit an <i>RRCSetupRequest</i> message by setting LCID to 36?	-->	NR RRC: <i>RRCSetupRequest</i>	1	P
6	The SS transmits an <i>RRCSetup</i> message.	<--	NR RRC: <i>RRCSetup</i>	-	-
7	Check: Does the UE transmit HARQ ACK for step 6 on PUCCH configured by <i>initialUplinkBWP-RedCap</i> ?	-->	HARQ ACK	2	P
8-13a1	Steps 4-9a1 of Generic procedure as specified in TS 38.508-1 [4] Table 4.9.4.2.2-1 are performed.	-	-	-	-

Note 1: The modification period, expressed in number of radio frames = modificationPeriodCoeff * defaultPagingCycle.

7.1.1.8.3.3.3 Specific message contents

Table 7.1.1.8.3.3.3-1: SIB1 (step 1, Table 7.1.1.8.3.3.2-1)

Derivation Path: TS 38.508-1 [4], Table 4.6.1-28			
Information Element	Value/remark	Comment	Condition
SIB1 ::= SEQUENCE {			
servingCellConfigCommon	ServingCellConfigComm onSIB	Table 7.1.1.8.3.3.3-2	
}			

Table 7.1.1.8.3.3.3-2: ServingCellConfigCommonSIB (Table 7.1.1.8.3.3.3-1)

Derivation Path: TS 38.508-1 [4], Table 4.6.3-169

Information Element	Value/remark	Comment	Condition
ServingCellConfigCommonSIB ::= SEQUENCE {			
downlinkConfigCommon	DownlinkConfigCommon SIB	Table 7.1.1.8.3.3.3-3	
uplinkConfigCommon	UplinkConfigCommonSIB	Table 7.1.1.8.3.3.3-7	
}			

Table 7.1.1.8.3.3.3-3: DownlinkConfigCommonSIB (Table 7.1.1.8.3.3.3-2)

Derivation Path: TS 38.508-1 [4], Table 4.6.3-53			
Information Element	Value/remark	Comment	Condition
DownlinkConfigCommonSIB ::= SEQUENCE {			
pei-Config-r17	Not present		
initialDownlinkBWP-RedCap-r17	BWP-DownlinkCommon-RedCap	Table 7.1.1.8.3.3.3-4	
}			

Table 7.1.1.8.3.3.3-4: BWP-DownlinkCommon-RedCap (Table 7.1.1.8.3.3.3-3)

Derivation Path: TS 38.508-1 [4], Table 4.6.3-10 with condition InitialBWP_SIB			
Information Element	Value/remark	Comment	Condition
BWP-DownlinkCommon ::= SEQUENCE {			
pdcch-ConfigCommon CHOICE {			
setup	PDCCH-ConfigCommon	Table 7.1.1.8.3.3.3-5	
}			
}			

Table 7.1.1.8.3.3.3-5: PDCCH-ConfigCommon (Table 7.1.1.8.3.3.3-4)

Derivation Path: TS 38.508-1 [4], Table 4.6.3-96			
Information Element	Value/remark	Comment	Condition
PDCCH-ConfigCommon ::= SEQUENCE {			
commonSearchSpaceList SEQUENCE (SIZE (1..4)) OF SearchSpace {	3 entries		
SearchSpace[1]	SearchSpace with condition CSS	entry 1	
SearchSpace[2]	SearchSpace with condition SISS	entry 2	
SearchSpace[3]	SearchSpace	entry 3, Table 7.1.1.8.3.3.3-6	
}			
pagingSearchSpace	4		
}			

Table 7.1.1.8.3.3.3-6: SearchSpace (Table 7.1.1.8.3.3.3-5)

Derivation Path: TS 38.508-1 [4], Table 4.6.3-162 with condition CSS			
Information Element	Value/remark	Comment	Condition
SearchSpace ::= SEQUENCE {			
searchSpaceId	4		
monitoringSlotPeriodicityAndOffset CHOICE {			
sl10	2		
}			
}			

Table 7.1.1.8.3.3.3-7: UplinkConfigCommonSIB (Table 7.1.1.8.3.3.3-2)

Derivation Path: TS 38.508-1 [4], Table 4.6.3-202			

Information Element	Value/remark	Comment	Condition
UplinkConfigCommonSIB ::= SEQUENCE {			
UplinkConfigCommonSIB-v1700 ::= SEQUENCE {			
initialUplinkBWP-RedCap-r17	BWP-UplinkCommon	Table 7.1.1.8.3.3.3-8	
}			
}			

Table 7.1.1.8.3.3.3-8: BWP-UplinkCommon (Table 7.1.1.8.3.3-7)

Derivation Path: TS 38.508-1 [4], Table 4.6.3-14			
Information Element	Value/remark	Comment	Condition
BWP-UplinkCommon ::= SEQUENCE {			
pucch-ConfigCommon CHOICE {			
setup	PUCCH-ConfigCommon	Table 7.1.1.8.3.3.3-9	
}			
}			

Table 7.1.1.8.3.3.3-9: PUCCH-ConfigCommon (Table 7.1.1.8.3.3-8)

Derivation Path: TS 38.508-1 [4], Table 4.6.3-113			
Information Element	Value/remark	Comment	Condition
PUCCH-ConfigCommon ::= SEQUENCE {			
nrofPRBs	Not present		
intra-SlotFH-r17	fromLowerEdge		
pucch-ResourceCommon-RedCap-r17	0		
additionalPRBOffset-r17	n2		
}			

7.1.1.9 MAC Reconfiguration and Reset

7.1.1.9.1 MAC Reset

7.1.1.9.1.1 Test Purpose (TP)

(1)

void

(2)

```
with { UE in RRC_CONNECTED state }
ensure that {
  when { UE MAC is reset, due to reconfiguration with sync on same cell }
  then { UE considers the next transmission for each DL HARQ process as very first }
}
```

(3)

void

(4)

```
with ( UE in RRC_CONNECTED state )
ensure that {
  when { UE MAC is reset, due to reconfiguration with sync on same cell }
  then { UE flushes UL HARQ buffer }
}
```

(5)

```

with (UE in RRC_CONNECTED state )
ensure that {
  when{ UE MAC is reset, due to reconfiguration with sync on same cell }
  then { UE Considers the next transmission for each UL HARQ process as very first }
}

```

7.1.1.9.1.2 Conformance requirements

References: The conformance requirements covered in the present TC are specified in: TS 38.321, clauses 5.12 and TS 38.331 clause 5.3.5.5.2. Unless otherwise stated these are Rel-15 requirements.

[TS 38.321, clause 5.12]

If a reset of the MAC entity is requested by upper layers, the MAC entity shall:

- 1> initialize B_j for each logical channel to zero;
- 1> stop (if running) all timers;
- 1> consider all *timeAlignmentTimers* as expired and perform the corresponding actions in subclause 5.2;
- 1> set the NDIs for all uplink HARQ processes to the value 0;
- 1> stop, if any, ongoing Random Access procedure;
- 1> discard explicitly signalled contention-free Random Access Resources, if any;
- 1> flush Msg3 buffer;
- 1> cancel, if any, triggered Scheduling Request procedure;
- 1> cancel, if any, triggered Buffer Status Reporting procedure;
- 1> cancel, if any, triggered Recommended bit rate query procedure;
- 1> cancel, if any, triggered Configured uplink grant confirmation;
- 1> cancel, if any, triggered Power Headroom Reporting procedure;
- 1> flush the soft buffers for all DL HARQ processes;
- 1> for each DL HARQ process, consider the next received transmission for a TB as the very first transmission;
- 1> release, if any, Temporary C-RNTI;
- 1> reset *BFI_COUNTER*.

[TS 38.331, clause 5.3.5.5.2]

The UE shall perform the following actions to execute a reconfiguration with sync.

- 1> if the AS security is not activated, perform the actions upon going to RRC_IDLE as specified in 5.3.11 with the release cause 'other' upon which the procedure ends;
- 1> stop timer T310 for the corresponding SpCell, if running;
- 1> start timer T304 for the corresponding SpCell with the timer value set to t_{304} , as included in the *reconfigurationWithSync*;
- 1> if the *frequencyInfoDL* is included:
 - 2> consider the target SpCell to be one on the SSB frequency indicated by the *frequencyInfoDL* with a physical cell identity indicated by the *physCellId*;
- 1> else:

2> consider the target SpCell to be one on the SSB frequency of the source SpCell with a physical cell identity indicated by the *physCellId*;

1> start synchronising to the DL of the target SpCell;

1> apply the specified BCCH configuration defined in 9.1.1.1;

1> acquire the *MIB*, which is scheduled as specified in TS 38.213 [13];

NOTE 1: The UE should perform the reconfiguration with sync as soon as possible following the reception of the RRC message triggering the reconfiguration with sync, which could be before confirming successful reception (HARQ and ARQ) of this message.

NOTE 2: The UE may omit reading the MIB if the UE already has the required timing information, or the timing information is not needed for random access.

1> reset the MAC entity of this cell group;

1> consider the SCell(s) of this cell group, if configured, to be in deactivated state;

1> apply the value of the *newUE-Identity* as the C-RNTI for this cell group;

1> configure lower layers in accordance with the received *spCellConfigCommon*;

1> configure lower layers in accordance with any additional fields, not covered in the previous, if included in the received *reconfigurationWithSync*.

7.1.1.9.1.3 Test description

7.1.1.9.1.3.1 Pre-test conditions

Same Pre-test conditions as in clause 7.1.1.0.

Table 7.1.1.9.1.3.1-1: Void

7.1.1.9.1.3.2 Test procedure sequence

Table 7.1.1.9.1.3.2-1: Main behaviour

St	Procedure	Message Sequence		TP	Verdict
		U - S	Message		
0	The SS stops the default downlink retransmission. (Note 4) SS ignores scheduling requests and does not allocate any uplink grant until after step 3	-	-	-	-
1	The SS transmits a MAC PDU containing one RLC SDU with P field set 0 on DRB	<--	MAC PDU (1 RLC SDU of 40 bytes on DRB)	-	-
2	Void	-	-	-	-
3	The SS transmits NR <i>RRCReconfiguration</i> message with <i>reconfigurationWithSync</i> with the same SpCell. (Note 1)	<--	RRCReconfiguration	-	-
-	EXCEPTION: Steps 4 and 4a can happen in any order	-	-	-	-
4	The UE transmits an NR <i>RRCReconfigurationComplete</i> message. (Note 2)	-->	RRCReconfigurationComplete	-	-
4a-5	Void	-	-	-	-
5A	The SS ignores scheduling requests and does not allocate any uplink grant.				

6	The SS transmits a MAC PDU containing RLC SDU with P field set 0 on DRB. The HARQ Process and NDI on PDCCH is same as in step 1. The SS shall ensure that the HARQ process used at step 1 will not be used in between steps 3 and 5.	<--	MAC PDU (1 RLC SDU of 40 bytes on DRB)	-	-
7	Check: Does the UE transmit a scheduling request?	-->	(SR)	2	P
-	Exception: The SS ignores following scheduling requests before step 9.	-	-	-	-
8	The SS allocates 1 UL Grant with size 384 bits and NDI indicates new transmission. (Note 5)	<--	Uplink Grant	-	-
9	The UE transmits a MAC PDU including one RLC SDU with P field set 1.	-->	MAC PDU	-	-
9A	The SS transmits a STATUS PDU on a different HARQ process than used in step 6.	<--	STATUS PDU	-	-
10-16	Void	-	-	-	-
16A	The SS ignores scheduling requests and does not allocate any uplink grant.	-	-	-	-
17	The SS transmits a MAC PDU containing RLC SDU with P field set 0 on DRB.	<--	MAC PDU (1 RLC SDU of 40 bytes on DRB)	-	-
18	The UE transmits a scheduling request	-->	(SR)	-	-
	Exception: The SS ignores following scheduling requests before step 20.	-	-	-	-
19	The SS allocates an UL Grant with size 384 bits for one HARQ process X, and NDI indicates new transmission. (Note 5)	<--	Uplink Grant	-	-
20	The UE transmit a MAC PDU including one RLC SDU with P field set 1.	-->	MAC PDU	-	-
20A	The SS transmits a STATUS PDU on a different HARQ process than used in step 17.	<--	STATUS PDU	-	-
21	Void				
22	The SS transmits NR <i>RRCReconfiguration</i> message with <i>reconfigurationWithSync</i> with the same <i>SpCellI</i> . Note 1	<--	RRCReconfiguration	-	-
23	The UE transmits an NR <i>RRCReconfigurationComplete</i> message. Note 2		RRCReconfigurationComplete	-	-
24	Void				
24A	The SS ignores scheduling requests and does not allocate any uplink grant.	-	-	-	-
25	The SS transmits a MAC PDU containing RLC SDU with P field set 0 on DRB. The HARQ Process and NDI on PDCCH is same as in step 17. The SS shall ensure that the HARQ process used at step 17 will not be used in between steps 22 and 23.	<--	MAC PDU (1 RLC SDU of 40 bytes on DRB)	-	-
26	The UE transmits a scheduling request	-->	(SR)	-	-
	Exception: The SS ignores following scheduling requests before step 28.	-	-	-	-
27	The SS allocates an UL Grant with with size 384 bits corresponding to HARQ process X, with NDI not toggled compared to step 19, and NDI indicates new transmission. (Note 5)	<--	Uplink Grant	-	-
28	Check: Does UE transmit a MAC PDU including one RLC SDU of 40 bytes on DRB and P field is set 1?	-->	MAC PDU	4,5	P
29	The SS transmits a STATUS PDU on a different HARQ process than used in step 25	<--	STATUS PDU	-	-

Note 1:	for EN-DC the NR <i>RRCReconfiguration</i> message is contained in <i>RRCConnectionReconfiguration</i> .
Note 2:	for EN-DC the NR <i>RRCReconfigurationComplete</i> message is contained in <i>RRCConnectionReconfigurationComplete</i> .
Note 3:	RLC re-establishment on DRB is used to make sure UE discard RLC PDU.
Note 4:	The SS stops the default downlink retransmission to avoid HARQ ACK for the retransmission of DRB data at step 1.
Note 5:	The UL grant of 384 bits (L_{RBs} & I_{MCS} as per 38.523-3[3] annex B) is chosen to allow the UE to transmit one PDU at a time (40 bytes RLC SDU + 3 bytes RLC Header + 2 bytes MAC Sub PDU header + 2 bytes for short BSR or padding).

7.1.1.9.1.3.3 Specific message contents

Table 7.1.1.9.1.3.3-0: SchedulingRequest-Config (Preamble)

Derivation Path: 38.508-1 [4], Table 4.6.3-155			
Information Element	Value/remark	Comment	Condition
sr-TransMax	n64		

Table 7.1.1.9.1.3.3-1: RRCReconfiguration for NR (steps 3 and 22 of Table 7.1.1.9.1.3.2-1)

Derivation Path: 38.508-1 [4], Table 4.6.1-13			
Information Element	Value/remark	Comment	Condition
RRCReconfiguration ::= SEQUENCE { criticalExtensions CHOICE { rrcReconfiguration ::= SEQUENCE { radioBearerConfig	RadioBearerConfig according to TS 38.508-1 [4], table 4.6.3-132 with with condition DRBn	n set to the default DRB of the first PDU session	NR
nonCriticalExtension SEQUENCE { masterCellGroup	CellGroupConfig according to TS 38.508-1 [4], table 4.6.3-19 with condition PCell_change		
}			
}			
}			
}			

Table 7.1.1.9.1.3.3-2: RRCConnectionReconfiguration for EN-DC (step 3 and 22 of Table 7.1.1.9.1.3.2-1)

Derivation Path: 36.508 Table 4.6.1-8			
Information Element	Value/remark	Comment	Condition
RRCConnectionReconfiguration ::= SEQUENCE { criticalExtensions CHOICE { c1 CHOICE { rrcConnectionReconfiguration-r8 ::= SEQUENCE { nonCriticalExtension ::= SEQUENCE { nonCriticalExtension ::= SEQUENCE { nonCriticalExtension ::= SEQUENCE { nr-Config-r15 CHOICE { nr-SecondaryCellGroupConfig-r15	OCTET STRING including the RRCReconfiguration message and the IE secondaryCellGroup according TS 38.508-1 [67], table 4.6.1-13 with condition EN-DC_HO		
}			
}			

nr-RadioBearerConfig1-r15	OCTET STRING including RadioBearerConfig according TS 38.508-1 [67], table 4.6.3-132 with conditions EN-DC_DRB		
}			
}			
}			
}			
}			
}			

7.1.1.10 Other Procedures

7.1.1.10.1 DataInactivityTimer expiry

7.1.1.10.1.1 Test Purpose (TP)

(1)

```
with { UE in NR RRC_CONNECTED state and dataInactivityTimer configured and running }
ensure that {
  when { UE receives or transmits MAC SDU from DRB }
  then { UE restarts the dataInactivityTimer }
}
```

(2)

```
with { UE in NR RRC_CONNECTED state and dataInactivityTimer configured and running }
ensure that {
  when { UE detecting data inactivity on expiry of DataInactivityTimer }
  then { UE enters RRC_IDLE state }
}
```

7.1.1.10.1.2 Conformance requirements

References: The conformance requirements covered in the present TC are specified in: 3GPP TS 38.321 clause 5.19 and TS 38.331 clause 5.3.8.5.

[TS 38.321, clause 5.19]

The UE may be configured by RRC with a Data inactivity monitoring functionality, when in RRC_CONNECTED. RRC controls Data inactivity operation by configuring the timer *dataInactivityTimer*.

When *dataInactivityTimer* is configured, the UE shall:

- 1> if any MAC entity receives a MAC SDU for DTCH logical channel, DCCH logical channel, or CCCH logical channel; or
- 1> if any MAC entity transmits a MAC SDU for DTCH logical channel, or DCCH logical channel:
 - 2> start or restart *dataInactivityTimer*.
- 1> if the *dataInactivityTimer* expires:
 - 2> indicate the expiry of the *dataInactivityTimer* to upper layers.

[TS 38.331 clause 5.3.8.5]

Upon receiving the expiry of *DataInactivityTimer* from lower layers while in RRC_CONNECTED, the UE shall:

- 1> perform the actions upon going to RRC_IDLE as specified in 5.3.11, with release cause 'RRC connection failure'.

7.1.1.10.1.3 Test description

7.1.1.10.1.3.1 Pre-test conditions

System Simulator:

- NR Cell 1.

UE:

- None.

Preamble:

- The UE is in state 3N-A and Test Mode Activated according to 38.508-1 [4] Table 4.4A.2-1 with UE test loop mode B is established IP PDU delay set to 6 seconds.

7.1.1.10.1.3.2 Test procedure sequence

Table 7.1.1.10.1.3.2-1: Main behaviour

St	Procedure	Message Sequence		TP	Verdict
		U - S	Message		
1	The SS waits (dataInactivityTimer/2 + 1) seconds	-	-	-	-
2	SS transmits a downlink assignment including the C-RNTI assigned to the UE	<--	(PDCCH (C-RNTI))	-	-
3	SS transmits in the indicated downlink assignment a RLC PDU in a MAC PDU.	<--	MAC PDU	-	-
4	Void	-	-	-	-
5	Void	-	-	-	-
6	Check: Does the UE transmits a MAC PDU containing Loop backed PDU on expiry of IP PDU delay?	-->	MAC PDU (containing 1 MAC sub PDU containing RLC SDU)	1	P
7-11	Repeat steps 1-5	-	-	-	-
12	Check: Does the UE transmits a MAC PDU containing Loop backed PDU?	-->	MAC PDU (containing 1 MAC sub PDU containing RLC SDU)	1	P
13	SS waits dataInactivityTimer seconds for the UE to enter RRC_IDLE.	-	-	-	-
14	Check: Does the test result of generic test procedure in TS 38.508-1 [4] Table 4.9.5.2.2-1 indicate that the UE is in RRC_IDLE?	-	-	2	-

7.1.1.10.1.3.3 Specific Message Contents

Table 7.1.1.10.1.3.3-1: MAC-CellGroupConfig (preamble)

Derivation path: 38.508-1[4], table 4.6.3-68			
Information Element	Value/Remark	Comment	Condition
MAC-CellGroupConfig ::= SEQUENCE {			
dataInactivityTimer	s10		
}			

Table 7.1.1.10.1.3.3-2: CLOSE UE TEST LOOP (Preamble)

Derivation path: 36.508-1 [7] table 4.7A-3 condition UE test loop mode B			
Information Element	Value/Remark	Comment	Condition
UE test loop mode B LB setup			
IP PDU delay	'0000 0110'B	6 seconds	

7.1.1.10.2 Recommended Bit Rate

7.1.1.10.2.1 Test Purpose (TP)

(1)

```
with { UE in RRC Connected state and MMTEL call established}
ensure that {
  when { IF upper Layers requested to query the gNB for the recommended bit rate for a logical
channel and for a direction and bitRateQueryProhibitTimer is not running }
    then { UE transmits a Recommended Bit Rate Query MAC Control Element}
}
```

(2)

```
with(UE in RRC Connected state and MMTEL call established)
ensure that {
  when{ IF upper Layers requested to query the gNB for the recommended bit rate for a logical
channel and for a direction and bitRateQueryProhibitTimer is running}
    then { UE does not transmits a Recommended Bit Rate Query MAC Control Element}
}
```

(3)

```
with ( UE in RRC Connected state and MMTEL call established)
ensure that {
  when{ UE receives MAC PDU from the gNB for the recommended bit rate for a logical channel and for
a direction }
    then { UE sends an HARQ ACK }
}
```

7.1.1.10.2.2 Conformance requirements

References: The conformance requirements covered in the present TC are specified in: TS 38.321, clauses 5.18.10 and 6.1.20. Unless otherwise stated these are Rel-15 requirements.

[TS 38.321, clause 5.18.10]

The recommended bit rate procedure is used to provide the MAC entity with information about the bit rate which the gNB recommends. The bit rate is the recommended bit rate of the physical layer. Averaging window of default value 2000 ms will apply as specified in TS 26.114 [13].

The gNB may transmit the Recommended bit rate MAC CE to the MAC entity to indicate the recommended bit rate for the UE for a specific logical channel and a specific direction (either uplink or downlink). Upon reception of a Recommended bit rate MAC CE the MAC entity shall:

- indicate to upper layers the recommended bit rate for the indicated logical channel and direction.

The MAC entity may request the gNB to indicate the recommended bit rate for a specific logical channel and a specific direction. If the MAC entity is requested by upper layers to query the gNB for the recommended bit rate for a logical channel and for a direction (i.e. for uplink or downlink), the MAC entity shall:

- 1> if a Recommended bit rate query for this logical channel and this direction has not been triggered:
- 2> trigger a Recommended bit rate query for this logical channel, direction, and desired bit rate.

If the MAC entity has UL resources allocated for new transmission the MAC entity shall:

- 1> for each Recommended bit rate query that the Recommended Bit Rate procedure determines has been triggered and not cancelled:
 - 2> if *bitRateQueryProhibitTimer* for the logical channel and the direction of this Recommended bit rate query is configured, and it is not running; and
 - 2> if the MAC entity has UL resources allocated for new transmission and the allocated UL resources can accommodate a Recommended bit rate MAC CE plus its subheader as a result of LCP as defined in clause 5.4.3.1:

- 3> instruct the Multiplexing and Assembly procedure to generate the Recommended bit rate MAC CE for the logical channel and the direction of this Recommended bit rate query;
- 3> start the *bitRateQueryProhibitTimer* for the logical channel and the direction of this Recommended bit rate query;
- 3> cancel this Recommended bit rate query.

[TS 38.321, clause 6.1.20]

The Recommended bit rate MAC CE is identified by a MAC subheader with LCID as specified in Tables 6.2.1-1 and 6.2.1-2 for bit rate recommendation message from the gNB to the UE and bit rate recommendation query message from the UE to the gNB, respectively. It has a fixed size and consists of two octets defined as follows (Figure 6.1.3.20-1):

- LCID: This field indicates the identity of the logical channel for which the recommended bit rate or the recommended bit rate query is applicable. The length of the field is 6 bits;
- Uplink/Downlink (UL/DL): This field indicates whether the recommended bit rate or the recommended bit rate query applies to uplink or downlink. The length of the field is 1 bit. The UL/DL field set to 0 indicates downlink. The UL/DL field set to 1 indicates uplink;
- Bit Rate: This field indicates an index to Table 6.1.3.20-1. The length of the field is 6 bits. For bit rate recommendation the value indicates the recommended bit rate. For bit rate recommendation query the value indicates the desired bit rate;
- R: reserved bit, set to 0.

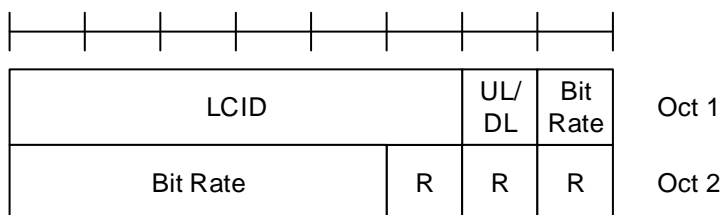

Figure 6.1.3.20-1: Recommended bit rate MAC CE

Table 6.1.3.20-1: Values (kbit/s) for Bit Rate field

Index	NR Recommended Bit Rate value [kbit/s]	Index	NR Recommended Bit Rate value [kbit/s]
0	Note 1	32	700
1	0	33	800
2	9	34	900
3	11	35	1000
4	13	36	1100
5	17	37	1200
6	21	38	1300
7	25	39	1400
8	29	40	1500
9	32	41	1750
10	36	42	2000
11	40	43	2250
12	48	44	2500
13	56	45	2750
14	72	46	3000
15	88	47	3500
16	104	48	4000
17	120	49	4500
18	140	50	5000
19	160	51	5500

20	180	52	6000
21	200	53	6500
22	220	54	7000
23	240	55	7500
24	260	56	8000
25	280	57	Reserved
26	300	58	Reserved
27	350	59	Reserved
28	400	60	Reserved
29	450	61	Reserved
30	500	62	Reserved
31	600	63	Reserved
Note 1: For bit rate recommendation message this index is used for indicating that no new recommendation on bit rate is given.			

7.1.1.10.2.3 Test description

7.1.1.10.2.3.1 Pre-test conditions

System Simulator:

- NR Cell 1
- System information combination NR-1 as defined in TS 38.508-1 [4] clause 4.4.3.1.3 is used in NR cell.

UE:

- None.

Preamble:

- The UE is in 5GS state 1N-A according to TS 38.508-1 [4], clause 4.4A.2 Table 4.4A.2-1.

7.1.1.10.2.3.2 Test procedure sequence

Table 7.1.1.10.2.3.2-2: Main behaviour

St	Procedure	Message Sequence		TP	Verdict
		U - S	Message		
1	The procedure in table 4.9.15.2.2-1 in TS 38.508-1 [4] is performed. The bitRateQueryProhibitTimer for the Logical channel of MMTEL QoS Flow is configured as s3 (3 seconds).	-	-	-	-
2	Trigger the UE to perform Recommended Bit Rate query for direction Downlink via AT (+CGBRRREQ) or MMI command.	-	-	-	-
3	Check: Does the UE transmit a MAC PDU containing Recommended bit rate MAC CE with Uplink/Downlink (UL/DL) set as 0?	->	MAC PDU	1	P
4	Trigger the UE to perform Recommended Bit Rate query for direction Uplink via AT (+CGBRRREQ) or MMI command.	-	-	-	-
5	Check: Does the UE transmit a MAC PDU containing Recommended bit rate MAC CE with Uplink/Downlink (UL/DL) set as 1?	->	MAC PDU	1	P
6	SS transmits a MAC PDU containing Recommended bit rate MAC CE with Uplink/Downlink (UL/DL) set as 0 and Bit Rate same as value received in step 5.	<-	MAC PDU	-	-
7	Trigger the UE to perform Recommended Bit Rate query for direction Up Link via AT	-	-	-	-

	(+CGBRRREQ) or MMI command.				
8	Check: Does the UE transmit a MAC PDU containing Recommended bit rate MAC CE ?	->	MAC PDU	2	P
9	While bitRateQueryProhibitTimer is running (3 seconds) in UE, trigger the UE to perform Recommended Bit Rate query for direction Up Link via AT (+CGBRRREQ) or MMI command.	-	-	-	-
10	Check: While bitRateQueryProhibitTimer is running, does the UE transmit a MAC PDU containing Recommended bit rate MAC CE ?	->	MAC PDU	2	F
11	Check: After bitRateQueryProhibitTimer expires, does the UE transmit a MAC PDU containing Recommended bit rate MAC CE with Uplink/Downlink (UL/DL) set as 1?	->	MAC PDU	2	P
12	SS transmits a MAC PDU containing Recommended bit rate MAC CE with Uplink/Downlink (UL/DL) set as 1 and Bit Rate same as value received in step 11.	<-	MAC PDU	-	-
13	Check: Does the UE transmit a HARQ ACK for the DL MAC PDU in Step 12?	-->	HARQ ACK	3	P
Note: The bitRateQueryProhibitTimer is configured only for UL direction as per asn.1 definition.					

7.1.1.10.2.3.3 Specific message contents

None

7.1.1.11 NR Dual Connectivity

7.1.1.11.1 DC power headroom reporting / PSCell activation and DL pathloss change reporting

7.1.1.11.1.1 Test Purpose (TP)

(1)

```
with { UE in RRC_CONNECTED state on Pcell and PSCell is added }
ensure that {
  when { phr is configured }
  then { UE transmits a Power Headroom Report for the PCell and PSCell }
}
```

(2)

```
with { UE in RRC_CONNECTED state with PSCell and with Power headroom reporting for phr-Tx-
PowerFactorChange }
ensure that {
  when { the DL Pathloss has changed more than phr-Tx-PowerFactorChange dB and phr-ProhibitTimer is
running }
  then { UE does not transmit a MAC PDU containing Power Headroom MAC Control Element }
}
```

(3)

```
with { UE in RRC_CONNECTED state with PSCell and with Power headroom reporting for phr-Tx-
PowerFactorChange }
ensure that {
  when { the phr-ProhibitTimer expires and power headroom report is triggered due to DL Pathloss
change }
  then { UE transmits a MAC PDU containing Power Headroom MAC Control Element for the Pcell and
PSCell }
}
```

7.1.1.11.1.2 Conformance requirements

References: The conformance requirements covered in the present TC are specified in: 3GPP TS 38.321 clause 5.4.6

[TS 38.321, clause 5.4.6]

A Power Headroom Report (PHR) shall be triggered if any of the following events occur:

- *phr-ProhibitTimer* expires or has expired and the path loss has changed more than *phr-Tx-PowerFactorChange* dB for at least one activated Serving Cell of any MAC entity which is used as a pathloss reference since the last transmission of a PHR in this MAC entity when the MAC entity has UL resources for new transmission;

NOTE 1: The path loss variation for one cell assessed above is between the pathloss measured at present time on the current pathloss reference and the pathloss measured at the transmission time of the last transmission of PHR on the pathloss reference in use at that time, irrespective of whether the pathloss reference has changed in between.

- *phr-PeriodicTimer* expires;
- upon configuration or reconfiguration of the power headroom reporting functionality by upper layers, which is not used to disable the function;
- activation of an SCell of any MAC entity with configured uplink;
- addition of the PSCell (i.e. PSCell is newly added or changed);
- *phr-ProhibitTimer* expires or has expired, when the MAC entity has UL resources for new transmission, and the following is true for any of the activated Serving Cells of any MAC entity with configured uplink:
 - there are UL resources allocated for transmission or there is a PUCCH transmission on this cell, and the required power backoff due to power management (as allowed by $P\text{-MPR}_c$ as specified in TS 38.101-1 [14], TS 38.101-2 [15], and TS 38.101-3 [16]) for this cell has changed more than *phr-Tx-PowerFactorChange* dB since the last transmission of a PHR when the MAC entity had UL resources allocated for transmission or PUCCH transmission on this cell.

NOTE 2: The MAC entity should avoid triggering a PHR when the required power backoff due to power management decreases only temporarily (e.g. for up to a few tens of milliseconds) and it should avoid reflecting such temporary decrease in the values of $P_{\text{CMAX},f,c}/\text{PH}$ when a PHR is triggered by other triggering conditions.

If the MAC entity has UL resources allocated for a new transmission the MAC entity shall:

- 1> if it is the first UL resource allocated for a new transmission since the last MAC reset:
 - 2> start *phr-PeriodicTimer*;
- 1> if the Power Headroom reporting procedure determines that at least one PHR has been triggered and not cancelled; and
- 1> if the allocated UL resources can accommodate the MAC CE for PHR which the MAC entity is configured to transmit, plus its subheader, as a result of LCP as defined in clause 5.4.3.1:
 - 2> if *multiplePHR* with value *true* is configured:
 - 3> for each activated Serving Cell with configured uplink associated with any MAC entity:
 - 4> obtain the value of the Type 1 or Type 3 power headroom for the corresponding uplink carrier as specified in clause 7.7 of TS 38.213 [6] for NR Serving Cell and clause 5.1.1.2 of TS 36.213 [17] for E-UTRA Serving Cell;
 - 4> if this MAC entity has UL resources allocated for transmission on this Serving Cell; or
 - 4> if the other MAC entity, if configured, has UL resources allocated for transmission on this Serving Cell and *phr-ModeOtherCG* is set to *real* by upper layers:
 - 5> obtain the value for the corresponding $P_{\text{CMAX},f,c}$ field from the physical layer.
 - 3> if *phr-Type2OtherCell* with value *true* is configured:
 - 4> if the other MAC entity is E-UTRA MAC entity:

- 5> obtain the value of the Type 2 power headroom for the SpCell of the other MAC entity (i.e. E-UTRA MAC entity);
- 5> if *phr-ModeOtherCG* is set to *real* by upper layers:
 - 6> obtain the value for the corresponding $P_{\text{CMAX},f,c}$ field for the SpCell of the other MAC entity (i.e. E-UTRA MAC entity) from the physical layer.
- 3> instruct the Multiplexing and Assembly procedure to generate and transmit the Multiple Entry PHR MAC CE as defined in clause 6.1.3.9 based on the values reported by the physical layer.
- 2> else (i.e. Single Entry PHR format is used):
 - 3> obtain the value of the Type 1 power headroom from the physical layer for the corresponding uplink carrier of the PCell;
 - 3> obtain the value for the corresponding $P_{\text{CMAX},f,c}$ field from the physical layer;
 - 3> instruct the Multiplexing and Assembly procedure to generate and transmit the Single Entry PHR MAC CE as defined in clause 6.1.3.8 based on the values reported by the physical layer.
- 2> start or restart *phr-PeriodicTimer*;
- 2> start or restart *phr-ProhibitTimer*;
- 2> cancel all triggered PHR(s).

7.1.1.11.1.3 Test description

7.1.1.11.1.3.1 Pre-test conditions

System Simulator:

- NR Cell 1 is the PCell and NR Cell 10 is the PSCell.
- System information combination NR-4 as defined in TS 38.508-1 [4] clause 4.4.3.1.3 is used in all cells.

UE:

- None.

Preamble:

- The UE is in state NR RRC_CONNECTED using generic procedure parameter Connectivity (*NR-DC*), Test Mode (*On*) associated with UE test loop mode A configured on NR Cell 1 according to TS 38.508-1 [4], clause 4.5.4.

7.1.1.11.1.3.2 Test procedure sequence

Table 7.1.1.11.1.3.2-0: Cell configuration power level changes over time for Conducted test environment

	Parameter	Unit	NR Cell 1	NR Cell 10	Remarks
T0	Cell-specific RS EPRE	dBm/SC S	-82	-82	
T1	Cell-specific RS EPRE	dBm/SC S	-89	-82	
T2	Cell-specific RS EPRE	dBm/SC S	-82	-82	
T3	Cell-specific RS	dBm/SC S	-82	-89	

	EPRE				
T4	Cell-specific RS EPRE	dBm/SC S	-82	-82	

Table 7.1.1.11.1.3.2-0A: Cell configuration power level changes over time for OTA test environment

	Parameter	Unit	NR Cell 1	NR Cell 10	Remarks
T0	Cell-specific RS EPRE	dBm/SC S	-82	-82	
T1	Cell-specific RS EPRE	dBm/SC S	n/a	n/a	
T2	Cell-specific RS EPRE	dBm/SC S	n/a	n/a	
T3	Cell-specific RS EPRE	dBm/SC S	-82	-91	
T4	Cell-specific RS EPRE	dBm/SC S	-82	-82	

Table 7.1.1.11.1.3.2-1: Main behaviour

St	Procedure	Message Sequence		TP	Verdict
		U - S	Message		
1	The SS transmits UL grant on PCell and PSCell to the UE at every 10ms in PDCCH occasion.	<--	-	-	-
2	SS transmits NR <i>RRCReconfiguration</i> message to configure to specific Power Headroom parameters for NR Cell	<--	<i>RRCReconfiguration</i>	-	-
3	Check: Does the UE transmit a MAC PDU containing Multiple-Entry PHR MAC CE on PCell? (Note 1)	-->	MAC PDU	1	P
3A	Check: Does the UE transmit a MAC PDU containing Multiple-Entry PHR MAC CE on PSCell? (Note 1)	-->	MAC PDU	1	P
4	The UE transmits an NR <i>RRCReconfigurationComplete</i> message including <i>nr-SCG-Response</i> (Note 1)	-->	<i>RRCReconfigurationComplete</i>	-	-
5	Void	-	-	-	-
-	EXCEPTION : Steps 6 to 12 shall be executed depending on PSCell Configuration. (Note 3)	-	-	-	-
6	IF PSCell is configured as FR1 THEN Reduce SS power level for NR PCell so as to cause a DL_Pathloss change at UE by 5dB, row T1 of Table 7.1.1.11.1.3.2-0.	-	-	-	-
7	Check: For 80% of <i>prohibitPHR-Timer</i> since step 3, does the UE transmit a MAC PDU containing Multiple-Entry PHR MAC CE on PCell?	-->	MAC PDU	2	F
8	Check: After <i>prohibitPHR-Timer</i> after step 3, does the UE transmit a MAC PDU containing Multiple-Entry PHR MAC CE on PCell?	-->	MAC PDU	3	P
9	Increase SS power level for NR PCell so as to cause a DL_Pathloss change at UE by 5dB, row T2 of Table 7.1.1.11.1.3.2-0/0A.	-	-	-	-

10	Check: For 80% of <i>prohibitPHR-Timer</i> since step 8, does the UE transmit a MAC PDU containing Power Headroom MAC Control Element on PCell?	-->	MAC PDU	2	F
11	Check: After <i>prohibitPHR-Timer</i> after step 8, does the UE transmit a MAC PDU containing Power Headroom MAC Control Element on PCell?	-->	MAC PDU	3	P
12	Void	-	-	-	-
13	Reduce SS power level for NR PSCell so as to cause a DL_Pathloss change at UE by 5dB, row T3 of Table 7.1.1.11.1.3.2-0/0A.	-	-	-	-
14	IF PSCell is configured as FR2 THEN Check: For 80% of <i>prohibitPHR-Timer</i> since step 3A, does the UE transmit a MAC PDU containing Multiple-Entry PHR MAC CE?	-->	MAC PDU	2	F
15	Check: Does the UE transmit a MAC PDU containing Multiple-Entry PHR MAC CE on PSCell?	-->	MAC PDU	3	P
16	Increase SS power level for NR PSCell so as to cause a DL_Pathloss change at UE by 5dB, row T4 of Table 7.1.1.11.1.3.2-0/0A.	-	-	-	-
17	Check: For 80% of <i>prohibitPHR-Timer</i> since step 15, does the UE transmit a MAC PDU containing Power Headroom MAC Control Element on PSCell?	-->	MAC PDU	2	F
18	Check: After <i>prohibitPHR-Timer</i> after step 15, does the UE transmit a MAC PDU containing Power Headroom MAC Control Element on PSCell?	-->	MAC PDU	3	P
19	The SS transmits an NR <i>RRCReconfiguration</i> message to disable Power Headroom reporting	<--	<i>RRCReconfiguration</i>	-	-
20	The UE transmits an NR <i>RRCReconfigurationComplete</i> message to confirm the disabling of Power Headroom parameters	-->	<i>RRCReconfigurationComplete</i>	-	-
<p>Note 1: Steps 3 and 4 can happen in any order. Note 2: Void. Note 3: Steps 6 to 12 are excluded when executed with FR1+FR2 band combination due to limitation in FR1 OTA requirements specified in 38.508-1 [4] clause 6.2.2.2.3. <i>phr-Tx-PowerFactorChange</i> for PCell is not tested due to this limitation</p>					

7.1.1.11.1.3.3 Specific Message Contents

Table 7.1.1.11.1.3.3-1: *RRCReconfiguration* (step 2, Table 7.1.1.11.1.3.2-1)

Derivation Path: TS 38.331 [6], clause 6.2.2			
Information Element	Value/remark	Comment	Condition
<i>RRCReconfiguration</i> ::= SEQUENCE {			
<code>rrc-TransactionIdentifier</code>	<i>RRC-TransactionIdentifier</i>		
criticalExtensions CHOICE {			
<code>rrcReconfiguration</code> SEQUENCE {			
<code>radioBearerConfig</code>	Not present		
nonCriticalExtension SEQUENCE {			
<code>masterCellGroup</code>	<i>CellGroupConfig-phr</i>		
nonCriticalExtension SEQUENCE {			
<code>mrdc-SecondaryCellGroupConfig</code> CHOICE {			
<code>setup</code> SEQUENCE {			
<code>mrdc-ReleaseAndAdd</code>	Not present		
<code>mrdc-SecondaryCellGroup</code> CHOICE {			
<code>nr-SCG</code>	<i>RRCReconfiguration-SCG-phr</i>	OCTET STRING (CONTAINING	

		RRCReconfigurati on)	
}			
}			
}			
}			
}			
}			
}			
}			

Table 7.1.1.11.1.3.3-1A: RRCReconfiguration-SCG-phr (step 2, Table 7.1.1.11.1.3.2-1)

Derivation Path: TS 38.331 [6], clause 6.2.2			
Information Element	Value/remark	Comment	Condition
RRCReconfiguration ::= SEQUENCE {			
rrc-TransactionIdentifier	RRC-TransactionIdentifier		
criticalExtensions CHOICE {			
rrcReconfiguration SEQUENCE {			
radioBearerConfig	Not present		
secondaryCellGroup	CellGroupConfig-phr		
}			
}			
}			

Table 7.1.1.11.1.3.3-2: CellGroupConfig-phr (step 2, Table 7.1.1.11.1.3.2-1)

Derivation Path: 38.508-1 [4], Table 4.6.3-19			
Information Element	Value/remark	Comment	Condition
cellGroupConfig ::= SEQUENCE {			
mac-CellGroupConfig SEQUENCE {			
phr-Config CHOICE {			
setup SEQUENCE {			
phr-PeriodicTimer	infinity		
phr-ProhibitTimer	sf500		
phr-Tx-PowerFactorChange	dB3		
multiplePHR	true		
dummy	false		
phr-Type2OtherCell	false		
phr-ModeOtherCG	real		
}			
}			
}			
}			

7.1.1.12 UE power saving

7.1.1.12.1 Void

7.1.1.12.2 Void

7.1.1.12.3 DRX adaptation / UE wakeup indication

7.1.1.12.3.1 Test Purpose (TP)

(1)

```
with { UE in RRC_CONNECTED state and long DRX is configured and [(SFN * 10) + subframe number]
modulo (drx-LongCycle) = drx-StartOffset and DCP is configured }
ensure that {
  when { a DCP indication with the value of wake-up indication 1 associated with the current DRX
cycle has been received }
  then { UE starts the drx-onDurationTimer after drx-SlotOffset from the beginning of the subframe
and monitors the PDCCH }
}
```

(2)

```
with { UE in RRC_CONNECTED state and long DRX is configured and [(SFN * 10) + subframe number]
modulo (drx-LongCycle) = drx-StartOffset and DCP is configured and ps-wakeup is configured with
value true }
ensure that {
  when { DCP indication associated with this cycle has not been received }
  then { UE starts the drx-onDurationTimer after drx-SlotOffset from the beginning of the subframe
and monitors the PDCCH for OnDurationTimer PDCCH-Occasions }
}
```

(3)

```
with { UE in RRC_CONNECTED state long DRX is configured and [(SFN * 10) + subframe number] modulo
(drx-LongCycle) = drx-StartOffset and DCP is configured }
ensure that {
  when { all DCP occasions in time domain occurred in DRX active time }
  then { UE starts the drx-onDurationTimer after drx-SlotOffset from the beginning of the subframe
and monitors the PDCCH }
}
```

(4)

```
with { UE in RRC_CONNECTED state long DRX is configured and DCP is configured }
ensure that {
  when { all DCP occasions in time domain occurred during measurement gap }
  then { UE starts the drx-onDurationTimer after drx-SlotOffset from the beginning of the subframe
and monitors the PDCCH }
}
```

(5)

```
with { UE in RRC_CONNECTED state and long DRX is configured and [(SFN * 10) + subframe number]
modulo (drx-LongCycle) = drx-StartOffset and DCP is configured }
ensure that {
  when { a DCP indication with the value of wake-up indication 0 associated with the current DRX
cycle has been received }
  then { UE does not start the drx-onDurationTimer after drx-SlotOffset from the beginning of the
subframe and skips monitoring the PDCCH }
}
```

7.1.1.12.3.2 Conformance requirements

References: The conformance requirements covered in the present TC are specified in: TS 38.321, clause 5.7, TS 38.213, clause 10.3 and 7.3.1.3.7. Unless otherwise stated these are Rel-16 requirements.

[TS 38.321, clause 5.7]

The MAC entity may be configured by RRC with a DRX functionality that controls the UE's PDCCH monitoring activity for the MAC entity's C-RNTI, CI-RNTI, CS-RNTI, INT-RNTI, SFI-RNTI, SP-CSI-RNTI, TPC-PUCCH-RNTI, TPC-PUSCH-RNTI, TPC-SRS-RNTI, and AI-RNTI. When using DRX operation, the MAC entity shall also monitor PDCCH according to requirements found in other clauses of this specification. When in RRC_CONNECTED, if DRX is configured, for all the activated Serving Cells, the MAC entity may monitor the PDCCH discontinuously using the DRX operation specified in this clause; otherwise the MAC entity shall monitor the PDCCH as specified in TS 38.213 [6].

NOTE 1: If Sidelink resource allocation mode 1 is configured by RRC, a DRX functionality is not configured.

RRC controls DRX operation by configuring the following parameters:

- *drx-onDurationTimer*: the duration at the beginning of a DRX Cycle;
- *drx-SlotOffset*: the delay before starting the *drx-onDurationTimer*;
- *drx-InactivityTimer*: the duration after the PDCCH occasion in which a PDCCH indicates a new UL or DL transmission for the MAC entity;
- *drx-RetransmissionTimerDL* (per DL HARQ process except for the broadcast process): the maximum duration until a DL retransmission is received;
- *drx-RetransmissionTimerUL* (per UL HARQ process): the maximum duration until a grant for UL retransmission is received;
- *drx-LongCycleStartOffset*: the Long DRX cycle and *drx-StartOffset* which defines the subframe where the Long and Short DRX Cycle starts;
- *drx-ShortCycle* (optional): the Short DRX cycle;
- *drx-ShortCycleTimer* (optional): the duration the UE shall follow the Short DRX cycle;
- *drx-HARQ-RTT-TimerDL* (per DL HARQ process except for the broadcast process): the minimum duration before a DL assignment for HARQ retransmission is expected by the MAC entity;
- *drx-HARQ-RTT-TimerUL* (per UL HARQ process): the minimum duration before a UL HARQ retransmission grant is expected by the MAC entity;
- *ps-Wakeup* (optional): the configuration to start associated *drx-onDurationTimer* in case DCP is monitored but not detected;
- *ps-TransmitOtherPeriodicCSI* (optional): the configuration to report periodic CSI that is not L1-RSRP on PUCCH during the time duration indicated by *drx-onDurationTimer* in case DCP is configured but associated *drx-onDurationTimer* is not started;
- *ps-TransmitPeriodicL1-RSRP* (optional): the configuration to transmit periodic CSI that is L1-RSRP on PUCCH during the time duration indicated by *drx-onDurationTimer* in case DCP is configured but associated *drx-onDurationTimer* is not started.

Serving Cells may be configured by RRC in two groups. When RRC does not configure a secondary DRX group, there is only one DRX group. When two DRX groups are configured each group of Serving Cells, which is called a DRX group, is configured by RRC with its own set of parameters: *drx-onDurationTimer*, *drx-InactivityTimer*. When two DRX groups are configured, the two groups share the following parameter values: *drx-SlotOffset*, *drx-RetransmissionTimerDL*, *drx-RetransmissionTimerUL*, *drx-LongCycleStartOffset*, *drx-ShortCycle* (optional), *drx-ShortCycleTimer* (optional), *drx-HARQ-RTT-TimerDL*, and *drx-HARQ-RTT-TimerUL*.

When a DRX cycle is configured, the Active Time for Serving Cells in a DRX group includes the time while:

- *drx-onDurationTimer* or *drx-InactivityTimer* configured for the DRX group is running; or
 - *drx-RetransmissionTimerDL* or *drx-RetransmissionTimerUL* is running on any Serving Cell in the DRX group;
- or

- *ra-ContentionResolutionTimer* (as described in clause 5.1.5) or *msgB-ResponseWindow* (as described in clause 5.1.4a) is running; or
- a Scheduling Request is sent on PUCCH and is pending (as described in clause 5.4.4); or
- a PDCCH indicating a new transmission addressed to the C-RNTI of the MAC entity has not been received after successful reception of a Random Access Response for the Random Access Preamble not selected by the MAC entity among the contention-based Random Access Preamble (as described in clauses 5.1.4 and 5.1.4a).

When DRX is configured, the MAC entity shall:

- 1> if the Long DRX Cycle is used, and $[(\text{SFN} \times 10) + \text{subframe number}] \bmod (\text{drx-LongCycle}) = \text{drx-StartOffset}$:
 - 2> if DCP monitoring is configured for the active DL BWP as specified in TS 38.213 [6], clause 10.3:
 - 3> if DCP indication associated with the current DRX Cycle received from lower layer indicated to start *drx-onDurationTimer*, as specified in TS 38.213 [6]; or
 - 3> if all DCP occasion(s) in time domain, as specified in TS 38.213 [6], associated with the current DRX Cycle occurred in Active Time considering grants/assignments/DRX Command MAC CE/Long DRX Command MAC CE received and Scheduling Request sent until 4 ms prior to start of the last DCP occasion, or within BWP switching interruption length, or during a measurement gap; or
 - 3> if *ps-Wakeup* is configured with value *true* and DCP indication associated with the current DRX Cycle has not been received from lower layers:
 - 4> start *drx-onDurationTimer* after *drx-SlotOffset* from the beginning of the subframe.
 - 2> else:
 - 3> start *drx-onDurationTimer* after *drx-SlotOffset* from the beginning of the subframe.

NOTE 2: In case of unaligned SFN across carriers in a cell group, the SFN of the SpCell is used to calculate the DRX duration.

- 1> if the DRX group is in Active Time:
 - 2> monitor the PDCCH on the Serving Cells in this DRX group as specified in TS 38.213 [6];
 - 2> if the PDCCH indicates a DL transmission:
 - 3> start the *drx-HARQ-RTT-TimerDL* for the corresponding HARQ process in the first symbol after the end of the corresponding transmission carrying the DL HARQ feedback;

NOTE 3: When HARQ feedback is postponed by PDSCH-to-HARQ_feedback timing indicating a non-numerical k1 value, as specified in TS 38.213 [6], the corresponding transmission opportunity to send the DL HARQ feedback is indicated in a later PDCCH requesting the HARQ-ACK feedback.

- 3> stop the *drx-RetransmissionTimerDL* for the corresponding HARQ process.
- 3> if the PDSCH-to-HARQ_feedback timing indicate a non-numerical k1 value as specified in TS 38.213 [6]:
 - 4> start the *drx-RetransmissionTimerDL* in the first symbol after the PDSCH transmission for the corresponding HARQ process.
- 2> if the PDCCH indicates a UL transmission:
 - 3> start the *drx-HARQ-RTT-TimerUL* for the corresponding HARQ process in the first symbol after the end of the first repetition of the corresponding PUSCH transmission;
 - 3> stop the *drx-RetransmissionTimerUL* for the corresponding HARQ process.
- 2> if the PDCCH indicates a new transmission (DL or UL) on a Serving Cell in this DRX group:

- 3> start or restart *drx-InactivityTimer* for this DRX group in the first symbol after the end of the PDCCH reception.
 - 1> if DCP monitoring is configured for the active DL BWP as specified in TS 38.213 [6], clause 10.3; and
 - 1> if the current symbol *n* occurs within *drx-onDurationTimer* duration; and
 - 1> if *drx-onDurationTimer* associated with the current DRX cycle is not started as specified in this clause:
 - 2> if the MAC entity would not be in Active Time considering grants/assignments/DRX Command MAC CE/Long DRX Command MAC CE received and Scheduling Request sent until 4 ms prior to symbol *n* when evaluating all DRX Active Time conditions as specified in this clause:
 - 3> not transmit periodic SRS and semi-persistent SRS defined in TS 38.214 [7];
 - 3> not report semi-persistent CSI configured on PUSCH;
 - 3> if *ps-TransmitPeriodicL1-RSRP* is not configured with value *true*:
 - 4> not report periodic CSI that is L1-RSRP on PUCCH.
 - 3> if *ps-TransmitOtherPeriodicCSI* is not configured with value *true*:
 - 4> not report periodic CSI that is not L1-RSRP on PUCCH.
 - 1> else:
 - 2> in current symbol *n*, if the DRX group would not be in Active Time considering grants/assignments scheduled on Serving Cell(s) in this DRX Group and DRX Command MAC CE/Long DRX Command MAC CE received and Scheduling Request sent until 4 ms prior to symbol *n* when evaluating all DRX Active Time conditions as specified in this clause:
 - 3> not transmit periodic SRS and semi-persistent SRS defined in TS 38.214 [7] in this DRX group;
 - 3> not report CSI on PUCCH and semi-persistent CSI configured on PUSCH in this DRX group.
- ...

Regardless of whether the MAC entity is monitoring PDCCH or not on the Serving Cells in this DRX group, the MAC entity transmits HARQ feedback, aperiodic CSI on PUSCH, and aperiodic SRS defined in TS 38.214 [7] on the Serving Cells in this DRX group when such is expected.

The MAC entity needs not to monitor the PDCCH if it is not a complete PDCCH occasion (e.g. the Active Time starts or ends in the middle of a PDCCH occasion).

[TS 38.213, clause 10.3]

A UE configured with DRX mode operation [11, TS 38.321] can be provided the following for detection of a DCI format 2_6 in a PDCCH reception on the PCell or on the SpCell [12, TS 38.331]

- a PS-RNTI for DCI format 2_6 by *ps-RNTI*
- a number of search space sets, by *dci-Format2-6*, to monitor PDCCH for detection of DCI format 2_6 on the active DL BWP of the PCell or of the SpCell according to a common search space as described in clause 10.1
- a payload size for DCI format 2_6 by *sizeDCI-2-6*
- a location in DCI format 2_6 of a Wake-up indication bit by *ps-PositionDCI-2-6*
- a '0' value for the Wake-up indication bit, when reported to higher layers, indicates to not start the *drx-onDurationTimer* for the next long DRX cycle [11, TS 38.321]
- a '1' value for the Wake-up indication bit, when reported to higher layers, indicates to start the *drx-onDurationTimer* for the next long DRX cycle [11, TS 38.321]
- a bitmap, when the UE is provided a number of groups of configured SCells by *dormancyGroupOutsideActiveTime*, where

- the bitmap location is immediately after the Wake-up indication bit location
- the bitmap size is equal to the number of groups of configured SCells where each bit of the bitmap corresponds to a group of configured SCells from the number of groups of configured SCells
- a '0' value for a bit of the bitmap indicates an active DL BWP, provided by *dormantBWP-Id*, for the UE [11, TS38.321] for each activated SCell in the corresponding group of configured SCells
- a '1' value for a bit of the bitmap indicates
 - an active DL BWP, provided by *firstOutsideActiveTimeBWP-Id*, for the UE for each activated SCell in the corresponding group of configured SCells, if a current active DL BWP is the dormant DL BWP
 - a current active DL BWP, for the UE for each activated SCell in the corresponding group of configured SCells, if the current active DL BWP is not the dormant DL BWP
- the UE sets the active DL BWP to the indicated active DL BWP
- an offset by *ps-Offset* indicating a time, where the UE starts monitoring PDCCH for detection of DCI format 2_6 according to the number of search space sets, prior to a slot where the *drx-onDurationTimer* would start on the PCell or on the SpCell [11, TS 38.321]
 - for each search space set, the PDCCH monitoring occasions are the ones in the first $T_s T_s = 1T_s$ slots indicated by *duration*, or $T_s = 1$ slot if *duration* is not provided, starting from the first slot of the first T_s slots and ending prior to the start of *drx-onDurationTimer*.

On PDCCH monitoring occasions associated with a same long DRX Cycle, a UE does not expect to detect more than one DCI format 2_6 with different values of the Wake-up indication bit for the UE or with different values of the bitmap for the UE.

The UE does not monitor PDCCH for detecting DCI format 2_6 during Active Time [11, TS 38.321].

If a UE reports for an active DL BWP a *MinTimeGap* value that is X slots prior to the beginning of a slot where the UE would start the *drx-onDurationTimer*, the UE is not required to monitor PDCCH for detection of DCI format 2_6 during the X slots, where X corresponds to the *MinTimeGap* value of the SCS of the active DL BWP in Table 10.3-1.

Table 10.3-1: Minimum time gap value X

SCS (kHz)	Minimum Time Gap X (slots)	
	Value 1	Value 2
15	1	3
30	1	6
60	1	12
120	2	24
480	8	96
960	16	192

If a UE is provided search space sets to monitor PDCCH for detection of DCI format 2_6 in the active DL BWP of the PCell or of the SpCell and the UE detects DCI format 2_6, the physical layer of a UE reports the value of the Wake-up indication bit for the UE to higher layers [11, TS 38.321] for the next long DRX cycle.

If a UE is provided search space sets to monitor PDCCH for detection of DCI format 2_6 in the active DL BWP of the PCell or of the SpCell and the UE does not detect DCI format 2_6, the physical layer of the UE does not report a value of the Wake-up indication bit to higher layers for the next long DRX cycle.

If a UE is provided search space sets to monitor PDCCH for detection of DCI format 2_6 in the active DL BWP of the PCell or of the SpCell and the UE

- is not required to monitor PDCCH for detection of DCI format 2_6, as described in clauses 10, 11.1, 12, and in clause 5.7 of [11, TS 38.321] for all corresponding PDCCH monitoring occasions outside Active Time prior to a next long DRX cycle, or

- does not have any PDCCH monitoring occasions for detection of DCI format 2_6 outside Active Time of a next long DRX cycle

the physical layer of the UE reports a value of 1 for the Wake-up indication bit to higher layers for the next long DRX cycle.

[TS 38.212, clause 7.3.1.3.7]

DCI format 2_6 is used for notifying the power saving information outside DRX Active Time for one or more UEs.

The following information is transmitted by means of the DCI format 2_6 with CRC scrambled by PS-RNTI:

- block number 1, block number 2, ..., block number N

where the starting position of a block is determined by the parameter *PSPositionDCI2-6* provided by higher layers for the UE configured with the block.

If the UE is configured with higher layer parameter *PS-RNTI* and *dci-Format2-6*, one block is configured for the UE by higher layers, with the following fields defined for the block:

- Wake-up indication - 1 bit
- SCell dormancy indication – 0 bit if higher layer parameter *Scell-groups-for-dormancy-outside-active-time* is not configured; otherwise 1, 2, 3, 4 or 5 bits bitmap determined according to higher layer parameter *Scell-groups-for-dormancy-outside-active-time*, where each bit corresponds to one of the SCell group(s) configured by higher layers parameter *Scell-groups-for-dormancy-outside-active-time*, with MSB to LSB of the bitmap corresponding to the first to last configured SCell group.

The size of DCI format 2_6 is indicated by the higher layer parameter *SizeDCI_2-6*, according to Clause 10.3 of [5, TS 38.213].

7.1.1.12.3.3 Test description

7.1.1.12.3.3.1 Pre-test conditions

Same Pre-test conditions as in clause 7.1.1.0 except that set to return no data in uplink.

7.1.1.12.3.3.2 Test procedure sequence

Table 7.1.1.12.3.3.2-1: Main behaviour

St	Procedure	Message Sequence		TP	Verdict
		U - S	Message		
1	SS transmits RRCReconfiguration to configure specific DCP parameters. (Note 1)	<--	<i>RRCReconfiguration</i>	-	-
2	The UE transmits RRCReconfigurationComplete. (Note 2)	-->	<i>RRCReconfigurationComplete</i>	-	-
3	Wait 1280ms to ensure UE is out DRX active time.	-	-	-	-
3A	The SS transmits DCI 2-6 on the PDCCH within the PS-offset time before the start of next long DRX <i>drx-onDurationTimer</i> and the DCI 2-6 indicates not to start the next <i>Drx-onDurationTimer</i> .	<--	(PDCCH (DCI 2-6))	-	-
3B	In a PDCCH occasion the SS indicates the transmission of a DL MAC PDU on the PDCCH.	<--	MAC PDU	-	-
3C	Check: Does the UE transmit a HARQ ACK for the DL MAC PDU in Step 28?	-->	HARQ ACK	5	F
4	The SS transmits DCI 2-6 on the PDCCH within the PS-offset time before the start of next long DRX <i>drx-onDurationTimer</i> and the DCI 2-6 indicates to start the next <i>Drx-onDurationTimer</i> .	<--	(PDCCH (DCI 2-6))	-	-
5	In the first PDCCH occasion when the <i>Drx-</i>	<--	MAC PDU	-	-

	onDurationTimer is running, the SS indicates the transmission of a DL MAC PDU on the PDCCH.				
6	Check: Does the UE transmit a HARQ ACK for the DL MAC PDU in Step 5?	-->	HARQ ACK	1	P
7	SS transmits RRCReconfiguration to configure ps-wakeup with value true. (Note 1)	<--	<i>RRCReconfiguration</i>	-	-
8	The UE transmits RRCReconfigurationComplete. (Note 2)	-->	<i>RRCReconfigurationComplete</i>	-	-
9	Wait 20ms to ensure UE is out DRX active time.	-	-	-	-
10	In the first PDCCH occasion when the <i>Drx-onDurationTimer</i> is running, the SS indicates the transmission of a DL MAC PDU on the PDCCH.	<--	MAC PDU	-	-
11	Check: Does the UE transmit a HARQ ACK for the DL MAC PDU in Step 10?	-->	HARQ ACK	2	P
12	SS transmits RRCReconfiguration to configure specific DCP parameters. (Note 1)	<--	<i>RRCReconfiguration</i>	-	-
13	The UE transmits RRCReconfigurationComplete. (Note 2)	-->	<i>RRCReconfigurationComplete</i>	-	-
14	Wait 1280ms to ensure UE is out DRX active time.	-	-	-	-
15	The SS transmits DCI 2-6 on the PDCCH within the PS-offset time before the start of next long DRX <i>drx-onDurationTimer</i> and the DCI 2-6 indicates to start the next <i>Drx-onDurationTimer</i> .	<--	(PDCCH (DCI 2-6))	-	-
16	In the last PDCCH occasion when the <i>Drx-onDurationTimer</i> is running, the SS indicates the transmission of an invalid DL MAC PDU on the PDCCH.	<--	Invalid MAC PDU	-	-
17	The UE transmit a HARQ NACK for the DL MAC PDU in Step 16.	-->	HARQ NACK	-	-
17 A	The SS transmits DCI 2-6 on the PDCCH within the PS-offset time before the start of next long DRX <i>drx-onDurationTimer</i> and the DCI 2-6 indicates not to start the next <i>Drx-onDurationTimer</i> .	<--	(PDCCH (DCI 2-6))	-	-
18	In the PDCCH occasion when the next <i>Drx-onDurationTimer</i> is running, the SS indicates the transmission of a DL MAC PDU on the PDCCH.	<--	MAC PDU	-	-
19	Check: Does the UE transmit a HARQ ACK for the DL MAC PDU in Step 18?	-->	HARQ ACK	3	P
20	SS transmits RRCReconfiguration to configure specific measonfig parameters. (Note 1)	<--	<i>RRCReconfiguration</i>	-	-
21	The UE transmits RRCReconfigurationComplete. (Note 2)	-->	<i>RRCReconfigurationComplete</i>	-	-
22	Wait 10ms to ensure UE is out DRX active time.	-	-	-	-
22 A	The SS transmits DCI 2-6 on the PDCCH within the PS-offset time before the start of next long DRX <i>drx-onDurationTimer</i> and the DCI 2-6 indicates not to start the next <i>Drx-onDurationTimer</i> .	<--	(PDCCH (DCI 2-6))	-	-
23	In the first PDCCH occasion when the <i>Drx-onDurationTimer</i> is running, the SS indicates the transmission of a DL MAC PDU on the PDCCH.	<--	MAC PDU	-	-
24	Check: Does the UE transmit a HARQ ACK for the DL MAC PDU in Step 23?	-->	HARQ ACK	4	P
Note 1: For EN-DC the NR RRCReconfiguration message is contained in RRCConnectionReconfiguration 36.508 [7], Table 4.6.1-8 using condition EN-DC_EmbedNR_RRCRecon.					
Note 2: For EN-DC the NR RRCReconfigurationComplete message is contained in RRCConnectionReconfigurationComplete.					

7.1.1.12.3.3.3 Specific message contents

Table 7.1.1.12.3.3.3-1: RRCReconfiguration (step 1, 7 and 12)

Derivation Path: TS 38.508-1 [6]			
Information Element	Value/remark	Comment	Condition
RRCReconfiguration ::= SEQUENCE {			
criticalExtensions CHOICE {			
rrcReconfiguration ::= SEQUENCE {			
secondaryCellGroup	CellGroupConfig		EN-DC
nonCriticalExtension ::= SEQUENCE {}	Not present		EN-DC
nonCriticalExtension SEQUENCE {			NR
masterCellGroup	CellGroupConfig		
}			
}			
}			
}			

Table 7.1.1.12.3.3.3-2: CellGroupConfig (Table 7.1.1.12.3.3.3-1: RRCReconfiguration)

Derivation Path: TS 38.331 [6], clause 6.3.2			
Information Element	Value/remark	Comment	Condition
CellGroupConfig ::= SEQUENCE {			
cellGroupId	CellGroupId	TS 38.508-1 default value	
mac-CellGroupConfig ::= SEQUENCE {			
drx-Config CHOICE {			
setup	DRX-Config	TS 38.508-1 default value	
}			
}			
physicalCellGroupConfig ::= SEQUENCE {			
dcp-Config-r16 CHOICE {			
setup	DCP-Config-r16	TS 38.508-1 default value	
}			
}			
spCellConfig SEQUENCE {			
spCellConfigDedicated	ServingCellConfig		
}			
}			

Table 7.1.1.12.3.3.3-3: ServingCellConfig (Table 7.1.1.13.3.3.3-2: CellGroupConfig)

Derivation Path: TS 38.508-1 [4] Table 4.6.3-167			
Information Element	Value/remark	Comment	Condition
ServingCellConfig ::= SEQUENCE {			
initialDownlinkBWP ::= SEQUENCE {			
pdccch-Config CHOICE {			Step 1, Step 7, Step 12, Step 20
setup	PDCCH-Config		
}			
}			
}			

Table 7.1.1.12.3.3.3-4: PDCCH-Config (Table 7.1.1.12.3.3.3-3: BWP-DownlinkDedicated)

Derivation Path: TS 38.508-1 [4], Table 4.6.3-95			
Information Element	Value/remark	Comment	Condition
PDCCH-Config ::= SEQUENCE {			
controlResourceSetToAddModList			

SEQUENCE(SEQUENCE(SIZE (1..3)) OF ControlResourceSet ::= SEQUENCE {			
controlResourceSetId	1		
}			
searchSpacesToAddModList SEQUENCE(SIZE (1..10)) OF SearchSpace {			
searchSpace ::= SEQUENCE {			
searchSpaceExt-r16 ::= SEQUENCE {			
controlResourceSetId-r16	1		
searchSpaceType-r16 SEQUENCE {			
common SEQUENCE {			
dci-Format2-6-r16 SEQUENCE {			
}			
}			
}			
}			
searchSpaceGroupIdList-r16	Not present		
freqMonitorLocations-r16	Not present		
}			
}			
}			
}			

Table 7.1.1.12.3.3.3-5: CellGroupConfig (Table 7.1.1.13.3.3.3-1: RRCReconfiguration step 7)

Derivation Path: TS 38.331 [6], clause 6.3.2			
Information Element	Value/remark	Comment	Condition
CellGroupConfig ::= SEQUENCE {			
cellGroupId	CellGroupId	TS 38.508-1 default value	
mac-CellGroupConfig ::= SEQUENCE {			
drx-Config CHOICE {			
setup	DRX-Config	TS 38.508-1 default value	
}			
}			
physicalCellGroupConfig ::= SEQUENCE {			
dcp-Config-r16 CHOICE {			
setup SEQUENCE {			
ps-WakeUp-r16	true		
}			
}			
}			
}			

Table 7.1.1.12.3.3.3-6: CellGroupConfig (Table 7.1.1.13.3.3.3-1: RRCReconfiguration step 12)

Derivation Path: TS 38.331 [6], clause 6.3.2			
Information Element	Value/remark	Comment	Condition
CellGroupConfig ::= SEQUENCE {			
cellGroupId	CellGroupId	TS 38.508-1 default value	
mac-CellGroupConfig ::= SEQUENCE {			
drx-Config CHOICE {			
setup SEQUENCE {			
drx-onDurationTimer CHOICE {			
ms10	ms10		
milliSeconds	ms10		
}			
drx-InactivityTimer	ms6		
drx-HARQ-RTT-TimerDL	56		
drx-HARQ-RTT-TimerUL	56		
drx-RetransmissionTimerDL	sl320		
drx-RetransmissionTimerUL	sl320		
drx-LongCycleStartOffset CHOICE {			

ms20	0		
}			
shortDRX	Not present		
drx-SlotOffset	ms0		
}			
physicalCellGroupConfig ::= SEQUENCE {			
dcp-Config-r16 CHOICE {			
setup SEQUENCE {			
ps-Offset-r16	40		
}			
}			
}			
}			

Table 7.1.1.12.3.3-7: RRCReconfiguration (step 20)

Derivation Path: TS 38.508-1 [6], Table 4.6.1-13			
Information Element	Value/remark	Comment	Condition
RRCReconfiguration ::= SEQUENCE {			
criticalExtensions CHOICE {			
rrcReconfiguration ::= SEQUENCE {			
secondaryCellGroup	CellGroupConfig		EN-DC
measConfig ::= SEQUENCE {			
measObjectToAddModList SEQUENCE (SIZE (1..maxNrofMeasId)) OF MeasObjectToAddMod {	2 entries		
MeasObjectToAddMod[1] SEQUENCE {		entry 1	
measObjectId	1		
measObject CHOICE {			
measObjectNR SEQUENCE {			
ssbFrequency	ARFCN-ValueNR for SSB of NR Cell 1		
absThreshSS-BlocksConsolidation	Not present		
nrofSS-BlocksToAverage	Not present		
}			
}			
MeasObjectToAddMod[2] SEQUENCE {			
measObjectId	2		
measObject CHOICE {			
measObjectNR SEQUENCE {			
ssbFrequency	ARFCN-ValueNR for SSB of NR Cell 3		
absThreshSS-BlocksConsolidation	Not present		
nrofSS-BlocksToAverage	Not present		
}			
}			
}			
reportConfigToAddModList SEQUENCE(SIZE (1..maxReportConfigId)) OF ReportConfigToAddMod {	1 entry		
ReportConfigToAddMod[1] SEQUENCE {		entry 1	
reportConfigId	1		
reportConfig CHOICE {			
reportConfigNR SEQUENCE {			
reportType CHOICE {			
eventTriggered SEQUENCE {			
eventId CHOICE {			
eventA3 SEQUENCE {			
a3-Offset CHOICE {			
rsrp	2	1 dB (2*0.5 dB)	
}			
}			
}			
}			
}			
}			
reportAmount	infinity		

}			
}			
}			

7.1.1.12.4 DRX adaptation / SCell dormancy indication

7.1.1.12.4.1 DRX adaptation / SCell dormancy indication / Intra-band Contiguous CA

7.1.1.12.4.1.1 Test Purpose (TP)

(1)

```
with { UE in RRC_CONNECTED state with SCell configured and long DRX is configured and DCP is
configured }
ensure that {
  when { UE is outside DRX active time and receives the PDCCH indicating entering dormant BWP for
SCell }
  then { UE activates the BWP indicated by dormantBWP-Id and stops monitoring the PDCCH}
}
```

(2)

```
with { UE in RRC_CONNECTED state with SCell configured and long DRX is configured and DCP is
configured }
ensure that {
  when { UE is outside DRX active time and the active DL BWP is dormant BWP and receives the PDCCH
indicating leaving dormant BWP from SCell }
  then { UE activates the BWP indicated by firstOutsideActiveTimeBWP-Id and starts normal MAC
operation on the new BWP }
}
```

7.1.1.12.4.1.2 Conformance requirements

References: The conformance requirements covered in the present TC are specified in: TS 38.212, clause 7.3.1.3.7, TS 38.213, clause 10.3, TS 38.321, clause 5.15.1 and 5.9. Unless otherwise stated these are Rel-15 requirements.

[TS 38.212, clause 7.3.1.3.7]

DCI format 2_6 is used for notifying the power saving information outside DRX Active Time for one or more UEs.

The following information is transmitted by means of the DCI format 2_6 with CRC scrambled by PS-RNTI:

- block number 1, block number 2,..., block number N

where the starting position of a block is determined by the parameter *ps-PositionDCI-2-6* provided by higher layers for the UE configured with the block.

If the UE is configured with higher layer parameter *ps-RNTI* and *dci-Format2-6*, one block is configured for the UE by higher layers, with the following fields defined for the block:

- Wake-up indication - 1 bit
- SCell dormancy indication – 0 bit if higher layer parameter *dormancyGroupOutsideActiveTime* is not configured; otherwise 1, 2, 3, 4 or 5 bits bitmap determined according to higher layer parameter *dormancyGroupOutsideActiveTime*, where each bit corresponds to one of the SCell group(s) configured by higher layers parameter *dormancyGroupOutsideActiveTime*, with MSB to LSB of the bitmap corresponding to the first to last configured SCell group.

The size of DCI format 2_6 is indicated by the higher layer parameter *sizeDCI-2-6*, according to Clause 10.3 of [5, TS 38.213].

[TS 38.213, clause 10.3]

A UE configured with DRX mode operation [11, TS 38.321] can be provided the following for detection of a DCI format 2_6 in a PDCCH reception on the PCell or on the SpCell [12, TS 38.331]

- a PS-RNTI for DCI format 2_6 by *ps-RNTI*
- a number of search space sets, by *dci-Format2-6*, to monitor PDCCH for detection of DCI format 2_6 on the active DL BWP of the PCell or of the SpCell according to a common search space as described in Clause 10.1
- a payload size for DCI format 2_6 by *sizeDCI_2-6*
- a location in DCI format 2_6 of a Wake-up indication bit by *psPositionDCI-2-6*
 - a '0' value for the Wake-up indication bit, when reported to higher layers, indicates to not start the *drx-onDurationTimer* for the next long DRX cycle [11, TS 38.321]
 - a '1' value for the Wake-up indication bit, when reported to higher layers, indicates to start the *drx-onDurationTimer* for the next long DRX cycle [11, TS 38.321]
- a bitmap, when the UE is provided a number of groups of configured SCells by *dormancyGroupOutsideActiveTime*, where
 - the bitmap location is immediately after the Wake-up indication bit location
 - the bitmap size is equal to the number of groups of configured SCells where each bit of the bitmap corresponds to a group of configured SCells from the number of groups of configured SCells
 - a '0' value for a bit of the bitmap indicates an active DL BWP, provided by *dormantBWP-Id*, for the UE [11, TS38.321] for each activated SCell in the corresponding group of configured SCells
 - a '1' value for a bit of the bitmap indicates
 - an active DL BWP, provided by *firstOutsideActiveTimeBWP-Id*, for the UE for each activated SCell in the corresponding group of configured SCells, if a current active DL BWP is the dormant DL BWP
 - a current active DL BWP, for the UE for each activated SCell in the corresponding group of configured SCells, if the current active DL BWP is not the dormant DL BWP
- an offset by *ps-Offset* indicating a time, where the UE starts monitoring PDCCH for detection of DCI format 2_6 according to the number of search space sets, prior to a slot where the *drx-onDurationTimer* would start on the PCell or on the SpCell [11, TS 38.321]
 - for each search space set, the PDCCH monitoring occasions are the ones in the first T_{g} slots indicated by *duration*, or $T_{\text{g}} = 1$ slot if *duration* is not provided, starting from the first slot of the first T_{g} slots and ending prior to the start of *drx-onDurationTimer*.

On PDCCH monitoring occasions associated with a same long DRX Cycle, a UE does not expect to detect more than one DCI format 2_6 with different values of the Wake-up indication bit for the UE or with different values of the bitmap for the UE.

The UE does not monitor PDCCH for detecting DCI format 2_6 during Active Time [11, TS 38.321].

If a UE reports for an active DL BWP a requirement of X slots prior to the beginning of a slot where the UE would start the *drx-onDurationTimer*, the UE is not required to monitor PDCCH for detection of DCI format 2_6 during the X slots, where X corresponds to the requirement of the SCS of the active DL BWP in Table 10.3-1.

Table 10.3-1: Minimum time gap value X

SCS (kHz)	Minimum Time Gap X (slots)	
	Value 1	Value 2
15	1	3
30	1	6
60	1	12
120	2	24

If a UE is provided search space sets to monitor PDCCH for detection of DCI format 2_6 in the active DL BWP of the PCell or of the SpCell and the UE detects DCI format 2_6, the physical layer of a UE reports the value of the Wake-up indication bit for the UE to higher layers [11, TS 38.321] for the next long DRX cycle.

If a UE is provided search space sets to monitor PDCCH for detection of DCI format 2_6 in the active DL BWP of the PCell or of the SpCell and the UE does not detect DCI format 2_6, the physical layer of the UE does not report a value of the Wake-up indication bit to higher layers for the next long DRX cycle.

If a UE is provided search space sets to monitor PDCCH for detection of DCI format 2_6 in the active DL BWP of the PCell or of the SpCell and the UE

- is not required to monitor PDCCH for detection of DCI format 2_6, as described in Clauses 10, 11.1, 12, and in Clause 5.7 of [11, TS 38.321] for all corresponding PDCCH monitoring occasions outside Active Time prior to a next long DRX cycle, or
- does not have any PDCCH monitoring occasions for detection of DCI format 2_6 outside Active Time of a next long DRX cycle

the physical layer of the UE reports a value of 1 for the Wake-up indication bit to higher layers for the next long DRX cycle.

...

If an active DL BWP provided by *dormantBWP-Id* for a UE on an activated SCell is not a default DL BWP for the UE on the activated SCell, as described in Clause 12, the BWP inactivity timer is not used for transitioning from the active DL BWP provided by *dormantBWP-Id* to the default DL BWP on the activated SCell.

[TS 38.321, clause 5.15.1]

In addition to clause 12 of TS 38.213 [6], this clause specifies requirements on BWP operation.

A Serving Cell may be configured with one or multiple BWPs, and the maximum number of BWP per Serving Cell is specified in TS 38.213 [6].

The BWP switching for a Serving Cell is used to activate an inactive BWP and deactivate an active BWP at a time. The BWP switching is controlled by the PDCCH indicating a downlink assignment or an uplink grant, by the *bwp-InactivityTimer*, by RRC signalling, or by the MAC entity itself upon initiation of Random Access procedure or upon detection of consistent LBT failure on SpCell. Upon RRC (re-)configuration of *firstActiveDownlinkBWP-Id* and/or *firstActiveUplinkBWP-Id* for SpCell or activation of an SCell, the DL BWP and/or UL BWP indicated by *firstActiveDownlinkBWP-Id* and/or *firstActiveUplinkBWP-Id* respectively (as specified in TS 38.331 [5]) is active without receiving PDCCH indicating a downlink assignment or an uplink grant. The active BWP for a Serving Cell is indicated by either RRC or PDCCH (as specified in TS 38.213 [6]). For unpaired spectrum, a DL BWP is paired with a UL BWP, and BWP switching is common for both UL and DL.

For each SCell a dormant BWP may be configured with *dormantBWP-Id* by RRC signalling as described in TS 38.331 [5]. Entering or leaving dormant BWP for SCells is done by BWP switching per SCell or per dormancy SCell group based on instruction from PDCCH (as specified in TS 38.213 [6]). The dormancy SCell group configurations are configured by RRC signalling as described in TS 38.331 [5]. Upon reception of the PDCCH indicating leaving dormant BWP, the DL BWP indicated by *firstOutsideActiveTimeBWP-Id* or by *firstWithinActiveTimeBWP-Id* (as specified in TS 38.331 [5] and TS 38.213 [6]) is activated. Upon reception of the PDCCH indicating entering dormant BWP, the DL BWP indicated by *dormantBWP-Id* (as specified in TS 38.331 [5]) is activated. The dormant BWP configuration for SpCell or PUCCH SCell is not supported.

For each activated Serving Cell configured with a BWP, the MAC entity shall:

- 1> if a BWP is activated and the active DL BWP for the Serving Cell is not the dormant BWP:
 - 2> transmit on UL-SCH on the BWP;
 - 2> transmit on RACH on the BWP, if PRACH occasions are configured;
 - 2> monitor the PDCCH on the BWP;
 - 2> transmit PUCCH on the BWP, if configured;
 - 2> report CSI for the BWP;

- 2> transmit SRS on the BWP, if configured;
- 2> receive DL-SCH on the BWP;
- 2> (re-)initialize any suspended configured uplink grants of configured grant Type 1 on the active BWP according to the stored configuration, if any, and to start in the symbol according to rules in clause 5.8.2;
- 2> if *lbt-FailureRecoveryConfig* is configured:
 - 3> stop the *lbt-FailureDetectionTimer*, if running;
 - 3> set *LBT_COUNTER* to 0;
 - 3> monitor LBT failure indications from lower layers as specified in clause 5.21.2.
- 1> if a BWP is activated and the active DL BWP for the Serving Cell is dormant BWP:
 - 2> stop the *bwp-InactivityTimer* of this Serving Cell, if running.
 - 2> not monitor the PDCCH on the BWP;
 - 2> not monitor the PDCCH for the BWP;
 - 2> not receive DL-SCH on the BWP;
 - 2> not report CSI on the BWP, report CSI except aperiodic CSI for the BWP;
 - 2> not transmit SRS on the BWP;
 - 2> not transmit on UL-SCH on the BWP;
 - 2> not transmit on RACH on the BWP;
 - 2> not transmit PUCCH on the BWP.
 - 2> clear any configured downlink assignment and any configured uplink grant Type 2 associated with the SCell respectively;
 - 2> suspend any configured uplink grant Type 1 associated with the SCell;
 - 2> if configured, perform beam failure detection and beam failure recovery for the SCell if beam failure is detected.
- 1> if a BWP is deactivated:
 - 2> not transmit on UL-SCH on the BWP;
 - 2> not transmit on RACH on the BWP;
 - 2> not monitor the PDCCH on the BWP;
 - 2> not transmit PUCCH on the BWP;
 - 2> not report CSI for the BWP;
 - 2> not transmit SRS on the BWP;
 - 2> not receive DL-SCH on the BWP;
 - 2> clear any configured downlink assignment and configured uplink grant of configured grant Type 2 on the BWP;
 - 2> suspend any configured uplink grant of configured grant Type 1 on the inactive BWP.

Upon initiation of the Random Access procedure on a Serving Cell, after the selection of carrier for performing Random Access procedure as specified in clause 5.1.1, the MAC entity shall for the selected carrier of this Serving Cell:

- 1> if PRACH occasions are not configured for the active UL BWP:

- 2> switch the active UL BWP to BWP indicated by *initialUplinkBWP*;
- 2> if the Serving Cell is an SpCell:
 - 3> switch the active DL BWP to BWP indicated by *initialDownlinkBWP*.
- 1> else:
 - 2> if the Serving Cell is an SpCell:
 - 3> if the active DL BWP does not have the same *bwp-Id* as the active UL BWP:
 - 4> switch the active DL BWP to the DL BWP with the same *bwp-Id* as the active UL BWP.
 - 1> stop the *bwp-InactivityTimer* associated with the active DL BWP of this Serving Cell, if running.
 - 1> if the Serving Cell is SCell:
 - 2> stop the *bwp-InactivityTimer* associated with the active DL BWP of SpCell, if running.
 - 1> perform the Random Access procedure on the active DL BWP of SpCell and active UL BWP of this Serving Cell.

If the MAC entity receives a PDCCH for BWP switching of a Serving Cell, the MAC entity shall:

- 1> if there is no ongoing Random Access procedure associated with this Serving Cell; or
- 1> if the ongoing Random Access procedure associated with this Serving Cell is successfully completed upon reception of this PDCCH addressed to C-RNTI (as specified in clauses 5.1.4, 5.1.4a, and 5.1.5):
 - 2> cancel, if any, triggered consistent LBT failure for this Serving Cell;
 - 2> perform BWP switching to a BWP indicated by the PDCCH.

If the MAC entity receives a PDCCH for BWP switching for a Serving Cell(s) or a dormancy SCell group(s) while a Random Access procedure associated with that Serving Cell is ongoing in the MAC entity, it is up to UE implementation whether to switch BWP or ignore the PDCCH for BWP switching, except for the PDCCH reception for BWP switching addressed to the C-RNTI for successful Random Access procedure completion (as specified in clauses 5.1.4, 5.1.4a, and 5.1.5) in which case the UE shall perform BWP switching to a BWP indicated by the PDCCH. Upon reception of the PDCCH for BWP switching other than successful contention resolution, if the MAC entity decides to perform BWP switching, the MAC entity shall stop the ongoing Random Access procedure and initiate a Random Access procedure after performing the BWP switching; if the MAC decides to ignore the PDCCH for BWP switching, the MAC entity shall continue with the ongoing Random Access procedure on the Serving Cell.

...

- 1> if a PDCCH for BWP switching is received, and the MAC entity switches the active DL BWP:
 - 2> if the *defaultDownlinkBWP-Id* is configured, and the MAC entity switches to the DL BWP which is not indicated by the *defaultDownlinkBWP-Id* and is not indicated by the *dormantBWP-Id* if configured; or
 - 2> if the *defaultDownlinkBWP-Id* is not configured, and the MAC entity switches to the DL BWP which is not the *initialDownlinkBWP* and is not indicated by the *dormantBWP-Id* if configured:
- 3> start or restart the *bwp-InactivityTimer* associated with the active DL BWP.

[TS 38.321, clause 5.9]

If the MAC entity is configured with one or more SCells, the network may activate and deactivate the configured SCells. Upon configuration of an SCell, the SCell is deactivated unless the parameter *sCellState* is set to *activated* for the SCell by upper layers.

The configured SCell(s) is activated and deactivated by:

- receiving the SCell Activation/Deactivation MAC CE described in clause 6.1.3.10;

- configuring *sCellDeactivationTimer* timer per configured SCell (except the SCell configured with PUCCH, if any): the associated SCell is deactivated upon its expiry;
- configuring *sCellState* per configured SCell: if configured, the associated SCell is activated upon SCell configuration.

The MAC entity shall for each configured SCell:

- 1> if an SCell is configured with *sCellState* set to *activated* upon SCell configuration, or an SCell Activation/Deactivation MAC CE is received activating the SCell:
 - 2> if the SCell was deactivated prior to receiving this SCell Activation/Deactivation MAC CE; or
 - 2> if the SCell is configured with *sCellState* set to *activated* upon SCell configuration:
 - 3> if *firstActiveDownlinkBWP-Id* is not set to dormant BWP:
 - 4> activate the SCell according to the timing defined in TS 38.213 [6]; i.e. apply normal SCell operation including:
 - 5> SRS transmissions on the SCell;
 - 5> CSI reporting for the SCell;
 - 5> PDCCH monitoring on the SCell;
 - 5> PDCCH monitoring for the SCell;
 - 5> PUCCH transmissions on the SCell, if configured.
 - 3> else (i.e. *firstActiveDownlinkBWP-Id* is set to dormant BWP):
 - 4> stop the *bwp-InactivityTimer* of this Serving Cell, if running.
 - 3> activate the DL BWP and UL BWP indicated by *firstActiveDownlinkBWP-Id* and *firstActiveUplinkBWP-Id* respectively.
 - 2> start or restart the *sCellDeactivationTimer* associated with the SCell according to the timing defined in TS 38.213 [6];
 - 2> if the active DL BWP is not the dormant BWP:
 - 3> (re-)initialize any suspended configured uplink grants of configured grant Type 1 associated with this SCell according to the stored configuration, if any, and to start in the symbol according to rules in clause 5.8.2.2;
 - 3> trigger PHR according to clause 5.4.6.
 - 1> else if an SCell Activation/Deactivation MAC CE is received deactivating the SCell; or
 - 1> if the *sCellDeactivationTimer* associated with the activated SCell expires:
 - 2> deactivate the SCell according to the timing defined in TS 38.213 [6];
 - 2> stop the *sCellDeactivationTimer* associated with the SCell;
 - 2> stop the *bwp-InactivityTimer* associated with the SCell;
 - 2> deactivate any active BWP associated with the SCell;
 - 2> clear any configured downlink assignment and any configured uplink grant Type 2 associated with the SCell respectively;
 - 2> clear any PUSCH resource for semi-persistent CSI reporting associated with the SCell;
 - 2> suspend any configured uplink grant Type 1 associated with the SCell;
 - 2> flush all HARQ buffers associated with the SCell;

- 2> cancel, if any, triggered consistent LBT failure for the SCell.
- 1> if PDCCH on the activated SCell indicates an uplink grant or downlink assignment; or
- 1> if PDCCH on the Serving Cell scheduling the activated SCell indicates an uplink grant or a downlink assignment for the activated SCell; or
- 1> if a MAC PDU is transmitted in a configured uplink grant and LBT failure indication is not received from lower layers; or
- 1> if a MAC PDU is received in a configured downlink assignment:
 - 2> restart the *sCellDeactivationTimer* associated with the SCell.
- 1> if the SCell is deactivated:
 - 2> not transmit SRS on the SCell;
 - 2> not report CSI for the SCell;
 - 2> not transmit on UL-SCH on the SCell;
 - 2> not transmit on RACH on the SCell;
 - 2> not monitor the PDCCH on the SCell;
 - 2> not monitor the PDCCH for the SCell;
 - 2> not transmit PUCCH on the SCell.

HARQ feedback for the MAC PDU containing SCell Activation/Deactivation MAC CE shall not be impacted by PCell, PSCell and PUCCH SCell interruptions due to SCell activation/deactivation in TS 38.133 [11].

When SCell is deactivated, the ongoing Random Access procedure on the SCell, if any, is aborted.

7.1.1.12.4.1.3 Test description

7.1.1.12.4.1.3.1 Pre-test conditions

Same Pre-test conditions as in clause 7.1.1.0 except that Test loop function(*Off*) System information combination NR-4 and in addition NR Cell 3 is configured as NR Active SCell.

7.1.1.12.4.1.3.2 Test procedure sequence

Table 7.1.1.12.4.1.3.2-1: Cell configuration power level changes over time for FR1

	Parameter	Unit	NR Cell 1	NR Cell 3	Remarks
T0	Cell-specific RS EPRE	dBm/SC S	-88	off	NR cell 1 is available and NR cell 3 is not available
T1	Cell-specific RS EPRE	dBm/SC S	-88	-88	NR cell 1 and NR cell 3 are available

Table 7.1.1.12.4.1.3.2-2: Cell configuration power level changes over time for FR2

	Parameter	Unit	NR Cell 1	NR Cell 3	Remarks
T0	Cell-specific RS EPRE	dBm/SC S	-82	off	NR cell 1 is available and NR cell 3 is not available
T1	Cell-specific RS EPRE	dBm/SC S	-82	-82	NR cell 1 and NR cell 3 are available

Table 7.1.1.12.4.1.3.2-3: Main behaviour

St	Procedure	Message Sequence		TP	Verdict
		U - S	Message		
0	Set the power levels according to "T1" as per Table 7.1.1.12.4.1.3.2-1/2.				
1	SS transmits an RRCReconfiguration message. (Note 1)	<--			
2	The UE transmits RRCReconfigurationComplete message. (Note 2)	-->			
3	The SS transmits a SCell Activation MAC-CE to activate SCell (NR Cell 3).	<--	MAC PDU (SCell Activation/Deactivation MAC CE of one octet (C ₁ =1))		
4	The SS transmits DCI 2-6 within ps-Offset time before the start of next long DRX drx-onDurationTimer on NR Cell 1. (Note 3)	<--	(PDCCH (DCI 2-6))		
5	The SS indicates a new transmission on PDCCH of SCell and transmits a MAC PDU on the initial BWP (BWP#0) when the Drx-onDurationTimer is running.	<--	MAC PDU		
6	Check: Does the UE transmit a HARQ ACK on the SCell for the DL MAC PDU in Step 5 within 5 seconds?	-->		1	F
7	The SS transmits DCI 2-6 within the ps-offset time before the start of next long DRX drx-onDurationTimer on NR Cell 1. (Note 4)	<--	(PDCCH (DCI 2-6))		
8	The SS indicates a new transmission on PDCCH of SCell and transmits a MAC PDU on the active BWP (BWP#0) when the Drx-onDurationTimer is running.	<--	MAC PDU		
9	Check: Does the UE transmit a HARQ ACK on the SCell for the DL MAC PDU in Step 8?	-->	HARQ ACK	2	P
Note 1: For EN-DC the NR RRCReconfiguration message is contained in RRCConnectionReconfiguration 36.508 [7], Table 4.6.1-8 using condition EN-DC_EmbedNR_RRCRecon. Note 2: For EN-DC the NR RRCReconfigurationComplete message is contained in RRCConnectionReconfigurationComplete. Note 3: The Wake-up indication is value 1 and the SCell dormancy indication is value 0 in the DCI 2-6. Note 4: The Wake-up indication is value 1 and the SCell dormancy indication is value 1 in the DCI 2-6.					

7.1.1.12.4.1.3.3 Specific message contents

Table 7.1.1.12.4.1.3.3-1: RRCReconfiguration (step 1)

Derivation Path: TS 38.508-1 [6]			
Information Element	Value/remark	Comment	Condition
RRCReconfiguration ::= SEQUENCE {			
criticalExtensions CHOICE {			
rrcReconfiguration ::= SEQUENCE {			
secondaryCellGroup	CellGroupConfig		EN-DC
nonCriticalExtension SEQUENCE {			NR
masterCellGroup	CellGroupConfig		
}			
}			
}			
}			

Table 7.1.1.12.4.1.3.3-2: CellGroupConfig (Table 7.1.1.12.4.3.3-1: RRCReconfiguration)

Derivation Path: TS 38.508-1 [4], Table 4.6.3-19 with condition SCell_add			
Information Element	Value/remark	Comment	Condition
CellGroupConfig ::= SEQUENCE {			
cellGroupId	CellGroupId	TS 38.508-1 default value	

mac-CellGroupConfig ::= SEQUENCE {			
drx-Config CHOICE {			
setup	DRX-Config	TS 38.508-1 default value	
}			
}			
physicalCellGroupConfig ::= SEQUENCE {			
dcp-Config-r16 CHOICE {			
setup	DCP-Config-r16	TS 38.508-1 default value	
}			
}			
spCellConfig SEQUENCE {			
spCellConfigDedicated SEQUENCE {			
servingCellConfig SEQUENCE {			
initialDownlinkBWP SEQUENCE {			
pdcch-Config CHOICE {			
setup	PDCCH-Config		
}			
}			
}			
}			
}			
sCellToAddModList SEQUENCE (SIZE (1..maxMeasId)) OF SCellConfig {	1 entry		
SCellConfig[1] SEQUENCE {		entry 1	
sCellIndex	SCellIndex as per TS 38.508-1 [4] table 4.6.3-154		
sCellConfigCommon	ServingCellConfigCommon		
sCellConfigDedicated	ServingCellConfig		
}			
}			
}			
}			

Table 7.1.1.12.4.1.3.3-3: PDCCH-Config (Table 7.1.1.12.4.3.3-2: CellGroupConfig)

Derivation Path: TS 38.508-1 [4], Table 4.6.3-95			
Information Element	Value/remark	Comment	Condition
PDCCH-Config ::= SEQUENCE {			
controlResourceSetToAddModList SEQUENCE(SIZE (1..3)) OF ControlResourceSet ::= SEQUENCE {	1 entry		
ControlResourceSet[1]	ControlResourceSet	TS 38.508-1 default value	
}			
searchSpacesToAddModListExt-r16 SEQUENCE(SIZE (1..10)) OF SearchSpace {			
searchSpaceExt-r16 ::= SEQUENCE {			
controlResourceSetId-r16	1		
searchSpaceType-r16 SEQUENCE {			
common SEQUENCE {			
dci-Format2-6-r16 SEQUENCE {			
}			
}			
}			
}			
}			
}			
}			

Table 7.1.1.12.4.1.3.3-4: ServingCellConfigCommon (Table 7.1.1.12.4.3.3-2: CellGroupConfig)

Derivation Path: TS 38.508-1 [4], Table 4.6.3-168 with condition SCell_add.

Information Element	Value/remark	Comment	Condition
ServingCellConfigCommon ::= SEQUENCE {			
physCellId	Physical Cell Identity of NR Cell 3		
}			

Table 7.1.1.12.4.1.3.3-5: ServingCellConfig (Table 7.1.1.12.4.3.3-2: CellGroupConfig)

Derivation Path: TS 38.508-1 [4], Table 4.6.3-167 with condition SCell_add			
Information Element	Value/remark	Comment	Condition
ServingCellConfig ::= SEQUENCE {			
downlinkBWP-ToAddModList SEQUENCE (SIZE (1..maxNrofBWPs)) BWP-Downlink {			
BWP-Downlink	BWP-Downlink		
}			
firstActiveDownlinkBWP-Id	0		
dormancyGroupID-r16	0		
dormantBWP-Config-r16 ::= SEQUENCE {			
dormantBWP-Id-r16	1		
outsideActiveTimeConfig-r16 CHOICE {			
setup SEQUENCE {			
firstOutsideActiveTimeBWP-Id-r16	0		
dormancyGroupOutsideActiveTime-r16	0		
}			
}			
}			
pdsch-ServingCellConfig CHOICE {			
setup SEQUENCE {			
pucch-Cell	1		
}			
}			
}			

Table 7.1.1.12.4.1.3.3-6: BWP-Downlink (Table 7.1.1.12.4.3.3-5: ServingCellConfig)

Derivation Path: TS 38.508-1 [4], Table 4.6.3-9			
Information Element	Value/remark	Comment	Condition
BWP-Downlink ::= SEQUENCE {			
bwp-Dedicated SEQUENCE {			
pdcch-Config CHOICE {			
setup SEQUENCE {			
controlResourceSetToAddModList	1 entry		
SEQUENCE(SIZE (1..3)) OF ControlResourceSet {			
ControlResourceSet[1]	ControlResourceSet	TS 38.508-1 default value	
}			
controlResourceSetToReleaseList	Not present		
}			
}			
}			
}			

7.1.1.12.4.2 DRX adaptation / SCell dormancy indication / Intra-band non Contiguous CA

The scope and description of the present TC is the same as test case 7.1.1.12.4.1 with the following differences:

- CA configuration: Intra-band non-Contiguous CA replaces Intra-band Contiguous CA

7.1.1.12.4.3 DRX adaptation / SCell dormancy indication / Inter-band CA

The scope and description of the present TC is the same as test case 7.1.1.12.4.1 with the following differences:

- CA configuration: Inter-band CA replaces Intra-band Contiguous CA
- Cells configuration: NR Cell 10 replaces NR Cell 3

7.1.2 RLC

7.1.2.1 Default Pre-Test Conditions for all RLC test cases

The following pre-test conditions shall be applied in all RLC test cases until the test case explicitly over writes these conditions.

7.1.2.1.1 Default Pre-Test Conditions for AM RLC test cases

System Simulator:

- The SS configures the test environment in accordance to the execution conditions in Table 7.1.2.1.1-1.

UE:

- None

Preamble:

- The SS performs the generic procedure in [4] to get UE in state RRC_CONNECTED in accordance to the execution conditions in Table 7.1.2.1.1-2 and the message condition UE TEST LOOP MODE A to return one UL PDCP SDU per DL PDCP SDU.

Table 7.1.2.1.1-1: Test environment

Execution Condition	Cell configuration	System Information Combination
IF pc_NG_RAN_NR	NR Cell 1	NR: System information Combination NR-1
ELSE IF pc_EN_DC	E-UTRA Cell 1 is PCell, NR Cell 1 is PSCell	EUTRA: System information Combination 1 NR: N/A
ELSE IF pc_NGEN_DC	NG-RAN E-UTRA Cell 1 is PCell, NR Cell 1 is PSCell	EUTRA: System information Combination 1 NR: N/A

Table 7.1.2.1.1-2: Preamble parameters

Execution Condition	Multi-PDN / Multi-PDU Sessions Condition	Generic Procedure Parameters	Primary DRB used for Data testing
IF pc_NG_RAN_NR	FALSE	Connectivity(NR), Test loop function(On) One DRB	Default DRB of the first PDU session on NR Cell
	TRUE	Connectivity(NR), Test loop function(On) N DRBs ($N \geq 2$)	
ELSE IF pc_EN_DC	FALSE	Connectivity(EN-DC), DC bearer(One MN Terminated MCG bearer and One SN terminated SCG bearer), Test loop function(On)	SN Terminated SCG bearer unless explicitly specified in test case
	TRUE	Connectivity(EN-DC), DC bearer(Two MN Terminated MCG bearer and One SN terminated SCG bearer), Test loop function(On)	

ELSE IF pc_NGEN_DC	FALSE	Connectivity(<i>NGEN-DC</i>), DC bearer(One MN Terminated MCG bearer and One <i>SN terminated SCG bearer</i>), Test loop function(<i>On</i>)	SN Terminated SCG bearer unless explicitly specified in test case
	TRUE	Connectivity(<i>EN-DC</i>), DC bearer(Two MN Terminated MCG bearer and One <i>SN terminated SCG bearer</i>), Test loop function(<i>On</i>)	

Table 7.1.2.1.1-3: Message conditions

Execution Condition	Message condition exceptions
IF pc_NG_RAN_NR	Message with condition AM is used for step 7 in 4.5.4.2 according to [4]
ELSE IF pc_EN_DC	Message condition MCG_and_SCG with condition SCG-DRB(1,0) is used for step 7 in 4.5.4.2 according to [4]
ELSE IF pc_NGEN_DC	Message condition MCG_and_SCG with condition SCG-DRB(1,0) is used for step 7 in 4.5.4.2 according to [4]

7.1.2.1.2 Default Pre-Test Conditions for UM RLC test cases

Same Pre-test conditions as in clause 7.1.2.1.1 with the exceptions in Table 7.1.2.1.2-1.

Table 7.1.2.1.2-1: Message conditions

Execution Condition	Message condition exceptions
IF pc_NG_RAN_NR	Message with condition UM is used for step 7 in 4.5.4.2 according to [4]
ELSE IF pc_EN_DC	Message condition MCG_and_SCG with condition SCG-DRB(0,1) is used for step 7 in 4.5.4.2 according to [4]
ELSE IF pc_NGEN_DC	Message condition MCG_and_SCG with condition SCG-DRB(0,1) is used for step 7 in 4.5.4.2 according to [4]

7.1.2.2 RLC Unacknowledged mode

7.1.2.2.1 UM RLC / Segmentation and reassembly / 6-bit SN / Segmentation Info (SI) field

7.1.2.2.1.1 Test Purpose (TP)

(1)

```
with { UE in RRC_CONNECTED state configured for 6 bit SN in RLC UM }
ensure that {
  when { UE receives UMD PDU containing a SI field set to 00 }
  then { UE correctly decodes the received UMD PDU }
}
```

(2)

```
with { UE in RRC_CONNECTED state configured for 6 bit SN in RLC UM }
ensure that {
  when { UE receives a 6 bit SN configured UMD PDU containing a SI field set to 01 }
  then { UE correctly decodes the received UMD PDU }
}
```

(3)

```

with { UE in RRC_CONNECTED state configured for 6 bit SN in RLC UM }
ensure that {
  when { UE receives a 6 bit SN configured UMD PDU containing a SI field set to 11 and SO field }
  then { UE correctly decodes the received UMD PDU }
}

```

(4)

```

with { UE in RRC_CONNECTED state configured for 6 bit SN in RLC UM }
ensure that {
  when { UE receives a 6 bit SN configured UMD PDU containing a SI field set to 10 and SO field }
  then { UE correctly decodes the received UMD PDU }
}

```

(5)

```

with { UE in RRC_CONNECTED state configured for 6 bit SN in RLC UM }
ensure that {
  when { UE has UL SDU to send and UL grant available is sufficient to send whole SDU in one PDU }
  then { UE transmits RLC SDU containing a SI field set to 00 }
}

```

(6)

```

with { UE in RRC_CONNECTED state configured for 6 bit SN in RLC UM }
ensure that {
  when { UE has UL SDU to send and UL grant available is not sufficient to send whole SDU in one PDU }
  then { UE transmits first RLC SDU segment containing a SI field set to 01 and including 6 bit SN }
}

```

(7)

```

with { UE in RRC_CONNECTED state configured for 6 bit SN in RLC UM }
ensure that {
  when { UE has UL SDU to send and UL grant available is not sufficient to send whole SDU in one PDU }
  then { UE transmits middle RLC SDU segment containing a SI field set to 11, including SO field
and including 6 bit SN }
}

```

(8)

```

with { UE in RRC_CONNECTED state configured for 6 bit SN in RLC UM }
ensure that {
  when { UE has UL SDU to send and UL grant available is not sufficient to send whole SDU in one PDU }
  then { UE transmits last RLC SDU segment containing a SI field set to 10, including SO field and
including 6 bit SN }
}

```

7.1.2.2.1.2 Conformance requirements

References: The conformance requirements covered in the present TC are specified in: TS 38.322, clauses 5.2.2.2.1, 5.2.2.2.2, 6.2.3.4 and 6.2.2.3. Unless otherwise stated these are Rel-15 requirements.

[TS 38.322, clause 5.2.2.2.1]

The receiving UM RLC entity shall maintain a reassembly window according to state variable `RX_Next_Highest` as follows:

- a SN falls within the reassembly window if $(RX_Next_Highest - UM_Window_Size) \leq SN < RX_Next_Highest$;
- a SN falls outside of the reassembly window otherwise.

When receiving an UMD PDU from lower layer, the receiving UM RLC entity shall:

- either deliver the UMD PDU after removing the RLC header, discard the received UMD PDU, or place it in the reception buffer (see sub clause 5.2.2.2.2);
- if the received UMD PDU was placed in the reception buffer:
 - update state variables, reassemble and deliver RLC SDUs to upper layer and start/stop *t-Reassembly* as needed (see sub clause 5.2.2.2.3).

When *t-Reassembly* expires, the receiving UM RLC entity shall:

- update state variables, discard RLC SDU segments and start *t-Reassembly* as needed (see sub clause 5.2.2.2.4).

[TS 38.322, clause 5.2.2.2.2]

When an UMD PDU is received from lower layer, the receiving UM RLC entity shall:

- if the UMD PDU header does not contain an SN:
 - remove the RLC header and deliver the RLC SDU to upper layer.
- else if $(RX_Next_Highest - UM_Window_Size) \leq SN < RX_Next_Reassembly$:
 - discard the received UMD PDU.
- else:
 - place the received UMD PDU in the reception buffer.

[TS 38.322, clause 6.2.2.3]

UMD PDU consists of a Data field and an UMD PDU header. The UMD PDU header is byte aligned

When an UMD PDU contains a complete RLC SDU, the UMD PDU header only contains the SI and R fields.

An UM RLC entity is configured by RRC to use either a 6 bit SN or a 12 bit SN. An UMD PDU header contains the SN field only when the corresponding RLC SDU is segmented. An UMD PDU carrying the first segment of an RLC SDU does not carry the SO field in its header. The length of the SO field is 16 bits.

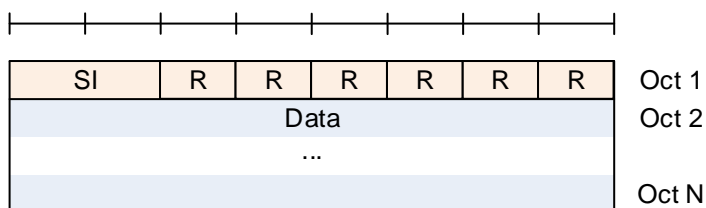

Figure 6.2.2.3-1: UMD PDU containing a complete RLC SDU

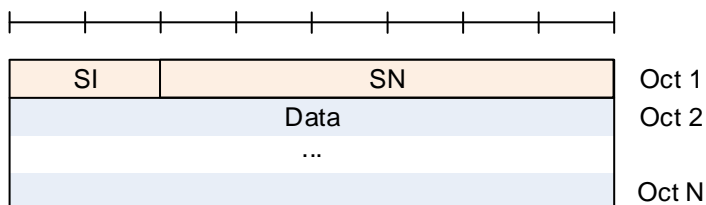

Figure 6.2.2.3-2: UMD PDU with 6 bit SN (No SO)

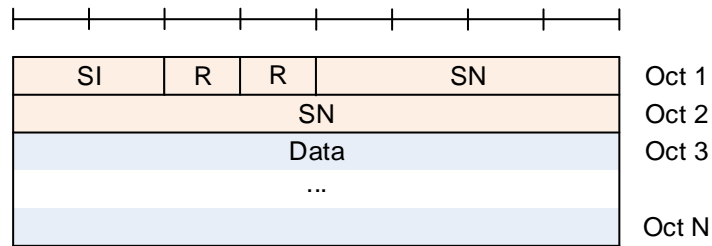

Figure 6.2.2.3-3: UMD PDU with 12 bit SN (No SO)

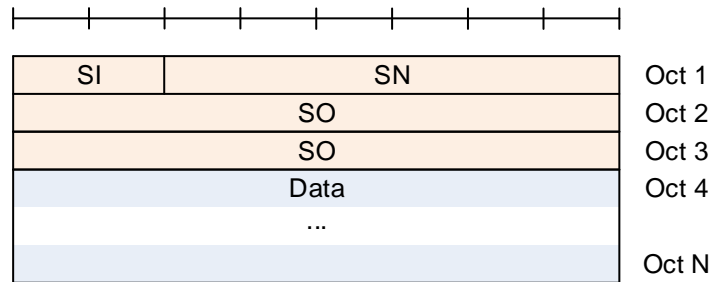

Figure 6.2.2.3-4: UMD PDU with 6 bit SN and with SO

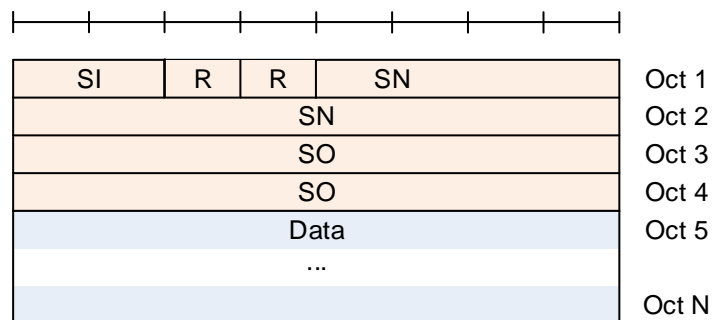

Figure 6.2.2.3-5: UMD PDU with 12 bit SN and with SO

[TS 38.322, clause 6.2.3.4]

Length: 2 bits.

The SI field indicates whether a RLC PDU contains a complete RLC SDU or the first, middle, last segment of a RLC SDU.

Table 6.2.2.6-1: SI field interpretation

Value	Description
00	Data field contains all bytes of a RLC SDU
01	Data field contains the first segment of a RLC SDU
10	Data field contains the last segment of a RLC SDU
11	Data field contains neither the first nor last segment of a RLC SDU

7.1.2.2.1.3 Test description

7.1.2.2.1.3.1 Pre-test conditions

Same Pre-test conditions as in clause 7.1.2.1.2 with the exception for the UM DRB is configured according to Table 7.1.2.2.1.3.1-1.

Table 7.1.2.2.1.3.1-1: RLC parameters

Uplink UM RLC sn-FieldLength	size6
Downlink UM RLC sn-FieldLength	size6

7.1.2.2.1.3.2 Test procedure sequence

Table 7.1.2.2.1.3.2-1: Main behaviour

St	Procedure	Message Sequence		TP	Verdict
		U - S	Message		
0	The SS stops allocating any UL grant.	-	-	-	-
1	The SS transmits UMD PDU#1 containing a complete RLC SDU#1 (SI field = 00).	<--	UMD PDU#1	-	-
2	SS allocates an UL grant sufficient to loop back RLC SDU#1 in one RLC/MAC PDU	<--	UL Grant	-	-
3	Check: Does the UE transmit RLC SDU#1?	-->	(RLC SDU#1)	1,5	P
4	The SS transmits UMD PDU#2 containing the first segment of RLC SDU#2 (SI field = 01). Note 3	<--	UMD PDU#2	-	-
5	The SS transmits UMD PDU#3 containing the second segment of RLC SDU#2 (SI field = 11) and including SO field. Note 3	<--	UMD PDU#3	-	-
6	The SS transmits UMD PDU#4 containing the last segment of RLC SDU#2 (SI field = 10) and including SO field. Note 3	<--	UMD PDU#4	-	-
7	SS allocates 3 UL grants at an interval of 20 ms so as to loop back RLC SDU#2 in 3 RLC/MAC PDUs. Note 1 & 2	<--	UL Grants	-	-
8	Check: Does the UE transmit UMD PDU#2 containing the first segment of RLC SDU#2 (SI field = 01)?	-->	(RLC SDU#2, first segment)	2,3, 4,6	P
9	Check: Does the UE transmit UMD PDU#3 containing the second segment of RLC SDU#2 (SI field = 11) and including SO field?	-->	(RLC SDU#2, second segment)	2,3, 4,7	P
10	Check: Does the UE transmit UMD PDU#4 containing the last segment of RLC SDU#2 (SI field = 10) and including SO field?	-->	(RLC SDU#2, last segment)	2,3, 4,8	P
Note 1:	The UL grants for step 8,9,10 are sufficiently small (240 bits, L _{RBs} & l _{MCS} as per 38.523-3[3] annex B) that UE transmits RLC SDU#2 in 3 UL RLC PDUs by segmenting.				
Note 2:	The RLC PDU containing a segment shall be of size 208 bits resp. 224 bits and a MAC sub PDU header of 16 bits and a 16-bit MAC BSR CE included in step 8 resulting in a MAC PDU of size 240 bits.				
Note 3:	The data part in step 4 first segment not including SO is 200 bits (25 bytes). Step 5, second segment SO=25 and data is 200 bits (25 bytes). Step 6, third segment SO=25+25=50 and data is 200 bits (25 bytes).				

7.1.2.2.1.3.3 Specific message contents

None.

7.1.2.2.2 UM RLC / Segmentation and reassembly / 12-bit SN / Segmentation Info (SI) field

7.1.2.2.2.1 Test Purpose (TP)

(1)

```
with { UE in RRC_CONNECTED state configured for 12 bit SN in RLC UM }
ensure that {
  when { UE receives UMD PDU containing a SI field set to 00 }
  then { UE correctly decodes the received UMD PDU }
}
```

(2)

```
with { UE in RRC_CONNECTED state configured for 12 bit SN in RLC UM }
ensure that {
  when { UE receives a 12 bit SN configured UMD PDU containing a SI field set to 01 }
  then { UE correctly decodes the received UMD PDU }
}
```

(3)

```
with { UE in RRC_CONNECTED state configured for 12 bit SN in RLC UM }
ensure that {
  when { UE receives a 12 bit SN configured UMD PDU containing a SI field set to 11 and SO field }
  then { UE correctly decodes the received UMD PDU }
}
```

(4)

```
with { UE in RRC_CONNECTED state configured for 12 bit SN in RLC UM }
ensure that {
  when { UE receives a 12 bit SN configured UMD PDU containing a SI field set to 10 and SO field }
  then { UE correctly decodes the received UMD PDU }
}
```

(5)

```
with { UE in RRC_CONNECTED state configured for 12 bit SN in RLC UM }
ensure that {
  when { UE has UL SDU to send and UL grant available is sufficient to send whole SDU in one PDU }
  then { UE transmits RLC SDU containing a SI field set to 00 }
}
```

(6)

```
with { UE in RRC_CONNECTED state configured for 12 bit SN in RLC UM }
ensure that {
  when { UE has UL SDU to send and UL grant available is not sufficient to send whole SDU in one PDU }
  then { UE transmits first RLC SDU segment containing a SI field set to 01 and including 12 bit SN }
}
```

(7)

```
with { UE in RRC_CONNECTED state configured for 12 bit SN in RLC UM }
ensure that {
  when { UE has UL SDU to send and UL grant available is not sufficient to send whole SDU in one PDU }
  then { UE transmits middle RLC SDU segment containing a SI field set to 11, including SO field and including 12 bit SN }
}
```

(8)

```
with { UE in RRC_CONNECTED state configured for 12 bit SN in RLC UM }
ensure that {
```

```

when { UE has UL SDU to send and UL grant available is not sufficient to send whole SDU in one PDU }
then { UE transmits last RLC SDU segment containing a SI field set to 10, including SO field and including 12 bit SN }

```

7.1.2.2.2.2 Conformance requirements

Same conformance requirements as clause 7.1.2.2.1.2

7.1.2.2.2.3 Test description

7.1.2.2.2.3.1 Pre-test conditions

Same Pre-test conditions as in clause 7.1.2.1.2 with the exception for the UM DRB is configured according to Table 7.1.2.2.2.3.1-1.

Table 7.1.2.2.3.1-1: RLC parameters

Uplink UM RLC sn-FieldLength	size12
Downlink UM RLC sn-FieldLength	size12

7.1.2.2.2.3.2 Test procedure sequence

Same test procedure sequence as 7.1.2.2.1.3.2 except that RLC UM SN is 12 bit and the data part in step 4 first segment not including SO is 192 bits (24 Bytes). Step 5, second segment SO=24 and data is 192 bits (24 bytes). Step 6, third segment SO=24+24=48 and data is 192 bits (24 bytes).

7.1.2.2.2.3.3 Specific message contents

None.

7.1.2.2.3 UM RLC / 6-bit SN / Correct use of sequence numbering

7.1.2.2.3.1 Test Purpose (TP)

(1)

```

with { UE in RRC_CONNECTED state with UM RLC 6 bit SN }
ensure that {
  when { UE transmits the first PDU which is segmented }
  then { UE includes the SN field equal to 0 in each RLC segment }
}

```

(2)

```

with { UE in RRC_CONNECTED state with UM RLC 6 bit SN }
ensure that {
  when { UE transmit subsequent segmented PDUs }
  then { UE includes the SN field incremented by 1 for each segmented PDU of one RLC SDU }
}

```

(3)

```

with { UE in RRC_CONNECTED state with UM RLC 6 bit SN }
ensure that {
  when { UE transmit segments belonging to more than 64 SDUs }
  then { UE wraps the SN after transmitting the segments of 64 SDUs }
}

```

(4)

```

with { UE in RRC_CONNECTED state with UM RLC 6 bit SN }
ensure that {

```

```

when { segments of more than 64 SDUs are sent to UE }
  then { UE accepts PDUs with SNs that wrap around every 64 segmented SDUs }
  }

```

7.1.2.2.3.2 Conformance requirements

References: The conformance requirements covered in the present TC are specified in: 3GPP TS 38.322, clause 5.2.2.1.1, 5.2.2.2, 6.2.2.3, 6.2.3.3 and 7.1. Unless otherwise stated these are Rel-15 requirements.

[TS 38.322, clause 5.2.2.1.1]

When submitting a UMD PDU to lower layer, the transmitting UM RLC entity shall:

- if the UMD PDU contains a segment of an RLC SDU, set the SN of the UMD PDU to TX_Next;
- if the UMD PDU contains a segment that maps to the last byte of an RLC SDU, then increment TX_Next by one.

[TS 38.322, clause 5.2.2.2]

The receiving UM RLC entity shall maintain a reassembly window according to state variable RX_Next_Highest as follows:

- a SN falls within the reassembly window if $(RX_Next_Highest - UM_Window_Size) \leq SN < RX_Next_Highest$;
- a SN falls outside of the reassembly window otherwise.

When receiving an UMD PDU from lower layer, the receiving UM RLC entity shall:

- either deliver the UMD PDU after removing the RLC header, discard the received UMD PDU, or place it in the reception buffer (see sub clause 5.2.2.2.2);
- if the received UMD PDU was placed in the reception buffer:
 - update state variables, reassemble and deliver RLC SDUs to upper layer and start/stop *t-Reassembly* as needed (see sub clause 5.2.2.2.3).

...

When an UMD PDU is received from lower layer, the receiving UM RLC entity shall:

- if the UMD PDU header does not contain an SN:
 - remove the RLC header and deliver the RLC SDU to upper layer.
- else if $(RX_Next_Highest - UM_Window_Size) \leq SN < RX_Next_Reassembly$:
 - discard the received UMD PDU.
- else:
 - place the received UMD PDU in the reception buffer.

...

When an UMD PDU with SN = x is placed in the reception buffer, the receiving UM RLC entity shall:

- if all byte segments with SN = x are received:
 - reassemble the RLC SDU from all byte segments with SN = x, remove RLC headers and deliver the reassembled RLC SDU to upper layer;
- if $x = RX_Next_Reassembly$:
 - update RX_Next_Reassembly to the SN of the first SN > current RX_Next_Reassembly that has not been reassembled and delivered to upper layer.

- else if x falls outside of the reassembly window:
 - update `RX_Next_Highest` to $x + 1$;
 - discard any UMD PDUs with SN that falls outside of the reassembly window;
 - if `RX_Next_Reassembly` falls outside of the reassembly window:
 - set `RX_Next_Reassembly` to the SN of the first SN $\geq (\text{RX_Next_Highest} - \text{UM_Window_Size})$ that has not been reassembled and delivered to upper layer.

[TS 38.322, clause 6.2.2.3]

An UM RLC entity is configured by RRC to use either a 6 bit SN or a 12 bit SN. An UMD PDU header contains the SN field only when the corresponding RLC SDU is segmented.

[TS 38.322, clause 6.2.3.3]

The SN field indicates the sequence number of the corresponding RLC SDU. For RLC UM, the sequence number is incremented by one for every segmented RLC SDU..

[TS 38.322, clause 7.1]

All state variables and all counters are non-negative integers.

...

All state variables related to UM data transfer can take values from 0 to 63 for 6 bit SN or from 0 to 4095 for 12 bit SN. All arithmetic operations contained in the present document on state variables related to UM data transfer are affected by the UM modulus (i.e. final value = [value from arithmetic operation] modulo 64 for 6 bit SN and 4096 for 12 bit SN).

...

Each transmitting UM RLC entity shall maintain the following state variables:

a) `TX_Next`

This state variable holds the value of the SN to be assigned for the next newly generated UMD PDU with segment. It is initially set to 0, and is updated after the UM RLC entity submits a UMD PDU including the last segment of an RLC SDU to lower layers.

Each receiving UM RLC entity shall maintain the following state variables and constant:

b) `RX_Next_Reassembly` – UM receive state variable

This state variable holds the value of the earliest SN that is still considered for reassembly. It is initially set to 0.

c) `RX_Timer_Trigger` – UM *t-Reassembly* state variable

This state variable holds the value of the SN following the SN which triggered *t-Reassembly*.

d) `RX_Next_Highest`– UM receive state variable

This state variable holds the value of the SN following the SN of the UMD PDU with the highest SN among received UMD PDUs. It serves as the higher edge of the reassembly window. It is initially set to 0.

7.1.2.2.3.3 Test description

7.1.2.2.3.3.1 Pre-test conditions

Same Pre-test conditions as in clause 7.1.2.1.2 with the exception for the UM DRB is configured according to Table 7.1.2.2.3.3.1-1.

Table 7.1.2.2.3.3.1-1: RLC parameters

Uplink UM RLC sn-FieldLength	size6
Downlink UM RLC sn-FieldLength	size6

7.1.2.2.3.3.2 Test procedure sequence

Table 7.1.2.2.3.3.2-1: Main behaviour

St	Procedure	Message Sequence		TP	Verdict
		U - S	Message		
0	The SS stops allocating any UL grant.	-	-	-	-
1	The SS transmits UMD PDU#1 with 6 bit SN = 0 containing the first segment of RLC SDU#1 (SI field = 01).	<--	UMD PDU#1	-	-
2	The SS transmits UMD PDU#2 with 6 bit SN=0 containing the last segment of RLC SDU#1 (SI field = 10) and including SO field.	<--	UMD PDU#2	-	-
3	SS allocates 2 UL grants at an interval of 20 ms so as to loop back RLC SDU#1 in 2 RLC/MAC PDUs. (Note 1)	<--	UL Grants	-	-
4	Check: Does the UE transmit UMD PDU#1 with 6 bit SN = 0 containing the first segment of RLC SDU#1 (SI field = 01)?	-->	(RLC SDU#1, first segment)	1	P
5	Check: Does the UE transmit UMD PDU#2 with 6 bit SN = 0 containing the last segment of RLC SDU#1 (SI field = 10)?	-->	(RLC SDU#1, last segment)	1	P
-	EXCEPTION: Steps 6 to 10 are executed 63 times, the initial value of k = 1, it is incremented by one for each iteration.	-	-	-	-
6	The SS transmits UMD PDU#(2*k+1) with 6 bit SN = k containing the first segment of RLC SDU#(k+1) (SI field = 01).	<--	UMD PDU#(2*k+1)	-	-
7	The SS transmits UMD PDU#(2*(k+1)) with 6 bit SN=k containing the last segment of RLC SDU#(k+1) (SI field = 10)	<--	UMD PDU#(2*(k+1))	-	-
8	SS allocates 2 UL grants at an interval of 20 ms so as to loop back RLC SDU#(k+1) in 2 RLC/MAC PDUs. (Note 1)	<--	UL Grants	-	-
9	Check: Does the UE transmit UMD PDU#(2*k+1) with 6 bit SN = k containing the first segment of RLC SDU#(k+1) (SI field = 01)? (Note 2)	-->	(RLC SDU#(k+1), first segment)	2	P
10	Check: Does the UE transmit UMD PDU#(2*(k+1)) with 6 bit SN = k containing the last segment of RLC SDU#(k+1) (SI field = 10) and including SO field? (Note 2)	-->	(RLC SDU#(k+1), last segment)	2	P
11	The SS transmits UMD PDU#129 with 6 bit SN = 0 containing the first segment of RLC SDU#65 (SI field = 01).	<--	UMD PDU#129	-	-
12	The SS transmits UMD PDU#130 with 6 bit SN= 0 containing the last segment of RLC SDU#65 (SI field = 10) and including SO field	<--	UMD PDU#130	-	-
13	SS allocates 2 UL grants at an interval of 20 ms so as to loop back RLC SDU#65 in 2 RLC/MAC PDUs. (Note 1)	<--	UL Grants	-	-
14	Check: Does the UE transmit UMD PDU#129 with 6 bit SN = 0 containing the first segment of RLC SDU#65 (SI field = 01)?	-->	(RLC SDU#65, first segment)	3.4	P
15	Check: Does the UE transmit UMD PDU#130 with 6 bit SN = 0 containing the last segment of RLC SDU#65 (SI field = 10) and including SO field?	-->	(RLC SDU#65, last segment)	3,4	P

Note 1: The RLC SDU size shall be 12 octets which are segmented into 6 and 6 octets. With 2 octets of MAC header, 2 octets of Short BSR and 1 octet of RLC header (without SO) the first segment consists of 88 bits and a TBS of this size shall be allocated. With 2 octets of MAC header and 3 octets of RLC header (with SO) the second segment consists of 88 bits and a TBS of this size shall be allocated. (L_{RBs} & I_{MCS} as per 38.523-3[3] annex B)

Note 2: The verdict shall be provided each time $(SN+1) \bmod 16 = 0$.

7.1.2.2.3.3.3 Specific message contents

None.

7.1.2.2.4 UM RLC / 12-bit SN / Correct use of sequence numbering

7.1.2.2.4.1 Test Purpose (TP)

(1)

```
with { UE in RRC_CONNECTED state with UM RLC 12 bit SN }
ensure that {
  when { UE transmits the first PDU which is segmented }
  then { UE includes the SN field equal to 0 in each RLC segment }
}
```

(2)

```
with { UE in RRC_CONNECTED state with UM RLC 12 bit SN }
ensure that {
  when { UE transmit subsequent segmented PDUs }
  then { UE includes the SN field incremented by 1 for each segmented PDU of one RLC SDU }
}
```

(3)

```
with { UE in RRC_CONNECTED state with UM RLC 12 bit SN }
ensure that {
  when { UE transmit segments belonging to more than 4096 SDUs }
  then { UE wraps the SN after transmitting the segments of 4096 SDUs }
}
```

(4)

```
with { UE in RRC_CONNECTED state with UM RLC 12 bit SN }
ensure that {
  when { segments of more than 4096 SDUs are sent to UE }
  then { UE accepts PDUs with SNs that wrap around every 4096 segmented SDUs }
}
```

7.1.2.2.4.2 Conformance requirements

References: The conformance requirements covered in the present TC are specified in: 3GPP TS 38.322, clause 5.2.2.1.1, 5.2.2.2, 6.2.2.3, 6.2.3.3 and 7.1. Unless otherwise stated these are Rel-15 requirements.

[TS 38.322, clause 5.2.2.1.1]

When submitting a UMD PDU to lower layer, the transmitting UM RLC entity shall:

- if the UMD PDU contains a segment of an RLC SDU, set the SN of the UMD PDU to TX_{Next};
- if the UMD PDU contains a segment that maps to the last byte of an RLC SDU, then increment TX_{Next} by one.

[TS 38.322, clause 5.2.2.2]

The receiving UM RLC entity shall maintain a reassembly window according to state variable RX_{Next_Highest} as follows:

- a SN falls within the reassembly window if $(RX_Next_Highest - UM_Window_Size) \leq SN < RX_Next_Highest$;
- a SN falls outside of the reassembly window otherwise.

When receiving an UMD PDU from lower layer, the receiving UM RLC entity shall:

- either deliver the UMD PDU after removing the RLC header, discard the received UMD PDU, or place it in the reception buffer (see sub clause 5.2.2.2.2);
- if the received UMD PDU was placed in the reception buffer:
 - update state variables, reassemble and deliver RLC SDUs to upper layer and start/stop *t-Reassembly* as needed (see sub clause 5.2.2.2.3).

...

When an UMD PDU is received from lower layer, the receiving UM RLC entity shall:

- if the UMD PDU header does not contain an SN:
 - remove the RLC header and deliver the RLC SDU to upper layer.
- else if $(RX_Next_Highest - UM_Window_Size) \leq SN < RX_Next_Reassembly$:
 - discard the received UMD PDU.
- else:
 - place the received UMD PDU in the reception buffer.

...

When an UMD PDU with SN = x is placed in the reception buffer, the receiving UM RLC entity shall:

- if all byte segments with SN = x are received:
 - reassemble the RLC SDU from all byte segments with SN = x, remove RLC headers and deliver the reassembled RLC SDU to upper layer;
 - if $x = RX_Next_Reassembly$:
 - update *RX_Next_Reassembly* to the SN of the first SN > current *RX_Next_Reassembly* that has not been reassembled and delivered to upper layer.
- else if x falls outside of the reassembly window:
 - update *RX_Next_Highest* to x + 1;
 - discard any UMD PDUs with SN that falls outside of the reassembly window;
 - if *RX_Next_Reassembly* falls outside of the reassembly window:
 - set *RX_Next_Reassembly* to the SN of the first SN $\geq (RX_Next_Highest - UM_Window_Size)$ that has not been reassembled and delivered to upper layer.

[TS 38.322, clause 6.2.2.3]

An UM RLC entity is configured by RRC to use either a 6 bit SN or a 12 bit SN. An UMD PDU header contains the SN field only when the corresponding RLC SDU is segmented.

[TS 38.322, clause 6.2.3.3]

The SN field indicates the sequence number of the corresponding RLC SDU. ... For RLC UM, the sequence number is incremented by one for every segmented RLC SDU.

[TS 38.322, clause 7.1]

All state variables and all counters are non-negative integers.

...

All state variables related to UM data transfer can take values from 0 to 63 for 6 bit SN or from 0 to 4095 for 12 bit SN. All arithmetic operations contained in the present document on state variables related to UM data transfer are affected by the UM modulus (i.e. final value = [value from arithmetic operation] modulo 64 for 6 bit SN and 4096 for 12 bit SN).

...

Each transmitting UM RLC entity shall maintain the following state variables:

a) TX_Next

This state variable holds the value of the SN to be assigned for the next newly generated UMD PDU with segment. It is initially set to 0, and is updated after the UM RLC entity submits a UMD PDU including the last segment of an RLC SDU to lower layers.

Each receiving UM RLC entity shall maintain the following state variables and constant:

b) RX_Next_Reassembly – UM receive state variable

This state variable holds the value of the earliest SN that is still considered for reassembly. It is initially set to 0.

c) RX_Timer_Trigger – UM *t-Reassembly* state variable

This state variable holds the value of the SN following the SN which triggered *t-Reassembly*.

d) RX_Next_Highest– UM receive state variable

This state variable holds the value of the SN following the SN of the UMD PDU with the highest SN among received UMD PDUs. It serves as the higher edge of the reassembly window. It is initially set to 0.

7.1.2.2.4.3 Test description

7.1.2.2.4.3.1 Pre-test conditions

Same Pre-test conditions as in clause 7.1.2.1.2 with the exception for the UM DRB is configured according to Table 7.1.2.2.4.3.1-1.

Table 7.1.2.2.4.3.1-1: RLC parameters

Uplink RLC sn-FieldLength	size12
Downlink RLC sn-FieldLength	size12

7.1.2.2.4.3.2 Test procedure sequence

Table 7.1.2.2.4.3.2-1: Main behaviour

St	Procedure	Message Sequence		TP	Verdict
		U - S	Message		
1	The SS transmits UMD PDU#1 with 12 bit SN = 0 containing the first segment of RLC SDU#1 (SI field = 01).	<--	UMD PDU#1	-	-
2	The SS transmits UMD PDU#2 with 12 bit SN=0 containing the last segment of RLC SDU#1 (SI field = 10) and including SO field	<--	UMD PDU#2	-	-
3	SS allocates 2 UL grants at an interval of 20 ms so as to loop back RLC SDU#1 in 2 RLC/MAC PDUs. (Note 1)	<--	UL Grants	-	-
4	Check: Does the UE transmit UMD PDU#1 with 12 bit SN = 0 containing the first segment of RLC SDU#1 (SI field = 01)?	-->	(RLC SDU#1, first segment)	1	P

5	Check: Does the UE transmit UMD PDU#2 with 12 bit SN = 0 containing the last segment of RLC SDU#1 (SI field = 10)?	-->	(RLC SDU#1, last segment)	1	P
-	EXCEPTION: Steps 6 to 10 are executed 4095 times, the initial value of k = 1, it is incremented by one for each iteration.	-	-	-	-
6	The SS transmits UMD PDU#(2*k+1) with 12 bit SN = k containing the first segment of RLC SDU#(k+1) (SI field = 01).	<--	UMD PDU#(2*k+1)	-	-
7	The SS transmits UMD PDU#(2*(k+1)) with 12 bit SN=k containing the last segment of RLC SDU#(k+1) (SI field = 10)	<--	UMD PDU#(2*(k+1))	-	-
8	SS allocates 2 UL grants at an interval of 20 ms so as to loop back RLC SDU#(k+1) in 2 RLC/MAC PDUs. (Note 1)	<--	UL Grants	-	-
9	Check: Does the UE transmit UMD PDU#(2*k+1) with 12 bit SN = k containing the first segment of RLC SDU#(k+1) (SI field = 01)? (Note 2)	-->	(RLC SDU#(k+1), first segment)	2	P
10	Check: Does the UE transmit UMD PDU#(2*(k+1)) with 12 bit SN = k containing the last segment of RLC SDU#(k+1) (SI field = 10) and including SO field? (Note 2)	-->	(RLC SDU#(k+1), last segment)	2	P
11	The SS transmits UMD PDU#8193 with 12 bit SN = 0 containing the first segment of RLC SDU#4097 (SI field = 01).	<--	UMD PDU#8193	-	-
12	The SS transmits UMD PDU#8194 with 12 bit SN= 0 containing the last segment of RLC SDU#4097 (SI field = 10) and including SO field	<--	UMD PDU#8194	-	-
13	SS allocates 2 UL grants at an interval of 20 ms so as to loop back RLC SDU#4097 in 2 RLC/MAC PDUs. (Note 1)	<--	UL Grants	-	-
14	Check: Does the UE transmit UMD PDU#8193 with 12 bit SN = 0 containing the first segment of RLC SDU#4097 (SI field = 01)?	-->	(RLC SDU#4097, first segment)	3,4	P
15	Check: Does the UE transmit UMD PDU#8194 with 12 bit SN = 0 containing the last segment of RLC SDU#4097 (SI field = 10) and including SO field?	-->	(RLC SDU#4097, last segment)	3,4	P
<p>Note 1: The RLC SDU size shall be 10 octets which are segmented into 5 and 5 octets. With 2 octets of MAC header, 2 octets of Short BSR and 2 octets of RLC header (without SO) the first segment consists of 88 bits and a TBS of this size shall be allocated. With 2 octets of MAC header and 4 octets of RLC header (with SO) the second segment consists of 88 bits and a TBS of this size shall be allocated. (L_{RBs} & I_{MCS} as per 38.523-3[3] annex B)</p> <p>Note 2: The verdict shall be provided each time (SN+1) mod 256 = 0.</p>					

7.1.2.2.4.3.3 Specific message contents

None.

7.1.2.2.5 UM RLC / Receive Window operation and t-Reassembly expiry

7.1.2.2.5.1 Test Purpose (TP)

(1)

```
with { UE in RRC_CONNECTED state and using UM RLC }
ensure that {
  when { UE receives a RLC PDU including SN and '(RX_Next_Highest - UM_Window_Size) <= SN <
RX_Next_Highest }
  then { UE discards any UMD PDUs with SN that falls outside of the reassembly window }
}
```

(2)

```

with { UE in RRC_CONNECTED state and using UM RLC }
ensure that {
  when { UE receives a RLC PDU including SN and '(RX_Next_Highest - UM_Window_Size) > SN or SN >=
RX_Next_Reassembly' }
    then { UE stores the PDU in receive buffer }
}

```

(3)

```

with { UE in RRC_CONNECTED state and using UM RLC }
ensure that {
  when { UE places a RLC PDU including SN into the reception buffer and all byte segments with that
SN are received }
    then { UE delivers the reassembled SDU to upper layers}
}

```

(4)

```

with { UE in RRC_CONNECTED state and using UM RLC }
ensure that {
  when { t-Reassembly expires }
    then { UE updates RX_Next_Reassembly and discards all segments with SN < updated
RX_Next_Reassembly }
}

```

7.1.2.2.5.2 Conformance requirements

References: The conformance requirements covered in the present TC are specified in: TS 38.322, clauses 5.2.2.2.1, 5.2.2.2.2, 5.2.2.2.3, 5.2.2.2.4 and 7.1. Unless otherwise stated these are Rel-15 requirements.

[TS 38.322, clause 5.2.2.2.1]

The receiving UM RLC entity shall maintain a reassembly window according to state variable `RX_Next_Highest` as follows:

- a SN falls within the reassembly window if $(RX_Next_Highest - UM_Window_Size) \leq SN < RX_Next_Highest$;
- a SN falls outside of the reassembly window otherwise.

When receiving an UMD PDU from lower layer, the receiving UM RLC entity shall:

- either deliver the UMD PDU to upper layer after removing the RLC header, discard the received UMD PDU, or place it in the reception buffer (see sub clause 5.2.2.2.2);
- if the received UMD PDU was placed in the reception buffer:
 - update state variables, reassemble and deliver RLC SDUs to upper layer and start/stop *t-Reassembly* as needed (see sub clause 5.2.2.2.3).

When *t-Reassembly* expires, the receiving UM RLC entity shall:

- update state variables, discard RLC SDU segments and start *t-Reassembly* as needed (see sub clause 5.2.2.2.4).

[TS 38.322, clause 5.2.2.2.2]

When an UMD PDU is received from lower layer, the receiving UM RLC entity shall:

- if the UMD PDU header does not contain an SN:
 - remove the RLC header and deliver the RLC SDU to upper layer.
- else if $(RX_Next_Highest - UM_Window_Size) \leq SN < RX_Next_Reassembly$:
 - discard the received UMD PDU.
- else:

- place the received UMD PDU in the reception buffer.

[TS 38.322, clause 5.2.2.2.3]

When an UMD PDU with SN = x is placed in the reception buffer, the receiving UM RLC entity shall:

- if all byte segments with SN = x are received:
 - reassemble the RLC SDU from all byte segments with SN = x, remove RLC headers and deliver the reassembled RLC SDU to upper layer;
 - if $x = \text{RX_Next_Reassembly}$:
 - update $\text{RX_Next_Reassembly}$ to the SN of the first $\text{SN} > \text{current RX_Next_Reassembly}$ that has not been reassembled and delivered to upper layer.
- else if x falls outside of the reassembly window:
 - update RX_Next_Highest to $x + 1$;
 - discard any UMD PDUs with SN that falls outside of the reassembly window;
 - if $\text{RX_Next_Reassembly}$ falls outside of the reassembly window:
 - set $\text{RX_Next_Reassembly}$ to the SN of the first $\text{SN} \geq (\text{RX_Next_Highest} - \text{UM_Window_Size})$ that has not been reassembled and delivered to upper layer.
- if *t-Reassembly* is running:
 - if $\text{RX_Timer_Trigger} \leq \text{RX_Next_Reassembly}$; or
 - if RX_Timer_Trigger falls outside of the reassembly window and RX_Timer_Trigger is not equal to RX_Next_Highest ; or
 - if $\text{RX_Next_Highest} = \text{RX_Next_Reassembly} + 1$ and there is no missing byte segment of the RLC SDU associated with SN = $\text{RX_Next_Reassembly}$ before the last byte of all received segments of this RLC SDU:
 - stop and reset *t-Reassembly*.
- if *t-Reassembly* is not running (includes the case when *t-Reassembly* is stopped due to actions above):
 - if $\text{RX_Next_Highest} > \text{RX_Next_Reassembly} + 1$; or
 - if $\text{RX_Next_Highest} = \text{RX_Next_Reassembly} + 1$ and there is at least one missing byte segment of the RLC SDU associated with SN = $\text{RX_Next_Reassembly}$ before the last byte of all received segments of this RLC SDU:
 - start *t-Reassembly*;
 - set RX_Timer_Trigger to RX_Next_Highest .

[TS 38.322, clause 5.2.2.2.4]

When *t-Reassembly* expires, the receiving UM RLC entity shall:

- update $\text{RX_Next_Reassembly}$ to the SN of the first $\text{SN} \geq \text{RX_Timer_Trigger}$ that has not been reassembled;
- discard all segments with SN < updated $\text{RX_Next_Reassembly}$;
- if $\text{RX_Next_Highest} > \text{RX_Next_Reassembly} + 1$; or
- if $\text{RX_Next_Highest} = \text{RX_Next_Reassembly} + 1$ and there is at least one missing byte segment of the RLC SDU associated with SN = $\text{RX_Next_Reassembly}$ before the last byte of all received segments of this RLC SDU:
 - start *t-Reassembly*;
 - set RX_Timer_Trigger to RX_Next_Highest .

[TS 38.322, clause 5.2.2.2.4]

This sub clause describes the state variables used in AM and UM entities in order to specify the RLC protocol. The state variables defined in this subclause are normative.

All state variables and all counters are non-negative integers.

...

All state variables related to UM data transfer can take values from 0 to 63 for 6 bit SN or from 0 to 4095 for 12 bit SN. All arithmetic operations contained in the present document on state variables related to UM data transfer are affected by the UM modulus (i.e. final value = [value from arithmetic operation] modulo 64 for 6 bit SN and 4096 for 12 bit SN).

When performing arithmetic comparisons of state variables or SN values, a modulus base shall be used.

...

$RX_Next_Highest - UM_Window_Size$ shall be assumed as the modulus base at the receiving side of an UM RLC entity. This modulus base is subtracted from all the values involved, and then an absolute comparison is performed (e.g. $(RX_Next_Highest - UM_Window_Size) \leq SN < RX_Next_Highest$ is evaluated as $[(RX_Next_Highest - UM_Window_Size) - (RX_Next_Highest - UM_Window_Size)] \bmod 2^{[sn-FieldLength]} \leq [SN - (RX_Next_Highest - UM_Window_Size)] \bmod 2^{[sn-FieldLength]} < [RX_Next_Highest - (RX_Next_Highest - UM_Window_Size)] \bmod 2^{[sn-FieldLength]}$), where *sn-FieldLength* is 6 or 12 for 6 bit SN and 12 bit SN, respectively.

...

Each transmitting UM RLC entity shall maintain the following state variables:

a) TX_Next

This state variable holds the value of the SN to be assigned for the next newly generated UMD PDU with segment. It is initially set to 0, and is updated after the UM RLC entity submits a UMD PDU including the last segment of an RLC SDU to lower layers.

Each receiving UM RLC entity shall maintain the following state variables and constant:

b) RX_Next_Reassembly – UM receive state variable

This state variable holds the value of the earliest SN that is still considered for reassembly. It is initially set to 0.

c) RX_Timer_Trigger – UM *t-Reassembly* state variable

This state variable holds the value of the SN following the SN which triggered *t-Reassembly*.

d) RX_Next_Highest – UM receive state variable

This state variable holds the value of the SN following the SN of the UMD PDU with the highest SN among received UMD PDUs. It serves as the higher edge of the reassembly window. It is initially set to 0.

7.1.2.2.5.3 Test description

7.1.2.2.5.3.1 Pre-test conditions

Same Pre-test conditions as in clause 7.1.2.1.2 with the exception that the UM DRB is configured according to Table 7.1.2.2.5.3.1-1.

Table 7.1.2.2.5.3.1-1: RLC parameters

t-Reassembly	ms200
Uplink UM RLC sn-FieldLength	IF (pc_um_WithShortSN) size6 ELSE size12
Downlink UM RLC sn-FieldLength	F (pc_um_WithShortSN) size6 ELSE size12

Table 7.1.2.2.5.3.1-2: PDCP Settings

Parameter	Value
t-Reordering	ms30

7.1.2.2.5.3.2 Test procedure sequence

Table 7.1.2.2.5.3.2-1: Main behaviour

St	Procedure	Message Sequence		TP	Verdict
		U - S	Message		
0	The SS ignores scheduling requests and does not allocate any uplink grant.	-	-	-	-
1	The SS transmits UMD PDU#1 containing first segment of RLC SDU#1, SN=0.	<--	UMD PDU#1	-	-
2	20 ms after step 1 the SS transmits UMD PDU#3 containing first segment of RLC SDU#2, SN=1.	<--	UMD PDU#3	-	-
3	40 ms after step 1 the SS transmits UMD PDU#4 containing last segment of RLC SDU#2, SN=1.	<--	UMD PDU#4	-	-
3A	60 ms after step 1 the SS transmits UMD PDU#9 containing first segment of RLC SDU#5, SN=w	<--	UMD PDU#9	-	-
3B	80 ms after step 1 the SS transmits UMD PDU#10 containing last segment of RLC SDU#5, SN=w	<--	UMD PDU#10	-	-
3C	100 ms after step 1 the SS assigns 2 UL grants (UL grant allocation type 2) with a time spacing of 20 ms so as to loop back RLC SDU#2.	-	-	-	-
4	Check: Does the UE transmit RLC SDU#2? (Note 3)	-->	(RLC SDU#2)	2,3	P
4A	Check: Does the UE transmit RLC SDU#5? (Note 4)	-->	(RLC SDU#5)	2,3	P
5	160 ms after step 1 the SS transmits UMD PDU#2 last segment of RLC SDU#1, SN=0.	<--	UMD PDU#2	-	-
5A	The SS starts the UL default grant transmissions.	-	-	-	-
6	Check: For 1 sec after step 5, does the UE transmit RLC SDU#1, SN=0? (Note 6)	-->	(RLC SDU#1)	1	F
6A		-	-	-	-
7	The SS transmits UMD PDU#5 containing first segment of RLC SDU#3, SN=5.	<--	UMD PDU#5	-	-
8	Wait for 200 ms to ensure that t-Reassembly for the UMD PDU#5 expires.	-	-	-	-
9	The SS transmits UMD PDU#6 containing last segment of RLC SDU#3, SN=5 (Note 7).	<--	UMD PDU#6	-	-
10	Check: For 1 sec after step 9, does the UE transmit RLC SDU#3? (Note 7)	-->	(RLC SDU#3)	4	F
11	The SS transmits UMD PDU#7 containing first segment of RLC SDU#6, SN=8.	<--	UMD PDU#7	-	-
12	The SS transmits UMD PDU#8 containing last segment of RLC SDU#6, SN=8.	<--	UMD PDU#8	-	-
13	Check: Does the UE transmit RLC SDU#6? (Note 5)	-->	(RLC SDU#4)	2,3	P
<p>Note 1: The RLC SDU size shall be 12 octets which are segmented into 7 and 5 octets.</p> <p>Note 2: UL grant of 144 bits (L_{RBS} & I_{MCS} as per 38.523-3[3] annex B) is chosen to allow the UE to transmit one PDU at a time (12 bytes RLC SDU + 1 or 2 bytes RLC Header + 2 bytes MAC Sub PDU header + 2 or 3 bytes for short BSR and/or padding).</p> <p>Note 3: The UE transmits the looped back PDCP data of RLC SDU#2 in a PDCP PDU with PDCP SN=0.</p> <p>Note 4: The UE transmits the looped back PDCP data of RLC SDU#5 in a PDCP PDU with PDCP SN=1.</p> <p>Note 5: The UE transmits the looped back PDCP data of RLC SDU#6 in a PDCP PDU with PDCP SN=2.</p> <p>Note 6: The UE transmits the looped back PDCP data of RLC SDU#1 in a PDCP PDU with PDCP SN=2.</p> <p>Note 7: The UE transmits the looped back PDCP data of RLC SDU#3 in a PDCP PDU with PDCP SN=2.</p>					

7.1.2.2.5.3.3 Specific message contents

None

7.1.2.2.6 UM RLC / RLC re-establishment procedure

7.1.2.2.6.1 Test Purpose (TP)

(1)

```
with { UE in RRC_CONNECTED state and using UM RLC }
ensure that {
  when { RLC re-establishment is performed upon request by RRC }
  then { The UE discards all UMD PDUs where no RLC SDUs can be reassembled }
}
```

(2)

```
with { UE in RRC_CONNECTED state and using UM RLC }
ensure that {
  when { RLC re-establishment is performed upon request by RRC }
  then { The UE resets variables TX_Next, RX_Next_Reassembly, and RX_Next_Highest to their initial
value of 0 }
}
```

7.1.2.2.6.2 Conformance requirements

References: The conformance requirements covered in the present TC are specified in: TS 38.322, clauses 5.1.2 and 7.1, TS 38.331 clause 5.3.5.5.4. Unless otherwise stated these are Rel-15 requirements.

[TS 38.322, clause 5.1.2]

When upper layers request an RLC entity re-establishment, the UE shall:

- discard all RLC SDUs, RLC SDU segments, and RLC PDUs, if any;
- stop and reset all timers;
- reset all state variables to their initial values.

[TS 38.322, clause 7.1]

d) RX_Next_Highest – Highest received state variable

This state variable holds the value of the SN following the SN of the RLC SDU with the highest SN among received RLC SDUs. It is initially set to 0.

Each transmitting UM RLC entity shall maintain the following state variables:

a) TX_Next

This state variable holds the value of the SN to be assigned for the next newly generated UMD PDU with segment. It is initially set to 0, and is updated after the UM RLC entity submits a UMD PDU including the last segment of an RLC SDU to lower layers.

Each receiving UM RLC entity shall maintain the following state variables and constant:

b) RX_Next_Reassembly – UM receive state variable

This state variable holds the value of the earliest SN that is still considered for reassembly. It is initially set to 0.

c) RX_Timer_Trigger – UM *t-Reassembly* state variable

This state variable holds the value of the SN following the SN which triggered *t-Reassembly*.

d) RX_Next_Highest– UM receive state variable

This state variable holds the value of the SN following the SN of the UMD PDU with the highest SN among received UMD PDUs. It serves as the higher edge of the reassembly window. It is initially set to 0.

[TS 38.331, clause 5.3.5.5.4]

For each *RLC-Bearer-Config* received in the *rlc-BearerToAddModList* IE the UE shall:

- 1> if the UE's current configuration contains a RLC bearer with the received *logicalChannelIdentity*:
- 2> if *reestablishRLC* is received:
 - 3> re-establish the RLC entity as specified in TS 38.322 [4];
- 2> reconfigure the RLC entity or entities in accordance with the received *rlc-Config*;
- 2> reconfigure the logical channel in accordance with the received *mac-LogicalChannelConfig*;

NOTE: The network does not re-associate an already configured logical channel with another radio bearer. Hence *servedRadioBearer* is not present in this case.

7.1.2.2.6.3 Test description

7.1.2.2.6.3.1 Pre-test conditions

Same Pre-test conditions as in clause 7.1.2.1.2 with the exception that the UM DRB is configured according to Table 7.1.2.2.6.3.1-1.

Table 7.1.2.2.6.3.1-1: RLC parameters

t-Reassembly	ms200
Uplink UM RLC sn-FieldLength	IF (pc_um_WithShortSN) size6 ELSE size12
Downlink UM RLC sn-FieldLength	IF (pc_um_WithShortSN) size6 ELSE size12

7.1.2.2.6.3.2 Test procedure sequence

Table 7.1.2.2.6.3.2-1: Main behaviour

St	Procedure	Message Sequence		TP	Verdict
		U - S	Message		
1	The SS transmits UMD PDU#1. Header of UMD PDU#1 does not contain an SN. This PDU carries RLC SDU#1.	<--	UMD PDU#1	-	-
2	The UE transmits RLC SDU#1.	-->	(RLC SDU#1)	-	-
3	The SS transmits UMD PDU#2. Header of UMD PDU#2 contains SN=0. This PDU carries the first segment of SDU#2.	<--	UMD PDU#2	-	-
4	The SS transmits NR <i>RRCReconfiguration</i> message to trigger RLC re-establishment on DRB using Reconfig with sync procedure. (Note 3)(Note 5)	<--	<i>RRCReconfiguration</i>	-	-
4A	The UE transmits a NR <i>RRCReconfigurationcomplete</i> message. (Note 4)	-->	<i>RRCReconfigurationComplete</i>	-	-
5	100 ms after step 4A the SS transmits UMD PDU#3. Header of UMD PDU#3 contains SN=0. This PDU carries the last segment of RLC SDU#2. The UE starts t-Reassembly.	<--	UMD PDU#3	-	-
6	Check: For 250 ms after step 5 does the UE transmit RLC SDU#2?	-->	(RLC SDU#2)	1	F
6A	The SS stops allocating any UL grant.				

7	300 ms (1.5 * t- Reassembly) after step 5 the SS transmits UMD PDU#4. This PDU carries the first segment of RLC SDU#3.SN=1.	<--	UMD PDU#4	-	-
8	20 ms after step 7 the SS transmits UMD PDU#5. This PDU carries the second and last segment of RLC SDU#3.SN=1.	<--	UMD PDU#5	-	-
8A	20 ms after step 8 the SS allocates 2 UL grants at an interval of 20 ms so as to loop back RLC SDU#3 in 2 RLC/MAC PDUs. Note 1 & 2	-	-	-	-
9	Check: Does the UE transmit first segment of RLC SDU#3? Header of UMD PDU contains SN=0.	-->	(RLC SDU#3 first segment)	2	P
10	Check: Does the UE transmit second and last segment of RLC SDU#3? Header of UMD PDU contains SN=0.	-->	(RLC SDU#3 last segment)	2	P
10A	The SS starts the UL default grant transmissions				
11	The SS transmits NR <i>RRCReconfiguration</i> message to trigger RLC re-establishment on DRB using Reconfig with sync procedure. (Note 3)	<--	<i>RRCReconfiguration</i>	-	-
11A	The UE transmits a NR <i>RRCReconfigurationcomplete</i> message. (Note 4)	-->	<i>RRCReconfigurationComplete</i>	-	-
11B	The SS stops allocating any UL grant.				
12	After 100 ms the SS transmits UMD PDU#6. Header of UMD PDU#6 contains SN=0. This PDU carries the first segment of SDU#4.	<--	UMD PDU#6	-	-
13	20 ms after step 12 the SS transmits UMD PDU#7. Header of UMD PDU#6 contains SN=0. This PDU carries the second segment of SDU#4.	<--	UMD PDU#7	-	-
13A	20 ms after step 13 the SS allocates 2 UL grants at an interval of 20 ms so as to loop back RLC SDU#4 in 2 RLC/MAC PDUs. Note 1 & 2	-	-	-	-
14	Check: Does the UE transmit first segment of RLC SDU#4? Header of UMD PDU contains SN=0.	-->	(RLC SDU#4 first segment)	2	P
15	Check: Does the UE transmit second and last segment of RLC SDU#4? Header of UMD PDU contains SN=0.	-->	(RLC SDU#4 last segment)	2	P
Note 1:	For SN size = size6 the RLC SDU size shall be 12 octets which are segmented into 6 and 6 octets. With 2 octets of MAC BSR and 2 octets of MAC header and 1 octet of RLC header (without SO) the first segment consists of 88 bits and a TBS of this size shall be allocated. With 2 octets of MAC header and 3 octets of RLC header (with SO) the second segment consists of 88 bits and a TBS of this size shall be allocated. (L _{RBs} & l _{mcs} as per 38.523-3[3] annex B)				
Note 2:	For SN size = size12 the RLC SDU size shall be 10 octets which are segmented into 5 and 5 octets. With 2 octets of MAC BSR and 2 octets of MAC header and 2 octets of RLC header (without SO) the first segment consists of 88 bits and a TBS of this size shall be allocated. With 2 octets of MAC header and 4 octets of RLC header (with SO) the second segment consists of 88 bits and a TBS of this size shall be allocated. (L _{RBs} & l _{mcs} as per 38.523-3[3] annex B)				
Note 3:	For EN-DC, the NR <i>RRCReconfiguration</i> message is contained in <i>RRCConnectionReconfiguration</i> as defined in Table 7.1.2.2.6.3.3-2				
Note 4:	For EN-DC, the NR <i>RRCReconfigurationComplete</i> message is contained in <i>RRCConnectionReconfigurationComplete</i> .				

7.1.2.2.6.3.3 Specific message contents

Table 7.1.2.2.6.3.3-1: *RRCReconfiguration* for NR (steps 4, 11, Table 7.1.2.2.6.3.2-1)

Derivation Path: 38.508-1 [4], Table 4.6.1-13			
Information Element	Value/remark	Comment	Condition
<i>RRCReconfiguration</i> ::= SEQUENCE {			
criticalExtensions CHOICE {			

rrcReconfiguration ::= SEQUENCE {			
radioBearerConfig	RadioBearerConfig according to TS 38.508-1 [4], table 4.6.3-132 with conditions SRB1 and SRB2 and DRBn	n set to the default DRB of the first PDU session	
}			
nonCriticalExtension ::= SEQUENCE {			
masterCellGroup	CellGroupConfig according to TS 38.508-1 [4], table 4.6.3-19 with condition PCell_change		
}			
}			
}			

Table 7.1.2.2.6.3.3-2: RRCConnectionReconfiguration for EN-DC (steps 4, 11 Table 7.1.2.2.6.3.2-1)

Derivation Path: 36.508 Table 4.6.1-8			
Information Element	Value/remark	Comment	Condition
RRCConnectionReconfiguration ::= SEQUENCE {			
criticalExtensions CHOICE {			
c1 CHOICE{			
rrcConnectionReconfiguration-r8 ::= SEQUENCE			
{			
nonCriticalExtension ::= SEQUENCE {			
nonCriticalExtension ::= SEQUENCE {			
nonCriticalExtension ::= SEQUENCE {			
nr-Config-r15 CHOICE {			
nr-SecondaryCellGroupConfig-r15	OCTET STRING including the RRCReconfiguration message and the IE secondaryCellGroup according TS 38.508-1 [67], table 4.6.1-13 with condition EN-DC_HO		
}			
}			
nr-RadioBearerConfig1-r15	OCTET STRING including RadioBearerConfig according TS 38.508-1 [67], table 4.6.3-132 with conditions EN-DC_DRB		
}			
}			
}			
}			
}			

7.1.2.3 RLC Acknowledged Mode

7.1.2.3.1 AM RLC / 12-bit SN / Segmentation and reassembly / Segmentation Info (SI) field

7.1.2.3.1.1 Test Purpose (TP)

(1)

```
with { UE in RRC_CONNECTED state }
ensure that {
  when { UE receives a 12 bit SN configured AMD PDU containing a SI field set to 00 }
```

```

    then { UE correctly decodes the received AMD PDU }
  }

```

(2)

```

with { UE in RRC_CONNECTED state }
ensure that {
  when { UE receives a 12 bit SN configured AMD PDU containing a SI field set to 01 }
  then { UE correctly decodes the received AMD PDU }
}

```

(3)

```

with { UE in RRC_CONNECTED state }
ensure that {
  when { UE receives a 12 bit SN configured AMD PDU containing a SI field set to 11 and SO field }
  then { UE correctly decodes the received AMD PDU }
}

```

(4)

```

with { UE in RRC_CONNECTED state }
ensure that {
  when { UE receives a 12 bit SN configured AMD PDU containing a SI field set to 10 and SO field }
  then { UE correctly decodes the received AMD PDU }
}

```

(5)

```

with { UE in RRC_CONNECTED state }
ensure that {
  when { UE has UL RLC SDU to send and the UL Grant is sufficient to send complete PDU }
  then { UE transmits AMD PDU containing a complete AMD SDU and SI field set to 00 }
}

```

(6)

```

with { UE in RRC_CONNECTED state }
ensure that {
  when { UE has UL RLC SDU to send and the UL Grant is sufficient to send first segment only }
  then { UE transmits AMD PDU containing first segment of AMD SDU and SI field set to 01 }
}

```

(7)

```

with { UE in RRC_CONNECTED state }
ensure that {
  when { UE has UL RLC SDU to send and the UL Grant is sufficient to send middle segment only }
  then { UE transmits AMD PDU containing middle segment of AMD SDU and SI field set to 11,
including SO field }
}

```

(8)

```

with { UE in RRC_CONNECTED state }
ensure that {
  when { UE has UL RLC SDU to send and the UL Grant is sufficient to send last segment only }
  then { UE transmits AMD PDU containing last segment of AMD SDU and SI field set to 10, including
SO field }
}

```

7.1.2.3.1.2 Conformance requirements

References: The conformance requirements covered in the present TC are specified in: TS 38.322, clauses 6.2.2.4 and 6.2.3.4. Unless otherwise stated these are Rel-15 requirements.

[TS 38.322, clause 6.2.2.4]

AMD PDU consists of a Data field and an AMD PDU header. The AMD PDU header is byte aligned.

An AM RLC entity is configured by RRC to use either a 12 bit SN or a 18 bit SN. The length of the AMD PDU header is two and three bytes respectively.

An AMD PDU header contains a D/C, a P, a SI, and a SN. An AMD PDU header contains the SO field only when the Data field consists of an RLC SDU segment which is not the first segment, in which case a 16 bit SO is present.

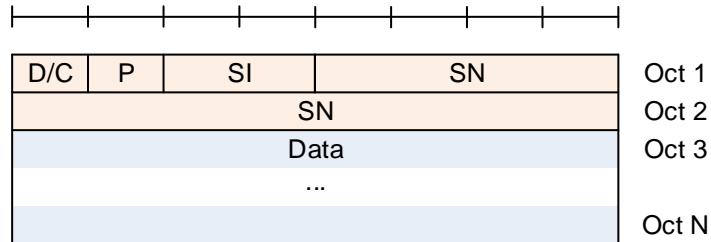

Figure 6.2.2.4-1: AMD PDU with 12 bit SN (No SO)

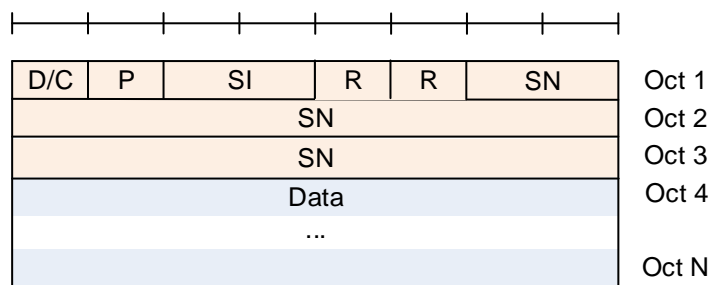

Figure 6.2.2.4-2: AMD PDU with 18 bit SN (No SO)

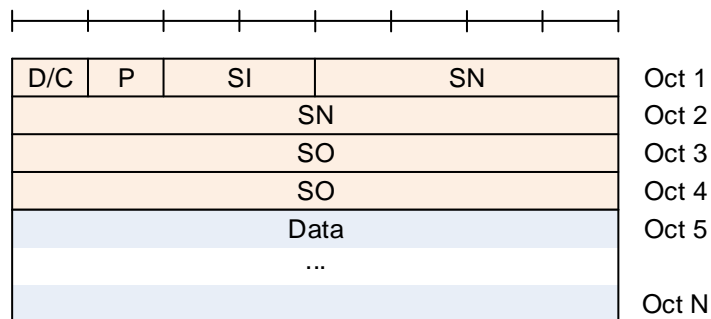

Figure 6.2.2.4-3: AMD PDU with 12 bit SN with SO

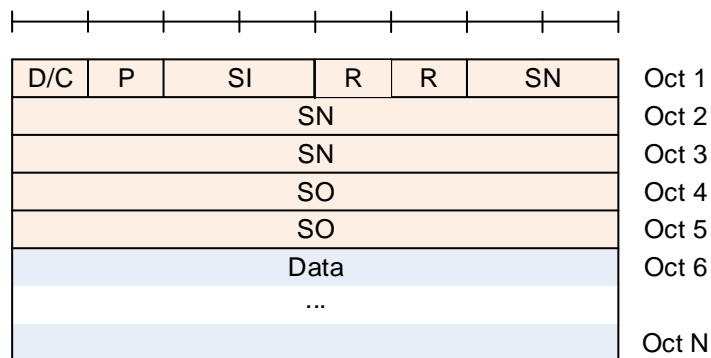

Figure 6.2.2.4-4: AMD PDU with 18 bit SN with SO

[TS 38.322, clause 6.2.3.4]

Length: 2 bits.

The SI field indicates whether an RLC PDU contains a complete RLC SDU or the first, middle, last segment of an RLC SDU.

Table 6.2.3.4-1: SI field interpretation

Value	Description
00	Data field contains all bytes of an RLC SDU
01	Data field contains the first segment of an RLC SDU
10	Data field contains the last segment of an RLC SDU
11	Data field contains neither the first nor last segment of an RLC SDU

7.1.2.3.1.3 Test description

7.1.2.3.1.3.1 Pre-test conditions

Same Pre-test conditions as in clause 7.1.2.1.1 with the exception that the AM DRB is configured according to Table 7.1.2.3.1.3.1-1.

Table 7.1.2.3.1.3.1-1: RLC parameters

Uplink SN-FieldLength-AM	size12
Downlink SN-FieldLength-AM	size12

7.1.2.3.1.3.2 Test procedure sequence

Table 7.1.2.3.1.3.2-1: Main behaviour

St	Procedure	Message Sequence		TP	Verdict
		U - S	Message		
0	The SS stops allocating any UL grant.	-	-	-	-
1	The SS transmits AMD PDU#1 containing a complete RLC SDU#1 (SI field = 00).	<--	AMD PDU#1	-	-
1A	60 ms after Step1, SS allocates an UL grant sufficient to loop back RLC SDU#1 in one RLC/MAC PDU	<--	UL Grant	-	-
2	Check: Does the UE transmit AMD PDU#1 containing a complete RLC SDU#1 (SI field = 00)?	-->	(RLC SDU#1)	1,5	P
3	The SS transmits a STATUS PDU.	<--	STATUS PDU (ACK SN=1)	-	-
4	The SS transmits AMD PDU#2 containing the first segment of RLC SDU#2 (SI field = 01). Note 3	<--	AMD PDU#2	-	-
5	The SS transmits AMD PDU#3 containing the second segment of RLC SDU#2 (SI field = 11) and including SO field. Note 3	<--	AMD PDU#3	-	-
6	The SS transmits AMD PDU#4 containing the last segment of RLC SDU#2 (SI field = 10) and including SO field. Note 3	<--	AMD PDU#4	-	-
6A	SS allocates 3 UL grants at an interval of 20 ms so as to loop back RLC SDU#2 in 3 RLC/MAC PDUs. (Note 1 and Note 2)	<--	UL Grants	-	-
7	Check: Does the UE transmit AMD PDU#2 containing the first segment of RLC SDU#2 (SI field = 01)?	-->	(RLC SDU#2)	2,3, 4,6	P
8	Check: Does the UE transmit AMD PDU#3 containing the middle segment of RLC SDU#2 (SI field = 11) and including SO field?	-->	(RLC SDU#2)	2,3, 4,7	P
9	Check: Does the UE transmit AMD PDU#4 containing the last segment of RLC SDU#2 (SI	-->	(RLC SDU#2)	2,3, 4,8	P

	field = 10) and including SO field?				
10	The SS transmits a STATUS PDU.	<--	STATUS PDU (ACK SN=2)	-	-
Note 1:	The UL grants for step 7,8,9 are sufficiently small (240 bits, L _{RBS} & l _{MCS} as per 38.523-3[3] annex B) that UE transmits RLC SDU#2 in 3 UL RLC PDUs by segmenting.				
Note 2:	The RLC PDU containing a segment shall be of size 208 bits resp. 224 bits and a MAC sub PDU header of 16 bits and a 16-bit MAC BSR CE included in step 8 resulting in a MAC PDU of size 240 bits.				
Note 3:	The data part in step 4 first segment not including SO is 192 bits (24 bytes). Step 5, second segment SO=24 and data is 192 bits (24 bytes). Step 6, third segment SO=24+24=48 and data is 192 bits (24 bytes).				

7.1.2.3.1.3.3 Specific message contents

None

7.1.2.3.2 AM RLC / 18-bit SN / Segmentation and reassembly / Segmentation Info (SI) field

7.1.2.3.2.1 Test Purpose (TP)

(1)

```
with { UE in RRC_CONNECTED state }
ensure that {
  when { UE receives a 18 bit SN configured AMD PDU containing a SI field set to 00 }
  then { UE correctly decodes the received AMD PDU or AMD PDU segment }
}
```

(2)

```
with { UE in RRC_CONNECTED state }
ensure that {
  when { UE receives a 18 bit SN configured AMD PDU containing a SI field set to 01 }
  then { UE correctly decodes the received AMD PDU or AMD PDU segment }
}
```

(3)

```
with { UE in RRC_CONNECTED state }
ensure that {
  when { UE receives a 18 bit SN configured AMD PDU containing a SI field set to 11 and SO field }
  then { UE correctly decodes the received AMD PDU or AMD PDU segment }
}
```

(4)

```
with { UE in RRC_CONNECTED state }
ensure that {
  when { UE receives a 18 bit SN configured AMD PDU containing a SI field set to 10 and SO field }
  then { UE correctly decodes the received AMD PDU or AMD PDU segment }
}
```

(5)

```
with { UE in RRC_CONNECTED state }
ensure that {
  when { UE has UL RLC SDU to send and the UL Grant is sufficient to send complete PDU }
  then { UE transmits AMD PDU containing a complete AMD SDU and SI field set to 00 }
}
```

(6)

```
with { UE in RRC_CONNECTED state }
ensure that {
  when { UE has UL RLC SDU to send and the UL Grant is sufficient to send first segment only }
  then { UE transmits AMD PDU containing first segment of AMD SDU and SI field set to 01 }
}
```

(7)

```

with { UE in RRC_CONNECTED state }
ensure that {
  when { UE has UL RLC SDU to send and the UL Grant is sufficient to send middle segment only }
  then { UE transmits AMD PDU containing middle segment of AMD SDU and SI field set to 11,
including SO field }
}

```

(8)

```

with { UE in RRC_CONNECTED state }
ensure that {
  when { UE has UL RLC SDU to send and the UL Grant is sufficient to send last segment only }
  then { UE transmits AMD PDU containing last segment of AMD SDU and SI field set to 10, including
SO field }
}

```

7.1.2.3.2.2 Conformance requirements

Same conformance requirements as in clause 7.1.2.3.1.2

7.1.2.3.2.3 Test description

7.1.2.3.2.3.1 Pre-test conditions

Same Pre-test conditions as in clause 7.1.2.1.1 with the exception that the AM DRB is configured according to Table 7.1.2.3.2.3.1-1.

Table 7.1.2.3.2.3.1-1: RLC parameters

Uplink SN-FieldLength-AM	size18
Downlink SN-FieldLength-AM	size18

7.1.2.3.2.3.2 Test procedure sequence

Same test procedure as in clause 7.1.2.3.1.3.2 except that SN is 18 bit and the data part in step 4 first segment not including SO is 184 bits (23 Bytes). Step 5, second segment SO=23 and data is 184 bits (23 bytes). Step 6, third segment SO=23+23=46 and data is 184 bits (23 bytes).

7.1.2.3.2.3.3 Specific message contents

None

7.1.2.3.3 AM RLC / 12-bit SN / Correct use of sequence numbering

7.1.2.3.3.1 Test Purpose (TP)

(1)

```

with { UE in RRC_CONNECTED state with AM RLC 12 bit SN }
ensure that {
  when { UE transmits the PDU corresponding to first SDU }
  then { UE includes the SN field equal to 0 in PDU }
}

```

(2)

```

with { UE in RRC_CONNECTED state with AM RLC 12 bit SN }
ensure that {
  when { UE transmits subsequent SDUs }
  then { UE includes the SN field incremented by 1 per SDU of each PDU transmitted }
}

```

(3)

```

with { UE in RRC_CONNECTED state with AM RLC 12 bit SN }
ensure that {
  with { UE transmits more than 4096 SDUs }
  then { UE wraps the SN after transmitting the 4096 SDUs }
}

```

(4)

```

with { UE in RRC_CONNECTED state with AM RLC 12 bit SN }
ensure that {
  with { more than 4096 SDUs are sent to UE }
  then { UE accepts PDUs with SNs that wrap around every 4096 SDUs }
}

```

7.1.2.3.3.2 Conformance requirements

References: The conformance requirements covered in the present TC are specified in: TS 38.322, clauses 5.2.3.1.1, 5.2.3.2.1, 5.2.3.2.2, 6.2.2.4 and 7.1. Unless otherwise stated these are Rel-15 requirements.

[TS 38.322, clause 5.2.3.2.1]

The receiving side of an AM RLC entity shall maintain a receiving window according to the state variable *RX_Next* as follows:

- a SN falls within the receiving window if $RX_Next \leq SN < RX_Next + AM_Window_Size$;
- a SN falls outside of the receiving window otherwise.

When receiving an AMD PDU from lower layer, the receiving side of an AM RLC entity shall:

- either discard the received AMD PDU or place it in the reception buffer (see sub clause 5.2.3.2.2);
- if the received AMD PDU was placed in the reception buffer:
 - update state variables, reassemble and deliver RLC SDUs to upper layer and start/stop *t-Reassembly* as needed (see sub clause 5.2.3.2.3).

When *t-Reassembly* expires, the receiving side of an AM RLC entity shall:

- update state variables and start *t-Reassembly* as needed (see sub clause 5.2.3.2.4).

[TS 38.322, clause 5.2.3.2.2]

When an AMD PDU is received from lower layer, where the AMD PDU contains byte segment numbers *y* to *z* of an RLC SDU with SN = *x*, the receiving side of an AM RLC entity shall:

- if *x* falls outside of the receiving window; or
- if byte segment numbers *y* to *z* of the RLC SDU with SN = *x* have been received before:
 - discard the received AMD PDU.
- else:
 - place the received AMD PDU in the reception buffer;
 - if some byte segments of the RLC SDU contained in the AMD PDU have been received before:
 - discard the duplicate byte segments.

[TS 38.322, clause 6.2.2.4]

AMD PDU consists of a Data field and an AMD PDU header. The AMD PDU header is byte aligned.

An AM RLC entity is configured by RRC to use either a 12 bit SN or a 18 bit SN. The length of the AMD PDU header is two and three bytes respectively.

An AMD PDU header contains a D/C, a P, a SI, and a SN. An AMD PDU header contains the SO field only when the Data field consists of an RLC SDU segment which is not the first segment, in which case a 16 bit SO is present.

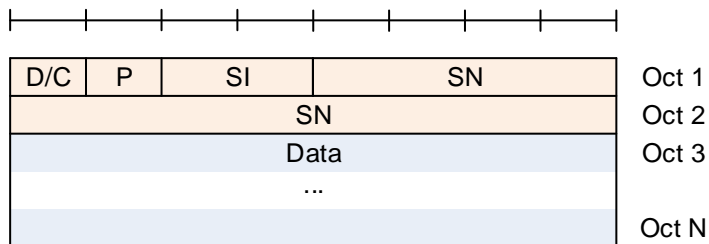

Figure 6.2.2.4-1: AMD PDU with 12 bit SN (No SO)

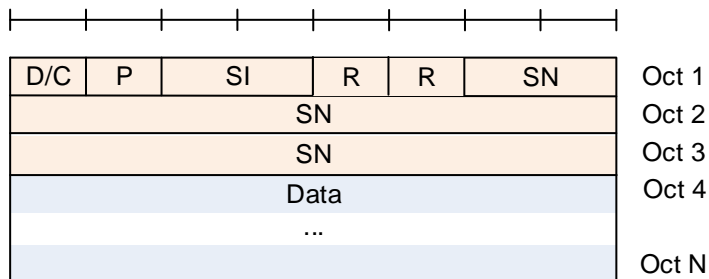

Figure 6.2.2.4-2: AMD PDU with 18 bit SN (No SO)

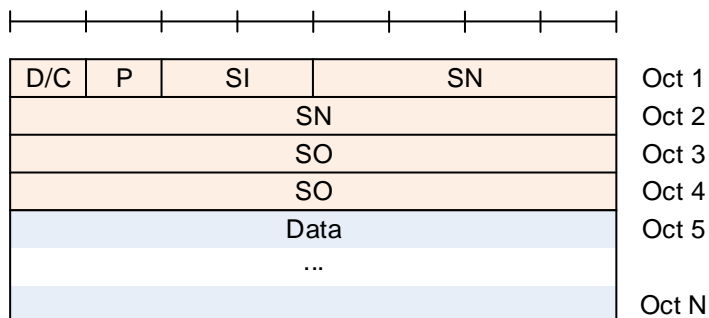

Figure 6.2.2.4-3: AMD PDU with 12 bit SN with SO

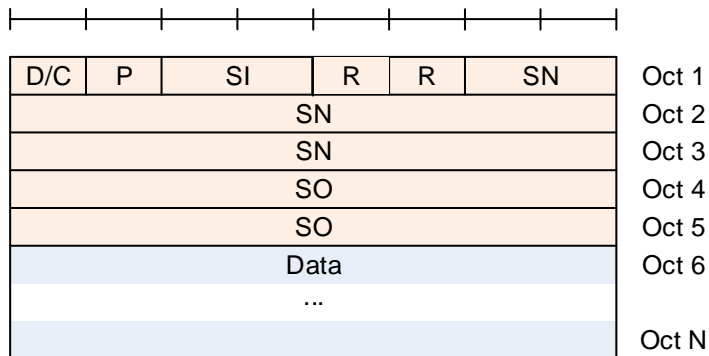

Figure 6.2.2.4-4: AMD PDU with 18 bit SN with SO

[TS 38.322, clause 7.1]

c) RETX_COUNT – Counter

This counter counts the number of retransmissions of an RLC SDU or RLC SDU segment (see subclause 5.3.2). There is one RETX_COUNT counter maintained per RLC SDU.

The receiving side of each AM RLC entity shall maintain the following state variables:

a) RX_Next – Receive state variable

This state variable holds the value of the SN following the last in-sequence completely received RLC SDU, and it serves as the lower edge of the receiving window. It is initially set to 0, and is updated whenever the AM RLC entity receives an RLC SDU with SN = RX_Next.

b) RX_Next_Status_Trigger – *t-Reassembly* state variable

This state variable holds the value of the SN following the SN of the RLC SDU which triggered *t-Reassembly*.

c) RX_Highest_Status – Maximum STATUS transmit state variable

This state variable holds the highest possible value of the SN which can be indicated by "ACK_SN" when a STATUS PDU needs to be constructed. It is initially set to 0.

d) RX_Next_Highest – Highest received state variable

This state variable holds the value of the SN following the SN of the RLC SDU with the highest SN among received RLC SDUs. It is initially set to 0.

Each transmitting UM RLC entity shall maintain the following state variables:

a) TX_Next

This state variable holds the value of the SN to be assigned for the next newly generated UMD PDU with segment. It is initially set to 0, and is updated after the UM RLC entity submits a UMD PDU including the last segment of an RLC SDU to lower layers.

Each receiving UM RLC entity shall maintain the following state variables and constant:

b) RX_Next_Reassembly – UM receive state variable

This state variable holds the value of the earliest SN that is still considered for reassembly. It is initially set to 0.

c) RX_Timer_Trigger – UM *t-Reassembly* state variable

This state variable holds the value of the SN following the SN which triggered *t-Reassembly*.

d) RX_Next_Highest – UM receive state variable

This state variable holds the value of the SN following the SN of the UMD PDU with the highest SN among received UMD PDUs. It serves as the higher edge of the reassembly window. It is initially set to 0.

7.1.2.3.3.3 Test description

7.1.2.3.3.3.1 Pre-test conditions

Same Pre-test conditions as in clause 7.1.2.1.1 with the exception that the AM DRB is configured according to Table 7.1.2.3.3.3.1-1.

Table 7.1.2.3.3.3.1-1: RLC parameters

Uplink SN-FieldLength-AM	size12
Downlink SN-FieldLength-AM	size12
pollPDU	p2048
pollByte	kB25

7.1.2.3.3.3.2 Test procedure sequence

Table 7.1.2.3.3.3.2-1: Main behaviour

St	Procedure	Message Sequence		TP	Verdict
		U - S	Message		
-	EXCEPTION: Steps 1 – 3a1 shall be repeated from j=0 to j=FLOOR(Maximum_RLC_SN/iteration_size). (Note 1, 4, 6)	-	-	-	-
1	SS transmits in one slot, several RLC PDUs in a RLC PDU List, the number of RLC PDUs sent is defined by the iteration_size. (Note 4, 5). Each RLC PDU contains one RLC SDU.	<--	RLC PDUs	-	-
-	EXCEPTION: In Step 2, SS may receive a RLC PDU or several RLC PDUs, then step 2 may be repeated multiple times until all RLC PDUs with SN=j*iteration_size to SN=((j+1)*iteration_size)-1 for each iteration are received.	-	-	-	-
2	CHECK: Does UE transmit RLC PDUs with SN=0 for the first iteration and all RLC PDUs for each iteration? (Note 2) (Note 7)	-->	RLC PDUs	1,2	P
-	EXCEPTION: Step 3a1 describes behaviour that depends on the contents of the AMD PDU transmitted at Step 2.	-	-	-	-
3a1	IF the UE has set the poll bit in the AMD PDU transmitted at Step 2 THEN the SS transmits a Status Report.	<--	STATUS PDU	-	-
4	SS transmits a RLC PDU containing one RLC SDU.	<--	RLC PDU	-	-
5	CHECK: Does UE transmit a RLC PDU with SN=0?	-->	RLC PDU	3,4	P
6	The SS transmits a STATUS PDU with ACK_SN = 1.	<--	STATUS PDU	-	-
Note 1: Maximum_RLC_SN = $2^{\lfloor \text{RLC-SN-SizeUL} \rfloor} - 1$. Note 2: The verdict shall be provided each time $[(\text{SN}+1) \bmod 256 = 0]$ for 12 bit SN and $[(\text{SN}+1) \bmod 4096 = 0]$ for 18 bit SN respectively. Note 3: Void Note 4: Iteration will be incremented by iteration_size of 1 for 12 bit SN and iteration_size of 2^5 for 18 bit SN. Small RLC SDU size will be used. Note 5: SS shall transmit a RLC PDU list with size equal to iteration_size and incrementing SN by 1 till SN = $((j + 1) * \text{iteration_size}) - 1$. Note 6: The RLC SDU size shall be 4 octets (3 octets of PDCP header + 1 octet PDCP SDU). Note 7: All RLC PDUs may be received by the SS in the same slot or in multiple slots (max one MAC PDU in a slot).					

7.1.2.3.3.3.3 Specific message contents

None.

7.1.2.3.4 AM RLC / 18-bit SN / Correct use of sequence numbering

7.1.2.3.4.1 Test Purpose (TP)

(1)

```

with { UE in RRC_CONNECTED state with AM RLC 18 bit SN }
ensure that {
  when { UE transmits the PDU corresponding to first SDU }
  then { UE includes the SN field equal to 0 in PDU }
}

```

(2)

```

with { UE in RRC_CONNECTED state with AM RLC 18 bit SN }
ensure that {
  when { UE transmits subsequent SDUs }
  then { UE includes the SN field incremented by 1 per SDU of each PDU transmitted }
}

```

(3)

```

with { UE in RRC_CONNECTED state with AM RLC 18 bit SN }
ensure that {
  with { UE transmits more than 262144 SDUs }
  then { UE wraps the SN after transmitting the 262144 SDUs }
}

```

(4)

```

with { UE in RRC_CONNECTED state with AM RLC 18 bit SN }
ensure that {
  with { more than 262144 SDUs are sent to UE }
  then { UE accepts PDUs with SNs that wrap around every 262144 SDUs }
}

```

7.1.2.3.4.2 Conformance requirements

Same as conformance requirements in clause 7.1.2.3.3.2

7.1.2.3.4.3 Test description

7.1.2.3.4.3.1 Pre-test conditions

Same Pre-test conditions as in clause 7.1.2.1.1 with the exception that the AM DRB is configured according to Table 7.1.2.3.4.3.1-1.

Table 7.1.2.3.4.3.1-1: RLC parameters

Uplink SN-FieldLength-AM	size18
Downlink SN-FieldLength-AM	size18
pollPDU	p2048
pollByte	kB25

7.1.2.3.4.3.2 Test procedure sequence

Same as test procedure in clause 7.1.2.3.3.2

7.1.2.3.4.3.3 Specific message contents

None.

7.1.2.3.5 AM RLC / 12-bit SN / Control of transmit window / Control of receive window

7.1.2.3.5.1 Test Purpose (TP)

(1)

```

with { UE in RRC_CONNECTED state with AM RLC 12 bit SN and pending uplink data for transmission }
ensure that {
  when { AMD PDUs in transmission buffer fall outside TX_Next_Ack <= SN < TX_Next_Ack +
  AM_Window_Size }
  then { UE does not transmit these AMD PDUs }
}

```

(2)

```

with { UE in RRC_CONNECTED state with AM RLC 12 bit SN and pending uplink data for transmission }
ensure that {
  when { receiving a STATUS PDU where ACK_SN acknowledges at least one AMD PDU not yet acknowledged }
  then { UE transmits AMD PDUs within updated window range }
}

```

(3)

```

with { UE in RRC_CONNECTED state with AM RLC 12 bit SN }
ensure that {
  when { the UE receives AMD PDUs with SN outside the upper boundary of the receive window }
  then { the UE discards these AMD PDUs }
}

```

(4)

```

with { UE in RRC_CONNECTED state with AM RLC 12 bit SN }
ensure that {
  when { the receive window has been moved }
  then { UE continues accepting AMD PDUs within updated window range }
}

```

7.1.2.3.5.2 Conformance requirements

References: The conformance requirements covered in the present TC are specified in: TS 38.322, clauses 5.2.3.2.1, 5.2.3.2.2, 5.2.3.2.3 and 7.2. Unless otherwise stated these are Rel-15 requirements.

[TS 38.322, clause 5.2.3.2.2]

When an AMD PDU is received from lower layer, where the AMD PDU contains byte segment numbers y to z of an RLC SDU with $SN = x$, the receiving side of an AM RLC entity shall:

- if x falls outside of the receiving window; or
- if byte segment numbers y to z of the RLC SDU with $SN = x$ have been received before:
 - discard the received AMD PDU.
- else:
 - place the received AMD PDU in the reception buffer;
 - if some byte segments of the RLC SDU contained in the AMD PDU have been received before:
 - discard the duplicate byte segments.

[TS 38.322, clause 5.2.3.2.3]

When an AMD PDU with $SN = x$ is placed in the reception buffer, the receiving side of an AM RLC entity shall:

- if $x \geq RX_Next_Highest$
 - update $RX_Next_Highest$ to $x + 1$.
- if all bytes of the RLC SDU with $SN = x$ are received:
 - reassemble the RLC SDU from AMD PDU(s) with $SN = x$, remove RLC headers when doing so and deliver the reassembled RLC SDU to upper layer;
 - if $x = RX_Highest_Status$,
 - update $RX_Highest_Status$ to the SN of the first RLC SDU with $SN > current\ RX_Highest_Status$ for which not all bytes have been received.
- if $x = RX_Next$:

- update RX_Next to the SN of the first RLC SDU with SN > current RX_Next for which not all bytes have been received.
- if *t-Reassembly* is running:
 - if RX_Next_Status_Trigger = RX_Next; or
 - if RX_Next_Status_Trigger = RX_Next + 1 and there is no missing byte segment of the SDU associated with SN = RX_Next before the last byte of all received segments of this SDU; or
 - if RX_Next_Status_Trigger falls outside of the receiving window and RX_Next_Status_Trigger is not equal to RX_Next + AM_Window_Size:
 - stop and reset *t-Reassembly*.
- if *t-Reassembly* is not running (includes the case *t-Reassembly* is stopped due to actions above):
 - if RX_Next_Highest > RX_Next + 1; or
 - if RX_Next_Highest = RX_Next + 1 and there is at least one missing byte segment of the SDU associated with SN = RX_Next before the last byte of all received segments of this SDU:
 - start *t-Reassembly*;
 - set RX_Next_Status_Trigger to RX_Next_Highest.

[TS 38.322, clause 7.2]

a) AM_Window_Size

This constant is used by both the transmitting side and the receiving side of each AM RLC entity. AM_Window_Size = 2048 when a 12 bit SN is used, AM_Window_Size = 131072 when an 18 bit SN is used.

7.1.2.3.5.3 Test description

7.1.2.3.5.3.1 Pre-test conditions

Same Pre-test conditions as in clause 7.1.2.1.1 with the exception that the AM DRB is configured according to Table 7.1.2.3.5.3.1-1.

Table 7.1.2.3.5.3.1-1: RLC parameters

t-PollRetransmit	ms300
pollPDU	infinity
pollByte	infinity
sn-FieldLength(UL-AM-RLC)	size12
sn-FieldLength(DL-AM-RLC)	size12

7.1.2.3.5.3.2 Test procedure sequence

Table 7.1.2.3.5.3.2-1: Main behaviour

St	Procedure	Message Sequence		TP	Verdict
		U - S	Message		
0	The SS does not allocate any uplink grant.	-	-	-	-
-	EXCEPTION: The SS is configured for step 1 500 ms in advance. The transmissions are performed every second radio frame. Step 2 is started 100 ms after the first DL AMD PDU has been transmitted in step 1.	-	-	-	-
-	EXCEPTION: Step 1 a1 shall be repeated from j=0 to j=	-	-	-	-

	FLOOR((Maximum_RLC_SN/iteration size) -1, and the last repetition shall execute Step 1b1. (Note 1) (Note 3) (Note 4) (Note 6)				
1a1	The SS transmits several RLC PDUs in a RLC PDU List, the number of RLC PDUs sent is defined by the iteration_size. Each RLC Data PDU contains one RLC SDU. (Note 8) (Note 9) (Note 5)	<--	RLC Data PDU (SN = j*iteration_size, SN=(((j+1)*iteration_size)-1))	-	-
1b1	The SS transmits several RLC PDUs in a RLC PDU List, the number of RLC PDUs sent is defined by the iteration_size+1. Each RLC Data PDU contains one RLC SDU. The SS transmits AMD PDU(SN=W+1) as last packet (Note 8) (Note 9) (Note 5)	<--	RLC Data PDU (SN = j*iteration_size, SN=(((j+1)*iteration_size))	-	-
1A	Void	-	-	-	-
2	In the following steps the SS transmits 1 UL grant in every second radio frame to enable the UE to return each received AMD PDU in one looped back AMD PDU. (Note 2)	<--	(UL grants)	-	-
-	EXCEPTION: Step 2A shall be repeated from j=0 to j=FLOOR((Maximum_RLC_SN/iteration size). (Note 1) (Note 3) (Note 4) (Note 6)	-	-	-	-
-	EXCEPTION: In Step 2A, SS shall receive a RLC PDU and step 2A is repeated from SN=j*iteration_size to SN=(((j+1)*iteration_size)-1). (Note 1) (Note 3) (Note 4) (Note 6) (Note 8) (Note 9)	-	-	-	-
2A	Check: Does UE transmit a RLC Data PDU with the Poll bit not set and with SN=0 for the first RLC Data PDU and then incremented by 1 at each RLC Data PDU? (Note 7)(Note 10)	-->	RLC Data PDU (SN = j*iteration_size, SN=(((j+1)*iteration_size)-1))	1	P
3	Check: Does the UE transmit the (W)st AMD PDU with the Poll bit set and with the contents of the SDU?	-->	AMD PDU(SN=W-1), Poll	1	P
4	The SS starts the UL default grant transmission.	-	-	-	-
5	Check: Does the UE transmit an AMD PDU within $t\text{-PollRetransmit}/2$?	-->	AMD PDU	1	F
6	The SS transmits a STATUS PDU to acknowledge the W uplink AMD PDUs with SN=0 to SN=W-1. ACK_SN = W.	<--	STATUS PDU	-	-
7	Check: Does the UE transmit an AMD PDU with the Poll bit set and with the contents of the SDU?	-->	AMD PDU(SN=W), Poll	2	P
8	The SS transmits a STATUS PDU with ACK_SN = W+1.	<--	STATUS PDU	-	-
9	The SS transmits the (W+2)nd AMD PDU containing a SDU to the UE with the Sequence Number field set to ((2W+1 mod AM_Modulus) = 1) and the Polling bit set. (Note 3) (Note 5)	<--	AMD PDU	-	-
10	Check: Does the UE transmit a STATUS PDU acknowledging W+1 SDUs? (ACK_SN = W+1). (Note 1)	-->	STATUS PDU	3	P
11	The SS transmits the (W+2)nd AMD PDU to the UE with the Sequence Number field set to W+1 and the Polling bit set. (Note 5)	<--	AMD PDU	-	-
-	EXCEPTION: Steps 12 and 13 can happen in any order	-	-	-	-
12	Check: Does the UE transmit a STATUS PDU acknowledging W+1 PDUs? (ACK_SN field = W+2). (Note 11)	-->	STATUS PDU	4	P
13	Check: Does the UE transmit an AMD PDU with the same data as received in the corresponding DL AMD PDU in step 11? (Note 11)	-->	AMD PDU	4	P
14	The SS transmits a STATUS PDU with ACK_SN = W+2.	<--	STATUS PDU	-	-

Note 1: PDUs are numbered 1,2, ..., W+2.
 Note 2: 20 ms gap between transmissions both in DL and UL respectively allows TTCN to tolerate one HARQ retransmission (FDD/TDD) per transport block.
 Note 3: AM_Modulus is 4096 resp 262144 for SN size is size12 or size18.
 Note 4: The RLC SDU size shall be 4 octets(3 octets of PDCP header + 1 octet PDCP SDU).
 If SN size is size18 is used the RLC SDU size shall be 7 octets. With 2 octets of BSR or padding, 2 octets of MAC header and 3 octets of RLC header (without SO) the RLC PDU consists of 56 bits and a TBS of 112 bits shall be allocated
 Note 5: PDCP SN=W+1
 Note 6: Maximum_RLC_SN = W-1.
 Note 7: The verdict shall be provided each time (SN+1) mod 256 = 0 resp. (SN+1) mod 4096 = 0, if SN size is size12 or size18.
 Note 8: Iteration will be 2¹¹ in case of len12bits. Small RLC SDU size will be used and no repetition will be needed.
 Note 9: Iteration will be incremented by iteration_size of 2¹¹ for SN len18bits. Small RLC SDU size will be used and it shall be repeated FLOOR(Maximum_RLC_SN/iteration_size).
 Note 10: -2 for the last iteration, as the last reception will be handled by step 3.
 Note 11: STATUS PDU at step 12 and AMD PDU at step 13 may be received by SS in the same slot or in multiple slots

7.1.2.3.5.3.3 Specific message contents

None

7.1.2.3.5a AM RLC / 18-bit SN / Control of transmit window / Control of receive window

7.1.2.3.5a.1 Test Purpose (TP)

(1)

```
with { UE in RRC_CONNECTED state with AM RLC 18 bit SN and pending uplink data for transmission }
ensure that {
  when { AMD PDUs in transmission buffer fall outside TX_Next_Ack <= SN < TX_Next_Ack +
AM_Window_Size }
  then { UE does not transmit these AMD PDUs }
}
```

(2)

```
with { UE in RRC_CONNECTED state with AM RLC 18 bit SN and pending uplink data for transmission }
ensure that {
  when { receiving a STATUS PDU where ACK_SN acknowledges at least one AMD PDU not yet acknowledged }
  then { UE transmits AMD PDUs within updated window range }
}
```

(3)

```
with { UE in RRC_CONNECTED state with AM RLC 18 bit SN }
ensure that {
  when { the UE receives AMD PDUs with SN outside the upper boundary of the receive window }
  then { the UE discards these AMD PDUs }
}
```

(4)

```
with { UE in RRC_CONNECTED state with AM RLC 18 bit SN }
ensure that {
  when { the receive window has been moved }
  then { UE continues accepting AMD PDUs within updated window range }
}
```

7.1.2.3.5a.2 Conformance requirements

Same as conformance requirements in clause 7.1.2.3.5.2.

7.1.2.3.5a.3 Test description

7.1.2.3.5a.3.1 Pre-test conditions

Same Pre-test conditions as in clause 7.1.2.1.1 with the exception that the AM DRB is configured according to Table 7.1.2.3.5a.3.1-1.

Table 7.1.2.3.5a.3.1-1: RLC parameters

t-PollRetransmit	ms300
pollPDU	infinity
pollByte	infinity
sn-FieldLength(UL-AM-RLC)	size18
sn-FieldLength(DL-AM-RLC)	size18

7.1.2.3.5a.3.2 Test procedure sequence

Same as test procedure in clause 7.1.2.3.5.3.2

7.1.2.3.5a.3.3 Specific message contents

None.

7.1.2.3.6 AM RLC / Polling for status

7.1.2.3.6.1 Test Purpose (TP)

(1)

```
with { UE in RRC_CONNECTED state and using AM RLC }
ensure that {
  when { last data in the UL buffer is being transmitted }
  then { UE transmits a Poll }
}
```

(2)

```
with { UE in RRC_CONNECTED state and using AM RLC }
ensure that {
  when { the t-PollRetransmit timer expires }
  then { UE transmits a Poll }
}
```

(3)

```
with { UE in RRC_CONNECTED state and using AM RLC }
ensure that {
  when { PDU_WITHOUT_POLL >= pollPDU }
  then { UE transmits a Poll }
}
```

(4)

```
with { UE in RRC_CONNECTED state and using AM RLC }
ensure that {
  when { BYTE_WITHOUT_POLL >= pollByte }
  then { UE transmits a Poll }
}
```

7.1.2.3.6.2 Conformance requirements

References: The conformance requirements covered in the present TC are specified in: TS 38.322, clauses 5.3.3.2, 7.3 and 7.4. Unless otherwise stated these are Rel-15 requirements.

[TS 38.322, clause 5.3.3.2]

Upon notification of a transmission opportunity by lower layer, for each AMD PDU submitted for transmission such that the AMD PDU contains either a not previously transmitted RLC SDU or an RLC SDU segment containing not previously transmitted byte segment, the transmitting side of an AM RLC entity shall:

- increment PDU_WITHOUT_POLL by one;
- increment BYTE_WITHOUT_POLL by every new byte of Data field element that it maps to the Data field of the AMD PDU;
- if PDU_WITHOUT_POLL \geq pollPDU; or
- if BYTE_WITHOUT_POLL \geq pollByte:
 - include a poll in the AMD PDU as described below.

Upon notification of a transmission opportunity by lower layer, for each AMD PDU submitted for transmission, the transmitting side of an AM RLC entity shall:

- if both the transmission buffer and the retransmission buffer becomes empty (excluding transmitted RLC SDUs or RLC SDU segments awaiting acknowledgements) after the transmission of the AMD PDU; or
- if no new RLC SDU can be transmitted after the transmission of the AMD PDU (e.g. due to window stalling);
 - include a poll in the AMD PDU as described below.

NOTE: Empty RLC buffer (excluding transmitted RLC SDUs or RLC SDU segments awaiting acknowledgements) should not lead to unnecessary polling when data awaits in the upper layer. Details are left up to UE implementation.

To include a poll in an AMD PDU, the transmitting side of an AM RLC entity shall:

- set the P field of the AMD PDU to "1";
- set PDU_WITHOUT_POLL to 0;
- set BYTE_WITHOUT_POLL to 0.

After submitting an AMD PDU including a poll to lower layer and after incrementing of TX_Next if necessary, the transmitting side of an AM RLC entity shall:

- set POLL_SN to TX_Next – 1;
- if *t-PollRetransmit* is not running:
 - start *t-PollRetransmit*.
- else:
 - restart *t-PollRetransmit*.

[TS 38.322, clause 5.3.3.4]

Upon expiry of *t-PollRetransmit*, the transmitting side of an AM RLC entity shall:

- if both the transmission buffer and the retransmission buffer are empty (excluding transmitted RLC SDU or RLC SDU segment awaiting acknowledgements); or
- if no new RLC SDU or RLC SDU segment can be transmitted (e.g. due to window stalling):
 - consider the RLC SDU with SN = TX_Next – 1 for retransmission; or
 - consider any RLC SDU which has not been positively acknowledged for retransmission.
- include a poll in an AMD PDU as described in section 5.3.3.2.

[TS 38.322, clause 7.3]

a) t-PollRetransmit

This timer is used by the transmitting side of an AM RLC entity in order to retransmit a poll (see sub clause 5.3.3).

[TS 38.322, clause 7.4]

b) pollPDU

This parameter is used by the transmitting side of each AM RLC entity to trigger a poll for every pollPDU PDUs (see subclause 5.3.3).

c) pollByte

This parameter is used by the transmitting side of each AM RLC entity to trigger a poll for every pollByte bytes (see subclause 5.3.3).

7.1.2.3.6.3 Test description

7.1.2.3.6.3.1 Pre-test conditions

Same Pre-test conditions as in clause 7.1.2.1.1 with the exception that the AM DRB is configured according to Table 7.1.2.3.6.3.1-1.

Table 7.1.2.3.6.3.1-1: RLC parameters

t-PollRetransmit	ms400
pollPDU	p256
pollByte	kB25

7.1.2.3.6.3.2 Test procedure sequence

Table 7.1.2.3.6.3.2-1: Main behaviour

St	Procedure	Message Sequence		TP	Verdict
		U - S	Message		
1	During the whole test sequence, the SS should not allocate UL grants unless when explicitly stated so in the procedure.	-	-	-	-
2	The SS transmits 4 AMD PDUs such that 1 AMD PDU is sent every two radio frame, each containing an RLC SDU of 976 bits. (Note 2)	<--	AMD PDU (SN=0) AMD PDU (SN=1) AMD PDU (SN=2) AMD PDU (SN=3)	-	-
-	EXCEPTION: In parallel to the events described in step 3, the step specified in Table 7.1.2.3.6.3.2-2 should take place.	-	-	-	-
3	The SS waits for 100 ms after the first DL AMD PDU has been transmitted in step 2, then starts assigning UL grants in every second radio frame of size 1032 bits. (Note 1) (Note 2)	-	-	-	-
4	Check 1: Does the UE transmit an AMD PDU with a SN in range 0 to 3 and P=1? Record time T_B . Check 2: Is $(T_B - T_A) = t\text{-PollRetransmit}$?	-->	AMD PDU	2	P
5	The SS starts the UL default grant transmission on reception of SR.	-	-	-	-
6	The SS transmits an RLC Status Report ACKing reception of PDU's 0-3.	<--	STATUS PDU	-	-
7	Check: Does the UE retransmit an AMD PDU within 1 sec?	-->	AMD PDU	2	F
8	The SS transmits NR RRCReconfiguration message changing <i>pollPDU</i> to p4. (Note 3)	<--	RRCReconfiguration	-	-
8A	The UE transmits a NR <i>RRCReconfigurationcomplete</i> message.	-->	RRCReconfigurationComplete	-	-

	(Note 4)				
9	The SS stops allocating any UL grant.	-	-	-	-
10	The SS transmits 8 AMD PDUs such that 1 AMD PDU is sent every second radio frame, each containing an RLC SDU of 976 bits. (Note 2)	<--	AMD PDU (SN=4) AMD PDU (SN=5) ... AMD PDU (SN=11)	-	-
-	EXCEPTION: In parallel to the events described in step 11, the step specified in Table 7.1.2.3.6.3.2-3 should take place.	-	-	-	-
11	The SS waits for 100 ms after the first DL AMD PDU has been transmitted in step 10, then starts assigning UL grants (UL grant allocation type 2) in every second radio frame of size 1032 bits. (Note 1) (Note 2)	-	-	-	-
12	The SS transmits a Status Report with ACK_SN=12, NACK_SN=4, NACK_SN=5, NACK_SN=6 (constructed by NACK_SN Range), NACK_SN=8 and NACK_SN=9 (constructed by NACK_SN Range).	<--	STATUS PDU	-	-
12 A	Void.	-	-	-	-
13	Check: Does the UE transmit AMD PDUs with the following SN and P values? AMD PDU, SN=4, P=0 AMD PDU, SN=5, P=0 AMD PDU, SN=6, P=0 AMD PDU, SN=8, P=0 AMD PDU, SN=9, P=1	-->	AMD PDU (SN=4, P=0) AMD PDU (SN=5, P=0) AMD PDU (SN=6, P=0) AMD PDU (SN=8, P=0) AMD PDU (SN=9, P=1)	2	P
14	The SS starts the UL default grant transmission on reception of SR.	-	-	-	-
15	The SS transmits a Status Report with ACK_SN=12 and no NACK_SN.	<--	STATUS PDU	-	-
16	The SS transmits NR RRCReconfiguration message changing <i>pollPDU</i> to p256. (Note 3)	<--	RRCReconfiguration	-	-
16 A	The UE transmits a NR <i>RRCReconfigurationComplete</i> message. (Note 4)	-->	RRCReconfigurationComplete	-	-
17	The SS does not allocate any UL grant.	-	-	-	-
18	After 500 ms the SS transmits 412 AMD PDUs such that 1 AMD PDU is sent every second radio frame, each containing an RLC SDU of size 976 bits. (Note 2)	<--	AMD PDU (SN=12) AMD PDU (SN=13) ... AMD PDU (SN=423)	-	-
-	EXCEPTION: In parallel to the events described in step 19, the steps specified in Table 7.1.2.3.6.3.2-4 should take place.	-	-	-	-
19	The SS waits for 100 ms after the first DL AMD PDU has been transmitted in step 10, then starts assigning UL grants (UL grant allocation type 2) in every second radio frame of size 1032 bits. (Note 1) (Note 2)	-	-	-	-
20	The SS starts the UL default grant transmission	-	-	-	-
<p>Note 1: UL grant of 1032 bits (L_{RBS} & l_{MCS} as per 38.523-3[3] annex B) is chosen to allow the UE to loop back one SDU of size 976 bits and one short BSR (16 bits) into each MAC PDU sent in the uplink (1032 bits - 24 bit AMD PDU header - 16 bit MAC BSR CE - 16 bit MAC PDU subheader). The UE will include an SDU of size 976 bits and one short BSR in the looped back MAC PDU.</p> <p>Note 2: 20ms gap between transmissions both in DL and UL respectively allows TTCN to tolerate one HARQ retransmission (FDD/TDD) per transport block, if such happen (TS 38.523-3 [3]).</p> <p>Note 3: For EN-DC the NR RRCReconfiguration message is contained in RRCConnectionReconfiguration 36.508 [7] Table 4.6.1-8 using condition EN-DC_EmbedNR_RRCRecon.</p> <p>Note 4: For EN-DC the NR RRCReconfigurationComplete message is contained in RRCConnectionReconfigurationComplete.</p>					

Table 7.1.2.3.6.3.2-2: Parallel behaviour

St	Procedure	Message Sequence		TP	Verdict
		U - S	Message		
1	Check: Does the UE transmit 4 AMD PDUs, with only the last one having the poll bit set? Record time T _A when the PDU with the poll bit set is received at the SS.	-->	AMD PDUs	1	P

Table 7.1.2.3.6.3.2-3: Parallel behaviour

St	Procedure	Message Sequence		TP	Verdict
		U - S	Message		
1	Check: Does the UE transmit 8 AMD PDUs, with the poll bit set only in the 4 th and the 8 th PDUs?	-->	AMD PDUs	3	P

Table 7.1.2.3.6.3.2-4: Parallel behaviour

St	Procedure	Message Sequence		TP	Verdict
		U - S	Message		
1	Check: Does the UE transmit 205 AMD PDUs, with the poll bit set only in the last (205 th) one? (Note 1)	-->	AMD PDUs	4	P
2	The SS transmits an RLC Status Report.	<--	STATUS PDU	-	-
3	Check: Does the UE transmit 205 AMD PDUs, with the poll bit set only in the last (410 th) one? (Note 1)	-->	AMD PDUs	4	P
4	The SS transmits an RLC Status Report.	<--	STATUS PDU	-	-
5	Check: Does the UE transmit 2 AMD PDUs, with the poll bit set only in the last (412 th) one?	-->	AMD PDUs	1	P
6	The SS transmits an RLC Status Report.	<--	STATUS PDU	-	-

Note 1: (976 bits x 205PDUs) / 8 = 25010 > 25 KB, with 1 kB = 1000 bytes (TS 38.331 [12], clause 3.2)

7.1.2.3.6.3.3 Specific message contents

Table 7.1.2.3.6.3.3-1: RRCReconfiguration (steps 8 and 16, Table 7.1.2.3.6.3.2-1)

Derivation Path: 38.508-1 [4], Table 4.6.1-13			
Information Element	Value/remark	Comment	Condition
RRCReconfiguration ::= SEQUENCE {			
criticalExtensions CHOICE {			
rrcReconfiguration ::= SEQUENCE {			
secondaryCellGroup	CellGroupConfig		EN-DC
nonCriticalExtension SEQUENCE {			NR
masterCellGroup	CellGroupConfig		
}			
}			
}			
}			

Table 7.1.2.3.6.3.3-2: CellGroupConfig (Table 7.1.2.3.6.3.3-1)

Derivation Path: 38.508-1 [4], Table 4.6.3-19			
Information Element	Value/remark	Comment	Condition
CellGroupConfig ::= SEQUENCE {			
rlc-BearerToAddModList SEQUENCE (SIZE(1..maxLCH)) OF RLC-BearerConfig {	1 entry		
RLC-BearerConfig[1]	RLC-BearerConfig	entry 1	
}			

mac-CellGroupConfig	Not present		
physicalCellGroupConfig	Not present		
spCellConfig	Not present		
}			

Table 7.1.2.3.6.3.3-3: RLC-BearerConfig (Table 7.1.2.3.6.3.3-2)

Derivation Path: 38.508-1 [4], Table 4.6.3-148 with condition AM			
Information Element	Value/remark	Comment	Condition
RLC-BearerConfig ::= SEQUENCE {			
logicalChannellIdentity	Set to LCID of the DRB under test		
rlc-Config	RLC-Config		
}			

Table 7.1.2.3.6.3.3-4: RLC-Config (Table 7.1.2.3.6.3.3-3)

Derivation Path: 38.508-1 [4], Table 4.6.3-149 with condition AM			
Information Element	Value/remark	Comment	Condition
RLC-Config ::= CHOICE {			
am SEQUENCE {			
ul-AM-RLC SEQUENCE {			
sn-FieldLength	Not present		
t-PollRetransmit	ms400		
pollPDU	p4		step 8
	p256		step 16
pollByte	kB25		
}			
dl-AM-RLC SEQUENCE {			
sn-FieldLength	Not present		
}			

7.1.2.3.7 AM RLC / Receiver status triggers

7.1.2.3.7.1 Test Purpose (TP)

(1)

```
with { UE in RRC_CONNECTED state and using AM RLC }
ensure that {
  when { Reception failure of an RLC data PDU is detected and t-Reassembly expires }
  then { UE initiates Status Reporting }
}
```

(2)

```
with { UE in RRC_CONNECTED state and using AM RLC }
ensure that {
  when { Status Reporting is triggered and t-StatusProhibit is running }
  then { UE wait until t-StatusProhibit has expired to send Status Report }
}
```

(3)

```
with { UE in RRC_CONNECTED state and using AM RLC }
ensure that {
  when { Polling from peer AM RLC entity is detected and the sequence number 'x' of the PDU that
  carries the Poll satisfies x < RX_Highest_Status or x >= RX_Next + AM_Window_Size }
  then { UE initiates Status Reporting }
}
```

(4)

```

with { UE in RRC_CONNECTED state and using AM RLC }
ensure that {
  when { Polling from peer AM RLC entity is detected and the sequence number 'x' of the PDU that
  carries the Poll does not satisfies  $x < RX\_Highest\_Status$  or  $x \geq RX\_Next + AM\_Window\_Size$  }
  then { UE waits until ' $x < RX\_Highest\_Status$  or  $x \geq RX\_Next + AM\_Window\_Size$ ' before initiating
  Status Reporting}
}

```

(5)

```

with { UE in RRC_CONNECTED state and using AM RLC }
ensure that {
  when { the UE needs to send a Status Report and the UL grant is not large enough to accommodate
  the whole report }
  then { UE includes as many NACK_SNs in the Status Report as allowed by the UL grant }
}

```

(6)

```

with { UE in RRC_CONNECTED state and using AM RLC }
ensure that {
  when { the UE needs to send a Status Report and continuous sequence of RLC SDUs that have not been
  received yet }
  then { UE includes NACK_SN with NACK range }
}

```

7.1.2.3.7.2 Conformance requirements

References: The conformance requirements covered in the present TC are specified in: TS 38.322, clause 5.3.4. Unless otherwise stated these are Rel-15 requirements.

[TS 38.322, clause 5.3.4]

An AM RLC entity sends STATUS PDUs to its peer AM RLC entity in order to provide positive and/or negative acknowledgements of RLC SDUs (or portions of them).

Triggers to initiate STATUS reporting include:

- Polling from its peer AM RLC entity:
 - When an AMD PDU with $SN = x$ and the P field set to "1" is received from lower layer, the receiving side of an AM RLC entity shall:
 - if the AMD PDU is to be discarded as specified in subclause 5.2.3.2.2; or
 - if $x < RX_Highest_Status$ or $x \geq RX_Next + AM_Window_Size$:
 - trigger a STATUS report.
 - else:
 - delay triggering the STATUS report until $x < RX_Highest_Status$ or $x \geq RX_Next + AM_Window_Size$.

NOTE 1: This ensures that the RLC Status report is transmitted after HARQ reordering.

- Detection of reception failure of an AMD PDU
 - The receiving side of an AM RLC entity shall trigger a STATUS report when *t-Reassembly* expires.

NOTE 2: The expiry of *t-Reassembly* triggers both $RX_Highest_Status$ to be updated and a STATUS report to be triggered, but the STATUS report shall be triggered after $RX_Highest_Status$ is updated.

When STATUS reporting has been triggered, the receiving side of an AM RLC entity shall:

- if *t-StatusProhibit* is not running:

- at the first transmission opportunity indicated by lower layer, construct a STATUS PDU and submit it to lower layer.
- else:
 - at the first transmission opportunity indicated by lower layer after *t-StatusProhibit* expires, construct a single STATUS PDU even if status reporting was triggered several times while *t-StatusProhibit* was running and submit it to lower layer.

When a STATUS PDU has been submitted to lower layer, the receiving side of an AM RLC entity shall:

- start *t-StatusProhibit*.

When constructing a STATUS PDU, the AM RLC entity shall:

- for the RLC SDUs with SN such that $RX_Next \leq SN < RX_Highest_Status$ that has not been completely received yet, in increasing SN order of RLC SDUs and increasing byte segment order within RLC SDUs, starting with $SN = RX_Next$ up to the point where the resulting STATUS PDU still fits to the total size of RLC PDU(s) indicated by lower layer:
- for an RLC SDU for which no byte segments have been received yet:
 - include in the STATUS PDU a *NACK_SN* which is set to the SN of the RLC SDU.
- for a continuous sequence of byte segments of a partly received RLC SDU that have not been received yet:
 - include in the STATUS PDU a set of *NACK_SN*, *SOstart* and *SOend*.
- for a continuous sequence of RLC SDUs that have not been received yet:
 - include in the STATUS PDU a set of *NACK_SN* and *NACK range*;
 - include in the STATUS PDU, if required, a pair of *SOstart* and *SOend*.
- set the *ACK_SN* to the SN of the next not received RLC SDU which is not indicated as missing in the resulting STATUS PDU.

7.1.2.3.7.3 Test description

7.1.2.3.7.3.1 Pre-test conditions

Same Pre-test conditions as in clause 7.1.2.1.1 with the exception that the AM DRB is configured according to Table 7.1.2.3.7.3.1-1.

Table 7.1.2.3.7.3.1-1: RLC parameters

<i>t-Reassembly</i>	ms150
<i>t-StatusProhibit</i>	ms300
<i>t-PollRetransmit</i>	ms500

7.1.2.3.7.3.2 Test procedure sequence

Table 7.1.2.3.7.3.2-1: Main behaviour

St	Procedure	Message Sequence		TP	Verdict
		U - S	Message		
-	The SS ignores scheduling requests and does not allocate any uplink grant.	-	-	-	-
1	The SS transmits 4 AMD PDUs with SN=0, 1, 2, and 4. The SS sets the P field of all the AMD PDUs to 0. A time spacing of 20 ms is applied. Record time T_A when the AMD PDU with SN=4 is sent.	<--	AMD PDU (SN=0, P=0) AMD PDU (SN=1, P=0) AMD PDU (SN=2, P=0) AMD PDU (SN=4, P=0)	-	-

2	The SS waits for 70 ms after the transmission of the first AMD PDU to ensure UE RLC has all the required SDUs available and then assigns 3 UL grants (UL grant allocation type 2) with a time spacing of 20 ms of size 848 bits (UL Grant Allocation type 2). (Note 1)	<--	(UL grants, 848 bits)	-	-
3	The UE transmits RLC SDU#1.	-->	(RLC SDU#1)	-	-
4	The UE transmits RLC SDU#2.	-->	(RLC SDU#2)	-	-
5	The UE transmits RLC SDU#3.	-->	(RLC SDU#3)	-	-
6	60 ms after step 5, the SS transmits a STATUS PDU	<--	STATUS PDU	-	-
7	80 ms after step 5, the SS starts the UL default grant transmission.	-	-	-	-
8	Check 1: Does the UE transmit a Status Report with NACK_SN=3 and ACK_SN=5? Record time T_B (Note 5) Check 2: $(T_B - T_A) = t\text{-Reassembly?}$	-->	STATUS PDU	1	P
9	100 ms after the Status Report is received at Step 8, the SS transmits 4 AMD PDUs with SN=5, 6, 8 and 9. The SS sets the P field of all the AMD PDUs to 0. A time spacing of 20 ms is applied.	<--	AMD PDU (SN=5, P=0) AMD PDU (SN=6, P=0) AMD PDU (SN=8, P=0) AMD PDU (SN=9, P=0)	-	-
10	Check 1: Does the UE transmit a Status Report with NACK_SN=3 and ACK_SN=7? Record time T_C Check 2: $(T_C - T_B) = t\text{-StatusProhibit?}$	-->	STATUS PDU	2	P
11	The SS ignores scheduling requests unless otherwise specified and does not allocate any uplink grant.	-	-	-	-
12	200 ms after step 10, the SS transmits 2 AMD PDUs with SN=3, SN=7. The SS sets the P field of all the AMD PDUs to 0 except for that of the AMD PDU with SN=7. A time spacing of 20 ms is applied.	<--	AMD PDU (SN=3, P=0) AMD PDU (SN=7, P=1)	-	-
13	The SS waits for 100 ms after the transmission of the last AMD PDU to ensure UE RLC has all the required SDUs available and then assigns 1 UL grant (UL grant allocation type 3) of size 88 bits. (Note 2)	<--	(UL grant, 88 bits)	-	-
14	Check: Does the UE transmit a Status Report with no NACK_SN and ACK_SN = 10?	-->	STATUS PDU	3	P
15	In the second frame following the one scheduled in step 13 the SS assigns 7 UL grants (UL grant allocation type 2) with a time spacing of 20 ms of size 848 bits. (Note 1)	<--	(UL grant, 848 bits)	-	-
16	The UE transmits RLC SDU#4.	-->	(RLC SDU#4)	-	-
17	The UE transmits RLC SDU#5.	-->	(RLC SDU#5)	-	-
18	The UE transmits RLC SDU#6.	-->	(RLC SDU#6)	-	-
19	The UE transmits RLC SDU#7.	-->	(RLC SDU#7)	-	-
20	The UE transmits RLC SDU#8.	-->	(RLC SDU#8)	-	-
21	The UE transmits RLC SDU#9.	-->	(RLC SDU#9)	-	-
22	The UE transmits RLC SDU#10.	-->	(RLC SDU#10)	-	-
23	The SS transmits a STATUS PDU	<--	STATUS PDU	-	-
24	After 300 ms the SS transmits an AMD PDU with SN=11 and P=0, and an AMD PDU with SN=12 and P=1. A time spacing of 20 ms is applied.	<--	AMD PDU (SN=11, P=0) AMD PDU (SN=12, P=1)	-	-
25	Check: Does the UE transmit a scheduling request within $t\text{-Reassembly}/ 2$ ms after the transmission of the first AMD PDU of Step 24?	-->	(SR)	4	F
26	At $t\text{-Reassembly}/ 2$ ms after the transmission of the second AMD PDU of Step 24, the SS transmits an AMD PDU with SN=10 and P=0.	<--	AMD PDU (SN=10, P=0)	-	-
27	The SS waits for 60 ms to ensure UE RLC has all the required SDUs available and then assigns 1 UL grant (UL grant allocation type 3) of size 88 bits. (Note 2)	<--	(UL grant, 88 bits)	-	-

28	Check: Does the UE transmit a Status Report with no NACK_SN and ACK_SN=13?	-->	STATUS PDU	4	P
29	The SS assigns 3 UL grants (UL grant allocation type 2) with a time spacing of 20 ms of size 848 bits. (Note 1)	<--	(UL grant, 848 bits)	-	-
30	The UE transmits RLC SDU#11.	-->	(RLC SDU#11)	-	-
31	The UE transmits RLC SDU#12.	-->	(RLC SDU#12)	-	-
32	The UE transmits RLC SDU#13.	-->	(RLC SDU#13)	-	-
33	The SS transmits a STATUS PDU.	<--	STATUS PDU	-	-
34	After 300 ms the SS transmits an AMD PDU with SN=17 and P=0, and an AMD PDU with SN=19 and P=1. A time spacing of 20 ms is applied.	<--	AMD PDU (SN=17, P=0) AMD PDU (SN=19, P=1)	-	-
35	The SS waits for <i>t-Reassembly</i> ms to ensure expiry.	-	-	-	-
36	60 ms after step 35 the SS assigns an UL grant (UL grant allocation type 3) of size 88 bits. (Note 3)	<--	(UL Grant, 88 bits)	-	-
37	Check: Does the UE transmit a Status Report with ACK_SN=18 and NACK_SN: 13 including NACK Range 4 (SN 13, 14, 15, 16)?	-->	STATUS PDU	5,6	P
38	After 300 ms the SS transmits an AMD PDU with SN=16 and P=1.	<--	AMD PDU (SN=16, P=1)	-	-
39	30 ms after step 38 the SS assigns an UL grant (UL grant allocation type 3) of size 112 bits. (Note 4)	<--	(UL Grant, size 112)	-	-
40	Check: Does the UE transmit a Status Report with ACK_SN=20 and NACK_SN: 13 including NACK Range 3 (SN 13, 14, 15) and NACK_SN=18 without NACK Range?	-->	STATUS PDU	5,6	P
41	60 ms after step 38 the SS transmits 4 AMD PDUs with SN=13, 14, 15 and 18. A time spacing of 20 ms is applied.	<--	AMD PDU (SN=13, P=0) AMD PDU (SN=14, P=0) AMD PDU (SN=15, P=0) AMD PDU (SN=18, P=0)	-	-
42	130 ms after the transmission of the first AMD PDU the SS assigns 7 UL grant (UL grant allocation type 3 with a time spacing of 20 ms of size 848 bits. (Note 1)	<--	(UL grant, 848 bits)	-	-
43	The UE loops back the complete RLC SDU.	-->	(RLC SDU#14)	-	-
44	The UE loops back the complete RLC SDU.	-->	(RLC SDU#15)	-	-
45	The UE loops back the complete RLC SDU.	-->	(RLC SDU#16)	-	-
46	The UE loops back the complete RLC SDU.	-->	(RLC SDU#17)	-	-
47	The UE loops back the complete RLC SDU.	-->	(RLC SDU#18)	-	-
48	The UE loops back the complete RLC SDU.	-->	(RLC SDU#19)	-	-
49	The UE loops back the complete RLC SDU.	-->	(RLC SDU#20)	-	-
50	The SS transmits a STATUS PDU.	<--	STATUS PDU	-	-
Note 1:	UL grant of 848 bits (L_{RBs} & I_{MCS} as per 38.523-3[3] annex B) is chosen to allow the UE to transmit one PDU at a time (99 bytes RLC SDU + 3 bytes RLC Header + 2 bytes MAC Sub PDU header + 2 bytes for short BSR or padding).				
Note 2:	UL grant of 88 bits (L_{RBs} & I_{MCS} as per 38.523-3[3] annex B) is chosen to allow the UE to transmit a Status Report with ACK_SN(3 byte) + 2 byte MAC PDU subheader and (2 byte short BSR). 4 Bytes additional space provided to confirm UE does not include NACK_SN and conformant UE instead will include MAC Padding.				
Note 3:	UL grant of 88 bits (L_{RBs} & I_{MCS} as per 38.523-3[3] annex B) is chosen to allow the UE to transmit (a Status Report with ACK_SN (3 Bytes)and 1 NACK_SNs with NACK Range(4 Bytes) + MAC PDU subheader (2 Bytes) + Short BSR (2 Byte).				
Note 4:	UL grant of 112 bits (L_{RBs} & I_{MCS} as per 38.523-3[3] annex B) is chosen to allow the UE to transmit (a Status Report with ACK_SN (3 Bytes)and 1 NACK_SNs with NACK Range(4 Bytes) +NACK SN (3 Bytes) + MAC PDU subheader (2 Bytes) + Short BSR (2 Byte).				
Note 5:	Time T_B should be recorded by factoring in the SR-Periodicity as configured in the <i>SchedulingRequestResourceConfig->periodicityAndOffset</i>				

7.1.2.3.7.3.3 Specific message contents

None

7.1.2.3.8 AM RLC / Reconfiguration of RLC parameters by upper layers

7.1.2.3.8.1 Test Purpose (TP)

(1)

```
with { UE in RRC_CONNECTED state and using AM RLC }
ensure that {
  when { t-PollRetransmit value is changed during reconfiguration of RLC parameters by upper layers }
  then { UE starts using new t-PollRetransmit value }
}
```

(2)

```
with { UE in RRC_CONNECTED state and using AM RLC }
ensure that {
  when { t-Reassembly value is changed during reconfiguration of RLC parameters by upper layers }
  then { UE starts using new t-Reassembly value }
}
```

(3)

```
with { UE in RRC_CONNECTED state and using AM RLC }
ensure that {
  when { t-StatusProhibit value is changed during reconfiguration of RLC parameters by upper layers }
  then { UE starts using new t-StatusProhibit value }
}
```

7.1.2.3.8.2 Conformance requirements

References: The conformance requirements covered in the present TC are specified in: TS 38.322, clauses 5.3.3.1, 5.3.3.2, 5.3.3.3, 5.3.4 and 7.3. TS 38.331 clause 5.3.5.5.4. Unless otherwise stated these are Rel-15 requirements.

[TS 38.322, clause 5.3.3.1]

An AM RLC entity can poll its peer AM RLC entity in order to trigger STATUS reporting at the peer AM RLC entity.

[TS 38.322, clause 5.3.3.2]

Upon notification of a transmission opportunity by lower layer, for each AMD PDU submitted for transmission such that the AMD PDU contains either a not previously transmitted RLC SDU or an RLC SDU segment containing not previously transmitted byte segment, the transmitting side of an AM RLC entity shall:

- increment PDU_WITHOUT_POLL by one;
- increment BYTE_WITHOUT_POLL by every new byte of Data field element that it maps to the Data field of the AMD PDU;
- if PDU_WITHOUT_POLL >= pollPDU; or
- if BYTE_WITHOUT_POLL >= pollByte:
 - include a poll in the AMD PDU as described below.

Upon notification of a transmission opportunity by lower layer, for each AMD PDU submitted for transmission, the transmitting side of an AM RLC entity shall:

- if both the transmission buffer and the retransmission buffer becomes empty (excluding transmitted RLC SDUs or RLC SDU segments awaiting acknowledgements) after the transmission of the AMD PDU; or
- if no new RLC SDU can be transmitted after the transmission of the AMD PDU (e.g. due to window stalling);
- include a poll in the AMD PDU as described below.

NOTE: Empty RLC buffer (excluding transmitted RLC SDUs or RLC SDU segments awaiting acknowledgements) should not lead to unnecessary polling when data awaits in the upper layer. Details are left up to UE implementation.

To include a poll in an AMD PDU, the transmitting side of an AM RLC entity shall:

- set the P field of the AMD PDU to "1";
- set PDU_WITHOUT_POLL to 0;
- set BYTE_WITHOUT_POLL to 0.

After submitting an AMD PDU including a poll to lower layer and after incrementing of TX_Next if necessary, the transmitting side of an AM RLC entity shall:

- set POLL_SN to TX_Next – 1;
- if *t-PollRetransmit* is not running:
 - start *t-PollRetransmit*.
- else:
 - restart *t-PollRetransmit*.

[TS 38.322, clause 5.3.3.3]

Upon reception of a STATUS report from the receiving RLC AM entity the transmitting side of an AM RLC entity shall:

- if the STATUS report comprises a positive or negative acknowledgement for the RLC SDU with sequence number equal to POLL_SN:
 - if *t-PollRetransmit* is running:
 - stop and reset *t-PollRetransmit*.

[TS 38.322, clause 5.3.4]

Upon expiry of *t-PollRetransmit*, the transmitting side of an AM RLC entity shall:

- if both the transmission buffer and the retransmission buffer are empty (excluding transmitted RLC SDU or RLC SDU segment awaiting acknowledgements); or
- if no new RLC SDU or RLC SDU segment can be transmitted (e.g. due to window stalling):
 - consider the RLC SDU with SN = TX_Next – 1 for retransmission; or
 - consider any RLC SDU which has not been positively acknowledged for retransmission.
- include a poll in an AMD PDU as described in section 5.3.3.2.

[TS 38.322, clause 7.3]

The following timers are configured by 3GPP TS 38.331 [5]:

a) *t-PollRetransmit*

This timer is used by the transmitting side of an AM RLC entity in order to retransmit a poll (see sub clause 5.3.3).

b) *t-Reassembly*

This timer is used by the receiving side of an AM RLC entity and receiving UM RLC entity in order to detect loss of RLC PDUs at lower layer (see sub clauses 5.2.2.2 and 5.2.3.2). If *t-Reassembly* is running, *t-Reassembly* shall not be started additionally, i.e. only one *t-Reassembly* per RLC entity is running at a given time.

c) *t-StatusProhibit*

This timer is used by the receiving side of an AM RLC entity in order to prohibit transmission of a STATUS PDU (see sub clause 5.3.4).

[TS 38.331, clause 5.3.5.5.4]

For each RLC-Bearer-Config received in the rlc-BearerToAddModList IE the UE shall:

- 1> if the UE's current configuration contains a RLC bearer with the received *logicalChannelIdentity*:
- 2> if *reestablishRLC* is received:
 - 3> re-establish the RLC entity as specified in TS 38.322 [4];
- 2> reconfigure the RLC entity or entities in accordance with the received *rlc-Config*;
- 2> reconfigure the logical channel in accordance with the received *mac-LogicalChannelConfig*;

NOTE: The network does not re-associate an already configured logical channel with another radio bearer. Hence *servedRadioBearer* is not present in this case.

7.1.2.3.8.3 Test description

7.1.2.3.8.3.1 Pre-test conditions

Same Pre-test conditions as in clause 7.1.2.1.1 with the exception that the AM DRB is configured according to Table 7.1.2.3.8.3.1-1.

Table 7.1.2.3.8.3.1-1: RLC parameters

Parameter	Value
<i>t-Reassembly</i>	ms150
<i>t-StatusProhibit</i>	ms300
<i>t-PollRetransmit</i>	ms400
<i>pollPDU</i>	infinity
<i>pollByte</i>	infinity

7.1.2.3.8.3.2 Test procedure sequence

Table 7.1.2.3.8.3.2-1: Main behaviour

St	Procedure	Message Sequence		TP	Verdict
		U - S	Message/PDU/SDU		
1-29	Same expected sequence as in Table 7.1.2.3.8.3.2-2 with (X=0, <i>t-Reassembly</i> = ms150, <i>t-StatusProhibit</i> = ms300, <i>t-PollRetransmit</i> =ms400) Note 1.	-	-	1,2,3	-
30	The SS transmits NR RRCReconfiguration message to reconfigure RLC in the UE and set: - <i>t-Reassembly</i> to ms200, - <i>t-StatusProhibit</i> to ms400, - <i>t-PollRetransmit</i> to ms500. (Note 1)	<--	RRCReconfiguration	-	-
30A	The UE transmits a NR <i>RRCReconfigurationcomplete</i> message. (Note 2)	-->	RRCReconfigurationComplete	-	-
31-59	Same expected sequence as in Table 7.1.2.3.8.3.2-2 with (X=11, <i>t-Reassembly</i> = ms200, <i>t-StatusProhibit</i> = ms400, <i>t-PollRetransmit</i> =ms500).	-	-	1,2,3	-
Note 1: For EN-DC the NR RRCReconfiguration message is contained in RRCConnectionReconfiguration 36.508 [7], Table 4.6.1-8 using condition EN-DC_EmbedNR_RRCRecon.					
Note 2: For EN-DC the NR RRCReconfigurationComplete message is contained in RRCConnectionReconfigurationComplete.					

Table 7.1.2.3.8.3.2-2: Behaviour Sequence (X, t-Reassembly, t-StatusProhibit, t-PollRetransmit)

St	Procedure	Message Sequence		TP	Verdict
		U - S	Message/PDU/SDU		
1	The SS ignores scheduling requests and does not allocate any uplink grant.	-	-	-	-
2	The SS transmits 4 AMD PDUs with P=0 and SN=X, X+1, X+2 and X+4. The SS record time T_A when AMD PDU#5 (with SN=X+4) is sent. A time spacing of 20 ms is applied.	<--	AMD PDU#1 (SN=X, P=0) AMD PDU#2 (SN=X+1, P=0) AMD PDU#3 (SN=X+2, P=0) AMD PDU#5 (SN=X+4, P=0)	-	-
3	The SS waits for 70 ms after the transmission of the first AMD PDU to ensure UE RLC has all the required SDUs available and then assigns 3 UL grants of size 848 bits with a time spacing of 20 ms. (Note 1)	<--	(UL grants, 848 bits)	-	-
4	The UE transmits RLC SDU#1+X.	-->	(RLC SDU#1+X)	-	-
5	The UE transmits RLC SDU#2+X.	-->	(RLC SDU#2+X)	-	-
6	The UE transmits RLC SDU#3+X.	-->	(RLC SDU#3+X)	-	-
7	60 ms after step 3 the SS transmits a STATUS PDU.	<--	STATUS PDU	-	-
8	The SS starts the UL default grant transmission.	-	-	-	-
9	Check 1: Does the UE transmit a STATUS PDU with NACK_SN=X+3 and ACK_SN=X+5? Record time T_B (Note 5). Check 2: Is $(T_B - T_A) = t\text{-Reassembly}$?	-->	STATUS PDU	2	P
10	100 ms after the Status Report received at Step 9, the SS sends 4 AMD PDUs with P=0 and SN=X+5, X+6, X+8 and X+9. A time spacing of 20 ms is applied.	<--	AMD PDU#6 (SN=X+5, P=0) AMD PDU#7 (SN=X+6, P=0) AMD PDU#9 (SN=X+8, P=0) AMD PDU#10 (SN=X+9, P=0)	-	-
11	Check 1: Does the UE transmit a Status Report with NACK_SN=X+3 and ACK_SN=X+7? Record time T_C Check 2: $(T_C - T_B) = t\text{-StatusProhibit}$?	-->	STATUS PDU	3	P
12	The SS ignores scheduling requests and does not allocate any uplink grant.	-	-	-	-
13	After 250 ms the SS transmits 3 AMD PDUs with SN=X+3, X+7 and X+9. The SS sets the P field of all the AMD PDUs to 0 except for that of the AMD PDU with SN=X+9. A time spacing of 20 ms is applied.	<--	AMD PDU#4 (SN=X+3, P=0) AMD PDU#8 (SN=X+7, P=0) AMD PDU#10 (SN=X+9, P=1)	-	-
14	The SS waits for 150 ms after AMD PDU#4 transmission to ensure UE RLC has all the required SDUs available and then assigns 1 UL grant of size 88 bits (UL Grant Allocation type 3). (Note 2)(Note 4)	<--	(UL grant, 88 bits)	-	-
15	The UE transmits a Status Report with no NACK_SN and ACK_SN=X+10.	-->	STATUS PDU	-	-
16	In the subframe following the one scheduled in step 14 the SS assigns 7 UL grants of size 848 bits (UL Grant Allocation type 2) with a time spacing of 20 ms. (Note 1)	<--	(UL grants, 848 bits)	-	-
17	The UE transmits RLC SDU#4+X.	-->	(RLC SDU#4+X)	-	-
18	The UE transmits RLC SDU#5+X.	-->	(RLC SDU#5+X)	-	-
19	The UE transmits RLC SDU#6+X.	-->	(RLC SDU#6+X)	-	-
20	The UE transmits RLC SDU#7+X.	-->	(RLC SDU#7+X)	-	-
21	The UE transmits RLC SDU#8+X.	-->	(RLC SDU#8+X)	-	-
22	The UE transmits RLC SDU#9+X.	-->	(RLC SDU#9+X)	-	-
23	The UE transmits RLC SDU#10+X.	-->	(RLC SDU#10+X)	-	-
24	The SS transmits a STATUS PDU.	<--	STATUS PDU	-	-
25	The SS transmits an AMD PDU to the UE.	<--	AMD PDU#11 (SN=X+10, P=0)	-	-
26	The SS starts the UL default grant transmission.	-	-	-	-

27	The UE transmits an AMD PDU with the same data as received in the corresponding DL AMD PDU. Record time T_D .	-->	AMD PDU#11 (SN=X+10, P=1)	-	-
28	Check 1: Does the UE set the poll bit as both the transmission and retransmission buffers become empty? Record time T_E . Check 2: Is $(T_E - T_D) = t\text{-PollRetransmit?}$	-->	AMD PDU#11 (SN=X+10, P=1)	1	P
29	The SS transmits a STATUS PDU	<--	STATUS PDU	-	-
<p>Note 1: UL grant of 848 bits (L_{RBs} & I_{MCS} as per 38.523-3[3] annex B) is chosen to allow the UE to transmit one PDU at a time.</p> <p>Note 2: UL grant of 88 bits (L_{RBs} & I_{MCS} as per 38.523-3[3] annex B) is chosen to allow the UE to transmit a Status Report with ACK_SN(3 byte) + 2 byte MAC PDU subheader and (2 byte short BSR). 4 Bytes additional space provided to confirm UE does not include NACK_SN and conformant UE instead will include MAC Padding.</p> <p>Note 3: Every DL AMD PDU contains 1 RLC SDU size of 99 bytes.</p> <p>Note 4: Timing difference between step 11 to step 15 is equal to t-statusProhibit timer. UE starts SR from step 13 with AMD-PDU#4. 150 ms is chosen so that UE does not reach sr-transMax(n16) otherwise UE RACHes.</p> <p>Note 5: Time T_B should be recorded by factoring in the SR-Periodicity as configured in the <i>SchedulingRequestResourceConfig->periodicityAndOffset</i>.</p>					

7.1.2.3.8.3.3 Specific message contents

Table 7.1.2.3.8.3.3-1: RRCReconfiguration (step 30, Table 7.1.2.3.8.3.2-1)

Derivation Path: 38.508-1 [4], Table 4.6.1-13			
Information Element	Value/remark	Comment	Condition
RRCReconfiguration ::= SEQUENCE {			
criticalExtensions CHOICE {			
rrcReconfiguration ::= SEQUENCE {			
secondaryCellGroup	CellGroupConfig		EN-DC
nonCriticalExtension SEQUENCE {			NR
masterCellGroup	CellGroupConfig		
}			
}			
}			
}			

Table 7.1.2.3.8.3.3-2: CellGroupConfig (Table 7.1.2.3.8.3.3-1)

Derivation Path: 38.508-1 [4], Table 4.6.3-19			
Information Element	Value/remark	Comment	Condition
CellGroupConfig ::= SEQUENCE {			
rlc-BearerToAddModList SEQUENCE (SIZE(1..maxLCH)) OF RLC-BearerConfig {	1 entry		
RLC-BearerConfig[1]	RLC-BearerConfig	entry 1	
}			
mac-CellGroupConfig	Not present		
physicalCellGroupConfig	Not present		
spCellConfig	Not present		
}			

Table 7.1.2.2.8.3.3-3: RLC-BearerConfig (Table 7.1.2.3.8.3.3-2)

Derivation Path: 38.508-1 [4], Table 4.6.3-148 with condition AM			
Information Element	Value/remark	Comment	Condition
RLC-BearerConfig ::= SEQUENCE {			
logicalChannellIdentity	Set to LCID of the DRB under test		
rlc-Config	RLC-Config		
}			

Table 7.1.2.2.8.3.3-4: RLC-Config (Table 7.1.2.3.8.3.3-3)

Derivation Path: 38.508-1 [4], Table 4.6.3-149 with condition AM			
Information Element	Value/remark	Comment	Condition
RLC-Config ::= CHOICE {			
am SEQUENCE {			
ul-AM-RLC SEQUENCE {			
sn-FieldLength	Not present		
t-PollRetransmit	ms500		
}			
dl-AM-RLC SEQUENCE {			
sn-FieldLength	Not present		
t-Reassembly	ms200		
t-StatusProhibit	ms400		
}			
}			
}			

7.1.2.3.9 AM RLC / Reassembling of AMD PDUs

7.1.2.3.9.1 Test Purpose (TP)

(1)

```
with { UE in RRC_CONNECTED state }
ensure that {
  when { UE receives AMD PDUs, and all bytes of the RLC SDU(s) with SN = x are received }
  then { UE reassembles the RLC SDU(s) from AMD PDU(s) with SN = x }
}
```

(2)

```
with { UE in RRC_CONNECTED state }
ensure that {
  when { t-Reassembly expires }
  then { update RX_Highest_Status to the SN of the first RLC SDU with SN >= RX_Next_Status_Trigger
for which not all bytes have been received }
}
```

(3)

```
with { UE in RRC_CONNECTED state }
ensure that {
  when { UE receives AM PDU segments }
  then { UE delivers reassembled RLC SDU to upper layer }
}
```

(4)

```
with { UE in RRC_CONNECTED state }
ensure that {
  when { UE receives duplicate RLC AM PDU segments }
  then { UE discards duplicate RLC AMD PDU segments }
}
```

(5)

```
with { UE in RRC_CONNECTED state }
ensure that {
  when { UE receives RLC AMD PDU segments with segments lost }
  then { UE transmits STATUS PDU to request retransmission of missing segments }
}
```

(6)

```
with { UE in RRC_CONNECTED state }
```

```

ensure that {
  when { UE receives overlapping RLC AMD PDU segments }
  then { UE discards duplicate RLC AMD PDU byte segments }
}

```

(7)

```

with { UE in RRC_CONNECTED state }
ensure that {
  when { UE receives an AMD PDU with a SN gap }
  then { UE sends STATUS PDU to request retransmissions of PDUs in the SN gap }
}

```

7.1.2.3.9.2 Conformance requirements

References: The conformance requirements covered in the present TC are specified in: 3GPP TS 38.322 clauses 4.2.1.3.3, 5.2.3.2.1, 5.2.3.2.2, 5.2.3.2.3, 5.2.3.2.4 and 5.3.4. Unless otherwise stated these are Rel-15 requirements.

[TS 38.322, clause 4.2.1.3.3]

When the receiving side of an AM RLC entity receives AMD PDUs, it shall:

- detect whether or not the AMD PDUs have been received in duplication, and discard duplicated AMD PDUs;
- detect the loss of AMD PDUs at lower layers and request retransmissions to its peer AM RLC entity;
- reassemble RLC SDUs from the received AMD PDUs and deliver the RLC SDUs to upper layer as soon as they are available.

[TS 38.322, clause 5.2.3.2.1]

The receiving side of an AM RLC entity shall maintain a receiving window according to the state variable `RX_Next` as follows:

- a SN falls within the receiving window if $RX_Next \leq SN < RX_Next + AM_Window_Size$;
- a SN falls outside of the receiving window otherwise.

When receiving an AMD PDU from lower layer, the receiving side of an AM RLC entity shall:

- either discard the received AMD PDU or place it in the reception buffer (see sub clause 5.2.3.2.2);
- if the received AMD PDU was placed in the reception buffer:
 - update state variables, reassemble and deliver RLC SDUs to upper layer and start/stop t-Reassembly as needed (see sub clause 5.2.3.2.3).

When t-Reassembly expires, the receiving side of an AM RLC entity shall:

- update state variables and start t-Reassembly as needed (see sub clause 5.2.3.2.4).

[TS 38.322, clause 5.2.3.2.2]

When an AMD PDU is received from lower layer, where the AMD PDU contains byte segment numbers y to z of an RLC SDU with $SN = x$, the receiving side of an AM RLC entity shall:

- if x falls outside of the receiving window; or
- if byte segment numbers y to z of the RLC SDU with $SN = x$ have been received before:
 - discard the received AMD PDU.
- else:
 - place the received AMD PDU in the reception buffer;
 - if some byte segments of the RLC SDU contained in the AMD PDU have been received before:
 - discard the duplicate byte segments.

[TS 38.322, clause 5.2.3.2.3]

When an AMD PDU with SN = x is placed in the reception buffer, the receiving side of an AM RLC entity shall:

- if $x \geq \text{RX_Next_Highest}$
 - update RX_Next_Highest to $x + 1$.
- if all bytes of the RLC SDU with SN = x are received:
 - reassemble the RLC SDU from AMD PDU(s) with SN = x, remove RLC headers when doing so and deliver the reassembled RLC SDU to upper layer;
 - if $x = \text{RX_Highest_Status}$,
 - update RX_Highest_Status to the SN of the first RLC SDU with SN > current RX_Highest_Status for which not all bytes have been received.
 - if $x = \text{RX_Next}$:
 - update RX_Next to the SN of the first RLC SDU with SN > current RX_Next for which not all bytes have been received.
- if t-Reassembly is running:
 - if $\text{RX_Next_Status_Trigger} = \text{RX_Next}$; or
 - if $\text{RX_Next_Status_Trigger} = \text{RX_Next} + 1$ and there is no missing byte segment of the SDU associated with SN = RX_Next before the last byte of all received segments of this SDU; or
 - if $\text{RX_Next_Status_Trigger}$ falls outside of the receiving window and $\text{RX_Next_Status_Trigger}$ is not equal to $\text{RX_Next} + \text{AM_Window_Size}$:
 - stop and reset t-Reassembly.
- if t-Reassembly is not running (includes the case t-Reassembly is stopped due to actions above):
 - if $\text{RX_Next_Highest} > \text{RX_Next} + 1$; or
 - if $\text{RX_Next_Highest} = \text{RX_Next} + 1$ and there is at least one missing byte segment of the SDU associated with SN = RX_Next before the last byte of all received segments of this SDU:
 - start t-Reassembly;
 - set $\text{RX_Next_Status_Trigger}$ to RX_Next_Highest .

[TS 38.322, clause 5.2.3.2.4]

When t-Reassembly expires, the receiving side of an AM RLC entity shall:

- update RX_Highest_Status to the SN of the first RLC SDU with SN $\geq \text{RX_Next_Status_Trigger}$ for which not all bytes have been received;
- if $\text{RX_Next_Highest} > \text{RX_Highest_Status} + 1$: or
- if $\text{RX_Next_Highest} = \text{RX_Highest_Status} + 1$ and there is at least one missing byte segment of the SDU associated with SN = RX_Highest_Status before the last byte of all received segments of this SDU:
 - start t-Reassembly;
 - set $\text{RX_Next_Status_Trigger}$ to RX_Next_Highest .

[TS 38.322, clause 5.3.4]

An AM RLC entity sends STATUS PDUs to its peer AM RLC entity in order to provide positive and/or negative acknowledgements of RLC SDUs (or portions of them).

Triggers to initiate STATUS reporting include:

- Polling from its peer AM RLC entity:
 - When an AMD PDU with SN = x and the P field set to "1" is received from lower layer, the receiving side of an AM RLC entity shall:
 - if the AMD PDU is to be discarded as specified in subclause 5.2.3.2.2; or
 - if $x < \text{RX_Highest_Status}$ or $x \geq \text{RX_Next} + \text{AM_Window_Size}$:
 - trigger a STATUS report.
 - else:
 - delay triggering the STATUS report until $x < \text{RX_Highest_Status}$ or $x \geq \text{RX_Next} + \text{AM_Window_Size}$.

NOTE 1: This ensures that the RLC Status report is transmitted after HARQ reordering.

- Detection of reception failure of an AMD PDU
 - The receiving side of an AM RLC entity shall trigger a STATUS report when t-Reassembly expires.

NOTE 2: The expiry of t-Reassembly triggers both RX_Highest_Status to be updated and a STATUS report to be triggered, but the STATUS report shall be triggered after RX_Highest_Status is updated.

When STATUS reporting has been triggered, the receiving side of an AM RLC entity shall:

- if *t-StatusProhibit* is not running:
 - at the first transmission opportunity indicated by lower layer, construct a STATUS PDU and submit it to lower layer.
- else:
 - at the first transmission opportunity indicated by lower layer after *t-StatusProhibit* expires, construct a single STATUS PDU even if status reporting was triggered several times while *t-StatusProhibit* was running and submit it to lower layer.

When a STATUS PDU has been submitted to lower layer, the receiving side of an AM RLC entity shall:

- start *t-StatusProhibit*.

When constructing a STATUS PDU, the AM RLC entity shall:

- for the RLC SDUs with SN such that $\text{RX_Next} \leq \text{SN} < \text{RX_Highest_Status}$ that has not been completely received yet, in increasing SN order of RLC SDUs and increasing byte segment order within RLC SDUs, starting with SN = RX_Next up to the point where the resulting STATUS PDU still fits to the total size of RLC PDU(s) indicated by lower layer:
 - for an RLC SDU for which no byte segments have been received yet:
 - include in the STATUS PDU a NACK_SN which is set to the SN of the RLC SDU.
 - for a continuous sequence of byte segments of a partly received RLC SDU that have not been received yet:
 - include in the STATUS PDU a set of NACK_SN, SOstart and SOend.
 - for a continuous sequence of RLC SDUs that have not been received yet:
 - include in the STATUS PDU a set of NACK_SN and NACK range;
 - include in the STATUS PDU, if required, a pair of SOstart and SOend.
- set the ACK_SN to the SN of the next not received RLC SDU which is not indicated as missing in the resulting STATUS PDU.

When STATUS reporting has been triggered, the receiving side of an AM RLC entity shall:

- if *t-StatusProhibit* is not running:
 - at the first transmission opportunity indicated by lower layer, construct a STATUS PDU and submit it to lower layer.
- else:
 - at the first transmission opportunity indicated by lower layer after *t-StatusProhibit* expires, construct a single STATUS PDU even if status reporting was triggered several times while *t-StatusProhibit* was running and submit it to lower layer.

When a STATUS PDU has been submitted to lower layer, the receiving side of an AM RLC entity shall:

- start *t-StatusProhibit*.

When constructing a STATUS PDU, the AM RLC entity shall:

- for the RLC SDUs with SN such that $RX_Next \leq SN < RX_Highest_Status$ that has not been completely received yet, in increasing SN order of RLC SDUs and increasing byte segment order within RLC SDUs, starting with SN = RX_Next up to the point where the resulting STATUS PDU still fits to the total size of RLC PDU(s) indicated by lower layer:
 - for an RLC SDU for which no byte segments have been received yet:
 - include in the STATUS PDU a NACK_SN which is set to the SN of the RLC SDU.
 - for a continuous sequence of byte segments of a partly received RLC SDU that have not been received yet:
 - include in the STATUS PDU a set of NACK_SN, SOstart and SOend.
 - for a continuous sequence of RLC SDUs that have not been received yet:
 - include in the STATUS PDU a set of NACK_SN and NACK range;
 - include in the STATUS PDU, if required, a pair of SOstart and SOend.
 - set the ACK_SN to the SN of the next not received RLC SDU which is not indicated as missing in the resulting STATUS PDU.

7.1.2.3.9.3 Test description

7.1.2.3.9.3.1 Pre-test conditions

Same Pre-test conditions as in clause 7.1.2.1.1 with the exception that the AM DRB is configured according to Table 7.1.2.3.9.3.1-1.

Table 7.1.2.3.9.3.1-1: RLC parameters

Parameter	Value
<i>t-Reassembly</i>	ms150
<i>t-StatusProhibit</i>	ms300
<i>t-PollRetransmit</i>	ms500

7.1.2.3.9.3.2 Test procedure sequence

Table 7.1.2.3.9.3.2-1: Main behaviour

St	Procedure	Message Sequence		TP	Verdict
		U - S	Message/PDU/SDU		
0	The SS stops the UL grant transmission.	-	-	-	-
1	The SS transmits AMD PDU#1	<--	AMD PDU#1 (SN=3)	-	-

	containing a complete RLC SDU#4 (89 bytes and SI field=00). (Note 4)				
2	The SS transmits AMD PDU#2 containing the last segment (44 bytes) of RLC SDU#1 (SI field=10, SO=45).	<--	AMD PDU#2 (SN=0) segment 2	-	-
3	The SS transmits AMD PDU#3 containing the last segment (44 bytes) of RLC SDU#2 (SI field=10, SO=45).	<--	AMD PDU#3 (SN=1) segment 2	-	-
4	The SS transmits AMD PDU#4 containing the first segment (45 bytes) of RLC SDU#2 (SI field=01).	<--	AMD PDU#4 (SN=1) segment 1	-	-
5	The SS transmits AMD PDU#5 containing the first segment (45 bytes) of RLC SDU#1 (SI field=01).	<--	AMD PDU#5 (SN=0) segment 1	-	-
6	The SS waits for 20 ms then SS transmits 2 uplink grants with a time spacing of 20 ms. (Note 1)	<--	UL Grants	-	-
7	Check: Does the UE transmit an AMD PDU containing RLC SDU#1 in its data field?	-->	AMD PDU (RLC SDU#1)	1,3	P
8	Check: Does the UE transmit an AMD PDU containing RLC SDU#2 in its data field?	-->	AMD PDU (RLC SDU#2)	1,3	P
9	Void				
9A	110 ms after step 5 the SS starts the UL default grant transmission.	<--	UL Grant	-	-
10	Wait for t-reassembly of UE side to expire. Check: Does the UE transmit an RLC STATUS PDU with NACK_SN=2 and ACK_SN=4 to correctly inform SS of missing RLC SDU#3?	-->	STATUS PDU (ACK_SN=4, NACK_SN=2)	2,7	P
10A	The SS stops the UL grant transmission.	-	-	-	-
11	120 ms after step 10 the SS transmits AMD PDU#6 containing the first 45 bytes of SDU#3 in its data field. SO=0 and LSF=0. No header extension part is provided.(Note 5)	<--	AMD PDU#6 (SN=2) segment 1	-	-
11A	20 ms after step 11 the SS transmits AMD PDU#6 containing the first 45 bytes of SDU#3 in its data field. SO=0 and LSF=0. No header extension part is provided.	<--	AMD PDU#6 (SN=2) segment 1	-	-
12	40 ms after step 11 the SS transmits AMD PDU#12 containing the last 44 bytes of SDU#3 in its data field, with the P-bit set. SO=45 and LSF=1. No header extension part is provided.	<--	AMD PDU#12 (SN=2, P=1) segment 2	-	-
13	After the expiry of t-StatusProhibit timer started at step 10, the SS assigns 1 UL grant (UL grant allocation type 3) of size 88 bits. (Note 2)	<--	UL Grant	-	-
14	Check: Does the UE transmit a STATUS PDU with ACK_SN=4, thus acknowledging the reception of PDUs with SN=0 to SN=3, and no NACK_SN provided?	-->	STATUS PDU	1,3,4	P

14A	The SS waits for 40 ms to ensure UE has all the required SDUs available and then assigns 2 UL grants of 768 bits (Note 1).	<--	UL Grant	-	-
15	Check: Does the UE transmit RLC SDU#3?	-->	(RLC SDU#3)	1,3,4	P
15A	Check: Does the UE transmit RLC SDU#4 with the P-bit set?	-->	(RLC SDU#4)	1,3,4	P
16	The SS transmits a STATUS PDU.	<--	STATUS PDU (ACK SN=4)	-	-
17	The SS transmits AMD PDU#7 containing the last segment (44 bytes) of RLC SDU#5 (SI field=10, SO=45).	<--	AMD PDU#7 (SN=4) segment 2	-	-
17A	The SS starts the UL default grant transmission.	<--	UL Grant	-	-
18	Wait for t-reassembly of UE side to expire. Check: Does the UE transmit an RLC STATUS PDU with ACK_SN=5, NACK_SN=4 with SOStart=0 and SOEnd=44?	-->	STATUS PDU (ACK_SN=5, NACK_SN=4 with SOStart=0 /SOEnd=44)	2,5	P
18A	The SS stops the UL grant transmission.	-	-	-	-
19	160 ms after step 18 The SS transmits AMD PDU#8 containing the first segment (45 bytes) of RLC SDU#5 (SI field=01). (Note 6)	<--	AMD PDU#8 (SN=4, P=1) segment 1	-	-
20	Void				
21	Void				
21A	After the expiry of t-StatusProhibit timer started at step 18, the SS assigns 1 UL grant (UL grant allocation type 3) of size 88 bits. (Note 2)	<--	UL Grant	-	-
22	Check: Does the UE transmit an RLC STATUS PDU with ACK_SN=5?	-->	STATUS PDU (ACK_SN=5)	1,3,5	P
22A	The SS waits for 100 ms then SS transmits one uplink grant. (Note 1)	<--	UL Grant	-	-
22B	Check: Does the UE transmit an AMD PDU containing RLC SDU#5 in its data field with the P-bit set?	-->	AMD PDU (RLC SDU#5)	1,3,5	P
22C	The SS transmits a STATUS PDU	<--	STATUS PDU (ACK SN=5)		
23	The SS transmits AMD PDU#9 containing the last 29 bytes of RLC SDU#6 (SI field=10, SO=60).	<--	AMD PDU#9 (SN=5) segment 3	-	-
23A	The SS starts the UL default grant transmission.	<--	UL Grant	-	-
24	Wait for t-reassembly of UE side to expire. Check: Does the UE transmit an RLC STATUS PDU with ACK_SN=6, NACK_SN=5 with SOStart=0 and SOEnd=59?	-->	STATUS PDU (ACK_SN=6, NACK_SN=5 with SOStart=0 / SOEnd=59)	2,5	P
25	The SS transmits AMD PDU#10 containing the last 49 byte of RLC SDU#6 (SI field=10, SO=40).	<--	AMD PDU#10 (SN=5) segment 2	-	-
25A	Void.				

26	Wait for t-reassembly of UE side to expire. Check: Does the UE transmit an RLC STATUS PDU with ACK_SN=6, NACK_SN=5 with SOStart=0 and SOEnd=39?	-->	STATUS PDU (ACK_SN=6, NACK_SN=5 with SOStart=0 / SOEnd=39)	2,6	P
26A	The SS stops the UL grant transmission.	-	-	-	-
27	160 ms after step 26 The SS transmits AMD PDU#11 containing the first 40 bytes of RLC SDU#6 (SI field =01).	<--	AMD PDU#11 (SN=5, P=1) segment 1	-	-
28	Void				
29	Void				
29A	After the expiry of t-StatusProhibit timer started at step 26, the SS assigns 1 UL grant (UL grant allocation type 3) of size 88 bits. (Note 2, Note 7)	<--	UL Grant	-	-
30	Check: Does the UE transmit an RLC STATUS PDU with ACK_SN=6, thus acknowledging the reception of RLC SDUs with SN=0 to SN=5, and no NACK_SN provided?	-->	STATUS PDU (ACK_SN=6)	1,3,6	P
30A	The SS transmits one uplink grant. (Note 1)	<--	UL Grant	-	-
30B	Check: Does the UE transmit an AMD PDU containing RLC SDU#6 in its data field with the P-bit set?	-->	AMD PDU (RLC SDU#6)	1,3,6	P
31	The SS transmits a STATUS PDU.	<--	STATUS PDU (ACK SN=6)	-	-
<p>Note 1: UL grant of 768 bits(L_{RBs} & I_{MCS} as per 38.523-3[3] annex B) is chosen to allow the UE to transmit one PDU at a time(89 bytes RLC SDU + 3 bytes RLC Header + 2 bytes MAC Sub PDU header + 2 bytes for short BSR or padding).</p> <p>Note 2: UL grant of 88 bits (L_{RBs} & I_{MCS} as per 38.523-3 [3] annex B) is chosen to allow the UE to transmit a Status Report with ACK_SN(3 byte) + 2 Bytes MAC PDU subheader and (2 Bytes short BSR). 4 Bytes additional space provided to confirm UE does include resp. does not include NACK_SN and conformant UE instead will include MAC Padding.</p> <p>Note 3: Void</p> <p>Note 4: The PDUs in steps 1-5 are scheduled with a 20 ms time spacing. The UL grant provision in step 6 is scheduled 20 ms later That way this step sequence takes less than t-Reassembly.</p> <p>Note 5: Timing difference between step 10 to step 14 is equal to t-statusProhibit timer. UE starts SR from step 12. 120 ms is chosen so that UE does not reach sr-transMax(n16) otherwise UE RACHes.</p> <p>Note 6: Timing difference between step 18 to step 22 is equal to t-statusProhibit timer. UE starts SR from step 19. 160 ms is chosen so that UE does not reach sr-transMax(n16) otherwise UE RACHes.</p> <p>Note 7: Timing difference between step 26 to step 30 is equal to t-statusProhibit timer. UE starts SR from step 27. 160 ms is chosen so that UE does not reach sr-transMax(n16) otherwise UE RACHes.</p>					

7.1.2.3.9.3.3 Specific message contents

None.

7.1.2.3.10 AM RLC / Re-transmission of RLC PDU with and without re-segmentation

7.1.2.3.10.1 Test Purpose (TP)

(1)

```

with { UE in RRC_CONNECTED state }
ensure that {
  when { UE receives a STATUS PDU including a NACK_SN for missing AMD PDUs and missing AMD PDUs can
be transmitted as indicated by lower layer at the particular transmission opportunity }
  then { UE successfully retransmits missing AMD PDUs without re-segmentation }

```

```
    }
```

(2)

```
with { UE in RRC_CONNECTED state }
ensure that {
  when { NACK received for missing AMD PDUs and RETX_COUNT < maxRetxThreshold }
  then { UE retransmits AMD PDUs }
}
```

(3)

```
with { UE in RRC_CONNECTED state }
ensure that {
  when { AMD PDU to be retransmitted does not fit in new allocated TBS }
  then { UE segments AMD PDU }
}
```

(4)

```
with { UE in RRC_CONNECTED state }
ensure that {
  when { AMD PDU segment to be retransmitted does not fit in new allocated TBS }
  then { UE re-segments AMD PDU segment to fit TBS }
}
```

7.1.2.3.10.2 Conformance requirements

References: The conformance requirements covered in the present test case are specified in: TS 38.322, clauses 5.3.2, 6.2.2.5, 6.2.3.3, 6.2.3.4, 6.2.3.5, 6.2.3.7, 6.2.3.10, 6.2.3.12, 6.2.3.14 and 6.2.3.15. Unless otherwise stated these are Rel-15 requirements.

[TS 38.322, clause 5.3.2]

The transmitting side of an AM RLC entity can receive a negative acknowledgement (notification of reception failure by its peer AM RLC entity) for an RLC SDU or an RLC SDU segment by the following:

- STATUS PDU from its peer AM RLC entity.

When receiving a negative acknowledgement for an RLC SDU or an RLC SDU segment by a STATUS PDU from its peer AM RLC entity, the transmitting side of the AM RLC entity shall:

- if the SN of the corresponding RLC SDU falls within the range $TX_Next_Ack \leq SN \leq$ the highest SN of the AMD PDU among the AMD PDUs submitted to lower layer:
 - consider the RLC SDU or the RLC SDU segment for which a negative acknowledgement was received for retransmission.

When an RLC SDU or an RLC SDU segment is considered for retransmission, the transmitting side of the AM RLC entity shall:

- if the RLC SDU or RLC SDU segment is considered for retransmission for the first time:
 - set the RETX_COUNT associated with the RLC SDU to zero.
- else, if it (the RLC SDU or the RLC SDU segment that is considered for retransmission) is not pending for retransmission already and the RETX_COUNT associated with the RLC SDU has not been incremented due to another negative acknowledgment in the same STATUS PDU:
 - increment the RETX_COUNT.
- if $RETX_COUNT = maxRetxThreshold$:
 - indicate to upper layers that max retransmission has been reached.

When retransmitting an RLC SDU or an RLC SDU segment, the transmitting side of an AM RLC entity shall:

- if needed, segment the RLC SDU or the RLC SDU segment;

- form a new AMD PDU which will fit within the total size of AMD PDU(s) indicated by lower layer at the particular transmission opportunity;
- submit the new AMD PDU to lower layer.

When forming a new AMD PDU, the transmitting side of an AM RLC entity shall:

- only map the original RLC SDU or RLC SDU segment to the Data field of the new AMD PDU;
- modify the header of the new AMD PDU in accordance with the description in sub clause 6.2.2.4;
- set the P field according to sub clause 5.3.3.

[TS 38.322, clause 6.2.2.4]

AMD PDU consists of a Data field and an AMD PDU header. The AMD PDU header is byte aligned.

An AM RLC entity is configured by RRC to use either a 12 bit SN or a 18 bit SN. The length of the AMD PDU header is two and three bytes respectively.

An AMD PDU header contains a D/C, a P, a SI, and a SN. An AMD PDU header contains the SO field only when the Data field consists of an RLC SDU segment which is not the first segment, in which case a 16 bit SO is present.

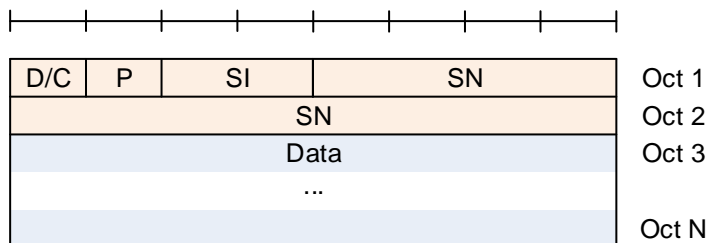

Figure 6.2.2.4-1: AMD PDU with 12 bit SN (No SO)

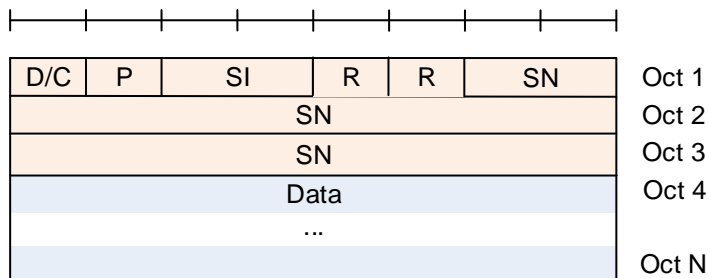

Figure 6.2.2.4-2: AMD PDU with 18 bit SN (No SO)

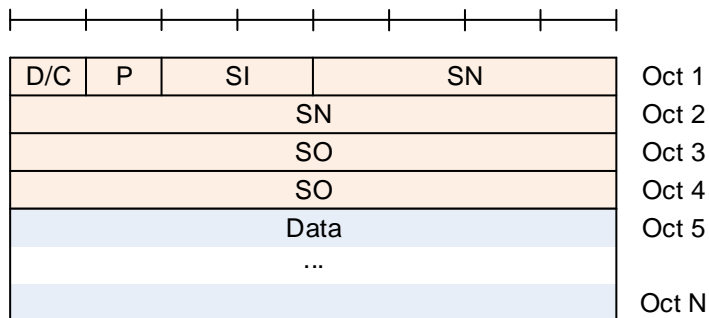

Figure 6.2.2.4-3: AMD PDU with 12 bit SN with SO

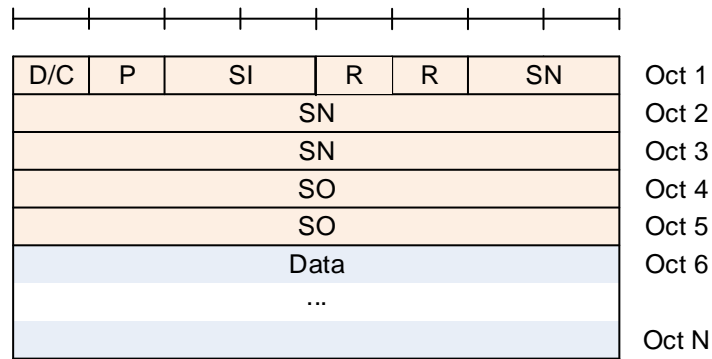

Figure 6.2.2.4-4: AMD PDU with 18 bit SN with SO

[TS 38.322, clause 6.2.2.5]

STATUS PDU consists of a STATUS PDU payload and an RLC control PDU header.

RLC control PDU header consists of a D/C and a CPT field.

The STATUS PDU payload starts from the first bit following the RLC control PDU header, and it consists of one ACK_SN and one E1, zero or more sets of a NACK_SN, an E1, an E2 and an E3, and possibly a pair of a SOstart and a SOend or a NACK range field for each NACK_SN.

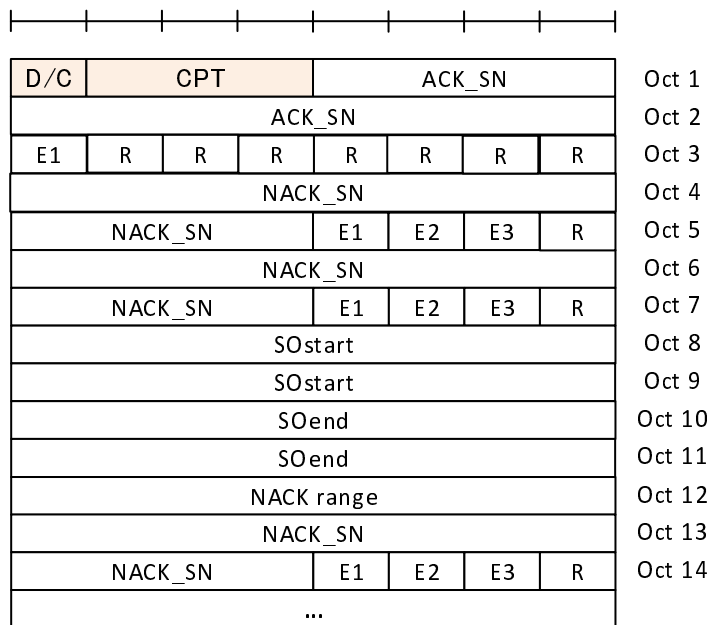

Figure 6.2.2.5-1: STATUS PDU with 12 bit SN

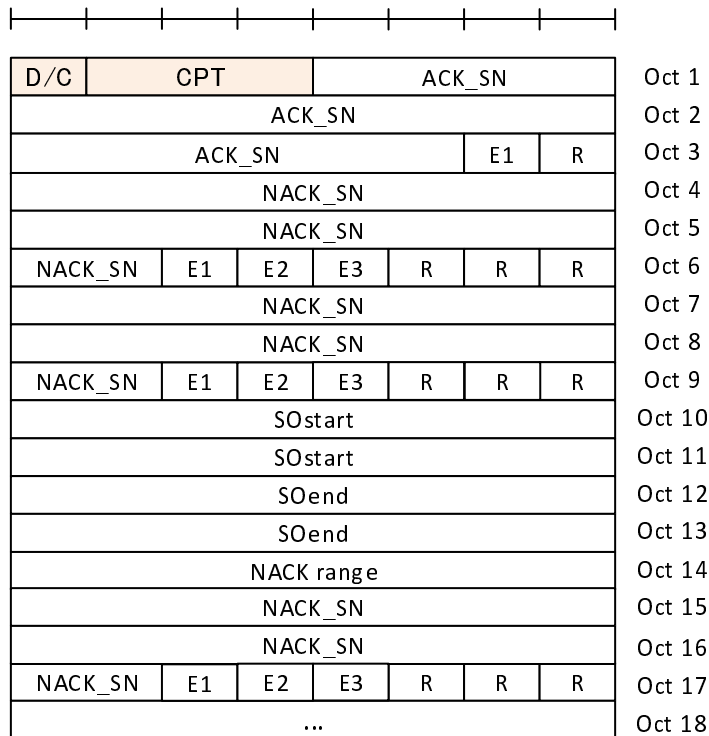

Figure 6.2.2.5-2: STATUS PDU with 18 bit SN

[TS 38.322, clause 6.2.3.3]

Length: 12 bits or 18 bits (configurable) for AMD PDU. 6 bits or 12 bits (configurable) for UMD PDU.

The SN field indicates the sequence number of the corresponding RLC SDU. For RLC AM, the sequence number is incremented by one for every RLC SDU. For RLC UM, the sequence number is incremented by one for every segmented RLC SDU.

[TS 38.322, clause 6.2.3.4]

Length: 2 bits.

The SI field indicates whether an RLC PDU contains a complete RLC SDU or the first, middle, last segment of an RLC SDU.

Table 6.2.3.4-1: SI field interpretation

Value	Description
00	Data field contains all bytes of an RLC SDU
01	Data field contains the first segment of an RLC SDU
10	Data field contains the last segment of an RLC SDU
11	Data field contains neither the first nor last segment of an RLC SDU

[TS 38.322, clause 6.2.3.5]

Length: 16 bits

The SO field indicates the position of the RLC SDU segment in bytes within the original RLC SDU. Specifically, the SO field indicates the position within the original RLC SDU to which the first byte of the RLC SDU segment in the Data field corresponds. The first byte of the original RLC SDU is referred by the SO field value "0000000000000000", i.e., numbering starts at zero.

[TS 38.322, clause 6.2.3.7]

Length: 1 bit.

The P field indicates whether or not the transmitting side of an AM RLC entity requests a STATUS report from its peer AM RLC entity. The interpretation of the P field is provided in Table 6.2.3.7-1.

Table 6.2.3.7-1: P field interpretation

Value	Description
0	Status report not requested
1	Status report is requested

[TS 38.322, clause 6.2.3.10]

Length: 12 bits or 18 bits (configurable).

The ACK_SN field indicates the SN of the next not received RLC SDU which is not reported as missing in the STATUS PDU. When the transmitting side of an AM RLC entity receives a STATUS PDU, it interprets that all RLC SDUs up to but not including the RLC SDU with SN = ACK_SN have been received by its peer AM RLC entity, excluding those RLC SDUs indicated in the STATUS PDU with NACK_SN, portions of RLC SDUs indicated in the STATUS PDU with NACK_SN, SOstart and SOend, RLC SDUs indicated in the STATUS PDU with NACK_SN and NACK_range, and portions of RLC SDUs indicated in the STATUS PDU with NACK_SN, NACK range, SOstart and SOend.

[TS 38.322, clause 6.2.3.12]

Length: 12 bits or 18 bits (configurable).

The NACK_SN field indicates the SN of the RLC SDU (or RLC SDU segment) that has been detected as lost at the receiving side of the AM RLC entity.

[TS 38.322, clause 6.2.3.14]

Length: 16 bits.

The SOstart field (together with the SOend field) indicates the portion of the RLC SDU with SN = NACK_SN (the NACK_SN for which the SOstart is related to) that has been detected as lost at the receiving side of the AM RLC entity. Specifically, the SOstart field indicates the position of the first byte of the portion of the RLC SDU in bytes within the original RLC SDU. The first byte of the original RLC SDU is referred by the SOstart field value "0000000000000000", i.e., numbering starts at zero.

[TS 38.322, clause 6.2.3.15]

Length: 16 bits.

When E3 is 0, the SOend field (together with the SOstart field) indicates the portion of the RLC SDU with SN = NACK_SN (the NACK_SN for which the SOend is related to) that has been detected as lost at the receiving side of the AM RLC entity. Specifically, the SOend field indicates the position of the last byte of the portion of the RLC SDU in bytes within the original RLC SDU. The first byte of the original RLC SDU is referred by the SOend field value "0000000000000000", i.e., numbering starts at zero. The special SOend value "1111111111111111" is used to indicate that the missing portion of the RLC SDU includes all bytes to the last byte of the RLC SDU.

When E3 is 1, the SOend field indicates the portion of the RLC SDU with SN = NACK_SN + NACK range - 1 that has been detected as lost at the receiving side of the AM RLC entity. Specifically, the SOend field indicates the position of the last byte of the portion of the RLC SDU in bytes within the original RLC SDU. The first byte of the original RLC SDU is referred by the SOend field value "0000000000000000", i.e., numbering starts at zero. The special SOend value "1111111111111111" is used to indicate that the missing portion of the RLC SDU includes all bytes to the last byte of the RLC SDU.

7.1.2.3.10.3 Test description

7.1.2.3.10.3.1 Pre-test conditions

Same Pre-test conditions as in clause 7.1.2.1.1 with the exception for the AM DRB is configured according to Tables 7.1.2.3.10.3.1-1.

Table 7.1.2.3.10.3.1-1: RLC settings

Parameter	Value
<i>t-PollRetransmit</i>	ms150

7.1.2.3.10.3.2 Test procedure sequence

Table 7.1.2.3.10.3.2-1: Main behaviour

St	Procedure	Message Sequence		TP	Verdict
		U - S	Message		
1	The SS transmits one AMD PDU containing SDU#1 (91 bytes) in its data field.	<--	AMD PDU#1	-	-
2	The UE transmits one AMD PDU containing SDU#1 in its data field.	-->	AMD PDU#1 (SN=0)	-	-
3	The SS transmits one AMD PDU containing SDU#2 (91 bytes) in its data field.	<--	AMD PDU#2	-	-
4	The UE transmits one AMD PDU containing SDU#2 in its data field.	-->	AMD PDU#2 (SN=1)	-	-
5	The SS transmits a RLC STATUS PDU. ACK_SN=2, NACK_SN=0.	<--	STATUS PDU	-	-
6	Check: Does the UE transmit the AMD PDU not yet acknowledged?	-->	AMD PDU#1 (SN=0)	1	P
7	The SS transmits a RLC STATUS PDU. ACK_SN=2.	<--	STATUS PDU	-	-
8	The SS transmits one AMD PDU containing SDU#3 (91 bytes) in its data field.	<--	AMD PDU#3	-	-
9	The UE transmits an AMD PDU containing SDU#3 in its data field.	-->	AMD PDU#3 (SN=2)	-	-
-	EXCEPTION: Steps 10 to 11 shall be repeated until RETX_COUNT= maxRetxThreshold-1.	-	-	-	-
10	The SS transmits a RLC STATUS PDU. ACK_SN=3 and NACK_SN=2.	<--	STATUS PDU	-	-
11	Check: Does the UE retransmit the AMD PDU not yet acknowledged?	-->	AMD PDU#3 (SN=2)	2	P
12	The SS transmits a RLC STATUS PDU. ACK_SN=3.	<--	STATUS PDU	-	-
13	The SS stops the UL grant transmission.	-	-	-	-
14	The SS transmits one AMD PDU containing SDU#4 (91 bytes) in its data field.	<--	AMD PDU#4 (SN=3)	-	-
15	The SS waits for 60 ms and allocates one UL grant of size 808 bits. (Note 1)	<--	(UL grant, 808 bits)	-	-
16	The UE transmits an AMD PDU with the same data contents as received in the corresponding part of SDU#4?	-->	AMD PDU#4 (SN=3)	-	-
17	The SS transmits a STATUS PDU. This PDU nacks the AMD PDU with SN=3. ACK_SN=4 and NACK_SN=3.	<--	STATUS PDU	-	-
18	The SS waits for 100 ms and then allocates 1 UL grant of size 408 bits (Note 2)	<--	(UL grant, 408 bits)	-	-
18A	The SS waits for 20 ms and then allocates 1 UL grant of size 456 bits (Note 5)	<--	(UL grant, 456 bits)	-	-
19	Check: Does the UE transmit an SDU segment with SI=01 and SOEnd=43 and the same data contents at the received positions as in the original SDU#4?	-->	SDU#4 segment 1 (SN=3)	3	P

20	Check: Does the UE transmit an SDU segment with SI=10 and SOStart=44 and the same data contents at the received positions as in the original SDU#4?	-->	SDU#4 segment 2 (SN=3)	3	P
21	After 100 ms SS transmits a STATUS PDU. This PDU nacks the SDU with SN=3. NACK_SN=3, SOStart=0, SOEnd=43 and ACK_SN=4.	<--	STATUS PDU	-	-
22	The SS waits for 100 ms and then allocates 2 UL grants (UL grant allocation type 2) at an interval of 20 ms of size 240 bits (Note 3, Note 6)	<--	(UL grant, 240 bits)	-	-
22A	Void			-	-
23	Check: Does the UE transmit an AMD PDU segment with SI=01 and SOEnd=22 and the same data contents at the received positions as in the original SDU#4?	-->	SDU#4 segment 1, first part (SN=3)	4	P
24	Check: Does the UE transmit an AMD PDU segment with SI=11, SOStart=23 and the same data contents at the received positions as in the original SDU#4?	-->	SDU#4 segment 1, second part (SN=3)	4	P
25	The SS transmits a STATUS PDU. This PDU acks the AMD PDUs with SN=3. ACK_SN=4.	<--	STATUS PDU	-	-
<p>Note 1: UL grant of 808 bits=101 bytes (L_{RBs} & I_{MCS} as per 38.523-3[3] annex B) is chosen to allow the UE to transmit one PDU and 2 bytes short BSR + 3 bytes padding or 5 bytes padding at a time.</p> <p>Note 2: UL grant of 408 bits (L_{RBs} & I_{MCS} as per 38.523-3[3] annex B) is chosen such that UE will segment into 2 AMD PDUs. MAC PDU of 408 bits=51 bytes fit an AMD PDU payload of 44 bytes + 3 bytes for the first segment of the AMD PDU header + 2 bytes for MAC header + 2 bytes for MAC BSR CE.</p> <p>Note 3: UL grant of 240 bits (L_{RBs} & I_{MCS} as per 38.523-3[3] annex B) is chosen such that UE will segment into 2 AMD PDUs. MAC PDU of 240 bits=30 bytes fit an AMD PDU payload of = 23 bytes + 3 bytes for the first segment of the AMD PDU header + 2 bytes for MAC header + 2 bytes for MAC BSR CE.</p> <p>Note 4: Void.</p> <p>Note 5: UL grant of 456 bits (L_{RBs} & I_{MCS} as per 38.523-3[3] annex B) is chosen such that UE will segment into 2 AMD PDUs. MAC PDU of 456 bits=57 bytes fit an AMD PDU payload of 46 bytes + 5 bytes for the first segment of the AMD PDU header + 2 bytes for MAC header +2 bytes for possible short BSR or padding</p> <p>Note 6: UL grant of 240 bits (L_{RBs} & I_{MCS} as per 38.523-3[3] annex B) is chosen such that UE will segment into 2 AMD PDUs. MAC PDU of 240 bits=28 bytes fit an AMD PDU payload of 21 bytes + 3 bytes for the first segment of the AMD PDU header + 2 bytes for MAC header +2 bytes for possible short BSR or padding</p>					

7.1.2.3.10.3.3 Specific message contents

None.

7.1.2.3.11 AM RLC / RLC re-establishment procedure

7.1.2.3.11.1 Test Purpose (TP)

(1)

```
with { UE in RRC_CONNECTED state }
ensure that {
  when { RLC re-establishment is performed upon request by RRC }
  then { The UE discards all RLC SDUs, RLC SDU segments, and RLC PDUs, if any }
}
```

(2)

```
with { UE in RRC_CONNECTED state }
ensure that {
  when { RLC re-establishment is performed upon request by RRC }
  then { The UE resets all state variables to their initial values }
}
```

7.1.2.3.11.2 Conformance requirements

References:

The conformance requirements covered in the present test case are specified in: TS 38.322, clauses 5.1.2, 7.1 and TS 38.331 clause 5.3.11. Unless otherwise stated these are Rel-15 requirements.

[TS 38.322, clause 5.1.2]

When upper layers request an RLC entity re-establishment, the UE shall:

- discard all RLC SDUs, RLC SDU segments, and RLC PDUs, if any;
- stop and reset all timers;
- reset all state variables to their initial values.

[TS 38.322, clause 7.1]

This sub clause describes the state variables used in AM and UM entities in order to specify the RLC protocol. The state variables defined in this subclause are normative.

All state variables and all counters are non-negative integers.

All state variables related to AM data transfer can take values from 0 to 4095 for 12 bit SN or from 0 to 262143 for 18 bit SN. All arithmetic operations contained in the present document on state variables related to AM data transfer are affected by the AM modulus (i.e. final value = [value from arithmetic operation] modulo 4096 for 12 bit SN and 262144 for 18 bit SN).

All state variables related to UM data transfer can take values from 0 to 63 for 6 bit SN or from 0 to 4095 for 12 bit SN. All arithmetic operations contained in the present document on state variables related to UM data transfer are affected by the UM modulus (i.e. final value = [value from arithmetic operation] modulo 64 for 6 bit SN and 4096 for 12 bit SN).

When performing arithmetic comparisons of state variables or SN values, a modulus base shall be used.

TX_Next_Ack and RX_Next shall be assumed as the modulus base at the transmitting side and receiving side of an AM RLC entity, respectively. This modulus base is subtracted from all the values involved, and then an absolute comparison is performed (e.g. $RX_Next \leq SN < RX_Next + AM_Window_Size$ is evaluated as $[RX_Next - RX_Next] \bmod 2^{[sn-FieldLength]} \leq [SN - RX_Next] \bmod 2^{[sn-FieldLength]} < [RX_Next + AM_Window_Size - RX_Next] \bmod 2^{[sn-FieldLength]}$), where *sn-FieldLength* is 12 or 18 for 12 bit SN and 18 bit SN, respectively.

$RX_Next_Highest - UM_Window_Size$ shall be assumed as the modulus base at the receiving side of an UM RLC entity. This modulus base is subtracted from all the values involved, and then an absolute comparison is performed (e.g. $(RX_Next_Highest - UM_Window_Size) \leq SN < RX_Next_Highest$ is evaluated as $[(RX_Next_Highest - UM_Window_Size) - (RX_Next_Highest - UM_Window_Size)] \bmod 2^{[sn-FieldLength]} \leq [SN - (RX_Next_Highest - UM_Window_Size)] \bmod 2^{[sn-FieldLength]} < [RX_Next_Highest - (RX_Next_Highest - UM_Window_Size)] \bmod 2^{[sn-FieldLength]}$), where *sn-FieldLength* is 6 or 12 for 6 bit SN and 12 bit SN, respectively.

The transmitting side of each AM RLC entity shall maintain the following state variables:

a) TX_Next_Ack – Acknowledgement state variable

This state variable holds the value of the SN of the next RLC SDU for which a positive acknowledgment is to be received in-sequence, and it serves as the lower edge of the transmitting window. It is initially set to 0, and is updated whenever the AM RLC entity receives a positive acknowledgment for an RLC SDU with SN = TX_Next_Ack.

b) TX_Next – Send state variable

This state variable holds the value of the SN to be assigned for the next newly generated AMD PDU. It is initially set to 0, and is updated whenever the AM RLC entity constructs an AMD PDU with SN = TX_Next and contains an RLC SDU or the last segment of a RLC SDU.

c) POLL_SN – Poll send state variable

This state variable holds the value of the highest SN of the AMD PDU among the AMD PDUs submitted to lower layer when POLL_SN is set according to sub clause 5.3.3.2. It is initially set to 0.

The transmitting side of each AM RLC entity shall maintain the following counters:

a) PDU_WITHOUT_POLL – Counter

This counter is initially set to 0. It counts the number of AMD PDUs sent since the most recent poll bit was transmitted.

b) BYTE_WITHOUT_POLL – Counter

This counter is initially set to 0. It counts the number of data bytes sent since the most recent poll bit was transmitted.

c) RETX_COUNT – Counter

This counter counts the number of retransmissions of an RLC SDU or RLC SDU segment (see subclause 5.3.2). There is one RETX_COUNT counter maintained per RLC SDU.

The receiving side of each AM RLC entity shall maintain the following state variables:

a) RX_Next – Receive state variable

This state variable holds the value of the SN following the last in-sequence completely received RLC SDU, and it serves as the lower edge of the receiving window. It is initially set to 0, and is updated whenever the AM RLC entity receives an RLC SDU with SN = RX_Next.

b) RX_Next_Status_Trigger – *t-Reassembly* state variable

This state variable holds the value of the SN following the SN of the RLC SDU which triggered *t-Reassembly*.

c) RX_Highest_Status – Maximum STATUS transmit state variable

This state variable holds the highest possible value of the SN which can be indicated by "ACK_SN" when a STATUS PDU needs to be constructed. It is initially set to 0.

d) RX_Next_Highest – Highest received state variable

This state variable holds the value of the SN following the SN of the RLC SDU with the highest SN among received RLC SDUs. It is initially set to 0.

Each transmitting UM RLC entity shall maintain the following state variables:

a) TX_Next

This state variable holds the value of the SN to be assigned for the next newly generated UMD PDU with segment. It is initially set to 0, and is updated after the UM RLC entity submits a UMD PDU including the last segment of an RLC SDU to lower layers.

Each receiving UM RLC entity shall maintain the following state variables and constant:

b) RX_Next_Reassembly – UM receive state variable

This state variable holds the value of the earliest SN that is still considered for reassembly. It is initially set to 0.

c) RX_Timer_Trigger – UM *t-Reassembly* state variable

This state variable holds the value of the SN following the SN which triggered *t-Reassembly*.

d) RX_Next_Highest – UM receive state variable

This state variable holds the value of the SN following the SN of the UMD PDU with the highest SN among received UMD PDUs. It serves as the higher edge of the reassembly window. It is initially set to 0.

[TS 38.331, clause 5.3.11]

UE shall:

- 1> reset MAC;

- 1> if T302 is running:
 - 2> stop timer T302;
 - 2> perform the actions as specified in 5.3.14.4;
- 1> stop all timers that are running except T320 and T325;
- 1> discard the UE Inactive AS context;
- 1> set the variable *pendingRnaUpdate* to *false*, if that is set to *true*;
- 1> discard the K_{gNB} , the K_{RRcenc} key, the K_{RRcint} , the K_{UPint} key and the K_{UPenc} key, if any;
- 1> release all radio resources, including release of the RLC entity, the MAC configuration and the associated PDCP entity and SDAP for all established RBs;
- 1> indicate the release of the RRC connection to upper layers together with the release cause;
- 1> enter RRC_IDLE and perform cell selection as specified in TS 38.304 [20], except if going to RRC_IDLE was triggered by selecting an inter-RAT cell while T311 was running;
- 1> if going to RRC_IDLE was triggered by reception of the *RRCRelease* message including a *waitTime*:
 - 2> start timer T302 with the value set to the *waitTime*;
 - 2> inform the upper layer that access barring is applicable for all access categories except categories '0' and '2'.

7.1.2.3.11.3 Test description

7.1.2.3.11.3.1 Pre-test conditions

Same Pre-test conditions as in clause 7.1.2.1.1 with the exception for the AM DRB is configured according to Table 7.1.2.3.11.3.1-1.

Table 7.1.2.3.11.3.1-1: RLC parameters

Parameter	Value
<i>t-Reassembly</i>	ms200
<i>t-PollRetransmit</i>	ms4000

Table 7.1.2.3.11.3.1-2: PDCP parameters

Parameter	Value
<i>t-Reordering</i>	ms160
<i>statusReportRequired</i>	Not present

7.1.2.3.11.3.2 Test procedure sequence

Table 7.1.2.3.11.3.2-1: Main behaviour

St	Procedure	Message Sequence		TP	Verdict
		U - S	Message		
-	The SS ignores scheduling requests and does not allocate any uplink grant.	-	-	-	-
1	The SS creates 2 RLC SDUs of size 40 bytes segmented into two AMD PDUs each. AMD PDU#1 and AMD PDU#2 belong to RLC SDU#1, AMD PDU#3 and #4 belong to RLC SDU#2. SS transmits AMD PDU#1 (SN=0), AMD PDU#2 (SN=0) and AMD PDU#4 (SN=1).	<--	AMD PDU#1 AMD PDU#2 AMD PDU#4	-	-
2	60 ms after sending PDU#1 in step 1 the SS	<--	(UL grant)	-	-

	allocates 1 UL grant of default size.				
3	The UE returns RLC SDU#1.	-->	(RLC SDU#1)	-	-
4	The SS does not acknowledge the reception of RLC SDU#1.	-	-	-	-
5	The SS transmits NR RRCReconfiguration message to trigger RLC re-establishment on DRB using Reconfig with sync procedure. (Note 1) (Note 4) (Note 6) (Note 7)	<--	RRCReconfiguration	-	-
6	The SS starts the UL default grant transmissions	-	-	-	-
-	EXCEPTION: Steps 7 and 8 can occur in any order. (Note 8)	-	-	-	-
7	The UE transmits a NR RRCReconfigurationComplete message. (Note 5)	-->	RRCReconfigurationComplete	-	-
8	The UE retransmits RLC SDU #1 (SN=0). (Note 2)	-->	(RLC SDU#1)	-	-
9	SS transmits a STATUS PDU (ACK_SN = 1).	<--	STATUS PDU	-	-
10	SS transmits AMD PDU#3 with SN=0 and the P field set to "1"	<--	AMD PDU#3	-	-
11	Void				
12	Check: For 1 second, does the UE return RLC SDU#2 (Note 3)	-->	(RLC SDU#2)	1	F
13	SS transmits AMD PDU#4 with SN=0	<--	AMD PDU#4	-	-
13 A	UE transmits a STATUS PDU (ACK_SN=1) (Note 9)	-->	STATUS PDU	-	-
14	Check: Does the UE return RLC SDU#2 with SN=1? (Note 9)	-->	(RLC SDU#2)	2	P
15	SS transmits a STATUS PDU (ACK_SN = 2)	<--	STATUS PDU	-	-
<p>Note 1: Upon a RLC re-establishment a conformant UE discards any remaining AMD PDUs in the receiver and transmitter side, stops and resets all timers and resets all state variables to their initial values.</p> <p>Note 2: The UE will retransmit the PDCP SDU associated with RLC SDU#1 in accordance to TS 38.323 clause 5.5</p> <p>Note 3: AMD PDU#4 is discarded by a conformant UE in step 5.</p> <p>Note 4: For EN-DC the NR RRCReconfiguration message is contained in RRCConnectionReconfiguration 36.508 [7], Table 4.6.1-8 using condition EN-DC_EmbedNR_RRCRecon, EN-DC_PSCell_HO and RBConfig_NoKeyChange.</p> <p>Note 5: For EN-DC the NR RRCReconfigurationComplete message is contained in RRCConnectionReconfigurationComplete.</p> <p>Note 6: For NR, the RRCReconfiguration message is as per RRCReconfiguration-HO with condition RBConfig_NoKeyChange according to 38.508-1 [4], Table 4.8.1-1A.</p> <p>Note 7: The expiry of t-Reassembly timer started in step 1 will trigger STATUS PDU from the UE. This starts SR. The RRC reconfiguration is scheduled 300 ms in advance. sr-transMax is therefore set to n32 so that the UE does not reach sr-transMax and then RACHes before reconfiguring.</p> <p>Note 8: Per 38.508-1 Table 4.6.3-66: <i>LogicalChannelConfig</i>, both SRB1 and DRB have the same logical channel priority with prioritisedBitRate as infinity.</p> <p>Note 9: RLC PDUs at steps 13A and 14 may be received by the SS in the same slot or in multiple slots (max one MAC PDU in a slot).</p>					

7.1.2.3.11.3.3 Specific message contents

Table 7.1.2.3.11.3.3-0: SchedulingRequest-Config (Preamble)

Derivation Path: 38.508-1 [4], Table 4.6.3-155			
Information Element	Value/remark	Comment	Condition
sr-TransMax	n32	7.1.2.3.11.3.2-1 Note 7	

Table 7.1.2.3.11.3.3-1: RRCReconfiguration-HO (step 5, Table 7.1.2.3.11.3.3-1)

Derivation Path: 38.508-1 [4], Table 4.8.1-1A with condition RBConfig_NoKeyChange

Table 7.1.2.3.11.3.3-2: Void

7.1.3 PDCP

7.1.3.0 Default Pre-Test Conditions for all PDCP test cases

The following pre-test conditions shall be applied in all PDCP test cases until the test case explicitly over writes these conditions

System Simulator:

- The SS configures the test environment in accordance to the execution conditions in Table 7.1.3.0-1.

UE:

- None

Preamble:

- The SS performs the generic procedure in [4] to get UE in state RRC_CONNECTED in accordance to the execution conditions in Table 7.1.3.0-2 and using the message condition UE TEST LOOP MODE A to return one UL PDCP SDU per DL PDCP SDU.

Table 7.1.3.0-1: Test environment

Execution Condition	Cell configuration	System Information Combination
IF pc_NG_RAN_NR and Connectivity(NR-DC)	NR Cell 1 is PCell NR Cell 10 is PSCell	NR System information Combination NR-1
IF pc_NG_RAN_NR	NR Cell 1	NR System information Combination NR-1
ELSE IF pc_EN_DC	E-UTRA Cell 1 is PCell, NR Cell 1 is PSCell	EUTRA: System information Combination 1 NR: N/A
ELSE IF pc_NGEN_DC	NG-RAN E-UTRA Cell 1 is PCell, NR Cell 1 is PSCell	EUTRA: System information Combination 1 NR: N/A
ELSE IF pc_NE_DC	NR Cell 1 is PCell, E-UTRA Cell 1 is PSCell	NR: System information Combination NR-1 EUTRA: N/A

Table 7.1.3.0-2: Preamble parameters

Execution Condition	Multi-PDN / Multi-PDU Sessions Condition	Generic Procedure Parameters	Primary DRB used for Data testing
IF pc_NG_RAN_NR	FALSE	Connectivity(NR), Test loop function(On) One DRB	Default DRB of the first PDU session on NR Cell
		Connectivity(NR-DC), DC bearer(One MN Terminated MCG bearer and One SN Terminated SCG bearer), Test loop function(On)	SN terminated SCG DRB
	TRUE	Connectivity(NR), Test loop function(On) N DRBs ($N \geq 2$)	Default DRB of the first PDU session on NR Cell
		Connectivity(NR-DC), DC bearer(N MN Terminated MCG bearers and One SN Terminated SCG bearer),	SN terminated SCG DRB

		N DRBs ($N \geq 2$) Test loop function(<i>On</i>)	
ELSE IF pc_EN_DC	FALSE	Connectivity(<i>EN-DC</i>), DC bearer(One MN Terminated MCG bearer and One <i>SN terminated SCG bearer</i>), Test loop function(<i>On</i>)	SN Terminated SCG bearer unless explicitly specified in test case
	TRUE	Connectivity(<i>EN-DC</i>), DC bearer(Two MN Terminated MCG bearer and One <i>SN terminated SCG bearer</i>), Test loop function(<i>On</i>)	
ELSE IF pc_NGEN_DC	FALSE	Connectivity(<i>NGEN-DC</i>), DC bearer(One MN Terminated MCG bearer and One <i>SN terminated SCG bearer</i>), Test loop function(<i>On</i>)	SN Terminated SCG bearer unless explicitly specified in test case
	TRUE	Connectivity(<i>NGEN-DC</i>), DC bearer(Two MN Terminated MCG bearer and One <i>SN terminated SCG bearer</i>), Test loop function(<i>On</i>)	
ELSE IF pc_NE_DC	FALSE	Connectivity(<i>NE-DC</i>), DC bearer(One MN Terminated MCG bearer and One <i>SN terminated SCG bearer</i>), Test loop function(<i>On</i>)	SN Terminated SCG bearer unless explicitly specified in test case
	TRUE	Connectivity(<i>NE-DC</i>), DC bearer($N \geq 2$ MN Terminated MCG bearer and One <i>SN terminated SCG bearer</i>), Test loop function(<i>On</i>)	

Table 7.1.3.0-3: Message conditions

Execution Condition	Message condition exceptions
IF pc_NG_RAN_NR	Message with condition AM is used for step 7 in 4.5.4.2 according to [4]
ELSE IF pc_EN_DC	Message condition MCG_and_SCG with condition AM is used for step 7 in 4.5.4.2 according to [4]
ELSE IF pc_NGEN_DC	Message condition MCG_and_SCG with condition AM is used for step 7 in 4.5.4.2 according to [4]
ELSE IF pc_NE_DC	Message condition MCG_and_SCG with condition AM is used for step 7 in 4.5.4.6 according to [4]

7.1.3.1 Maintenance of PDCP sequence numbers for radio bearers

7.1.3.1.1 Maintenance of PDCP sequence numbers / User plane / 12 bit SN

7.1.3.1.1.1 Test Purpose (TP)

(1)

```

with { UE in RRC_CONNECTED state with PDCP configured for 12 bit SN}
ensure that {
  when { UE transmits a PDCP Data SDU on a DRB }
  then { UE increments SN with 1 for each transmitted PDU for SN=0 to Maximum_PDCP_SN (2[pdcp-SN-SizeUL]
-1) }
}
    
```

(2)

```

with { UE in RRC_CONNECTED state with PDCP configured for 12 bit SN }
ensure that {
  when { UE transmits a PDCP Data SDU on a DRB and, after incrementation, TX_NEXT is larger than the
Maximum_PDCP_SN (2[pdcp-SN-SizeUL] - 1) }
  then { UE sets SN to 0 in the next transmitted PDCP SDU }
}

```

7.1.3.1.1.2 Conformance requirements

References: The conformance requirements covered in the present TC are specified in: TS 38.323, clauses 5.2.1, 5.2.2.1 and 6.2.2.2. Unless otherwise stated these are Rel-15 requirements.

[TS 38.323, clause 5.2.1]

At reception of a PDCP SDU from upper layers, the transmitting PDCP entity shall:

- start the *discardTimer* associated with this PDCP SDU (if configured).

For a PDCP SDU received from upper layers, the transmitting PDCP entity shall:

- associate the COUNT value corresponding to TX_NEXT to this PDCP SDU;

NOTE 1: Associating more than half of the PDCP SN space of contiguous PDCP SDUs with PDCP SNs, when e.g., the PDCP SDUs are discarded or transmitted without acknowledgement, may cause HFN desynchronization problem. How to prevent HFN desynchronization problem is left up to UE implementation.

- perform header compression of the PDCP SDU as specified in the subclause 5.7.4;
- perform integrity protection, and ciphering using the TX_NEXT as specified in the subclause 5.9 and 5.8, respectively;
- set the PDCP SN of the PDCP Data PDU to TX_NEXT modulo $2^{[pdcp-SN-Size]}$;
- increment TX_NEXT by one;
- submit the resulting PDCP Data PDU to lower layer as specified below.

When submitting a PDCP Data PDU to lower layer, the transmitting PDCP entity shall:

- if the transmitting PDCP entity is associated with one RLC entity:
 - submit the PDCP Data PDU to the associated RLC entity.
- else, if the transmitting PDCP entity is associated with two RLC entities:
 - if *pdcpDuplication* is configured and activated:
 - duplicate the PDCP Data PDU and submit the PDCP Data PDU to both associated RLC entities.
 - else, if *pdcpDuplication* is configured but not activated:
 - submit the PDCP Data PDU to the primary RLC entity.
 - else:
 - if the total amount of PDCP data volume and RLC data volume pending for initial transmission (as specified in TS 36.322 [5]) in the two associated RLC entities is less than *ul-DataSplitThreshold*:
 - submit the PDCP Data PDU to the primary RLC entity.
 - else:
 - submit the PDCP Data PDU to either the primary RLC entity or the secondary RLC entity.

NOTE 2: If the transmitting PDCP entity is associated with two RLC entities, the UE should minimize the amount of PDCP PDUs submitted to lower layers before receiving request from lower layers and minimize the PDCP SN gap between PDCP PDUs submitted to two associated RLC entities to minimize PDCP reordering delay in the receiving PDCP entity.

[TS 38.323, clause 5.2.2.1]

In this section, following definitions are used:

- HFN(State Variable): the HFN part (i.e. the number of most significant bits equal to HFN length) of the State Variable;
- SN(State Variable): the SN part (i.e. the number of least significant bits equal to PDCP SN length) of the State Variable;
- RCVD_SN: the PDCP SN of the received PDCP Data PDU, included in the PDU header;
- RCVD_HFN: the HFN of the received PDCP Data PDU, calculated by the receiving PDCP entity;
- RCVD_COUNT: the COUNT of the received PDCP Data PDU = [RCVD_HFN, RCVD_SN]

At reception of a PDCP Data PDU from lower layers, the receiving PDCP entity shall determine the COUNT value of the received PDCP Data PDU, i.e. RCVD_COUNT, as follows:

- if $RCVD_SN < SN(RX_DELIV) - Window_Size$:
 - $RCVD_HFN = HFN(RX_DELIV) + 1$.
- else if $RCVD_SN \geq SN(RX_DELIV) + Window_Size$:
 - $RCVD_HFN = HFN(RX_DELIV) - 1$.
- else:
 - $RCVD_HFN = HFN(RX_DELIV)$;
 - $RCVD_COUNT = [RCVD_HFN, RCVD_SN]$.

After determining the COUNT value of the received PDCP Data PDU = RCVD_COUNT, the receiving PDCP entity shall:

- if $RCVD_COUNT < RX_DELIV$; or
- if the PDCP Data PDU with COUNT = RCVD_COUNT has been received before:
 - perform deciphering and integrity verification of the PDCP Data PDU using COUNT = RCVD_COUNT;
 - if integrity verification fails:
 - indicate the integrity verification failure to upper layer;
 - discard the PDCP Data PDU.
- else:
 - perform deciphering and integrity verification of the PDCP Data PDU using COUNT = RCVD_COUNT;
 - if integrity verification fails:
 - indicate the integrity verification failure to upper layer;
 - discard the PDCP Data PDU.

If the received PDCP Data PDU with COUNT value = RCVD_COUNT is not discarded above, the receiving PDCP entity shall:

- store the resulting PDCP SDU in the reception buffer;

- if RCVD_COUNT >= RX_NEXT:
 - update RX_NEXT to RCVD_COUNT + 1.
- if *outOfOrderDelivery* is configured:
 - deliver the resulting PDCP SDU to upper layers.
- if RCVD_COUNT = RX_DELIV:
 - deliver to upper layers in ascending order of the associated COUNT value after performing header decompression, if not decompressed before;
 - all stored PDCP SDU(s) with consecutively associated COUNT value(s) starting from COUNT = RX_DELIV;
 - update RX_DELIV to the COUNT value of the first PDCP SDU which has not been delivered to upper layers, with COUNT value > RX_DELIV;
- if *t-Reordering* is running, and if RX_DELIV >= RX_REORD:
 - stop and reset *t-Reordering*.
- if *t-Reordering* is not running (includes the case when *t-Reordering* is stopped due to actions above), and RX_DELIV < RX_NEXT:
 - update RX_REORD to RX_NEXT;
- start *t-Reordering*.

[TS 38.322, clause 6.2.2.2]

Figure 6.2.2.2-1 shows the format of the PDCP Data PDU with 12 bits PDCP SN. This format is applicable for UM DRBs and AM DRBs.

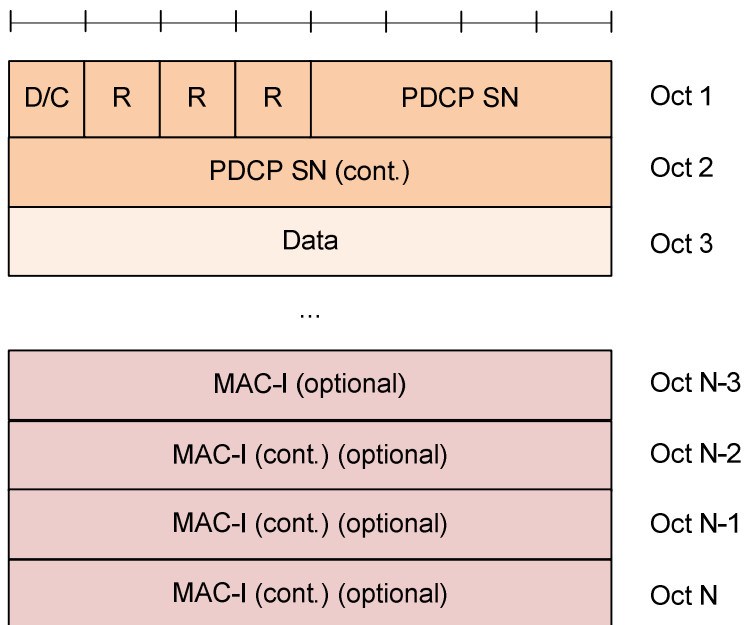

Figure 6.2.2.2-1: PDCP Data PDU format with 12 bits PDCP SN

7.1.3.1.1.3 Test description

7.1.3.1.1.3.1 Pre-test conditions

Same Pre-test conditions as in clause 7.1.3.0 exception of PDCP parameters according to Table 7.1.3.1.1.3.1-1.

Table 7.1.3.1.1.3.1-1: PDCP parameters

PDCP-Config pdcp-SN-SizeUL	len12bits
PDCP-Config pdcp-SN-SizeDL	len12bits

7.1.3.1.1.3.2 Test procedure sequence

Table 7.1.3.1.1.3.2-1: Main behaviour

St	Procedure	Message Sequence		TP	Verdict
		U - S	Message		
-	EXCEPTION: Steps 1 – 2 shall be repeated from $j = 0$ to $j = \text{FLOOR}(\text{Maximum_PDCP_SN}/\text{iteration_size})$. (Note 1, 4)	-	-	-	-
1	SS transmits in one slot, several PDCP PDUs in a PDCP PDU list without header compression, the number of PDCP PDUs sent in each PDCP PDU list is defined by the iteration_size. (Note 4, 5).	<--	PDCP PDUs	-	-
-	EXCEPTION: In Step 2, SS may receive a PDCP PDU or several PDCP PDUs, then step 2 may be repeated multiple times until all PDCP PDUs with $\text{SN}=j*\text{iteration_size}$ to $\text{SN}=\left(\left(j+1\right)*\text{iteration_size}\right)-1$ for each iteration are received.	-	-	-	-
2	CHECK: Does UE transmit PDCP PDUs with $\text{SN}=0$ for the first iteration and all PDCP PDUs for each iteration? (Note 2) (Note 6)	-->	PDCP PDUs	1	P
3	SS transmits a PDCP PDU containing one PDCP SDU without header compression.	<--	PDCP PDU	-	-
4	CHECK: Does UE transmit a PDCP PDU with $\text{SN}=0$?	-->	PDCP PDU	2	P
5	SS transmits a PDCP PDU containing one PDCP SDU without header compression.	<--	PDCP PDU	-	-
6	CHECK: Does UE transmit a PDCP PDU with $\text{SN}=1$?	-->	PDCP PDU	1	P
Note 1: $\text{Maximum_PDCP_SN} = 2^{\lfloor \text{pdcp-SN-SizeUL} \rfloor} - 1$. Note 2: The verdict shall be provided each time $[(\text{SN}+1) \bmod 256 = 0]$ for 12 bit SN and $[(\text{SN}+1) \bmod 4096 = 0]$ for 18 bit SN respectively. Note 3: Void Note 4: Iteration will be incremented by iteration_size of 1 for 12 bit SN and iteration_size of 2^5 .for 18 bits SN. Small PDCP SDU size will be used. Note 5: SS shall transmit a PDCP PDU list with size equal to iteration_size and incrementing SN by 1 till $\text{SN} = \left(\left(j+1\right)*\text{iteration_size}\right)-1$. Note 6: All PDCP PDUs may be received by the SS in the same slot or in multiple slots (max one MAC PDU in a slot)					

7.1.3.1.1.3.3 Specific message contents

None.

7.1.3.1.2 Maintenance of PDCP sequence numbers / User plane / 18 bit SN

7.1.3.1.2.1 Test Purpose (TP)

(1)

```

with { UE in RRC_CONNECTED state with PDCP configured for 18 bit SN }
ensure that {
  when { UE transmits a PDCP Data SDU on a DRB }
  then { UE increments SN with 1 for each transmitted PDU for SN=0 to Maximum_PDCP_SN (2[pdcp-SN-SizeUL]
-1) }
}

```

(2)

```

with { UE in RRC_CONNECTED state with PDCP configured for 18 bit SN }
ensure that {
  when { UE transmits a PDCP Data SDU on a DRB and, after incrementation, TX_Next is larger than the
Maximum_PDCP_SN (2[pdcp-SN-SizeUL] -1) }
  then { UE sets SN to 0 in the next transmitted PDCP SDU }
}

```

7.1.3.1.2.2 Conformance requirements

Same as conformance requirements in clause 7.1.3.1.1.2

7.1.3.1.2.3 Test description

7.1.3.1.2.3.1 Pre-test conditions

Same Pre-test conditions as in clause 7.1.3.0 exception of PDCP parameters according to Table 7.1.3.1.2.3.1-1.

Table 7.1.3.1.2.3.1-1: PDCP parameters

PDCP-Config pdcp-SN-SizeUL	len18bits
PDCP-Config pdcp-SN-SizeDL	len18bits

7.1.3.1.2.3.2 Test procedure sequence

Same as test procedure in clause 7.1.3.1.1.3.2

7.1.3.1.2.3.3 Specific message contents

None.

7.1.3.2 PDCP integrity protection

7.1.3.2.1 Integrity protection / Correct functionality of integrity algorithm SNOW3G / SRB / DRB

(1)

```

with { UE in RRC_CONNECTED state and SRB is configured with NR-PDCP }
ensure that {
  when { Functionality of integrity algorithms with SNOW3G is taken into use on SRB }
  then { UE performs correct integrity protection function in NR-PDCP entities associated with SRB }
}

```

(2)

```

with { UE in RRC_CONNECTED state and NOT EN-DC }
ensure that {

```

```

when { Functionality of integrity algorithms with SNOW3G is taken into use on DRB }
  then { UE performs correct integrity protection function in PDCP entities associated with DRB }
}

```

(3)

```

with { UE in RRC_CONNECTED state and SRB3 is configured }
ensure that {
  when { message on SRB 3 is received and fails the integrity protection check }
    then { UE transmits SCGFailureInformationNR message with failure type 'srb3-IntegrityFailure' }
}

```

NOTE: TP2 (integrity on DRB) is not applicable to EN-DC as per 38.331 clause 6.3.2, the IE *PDCP-Config.drb.integrityProtection* is 'Cond ConnectedTo5GC'.

7.1.3.2.1.2 Conformance requirements

References: The conformance requirements covered in the present TC are specified in: TS 38.323, clauses 5.9, 5.2.2.1, TS 33.501 clauses 5.6.2, D.3.1 and TS 38.331 clauses 5.7.3.1, 5.7.3.2, 5.7.3.3. Unless otherwise stated these are Rel-15 requirements.

[TS 38.323, clause 5.9]

The integrity protection function includes both integrity protection and integrity verification and is performed in PDCP, if configured. The data unit that is integrity protected is the PDU header and the data part of the PDU before ciphering. The integrity protection is always applied to PDCP Data PDUs of SRBs. The integrity protection is applied to PDCP Data PDUs of DRBs for which integrity protection is configured. The integrity protection is not applicable to PDCP Control PDUs.

The integrity protection algorithm and key to be used by the PDCP entity are configured by upper layers TS 38.331 [3] and the integrity protection method shall be applied as specified in TS 33.501 [6].

The integrity protection function is activated by upper layers TS 38.331 [3]. When security is activated, the integrity protection function shall be applied to all PDUs including and subsequent to the PDU indicated by upper layers TS 38.331 [3] for the downlink and the uplink, respectively.

NOTE: As the RRC message which activates the integrity protection function is itself integrity protected with the configuration included in this RRC message, this message needs first be decoded by RRC before the integrity protection verification could be performed for the PDU in which the message was received.

For downlink and uplink integrity protection and verification, the parameters that are required by PDCP for integrity protection are defined in TS 33.501 [6] and are input to the integrity protection algorithm. The required inputs to the integrity protection function include the COUNT value, and DIRECTION (direction of the transmission: set as specified in TS 33.501 [6]). The parameters required by PDCP which are provided by upper layers TS 38.331 [3] are listed below:

- BEARER (defined as the radio bearer identifier in TS 33.501 [6]. It will use the value RB identity –1 as in TS 38.331 [3]);
- KEY (the integrity protection keys for the control plane and for the user plane are K_{RRCint} and K_{UPint} , respectively).

At transmission, the UE computes the value of the MAC-I field and at reception it verifies the integrity of the PDCP Data PDU by calculating the X-MAC based on the input parameters as specified above. If the calculated X-MAC corresponds to the received MAC-I, integrity protection is verified successfully.

[TS 38.323, clause 5.2.2.1]

At reception of a PDCP Data PDU from lower layers, the receiving PDCP entity shall determine the COUNT value of the received PDCP Data PDU, i.e. RCVD_COUNT, as follows:

- if $\text{RCVD_SN} < \text{SN}(\text{RX_DELIV}) - \text{Window_Size}$:
 - $\text{RCVD_HFN} = \text{HFN}(\text{RX_DELIV}) + 1$.
- else if $\text{RCVD_SN} \geq \text{SN}(\text{RX_DELIV}) + \text{Window_Size}$:

- $RCVD_HFN = HFN(RX_DELIV) - 1$.
- else:
 - $RCVD_HFN = HFN(RX_DELIV)$;
 - $RCVD_COUNT = [RCVD_HFN, RCVD_SN]$.

After determining the COUNT value of the received PDCP Data PDU = RCVD_COUNT, the receiving PDCP entity shall:

- perform deciphering and integrity verification of the PDCP Data PDU using COUNT = RCVD_COUNT;
 - if integrity verification fails:
 - indicate the integrity verification failure to upper layer;
 - discard the PDCP Data PDU;
- if $RCVD_COUNT < RX_DELIV$; or
- if the PDCP Data PDU with COUNT = RCVD_COUNT has been received before:
 - discard the PDCP Data PDU;

[TS 33.501, clause 5.6.2]

All Identifiers and names specified in the present subclause are for 5G.

Each Integrity Algorithm used for 5G will be assigned a 4-bit identifier. The following values for integrity algorithms are defined:

- "0000₂" NIA0 Null Integrity Protection algorithm;
- "0001₂" 128-NIA1 128-bit SNOW 3G based algorithm;
- "0010₂" 128-NIA2 128-bit AES based algorithm; and
- "0011₂" 128-NIA3 128-bit ZUC based algorithm.

128-NIA1 is based on SNOW 3G (see TS35.215 [14]).

128-NIA2 is based on 128-bit AES [15] in CMAC mode [17].

128-NIA3 is based on 128-bit ZUC (see TS35.221 [18]).

Full details of the algorithms are specified in Annex D.

[TS 33.501, clause D.3.1.1]

The input parameters to the integrity algorithm are a 128-bit integrity key named KEY, a 32-bit COUNT, a 5-bit bearer identity called BEARER, the 1-bit direction of the transmission i.e. DIRECTION, and the message itself i.e. MESSAGE. The DIRECTION bit shall be 0 for uplink and 1 for downlink. The bit length of the MESSAGE is LENGTH.

Figure D.3.1.1-1 illustrates the use of the integrity algorithm NIA to authenticate the integrity of messages.

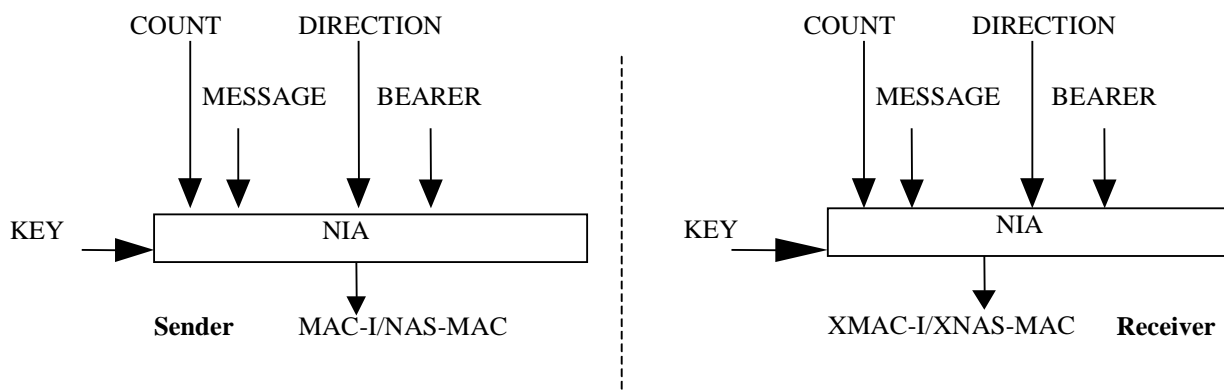

Figure D.3.1.1-1: Derivation of MAC-I/NAS-MAC (or XMAC-I/XNAS-MAC)

Based on these input parameters the sender computes a 32-bit message authentication code (MAC-I/NAS-MAC) using the integrity algorithm NIA. The message authentication code is then appended to the message when sent. For integrity protection algorithms, the receiver computes the expected message authentication code (XMAC-I/XNAS-MAC) on the message received in the same way as the sender computed its message authentication code on the message sent and verifies the data integrity of the message by comparing it to the received message authentication code, i.e. MAC-I/NAS-MAC.

[TS 38.331, clause 5.7.3.1]

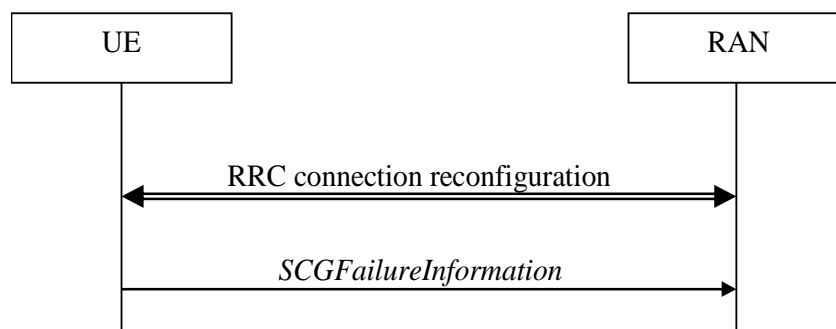

Figure 5.7.3.1-1: SCG failure information

The purpose of this procedure is to inform EUTRAN or NR MN about an SCG failure the UE has experienced i.e. SCG radio link failure, e failure of SCG reconfiguration with sync, SCG configuration failure for RRC message on SRB3, SCG integrity check failure and exceeding the maximum uplink transmission timing difference.

[TS 38.331, clause 5.7.3.2]

A UE initiates the procedure to report SCG failures when SCG transmission is not suspended and when one of the following conditions is met:

- 1> upon detecting radio link failure for the SCG, in accordance with subclause 5.3.10.3;
- 1> upon reconfiguration with sync failure of the SCG, in accordance with subclause 5.3.5.9.3;
- 1> upon SCG configuration failure, in accordance with subclause 5.3.5.9.2;
- 1> upon integrity check failure indication from SCG lower layers, in accordance with subclause 5.3.5.9.1.

Upon initiating the procedure, the UE shall:

- 1> suspend SCG transmission for all SRBs and DRBs;
- 1> reset SCG-MAC;

1> stop T304, if running;

1> if the UE is operating in EN-DC:

2> initiate transmission of the *SCGFailureInformationNR* message as specified in TS 36.331 [10, 5.6.13a].

[TS 38.331, clause 5.7.3.3]

The UE shall set the SCG failure type as follows:

...

1> else, if the UE initiates transmission of the *SCGFailureInformationNR* message due to SRB3 IP check failure:

2> set the failureType as srb3-IntegrityFailure;

7.1.3.2.1.3 Test description

7.1.3.2.1.3.1 Pre-test conditions

- Same Pre-test conditions as in clause 7.1.3.0 with the exception that integrity protection algorithm 'nia1 (SNOW3G)' is configured.
- For EN_DC, same Pre-test conditions as in clause 7.1.3.0 with the exception that integrity protection algorithms 'nia1 (SNOW3G)' and 'eia1 (SNOW3G)' are configured and without message condition UE TEST LOOP MODE A.
- For EN_DC or NGEN_DC, RRCConnectionReconfiguration message including MobilityControlInfo IE is transmitted on E-UTRA Cell 1 to reconfigure SRB1 and SRB2 from E-UTRA PDCP to NR PDCP.

7.1.3.2.1.3.2 Test procedure sequence

Table 7.1.3.2.1.3.2-1: Main behaviour

St	Procedure	Message Sequence		TP	Verdict
		U - S	Message		
-	EXCEPTION: Steps 1a1 to 1b2 describe behaviour that depends on UE configuration; the "lower case letter" identifies a step sequence that takes place depending on a particular configuration.	-	-	-	-
1a1	IF <i>Connectivity</i> is EN-DC or NGEN-DC, the SS sends EUTRA RRC <i>UECapabilityEnquiry</i> message including <i>RAT-Type eutra-nr</i> to the UE integrity protected.	<--	RRC: <i>UECapabilityEnquiry</i>	-	-
1a2	Check: Does the UE send a EUTRA RRC <i>UECapabilityInformation</i> message integrity protected?	-->	RRC: <i>UECapabilityInformation</i>	1	P
1b1	ELSE the SS sends NR RRC <i>UECapabilityEnquiry</i> message to the UE.	<--	NR RRC: <i>UECapabilityEnquiry</i>	-	-
1b2	Check: Does the UE send a NR RRC <i>UECapabilityInformation</i> message?	-->	NR RRC: <i>UECapabilityInformation</i>	1	P
-	EXCEPTION: Steps 2a1-2a4 describe behaviour that depends on UE configuration; the "lower case letter" identifies a step sequence that takes place if SRB3 is configured	-	-	-	-
2a1	IF <i>Connectivity</i> is EN-DC or NGEN-DC, IF <i>pc_srb3</i> then the SS transmits an <i>RRCReconfiguration</i> message to reconfigure NR MAC, sent on SRB3 integrity protected. Note 1	<--	<i>RRCReconfiguration</i>	-	-
2a2	Check: Does the UE transmit an <i>RRCReconfigurationComplete</i> message on SRB3 integrity protected?	-->	<i>RRCReconfigurationComplete</i>	1	P
2a3	The SS sends <i>RRCReconfiguration</i> message	<--	<i>RRCReconfiguration</i>	-	-

	to the UE integrity protected on SRB3. The MAC-I is corrupted so as to result in integrity failure at UE.				
2a4	Check: Does the UE send <i>SCGFailureInformationNR</i> with failureType 'srb3-IntegrityFailure' on SRB1?	-->	<i>SCGFailureInformationNR</i>	3	P
-	EXCEPTION: Steps 3a1-3a2 describe behaviour that depends on whether 5GC is being emulated; the "lower case letter" identifies a step sequence that takes place if 5GC is being emulated.	-	-	-	-
3a1	SS transmits PDCP PDU on DRB integrity protected.	<--	PDCP PDU	-	-
3a2	Check: Does the UE transmit looped back PDCP PDU integrity protected on DRB?	-->	PDCP PDU	2	P
Note 1: For EN-DC the NR RRCReconfiguration is contained in <i>RRCConnectionReconfiguration</i> Table 7.1.3.2.1.3.3-1					

7.1.3.2.1.3.3 Specific message contents

Table 7.1.3.2.1.3.3-1: *RRCConnectionReconfiguration* (Preamble for EN-DC or NGEN-DC)

Derivation Path: 36.508 [7] Table 4.6.1-8			
Information Element	Value/remark	Comment	Condition
<i>RRCConnectionReconfiguration</i> ::= SEQUENCE {			
criticalExtensions CHOICE {			
c1 CHOICE{			
rrcConnectionReconfiguration-r8 ::= SEQUENCE			
{			
mobilityControllInfo	MobilityControllInfo-HO-SameCell	As per Table 7.1.3.2.1.3.3-1A	
nonCriticalExtension ::= SEQUENCE {			
nonCriticalExtension ::= SEQUENCE {			
nonCriticalExtension ::= SEQUENCE {			
nonCriticalExtension ::= SEQUENCE {			
nonCriticalExtension ::= SEQUENCE {			
nonCriticalExtension ::= SEQUENCE {			
nonCriticalExtension ::= SEQUENCE {			
nr-Config-r15 CHOICE {			
setup SEQUENCE {			
nr-SecondaryCellGroupConfig-r15	OCTET STRING including the RRCReconfiguration message according to TS 38.508-1 [4], table 4.6.1-13 with condition EN-DC_HO		
}			
}			
sk-Counter-r15	Increment the value by 1 from the previous value		
nr-RadioBearerConfig1-r15	OCTET STRING including RadioBearerConfig according TS 38.508-1 [4], Table 4.6.3-132 with conditions EN-DC_DRB and Re-establish_PDCP		
nr-RadioBearerConfig1-r15	OCTET STRING including RadioBearerConfig according TS 38.508-1 [4], Table 4.6.3-132 with conditions EN-DC_DRB		SRB3

	and Re-establish_PDCP and SRB3		
nr-RadioBearerConfig2-r15	OCTET STRING including RadioBearerConfig according TS 38.508-1 [4], table 4.6.3-132 with condition SRB_NR_PDCP		
}			
}			
}			
}			
}			
}			
}			
}			
}			
}			
}			
}			
}			
}			

Condition	Explanation
SRB3	Establishment of SRB3

Table 7.1.3.2.1.3.3-1A: MobilityControllInfo-HO-SameCell (Table 7.1.3.2.1.3.3-1)

Derivation Path: 36.508 [7], Table 4.6.5-1			
Information Element	Value/remark	Comment	Condition
MobilityControllInfo-HO ::= SEQUENCE {			
targetPhysCellId	PhysicalCellIdentity of E-UTRA Cell 1		
carrierFreq	Not present		
}			

Table 7.1.3.2.1.3.3-2: MAC-CellGroupConfig (step 2a1, Table 7.1.3.2.1.3.2-1)

Derivation Path: TS 38.508-1 [4], Table 4.6.3-68			
Information Element	Value/remark	Comment	Condition
MAC-CellGroupConfig ::= SEQUENCE {			
bsr-Config SEQUENCE {			
periodicBSR-Timer	sf10	Different from default	
}			
}			

Table 7.1.3.2.1.3.3-3: SCGFailureInformationNR message (step 2a4, Table 7.1.3.2.1.3.2-1)

Derivation Path: 36.508 [7], Table 4.6.1-18AA			
Information Element	Value/remark	Comment	Condition
SCGFailureInformationNR-r15 ::= SEQUENCE {			
criticalExtensions CHOICE {			
c1 CHOICE {			
scgFailureInformationNR-r15 SEQUENCE {			
failureReportSCG-NR-r15 SEQUENCE {			
failureType-r15	srb3-IntegrityFailure		
measResultFreqListNR-r15	Not checked		
measResultSCG-r15	Not checked		
}			
nonCriticalExtension SEQUENCE {}			
}			
}			

}			
}			
}			

Table 7.1.3.2.1.3.3-4: RRCReconfiguration (Preamble for NR/5GC)

Derivation Path: TS 38.508-1 [4], Table 4.6.1-13 with condition NR			
Information Element	Value/remark	Comment	Condition
RRCReconfiguration ::= SEQUENCE {			
criticalExtensions CHOICE {			
rrcReconfiguration ::= SEQUENCE {			
radioBearerConfig	RadioBearerConfig-IntegrityOnDRB		
}			
}			
}			

Table 7.1.3.2.1.3.3-5: RadioBearerConfig-IntegrityOnDRB (Preamble for NR/5GC)

Derivation Path: TS 38.508-1 [4], Table 4.6.3-132 with conditions SRB2 and DRB1			
Information Element	Value/remark	Comment	Condition
RadioBearerConfig ::= SEQUENCE {			
drb-ToAddModList SEQUENCE (SIZE (1..maxDRB)) OF DRB-ToAddMod {	1 entry	Primary DRB as per Table 7.1.3.0-2	DRB1
DRB-ToAddMod[1] SEQUENCE {		entry 1	
cnAssociation CHOICE {			
sdap-Config	SDAP-Config		
}			
drb-Identity	DRB-Identity using condition DRB1		
reestablishPDCP	Not present		
recoverPDCP	Not present		
pdcp-Config	PDCP-Config-IntegrityOnDRB		
}			
}			
}			

Table 7.1.3.2.1.3.3-6: PDCP-Config-IntegrityOnDRB (Preamble for NR/5GC)

Derivation Path: TS 38.508-1 [4], Table 4.6.3-99			
Information Element	Value/remark	Comment	Condition
PDCP-Config ::= SEQUENCE {			
drb SEQUENCE {			
discardTimer	infinity		
pdcp-SN-Size-UL	len18bits		
pdcp-SN-Size-DL	len18bits		
headerCompression CHOICE {			
notUsed	NULL		
}			
integrityProtection	enabled		
statusReportRequired	true		
outOfOrderDelivery	Not present		
}			
moreThanOneRLC	Not present		
t-Reordering	Not present		
}			

7.1.3.2.2 Integrity protection / Correct functionality of integrity algorithm AES / SRB / DRB

7.1.3.2.2.1 Test Purpose (TP)

(1)

```
with { UE in RRC_CONNECTED state and SRB is configured with NR-PDCP }
ensure that {
  when { Functionality of integrity algorithms with AES is taken into use on SRB }
  then { UE performs correct integrity protection function in NR-PDCP entity associated with SRB }
}
```

(2)

```
with { UE in RRC_CONNECTED state and NOT EN-DC }
ensure that {
  when { Functionality of integrity algorithms with AES is taken into use on DRB }
  then { UE performs correct integrity protection function in PDCP entities associated with DRB }
}
```

(3)

```
with { UE in RRC_CONNECTED state and SRB3 is configured }
ensure that {
  when { message on SRB 3 is received and fails the integrity protection check }
  then { UE transmits SCGFailureInformationNR message with failure type as srb3-IntegrityFailure }
}
```

NOTE: TP2 (integrity on DRB) is not applicable to EN-DC as per TS 38.331 [12] clause 6.3.2, the IE *PDCP-Config.drb.integrityProtection* is 'Cond ConnectedTo5GC'.

7.1.3.2.2.2 Conformance requirements

Same conformance requirements as in clause 7.1.3.2.1.2

7.1.3.2.2.3 Test description

7.1.3.2.2.3.1 Pre-test conditions

Same Pre-test conditions as in clause 7.1.3.2.1.3.1 except that integrity protection algorithm 'nia2 (AES)' and 'eia2 (AES)' is configured.

7.1.3.2.2.3.2 Test procedure sequence

Same test procedure sequence as in clause 7.1.3.2.1.3.2.

7.1.3.2.2.3.3 Specific message contents

Same specific message contents as in clause 7.1.3.2.1.3.3 except for integrity protection algorithm 'nia2 (AES)' and 'eia2 (AES)'.

7.1.3.2.3 Integrity protection / Correct functionality of integrity algorithm ZUC / SRB / DRB

(1)

```
with { UE in RRC_CONNECTED state and SRB is configured with NR-PDCP }
ensure that {
  when { Functionality of integrity algorithms with ZUC is taken into use on SRB }
  then { UE performs correct integrity protection function in NR-PDCP entities associated with SRB }
}
```

(2)

```
with { UE in RRC_CONNECTED state and NOT EN-DC }
```

```

ensure that {
  when { Functionality of integrity algorithms with ZUC is taken into use on DRB }
  then { UE performs correct integrity protection function in PDCP entities associated with DRB }
}

```

(3)

```

with { UE in RRC_CONNECTED state and SRB3 is configured }
ensure that {
  when { message on SRB 3 is received and fails the integrity protection check }
  then { UE transmits SCGFailureInformationNR message with failure type as srb3-IntegrityFailure }
}

```

NOTE: TP2 (integrity on DRB) is not applicable to EN-DC as per TS 38.331 [12] clause 6.3.2, the IE *PDCP-Config.drb.integrityProtection* is 'Cond ConnectedTo5GC'.

7.1.3.2.3.2 Conformance requirements

Same conformance requirements as in clause 7.1.3.2.1.2.

7.1.3.2.3.3 Test description

7.1.3.2.3.3.1 Pre-test conditions

Same Pre-test conditions as in clause 7.1.3.2.1.3.1 except that integrity protection algorithm 'nia3 (ZUC)' and 'eia3 (ZUC)' is configured.

7.1.3.2.3.3.2 Test procedure sequence

Same test procedure sequence as in clause 7.1.3.2.1.3.2.

7.1.3.2.3.3.3 Specific message contents

Same specific message contents as in clause 7.1.3.2.1.3.3 except integrity protection algorithm 'nia3 (ZUC)' and 'eia3 (ZUC)'.

7.1.3.3 PDCP Cipherng and deciphering

7.1.3.3.1 Cipherng and deciphering / Correct functionality of encryption algorithm SNOW3G / SRB / DRB

7.1.3.3.1.1 Test Purpose (TP)

(1)

(1)

```

with { UE in RRC_CONNECTED state and SRB is configured with NR-PDCP }
ensure that {
  when { Functionality of encryption algorithms with SNOW3G is taken into use on SRB }
  then { UE performs correct cipherng/deciphering function in NR-PDCP entity associated with SRB }
}

```

(2)

```

with { UE in RRC_CONNECTED state }
ensure that {
  when { Functionality of encryption algorithms with SNOW3G is taken into use on DRB }
  then { UE performs correct cipherng/deciphering function in NR-PDCP entity associated with DRB }
}

```

7.1.3.3.1.2 Conformance requirements

References: The conformance requirements covered in the present TC are specified in: TS 38.323 clause 5.8, TS 33.501 clauses 5.6.1, D.2.1.1 and TS 36.331 clause 6.3.2. Unless otherwise stated these are Rel-15 requirements.

[TS 38.323, clause 5.8]

The ciphering function includes both ciphering and deciphering and is performed in PDCP, if configured. The data unit that is ciphered is the data part of the PDCP Data PDU (see subclause 6.3.3) except the SDAP header if included in the PDCP SDU, and the MAC-I (see subclause 6.3.4). The ciphering is not applicable to PDCP Control PDUs.

The ciphering algorithm and key to be used by the PDCP entity are configured by upper layers TS 38.331 [3] and the ciphering method shall be applied as specified in TS 33.501 [6].

The ciphering function is activated by upper layers TS 38.331 [3]. When security is activated, the ciphering function shall be applied to all PDCP Data PDUs indicated by upper layers TS 38.331 [3] for the downlink and the uplink, respectively.

For downlink and uplink ciphering and deciphering, the parameters that are required by PDCP for ciphering are defined in TS 33.501 [6] and are input to the ciphering algorithm. The required inputs to the ciphering function include the COUNT value, and DIRECTION (direction of the transmission: set as specified in TS 33.501 [6]). The parameters required by PDCP which are provided by upper layers TS 38.331 [3] are listed below:

- BEARER (defined as the radio bearer identifier in TS 33.501 [6]. It will use the value RB identity –1 as in TS 38.331 [3]);
- KEY (the ciphering keys for the control plane and for the user plane are $K_{RRCCenc}$ and K_{UPenc} , respectively).

[TS 33.501, clause 5.6.1]

All Identifiers and names specified in this subclause are for 5G.

Each Encryption Algorithm used for 5G will be assigned a 4-bit identifier. The following values for ciphering algorithms are defined:

"0000 ₂ "	NEA0	Null ciphering algorithm;
"0001 ₂ "	128-NEA1	128-bit SNOW 3G based algorithm;
"0010 ₂ "	128-NEA2	128-bit AES based algorithm; and
"0011 ₂ "	128-NEA3	128-bit ZUC based algorithm.

128-NEA1 is based on SNOW 3G (see TS35.215 [14]).

128-NEA2 is based on 128-bit AES [15] in CTR mode [16].

128-NEA3 is based on 128-bit ZUC (see TS35.221 [18]).

Full details of the algorithms are specified in Annex D.

[TS 33.501, clause D.2.1.1]

The input parameters to the ciphering algorithm are a 128-bit cipher key named KEY, a 32-bit COUNT, a 5-bit bearer identity BEARER, the 1-bit direction of the transmission i.e. DIRECTION, and the length of the keystream required i.e. LENGTH. The DIRECTION bit shall be 0 for uplink and 1 for downlink.

Editor's Note: For NAS layer security, the inputs may need to change depending on the solution that is selected for having simultaneous NAS connections for 3GPP and non-3GPP.

Figure D.2.1.1-1 illustrates the use of the ciphering algorithm NEA to encrypt plaintext by applying a keystream using a bit per bit binary addition of the plaintext and the keystream. The plaintext may be recovered by generating the same keystream using the same input parameters and applying a bit per bit binary addition with the ciphertext.

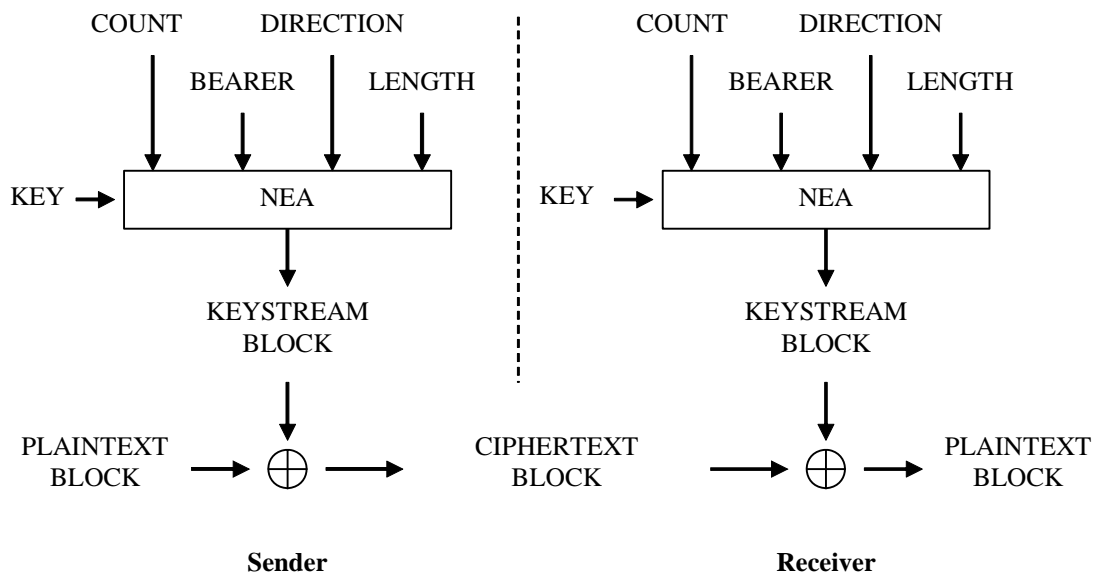

Figure D.2.1.1-1: Ciphering of data

Based on the input parameters the algorithm generates the output keystream block KEYSTREAM which is used to encrypt the input plaintext block PLAINTEXT to produce the output ciphertext block CIPHERTEXT.

The input parameter LENGTH shall affect only the length of the KEYSTREAM BLOCK, not the actual bits in it.

[TS 36.331, clause 6.3.3]

The IE *SecurityAlgorithmConfig* is used to configure AS integrity protection algorithm (SRBs) and AS ciphering algorithm (SRBs and DRBs).

...

SecurityAlgorithmConfig field descriptions	
cipheringAlgorithm	Indicates the ciphering algorithm to be used for SRBs and DRBs, as specified in TS 33.501 [11]. The algorithms nea0-nea3 are identical to the LTE algorithms eea0-3. For EN-DC, the algorithms configured for bearers using KeNB shall be the same as for all bearers using KeNB.
integrityProtAlgorithm	For EN-DC, this IE indicates the integrity protection algorithm to be used for SRBs, as specified in TS 33.501 [11]. The algorithms nia0-nia3 is identical to the LTE algorithms eia0-3. For EN-DC, the algorithms configured for SRBs using KeNB shall be the same as for all SRBs using KeNB.

7.1.3.3.1.3 Test description

7.1.3.3.1.3.1 Pre-test conditions

- Same Pre-test conditions as in clause 7.1.3.0 with the exception that ciphering algorithm ‘nea1 (SNOW3G)’ is configured.
- For EN_DC or NGEN_DC, same Pre-test conditions as in clause 7.1.3.0 with the exception that ciphering algorithms ‘eea1 (SNOW3G)’ and ‘nea1 (SNOW3G)’ are configured and without message condition UE TEST LOOP MODE A, then RRCConnectionReconfiguration message including MobilityControlInfo IE is transmitted on E-UTRA Cell 1 to reconfigure SRB1, SRB2 and MCG DRB from E-UTRA PDCP to NR PDCP and Test Loop Function (On) with UE test loop mode A (message condition UE TEST LOOP MODE A to return one UL PDCP SDU per DL PDCP SDU) according to TS 38.508-1 [4].

7.1.3.3.1.3.2 Test procedure sequence

Table 7.1.3.3.1.3.2-1: Main behaviour

St	Procedure	Message Sequence		TP	Verdict
		U – S	Message		
-	Exception steps 1a1 to 1b2 depends on UE configuration.	-	-	-	-
1a1	IF <i>Connectivity</i> is <i>EN-DC</i> or <i>NGEN-DC</i> , the SS sends EUTRA RRC <i>UECapabilityEnquiry</i> including <i>RAT-Type eutra</i> message to the UE.	<--	RRC: <i>UECapabilityEnquiry</i>	-	-
1a2	Check: Does the UE send a EUTRA RRC <i>UECapabilityInformation</i> message?	-->	RRC: <i>UECapabilityInformation</i>	1	P
1b1	ELSE the SS sends NR RRC <i>UECapabilityEnquiry</i> message to the UE.	<--	NR RRC: <i>UECapabilityEnquiry</i>	-	-
1b2	Check: Does the UE send a NR RRC <i>UECapabilityInformation</i> message?	-->	NR RRC: <i>UECapabilityInformation</i>	1	P
-	EXCEPTION: steps 2a1-2a2 depends on UE configuration, executed if SCG DRB is configured	-	-	-	-
2a1	IF <i>Connectivity</i> is <i>EN-DC</i> or <i>NGEN-DC</i> , SS transmits PDCP PDU on SCG DRB ciphered.	<--	PDCP PDU	-	-
2a2	Check: Does the UE transmit looped back PDCP PDU ciphered on SCG DRB?	-->	PDCP PDU	2	P
3	SS transmits PDCP PDU on MCG DRB ciphered.	<--	PDCP PDU	-	-
4	Check: Does the UE transmit looped back PDCP PDU ciphered on MCG DRB?	-->	PDCP PDU	2	P

7.1.3.3.1.3.3 Specific message contents

Table 7.1.3.3.1.3.3-1: RRCConnectionReconfiguration (Preamble for EN-DC or NGEN-DC)

Derivation Path: 36.508[47] Table 4.6.1-8			
Information Element	Value/remark	Comment	Condition
RRCConnectionReconfiguration ::= SEQUENCE {			
criticalExtensions CHOICE {			
c1 CHOICE{			
rrcConnectionReconfiguration-r8 ::= SEQUENCE {			
mobilityControlInfo	MobilityControlInfo-HO-SameCell	As per Table 7.1.3.3.1.3.3-2	
radioResourceConfigDedicated	RadioResourceConfigDedicated-DRB-Rel-Add	As per Table 7.1.3.3.1.3.3-3	
nonCriticalExtension ::= SEQUENCE {			
nonCriticalExtension ::= SEQUENCE {			
nonCriticalExtension ::= SEQUENCE {			
nonCriticalExtension ::= SEQUENCE {			
nonCriticalExtension ::= SEQUENCE {			
nonCriticalExtension ::= SEQUENCE {			
nonCriticalExtension ::= SEQUENCE {			
nr-Config-r15 CHOICE {			
setup SEQUENCE {			
nr-SecondaryCellGroupConfig-r15	OCTET STRING including the RRCReconfiguration message according to TS 38.508-1 [4], table 4.6.1-13 with condition EN-DC_HO.		
}			
}			
sk-Counter-r15	Increment the value by 1		

	from the previous value		
nr-RadioBearerConfig1-r15	OCTET STRING including RadioBearerConfig according TS 38.508-1 [4], table 4.6.3-132 with condition EN-DC_DRB and Re-establish_PDCP		
nr-RadioBearerConfig2-r15	OCTET STRING including RadioBearerConfig according TS 38.508-1 [4], table 4.6.3-132 with conditions SRB_NR_PDCP and MCG_NR_PDCP		
}			
}			
}			
}			
}			
}			
}			
}			
}			
}			
}			
}			
}			
}			
}			

Table 7.1.3.3.1.3.3-2: MobilityControllInfo-HO-SameCell (Table 7.1.3.3.1.3.3-1)

Derivation Path: 36.508 [7], Table 4.6.5-1			
Information Element	Value/remark	Comment	Condition
MobilityControllInfo-HO ::= SEQUENCE {			
targetPhysCellId	PhysicalCellIdentity of E-UTRA Cell 1		
carrierFreq	Not present		
}			

Table 7.1.3.3.1.3.3-3: RadioResourceConfigDedicated-DRB-Rel-Add (Table 7.1.3.3.1.3.3-1)

Derivation Path: 36.508 [7], Table 4.6.3-19AAAAAD			
Information Element	Value/remark	Comment	Condition
RadioResourceConfigDedicated-SRB2-DRB ::= SEQUENCE {			
srb-ToAddModList	Not present		
drb-ToAddModList SEQUENCE (SIZE (1..maxDRB)) OF DRB-ToAddMod {	1 entry		
drb-ToAddMod[1]	DRB-ToAddMod-DEFAULT (8) using condition AM except pdcp-Config not included	entry 1 See TS 36.508 subclause 4.8.2	
}			
drb-ToReleaseList SEQUENCE (SIZE (1..maxDRB)) OF DRB-Identity {	1 entry		
DRB-Identity[1]	8	entry 1 Same as the DRB Identity associated with the default EPS bearer	
}			
}			

7.1.3.3.2 Ciphering and deciphering / Correct functionality of encryption algorithm AES / SRB / DRB

7.1.3.3.2.1 Test Purpose (TP)

(1)

```
with { UE in RRC_CONNECTED state and SRB is configured with NR-PDCP }
ensure that {
  when { Functionality of encryption algorithms with AES is taken into use on SRB }
  then { UE performs correct ciphering/deciphering function in NR-PDCP entity associated with SRB }
}
```

(2)

```
with { UE in RRC_CONNECTED state }
ensure that {
  when { Functionality of encryption algorithms with AES is taken into use on DRB }
  then { UE performs correct ciphering/deciphering function in NR-PDCP entity associated with DRB }
}
```

7.1.3.3.2.2 Conformance requirements

Same conformance requirement as in clause 7.1.3.3.1.2.

7.1.3.3.2.3 Test description

7.1.3.3.2.3.1 Pre-test conditions

Same Pre-test conditions as in clause 7.1.3.3.1.3.1 with the exception that ciphering algorithm 'nea2 (AES)' and 'eea2 (AES)' is configured.

7.1.3.3.2.3.2 Test procedure sequence

Same Test procedure sequence as in clause 7.1.3.3.1.3.2

7.1.3.3.2.3.3 Specific message contents

None

7.1.3.3.3 Ciphering and deciphering / Correct functionality of encryption algorithm ZUC / SRB / DRB

7.1.3.3.3.1 Test Purpose (TP)

(1)

```
with { UE in RRC_CONNECTED state and SRB is configured with NR-PDCP}
ensure that {
  when { Functionality of encryption algorithms with ZUC is taken into use on SRB }
  then { UE performs correct ciphering/deciphering function in NR-PDCP entity associated with SRB }
}
```

(2)

```
with { UE in RRC_CONNECTED state and DRB is configured with NR-PDCP}
ensure that {
  when { Functionality of encryption algorithms with ZUC is taken into use on DRB }
  then { UE performs correct ciphering/deciphering function in NR-PDCP entity associated with DRB }
}
```

7.1.3.3.3.2 Conformance requirements

Same conformance requirement as in clause 7.1.3.3.1.2.

7.1.3.3.3.3 Test description

7.1.3.3.3.3.1 Pre-test conditions

Same Pre-test conditions as in clause 7.1.3.3.1.3.1 with the exception that ciphering algorithm ‘nea3 (ZUC)’ and ‘eea3 (ZUC)’ is configured.

7.1.3.3.3.3.2 Test procedure sequence

Same Test procedure sequence as in clause 7.1.3.3.1.3.2.

7.1.3.3.3.3.3 Specific message contents

None

7.1.3.4 PDCP Handover

7.1.3.4.1 PDCP handover / Lossless handover / PDCP sequence number maintenance / PDCP status report to convey the information on missing or acknowledged PDCP SDUs at handover / In-order delivery and duplicate elimination in the downlink

7.1.3.4.1.1 Test Purpose (TP)

(1)

```
with { UE in RRC_CONNECTED state with default RB using RLC-AM }
ensure that {
  when { UE is requested to make a lossless handover by SS }
  then { UE creates a PDCP status report to SS }
}
```

(2)

```
with { UE in RRC_CONNECTED state with default RB using RLC-AM }
ensure that {
  when { UE is requested to make a lossless handover by SS }
  then { UE retransmits the unacknowledged data }
}
```

(3)

```
with { UE in RRC_CONNECTED state with default RB using RLC-AM }
ensure that {
  when { UE is requested to make a lossless handover by SS }
  then { UE achieves in-order delivery and discards a PDCP PDU already received in the downlink }
}
```

7.1.3.4.1.2 Conformance requirements

References: The conformance requirements covered in the present test case are specified in: TS 38.323, clauses 5.1.2, 5.2.2.1, 5.3, 5.4.1, 5.4.2 and 7.1. Unless otherwise stated these are Rel-15 requirements.

[TS 38.323, clause 5.1.2]

When upper layers request a PDCP entity re-establishment, the UE shall additionally perform once the procedures described in this section. After performing the procedures in this section, the UE shall follow the procedures in subclause 5.2.

When upper layers request a PDCP entity re-establishment, the transmitting PDCP entity shall:

- for UM DRBs and AM DRBs, reset the header compression protocol for uplink and start with an IR state in U-mode (as defined in RFC 3095 [8] and RFC 4815 [9]) if *drb-ContinueROHC* is not configured in TS 38.331 [3];
- for UM DRBs and SRBs, set TX_NEXT to the initial value;
- for SRBs, discard all stored PDCP SDUs and PDCP PDUs;
- apply the ciphering algorithm and key provided by upper layers during the PDCP entity re-establishment procedure;
- apply the integrity protection algorithm and key provided by upper layers during the PDCP entity re-establishment procedure;
- for UM DRBs, for each PDCP SDU already associated with a PDCP SN but for which a corresponding PDU has not previously been submitted to lower layers:
 - consider the PDCP SDUs as received from upper layer;
 - perform transmission of the PDCP SDUs in ascending order of the COUNT value associated to the PDCP SDU prior to the PDCP re-establishment without restarting the *discardTimer*, as specified in subclause 5.2.1;
- for AM DRBs, from the first PDCP SDU for which the successful delivery of the corresponding PDCP Data PDU has not been confirmed by lower layers, perform retransmission or transmission of all the PDCP SDUs already associated with PDCP SNs in ascending order of the COUNT values associated to the PDCP SDU prior to the PDCP entity re-establishment as specified below:
 - perform header compression of the PDCP SDU as specified in the subclause 5.7.4;
 - perform integrity protection and ciphering of the PDCP SDU using the COUNT value associated with this PDCP SDU as specified in the subclause 5.9 and 5.8;
 - submit the resulting PDCP Data PDU to lower layer, as specified in subclause 5.2.1.

When upper layers request a PDCP entity re-establishment, the receiving PDCP entity shall:

- process the PDCP Data PDUs that are received from lower layers due to the re-establishment of the lower layers, as specified in the subclause 5.2.2.1;
- for SRBs, discard all stored PDCP SDUs and PDCP PDUs;
- for SRBs and UM DRBs, if *t-Reordering* is running:
 - stop and reset *t-Reordering*;
 - for UM DRBs, deliver all stored PDCP SDUs to the upper layers in ascending order of associated COUNT values after performing header decompression;
- for AM DRBs, perform header decompression for all stored PDCP SDUs if *drb-ContinueROHC* is not configured in TS 38.331 [3];
- for UM DRBs and AM DRBs, reset the header compression protocol for downlink and start with NC state in U-mode (as defined in RFC 3095 [8] and RFC 4815 [9]) if *drb-ContinueROHC* is not configured in TS 38.331 [3];
- for UM DRBs and SRBs, set RX_NEXT and RX_DELIV to the initial value;
- apply the ciphering algorithm and key provided by upper layers during the PDCP entity re-establishment procedure;
- apply the integrity protection algorithm and key provided by upper layers during the PDCP entity re-establishment procedure.

[TS 38.323, clause 5.2.2.1]

In this section, following definitions are used:

- HFN(State Variable): the HFN part (i.e. the number of most significant bits equal to HFN length) of the State Variable;

- SN(State Variable): the SN part (i.e. the number of least significant bits equal to PDCP SN length) of the State Variable;
- RCVD_SN: the PDCP SN of the received PDCP Data PDU, included in the PDU header;
- RCVD_HFN: the HFN of the received PDCP Data PDU, calculated by the receiving PDCP entity;
- RCVD_COUNT: the COUNT of the received PDCP Data PDU = [RCVD_HFN, RCVD_SN].

At reception of a PDCP Data PDU from lower layers, the receiving PDCP entity shall determine the COUNT value of the received PDCP Data PDU, i.e. RCVD_COUNT, as follows:

- if $RCVD_SN < SN(RX_DELIV) - Window_Size$:
 - $RCVD_HFN = HFN(RX_DELIV) + 1$.
- else if $RCVD_SN \geq SN(RX_DELIV) + Window_Size$:
 - $RCVD_HFN = HFN(RX_DELIV) - 1$.
- else:
 - $RCVD_HFN = HFN(RX_DELIV)$;
- $RCVD_COUNT = [RCVD_HFN, RCVD_SN]$.

After determining the COUNT value of the received PDCP Data PDU = RCVD_COUNT, the receiving PDCP entity shall:

- perform deciphering and integrity verification of the PDCP Data PDU using $COUNT = RCVD_COUNT$;
- if integrity verification fails:
 - indicate the integrity verification failure to upper layer;
 - discard the PDCP Data PDU;
- if $RCVD_COUNT < RX_DELIV$; or
- if the PDCP Data PDU with $COUNT = RCVD_COUNT$ has been received before:
 - discard the PDCP Data PDU;

If the received PDCP Data PDU with COUNT value = RCVD_COUNT is not discarded above, the receiving PDCP entity shall:

- store the resulting PDCP SDU in the reception buffer;
- if $RCVD_COUNT \geq RX_NEXT$:
 - update RX_NEXT to $RCVD_COUNT + 1$.
- if *outOfOrderDelivery* is configured:
 - deliver the resulting PDCP SDU to upper layers.
- if $RCVD_COUNT = RX_DELIV$:
 - deliver to upper layers in ascending order of the associated COUNT value after performing header decompression, if not decompressed before;
 - all stored PDCP SDU(s) with consecutively associated COUNT value(s) starting from $COUNT = RX_DELIV$;
 - update RX_DELIV to the COUNT value of the first PDCP SDU which has not been delivered to upper layers, with COUNT value $> RX_DELIV$;
- if *t-Reordering* is running, and if $RX_DELIV \geq RX_REORD$:

- stop and reset *t-Reordering*.
- if *t-Reordering* is not running (includes the case when *t-Reordering* is stopped due to actions above), and $RX_DELIV < RX_NEXT$:
 - update RX_REORD to RX_NEXT ;
- start *t-Reordering*.

[TS 38.323, clause 5.3]

When the *discardTimer* expires for a PDCP SDU, or the successful delivery of a PDCP SDU is confirmed by PDCP status report, the transmitting PDCP entity shall discard the PDCP SDU along with the corresponding PDCP Data PDU. If the corresponding PDCP Data PDU has already been submitted to lower layers, the discard is indicated to lower layers.

For SRBs, when upper layers request a PDCP SDU discard, the PDCP entity shall discard all stored PDCP SDUs and PDCP PDUs.

NOTE: Discarding a PDCP SDU already associated with a PDCP SN causes a SN gap in the transmitted PDCP Data PDUs, which increases PDCP reordering delay in the receiving PDCP entity. It is up to UE implementation how to minimize SN gap after SDU discard.

[TS 38.323, clause 5.4.1]

For AM DRBs configured by upper layers to send a PDCP status report in the uplink (*statusReportRequired* in TS 38.331 [3]), the receiving PDCP entity shall trigger a PDCP status report when:

- upper layer requests a PDCP entity re-establishment;
- upper layer requests a PDCP data recovery.

If a PDCP status report is triggered, the receiving PDCP entity shall:

- compile a PDCP status report as indicated below by:
 - setting the FMC field to RX_DELIV ;
 - if $RX_DELIV < RX_NEXT$:
 - allocating a Bitmap field of length in bits equal to the number of COUNTs from and not including the first missing PDCP SDU up to and including the last out-of-sequence PDCP SDUs, rounded up to the next multiple of 8, or up to and including a PDCP SDU for which the resulting PDCP Control PDU size is equal to 9000 bytes, whichever comes first;
 - setting in the bitmap field as '0' for all PDCP SDUs that have not been received, and optionally PDCP SDUs for which decompression have failed;
 - setting in the bitmap field as '1' for all PDCP SDUs that have been received;
- submit the PDCP status report to lower layers as the first PDCP PDU for transmission via the transmitting PDCP entity as specified in subclause 5.2.1..

[TS 38.323, clause 5.4.2]

For AM DRBs, when a PDCP status report is received in the downlink, the transmitting PDCP entity shall:

- consider for each PDCP SDU, if any, with the bit in the bitmap set to '1', or with the associated COUNT value less than the value of FMC field as successfully delivered, and discard the PDCP SDU as specified in the subclause 5.3.

[TS 38.323, clause 7.1]

This sub clause describes the state variables used in PDCP entities in order to specify the PDCP protocol. The state variables defined in this subclause are normative.

All state variables are non-negative integers, and take values from 0 to $[2^{32} - 1]$.

PDCP Data PDUs are numbered integer sequence numbers (SN) cycling through the field: 0 to $[2^{[pdc\text{-}SN\text{-}Size]} - 1]$.

The transmitting PDCP entity shall maintain the following state variables:

a) TX_NEXT

This state variable indicates the COUNT value of the next PDCP SDU to be transmitted. The initial value is 0.

The receiving PDCP entity shall maintain the following state variables:

a) RX_NEXT

This state variable indicates the COUNT value of the next PDCP SDU expected to be received. The initial value is 0.

b) RX_DELIV

This state variable indicates the COUNT value of the first PDCP SDU not delivered to the upper layers, but still waited for. The initial value is 0.

c) RX_REORD

This state variable indicates the COUNT value following the COUNT value associated with the PDCP Data PDU which triggered *t-Reordering*.

7.1.3.4.1.3 Test description

7.1.3.4.1.3.1 Pre-test conditions

Same Pre-test conditions as in clause 7.1.3.0 except the following:

- 2 NR cells (NR Cell 1 and NR Cell 2) are configured with DRBs in RLC AM mode.
- The cell power levels are configured as per the Table 7.1.3.4.1.3.1-1.
- DRB of NR Cell 1 is configured according to Table 7.1.3.4.1.3.1-3.

Table 7.1.3.4.1.3.1-1: Time instances of cell power level in FR1

	Parameter	Unit	EUTRA Cell 1	NR Cell 1	NR Cell 2	Remark
T0	Cell-specific RS EPRE	dBm/SCS	-85	-	-	
	SS/PBCH SSS EPRE	dBm/SCS	-	-88	Off	
T1	Cell-specific RS EPRE	dBm/SCS	-85	-	-	
	SS/PBCH SSS EPRE	dBm/SCS	-	-88	-82	
T2	Cell-specific RS EPRE	dBm/SCS	-85	-	-	
	SS/PBCH SSS EPRE	dBm/SCS	-	-82	-88	

Table 7.1.3.4.1.3.1-2: Time instances of cell power level in FR2

	Parameter	Unit	EUTRA Cell 1	NR Cell 1	NR Cell 2	Remark
T0	Cell-specific RS EPRE	dBm/SCS	-96	-	-	
	SS/PBCH SSS EPRE	dBm/SCS	-	-91	Off	
T1	Cell-specific RS EPRE	dBm/SCS	-96	-	-	
	SS/PBCH SSS EPRE	dBm/SCS	-	-91	-82	

T2	Cell-specific RS EPRE	dBm/SCS	-96	-		
	SS/PBCH SSS EPRE	dBm/SCS	-	-82	-91	

Table 7.1.3.4.1.3.1-3: RLC parameters

<i>t-PollRetransmit</i>	ms150
-------------------------	-------

Table 7.1.3.4.1.3.1-4: MAC-CellGroupConfig

Derivation Path: TS 38.508, clause Table 4.6.3-68			
Information Element	Value/remark	Comment	Condition
MAC-CellGroupConfig ::= SEQUENCE {			
bsr-Config SEQUENCE {			
retxBSR-Timer	sf80		
}			

7.1.3.4.1.3.2 Test procedure sequence

Table 7.1.3.4.1.3.2-1: Main behaviour

St	Procedure	Message Sequence		TP	Verdict
		U - S	Message		
1	The SS creates 5 PDCP Data PDUs and the TX_NEXT is set to "0".	-	-	-	-
-	EXCEPTION: Step 2 and 3 shall be repeated for k=0 to 1(increment=1).	-	-	-	-
2	The SS sends the PDCP Data PDU#k via RLC-AM RB with the following content to the UE: D/C field = 1 (PDCP Data PDU) and PDCP SN = k on NR Cell 1. After having sent a PDU, the SS set TX_NEXT = k+1.	<--	PDCP PDU DATA #k	-	-
3	The UE sends the PDCP Data PDU#k via RLC-AM RB with the following content to the UE: D/C field = 1 (PDCP Data PDU) and PDCP SN = k on NR Cell 1. Data is previously received data from PDU #k. (Note 1)	-->	PDCP PDU DATA #k	-	-
3A	The SS changes NR Cell 2 parameters according to the row "T1" in table 7.1.3.4.1.3.1-1(FR1) / 7.1.3.4.1.3.1-2(FR2).				
-	EXCEPTION: Step 4 to 6 shall be repeated for m=2 to 4 (increment=1).	-	-	-	-
4	The SS is configured on NR Cell 1 not to send RLC acknowledgement (RLC ACK) to the next received RLC SDU to the UE.	-	-	-	-
5	The SS sends the PDCP Data PDU #m via RLC-AM RB with the following content to the UE: D/C field = 1 (PDCP Data PDU) and PDCP SN =m. After having sent a PDU, the SS set TX_NEXT = m+1. (Note 6)	<--	PDCP PDU DATA #m	-	-

6	The UE sends the PDCP Data PDU#m via RLC-AM RB with the following content to the UE: D/C field = 1 (PDCP Data PDU) and PDCP SN = m. Data is previously received data from PDU #m. (Note 2)	-->	PDCP PDU DATA #m	-	-
6A	Configure SS not to allocate UL grant to the UE in NR Cell 1				
7	Void	-	-	-	-
8	The SS transmits NR RRCReconfiguration message to perform SpCell change from NR Cell1 to NR Cell2 (Note 3)	<--	<i>RRCReconfiguration</i>	-	-
9	The SS assigns UL grant during the Random Access procedure on NR Cell 2 to allow the UE to send PDCP status report.(Note 5)	-	-	-	-
-	EXCEPTION: Steps 10 and 11 can occur in any order. (Note 7)	-	-	-	-
10	The UE transmits a NR <i>RRCReconfigurationComplete</i> message. (Note 4)	-->	<i>RRCReconfigurationComplete</i>	-	-
11	Check: Does the UE send PDCP Control PDUs via RLC-AM RB with the following content to the SS: D/C field = 0 (PDCP control PDU) and PDU Type =000, FMC field = 5 on NR Cell 2?	-->	PDCP STATUS REPORT	1	P
12	The SS generates a PDCP status report message and sends it to UE: D/C field = 0 (PDCP control PDU) and PDU Type =000, FMC field = 2 on NR Cell 2.	<--	PDCP STATUS REPORT	-	-
13	Configure the SS to allocate Default UL grants to the UE in NR Cell 2.	-	-	-	-
14	Void	-	-	-	-
-	EXCEPTION: Step 15 shall be repeated for m=2 to 4 (increment=1).	-	-	-	-
15	Check: Does the UE send the PDCP Data PDU #m via RLC-AM RB with the following content to the SS: D/C field = 1 (PDCP Data PDU) and PDCP SN = m on NR Cell 2? Note: Data is previously received data from PDU #m. (Note 8)	-->	PDCP PDU DATA #m	2	P
16	The SS sends the PDCP Data PDU#5 via RLC-AM RB with the following content to the UE: PDCP Data PDU #5 (D/C field = 1 (PDCP Data PDU) and PDCP SN=5) on NR Cell 2.	<--	PDCP DATA PDU#5	-	-
17	The UE transmits a PDCP Data PDU via RLC-AM RB with the following content back to the SS: D/C field = 1 (PDCP Data PDU) and PDCP SN=5 on NR Cell 2. Note: Data is previously received packet in PDCP Data PDU#5. (Note 1)	-->	PDCP DATA PDU #5	-	-
18	TX_NEXT is set to "6". The SS creates a PDCP Data PDU#6 (not transmitted).	-	-	-	-
19	The TX_NEXT is set to "7". The SS creates a PDCP Data PDU #7.	-	-	-	-
20	The SS sends PDCP Data PDU#7 via RLC-AM RB with the following content to the UE: PDCP Data PDU#7; D/C field = 1 (PDCP Data PDU) and PDCP SN=7 on NR Cell 2.	<--	PDCP DATA PDU #7	-	-

21	Check: Does the UE transmit a PDCP DATA PDU#7 on NR Cell 2?	-->	PDCP DATA PDU#7	3	F
21A	Configure SS not to allocate UL grant to the UE in NR Cell 1	-	-	-	-
22	The SS changes NR Cell 1 and NR Cell 2 parameters according to row "T2" in Table 7.1.3.4.1.3.1-1(FR1) / 7.1.3.4.1.3.1-2(FR2).	-	-	-	-
23	The SS requests transmits NR RRCReconfiguration message to perform SpCell change from NR Cell2 to NR Cell1 with key change. (Note 3)	<--	<i>RRCReconfiguration</i>	-	-
24	SS assigns UL grant during the Random Access procedure on NR Cell 1 to allow the UE to send PDCP status report.(Note 5)	-	-	-	-
-	EXCEPTION: Steps 25 and 26 can occur in any order. (Note 7)	-	-	-	-
25	The UE transmits a NR <i>RRCReconfigurationComplete</i> message. (Note 4)	-->	<i>RRCReconfigurationComplete</i>	-	-
26	The UE sends PDCP Control PDUs via RLC-AM RB with the following content to the SS: D/C field = 0 (PDCP control PDU) and PDU Type =000, FMC field = 6, Bitmap = 0x80 on NR Cell 1.	-->	PDCP STATUS REPORT	-	-
27	The SS generates a PDCP status report message and sends it to UE: D/C field = 0 (PDCP control PDU) and PDU Type =000, FMC field = 6 on NR Cell 1.	<--	PDCP STATUS REPORT	-	-
28	Configure the SS to allocate Default UL grants to the UE in NR Cell 1	-	-	-	-
28A	The SS sends the PDCP Data PDU#5 via RLC-AM RB with the following content to the UE: PDCP Data PDU #5 (D/C field = 1 (PDCP Data PDU) and PDCP SN=5) on NR Cell 1.	<--	PDCP DATA PDU#5	-	-
28B	Check: Does the UE transmit a PDCP Data PDU via RLC-AM RB with the following content back to the SS: D/C field = 1 (PDCP Data PDU) and PDCP SN=5 on NR Cell 1 within the next 5 seconds?	-->	PDCP DATA PDU #5	3	F
29	The SS sends the PDCP Data PDU#6 via RLC-AM RB with the following content to the UE: PDCP Data PDU#6 (D/C field = 1 (PDCP Data PDU) and PDCP SN=6) on NR Cell 1.	<--	PDCP DATA PDU #6	-	-
30	Check: Does the UE transmit a PDCP Data PDU via RLC-AM RB with the following content back to the SS? D/C field = 1 (PDCP Data PDU) and PDCP SN=6 on NR Cell 1. Note: Data is previously received packet in PDCP Data PDU#6 (Note 9)	-->	PDCP DATA PDU #6	3	P
31	Check: Does the UE transmit PDCP Data PDU via RLC-AM RB with the following content back to the SS? D/C field = 1 (PDCP Data PDU) and PDCP SN=7 on NR Cell 1. Note: Data is previously received packet in PDCP Data PDU#7 (Note 9)	-->	PDCP DATA PDU #7	3	P

Note 1:	The SS acknowledges the received data.
Note 2:	SS doesn't send the RLC ACK for this data.
Note 3:	For EN-DC the NR RRCReconfiguration (Table 7.1.3.4.1.3.3-1 with <i>cond EN-DC</i>) and <i>RadioBearerConfig</i> message (Table 7.1.3.4.1.3.3-2) are contained in RRCConnectionReconfiguration 36.508 [7], Table 4.6.1-8 using conditions EN-DC_EmbedNR_RRCRecon, EN-DC_PSCell_HO and RBConfig_KeyChange. IE sk-Counter-r15 is included with a value incremented by 1 than previous value.
Note 4:	For EN-DC the NR RRCReconfigurationComplete message is contained in RRCConnectionReconfigurationComplete.
Note 5:	The PDCP STATUS REPORT PDU size shall be 6 octets with 3 octets of RLC header, 2 octets of MAC header and 3 octets of MAC BSR or padding, so TBS of 112 bits shall be allocated.
Note 6:	PDCP PDU with $m = 2$ is sent at $t = 0$ and the subsequent PDCP PDUs are sent at $t = (m-2)*100$.
Note 7:	Per 38.508-1 Table 4.6.3-66: <i>LogicalChannelConfig</i> , both SRB1 and DRB have the same logical channel priority with <i>prioritisedBitRate</i> as infinity.
Note 8:	PDCP PDUs at step 15 ($m=2$ to 4) may be received by the SS in the same slot or in multiple slots (max one MAC PDU in a slot).
Note 9:	PDCP PDUs at steps 30 and 31 may be received by the SS in the same slot or in multiple slots (max one MAC PDU in a slot).

7.1.3.4.1.3.3 Specific message contents

Table 7.1.3.4.1.3.3-0: SchedulingRequest-Config (Preamble)

Derivation Path: 38.508-1 [4], Table: 4.6.3-155			
Information Element	Value/remark	Comment	Condition
sr-TransMax	n64		

Table 7.1.3.4.1.3.3-1: RRCReconfiguration (steps 8, 23)

Derivation Path: 38.508-1 [4], Table: 4.6.1-13			
Information Element	Value/remark	Comment	Condition
RRCReconfiguration ::= SEQUENCE {			
criticalExtensions CHOICE {			
rrcReconfiguration ::= SEQUENCE {			
radioBearerConfig	RadioBearerConfig		NR
secondaryCellGroup	CellGroupConfig		EN-DC
}			
nonCriticalExtension ::= SEQUENCE {			NR
masterCellGroup	CellGroupConfig		
masterKeyUpdate ::= SEQUENCE {			
keySetChangeIndicator	false		
nextHopChainingCount	0		
nas-Container	Not present	Horizontal key derivation	
}			
}			
}			

Table 7.1.3.4.1.3.3-2: RadioBearerConfig (Table 7.1.3.4.1.3.3-1)

Derivation Path: 38.508-1 [4], Table: 4.6.3-132			
Information Element	Value/remark	Comment	Condition
RadioBearerConfig ::= SEQUENCE {			
drb-ToAddModList SEQUENCE (SIZE (1..maxDRB)) OF DRB-ToAddMod {	1 entry		
DRB-ToAddMod[1] SEQUENCE {		entry 1	
drb-Identity	2	SCG DRB Id	EN-DC
	Default DRB of the first PDU session		NR
reestablishPDCP	True		
recoverPDCP	Not present		
pdcp-Config	PDCP-Config		

}			
}			
}			

Table 7.1.3.4.1.3.3-3: PDCP-Config (Table 7.1.3.4.1.3.3-2)

Derivation Path: 38.508-1 [4], Table: 4.6.3-99			
Information Element	Value/remark	Comment	Condition
PDCP-Config ::= SEQUENCE {			
drb SEQUENCE {			
statusReportRequired	True		
}			
}			

Table 7.1.3.4.1.3.3-4: CellGroupConfig for EN-DC (Table 7.1.3.4.1.3.3-1)

Derivation Path: 38.508-1 [4], Table: 4.6.3-19 with condition PSCell_change			
Information Element	Value/remark	Comment	Condition
CellGroupConfig ::= SEQUENCE {			
spCellConfig SEQUENCE {			
reconfigurationWithSync SEQUENCE {			
spCellConfigCommon	ServingCellConfigCommon		
}			
}			
}			

Table 7.1.3.4.1.3.3-4A: CellGroupConfig for NR/5GC (Table 7.1.3.4.1.3.3-1)

Derivation Path: 38.508-1 [4], Table: 4.6.3-19 with condition PCell_change			
--	--	--	--

Table 7.1.3.4.1.3.3-5: Void**Table 7.1.3.4.1.3.3-6: Void**

7.1.3.4.2 PDCP handover / Non-lossless handover / PDCP sequence number maintenance

7.1.3.4.2.1 Test Purpose (TP)

(1)

```
with { UE in RRC_CONNECTED state with default RB using RLC-UM }
ensure that {
  when { UE is requested to make a non-lossless handover by SS }
  then { UE transmits next PDCP Data PDU with SN value 0 }
}
```

(2)

```
with { UE in RRC_CONNECTED state with default RB using RLC-UM }
ensure that {
  when { UE is requested to make a non-lossless handover by SS }
  then { UE is able to receive next PDCP Data PDU with SN value 0 }
}
```

7.1.3.4.2.2 Conformance requirements

References: The conformance requirements covered in the present TC are specified in: TS 38.323, clause 5.1.2. Unless otherwise stated these are Rel-15 requirements.

[TS 38.323, clause 5.1.2]

When upper layers request a PDCP entity re-establishment, the UE shall additionally perform once the procedures described in this section. After performing the procedures in this section, the UE shall follow the procedures in subclause 5.2.

When upper layers request a PDCP entity re-establishment, the transmitting PDCP entity shall:

- for UM DRBs and AM DRBs, reset the header compression protocol for uplink and start with an IR state in U-mode (as defined in RFC 3095 [8] and RFC 4815 [9]) if *drb-ContinueROHC* is not configured in TS 38.331 [3];
- for UM DRBs and SRBs, set TX_NEXT to the initial value;
- for SRBs, discard all stored PDCP SDUs and PDCP PDUs;
- apply the ciphering algorithm and key provided by upper layers during the PDCP entity re-establishment procedure;
- apply the integrity protection algorithm and key provided by upper layers during the PDCP entity re-establishment procedure;
- for UM DRBs, for each PDCP SDU already associated with a PDCP SN but for which a corresponding PDU has not previously been submitted to lower layers:
 - consider the PDCP SDUs as received from upper layer;
 - perform transmission of the PDCP SDUs in ascending order of the COUNT value associated to the PDCP SDU prior to the PDCP re-establishment without restarting the *discardTimer*.
- for AM DRBs, from the first PDCP SDU for which the successful delivery of the corresponding PDCP Data PDU has not been confirmed by lower layers, perform retransmission or transmission of all the PDCP SDUs already associated with PDCP SNs in ascending order of the COUNT values associated to the PDCP SDU prior to the PDCP entity re-establishment as specified below:
 - perform header compression of the PDCP SDU as specified in the subclause 5.7.4;
 - perform integrity protection and ciphering of the PDCP SDU using the COUNT value associated with this PDCP SDU as specified in the subclause 5.9 and 5.8;
- submit the resulting PDCP Data PDU to lower layer.

When upper layers request a PDCP entity re-establishment, the receiving PDCP entity shall:

- process the PDCP Data PDUs that are received from lower layers due to the re-establishment of the lower layers, as specified in the subclause 5.2.2.1;
- for SRBs, discard all stored PDCP SDUs and PDCP PDUs;
- for UM DRBs, if *t-Reordering* is running:
 - stop and reset *t-Reordering*;
 - deliver all stored PDCP SDUs to the upper layers in ascending order of associated COUNT values after performing header decompression.
- for AM DRBs, perform header decompression for all stored PDCP SDUs if *drb-ContinueROHC* is not configured in TS 38.331 [3];
- for UM DRBs and AM DRBs, reset the header compression protocol for downlink and start with NC state in U-mode (as defined in RFC 3095 [8] and RFC 4815 [9]) if *drb-ContinueROHC* is not configured in TS 38.331 [3];
- for UM DRBs and SRBs, set RX_NEXT and RX_DELIV to the initial value;

- apply the ciphering algorithm and key provided by upper layers during the PDCP entity re-establishment procedure;
- apply the integrity protection algorithm and key provided by upper layers during the PDCP entity re-establishment procedure.

7.1.3.4.2.3 Test description

7.1.3.4.2.3.1 Pre-test conditions

Same Pre-test conditions as in clause 7.1.3.0 except that the DRB under test is configured in RLC UM mode. For EN-DC, ciphering algorithm is configured as null on E-UTRA.

7.1.3.4.2.3.2 Test procedure sequence

Table 7.1.3.4.2.3.2-1: Main behaviour

St	Procedure	Message Sequence		TP	Verdict
		U - S	Message		
1	The SS creates 3 PDCP Data PDUs and the TX_NEXT is set to "0".	-	-	-	-
-	EXCEPTION: Step 2 and 3 shall be repeated for k=0 to 1 (increment=1).	-	-	-	-
2	The SS sends the PDCP Data PDU #k via RLC-UM RB with the following content to the UE: D/C field = 1 (PDCP Data PDU) and PDCP SN = k. After having sent a PDU, the SS set TX_NEXT= k+1.	<--	PDCP PDU DATA #k	-	-
3	The UE sends the PDCP Data PDU #k via RLC-UM RB with the following content to the SS: D/C field = 1 (PDCP Data PDU) and PDCP SN = k.	-->	PDCP PDU DATA #k	-	-
4	The SS transmits NR <i>RRCReconfiguration</i> message to trigger non-lossless handover to the same SpCell. (Note 1, Note 3 and Note4)	<--	<i>RRCReconfiguration</i>	-	-
5	The UE transmits a NR <i>RRCReconfigurationComplete</i> message. (Note 2)	-->	<i>RRCReconfigurationComplete</i>	-	-
6	The SS sends the PDCP Data PDU #2 via RLC-UM RB with the following content to the UE: D/C field = 1 (PDCP Data PDU) and PDCP SN = 0. After having sent a PDU, the SS set TX_NEXT= 1.	<--	PDCP PDU DATA #2	-	-
7	Check: Does the UE send the PDCP Data PDU #2 via RLC-UM RB with the following content back to the SS: D/C field = 1 (PDCP Data PDU) and PDCP SN = 0?	-->	PDCP PDU DATA #2	1, 2	P
Note 1:	For EN-DC the NR <i>RRCReconfiguration</i> message with SCG Key change (secondary to master) is contained in <i>RRCConnectionReconfiguration</i> 36.508 [7], Table 4.6.1-8 using condition EN-DC_PSCell_HO and <i>RBConfig_KeyChange</i> .				
Note 2:	For EN-DC the NR <i>RRCReconfigurationComplete</i> message is contained in <i>RRCConnectionReconfigurationComplete</i> .				
Note 3:	The <i>RRCReconfiguration</i> message triggers UE to perform the Random Access procedure, MAC reset, RLC and PDCP re-establishment.				
Note 4:	For NR, the <i>RRCReconfiguration</i> message with master key change is as per <i>RRCReconfiguration-HO</i> with condition <i>RBConfig_KeyChange</i> according to 38.508-1 [4], Table 4.8.1-1A.				

7.1.3.4.2.3 Specific message contents

Table 7.1.3.4.2.3-1: RRCReconfiguration for EN-DC (step 4, Table 7.1.3.4.2.3.2-1)

Derivation Path: TS 38.508-1 [4], Table 4.6.1-13 with condition EN-DC_HO.

Table 7.1.3.4.2.3-1A: RRCReconfiguration for NR/5GC (step 4, Table 7.1.3.4.2.3.2-1)

Derivation Path: TS 38.508-1 [4], Table 4.8.1-1A with condition RBConfig_KeyChange			
Information Element	Value/remark	Comment	Condition
RRCReconfiguration ::= SEQUENCE {			
criticalExtensions CHOICE {			
rrcReconfiguration ::= SEQUENCE {			
nonCriticalExtension SEQUENCE {			
masterCellGroup	CellGroupConfig	OCTET STRING (CONTAINING CellGroupConfig)	
masterKeyUpdate SEQUENCE {			
keySetChangeIndicator	false	K	
nextHopChainingCount	0	Horizontal key derivation	
nas-Container	not present		
}			
}			

Table 7.1.3.4.2.3-2: RadioBearerConfig for EN-DC (step 4, Table 7.1.3.4.2.3.2-1)

Derivation Path: 38.508-1 [4], Table 4.6.3-132 with condition EN-DC_DRB AND Re-establish_PDCP			
Information Element	Value/remark	Comment	Condition
RadioBearerConfig ::= SEQUENCE {			
securityConfig SEQUENCE {			
securityAlgorithmConfig	SecurityAlgorithmConfig		
keyToUse	master		
}			
}			

Table 7.1.3.4.2.3-3: SecurityAlgorithmConfig for EN-DC (Table 7.1.3.4.2.3-2)

Derivation Path: 38.508-1 [4], Table 4.6.3-165			
Information Element	Value/remark	Comment	Condition
SecurityAlgorithmConfig ::= SEQUENCE {			
cipheringAlgorithm	nea0		
}			

Table 7.1.3.4.2.3-4: CellGroupConfig for EN-DC (step 4, Table 7.1.3.4.2.3.2-1)

Derivation Path: 38.508-1 [4], Table 4.6.3-19 with condition PSCell_change			
Information Element	Value/remark	Comment	Condition
CellGroupConfig ::= SEQUENCE {			
rlc-BearerToAddModList SEQUENCE (SIZE(1..maxLCH)) OF RLC-BearerConfig {	1 entry		EN-DC
RLC-Bearer-Config[1]	RLC-BearerConfig with conditions UM and DRB2 and Re-establish_RLC	entry 1	
}			
}			

Table 7.1.3.4.2.3-5: CellGroupConfig for NR/5GC (step 4, Table 7.1.3.4.2.3.2-1)

Derivation Path: 38.508-1 [4], Table 4.6.3-19 with condition PCell_change

7.1.3.4.3 PDCP handover / DAPS handover / Status reporting / Intra-frequency

7.1.3.4.3.1 Test Purpose (TP)

(1)

```
with { UE in NR RRC_CONNECTED state and supporting Intra-frequency DAPS handover }
ensure that {
  when { UE receives an RRCReconfiguration message including a reconfigurationWithSync for Intra-
frequency DAPS handover }
  then { PDCP entity associated with a DAPS bearer shall keep DL/UL reception/transmission with
the source gNB }
}
```

(2)

```
with { UE in NR RRC_CONNECTED state and supporting Intra-frequency DAPS handover and receiving an
RRCReconfiguration message including a reconfigurationWithSync for Intra-frequency DAPS handover }
ensure that {
  when { UE has performed random access procedure to the target cell successfully }
  then { UE shall perform uplink data switching }
}
```

(3)

```
with { UE in NR RRC_CONNECTED state and supporting Intra-frequency DAPS handover and receiving an
RRCReconfiguration message including a reconfigurationWithSync for Intra-frequency DAPS handover }
ensure that {
  when { upper layer requests a uplink data switching }
  then { UE shall send a PDCP status report for the DAPS bearer }
}
```

(4)

```
with { UE in NR RRC_CONNECTED state and supporting Intra-frequency DAPS handover and receiving an
RRCReconfiguration message including a reconfigurationWithSync for Intra-frequency DAPS handover }
ensure that {
  when { upper layer requests a PDCP entity reconfiguration and the associated RLC entity is
released for a radio bearer }
  then { UE shall send a PDCP status report for the DAPS bearer }
}
```

7.1.3.4.3.2 Conformance requirements

References: The conformance requirements covered in the present TC are specified in: TS 38.331 clause 5.3.5.5.2 and TS 38323 clause 4.2.2, 5.4.1, 5.8, 5.9 and 5.13. Unless otherwise stated these are Rel-16 requirements.

[TS 38.331, clause 5.3.5.5.2]

The UE shall perform the following actions to execute a reconfiguration with sync.

- 1> if the AS security is not activated, perform the actions upon going to RRC_IDLE as specified in 5.3.11 with the release cause 'other' upon which the procedure ends;

...

- 1> If any DAPS bearer is configured:

- 2> create a MAC entity for the target cell group with the same configuration as the MAC entity for the source cell group;
- 2> for each DAPS bearer:
 - 3> establish an RLC entity or entities for the target cell group, with the same configurations as for the source cell group;
 - 3> establish the logical channel for the target cell group, with the same configurations as for the source cell group;

NOTE 2b: In order to understand if a DAPS bearer is configured, the UE needs to check the presence of the field *daps-Config* within the *RadioBearerConfig* IE received in *radioBearerConfig* or *radioBearerConfig2*.

2> for each SRB:

3> establish an RLC entity for the target cell group, with the same configurations as for the source cell group;

3> establish the logical channel for the target cell group, with the same configurations as for the source cell group;

3> suspend SRBs for the source cell group;

NOTE 3: Void

2> apply the value of the *newUE-Identity* as the C-RNTI in the target cell group;

2> configure lower layers for the target SpCell in accordance with the received *spCellConfigCommon*;

2> configure lower layers for the target SpCell in accordance with any additional fields, not covered in the previous, if included in the received *reconfigurationWithSync*.

[TS 38.323, clause 4.2.2]

The PDCP entities are located in the PDCP sublayer. Several PDCP entities may be defined for a UE. Each PDCP entity is carrying the data of one radio bearer. A PDCP entity is associated either to the control plane or the user plane depending on which radio bearer it is carrying data for.

Figure 4.2.2.1 represents the functional view of the PDCP entity for the PDCP sublayer; it should not restrict implementation. The figure is based on the radio interface protocol architecture defined in TS 38.300 [2].

For split bearers and DAPS bearers, routing is performed in the transmitting PDCP entity.

A PDCP entity associated with DRB can be configured by upper layers TS 38.331 [3] to use header compression. In this version of the specification, the robust header compression protocol (ROHC) and the Ethernet header compression protocol (EHC) are supported. Each header compression protocol is independently configured for a DRB.

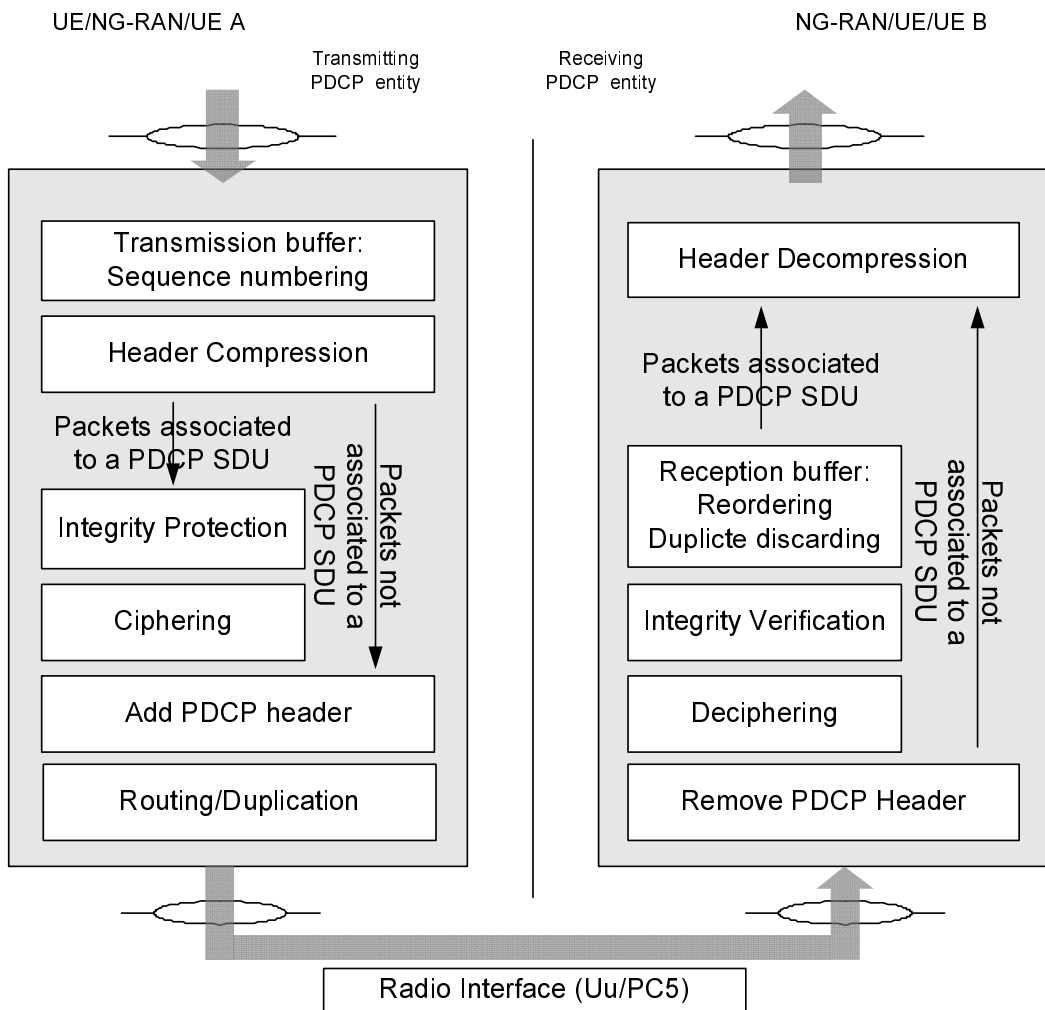

Figure 4.2.2-1: PDCP layer, functional view

Figure 4.2.2-2 represents the functional view of the PDCP entity associated with the DAPS bearer for the PDCP sublayer; it should not restrict implementation. The figure is based on the radio interface protocol architecture defined in TS 38.300 [2].

For DAPS bearers, the PDCP entity is configured with two sets of security functions and keys and two sets of header compression protocols.

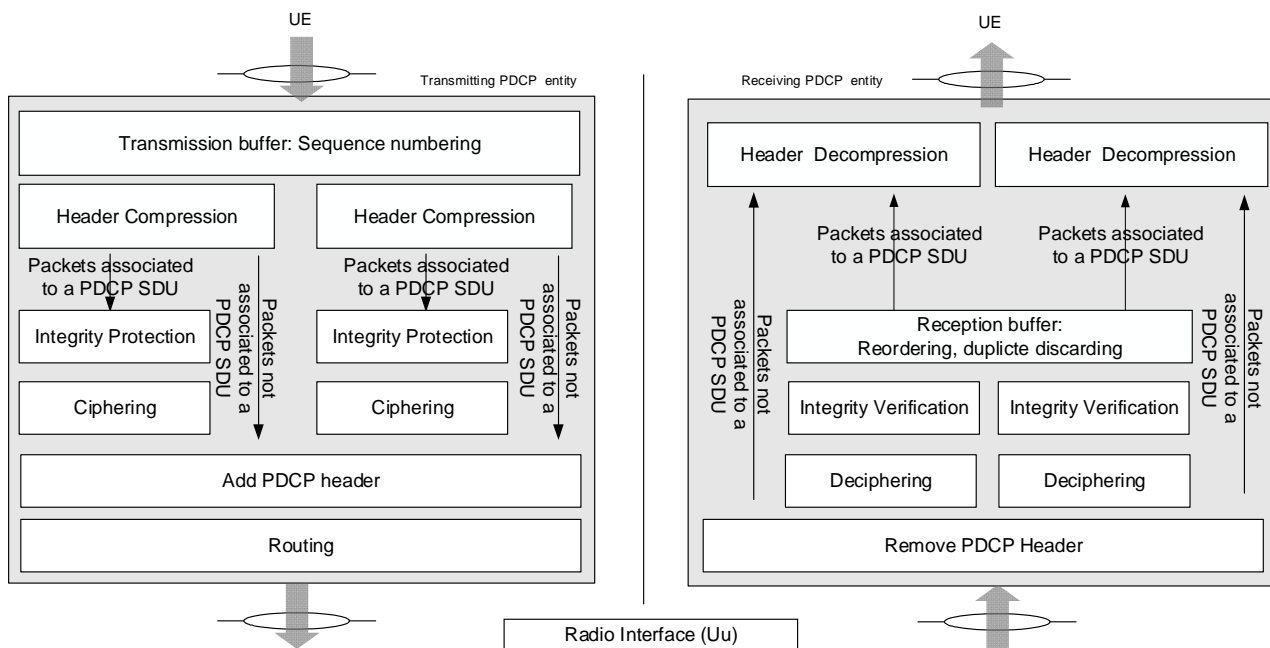

Figure 4.2.2-2: PDCP layer associated with DAPS bearer, functional view

[TS 38.323, clause 5.4.1]

For AM DRBs configured by upper layers to send a PDCP status report in the uplink (*statusReportRequired* in TS 38.331 [3]), the receiving PDCP entity shall trigger a PDCP status report when:

- upper layer requests a PDCP entity re-establishment;
- upper layer requests a PDCP data recovery;
- upper layer requests a uplink data switching;
- upper layer reconfigures the PDCP entity to release DAPS and *daps-SourceRelease* is configured in TS 38.331 [3].

For UM DRBs configured by upper layers to send a PDCP status report in the uplink (*statusReportRequired* in TS 38.331 [3]), the receiving PDCP entity shall trigger a PDCP status report when:

- upper layer requests a uplink data switching.

[TS 38.323, clause 5.8]

The ciphering function includes both ciphering and deciphering and is performed in PDCP, if configured. The data unit that is ciphered is the MAC-I (see clause 6.3.4) and the data part of the PDCP Data PDU (see clause 6.3.3) except the SDAP header and the SDAP Control PDU if included in the PDCP SDU. The ciphering is not applicable to PDCP Control PDUs.

For downlink and uplink, the ciphering algorithm and key to be used by the PDCP entity are configured by upper layers TS 38.331 [3] and the ciphering method shall be applied as specified in TS 33.501 [6].

The ciphering function is activated/suspended/resumed by upper layers TS 38.331 [3]. When security is activated and not suspended, the ciphering function shall be applied to all PDCP Data PDUs indicated by upper layers TS 38.331 [3] for the downlink and the uplink, respectively.

For DAPS bearers, the PDCP entity shall perform the ciphering or deciphering for the PDCP SDU using the ciphering algorithm and key either configured for the source cell or configured for the target cell, based on to/from which cell the PDCP SDU is transmitted/received.

For downlink and uplink ciphering and deciphering, the parameters that are required by PDCP for ciphering are defined in TS 33.501 [6] and are input to the ciphering algorithm. The required inputs to the ciphering function include the

COUNT value, and DIRECTION (direction of the transmission: set as specified in TS 33.501 [6]). The parameters required by PDCP which are provided by upper layers TS 38.331 [3] are listed below:

- BEARER (defined as the radio bearer identifier in TS 33.501 [6]. It will use the value RB identity –1 as in TS 38.331 [3]);
- KEY (the ciphering keys for the control plane and for the user plane are K_{RRCenc} and K_{UPenc} , respectively).

[TS 38.323, clause 5.9]

The integrity protection function includes both integrity protection and integrity verification and is performed in PDCP, if configured. The data unit that is integrity protected is the PDU header and the data part of the PDU before ciphering. The integrity protection is always applied to PDCP Data PDUs of SRBs. The integrity protection is applied to sidelink SRB1, SRB2 and SRB3. The integrity protection is applied to PDCP Data PDUs of DRBs (including sidelink DRBs for unicast) for which integrity protection is configured. The integrity protection is not applicable to PDCP Control PDUs.

For downlink and uplink, the integrity protection algorithm and key to be used by the PDCP entity are configured by upper layers TS 38.331 [3] and the integrity protection method shall be applied as specified in TS 33.501 [6].

The integrity protection function is activated/suspended/resumed by upper layers TS 38.331 [3]. When security is activated and not suspended, the integrity protection function shall be applied to all PDUs including and subsequent to the PDU indicated by upper layers TS 38.331 [3] for the downlink and the uplink, respectively.

NOTE 1: As the RRC message which activates the integrity protection function is itself integrity protected with the configuration included in this RRC message, this message needs first be decoded by RRC before the integrity protection verification could be performed for the PDU in which the message was received.

NOTE 2: As the PC5-S message which activates the integrity protection function is itself integrity protected with the configuration included in this PC5-S message, this message needs first be decoded by upper layer before the integrity protection verification could be performed for the PDU in which the message was received.

For DAPS bearers, the PDCP entity shall perform the integrity protection or verification for the PDCP SDU using the integrity protection algorithm and key either configured for the source cell or configured for the target cell, based on to/from which cell the PDCP SDU is transmitted/received.

For downlink and uplink integrity protection and verification, the parameters that are required by PDCP for integrity protection are defined in TS 33.501 [6] and are input to the integrity protection algorithm. The required inputs to the integrity protection function include the COUNT value, and DIRECTION (direction of the transmission: set as specified in TS 33.501 [6]). The parameters required by PDCP which are provided by upper layers TS 38.331 [3] are listed below:

- BEARER (defined as the radio bearer identifier in TS 33.501 [6]. It will use the value RB identity –1 as in TS 38.331 [3]);
- KEY (the integrity protection keys for the control plane and for the user plane are K_{RRCint} and K_{UPint} , respectively).

[TS 38.323, clause 5.13]

For DAPS bearers, when upper layers request uplink data switching, the transmitting PDCP entity shall:

- for AM DRBs, from the first PDCP SDU for which the successful delivery of the corresponding PDCP Data PDU has not been confirmed by the RLC entity associated with the source cell, perform retransmission or transmission of all the PDCP SDUs already associated with PDCP SNs in ascending order of the COUNT values associated to the PDCP SDU prior to uplink data switching to the RLC entity associated with the target cell as specified below:
 - perform header compression of the PDCP SDU using ROHC as specified in the clause 5.7.4;
 - perform integrity protection and ciphering of the PDCP SDU using the COUNT value associated with this PDCP SDU as specified in the clause 5.9 and 5.8;
 - submit the resulting PDCP Data PDU to lower layer, as specified in clause 5.2.1.

- for UM DRBs, for all PDCP SDUs which have been processed by PDCP but which have not yet been submitted to lower layers, perform transmission of the PDCP SDUs in ascending order of the COUNT values to the RLC entity associated with the target cell as specified below:
 - perform header compression of the PDCP SDU using ROHC as specified in the clause 5.7.4;
 - perform integrity protection and ciphering of the PDCP SDU using the COUNT value associated with this PDCP SDU as specified in the clause 5.9 and 5.8;
 - submit the resulting PDCP Data PDU to lower layer, as specified in clause 5.2.1.

7.1.3.4.3.3 Test description

7.1.3.4.3.3.1 Pre-test conditions

System Simulator:

Same Pre-test conditions as in clause 7.1.3.0 except the following:

- NR Cell 1 is the Serving cell and the power level is configured to "Serving Cell" defined in TS 38.508-1 [4] Table 6.2.2.1-3.
- NR Cell 2 is the Suitable neighbour intra-frequency cell and the power level is configured to " Suitable neighbour intra-frequency cell" defined in TS 38.508-1 [4] Table 6.2.2.1-3.
- System information combination NR-2 as defined in TS 38.508-1 [4] clause 4.4.3.1.3 is used for both NR Cells.
- Test Loop Function (On) with UE test loop mode B activated according to TS 38.508-1 [4], table 4.5.4.2-3.

UE:

- None.

Preamble:

- The UE is in 3N-A state configured with DRB#1 in RLC AM mode according to TS 38.508-1 [4], Table 4.4A.2-3.

7.1.3.4.3.3.2 Test procedure sequence

Table 7.1.3.4.3.3.2-1: Main behaviour

St	Procedure	Message Sequence		TP	Verdict
		U - S	Message		
1	The SS transmits an <i>RRCReconfiguration</i> message containing <i>reconfigurationWithSync</i> to order UE to perform DAPS handover to NR Cell 2. DRB#n of the first PDU session is configured as DAPS bearer.	<--	NR RRC: <i>RRCReconfiguration</i>	-	-
-	EXCEPTION: In parallel with step 2-3, parallel behaviour defined in table 7.1.3.4.3.3.2-2 is executed repeatedly.	-	-	-	-
2	The SS sends one IP Packet to the UE via DRB#n of the first PDU session in NR Cell 1 and	<--	PDCP PDU DATA #0	-	-
2A	The SS stops sending RLC acknowledgements.	-	-	-	-
3	Check: Does the UE loop back the IP packet received at step 2 in NR Cell 1?	-->	PDCP PDU DATA #0	1	P
4	The SS transmits Random Access Response to respond to the latest preamble in NR Cell 2.	<-	Random Access Response	-	-
-	EXCEPTION: Steps 5-7 can occur in any order.	-	-	-	-
5	The UE transmits an	-->	NR RRC:	-	-

	<i>RRCReconfigurationComplete</i> message in NR Cell 2.		<i>RRCReconfigurationComplete</i>		
6	Check: Does the UE retransmit the IP packet received at step 2 in NR Cell 2?	-->	PDCP PDU DATA #0	2	P
7	Check: Does the UE send PDCP status report in NR Cell 2? (Note 1)	-->	PDCP STATUS REPORT	3	P
8	The SS transmits an <i>RRCReconfiguration</i> message with condition DAPS_HO_ReleaseSource in NR Cell 2.	<--	NR RRC: <i>RRCReconfiguration</i>	-	-
-	EXCEPTION: Steps 9-10 can occur in any order.	-	-	-	-
9	The UE transmits an <i>RRCReconfigurationComplete</i> message in NR Cell 2.	-->	NR RRC: <i>RRCReconfigurationComplete</i>	-	-
10	Check: Does the UE send PDCP status report in NR Cell 2? (Note 1)	-->	PDCP STATUS REPORT	4	P
Note 1: D/C field = 0 (PDCP control PDU) and PDU Type =000 (PDCP status report), FMC field = 1.					

Table 7.1.3.4.3.3.2-2: Parallel behaviour

St	Procedure	Message Sequence		TP	Verdict
		U - S	Message		
1	The UE transmits preamble to NR Cell 2.	->	(PRACH Preamble)	-	-

7.1.3.4.3.3.3 Specific message contents

Table 7.1.3.4.3.3.3-1: *RRCReconfiguration* (step 1, Table 7.1.3.4.3.3.2-1)

Derivation Path: TS 38.508-1 [4], Table 4.8.1-1A with Condition RBConfig_NoKeyChange			
Information Element	Value/remark	Comment	Condition
<i>RRCReconfiguration</i> ::= SEQUENCE {			
criticalExtensions CHOICE {			
rrcReconfiguration SEQUENCE {			
radioBearerConfig	RadioBearerConfig with conditions DRBn and DAPS_PDCP		
nonCriticalExtension SEQUENCE{			
masterCellGroup	CellGroupConfig	OCTET STRING (CONTAINING CellGroupConfig)	
}			
}			
}			
}			

Table 7.1.3.4.3.3.3-2: *CellGroupConfig* (Table 7.1.3.4.3.3.3-1)

Derivation Path: TS 38.508-1 [4], Table 4.6.3-19			
Information Element	Value/remark	Comment	Condition
<i>CellGroupConfig</i> ::= SEQUENCE {			
rlc-BearerToAddModList SEQUENCE (SIZE(1..maxLCH)) OF RLC-BearerConfig {	1 entry		
RLC-BearerConfig[1]	RLC-BearerConfig with conditions AM, DRBn	entry1	
}			
spCellConfig SEQUENCE {			
reconfigurationWithSync SEQUENCE {			
spCellConfigCommon SEQUENCE {			
physCellId	Physical Cell Identity of NR Cell 2		
}			
rach-ConfigDedicated CHOICE {			

uplink	RACH-ConfigDedicated	OCTET STRING (CONTAINING RACH-ConfigDedicated)	
}			
}			
}			
}			

Table 7.1.3.4.3.3.3-3: RACH-ConfigDedicated (Table 7.1.3.4.3.3.3-2)

Derivation Path: TS 38.508-1 [4], Table 4.6.3-129			
Information Element	Value/remark	Comment	Condition
RACH-ConfigDedicated ::= SEQUENCE {			
cfra SEQUENCE {			
occasions SEQUENCE {			
rach-ConfigGeneric	RACH-ConfigGeneric	OCTET STRING (CONTAINING RACH-ConfigGeneric)	
}			
}			
}			

Table 7.1.3.4.3.3.3-4: RACH-ConfigGeneric (Table 7.1.3.4.3.3.3-3)

Derivation Path: TS 38.508-1 [4], Table 4.6.3-130			
Information Element	Value/remark	Comment	Condition
RACH-ConfigGeneric ::= SEQUENCE {			
preambleTransMax	n200		
}			

Table 7.1.3.4.3.3.3-5: RRCReconfiguration (step 8, Table 7.1.3.4.3.3.2-1)

Derivation Path: TS 38.508-1 [4], Table 4.8.1-1A with Condition DAPS_HO_ReleaseSource

7.1.3.4.4 PDCP handover / DAPS handover / Status reporting / Inter-frequency

7.1.3.4.4.1 Test Purpose (TP)

(1)

```
with { UE in NR RRC_CONNECTED state and supporting Inter-frequency DAPS handover }
ensure that {
  when { UE receives an RRCReconfiguration message including a reconfigurationWithSync for Inter-frequency DAPS handover }
  then { PDCP entity associated with a DAPS bearer shall keep DL/UL reception/transmission with the source gNB }
}
```

(2)

```
with { UE in NR RRC_CONNECTED state and supporting Inter-frequency DAPS handover and receiving an RRCReconfiguration message including a reconfigurationWithSync for Inter-frequency DAPS handover }
ensure that {
  when { UE has performed random access procedure to the target cell successfully }
  then { UE shall perform uplink data switching }
}
```

(3)

```

with { UE in NR RRC_CONNECTED state and supporting Inter-frequency DAPS handover and receiving an
RRCReconfiguration message including a reconfigurationWithSync for Inter-frequency DAPS handover }
ensure that {
  when { upper layer requests a uplink data switching }
  then { UE shall send a PDCP status report for the DAPS bearer }
}

```

(4)

```

with { UE in NR RRC_CONNECTED state and supporting Inter-frequency DAPS handover and receiving an
RRCReconfiguration message including a reconfigurationWithSync for Inter-frequency DAPS handover }
ensure that {
  when { upper layer requests a PDCP entity reconfiguration and the associated RLC entity is
released for a radio bearer }
  then { UE shall send a PDCP status report for the DAPS bearer }
}

```

7.1.3.4.4.2 Conformance requirements

Same as test case 7.1.3.4.3.2.

7.1.3.4.4.3 Test description

7.1.3.4.4.3.1 Pre-test conditions

Same as test case 7.1.3.4.3 with the following differences:

- Cells configuration: NR Cell 3 replaces NR Cell 2.
- System information combination: NR-4 replaces NR-2.

7.1.3.4.4.3.2 Test procedure sequence

Same as test case 7.1.3.4.3 with the following differences:

- Cells configuration: NR Cell 3 replaces NR Cell 2.

7.1.3.4.4.3.3 Specific message contents

Same as test case 7.1.3.4.3 with the following differences:

- Cells configuration: NR Cell 3 replaces NR Cell 2.

7.1.3.5 PDCP other

7.1.3.5.1 PDCP Discard

7.1.3.5.1.1 Test Purpose (TP)

(1)

```

with { UE in RRC_CONNECTED state }
ensure that {
  when { the Discard Timer for a PDCP SDU expires }
  then { UE discards the corresponding PDCP SDU }
}

```

7.1.3.5.1.2 Conformance requirements

References: The conformance requirements covered in the present TC are specified in: TS 38.323, clause 5.3. Unless otherwise stated these are Rel-15 requirements.

[TS 38.323, clause 5.3]

When the *discardTimer* expires for a PDCP SDU, or the successful delivery of a PDCP SDU is confirmed by PDCP status report, the transmitting PDCP entity shall discard the PDCP SDU along with the corresponding PDCP Data PDU. If the corresponding PDCP Data PDU has already been submitted to lower layers, the discard is indicated to lower layers.

For SRBs, when upper layers request a PDCP SDU discard, the PDCP entity shall discard all stored PDCP SDUs and PDCP PDUs.

NOTE: Discarding a PDCP SDU already associated with a PDCP SN causes a SN gap in the transmitted PDCP Data PDUs, which increases PDCP reordering delay in the receiving PDCP entity. It is up to UE implementation how to minimize SN gap after SDU discard.

[TS 38.323, clause 7.1]

This sub clause describes the state variables used in PDCP entities in order to specify the PDCP protocol. The state variables defined in this subclause are normative.

All state variables are non-negative integers, and take values from 0 to $[2^{32} - 1]$.

PDCP Data PDUs are numbered integer sequence numbers (SN) cycling through the field: 0 to $[2^{[pdep-SN-Size]} - 1]$.

The transmitting PDCP entity shall maintain the following state variables:

a) TX_NEXT

This state variable indicates the COUNT value of the next PDCP SDU to be transmitted. The initial value is 0.

The receiving PDCP entity shall maintain the following state variables:

a) RX_NEXT

This state variable indicates the COUNT value of the next PDCP SDU expected to be received. The initial value is 0.

b) RX_DELIV

This state variable indicates the COUNT value of the first PDCP SDU not delivered to the upper layers, but still waited for. The initial value is 0.

c) RX_REORD

This state variable indicates the COUNT value following the COUNT value associated with the PDCP Data PDU which triggered *t-Reordering*.

[TS 38.323, clause 6.3.5]

Length: 32 bits

The COUNT value is composed of a HFN and the PDCP SN. The size of the HFN part in bits is equal to 32 minus the length of the PDCP SN.



Figure 6.3.5-1: Format of COUNT

NOTE: COUNT does not wrap around.

7.1.3.5.1.3 Test description

7.1.3.5.1.3.1 Pre-test conditions

Same Pre-test conditions as in clause 7.1.3.0 with exceptions listed in Table 7.1.3.5.1.3.1-1 applicable for the configured UM DRB and Table 7.1.3.5.1.3.3-1 for SR configuration except that PDCP is configured for 18 bit SN.

Table 7.1.3.5.1.3.1-1: PDCP Settings

Parameter	Value
Discard_Timer	500 ms

7.1.3.5.1.3.2 Test procedure sequence

Table 7.1.3.5.1.3.2-1: Main behaviour

St	Procedure	Message Sequence		TP	Verdict
		U - S	Message		
-	EXCEPTION: The SS does not allocate UL grants unless when explicitly stated so in the procedure.	-	-	-	-
1	The SS creates 5 PDCP Data PDUs and the PDCP SN = "0" within TX_NEXT.	-	-	-	-
2	Void				
-	EXCEPTION: Step 3 shall be repeated for k=0 to 2 (increment=1) with the below specified PDU size sent to the UE: Data PDU#1 = 46 bytes for k=0 Data PDU#2 = 62 bytes for k=1 Data PDU#3 = 78 bytes for k=2	-	-	-	-
3	The SS sends a PDCP Data PDU via RLC-UM RB with the following content to the UE: D/C field = 1 (PDCP Data PDU) and PDCP SN = k After having sent a PDU, the SS sets PDCP SN is set to k+1 within TX_NEXT.	<--	PDCP DATA PDU (SN=k)	-	-
4	Wait for Discard_Timer to expire. Note: According to TS38.508-1, timer tolerance should be 10% of Discard_Timer.	-	-	-	-
-	EXCEPTION: Step 5 shall be repeated for k=3 to 4 (increment=1) with the below specified PDU size sent to the UE: Data PDU#4 = 94 bytes for k=3 Data PDU#5 = 110 bytes for k=4	-	-	-	-
5	The SS sends a PDCP Data PDU via RLC-UM RB with the following content to the UE: D/C field = 1 (PDCP Data PDU) and PDCP SN = k After having sent a PDU, the SS sets PDCP SN is set to k+1 within TX_NEXT.	<--	PDCP DATA PDU (SN=k)	-	-
6	The SS resumes normal UL grant allocation.	-	-	-	-
7	Check: Does UE transmit a PDCP Data PDU # 4 of size 94 bytes? (Note1) (Note 2)	-->	PDCP Data PDU # 4	1	P
8	Check: Does UE transmit a PDCP Data PDU # 5 of size 110 bytes? (Note1) (Note 2)	-->	PDCP Data PDU # 5	1	P
Note 1	PDCP Data PDU contents are checked to verify that the UL PDU is same as the DL PDU. According to the Note in TS 38.323 [19] clause 5.3 in case of PDCP SDUs being discarded it is up to the UE implementation which SN to be used and therefore the SN cannot be checked.				
Note 2	PDCP PDUs at steps 7 and 8 may be received by the SS in the same slot or in multiple slots (max one MAC PDU in a slot).				

7.1.3.5.1.3.3 Specific message contents

Table 7.1.3.5.1.3.3-1: SchedulingRequest-Config (Preamble)

Derivation Path: 38.508-1 [4], Table 4.6.3-155
--

Information Element	Value/remark	Comment	Condition
sr-TransMax	n64		

7.1.3.5.2 PDCP Uplink Routing / Split DRB

7.1.3.5.2.1 Test Purpose

(1)

```
with { UE in RRC_CONNECTED state with SCG activated with a Split DRB established and total amount of
PDCP data volume is less than ul-DataSplitThreshold and not yet transmitted RLC data volume in the
two associated RLC entities }
ensure that {
  when { UE has PDCP SDUs available for transmission }
  then { the UE transmits the PDCP SDUs on the Primary RLC entity }
}
```

(2)

```
with { UE in RRC_CONNECTED state with SCG activated with a Split DRB established and total amount of
PDCP data volume is not less than ul-DataSplitThreshold and not yet transmitted RLC data volume in
the two associated RLC entities }
ensure that {
  when { UE has PDCP SDUs available for transmission }
  then { the UE transmits the PDCP SDUs on the primary or secondary RLC entity }
}
```

7.1.3.5.2.2 Conformance requirements

References: The conformance requirements covered in the present TC are specified in: TS 38.323, clause 5.2.1. Unless otherwise stated these are Rel-15 requirements.

[TS 38.323, clause 5.2.1]

At reception of a PDCP SDU from upper layers, the transmitting PDCP entity shall:

- start the *discardTimer* associated with this PDCP SDU (if configured).

For a PDCP SDU received from upper layers, the transmitting PDCP entity shall:

- associate the COUNT value corresponding to TX_NEXT to this PDCP SDU;

NOTE 1: Associating more than half of the PDCP SN space of contiguous PDCP SDUs with PDCP SNs, when e.g., the PDCP SDUs are discarded or transmitted without acknowledgement, may cause HFN desynchronization problem. How to prevent HFN desynchronization problem is left up to UE implementation.

- perform header compression of the PDCP SDU as specified in the subclause 5.7.4;
- perform integrity protection, and ciphering using the TX_NEXT as specified in the subclause 5.9 and 5.8, respectively;
- set the PDCP SN of the PDCP Data PDU to TX_NEXT modulo $2^{[pdcp-SN-Size]}$;
- increment TX_NEXT by one;
- submit the resulting PDCP Data PDU to lower layer as specified below.

When submitting a PDCP Data PDU to lower layer, the transmitting PDCP entity shall:

- if the transmitting PDCP entity is associated with one RLC entity:
 - submit the PDCP Data PDU to the associated RLC entity.
- else, if the transmitting PDCP entity is associated with two RLC entities:

- if the PDCP duplication is activated:
 - if the PDCP PDU is a PDCP Data PDU:
 - duplicate the PDCP Data PDU and submit the PDCP Data PDU to both associated RLC entities.
 - else:
 - if the two associated RLC entities belong to the different Cell Groups; and
 - if the total amount of PDCP data volume and RLC data volume pending for initial transmission (as specified in TS 36.322 [5]) in the two associated RLC entities is equal to or larger than *ul-DataSplitThreshold*:
 - submit the PDCP Data PDU to either the primary RLC entity or the secondary RLC entity;
 - else:
 - submit the PDCP Data PDU to the primary RLC entity.

NOTE 2: If the transmitting PDCP entity is associated with two RLC entities, the UE should minimize the amount of PDCP PDUs submitted to lower layers before receiving request from lower layers and minimize the PDCP SN gap between PDCP PDUs submitted to two associated RLC entities to minimize PDCP reordering delay in the receiving PDCP entity.

7.1.3.5.2.3 Test description

7.1.3.5.2.3.1 Pre-test conditions

Same Pre-test conditions as in clause 7.1.3.0 with exceptions listed in Table 7.1.3.5.2.3.1-1 and Generic procedure parameter DC bearer(*MCG and split*).

For NR/5GC, NR Cell 1 is the PCell and NR Cell 10 is the PSCell and same Pre-test conditions as in clause 7.1.3.0 using generic procedure parameter Connectivity (NR-DC) with DC bearer(*MCG and split*).

Table 7.1.3.5.2.3.1-1: PDCP Settings

Parameter	Value
Discard_Timer	500 ms
ul-DataSplitThreshold	b100

7.1.3.5.2.3.2 Test procedure sequence

Table 7.1.3.5.2.3.2-1: Main behaviour

St	Procedure	Message Sequence		TP	Verdict
		U - S	Message		
0A	SS transmits NR <i>RRCReconfiguration</i> message to configure the primary path on the MCG Cell.	<--	<i>RRCReconfiguration</i>	-	-
0B	UE transmits <i>RRCReconfigurationComplete</i> (Note 2).	-->	<i>RRCReconfigurationComplete</i>	-	-
1	The SS sends a PDCP Data PDU on the split DRB on AM RLC entity configured for SCG on PSCell. Data PDU = 64 bytes.	<--	PDCP DATA PDU	-	-
-	EXCEPTION: In parallel with step 2, UE may execute parallel behaviour defined in table 7.1.3.5.2.3.2-2.	-	-	-	-
2	Check: Does UE transmit a PDCP Data PDU on the AM RLC primary entity?	-->	PDCP DATA PDU	1	P
2A	SS transmits NR <i>RRCReconfiguration</i> message to configure the primary path on the SCG Cell.	<--	<i>RRCReconfiguration</i>	-	-
2B	UE transmits <i>RRCReconfigurationComplete</i> (Note 2).	-->	<i>RRCReconfigurationComplete</i>	-	-
2C	The SS sends a PDCP Data PDU on the split DRB	<--	PDCP DATA PDU	-	-

	on AM RLC entity configured for SCG on PSCell. Data PDU = 64 bytes.				
-	EXCEPTION: In parallel with step 2D, UE may execute parallel behaviour defined in table 7.1.3.5.2.3.2-2.	-	-	-	-
2D	Check: Does UE transmit a PDCP Data PDU on the primary AM RLC entity?	-->	PDCP DATA PDU	1	P
3	The SS sends a PDCP Data PDU on the split DRB on AM RLC entity configured for SCG on PSCell. Data PDU = 164 bytes.	<--	PDCP DATA PDU	-	-
-	EXCEPTION: Steps 4a1 to 4b2 describe optional behaviour that depends on the UE uplink path	-	-	-	-
4a1	Check: Does UE transmit a PDCP Data PDU on the AM RLC primary entity?	-->	PDCP DATA PDU	2	P
4a2	Check: Does UE transmit a PDCP Data PDU on the AM RLC secondary entity	-->	PDCP DATA PDU	2	F
4b1	Check: Does UE transmit a PDCP Data PDU on the AM RLC secondary entity?	-->	PDCP DATA PDU	2	P
4b2	Check: Does UE transmit a PDCP Data PDU on the AM RLC primary entity?	-->	PDCP DATA PDU	2	F
5	SS transmits NR <i>RRCReconfiguration</i> message to configure new split DRB parameters, where the ul-DataSplitThreshold is equal to 0 bytes (Note 1).	<--	<i>RRCReconfiguration</i>	-	-
6	UE transmits <i>RRCReconfigurationComplete</i> (Note 2).	-->	<i>RRCReconfigurationComplete</i>	-	-
7	The SS sends a PDCP Data PDU on the split DRB on AM RLC entity configured for SCG on PSCell. Data PDU = 64 bytes	<--	PDCP Data PDU	-	-
-	EXCEPTION: Steps 8a1 to 8b2 describe optional behaviour that depends on the UE uplink path	-	-	-	-
8a1	Check: Does UE transmit a PDCP Data PDU on the AM RLC primary entity?	-->	PDCP DATA PDU	2	P
8a2	Check: Does UE transmit a PDCP Data PDU on the AM RLC secondary entity?	-->	PDCP DATA PDU	2	F
8b1	Check: Does UE transmit a PDCP Data PDU on the AM RLC secondary?	-->	PDCP DATA PDU	2	P
8b2	Check: Does UE transmit a PDCP Data PDU on the AM RLC primary?	-->	PDCP DATA PDU	2	F
Note 1: For EN-DC the NR <i>RRCReconfiguration</i> message is contained in <i>RRCConnectionReconfiguration</i> .					
Note 2: For EN-DC the NR <i>RRCReconfigurationComplete</i> message is contained in <i>RRCConnectionReconfigurationComplete</i> .					

Table 7.1.3.5.2.3.2-2: Parallel behaviour

St	Procedure	Message Sequence		TP	Verdict
		U - S	Message		
1	Check: Does UE transmit a PDCP Data PDU on the AM RLC secondary entity in next 2 seconds? NOTE: 2 seconds is sufficient time to discard PDCP PDU.	-->	PDCP DATA PDU	1	F

7.1.3.5.2.3.3 Specific message contents

Table 7.1.3.5.2.3.3-0A: *RRCConnectionReconfiguration* (step 0A, step 2A, step 5, Table 7.1.3.5.3.3.2-1)

Derivation Path: 36.508 [7], Table 4.6.1-8			
Information Element	Value/remark	Comment	Condition
<i>RRCConnectionReconfiguration</i> ::= SEQUENCE {			
criticalExtensions CHOICE {			
c1 CHOICE{			
rrcConnectionReconfiguration-r8 ::= SEQUENCE			
{			
nonCriticalExtension SEQUENCE {			

}		
---	--	--

7.1.3.5.3 PDCP Data Recovery

7.1.3.5.3.1 Test Purpose (TP)

(1)

```
with { UE in RRC_CONNECTED state with a DRB established using RLC-AM }
ensure that {
  when { network requests reconfiguration and recovery of the DRB (without handover) }
  then { UE reconfigures the DRB and performs retransmission of all the PDCP PDUs previously
submitted to re-established AM RLC entity in ascending order of the associated COUNT values from the
first PDCP PDU for which the successful delivery has not been confirmed by lower layers }
}
```

7.1.3.5.3.2 Conformance requirements

References: The conformance requirements covered in the present TC are specified in: TS 38.323, clauses 5.2.1, 5.4.1 and 5.5; TS 38.331, clause 5.3.5.4.3. Unless otherwise stated these are Rel-15 requirements.

[TS 38.323, clause 5.2.1]

At reception of a PDCP SDU from upper layers, the transmitting PDCP entity shall:

- start the *discardTimer* associated with this PDCP SDU (if configured).

For a PDCP SDU received from upper layers, the transmitting PDCP entity shall:

- associate the COUNT value corresponding to TX_NEXT to this PDCP SDU;

NOTE 1: Associating more than half of the PDCP SN space of contiguous PDCP SDUs with PDCP SNs, when e.g., the PDCP SDUs are discarded or transmitted without acknowledgement, may cause HFN desynchronization problem. How to prevent HFN desynchronization problem is left up to UE implementation.

- perform header compression of the PDCP SDU as specified in the subclause 5.7.4;
- perform integrity protection, and ciphering using the TX_NEXT as specified in the subclause 5.9 and 5.8, respectively;
- set the PDCP SN of the PDCP Data PDU to TX_NEXT modulo $2^{[pdc\text{-}SN\text{-}Size]}$;
- increment TX_NEXT by one;
- submit the resulting PDCP Data PDU to lower layer as specified below.

When submitting a PDCP PDU to lower layer, the transmitting PDCP entity shall:

- if the transmitting PDCP entity is associated with one RLC entity:
 - submit the PDCP PDU to the associated RLC entity;
- else, if the transmitting PDCP entity is associated with two RLC entities:
 - if *pdc\text{-}Duplication* is configured and activated:
 - duplicate the PDCP Data PDU and submit the PDCP Data PDU to both associated RLC entities;
 - else, if *pdc\text{-}Duplication* is configured but not activated:
 - submit the PDCP Data PDU to the primary RLC entity;
 - else:

- if the total amount of PDCP data volume and RLC data volume pending for initial transmission (as specified in TS 38.322 [5]) in the two associated RLC entities is less than *ul-DataSplitThreshold*:
 - submit the PDCP PDU to the primary RLC entity;
- else:
 - submit the PDCP PDU to either the primary RLC entity or the secondary RLC entity.

NOTE 2: If the transmitting PDCP entity is associated with two RLC entities, the UE should minimize the amount of PDCP PDUs submitted to lower layers before receiving request from lower layers and minimize the PDCP SN gap between PDCP PDUs submitted to two associated RLC entities to minimize PDCP reordering delay in the receiving PDCP entity.

[TS 38.323, clause 5.4.1]

For AM DRBs configured by upper layers to send a PDCP status report in the uplink (*statusReportRequired* in TS 38.331 [3]), the receiving PDCP entity shall trigger a PDCP status report when:

- upper layer requests a PDCP entity re-establishment;
- upper layer requests a PDCP data recovery.

If a PDCP status report is triggered, the receiving PDCP entity shall:

- compile a PDCP status report as indicated below by:
 - setting the FMC field to RX_DELIV;
 - if RX_DELIV < RX_NEXT:
 - allocating a Bitmap field of length in bits equal to the number of COUNTs from and not including the first missing PDCP SDU up to and including the last out-of-sequence PDCP SDUs, rounded up to the next multiple of 8, or up to and including a PDCP SDU for which the resulting PDCP Control PDU size is equal to 9000 bytes, whichever comes first;
 - setting in the bitmap field as '0' for all PDCP SDUs that have not been received, and optionally PDCP SDUs for which decompression have failed;
 - setting in the bitmap field as '1' for all PDCP SDUs that have been received;
- submit the PDCP status report to lower layers as the first PDCP PDU for transmission.

[TS 38.323, clause 5.4.2]

For AM DRBs, when a PDCP status report is received in the downlink, the transmitting PDCP entity shall:

- consider for each PDCP SDU, if any, with the bit in the bitmap set to '1', or with the associated COUNT value less than the value of FMC field as successfully delivered, and discard the PDCP SDU as specified in the subclause 5.3.

[TS 38.323, clause 5.5]

For AM DRBs, when upper layers request a PDCP data recovery for a radio bearer, the transmitting PDCP entity shall:

- perform retransmission of all the PDCP Data PDUs previously submitted to re-established or released AM RLC entity in ascending order of the associated COUNT values for which the successful delivery has not been confirmed by lower layers.

After performing the above procedures, the transmitting PDCP entity shall follow the procedures in subclause 5.2.1.

7.1.3.5.3.3 Test description

7.1.3.5.3.3.1 Pre-test conditions

Same Pre-test conditions as in clause 7.1.3.0 except that DRB is configured in RLC AM mode according to Table 7.1.3.5.3.3.1-1.

For NR 5GC, NRCell 1 is the PCell and NR Cell 10 is the PSCell and same Pre-test conditions as in clause 7.1.3.0 using generic procedure parameter Connectivity (*NR-DC*).

Table 7.1.3.5.3.3.1-1: RLC parameters

<i>t-PollRetransmit</i>	ms150
-------------------------	-------

7.1.3.5.3.3.2 Test procedure sequence

Table 7.1.3.5.3.3.2-1: Main behaviour

St	Procedure	Message Sequence		TP	Verdict
		U - S	Message		
1	Void	-	-	-	-
2	The SS creates 3 PDCP Data PDUs and the Next_PDCP_TX_SN is set to "0".	-	-	-	-
-	EXCEPTION: Steps 2A and 4 shall be repeated for k=0 to 2 (increment=1).	-	-	-	-
2A	The SS is configured on PSCell to not send RLC acknowledgement (RLC ACK) to the UE	-	-	-	-
3	The SS sends the PDCP Data PDU #k on SCG DRB on (PSCell): D/C field = 1 (PDCP Data PDU) and PDCP SN = k. After having sent a PDU, the SS sets Next_PDCP_TX_SN= k+1.	<--	PDCP PDU DATA #k	-	-
4	The UE sends the PDCP Data PDU #k on the AM RLC entity configured for PSCell: D/C field = 1 (PDCP Data PDU) and PDCP SN = k. Data is previously received data from PDU #k.	-->	PDCP PDU DATA #k	-	-
4A	The SS does not allocate any UL grant.	-	-	-	-
5	The SS transmits a NR <i>RRCReconfiguration</i> . (Note 1).	<--	<i>RRCReconfiguration</i>	-	-
6	The UE transmits a NR <i>RRCReconfigurationComplete</i> . (Note 2).	-->	<i>RRCReconfigurationComplete</i>	-	-
7	The SS assigns 1 UL grant of sufficient size to allow the UE to send only PDCP status report.	-	-	-	-
8	The UE sends PDCP Control PDUs on PSCell via RLC-AM RB with the following content to the SS: D/C field = 0 (PDCP control PDU) and PDU Type =000, FMC field = 3.	-->	PDCP STATUS REPORT	-	-
8A	After 100 ms the SS allocates 3 UL grants every 20ms of sufficient size to enable the UE to return each received PDCP PDU in one looped back PDCP PDU on PSCell.	-	-	-	-
-	EXCEPTION: Step 9 shall be repeated for k=0 to 2 (increment=1).	-	-	-	-
9	Check: Does the UE send the PDCP Data PDU #k via the AM RLC entity configured for PSCell for Connectivity ENDC and PCell for Connectivity (NR-DC). D/C field = 1 (PDCP Data PDU) and PDCP SN = k. Data is previously received data from PDU #k ?	-->	PDCP DATA PDU #k	1	P
Note 1:	For EN-DC the NR <i>RRCReconfiguration</i> message is contained in <i>RRCConnectionReconfiguration</i> .				
Note 2:	For EN-DC the NR <i>RRCReconfigurationComplete</i> message is contained in <i>RRCConnectionReconfigurationComplete</i> .				

7.1.3.5.3.3.3 Specific message contents

Table 7.1.3.5.3.3-1: RRCConnectionReconfiguration (step 5, Table 7.1.3.5.3.3-1)

Derivation Path: 36.508 [7], Table 4.6.1-8 with condition MCG_and_SCG			
Information Element	Value/remark	Comment	Condition
RRCConnectionReconfiguration ::= SEQUENCE {			
criticalExtensions CHOICE {			
c1 CHOICE {			
rrcConnectionReconfiguration-r8 ::= SEQUENCE			
{			
nonCriticalExtension SEQUENCE {			
nonCriticalExtension SEQUENCE {			
nonCriticalExtension SEQUENCE {			
nonCriticalExtension SEQUENCE {			
nonCriticalExtension SEQUENCE {			
nonCriticalExtension SEQUENCE {			
nonCriticalExtension SEQUENCE {			
nr-Config-r15 CHOICE {			
setup SEQUENCE {			
nr-SecondaryCellGroupConfig-r15	OCTET STRING including the RRCReconfiguration-PDCP message and the IE secondaryCellGroup		
}			
}			
nr-RadioBearerConfig1-r15	OCTET STRING including RadioBearerConfig-PDCP-ENDC		
}			
}			
}			
}			
}			
}			
}			
}			
}			
}			
}			
}			

Table 7.1.3.5.3.3-2: RRCReconfiguration-PDCP (Step 5, Table 7.1.3.5.3.3-1)

Derivation Path: 38.508-1 [4], Table 4.6.1-13			
Information Element	Value/remark	Comment	Condition
RRCReconfiguration ::= SEQUENCE {			
criticalExtensions CHOICE {			
rrcReconfiguration SEQUENCE {			
radioBearerConfig	Not present		NR-DC
secondaryCellGroup	CellGroupConfig-PDCP-ENDC		EN-DC
	Not present		NR-DC
nonCriticalExtension SEQUENCE {			NR-DC
masterCellGroup	CellGroupConfig with condition DRBn as per 38.508-1[4] Table 4.6.3-19	SCG DRBn added in master cell group	
nonCriticalExtension SEQUENCE {			
nonCriticalExtension SEQUENCE {			
mrdc-SecondaryCellGroupConfig CHOICE {			
setup SEQUENCE {			

mrdc-SecondaryCellGroup CHOICE { nr-SCG	RRCReconfiguration-SCGRLCreEst	OCTET STRING (CONTAINING RRCReconfiguration)	
radioBearerConfig2	RadioBearerConfig-PDCPsplit		
}			
}			
}			
}			
}			
}			
}			
}			
}			
}			

Table 7.1.3.5.3.3.3-2A: RRCReconfiguration-SCGRLCreEst (Table 7.1.3.5.3.3.3-2)

Derivation Path: 38.508-1 [4], Table 4.6.1-13 with condition NR-DC_SCG			
Information Element	Value/remark	Comment	Condition
RRCReconfiguration ::= SEQUENCE { criticalExtensions CHOICE { rrcReconfiguration SEQUENCE { secondaryCellGroup	CellGroupConfig-SCG-RLC	OCTET STRING (CONTAINING CellGroupConfig)	
}			
}			
}			

Table 7.1.3.5.3.3.3-2B: CellGroupConfig-PDCP-ENDC (Table 7.1.3.5.3.3.3-2)

Derivation Path: 38.508-1 [4], Table 4.6.3-19			
Information Element	Value/remark	Comment	Condition
CellGroupConfig ::= SEQUENCE { rlc-BearerToAddModList SEQUENCE (SIZE(1..maxLCH)) OF RLC-BearerConfig { RLC-BearerConfig[1]	1 entry RLC-BearerConfig with conditions AM and DRB2 and Re-establish_RLC	entry 1	
}			
}			

Table 7.1.3.5.3.3.3-2C: CellGroupConfig-SCG-RLC (Table 7.1.3.5.3.3.3-2A)

Derivation Path: 38.508-1 [4], Table 4.6.1-19 with condition NR-DC_SCG			
Information Element	Value/remark	Comment	Condition
CellGroupConfig ::= SEQUENCE { rlc-BearerToAddModList SEQUENCE (SIZE(1..maxLCH)) OF RLC-BearerConfig {	1 entry RLC-BearerConfig with conditions AM and DRBn and Re-establish_RLC		
}			
}			

Table 7.1.3.5.3.3.3-3: RadioBearerConfig-PDCP-ENDC (Table 4.1.3.5.3.3.3-2)

Derivation Path: TS 38.508-1 [7], Table 4.6.3-132

Information Element	Value/remark	Comment	Condition
RadioBearerConfig ::= SEQUENCE {			
srb3-ToRelease	Not present		
drb-ToAddModList	Not present		
drb-ToAddModList SEQUENCE (SIZE (1..maxDRB)) OF DRB-ToAddMod {	1 entry		
DRB-ToAddMod[1] SEQUENCE {		entry 1	
cnAssociation CHOICE {			
eps-BearerIdentity	6		
sdap-Config	Not present		
}			
drb-Identity	2		
reestablishPDCP	Not present		
recoverPDCP	true		
pdcpc-Config	PDCP-Config-Split		
}			
}			
drb-ToReleaseList	Not present		
}			

Table 7.1.3.5.3.3.3-3A: RadioBearerConfig-PDCPSplit (Table 7.1.3.5.3.3.3-2)

Derivation Path: TS 38.508-1 [4], Table 4.6.3-132			
Information Element	Value/remark	Comment	Condition
RadioBearerConfig ::= SEQUENCE {			
drb-ToAddModList SEQUENCE (SIZE (1..maxDRB)) OF {	1 entry		
DRB-ToAddMod[1] SEQUENCE {			
cnAssociation	Not present		
drb-Identity	DRB-Identity with condition DRBn	SGC DRBn	
reestablishPDCP	Not present		
recoverPDCP	true		
pdcpc-Config	PDCP-Config-Split		
}			
}			
}			

Table 7.1.3.5.3.3.3-4: PDCP-Config-Split (Table 7.1.3.5.3.3.3-3)

Derivation Path: 38.508-1 [4], Table 4.6.3-99 condition EN-DC			
Information Element	Value/remark	Comment	Condition
PDCP-Config ::= SEQUENCE {			
moreThanOneRLC SEQUENCE {			
primaryPath SEQUENCE {			
cellGroup	1		EN-DC
}	0	MCG Path	NR-DC
}			
ul-DataSplitThreshold	infinity		
}			
}			

7.1.3.5.4 PDCP reordering / Maximum re-ordering delay below t-Reordering / t-Reordering timer operations

7.1.3.5.4.1 Test Purpose (TP)

(1)

```
with { UE in RRC_CONNECTED state using RLC-AM }
ensure that {
  when { a PDCP PDU is received from the lower layers and the COUNT value of the received PDCP Data
PDU is out of the re-ordering window }
    then { UE discards the PDCP PDU }
}
```

(2)

```
with { UE in RRC_CONNECTED state using RLC-AM }
ensure that {
  when { a PDCP PDU is received from the lower layers and the COUNT value of the received PDCP Data
PDU is within the re-ordering window }
    then { UE stores the resulting PDCP SDU }
}
```

(3)

```
with { UE in RRC_CONNECTED state using RLC-AM, and the RX_DELIV is not equal to the COUNT value of
the RX_NEXT (there is missing PDCP PDUs) }
ensure that {
  when { a PDCP PDU is received from the lower layers and the RCVD_COUNT = RX_DELIV }
    then { UE delivers the resulting PDCP SDU and all stored PDCP SDUs with consecutive COUNT value
to upper layer, in ascending order }
}
```

(4)

```
with { UE in RRC_CONNECTED state using RLC-AM and the associated PDCP t-Reordering timer is running
}
ensure that {
  when { RX_DELIV >= RX_REORD }
    then { UE stops and resets t-Reordering timer }
}
```

(5)

```
with { UE in RRC_CONNECTED state using RLC-AM and the associated PDCP t-Reordering timer is running
}
ensure that {
  when { the t-Reordering timer expires }
    then { UE delivers all stored PDCP SDUs to upper layer }
}
```

(6)

```
with { UE in RRC_CONNECTED state using RLC-AM and the associated PDCP t-Reordering timer is running
}
ensure that {
  when { the t-Reordering is reconfigured by upper layers }
    then { UE stops and resets t-Reordering timer }
}
```

7.1.3.5.4.2 Conformance requirements

References: The conformance requirements covered in the present test case are specified in: TS 38.323, clause 5.2.2.1, 5.2.2.2 and 5.2.2.3. Unless otherwise stated these are Rel-15 requirements.

[TS 38.323, clause 5.2.2.1]

In this section, following definitions are used:

- HFN(State Variable): the HFN part (i.e. the number of most significant bits equal to HFN length) of the State Variable;
- SN(State Variable): the SN part (i.e. the number of least significant bits equal to PDCP SN length) of the State Variable;
- RCVD_SN: the PDCP SN of the received PDCP Data PDU, included in the PDU header;
- RCVD_HFN: the HFN of the received PDCP Data PDU, calculated by the receiving PDCP entity;
- RCVD_COUNT: the COUNT of the received PDCP Data PDU = [RCVD_HFN, RCVD_SN].

At reception of a PDCP Data PDU from lower layers, the receiving PDCP entity shall determine the COUNT value of the received PDCP Data PDU, i.e. RCVD_COUNT, as follows:

- if $RCVD_SN < SN(RX_DELIV) - Window_Size$:
 - $RCVD_HFN = HFN(RX_DELIV) + 1$.
- else if $RCVD_SN \geq SN(RX_DELIV) + Window_Size$:
 - $RCVD_HFN = HFN(RX_DELIV) - 1$.
- else:
 - $RCVD_HFN = HFN(RX_DELIV)$;
 - $RCVD_COUNT = [RCVD_HFN, RCVD_SN]$.

After determining the COUNT value of the received PDCP Data PDU = RCVD_COUNT, the receiving PDCP entity shall:

- perform deciphering and integrity verification of the PDCP Data PDU using $COUNT = RCVD_COUNT$;
- if integrity verification fails:
 - indicate the integrity verification failure to upper layer;
 - discard the PDCP Data PDU;
- if $RCVD_COUNT < RX_DELIV$; or
- if the PDCP Data PDU with $COUNT = RCVD_COUNT$ has been received before:
 - discard the PDCP Data PDU;

If the received PDCP Data PDU with COUNT value = RCVD_COUNT is not discarded above, the receiving PDCP entity shall:

- store the resulting PDCP SDU in the reception buffer;
- if $RCVD_COUNT \geq RX_NEXT$:
 - update RX_NEXT to $RCVD_COUNT + 1$.
- if *outOfOrderDelivery* is configured:
 - deliver the resulting PDCP SDU to upper layers.
- if $RCVD_COUNT = RX_DELIV$:
 - deliver to upper layers in ascending order of the associated COUNT value after performing header decompression, if not decompressed before;
 - all stored PDCP SDU(s) with consecutively associated COUNT value(s) starting from $COUNT = RX_DELIV$;

- update RX_DELIV to the COUNT value of the first PDCP SDU which has not been delivered to upper layers, with COUNT value > RX_DELIV;
- if *t-Reordering* is running, and if RX_DELIV >= RX_REORD:
 - stop and reset *t-Reordering*.
- if *t-Reordering* is not running (includes the case when *t-Reordering* is stopped due to actions above), and RX_DELIV < RX_NEXT:
 - update RX_REORD to RX_NEXT;
 - start *t-Reordering*.

[TS 38.323, clause 5.2.2.2]

When *t-Reordering* expires, the receiving PDCP entity shall:

- deliver to upper layers in ascending order of the associated COUNT value after performing header decompression, if not decompressed before:
 - all stored PDCP SDU(s) with associated COUNT value(s) < RX_REORD;
 - all stored PDCP SDU(s) with consecutively associated COUNT value(s) starting from RX_REORD;
- update RX_DELIV to the COUNT value of the first PDCP SDU which has not been delivered to upper layers, with COUNT value >= RX_REORD;
- if RX_DELIV < RX_NEXT:
 - update RX_REORD to RX_NEXT;
 - start *t-Reordering*.

[TS 38.323, clause 5.2.2.3]

When the value of the *t-Reordering* is reconfigured by upper layers while the *t-Reordering* is running, the receiving PDCP entity shall:

- update RX_REORD to RX_NEXT;
- stop and restart *t-Reordering*.

7.1.3.5.4.3 Test description

7.1.3.5.4.3.1 Pre-test conditions

Same Pre-test conditions as in clause 7.1.3.0 exception of PDCP parameters according to Table 7.1.3.5.4.3.1-1.

Table 7.1.3.5.4.3.1-1: PDCP parameters

t-Reordering	ms300
--------------	-------

7.1.3.5.4.3.2 Test procedure sequence

Table 7.1.3.5.4.3.2-1: Main behaviour

St	Procedure	Message Sequence		TP	Verdict
		U - S	Message		
1	The SS sends the PDCP SDU #131072 D/C field = 1 (PDCP Data PDU) and PDCP SN = 131072. (Note 1)	<--	(PDCP SDU #131072)	-	-
2	Check: Does the UE transmit a PDCP SDU via the AM RLC entity in the next 1s?	-->	(PDCP SDU)	1	F
3	The SS sends the PDCP SDU #1	<--	(PDCP SDU #1)	-	-

	D/C field = 1 (PDCP Data PDU) and PDCP SN = 1. The UE starts <i>t-Reordering</i> .				
4	The SS sends the PDCP SDU #2 D/C field = 1 (PDCP Data PDU) and PDCP SN = 2.	<--	(PDCP SDU #2)	-	-
5	Wait for 100ms (< configured <i>t-Reordering</i>).	-	-	-	-
6	The SS sends the PDCP SDU #0 D/C field = 1 (PDCP Data PDU) and PDCP SN = 0.	<--	(PDCP SDU #0)	-	-
7	Check: Does the UE transmit the PDCP SDU #0 via the AM RLC entity D/C field = 1 (PDCP Data PDU) and PDCP SN = 0? (Note 4)	-->	(PDCP SDU #0)	2, 3	P
8	Check: Does the UE transmit the PDCP SDU #1 via the AM RLC entity D/C field = 1 (PDCP Data PDU) and PDCP SN = 1? (Note 4)	-->	(PDCP SDU #1)	2, 3	P
9	Check: Does the UE transmit the PDCP SDU #2 via the AM RLC entity D/C field = 1 (PDCP Data PDU) and PDCP SN = 2? (Note 4)	-->	(PDCP SDU #2)	2, 3	P
10	The SS sends the PDCP SDU #4 D/C field = 1 (PDCP Data PDU) and PDCP SN = 4. The UE starts <i>t-Reordering</i> .	<--	(PDCP SDU #4)	-	-
11	Wait for 100ms (< configured <i>t-Reordering</i>)	-	-	-	-
12	The SS sends the PDCP SDU #7 D/C field = 1 (PDCP Data PDU) and PDCP SN = 7.	<--	(PDCP SDU #7)	-	-
13	The SS sends the PDCP SDU #3 D/C field = 1 (PDCP Data PDU) and PDCP SN = 3. The UE restarts <i>t-Reordering</i> timer. Note T ₁	<--	(PDCP SDU #3)	-	-
14	Check: Does the UE transmit the PDCP SDU #3 via the AM RLC entity? (Note 5)	-->	(PDCP SDU #3)	3	P
15	Check: Does the UE transmit the PDCP SDU #4 via the AM RLC entity? (Note 5)	-->	(PDCP SDU #4)	3	P
16	Check 1: Does the UE transmit the PDCP SDU #7 with PDCP SN=5 via the AM RLC entity after <i>t-Reordering</i> expiry? Note T ₂ Check 2: Is (T ₂ - T ₁) > <i>t-Reordering</i> ?	-->	(PDCP SDU #7)	4,5	P
17	The SS sends the PDCP SDU #9 D/C field = 1 (PDCP Data PDU) and PDCP SN = 9. The UE starts <i>t-Reordering</i> .	<--	(PDCP SDU #9)	-	-
18	Wait for 100ms (< configured <i>t-Reordering</i>)	-	-	-	-
19	The SS reconfigures the <i>t-Reordering</i> by sending a NR <i>RRCReconfiguration</i> message. The UE restarts <i>t-Reordering</i> timer. (Note 2) Note T ₃	<--	<i>RRCReconfiguration</i>	-	-
20	The UE transmits a NR <i>RRCReconfigurationComplete</i> message. (Note 3)	-->	<i>RRCReconfigurationComplete</i>	-	-
21	Check 1: Does the UE transmit the PDCP SDU #9 with PDCP SN=6 via the AM RLC entity after <i>t-Reordering</i> expiry? Note T ₄ Check 2: Is (T ₄ - T ₃) > <i>t-Reordering</i> ?	-->	(PDCP SDU #9)	6	P
Note 1:	The Reordering Window size is 131072 when 18 bit SN length is used.				
Note 2:	For EN-DC the NR <i>RRCReconfiguration</i> message is contained in <i>RRCConnectionReconfiguration</i> 36.508 [7], Table 4.6.1-8 using condition EN-DC_Embed_RBConfig.				
Note 3:	For EN-DC the NR <i>RRCReconfigurationComplete</i> message is contained in <i>RRCConnectionReconfigurationComplete</i> .				
Note 4:	PDCP SDUs at steps 7, 8 and 9 may be received by the SS in the same slot or in multiple slots (max one MAC PDU in a slot)				
Note 5:	PDCP SDUs at steps 14 and 15 may be received by the SS in the same slot or in multiple slots (max one MAC PDU in a slot).				

7.1.3.5.4.3.3 Specific message contents

Table 7.1.3.5.4.3.3-1: RRCReconfiguration (step 19, Table 7.1.3.5.4.3.2-1)

Derivation Path: 38.508-1 [4], Table: 4.6.1-13			
Information Element	Value/remark	Comment	Condition
RRCReconfiguration ::= SEQUENCE {			
criticalExtensions CHOICE {			
rrcReconfiguration ::= SEQUENCE {			
radioBearerConfig	RadioBearerConfig		Not EN-DC
secondaryCellGroup	CellGroupConfig		EN-DC
}			
RRCReconfiguration-v1530-IEs ::= SEQUENCE {			
masterCellGroup	CellGroupConfig		Not-EN-DC
}			
}			

Table 7.1.3.5.4.3.3-2: RadioBearerConfig (Table 7.1.3.5.4.3.3-1)

Derivation path: 38.508-1 [4], Table 4.6.3-132			
Information Element	Value/Remark	Comment	Condition
RadioBearerConfig ::= SEQUENCE {			
drb-ToAddModList ::= SEQUENCE (SIZE 1..2) OF DRB-ToAddMod {	1 entry		
DRB-ToAddMod[1] SEQUENCE {		entry 1	
pdcp-Config SEQUENCE {			
drb SEQUENCE {			
outOfOrderDelivery	False		
}			
t-Reordering	ms750		
}			
}			
}			
}			

7.1.3.5.5 PDCP Duplication

7.1.3.5.5.1 Test Purpose (TP)

(1)

```
with { UE in RRC_CONNECTED state and pdcpDuplication is configured and activated }
ensure that {
  when { UE has PDCP SDUs available for transmission }
  then { the UE transmits the PDCP SDUs on both the associated RLC entities }
}
```

(2)

```
with { UE in RRC_CONNECTED state and pdcpDuplication is configured and not activated }
ensure that {
  when { UE receives MAC Control Element to Activate PDCP Duplication on a DRB configured with PDCP duplication }
  then { the UE activates PDCP Duplication on the PDCP associated with the DRB }
}
```

(3)

```
with { UE in RRC_CONNECTED state and pdcpDuplication is configured }
ensure that {
  when { UE has PDCP SDUs available for transmission }
}
```



```

then { the UE transmits the PDCP SDUs on the primary RLC entity}
}

```

(4)

```

with { UE in RRC_CONNECTED state and pdcpDuplication is configured and activated}
ensure that {
  when { the UE had transmitted the PDCP SDUs on both the associated RLC entities and successful
  delivery of a PDCP Data PDU is confirmed by one of the two associated AM RLC entities}
  then { the other AM RLC entity discards the duplicated PDCP Data PDU}
}

```

7.1.3.5.5.2 Conformance requirements

References: The conformance requirements covered in the present TC are specified in: TS 38.321:5.10, 6.1.3.10 and TS 38.323:5.2.1, 5.11.1, 5.11.2 and TS 38.331: 5.3.5.6.4. Unless otherwise stated these are Rel-15 requirements.

[TS 38.323, clause 5.2.1]

When submitting a PDCP PDU to lower layer, the transmitting PDCP entity shall:

- if the transmitting PDCP entity is associated with one RLC entity:
 - submit the PDCP PDU to the associated RLC entity;
- else, if the transmitting PDCP entity is associated with two RLC entities:
 - if the PDCP duplication is activated:
 - if the PDCP PDU is a PDCP Data PDU:
 - duplicate the PDCP Data PDU and submit the PDCP Data PDU to both associated RLC entities;
 - else:
 - submit the PDCP Control PDU to the primary RLC entity;
 - else:
 - if the two associated RLC entities belong to the different Cell Groups; and
 - if the total amount of PDCP data volume and RLC data volume pending for initial transmission (as specified in TS 38.322 [5]) in the two associated RLC entities is equal to or larger than *ul-DataSplitThreshold*:
 - submit the PDCP PDU to either the primary RLC entity or the secondary RLC entity;
 - else:
 - submit the PDCP PDU to the primary RLC entity.

[TS 38.331, clause 5.3.5.6.4]

The UE shall:

- 1> for each *drb-Identity* value included in the *drb-ToReleaseList* that is part of the current UE configuration; or
- 1> for each *drb-Identity* value that is to be released as the result of full configuration according to 5.3.5.11:
 - 2> release the PDCP entity and the *drb-Identity*;
 - 2> if SDAP entity associated with this DRB is configured:
 - 3> indicate the release of the DRB to SDAP entity associated with this DRB (TS 37.324 [24], clause 5.3.3);
 - 2> if the UE is operating in EN-DC:
 - 3> if a new bearer is not added either with NR or E-UTRA with same *eps-BearerIdentity*;

4> indicate the release of the DRB and the *eps-BearerIdentity* of the released DRB to upper layers.

NOTE 1: The UE does not consider the message as erroneous if the *drb-ToReleaseList* includes any *drb-Identity* value that is not part of the current UE configuration.

NOTE 2: Whether or not the RLC and MAC entities associated with this PDCP entity are reset or released is determined by the *CellGroupConfig*.

[TS 38.323, clause 5.11.1]

For the PDCP entity configured with *pdcp-Duplication*, the transmitting PDCP entity shall:

- for SRBs:
 - activate the PDCP duplication;
- for DRBs:
 - if the activation of PDCP duplication is indicated:
 - activate the PDCP duplication;
 - if the deactivation of PDCP duplication is indicated:
 - deactivate the PDCP duplication.

[TS 38.323, clause 5.11.2]

For the PDCP entity configured with *pdcp-Duplication*, the transmitting PDCP entity shall:

- if the successful delivery of a PDCP Data PDU is confirmed by one of the two associated AM RLC entities:
 - indicate to the other AM RLC entity to discard the duplicated PDCP Data PDU;
- if the deactivation of PDCP duplication is indicated:
 - indicate to the secondary RLC entity to discard all duplicated PDCP Data PDUs.

[TS 38.321, clause 5.10]

If one or more DRBs are configured with PDCP duplication, the network may activate and deactivate the PDCP duplication for the configured DRB(s).

The PDCP duplication for the configured DRB(s) is activated and deactivated by:

- receiving the Duplication Activation/Deactivation MAC CE described in subclause 6.1.3.11;
- indication by RRC.

The MAC entity shall for each DRB configured with PDCP duplication:

- 1> if a Duplication Activation/Deactivation MAC CE is received activating the PDCP duplication of the DRB:
 - 2> indicate the activation of PDCP duplication of the DRB to upper layers.
- 1> if a Duplication Activation/Deactivation MAC CE is received deactivating the PDCP duplication of the DRB:
 - 2> indicate the deactivation of PDCP duplication of the DRB to upper layers.

7.1.3.5.5.3 Test description

7.1.3.5.5.3.1 Pre-test conditions

System Simulator:

- For NR 5GC NR Cell 1 and NR Cell 10

UE:

- None

Preamble:

- Same Pre-test conditions as in clause 7.1.3.0 and Generic procedure parameter DC bearer (MCG and split).
- For NR 5GC, Same Pre-test conditions as in clause 7.1.3.0 using generic procedure parameter Connectivity (NR-DC), Bearers(MCG(s) and Split),

7.1.3.5.5.3.2 Test procedure sequence

Table 7.1.3.5.5.3.2-1: Main behaviour

St	Procedure	Message Sequence		TP	Verdict
		U - S	Message		
1	Void	-	-	-	-
2	SS transmits a Duplication Activation MAC CE to activate PDCP Duplication for split DRB.	<--	MAC PDU (Duplication Activation MAC Control Element)	-	-
2A	The SS is configured not to send RLC ACK for the next PDU on split DRB. (Note 6)	-	-	-	-
3	The SS sends a PDCP Data PDU on the split DRB on the AM RLC primary entity.	<--	PDCP DATA PDU	-	-
-	EXCEPTION: Steps 4-4A below occur in any sequence	-	-	-	-
4	Check: Does UE transmit a PDCP Data PDU on the AM RLC primary entity?	-->	PDCP DATA PDU	3	P
4A	Check: Does UE transmit a PDCP Data PDU on the AM RLC secondary entity?	-->	PDCP DATA PDU	2	P
4B-4C	Void	-	-	-	-
5	SS transmits a Duplication Deactivation MAC CE to deactivate PDCP Duplication for split DRB.	<--	MAC PDU (Duplication Deactivation MAC Control Element)	-	-
6	The SS sends a PDCP Data PDU on the split DRB on the AM RLC primary entity.	<--	PDCP DATA PDU	-	-
7	Check: Does UE transmit a PDCP Data PDU on the AM RLC entity configured on the AM RLC primary entity?	-->	PDCP DATA PDU	3	P
8	The SS transmits an NR <i>RRCReconfiguration</i> message to activate parameters for PdcpDuplication(Note 2)	<--	<i>RRCReconfiguration</i>	-	-
8A	UE responses NR <i>RRCReconfigurationComplete</i> message.(Note 3)	-->	<i>RRCReconfigurationComplete</i>	-	-
8AA	The SS is configured not to send RLC ACK for the next PDU on split DRB. (Note 6)	-	-	-	-
8B	The SS sends a PDCP Data PDU on the split DRB on the AM RLC primary entity.	<--	PDCP DATA PDU	-	-
-	EXCEPTION: Steps 8C-8D below occur in any sequence	-	-	-	-
8C	Check: Does UE transmit a PDCP Data PDU on the AM RLC primary entity?	-->	PDCP DATA PDU	1	P
8D	Check: Does UE transmit a PDCP Data PDU on the AM RLC secondary entity?	-->	PDCP DATA PDU	1	P
8E-8F	Void	-	-	-	-
9	The SS stops allocating any UL grant for the AM RLC secondary entity(Note 1)	-	-	-	-
10	The SS sends a PDCP Data PDU on the split DRB on the AM RLC primary entity.	<--	PDCP DATA PDU	-	-
11	UE transmits a PDCP Data PDU on the AM RLC primary entity	-->	PDCP DATA PDU	-	-
12	The SS resumes normal UL grant allocation for the AM RLC secondary entity.	-	-	-	-

13	Check: Does UE transmit a PDCP Data PDU on the AM RLC primary or secondary entity in next five seconds?	-->	PDCP DATA PDU	4	F
Note 1:	Discard of RLC SDU is not possible if submitted to lower layers. Therefore, Grant is not provided so that RLC SDU is not submitted to lower layers.				
Note 2:	For EN-DC the NR RRCReconfiguration is contained in <i>RRCConnectionReconfiguration</i> Table 7.1.3.5.5.3.3-4.				
Note 3:	For EN-DC the NR RRCReconfigurationComplete message is contained in <i>RRCConnectionReconfigurationComplete</i> .				
Note 4:	Void				
Note 5:	Void				
Note 6:	SS is configured not to send RLC ACK for the next PDU on split DRB to ensure that UE side primary or secondary entities do not discard the PDU before PDSCH transmission upon receipt of RLC ACK on one of the entities. This may cause UE side entities to retransmit the PDU but it shall be ignored by SS side RLC entity as it has already been received though not acknowledged due to SS side RLC being configured in test mode.				

7.1.3.5.5.3.3 Specific message contents

Table 7.1.3.5.5.3.3-0A: *RRCConnectionReconfiguration* (step 8, Table 7.1.3.5.5.3.2-1)

Derivation Path: 36.508 [7], Table 4.6.1-8			
Information Element	Value/remark	Comment	Condition
<i>RRCConnectionReconfiguration</i> ::= SEQUENCE {			
<i>criticalExtensions</i> CHOICE {			
c1 CHOICE{			
<i>rrcConnectionReconfiguration-r8</i> ::= SEQUENCE			
{			
<i>nonCriticalExtension</i> SEQUENCE {			
<i>nonCriticalExtension</i> SEQUENCE {			
<i>nonCriticalExtension</i> SEQUENCE {			
<i>nonCriticalExtension</i> SEQUENCE {			
<i>nonCriticalExtension</i> SEQUENCE {			
<i>nonCriticalExtension</i> SEQUENCE {			
<i>nonCriticalExtension</i> SEQUENCE {			
<i>nr-RadioBearerConfig1-r15</i>	OCTET STRING including <i>RadioBearerConfig-PDCP</i>		
}			
}			
}			
}			
}			
}			
}			
}			
}			
}			

Table 7.1.3.5.5.3.3-0B: *RRCReconfiguration* (step 8, Table 7.1.3.5.5.3.2-1)

Derivation Path: 38.508-1 [4], Table 4.6.1-13			
Information Element	Value/remark	Comment	Condition
<i>RRCReconfiguration</i> ::= SEQUENCE {			
<i>criticalExtensions</i> CHOICE {			
<i>rrcReconfiguration</i> SEQUENCE {			
<i>nonCriticalExtension</i> SEQUENCE {			
<i>nonCriticalExtension</i> SEQUENCE {			
<i>nonCriticalExtension</i> SEQUENCE {			

radioBearerConfig2	OCTET STRING including <i>RadioBearerConfig- PDCP</i>		
}			
}			
}			
}			
}			
}			

Table 7.1.3.5.5.3.3-1: *RadioBearerConfig-PDCP* (Table 7.1.3.5.5.3.3-0A and Table 7.1.3.5.5.3.3-0B , Step 8)

Derivation Path: TS 38.508-1 [7], Table 4.6.3-132			
Information Element	Value/remark	Comment	Condition
RadioBearerConfig ::= SEQUENCE {			
srb3-ToRelease	Not present		
drb-ToAddModList	Not present		
drb-ToAddModList SEQUENCE (SIZE (1..maxDRB)) OF DRB-ToAddMod {	1 entry		
DRB-ToAddMod[1] SEQUENCE {		entry 1	
drb-Identity	2		EN-DC NR
pdcp-Config	PDCP-Config-Split		
}			
}			
drb-ToReleaseList	Not present		
}			

Table 7.1.3.5.5.3.3-2: *PDCP-Config-Split* (Table 7.1.3.5.5.3.3-1)

Derivation Path: 38.508-1 [4], Table 4.6.3-99 condition Split			
Information Element	Value/remark	Comment	Condition
PDCP-Config ::= SEQUENCE {			
moreThanOneRLC SEQUENCE {			
primaryPath SEQUENCE {			
cellGroup	1		EN-DC
	0		NR
}			
ul-DataSplitThreshold	infinity		
pdcp-Duplication	true		
}			
}			

7.1.3.5.6 PDCP Duplication / 3 RLC entities

7.1.3.5.6.1 PDCP Duplication / 3 RLC entities / Intra-band Contiguous CA

7.1.3.5.6.1.1 Test Purpose (TP)

(1)

```
with { UE in RRC_CONNECTED state and PDCP CA duplication is configured and activated}
ensure that {
  when { UE has a PDCP SDU available for transmission }
  then { the UE transmits the PDCP SDU on all the associated RLC entities }
}
```

(2)

Void

(3)

```

with { UE in RRC_CONNECTED state and PDCP CA duplication is configured }
ensure that {
  when { UE has a PDCP SDU available for transmission }
  then { the UE transmits the PDCP SDU on the primary RLC entity }
}

```

(4)

```

with { UE in RRC_CONNECTED state and PDCP CA duplication is configured and activated }
ensure that {
  when { the UE had transmitted the PDCP SDU on all the associated RLC entities and successful
  delivery of a PDCP Data PDU is confirmed by one of the associated AM RLC entities }
  then { the other AM RLC entities discard the duplicated PDCP Data PDU }
}

```

(5)

```

with { UE in RRC_CONNECTED state and PDCP CA duplication is configured and activated }
ensure that {
  when { UE receives MAC Control Element to deactivate PDCP Duplication on one of the associated RLC
  entity configured with PDCP duplication }
  then { the UE deactivates the PDCP duplication for the indicated associated RLC entity }
}

```

7.1.3.5.6.1.2 Conformance requirements

References: The conformance requirements covered in the present TC are specified in: TS 38.321:5.10, 6.1.3.11, 6.1.3.32, TS 38.323:5.2.1, 5.11.1, 5.11.2 and TS 38.331: 5.3.5.6.4. Unless otherwise stated these are Rel-16 requirements.

[TS 38.323, clause 5.2.1]

When submitting a PDCP PDU to lower layer, the transmitting PDCP entity shall:

- if the transmitting PDCP entity is associated with one RLC entity:
 - submit the PDCP PDU to the associated RLC entity;
- else, if the transmitting PDCP entity is associated with at least two RLC entities:
 - if the PDCP duplication is activated for the RB:
 - if the PDCP PDU is a PDCP Data PDU:
 - duplicate the PDCP Data PDU and submit the PDCP Data PDU to the associated RLC entities activated for PDCP duplication;
 - else:
 - submit the PDCP Control PDU to the primary RLC entity;
 - else (i.e. the PDCP duplication is deactivated for the RB):
 - if the split secondary RLC entity is configured; and
 - if the total amount of PDCP data volume and RLC data volume pending for initial transmission (as specified in TS 38.322 [5]) in the primary RLC entity and the split secondary RLC entity is equal to or larger than *ul-DataSplitThreshold*:
 - submit the PDCP PDU to either the primary RLC entity or the split secondary RLC entity;
- else, if the transmitting PDCP entity is associated with the DAPS bearer:
 - if the uplink data switching has not been requested:

- submit the PDCP PDU to the RLC entity associated with the source cell;
- else:
 - if the PDCP PDU is a PDCP Data PDU:
 - submit the PDCP Data PDU to the RLC entity associated with the target cell;
 - else:
 - if the PDCP Control PDU is associated with source cell:
 - submit the PDCP Control PDU to the RLC entity associated with the source cell;
 - else:
 - submit the PDCP Control PDU to the RLC entity associated with the target cell;
- else:
 - submit the PDCP PDU to the primary RLC entity.

[TS 38.323, clause 5.11.1]

For the PDCP entity configured with *pdcp-Duplication*, the transmitting PDCP entity shall:

- for SRBs:
 - activate the PDCP duplication;
- for DRBs:
 - if the activation of PDCP duplication is indicated for the DRB:
 - activate the PDCP duplication for the DRB;
 - if the activation of PDCP duplication is indicated for at least one associated RLC entities:
 - activate the PDCP duplication for the indicated associated RLC entities;
 - activate the PDCP duplication for the DRB;
 - if the deactivation of PDCP duplication is indicated for the DRB:
 - deactivate the PDCP duplication for the DRB;
 - if the deactivation of PDCP duplication is indicated for at least one associated RLC entities:
 - deactivate the PDCP duplication for the indicated associated RLC entities;
 - if all associated RLC entities other than the primary RLC entity are deactivated for PDCP duplication:
 - deactivate the PDCP duplication for the DRB.

[TS 38.323, clause 5.11.2]

For the PDCP entity configured with *pdcp-Duplication*, the transmitting PDCP entity shall:

- if the successful delivery of a PDCP Data PDU is confirmed by one of the associated AM RLC entities:
 - indicate to the other AM RLC entities to discard the duplicated PDCP Data PDU;
- if the deactivation of PDCP duplication is indicated for the DRB:
 - indicate to the RLC entities other than the primary RLC entity to discard all duplicated PDCP Data PDUs;
- if the deactivation of PDCP duplication is indicated for at least one associated RLC entities:
 - indicate to the RLC entities deactivated for PDCP duplication to discard all duplicated PDCP Data PDUs.

[TS 38.321, clause 5.10]

If one or more DRBs are configured with PDCP duplication, the network may activate and deactivate the PDCP duplication for all or a subset of associated RLC entities for the configured DRB(s).

The PDCP duplication for the configured DRB(s) is activated and deactivated by:

- receiving the Duplication Activation/Deactivation MAC CE described in clause 6.1.3.11;
- receiving the Duplication RLC Activation/Deactivation MAC CE described in clause 6.1.3.32;
- indication by RRC.

The PDCP duplication for all or a subset of associated RLC entities for the configured DRB(s) is activated and deactivated by:

- receiving the Duplication RLC Activation/Deactivation MAC CE described in clause 6.1.3.32;
- indication by RRC.

The MAC entity shall for each DRB configured with PDCP duplication:

- 1> if a Duplication Activation/Deactivation MAC CE is received activating the PDCP duplication of the DRB:
 - 2> indicate the activation of PDCP duplication of the DRB to upper layers.
- 1> if a Duplication Activation/Deactivation MAC CE is received deactivating the PDCP duplication of the DRB:
 - 2> indicate the deactivation of PDCP duplication of the DRB to upper layers.
- 1> if a Duplication RLC Activation/Deactivation MAC CE is received activating PDCP duplication for associated RLC entities of a DRB configured with PDCP duplication:
 - 2> indicate the activation of PDCP duplication for the indicated secondary RLC entity(ies) of the DRB to upper layers.
- 1> if a Duplication RLC Activation/Deactivation MAC CE is received deactivating PDCP duplication for associated RLC entities of a DRB configured with PDCP duplication:
 - 2> indicate the deactivation of PDCP duplication for the indicated secondary RLC entity(ies) of the DRB to upper layers.

[TS 38.331, clause 5.3.5.6.4]

The UE shall:

- 1> for each *drb-Identity* value included in the *drb-ToReleaseList* that is part of the current UE configuration; or
- 1> for each *drb-Identity* value that is to be released as the result of full configuration according to 5.3.5.11:
 - 2> release the PDCP entity and the *drb-Identity*;
 - 2> if SDAP entity associated with this DRB is configured:
 - 3> indicate the release of the DRB to SDAP entity associated with this DRB (TS 37.324 [24], clause 5.3.3);
 - 2> if the UE is operating in EN-DC:
 - 3> if a new bearer is not added either with NR or E-UTRA with same *eps-BearerIdentity*:
 - 4> indicate the release of the DRB and the *eps-BearerIdentity* of the released DRB to upper layers.

NOTE 1: The UE does not consider the message as erroneous if the *drb-ToReleaseList* includes any *drb-Identity* value that is not part of the current UE configuration.

NOTE 2: Whether or not the RLC and MAC entities associated with this PDCP entity are reset or released is determined by the *CellGroupConfig*.

7.1.3.5.6.1.3 Test description

7.1.3.5.6.1.3.1 Pre-test conditions

System Simulator:

- NR Cell 1 is the PCell, NR Cell 3 and NR Cell 6 are the SCells.

UE:

- None

Preamble:

- Same Pre-test conditions as in clause 7.1.3.0.

7.1.3.5.6.1.3.2 Test procedure sequence

Table 7.1.3.5.6.1.3.2-1: Main behaviour

St	Procedure	Message Sequence		TP	Verdict
		U - S	Message		
1	The SS transmits an NR <i>RRCReconfiguration</i> message to add 2 SCells and to configure parameters for PDCP CA duplication	<--	<i>RRCReconfiguration</i>	-	-
1A	UE transmits NR <i>RRCReconfigurationComplete</i> message.	-->	<i>RRCReconfigurationComplete</i>	-	-
1B	The SS transmits a SCell Activation MAC-CE on PCell (NR Cell 1) to activate NR SCells (NR Cell 3 and NR Cell 6).	<--	MAC PDU (SCell Activation/Deactivation MAC CE of one octet (C ₁ =1))	-	-
2	The SS sends a PDCP Data PDU on the DRB on the AM RLC primary entity.	<--	PDCP DATA PDU	-	-
3	Check: Does UE transmit a PDCP Data PDU on the AM RLC primary entity?	-->	PDCP DATA PDU	3	P
3A	SS transmits a MAC CE to activate PDCP Duplication for all AM RLC entities associated to the DRB.	<--	MAC PDU (Duplication RLC Activation MAC Control Element)	-	-
3B	The SS is configured not to send RLC ACK on all 3 RLC entities. (Note 2)	-	-	-	-
3C	The SS sends a PDCP Data PDU on the DRB on the AM RLC primary entity.	<--	PDCP DATA PDU	-	-
	EXCEPTION: Steps 3D, 4 & 4A below can occur in any order.	-	-	-	-
3D	Check: Does UE transmit a PDCP Data PDU on the AM RLC primary entity?	-->	PDCP DATA PDU	1	P
4	Check: Does UE transmit a PDCP Data PDU on the associated AM RLC entity on the SCell (NR Cell3)?	-->	PDCP DATA PDU	1	P
4A	Check: Does UE transmit a PDCP Data PDU on the associated AM RLC entity on the SCell (NR Cell6)?	-->	PDCP DATA PDU	1	P
5	The SS transmits a MAC CE to deactivate PDCP Duplication for the AM RLC entity associated with theDRB on SCell (NR Cell 6).	<--	MAC PDU (Duplication RLC Deactivation MAC Control Element)	-	-
5A	The SS is configured not to send RLC ACK on all 3 RLC entities.	-	-	-	-
6	The SS sends a PDCP Data PDU on the DRB on the AM RLC primary entity.	<--	PDCP DATA PDU	-	-
-	EXCEPTION: Steps 6A-6B below can occur in any order.	-	-	-	-
6A	The UE transmits a PDCP Data PDU on the activated primary AM RLC entity.	-->	PDCP DATA PDU	-	-
6B	The UE transmits a PDCP Data PDU on the activated secondary AM RLC entity.	-->	PDCP DATA PDU	-	-

7	Check: Does UE transmit a PDCP Data PDU on the deactivated AM RLC entity by step 5?	-->	PDCP DATA PDU	5	F
8-14	Void	-	-	-	-
15	The SS stops allocating any UL grant on the SCells.(Note 1)	-	-	-	-
16	The SS sends a PDCP Data PDU on the DRB on the AM RLC primary entity.	<--	PDCP DATA PDU	-	-
17	UE transmits a PDCP Data PDU on the AM RLC primary entity	-->	PDCP DATA PDU	-	-
18	The SS resumes normal UL grant allocation on the SCells.	-	-	-	-
-	EXCEPTION: Steps 19-21 below can occur in any order in the next five seconds.	-	-	-	-
19	Check: Does UE transmit a PDCP Data PDU on the AM RLC primary?	-->	PDCP DATA PDU	4	F
20	Check: Does UE transmit a PDCP Data PDU on the AM RLC primary or the associated AM RLC entity on the SCell (NR Cell 3)?	-->	PDCP DATA PDU	4	F
21	Check: Does UE transmit a PDCP Data PDU on the AM RLC primary or the associated AM RLC entity on the SCell (NR Cell 6)?	-->	PDCP DATA PDU		F
Note 1:	Discard of RLC SDU is not possible if submitted to lower layers. Therefore, Grant is not provided so that RLC SDU is not submitted to lower layers.				
Note2:	SS is configured not to send RLC ACK for the next PDU on all RLC entities to ensure that UE side primary or secondary entities do not discard the PDU before PDSCH transmission upon receipt of RLC ACK on one of the entities. This may cause UE side entities to retransmit the PDU but it shall be ignored by SS side RLC entity as it has already been received though not acknowledged due to SS side RLC being configured in test mode.				

7.1.3.5.6.1.3.3 Specific message contents

Table 7.1.3.5.6.1.3.3-1: Void

Table 7.1.3.5.6.1.3.3-1A: RRCReconfiguration (Step 1, Table 7.1.3.5.6.1.3.2-1)

Derivation Path: TS 38.508-1 [4], Table 4.6.1-13 with condition SCell_add			
Information Element	Value/remark	Comment	Condition
RRCReconfiguration ::= SEQUENCE {			
criticalExtensions CHOICE {			
rrcReconfiguration SEQUENCE {			
radioBearerConfig	RadioBearerConfig-DRB		
nonCriticalExtension SEQUENCE {			
masterCellGroup	CellGroupConfig-SCells		
nonCriticalExtension SEQUENCE {			
nonCriticalExtension SEQUENCE {			
}			
}			
}			
}			
}			
}			

Table 7.1.3.5.6.1.3.3-1B: RadioBearerConfig-DRB (Table 7.1.3.5.6.1.3.3-1A)

Derivation Path: TS 38.508-1 [7], Table 4.6.3-132			
Information Element	Value/remark	Comment	Condition
RadioBearerConfig ::= SEQUENCE {			
srb3-ToRelease	Not present		
drb-ToAddModList SEQUENCE (SIZE (1..maxDRB)) OF DRB-ToAddMod {	1 entry		
DRB-ToAddMod[1] SEQUENCE {		entry 1	

drb-Identity	DRBi		
pdcp-Config	PDCP-Config		
}			
}			
}			

Table 7.1.3.5.6.1.3.3-1C: CellGroupConfig-SCells (Table 7.1.3.5.6.1.3.3-1A)

Derivation Path: TS 38.508-1 [4], Table 4.6.3-19 with condition SCell_add			
Information Element	Value/remark	Comment	Condition
CellGroupConfig ::= SEQUENCE {			
rlc-BearerToAddModList SEQUENCE (SIZE(1..max LC-ID)) OF RLC-BearerConfig {	3 entries		
RLC-BearerConfig[1]	RLC-BearerConfig-1	entry 1 Table 7.1.3.5.6.3.3-3 RLC entity 1 (primary)	
RLC-BearerConfig[2]	RLC-BearerConfig-2	entry 2 Table 7.1.3.5.6.3.3-4 RLC entity 2 (secondary)	
RLC-BearerConfig[3]	RLC-BearerConfig-3	entry 3 Table 7.1.3.5.6.3.3-5 RLC entity 3 (secondary)	
}			
mac-CellGroupConfig	Not present		
physicalCellGroupConfig	Not present		
spCellConfig	Not present		
sCellToAddModList SEQUENCE (SIZE (1..maxNrofSCells)) OF SCellConfig {	2 entries		
SCellConfig[1] SEQUENCE {		entry 1	
sCellIndex	SCellIndex for NR Cell 3		
sCellConfigCommon	ServingCellConfigCommon as per TS 38.508-1 [4] Table 4.6.3-168		
sCellConfigDedicated	ServingCellConfig as per TS 38.508-1 [4] Table 4.6.3-167		
}			
SCellConfig[2] SEQUENCE {		entry 2	
sCellIndex	SCellIndex for NR Cell 6		
sCellConfigCommon	ServingCellConfigCommon as per TS 38.508-1 [4] Table 4.6.3-168		
sCellConfigDedicated	ServingCellConfig as per TS 38.508-1 [4] Table 4.6.3-167		
}			
}			
}			

Table 7.1.3.5.6.1.3.3-2: PDCP-Config (Table 7.1.3.5.6.1.3.3-1B)

Derivation Path: 38.508-1 [4], Table 4.6.3-99			
Information Element	Value/remark	Comment	Condition
PDCP-Config ::= SEQUENCE {			
t-Reordering	Not present		
moreThanTwoRLC-DRB-r16 SEQUENCE {			
duplicationState-r16 SEQUENCE (SIZE (3))	3 entries		

duplicationState-r16[1]	true		
duplicationState-r16[2]	true		
duplicationState-r16[3]	false		
}			
}			

Table 7.1.3.5.6.1.3.3-3: RLC-BearerConfig-1 (Table 7.1.3.5.6.1.3.3-1C)

Derivation Path: TS 38.508-1 [4], Table 4.6.3-148 with Condition AM			
Information Element	Value/remark	Comment	Condition
RLC-BearerConfig ::= SEQUENCE {			
logicalChannelIdentity	LogicalChannelIdentity with condition DRB j	ID of primary logical channel	
servedRadioBearer CHOICE {			
drb-Identity	DRB-Identity with condition DRB j	DRB	
}			
rlc-Config CHOICE {			
am SEQUENCE {			
ul-AM-RLC SEQUENCE {			
maxRetxThreshold	t32	To ensure RLC failure happens before RLF	
}			
}			
}			
mac-LogicalChannelConfig SEQUENCE {			
ul-SpecificParameters SEQUENCE {			
allowedServingCells SEQUENCE (SIZE (1..maxNrofServingCells-1)) OF ServCellIndex {	1 entry		
ServCellIndex[1]	ServCellIndex of NR Cell 1	entry 1	
}			
}			
}			
}			

Table 7.1.3.5.6.1.3.3-4: RLC-BearerConfig-2 (Table 7.1.3.5.6.1.3.3-1C)

Derivation Path: TS 38.508-1 [4], Table 4.6.3-148 with Condition AM			
Information Element	Value/remark	Comment	Condition
RLC-BearerConfig ::= SEQUENCE {			
logicalChannelIdentity	LogicalChannelIdentity with condition DRB j+1	To ensure ID of secondary logical channel ID is different with existing logical channel and the primary logical channel	
servedRadioBearer CHOICE {			
drb-Identity	DRB-Identity with condition DRB j	DRB	
}			
rlc-Config CHOICE {			
am SEQUENCE {			
ul-AM-RLC SEQUENCE {			
maxRetxThreshold	t1	To ensure RLC failure happens before RLF	
}			
}			
}			
mac-LogicalChannelConfig SEQUENCE {			

ul-SpecificParameters SEQUENCE {			
allowedServingCells SEQUENCE (SIZE (1..maxNrofServingCells-1)) OF ServCellIndex {	1 entry		
ServCellIndex[1]	ServCellIndex of NR Cell 3	entry 1	
}			
}			
}			
}			

Table 7.1.3.5.6.1.3.3-5: RLC-BearerConfig-3 (Table 7.1.3.5.6.1.3.3-1C)

Derivation Path: TS 38.508-1 [4], Table 4.6.3-148 with Condition AM			
Information Element	Value/remark	Comment	Condition
RLC-BearerConfig ::= SEQUENCE {			
logicalChannelIdentity	LogicalChannelIdentity with condition DRB j+2	To ensure ID of secondary logical channel ID is different with existing logical channel and the primary logical channel	
servedRadioBearer CHOICE {			
drb-Identity	DRB-Identity with condition DRB j	DRB	
}			
rlc-Config CHOICE {			
am SEQUENCE {			
ul-AM-RLC SEQUENCE {			
maxRetxThreshold	t1	To ensure RLC failure happens before RLF	
}			
}			
}			
mac-LogicalChannelConfig SEQUENCE {			
ul-SpecificParameters SEQUENCE {			
allowedServingCells SEQUENCE (SIZE (1..maxNrofServingCells-1)) OF ServCellIndex {	1 entry		
ServCellIndex[1]	ServCellIndex of NR Cell 6	entry 1	
}			
}			
}			
}			

7.1.3.5.6.2 PDCP Duplication / 3 RLC entities / Intra-band non-Contiguous CA

The scope and description of the present TC is the same as test case 7.1.3.5.6.1 with the following differences:

- CA configuration: Intra-band non-Contiguous CA replaces Intra-band Contiguous CA.

7.1.3.5.7 Ethernet header compression and decompression / Correct functionality of ethernet header compression and decompression

7.1.3.5.7.1 Test Purpose (TP)

(1)

```
with { UE in RRC_CONNECTED state }
ensure that {
```

```

when { SS sends PDCP Data PDU containing EHC compressed ethernet packet with Context ID A and with
full ethernet header A to UE }
  then { UE sends PDCP Control PDU to SS containing EHC feedback packet with Context ID A }
}

```

(2)

```

with { UE in RRC_CONNECTED state }
ensure that {
  when { SS sends PDCP Data PDU containing EHC compressed ethernet packet with Context ID A and with
full ethernet header A to UE }
    then { UE sends PDCP Data PDU to SS containing EHC compressed ethernet packet with Context ID B
and with full ethernet header A generated from the looped back ethernet packet }
}

```

(3)

```

with { UE in RRC_CONNECTED state }
ensure that {
  when { SS sends PDCP Data PDU containing EHC compressed ethernet packet with Context ID A and
without ethernet header to UE }
    then { UE sends PDCP Data PDU to SS containing EHC compressed ethernet packet with Context ID B
and with full ethernet header A generated from the looped back ethernet packet with decompressed
ethernet header }
}

```

(4)

```

with { UE in RRC_CONNECTED state }
ensure that {
  when { SS has sent PDCP Control PDU to UE containing EHC feedback packet with Context ID B and SS
sends PDCP Data PDU to UE containing EHC compressed ethernet packet with Context ID A without
ethernet header to UE }
    then { UE sends PDCP Data PDU to SS containing EHC compressed ethernet packet with Context ID B
and without ethernet header generated from the looped back ethernet packet with decompressed
ethernet header }
}

```

7.1.3.5.7.2 Conformance requirements

References: The conformance requirements covered in the present TC are specified in: TS 38.323, clause 5.12. These are Rel-16 requirements.

[TS 38.323, clause 5.12.2]

PDCP entities associated with DRBs can be configured by upper layers TS 38.331 [3] to use EHC. Each PDCP entity carrying user plane data may be configured to use EHC. Every PDCP entity uses at most one EHC compressor instance and at most one EHC decompressor instance.

[TS 38.323, clause 5.12.3]

The usage and definition of the parameters shall be as specified below.

- MAX_CID_EHC_UL: This is the maximum CID value that can be used for uplink. One CID value shall always be reserved for uncompressed flows. The parameter MAX_CID_EHC_UL is configured by upper layers (*maxCID-EHC-UL* in TS 38.331 [3]);

[TS 38.323, clause 5.12.4]

If EHC is configured, the EHC protocol generates two types of output packets:

- EHC compressed packets (i.e. EHC full header packets and EHC compressed header packets), each associated with one PDCP SDU;
- standalone packets not associated with a PDCP SDU, i.e. EHC feedback.

An EHC compressed packet is associated with the same PDCP SN and COUNT value as the related PDCP SDU. The header compression is not applicable to the SDAP header and the SDAP Control PDU if included in the PDCP SDU.

EHC feedback are not associated with a PDCP SDU. They are not associated with a PDCP SN and are not ciphered.

[TS 38.323, clause 5.12.5]

If EHC is configured by upper layers for PDCP entities associated with user plane data, the PDCP Data PDUs are decompressed by the EHC protocol after performing deciphering as explained in clause 5.8. The header decompression is not applicable to the SDAP header and the SDAP Control PDU if included in the PDCP Data PDU.

[TS 38.323, clause 5.12.6.1]

When an EHC feedback is generated by the EHC protocol, the transmitting PDCP entity shall:

- submit to lower layers the corresponding PDCP Control PDU as specified in clause 6.2.3.3 i.e. without associating a PDCP SN, nor performing ciphering.

[TS 38.323, clause 5.12.6.2]

At reception of a PDCP Control PDU for EHC feedback from lower layers, the receiving PDCP entity shall:

- deliver the corresponding EHC feedback to the EHC protocol without performing deciphering.

7.1.3.5.7.3 Test description

7.1.3.5.7.3.1 Pre-test conditions

Pre-test conditions as in clause 7.1.3.0 with condition pc_NG_RAN_NR, PDN/PDU session type Ethernet used in 4.5A.2 and message with condition UM used for step 7 in 4.5.4.2 according to [4] for primary DRB.

7.1.3.5.7.3.2 Test procedure sequence

Table 7.1.3.5.7.3.2-1: Main behaviour

St	Procedure	Message Sequence		TP	Verdict
		U - S	Message		
1	SS transmits an <i>RRCReconfiguration</i> message to configure DRB to use ethernet header compression.	<--	<i>RRCReconfiguration</i>	-	-
2	UE transmits <i>RRCReconfigurationComplete</i> message to confirm that reconfiguration with ethernet header compression configuration is completed.	-->	<i>RRCReconfigurationComplete</i>	-	-
3	SS transmits PDCP Data PDU containing EHC compressed ethernet packet with Context ID A and with full ethernet header information A.	<--	PDCP Data PDU #0	-	-
4	CHECK: Does UE transmit PDCP Control PDU containing unciphered EHC feedback packet with Context ID A?	-->	PDCP Control PDU #0	1	P
5	CHECK: Does UE transmit PDCP Data PDU containing EHC compressed ethernet packet with Context ID B and with full ethernet header information A?	-->	PDCP Data PDU #0	1	P
6	SS transmits PDCP Data PDU containing EHC compressed ethernet packet with Context ID A and without ethernet header information.	<--	PDCP Control PDU #0	-	-
7	CHECK: Does UE transmit PDCP Data PDU containing EHC compressed ethernet packet with Context ID B and with full ethernet header information A?	-->	PDCP Data PDU #1	-	-
8	SS transmits PDCP Control PDU containing unciphered EHC feedback packet with Context ID B.	<--	PDCP Control PDU #1	-	-
9	SS transmits PDCP Data PDU containing EHC compressed ethernet packet with Context ID A and without ethernet header information.	<--	PDCP Data PDU #2	-	-
10	CHECK: Does UE transmit PDCP Data PDU containing EHC compressed ethernet packet with Context ID B and without ethernet header information?	-->	PDCP Data PDU #2	4	P

Note 1: PDCP PDUs will be checked before and after decompressor on the NW side for test steps 5, 7 and 10.
 Note 2: The value of Context ID A and Context ID B can be any value. However, value of Context ID A and Context ID B should stay the same in all steps.

7.1.3.5.7.3.3 Specific message contents

Table 7.1.3.5.7.3.3-1: RRCReconfiguration (step 1, Table 7.1.3.5.7.3.2-1)

Derivation Path: TS 38.508 [4], clause 4.6.1, table 4.6.1-13 RRCReconfiguration			
Information Element	Value/remark	Comment	Condition
RRCReconfiguration ::= SEQUENCE {			
criticalExtensions CHOICE {			
rrcReconfiguration SEQUENCE {			
radioBearerConfig	RadioBearerConfig-EHC		
}			
}			
}			

Table 7.1.3.5.7.3.3-2: RadioBearerConfig-EHC (Table 7.1.3.5.7.3.3-1)

Derivation Path: TS 38.331 [12], clause 6.3.2			
Information Element	Value/remark	Comment	Condition
RadioBearerConfig ::= SEQUENCE {			
drb-ToAddModList SEQUENCE (SIZE (1..maxDRB))	1 entry		
OF DRB-ToAddMod {			
DRB-ToAddMod[1] SEQUENCE {		entry 1	
drb-Identity	DRB-Identity for DRB created in pre-test conditions		
pdcp-Config	PDCP-Config-EHC		
}			
}			
}			

Table 7.1.3.5.7.3.3-3: PDCP-Config-EHC

Derivation Path: TS38.331 [12], clause 6.3.2			
Information Element	Value/remark	Comment	Condition
PDCP-Config ::= SEQUENCE {			
ethernetHeaderCompression-r16 SEQUENCE {			
ehc-Common-r16 SEQUENCE {			
ehc-CID-Length-r16	bits15		
}			
ehc-Downlink-r16 SEQUENCE {			
drb-ContinueEHC-DL-r16	true		
}			
ehc-Uplink-r16 SEQUENCE {			
maxCID-EHC-UL-r16	32767		
drb-ContinueEHC-UL-r16	true		
}			
}			
}			

7.1.4 SDAP

7.1.4.1 SDAP Data Transfer and PDU Header Handling UL/DL

7.1.4.1.1 Test Purpose (TP)

(1)

```
with { UE in RRC_CONNECTED state with multiple DRB's established, each mapping more than one QoS
flow }
ensure that {
  when { UE receives an SDAP PDU with SDAP header }
  then { UE SDAP entity retrieves the SDAP SDU from the SDAP PDU and delivers it to upper layer }
}
```

(2)

```
with { UE in RRC_CONNECTED state with multiple DRB's established configured with UL SDAP header,
each mapping more than one QoS flow configured by RRC }
ensure that {
  when { UE has to transmit a SDAP PDU with header to be included }
  then { UE builds an SDAP PDU from the SDAP SDU including the header, and maps it to the DRB as
per stored DRB mapping rule for the QoS flow }
}
```

(3)

```
with { UE in RRC_CONNECTED state with multiple DRB's and QoS flows established }
ensure that {
  when { UE receives a SDAP PDU with SDAP header and RDI fields set to 1 }
  then { UE stores the QoS flow to DRB mapping of the DL SDAP PDU as the QoS flow to DRB mapping
rule for the UL and uses it for further UL SDAP PDU transmissions }
}
```

(4)

```
with { UE in RRC_CONNECTED state with multiple DRB's and QoS flows established }
ensure that {
  when { UE receives a SDAP PDU with SDAP header and RDI field set to 1 and the stored QoS flow to
DRB mapping rule for the QoS flow is different from the QoS flow to DRB mapping of the DL SDAP data
PDU }
  then { UE stores the QoS flow to DRB mapping of the DL SDAP PDU as the QoS flow to DRB mapping
rule for the UL, to be used for further UL SDAP PDU transmissions and transmits an end-marker
control PDU for the QoS flow on the old DRB }
}
```

(5)

```
with { UE in RRC_CONNECTED state with multiple DRB's and QoS flows established with QoS flow to DRB
mapping }
ensure that {
  when { UE receives a message which configures a new QoS flow to DRB mapping, different from the
existing mapping }
  then { UE stores the QoS flow to DRB mapping to be used for further UL SDAP PDU transmissions
and transmits an end-marker control PDU for the QoS flow on the old DRB }
}
```

7.1.4.1.2 Conformance requirements

References: The conformance requirements covered in the present test case are specified in: TS 37.324, clauses 5.2.1, 5.2.2, 5.3.1, 5.3.2, 6.2.2.1, 6.2.2.2, 6.2.2.3, 6.2.3 and 6.3.4, TS 24.501 clause 6.2.5.1.3. Unless otherwise stated these are Rel-15 requirements.

[TS 37.324 clause 5.2.1]

At the reception of an SDAP SDU from upper layer for a QoS flow, the transmitting SDAP entity shall:

- if there is no stored QoS flow to DRB mapping rule for the QoS flow as specified in the subclause 5.3:

- map the SDAP SDU to the default DRB;
- else:
 - map the SDAP SDU to the DRB according to the stored QoS flow to DRB mapping rule;
- if the DRB to which the SDAP SDU is mapped is configured by RRC (3GPP TS 38.331 [3]) with the presence of SDAP header,
 - construct the UL SDAP data PDU as specified in the subclause 6.2.2.3;
- else:
 - construct the UL SDAP data PDU as specified in the subclause 6.2.2.1;
- submit the constructed UL SDAP data PDU to the lower layers.

NOTE 1: UE behaviour is not defined if there is neither a default DRB nor a stored QoS flow to DRB mapping rule for the QoS flow.

NOTE 2: Default DRB is always configured with UL SDAP header (3GPP TS 38.331 [3]).

[TS 37.324 clause 5.2.2]

At the reception of an SDAP data PDU from lower layers for a QoS flow, the receiving SDAP entity shall:

- if the DRB from which this SDAP data PDU is received is configured by RRC (3GPP TS 38.331 [3]) with the presence of SDAP header:
 - perform reflective QoS flow to DRB mapping as specified in the subclause 5.3.2;
 - perform RQI handling as specified in the subclause 5.4;
 - retrieve the SDAP SDU from the DL SDAP data PDU as specified in the subclause 6.2.2.2.
- else:
 - retrieve the SDAP SDU from the DL SDAP data PDU as specified in the subclause 6.2.2.1;
- deliver the retrieved SDAP SDU to the upper layer.

[TS 37.324 clause 5.3.1]

When RRC (3GPP TS 38.331 [3]) configures an UL QoS flow to DRB mapping rule for a QoS flow, the SDAP entity shall:

- if the SDAP entity has already been established and there is no stored QoS flow to DRB mapping rule for the QoS flow and a default DRB is configured:
 - construct an end-marker control PDU, as specified in the subclause 6.2.3, for the QoS flow;
 - map the end-marker control PDU to the default DRB;
 - submit the end-marker control PDU to the lower layers.
- if the stored UL QoS flow to DRB mapping rule is different from the configured QoS flow to DRB mapping rule for the QoS flow and the DRB according to the stored QoS flow to DRB mapping rule is configured by RRC (3GPP TS 38.331 [3]) with the presence of UL SDAP header:
 - construct an end-marker control PDU, as specified in the subclause 6.2.3, for the QoS flow;
 - map the end-marker control PDU to the DRB according to the stored QoS flow to DRB mapping rule;
 - submit the end-marker control PDU to the lower layers.
- store the configured UL QoS flow to DRB mapping rule for the QoS flow.

When RRC (3GPP TS 38.331 [3]) releases an UL QoS flow to DRB mapping rule for a QoS flow, the SDAP entity shall:

- remove the UL QoS flow to DRB mapping rule for the QoS flow.

[TS 37.324 clause 5.3.2]

For each received DL SDAP dataPDU with RDI set to 1, the SDAP entity shall:

- process the QFI field in the SDAP header and determine the QoS flow;
- if there is no stored QoS flow to DRB mapping rule for the QoS flow and a default DRB is configured:
 - construct an end-marker control PDU, as specified in the subclause 6.2.3, for the QoS flow;
 - map the end-marker control PDU to the default DRB;
 - submit the end-marker control PDU to the lower layers;
- if the stored QoS flow to DRB mapping rule for the QoS flow is different from the QoS flow to DRB mapping of the DL SDAP data PDU and the DRB according to the stored QoS flow to DRB mapping rule is configured by RRC (3GPP TS 38.331 [3]) with the presence of UL SDAP header:
 - construct an end-marker control PDU, as specified in the subclause 6.2.3, for the QoS flow;
 - map the end-marker control PDU to the DRB according to the stored QoS flow to DRB mapping rule;
 - submit the end-marker control PDU to the lower layers;
- store the QoS flow to DRB mapping of the DL SDAP data PDU as the QoS flow to DRB mapping rule for the UL.

[TS 37.324 clause 6.2.2.1]

An SDAP PDU consists only of a data field and does not consist of any SDAP header, as described in Figure 6.2.2.1-1.

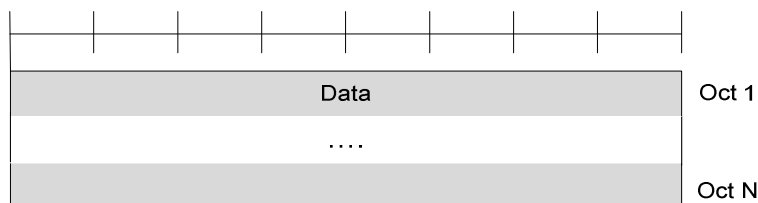

Figure 6.2.2.1-1: SDAP Data PDU format without SDAP header

[TS 37.324 clause 6.2.2.2]

Figure 6.2.2.2 – 1 shows the format of SDAP Data PDU of DL with SDAP header being configured.

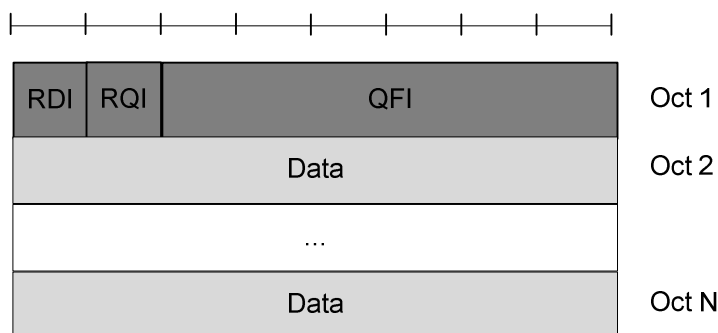

Figure 6.2.2.2-1: DL SDAP Data PDU format with SDAP header

[TS 37.324 clause 6.2.2.3]

Figure 6.2.2.3 – 1 shows the format of SDAP Data PDU of UL with SDAP header being configured.

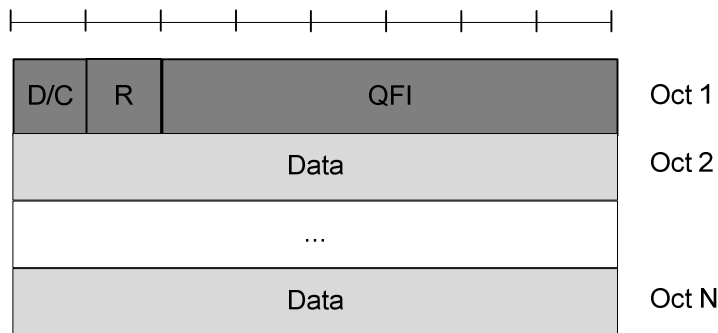

Figure 6.2.2.3-1: UL SDAP Data PDU format with SDAP header

[TS 37.324 clause 6.2.3]

Figure 6.2.3 – 1 shows the format of End-Marker Control PDU.

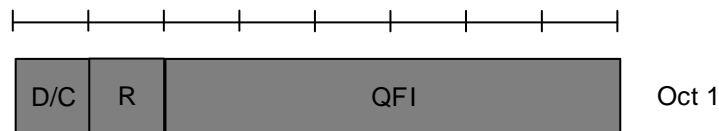

Figure 6.2.2.3-1: UL SDAP Data PDU format with SDAP header

[TS 37.324 clause 6.3.4]

Length: 6 bits

The QFI field indicates the ID of the QoS flow (3GPP TS 23.501 [4]) to which the SDAP PDU belongs.

[TS 24.501 clause 6.2.5.1.3]

For PDU session of IPv4, IPv6, IPv4v6 or Ethernet PDU session type, upon receiving an UL user data packet from the upper layers for transmission via a PDU session, the UE shall attempt to associate the UL user data packet with:

- a) the QFI of a signalled QoS rule associated with the PDU session which has a set of packet filters containing a packet filter for UL direction matching the UL user data packet or containing a packet filter for both UL and DL directions matching the UL user data packet; or
- b) the QFI of a derived QoS rule associated with the PDU session which has the packet filter for UL direction matching the UL user data packet;

by evaluating the QoS rules in increasing order of their precedence values until the UL user data packet is associated with a QFI or all QoS rules are evaluated.

For PDU session of unstructured PDU session type, upon receiving an UL user data packet from the upper layers for transmission via a PDU session, the UE shall associate the UL user data packet with the QFI of the default QoS rule associated with the PDU session.

If the UL user data packet is associated with a QFI, the UE shall pass the QFI along the UL user data packet to the lower layers for transmission.

NOTE: Marking of the UL user data packet with the QFI is performed by the lower layers.

If all QoS rules are evaluated and the UL user data packet is not associated with a QFI, the UE shall discard the UL user data packet.

7.1.4.1.3 Test description

7.1.4.1.3.1 Pre-test conditions

System Simulator:

- NR Cell 1

UE:

- None.

Preamble:

- The UE is in 5GS state 3N-A with one PDU session active according to TS 38.508-1 [4], clause 4.4A.3, Table 4.4A.3-1 and using the message condition UE TEST LOOP MODE B active with IP PDU delay = 1 second, to return one SDAP SDU per DL SDAP SDU. 2 DRBs are configured where DRB j is defined as default DRB. The NAS QoS rules for the QoS flows with QFI=1, QFI=2, QFI=5 and QFI=6 are configured. QoS flows with QFI=5 and QFI=6 are mapped to DRB j, QoS flows with QFI=1 and QFI=2 are mapped to DRB k.

7.1.4.1.3.2 Test procedure sequence

Table 7.1.4.1.3.2-1: Main behaviour

St	Procedure	Message Sequence		TP	Verdict
		U - S	Message		
1	The SS sends the SDAP Data PDU with SDAP header on DRB k and the following content to the UE: RDI=0, RQI=0, QFI=2.	<--	SDAP DL Data PDU	-	-
2	Check: Does the UE re-transmit SDAP Data PDU on DRB k with SDAP header as per the stored DRB mapping flow with QFI=2?	-->	SDAP UL Data PDU	1,2	P
2A	The SS transmits an OPEN UE TEST LOOP message.	<--	OPEN UE TEST LOOP	-	-
2B	The UE transmits an OPEN UE TEST LOOP COMPLETE message.	-->	OPEN UE TEST LOOP COMPLETE	-	-
2C	The SS transmits a CLOSE UE TEST LOOP Message with IP PDU delay = 1 second.	<--	CLOSE UE TEST LOOP	-	-
2D	The UE transmits a CLOSE UE TEST LOOP COMPLETE message.	-->	CLOSE UE TEST LOOP COMPLETE	-	-
3	The SS sends the SDAP Data PDU with SDAP header on DRB k and the following content to the UE: RDI=1, RQI=0, QFI=5.	<--	SDAP DL Data PDU	-	-
-	EXCEPTION: In parallel to the event described in step 4 the events specified in Table 7.1.4.1.3.2-2 shall take place.	-	-	-	-
4	Check: Does the UE re-transmit SDAP Data PDU on DRB k with SDAP header as per the stored DRB mapping Flow with QFI=5?	-->	SDAP UL Data PDU	3	P
4A	The SS transmits an OPEN UE TEST LOOP message.	<--	OPEN UE TEST LOOP	-	-
4B	The UE transmits an OPEN UE TEST LOOP COMPLETE message.	-->	OPEN UE TEST LOOP COMPLETE	-	-
4C	The SS transmits a CLOSE UE TEST LOOP Message with IP PDU delay = 1 second.	<--	CLOSE UE TEST LOOP	-	-
4D	The UE transmits a CLOSE UE TEST LOOP COMPLETE message.	-->	CLOSE UE TEST LOOP COMPLETE	-	-
5	The SS transmits an RRCReconfiguration message including a PDU SESSION MODIFICATION COMMAND	<--	<i>RRCReconfiguration</i> (PDU SESSION MODIFICATION COMMAND)	-	-

-	EXCEPTION: In parallel to the event described in step 6 the events specified in Tables 7.1.4.1.3.2-3 and 7.1.4.1.3.2-4 shall take place.	-	-	-	-
6	The UE transmits an RRCReconfigurationComplete message.	-->	RRCReconfigurationComplete	-	-
7	The SS sends the SDAP Data PDU with SDAP header on DRB k and the following content to the UE: RDI=0, RQI=0, QFI=4.	<--	SDAP DL Data PDU	-	-
8	Check: Does the UE re-transmit SDAP Data PDU on DRB k with SDAP header as per the stored DRB mapping Flow with QFI=4?	-->	SDAP UL Data PDU	5	P

Table 7.1.4.1.3.2-2: Parallel behaviour

St	Procedure	Message Sequence		TP	Verdict
		U - S	Message		
1	Check: Does the UE transmit End-Marker Control PDU on DRB j for QFI=5?	-->	SDAP UL Control PDU	4	P

Table 7.1.4.1.3.2-3: Parallel behaviour

St	Procedure	Message Sequence		TP	Verdict
		U - S	Message		
1	Check: Does the UE transmit End-Marker Control PDU on DRB j for QFI=4?	-->	SDAP UL Control PDU	5	P

Table 7.1.4.1.3.2-4: Parallel behaviour

St	Procedure	Message Sequence		TP	Verdict
		U - S	Message		
1	The UE Transmits PDU SESSION MODIFICATION COMPLETE	-->	ULInformationTransfer (PDU SESSION MODIFICATION COMPLETE)	-	-

7.1.4.1.3.3 Specific message contents

Table 7.1.4.1.3.3-1: RadioBearerConfig-DRB (Preamble)

Derivation Path: TS 38.508-1 [4], table 4.6.3-132 and condition NR			
Information Element	Value/remark	Comment	Condition
RadioBearerConfig ::= SEQUENCE {			
drb-ToAddModList SEQUENCE (SIZE (1..maxDRB))	2 entries		
OF DRB-ToAddMod {			
DRB-ToAddMod[1] SEQUENCE {		entry 1	
cnAssociation CHOICE {			
sdap-Config SEQUENCE {			
pdu-Session	The same as the PDU session ID in PDU SESSION ESTABLISHMENT REQUEST		
sdap-HeaderDL	present		
sdap-HeaderUL	present		
defaultDRB	false		
mappedQoS-FlowsToAdd SEQUENCE {			
QFI	1		
QFI	2		
}			
}			

}			
drb-Identity	k	k is allocated according to internal TTCN mapping	
}			
DRB-ToAddMod[2] SEQUENCE {		entry 2	
cnAssociation CHOICE {			
sdap-Config SEQUENCE {			
pdu-Session	The same as the PDU session ID in PDU SESSION ESTABLISHMENT REQUEST		
sdap-HeaderDL	present		
sdap-HeaderUL	present		
defaultDRB	true		
mappedQoS-FlowsToAdd SEQUENCE {			
QFI	5		
QFI	6		
}			
}			
}			
drb-Identity	j	j is allocated according to internal TTCN mapping	
}			
}			
}			

Table 7.1.4.1.3.3-2: RadioBearerConfig-DRB (step 5, Table 7.1.4.1.3.2-1)

Derivation Path: TS 38.508-1 [4], table 4.6.3-132 and condition NR			
Information Element	Value/remark	Comment	Condition
RadioBearerConfig ::= SEQUENCE {	-	-	
drb-ToAddModList SEQUENCE (SIZE (1..maxDRB)) OF DRB-ToAddMod {	1 entry	BID is the total number of established DRBs in the UE, before applying the contents of this IE	
DRB-ToAddMod[1] SEQUENCE {		entry 1	
cnAssociation CHOICE {			
sdap-Config SEQUENCE {			
pdu-Session	The same as the PDU session ID in PDU SESSION ESTABLISHMENT REQUEST		
sdap-HeaderDL	present		
sdap-HeaderUL	present		
defaultDRB	false		
mappedQoS-FlowsToAdd SEQUENCE {			
QFI	4		
}			
}			
}			
drb-Identity	k	k is allocated according to internal TTCN mapping	
}			
}			

}		
---	--	--

Table 7.1.4.1.3.3-3: PDU SESSION MODIFICATION COMMAND (step 5, Table 7.1.4.1.3.2-1)

Derivation Path: TS 38.508-1 [4], table 4.7.2-9			
Information Element	Value/remark	Comment	Condition
PDU session ID	The same as the PDU session ID in PDU SESSION ESTABLISHMENT REQUEST		
Authorized QoS rules	1 entry		
QoS rule [1]	Reference QoS rule #4a as defined in TS 38.508-1 [4], Table 4.8.2.1-4a.	QFI=4	
Authorized QoS flow descriptions	1 entry		
QoS flow [1]	Reference QoS flow #2a as defined in TS 38.508-1 [4], Table 4.8.2.3-2a.	QFI=4	

Table 7.1.4.1.3.3-4: PDU SESSION ESTABLISHMENT ACCEPT (Preamble)

Derivation Path: TS 38.508-1 [4], table 4.7.2-2			
Information Element	Value/remark	Comment	Condition
PDU session ID	The same as the PDU session ID in PDU SESSION ESTABLISHMENT REQUEST		
Authorized QoS rules	4 entries		
QoS rule [1]	Reference QoS rule #1 as defined in TS 38.508-1 [4], Table 4.8.2.1-1	QFI=1	
QoS rule [2]	Reference QoS rule #4 as defined in Table 7.1.4.1.3.3-7	QFI=2	
QoS rule [3]	Reference QoS rule #5 as defined in TS 38.508-1 [4], Table 4.8.2.1-5	QFI=5	
QoS rule [4]	Reference QoS rule #6 as defined in TS 38.508-1 [4], Table 4.8.2.1-6	QFI=6	
Mapped EPS Bearer contexts	Not Present		
Authorized QoS flow descriptions	4 entries		
QoS flow [1]	Reference QoS flow #1 as defined in Table 7.1.4.1.3.3-5	QFI=1	
QoS flow [2]	Reference QoS flow #2 as defined in Table 7.1.4.1.3.3-6	QFI=2	
QoS flow [3]	Reference QoS flow #3 as defined in TS 38.508-1 [4], Table 4.8.2.3-3	QFI=5	
QoS flow [4]	Reference QoS flow #4 as defined in TS 38.508-1 [4], Table 4.8.2.3-4	QFI=6	

Table 7.1.4.1.3.3-5: Reference QoS flow #1 (Preamble)

Derivation Path: TS 38.508-1 [4], table 4.8.2.3-1			
Information Element	Value/remark	Comment	Condition
QoS flow descriptions			
QoS flow description	1 entry		

QFI	'00 0001'B	QFI 1	
Operation code	'001'B	Create new QoS flow description	
E bit	'1'B	Parameters list is included	
Number of parameters	'00 0001'B	1 parameter	
5QI	'0000 1001'B	5QI 9	

Table 7.1.4.1.3.3-6: Reference QoS flow #2 (Preamble)

Derivation Path: TS 38.508-1 [4], table 4.8.2.3-2			
Information Element	Value/remark	Comment	Condition
QoS flow descriptions			
QoS flow description	1 entry		
QFI	'00 0010'B	QFI 2	
Operation code	'001'B	Create new QoS flow description	
E bit	'1'B	Parameters list is included	
Number of parameters	'00 0001'B	1 parameter	
5QI	'0000 0101'B	5QI 5	

Table 7.1.4.1.3.3-7: Reference QoS rule #4

Derivation Path: TS 38.508-1[4], table 4.8.2.1-4			
Information Element	Value/remark	Comment	Condition
QoS rules			
QoS rule			
DQR bit	'0'B		

7.1.4.2 SDAP Data Transfer handling without Header UL/DL

7.1.4.2.1 Test Purpose (TP)

(1)

```
with { UE in RRC_CONNECTED state with multiple DRB's established. SDAP configured without header and no stored QoS flow mapping }
ensure that {
  when { UE receives a SDAP SDU from upper layers }
  then { UE SDAP entity transmits the SDAP PDU with header on default DRB }
}
```

(2)

```
with { UE in RRC_CONNECTED state with multiple DRB's established. SDAP configured without header and no stored QoS flow mapping }
ensure that {
  when { UE SDAP recieves from RRC new QoS Flow mapping }
  then { UE SDAP entity transmits an end-marker control PDU for the QoS flow on default DRB }
}
```

(3)

```
with { UE in RRC_CONNECTED state with multiple DRB's established. SDAP configured without header and stored QoS flow mapping configured by RRC }
ensure that {
  when { UE receives a SDAP SDU from upper layers }
  then { UE SDAP entity transmits the SDAP PDU without header on non default DRB as per configured QoS flow mapping }
}
```

7.1.4.2.2 Conformance requirements

References: The conformance requirements covered in the present test case are specified in: TS 37.324, clauses 5.2.1, 5.2.2, 5.3.1, 6.2.2.1 and 6.2.3, TS 24.501 clause 6.2.5.1.3. Unless otherwise stated these are Rel-15 requirements.

[TS 37.324 clause 5.2.1]

At the reception of an SDAP SDU from upper layer for a QoS flow, the transmitting SDAP entity shall:

- if there is no stored QoS flow to DRB mapping rule for the QoS flow as specified in the subclause 5.3:
 - map the SDAP SDU to the default DRB;
- else:
 - map the SDAP SDU to the DRB according to the stored QoS flow to DRB mapping rule;
- if the DRB to which the SDAP SDU is mapped is configured by RRC (3GPP TS 38.331 [3]) with the presence of SDAP header,
 - construct the UL SDAP data PDU as specified in the subclause 6.2.2.3;
- else:
 - construct the UL SDAP data PDU as specified in the subclause 6.2.2.1;
- submit the constructed UL SDAP data PDU to the lower layers.

NOTE 1: UE behaviour is not defined if there is neither a default DRB nor a stored QoS flow to DRB mapping rule for the QoS flow.

NOTE 2: Default DRB is always configured with UL SDAP header (3GPP TS 38.331 [3]).

[TS 37.324 clause 5.2.2]

At the reception of an SDAP data PDU from lower layers for a QoS flow, the receiving SDAP entity shall:

- if the DRB from which this SDAP data PDU is received is configured by RRC (3GPP TS 38.331 [3]) with the presence of SDAP header:
 - perform reflective QoS flow to DRB mapping as specified in the subclause 5.3.2;
 - perform RQI handling as specified in the subclause 5.4;
 - retrieve the SDAP SDU from the DL SDAP data PDU as specified in the subclause 6.2.2.2.
- else:
 - retrieve the SDAP SDU from the DL SDAP data PDU as specified in the subclause 6.2.2.1;
- deliver the retrieved SDAP SDU to the upper layer.

[TS 37.324 clause 5.3.1]

When RRC (3GPP TS 38.331 [3]) configures an UL QoS flow to DRB mapping rule for a QoS flow, the SDAP entity shall:

- if the SDAP entity has already been established and there is no stored QoS flow to DRB mapping rule for the QoS flow and a default DRB is configured:
 - construct an end-marker control PDU, as specified in the subclause 6.2.3, for the QoS flow;
 - map the end-marker control PDU to the default DRB;
 - submit the end-marker control PDU to the lower layers.

- if the stored UL QoS flow to DRB mapping rule is different from the configured QoS flow to DRB mapping rule for the QoS flow and the DRB according to the stored QoS flow to DRB mapping rule is configured by RRC (3GPP TS 38.331 [3]) with the presence of UL SDAP header:
 - construct an end-marker control PDU, as specified in the subclause 6.2.3, for the QoS flow;
 - map the end-marker control PDU to the DRB according to the stored QoS flow to DRB mapping rule;
 - submit the end-marker control PDU to the lower layers.
- store the configured UL QoS flow to DRB mapping rule for the QoS flow.

When RRC (3GPP TS 38.331 [3]) releases an UL QoS flow to DRB mapping rule for a QoS flow, the SDAP entity shall:

- remove the UL QoS flow to DRB mapping rule for the QoS flow.

[TS 37.324 clause 6.2.2.1]

An SDAP PDU consists only of a data field and does not consist of any SDAP header, as described in Figure 6.2.2.1-1.

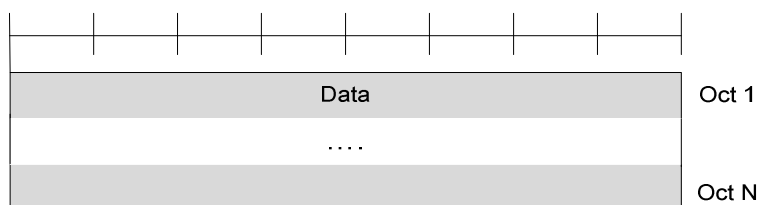

Figure 6.2.2.1-1: SDAP Data PDU format without SDAP header

[TS 37.324 clause 6.2.3]

Figure 6.2.3 – 1 shows the format of End-Marker Control PDU.

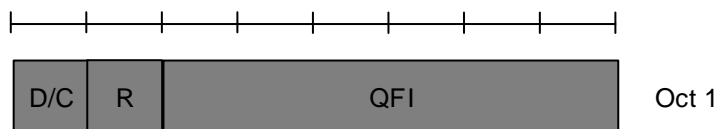

Figure 6.2.3-1: End-Marker Control PDU

[TS 24.501 clause 6.2.5.1.3]

For PDU session of IPv4, IPv6, IPv4v6 or Ethernet PDU session type, upon receiving an UL user data packet from the upper layers for transmission via a PDU session, the UE shall attempt to associate the UL user data packet with:

- a) the QFI of a signalled QoS rule associated with the PDU session which has a set of packet filters containing a packet filter for UL direction matching the UL user data packet or containing a packet filter for both UL and DL directions matching the UL user data packet; or
- b) the QFI of a derived QoS rule associated with the PDU session which has the packet filter for UL direction matching the UL user data packet;

by evaluating the QoS rules in increasing order of their precedence values until the UL user data packet is associated with a QFI or all QoS rules are evaluated.

For PDU session of unstructured PDU session type, upon receiving an UL user data packet from the upper layers for transmission via a PDU session, the UE shall associate the UL user data packet with the QFI of the default QoS rule associated with the PDU session.

If the UL user data packet is associated with a QFI, the UE shall pass the QFI along the UL user data packet to the lower layers for transmission.

NOTE: Marking of the UL user data packet with the QFI is performed by the lower layers.

If all QoS rules are evaluated and the UL user data packet is not associated with a QFI, the UE shall discard the UL user data packet.

7.1.4.2.3 Test description

7.1.4.2.3.1 Pre-test conditions

System Simulator:

- NR Cell 1

UE:

- None.

Preamble:

- The UE is in 5GS state 3N-A with one PDU session active according to TS 38.508-1 [4], clause 4.4A.3, Table 4.4A.3-1 and using the message condition UE TEST LOOP MODE B active to return one UL SDAP SDU per DL SDAP SDU. 2 DRBs are configured where DRBj is defined as default DRB. The NAS QoS rules for QoS flows QFI = 5 and QFI = 2 are configured. The 'mappedQoS-Flows' is empty for both DRB's for SDAP layer.

7.1.4.2.3.2 Test procedure sequence

Table 7.1.4.2.3.2-1: Main behaviour

St	Procedure	Message Sequence		TP	Verdict
		U - S	Message		
1	The SS sends the SDAP Data PDU without SDAP header on DRB k for QFI =2.	<--	SDAP DL Data PDU	-	-
2	Check: Does the UE transmit SDAP Data PDU on DRB j, which is default DRB, with SDAP header including QFI=2?	-->	SDAP UL Data PDU	1	P
3	The SS sends the SDAP Data PDU without SDAP header on DRB j for QFI 5.	<--	SDAP DL Data PDU	-	-
4	Check: Does the UE transmit SDAP Data PDU on DRB j, which is default DRB, with SDAP header including QFI=5?	-->	SDAP UL Data PDU	1	P
5	The SS transmits an NR RRCReconfiguration message to configure QoS Flow rules	<--	<i>(RRCReconfiguration)</i>	-	-
-	EXCEPTION: In parallel to the event described in step 6 the events specified in Table 7.1.4.2.3.2-2 shall take place.	-	-	-	-
6	The UE transmit an NR <i>RRCReconfigurationComplete</i> message.	-->	<i>(RRCReconfigurationComplete)</i>	-	-
7	The SS sends the SDAP Data PDU without SDAP header on DRB k for QFI =2.	<--	SDAP DL Data PDU	-	-
8	Check: Does the UE transmit SDAP Data PDU on DRB k?	-->	SDAP UL Data PDU	3	P
9	The SS sends the SDAP Data PDU without SDAP header on DRB j for QFI 5.	<--	SDAP DL Data PDU	-	-
10	Check: Does the UE transmit SDAP Data PDU on DRB j, with SDAP header including QFI=5?	-->	SDAP UL Data PDU	3	P

Table 7.1.4.2.3.2-2: Parallel behaviour

St	Procedure	Message Sequence		TP	Verdict
		U - S	Message		
1	Check: Does the UE transmit End-Marker Control PDU on DRBj for QFI=2?	-->	SDAP UL Control PDU	2	P

Table 7.1.4.2.3.2-3: Void

7.1.4.2.3.3 Specific message contents

Table 7.1.4.2.3.3-1: RadioBearerConfig-DRB (Preamble)

Derivation Path: TS 38.508-1 [4], table 4.6.3-132 and condition NR			
Information Element	Value/remark	Comment	Condition
RadioBearerConfig ::= SEQUENCE {			
drb-ToAddModList SEQUENCE (SIZE (1..maxDRB))	2 entries		
OF SEQUENCE {			
DRB-ToAddMod[1] SEQUENCE {		entry 1	
cnAssociation CHOICE {			
sdap-Config SEQUENCE {			
pdu-Session	The same as the PDU session ID in PDU SESSION ESTABLISHMENT REQUEST		
sdap-HeaderDL	absent		
sdap-HeaderUL	absent		
defaultDRB	false		
}			
}			
drb-Identity	k	k is allocated according to internal TTCN mapping	
}			
DRB-ToAddMod[2] SEQUENCE {		entry 2	
cnAssociation CHOICE {			
sdap-Config SEQUENCE {			
pdu-Session	The same as the PDU session ID in PDU SESSION ESTABLISHMENT REQUEST		
sdap-HeaderDL	absent		
sdap-HeaderUL	present		
defaultDRB	true		
}			
}			
drb-Identity	j	j is allocated according to internal TTCN mapping	
}			
}			
}			

Table 7.1.4.2.3.3-2: RadioBearerConfig-DRB (step 5, Table 7.1.4.2.3.2-1)

Derivation Path: TS 38.508-1 [4], table 4.6.3-132 and condition NR			
Information Element	Value/remark	Comment	Condition
RadioBearerConfig ::= SEQUENCE {			
drb-ToAddModList SEQUENCE (SIZE (1..maxDRB))	2 entries		
OF SEQUENCE {			
DRB-ToAddMod[1] SEQUENCE {		entry 1	
cnAssociation CHOICE {			
sdap-Config SEQUENCE {			

pdu-Session	The same as the PDU session ID in PDU SESSION ESTABLISHMENT REQUEST		
sdap-HeaderDL	absent		
sdap-HeaderUL	absent		
defaultDRB	false		
mappedQoS-FlowsToAdd SEQUENCE {			
QFI	2		
}			
}			
drb-Identity	k	k is allocated according to internal TTCN mapping	
}			
DRB-ToAddMod[2] SEQUENCE {		entry 2	
cnAssociation CHOICE {			
sdap-Config SEQUENCE {			
pdu-Session	The same as the PDU session ID in PDU SESSION ESTABLISHMENT REQUEST		
sdap-HeaderDL	absent		
sdap-HeaderUL	present		
defaultDRB	true		
mappedQoS-FlowsToAdd	Not present	The 'mappedQoS-Flows' is empty for the DRB.	
}			
}			
}			
drb-Identity	j	j is allocated according to internal TTCN mapping	
}			
}			
}			

Table 7.1.4.2.3.3-3: PDU SESSION ESTABLISHMENT ACCEPT (Preamble)

Derivation Path: TS 38.508-1 [4], table 4.7.2-2			
Information Element	Value/remark	Comment	Condition
PDU session ID	The same as the PDU session ID in PDU SESSION ESTABLISHMENT REQUEST		
Authorized QoS rules	3 entries		
QoS rule [1]	Reference QoS rule #1 as defined in Table 4.8.2.1-1	QFI=1	
QoS rule [2]	Reference QoS rule #4 as defined in Table 4.8.2.1-4 except DQR bit set to '0'	QFI=2	
QoS rule [3]	Reference QoS rule #5 as defined in Table 4.8.2.1-5	QFI=5	
Mapped EPS bearer contexts	Not Present		
Authorized QoS flow descriptions	3 entries		
QoS flow [1]	Reference QoS flow #1	QFI=1	

	as defined in Table 7.1.4.2.3.3-4		
QoS flow [2]	Reference QoS flow #2 as defined in Table 7.1.4.2.3.3-5	QFI=2	
QoS flow [3]	Reference QoS flow #3 as defined in Table 4.8.2.3-3	QFI=5	

Table 7.1.4.2.3.3-4: Reference QoS flow #1 (Preamble)

Derivation Path: TS 38.508-1 [4], table 4.8.2.3-1			
Information Element	Value/remark	Comment	Condition
QoS flow descriptions			
QoS flow description	1 entry		
QFI	'00 0001'B	QFI 1	
Operation code	'001'B	Create new QoS flow description	
E bit	'1'B	Parameters list is included	
Number of parameters	'00 0001'B	1 parameter	
5QI	'0000 1001'B	5QI 9	

Table 7.1.4.2.3.3-5: Reference QoS flow #2 (Preamble)

Derivation Path: TS 38.508-1 [4], table 4.8.2.3-2			
Information Element	Value/remark	Comment	Condition
QoS flow descriptions			
QoS flow description	1 entry		
QFI	'00 0010'B	QFI 2	
Operation code	'001'B	Create new QoS flow description	
E bit	'1'B	Parameters list is included	
Number of parameters	'00 0001'B	1 parameter	
5QI	'0000 0101'B	5QI 5	

8 RRC

8.1 NR RRC

8.1.1 RRC connection management procedures

8.1.1.1 Paging

8.1.1.1.1 RRC / Paging for connection / Multiple paging records

8.1.1.1.1.1 Test Purpose (TP)

(1)

```
with { UE in NR RRC_IDLE state }
ensure that {
  when { UE receives a Paging message including only unmatched identities }
  then { UE does not establish any RRC connection }
}
```

(2)

```
with { UE in NR RRC_IDLE state }
ensure that {
  when { UE receives a Paging message including a matched identity ng-5G-S-TMSI }
  then { UE successfully establishes the RRC connection }
}
```

(3)

```
with { UE in NR RRC_INACTIVE state }
ensure that {
  when { UE receives a Paging message including only unmatched identities }
  then { UE does not resume RRC connection }
}
```

(4)

```
with { UE in NR RRC_INACTIVE state }
ensure that {
  when { UE receives a Paging message including a matched identity fullI-RNTI }
  then { UE successfully resumes the RRC connection }
}
```

8.1.1.1.1.2 Conformance requirements

References: The conformance requirements covered in the current TC is specified in: TS 38.331 clause 5.3.2.3.

[TS 38.331, clause 5.3.2.3]

Upon receiving the *Paging* message, the UE shall:

- 1> if in RRC_IDLE, for each of the *PagingRecord*, if any, included in the *Paging* message:
 - 2> if the *ue-Identity* included in the *PagingRecord* matches the UE identity allocated by upper layers:
 - 3> forward the *ue-Identity* and *accessType* (if present) to the upper layers;
- 1> if in RRC_INACTIVE, for each of the *PagingRecord*, if any, included in the *Paging* message:
 - 2> if the *ue-Identity* included in the *PagingRecord* matches the UE's stored *fullI-RNTI*:

- 3> if the UE is configured by upper layers with Access Identity 1:
- 4> initiate the RRC connection resumption procedure according to 5.3.13 with *resumeCause* set to *mps-PriorityAccess*;
- 3> else if the UE is configured by upper layers with Access Identity 2:
- 4> initiate the RRC connection resumption procedure according to 5.3.13 with *resumeCause* set to *mcs-PriorityAccess*;
- 3> else if the UE is configured by upper layers with one or more Access Identities equal to 11-15:
- 4> initiate the RRC connection resumption procedure according to 5.3.13 with *resumeCause* set to *highPriorityAccess*;
- 3> else:
- 4> initiate the RRC connection resumption procedure according to 5.3.13 with *resumeCause* set to *mt-Access*;
- 2> else if the *ue-Identity* included in the *PagingRecord* matches the UE identity allocated by upper layers:
- 3> forward the *ue-Identity* to upper layers and *accessType* (if present) to the upper layers;
- 3> perform the actions upon going to RRC_IDLE as specified in 5.3.11 with release cause 'other'.

8.1.1.1.1.3 Test Description

8.1.1.1.1.3.1 Pre-test conditions

System Simulator:

- NR Cell 1
- System information combination NR-1 as defined in TS 38.508-1 [4] clause 4.4.3.1.3 is used in NR cell.

UE:

- None.

Preamble:

- The UE is in 5GS state 1N-A according to TS 38.508-1 [4], clause 4.4A.2 Table 4.4A.2-1.

8.1.1.1.1.3.2 Test procedure sequence

Table 8.1.1.1.1.3.2-1: Main behaviour

St	Procedure	Message Sequence		TP	Verdict
		U - S	Message		
1	The SS transmits a <i>Paging</i> message including only unmatched identities (incorrect <i>ng-5G-S-TMSI</i>).	<--	NR RRC: <i>Paging</i>	-	-
2	Check: Does the UE transmit an <i>RRCSetupRequest</i> message within 10s?	-->	NR RRC: <i>RRCSetupRequest</i>	1	F
3	The SS transmits a <i>Paging</i> message including two unmatched identities (incorrect <i>ng-5G-S-TMSI</i>) and a matched identity (correct <i>ng-5G-S-TMSI</i>).	<--	NR RRC: <i>Paging</i>	-	-
4	Check: Does the UE transmit an <i>RRCSetupRequest</i> message?	-->	NR RRC: <i>RRCSetupRequest</i>	2	P
5	The SS transmits an <i>RRCSetup</i> message.	<--	NR RRC: <i>RRCSetup</i>	-	-
6	The UE transmit an <i>RRCSetupComplete</i> message including SERVICE REQUEST to	-->	NR RRC: <i>RRCSetupComplete</i> 5GMM: SERVICE REQUEST	-	-

	confirm the successful completion of the connection establishment.				
7-10	Steps 5 to 8 of the NR RRC_CONNECTED procedure in TS 38.508-1 Table 4.5.4.2-3 are executed to successfully complete the service request procedure.	-	-	-	-
-	EXCEPTION: Steps 11a1-11a7 describe behaviour that depends on UE configuration; the "lower case letter" identifies a step sequence that takes place if inactiveState is configured	-	-	-	-
11a1	IF pc_inactiveState THEN the SS transmits an RRCRelease message including suspendConfig.	<--	NR RRC: RRCRelease	-	-
11a2	The SS transmits a Paging message including only unmatched identities (incorrect fullI-RNTI).	<--	NR RRC: Paging	-	-
11a3	Check: Does the UE transmit an RRCResumeRequest message within 10s?	-->	NR RRC: RRCResumeRequest	3	F
11a4	The SS transmits a Paging message including two unmatched identities (incorrect fullI-RNTI) and a matched identity (correct fullI-RNTI).	<--	NR RRC: Paging	-	-
11a5	Check: Does the UE transmit an RRCResumeRequest message?	-->	NR RRC: RRCResumeRequest	4	P
11a6	The SS transmits an RRCResume message.	<--	NR RRC: RRCResume	-	-
11a7	The UE transmits an RRCResumeComplete message.	-->	NR RRC: RRCResumeComplete	-	-
12-17	Void	-	-	-	-

8.1.1.1.3.3 Specific message contents

Table 8.1.1.1.3.3-1: Paging (step 1, Table 8.1.1.1.3.2-1)

Derivation Path: TS 38.508-1 [4], Table 4.6.1-9			
Information Element	Value/remark	Comment	Condition
Paging ::= SEQUENCE {			
pagingRecordList SEQUENCE (SIZE(1..maxNrofPageRec)) OF PagingRecord {	3 entries		
PagingRecord[1] SEQUENCE {		entry 1	
ue-Identity CHOICE {			
ng-5G-S-TMSI	Set to the different value from the NG-5G-S-TMSI of the UE		
}			
}			
PagingRecord[2] SEQUENCE {		entry 2	
ue-Identity CHOICE {			
ng-5G-S-TMSI	Set to the different value from the NG-5G-S-TMSI of the UE		
}			
}			
PagingRecord[3] SEQUENCE {		entry 3	
ue-Identity CHOICE {			
ng-5G-S-TMSI	Set to the different value from the NG-5G-S-TMSI of the UE		
}			
}			
}			
}			

Table 8.1.1.1.3.3-2: *Paging* (step 3, Table 8.1.1.1.3.2-1)

Derivation Path: TS 38.508-1[4], Table 4.6.1-9			
Information Element	Value/remark	Comment	Condition
Paging ::= SEQUENCE {			
pagingRecordList SEQUENCE	3 entries		
(SIZE(1..maxNrofPageRec)) OF PagingRecord {			
PagingRecord[1] SEQUENCE {		entry 1	
ue-Identity CHOICE {			
ng-5G-S-TMSI	Set to the different value from the NG-5G-S-TMSI of the UE		
}			
}			
PagingRecord[2] SEQUENCE {		entry 2	
ue-Identity CHOICE {			
ng-5G-S-TMSI	Set to the different value from the NG-5G-S-TMSI of the UE		
}			
}			
PagingRecord[3] SEQUENCE {		entry 3	
ue-Identity CHOICE {			
ng-5G-S-TMSI	Set to the value of the NG-5G-S-TMSI of the UE		
}			
}			
}			
}			

Table 8.1.1.1.3.3-3: *RRCSetupRequest* (step 4, Table 8.1.1.1.3.2-1)

Derivation Path: TS 38.508-1 [4], Table 4.6.1-23			
Information Element	Value/remark	Comment	Condition
RRCSetupRequest ::= SEQUENCE {			
rrcSetupRequest SEQUENCE {			
establishmentCause	mt-Access		
}			
}			

Table 8.1.1.1.3.3-4: *Paging* (step 11a2, Table 8.1.1.1.3.2-1)

Derivation Path: TS 38.508-1 Table 4.6.1-9			
Information Element	Value/remark	Comment	Condition
Paging ::= SEQUENCE {			
pagingRecordList SEQUENCE	3 entries		
(SIZE(1..maxNrofPageRec)) OF PagingRecord {			
PagingRecord[1] SEQUENCE {		entry 1	
ue-Identity CHOICE {			
fullI-RNTI	Set to the different value from the I-RNTI-Value of the UE		
}			
}			
PagingRecord[2] SEQUENCE {		entry 2	
ue-Identity CHOICE {			
fullI-RNTI	Set to the different value from the I-RNTI-Value of the UE		
}			
}			
PagingRecord[3] SEQUENCE {		entry 3	
ue-Identity CHOICE {			

<i>fullI-RNTI</i>	Set to the different value from the I-RNTI-Value of the UE		
}			
}			
}			
}			

Table 8.1.1.1.1.3.3-5: Paging (step 11a4, Table 8.1.1.1.1.3.2-1)

Derivation Path: TS 38.508-1 Table 4.6.1-9			
Information Element	Value/remark	Comment	Condition
Paging ::= SEQUENCE {			
pagingRecordList SEQUENCE (SIZE(1..maxNrofPageRec)) OF PagingRecord {	3 entries		
PagingRecord[1] SEQUENCE {		entry 1	
ue-Identity CHOICE {			
<i>fullI-RNTI</i>	Set to the different value from the I-RNTI-Value of the UE		
}			
}			
PagingRecord[2] SEQUENCE {		entry 2	
ue-Identity CHOICE {			
<i>fullI-RNTI</i>	Set to the different value from the I-RNTI-Value of the UE		
}			
}			
PagingRecord[3] SEQUENCE {		entry 3	
ue-Identity CHOICE {			
<i>fullI-RNTI</i>	Set to the value of the I-RNTI-Value of the UE		
}			
}			
}			
}			

8.1.1.1.2 RRC / Paging for connection / Shared network environment

8.1.1.1.2.1 Test Purpose (TP)

(1)

```
with { UE in NR RRC_IDLE state having been registered in the TA of the current cell which has
broadcasted a SIB1 message including multiple PLMN identities }
ensure that {
  when { UE receives a Paging message including an IE ue-Identity set to the ng-5G-S-TMSI which was
allocated to the UE during the UE registration procedure }
    then { UE initiates RRCSetupRequest with ue-Identity set to ng-5G-S-TMSI-Part1 }
}
```

(2)

```
with { UE having sent RRCSetupRequest with ue-Identity set to ng-5G-S-TMSI-Part1 }
ensure that {
  when { the UE receives RRCSetup message }
    then { UE will set the ng-5G-S-TMSI-Value to ng-5G-S-TMSI-Part2 in RRCSetupComplete message }
}
```

(3)

```
with { UE in NR RRC_INACTIVE state having been registered in the TA of the current cell which has
broadcasted a SIB1 message including multiple PLMN identities }
```

```

ensure that {
  when { UE receives a Paging message including an IE ue-Identity set to the ng-5G-S-TMSI which was
    allocated to the UE during the UE registration procedure }
    then { UE releases RRC connection with release cause 'other' and goes to NR RRC_IDLE state }
}

```

8.1.1.1.2.2 Conformance requirements

Editor's note: conformance requirements will be updated according to latest core specification.

References: The conformance requirements covered in the current TC are specified in: TS 38.331, clause 5.3.2.3, 5.3.3.3, 5.3.3.4 and 5.3.11, TS 24.501, clause 5.3.1.4 and 5.6.1.1. Unless otherwise stated these are Rel-15 requirements.

[TS 38.331, clause 5.3.2.3]

Upon receiving the *Paging* message, the UE shall:

- 1> if in RRC_IDLE, for each of the *PagingRecord*, if any, included in the *Paging* message:
 - 2> if the *ue-Identity* included in the *PagingRecord* matches the UE identity allocated by upper layers:
 - 3> forward the *ue-Identity* and *accessType* (if present) to the upper layers;
- 1> if in RRC_INACTIVE, for each of the *PagingRecord*, if any, included in the *Paging* message:
 - 2> if the *ue-Identity* included in the *PagingRecord* matches the UE's stored *fullI-RNTI*:

...
 - 2> else if the *ue-Identity* included in the *PagingRecord* matches the UE identity allocated by upper layers:
 - 3> forward the *ue-Identity* to upper layers and *accessType* (if present) to the upper layers;
 - 3> perform the actions upon going to RRC_IDLE as specified in 5.3.11 with release cause 'other'.

[TS 38.331, clause 5.3.3.3]

The UE shall set the contents of *RRCSetupRequest* message as follows:

- 1> set the *ue-Identity* as follows:
 - 2> if upper layers provide an *5G-S-TMSI*:
 - 3> set the *ue-Identity* to *ng-5G-S-TMSI-Part1*;
 - 2> else:
 - 3> draw a 39-bit random value in the range $0..2^{39}-1$ and set the *ue-Identity* to this value;

NOTE 1: Upper layers provide the *5G-S-TMSI* if the UE is registered in the TA of the current cell.

- 1> set the *establishmentCause* in accordance with the information received from upper layers;

The UE shall submit the *RRCSetupRequest* message to lower layers for transmission.

The UE shall continue cell re-selection related measurements as well as cell re-selection evaluation. If the conditions for cell re-selection are fulfilled, the UE shall perform cell re-selection as specified in 5.3.3.6.

[TS 38.331, clause 5.3.3.4]

The UE shall perform the following actions upon reception of the *RRCSetup*:

...

- 1> set the content of *RRCSetupComplete* message as follows:
 - 2> if upper layers provide an *5G-S-TMSI*:
 - 3> if the *RRCSetup* is received in response to an *RRCSetupRequest*:

4> set the *ng-5G-S-TMSI-Value* to *ng-5G-S-TMSI-Part2*;

3> else:

4> set the *ng-5G-S-TMSI-Value* to *ng-5G-S-TMSI*;

...

1> submit the *RRCSetupComplete* message to lower layers for transmission, upon which the procedure ends

[TS 38.331, clause 5.3.11]

UE shall:

1> reset MAC;

1> if T302 is running:

2> stop timer T302;

2> perform the actions as specified in 5.3.14.4;

1> stop all timers that are running except T320 and T325;

1> discard the UE Inactive AS context;

1> set the variable *pendingRnaUpdate* to *false*, if that is set to *true*;

1> discard the K_{gNB} , the K_{RRCenc} key, the K_{RRCint} , the K_{UPint} key and the K_{UPenc} key, if any;

1> release all radio resources, including release of the RLC entity, the MAC configuration and the associated PDCP entity and SDAP for all established RBs;

1> indicate the release of the RRC connection to upper layers together with the release cause;

1> enter RRC_IDLE and perform cell selection as specified in TS 38.304 [20], except if going to RRC_IDLE was triggered by selecting an inter-RAT cell while T311 was running;

1> if going to RRC_IDLE was triggered by reception of the *RRCRelease* message including a *waitTime*:

2> start timer T302 with the value set to the *waitTime*;

2> inform the upper layer that access barring is applicable for all access categories except categories '0' and '2'.

[TS 24.501, clause 5.3.1.4]

...

Upon receiving AMF paging indication from the lower layers, the UE shall transition from 5GMM-CONNECTED mode with RRC inactive indication to 5GMM-IDLE mode over 3GPP access and handle the AMF paging same as the paging request received in the 5GMM-IDLE mode over 3GPP access as specified in clause 5.6.1.

[TS 24.501, clause 5.6.1.1]

...

The UE shall invoke the service request procedure when:

a) the UE, in 5GMM-IDLE mode over 3GPP access, receives a paging request from the network;

8.1.1.1.2.3 Test description

8.1.1.1.2.3.1 Pre-test conditions

System Simulator:

- NR Cell 1.

UE:

- None.

Preamble:

- The UE is in state 1N-A as defined in TS 38.508-1 [4], clause 4.4A on NR Cell 1 and 5G-GUTI is allocated in REGISTRATION ACCEPT.

8.1.1.1.2.3.2 Test procedure sequence

Table 8.1.1.1.2.3.2-1: Main behaviour

St	Procedure	Message Sequence		TP	Verdict
		U - S	Message		
1	The SS transmits a <i>Paging</i> message including a matched ng-5G-S-TMSI.	<--	NR RRC: <i>Paging</i>	-	-
2	Check: Does the UE transmit an <i>RRCSetupRequest</i> message with ue-Identity set to ng-5G-S-TMSI-Part1?	-->	NR RRC: <i>RRCSetupRequest</i>	1	P
3	The SS transmits an <i>RRCSetup</i> message.	<--	NR RRC: <i>RRCSetup</i>	-	-
4	Check: Does the UE transmit an <i>RRCSetupComplete</i> message including ng-5G-S-TMSI-Part2 and a SERVICE REQUEST message and an IE <i>selectedPLMN-Identity</i> corresponding to the PLMN on which the UE has been registered to confirm the successful completion of the connection establishment?	-->	NR RRC: <i>RRCSetupComplete</i>	2	P
5-8	Steps 5 to 8 of the generic radio bearer establishment procedure (TS 38.508-1 [4] Table 4.5.4.2-3) are executed to successfully complete the service request procedure.	-	-	-	-
-	EXCEPTION: Steps 9a1-9b1 describe behaviour that depends on UE configuration; the "lower case letter" identifies a step sequence that takes place if inactiveState is configured	-	-	-	-
9 a1	IF pc_inactiveState THEN the SS transmits an <i>RRCRelease</i> message with suspendConfig to suspend RRC connection and move to RRC_INACTIVE state.	<--	NR RRC: <i>RRCRelease</i>	-	-
9a2	Wait 5s and the SS transmits a <i>Paging</i> message including a matched ng-5G-S-TMSI.	<--	NR RRC: <i>Paging</i>	-	-
9a3	Check: Does the UE transmit an <i>RRCSetupRequest</i> message on the cell specified in the test case?	-->	NR RRC: <i>RRCSetupRequest</i>	3	P
9a49 a10-	Steps 3-9 of Generic procedure for checking UE is in state 5GC RRC_IDLE on a certain cell as specified in Table 4.9.4.2.2-1 of TS 38.508-1 [4] are performed.	-	-	-	-
9b1	ELSE the SS transmits an <i>RRCRelease</i> message	<--	NR RRC: <i>RRCRelease</i>	-	-
10- 18	Void	-	-	-	-

8.1.1.1.2.3.3 Specific message contents

Table 8.1.1.1.2.3.3-1: SIB1 (preamble and all steps, Table 8.1.1.1.2.3.2-1)

Derivation Path: TS 38.508-1 [4] Table 4.6.1-28			
Information Element	Value/remark	Comment	Condition
SIB1 ::= SEQUENCE {			
CellAccessRelatedInfo SEQUENCE {			
plmn-IdentityList	PLMN-IdentityInfoList		

}			
}			

Table 8.1.1.1.2.3.3-2: PLMN-IdentityInfoList (Table 8.1.1.1.2.3.3-1)

Derivation Path: TS 38.508-1 [4] Table 4.6.3-108			
Information Element	Value/remark	Comment	Condition
PLMN-IdentityInfoList ::= SEQUENCE (SIZE (1..maxPLMN)) OF PLMN-IdentityInfo {	1 entry		
PLMN-IdentityInfo[1] SEQUENCE {		entry 1	
plmn-IdentityList SEQUENCE (SIZE (1..maxPLMN)) OF PLMN-Identity {	2 entries		
plmn-Identity[1] SEQUENCE {		entry 1	
mcc	See Table 8.1.1.1.2.3.3-2A	PLMN1	
mnc	See Table 8.1.1.1.2.3.3-2A	PLMN1	
}			
plmn-Identity[2] SEQUENCE {		entry 2	
mcc	See Table 8.1.1.1.2.3.3-2A	PLMN2	
mnc	See Table 8.1.1.1.2.3.3-2A	PLMN2	
}			
}			
}			

The PLMN Identity list broadcasted on the BCCH in NR Cell 1 shall be configured as defined in the table below.

Table 8.1.1.1.2.3.3-2A: PLMN Identity List broadcasted for NR Cell 1

Cell	PLMN Identity [1]		PLMN Identity [2]	
	MCC digits	MNC digits	MCC digits	MNC digits
1	PLMN 1	PLMN 1	PLMN 2	PLMN 2

The definition of each PLMN code is found in table below:

Table 8.1.1.1.2.3.3-2B: definition of each PLMN code

PLMN	MCC digit			MNC digit		
	1	2	3	1	2	3
1	(NOTE 2)			(NOTE 2)		
2	(NOTE 3)			0	2	-

NOTE 1: "-" (dash) denotes "not present"

NOTE 2: Set to the same Mobile Country Code and Mobile Network Code stored in EF_{IMSI} on the test USIM card for PLMN 1.

NOTE 3: Set to the same Mobile Country Code stored in EF_{IMSI} on the test USIM card for PLMN 2.

Table 8.1.1.1.2.3.3-3: RRCSetupRequest (step 2, 9a3, Table 8.1.1.1.2.3.2-1)

Derivation Path: TS 38.508-1 [4], Table 4.6.1-23			
Information Element	Value/remark	Comment	Condition
RRCSetupRequest ::= SEQUENCE {			
rrcSetupRequest SEQUENCE {			
ue-Identity CHOICE {			
ng-5G-S-TMSI-Part1	ng-5G-S-TMSI-Part1	ng-5G-S-TMSI-Part1 is rightmost	

		39 bits of 5G-S-TMSI. 5G-S-TMSI is derived from 5G-GUTI in REGISTRATION ACCEPT according to TS 23.003 [34]	
}			
establishmentCause	mt-Access		
}			
}			

Table 8.1.1.1.2.3.3-4: RRCSetupComplete (step 4, Table 8.1.1.1.2.3.2-1)

Derivation Path: TS 38.508-1 [4], Table 4.6.1-22			
Information Element	Value/remark	Comment	Condition
RRCSetupComplete ::= SEQUENCE {			
rrc-TransactionIdentifier	RRC-TransactionIdentifier		
criticalExtensions CHOICE {			
rrcSetupComplete SEQUENCE {			
ng-5G-S-TMSI-Value	ng-5G-S-TMSI-Part2	ng-5G-S-TMSI-Part2 is the leftmost 9 bits of 5G-S-TMSI. 5G-S-TMSI is derived from 5G-GUTI in REGISTRATION ACCEPT according to TS 23.003 [34]	
selectedPLMN-Identity	1 or 2	PLMN1 or PLMN2 Note1	
}			
}			
}			
Note1: If RPLMN is PLMN1, UE will select PLMN1; if RPLMN is PLMN2, UE will select PLMN2			

Table 8.1.1.1.2.3.3-5: RRCRelease (step 9a1, Table 8.1.1.1.2.3.2-1)

Derivation Path: TS 38.508-1 [4] Table 4.6.1-16			
Information Element	Value/remark	Comment	Condition
RRCRelease ::= SEQUENCE {			
rrc-TransactionIdentifier	RRC-TransactionIdentifier		
criticalExtensions CHOICE {			
rrcRelease SEQUENCE {			
suspendConfig SEQUENCE {			
fullI-RNTI	I-RNTI-Value	38.508-1[4] Table 4.6.3-64	
shortI-RNTI	ShortI-RNTI-Value	38.508-1[4] Table 4.6.3-170	
ran-PagingCycle	rf256		
ran-NotificationAreaInfo CHOICE {			
cellList SEQUENCE (SIZE (1..maxPLMNIdentities)) OF PLMN-RAN-AreaCell {	2 entries		
PLMN-RAN-AreaCellList[1] SEQUENCE {		entry 1	
plmn-Identity	PLMN1		
ran-AreaCells SEQUENCE (SIZE (1..32)) OF CellIdentity {	1 entry		
CellIdentity[1]	CellIdentity of NR Cell 1	entry 1	
}			
}			
}			
}			

PLMN-RAN-AreaCellList[2] SEQUENCE {		entry 2	
plmn-Identity	PLMN2		
ran-AreaCells SEQUENCE (SIZE (1..32)) OF CellIdentity {	1 entry		
CellIdentity[1]	CellIdentity of NR Cell 1	entry 1	
}			
}			
t380	Not Present		
nextHopChainingCount	NextHopChainingCount	38.508-1[4] Table 4.6.3-83	
}			
}			
}			
}			

8.1.1.2 RRC connection establishment

8.1.1.2.1 RRC connection establishment / Return to idle state after T300 expiry / connEstFailOffsetValidity / T300 expired

8.1.1.2.1.1 Test Purpose (TP)

(1)

```
with { UE in NR RRC_IDLE state having sent an RRCSetupRequest message }
ensure that {
  when { the SS does not answer to the UE during T300 }
  then { UE goes to RRC_IDLE state }
}
```

(2)

```
with { UE in NR RRC_IDLE state }
ensure that {
  when { T300 has expired a consecutive connEstFailCount times on the same cell for which
connEstFailureControl is included in SIB1 for a period as indicated by connEstFailOffsetValidity }
  then { UE uses connEstFailOffset for the parameter Qoffsettemp when performing cell reselection }
}
```

(3)

```
with { UE in NR RRC_IDLE state }
ensure that {
  when { connEstFailOffsetValidity has expired }
  then { UE stops using the parameter Qoffsettemp when performing cell reselection }
}
```

(4)

```
with { UE in NR RRC_IDLE state }
ensure that {
  when { UE receives a short message transmitted on PDCCH using P-RNTI indicating a
systemInfoModification }
  then { UE re-acquires and applies the new system information }
}
```

8.1.1.2.1.2 Conformance requirements

References: The conformance requirements covered in the current TC are specified in: TS 38.331, clause 5.3.3.7. Unless otherwise stated these are Rel-15 requirements.

[TS 38.331, clause 5.3.3.7]

The UE shall:

- 1> if timer T300 expires:
 - 2> reset MAC, release the MAC configuration and re-establish RLC for all RBs that are established;
 - 2> if the T300 has expired a consecutive *connEstFailCount* times on the same cell for which *connEstFailureControl* is included in *SIB1*:
 - 3> for a period as indicated by *connEstFailOffsetValidity*:
 - 4> use *connEstFailOffset* for the parameter *Qoffsettemp* for the concerned cell when performing cell selection and reselection according to TS 38.304 [20] and TS 36.304 [27];

NOTE: When performing cell selection, if no suitable or acceptable cell can be found, it is up to UE implementation whether to stop using *connEstFailOffset* for the parameter *Qoffsettemp* during *connEstFailOffsetValidity* for the concerned cell.

- 2> inform upper layers about the failure to establish the RRC connection, upon which the procedure ends;

8.1.1.2.1.3 Test description

8.1.1.2.1.3.1 Pre-test conditions

System Simulator:

- NR Cell 1 and NR Cell 3.
- System information combination NR-4 as defined in TS 38.508-1 [4] clause 4.4.3.1.3 is used in NR cells.

UE:

- None.

Preamble:

- The UE is in state 1N-A as defined in TS 38.508-1 [4], clause 4.4A on NR Cell 1 and 5G-GUTI is allocated in REGISTRATION ACCEPT.

8.1.1.2.1.3.2 Test procedure sequence

Table 8.1.1.2.1.3.2-1/2 illustrates the downlink power levels and other changing parameters to be applied for the NR cells at various time instants of the test execution. The exact instants on which these values shall be applied are described in the texts in this clause. The configuration "T0" indicates the initial conditions. Subsequent configuration marked "T1" is applied at the points indicated in the Main behaviour description in Table 8.1.1.2.1.3.2-3.

Table 8.1.1.2.1.3.2-1: Time instances of cell power level and parameter changes for FR1

	Parameter	Unit	NR Cell 1	NR Cell 3	Remark
T0	SS/PBCH SSS EPRE	dBm/SCS	-78	Off	
T1	SS/PBCH SSS EPRE	dBm/SCS	-78	-88	
Note: Power level "Off" is defined in TS 38.508-1 [4] Table 6.2.2.1-3.					

Table 8.1.1.2.1.3.2-2: Time instances of cell power level and parameter changes for FR2

	Parameter	Unit	NR Cell 1	NR Cell 3	Remark
T0	SS/PBCH SSS EPRE	dBm/SCS	-82	Off	
	Qrxlevmin	dBm	-91+Delta(NRf1)	-	
T1	SS/PBCH	dBm/SCS	-82	-91	

	SSS EPRE				
	Qrxlevmin	dBm	-91+Delta(NRf1)	-100+Delta(NRf2)	

Table 8.1.1.2.1.3.2-3: Main behaviour

St	Procedure	Message Sequence		TP	Verdict
		U - S	Message		
1	The SS transmits a <i>Paging</i> message including a matched ng-5G-S-TMSI.	<--	NR RRC: <i>Paging</i>	-	-
2	The UE transmits an <i>RRCSetupRequest</i> message.	-->	NR RRC: <i>RRCSetupRequest</i>	-	-
3	The SS waits for 2s (T300 expire).	-	-	-	-
4	Check: Does UE send <i>RRCSetupRequest</i> in 5 second?	-->	NR RRC: <i>RRCSetupRequest</i>	1	F
5	Check: Does the test result of generic test procedure step 1-8 in TS 38.508-1 [4] Table 4.9.4.2.2-1 indicate that the UE is in RRC_IDLE?	-	-	1	-
6	SS transmits an <i>RRCRelease</i> message to release RRC connection and move the UE to RRC_IDLE	<--	NR RRC: <i>RRCRelease</i>	-	-
7	The SS remove connEstFailOffset in SIB1.	-	-	-	-
8	The SS transmits a Short message on PDCCH using P-RNTI indicating a <i>systemInfoModification</i> .	-	PDCCH (DCI 1_0): Short Message	-	-
8A	Wait for 2.1* modification period to allow the new system information to take effect.	-	-	-	-
9	Void	-	-	-	-
10	The SS transmits a <i>Paging</i> message including a matched ng-5G-S-TMSI.	<--	NR RRC: <i>Paging</i>	-	-
11	The UE transmits an <i>RRCSetupRequest</i> message.	-->	NR RRC: <i>RRCSetupRequest</i>	-	-
12	The SS waits for 2s to let T300 expire.	-	-	-	-
12 A	The SS re-adjusts the SS levels according to row "T1" in table 8.1.1.2.1.3.2-1/2 and waits for 35s to allow UE to perform cell reselection.	-	-	-	-
13	The SS transmits a <i>Paging</i> message including a matched ng-5G-S-TMSI on NR Cell 1.	<--	NR RRC: <i>Paging</i>	-	-
14	Check: Does UE send <i>RRCSetupRequest</i> in 5 second?	-->	NR RRC: <i>RRCSetupRequest</i>	2	F
15	Void	-	-	-	-
16	After expiry of connEstFailOffsetValidity, the SS waits 35s to allow UE to perform cell reselection.	-	-	-	-
17	Check: Does the test result of generic test procedure step 1-9a1 in TS 38.508-1 [4] Table 4.9.4.2.2-1 indicate that the UE is in RRC_IDLE on NR Cell 1?	-	-	3	-
18	The SS changes NR Cell 3 to high priority in SIB4 and the <i>ValueTag</i> of SIB4 in the SI-SchedulingInfo of SIB1 is increased on NR Cell 1.	-	-	-	-
18 A	The SS changes NR cell reselection priority of NR Cell 3 in the SIB2 of NR Cell 3 and the <i>ValueTag</i> of SIB2 in the SI-SchedulingInfo of SIB1 is increased on NR Cell 3.	-	-	-	-
19	The SS transmits a Short message on PDCCH using P-RNTI indicating a <i>systemInfoModification</i> .	-	PDCCH (DCI 1_0): Short Message	-	-
20	Wait for 2.1* modification period to allow the new system information to take effect.	-	-	-	-
21	Check: Does the test result of generic test procedure step 1-9a1 in TS 38.508-1 [4] Table 4.9.4.2.2-1 indicate that the UE is in RRC_IDLE on NR Cell 3?	-	-	4	-

8.1.1.2.1.3.3 Specific message contents

Table 8.1.1.2.1.3.3-1: RRCSetupRequest (steps 2 and 11, Table 8.1.1.2.1.3.2-3)

Derivation Path: TS 38.508-1 [4], Table 4.6.1-23			
Information Element	Value/remark	Comment	Condition
RRCSetupRequest ::= SEQUENCE {			
rrcSetupRequest SEQUENCE {			
establishmentCause	mt-Access		
}			
}			

Table 8.1.1.2.1.3.3-2: SIB1 (step 7, Table 8.1.1.2.1.3.2-3)

Derivation Path: TS 38.508-1 [4], Table 4.6.1-28			
Information Element	Value/remark	Comment	Condition
SIB1 ::= SEQUENCE {			
connEstFailureControl	ConnEstFailureControl	Table 8.1.1.2.1.3.3-3	
}			

Table 8.1.1.2.1.3.3-3: ConnEstFailureControl (Table 8.1.1.2.1.3.3-2)

Derivation Path: TS 38.508-1 [4], Table 4.6.3-27			
Information Element	Value/remark	Comment	Condition
ConnEstFailureControl ::= SEQUENCE {			
connEstFailOffsetValidity	s60		
connEstFailOffset	Not present	Value of infinity shall be used for Qoffset _{temp}	
}			

Table 8.1.1.2.1.3.3-4: SIB4 of NR Cell 1 (steps 18, Table 8.1.1.2.1.3.2-3)

Derivation Path: TS 38.508-1 [4] Table 4.6.2-3			
Information Element	Value/remark	Comment	Condition
SIB4 ::= SEQUENCE {			
interFreqCarrierFreqList SEQUENCE (SIZE (1..maxFreq)) OF InterFreqCarrierFreqInfo {	1 entry		
InterFreqCarrierFreqInfo[1] SEQUENCE {		entry 1 The entry corresponding to the carrier of NR Cell 3	
cellReselectionPriority	7	Higer priority than NR Cell 1	
}			
}			
}			

Table 8.1.1.2.1.3.3-5: SIB2 of NR Cell 3 (steps 18A, Table 8.1.1.2.1.3.2-3)

Derivation Path: TS 38.508-1 [4], Table 4.6.2-1			
Information Element	Value/remark	Comment	Condition
SIB2 ::= SEQUENCE {			
cellReselectionServingFreqInfo SEQUENCE {			
cellReselectionPriority	7	Higer priority than NR Cell 1	
}			
}			

Table 8.1.1.2.1.3.3-6: SIB1 of NR Cell 1 (Step 18), Table 8.1.1.2.1.3.2-3)

Derivation Path: TS 38.508-1 [4], Table 4.6.1-28			
Information Element	Value/remark	Comment	Condition
SIB1 ::= SEQUENCE {			
si-SchedulingInfo	SI-SchedulingInfo		
}			

Table 8.1.1.2.1.3.3-7: SI-SchedulingInfo (si-SchedulingInfo in Table 8.1.1.2.1.3.3-6)

Derivation Path: TS 38.508-1 [4], Table 4.6.3-173			
Information Element	Value/remark	Comment	Condition
SI-SchedulingInfo ::= SEQUENCE {			
schedulingInfoList SEQUENCE (SIZE(1..maxSI-Message)) OF SchedulingInfo {	1 entry		
SchedulingInfo[1] SEQUENCE {		entry 1	
sib-MappingInfo SEQUENCE (SIZE(1..maxSIB)) OF SIB-TypeInfo {	2 entries		
SIB-TypeInfo[1] SEQUENCE {		entry 1	
Type[1]	sibType2		
valueTag[1]	0		
}			
SIB-TypeInfo[1] SEQUENCE {		entry 2	
Type[1]	sibType4		
valueTag[1]	1		
}			
}			
}			
}			
}			

Table 8.1.1.2.1.3.3-8: SIB1 of NR Cell 3 (Step 18A), Table 8.1.1.2.1.3.2-3)

Derivation Path: TS 38.508-1 [4], Table 4.6.1-28			
Information Element	Value/remark	Comment	Condition
SIB1 ::= SEQUENCE {			
si-SchedulingInfo	SI-SchedulingInfo		
}			

Table 8.1.1.2.1.3.3-9: SI-SchedulingInfo (si-SchedulingInfo in Table 8.1.1.2.1.3.3-8)

Derivation Path: TS 38.508-1 [4], Table 4.6.3-173			
Information Element	Value/remark	Comment	Condition
SI-SchedulingInfo ::= SEQUENCE {			
schedulingInfoList SEQUENCE (SIZE(1..maxSI-Message)) OF SchedulingInfo {	1 entry		
SchedulingInfo[1] SEQUENCE {		entry 1	
sib-MappingInfo SEQUENCE (SIZE(1..maxSIB)) OF SIB-TypeInfo {	2 entries		
SIB-TypeInfo[1] SEQUENCE {		entry 1	
Type[1]	sibType2		
valueTag[1]	1		
}			
SIB-TypeInfo[1] SEQUENCE {		entry 2	
Type[1]	sibType4		
valueTag[1]	0		
}			
}			
}			
}			
}			

}			
}			
}			

8.1.1.2.2 Void

8.1.1.2.3 RRC connection establishment / RRC Reject with wait time

8.1.1.2.3.1 Test Purpose (TP)

(1)

```
with { UE in NR RRC_IDLE state and has sent an RRCSetupRequest message }
ensure that {
  when { UE receives an RRCReject message including an IE waitTime }
  then { UE doesn't re-send RRCSetupRequest message before the waitTime is expired }
}
```

8.1.1.2.3.2 Conformance requirements

References: The conformance requirements covered in the current TC is specified in: TS 38.331 clause 5.3.15.2.

[TS 38.331, clause 5.3.15.2]

The UE shall:

- 1> stop timer T300, if running;
- 1> stop timer T319, if running;
- 1> stop timer T302, if running;
- 1> reset MAC and release the default MAC Cell Group configuration;
- 1> if *waitTime* is configured in the *RRCReject*:
 - 2> start timer T302, with the timer value set to the *waitTime*;
- 1> if *RRCReject* is received in response to a request from upper layers:
 - 2> inform the upper layer that access barring is applicable for all access categories except categories '0' and '2';
- 1> if *RRCReject* is received in response to an *RRCSetupRequest*:
 - 2> inform upper layers about the failure to setup the RRC connection, upon which the procedure ends;
- 1> else if *RRCReject* is received in response to an *RRCResumeRequest* or an *RRCResumeRequest1*:
 - 2> if resume is triggered by upper layers:
 - 3> inform upper layers about the failure to resume the RRC connection;
 - 2> if resume is triggered due to an RNA update:
 - 3> set the variable *pendingRnaUpdate* to *true*;
 - 2> discard the current K_{gNB} key, the K_{RRCenc} key, the K_{RRCint} key, the K_{UPint} key and the K_{UPenc} key derived in accordance with 5.3.13.3;
 - 2> suspend SRB1, upon which the procedure ends;

The RRC_INACTIVE UE shall continue to monitor paging while the timer T302 is running.

8.1.1.2.3.3 Test Description

8.1.1.2.3.3.1 Pre-test conditions

System Simulator:

- NR Cell 1
- System information combination NR-1 as defined in TS 38.508-1 [4] clause 4.4.3.1.3 is used in NR cell.

UE:

- None.

Preamble:

- The UE is in 5GS state 3N-A according to TS 38.508-1 [4], clause 4.4A.2 Table 4.4A.2-3 and Test Loop Function (On) with UE test loop mode B is established.

8.1.1.2.3.3.2 Test procedure sequence

Table 8.1.1.2.3.3.2-1: Main behaviour

St	Procedure	Message Sequence		TP	Verdict
		U - S	Message		
1	The SS transmits one IP packet to the UE on the DRB associated with the first PDU session on NR Cell 1.	-	-	-	-
2	Wait for 1 second after the IP packet has been transmitted in step 1. (Note 1)	-	-	-	-
3	The SS transmits an <i>RRCRelease</i> message on NR Cell 1.	<--	NR RRC: <i>RRCRelease</i>	-	-
4-4A	Steps 1-2 of the NR RRC_CONNECTED procedure in table 4.5.4.2-3 in TS 38.508-1[4] are performed.	-	-	-	-
5	The SS responds with <i>RRCReject</i> message with IE <i>waitTime</i> set to 10s.	<--	NR RRC: <i>RRCReject</i>	-	-
6	Check: Does the UE transmit an <i>RRCSetupRequest</i> message while timer T302 is running?	-->	NR RRC: <i>RRCSetupRequest</i>	1	F
6A	The SS starts timer <i>Timer_1</i> = 10 s	-	-	-	-
-	EXCEPTION: Steps 15a1 to 15b1 describe a transaction that depends on the UE behaviour; the "lower case letter" identifies a step sequence that takes place if a specific behaviour happens. (Note 3)	-	-	-	-
7-14	Void	-	-	-	-
15a1	Check: Does UE transmit <i>RRCSetupRequest</i> message for sending the IP packet received in step 1 after timer T302 expires?	-	NR RRC: <i>RRCSetupRequest</i>	1	P
15a2-15a6	Steps 3 to 7 of the NR RRC_CONNECTED procedure in TS 38.508-1 [4] Table 4.5.4.2-3 are executed.	-	-	-	-
-	EXCEPTION: Steps 15a7 and 15a8 can occur in any order.	-	-	-	-
15a7	The UE transmits an <i>RRCReconfigurationComplete</i> message on Cell 1.	-->	NR RRC: <i>RRCReconfigurationComplete</i>	-	-
15a8	The UE loops back the IP packet received in step 1 on the DRB associated with the first PDU session on NR Cell 1.	-	-	-	-
15a9	The SS transmits an <i>RRCRelease</i> message on NR Cell 1.	<--	NR RRC: <i>RRCRelease</i>	-	-

15b 1	The SS waits for Timer_1 expiry	-	-	-	-
Note 1: The 1 second delay is used to secure that the UE has received and forwarded the IP Packet transmitted by the SS in step 1 to the UE test loop function before the <i>RRCRelease</i> message is sent by the SS in step 3.					
Note 2: Void					

8.1.1.2.3.3.3 Specific message contents

Table 8.1.1.2.3.3.3-1: RRCReject (step 5, table 8.1.1.2.3.3.2-1)

Derivation Path: TS 38.508-1 [4] Table 4.6.1-15			
Information Element	Value/remark	Comment	Condition
RRCReject ::= SEQUENCE {			
criticalExtensions CHOICE {			
rrcReject SEQUENCE {			
waitTime	10	10 seconds	
}			
}			
}			

Table 8.1.1.2.3.3.3-2: CLOSE UE TEST LOOP (Preamble, Table 8.1.1.2.3.3.2-1)

Derivation Path: TS 36.508 [7], Table 4.7A-3, condition UE TEST LOOP MODE B			
Information Element	Value/remark	Comment	Condition
UE test loop mode B LB setup			
IP PDU delay	'0000 0101'B	5 seconds	

Table 8.1.1.2.3.3.3-3: SERVICE REQUEST (Step 15a3, Table 8.1.1.2.3.3.2-1)

Derivation Path: TS 38.508-1[4], Table 4.7.1-16			
Information Element	Value/remark	Comment	Condition
Service type	'0001'B	data	

8.1.1.2.4 RRC connection establishment / Extended and spare fields in SI

8.1.1.2.4.1 Test Purpose (TP)

(1)

```
with { UE is powered on and receives system information }
ensure that {
  when { UE receives an optional spare or extended field in system information that it does not
comprehend }
  then { UE treats system information as if the spare or extended field were absent and system
information is not ignored, and UE establishes an RRC connection }
}
```

8.1.1.2.4.2 Conformance requirements

References: The conformance requirements covered in the current TC are specified in: TS 36.331, clauses 5.2.2.3.1, 10.1 and 10.3. Unless otherwise stated, these are Rel-15 requirements.

[TS 38.331, clause 5.2.2.3.1]

The UE shall:

- 1> apply the specified BCCH configuration defined in 9.1.1.1;
- 1> if the UE is in RRC_IDLE or in RRC_INACTIVE; or
- 1> if the UE is in RRC_CONNECTED while T311 is running:

- 2> acquire the *MIB*, which is scheduled as specified in TS 38.213 [13];
- 2> if the UE is unable to acquire the *MIB*;
 - 3> perform the actions as specified in clause 5.2.2.5;
- 2> else:
 - 3> perform the actions specified in clause 5.2.2.4.1.
- 1> if the UE is in RRC_CONNECTED with an active BWP with common search space configured by *searchSpaceSIB1* and *pagingSearchSpace* and has received an indication about change of system information; or
- 1> if the UE is in RRC_IDLE or in RRC_INACTIVE; or
- 1> if the UE is in RRC_CONNECTED while T311 is running:
 - 2> if *ssb-SubcarrierOffset* indicates *SIB1* is transmitted in the cell (TS 38.213 [13]) and if *SIB1* acquisition is required for the UE:
 - 3> acquire the *SIB1*, which is scheduled as specified in TS 38.213 [13];
 - 3> if the UE is unable to acquire the *SIB1*:
 - 4> perform the actions as specified in clause 5.2.2.5;
 - 3> else:
 - 4> upon acquiring *SIB1*, perform the actions specified in clause 5.2.2.4.2.
 - 2> else if *SIB1* acquisition is required for the UE and *ssb-SubcarrierOffset* indicates that *SIB1* is not scheduled in the cell:
 - 3> perform the actions as specified in clause 5.2.2.5.

NOTE: The UE in RRC_CONNECTED is only required to acquire broadcasted *SIB1* if the UE can acquire it without disrupting unicast data reception, i.e. the broadcast and unicast beams are quasi co-located.

[TS 38.331, clause 10.1]

The generic error handling defined in the subsequent clauses applies unless explicitly specified otherwise e.g. within the procedure specific error handling.

The UE shall consider a value as not comprehended when it is set:

- to an extended value that is not defined in the version of the transfer syntax supported by the UE;
- to a spare or reserved value unless the specification defines specific behaviour that the UE shall apply upon receiving the concerned spare/reserved value.

The UE shall consider a field as not comprehended when it is defined:

- as spare or reserved unless the specification defines specific behaviour that the UE shall apply upon receiving the concerned spare/reserved field.

[TS 38.331 clause 10.3]

The UE shall, when receiving an RRC message on any logical channel:

- 1> if the message includes a field that has a value that the UE does not comprehend:
 - 2> if a default value is defined for this field:
 - 3> treat the message while using the default value defined for this field;
 - 2> else if the concerned field is optional:

3> treat the message as if the field were absent and in accordance with the need code for absence of the concerned field;

2> else:

3> treat the message as if the field were absent and in accordance with sub-clause 10.4.

8.1.1.2.4.3 Test description

8.1.1.2.4.3.1 Pre-test conditions

System Simulator:

- NR Cell 1.

UE:

None.

Preamble:

- The UE is switched off

8.1.1.2.4.3.2 Test procedure sequence

Table 8.1.1.2.4.3.2-1: Main behaviour

St	Procedure	Message Sequence		TP	Verdict
		U - S	Message		
1	System information that includes extended and spare fields that the UE does not comprehend is broadcasted on BCCH. (Note 1)	<--	RRC: SYSTEM INFORMATION (BCCH)	-	-
2	The UE is switched on.	-	-	-	-
3	Does the UE transmit an <i>RRCSetupRequest</i> message on NR Cell 1?	-->	<i>RRCSetupRequest</i>	1	P
4	The SS transmits an <i>RRCSetup</i> message on Cell 1.	<--	<i>RRCSetup</i>	-	-
5	Check: Does the UE transmit an <i>RRCSetupComplete</i> message to confirm the successful completion of the connection establishment and initiates the registration procedure by including the REGISTRATION REQUEST message?	-->	<i>RRCSetupComplete</i> 5GMM: REGISTRATION REQUEST	1	P
6-21a 1	Steps 5 to 20a1 of the registration procedure described in TS 38.508 Table 4.5.2.2-2 are performed on NR Cell 1.	-	-	-	-
Note 1 The NR-19 in Table 4.4.3.1.2-1 Combinations of system information blocks of TS 38.508-1 [4] is used					

8.1.1.2.4.3.3 Specific message contents

Table 8.1.1.2.4.3.3-1: MIB (step 1, Table 8.1.1.2.4.3.2-1)

Derivation Path: TS 38.508-1 Table 4.6.1-6			
Information Element	Value/remark	Comment	Condition
MIB ::= SEQUENCE {			
spare	'1'B	In Rel-15, the lowest bit is considered a spare according to TS 38.331 [12].	For Rel-15
}			

Table 8.1.1.2.4.3.3-2: SystemInformation (step 1, Table 8.1.1.2.4.3.2-1)

Derivation Path: TS 38.508-1, Table 4.6.1-29			
Information Element	Value/remark	Comment	Condition
SystemInformation ::= SEQUENCE {			
criticalExtensions CHOICE {			
systemInformation SEQUENCE {			
sib-TypeAndInfo SEQUENCE (SIZE (1..maxSIB))			
OF CHOICE {			
SIB2			
SIB11-r16		In Rel-15, SIB11 is considered an extended field according to TS 38.331 [12].	
}			
lateNonCriticalExtension	Not present		
nonCriticalExtension	Not present		
}			
}			
}			
}			
}			

Table 8.1.1.2.4.3.3-3: SIB11 (Table 8.1.1.2.4.3.3-2)

Derivation Path: TS 38.508-1, Table 4.6.2-13			
Information Element	Value/remark	Comment	Condition
SIB11-r16 ::= SEQUENCE {			
measIdleConfigSIB-r16	Not Present		
lateNonCriticalExtension	Not Present		
}			

8.1.1.3 RRC release

8.1.1.3.1 RRC connection release / Redirection to another NR frequency

8.1.1.3.1.1 Test Purpose (TP)

(1)

```
with { UE in NR RRC_CONNECTED state }
ensure that {
  when { UE receives an RRCRelease message including an IE redirectedCarrierInfo with nr and
carrierFreq different from the frequency UE was on in RRC_CONNECTED state }
  then { UE enters RRC_IDLE state on new frequency included in IE redirectedCarrierInfo }
}
```

8.1.1.3.1.2 Conformance requirements

References: The conformance requirements covered in the current TC are specified in: TS 38.331, clause 5.3.8.3, TS 38.304, clause 5.2.4.1. Unless otherwise stated these are Rel-15 requirements.

[TS 38.331, clause 5.3.8.3]

The UE shall:

- 1> delay the following actions defined in this clause 60ms from the moment the *RRCRelease* message was received or optionally when lower layers indicate that the receipt of the *RRCRelease* message has been successfully acknowledged, whichever is earlier;
- 1> stop timer T320, if running;
- 1> if the *RRCRelease* message includes *redirectedCarrierInfo* indicating redirection to *eutra*:

2> if *cnType* is included:

3> the received *cnType* is provided to upper layers;

NOTE: Handling the case if the E-UTRA cell selected after the redirection does not support the core network type specified by the *cnType*, is up to UE implementation.

1> if the *RRCRelease* message includes the *cellReselectionPriorities*:

2> store the cell reselection priority information provided by the *cellReselectionPriorities*;

2> if the *t320* is included:

3> start timer T320, with the timer value set according to the value of *t320*;

1> else:

2> apply the cell reselection priority information broadcast in the system information;

...

[TS 38.304, clause 5.2.4.1]

...

The UE shall only perform cell reselection evaluation for NR frequencies and inter-RAT frequencies that are given in system information and for which the UE has a priority provided.

...

[TS 38.304, clause 5.2.6]

On transition from RRC_CONNECTED to RRC_IDLE state or RRC_INACTIVE state, UE shall attempt to camp on a suitable cell according to *redirectedCarrierInfo* if included in the *RRCRelease* message used for this transition. If the UE cannot find a suitable cell, the UE is allowed to camp on any suitable cell of the indicated RAT. If the *RRCRelease* message does not contain the *redirectedCarrierInfo*, UE shall attempt to select a suitable cell on an NR carrier. If no suitable cell is found according to the above, the UE shall perform cell selection using stored information in order to find a suitable cell to camp on.

When returning to RRC_IDLE state after UE moved to RRC_CONNECTED state from *camped on any cell* state, UE shall attempt to camp on an acceptable cell according to *redirectedCarrierInfo*, if included in the *RRCRelease* message. If the UE cannot find an acceptable cell, the UE is allowed to camp on any acceptable cell of the indicated RAT. If the *RRCRelease* message does not contain *redirectedCarrierInfo* UE shall attempt to select an acceptable cell on an NR frequency. If no acceptable cell is found according to the above, the UE shall continue to search for an acceptable cell of any PLMN in state *any cell selection*.

8.1.1.3.1.3 Test description

8.1.1.3.1.3.1 Pre-test conditions

System Simulator:

- 2 cells on different NR frequencies and different tracking areas:
 - NR Cell 1 (TAI-1) serving cell
 - NR Cell 23 (TAI-2) suitable neighbour inter-frequency cell
- Cell power levels are selected according to 38.508-1 [4] Table 6.2.2.1-3 for FR1 or Table 6.2.2.2-2 for FR2. NR Cell 23 is switched on after UE has registered on NR Cell 1.
- System information combination NR-4 as defined in TS 38.508-1 [4] clause 4.4.3.1.2 is used in NR cells.

UE:

- None.

Preamble:

- If pc_IP_Ping is set to TRUE then, the UE is in 5GS state 3N-A according to TS 38.508-1 [4], clause 4.4A.2 Table 4.4A.2-3.
- Else, the UE is in 5GS state 3N-A and Test Loop Function (*On*) with UE test loop mode B on NR Cell 1 according to 38.508-1[4], clause 4.4A.2 Table 4.4A.2-3.

8.1.1.3.1.3.2 Test procedure sequence

Table 8.1.1.3.1.3.2-1: Main behaviour

St	Procedure	Message Sequence		TP	Verdict
		U - S	Message		
1	The SS transmits an <i>RRCRelease</i> message (IE <i>redirectedCarrierInfo</i> including NR Cell 23).	<--	NR RRC: <i>RRCRelease</i>	-	-
2A	Check: Does the UE transmits an <i>RRCSetupRequest</i> message?	-->	NR RRC: <i>RRCSetupRequest</i>	1	P
2B	SS transmit an <i>RRCSetup</i> message on on the NGC Cell 23.	<--	NR RRC: <i>RRCSetup</i>	-	-
2C	Check: Does the UE transmits an <i>RRCSetupComplete</i> message to confirm the successful completion of the connection establishment and a REGISTRATION REQUEST message indicating "mobility registration updating" is sent to update the registration of the actual tracking area?	-->	NR RRC: <i>RRCSetupComplete</i> 5GMM: <i>REGISTRATION REQUEST</i>	1	-
3	The SS transmits a <i>SecurityModeCommand</i> message.	<--	NR RRC: <i>SecurityModeCommand</i>	-	-
4	The UE transmits a <i>SecurityModeComplete</i> message.	-->	NR RRC: <i>SecurityModeComplete</i>	-	-
5-6	Steps 4-5 of TS 38.508-1 [4] Table 4.9.5.2.2-1 of the generic procedure are performed.	-	-	-	-
7	The SS transmits an <i>RRCReconfiguration</i> message to establish SRB2 and DRB.	<--	NR RRC: <i>RRCReconfiguration</i>	-	-
8	The UE transmits an <i>RRCReconfigurationComplete</i> message.	-->	NR RRC: <i>RRCReconfigurationComplete</i>	-	-
9	Check: Does the test result of generic test procedure in TS 38.508-1[4] subclause 4.9.1 indicate that the UE is capable of exchanging IP data on DRB#n associated with the first PDU session?	-	-	1	P

8.1.1.3.1.3.3 Specific message contents

Table 8.1.1.3.1.3.3-1: SIB4 for NR cells 1 and 23 (preamble and all steps, Table 8.1.1.3.1.3.2-1)

Derivation Path: TS 38.508-1 [4] Table 4.6.2-3			
Information Element	Value/remark	Comment	Condition
SIB4 ::= SEQUENCE {			
interFreqCarrierFreqList SEQUENCE (SIZE (1..maxFreq)) OF InterFreqCarrierFreqInfo {	1 entry		
InterFreqCarrierFreqInfo[1] SEQUENCE {		entry 1	
dl-CarrierFreq	Same downlink NR ARFCN as used for NR Cell 23		NR Cell 1
	Same downlink NR ARFCN as used for NR Cell 1		NR Cell 23
cellReselectionPriority	Not present		

}			
}			
}			

Table 8.1.1.3.1.3.3-2: RRCRelease message (step 1, Table 8.1.1.3.1.3.2-1)

Derivation Path: TS 38.508-1 [4] Table 4.6.1-16			
Information Element	Value/remark	Comment	Condition
RRCRelease ::= SEQUENCE {			
rrc-TransactionIdentifier	RRC-TransactionIdentifier		
criticalExtensions CHOICE {			
rrcRelease SEQUENCE {			
redirectedCarrierInfo CHOICE {			
nr SEQUENCE {			
carrierFreq	ARFCN-ValueNR for NR Cell 23 frequency		
ssbSubcarrierSpacing	Subcarrier spacing of SSB for NR Cell 23		
smtc	SSB-MTC	38.508-1 [4] Table 4.6.3-185	
}			
}			
}			
}			
}			

Table 8.1.1.3.1.3.3-3: RRCReconfiguration message (step 6, Table 8.1.1.3.1.3.2-1)

Derivation Path: TS 38.508-1 [4] Table 4.6.1-13			
Information Element	Value/remark	Comment	Condition
RRCReconfiguration ::= SEQUENCE {			
criticalExtensions CHOICE {			
rrcReconfiguration SEQUENCE {			
RadioBearerConfig-SRB2-DRB (n, m)		38.508-1 [4] Table 4.8.1-4	
nonCriticalExtension SEQUENCE {			
masterCellGroup	CellGroupConfig-SRB2-DRB(n, m)	38.508-1 [4] Table 4.8.1-2B	
}			
}			
}			

8.1.1.3.2 RRC connection release / Redirection from NR to E-UTRA

8.1.1.3.2.1 Test Purpose (TP)

(1)

```
with { UE in NR RRC_CONNECTED state }
ensure that {
  when { UE receives an RRCRelease message including an IE redirectionInformation with E-UTRA frequency }
  then { UE enters RRC_IDLE state on E-UTRA frequency included in IE redirectionInformation }
}
```

8.1.1.3.2.2 Conformance requirements

References: The conformance requirements covered in the present TC are specified in: TS 38.331, clause 5.3.8.3, TS 38.304, clause 5.2.6.

[TS 38.331, clause 5.3.8.3]

The UE shall:

- 1> delay the following actions defined in this clause 60ms from the moment the *RRCRelease* message was received or optionally when lower layers indicate that the receipt of the *RRCRelease* message has been successfully acknowledged, whichever is earlier;
- 1> stop timer T320, if running;
- 1> if the *RRCRelease* message includes *redirectedCarrierInfo* indicating redirection to *eutra*:
 - 2> if *cnType* is included:
 - 3> after the cell selection, indicate the available CN Type(s) and the received *cnType* to upper layers;

NOTE: Handling the case if the E-UTRA cell selected after the redirection does not support the core network type specified by the *cnType*, is up to UE implementation.

[TS 38.304, clause 5.2.6]

At reception of *RRCRelease* message to transition the UE to RRC_IDLE or RRC_INACTIVE, UE shall attempt to camp on a suitable cell according to *redirectedCarrierInfo* if included in the *RRCRelease* message used for this transition. If the UE cannot find a suitable cell, the UE is allowed to camp on any suitable cell of the indicated RAT. If the *RRCRelease* message does not contain the *redirectedCarrierInfo*, UE shall attempt to select a suitable cell on an NR carrier. If no suitable cell is found according to the above, the UE shall perform cell selection using stored information in order to find a suitable cell to camp on.

When returning to RRC_IDLE state after UE moved to RRC_CONNECTED state from *camped on any cell* state, UE shall attempt to camp on an acceptable cell according to *redirectedCarrierInfo*, if included in the *RRCRelease* message. If the UE cannot find an acceptable cell, the UE is allowed to camp on any acceptable cell of the indicated RAT. If the *RRCRelease* message does not contain *redirectedCarrierInfo* UE shall attempt to select an acceptable cell on an NR frequency. If no acceptable cell is found according to the above, the UE shall continue to search for an acceptable cell of any PLMN in state *any cell selection*.

8.1.1.3.2.3 Test description

8.1.1.3.2.3.1 Pre-test conditions

System Simulator:

- NR Cell 1 is the serving cell. System information combination NR-6 as defined in TS 38.508 -1 [4] clause 4.4.3.1.2 is used
- E-UTRA Cell 1 is a suitable neighbour cell. System information combination 31 as defined in TS 38.508 [7], subclause 4.4.3.1.1
- The parameters settings and power levels for NR Cell 1, E-UTRA Cell 1 are selected to ensure that camping on NR Cell 1 is guaranteed and no cell re-selection to E-UTRA Cell 1 can take place (E-UTRA Cell 1 priority is lower than serving NR Cell 1).

UE:

- None

Preamble:

- With E-UTRA Cell 1 "Serving cell" and NR Cell 1 "Non-suitable "Off" cell", the UE is brought to state 1E-A, RRC_IDLE using generic procedure parameters Connectivity (*E-UTRA/EPC*) and Unrestricted nr PDN (*On*), in accordance with the procedure described in TS 38.508-1 [4], clause 4.5.2.
- the UE is switched-off

- With E-UTRA Cell 1 and NR Cell 1 power levels set according to T0, the UE is brought to state 3N-A as defined in TS 38.508-1 [4], clause 4.4A.2.

8.1.1.3.2.3.2 Test procedure sequence

Tables 8.1.1.3.2.3.2-1/ 8.1.1.3.2.3.2-1A illustrates the downlink power levels to be applied for NR Cell 1, E-UTRA Cell 1 for the test execution.

Table 8.1.1.3.2.3.2-1: Time instances of cell power level and parameter changes for conducted test environment

	Parameter	Unit	NR Cell 1	E-UTRA Cell 1	Remark
T0	Cell-specific RS EPRE	dBm/15 kHz		"Off"	
	SS/PBCH SSS EPRE	dBm/S CS	-85	-	
T1	Cell-specific RS EPRE	dBm/15 kHz		-91	The power levels are such that camping on NR Cell 1 is guaranteed.
	SS/PBCH SSS EPRE	dBm/S CS	-85	-	
T2	Cell-specific RS EPRE	dBm/15 kHz		-91	The power levels are such that UE performs deregistration on E-UTRA cell and does not reselect NR Cell
	SS/PBCH SSS EPRE	dBm/S CS	-110	-	

Table

8.1.1.3.2.3.2-1/1A: Time instances of cell power level and parameter changes for OTA test environment

	Parameter	Unit	NR Cell 1	E-UTRA Cell 1	Remark
T0	Cell-specific RS EPRE	dBm/15 kHz		"Off"	
	SS/PBCH SSS EPRE	dBm/S CS	-82	-	
T1	Cell-specific RS EPRE	dBm/15 kHz		-96	The power levels are such that camping on NR Cell 1 is guaranteed.
	SS/PBCH SSS EPRE	dBm/S CS	-82	-	
T2	Cell-specific RS EPRE	dBm/15 kHz		-96	The power levels are such that UE performs deregistration on E-UTRA cell and does not reselect NR Cell
	SS/PBCH SSS EPRE	dBm/S CS	-139	-	

Table 8.1.1.3.2.3.2-2: Main behaviour

St	Procedure	Message Sequence		TP	Verdict
		U - S	Message		
0	The SS changes NR Cell 1 and E-UTRA Cell 1 level according to the row "T1" in Table 8.1.1.3.2.3.2-1/1A	-	-	-	-
1	SS transmits an <i>RRCRelease</i> message (IE <i>redirectionInformation</i> including ARFCN-ValueEUTRA of E-UTRA Cell 1).	<--	NR RRC: <i>RRCRelease</i>	-	-
2	Check: Does the test result of generic test procedure in TS 38.508-1 Table 4.9.7.2.2-1 is performed and the UE is camped on E-UTRAN Cell 1, with connected without release"?	-	-	1	-
2A	SS changes NR Cell 1 SSS levels according to the row "T2" in Table 8.1.1.3.2.3.2-1/1A.	-	-	-	-

3	At the end of this test procedure sequence, the UE is in end state E-UTRA connected (E2_T3440) according to TS 36.508 [7].	-	-	-	-
---	--	---	---	---	---

8.1.1.3.2.3.3 Specific message contents

Table 8.1.1.3.2.3.3-1 RRCRelease (step 1, Table 8.1.1.3.2.3.2-2)

Derivation Path: TS 38.508-1 table 4.6.1-16			
Information Element	Value/remark	Comment	Condition
RRCRelease ::= SEQUENCE {			
criticalExtensions CHOICE {			
rrcRelease SEQUENCE {			
redirectedCarrierInfo CHOICE {			
eutra SEQUENCE {			
eutraFrequency	EARFCN of E-UTRA Cell 1		
cnType	epc		
}			
}			
}			
}			
}			

8.1.1.3.3 RRC connection release / Success / With priority information / T320 expiry

8.1.1.3.3.1 Test Purpose (TP)

(1)

```
with { UE in NR RRC_IDLE state having received an RRCRelease message with the freqPriorityListNR with higher priority frequency }
ensure that {
  when { UE detects the cell re-selection criteria are met for the cell which belongs to the higher priority frequency }
  then { UE reselects the cell which belongs to the higher priority frequency }
}
```

(2)

```
with { UE in NR RRC_IDLE state having received an RRCRelease message with the freqPriorityListNR with higher priority frequency and timer T320 }
ensure that {
  when { T320 timer expires }
  then { UE discards the cell reselection priority information provided by the cellReselectionPriorities and apply the cell reselection priority information broadcast in the system information to perform reselection to another NR cell }
}
```

8.1.1.3.3.2 Conformance requirements

References: The conformance requirements covered in the current TC are specified in: TS 38.331, clause 5.3.8.3 and TS38.304, clause 5.2.4.1, 5.2.4.2 and 5.2.4.5. Unless otherwise stated these are Rel-15 requirements.

[TS 38.331, clause 5.3.8.3]

The UE shall:

- 1> delay the following actions defined in this sub-clause 60 ms from the moment the *RRCRelease* message was received or optionally when lower layers indicate that the receipt of the *RRCRelease* message has been successfully acknowledged, whichever is earlier;
- 1> stop timer T380, if running;
- 1> stop timer T320, if running;

- 1> stop timer T390, if running;
- 1> if the security is not activated, perform the actions upon going to RRC_IDLE as specified in 5.3.11 with the release cause 'other' upon which the procedure ends;
- 1> if the *RRCRelease* message includes *redirectedCarrierInfo* indicating redirection to *eutra*:
 - 2> if *cnType* is included:
 - 3> after the cell selection, indicate the available CN Type(s) and the received *cnType* to upper layers;

NOTE: Handling the case if the E-UTRA cell selected after the redirection does not support the core network type specified by the *cnType*, is up to UE implementation.

- 1> if the *RRCRelease* message includes the *cellReselectionPriorities*:
 - 2> store the cell reselection priority information provided by the *cellReselectionPriorities*;
 - 2> if the *t320* is included:
 - 3> start timer T320, with the timer value set according to the value of *t320*;
- 1> else:
 - 2> apply the cell reselection priority information broadcast in the system information;
- 1> if *deprioritisationReq* is included:
 - 2> start or restart timer T325 with the timer value set to the *deprioritisationTimer* signalled;
 - 2> store the *deprioritisationReq* until T325 expiry;
- 1> if the *RRCRelease* includes *suspendConfig*:
 - 2> apply the received *suspendConfig*;
 - 2> reset MAC and release the default MAC Cell Group configuration, if any;
 - 2> re-establish RLC entities for SRB1;
 - 2> if the *RRCRelease* message with *suspendConfig* was received in response to an *RRCResumeRequest* or an *RRCResumeRequest1*:
 - 3> stop the timer T319 if running;
 - 3> in the stored UE Inactive AS context:
 - 4> replace the K_{gNB} and K_{RRCint} keys with the current K_{gNB} and K_{RRCint} keys;
 - 4> replace the C-RNTI with the temporary C-RNTI in the cell the UE has received the *RRCRelease* message;
 - 4> replace the *cellIdentity* with the *cellIdentity* of the cell the UE has received the *RRCRelease* message;
 - 4> replace the physical cell identity with the physical cell identity of the cell the UE has received the *RRCRelease* message;
 - 4> replace the *suspendConfig* with the current *suspendConfig*;
- 2> else:
 - 3> store in the UE Inactive AS Context the received *suspendConfig*, all current parameters configured with *RRCReconfiguration* or *RRCResume*, the current K_{gNB} and K_{RRCint} keys, the ROHC state, the C-RNTI used in the source PCell, the *cellIdentity* and the physical cell identity of the source PCell;
- 2> suspend all SRB(s) and DRB(s), except SRB0;
- 2> indicate PDCP suspend to lower layers of all DRBs;

2> if the *t380* is included:

3> start timer T380, with the timer value set to *t380*;

2> if the *RRCRelease* message is including the *waitTime*:

3> start timer T302 with the value set to the *waitTime*;

3> inform the upper layer that access barring is applicable for all access categories except categories '0' and '2';

2> indicate the suspension of the RRC connection to upper layers;

2> enter RRC_INACTIVE and perform cell selection as specified in TS 38.304 [20];

1> else

2> perform the actions upon going to RRC_IDLE as specified in 5.3.11, with the release cause 'other'.

[TS 38.331, clause 5.3.8.4]

The UE shall:

1> if T320 expires:

2> if stored, discard the cell reselection priority information provided by the *cellReselectionPriorities* or inherited from another RAT;

2> apply the cell reselection priority information broadcast in the system information.

[TS 38.304, clause 5.2.4.1]

Absolute priorities of different NR frequencies or inter-RAT frequencies may be provided to the UE in the system information, in the *RRCRelease* message, or by inheriting from another RAT at inter-RAT cell (re)selection. In the case of system information, an NR frequency or inter-RAT frequency may be listed without providing a priority (i.e. the field *cellReselectionPriority* is absent for that frequency). If priorities are provided in dedicated signalling, the UE shall ignore all the priorities provided in system information. If UE is in *camped on any cell* state, UE shall only apply the priorities provided by system information from current cell, and the UE preserves priorities provided by dedicated signalling and *deprioritisationReq* received in *RRCRelease* unless specified otherwise. When the UE in *camped normally* state, has only dedicated priorities other than for the current frequency, the UE shall consider the current frequency to be the lowest priority frequency (i.e. lower than any of the network configured values).

The UE shall only perform cell reselection evaluation for NR frequencies and inter-RAT frequencies that are given in system information and for which the UE has a priority provided.

In case UE receives *RRCRelease* with *deprioritisationReq*, UE shall consider current frequency and stored frequencies due to the previously received *RRCRelease* with *deprioritisationReq* or all the frequencies of NR to be the lowest priority frequency (i.e. lower than any of the network configured values) while T325 is running irrespective of *camped* RAT. The UE shall delete the stored deprioritisation request(s) when a PLMN selection is performed on request by NAS (TS 23.122 [9]).

NOTE: UE should search for a higher priority layer for cell reselection as soon as possible after the change of priority. The minimum related performance requirements specified in TS 38.133 [8] are still applicable.

The UE shall delete priorities provided by dedicated signalling when:

- the UE enters a different RRC state; or
- the optional validity time of dedicated priorities (T320) expires; or
- a PLMN selection is performed on request by NAS (TS 23.122 [9]).

NOTE 2: Equal priorities between RATs are not supported.

The UE shall not consider any black listed cells as candidate for cell reselection.

The UE shall inherit the priorities provided by dedicated signalling and the remaining validity time (i.e. T320 in NR and E-UTRA), if configured, at inter-RAT cell (re)selection.

NOTE 3: The network may assign dedicated cell reselection priorities for frequencies not configured by system information.

[TS 38.304, clause 5.2.4.1]

Absolute priorities of different NR frequencies or inter-RAT frequencies may be provided to the UE in the system information, in the *RRCRelease* message, or by inheriting from another RAT at inter-RAT cell (re)selection. In the case of system information, an NR frequency or inter-RAT frequency may be listed without providing a priority (i.e. the field *cellReselectionPriority* is absent for that frequency). If priorities are provided in dedicated signalling, the UE shall ignore all the priorities provided in system information. If UE is in *camped on any cell* state, UE shall only apply the priorities provided by system information from current cell, and the UE preserves priorities provided by dedicated signalling and *deprioritisationReq* received in *RRCRelease* unless specified otherwise. When the UE in *camped normally* state, has only dedicated priorities other than for the current frequency, the UE shall consider the current frequency to be the lowest priority frequency (i.e. lower than any of the network configured values).

The UE shall only perform cell reselection evaluation for NR frequencies and inter-RAT frequencies that are given in system information and for which the UE has a priority provided.

In case UE receives *RRCRelease* with *deprioritisationReq*, UE shall consider current frequency and stored frequencies due to the previously received *RRCRelease* with *deprioritisationReq* or all the frequencies of NR to be the lowest priority frequency (i.e. lower than any of the network configured values) while T325 is running irrespective of *camped RAT*. The UE shall delete the stored deprioritisation request(s) when a PLMN selection is performed on request by NAS (TS 23.122 [9]).

NOTE: UE should search for a higher priority layer for cell reselection as soon as possible after the change of priority. The minimum related performance requirements specified in TS 38.133 [8] are still applicable.

The UE shall delete priorities provided by dedicated signalling when:

- the UE enters a different RRC state; or
- the optional validity time of dedicated priorities (T320) expires; or
- a PLMN selection is performed on request by NAS (TS 23.122 [9]).

NOTE 2: Equal priorities between RATs are not supported.

The UE shall not consider any black listed cells as candidate for cell reselection.

The UE shall inherit the priorities provided by dedicated signalling and the remaining validity time (i.e. T320 in NR and E-UTRA), if configured, at inter-RAT cell (re)selection.

NOTE 3: The network may assign dedicated cell reselection priorities for frequencies not configured by system information.

[TS 38.304, clause 5.2.4.2]

Following rules are used by the UE to limit needed measurements:

- If the serving cell fulfils $S_{rxlev} > S_{IntraSearchP}$ and $S_{qual} > S_{IntraSearchQ}$, the UE may choose not to perform intra-frequency measurements.
- Otherwise, the UE shall perform intra-frequency measurements.
- The UE shall apply the following rules for NR inter-frequencies and inter-RAT frequencies which are indicated in system information and for which the UE has priority provided as defined in 5.2.4.1:
 - For a NR inter-frequency or inter-RAT frequency with a reselection priority higher than the reselection priority of the current NR frequency, the UE shall perform measurements of higher priority NR inter-frequency or inter-RAT frequencies according to TS 38.133 [8].

- For a NR inter-frequency with an equal or lower reselection priority than the reselection priority of the current NR frequency and for inter-RAT frequency with lower reselection priority than the reselection priority of the current NR frequency:
 - If the serving cell fulfils $S_{rxlev} > S_{nonIntraSearchP}$ and $S_{qual} > S_{nonIntraSearchQ}$, the UE may choose not to perform measurements of NR inter-frequencies or inter-RAT frequency cells of equal or lower priority;
- Otherwise, the UE shall perform measurements of NR inter-frequencies or inter-RAT frequency cells of equal or lower priority according to TS 38.133 [8].

[TS 38.304, clause 5.2.4.5]

If *threshServingLowQ* is broadcast in system information and more than 1 second has elapsed since the UE camped on the current serving cell, cell reselection to a cell on a higher priority NR frequency or inter-RAT frequency than the serving frequency shall be performed if:

- A cell of a higher priority NR or EUTRAN RAT/frequency fulfils $S_{qual} > Thresh_{X, HighQ}$ during a time interval $T_{reselection_{RAT}}$

Otherwise, cell reselection to a cell on a higher priority NR frequency or inter-RAT frequency than the serving frequency shall be performed if:

- A cell of a higher priority RAT/ frequency fulfils $S_{rxlev} > Thresh_{X, HighP}$ during a time interval $T_{reselection_{RAT}}$; and
- More than 1 second has elapsed since the UE camped on the current serving cell.

Cell reselection to a cell on an equal priority NR frequency shall be based on ranking for intra-frequency cell reselection as defined in sub-clause 5.2.4.6.

If *threshServingLowQ* is broadcast in system information and more than 1 second has elapsed since the UE camped on the current serving cell, cell reselection to a cell on a lower priority NR frequency or inter-RAT frequency than the serving frequency shall be performed if:

- The serving cell fulfils $S_{qual} < Thresh_{Serving, LowQ}$ and a cell of a lower priority NR or E-UTRAN RAT/ frequency fulfils $S_{qual} > Thresh_{X, LowQ}$ during a time interval $T_{reselection_{RAT}}$.

Otherwise, cell reselection to a cell on a lower priority NR frequency or inter-RAT frequency than the serving frequency shall be performed if:

- The serving cell fulfils $S_{rxlev} < Thresh_{Serving, LowP}$ and a cell of a lower priority RAT/ frequency fulfils $S_{rxlev} > Thresh_{X, LowP}$ during a time interval $T_{reselection_{RAT}}$; and
- More than 1 second has elapsed since the UE camped on the current serving cell.

Cell reselection to a higher priority RAT/frequency shall take precedence over a lower priority RAT/frequency if multiple cells of different priorities fulfil the cell reselection criteria.

If more than one cell meets the above criteria, the UE shall reselect a cell as follows:

- If the highest-priority frequency is an NR frequency, the highest ranked cell among the cells on the highest priority frequency(ies) meeting the criteria according to clause 5.2.4.6;
- If the highest-priority frequency is from another RAT, the highest ranked cell among the cells on the highest priority frequency(ies) meeting the criteria of that RAT.

[TS 38.304, clause 5.2.4.6]

The cell-ranking criterion R_s for serving cell and R_n for neighbouring cells is defined by:

$$R_s = Q_{meas,s} + Q_{hyst} - Q_{offset_{temp}}$$

$$R_n = Q_{meas,n} - Q_{offset} - Q_{offset_{temp}}$$

where:

Q_{meas}	RSRP measurement quantity used in cell reselections.
Q_{offset}	For intra-frequency: Equals to $Q_{offset_{s,n}}$, if $Q_{offset_{s,n}}$ is valid, otherwise this equals to zero. For inter-frequency: Equals to $Q_{offset_{s,n}}$ plus $Q_{offset_{frequency}}$, if $Q_{offset_{s,n}}$ is valid, otherwise this equals to $Q_{offset_{frequency}}$.
$Q_{offset_{temp}}$	Offset temporarily applied to a cell as specified in TS 38.331 [3].

The UE shall perform ranking of all cells that fulfil the cell selection criterion S, which is defined in 5.2.3.2.

The cells shall be ranked according to the R criteria specified above by deriving $Q_{meas,n}$ and $Q_{meas,s}$ and calculating the R values using averaged RSRP results.

If *rangeToBestCell* is not configured, the UE shall perform cell reselection to the highest ranked cell. If this cell is found to be not-suitable, the UE shall behave according to clause 5.2.4.4.

If *rangeToBestCell* is configured, then the UE shall perform cell reselection to the cell with the highest number of beams above the threshold (i.e. *absThreshSS-BlocksConsolidation*) among the cells whose R value is within *rangeToBestCell* of the R value of the highest ranked cell. If there are multiple such cells, the UE shall perform cell reselection to the highest ranked cell among them. If this cell is found to be not-suitable, the UE shall behave according to clause 5.2.4.4.

In all cases, the UE shall reselect the new cell, only if the following conditions are met:

- the new cell is better than the serving cell according to the cell reselection criteria specified above during a time interval $T_{reselection_{RAT}}$;
- more than 1 second has elapsed since the UE camped on the current serving cell.

NOTE: If *rangeToBestCell* is configured but *absThreshSS-BlocksConsolidation* is not configured on an NR frequency, the UE considers that there is one beam above the threshold for each cell on that frequency.

8.1.1.3.3.3 Test description

8.1.1.3.3.3.1 Pre-test conditions

System Simulator:

- NR Cell 1, NR Cell 3 and NR Cell6.
- NR Cell 1 (TAI-1) serving cell.
- System information combination NR-4 as defined in TS 38.508-1 [4] clause 4.4.3.1.2-1 is used in NR cells.

NOTE: For Cell 3 and 6 TAI is set to TAI-2

UE:

- None.

Preamble:

- If *pc_IP_Ping* is set to TRUE then, the UE is in 5GS state 3N-A according to TS 38.508-1 [4], clause 4.4A.2 Table 4.4A.2-3.
- Else, the UE is in 5GS state 3N-A and Test Loop Function (On) with UE test loop mode B on NR Cell 1 according to 38.508-1[4], clause 4.4A.2 Table 4.4A.2-3.

8.1.1.3.3.3.2 Test procedure sequence

Table 8.1.1.3.3.3.2-1/2 illustrates the downlink power levels and other changing parameters to be applied for the cells at various time instants of the test execution. Row marked "T0" denotes the initial conditions after preamble, while columns marked "T1" is to be applied subsequently. The exact instants on which these values shall be applied are described in the texts in this clause.

Table 8.1.1.3.3.2-1: Time instances of cell power level and parameter changes for FR1

	Parameter	Unit	NR Cell 1	NR Cell 3	NR Cell 6	Remark
T0	SS/PBCH SSS EPRE	dBm/ SCS	-88	Off	Off	The power level values are assigned to satisfy $S_{rxlevCell 1} > S_{intrasearch}$. (NOTE 1)
T1	SS/PBCH SSS EPRE	dBm/ SCS	-88	-94	-88	The power level values are assigned to satisfy both $Thresh_{x, high} < S_{rxlevCell 3}$ and $Thresh_{x, low} < S_{rxlevCell 6}$.
T2	SS/PBCH SSS EPRE	dBm/ SCS	-88	Off	-88	The power level values are assigned to satisfy $Thresh_{x, high} < S_{rxlevCell 6}$.

NOTE 1: Power level "Off" is defined in TS38.508 Table 6.2.2.1-3.

Table 8.1.1.3.3.2-2 Time instances of cell power level and parameter changes for FR2

	Parameter	Unit	NR Cell 1	NR Cell 3	NR Cell 6	Remark
T0	SS/PBCH SSS EPRE	dBm/ SCS	-82	Off	Off	The power level values are assigned to satisfy $S_{rxlevCell 1} > S_{intrasearch}$. (NOTE 1)
T1	SS/PBCH SSS EPRE	dBm/ SCS	-82	-91	-82	The power level values are assigned to satisfy both $Thresh_{x, high} < S_{rxlevCell 3}$ and $Thresh_{x, low} < S_{rxlevCell 6}$.
T2	SS/PBCH SSS EPRE	dBm/ SCS	-82	Off	-82	The power level values are assigned to satisfy $Thresh_{x, high} < S_{rxlevCell 6}$.

NOTE 1: Power level "Off" is defined in TS38.508 Table 6.2.2.1-3.

Table 8.1.1.3.3.2-3: Main behaviour

St	Procedure	Message Sequence		TP	Verdict
		U - S	Message		
1	The SS changes NR Cell 1, NR Cell 3 and NR Cell 6 power level according to the row "T1" in table 8.1.1.3.3.2-1/2.	-	-	-	-
2	The SS transmits an <i>RRCRelease</i> message including the <i>freqPriorityListNR</i> on NR Cell 1.	<--	NR RRC: <i>RRCRelease</i>	-	-
2A	Check: Does the UE transmits an <i>RRCSetupRequest</i> message on NR Cell3?	-->	NR RRC: <i>RRCSetupRequest</i>	1	P
2B	SS transmit an <i>RRCSetup</i> message on NR Cell3.	<--	NR RRC: <i>RRCSetup</i>	-	-
2C	Check: Does the UE transmits an <i>RRCSetupComplete</i> message to confirm the successful completion of the connection establishment and a REGISTRATION REQUEST message indicating "mobility registration updating" is sent to update the registration of the actual tracking area?	-->	NR RRC: <i>RRCSetupComplete</i> 5GMM: REGISTRATION REQUEST	1	P
3	Void				
3A	The SS transmits a <i>SecurityModeCommand</i> message.	<--	NR RRC: <i>SecurityModeCommand</i>		
3B	The UE transmits a <i>SecurityModeComplete</i> message.	-->	NR RRC: <i>SecurityModeComplete</i>		
3C- 3D	Steps 4-5 of TS 38.508-1 [4] Table 4.9.5.2.2-1 of the generic procedure are performed.	-	-	-	-
3E	The SS transmits an <i>RRCReconfiguration</i> message to establish SRB2 and DRB.	<--	NR RRC: <i>RRCReconfiguration</i>	-	-
3F	The UE transmits an <i>RRCReconfigurationComplete</i> message.	-->	NR RRC: <i>RRCReconfigurationComplete</i>	-	-
3G	Check: Does the test result of generic test procedure in TS 38.508-1 [4] subclause 4.9.1 indicate that the UE is capable of exchanging	-	-	1	-

	IP data on DRB #n associated with the first PDU session on NR Cell 3?				
3H	The SS releases RRC connection.	-	-	-	-
4	The SS changes NR Cell 1, NR Cell 3 and NR Cell 6 power level according to the row "T0" in table 8.1.1.3.3.3.2-1/2.	-	-	-	-
5-5B	Steps 1-3 in TS 38.508-1 [4] Table 4.9.5.2.2-1 are performed on NR Cell 1.	-	-	-	-
5C	The SS transmits a <i>SecurityModeCommand</i> message.	<--	NR RRC: <i>SecurityModeCommand</i>	-	-
5D	The UE transmits a <i>SecurityModeComplete</i> message.	-->	NR RRC: <i>SecurityModeComplete</i>	-	-
5E-5F	Steps 4-5 in TS 38.508-1 [4] Table 4.9.5.2.2-1 are performed.			-	-
6	The SS transmits an <i>RRCRelease</i> message containing IE <i>freqPriorityListNR</i> to update the cell reselection priority of NR Cell 6 and the timer T320.	<--	NR RRC: <i>RRCRelease</i>	-	-
7	The SS changes NR Cell 1, NR Cell 3 and NR Cell 6 power level according to the row "T2" in table 8.1.1.3.3.3.2-1/2.	-	-	-	-
8	Check: Does the UE transmit an <i>RRCSetupRequest</i> message within T320 running?	-->	NR RRC: <i>RRCSetupRequest</i>	2	F
9	Check: After timer T320 expiry, does the UE perform the Registration procedure for mobility registration update as described in steps 1-3 of Table 4.9.5.2.2-1 on NR Cell 6?	-	-	2	-
10	The SS transmits a <i>SecurityModeCommand</i> message.	<--	NR RRC: <i>SecurityModeCommand</i>	-	-
11	The UE transmits a <i>SecurityModeComplete</i> message.	-->	NR RRC: <i>SecurityModeComplete</i>	-	-
12-13	Steps 4-5 of Table 4.9.5.2.2-1 of the generic procedure are performed.	-	-	-	-
14	The SS transmits an <i>RRCReconfiguration</i> message to establish SRB2 and DRB.	<--	NR RRC: <i>RRCReconfiguration</i>	-	-
15	The UE transmits an <i>RRCReconfigurationComplete</i> message.	-->	NR RRC: <i>RRCReconfigurationComplete</i>	-	-
16	Check: Does the test result of generic test procedure in TS 38.508-1 subclause 4.9.1 indicate that the UE is capable of exchanging IP data on DRB #n associated with the first PDU session on NR Cell 6?	-	-	2	-

8.1.1.3.3.3.3 Specific message contents

Table 8.1.1.3.3.3.3-1: *RRCRelease* (step 2, Table 8.1.1.3.3.3.2-3)

Derivation Path: TS 38.508 [4] Table 4.6.1-16			
Information Element	Value/remark	Comment	Condition
<i>RRCRelease</i> ::= SEQUENCE {			
criticalExtensions CHOICE {			
rrcRelease SEQUENCE {			
cellReselectionPriorities SEQUENCE {			
freqPriorityListEUTRA	Not present		
freqPriorityListNR SEQUENCE (SIZE (1..maxFreq)) OF FreqPriorityNR {	3 entries		
FreqPriorityNR[1] SEQUENCE {		entry 1	
carrierFreq	Same downlink ARFCN as used for NR Cell 1		
cellReselectionPriority	4		
cellReselectionSubPriority	Not present		
}			
FreqPriorityNR[2] SEQUENCE {		entry 2	

carrierFreq	Same downlink ARFCN as used for NR Cell 3		
cellReselectionPriority	5		
cellReselectionSubPriority	Not present		
}			
FreqPriorityNR[3] SEQUENCE {		entry 3	
carrierFreq	Same downlink ARFCN as used for NR Cell 6		
cellReselectionPriority	1		
cellReselectionSubPriority	Not present		
}			
}			
}			
}			
}			
}			

Table 8.1.1.3.3.3.2-2: SIB4 for Cell 1 (preamble and all steps, Table 8.1.1.3.3.3.2-3)

Derivation Path: TS 38.508-1 [4], Table 4.6.2-3			
Information Element	Value/Remark	Comment	Condition
SystemInformationBlockType4 ::= SEQUENCE {			
interFreqCarrierFreqList SEQUENCE (SIZE (1..maxFreq)) OF InterFreqCarrierFreqInfo {	2 entries		
InterFreqCarrierFreqInfo[1] SEQUENCE {		entry 1	
dl-CarrierFreq	Same downlink NR ARFCN as used for NR Cell 3		
cellReselectionPriority	1		
}			
InterFreqCarrierFreqInfo[2] SEQUENCE {		entry 2	
dl-CarrierFreq	Same downlink NR ARFCN as used for NR Cell 6		
cellReselectionPriority	5		
}			
}			
}			

Table 8.1.1.3.3.3.3-3: SIB4 for Cell 6 (all steps, Table 8.1.1.3.3.3.2-3)

Derivation Path: TS 38.508-1 [4], Table 4.6.2-3			
Information Element	Value/Remark	Comment	Condition
SystemInformationBlockType4 ::= SEQUENCE {			
interFreqCarrierFreqList SEQUENCE (SIZE (1..maxFreq)) OF InterFreqCarrierFreqInfo {	2 entries		
InterFreqCarrierFreqInfo[1] SEQUENCE {		entry 1	
dl-CarrierFreq	Same downlink NR ARFCN as used for NR Cell 1		
cellReselectionPriority	4		
}			
InterFreqCarrierFreqInfo[2] SEQUENCE {		entry 2	
dl-CarrierFreq	Same downlink NR ARFCN as used for NR Cell 3		
cellReselectionPriority	1		
}			
}			
}			

Table 8.1.1.3.3.3-4: RRCRelease (step 6, Table 8.1.1.3.5.3.2-3)

Derivation Path: TS 38.508-1 [4], Table 4.6.1-16			
Information Element	Value/remark	Comment	Condition
RRCRelease ::= SEQUENCE {			
criticalExtensions CHOICE {			
rrcRelease SEQUENCE {			
cellReselectionPriorities SEQUENCE {			
freqPriorityListEUTRA	Not present		
freqPriorityListNR SEQUENCE (SIZE (1..maxFreq)) OF FreqPriorityNR {	2 entries		
FreqPriorityNR[1] SEQUENCE {		entry 1	
carrierFreq	ARFCN-ValueNR of NR Cell 1		
cellReselectionPriority	4		
cellReselectionSubPriority	Not present		
}			
FreqPriorityNR[1] SEQUENCE {		entry 1	
carrierFreq	ARFCN-ValueNR of NR Cell 6		
cellReselectionPriority	3		
cellReselectionSubPriority	Not present		
}			
}			
t320	min5		
}			
}			

Table 8.1.1.3.3.3-5: RRCReconfiguration message (step 3E and step 14, Table 8.1.1.3.1.3.2-1)

Derivation Path: TS 38.508-1 [4] Table 4.6.1-13			
Information Element	Value/remark	Comment	Condition
RRCReconfiguration ::= SEQUENCE {			
criticalExtensions CHOICE {			
rrcReconfiguration SEQUENCE {			
radioBearerConfig SRB2-DRB (n, m)	RadioBearerConfig-SRB2-DRB (n, m)	38.508-1 [4] Table 4.8.1-4	
nonCriticalExtension SEQUENCE {			
masterCellGroup	CellGroupConfig-SRB2-DRB(n, m)	38.508-1 [4] Table 4.8.1-2B	
}			
}			
}			
}			

Table 8.1.1.3.3.3-6: SIB4 for Cell 3 (all steps, Table 8.1.1.3.3.2-3)

Derivation Path: TS 38.508-1 [4], Table 4.6.2-3			
Information Element	Value/Remark	Comment	Condition
SystemInformationBlockType4 ::= SEQUENCE {			
interFreqCarrierFreqList SEQUENCE (SIZE (1..maxFreq)) OF InterFreqCarrierFreqInfo {	2 entries		
InterFreqCarrierFreqInfo[1] SEQUENCE {		entry 1	
dl-CarrierFreq	Same downlink NR ARFCN as used for NR Cell 1		
t-ReselectionNR	1		
}			
InterFreqCarrierFreqInfo[2] SEQUENCE {		entry 2	
dl-CarrierFreq	Same downlink NR ARFCN as used for NR Cell 3		

}			
}			
}			

8.1.1.3.4 RRC connection release / Success / With priority information / T320 expiry / E-UTRA

8.1.1.3.4.1 Test Purpose (TP)

(1)

```
with { UE in NR RRC_IDLE state having received an RRCRelease message with the freqPriorityListEUTRA
with higher priority frequency }
ensure that {
  when { UE detects the cell re-selection criteria are met for the cell which belongs to the higher
priority EUTRA frequency }
  then { UE reselects the cell which belongs to the higher priority EUTRA frequency }
}
```

(2)

```
with { UE in NR RRC_IDLE state having received an RRCRelease message with the freqPriorityListEUTRA
with higher priority frequency and timer T320 }
ensure that {
  when { T320 timer expires }
  then { UE discards the cell reselection priority information provided by the
cellReselectionPriorities and apply the cell reselection priority information broadcast in the
system information to perform reselection to an E-UTRA cell }
}
```

8.1.1.3.4.2 Conformance requirements

References: The conformance requirements covered in the current TC are specified in: TS 38.331, clause 5.3.8.3 and T 38.304, clause 5.2.4.1. Unless otherwise stated these are Rel-15 requirements.

[TS 38.331, clause 5.3.8.3]

The UE shall:

1> delay the following actions defined in this sub-clause 60 ms from the moment the *RRCRelease* message was received or optionally when lower layers indicate that the receipt of the *RRCRelease* message has been successfully acknowledged, whichever is earlier;

1> stop timer T380, if running;

1> stop timer T320, if running;

1> stop timer T390, if running;

1> if the security is not activated, perform the actions upon going to RRC_IDLE as specified in 5.3.11 with the release cause 'other' upon which the procedure ends;

...

1> if the *RRCRelease* message includes the *cellReselectionPriorities*:

2> store the cell reselection priority information provided by the *cellReselectionPriorities*;

2> if the *t320* is included:

3> start timer T320, with the timer value set according to the value of *t320*;

1> else:

2> apply the cell reselection priority information broadcast in the system information;

[TS 38.304, clause 5.2.4.1]

Absolute priorities of different NR frequencies or inter-RAT frequencies may be provided to the UE in the system information, in the *RRCRelease* message, or by inheriting from another RAT at inter-RAT cell (re)selection. In the case of system information, an NR frequency or inter-RAT frequency may be listed without providing a priority (i.e. the field *cellReselectionPriority* is absent for that frequency). If priorities are provided in dedicated signalling, the UE shall ignore all the priorities provided in system information. If UE is in *camped on any cell* state, UE shall only apply the priorities provided by system information from current cell, and the UE preserves priorities provided by dedicated signalling and *deprioritisationReq* received in *RRCRelease* unless specified otherwise. When the UE in camped normally state, has only dedicated priorities other than for the current frequency, the UE shall consider the current frequency to be the lowest priority frequency (i.e. lower than any of the network configured values).

The UE shall only perform cell reselection evaluation for NR frequencies and inter-RAT frequencies that are given in system information and for which the UE has a priority provided.

In case UE receives *RRCRelease* with *deprioritisationReq*, UE shall consider current frequency and stored frequencies due to the previously received *RRCRelease* with *deprioritisationReq* or all the frequencies of NR to be the lowest priority frequency (i.e. lower than any of the network configured values) while T325 is running irrespective of camped RAT. The UE shall delete the stored deprioritisation request(s) when a PLMN selection is performed on request by NAS (TS 23.122 [9]).

NOTE: UE should search for a higher priority layer for cell reselection as soon as possible after the change of priority. The minimum related performance requirements specified in TS 38.133 [8] are still applicable.

The UE shall delete priorities provided by dedicated signalling when:

- the UE enters a different RRC state; or
- the optional validity time of dedicated priorities (T320) expires; or
- a PLMN selection is performed on request by NAS (TS 23.122 [9]).

NOTE 2: Equal priorities between RATs are not supported.

The UE shall not consider any black listed cells as candidate for cell reselection.

The UE shall inherit the priorities provided by dedicated signalling and the remaining validity time (i.e. T320 in NR and E-UTRA), if configured, at inter-RAT cell (re)selection.

NOTE 3: The network may assign dedicated cell reselection priorities for frequencies not configured by system information.

[TS 38.331, clause 5.3.8.4]

The UE shall:

- 1> if T320 expires:
 - 2> if stored, discard the cell reselection priority information provided by the *cellReselectionPriorities* or inherited from another RAT;
 - 2> apply the cell reselection priority information broadcast in the system information.

[TS 38.304, clause 5.2.4.2]

Following rules are used by the UE to limit needed measurements:

- If the serving cell fulfils $S_{rxlev} > S_{IntraSearchP}$ and $S_{qual} > S_{IntraSearchQ}$, the UE may choose not to perform intra-frequency measurements.
- Otherwise, the UE shall perform intra-frequency measurements.
- The UE shall apply the following rules for NR inter-frequencies and inter-RAT frequencies which are indicated in system information and for which the UE has priority provided as defined in 5.2.4.1:

- For a NR inter-frequency or inter-RAT frequency with a reselection priority higher than the reselection priority of the current NR frequency, the UE shall perform measurements of higher priority NR inter-frequency or inter-RAT frequencies according to TS 38.133 [8].
- For a NR inter-frequency with an equal or lower reselection priority than the reselection priority of the current NR frequency and for inter-RAT frequency with lower reselection priority than the reselection priority of the current NR frequency:
 - If the serving cell fulfils $S_{rxlev} > S_{nonIntraSearchP}$ and $S_{qual} > S_{nonIntraSearchQ}$, the UE may choose not to perform measurements of NR inter-frequencies or inter-RAT frequency cells of equal or lower priority;
 - Otherwise, the UE shall perform measurements of NR inter-frequencies or inter-RAT frequency cells of equal or lower priority according to TS 38.133 [8].

[TS 38.304, clause 5.2.4.5]

If *threshServingLowQ* is broadcast in system information and more than 1 second has elapsed since the UE camped on the current serving cell, cell reselection to a cell on a higher priority NR frequency or inter-RAT frequency than the serving frequency shall be performed if:

- A cell of a higher priority NR or EUTRAN RAT/frequency fulfils $S_{qual} > Thresh_{X, HighQ}$ during a time interval $T_{reselection_{RAT}}$

Otherwise, cell reselection to a cell on a higher priority NR frequency or inter-RAT frequency than the serving frequency shall be performed if:

- A cell of a higher priority RAT/ frequency fulfils $S_{rxlev} > Thresh_{X, HighP}$ during a time interval $T_{reselection_{RAT}}$; and
- More than 1 second has elapsed since the UE camped on the current serving cell.

Cell reselection to a cell on an equal priority NR frequency shall be based on ranking for intra-frequency cell reselection as defined in sub-clause 5.2.4.6.

If *threshServingLowQ* is broadcast in system information and more than 1 second has elapsed since the UE camped on the current serving cell, cell reselection to a cell on a lower priority NR frequency or inter-RAT frequency than the serving frequency shall be performed if:

- The serving cell fulfils $S_{qual} < Thresh_{Serving, LowQ}$ and a cell of a lower priority NR or E-UTRAN RAT/ frequency fulfils $S_{qual} > Thresh_{X, LowQ}$ during a time interval $T_{reselection_{RAT}}$.

Otherwise, cell reselection to a cell on a lower priority NR frequency or inter-RAT frequency than the serving frequency shall be performed if:

- The serving cell fulfils $S_{rxlev} < Thresh_{Serving, LowP}$ and a cell of a lower priority RAT/ frequency fulfils $S_{rxlev} > Thresh_{X, LowP}$ during a time interval $T_{reselection_{RAT}}$; and
- More than 1 second has elapsed since the UE camped on the current serving cell.

Cell reselection to a higher priority RAT/frequency shall take precedence over a lower priority RAT/frequency if multiple cells of different priorities fulfil the cell reselection criteria.

If more than one cell meets the above criteria, the UE shall reselect a cell as follows:

- If the highest-priority frequency is an NR frequency, the highest ranked cell among the cells on the highest priority frequency(ies) meeting the criteria according to clause 5.2.4.6;
- If the highest-priority frequency is from another RAT, the highest ranked cell among the cells on the highest priority frequency(ies) meeting the criteria of that RAT.

[TS 38.304, clause 5.2.4.6]

The cell-ranking criterion R_s for serving cell and R_n for neighbouring cells is defined by:

$$R_s = Q_{\text{meas},s} + Q_{\text{hyst}} - Q_{\text{offset,temp}}$$

$$R_n = Q_{\text{meas},n} - Q_{\text{offset}} - Q_{\text{offset,temp}}$$

where:

Q_{meas}	RSRP measurement quantity used in cell reselections.
Q_{offset}	For intra-frequency: Equals to $Q_{\text{offset},s,n}$, if $Q_{\text{offset},s,n}$ is valid, otherwise this equals to zero. For inter-frequency: Equals to $Q_{\text{offset},s,n}$ plus $Q_{\text{offset,frequency}}$, if $Q_{\text{offset},s,n}$ is valid, otherwise this equals to $Q_{\text{offset,frequency}}$.
$Q_{\text{offset,temp}}$	Offset temporarily applied to a cell as specified in TS 38.331 [3].

The UE shall perform ranking of all cells that fulfil the cell selection criterion S, which is defined in 5.2.3.2.

The cells shall be ranked according to the R criteria specified above by deriving $Q_{\text{meas},n}$ and $Q_{\text{meas},s}$ and calculating the R values using averaged RSRP results.

If *rangeToBestCell* is not configured, the UE shall perform cell reselection to the highest ranked cell. If this cell is found to be not-suitable, the UE shall behave according to subclause 5.2.4.4.

If *rangeToBestCell* is configured, then the UE shall perform cell reselection to the cell with the highest number of beams above the threshold (i.e. *absThreshSS-BlocksConsolidation*) among the cells whose R value is within *rangeToBestCell* of the R value of the highest ranked cell. If there are multiple such cells, the UE shall perform cell reselection to the highest ranked cell among them. If this cell is found to be not-suitable, the UE shall behave according to subclause 5.2.4.4.

In all cases, the UE shall reselect the new cell, only if the following conditions are met:

- the new cell is better than the serving cell according to the cell reselection criteria specified above during a time interval $T_{\text{reselection,RAT}}$;
- more than 1 second has elapsed since the UE camped on the current serving cell.

8.1.1.3.4.3 Test description

8.1.1.3.4.3.1 Pre-test conditions

System Simulator:

- NR Cell 1, E-UTRA Cell 1 and E-UTRA Cell 3.
- NR Cell 1 is configured to operate in FR1 bands as defined in TS 38.508-1 [4] clause 6.2.3.
- System information combination NR-6 as defined in TS 38.508-1 [4] clause 4.4.3.1.2 is used in NR cell.
- System information combination 1 as defined in TS 36.508 [7] clause 4.4.3.1 is used in E-UTRA cells.

UE:

None.

Preamble:

- With E-UTRA Cell 1 "Serving cell", E-UTRA Cell 3 "Non-suitable "Off" cell" and NR Cell 1 "Non-suitable "Off" cell" in accordance with TS 38.508-1 [4], Table 6.2.2.1-3, the UE is brought to state RRC_IDLE using generic procedure parameters Connectivity (*E-UTRA/EPC*) and Unrestricted nr PDN (*On*), in accordance with the procedure described in TS 38.508-1 [4], clause 4.5.2. 4G GUTI and eKSI are assigned and security context established.
- the UE is switched-off.

- With E-UTRA Cell 1 "Non-suitable "Off" cell" and NR Cell 1 "Serving cell" in accordance with TS 38.508-1 [4], Table 6.2.2.1-3, the UE is brought to state 3N-A, NR RRC_CONNECTED, in accordance with the procedure described in TS 38.508-1 [4], Table 4.5.2.2-2. 5G-GUTI and ngKSI are assigned and security context established.
- The UE is in 5GS state 3N-A and Test Loop Function (*On*) with UE test loop mode B on NR Cell 1 according to 38.508-1[4], clause 4.4A.2 Table 4.4A.2-3.

8.1.1.3.4.3.2 Test procedure sequence

Table 8.1.1.3.4.3.2-1 illustrates the downlink power levels and other changing parameters to be applied for the cells at various time instants of the test execution. Row marked "T0" denotes the initial conditions after preamble, while columns marked "T1" is to be applied subsequently. The exact instants on which these values shall be applied are described in the texts in this clause.

Table 8.1.1.3.4.3.2-1: Time instances of cell power level and parameter changes in FR1

	Parameter	Unit	NR Cell 1	E-UTRA Cell 1	E-UTRA Cell 3	Remark
T0	Cell-specific RS EPRE	dBm/15kHz	-	"off"	"off"	
	SS/PBCH SSS EPRE	dBm/SCS	-88	-	-	
T1	Cell-specific RS EPRE	dBm/15kHz	-	-73	-73	The power level values are assigned to satisfy both $\text{Thresh}_{x, \text{low}} < \text{Srxlev}_{\text{E-UTRACell 1}}$ and $\text{Thresh}_{x, \text{high}} < \text{Srxlev}_{\text{E-UTRACell 3}}$ but not to satisfy $\text{Srxlev}_{\text{NR Cell 1}} < \text{Thresh}_{\text{servicing, low}}$
	SS/PBCH SSS EPRE	dBm/SCS	-88	-	-	
T2	Cell-specific RS EPRE	dBm/15kHz	-	"off"	"off"	The power level values are assigned to satisfy $\text{Srxlev}_{\text{NR Cell 1}} > \text{S}_{\text{nonintrasearch}}$. (NOTE 1)
	SS/PBCH SSS EPRE	dBm/SCS	-88	-	-	
T3	Cell-specific RS EPRE	dBm/15kHz	-	-73	"off"	The power level values are assigned to satisfy $\text{Thresh}_{x, \text{high}} < \text{Srxlev}_{\text{E-UTRA Cell 1}}$.
	SS/PBCH SSS EPRE	dBm/SCS	-88	-	-	
NOTE 1: Power level "Off" is defined in TS36.508 [7] Table 6.2.2.1-3.						

Table 8.1.1.3.4.3.2-2: Void

Table 8.1.1.3.4.3.2-3: Main behaviour

St	Procedure	Message Sequence		TP	Verdict
		U - S	Message		
1	The SS changes NR Cell 1, E-UTRA Cell 1 and E-UTRA Cell 3 level according to the row "T1" in Table 8.1.1.3.4.3.2-1	-	-	-	-
2	The SS transmits an <i>RRCRelease</i> message including the <i>freqPriorityListEUTRA</i> on NR Cell 1.	<--	NR RRC: <i>RRCRelease</i>	-	-
2A	Check: Does the UE transmits an <i>RRCConnectionRequest</i> message on E-UTRA cell 3?	-->	RRC: <i>RRCConnectionRequest</i>	1	P
2B	SS transmits an <i>RRCConnectionSetup</i> message on E-UTRA cell 3.	<--	RRC: <i>RRCConnectionSetup</i>	-	-
2C	Check: Does the UE transmits an <i>RRCConnectionSetupComplete</i> message to confirm the successful completion of the connection establishment and a TRACKING AREA UPDATE REQUEST message is sent to update the registration of the actual tracking	-->	RRC: <i>RRCConnectionSetupComplete</i> NAS: TRACKING AREA UPDATE REQUEST	1	P

	area?				
3	Void				
3A	The SS transmits a SecurityModeCommand message.	<--	E-UTRA RRC: <i>SecurityModeCommand</i>	-	-
3B	The UE transmits a SecurityModeComplete message.	-->	E-UTRA RRC: <i>SecurityModeComplete</i>	-	-
3C-3D	Steps 5-6 of TS 38.508-1 [4] Table 4.9.7.2.2-1 of the generic procedure are performed.	-	-	-	-
3E	The SS transmits an <i>RRCCONNECTIONRECONFIGURATION</i> message to establish DRB #n	<--	E-UTRA RRC: <i>RRCCONNECTIONRECONFIGURATION</i>	-	-
3F	The UE transmits an <i>RRCCONNECTIONRECONFIGURATIONCOMPLETE</i> message.	-->	E-UTRA RRC: <i>RRCCONNECTIONRECONFIGURATIONCOMPLETE</i>	-	-
3G	Void	-	-	1	-
3GA	The SS sends one IP Packet to the UE on the default DRB associated with the first PDU session.	-	-	-	-
3GB	The UE loop backs the IP packet received in step 3GA.	-	-	1	P
3H	The SS transmits an <i>RRCCONNECTIONRELEASE</i>	<--	E-UTRA RRC: <i>RRCCONNECTIONRELEASE</i>	-	-
4	The SS changes NR Cell 1, E-UTRA Cell 1 and E-UTRA Cell 3 level according to the row "T2" in Table 8.1.1.3.4.3.2-1	-	-	-	-
5	UE perform on the NR Cell 1 the mobility and periodic registration update procedure in TS 38.508-1[4] subclause 4.9.9.2.2	-	-	-	-
5AA	The SS transmits an <i>RRCCONNECTIONRECONFIGURATION</i> message to establish SRB2 and DRB.	<--	NR RRC: <i>RRCCONNECTIONRECONFIGURATION</i>	-	-
5AB	The UE transmits an <i>RRCCONNECTIONRECONFIGURATIONCOMPLETE</i> message.	-->	NR RRC: <i>RRCCONNECTIONRECONFIGURATIONCOMPLETE</i>	-	-
5A	Void	-	-	1	-
5B	The SS sends one IP Packet to the UE on the default DRB associated with the first PDU session.	-	-	-	-
5C	The UE loop backs the IP packet received in step 5B.	-	-	1	P
6	The SS transmits an <i>RRCCONNECTIONRELEASE</i> message containing IE <i>freqPriorityListEUTRA</i> to update the cell reselection priority of E-UTRA Cell 1 and the timer T320.	<--	NR RRC: <i>RRCCONNECTIONRELEASE</i>	-	-
7	The SS changes power levels of NR Cell 1, E-UTRA Cell 1 and E-UTRA Cell 3 according to row "T3" in Table 8.1.1.3.4.3.2-1.	-	-	-	-
8	Check: While timer T320 is running, does the UE transmit an <i>RRCCONNECTIONSETUPREQUEST</i> message?	-	-	2	F
9	Void	-	-	2	-
9A	Check: Does the UE transmits an <i>RRCCONNECTIONREQUEST</i> message on E-UTRA cell 1?	-->	RRC: <i>RRCCONNECTIONREQUEST</i>	2	P
9B	SS transmits an <i>RRCCONNECTIONSETUP</i> message on E-UTRA cell 1.	<--	RRC: <i>RRCCONNECTIONSETUP</i>	-	-
9C	Check: Does the UE transmits an <i>RRCCONNECTIONSETUPCOMPLETE</i> message to confirm the successful completion of the connection establishment and a TRACKING AREA UPDATE REQUEST message is sent to update the registration of the actual tracking area?	-->	RRC: <i>RRCCONNECTIONSETUPCOMPLETE</i> NAS: TRACKING AREA UPDATE REQUEST	2	P
10	The SS transmits a SecurityModeCommand message.	<--	E-UTRA RRC: <i>SecurityModeCommand</i>	-	-
11	The UE transmits a SecurityModeComplete message.	-->	E-UTRA RRC: <i>SecurityModeComplete</i>	-	-
12-13	Steps 5-6 of TS 38.508-1 [4] Table 4.9.7.2.2-1 of the generic procedure are performed.	-	-	-	-

14	The SS transmits an <i>RRCConnectionReconfiguration</i> message to establish DRB #n	<--	E-UTRA RRC: <i>RRCConnectionReconfiguration</i>	-	-
15	The UE transmits an <i>RRCReconfigurationComplete</i> message.	-->	E-UTRA RRC: <i>RRCConnectionReconfigurationComplete</i>	-	-
16	Void	-	-	2	-
16A	The SS sends one IP Packet to the UE on the default DRB associated with the first PDU session.	-	-	-	-
16B	The UE loop backs the IP packet received in step 16A.	-	-	2	P

8.1.1.3.4.3.3 Specific message contents

Table 8.1.1.3.4.3.3-1: *RRCRelease* (step 1, Table 8.1.1.3.4.3.2-3)

Derivation Path: TS 38.508-1 [4] Table 4.6.1-16			
Information Element	Value/remark	Comment	Condition
<i>RRCRelease</i> ::= SEQUENCE {			
<i>criticalExtensions</i> CHOICE {			
<i>rrcRelease</i> SEQUENCE {			
<i>cellReselectionPriorities</i> SEQUENCE {			
<i>freqPriorityListEUTRA</i> SEQUENCE (SIZE (1.. <i>maxFreq</i>)) OF <i>FreqPriorityEUTRA</i> {	2 entries		
<i>freqPriorityListEUTRA</i> [1] SEQUENCE {		entry 1	
<i>carrierFreq</i>	ARFCN-ValueEUTRA for EUTRA Cell 1 frequency		
<i>cellReselectionPriority</i>	3		
<i>cellReselectionSubPriority</i>	Not present		
}			
<i>freqPriorityListEUTRA</i> [1] SEQUENCE {		entry 2	
<i>carrierFreq</i>	ARFCN-ValueEUTRA for EUTRA Cell 3 frequency		
<i>cellReselectionPriority</i>	5		
<i>cellReselectionSubPriority</i>	Not present		
}			
}			
<i>freqPriorityListNR</i> SEQUENCE (SIZE (1.. <i>maxFreq</i>)) OF <i>FreqPriorityNR</i> {	1 entry		
<i>FreqPriorityNR</i> [1] SEQUENCE {		entry 1	
<i>carrierFreq</i>	ARFCN-ValueNR for NR Cell 1 frequency		
<i>cellReselectionPriority</i>	4		
<i>cellReselectionSubPriority</i>	Not present		
}			
}			
<i>t320</i>	Not Present		
}			
}			
}			

Table 8.1.1.3.4.3.3-2: *SIB5* for NR cell 1 (preamble and all steps, Table 8.1.1.3.4.3.2-3)

Derivation Path: TS 38.508-1 [4] Table 4.6.2-4			
Information Element	Value/remark	Comment	Condition
<i>SIB5</i> ::= SEQUENCE {			
<i>carrierFreqListEUTRA</i> SEQUENCE (SIZE (1.. <i>maxEUTRA-Carrier</i>)) OF <i>CarrierFreqEUTRA</i> {	2 entries		
<i>CarrierFreqEUTRA</i> [1] SEQUENCE {		entry 1	
<i>carrierFreq</i>	ARFCN-ValueEUTRA for EUTRA Cell 1 frequency		

cellReselectionPriority	5		
}			
CarrierFreqEUTRA[2] SEQUENCE {		entry 2	
carrierFreq	ARFCN-ValueEUTRA for EUTRA Cell 3 frequency		
cellReselectionPriority	3		
}			
}			
}			

Table 8.1.1.3.4.3.3-3: RRCRelease (step 6, Table 8.1.1.3.4.3.2-3)

Derivation Path: TS 38.508-1 [4], Table 4.6.1-16			
Information Element	Value/remark	Comment	Condition
RRCRelease ::= SEQUENCE {			
criticalExtensions CHOICE {			
rrcRelease SEQUENCE {			
cellReselectionPriorities SEQUENCE {			
freqPriorityListEUTRA SEQUENCE (SIZE (1..maxFreq)) OF FreqPriorityEUTRA {	1 entry		
freqPriorityListEUTRA[1] SEQUENCE {		entry 1	
carrierFreq	ARFCN-ValueEUTRA of E-UTRA Cell 1		
cellReselectionPriority	3		
cellReselectionSubPriority	Not present		
}			
}			
freqPriorityListNR SEQUENCE (SIZE (1..maxFreq)) OF FreqPriorityNR {	1 entry		
FreqPriorityNR[1] SEQUENCE {		entry 1	
carrierFreq	ARFCN-ValueNR for NR Cell 1 frequency		
cellReselectionPriority	4		
cellReselectionSubPriority	Not present		
}			
}			
t320	min5		
}			
}			
}			
}			

Table 8.1.1.3.4.3.3-4: RRCConnectionReconfiguration (steps 3E and 14 Table 8.1.1.3.4.3.2-3)

Derivation Path: TS 36.508[7] Table 4.6.1-8			
Information Element	Value/remark	Comment	Condition
RRCConnectionReconfiguration ::= SEQUENCE {			
criticalExtensions CHOICE {			
c1 CHOICE {			
rrcConnectionReconfiguration-r8 SEQUENCE {			
radioResourceConfigDedicated	RadioResourceConfigDedicated-DRB(n, m)		
}			
}			
}			
}			

Table 8.1.1.3.4.3.3-5: RRCReconfiguration-SRB2-DRB (n, m) (step 5AA, Table 8.1.1.3.4.3.2-3)

Derivation Path: TS 38.508-1 [4] Table 4.8.1-1B

Table 8.1.1.3.4.3.3-6: REGISTRATION REQUEST (Step 5, Table 8.1.1.3.4.3.2-3)

Derivation Path: TS 38.508-1 [4], Table 4.7.1-6.			
Information Element	Value/remark	Comment	Condition
EPS NAS message container	TRACKING AREA UPDATE REQUEST message	See Table 8.1.1.3.4.3.3-7	

Table 8.1.1.3.4.3.3-7: TRACKING AREA UPDATE REQUEST (Table 8.1.1.3.4.3.3-6)

Derivation Path: TS 38.508-1 [4], Table 4.9.9.2.3-2 with condition Mapped EPS security context			
--	--	--	--

8.1.1.3.5 Void

8.1.1.3.6 Void

8.1.1.3.7 RRC connection release / Success / Deprioritisation / Frequency / T325 expiry

8.1.1.3.7.1 Test Purpose (TP)

(1)

```
with { UE in NR RRC_CONNECTED state }
ensure that {
  when { UE receives an RRCRelease message including IE deprioritisationReq with
deprioritisationType indicating 'frequency' and a deprioritisationTimer }
  then { UE considers the current frequency to be the lowest priority frequency (i.e. lower than
any of the network configured values) while T325 is running }
}
```

8.1.1.3.7.2 Conformance requirements

References: The conformance requirements covered in the current TC is specified in: TS 38.331 clause 5.3.8.3 and TS 38.304 clause 5.2.4.1.

[TS 38.331, clause 5.3.8.3]

...

The UE shall:

- 1> if *deprioritisationReq* is included and the UE supports RRC connection release with deprioritisation:
- 2> start or restart timer T325 with the timer value set to the *deprioritisationTimer* signalled;
- 2> store the *deprioritisationReq* until T325 expiry;

[TS 38.304, clause 5.2.4.1]

...

In case UE receives *RRCRelease* with *deprioritisationReq*, UE shall consider current frequency and stored frequencies due to the previously received *RRCRelease* with *deprioritisationReq* or all the frequencies of NR to be the lowest priority frequency (i.e. lower than any of the network configured values) while T325 is running irrespective of camped RAT. The UE shall delete the stored deprioritisation request(s) when a PLMN selection or SNPN selection is performed on request by NAS (TS 23.122 [9]).

NOTE: UE should search for a higher priority layer for cell reselection as soon as possible after the change of priority. The minimum related performance requirements specified in TS 38.133 [8] are still applicable.

8.1.1.3.7.3 Test Description

8.1.1.3.7.3.1 Pre-test conditions

System Simulator:

- NR Cell 1 and NR Cell 3 have different tracking areas and equal priority.
- System information combination NR-4 as defined in TS 38.508-1 [4] clause 4.4.3.1.2 is used in NR cells.

UE:

- None.

Preamble:

- The UE is in 5GS state 3N-A on NR Cell 1 according to TS 38.508-1 [4], clause 4.4A.2 Table 4.4A.2-3.

8.1.1.3.7.3.2 Test procedure sequence

Table 8.1.1.3.7.3.2-1 illustrates the downlink power levels to be applied for NR Cell 1, Cell 2 and Cell 3 at various time instants of the test execution. Row marked "T0" denotes the conditions after the preamble, while rows marked "T1" and "T2" are to be applied subsequently. The exact instants on which these values shall be applied are described in the texts in this clause.

Table 8.1.1.3.7.3.2-1: Time instances of cell power level and parameter changes for FR1

	Parameter	Unit	NR Cell 1	NR Cell 3	Remark
T0	SS/PBCH SSS EPRE	dBm/ SCS	-88	Off	
T1	SS/PBCH SSS EPRE	dBm/ SCS	-85	-91	The power level values are set so that $R_{NRCell 1} > R_{NRCell 3}$.

Table 8.1.1.3.7.3.2-2: Time instances of cell power level and parameter changes for FR2

	Parameter	Unit	NR Cell 1	NR Cell 3	Remark
T0	SS/PBCH SSS EPRE	dBm/ SCS	FFS	FFS	
T1	SS/PBCH SSS EPRE	dBm/ SCS	FFS	FFS	The power level values are set so that $R_{NRCell 1} > R_{NRCell 3}$.

Table 8.1.1.3.7.3.2-3: Main behaviour

St	Procedure	Message Sequence		TP	Verdict
		U - S	Message		
1	The SS transmits an <i>RRCRelease</i> message on NR Cell 1 including IE deprioritisationReq.	<--	NR RRC: <i>RRCRelease</i>	-	-
2	SS starts timer T325.	-	-	-	-
2A	The SS adjusts the SS/PBCH EPRE levels according to row "T1" in table 8.1.1.3.7.2-1/2	-	-	-	-
3	Check: Does the test result of generic test procedure in TS 38.508-1 [4] Table 4.9.5.2.2-1 indicate that the UE is camped on NR Cell 3?	-	-	1	P
4	SS waits for T325 expiry.	-	-	-	-
5	Check: Does the test result of generic test procedure in TS 38.508-1 [4] Table 4.9.5.2.2-1 indicate that the UE is camped on NR Cell 1?	-	-	1	P

8.1.1.3.7.3.3 Specific message contents

Table 8.1.1.3.7.3.3-1: *RRCRelease* (step 1, Table 8.1.1.3.7.3.2-3)

Derivation Path: TS 38.508-1 [4] Table 4.6.1-16			
Information Element	Value/remark	Comment	Condition
<i>RRCRelease</i> ::= SEQUENCE {			
<i>rrc-TransactionIdentifier</i>	RRC- TransactionIdentifier		
criticalExtensions CHOICE {			
<i>rrcRelease</i> SEQUENCE {			
<i>deprioritisationReq</i> SEQUENCE {			
<i>deprioritisationType</i>	frequency		
<i>deprioritisationTimer</i>	min5		
}			
}			
}			
}			

8.1.1.3.7a RRC connection release / Success / Deprioritisation / NR / T325 expiry

8.1.1.3.7a.1 Test Purpose (TP)

(1)

```

with { UE in NR RRC_CONNECTED state }
ensure that {
  when { UE receives an RRCRelease message including IE deprioritisationReq with
deprioritisationType indicating 'nr' and a deprioritisationTimer }
  then { UE considers all frequencies of NR to be the lowest priority frequency (i.e. lower than
any of the network configured values) while T325 is running }
}

```

8.1.1.3.7a.2 Conformance requirements

References: The conformance requirements covered in the current TC is specified in: TS 38.331 clause 5.3.8.3 and TS 38.304 clause 5.2.4.1.

[TS 38.331, clause 5.3.8.3]

...

The UE shall:

- 1> if *deprioritisationReq* is included and the UE supports RRC connection release with deprioritisation:
- 2> start or restart timer T325 with the timer value set to the *deprioritisationTimer* signalled;
- 2> store the *deprioritisationReq* until T325 expiry;

[TS 38.304, clause 5.2.4.1]

...

In case UE receives *RRCRelease* with *deprioritisationReq*, UE shall consider current frequency and stored frequencies due to the previously received *RRCRelease* with *deprioritisationReq* or all the frequencies of NR to be the lowest priority frequency (i.e. lower than any of the network configured values) while T325 is running irrespective of camped RAT. The UE shall delete the stored deprioritisation request(s) when a PLMN selection or SNPN selection is performed on request by NAS (TS 23.122 [9]).

NOTE: UE should search for a higher priority layer for cell reselection as soon as possible after the change of priority. The minimum related performance requirements specified in TS 38.133 [8] are still applicable.

8.1.1.3.7a.3 Test Description

8.1.1.3.7a.3.1 Pre-test conditions

System Simulator:

- NR Cell 1 and NR Cell 3 have different tracking areas and equal priority.
- E-UTRA Cell 1 is a lower priority cell.
- System information combination NR-7 as defined in TS 38.508-1 [4] clause 4.4.3.1.2 is used in NR cells.
- System information combination 31 as defined in TS 36.508-1 [18] clause 4.4.3.1 is used in E-UTRA Cell.

UE:

- None.

Preamble:

- The UE is in 5GS state 3N-A on NR Cell 1 according to TS 38.508-1 [4], clause 4.4A.2 Table 4.4A.2-3.

8.1.1.3.7a.3.2 Test procedure sequence

Table 8.1.1.3.7a.3.2-1 illustrates the downlink power levels to be applied for NR Cell 1, NR Cell 3 and E-UTRA Cell 1 at various time instants of the test execution. Row marked "T0" denotes the conditions after the preamble, while rows marked "T1" and "T2" are to be applied subsequently. The exact instants on which these values shall be applied are described in the texts in this clause.

Table 8.1.1.3.7a.3.2-1: Time instances of cell power level and parameter changes for conducted test environment

	Parameter	Unit	NR Cell 1	NR Cell 3	E-UTRA Cell 1	Remark
T0	SS/PBCH SSS EPRE	dBm/S CS	-88	Off	-	
	Cell-specific RS EPRE	dBm/15 kHz	-	-	Off	
T1	SS/PBCH SSS EPRE	dBm/S CS	-85	-79	-	The power level values are assigned to satisfy $S_{rxlev_{E-UTRA\ Cell\ 1}} > Thresh_{x, high}$
	Cell-specific RS EPRE	dBm/15 kHz	-	-	-75	

Table 8.1.1.3.7a.3.2-2: Time instances of cell power level and parameter changes for OTA test environment

	Parameter	Unit	NR Cell 1	NR Cell 3	E-UTRA Cell 1	Remark
T0	SS/PBCH SSS EPRE	dBm/S CS	FFS	FFS	-	
	Cell-specific RS EPRE	dBm/15 kHz	-	-	Off	
T1	SS/PBCH SSS EPRE	dBm/S CS	FFS	FFS	-	The power level values are assigned to satisfy $S_{rxlev_{E-UTRA\ Cell\ 1}} > Thresh_{x, high}$
	Cell-specific RS EPRE	dBm/15 kHz	-	-	-75	

Table 8.1.1.3.7a.3.2-3: Main behaviour

St	Procedure	Message Sequence		TP	Verdict
		U - S	Message		

1	The SS adjusts the SS/PBCH EPRE levels according to row "T1" in table 8.1.1.3.7a.3.2-1/2	-	-	-	-
2	The SS transmits an <i>RRCRelease</i> message on NR Cell 1 including IE <i>deprioritisationReq</i> .	<--	NR RRC: <i>RRCRelease</i>	-	-
3	SS starts timer T325.	-	-	-	-
4	Check: Does the test result of generic test procedure in TS 38.508-1 [4] Table 4.9.7.2.2-1 is performed and the UE is camped on E-UTRAN Cell 1?	-	-	1	P
5	SS waits for T325 expiry.	-	-	-	-
6	Check: Does the test result of generic test procedure in TS 38.508-1 [4] Table 4.9.9.2.2-1 indicate that the UE is camped on NR Cell 3?	-->	NR RRC: <i>RRCSetupRequest</i>	1	P

8.1.1.3.7a.3.3 Specific message contents

Table 8.1.1.3.7a.3.3-1: *RRCRelease* (step 2, Table 8.1.1.3.7a.3.2-3)

Derivation Path: TS 38.508-1 [4] Table 4.6.1-16			
Information Element	Value/remark	Comment	Condition
<i>RRCRelease</i> ::= SEQUENCE {			
<code>rrc-TransactionIdentifier</code>	RRC-TransactionIdentifier		
criticalExtensions CHOICE {			
<code>rrcRelease</code> SEQUENCE {			
<code>deprioritisationReq</code> SEQUENCE {			
<code>deprioritisationType</code>	nr		
<code>deprioritisationTimer</code>	min5		
}			
}			
}			
}			

8.1.1.3.7b RRC connection release / Success / Deprioritisation / Deletion of Stored deprioritisation request

8.1.1.3.7b.1 Test Purpose (TP)

(1)
 with { UE in NR RRC_CONNECTED state and T325 is running }
 ensure that {
 when { UE is requested to perform manual PLMN selection }
 then { UE deletes the stored deprioritisation request(s) and proceeds with the PLMN selection }
 }

8.1.1.3.7b.2 Conformance requirements

References: The conformance requirements covered in the current TC is specified in: TS 38.331 clause 5.3.8.3 and TS 38.304 clause 5.2.4.1.

[TS 38.331, clause 5.3.8.3]

...

The UE shall:

- 1> if *deprioritisationReq* is included and the UE supports RRC connection release with deprioritisation:
- 2> start or restart timer T325 with the timer value set to the *deprioritisationTimer* signalled;
- 2> store the *deprioritisationReq* until T325 expiry;

[TS 38.304, clause 5.2.4.1]

...

In case UE receives *RRCRelease* with *deprioritisationReq*, UE shall consider current frequency and stored frequencies due to the previously received *RRCRelease* with *deprioritisationReq* or all the frequencies of NR to be the lowest priority frequency (i.e. lower than any of the network configured values) while T325 is running irrespective of camped RAT. The UE shall delete the stored deprioritisation request(s) when a PLMN selection or SNPN selection is performed on request by NAS (TS 23.122 [9]).

NOTE: UE should search for a higher priority layer for cell reselection as soon as possible after the change of priority. The minimum related performance requirements specified in TS 38.133 [8] are still applicable.

8.1.1.3.7b.3 Test Description

8.1.1.3.7b.3.1 Pre-test conditions

System Simulator:

- 2 NR cells: NR Cells 1 and 3 as specified in TS 38.508-1 [4] table 6.3.2.2-1 are configured as shown in Table 8.1.1.3.7b.3.1-1. PLMN settings are defined in TS 36.523-1 [13] table 6.0.1-1.
- System information combination NR-4 as defined in TS 38.508-1 [4] clause 4.4.3.1.2 is used in NR cells.

Table 8.1.1.3.7b.3.1-1: PLMN identifiers

NR Cell	PLMN identifiers
NR Cell 1	PLMN1
NR Cell 3	PLMN2

UE:

- None.

Preamble:

- The UE is in 5GS state 3N-A on NR Cell 1 according to TS 38.508-1 [4], clause 4.4A.2 Table 4.4A.2-3.

8.1.1.3.7b.3.2 Test procedure sequence

Table 8.1.1.3.7b.3.2-1 illustrates the downlink power levels to be applied for NR Cell 1, Cell 2 and Cell 3 at various time instants of the test execution. Row marked "T0" denotes the conditions after the preamble, while rows marked "T1" and "T2" are to be applied subsequently. The exact instants on which these values shall be applied are described in the texts in this clause.

Table 8.1.1.3.7b.3.2-1: Time instances of cell power level and parameter changes for FR1

	Parameter	Unit	NR Cell 1	NR Cell 3	Remark
T0	SS/PBCH SSS EPRE	dBm/ SCS	-88	Off	
T1	SS/PBCH SSS EPRE	dBm/ SCS	-85	-91	The power level values are set so that $R_{NRCell\ 1} > R_{NRCell\ 3}$.

Table 8.1.1.3.7b.3.2-2: Time instances of cell power level and parameter changes for FR2

	Parameter	Unit	NR Cell 1	NR Cell 3	Remark
T0	SS/PBCH SSS EPRE	dBm/ SCS	FFS	FFS	
T1	SS/PBCH SSS EPRE	dBm/ SCS	FFS	FFS	

Table 8.1.1.3.7b.3.2-3: Main behaviour

St	Procedure	Message Sequence		TP	Verdict
		U - S	Message		
1	The SS adjusts the SS/PBCH EPRE levels according to row "T1" in table 8.1.1.3.7b.2-1/2.	-	-	-	-
2	The SS transmits an <i>RRCRelease</i> message on NR Cell 1 including IE <i>deprioritisationReq</i> .	<--	NR RRC: <i>RRCRelease</i>	-	-
3	SS starts timer T325.	-	-	-	-
4	PLMN2 is manually selected.				
5	Check: Does the test result of generic test procedure in TS 38.508-1 [4] Table 4.9.5.2.2-1 indicate that the UE is camped on NR Cell 3?	-->	NR RRC: <i>RRCSetupRequest</i>	-	-
6	PLMN1 is manually selected before T325 expiry.	-	-	-	-
7	Check: Does the test result of generic test procedure in TS 38.508-1 [4] Table 4.9.5.2.2-1 indicate that the UE is camped on NR Cell 1 before T325 expiry?	-->	NR RRC: <i>RRCSetupRequest</i>	1	P

8.1.1.3.7b.3.3 Specific message contents

Table 8.1.1.3.7b.3.3-1: *RRCRelease* (step 2, Table 8.1.1.3.7b.3.2-3)

Derivation Path: TS 38.508-1 [4] Table 4.6.1-16			
Information Element	Value/remark	Comment	Condition
<i>RRCRelease</i> ::= SEQUENCE {			
<i>rrc-TransactionIdentifier</i>	RRC- TransactionIdentifier		
criticalExtensions CHOICE {			
<i>rrcRelease</i> SEQUENCE {			
<i>deprioritisationReq</i> SEQUENCE {			
<i>deprioritisationType</i>	frequency		
<i>deprioritisationTimer</i>	min5		
}			
}			
}			
}			

8.1.1.4 RRC resume

8.1.1.4.1 RRC resume / Suspend-Resume / RNA update / Success / Short message for SI update

8.1.1.4.1.1 Test Purpose (TP)

(1)

```

with { UE in NR RRC_INACTIVE state, with stored shortI-RNTI and useFullResumeID is not signalled in SIB1 }
ensure that {
  when { UE receives a Paging message to resume RRC connection }
  then { UE sends RRCResumeRequest message by setting resumeIdentity to the stored shortI-RNTI value }
}

```

(2)

```

with { UE in NR RRC_INACTIVE state, with stored fullI-RNTI and useFullResumeID is signalled in SIB1 }
ensure that {

```

```

    when { UE receives a Paging message to resume RRC connection }
    then { UE sends RRCResumeRequest1 message by setting resumeIdentity to the stored fullI-RNTI
value }
}

```

(3)

```

with { UE in NR RRC_INACTIVE state }
ensure that {
    when { UE performs cell reselection and enters an RNA not belonging to the configured ran-
NotificationAreaInfo }
    then { UE shall initiate RRC connection resume procedure with cause value set to rna-Update }
}

```

(4)

```

with { UE in NR RRC_INACTIVE state }
ensure that {
    when { UE receives a short message transmitted on PDCCH using P-RNTI indicating a
systemInfoModification }
    then { UE re-acquires and applies the new system information about the correct prach-
ConfigurationIndex in random access to resume RRC connection }
}

```

8.1.1.4.1.2 Conformance requirements

References: The conformance requirements covered in the current TC is specified in: TS 38.331 clause 5.2.2.2.2, 5.2.2.3.1, 5.2.2.4.2, 5.3.8.3, 5.3.13.2, 5.3.13.3, 5.3.13.8 and 6.5. Unless otherwise stated these are Rel-15 requirements.

[TS 38.331, clause 5.2.2.2.2]

A modification period is used, i.e. updated SI message (other than SI message for ETWS, CMAS and positioning assistance data) is broadcasted in the modification period following the one where SI change indication is transmitted. The modification period boundaries are defined by SFN values for which $SFN \bmod m = 0$, where m is the number of radio frames comprising the modification period. The modification period is configured by system information. The UE receives indications about SI modifications and/or PWS notifications using Short Message transmitted with P-RNTI over DCI (see clause 6.5). Repetitions of SI change indication may occur within preceding modification period. SI change indication is not applicable for SI messages containing posSIBs.

UEs in RRC_IDLE or in RRC_INACTIVE shall monitor for SI change indication in its own paging occasion every DRX cycle. UEs in RRC_CONNECTED shall monitor for SI change indication in any paging occasion at least once per modification period if the UE is provided with common search space, including *pagingSearchSpace*, *searchSpaceSIB1* and *searchSpaceOtherSystemInformation*, on the active BWP to monitor paging, as specified in TS 38.213 [13], clause 13.

...

If the UE receives a Short Message, the UE shall:

...

- 1> if the *systemInfoModification* bit of Short Message is set:
 - 2> apply the SI acquisition procedure as defined in sub-clause 5.2.2.3 from the start of the next modification period.

[TS 38.331, clause 5.2.2.3.1]

The UE shall:

- 1> apply the specified BCCH configuration defined in 9.1.1.1;
- 1> if the UE is in RRC_IDLE or in RRC_INACTIVE; or
- 1> if the UE is in RRC_CONNECTED while T311 is running:
 - 2> acquire the *MIB*, which is scheduled as specified in TS 38.213 [13];

- 2> if the UE is unable to acquire the *MIB*;
- 3> perform the actions as specified in clause 5.2.2.5;
- 2> else:
- 3> perform the actions specified in clause 5.2.2.4.1.

...

1> if the UE is in RRC_IDLE or in RRC_INACTIVE; or

1> if the UE is in RRC_CONNECTED while T311 is running:

- 2> if *ssb-SubcarrierOffset* indicates *SIB1* is transmitted in the cell (TS 38.213 [13]) and if *SIB1* acquisition is required for the UE:
 - 3> acquire the *SIB1*, which is scheduled as specified in TS 38.213 [13];
 - 3> if the UE is unable to acquire the *SIB1*:
 - 4> perform the actions as specified in clause 5.2.2.5;
 - 3> else:
 - 4> upon acquiring *SIB1*, perform the actions specified in clause 5.2.2.4.2.
- 2> else if *SIB1* acquisition is required for the UE and *ssb-SubcarrierOffset* indicates that *SIB1* is not scheduled in the cell:
 - 3> perform the actions as specified in clause 5.2.2.5.

...

[TS 38.331, clause 5.2.2.4.2]

Upon receiving the *SIB1* the UE shall:

- 1> store the acquired *SIB1*;
- 1> if the *cellAccessRelatedInfo* contains an entry with the *PLMN-Identity* of the selected PLMN:
 - 2> in the remainder of the procedures use *plmn-IdentityList*, *trackingAreaCode*, and *cellIdentity* for the cell as received in the corresponding *PLMN-IdentityInfo* containing the selected PLMN;

...

1> else:

...

- 2> if the UE supports the bandwidth of the initial uplink BWP and of the initial downlink BWPs indicated in the *locationAndBandwidth* fields in *uplinkConfigCommon*:
 - 3> select the first frequency band in the *frequencyBandList* which the UE supports and for which the UE supports at least one of the *additionalSpectrumEmission* values in *nr-NS-PmaxList*, if present;
 - 3> forward the *cellIdentity* to upper layers;
 - 3> if *trackingAreaCode* is not provided for the selected PLMN nor the registered PLMN nor PLMN of the equivalent PLMN list:
 - 4> consider the cell as barred in accordance with TS 38.304 [20];
 - 4> if *intraFreqReselection* is set to *notAllowed*:
 - 5> consider cell re-selection to other cells on the same frequency as the barred cell as not allowed, as specified in TS 38.304 [20];

4> else:

5> consider cell re-selection to other cells on the same frequency as the barred cell as allowed, as specified in TS 38.304 [20];

3> else:

4> forward the *trackingAreaCode* to upper layers;

3> forward the PLMN identity to upper layers;

3> if in RRC_INACTIVE and the forwarded information does not trigger message transmission by upper layers:

4> if the serving cell does not belong to the configured *ran-NotificationAreaInfo*:

5> initiate an RNA update as specified in 5.3.13.8;

[TS 38.331, clause 5.3.8.3]

The UE shall:

...

1> if the *RRCRelease* includes *suspendConfig*:

2> apply the received *suspendConfig*;

2> reset MAC and release the default MAC Cell Group configuration, if any;

2> re-establish RLC entities for SRB1;

2> if the *RRCRelease* message with *suspendConfig* was received in response to an *RRCResumeRequest* or an *RRCResumeRequest1*:

3> stop the timer T319 if running;

3> in the stored UE Inactive AS context:

4> replace the K_{gNB} and K_{RRCint} keys with the current K_{gNB} and K_{RRCint} keys;

4> replace the C-RNTI with the temporary C-RNTI in the cell the UE has received the *RRCRelease* message;

4> replace the *cellIdentity* with the *cellIdentity* of the cell the UE has received the *RRCRelease* message;

4> replace the physical cell identity with the physical cell identity of the cell the UE has received the *RRCRelease* message;

4> replace the *suspendConfig* with the current *suspendConfig*;

2> else:

3> store in the UE Inactive AS Context the configured *suspendConfig*, the current K_{gNB} and K_{RRCint} keys, the ROHC state, the C-RNTI used in the source PCell, the *cellIdentity* and the physical cell identity of the source PCell, and all other parameters configured except with *ReconfigurationWithSync*;

...

[TS 38.331, clause 5.3.13.2]

The UE initiates the procedure when upper layers or AS (when responding to RAN paging or upon triggering RNA updates while the UE is in RRC_INACTIVE) requests the resume of a suspended RRC connection.

The UE shall ensure having valid and up to date essential system information as specified in clause 5.2.2.2 before initiating this procedure.

Upon initiation of the procedure, the UE shall:

- 1> if the resumption of the RRC connection is triggered by response to NG-RAN paging:
 - 2> select '0' as the Access Category;
 - 2> perform the unified access control procedure as specified in 5.3.14 using the selected Access Category and one or more Access Identities provided by upper layers;
 - 3> if the access attempt is barred, the procedure ends;
- 1> else if the resumption of the RRC connection is triggered by upper layers:
 - 2> if the upper layers provide an Access Category and one or more Access Identities:
 - 3> perform the unified access control procedure as specified in 5.3.14 using the Access Category and Access Identities provided by upper layers;
 - 4> if the access attempt is barred, the procedure ends;
 - 2> set the *resumeCause* in accordance with the information received from upper layers;
- 1> else if the resumption of the RRC connection is triggered due to an RNA update as specified in 5.3.13.8:
 - 2> if an emergency service is ongoing:

NOTE: How the RRC layer in the UE is aware of an ongoing emergency service is up to UE implementation.

- 3> select '2' as the Access Category;
- 3> set the *resumeCause* to *emergency*;
- 2> else:
 - 3> select '8' as the Access Category;
 - 2> perform the unified access control procedure as specified in 5.3.14 using the selected Access Category and one or more Access Identities to be applied as specified in TS 24.501 [23];
 - 3> if the access attempt is barred:
 - 4> set the variable *pendingRnaUpdate* to *true*;
 - 4> the procedure ends;
- ...
- 1> release the MCG SCell(s) from the UE Inactive AS context, if stored;
- 1> apply the default L1 parameter values as specified in corresponding physical layer specifications, except for the parameters for which values are provided in *SIB1*;
- 1> apply the default SRB1 configuration as specified in 9.2.1;
- 1> apply the default MAC Cell Group configuration as specified in 9.2.2;
- 1> release *delayBudgetReportingConfig* from the UE Inactive AS context, if stored;
- 1> stop timer T342, if running;
- 1> release *overheatingAssistanceConfig* from the UE Inactive AS context, if stored;
- 1> stop timer T345, if running;
- 1> apply the CCCH configuration as specified in 9.1.1.2;
- 1> apply the *timeAlignmentTimerCommon* included in *SIB1*;
- 1> start timer T319;
- 1> set the variable *pendingRnaUpdate* to *false*;

1> initiate transmission of the *RRCResumeRequest* message or *RRCResumeRequest1* in accordance with 5.3.13.3.

[TS 38.331, clause 5.3.13.3]

The UE shall set the contents of *RRCResumeRequest* or *RRCResumeRequest1* message as follows:

- 1> if field *useFullResumeID* is signalled in *SIB1*:
 - 2> select *RRCResumeRequest1* as the message to use;
 - 2> set the *resumeIdentity* to the stored *fullI-RNTI* value;
- 1> else:
 - 2> select *RRCResumeRequest* as the message to use;
 - 2> set the *resumeIdentity* to the stored *shortI-RNTI* value;

...

1> submit the selected message *RRCResumeRequest* or *RRCResumeRequest1* for transmission to lower layers.

NOTE 2: Only DRBs with previously configured UP ciphering shall resume ciphering.

...

[TS 38.331, clause 5.3.13.8]

In *RRC_INACTIVE* state, the UE shall:

- 1> if T380 expires; or
- 1> if RNA Update is triggered at reception of SIB1, as specified in 5.2.2.4.2:
 - 2> initiate RRC connection resume procedure in 5.3.13.2 with *resumeCause* set to *rna-Update*;
- 1> if barring is alleviated for Access Category '8', as specified in 5.3.14.4:
 - 2> if upper layers do not request RRC the resumption of an RRC connection, and
 - 2> if the variable *pendingRnaUpdate* is set to *true*:
 - 3> initiate RRC connection resume procedure in 5.3.13.2 with *resumeCause* value set to *rna-Update*.

If the UE in *RRC_INACTIVE* state fails to find a suitable cell and camps on the acceptable cell to obtain limited service as defined in TS 38.304 [20], the UE shall:

- 1> perform the actions upon going to *RRC_IDLE* as specified in 5.3.11 with release cause 'other'.

NOTE: It is left to UE implementation how to behave when T380 expires while the UE is camped neither on a suitable nor on an acceptable cell.

[TS 38.331, clause 6.5]

Short Messages can be transmitted on PDCCH using P-RNTI with or without associated *Paging* message using Short Message field in DCI format 1_0 (see TS 38.212 [17], clause 7.3.1.2.1).

Table 6.5-1 defines Short Messages. Bit 1 is the most significant bit.

Table 6.5-1: Short Messages

Bit	Short Message
1	<i>systemInfoModification</i> If set to 1: indication of a BCCH modification other than SIB6, SIB7 and SIB8.
2	<i>etwsAndCmasIndication</i> If set to 1: indication of an ETWS primary notification and/or an ETWS secondary notification and/or a CMAS notification.
3	<i>stopPagingMonitoring</i>

	This bit can be used for only operation with shared spectrum channel access and if <i>nrofPDCCH-MonitoringOccasionPerSSB-InPO</i> is present. If set to 1: indication that the UE may stop monitoring PDCCH occasion(s) for paging in this Paging Occasion as specified in TS 38.304 [20], clause 7.1.
4 – 8	Not used in this release of the specification, and shall be ignored by UE if received.

8.1.1.4.1.3 Test Description

8.1.1.4.1.3.1 Pre-test conditions

System Simulator:

- NR Cell 1 is the serving cell and NR Cell 2 is a suitable neighbour intra-frequency cell.
- Cell power levels are selected according to 38.508-1 [4] Table 6.2.2.1-3 and NR Cell 2 is switched on after UE has registered on NR Cell 1.
- System information combination NR-2 as defined in TS 38.508-1 [4] clause 4.4.3.1.2 is used in NR cells.

UE:

- None.

Preamble:

- If *pc_IP_Ping* is set to TRUE then, the UE is in 5GS state 2N-A according to TS 38.508-1 [4], clause 4.4A.2 Table 4.4A.2-3.
- Else, the UE is in 5GS state 2N-A and Test Loop Function (*On*) with UE test loop mode B on NR Cell 1 according to 38.508-1[4], clause 4.4A.2 Table 4.4A.2-3.

8.1.1.4.1.3.2 Test procedure sequence

Table 8.1.1.4.1.3.2-1 for FR1 and table 8.1.1.4.1.3.2-2 for FR2 illustrate the downlink power levels to be applied for the cells at various time instants of the test execution. Row marked "T0" denotes the initial conditions after preamble, while columns marked "T1" is to be applied subsequently in the Main behaviour. The exact instants on which these values shall be applied are described in the texts in this clause.

Table 8.1.1.4.1.3.2-1: Cell configuration changes over time for FR1

	Parameter	Unit	NR Cell 1	NR Cell 2	Remarks
T0	SS/PBCH SSS EPRE	dBm/SCS	-88	-94	
T1	SS/PBCH SSS EPRE	dBm/SCS	"Off"	-94	Power level "Off" is defined in TS 38.508-1 [4] Table 6.2.2.1-3

Table 8.1.1.4.1.3.2-2: Cell configuration changes over time for FR2

	Parameter	Unit	NR Cell 1	NR Cell 2	Remarks
T0	SS/PBCH SSS EPRE	dBm/SCS	-82	-91	
	Qrxlevmin	dBm	- 110+Delta(NRf1)	- 110+Delta(N Rf1)	
T1	SS/PBCH SSS EPRE	dBm/SCS	"Off"	-91	Power level "Off" is defined in TS

	Qrxlevmin	dBm	-	- 110+Delta(N Rf1)	38.508-1 [4] Table 6.2.2.2-2
--	-----------	-----	---	--------------------------	---------------------------------

Table 8.1.1.4.1.3.2-3: Main behaviour

St	Procedure	Message Sequence		TP	Verdict
		U - S	Message		
-	The following messages are to be observed on NR Cell 1 unless explicitly stated otherwise	-	-	-	-
1	The SS transmits a <i>Paging</i> message including a matched identity (correct <i>fullI-RNTI</i>).	<--	NR RRC: <i>Paging</i>	-	-
2	Check: Does the UE transmit an <i>RRCResumeRequest</i> message by setting <i>resumeIdentity</i> to the stored <i>shortI-RNTI</i> value?	-->	NR RRC: <i>RRCResumeRequest</i>	1	P
3	The SS transmits an <i>RRCResume</i> message.	<--	NR RRC: <i>RRCResume</i>	-	-
4	The UE transmits an <i>RRCResumeComplete</i> message.	-->	NR RRC: <i>RRCResumeComplete</i>	-	-
5	Check: Does the test result of generic test procedure in TS 38.508-1 subclause 4.9.1 indicate that the UE is capable of exchanging IP data on DRB#n associated with default Internet PDU session?	-	-	1	-
6	The SS transmits an <i>RRCRelease</i> message including both <i>fullI-RNTI</i> and <i>shortI-RNTI</i> in <i>suspendConfig</i> .	<--	NR RRC: <i>RRCRelease</i>	-	-
7	The SS changes the SIB1 of NR Cell 1 to set the <i>useFullResumeID</i> to True.	-	-	-	-
8	The SS transmits a Short message on PDCCH using P-RNTI indicating a <i>systemInfoModification</i> .	<--	PDCCH (DCI 1_0): Short Message	-	-
9	Wait for 2.1* modification period second for the UE to receive new system information. (Note 1)	-	-	-	-
10	The SS transmits a <i>Paging</i> message including a matched identity (correct <i>fullI-RNTI</i>).	<--	NR RRC: <i>Paging</i>	-	-
11	Check: Does the UE transmit an <i>RRCResumeRequest1</i> message by setting <i>resumeIdentity</i> to the stored <i>fullI-RNTI</i> value?	-->	NR RRC: <i>RRCResumeRequest1</i>	2	P
12	The SS transmits an <i>RRCResume</i> message.	<--	NR RRC: <i>RRCResume</i>	-	-
13	The UE transmits an <i>RRCResumeComplete</i> message.	-->	NR RRC: <i>RRCResumeComplete</i>	-	-
14	The SS transmits an <i>RRCRelease</i> message including both <i>fullI-RNTI</i> and <i>shortI-RNTI</i> in <i>suspendConfig</i> .	<--	NR RRC: <i>RRCRelease</i>	-	-
15	The SS adjusts cell levels according to row T1 of table 8.1.1.4.1.3.2-1 for FR1 and table 8.1.1.4.1.3.2-2 for FR2.	-	-	-	-
-	The following messages are to be observed on NR Cell 2 unless explicitly stated otherwise.	-	-	-	-
16	Check: Does the UE transmit an <i>RRCResumeRequest</i> message with <i>resumeCause</i> set to <i>rna-Update</i> on NR Cell 2 within 60s?	-->	NR RRC: <i>RRCResumeRequest</i>	3	P
17	The SS transmits an <i>RRCResume</i> message.	<--	NR RRC: <i>RRCResume</i>	-	-
18	The UE transmit an <i>RRCResumeComplete</i> message.	-->	NR RRC: <i>RRCResumeComplete</i>	-	-
19	Check: Does the test result of generic test procedure in TS 38.508-1 subclause 4.9.1 indicate that the UE is capable of exchanging IP data on DRB#n associated with default Internet PDU session?	-	-	3	-
20	The SS transmits an <i>RRCRelease</i> message including both <i>fullI-RNTI</i> and <i>shortI-RNTI</i> in <i>suspendConfig</i> .	<--	NR RRC: <i>RRCRelease</i>	-	-

21-22	Void	-	-	-	-
22A	The SS changes the <i>prach-ConfigurationIndex</i> and <i>ra-responseWindow</i> in the system information.	-	-	-	-
22B	The SS transmits a Short message on PDCCH using P-RNTI indicating a <i>systemInfoModification</i> .	-	PDCCH (DCI 1_0): Short Message	-	-
23	Wait for 2.1* modification period second for the UE to receive new system information. (Note 1)	-	-	-	-
24	The SS transmits a <i>Paging</i> message including a matched identity (correct <i>fullI-RNTI</i>).	-	NR RRC: <i>Paging</i>	-	-
25	Check: Does the UE transmit a random access using <i>prach-ConfigurationIndex</i> given in step 22?	-	-	4	P
26	The UE transmits an <i>RRCResumeRequest</i> message.	-->	<i>RRCResumeRequest</i>	-	-
27	The SS transmits an <i>RRCResume</i> message.	<--	<i>RRCResume</i>	-	-
28	The UE transmits an <i>RRCResumeComplete</i> message.	-->	<i>RRCResumeComplete</i>	-	-
Note 1: The modification period, expressed in number of radio frames = $\text{modificationPeriodCoeff} * \text{defaultPagingCycle}$.					

8.1.1.4.1.3.3 Specific message contents

Table 8.1.1.4.1.3.3-1: Paging (step 1, Table 8.1.1.4.1.3.2-3)

Derivation Path: TS 38.508-1 [4], Table 4.6.1-9 with condition NR_RRC_RESUME

Table 8.1.1.4.1.3.3-2: RRCRelease (step 6, 13, Table 8.1.1.4.1.3.2-3)

Derivation Path: TS 38.508-1 [4], Table 4.6.1-16 with condition NR_RRC_INACTIVE

Table 8.1.1.4.1.3.3-3: SIB1 (step 7, Table 8.1.1.4.1.3.2-3)

Derivation Path: TS 38.508-1 [4], Table 4.6.1-28			
Information Element	Value/remark	Comment	Condition
SIB1 ::= SEQUENCE {			
useFullResumeID	true		
}			

Table 8.1.1.4.1.3.3-4: Paging (step 10 and 24, Table 8.1.1.4.1.3.2-3)

Derivation Path: TS 38.508-1 [4], Table 4.6.1-9 with condition NR_RRC_RESUME

Table 8.1.1.4.1.3.3-5: RRCResumeRequest (step 16, Table 8.1.1.4.1.3.2-3)

Derivation Path: TS 38.508-1 [4], Table 4.6.1-19			
Information Element	Value/remark	Comment	Condition
RRCResumeRequest ::= SEQUENCE {			
rrcResumeRequest SEQUENCE {			
resumeCause	rna-Update		
}			
}			

Table 8.1.1.4.1.3.3-6: RRCResume (step 3, 12, Table 8.1.1.4.1.3.2-3)

Derivation Path: TS 38.508-1 [4], Table 4.6.1-17

Table 8.1.1.4.1.3.3-7: Void**Table 8.1.1.4.1.3.3-8: RRCResume (step 17, Table 8.1.1.4.1.3.2-3)**

Derivation Path: TS 38.508-1 [4], Table 4.6.1-17			
Information Element	Value/remark	Comment	Condition
RRCResume ::= SEQUENCE {			
criticalExtensions CHOICE {			
rrcResume SEQUENCE {			
masterCellGroup := SEQUENCE {	CellGroupConfig	Table 8.1.1.4.1.3.3-10	
}			
}			
}			

Table 8.1.1.4.1.3.3-9: Void**Table 8.1.1.4.1.3.3-10: CellGroupConfig (Table 8.1.1.4.1.3.3-8)**

Derivation Path: TS 38.508-1 [4], Table 4.6.3-19 with condition RESUME			
Information Element	Value/remark	Comment	Condition
CellGroupConfig ::= SEQUENCE {			
spCellConfigDedicated	ServingCellConfig		
}			

Table 8.1.1.4.1.3.3-11: ServingCellConfig (Table 8.1.1.4.1.3.3-10: CellGroupConfig)

Derivation Path: TS 38.508-1 [4], Table 4.6.3-167 with condition RESUME			
Information Element	Value/remark	Comment	Condition
ServingCellConfig ::= SEQUENCE {			
initialDownlinkBWP	BWP-DownlinkDedicated		
}			

Table 8.1.1.4.1.3.3-12: BWP-DownlinkDedicated (Table 8.1.1.4.1.3.3-11: ServingCellConfig)

Derivation Path: TS 38.508-1 [4], Table 4.6.3-11			
Information Element	Value/remark	Comment	Condition
BWP-DownlinkDedicated ::= SEQUENCE {			
pdcch-Config	Not present		
pdsch-Config CHOICE {			
setup	PDSCH-Config		
}			
}			

Table 8.1.1.4.1.3.3-13: PDSCH-Config (Table 8.1.1.4.1.3.3-12: BWP-DownlinkDedicated)

Derivation Path: TS 38.508-1 [4], Table 4.6.3-100			
Information Element	Value/remark	Comment	Condition
PDSCH-Config ::= SEQUENCE {			
dmrs-DownlinkForPDSCH-MappingTypeA	Not present		
tci-StatesToAddModList SEQUENCE(SIZE (1.. maxNrofTCI-States)) OF TCI-State {	1 entry		
TCI-State[1] SEQUENCE {		entry 1	
tci-StateId	0		

qcl-type1 SEQUENCE {			
referenceSignal CHOICE {			
ssb	SSB index #n	SSB index of NR Cell 2	
}			
}			
}			
}			
}			

Table 8.1.1.4.1.3.3-14: SIB1 (step 22A, Table 8.1.1.4.1.3.2-3)

Derivation Path: TS 38.508-1 [4] table 4.6.1-28			
Information Element	Value/Remark	Comment	Condition
SIB1 ::= SEQUENCE {			
servingCellConfigCommon SEQUENCE {			
uplinkConfigCommon SEQUENCE {			
initialUplinkBWP SEQUENCE {			
rach-ConfigCommon SEQUENCE {			
rach-ConfigGeneric SEQUENCE {			
prach-ConfigurationIndex	91		FR1
	156		FR2
ra-ResponseWindow	sl20		
}			
}			
}			
}			
}			
}			

Condition	Explanation
FR1	410 MHz – 7125 MHz
FR2	24250 MHz – 52600 MHz

8.1.1.4.2 RRC resume / Suspend-Resume / RRC setup / T319 expiry

8.1.1.4.2.1 Test Purpose (TP)

(1)

```
with { UE in NR RRC_INACTIVE state and sends RRCResumeRequest message to resume RRC Connection }
ensure that {
  when { UE receives a RRCSetup message }
  then { UE shall discards any stored UE Inactive AS context, suspendConfig and send RRCSetupComplete message with ng-5G-S-TMSI-Value set to ng-5G-S-TMSI }
}
```

(2)

```
with { UE in NR RRC_INACTIVE state and sends RRCResumeRequest message to resume RRC Connection }
ensure that {
  when { T319 expires }
  then { UE shall release RRC connection with release cause RRC Resume failure and go to NR RRC_IDLE state }
}
```

8.1.1.4.2.2 Conformance requirements

References: The conformance requirements covered in the present TC are specified in: TS 38.331, clauses 5.3.3.4, 5.3.11, 5.3.13.5 and 5.3.13.7 and TS 24.501 clause 5.3.1.4. Unless otherwise stated these are Rel-15 requirements.

[TS 38.331, clause 5.3.3.4]

The UE shall perform the following actions upon reception of the *RRCSetup*:

...

- 1> if the *RRCSetup* is received in response to an *RRCResumeRequest* or *RRCResumeRequest1*:
 - 2> discard any stored UE Inactive AS context and *suspendConfig*;
 - 2> discard any current AS security context including the K_{RRCEnc} key, the K_{RRCint} key, the K_{UPint} key and the K_{UPenc} key;
 - 2> release radio resources for all established RBs except SRB0, including release of the RLC entities, of the associated PDCP entities and of SDAP;
 - 2> release the RRC configuration except for the default MAC Cell Group configuration and CCCH configuration;
 - 2> indicate to upper layers fallback of the RRC connection;
 - 2> stop timer T380, if running;
- 1> perform the cell group configuration procedure in accordance with the received *masterCellGroup* and as specified in 5.3.5.5;
- 1> perform the radio bearer configuration procedure in accordance with the received *radioBearerConfig* and as specified in 5.3.5.6;
- 1> if stored, discard the cell reselection priority information provided by the *cellReselectionPriorities* or inherited from another RAT;
- 1> stop timer T300, T301 or T319 if running;
- 1> if T390 is running:
 - 2> stop timer T390 for all access categories;
 - 2> perform the actions as specified in 5.3.14.4.
- 1> stop timer T302, if running;
- 1> stop timer T320, if running;
- 1> if the *RRCSetup* is received in response to an *RRCResumeRequest*, *RRCResumeRequest1* or *RRCSetupRequest*:
 - 2> enter RRC_CONNECTED;
 - 2> stop the cell re-selection procedure;
- 1> consider the current cell to be the PCell;
- 1> set the content of *RRCSetupComplete* message as follows:
 - 2> if upper layers provide an *5G-S-TMSI*:
 - 3> if the *RRCSetup* is received in response to an *RRCSetupRequest*:
 - 4> set the *ng-5G-S-TMSI-Value* to *ng-5G-S-TMSI-Part2*;
 - 3> else:
 - 4> set the *ng-5G-S-TMSI-Value* to *ng-5G-S-TMSI*;
 - 2> set the *selectedPLMN-Identity* to the PLMN selected by upper layers (TS 24.501 [23]) from the PLMN(s) included in the *plmn-IdentityList* in *SIB1*;
 - 2> if upper layers provide the 'Registered AMF':
 - 3> include and set the *registeredAMF* as follows:

4> if the PLMN identity of the 'Registered AMF' is different from the PLMN selected by the upper layers:

5> include the *plmnIdentity* in the *registeredAMF* and set it to the value of the PLMN identity in the 'Registered AMF' received from upper layers;

4> set the *amf-Identifier* to the value received from upper layers;

3> include and set the *guami-Type* to the value provided by the upper layers;

2> if upper layers provide one or more S-NSSAI (see TS 23.003 [21]):

3> include the *s-nssai-List* and set the content to the values provided by the upper layers;

2> set the *dedicatedNAS-Message* to include the information received from upper layers;

1> submit the *RRCSetupComplete* message to lower layers for transmission, upon which the procedure ends

[TS 38.331, clause 5.3.11]

UE shall:

1> reset MAC;

1> if T302 is running:

2> stop timer T302;

2> perform the actions as specified in 5.3.14.4;

1> stop all timers that are running except T320 and T325;

1> discard the UE Inactive AS context;

1> set the variable *pendingRnaUpdate* to *false*, if that is set to *true*;

1> discard the K_{gNB} , the K_{RRCenc} key, the K_{RRCint} , the K_{UPint} key and the K_{UPenc} key, if any;

1> release all radio resources, including release of the RLC entity, the MAC configuration and the associated PDCP entity and SDAP for all established RBs;

1> indicate the release of the RRC connection to upper layers together with the release cause;

1> enter RRC_IDLE and perform cell selection as specified in TS 38.304 [20], except if going to RRC_IDLE was triggered by selecting an inter-RAT cell while T311 was running;

[TS 38.331, clause 5.3.13.5]

The UE shall:

1> if timer T319 expires or upon receiving Integrity check failure indication from lower layers while T319 is running:

2> perform the actions upon going to RRC_IDLE as specified in 5.3.11 with release cause 'RRC Resume failure'.

[TS 38.331, clause 5.3.13.7]

The UE shall:

1> perform the RRC connection setup procedure as specified in 5.3.3.4.

[TS 24.501, clause 5.3.1.4]

...

If the UE in 5GMM-CONNECTED mode with RRC inactive indication receives an indication from the lower layers that the resumption of the RRC connection has failed, and:

- a) if the lower layers indicate that access barring is applicable for all access categories except categories 0 and 2, the UE shall:
- 1) stay in 5GMM-CONNECTED mode with RRC inactive indication;
- b) else, the UE shall:
- 1) enter 5GMM-IDLE mode; and
 - 2) initiate the registration procedure for mobility and periodic registration update used for mobility (i.e. the 5GS registration type IE set to "mobility registration updating" in the REGISTRATION REQUEST message) for N1 NAS signalling connection recovery as specified in subclause 5.5.1.3.2.

NOTE 2: An indication from the lower layer that the RRC connection has been released with cause "RRC resume failure" can be considered as an indication that the resumption of the RRC connection has failed.

8.1.1.4.2.3 Test description

8.1.1.4.2.3.1 Pre-test conditions

System Simulator:

- NR Cell 1 is the serving cell.
- System information combination NR-1 as defined in TS 38.508-1 [4] clause 4.4.3.1.2 is used in NR cell.

UE:

- None.

Preamble:

- The UE is in state 2N-A as defined in TS 38.508-1 [4], Table 4.4A.2-2 on NR Cell 1.

8.1.1.4.2.3.2 Test procedure sequence

Table 8.1.1.4.2.3.2-1: Main behaviour

St	Procedure	Message Sequence		TP	Verdict
		U - S	Message		
1	The SS transmits a <i>Paging</i> message including a matched identity (correct <i>fullI-RNTI</i>).	<--	NR RRC: <i>Paging</i>	-	-
2	The UE transmit an <i>RRCResumeRequest</i> message to resume RRC Connection by setting <i>resumIdentity</i> to the stored <i>shortI-RNTI</i> value?	-->	NR RRC: <i>RRCResumeRequest</i>	-	-
3	The SS transmits an <i>RRCSetup</i> message in response to <i>RRCResumeRequest</i> message.	<--	NR RRC: <i>RRCSetup</i>	-	-
4	Check: Does the UE transmits an <i>RRCSetupComplete</i> message and a REGISTRATION REQUEST message by discarding any stored UE Inactive AS context and <i>suspendConfig</i> , setting the <i>ng-5G-S-TMSI-Value</i> to <i>ng-5G-S-TMSI</i> ?	-->	NR RRC: <i>RRCSetupComplete</i> 5GMM: REGISTRATION REQUEST	1	P
4A-4B	Steps 4-5 as defined in TS 38.508-1 [4] Table 4.9.5.2.2-1.	-	-	-	-
4C-4F	Steps 5-8 as defined in TS 38.508-1 [4] Table 4.5.4.2-3.	-	-	-	-
5	The SS transmits an <i>RRCRelease</i> message including both <i>fullI-RNTI</i> and <i>shortI-RNTI</i> in <i>suspendConfig</i> .	<--	NR RRC: <i>RRCRelease</i>	-	-
6	The SS transmits a <i>Paging</i> message including a matched identities (correct <i>fullI-RNTI</i>).	<--	NR RRC: <i>Paging</i>	-	-

7	The UE transmits an <i>RRCResumeRequest</i> message to resume RRC Connection by setting <i>resumeIdentity</i> to the stored <i>shortI-RNTI</i> value?	-->	NR RRC: <i>RRCResumeRequest</i>	-	-
8	The SS waits for T319 expiry.	-	-	-	-
9	Check: Does the test result of test procedure in TS 38.508-1 [4] subclause 4.9.5 indicate that the UE has performed mobility registration on NR cell 1 started in NR RRC_IDLE?	-	-	2	-

8.1.1.4.2.3.3 Specific message contents

Table 8.1.1.4.2.3.3-1: *RRCRelease* (preamble and step 5 in Table 8.1.1.4.2.3.2-1)

Derivation Path: TS 38.508-1 [4], Table 4.6.1-16			
Information Element	Value/remark	Comment	Condition
<i>RRCRelease</i> ::= SEQUENCE {			
<i>criticalExtensions</i> CHOICE {			
<i>rrcRelease</i> SEQUENCE {			
<i>suspendConfig</i> SEQUENCE {			NR_RRC_I NACTIVE
fullI-RNTI	I-RNTI-Value		
shortI-RNTI	ShortI-RNTI-Value		
}			
}			
}			
}			

Table 8.1.1.4.2.3.3-1a: *Void*

Table 8.1.1.4.2.3.3-2: *RRCResumeRequest* (step 2 and 7 Table 8.1.1.4.2.3.2-1)

Derivation Path: TS 38.508-1 [4], Table 4.6.1-19			
Information Element	Value/remark	Comment	Condition
<i>RRCResumeRequest</i> ::= SEQUENCE {			
<i>rrcResumeRequest</i> SEQUENCE {			
<i>resumeCause</i>	mt-Access		
}			
}			

Table 8.1.1.4.2.3.3-3: *RRCSetupComplete* (step 4 in Table 8.1.1.4.2.3.2-1)

Derivation Path: TS 38.508-1 [4], Table 4.6.1-22			
Information Element	Value/remark	Comment	Condition
<i>RRCSetupComplete</i> ::= SEQUENCE {			
<i>criticalExtensions</i> CHOICE {			
<i>rrcSetupComplete</i> SEQUENCE {			
ng-5G-S-TMSI-Value	ng-5G-S-TMSI		
}			
}			
}			

Table 8.1.1.4.2.3.3-4: REGISTRATION REQUEST (step 4 in Table 8.1.1.4.2.3.2-1)

Derivation Path: TS 38.508-1 [4], Table 4.7.1-6			
Information Element	Value/remark	Comment	Condition
5GS registration type			

5GS registration type value	'010'B	Mobility registration updating	
Uplink data status	Present but contents not checked		

Table 8.1.1.4.2.3.3-5: RRCReconfiguration (step 4E in Table 8.1.1.4.2.3.2-1)

Derivation Path: TS 38.508-1 [4], Table 4.6.1-13 condition NR and SRB2			
Information Element	Value/remark	Comment	Condition
RRCReconfiguration ::= SEQUENCE {			
dedicatedNAS-MessageList	Not present		
}			

8.1.1.4.3 Void

8.1.1.4.4 RRC resume / Suspend-Resume / RRC reconfiguration / Active MCG SCell addition / Intra-band Contiguous CA

8.1.1.4.4.1 Test Purpose (TP)

FFS

8.1.1.4.4.2 Conformance requirements

FFS

8.1.1.4.4.3 Test description

8.1.1.4.4.3.1 Pre-test conditions

System Simulator:

- NR Cell 1 is the PCell, NR Cell 3 is the SCell.
- System information combination NR-1 as defined in TS 38.508-1 [4] clause 4.4.3.1.2 is used in NR cell.

UE:

- None.

Preamble:

- The UE is in state 2N-A as defined in TS 38.508-1 [4], Table 4.4A.2-2 on NR Cell 1.

8.1.1.4.4.3.2 Test procedure sequence

Table 8.1.1.4.4.3.2-1: Main behaviour

St	Procedure	Message Sequence		TP	Verdict
		U - S	Message		
1	The SS transmits a <i>Paging</i> message including a matched identity (correct <i>fullI-RNTI</i>).	<--	NR RRC: <i>Paging</i>	-	-
2	Check: Does the UE transmit an <i>RRCResumeRequest</i> message by setting <i>resumeIdentity</i> to the stored <i>shortI-RNTI</i> value?	-->	NR RRC: <i>RRCResumeRequest</i>	1	P
3	The SS transmits an <i>RRCResume</i> message.	<--	NR RRC: <i>RRCResume</i>	-	-

4	The UE transmits an <i>RRCResumeComplete</i> message.	-->	NR RRC: <i>RRCResumeComplete</i>	-	-
---	---	-----	----------------------------------	---	---

FFS

8.1.1.4.4.3.3 Specific message contents

Table 8.1.1.4.4.3.3-1: Paging (step 1, Table 8.1.1.4.4.3.2-1)

Derivation Path: TS 38.508-1 [4], Table 4.6.1-9 with condition NR_RRC_RESUME
--

Table 8.1.1.4.4.3.3-2: *RRCResume* (step 3, Table 8.1.1.4.4.3.2-1)

Derivation Path: TS 38.508-1 [4] Table 4.6.1-17			
Information Element	Value/remark	Comment	Condition
<i>RRCResume</i> ::= SEQUENCE {			
rrc-TransactionIdentifier	RRC-TransactionIdentifier		
criticalExtensions CHOICE {			
rrcResume SEQUENCE {			
masterCellGroup	CellGroupConfig with condition RESUME and SCell_add		
}			
}			
}			

Table 8.1.1.4.4.3.3-3: *CellGroupConfig* (Table 8.1.1.4.4.3.2-2)

Derivation Path: TS 38.508-1 [4] Table 4.6.3-19			
Information Element	Value/remark	Comment	Condition
<i>CellGroupConfig</i> ::= SEQUENCE {			
sCellToAddModList SEQUENCE (SIZE (1..maxNrofSCells)) OF SCellConfig {	1 entry		
SCellConfig[1] SEQUENCE {		entry 1	
sCellState-r16	activated		
}			
}			
}			

FFS

8.1.1.4.5 RRC resume / Suspend-Resume / RRC reconfiguration / Active MCG SCell addition / Intra-band non-Contiguous CA

8.1.1.4.5.1 Test Purpose (TP)

Same as TC 8.1.1.4.4 but applied to Intra-band non-Contiguous CA.

8.1.1.4.5.2 Conformance requirements

Same as TC 8.1.1.4.4 but applied to Intra-band non-Contiguous CA.

8.1.1.4.5.3 Test description

8.1.1.4.5.3.1 Pre-test conditions

Same as TC 8.1.1.4.4 with the following differences:

- CA configuration: Intra-band non-contiguous replaces Intra-band Contiguous CA

8.1.1.4.5.3.2 Test procedure sequence

Same as TC 8.1.1.4.4 with the following differences:

- CA configuration: Intra-band non-contiguous replaces Intra-band Contiguous CA

8.1.1.4.6 RRC resume / Suspend-Resume / RRC reconfiguration / Active MCG SCell addition / Inter-band CA

8.1.1.4.6.1 Test Purpose (TP)

Same as TC 8.1.1.4.4 but applied to Inter-band CA case.

8.1.1.4.6.2 Conformance requirements

Same as TC 8.1.1.4.4 but applied to Inter-band CA case.

8.1.1.4.6.3 Test description

8.1.1.4.6.3.1 Pre-test conditions

Same as TC 8.1.1.4.4 with the following differences:

- CA configuration: Inter-band CA replaces Intra-band Contiguous CA
- Cells configuration: NR Cell 10 replaces NR Cell 3

8.1.1.4.6.3.2 Test procedure sequence

Same as TC 8.1.1.4.4 with the following differences:

- CA configuration: Inter-band CA replaces Intra-band Contiguous CA
- Cells configuration: NR Cell 10 replaces NR Cell 3

8.1.1.4.7 RRC resume / Suspend-Resume / RRC setup / Active SCG SCell addition / Intra-band Contiguous CA

8.1.1.4.7.1 Test Purpose (TP)

FFS

8.1.1.4.7.2 Conformance requirements

FFS

8.1.1.4.7.3 Test description

8.1.1.4.7.3.1 Pre-test conditions

System Simulator:

- NR Cell 1 is the PCell, NR Cell 3 is the PSCell, NR Cell 12 is the SCell
- System information combination NR-1 as defined in TS 38.508-1 [4] clause 4.4.3.1.2 is used in NR cells.

UE:

- None.

Preamble:

- The UE is in state 2N-A as defined in TS 38.508-1 [4], Table 4.4A.2-2 on NR Cell 1.

8.1.1.4.7.3.2 Test procedure sequence

Table 8.1.1.4.7.3.2-1: Main behaviour

St	Procedure	Message Sequence		TP	Verdict
		U - S	Message		
1	The SS transmits a <i>Paging</i> message including a matched identity (correct <i>fullI-RNTI</i>).	<--	NR RRC: <i>Paging</i>	-	-
2	The UE transmit an <i>RRCResumeRequest</i> message to resume RRC Connection by setting <i>resumelidentity</i> to the stored <i>shortI-RNTI</i> value?	-->	NR RRC: <i>RRCResumeRequest</i>	-	-
3	The SS transmits an <i>RRCSetup</i> message in response to <i>RRCResumeRequest</i> message.	<--	NR RRC: <i>RRCSetup</i>	-	-
4	The UE transmits an <i>RRCSetupComplete</i> message and a REGISTRATION REQUEST message by discarding any stored UE Inactive AS context and suspendConfig, setting the <i>ng-5G-S-TMSI-Value</i> to <i>ng-5G-S-TMSI</i> ?	-->	NR RRC: <i>RRCSetupComplete</i> 5GMM: REGISTRATION REQUEST	-	-
5-6	Steps 4-5 as defined in TS 38.508-1 [4] Table 4.9.5.2.2-1.	-	-	-	-
7-8	Steps 5-6 as defined in TS 38.508-1 [4] Table 4.5.4.2-3.	-	-	-	-
9	Step 7 as defined in TS 38.508-1 [4] Table 4.5.4.2-3 and FFS.	-	-	-	-
10	Step 8 as defined in TS 38.508-1 [4] Table 4.5.4.2-3.	-	-	-	-

FFS

8.1.1.4.7.3.3 Specific message contents

Table 8.1.1.4.7.3.3-1: Paging (step 1, Table 8.1.1.4.7.3.2-1)

Derivation Path: TS 38.508-1 [4], Table 4.6.1-9 with condition NR_RRC_RESUME
--

Table 8.1.1.4.7.3.3-2: RRCSetup (step 3, Table 8.1.1.4.7.3.2-1)

Derivation Path: TS 38.508-1 [4] Table 4.6.1-21			
Information Element	Value/remark	Comment	Condition
RRCSetup ::= SEQUENCE {			
rrc-TransactionIdentifier	RRC-TransactionIdentifier		
criticalExtensions CHOICE {			
rrcSetup SEQUENCE {			
radioBearerConfig	RadioBearerConfig with condition RESUME		
masterCellGroup	CellGroupConfig with condition RESUME and SCell_add		
}			
}			
}			

Table 8.1.1.4.7.3.3-3: CellGroupConfig (Table 8.1.1.4.7.3.3-2)

Derivation Path: TS 38.508-1 [4] Table 4.6.3-19			
Information Element	Value/remark	Comment	Condition
CellGroupConfig ::= SEQUENCE {			
sCellToAddModList SEQUENCE (SIZE (1..maxNrofSCells)) OF SCellConfig {	1 entry		
SCellConfig[1] SEQUENCE {		entry 1	
sCellState-r16	activated		
}			
}			
}			

8.1.1.4.8 RRC resume / Suspend-Resume / RRC setup / Active SCG SCell addition / Intra-band non-Contiguous CA

8.1.1.4.8.1 Test Purpose (TP)

Same as TC 8.1.1.4.7 but applied to Intra-band non-Contiguous CA.

8.1.1.4.8.2 Conformance requirements

Same as TC 8.1.1.4.7 but applied to Intra-band non-Contiguous CA.

8.1.1.4.8.3 Test description

8.1.1.4.8.3.1 Pre-test conditions

Same as TC 8.1.1.4.7 with the following differences:

- CA configuration: Intra-band non-contiguous replaces Intra-band Contiguous CA

8.1.1.4.8.3.2 Test procedure sequence

Same as TC 8.1.1.4.7 with the following differences:

- CA configuration: Intra-band non-contiguous replaces Intra-band Contiguous CA

8.1.1.4.9 RRC resume / Suspend-Resume / RRC setup / Active SCG SCell addition / Inter-band CA

8.1.1.4.9.1 Test Purpose (TP)

Same as TC 8.1.1.4.7 but applied to Inter-band CA case.

8.1.1.4.9.2 Conformance requirements

Same as TC 8.1.1.4.7 but applied to Inter-band CA case.

8.1.1.4.9.3 Test description

8.1.1.4.9.3.1 Pre-test conditions

Same as TC 8.1.1.4.7 with the following differences:

- CA configuration: Inter-band CA replaces Intra-band Contiguous CA
- Cells configuration: NR Cell 10 replaces NR Cell 3

8.1.1.4.9.3.2 Test procedure sequence

Same as TC 8.1.1.4.7 with the following differences:

- CA configuration: Inter-band CA replaces Intra-band Contiguous CA
- Cells configuration: NR Cell 10 replaces NR Cell 3

8.1.2 RRC reconfiguration

8.1.2.1 Radio bearer establishment / reconfiguration / release

8.1.2.1.1 RRC reconfiguration / DRB / SRB / Establishment / Modification / Release / Success

8.1.2.1.1.1 Test Purpose (TP)

(1)

```
with { UE having completed the RRC connection establishment procedure }
ensure that {
  when { SS sends in sequence a SecurityModeCommand and an RRCReconfiguration message to establish a
  DRB and SRB2 }
  then { UE establishes the initial security configuration in accordance with the received
  securityConfigSMC included in SecurityModeCommand and successfully establish the data and signalling
  radio bearers }
}
```

(2)

```
with { UE in NR RRC_CONNECTED state }
ensure that {
  when { UE receives an RRCReconfiguration message to reconfigure the current UE configuration of
  SRB and DRB }
  then { UE reconfigures the data and signalling radio bearers and sends an
  RRCReconfigurationComplete message }
}
```

(3)

```
with { UE in NR RRC_CONNECTED state }
ensure that {
  when { UE receives an RRCReconfiguration message including a drb-ToReleaseList }
  then { for each drb-Identity release the PDCP entity and RLC entity and logical channel and
  indicate release of the DRB(s) to upper layers }
}
```

8.1.2.1.1.2 Conformance requirements

References: The conformance requirements covered in the present TC are specified in: TS 38.331, clauses 5.3.4.3, 5.3.5.6.3, 5.3.5.6.4, and 5.3.5.6.5. Unless otherwise stated these are Rel-15 requirements.

[TS 38.331, clause 5.3.4.3]

The UE shall:

- 1> derive the K_{gNB} key, as specified in TS 33.501 [11];
- 1> derive the K_{RRCint} key associated with the *integrityProtAlgorithm* indicated in the *SecurityModeCommand* message, as specified in TS 33.501 [11];
- 1> request lower layers to verify the integrity protection of the *SecurityModeCommand* message, using the algorithm indicated by the *integrityProtAlgorithm* as included in the *SecurityModeCommand* message and the K_{RRCint} key;
- 1> if the *SecurityModeCommand* message passes the integrity protection check:

- 2> derive the K_{RRCEnc} key and the K_{UPenc} key associated with the *cipheringAlgorithm* indicated in the *SecurityModeCommand* message, as specified in TS 33.501 [11];
- 2> derive the K_{UPint} key associated with the *integrityProtAlgorithm* indicated in the *SecurityModeCommand* message, as specified in TS 33.501 [11];
- 2> configure lower layers to apply SRB integrity protection using the indicated algorithm and the K_{RRCint} key immediately, i.e. integrity protection shall be applied to all subsequent messages received and sent by the UE, including the *SecurityModeComplete* message;

[TS 38.331, clause 5.3.5.6.3]

The UE shall:

- 1> for each *srb-Identity* value included in the *srb-ToAddModList* that is not part of the current UE configuration (SRB establishment or reconfiguration from E-UTRA PDCP to NR PDCP):
 - 2> establish a PDCP entity;
 - 2> if AS security has been activated:
 - 3> if target RAT of handover is E-UTRA/5GC, or;
 - 3> if the UE is only connected to E-UTRA/5GC:
 - 4> configure the PDCP entity with the security algorithms and keys (K_{RRCEnc} and K_{RRCint}) configured/derived as specified in TS 36.331 [10];
 - 3> else:
 - 4> configure the PDCP entity with the security algorithms according to *securityConfig* and apply the keys (K_{RRCEnc} and K_{RRCint}) associated with the master key (K_{eNB}/K_{gNB}) or secondary key ($S-K_{gNB}$) as indicated in *keyToUse*, if applicable;
 - 2> if the current UE configuration as configured by E-UTRA in TS 36.331 [10] includes an SRB identified with the same *srb-Identity* value:
 - 3> associate the E-UTRA RLC entity and DCCH of this SRB with the NR PDCP entity;
 - 3> release the E-UTRA PDCP entity of this SRB;
 - 2> if the *pdcp-Config* is included:
 - 3> configure the PDCP entity in accordance with the received *pdcp-Config*;
 - 2> else:
 - 3> configure the PDCP entity in accordance with the default configuration defined in 9.2.1 for the corresponding SRB;
- 1> for each *srb-Identity* value included in the *srb-ToAddModList* that is part of the current UE configuration:
 - 2> if the *reestablishPDCP* is set:
 - 3> if target RAT of handover is E-UTRA/5GC, or;
 - 3> if the UE is only connected to E-UTRA/5GC:
 - 4> configure the PDCP entity to apply the integrity protection algorithm and K_{RRCint} key configured/derived as specified in TS 36.331 [10], i.e. the integrity protection configuration shall be applied to all subsequent messages received and sent by the UE, including the message used to indicate the successful completion of the procedure;
 - 4> configure the PDCP entity to apply the ciphering algorithm and K_{RRCEnc} key configured/derived as specified in TS 36.331 [10], i.e. the ciphering configuration shall be applied to all subsequent messages received and sent by the UE, including the message used to indicate the successful completion of the procedure;

3> else:

- 4> configure the PDCP entity to apply the integrity protection algorithm and K_{RRCint} key associated with the master key (K_{eNB}/K_{gNB}) or secondary key ($S-K_{gNB}$), as indicated in *keyToUse*, i.e. the integrity protection configuration shall be applied to all subsequent messages received and sent by the UE, including the message used to indicate the successful completion of the procedure;
- 4> configure the PDCP entity to apply the ciphering algorithm and K_{RRCenc} key associated with the master key (K_{eNB}/K_{gNB}) or secondary key ($S-K_{gNB}$) as indicated in *keyToUse*, i.e. the ciphering configuration shall be applied to all subsequent messages received and sent by the UE, including the message used to indicate the successful completion of the procedure;
- 4> re-establish the PDCP entity of this SRB as specified in TS 38.323 [5];

2> else, if the *discardOnPDCP* is set:

3> trigger the PDCP entity to perform SDU discard as specified in TS 38.323 [5];

2> if the *pdcp-Config* is included:

3> reconfigure the PDCP entity in accordance with the received *pdcp-Config*.

[TS 38.331, clause 5.3.5.6.4]

The UE shall:

1> for each *drb-Identity* value included in the *drb-ToReleaseList* that is part of the current UE configuration; or

1> for each *drb-Identity* value that is to be released as the result of full configuration according to 5.3.5.11:

2> release the PDCP entity and the *drb-Identity*;

2> if SDAP entity associated with this DRB is configured:

3> indicate the release of the DRB to SDAP entity associated with this DRB (TS 37.324 [24], clause 5.3.3);

2> if the UE is operating in EN-DC:

3> if a new bearer is not added either with NR or E-UTRA with same *eps-BearerIdentity*:

4> indicate the release of the DRB and the *eps-BearerIdentity* of the released DRB to upper layers.

NOTE 1: The UE does not consider the message as erroneous if the *drb-ToReleaseList* includes any *drb-Identity* value that is not part of the current UE configuration.

NOTE 2: Whether or not the RLC and MAC entities associated with this PDCP entity are reset or released is determined by the *CellGroupConfig*.

[TS 38.331, clause 5.3.5.6.5]

The UE shall:

1> for each *drb-Identity* value included in the *drb-ToAddModList* that is not part of the current UE configuration (DRB establishment including the case when full configuration option is used):

2> establish a PDCP entity and configure it in accordance with the received *pdcp-Config*;

2> if the PDCP entity of this DRB is not configured with *cipheringDisabled*:

3> if target RAT of handover is E-UTRA/5GC, or;

3> if the UE is only connected to E-UTRA/5GC:

4> configure the PDCP entity with the ciphering algorithm and K_{UPenc} key configured/derived as specified in TS 36.331 [10];

3> else:

- 4> configure the PDCP entity with the ciphering algorithms according to *securityConfig* and apply the K_{UPenc} key associated with the master key (K_{eNB}/K_{gNB}) or the secondary key ($S-K_{gNB}$) as indicated in *keyToUse*;
- 2> if the PDCP entity of this DRB is configured with *integrityProtection*:
- 3> configure the PDCP entity with the integrity algorithms according to *securityConfig* and apply the K_{UPint} key associated with the master (K_{eNB}/K_{gNB}) or the secondary key ($S-K_{gNB}$) as indicated in *keyToUse*;
- 2> if an *sdap-Config* is included:
- 3> if an SDAP entity with the received *pdu-Session* does not exist:
- 4> establish an SDAP entity as specified in TS 37.324 [24] clause 5.1.1;
- 4> If an SDAP entity with the received *pdu-Session* did not exist prior to receiving this reconfiguration:
- 5> indicate the establishment of the user plane resources for the *pdu-Session* to upper layers;
- 3> configure the SDAP entity in accordance with the received *sdap-Config* as specified in TS 37.324 [24] and associate the DRB with the SDAP entity;
- 2> if the UE is operating in EN-DC:
- 3> if the DRB was configured with the same *eps-BearerIdentity* either by NR or E-UTRA prior to receiving this reconfiguration:
- 4> associate the established DRB with the corresponding *eps-BearerIdentity*;
- 3> else:
- 4> indicate the establishment of the DRB(s) and the *eps-BearerIdentity* of the established DRB(s) to upper layers;

8.1.2.1.1.3 Test description

8.1.2.1.1.3.1 Pre-test conditions

System Simulator:

- NR Cell 1

UE:

- None

Preamble:

- If *pc_IP_Ping* is set to TRUE then the UE is in 5GS state 1N-A, PDU SESSION ACTIVE according to TS 38.508-1 [4], clause 4.4A.2 Table 4.4A.2-1
- Else, the UE is in 5GS state 1N-A and Test Loop Function (*On*) with UE test loop mode B on NR Cell 1 according to 38.508-1[4], clause 4.4A.2 Table 4.4A.2-3.

8.1.2.1.1.3.2 Test procedure sequence

Table 8.1.2.1.1.3.2-1: Main behaviour

St	Procedure	Message Sequence		TP	Verdict
		U - S	Message		
1	SS transmits a <i>Paging</i> message to the UE on the appropriate paging block, and including the UE identity in one entry of the IE <i>pagingRecordList</i> .	<--	NR RRC: <i>Paging</i>	-	-

2	UE transmits an <i>RRCSetupRequest</i> message.	-->	NR RRC: <i>RRCSetupRequest</i>	-	-
3	SS transmits an <i>RRCSetup</i> message	<--	NR RRC: <i>RRCSetup</i>	-	-
4	The UE transmits an <i>RRCSetupComplete</i> to confirm the successful completion of the connection establishment.	-->	NR RRC: <i>RRCSetupComplete</i>	-	-
5	SS transmits a <i>SecurityModeCommand</i> message to activate AS security.	<--	NR RRC: <i>SecurityModeCommand</i>	-	-
6	Using the same slot as the <i>SecurityModeCommand</i> message in step 5, the SS transmits an <i>RRCReconfiguration</i> message to establish a data radio bearer, DRB1 and signalling radio bearer, SRB2.	<--	NR RRC: <i>RRCReconfiguration</i>	-	-
7	Check: Does the UE transmit a <i>SecurityModeComplete</i> message?	-->	NR RRC: <i>SecurityModeComplete</i>	1	P
8	Check: Does the UE transmit an <i>RRCReconfigurationComplete</i> message to confirm the establishment of data radio bearer, DRB1 and signalling radio bearer, SRB2?	-->	NR RRC: <i>RRCReconfigurationComplete</i>	1	P
9	Void			-	-
10	Void			-	-
11	The SS transmits an <i>RRCReconfiguration</i> message to modify SRB and DRB configuration.	<--	NR RRC: <i>RRCReconfiguration</i>	-	-
12	Check: Does the UE transmit an <i>RRCReconfigurationComplete</i> message?	-->	NR RRC: <i>RRCReconfigurationComplete</i>	2	P
12A	Check: Does the test result of generic test procedure in TS 38.508-1 [4] subclause 4.9.1 indicate that the UE is capable of exchanging IP data on DRB#1 established in Step 11?	-	-	2	-
12A1	The SS transmits an OPEN UE TEST LOOP Message.	<--	OPEN UE TEST LOOP	-	-
12A2	The UE transmits an OPEN UE TEST LOOP COMPLETE Message.	-->	OPEN UE TEST LOOP COMPLETE	-	-
12A3	The SS transmits DEACTIVATE TEST MODE message.	<--	DEACTIVATE TEST MODE	-	-
12A4	The UE transmits DEACTIVATE TEST MODE COMPLETE message.	-->	DEACTIVATE TEST MODE COMPLETE	-	-
12B	Cause the UE to request establishment of PDU session.(Note 1)	-	-	-	-
12C	The PDU session establishment procedure as specified in TS 38.508-1 [4] subclause 4.5A.2 takes place.	-	-	-	-
13	The SS transmits an <i>RRCReconfiguration</i> message with a <i>drb-ToReleaseList</i> and PDU SESSION RELEASE COMMAND to release the PDU session to which the released DRB is associated	<--	NR RRC: <i>RRCReconfiguration</i> 5GMM: DL NAS TRANSPORT 5GSM: PDU SESSION RELEASE COMMAND	-	-
14	Check: Does the UE transmit an <i>RRCReconfigurationComplete</i> message?	-->	NR RRC: <i>RRCReconfigurationComplete</i>	3	P
16	The UE transmits an <i>ULInformationTransfer</i> message and a UL NAS TRASPORT containing PDU SESSION RELEASE COMPLETE.	-->	NR RRC: <i>ULInformationTransfer</i> 5GMM: UL NAS TRANSPORT 5GSM: PDU SESSION RELEASE COMPLETE	-	-

NOTE 1: The request to establish a PDU session may be performed by MMI or AT Command.

8.1.2.1.1.3.3 Specific message contents

Table 8.1.2.1.1.3.3-1: RRCReconfiguration (Step 6, Table 8.1.2.1.1.3.2-1)

Derivation Path: TS 38.508-1, table 4.6.1-13

Information Element	Value/remark	Comment	Condition
RRCReconfiguration ::= SEQUENCE {			
criticalExtensions CHOICE {			
rrcReconfiguration SEQUENCE {			
radioBearerConfig	RadioBearerConfig with conditions SRB2 and DRB1		
nonCriticalExtension SEQUENCE {			
masterCellGroup	CellGroupConfig	OCTET STRING (CONTAINING CellGroupConfig)	
}			
}			
}			

Table 8.1.2.1.1.3.3-1A: CellGroupConfig (Table 8.1.2.1.1.3.3-1)

Derivation Path: TS 38.508-1, table 4.6.3-19			
Information Element	Value/remark	Comment	Condition
CellGroupConfig ::= SEQUENCE {			
rlc-BearerToAddModList SEQUENCE (SIZE(1..maxLC-ID)) OF RLC-BearerConfig {	2 entries		
RLC-Bearer-Config[1] SEQUENCE {		entry 1	
logicalChannelIdentity	LogicalChannelIdentity		
servedRadioBearer CHOICE {			
drb-Identity	DRB-Identity with condition DRB1		
}			
reestablishRLC	Not present		
RLC-Config	RLC-Config with condition AM according to 38.508-1 [4], table 4.6.3-149		
mac-LogicalChannelConfig	LogicalChannelConfig according to 38.508-1 [4], table 4.6.3-66		
}			
RLC-Bearer-Config[2] SEQUENCE {		entry 2	
logicalChannelIdentity	LogicalChannelIdentity		
servedRadioBearer CHOICE {			
srb-Identity	SRB-Identity with condition SRB2		
}			
reestablishRLC	Not present		
RLC-Config	Not present		
mac-LogicalChannelConfig	LogicalChannelConfig according to 38.508-1 [4], table 4.6.3-66		
}			
}			
mac-CellGroupConfig	Not present		
physicalCellGroupConfig	Not present		
spCellConfig SEQUENCE	Not present		
}			

Table 8.1.2.1.1.3.3-2: Void

Table 8.1.2.1.1.3.3-2A: Void

Table 8.1.2.1.1.3.3-3: RRCReconfiguration (Step 11, Table 8.1.2.1.1.3.2-1)

Derivation Path: TS 38.508-1, table 4.6.1-13			
Information Element	Value/remark	Comment	Condition
RRCReconfiguration ::= SEQUENCE {			
criticalExtensions CHOICE {			
rrcReconfiguration SEQUENCE {			
nonCriticalExtension SEQUENCE {			
masterCellGroup	CellGroupConfig	OCTET STRING (CONTAINING CellGroupConfig)	
}			
}			
}			
}			

Table 8.1.2.1.1.3.3-4: CellGroupConfig (Table 8.1.2.1.1.3.3-3)

Derivation Path: TS 38.508-1, table 4.6.3-19			
Information Element	Value/remark	Comment	Condition
CellGroupConfig ::= SEQUENCE {			
rlc-BearerToAddModList SEQUENCE (SIZE(1..maxLC-ID)) OF RLC-BearerConfig {	2 entries		
RLC-Bearer-Config[1] SEQUENCE {		entry 1	
logicalChannelIdentity	LogicalChannelIdentity		
servedRadioBearer CHOICE {			
srb-Identity	SRB-Identity with condition SRB2		
}			
reestablishRLC	true		
RLC-Config	RLC-Config with condition AM according to 38.508-1 [4], table 4.6.3-149		
mac-LogicalChannelConfig	LogicalChannelConfig according to 38.508-1 [4], table 4.6.3-66		
}			
RLC-Bearer-Config[2] SEQUENCE {		entry 2	
logicalChannelIdentity	LogicalChannelIdentity		
servedRadioBearer CHOICE {			
drb-Identity	DRB-Identity with condition DRB1		
}			
reestablishRLC	true		
RLC-Config	Not present		
mac-LogicalChannelConfig	LogicalChannelConfig according to 38.508-1 [4], table 4.6.3-66		
}			
}			
mac-CellGroupConfig	Not present		
physicalCellGroupConfig	Not present		
spCellConfig SEQUENCE	Not present		
}			

Table 8.1.2.1.1.3.3-5: RRCReconfiguration (Step 13, Table 8.1.2.1.1.3.2-1)

Derivation Path: TS 38.508-1, table 4.6.1-3			
Information Element	Value/remark	Comment	Condition
RRCReconfiguration ::= SEQUENCE {			
criticalExtensions CHOICE {			
rrcReconfiguration SEQUENCE {			

radioBearerConfig	RadioBearerConfig		
nonCriticalExtension SEQUENCE {			
masterCellGroup	CellGroupConfig	OCTET STRING (CONTAINING CellGroupConfig)	
}			
}			
}			

Table 8.1.2.1.1.3.3-6: RadioBearerConfig (Table 8.1.2.1.1.3.3-5)

Derivation Path: TS 38.508-1 [4], Table 4.6.3-132			
Information Element	Value/remark	Comment	Condition
RadioBearerConfig ::= SEQUENCE {			
drb-ToReleaseList	1	DRB1	
}			

Table 8.1.2.1.1.3.3-7: CellGroupConfig (Table 8.1.2.1.1.3.3-5)

Derivation Path: TS 38.508-1 [4], Table 4.6.3-19			
Information Element	Value/remark	Comment	Condition
CellGroupConfig ::= SEQUENCE {			
cellGroupId	1		
ric-BearerToAddModList	Not Present		
ric-BearerToReleaseList SEQUENCE (SIZE(1..maxLC-ID)) OF LogicalChannelIdentity {	1 entry		
logicalChannelIdentity[1]	LogicalChannelIdentity	entry 1	
}			
mac-CellGroupConfig	Not Present		
tag-Config	Not Present		
phr-Config	Not Present		
physicalCellGroupConfig	Not Present		
rlf-TimersAndConstants	Not Present		
}			

8.1.2.1.2 RRC reconfiguration / RRC bearer establishment / uplinkTxDirectCurrentList

8.1.2.1.2.1 Test Purpose (TP)

(1)

```
with { UE in NR RRC_CONNECTED state }
ensure that {
  when { UE receives a RRCReconfiguration message containing reportUplinkTxDirectCurrent }
  then { UE will include the uplinkTxDirectCurrentList in RRCReconfigurationComplete message. }
}
```

8.1.2.1.2.2 Conformance requirements

References: The conformance requirements covered in the current TC are specified in: TS 38.331 clauses 5.3.5.3. Unless otherwise stated these are Rel-15 requirements.

[TS 38.331, clause 5.3.5.3]

The UE shall perform the following actions upon reception of the *RRCReconfiguration*:

...

1> set the content of *RRCReconfigurationComplete* message as follows:

- 2> if the *RRCReconfiguration* includes the *masterCellGroup* containing the *reportUplinkTxDirectCurrent*, or;
- 2> if the *RRCReconfiguration* includes the *secondaryCellGroup* containing the *reportUplinkTxDirectCurrent*:
- 3> include the *uplinkTxDirectCurrentList*;

8.1.2.1.2.3 Test description

8.1.2.1.2.3.1 Pre-test conditions

System Simulator:

- NR Cell 1.
- System information combination NR-1 as defined in TS 38.508-1 [4] clause 4.4.3.1 is used in NR cell.

UE:

- None.

Preamble:

- The UE is in state 3N-A according to TS 38.508-1 [4], clause 4.4A.2 Table 4.4A.2-3.

8.1.2.1.2.3.2 Test procedure sequence

Table 8.1.2.1.2.3.2-1: Main behaviour

St	Procedure	Message Sequence		TP	Verdict
		U - S	Message		
1	The SS transmits a <i>RRCReconfiguration</i> message containing <i>uplinkBWP-ToAddModList</i> IE to add BWP#1 and including <i>reportUplinkTxDirectCurrent</i> IE.	<--	NR RRC: <i>RRCReconfiguration</i>	-	-
2	Check: Does the UE transmit the <i>RRCReconfigurationComplete</i> message including the <i>uplinkTxDirectCurrentList</i> ?	-->	NR RRC: <i>RRCReconfigurationComplete</i>	1	P

8.1.2.1.2.3.3 Specific message contents

Table 8.1.2.1.2.3.3-1: *RRCReconfiguration* (step 1, Table 8.1.2.1.2.3.2-1)

Derivation Path: TS 38.508-1 [4], Table 4.6.1-13			
Information Element	Value/remark	Comment	Condition
<i>RRCReconfiguration</i> ::= SEQUENCE {			
<i>criticalExtensions</i> CHOICE {			
<i>rrcReconfiguration</i> SEQUENCE {			
<i>nonCriticalExtension</i> SEQUENCE {			
<i>masterCellGroup</i>	CellGroupConfig		
}			
}			
}			
}			

Table 8.1.2.1.2.3.3-2: *CellGroupConfig* (Table 8.1.2.1.2.3.3-1)

Derivation Path: TS 38.508-1 [4], Table 4.6.3-19			
Information Element	Value/remark	Comment	Condition
<i>CellGroupConfig</i> ::= SEQUENCE {			
<i>spCellConfig</i> SEQUENCE {			
<i>spCellConfigDedicated</i>	ServingCellConfig		

}			
reportUplinkTxDirectCurrent-v1530	true		
}			

Table 8.1.2.1.2.3.3-3: ServingCellConfig (Table 8.1.2.1.2.3.3-2)

Derivation Path: TS 38.508-1 [4] Table 4.6.3-167			
Information Element	Value/remark	Comment	Condition
ServingCellConfigCommon ::= SEQUENCE {			
uplinkConfig SEQUENCE {			
uplinkBWP-ToAddModList SEQUENCE (SIZE (1..maxNrofBWPs)) OF BWP-Uplink {	1 entry		
BWP-Uplink[1]	BWP-Uplink	entry 1 TS 38.508-1 [4], Table 4.6.3-13 to add BWP#1	
}			
}			
}			

Table 8.1.2.1.2.3.3-4: RRCReconfigurationComplete (step 2, Table 8.1.2.1.2.3.2-1)

Derivation Path: TS 38.508-1 [4], Table 4.6.1-14			
Information Element	Value/remark	Comment	Condition
RRCReconfigurationComplete ::= SEQUENCE {			
rrc-TransactionIdentifier	Not checked		
criticalExtensions CHOICE {			
rrcReconfigurationComplete SEQUENCE {			
lateNonCriticalExtension	Not checked		
nonCriticalExtension SEQUENCE {			
UplinkTxDirectCurrentList SEQUENCE (SIZE (1..maxNrofServingCells)) OF UplinkTxDirectCurrentCell {	1 entry		
UplinkTxDirectCurrentCell[1] SEQUENCE {		entry 1	
servCellIndex	0		
UplinkTxDirectCurrentBWP SEQUENCE (SIZE (1..maxNrofBWPs)) OF UplinkTxDirectCurrentBWP {	2 entries		
UplinkTxDirectCurrentBWP[1] SEQUENCE {		entry 1	
bwp-Id	0		
shift7dot5kHz	Not checked		
txDirectCurrentLocation	Any value between 0 and 3299		
}			
UplinkTxDirectCurrentBWP[2] SEQUENCE {		entry 2	
bwp-Id	1		
shift7dot5kHz	Not checked		
txDirectCurrentLocation	Any value between 0 and 3299		
}			
}			
}			
nonCriticalExtension	Not checked		
}			
}			
}			

8.1.2.1.3 Void

8.1.2.1.4 RRC reconfiguration / Dedicated RLF timer

8.1.2.1.4.1 Test Purpose (TP)

(1)

```
with { UE in NR RRC_CONNECTED state configured with timers according rlf-TimersAndConstants }
ensure that {
  when { UE detecting radio link failure on expiring of timer T310 }
  then { UE sends an RRCReestablishmentRequest message according rlf-TimersAndConstants }
}
```

(2)

```
with { UE in NR RRC_CONNECTED state with rlf-TimersAndConstants released}
ensure that {
  when { UE detecting radio link failure on expiring of timer T310 }
  then { UE sends an RRCReestablishmentRequest message according ue-TimersAndConstants }
}
```

8.1.2.1.4.2 Conformance requirements

References: The conformance requirements covered in the current TC are specified in: TS 38.331 clauses 5.3.5.3, 5.3.5.5, 5.3.5.5.6 and 5.3.5.5.7.

[TS 38.331 clause 5.3.5.3]

The UE shall perform the following actions upon reception of the *RRCReconfiguration*:

...

1> if the *RRCReconfiguration* includes the *masterCellGroup*:

2> perform the cell group configuration for the received *masterCellGroup* according to 5.3.5.5;

...

1> else:

2> submit the *RRCReconfigurationComplete* message via SRB1 to lower layers for transmission using the new configuration;

[TS 38.331 clause 5.3.5.5]

The UE performs the following actions based on a received *CellGroupConfig* IE:

...

1> if the *CellGroupConfig* contains the *spCellConfig*:

2> configure the SpCell as specified in 5.3.5.5.7;

[TS 38.331 clause 5.3.5.5.7]

The UE shall:

1> if the *SpCellConfig* contains the *rlf-TimersAndConstants*:

2> configure the RLF timers and constants for this cell group as specified in 5.3.5.5.6;

[TS 38.331 clause 5.3.5.5.6]

The UE shall:

1> if the received *rlf-TimersAndConstants* is set to *release*:

2> use values for timers T301, T310, T311 and constants N310, N311, as included in *ue-TimersAndConstants* received in *SIB1*;

1> else:

2> (re-)configure the value of timers and constants in accordance with received *rlf-TimersAndConstants*;

8.1.2.1.4.3 Test description

8.1.2.1.4.3.1 Pre-test conditions

System Simulator:

- NR Cell 1 and NR Cell 2.
- System information combination NR-2 as defined in TS 38.508-1 [4] clause 4.4.3.1.2 is used in NR cells.

None.

Preamble:

- The UE is in state 3N-A as defined in TS 38.508-1 [4], subclause 4.4A on NR Cell 1.

8.1.2.1.4.3.2 Test procedure sequence

Table 8.1.2.1.4.3.2-1: Time instances of cell power level and parameter changes for FR1

	Parameter	Unit	NR Cell 1	NR Cell 2
T1	SS/PBCH SSS EPRE	dBm/SCS	"Off"	-88
T2	SS/PBCH SSS EPRE	dBm/SCS	"-88"	"Off"

Table 8.1.2.1.4.3.2-2: Time instances of cell power level and parameter changes for FR2

	Parameter	Unit	NR Cell 1	NR Cell 2
T1	SS/PBCH SSS EPRE	dBm/SCS	"Off"	-82
T2	SS/PBCH SSS EPRE	dBm/SCS	"-82"	"Off"

Table 8.1.2.1.4.3.2-3: Main behaviour

St	Procedure	Message Sequence		TP	Verdict
		U - S	Message		
1	The SS changes NR Cell 1 and NR Cell 2 parameters according to the row "T1" in table 8.1.2.1.4.3.2-1 or 8.1.2.1.4.3.2-2 in order that the radio link quality of NR Cell 1 is degraded, and NR Cell 2 is suitable for camping.	-	-	-	-
2	Check: Does the UE send <i>RRCReestablishmentRequest</i> message on NR Cell 2 after T310 expired (ms6000)?	-->	NR RRC: <i>RRCReestablishmentRequest</i>	1	P
3	The SS transmits an <i>RRCReestablishment</i> message.	<--	NR RRC: <i>RRCReestablishment</i>	-	-
4	The UE transmits an <i>RRCReestablishmentComplete</i> message.	-->	NR RRC: <i>RRCReestablishmentComplete</i>	-	-
5	The SS transmits an <i>RRCReconfiguration</i> message containing <i>RLF-TimersAndConstants</i> set to release.	<--	NR RRC: <i>RRCReconfiguration</i>	-	-

6	The UE transmits an <i>RRCReconfigurationComplete</i> message.	-->	NR RRC: <i>RRCReconfigurationComplete</i>	-	-
7	The SS changes NR Cell 1 and NR Cell 2 parameters according to the row "T2" in table 8.1.2.1.4.3.2-1 or 8.1.2.1.4.3.2-2 in order that the radio link quality of NR Cell 2 is degraded, and NR Cell 1 is suitable for camping.	-	-	-	-
8	Check: Does the UE send <i>RRCReestablishmentRequest</i> message on NR Cell 1 after T310 expired (ms1000)?	-->	NR RRC: <i>RRCReestablishmentRequest</i>	2	P
9	The SS transmits <i>RRCReestablishment</i> message.	<--	NR RRC: <i>RRCReestablishment</i>	-	-
10	The UE transmits an <i>RRCReestablishmentComplete</i> message.	-->	NR RRC: <i>RRCReestablishmentComplete</i>	-	-
11	The SS transmits an <i>RRCReconfiguration</i> message to establish SRB2 and DRB.	<--	NR RRC: <i>RRCReconfiguration</i>	-	-
12	The UE transmits an <i>RRCReconfigurationComplete</i> message.	-->	NR RRC: <i>RRCReconfigurationComplete</i>	-	-

8.1.2.1.4.3.3 Specific message contents

Table 8.1.2.1.4.3.3-1: RLF-TimersAndConstants (preamble)

Derivation Path: TS 38.508-1 [4] Table 4.6.1-150			
Information Element	Value/remark	Comment	Condition
RLF-TimersAndConstants ::= SEQUENCE {			
t310	ms6000		
n310	n20		
}			

Table 8.1.2.1.4.3.3-2: RRCReconfiguration (step 5, Table 8.1.2.1.4.3.2-3)

Derivation Path: TS 38.508-1 [4] Table 4.6.1-13 with condition REEST			
Information Element	Value/remark	Comment	Condition
RRCReconfiguration ::= SEQUENCE {			
criticalExtensions CHOICE {			
rrcReconfiguration SEQUENCE {			
nonCriticalExtension SEQUENCE {			
masterCellGroup	CellGroupConfig		
}			
}			
}			
}			

Table 8.1.2.1.4.3.3-3: CellGroupConfig (Table 8.1.2.1.4.3.3-2)

Derivation Path: TS 38.508-1 [4] Table 4.6.3-19 with condition REEST			
Information Element	Value/remark	Comment	Condition
CellGroupConfig ::= SEQUENCE {			
spCellConfig SEQUENCE {			
rlf-TimersAndConstants CHOICE {			
release	NULL		
}			
}			
}			

Table 8.1.2.1.4.3.3-4: RRCReconfiguration (step 11 Table 8.1.2.1.4.3.2-3)

Derivation Path: TS 38.508-1 [4] Table 4.6.1-13 with condition REEST			
--	--	--	--

8.1.2.1.5 NR CA / RRC reconfiguration / SCell addition / modification / release / Success

8.1.2.1.5.1 NR CA / RRC reconfiguration / SCell addition / modification / release / Success / Intra-band Contiguous CA

8.1.2.1.5.1.1 Test Purpose (TP)

(1)

```
with { UE in NR RRC_CONNECTED state }
ensure that {
  when { UE receives an RRCReconfiguration message containing sCellToAddModList for SCell addition }
  then { UE adds the new SCell and sends an RRCReconfigurationComplete message }
}
```

(2)

```
with { UE in NR RRC_CONNECTED state with SCell configured}
ensure that {
  when { UE receives an RRCReconfiguration message containing sCellToAddModList for SCell
modification }
  then { UE modifies the SCell configuration and sends an RRCReconfigurationComplete message }
}
```

(3)

```
with { UE in NR RRC_CONNECTED state with SCell configured}
ensure that {
  when { UE receives an RRCReconfiguration message containing sCellToReleaseList }
  then { UE sends an RRCReconfigurationComplete message }
}
```

8.1.2.1.5.1.2 Conformance requirements

References: The conformance requirements covered in the current TC are specified in: TS 38.331 clauses 5.3.5.3, 5.3.5.5.1 and 5.3.5.5.9.

[TS 38.331 clause 5.3.5.3]

The UE shall perform the following actions upon reception of the *RRCReconfiguration*:

...

1> if the *RRCReconfiguration* includes the *masterCellGroup*:

2> perform the cell group configuration for the received *masterCellGroup* according to 5.3.5.5;

...

1> else:

2> submit the *RRCReconfigurationComplete* message via SRB1 to lower layers for transmission using the new configuration;

[TS 38.331 clause 5.3.5.5.1]

The UE performs the following actions based on a received *CellGroupConfig* IE:

...

1> if the *CellGroupConfig* contains the *sCellToReleaseList*:

2> perform SCell release as specified in 5.3.5.5.8;

...

1> if the *CellGroupConfig* contains the *sCellToAddModList*:

2> perform SCell addition/modification as specified in 5.3.5.5.9.

[TS 38.331 clause 5.3.5.5.9]

The UE shall:

1> for each *sCellIndex* value included in the *sCellToAddModList* that is not part of the current UE configuration (SCell addition):

2> add the SCell, corresponding to the *sCellIndex*, in accordance with the *sCellConfigCommon* and *sCellConfigDedicated*;

2> configure lower layers to consider the SCell to be in deactivated state;

...

1> for each *sCellIndex* value included in the *sCellToAddModList* that is part of the current UE configuration (SCell modification):

2> modify the SCell configuration in accordance with the *sCellConfigDedicated*.

8.1.2.1.5.1.3 Test description

8.1.2.1.5.1.3.1 Pre-test conditions

System Simulator:

- NR Cell 1 is the PCell, NR Cell 3 is the SCell.

None.

Preamble:

- The UE is in state 3N-A, and with UE test loop mode B active if *pc_IP_Ping* is set to FALSE, as defined in TS 38.508-1 [4], subclause 4.4A on NR Cell 1.

8.1.2.1.5.1.3.2 Test procedure sequence

Table 8.1.2.1.5.1.3.2-1: Main behaviour

St	Procedure	Message Sequence		TP	Verdict
		U - S	Message		
1	The SS transmits an <i>RRCReconfiguration</i> message containing an <i>sCellToAddModList</i> with SCell NR Cell 3 addition,	<--	NR RRC: <i>RRCReconfiguration</i>	-	-
2	Check: Does the UE transmits an <i>RRCReconfigurationComplete</i> message?	-->	NR RRC: <i>RRCReconfigurationComplete</i>	1	P
3	Check: Does the test result of generic test procedure in TS 38.508-1 subclause 4.9.1 indicate that the UE is capable of exchanging IP data on DRB1 and Cell 3?	-	-	1	P
4	The SS transmits an <i>RRCReconfiguration</i> message containing an <i>sCellToAddModList</i> with SCell NR Cell 3 modification.	<--	NR RRC: <i>RRCReconfiguration</i>	-	-
5	Check: Does the UE transmit an <i>RRCReconfigurationComplete</i> message?	-->	NR RRC: <i>RRCReconfigurationComplete</i>	2	P
6	Check: Does the test result of generic test procedure in TS 38.508-1 subclause 4.9.1 indicate that the UE is capable of exchanging IP data on DRB1 and Cell 3?	-	-	2	P
7	The SS transmits an <i>RRCReconfiguration</i> message containing an <i>sCellToReleaseList</i> with SCell NR Cell 3.	<--	NR RRC: <i>RRCReconfiguration</i>	-	-

8	Check: Does the UE transmit an <i>RRCReconfigurationComplete</i> message?	-->	NR RRC: <i>RRCReconfigurationComplete</i>	3	P
---	---	-----	--	---	---

8.1.2.5.1.1.3.3 Specific message contents

Table 8.1.2.5.1.1.3.3-1: *RRCReconfiguration* (step 1, Table 8.1.2.1.5.1.3.2-1)

Derivation Path: TS 38.508-1 [4] Table 4.6.1-13 with condition *SCell_add*

Table 8.1.2.5.1.1.3.3-2: *RRCReconfiguration* (step 4, Table 8.1.2.1.5.1.3.2-1)

Derivation Path: TS 38.508-1 [4] Table 4.6.1-13 with condition <i>SCell_add</i>			
Information Element	Value/remark	Comment	Condition
<i>RRCReconfiguration</i> ::= SEQUENCE {			
<i>criticalExtensions</i> CHOICE {			
<i>rrcReconfiguration</i> SEQUENCE {			
<i>nonCriticalExtension</i> SEQUENCE {			
<i>masterCellGroup</i>	CellGroupConfig		
}			
}			
}			
}			

Table 8.1.2.5.1.1.3.3-3: *CellGroupConfig* (Table 8.1.2.5.1.1.3.3-2)

Derivation Path: TS 38.508-1 [4] Table 4.6.3-19 with condition <i>SCell_add</i>			
Information Element	Value/remark	Comment	Condition
<i>CellGroupConfig</i> ::= SEQUENCE {			
<i>sCellToAddModList</i> SEQUENCE (SIZE (1.. <i>maxNrofSCells</i>)) OF <i>SCellConfig</i> {	1 entry		
<i>SCellConfig</i> [1] SEQUENCE {		entry 1	
<i>sCellConfigCommon</i>	Not present		
<i>sCellConfigDedicated</i>	ServingCellConfig		
}			
}			
}			

Table 8.1.2.5.1.1.3.3-4: *ServingCellConfig* (Table 8.1.2.5.1.1.3.3-3)

Derivation Path: TS 38.508-1 [4] Table 4.6.3-167			
Information Element	Value/remark	Comment	Condition
<i>ServingCellConfig</i> ::= SEQUENCE {			
<i>firstActiveDownlinkBWP-Id</i>	Not present		
<i>uplinkConfig</i> SEQUENCE {			
<i>firstActiveUplinkBWP-Id</i>	Not present		
}			
<i>pdsch-ServingCellConfig</i> CHOICE {			
<i>setup</i>	PDSCH-ServingCellConfig		
}			
}			

Table 8.1.2.5.1.1.3.3-5: *PDSCH-ServingCellConfig* (Table 8.1.2.5.1.1.3.3-4)

Derivation Path: TS 38.508-1 [4] Table 4.6.3-102			
Information Element	Value/remark	Comment	Condition
<i>PDSCH-ServingCellConfig</i> ::= SEQUENCE {			
<i>nrofHARQ-ProcessesForPDSCH</i>	n16		
}			

Table 8.1.2.5.1.1.3.3-6: RRCReconfiguration (step 7, Table 8.1.2.1.5.1.3.2-1)

Derivation Path: TS 38.508-1 [4] Table 4.6.1-13 with condition SCell_add			
Information Element	Value/remark	Comment	Condition
RRCReconfiguration ::= SEQUENCE {			
criticalExtensions CHOICE {			
rrcReconfiguration SEQUENCE {			
nonCriticalExtension SEQUENCE{			
masterCellGroup	CellGroupConfig		
}			
}			
}			
}			

Table 8.1.2.5.1.1.3.3-7: CellGroupConfig (Table 8.1.2.5.1.1.3.3-6)

Derivation Path: TS 38.508-1 [4] Table 4.6.3-19 with condition SCell_add			
Information Element	Value/remark	Comment	Condition
CellGroupConfig ::= SEQUENCE {			
sCellToAddModList	Not present		
sCellToReleaseList SEQUENCE (SIZE (1..maxNrofSCells)) OF SCellIndex {	1 entry		
SCellIndex[1]	1	entry 1	
}			
}			

8.1.2.1.5.2 NR CA / RRC reconfiguration / SCell addition / modification / release / Success / Inter-band CA

8.1.2.1.5.2.1 Test Purpose (TP)

Same as TC 8.1.2.1.5.1 but applied to Inter-band CA.

8.1.2.1.5.2.2 Conformance requirements

Same as TC 8.1.2.1.5.1 but applied to Inter-band CA.

8.1.2.1.5.2.3 Test description

8.1.2.1.5.2.3.1 Pre-test conditions

Same as TC 8.1.2.1.5.1 with the following differences:

- CA configuration: Inter-band CA replaces Intra-band Contiguous CA
- Cells configuration: NR Cell 10 replaces NR Cell 3

8.1.2.1.5.2.3.2 Test procedure sequence

Same as TC 8.1.2.1.5.1 with the following differences:

- CA configuration: Inter-band CA replaces Intra-band Contiguous CA
- Cells configuration: NR Cell 10 replaces NR Cell 3

8.1.2.1.5.3 NR CA / RRC reconfiguration / SCell addition / modification / release / Success / Intra-band non-contiguous CA

8.1.2.1.5.3.1 Test Purpose (TP)

Same as TC 8.1.2.1.5.1 but applied to Intra-band non-contiguous CA.

8.1.2.1.5.3.2 Conformance requirements

Same as TC 8.1.2.1.5.1 but applied to Intra-band non-contiguous CA.

8.1.2.1.5.3.3 Test description

8.1.2.1.5.3.3.1 Pre-test conditions

Same as TC 8.1.2.1.5.1 with the following differences:

- CA configuration: Intra-band non-contiguous replaces Intra-band Contiguous CA

8.1.2.1.5.3.3.2 Test procedure sequence

Same as TC 8.1.2.1.5.1 with the following differences:

- CA configuration: Intra-band non-contiguous replaces Intra-band Contiguous CA

8.1.3 Measurement configuration control and reporting

8.1.3.1 Intra NR measurements

8.1.3.1.1 Measurement configuration control and reporting / Intra NR measurements / Event A1 / Event A2

8.1.3.1.1.1 Test Purpose (TP)

(1)

```
with { UE in NR RRC_CONNECTED and measurement configured for event A1 and event A2 with event based
periodical reporting }
ensure that {
  when { Serving cell becomes better than absolute threshold plus hysteresis and entering condition
for event A1 is met }
  then { UE sends MeasurementReport message at regular intervals while entering condition for
event A1 is satisfied }
}
```

(2)

```
with { UE in NR RRC_CONNECTED and periodical measurement reporting triggered by event A1 ongoing }
ensure that {
  when { Serving cell becomes worse than absolute threshold minus hysteresis }
  then { UE stops sending MeasurementReport message }
}
```

(3)

```
with { UE in NR RRC_CONNECTED and measurement configured for event A1 and event A2 with event based
periodical reporting }
ensure that {
  when { Serving cell becomes worse than absolute threshold minus hysteresis and entering condition
for event A2 is met }
  then { UE sends MeasurementReport message at regular intervals while entering condition for
event A2 is satisfied }
}
```

(4)

```

with { UE in NR RRC_CONNECTED state and periodical measurement reporting triggered by event A2
ongoing }
ensure that {
  when { Serving cell becomes better than absolute threshold plus hysteresis }
  then { UE stops sending MeasurementReport message }
}

```

(5)

```

with { UE in NR RRC_CONNECTED and measurements are re-configured for event A1 with event based
periodical reporting to report on leaving condition }
ensure that {
  when { Serving cell becomes worse than absolute threshold minus hysteresis }
  then { UE sends MeasurementReport message while leaving condition for event A1 is satisfied }
}

```

8.1.3.1.1.2 Conformance requirements

References: The conformance requirements covered in the current TC are specified in: TS 38.331, clause 5.3.5.3, 5.5.2, 5.5.4.1, 5.5.4.2, 5.5.4.3 and 5.5.5. Unless otherwise stated these are Rel-15 requirements.

[TS 38.331, clause 5.3.5.3]

The UE shall perform the following actions upon reception of the *RRCReconfiguration*:

...

1> if the *RRCReconfiguration* message includes the *measConfig*:

2> perform the measurement configuration procedure as specified in 5.5.2;

...

1> if the UE is configured with E-UTRA *nr-SecondaryCellGroupConfig* (MCG is E-UTRA):

...

1> else:

2> submit the *RRCReconfigurationComplete* message via SRB1 to lower layers for transmission using the new configuration;

...

[TS 38.331, clause 5.5.2.1]

...

The UE shall:

...

1> if the received *measConfig* includes the *measObjectToAddModList*:

2> perform the measurement object addition/modification procedure as specified in 5.5.2.5;

...

1> if the received *measConfig* includes the *reportConfigToAddModList*:

2> perform the reporting configuration addition/modification procedure as specified in 5.5.2.7;

1> if the received *measConfig* includes the *quantityConfig*:

2> perform the quantity configuration procedure as specified in 5.5.2.8;

1> if the received *measConfig* includes the *measIdToRemoveList*:

2> perform the measurement identity removal procedure as specified in 5.5.2.2;

1> if the received *measConfig* includes the *measIdToAddModList*:

2> perform the measurement identity addition/modification procedure as specified in 5.5.2.3;

[TS 38.331, clause 5.5.4.1]

If security has been activated successfully, the UE shall:

1> for each *measId* included in the *measIdList* within *VarMeasConfig*:

2> if the corresponding *reportConfig* includes a *reportType* set to *eventTriggered* or *periodical*;

3> if the corresponding *measObject* concerns NR;

4> if the *eventA1* or *eventA2* is configured in the corresponding *reportConfig*:

5> consider only the serving cell to be applicable;

...

2> if the *reportType* is set to *eventTriggered* and if the entry condition applicable for this event, i.e. the event corresponding with the *eventId* of the corresponding *reportConfig* within *VarMeasConfig*, is fulfilled for one or more applicable cells for all measurements after layer 3 filtering taken during *timeToTrigger* defined for this event within the *VarMeasConfig*, while the *VarMeasReportList* does not include a measurement reporting entry for this *measId* (a first cell triggers the event):

3> include a measurement reporting entry within the *VarMeasReportList* for this *measId*;

3> set the *numberOfReportsSent* defined within the *VarMeasReportList* for this *measId* to 0;

3> include the concerned cell(s) in the *cellsTriggeredList* defined within the *VarMeasReportList* for this *measId*;

3> initiate the measurement reporting procedure, as specified in 5.5.5;

...

2> else if the *reportType* is set to *eventTriggered* and if the leaving condition applicable for this event is fulfilled for one or more of the cells included in the *cellsTriggeredList* defined within the *VarMeasReportList* for this *measId* for all measurements after layer 3 filtering taken during *timeToTrigger* defined within the *VarMeasConfig* for this event:

3> remove the concerned cell(s) in the *cellsTriggeredList* defined within the *VarMeasReportList* for this *measId*;

3> if *reportOnLeave* is set to *TRUE* for the corresponding reporting configuration:

4> initiate the measurement reporting procedure, as specified in 5.5.5;

3> if the *cellsTriggeredList* defined within the *VarMeasReportList* for this *measId* is empty:

4> remove the measurement reporting entry within the *VarMeasReportList* for this *measId*;

4> stop the periodical reporting timer for this *measId*, if running;

...

2> upon expiry of the periodical reporting timer for this *measId*:

3> initiate the measurement reporting procedure, as specified in 5.5.5.

...

[TS 38.331, clause 5.5.4.2]

The UE shall:

- 1> consider the entering condition for this event to be satisfied when condition A1-1, as specified below, is fulfilled;
- 1> consider the leaving condition for this event to be satisfied when condition A1-2, as specified below, is fulfilled;
- 1> for this measurement, consider the NR serving cell corresponding to the associated *measObjectNR* associated with this event.

Inequality A1-1 (Entering condition)

$$Ms - Hys > Thresh$$

Inequality A1-2 (Leaving condition)

$$Ms + Hys < Thresh$$

The variables in the formula are defined as follows:

Ms is the measurement result of the serving cell, not taking into account any offsets.

Hys is the hysteresis parameter for this event (i.e. *hysteresis* as defined within *reportConfigNR* for this event).

Thresh is the threshold parameter for this event (i.e. *a1-Threshold* as defined within *reportConfigNR* for this event).

Ms is expressed in dBm in case of RSRP, or in dB in case of RSRQ and RS-SINR.

Hys is expressed in dB.

Thresh is expressed in the same unit as ***Ms***.

[TS 38.331, clause 5.5.4.3]

The UE shall:

- 1> consider the entering condition for this event to be satisfied when condition A2-1, as specified below, is fulfilled;
- 1> consider the leaving condition for this event to be satisfied when condition A2-2, as specified below, is fulfilled;
- 1> for this measurement, consider the serving cell indicated by the *measObjectNR* associated to this event.

Inequality A2-1 (Entering condition)

$$Ms + Hys < Thresh$$

Inequality A2-2 (Leaving condition)

$$Ms - Hys > Thresh$$

The variables in the formula are defined as follows:

Ms is the measurement result of the serving cell, not taking into account any offsets.

Hys is the hysteresis parameter for this event (i.e. *hysteresis* as defined within *reportConfigNR* for this event).

Thresh is the threshold parameter for this event (i.e. *a2-Threshold* as defined within *reportConfigNR* for this event).

Ms is expressed in dBm in case of RSRP, or in dB in case of RSRQ and RS-SINR.

Hys is expressed in dB.

Thresh is expressed in the same unit as ***Ms***.

[TS 38.331, clause 5.5.5]



Figure 5.5.5.1-1: Measurement reporting

The purpose of this procedure is to transfer measurement results from the UE to the network. The UE shall initiate this procedure only after successful security activation.

For the *measId* for which the measurement reporting procedure was triggered, the UE shall set the *measResults* within the *MeasurementReport* message as follows:

- 1> set the *measId* to the measurement identity that triggered the measurement reporting;
- 1> set the *measResultServingCell* within *measResultServingMOList* to include , for each NR serving cell that is configured with *servingCellMO*, RSRP, RSRQ and the available SINR derived based on the *rsType* if indicated in the associated *reportConfig* , otherwise based on SSB if available, otherwise based on CSI-RS;
- 1> set the *measResultServingCell* within *measResultServingMOList* to include for each NR serving cell that is configured with *servingCellMO*, if any, the *servCellId*;
- ...
- 1> increment the *numberOfReportsSent* as defined within the *VarMeasReportList* for this *measId* by 1;
- 1> stop the periodical reporting timer, if running;
- 1> if the *numberOfReportsSent* as defined within the *VarMeasReportList* for this *measId* is less than the *reportAmount* as defined within the corresponding *reportConfig* for this *measId*:
 - 2> start the periodical reporting timer with the value of *reportInterval* as defined within the corresponding *reportConfig* for this *measId*;
- 1> else:
 - 2> if the *reportType* is set to *periodical*:
 - 3> remove the entry within the *VarMeasReportList* for this *measId*;
 - 3> remove this *measId* from the *measIdList* within *VarMeasConfig*;
- 1> if the UE is configured with EN-DC:
 - ...
- 1> else:
 - 2> submit the *MeasurementReport* message to lower layers for transmission, upon which the procedure ends.

8.1.3.1.1.3 Test description

8.1.3.1.1.3.1 Pre-test conditions

System Simulator:

- NR Cell 1

UE:

- None.

Preamble:

- The UE is in state 3N-A as defined in TS 38.508-1 [4], subclause 4.4A on NR Cell 1.

8.1.3.1.1.3.2 Test procedure sequence

Table 8.1.3.1.1.3.2-1/2 illustrates the downlink power levels and other changing parameters to be applied for the cells at various time instants of the test execution. Row marked "T0" denotes the initial conditions after preamble, while columns marked "T1" and "T2", are to be applied subsequently. The exact instants on which these values shall be applied are described in the texts in this clause.

Table 8.1.3.1.1.3.2-1: Time instances of cell power level and parameter changes in FR1

	Parameter	Unit	NR Cell 1	Remark
T0	SS/PBCH SSS EPRE	dBm/SCS	-98	Power level is such that entry condition for event A2 is satisfied $M_s + H_{ys} < Thresh$
T1	SS/PBCH SSS EPRE	dBm/SCS	-78	Power level is such that entry condition for event A1 is satisfied $M_s - H_{ys} > Thresh$ and exit condition for event A2 is satisfied too.
T2	SS/PBCH SSS EPRE	dBm/SCS	-98	Power level is such that exit condition for event A1 is satisfied $M_s + H_{ys} < Thresh$

Table 8.1.3.1.1.3.2-2: Time instances of cell power level and parameter changes in FR2

	Parameter	Unit	NR Cell 1	Remark
T0	SS/PBCH SSS EPRE	dBm/SCS	FFS	Power level is such that entry condition for event A2 is satisfied $M_s + H_{ys} < Thresh$
T1	SS/PBCH SSS EPRE	dBm/SCS	FFS	Power level is such that entry condition for event A1 is satisfied $M_s - H_{ys} > Thresh$ and exit condition for event A2 is satisfied too.
T2	SS/PBCH SSS EPRE	dBm/SCS	FFS	Power level is such that exit condition for event A1 is satisfied $M_s + H_{ys} < Thresh$

Table 8.1.3.1.1.3.2-3: Main behaviour

St	Procedure	Message Sequence		TP	Verdict
		U - S	Message		
1	SS transmits an <i>RRCReconfiguration</i> message including <i>measConfig</i> to setup intra NR measurement and reporting for event A1 and event A2.	<--	NR RRC: <i>RRCReconfiguration</i>	-	-
2	The UE transmits an <i>RRCReconfigurationComplete</i> message.	-->	NR RRC: <i>RRCReconfigurationComplete</i>	-	-
3	Check: Does the UE transmit a <i>MeasurementReport</i> message to report event A2 with the measured RSRP, RSRQ and SINR value for NR Cell 1?	-->	NR RRC: <i>MeasurementReport</i>	3	P
-	EXCEPTION: Step 4 below is repeated until 3 <i>MeasurementReport</i> messages are received from the UE and Interval between two	-	-	-	-

	<i>MeasurementReport</i> is same as the IE <i>reportInterval</i> configured in <i>measConfig</i> .				
4	Check: Does the UE transmit a <i>MeasurementReport</i> message at regular intervals, with the measured RSRP, RSRQ and SINR value for NR Cell 1?	-->	NR RRC: <i>MeasurementReport</i>	3	P
5	SS re-adjusts the SS/PBCH EPRE level according to row "T1" in Table 8.1.3.1.1.3.2-1/2.	-	-	-	-
6	Wait and ignore <i>MeasurementReport</i> messages for 15 s to allow change of power levels for NR Cell 1 and UE measurement.	-	-	-	-
-	EXCEPTION: In parallel with step 7, parallel behaviour defined in table 8.1.3.1.1.3.2-4 is executed	-	-	-	-
7	Check: Does the UE transmit a <i>MeasurementReport</i> message to report event A1 with the measured RSRP, RSRQ and SINR value for NR Cell 1?	-->	NR RRC: <i>MeasurementReport</i>	1	P
-	EXCEPTION: Step 8 below is repeated until 3 <i>MeasurementReport</i> messages are received from the UE and Interval between two <i>MeasurementReport</i> is same as the IE <i>reportInterval</i> configured in <i>measConfig</i> .	-	-	-	-
8	Check: Does the UE transmit a <i>MeasurementReport</i> message at regular intervals, with the measured RSRP, RSRQ and SINR value for NR Cell 1?	-->	NR RRC: <i>MeasurementReport</i>	1	P
9	SS re-adjusts the SS/PBCH EPRE level according to row "T2" in Table 8.1.3.1.1.3.2-1/2.	-	-	-	-
10	Wait and ignore <i>MeasurementReport</i> messages for 15 s to allow change of power levels for NR Cell 1 and UE measurement.	-	-	-	-
11	Check: Does the UE transmit a <i>MeasurementReport</i> message to report event A1 with the measured RSRP, RSRQ and SINR value for NR Cell 1 within the next 10s? NOTE: SS ignore <i>MeasurementReport</i> message for event A2.	-	-	2	F
12	SS transmits an <i>RRCReconfiguration</i> message to re-configure for event A1 with event based periodical reporting to report on leaving condition and release event A2.	<--	NR RRC: <i>RRCReconfiguration</i>	-	-
13	The UE transmits an <i>RRCReconfigurationComplete</i> message.	-->	NR RRC: <i>RRCReconfigurationComplete</i>	-	-
14	SS re-adjusts the SS/PBCH EPRE level according to row "T1" in Table 8.1.3.1.1.3.2-1/2.	-	-	-	-
15	SS receive four <i>MeasurementReport</i> messages for A1 and then wait 5s.	-	-	-	-
16	SS re-adjusts the SS/PBCH EPRE level according to row "T2" in Table 8.1.3.1.1.3.2-1/2.	-	-	-	-
17	Check: Does the UE transmit a <i>MeasurementReport</i> message to report event A1 with the measured RSRP, RSRQ and SINR value for NR Cell 1?	-->	NR RRC: <i>MeasurementReport</i>	5	P
18	Check: Does the UE attempt to transmit <i>MeasurementReport</i> message within the next 10s?	-	-	5	F

Table 8.1.3.1.1.3.2-4: Parallel behaviour

St	Procedure	Message Sequence		TP	Verdict
		U - S	Message		

1	Check: Does the UE transmit a <i>MeasurementReport</i> message to report event A2 with the measured RSRP, RSRQ and SINR value for NR Cell 1?	-	-	4	F
---	--	---	---	---	---

8.1.3.1.1.3.3 Specific message contents

Table 8.1.3.1.1.3.3-1: RRCReconfiguration (step 1 Table 8.1.3.1.1.3.2-3)

Derivation Path: TS 38.508-1 [4], Table 4.6.1-13 with condition NR_MEAS

Table 8.1.3.1.1.3.3-2: MeasConfig (Table 8.1.3.1.1.3.3-1)

Derivation Path: TS 38.508-1 [4] Table 4.6.3-69			
Information Element	Value/Remark	Comment	Condition
measConfig ::= SEQUENCE {			
measObjectToAddModList SEQUENCE (SIZE (1..maxNrofObjectId)) OF MeasObjectToAddMod {	1 entry		
MeasObjectToAddMod[1] SEQUENCE {		entry 1	
measObjectId	1		
measObject CHOICE {			
measObjectNR	MeasObjectNR(57)	Thres=57(-100dBm ≤ SS-RSRP <-99dBm)	
}			
}			
reportConfigToAddModList SEQUENCE (SIZE (1..maxReportConfigId)) OF ReportConfigToAddMod {	2 entries		
ReportConfigToAddMod[1] SEQUENCE {		entry 1	
reportConfigId	1		
reportConfig	ReportConfigNR-EventA1		
}			
ReportConfigToAddMod[2] SEQUENCE {		entry 2	
reportConfigId	2		
reportConfig	ReportConfigNR-EventA2		
}			
}			
measIdToAddModList SEQUENCE (SIZE (1..maxNrofMeasId)) OF MeasIdToAddMod {	2 entries		
MeasIdToAddMod[1] SEQUENCE {		entry 1	
measId	1		
measObjectId	1		
reportConfigId	1		
}			
MeasIdToAddMod[2] SEQUENCE {		entry 2	
measId	2		
measObjectId	1		
reportConfigId	2		
}			
quantityConfig	QuantityConfig		
}			

Table 8.1.3.1.1.3.3-3: MeasObjectNR (Table 8.1.3.1.1.3.3-2)

Derivation Path: TS 38.508-1 [4], Table 4.6.3-76			
Information Element	Value/remark	Comment	Condition

MeasObjectNR ::= SEQUENCE {			
ssbFrequency	Downlink ARFCN of NR cell 1 SSB		
}			

Table 8.1.3.1.1.3.3-4: ReportConfigNR-EventA1 (Table 8.1.3.1.1.3.3-2)

Derivation Path: TS 38.508-1 [4], Table 4.6.3-142 with condition EVENT_A1			
Information Element	Value/remark	Comment	Condition
ReportConfigNR ::= SEQUENCE {			
reportType CHOICE {			
eventTriggered SEQUENCE {			
eventId CHOICE {			
eventA1 SEQUENCE {			EVENT_A1
a1-Threshold CHOICE {			
rsrp	69	-88dBm ≤ SS-RSRP < -87dBm	FR1
rsrp	FFS		FR2
}			
}			
}			
reportAmount	Infinity		
}			
}			

Table 8.1.3.1.1.3.3-5: ReportConfigNR-EventA2 (Table 8.1.3.1.1.3.3-2)

Derivation Path: TS 38.508-1 [4], Table 4.6.3-142 with condition EVENT_A2			
Information Element	Value/remark	Comment	Condition
ReportConfigNR ::= SEQUENCE {			
reportType CHOICE {			
eventTriggered SEQUENCE {			
eventId CHOICE {			
eventA2 SEQUENCE {			EVENT_A2
a2-Threshold CHOICE {			
rsrp	69	-88dBm ≤ SS-RSRP < -87dBm	FR1
rsrp	73	-84dBm ≤ SS-RSRP < -83dBm	FR2
}			
}			
}			
reportAmount	Infinity		
}			
}			

Table 8.1.3.1.1.3.3-6: QuantityConfig (Table 8.1.3.1.1.3.3-2)

Derivation Path: TS 38.508-1 [4], Table 4.6.3-127			
Information Element	Value/remark	Comment	Condition
QuantityConfig ::= SEQUENCE {			
quantityConfigNR-List SEQUENCE (SIZE (1..maxNrofQuantityConfig)) OF QuantityConfigNR {	1 entry		
QuantityConfigNR[1] SEQUENCE {		entry 1	
quantityConfigCell SEQUENCE {			
ssb-FilterConfig SEQUENCE {			
filterCoefficientRSRP	fc4		

filterCoefficientRSRQ	fc4		
filterCoefficientRS-SINR	fc4		
}			
}			
}			
}			
}			

Table 8.1.3.1.1.3.3-7: MeasurementReport (steps 3, 4, 7, 8, 17, Table 8.1.3.1.1.3.2-3)

Derivation Path: TS 38.508-1 [4], Table 4.6.1-5A			
Information Element	Value/remark	Comment	Condition
MeasurementReport ::= SEQUENCE {			
criticalExtensions CHOICE {			
measurementReport SEQUENCE {			
measResults SEQUENCE {			
measId	2		Step 3, 4
measId	1		Step 7,8,17
measResultServingMOList SEQUENCE {	1 entry		
servCellId	ServCellIndex of NR Cell 1		
measResultServingCell SEQUENCE {			
physCellId	Physical CellID of the NR Cell 1		
measResult SEQUENCE {			
cellResults SEQUENCE {			
resultsSSB-Cell SEQUENCE {			
rsrp	(0..127)		
rsrq	(0..127)		
sinr	Not present (0..127)		pc_ss_SINR_Meas
}			
}			
}			
}			
}			
}			
}			
}			
}			

Table 8.1.3.1.1.3.3-8: RRCReconfiguration (step 12, Table 8.1.3.1.1.3.2-3)

Derivation Path: TS 38.508-1 [4], Table 4.6.1-13 with condition NR_MEAS

Table 8.1.3.1.1.3.3-9: MeasConfig (Table 8.1.3.1.1.3.3-8)

Derivation Path: TS 38.508-1 [4] Table 4.6.3-69			
Information Element	Value/Remark	Comment	Condition
measConfig ::= SEQUENCE {			
measObjectToAddModList	Not Present		
reportConfigToAddModList SEQUENCE (SIZE (1..maxReportConfigId)) OF ReportConfigToAddMod {	1 entry		
ReportConfigToAddMod[1] SEQUENCE {		entry 1	
reportConfigId	ReportConfigId		
reportConfig	ReportConfigNR-EventA1		
}			
}			
measIdToAddModList	Not Present		

measIdToRemoveList SEQUENCE (SIZE (1..maxNrofMeasId)) OF MeasId {	1 entry		
MeasId[1]	2	ebtry 1 Release event A2	
}			
quantityConfig	Not Present		
}			

Table 8.1.3.1.1.3.3-10: ReportConfigNR-EventA1 (Table 8.1.3.1.1.3.3-9)

Derivation Path: TS 38.508-1 [4], Table 4.6.3-142 with condition EVENT_A1			
Information Element	Value/remark	Comment	Condition
ReportConfigNR ::= SEQUENCE {			
reportType CHOICE {			
eventTriggered SEQUENCE {			
eventId CHOICE {			
eventA1 SEQUENCE {			
a1-Threshold CHOICE {			
rsrp	69	-88dBm ≤ SS-RSRP <- 87dBm	FR1
rsrp	FFS		FR2
}			
reportOnLeave	true		
}			
}			
reportAmount	r4		
}			
}			

8.1.3.1.2 Measurement configuration control and reporting / Event A3 / Measurement of Neighbour NR cell / Intra-frequency measurements

8.1.3.1.2.1 Test Purpose (TP)

(1)

```
with { UE in NR RRC_CONNECTED state and intra-frequency measurements configured for event A3 }
ensure that {
  when { Entry condition for event A3 is not met for neighbor cell }
  then { UE does not send MeasurementReport }
}
```

(2)

```
with { UE in NR RRC_CONNECTED state and intra-frequency measurements configured for event A3 }
ensure that {
  when { Neighbor cell becomes offset better than serving cell }
  then { UE sends MeasurementReport with correct measId for event A3 }
}
```

8.1.3.1.2.2 Conformance requirements

References: The conformance requirements covered in the current TC are specified in: TS 38.331, clause 5.3.5.3, 5.5.2, 5.5.4.1, 5.5.4.4 and 5.5.5. Unless otherwise stated these are Rel-15 requirements.

[TS 38.331, clause 5.3.5.3]

The UE shall perform the following actions upon reception of the *RRCReconfiguration*:

...

1> if the *RRCReconfiguration* message includes the *measConfig*:

2> perform the measurement configuration procedure as specified in 5.5.2;

...

1> if the UE is configured with E-UTRA *nr-SecondaryCellGroupConfig* (MCG is E-UTRA):

...

1> else:

2> submit the *RRCReconfigurationComplete* message via SRB1 to lower layers for transmission using the new configuration;

...

[TS 38.331, clause 5.5.2.1]

...

The UE shall:

...

1> if the received *measConfig* includes the *measObjectToAddModList*:

2> perform the measurement object addition/modification procedure as specified in 5.5.2.5;

...

1> if the received *measConfig* includes the *reportConfigToAddModList*:

2> perform the reporting configuration addition/modification procedure as specified in 5.5.2.7;

1> if the received *measConfig* includes the *quantityConfig*:

2> perform the quantity configuration procedure as specified in 5.5.2.8;

[TS 38.331, clause 5.5.4.1]

If security has been activated successfully, the UE shall:

1> for each *measId* included in the *measIdList* within *VarMeasConfig*:

2> if the corresponding *reportConfig* includes a *reportType* set to *eventTriggered* or *periodical*;

3> if the corresponding *measObject* concerns NR;

4> if the *eventA3* or *eventA5* is configured in the corresponding *reportConfig*:

5> if a serving cell is associated with a *measObjectNR* and neighbors are associated with another *measObjectNR*, consider any serving cell associated with the other *measObjectNR* to be a neighboring cell as well;

...

2> if the *reportType* is set to *eventTriggered* and if the entry condition applicable for this event, i.e. the event corresponding with the *eventId* of the corresponding *reportConfig* within *VarMeasConfig*, is fulfilled for one or more applicable cells for all measurements after layer 3 filtering taken during *timeToTrigger* defined for this event within the *VarMeasConfig*, while the *VarMeasReportList* does not include a measurement reporting entry for this *measId* (a first cell triggers the event):

3> include a measurement reporting entry within the *VarMeasReportList* for this *measId*;

3> set the *numberOfReportsSent* defined within the *VarMeasReportList* for this *measId* to 0;

3> include the concerned cell(s) in the *cellsTriggeredList* defined within the *VarMeasReportList* for this *measId*;

3> initiate the measurement reporting procedure, as specified in 5.5.5;

[TS 38.331, clause 5.5.4.4]

The UE shall:

- 1> consider the entering condition for this event to be satisfied when condition A3-1, as specified below, is fulfilled;
- 1> consider the leaving condition for this event to be satisfied when condition A3-2, as specified below, is fulfilled;
- 1> use the SpCell for M_p , O_{fp} and O_{cp} .

NOTE The cell(s) that triggers the event has reference signals indicated in the *measObjectNR* associated to this event which may be different from the NR SpCell *measObjectNR*.

Inequality A3-1 (Entering condition)

$$M_n + O_{fn} + O_{cn} - H_{ys} > M_p + O_{fp} + O_{cp} + O_{ff}$$

Inequality A3-2 (Leaving condition)

$$M_n + O_{fn} + O_{cn} + H_{ys} < M_p + O_{fp} + O_{cp} + O_{ff}$$

The variables in the formula are defined as follows:

M_n is the measurement result of the neighboring cell, not taking into account any offsets.

O_{fn} is the measurement object specific offset of the reference signal of the neighbor cell (i.e. *offsetMO* as defined within *measObjectNR* corresponding to the neighbor cell).

O_{cn} is the cell specific offset of the neighbor cell (i.e. *cellIndividualOffset* as defined within *measObjectNR* corresponding to the frequency of the neighbor cell), and set to zero if not configured for the neighbor cell.

M_p is the measurement result of the SpCell, not taking into account any offsets.

O_{fp} is the measurement object specific offset of the SpCell (i.e. *offsetMO* as defined within *measObjectNR* corresponding to the SpCell).

O_{cp} is the cell specific offset of the SpCell (i.e. *cellIndividualOffset* as defined within *measObjectNR* corresponding to the SpCell), and is set to zero if not configured for the SpCell.

H_{ys} is the hysteresis parameter for this event (i.e. *hysteresis* as defined within *reportConfigNR* for this event).

O_{ff} is the offset parameter for this event (i.e. *a3-Offset* as defined within *reportConfigNR* for this event).

M_n , M_p are expressed in dBm in case of RSRP, or in dB in case of RSRQ and RS-SINR.

O_{fn} , O_{cn} , O_{fp} , O_{cp} , H_{ys} , O_{ff} are expressed in dB.

[TS 38.331, clause 5.5.5]



Figure 5.5.5.1-1: Measurement reporting

The purpose of this procedure is to transfer measurement results from the UE to the network. The UE shall initiate this procedure only after successful security activation.

For the *measId* for which the measurement reporting procedure was triggered, the UE shall set the *measResults* within the *MeasurementReport* message as follows:

- 1> set the *measId* to the measurement identity that triggered the measurement reporting;
- 1> set the *measResultServingCell* within *measResultServingMOList* to include, for each NR serving cell that is configured with *servingCellMO*, RSRP, RSRQ and the available SINR, derived based on the *rsType* if indicated in the associated *reportConfig*, otherwise based on SSB if available, otherwise based on CSI-RS;
- 1> set the *servCellId* within *measResultServingMOList* to include each NR serving cell that is configured with *servingCellMO*, if any;
- ...
- 1> if the *numberOfReportsSent* as defined within the *VarMeasReportList* for this *measId* is less than the *reportAmount* as defined within the corresponding *reportConfig* for this *measId*:
 - 2> start the periodical reporting timer with the value of *reportInterval* as defined within the corresponding *reportConfig* for this *measId*;
- 1> if there is at least one applicable neighboring cell to report:
 - 2> if the *reportType* is set to *eventTriggered* or *periodical*:
 - 3> set the *measResultNeighCells* to include the best neighboring cells up to *maxReportCells* in accordance with the following:
 - 4> if the *reportType* is set to *eventTriggered*:
 - 5> include the cells included in the *cellsTriggeredList* as defined within the *VarMeasReportList* for this *measId*;
 - 4> for each cell that is included in the *measResultNeighCells*, include the *physCellId*;
 - 4> if the *reportType* is set to *eventTriggered* or *periodical*:
 - 5> for each included cell, include the layer 3 filtered measured results in accordance with the *reportConfig* for this *measId*, ordered as follows:
 - 6> if the *measObject* associated with this *measId* concerns NR:
 - 7> if *rsType* in the associated *reportConfig* is set to *ssb*:
 - 8> set *resultsSSB-Cell* within the *measResult* to include the SS/PBCH block based quantity(ies) indicated in the *reportQuantityCell* within the concerned *reportConfig*, in decreasing order of the sorting quantity, determined as specified in 5.5.5.3, i.e. the best cell is included first:

8.1.3.1.2.3 Test description

8.1.3.1.2.3.1 Pre-test conditions

System Simulator:

- NR Cell 1 is the serving cell.
- NR Cell 2 is the intra-frequency neighbor cell.
- System information combination NR-2 as defined in TS 38.508-1 [4] clause 4.4.3.1.2 is used in NR cells.

UE:

- None.

Preamble:

- The UE is in state 3N-A as defined in TS 38.508-1 [4], subclause 4.4A.

8.1.3.1.2.3.2 Test procedure sequence

Table 8.1.3.1.2.3.2-1 and 8.1.3.1.2.3.2-2 illustrates the downlink power levels to be applied for NR Cell 1 and NR Cell 2 at various time instants of the test execution. Row marked "T0" denotes the conditions after the preamble, while the configuration marked "T1" and "T2", are applied at the point indicated in the Main behaviour description in Table 8.1.3.1.2.3.2-3.

Table 8.1.3.1.2.3.2-1: Time instances of cell power level and parameter changes for NR Cell 1 and NR Cell 2 in conducted test environment

	Parameter	Unit	NR Cell 1	NR Cell 2	Remark
T0	SS/PBCH SSS EPRE	dBm/ SCS	-85	-91	Power levels are such that entry condition for event A3 is not satisfied for the neighbour NR cell: $M_n + O_{fn} + O_{cn} - H_{ys} > M_p + O_{fp} + O_{cp} + O_{off}$
T1	SS/PBCH SSS EPRE	dBm/ SCS	-85	-79	Power levels are such that entry condition for event A3 is satisfied for intra-frequency neighbour NR cell (measId 1): $M_n + O_{fn} + O_{cn} - H_{ys} > M_p + O_{fp} + O_{cp} + O_{off}$
T2	SS/PBCH SSS EPRE	dBm/ SCS	-85	-91	Power levels are such that leaving condition for event A3 is satisfied (measId 1): $M_n + O_{fn} + O_{cn} + H_{ys} < M_p + O_{fp} + O_{cp} + O_{off}$

Table 8.1.3.1.2.3.2-2: Time instances of cell power level and parameter changes for NR Cell 1 and NR Cell 2 in OTA test environment

	Parameter	Unit	NR Cell 1	NR Cell 2	Remark
T0	SS/PBCH SSS EPRE	dBm/ SCS	FFS	FFS	Power levels are such that entry condition for event A3 is not satisfied for the neighbour NR cell: $M_n + O_{fn} + O_{cn} - H_{ys} > M_p + O_{fp} + O_{cp} + O_{off}$
T1	SS/PBCH SSS EPRE	dBm/ SCS	FFS	FFS	Power levels are such that entry condition for event A3 is satisfied for intra-frequency neighbour NR cell (measId 1): $M_n + O_{fn} + O_{cn} - H_{ys} > M_p + O_{fp} + O_{cp} + O_{off}$
T2	SS/PBCH SSS EPRE	dBm/ SCS	FFS	FFS	Power levels are such that leaving condition for event A3 is satisfied (measId 1): $M_n + O_{fn} + O_{cn} + H_{ys} < M_p + O_{fp} + O_{cp} + O_{off}$

Table 8.1.3.1.2.3.2-3: Main behaviour

St	Procedure	Message Sequence		TP	Verdict
		U - S	Message		
1	The SS transmits an <i>RRCReconfiguration</i> message including <i>MeasConfig</i> to setup NR measurement and reporting for intra-frequency event A3 (<i>measId 1</i>).	<--	NR RRC: <i>RRCReconfiguration</i>	-	-
2	The UE transmits an <i>RRCReconfigurationComplete</i> message.	-->	NR RRC: <i>RRCReconfigurationComplete</i>	-	-

3	SS re-adjusts the cell-specific reference signal level according to row "T1" in table 8.1.3.1.2.3.2-1/2.	-	-	-	-
4	Check: Does the UE transmit a <i>MeasurementReport</i> message to report event A3 (<i>measId</i> 1) with the measured RSRP value for NR Cell 2?	-->	NR RRC: <i>MeasurementReport</i>	2	P
5A	Wait and ignore <i>MeasurementReport</i> messages for 10s to allow change of power levels for NR Cell 2 and UE measurement				
5	SS re-adjusts the cell-specific reference signal level according to row "T2" in table 8.1.3.1.2.2-1/2.	-	-	-	-
6	Check: Does the UE transmit a <i>MeasurementReport</i> message within the next 10s?	-	-	1	F

8.1.3.1.2.3.3 Specific message contents

Table 8.1.3.1.2.3.3-1: RRCReconfiguration (step 1, Table 8.1.3.1.2.3.2-3)

Derivation Path: TS 38.508-1 [4] Table 4.6.1-13 with condition NR_MEAS

Table 8.1.3.1.2.3.3-2: MeasConfig (Table 8.1.3.1.2.3.3-1)

Derivation Path: TS 38.508-1 [4] Table 4.6.3-69			
Information Element	Value/remark	Comment	Condition
MeasConfig ::= SEQUENCE {			
measObjectToAddModList SEQUENCE (SIZE (1..maxNrofMeasId)) OF MeasObjectToAddMod {	1 entry		
MeasObjectToAddMod[1] SEQUENCE {		entry 1	
measObjectId	1		
measObject CHOICE {			
measObjectNR	MeasObjectNR	Table 8.1.3.1.2.3.3-3	
}			
}			
reportConfigToAddModList SEQUENCE(SIZE (1..maxReportConfigId)) OF ReportConfigToAddMod {	1 entry		
ReportConfigToAddMod[1] SEQUENCE {		entry 1	
reportConfigId	1		
reportConfig CHOICE {			
reportConfigNR	ReportConfigNR-EventA3	Table 8.1.3.1.2.3.3-4	
}			
}			
measIdToAddModList SEQUENCE (SIZE (1..maxNrofMeasId)) OF MeasIdToAddMod {	1 entry		
MeasIdToAddMod[1] SEQUENCE {		entry 1	
measId	1		
measObjectId	1		
reportConfigId	1		
}			
}			
}			

Table 8.1.3.1.2.3.3-3: MeasObjectNR (Table 8.1.3.1.2.3.3-2)

Derivation Path: TS 38.508-1 [4], Table 4.6.3-76			
Information Element	Value/remark	Comment	Condition

MeasObjectNR ::= SEQUENCE {			
ssbFrequency	ARFCN-ValueNR for SSB of NR Cell 1		
absThreshSS-BlocksConsolidation	Not present		
nrofSS-BlocksToAverage	Not present		
}			

Table 8.1.3.1.2.3.3-4: ReportConfigNR-EventA3 (Table 8.1.3.1.2.3.3-2)

Derivation Path: TS 38.508-1 [4] Table 4.6.3-142 with condition EVENT_A3			
Information Element	Value/remark	Comment	Condition
ReportConfigNR ::= SEQUENCE {			
reportType CHOICE {			
eventTriggered SEQUENCE {			
eventId CHOICE {			
eventA3 SEQUENCE {			
a3-Offset CHOICE {			
rsrp	2	1 dB (2*0.5 dB)	FR1
	FFS		FR2
}			
}			
}			
}			
reportAmount	infinity		
reportQuantityCell SEQUENCE {			
rsrp	true		
rsrq	false		
sinr	false		
}			
}			

Table 8.1.3.1.2.3.3-5: MeasurementReport (step 4, Table 8.1.3.1.2.3.2-3)

Derivation Path: TS 38.508-1 [4] Table 4.6.1-5A			
Information Element	Value/remark	Comment	Condition
MeasurementReport ::= SEQUENCE {			
criticalExtensions CHOICE {			
measurementReport SEQUENCE {			
measResults SEQUENCE {			
measId	1		
measResultServingMOList SEQUENCE (SIZE (1..maxNrofServingCells)) OF MeasResultServMO {	1 entry	Measurement report for NR Cell 1	
MeasResultServMO[1] SEQUENCE {		entry 1	
servCellId	ServCellIndex of NR Cell 1		
measResultServingCell SEQUENCE {			
physCellId	PCI of NR Cell 1		
measResult SEQUENCE {			
cellResults SEQUENCE {			
resultsSSB-Cell SEQUENCE {			
rsrp	(0..127)		
rsrq	(0..127)		
sinr	Not present		
}	Not checked		pc_ss_SINR_Meas
}			
}			
}			
}			
}			
}			
measResultNeighCells CHOICE {			

measResultListNR SEQUENCE (SIZE (1..maxCellReport)) OF MeasResultNR {	1 entry	Measurement report for NR Cell 2	
MeasResultNR[1] SEQUENCE {		entry 1	
physCellId	Physical layer cell identity of NR Cell 2		
measResult SEQUENCE {			
cellResults SEQUENCE {			
resultsSSB-Cell SEQUENCE {			
rsrp	(0..127)		
rsrq	Not present		
sinr	Not present		
}			
resultsCSI-RS-Cell	Not present		
}			
rsIndexResults	Not present		
}			
cgi-Info	Not present		
}			
}			
}			
}			
}			
}			
}			
}			
}			
}			

8.1.3.1.3 Measurement configuration control and reporting / Event A3 / Measurement of Neighbour NR cell / Inter-frequency measurements

8.1.3.1.3.1 Test Purpose (TP)

(1)

```
with { UE in NR RRC_CONNECTED state and inter-frequency measurements configured for event A3 using
measurement gaps configured as gapUE }
ensure that {
  when { Entry condition for event A3 is not met for neighbour cell }
  then { UE does not send MeasurementReport }
}
```

(2)

```
with { UE in NR RRC_CONNECTED state and inter-frequency measurements configured for event A3 using
measurement gaps configured as gapUE }
ensure that {
  when { Neighbour cell becomes offset better than serving cell }
  then { UE sends MeasurementReport with correct measId for event A3 }
}
```

8.1.3.1.3.2 Conformance requirements

Same as test case 8.1.3.1.2 with the following difference:

[TS 38.331, clause 5.5.2.9]

The UE shall:

...

1> if *gapUE* is set to *setup*:

2> if a per UE measurement gap configuration is already setup, release the per UE measurement gap configuration;

2> setup the per UE measurement gap configuration indicated by the *measGapConfig* in accordance with the received *gapOffset*, i.e., the first subframe of each gap occurs at an SFN and subframe meeting the following condition:

$$\text{SFN mod } T = \text{FLOOR}(\text{gapOffset}/10);$$

$$\text{subframe} = \text{gapOffset mod } 10;$$

with $T = \text{MGRP}/10$ as defined in TS 38.133 [14];

2> if *mgta* is configured, apply the specified timing advance to the gap occurrences calculated above (i.e. the UE starts the measurement *mgta* ms before the gap subframe occurrences);

...

8.1.3.1.3.3 Test description

8.1.3.1.3.3.1 Pre-test conditions

Same as test case 8.1.3.1.2 with the following differences:

- Cells configuration: NR Cell 3 replaces NR Cell 2.
- System information combination: NR-4 replaces NR-2.

8.1.3.1.3.3.2 Test procedure sequence

Same as test case 8.1.3.1.2 with the following differences:

- Cells configuration: NR Cell 3 replaces NR Cell 2.

8.1.3.1.3.3.3 Specific message contents

Same as test case 8.1.3.1.2 with the following difference:

- Cells configuration: NR Cell 3 replaces NR Cell 2.

Table 8.1.3.1.3.3.3-1: MeasConfig (Table 8.1.3.1.2.3.3-1)

Derivation Path: TS 38.508-1 [4] Table 4.6.3-69			
Information Element	Value/remark	Comment	Condition
MeasConfig ::= SEQUENCE {			
measObjectToAddModList SEQUENCE (SIZE (1..maxNrofMeasId)) OF MeasObjectToAddMod {	2 entries		
MeasObjectToAddMod[1] SEQUENCE {		entry 1	
measObjectId	1		
measObject CHOICE {			
measObjectNR	MeasObjectNR-f1	Table 8.1.3.1.3.3.3-2	
}			
MeasObjectToAddMod[2] SEQUENCE {		entry 2	
measObjectId	2		
measObject CHOICE {			
measObjectNR	MeasObjectNR-f2	Table 8.1.3.1.3.3.3-3	
}			
}			
reportConfigToAddModList SEQUENCE(SIZE (1..maxReportConfigId)) OF ReportConfigToAddMod {	1 entry		
ReportConfigToAddMod[1] SEQUENCE {		entry 1	
reportConfigId	1		
reportConfig CHOICE {			
}			
}			

reportConfigNR	ReportConfigNR-EventA3	Table 8.1.3.1.2.3.3-4	
}			
}			
measIdToAddModList SEQUENCE (SIZE (1..maxNrofMeasId)) OF MeasIdToAddMod {	1 entry		
MeasIdToAddMod[1] SEQUENCE {		entry 1	
measId	1		
measObjectId	2		
reportConfigId	1		
}			
}			
measGapConfig	MeasGapConfig		
}			

Table 8.1.3.1.3.3.3-2: *MeasObjectNR-f1* (Table 8.1.3.1.3.3.3-1)

Derivation Path: TS 38.508-1 [4], Table 4.6.3-76			
Information Element	Value/remark	Comment	Condition
MeasObjectNR ::= SEQUENCE {			
ssbFrequency	ARFCN-ValueNR for SSB of NR Cell 1		
absThreshSS-BlocksConsolidation	Not present		
nrofSS-BlocksToAverage	Not present		
}			

Table 8.1.3.1.3.3.3-3: *MeasObjectNR-f2* (Table 8.1.3.1.3.3.3-1)

Derivation Path: TS 38.508-1 [4], Table 4.6.3-76			
Information Element	Value/remark	Comment	Condition
MeasObjectNR ::= SEQUENCE {			
ssbFrequency	ARFCN-ValueNR for SSB of NR Cell 3		
absThreshSS-BlocksConsolidation	Not present		
nrofSS-BlocksToAverage	Not present		
}			

8.1.3.1.4 Measurement configuration control and reporting / Event A3 / Measurement of Neighbour NR cell / Inter-band measurements

8.1.3.1.4.1 Test Purpose (TP)

(1)

```
with { UE in NR RRC_CONNECTED state and inter-band measurements configured for event A3 using
measurement gaps configured as gapUE }
ensure that {
  when { Entry condition for event A3 is not met for neighbour cell }
  then { UE does not send MeasurementReport }
}
```

(2)

```
with { UE in NR RRC_CONNECTED state and inter-band measurements configured for event A3 using
measurement gaps configured as gapUE }
ensure that {
  when { Neighbour cell becomes offset better than serving cell }
  then { UE sends MeasurementReport with correct measId for event A3 }
}
```

8.1.3.1.4.2 Conformance requirements

Same as test case 8.1.3.1.2 with the following difference:

[TS 38.331, clause 5.5.2.9]

The UE shall:

...

1> if *gapUE* is set to *setup*:

- 2> if a per UE measurement gap configuration is already setup, release the per UE measurement gap configuration;
- 2> setup the per UE measurement gap configuration indicated by the *measGapConfig* in accordance with the received *gapOffset*, i.e., the first subframe of each gap occurs at an SFN and subframe meeting the following condition:

$$\text{SFN mod } T = \text{FLOOR}(\text{gapOffset}/10);$$

$$\text{subframe} = \text{gapOffset mod } 10;$$

with $T = \text{MGRP}/10$ as defined in TS 38.133 [14];

- 2> if *mgta* is configured, apply the specified timing advance to the gap occurrences calculated above (i.e. the UE starts the measurement *mgta* ms before the gap subframe occurrences);

...

8.1.3.1.4.3 Test description

8.1.3.1.4.3.1 Pre-test conditions

Same as test case 8.1.3.1.2 with the following differences:

- Cells configuration: NR Cell 10 replaces NR Cell 2.
- System information combination: NR-4 replaces NR-2.

8.1.3.1.4.3.2 Test procedure sequence

Same as test case 8.1.3.1.2 with the following differences:

- Cells configuration: NR Cell 10 replaces NR Cell 2.

Specific message contents

Same as test case 8.1.3.1.222 with the following difference:

- Cells configuration: NR Cell 10 replaces NR Cell 2.

Table 8.1.3.1.4.3.3-1: MeasConfig (Table 8.1.3.1.2.3.3-1)

Derivation Path: TS 38.508-1 [4] Table 4.6.3-69			
Information Element	Value/remark	Comment	Condition
MeasConfig ::= SEQUENCE {			
measObjectToAddModList SEQUENCE (SIZE (1..maxNrofMeasId)) OF MeasObjectToAddMod {	2 entries		
MeasObjectToAddMod[1] SEQUENCE {		entry 1	
measObjectId	1		
measObject CHOICE {			
measObjectNR	MeasObjectNR-f1	Table 8.1.3.1.4.3.3-2	
}			

}			
MeasObjectToAddMod[2] SEQUENCE {		entry 2	
measObjectId	2		
measObject CHOICE {			
measObjectNR	MeasObjectNR-f2	Table 8.1.3.1.4.3.3-3	
}			
}			
}			
reportConfigToAddModList SEQUENCE(SIZE (1..maxReportConfigId)) OF ReportConfigToAddMod {	1 entry		
ReportConfigToAddMod[1] SEQUENCE {		entry 1	
reportConfigId	1		
reportConfig CHOICE {			
reportConfigNR	ReportConfigNR- EventA3	Table 8.1.3.1.2.3.3-4	
}			
}			
}			
measIdToAddModList SEQUENCE (SIZE (1..maxNrofMeasId)) OF MeasIdToAddMod {	1 entry		
MeasIdToAddMod[1] SEQUENCE {		entry 1	
measId	1		
measObjectId	2		
reportConfigId	1		
}			
}			
measGapConfig	MeasGapConfig		
}			

Table 8.1.3.1.4.3.3-2: MeasObjectNR-f1 (Table 8.1.3.1.4.3.3-1)

Derivation Path: TS 38.508-1 [4], Table 4.6.3-76			
Information Element	Value/remark	Comment	Condition
MeasObjectNR ::= SEQUENCE {			
ssbFrequency	ARFCN-ValueNR for SSB of NR Cell 1		
absThreshSS-BlocksConsolidation	Not present		
nrofSS-BlocksToAverage	Not present		
}			

Table 8.1.3.1.4.3.3-3: MeasObjectNR-f2 (Table 8.1.3.1.4.3.3-1)

Derivation Path: TS 38.508-1 [4], Table 4.6.3-76			
Information Element	Value/remark	Comment	Condition
MeasObjectNR ::= SEQUENCE {			
ssbFrequency	ARFCN-ValueNR for SSB of NR Cell 10		
absThreshSS-BlocksConsolidation	Not present		
nrofSS-BlocksToAverage	Not present		
}			

8.1.3.1.5 Measurement configuration control and reporting / Event A4 / Measurement of Neighbour NR cell / Intra-frequency measurements

8.1.3.1.5.1 Test Purpose (TP)

(1)

with { UE in NR RRC_CONNECTED state and intra-frequency measurements configured for event A4 with event based periodical reporting }

```

ensure that {
  when { Neighbour cell becomes better than absolute threshold }
  then { UE sends MeasurementReport message at regular intervals while entering condition for
event A4 is satisfied }
}

```

(2)

```

with { UE in NR RRC_CONNECTED state and periodical measurement reporting triggered by event A4
ongoing }
ensure that {
  when { Neighbour cell becomes worse than absolute threshold }
  then { UE stops sending MeasurementReport message }
}

```

8.1.3.1.5.2 Conformance requirements

References: The conformance requirements covered in the current TC are specified in: TS 38.331, clauses 5.3.5.3, 5.5.2.1, 5.5.4.1, 5.5.4.5 and 5.5.5.1. Unless otherwise stated these are Rel-15 requirements.

[TS 38.331, clause 5.3.5.3]

The UE shall perform the following actions upon reception of the *RRCReconfiguration*:

...

1> if the *RRCReconfiguration* message includes the *measConfig*:

2> perform the measurement configuration procedure as specified in 5.5.2;

...

1> if the UE is configured with E-UTRA *nr-SecondaryCellGroupConfig* (MCG is E-UTRA):

...

1> else:

2> submit the *RRCReconfigurationComplete* message via SRB1 to lower layers for transmission using the new configuration;

...

[TS 38.331, clause 5.5.2.1]

...

The UE shall:

...

1> if the received *measConfig* includes the *measObjectToAddModList*:

2> perform the measurement object addition/modification procedure as specified in 5.5.2.5;

...

1> if the received *measConfig* includes the *reportConfigToAddModList*:

2> perform the reporting configuration addition/modification procedure as specified in 5.5.2.7;

...

1> if the received *measConfig* includes the *measIdToAddModList*:

2> perform the measurement identity addition/modification procedure as specified in 5.5.2.3;

...

[TS 38.331, clause 5.5.4.1]

If AS security has been activated successfully, the UE shall:

- 1> for each *measId* included in the *measIdList* within *VarMeasConfig*:
 - 2> if the corresponding *reportConfig* includes a *reportType* set to *eventTriggered* or *periodical*;
 - 3> if the corresponding *measObject* concerns NR;
 - ...
 - 4> for measurement events other than *eventA1* or *eventA2*:
 - ...
 - 5> else:
 - 6> consider any neighbouring cell detected based on parameters in the associated *measObjectNR* to be applicable when the concerned cell is not included in the *blackCellsToAddModList* defined within the *VarMeasConfig* for this *measId*;
 - ...
 - 4> if the *eventA1* or *eventA2* is configured in the corresponding *reportConfig*:
 - ...
 - 4> else:
 - 5> for events involving a serving cell associated with a *measObjectNR* and neighbours associated with another *measObjectNR*, consider any serving cell associated with the other *measObjectNR* to be a neighbouring cell as well;
 - ...
 - 2> if the *reportType* is set to *eventTriggered* and if the entry condition applicable for this event, i.e. the event corresponding with the *eventId* of the corresponding *reportConfig* within *VarMeasConfig*, is fulfilled for one or more applicable cells for all measurements after layer 3 filtering taken during *timeToTrigger* defined for this event within the *VarMeasConfig*, while the *VarMeasReportList* does not include a measurement reporting entry for this *measId* (a first cell triggers the event):
 - 3> include a measurement reporting entry within the *VarMeasReportList* for this *measId*;
 - 3> set the *numberOfReportsSent* defined within the *VarMeasReportList* for this *measId* to 0;
 - 3> include the concerned cell(s) in the *cellsTriggeredList* defined within the *VarMeasReportList* for this *measId*;
 - 3> initiate the measurement reporting procedure, as specified in 5.5.5;
 - 2> else if the *reportType* is set to *eventTriggered* and if the entry condition applicable for this event, i.e. the event corresponding with the *eventId* of the corresponding *reportConfig* within *VarMeasConfig*, is fulfilled for one or more applicable cells not included in the *cellsTriggeredList* for all measurements after layer 3 filtering taken during *timeToTrigger* defined for this event within the *VarMeasConfig* (a subsequent cell triggers the event):
 - 3> set the *numberOfReportsSent* defined within the *VarMeasReportList* for this *measId* to 0;
 - 3> include the concerned cell(s) in the *cellsTriggeredList* defined within the *VarMeasReportList* for this *measId*;
 - 3> initiate the measurement reporting procedure, as specified in 5.5.5;
 - 2> else if the *reportType* is set to *eventTriggered* and if the leaving condition applicable for this event is fulfilled for one or more of the cells included in the *cellsTriggeredList* defined within the *VarMeasReportList* for this

measId for all measurements after layer 3 filtering taken during *timeToTrigger* defined within the *VarMeasConfig* for this event:

3> remove the concerned cell(s) in the *cellsTriggeredList* defined within the *VarMeasReportList* for this *measId*;

...

3> if *reportOnLeave* is set to *TRUE* for the corresponding reporting configuration:

4> initiate the measurement reporting procedure, as specified in 5.5.5;

3> if the *cellsTriggeredList* defined within the *VarMeasReportList* for this *measId* is empty:

4> remove the measurement reporting entry within the *VarMeasReportList* for this *measId*;

4> stop the periodical reporting timer for this *measId*, if running;

...

2> upon expiry of the periodical reporting timer for this *measId*:

3> initiate the measurement reporting procedure, as specified in 5.5.5.

...

[TS 38.331, clause 5.5.4.5]

The UE shall:

1> consider the entering condition for this event to be satisfied when condition A4-1, as specified below, is fulfilled;

1> consider the leaving condition for this event to be satisfied when condition A4-2, as specified below, is fulfilled.

Inequality A4-1 (Entering condition)

$$Mn + Ofn + Ocn - Hys > Thresh$$

Inequality A4-2 (Leaving condition)

$$Mn + Ofn + Ocn + Hys < Thresh$$

The variables in the formula are defined as follows:

Mn is the measurement result of the neighbouring cell, not taking into account any offsets.

Ofn is the measurement object specific offset of the neighbour cell (i.e. *offsetMO* as defined within *measObjectNR* corresponding to the neighbour cell).

Ocn is the measurement object specific offset of the neighbour cell (i.e. *cellIndividualOffset* as defined within *measObjectNR* corresponding to the neighbour cell), and set to zero if not configured for the neighbour cell.

Hys is the hysteresis parameter for this event (i.e. *hysteresis* as defined within *reportConfigNR* for this event).

Thresh is the threshold parameter for this event (i.e. *a4-Threshold* as defined within *reportConfigNR* for this event).

Mn is expressed in dBm in case of RSRP, or in dB in case of RSRQ and RS-SINR.

Ofn*, *Ocn*, *Hys are expressed in dB.

Thresh is expressed in the same unit as ***Mn***.

[TS 38.331, clause 5.5.5.1]



Figure 5.5.5-1: Measurement reporting

The purpose of this procedure is to transfer measurement results from the UE to the network. The UE shall initiate this procedure only after successful AS security activation.

For the *measId* for which the measurement reporting procedure was triggered, the UE shall set the *measResults* within the *MeasurementReport* message as follows:

- 1> set the *measId* to the measurement identity that triggered the measurement reporting;
- 1> set the *measResultServingCell* within *measResultServingMOList* to include RSRP, RSRQ and the available SINR for each configured serving cell derived based on the *rsType* indicated in the associated *reportConfig*;
- 1> set the *measResultServingCell* within *measResultServingMOList* to include for each NR serving cell that is configured with *servingCellMO*, if any, the *servCellId*;
- ...
- 1> if there is at least one applicable neighbouring cell to report:
 - 2> if the *reportType* is set to *eventTriggered* or *periodical*:
 - 3> set the *measResultNeighCells* to include the best neighbouring cells up to *maxReportCells* in accordance with the following:
 - 4> if the *reportType* is set to *eventTriggered*:
 - 5> include the cells included in the *cellsTriggeredList* as defined within the *VarMeasReportList* for this *measId*;
 - ...
 - 4> for each cell that is included in the *measResultNeighCells*, include the *physCellId*;
 - 4> if the *reportType* is set to *eventTriggered* or *periodical*:
 - 5> for each included cell, include the layer 3 filtered measured results in accordance with the *reportConfig* for this *measId*, ordered as follows:
 - 6> if the *measObject* associated with this *measId* concerns NR:
 - 7> if *rsType* in the associated *reportConfig* is set to *ssb*:
 - 8> set *resultsSSB-Cell* within the *measResult* to include the SS/PBCH block based quantity(ies) indicated in the *reportQuantityCell* within the concerned *reportConfig*, in decreasing order of the sorting quantity, determined as specified in 5.5.5.3, i.e. the best cell is included first;
 - ...
 - 2> set the *measResultNeighCells* to include the best neighbouring cells up to *maxReportCells* in accordance with the following:
 - 3> if the *reportType* is set to *eventTriggered*:
 - 4> include the cells included in the *cellsTriggeredList* as defined within the *VarMeasReportList* for this *measId*;

...

3> for each cell that is included in the *measResultNeighCells*, include the *physCellId*;

3> if the *reportType* is set to *eventTriggered*:

4> for each included cell, include the layer 3 filtered measured results in accordance with the *reportConfig* for this *measId*, ordered as follows:

5> if the *measObject* associated with this *measId* concerns NR:

6> if *rsType* in the associated *reportConfig* is set to *ssb*:

7> set *results SSB-Cell* within the *measResult* to include the SS/PBCH block based quantity(ies) indicated in the *reportQuantityCell* within the concerned *reportConfig*, in order of decreasing trigger quantity, i.e. the best cell is included first:

...

1> increment the *numberOfReportsSent* as defined within the *VarMeasReportList* for this *measId* by 1;

1> stop the periodical reporting timer, if running;

1> if the *numberOfReportsSent* as defined within the *VarMeasReportList* for this *measId* is less than the *reportAmount* as defined within the corresponding *reportConfig* for this *measId*:

2> start the periodical reporting timer with the value of *reportInterval* as defined within the corresponding *reportConfig* for this *measId*;

...

...

1> if the UE is configured with EN-DC:

...

1> else:

2> submit the *MeasurementReport* message to lower layers for transmission, upon which the procedure ends.

8.1.3.1.5.3 Test description

8.1.3.1.5.3.1 Pre-test conditions

System Simulator:

- NR Cell 1 is the serving cell, NR Cell 2 is the intra-frequency neighbour cell of NR Cell 1.
- System information combination NR-2 as defined in TS 38.508-1 [4] clause 4.4.3.1.2 is used in NR cells.

UE:

- None.

Preamble:

- The UE is in state 3N-A as defined in TS 38.508-1 [4], subclause 4.4A.

8.1.3.1.5.3.2 Test procedure sequence

Table 8.1.3.1.5.3.2-1 and 8.1.3.1.5.3.2-2 illustrates the downlink power levels to be applied for NR Cell 1 and NR Cell 2 at various time instants of the test execution. Row marked "T0" denotes the conditions after the preamble, while the configuration marked "T1" and "T2", are applied at the point indicated in the Main behaviour description in Table 8.1.3.1.5.3.2-3.

Table 8.1.3.1.5.3.2-1: Time instances of cell power level and parameter changes in conducted test environment

	Parameter	Unit	NR Cell 1	NR Cell 2	Remark
T0	SS/PBCH SSS EPRE	dBm/ SCS	-85	-91	Power levels are such that entry condition for event A4 (measId 1) is not satisfied: $Mn + Ofn + Ocn - Hys \leq Thresh$
T1	SS/PBCH SSS EPRE	dBm/ SCS	-85	-79	Power levels are such that entry condition for event A4 (measId 1) is satisfied: $Mn + Ofn + Ocn - Hys > Thresh$
T2	SS/PBCH SSS EPRE	dBm/ SCS	-85	-93	Power levels are such that leaving condition for event A4 (measId 1) is satisfied: $Mn + Ofn + Ocn + Hys < Thresh$

Table 8.1.3.1.5.3.2-2: Time instances of cell power level and parameter changes in OTA test environment

	Parameter	Unit	NR Cell 1	NR Cell 2	Remark
T0	SS/PBCH SSS EPRE	dBm/ SCS	FFS	FFS	Power levels are such that entry condition for event A4 (measId 1) is not satisfied: $Mn + Ofn + Ocn - Hys \leq Thresh$
T1	SS/PBCH SSS EPRE	dBm/ SCS	FFS	FFS	Power levels are such that entry condition for event A4 (measId 1) is satisfied: $Mn + Ofn + Ocn - Hys > Thresh$
T2	SS/PBCH SSS EPRE	dBm/ SCS	FFS	FFS	Power levels are such that leaving condition for event A4 (measId 1) is satisfied: $Mn + Ofn + Ocn + Hys < Thresh$

Table 8.1.3.1.5.3.2-3: Main behaviour

St	Procedure	Message Sequence		TP	Verdict
		U - S	Message		
1	The SS transmits an <i>RRCReconfiguration</i> message including <i>MeasConfig</i> to setup NR measurement and reporting for intra-frequency event A4 (<i>measId 1</i>).	<--	NR RRC: <i>RRCReconfiguration</i>	-	-
2	The UE transmits an <i>RRCReconfigurationComplete</i> message.	-->	NR RRC: <i>RRCReconfigurationComplete</i>	-	-
3	SS re-adjusts the cell-specific reference signal level according to row "T1" in table 8.1.3.1.5.3.2-1/2.	-	-	-	-
-	EXCEPTION: In parallel to events described in step 4 the steps specified in table 8.1.3.1.5.3.2-4 shall take place	-	-	-	-
4	Wait for 30 seconds to ensure that the UE performs a periodical intra-frequency reporting for NR Cell 2	-	-	1	-
5	SS re-adjusts the cell-specific reference signal level according to row "T2" in table 8.1.3.1.5.3.2-1/2.	-	-	-	-
6	Wait and ignore <i>MeasurementReport</i> messages for 10s to allow change of power levels for NR Cell 2 and UE measurement	-	-	-	-
7	Check: Does the UE transmit a <i>MeasurementReport</i> message within the next 10s?	-->	NR RRC: <i>MeasurementReport</i>	2	F

Table 8.1.3.1.5.3.2-4: Parallel behaviour

St	Procedure	Message Sequence		TP	Verdict
		U - S	Message		
-	EXCEPTION: After the 1st message is received, step 1 below shall be repeated every time the duration indicated in the IE <i>reportInterval</i> has elapsed	-	-	-	-
1	Check: Does the UE transmit a <i>MeasurementReport</i> message to report event A4 (<i>measId</i> 1) with the measured RSRP value for NR Cell 2?	-->	NR RRC: <i>MeasurementReport</i>	1	P

8.1.3.1.5.3.3 Specific message contents

Table 8.1.3.1.5.3.3-1: RRCReconfiguration (step 1, Table 8.1.3.1.5.3.2-3)

Derivation Path: TS 38.508-1 [4] Table 4.6.1-13 with condition NR_MEAS
--

Table 8.1.3.1.5.3.3-2: MeasConfig (Table 8.1.3.1.5.3.3-1)

Derivation Path: TS 38.508-1 [4] Table 4.6.3-69			
Information Element	Value/remark	Comment	Condition
MeasConfig ::= SEQUENCE {			
measObjectToAddModList SEQUENCE (SIZE (1..maxNrofMeasId)) OF MeasObjectToAddMod {	1 entry		
MeasObjectToAddMod[1] SEQUENCE {		entry 1	
measObjectId	1	MeasObjectIdNR-f1	
measObject CHOICE {			
measObjectNR SEQUENCE {			
ssbFrequency	ssbFrequency IE equals the ARFCN for NR Cell 2		
absThreshSS-BlocksConsolidation	Not present		
}			
}			
}			
reportConfigToAddModList SEQUENCE(SIZE (1..maxReportConfigId)) OF ReportConfigToAddMod {	1 entry		
ReportConfigToAddMod[1] SEQUENCE {		entry 1	
reportConfigId	1		
reportConfig CHOICE {			
reportConfigNR	ReportConfigNR-EventA4	Table 8.1.3.1.5.3.3-3	
}			
}			
}			
measIdToAddModList SEQUENCE (SIZE (1..maxNrofMeasId)) OF MeasIdToAddMod {	1 entry		
MeasIdToAddMod[1] SEQUENCE {		entry 1	
measId	1		
measObjectId	1		
reportConfigId	1		
}			
}			
}			

Table 8.1.3.1.5.3.3-3: ReportConfigNR-EventA4 (Table 8.1.3.1.5.3.3-2)

Derivation Path: TS 38.508-1 [4] Table 4.6.3-142 with condition EVENT_A4			
Information Element	Value/remark	Comment	Condition

}			
resultsCSI-RS-Cell	Not present		
}			
rsIndexResults	Not present		
}			
cgi-Info	Not present		
}			
}			
}			
}			
}			
}			
}			

8.1.3.1.6 Measurement configuration control and reporting / Event A4 / Measurement of Neighbour NR cell / Inter-frequency measurements

8.1.3.1.6.1 Test Purpose (TP)

Same as test case 8.1.3.1.5 but applied to inter-frequency case.

8.1.3.1.6.2 Conformance requirements

Same as test case 8.1.3.1.5 with the following difference:

[TS 38.331, clause 5.5.2.9]

The UE shall:

...

1> if *gapUE* is set to *setup*:

2> if a per UE measurement gap configuration is already setup, release the per UE measurement gap configuration;

2> setup the per UE measurement gap configuration indicated by the *measGapConfig* in accordance with the received *gapOffset*, i.e., the first subframe of each gap occurs at an SFN and subframe meeting the following condition:

$$\text{SFN mod } T = \text{FLOOR}(\text{gapOffset}/10);$$

$$\text{subframe} = \text{gapOffset mod } 10;$$

with $T = \text{MGRP}/10$ as defined in TS 38.133 [14];

2> if *mgta* is configured, apply the specified timing advance to the gap occurrences calculated above (i.e. the UE starts the measurement *mgta* ms before the gap subframe occurrences);

...

8.1.3.1.6.3 Test description

8.1.3.1.6.3.1 Pre-test conditions

Same as test case 8.1.3.1.5 with the following differences:

- Cells configuration: NR Cell 3 replaces NR Cell 2.
- System information combination: NR-4 replaces NR-2.

8.1.3.1.6.3.2 Test procedure sequence

Same as test case 8.1.3.1.5 with the following differences:

- Cells configuration: NR Cell 3 replaces NR Cell 2.

8.1.3.1.6.3.3 Specific message contents

Same as test case 8.1.3.1.5 with the following difference:

- Cells configuration: NR Cell 3 replaces NR Cell 2.

Table 8.1.3.1.6.3.3-1: MeasConfig (Table 8.1.3.1.5.3.3-1)

Derivation Path: TS 38.508-1 [4] Table 4.6.3-69			
Information Element	Value/remark	Comment	Condition
MeasConfig ::= SEQUENCE {			
measObjectToAddModList SEQUENCE (SIZE (1..maxNrofMeasId)) OF MeasObjectToAddMod {	2 entries		
MeasObjectToAddMod[1] SEQUENCE {		entry 1	
measObjectId	1		
measObject CHOICE {			
measObjectNR	MeasObjectNR-f1	Table 8.1.3.1.6.3.3-2	
}			
}			
MeasObjectToAddMod[2] SEQUENCE {		entry 2	
measObjectId	2		
measObject CHOICE {			
measObjectNR	MeasObjectNR-f2	Table 8.1.3.1.6.3.3-3	
}			
}			
reportConfigToAddModList SEQUENCE(SIZE (1..maxReportConfigId)) OF ReportConfigToAddMod {	1 entry		
ReportConfigToAddMod[1] SEQUENCE {		entry 1	
reportConfigId	1		
reportConfig CHOICE {			
reportConfigNR	ReportConfigNR-EventA4	Table 8.1.3.1.5.3.3-3	
}			
}			
measIdToAddModList SEQUENCE (SIZE (1..maxNrofMeasId)) OF MeasIdToAddMod {	1 entry		
MeasIdToAddMod[1] SEQUENCE {		entry 1	
measId	1		
measObjectId	2		
reportConfigId	1		
}			
}			
measGapConfig	MeasGapConfig		
}			

Table 8.1.3.1.6.3.3-2: MeasObjectNR-f1 (Table 8.1.3.1.6.3.3-1)

Derivation Path: TS 38.508-1 [4], Table 4.6.3-76			
Information Element	Value/remark	Comment	Condition
MeasObjectNR ::= SEQUENCE {			
ssbFrequency	ARFCN-ValueNR for SSB of NR Cell 1		
absThreshSS-BlocksConsolidation	Not present		
nrofSS-BlocksToAverage	Not present		

}		
---	--	--

Table 8.1.3.1.6.3.3-3: *MeasObjectNR-f2* (Table 8.1.3.1.6.3.3-1)

Derivation Path: TS 38.508-1 [4], Table 4.6.3-76			
Information Element	Value/remark	Comment	Condition
MeasObjectNR ::= SEQUENCE {			
ssbFrequency	ARFCN-ValueNR for SSB of NR Cell 3		
absThreshSS-BlocksConsolidation	Not present		
nrofSS-BlocksToAverage	Not present		
}			

8.1.3.1.7 Measurement configuration control and reporting / Event A4 / Measurement of Neighbour NR cell / Inter-band measurements

8.1.3.1.7.1 Test Purpose (TP)

Same as test case 8.1.3.1.5 but applied to inter-band case.

8.1.3.1.7.2 Conformance requirements

Same as test case 8.1.3.1.5 with the following differences:

[TS 38.331, clause 5.5.2.9]

The UE shall:

...

1> if *gapUE* is set to *setup*:

2> if a per UE measurement gap configuration is already setup, release the per UE measurement gap configuration;

2> setup the per UE measurement gap configuration indicated by the *measGapConfig* in accordance with the received *gapOffset*, i.e., the first subframe of each gap occurs at an SFN and subframe meeting the following condition:

$$\text{SFN mod } T = \text{FLOOR}(\text{gapOffset}/10);$$

$$\text{subframe} = \text{gapOffset mod } 10;$$

with $T = \text{MGRP}/10$ as defined in TS 38.133 [14];

2> if *mgta* is configured, apply the specified timing advance to the gap occurrences calculated above (i.e. the UE starts the measurement *mgta* ms before the gap subframe occurrences);

...

8.1.3.1.7.3 Test description

8.1.3.1.7.3.1 Pre-test conditions

Same as test case 8.1.3.1.5 with the following differences:

- Cells configuration: NR Cell 10 replaces NR Cell 2.
- System information combination: NR-4 replaces NR-2.

8.1.3.1.7.3.2 Test procedure sequence

Same as test case 8.1.3.1.5 with the following differences:

- Cells configuration: NR Cell 10 replaces NR Cell 2.

8.1.3.1.7.3.3 Specific message contents

Same as test case 8.1.3.1.5 with the following difference:

- Cells configuration: NR Cell 10 replaces NR Cell 2.

Table 8.1.3.1.7.3.3-1: MeasConfig (Table 8.1.3.1.5.3.3-1)

Derivation Path: TS 38.508-1 [4] Table 4.6.3-69			
Information Element	Value/remark	Comment	Condition
MeasConfig ::= SEQUENCE {			
measObjectToAddModList SEQUENCE (SIZE (1..maxNrofMeasId)) OF MeasObjectToAddMod {	2 entries		
MeasObjectToAddMod[1] SEQUENCE {		entry 1	
measObjectId	1		
measObject CHOICE {			
measObjectNR	MeasObjectNR-f1	Table 8.1.3.1.7.3.3-2	
}			
}			
MeasObjectToAddMod[2] SEQUENCE {		entry 2	
measObjectId	2		
measObject CHOICE {			
measObjectNR	MeasObjectNR-f2	Table 8.1.3.1.7.3.3-3	
}			
}			
reportConfigToAddModList SEQUENCE(SIZE (1..maxReportConfigId)) OF ReportConfigToAddMod {	1 entry		
ReportConfigToAddMod[1] SEQUENCE {		entry 1	
reportConfigId	1		
reportConfig CHOICE {			
reportConfigNR	ReportConfigNR-EventA4	Table 8.1.3.1.5.3.3-3	
}			
}			
measIdToAddModList SEQUENCE (SIZE (1..maxNrofMeasId)) OF MeasIdToAddMod {	1 entry		
MeasIdToAddMod[1] SEQUENCE {		entry 1	
measId	1		
measObjectId	2		
reportConfigId	1		
}			
}			
measGapConfig	MeasGapConfig		
}			

Table 8.1.3.1.7.3.3-2: MeasObjectNR-f1 (Table 8.1.3.1.7.3.3-1)

Derivation Path: TS 38.508-1 [4], Table 4.6.3-76			
Information Element	Value/remark	Comment	Condition
MeasObjectNR ::= SEQUENCE {			
ssbFrequency	ARFCN-ValueNR for SSB of NR Cell 1		
absThreshSS-BlocksConsolidation	Not present		
nrofSS-BlocksToAverage	Not present		

}		
---	--	--

Table 8.1.3.1.7.3.3-3: *MeasObjectNR-f2* (Table 8.1.3.1.7.3.3-1)

Derivation Path: TS 38.508-1 [4], Table 4.6.3-76			
Information Element	Value/remark	Comment	Condition
MeasObjectNR ::= SEQUENCE {			
ssbFrequency	ARFCN-ValueNR for SSB of NR Cell 10		
absThreshSS-BlocksConsolidation	Not present		
nrofSS-BlocksToAverage	Not present		
}			

8.1.3.1.8 Measurement configuration control and reporting / Event A5 / Measurement of Neighbour NR cell / Intra-frequency measurements

8.1.3.1.8.1 Test Purpose (TP)

(1)

```
with { UE in NR RRC_CONNECTED state and intra-frequency measurements configured for event A5 with
event based periodical reporting }
ensure that {
  when { Serving cell becomes worse than absolute threshold1 and neighbour cell becomes better than
absolute threshold2 }
    then { UE sends MeasurementReport message at regular intervals while entering conditions for
event A5 are satisfied }
}
```

(2)

```
with { UE in NR RRC_CONNECTED state and periodical measurement reporting triggered by event A5
ongoing }
ensure that {
  when { Serving cell becomes better than absolute threshold1 or neighbour cell becomes worse than
absolute threshold2 }
    then { UE stops sending MeasurementReport message }
}
```

8.1.3.1.8.2 Conformance requirements

References: The conformance requirements covered in the current TC are specified in: TS 38.331, clauses 5.3.5.3, 5.5.2.1, 5.5.4.1, 5.5.4.6 and 5.5.5.1. Unless otherwise stated these are Rel-15 requirements.

[TS 38.331, clause 5.3.5.3]

The UE shall perform the following actions upon reception of the *RRCReconfiguration*:

...

1> if the *RRCReconfiguration* message includes the *measConfig*:

2> perform the measurement configuration procedure as specified in 5.5.2;

...

1> if the UE is configured with E-UTRA *nr-SecondaryCellGroupConfig* (MCG is E-UTRA):

...

1> else:

2> submit the *RRCReconfigurationComplete* message via SRB1 to lower layers for transmission using the new configuration;

...

[TS 38.331, clause 5.5.2.1]

...

The UE shall:

...

- 1> if the received *measConfig* includes the *measObjectToAddModList*:
 - 2> perform the measurement object addition/modification procedure as specified in 5.5.2.5;
- ...
- 1> if the received *measConfig* includes the *reportConfigToAddModList*:
 - 2> perform the reporting configuration addition/modification procedure as specified in 5.5.2.7;
- ...
- 1> if the received *measConfig* includes the *measIdToAddModList*:
 - 2> perform the measurement identity addition/modification procedure as specified in 5.5.2.3;

...

[TS 38.331, clause 5.5.4.1]

If AS security has been activated successfully, the UE shall:

- 1> for each *measId* included in the *measIdList* within *VarMeasConfig*:
 - 2> if the corresponding *reportConfig* includes a *reportType* set to *eventTriggered* or *periodical*;
 - 3> if the corresponding *measObject* concerns NR;
 - ...
 - 4> if the *eventA3* or *eventA5* is configured in the corresponding *reportConfig*:
 - 5> if a serving cell is associated with a *measObjectNR* and neighbours are associated with another *measObjectNR*, consider any serving cell associated with the other *measObjectNR* to be a neighbouring cell as well;
 - ...
 - 4> if the *eventA1* or *eventA2* is configured in the corresponding *reportConfig*:
 - ...
 - 4> else:
 - 5> for events involving a serving cell associated with a *measObjectNR* and neighbours associated with another *measObjectNR*, consider any serving cell associated with the other *measObjectNR* to be a neighbouring cell as well;
 - ...
 - 2> if the *reportType* is set to *eventTriggered* and if the entry condition applicable for this event, i.e. the event corresponding with the *eventId* of the corresponding *reportConfig* within *VarMeasConfig*, is fulfilled for one or more applicable cells for all measurements after layer 3 filtering taken during *timeToTrigger* defined for this event within the *VarMeasConfig*, while the *VarMeasReportList* does not include a measurement reporting entry for this *measId* (a first cell triggers the event):
 - 3> include a measurement reporting entry within the *VarMeasReportList* for this *measId*;

- 3> set the *numberOfReportsSent* defined within the *VarMeasReportList* for this *measId* to 0;
- 3> include the concerned cell(s) in the *cellsTriggeredList* defined within the *VarMeasReportList* for this *measId*;
- 3> initiate the measurement reporting procedure, as specified in 5.5.5;
- 2> else if the *reportType* is set to *eventTriggered* and if the entry condition applicable for this event, i.e. the event corresponding with the *eventId* of the corresponding *reportConfig* within *VarMeasConfig*, is fulfilled for one or more applicable cells not included in the *cellsTriggeredList* for all measurements after layer 3 filtering taken during *timeToTrigger* defined for this event within the *VarMeasConfig* (a subsequent cell triggers the event):
 - 3> set the *numberOfReportsSent* defined within the *VarMeasReportList* for this *measId* to 0;
 - 3> include the concerned cell(s) in the *cellsTriggeredList* defined within the *VarMeasReportList* for this *measId*;
 - 3> initiate the measurement reporting procedure, as specified in 5.5.5;
- 2> else if the *reportType* is set to *eventTriggered* and if the leaving condition applicable for this event is fulfilled for one or more of the cells included in the *cellsTriggeredList* defined within the *VarMeasReportList* for this *measId* for all measurements after layer 3 filtering taken during *timeToTrigger* defined within the *VarMeasConfig* for this event:
 - 3> remove the concerned cell(s) in the *cellsTriggeredList* defined within the *VarMeasReportList* for this *measId*;
 - ...
 - 3> if *reportOnLeave* is set to *TRUE* for the corresponding reporting configuration:
 - 4> initiate the measurement reporting procedure, as specified in 5.5.5;
 - 3> if the *cellsTriggeredList* defined within the *VarMeasReportList* for this *measId* is empty:
 - 4> remove the measurement reporting entry within the *VarMeasReportList* for this *measId*;
 - 4> stop the periodical reporting timer for this *measId*, if running;
 - ...
- 2> upon expiry of the periodical reporting timer for this *measId*:
 - 3> initiate the measurement reporting procedure, as specified in 5.5.5.
- ...

[TS 38.331, clause 5.5.4.6]

The UE shall:

- 1> consider the entering condition for this event to be satisfied when both condition A5-1 and condition A5-2, as specified below, are fulfilled;
- 1> consider the leaving condition for this event to be satisfied when condition A5-3 or condition A5-4, i.e. at least one of the two, as specified below, is fulfilled;
- 1> use the SpCell for *Mp*.

NOTE: The parameters of the reference signal(s) of the cell(s) that triggers the event are indicated in the *measObjectNR* associated to the event which may be different from the *measObjectNR* of the NR SpCell.

Inequality A5-1 (Entering condition 1)

$$M_p + H_{ys} < Thresh1$$

Inequality A5-2 (Entering condition 2)

$$Mn + Ofn + Ocn - Hys > Thresh2$$

Inequality A5-3 (Leaving condition 1)

$$Mp - Hys > Thresh1$$

Inequality A5-4 (Leaving condition 2)

$$Mn + Ofn + Ocn + Hys < Thresh2$$

The variables in the formula are defined as follows:

Mp is the measurement result of the NR SpCell, not taking into account any offsets.

Mn is the measurement result of the neighbouring cell/SCell, not taking into account any offsets.

Ofn is the measurement object specific offset of the neighbour/SCell cell (i.e. *offsetMO* as defined within *measObjectNR* corresponding to the neighbour cell/SCell).

Ocn is the cell specific offset of the neighbour cell/SCell (i.e. *cellIndividualOffset* as defined within *measObjectNR* corresponding to the neighbour cell/SCell), and set to zero if not configured for the neighbour cell.

Hys is the hysteresis parameter for this event (i.e. *hysteresis* as defined within *reportConfigNR* for this event).

Thresh1 is the threshold parameter for this event (i.e. *a5-Threshold1* as defined within *reportConfigNR* for this event).

Thresh2 is the threshold parameter for this event (i.e. *a5-Threshold2* as defined within *reportConfigNR* for this event).

Mn, Mp are expressed in dBm in case of RSRP, or in dB in case of RSRQ and RS-SINR.

Ofn, Ocn, Hys are expressed in dB.

Thresh1 is expressed in the same unit as ***Mp***.

Thresh2 is expressed in the same unit as ***Mn***.

[TS 38.331, clause 5.5.5.1]



Figure 5.5.5-1: Measurement reporting

The purpose of this procedure is to transfer measurement results from the UE to the network. The UE shall initiate this procedure only after successful AS security activation.

For the *measId* for which the measurement reporting procedure was triggered, the UE shall set the *measResults* within the *MeasurementReport* message as follows:

- 1> set the *measId* to the measurement identity that triggered the measurement reporting;
- 1> set the *measResultServingCell* within *measResultServingMOList* to include, for each NR serving cell that is configured with *-servingCellMO*, RSRP, RSRQ and the available SINR derived based on the *rsType* if indicated in the associated *reportConfig*, otherwise based on SSB if available, otherwise based on CSI-RS; for each configured serving cell derived based on the *rsType* indicated in the associated *reportConfig*;

set the *servCellId* within *measResultServingMOList* to include each NR serving cell that is configured with *servingCellMO*, if any;

1> set the *measResultServingCell* within *measResultServingMOList* to include for each NR serving cell that is configured with *servingCellMO*, if any, the *servCellId*;

...

1> if there is at least one applicable neighbouring cell to report:

2> if the *reportType* is set to *eventTriggered* or *periodical*:

3> set the *measResultNeighCells* to include the best neighbouring cells up to *maxReportCells* in accordance with the following:

4> if the *reportType* is set to *eventTriggered*:

5> include the cells included in the *cellsTriggeredList* as defined within the *VarMeasReportList* for this *measId*;

...

4> for each cell that is included in the *measResultNeighCells*, include the *physCellId*;

4> if the *reportType* is set to *eventTriggered* or *periodical*:

5> for each included cell, include the layer 3 filtered measured results in accordance with the *reportConfig* for this *measId*, ordered as follows:

6> if the *measObject* associated with this *measId* concerns NR:

7> if *rsType* in the associated *reportConfig* is set to *ssb*:

8> set *resultsSSB-Cell* within the *measResult* to include the SS/PBCH block based quantity(ies) indicated in the *reportQuantityCell* within the concerned *reportConfig*, in decreasing order of the sorting quantity, determined as specified in 5.5.5.3, i.e. the best cell is included first;

...

2> set the *measResultNeighCells* to include the best neighbouring cells up to *maxReportCells* in accordance with the following:

3> if the *reportType* is set to *eventTriggered*:

4> include the cells included in the *cellsTriggeredList* as defined within the *VarMeasReportList* for this *measId*;

...

3> for each cell that is included in the *measResultNeighCells*, include the *physCellId*;

3> if the *reportType* is set to *eventTriggered*:

4> for each included cell, include the layer 3 filtered measured results in accordance with the *reportConfig* for this *measId*, ordered as follows:

5> if the *measObject* associated with this *measId* concerns NR:

6> if *rsType* in the associated *reportConfig* is set to *ssb*:

7> set *resultsSSB-Cell* within the *measResult* to include the SS/PBCH block based quantity(ies) indicated in the *reportQuantityCell* within the concerned *reportConfig*, in order of decreasing trigger quantity, i.e. the best cell is included first;

...

- 1> increment the *numberOfReportsSent* as defined within the *VarMeasReportList* for this *measId* by 1;
- 1> stop the periodical reporting timer, if running;
- 1> if the *numberOfReportsSent* as defined within the *VarMeasReportList* for this *measId* is less than the *reportAmount* as defined within the corresponding *reportConfig* for this *measId*:
 - 2> start the periodical reporting timer with the value of *reportInterval* as defined within the corresponding *reportConfig* for this *measId*;
- ...
- ...
- 1> if the UE is configured with EN-DC:
 - ...
 - 1> else:
 - 2> submit the *MeasurementReport* message to lower layers for transmission, upon which the procedure ends.

8.1.3.1.8.3 Test description

8.1.3.1.8.3.1 Pre-test conditions

System Simulator:

- NR Cell 1 is the PCell, NR Cell 2 is the intra-frequency neighbour cell of NR Cell 1.
- System information combination NR-2 as defined in TS 38.508-1 [4] clause 4.4.3.1.2 is used in NR cells.

UE:

- None.

Preamble:

- The UE is in state 3N-A as defined in TS 38.508-1 [4], subclause 4.4A.

8.1.3.1.8.3.2 Test procedure sequence

Table 8.1.3.1.8.3.2-1 and 8.1.3.1.8.3.2-2 illustrates the downlink power levels to be applied for NR Cell 1 and NR Cell 2 at various time instants of the test execution. Row marked "T0" denotes the conditions after the preamble, while the configuration marked "T1" and "T2" are applied at the point indicated in the Main behaviour description in Table 8.1.3.1.8.3.2-3.

Table 8.1.3.1.8.3.2-1: Time instances of cell power level and parameter changes in conducted test environment

	Parameter	Unit	NR Cell 1	NR Cell 2	Remark
T0	SS/PBCH SSS EPRE	dBm/ SCS	-85	-91	Power levels are such that entry condition for event A5 (measId 1) is not satisfied: $Mp + Hys \geq Thresh1$ or $Mn + Ofn + Ocn + Hys \leq Thresh2$
T1	SS/PBCH SSS EPRE	dBm/ SCS	-85	-79	Power levels are such that entry condition for event A5 (measId 1) is satisfied: $Mp + Hys < Thresh1$ and $Mn + Ofn + Ocn - Hys > Thresh2$

T2	SS/PBCH SSS EPRE	dBm/ SCS	-85	-93	Power levels are such that leaving condition for event A5 (measId 1) is satisfied: $Mp - Hys > Thresh1$ or $Mn + Ofn + Ocn + Hys < Thresh2$
----	---------------------	-------------	-----	-----	--

Table 8.1.3.1.8.3.2-2: Time instances of cell power level and parameter changes in OTA test environment

	Parameter	Unit	NR Cell 1	NR Cell 2	Remark
T0	SS/PBCH SSS EPRE	dBm/ SCS	FFS	FFS	Power levels are such that entry condition for event A5 (measId 1) is not satisfied: $Mp + Hys \geq Thresh1$ or $Mn + Ofn + Ocn + Hys \leq Thresh2$
T1	SS/PBCH SSS EPRE	dBm/ SCS	FFS	FFS	Power levels are such that entry condition for event A5 (measId 1) is satisfied: $Mp + Hys < Thresh1$ and $Mn + Ofn + Ocn - Hys > Thresh2$
T2	SS/PBCH SSS EPRE	dBm/ SCS	FFS	FFS	Power levels are such that leaving condition for event A5 (measId 1) is satisfied: $Mp - Hys > Thresh1$ or $Mn + Ofn + Ocn + Hys < Thresh2$

Table 8.1.3.1.8.3.2-3: Main behaviour

St	Procedure	Message Sequence		TP	Verdict
		U - S	Message		
1	The SS transmits an <i>RRCReconfiguration</i> message including <i>MeasConfig</i> to setup NR measurement and reporting for intra-frequency event A5 (<i>measId 1</i>)	<--	NR RRC: <i>RRCReconfiguration</i>	-	-
2	The UE transmits an <i>RRCReconfigurationComplete</i> message.	-->	NR RRC: <i>RRCReconfigurationComplete</i>	-	-
3	SS re-adjusts the cell-specific reference signal level according to row "T1" in table 8.1.3.1.8.3.2-1/2.	-	-	-	-
-	EXCEPTION: In parallel to events described in step 4 the steps specified in table 8.1.3.1.8.3.2-4 shall take place	-	-	-	-
4	Wait for 30 seconds to ensure that the UE performs a periodical intra-frequency reporting for NR Cell 2	-	-	1	-
5	SS re-adjusts the cell-specific reference signal level according to row "T2" in table 8.1.3.1.8.3.2-1/2.	-	-	-	-
6	Wait and ignore <i>MeasurementReport</i> messages for 10s to allow change of power levels for NR Cell 2 and UE measurement	-	-	-	-
7	Check: Does the UE transmit a <i>MeasurementReport</i> message within the next 10s?	-->	NR RRC: <i>MeasurementReport</i>	2	F

Table 8.1.3.1.8.3.2-4: Parallel behaviour

St	Procedure	Message Sequence		TP	Verdict
		U - S	Message		
-	EXCEPTION: After the 1st message is received, step 1 below shall be repeated every time the duration indicated in the IE <i>reportInterval</i> has elapsed	-	-	-	-

1	Check: Does the UE transmit a <i>MeasurementReport</i> message to report event A5 (<i>measId</i> 1) with the measured RSRP value for NR Cell 2?	-->	<i>MeasurementReport</i>	1	P
---	--	-----	--------------------------	---	---

8.1.3.1.8.3.3 Specific message contents

Table 8.1.3.1.8.3.3-1: RRCReconfiguration (step 1, Table 8.1.3.1.8.3.2-3)

Derivation Path: TS 38.508-1 [4] Table 4.6.1-13 with condition NR_MEAS

Table 8.1.3.1.8.3.3-2: MeasConfig (Table 8.1.3.1.8.3.3-1)

Derivation Path: TS 38.508-1 [4] Table 4.6.3-69			
Information Element	Value/remark	Comment	Condition
MeasConfig ::= SEQUENCE {			
measObjectToAddModList SEQUENCE (SIZE (1..maxNrofMeasId)) OF MeasObjectToAddMod {	1 entry		
MeasObjectToAddMod[1] SEQUENCE {		entry 1	
measObjectId	1	MeasObjectIdNR-f1	
measObject CHOICE {			
measObjectNR SEQUENCE {			
ssbFrequency	ssbFrequency IE equals the ARFCN for NR Cell 2		
absThreshSS-BlocksConsolidation	Not present		
}			
}			
}			
reportConfigToAddModList SEQUENCE(SIZE (1..maxReportConfigId)) OF ReportConfigToAddMod {	1 entry		
ReportConfigToAddMod[1] SEQUENCE {		entry 1	
reportConfigId	1		
reportConfig CHOICE {			
reportConfigNR	ReportConfigNR-EventA5	Table 8.1.3.1.8.3.3-3	
}			
}			
}			
measIdToAddModList SEQUENCE (SIZE (1..maxNrofMeasId)) OF MeasIdToAddMod {	1 entry		
MeasIdToAddMod[1] SEQUENCE {		entry 1	
measId	1		
measObjectId	1		
reportConfigId	1		
}			
}			
}			

Table 8.1.3.1.8.3.3-3: ReportConfigNR-EventA5 (Table 8.1.3.1.8.3.3-2)

Derivation Path: TS 38.508-1 [4] Table 4.6.3-142 with condition EVENT_A5			
Information Element	Value/remark	Comment	Condition
ReportConfigNR ::= SEQUENCE {			
reportType CHOICE {			
eventTriggered SEQUENCE {			
eventId CHOICE {			
eventA5 SEQUENCE {			
a5-Threshold1 CHOICE {			
rsrp	76	-80dBm	FR1
	FFS		FR2

}			
a5-Threshold2 CHOICE {			
rsrp	70	-86dBm	FR1
	FFS		FR2
}			
}			
reportAmount	infinity		
reportQuantityCell SEQUENCE {			
rsrp	true		
rsrq	false		
sinr	false		
}			
}			
}			
}			

Table 8.1.3.1.8.3.3-4: MeasurementReport (step 1, Table 8.1.3.1.8.3.2-4)

Derivation Path: TS 38.508-1 [4] Table 4.6.1-5A			
Information Element	Value/remark	Comment	Condition
MeasurementReport ::= SEQUENCE {			
criticalExtensions CHOICE {			
measurementReport SEQUENCE {			
measResults SEQUENCE {			
measId	1		
measResultServingMOList SEQUENCE (SIZE (1..maxNrofServingCells)) OF MeasResultServMO {	1 entry	Report NR Cell 1	
MeasResultServMO[1] SEQUENCE {		entry 1	
servCellId	ServCellIndex of NR Cell 1		
measResultServingCell SEQUENCE {			
physCellId	Physical layer cell identity of NR Cell 1		
measResult SEQUENCE {			
cellResults SEQUENCE {			
resultsSSB-Cell SEQUENCE {			
rsrp	(0..127)		
rsrq	(0..127)		
sinr	Not present		
}	Not checked		pc_ss_SINR_Meas
}			
}			
}			
}			
}			
}			
measResultNeighCells CHOICE {			
measResultListNR SEQUENCE (SIZE (1..maxCellReport)) OF MeasResultNR {	1 entry	Report NR neighbour cell	
MeasResultNR[1] SEQUENCE {		entry 1	
physCellId	Physical layer cell identity of NR Cell 2		
measResult SEQUENCE {			
cellResults SEQUENCE {			
resultsSSB-Cell SEQUENCE {			
rsrp	(0..127)		
rsrq	Not present		
sinr	Not present		
}			
resultsCSI-RS-Cell	Not present		
}			
rsIndexResults	Not present		
}			

cgi-Info	Not present		
}			
}			
}			
}			
}			
}			
}			

8.1.3.1.9 Measurement configuration control and reporting / Event A5 / Measurement of Neighbour NR cell / Inter-frequency measurements

8.1.3.1.9.1 Test Purpose (TP)

Same as test case 8.1.3.1.8 but applied to inter-frequency case.

8.1.3.1.9.2 Conformance requirements

Same as test case 8.1.3.1.8 with the following difference:

[TS 38.331, clause 5.5.2.9]

The UE shall:

...

1> if *gapUE* is set to *setup*:

2> if a per UE measurement gap configuration is already setup, release the per UE measurement gap configuration;

2> setup the per UE measurement gap configuration indicated by the *measGapConfig* in accordance with the received *gapOffset*, i.e., the first subframe of each gap occurs at an SFN and subframe meeting the following condition:

$$\text{SFN mod } T = \text{FLOOR}(\text{gapOffset}/10);$$

$$\text{subframe} = \text{gapOffset mod } 10;$$

with $T = \text{MGRP}/10$ as defined in TS 38.133 [14];

2> if *mgta* is configured, apply the specified timing advance to the gap occurrences calculated above (i.e. the UE starts the measurement *mgta* ms before the gap subframe occurrences);

...

8.1.3.1.9.3 Test description

8.1.3.1.9.3.1 Pre-test conditions

Same as test case 8.1.3.1.8 with the following difference:

- Cells configuration: NR Cell 3 replaces NR Cell 2.
- System information combination: NR-4 replaces NR-2.

8.1.3.1.9.3.2 Test procedure sequence

Same as test case 8.1.3.1.8 with the following difference:

- Cells configuration: NR Cell 3 replaces NR Cell 2.

8.1.3.1.9.3.3 Specific message contents

Same as test case 8.1.3.1.5 with the following difference:

- Cells configuration: NR Cell 3 replaces NR Cell 2.

Table 8.1.3.1.9.3.3-1: MeasConfig (Table 8.1.3.1.8.3.3-1)

Derivation Path: TS 38.508-1 [4] Table 4.6.3-69			
Information Element	Value/remark	Comment	Condition
MeasConfig ::= SEQUENCE {			
measObjectToAddModList SEQUENCE (SIZE (1..maxNrofMeasId)) OF MeasObjectToAddMod {	2 entries		
MeasObjectToAddMod[1] SEQUENCE {		entry 1	
measObjectId	1		
measObject CHOICE {			
measObjectNR	MeasObjectNR-f1	Table 8.1.3.1.9.3.3-2	
}			
}			
MeasObjectToAddMod[2] SEQUENCE {		entry 2	
measObjectId	2		
measObject CHOICE {			
measObjectNR	MeasObjectNR-f2	Table 8.1.3.1.9.3.3-3	
}			
}			
reportConfigToAddModList SEQUENCE (SIZE (1..maxReportConfigId)) OF ReportConfigToAddMod {	1 entry		
ReportConfigToAddMod[1] SEQUENCE {		entry 1	
reportConfigId	1		
reportConfig CHOICE {			
reportConfigNR	ReportConfigNR-EventA5	Table 8.1.3.1.8.3.3-3	
}			
}			
measIdToAddModList SEQUENCE (SIZE (1..maxNrofMeasId)) OF MeasIdToAddMod {	1 entry		
MeasIdToAddMod[1] SEQUENCE {		entry 1	
measId	1		
measObjectId	2		
reportConfigId	1		
}			
}			
measGapConfig	MeasGapConfig		
}			

Table 8.1.3.1.9.3.3-2: MeasObjectNR-f1 (Table 8.1.3.1.9.3.3-1)

Derivation Path: TS 38.508-1 [14], Table 4.6.3-76			
Information Element	Value/remark	Comment	Condition
MeasObjectNR ::= SEQUENCE {			
ssbFrequency	ARFCN-ValueNR for SSB of NR Cell 1		
absThreshSS-BlocksConsolidation	Not present		
nrofSS-BlocksToAverage	Not present		
}			

Table 8.1.3.1.9.3.3-3: MeasObjectNR-f2 (Table 8.1.3.1.9.3.3-1)

Derivation Path: TS 38.508-1 [14], Table 4.6.3-76			
Information Element	Value/remark	Comment	Condition

MeasObjectNR ::= SEQUENCE {			
ssbFrequency	ARFCN-ValueNR for SSB of NR Cell 3		
absThreshSS-BlocksConsolidation	Not present		
nrofSS-BlocksToAverage	Not present		
}			

8.1.3.1.10 Measurement configuration control and reporting / Event A5 / Measurement of Neighbour NR cell / Inter-band measurements

8.1.3.1.10.1 Test Purpose (TP)

Same as test case 8.1.3.1.8 but applied to inter-band case.

8.1.3.1.10.2 Conformance requirements

Same as test case 8.1.3.1.8 with the following difference:

[TS 38.331, clause 5.5.2.9]

The UE shall:

...

1> if *gapUE* is set to *setup*:

2> if a per UE measurement gap configuration is already setup, release the per UE measurement gap configuration;

2> setup the per UE measurement gap configuration indicated by the *measGapConfig* in accordance with the received *gapOffset*, i.e., the first subframe of each gap occurs at an SFN and subframe meeting the following condition:

$SFN \bmod T = \text{FLOOR}(gapOffset/10)$;

$subframe = gapOffset \bmod 10$;

with $T = MGRP/10$ as defined in TS 38.133 [14];

2> if *mgta* is configured, apply the specified timing advance to the gap occurrences calculated above (i.e. the UE starts the measurement *mgta* ms before the gap subframe occurrences);

...

8.1.3.1.10.3 Test description

8.1.3.1.10.3.1 Pre-test conditions

Same as test case 8.1.3.1.8 with the following difference:

- Cells configuration: NR Cell 10 replaces NR Cell 2.
- System information combination: NR-4 replaces NR-2.

8.1.3.1.10.3.2 Test procedure sequence

Same as test case 8.1.3.1.8 with the following difference:

- Cells configuration: NR Cell 10 replaces NR Cell 2.

8.1.3.1.10.3.3 Specific message contents

Same as test case 8.1.3.1.8 with the following difference:

- Cells configuration: NR Cell 10 replaces NR Cell 2.

Table 8.1.3.1.10.3.3-1: MeasConfig (Table 8.1.3.1.8.3.3-1)

Derivation Path: TS 38.508-1 [4] Table 4.6.3-69			
Information Element	Value/remark	Comment	Condition
MeasConfig ::= SEQUENCE {			
measObjectToAddModList SEQUENCE (SIZE (1..maxNrofMeasId)) OF MeasObjectToAddMod {	2 entries		
MeasObjectToAddMod[1] SEQUENCE {		entry 1	
measObjectId	1		
measObject CHOICE {			
measObjectNR	MeasObjectNR-f1	Table 8.1.3.1.10.3.3-2	
}			
}			
MeasObjectToAddMod[2] SEQUENCE {		entry 2	
measObjectId	2		
measObject CHOICE {			
measObjectNR	MeasObjectNR-f2	Table 8.1.3.1.10.3.3-3	
}			
}			
reportConfigToAddModList SEQUENCE(SIZE (1..maxReportConfigId)) OF ReportConfigToAddMod {	1 entry		
ReportConfigToAddMod[1] SEQUENCE {		entry 1	
reportConfigId	1		
reportConfig CHOICE {			
reportConfigNR	ReportConfigNR-EventA5	Table 8.1.3.1.8.3.3-3	
}			
}			
measIdToAddModList SEQUENCE (SIZE (1..maxNrofMeasId)) OF MeasIdToAddMod {	1 entry		
MeasIdToAddMod[1] SEQUENCE {		entry 1	
measId	1		
measObjectId	2		
reportConfigId	1		
}			
}			
measGapConfig	MeasGapConfig		
}			

Table 8.1.3.1.10.3.3-2: MeasObjectNR-f1 (Table 8.1.3.1.10.3.3-1)

Derivation Path: TS 38.508-1 [4], Table 4.6.3-76			
Information Element	Value/remark	Comment	Condition
MeasObjectNR ::= SEQUENCE {			
ssbFrequency	ARFCN-ValueNR for SSB of NR Cell 1		
absThreshSS-BlocksConsolidation	Not present		
nrofSS-BlocksToAverage	Not present		
}			

Table 8.1.3.1.10.3.3-3: MeasObjectNR-f2 (Table 8.1.3.1.10.3.3-1)

Derivation Path: TS 38.508-1 [4], Table 4.6.3-76			
Information Element	Value/remark	Comment	Condition
MeasObjectNR ::= SEQUENCE {			
ssbFrequency	ARFCN-ValueNR for SSB of NR Cell 10		

absThreshSS-BlocksConsolidation	Not present		
nrofSS-BlocksToAverage	Not present		
}			

8.1.3.1.11 Measurement configuration control and reporting / Intra NR measurements / Two simultaneous events A3 (intra and inter-frequency measurements) / RSRQ based measurements

8.1.3.1.11.1 Test Purpose (TP)

(1)

```
with { UE in NR RRC_CONNECTED state, measurements configured for two event A3 at the same time and
triggerQuantity set to rsrq }
ensure that {
  when { Entry condition for event A3 is not met }
  then { UE does not send MeasurementReport }
}
```

(2)

```
with { UE in NR RRC_CONNECTED state, measurements configured for two event A3 at the same time and
triggerQuantity set to rsrq }
ensure that {
  when { Neighbour becomes offset better than serving }
  then { UE sends MeasurementReport with correct measId for event A3 }
}
```

8.1.3.1.11.2 Conformance requirements

References: The conformance requirements covered in the present TC are specified in: TS 38.331, clause 5.3.5.3, 5.5.2.1, 5.5.2.9, 5.5.4.1, 5.5.4.4 and 5.5.5.

[TS 38.331, clause 5.3.5.3]

The UE shall perform the following actions upon reception of the *RRCReconfiguration*:

...

- 1> if the *RRCReconfiguration* message includes the *measConfig*:
- 2> perform the measurement configuration procedure as specified in 5.5.2;

...

[TS 38.331, clause 5.5.2.1]

The UE shall:

...

- 1> if the received *measConfig* includes the *measObjectToAddModList*:
- 2> perform the measurement object addition/modification procedure as specified in 5.5.2.5;

...

- 1> if the received *measConfig* includes the *reportConfigToAddModList*:
- 2> perform the reporting configuration addition/modification procedure as specified in 5.5.2.7;

- 1> if the received *measConfig* includes the *quantityConfig*:
- 2> perform the quantity configuration procedure as specified in 5.5.2.8;

...

- 1> if the received *measConfig* includes the *measIdToAddModList*:
 - 2> perform the measurement identity addition/modification procedure as specified in 5.5.2.3;
- 1> if the received *measConfig* includes the *measGapConfig*:
 - 2> perform the measurement gap configuration procedure as specified in 5.5.2.9;

...

[TS 38.331, clause 5.5.2.9]

The UE shall:

...

- 1> if *gapUE* is set to setup:
 - 2> if a per UE measurement gap configuration is already setup, release the per UE measurement gap configuration;
 - 2> setup the per UE measurement gap configuration indicated by the *measGapConfig* in accordance with the received *gapOffset*, i.e., the first subframe of each gap occurs at an SFN and subframe meeting the following condition:
 - SFN mod $T = \text{FLOOR}(\text{gapOffset}/10)$;
 - subframe = $\text{gapOffset} \bmod 10$;
 - with $T = \text{MGRP}/10$ as defined in TS 38.133 [14];
 - 2> if *mgta* is configured, apply the specified timing advance to the gap occurrences calculated above (i.e. the UE starts the measurement *mgta* ms before the gap subframe occurrences);

...

[TS 38.331, clause 5.5.4.1]

If security has been activated successfully, the UE shall:

- 1> for each *measId* included in the *measIdList* within *VarMeasConfig*:
 - 2> if the corresponding *reportConfig* includes a *reportType* set to *eventTriggered* or *periodical*;
 - 3> if the corresponding *measObject* concerns NR;
 - 4> if the *eventA1* or *eventA2* is configured in the corresponding *reportConfig*:
 - ...
 - 4> else:
 - 5> for events involving a serving cell associated with a *measObjectNR* and neighbours associated with another *measObjectNR*, consider any serving cell associated with the other *measObjectNR* to be a neighbouring cell as well;
 - 5> if *useWhiteCellList* is set to TRUE:
 - ...
 - 5> else:
 - 6> consider any neighbouring cell detected based on parameters in the associated *measObjectNR* to be applicable when the concerned cell is not included in the *blackCellsToAddModList* defined within the *VarMeasConfig* for this *measId*;

...

- 2> if the *reportType* is set to *eventTriggered* and if the entry condition applicable for this event, i.e. the event corresponding with the *eventId* of the corresponding *reportConfig* within *VarMeasConfig*, is fulfilled for one or more applicable cells for all measurements after layer 3 filtering taken during *timeToTrigger* defined for this event within the *VarMeasConfig*, while the *VarMeasReportList* does not include a measurement reporting entry for this *measId* (a first cell triggers the event):
- 3> include a measurement reporting entry within the *VarMeasReportList* for this *measId*;
 - 3> set the *numberOfReportsSent* defined within the *VarMeasReportList* for this *measId* to 0;
 - 3> include the concerned cell(s) in the *cellsTriggeredList* defined within the *VarMeasReportList* for this *measId*;
 - 3> initiate the measurement reporting procedure, as specified in 5.5.5;
- 2> if the *reportType* is set to *eventTriggered* and if the entry condition applicable for this event, i.e. the event corresponding with the *eventId* of the corresponding *reportConfig* within *VarMeasConfig*, is fulfilled for one or more applicable cells not included in the *cellsTriggeredList* for all measurements after layer 3 filtering taken during *timeToTrigger* defined for this event within the *VarMeasConfig* (a subsequent cell triggers the event):
- 3> set the *numberOfReportsSent* defined within the *VarMeasReportList* for this *measId* to 0;
 - 3> include the concerned cell(s) in the *cellsTriggeredList* defined within the *VarMeasReportList* for this *measId*;
 - 3> initiate the measurement reporting procedure, as specified in 5.5.5;
- 2> if the *reportType* is set to *eventTriggered* and if the leaving condition applicable for this event is fulfilled for one or more of the cells included in the *cellsTriggeredList* defined within the *VarMeasReportList* for this *measId* for all measurements after layer 3 filtering taken during *timeToTrigger* defined within the *VarMeasConfig* for this event:
- 3> remove the concerned cell(s) in the *cellsTriggeredList* defined within the *VarMeasReportList* for this *measId*;
 - ...3> if the *cellsTriggeredList* defined within the *VarMeasReportList* for this *measId* is empty:
 - 4> remove the measurement reporting entry within the *VarMeasReportList* for this *measId*;
 - 4> stop the periodical reporting timer for this *measId*, if running;

...

[TS 38.331, clause 5.5.4.4]

The UE shall:

- 1> consider the entering condition for this event to be satisfied when condition A3-1, as specified below, is fulfilled;
- 1> consider the leaving condition for this event to be satisfied when condition A3-2, as specified below, is fulfilled;
- 1> use the SpCell for *Mp*, *Ofp* and *Ocp*.

NOTE The cell(s) that triggers the event has reference signals indicated in the *measObjectNR* associated to this event which may be different from the NR SpCell *measObjectNR*.

Inequality A3-1 (Entering condition)

$$Mn + Ofn + Ocn - Hys > Mp + Ofp + Ocp + Off$$

Inequality A3-2 (Leaving condition)

$$Mn + Ofn + Ocn + Hys < Mp + Ofp + Ocp + Off$$

The variables in the formula are defined as follows:

M_n is the measurement result of the neighbouring cell, not taking into account any offsets.

Of_n is the measurement object specific offset of the reference signal of the neighbour cell (i.e. *offsetMO* as defined within *measObjectNR* corresponding to the neighbour cell).

O_{cn} is the cell specific offset of the neighbour cell (i.e. *cellIndividualOffset* as defined within *measObjectNR* corresponding to the frequency of the neighbour cell), and set to zero if not configured for the neighbour cell.

M_p is the measurement result of the SpCell, not taking into account any offsets.

Of_p is the measurement object specific offset of the SpCell (i.e. *offsetMO* as defined within *measObjectNR* corresponding to the SpCell).

O_{cp} is the cell specific offset of the SpCell (i.e. *cellIndividualOffset* as defined within *measObjectNR* corresponding to the SpCell), and is set to zero if not configured for the SpCell.

H_{ys} is the hysteresis parameter for this event (i.e. *hysteresis* as defined within *reportConfigNR* for this event).

Off is the offset parameter for this event (i.e. *a3-Offset* as defined within *reportConfigNR* for this event).

M_n*, *M_p are expressed in dBm in case of RSRP, or in dB in case of RSRQ and RS-SINR.

Of_n*, *O_{cn}*, *Of_p*, *O_{cp}*, *H_{ys}*, *Off are expressed in dB.

[TS 38.331, clause 5.5.5.1]



Figure 5.5.5.1-1: Measurement reporting

The purpose of this procedure is to transfer measurement results from the UE to the network. The UE shall initiate this procedure only after successful security activation.

For the *measId* for which the measurement reporting procedure was triggered, the UE shall set the *measResults* within the *MeasurementReport* message as follows:

1> set the *measId* to the measurement identity that triggered the measurement reporting;

1> set the *measResultServingCell* within *measResultServingMOList* to include RSRP, RSRQ and the available SINR for each configured serving cell derived based on the *rsType* indicated in the associated *reportConfig*;

1> set the *measResultServingCell* within *measResultServingMOList* to include for each NR serving cell that is configured with *servingCellMO*, if any, the *servCellId*;

...

1> if there is at least one applicable neighbouring cell to report:

2> if the *reportType* is set to *eventTriggered* or *periodical*:

3> set the *measResultNeighCells* to include the best neighbouring cells up to *maxReportCells* in accordance with the following:

4> if the *reportType* is set to *eventTriggered*:

5> include the cells included in the *cellsTriggeredList* as defined within the *VarMeasReportList* for this *measId*;

- 4> for each cell that is included in the *measResultNeighCells*, include the *physCellId*;
- 4> if the *reportType* is set to *eventTriggered* or *periodical*:
 - 5> for each included cell, include the layer 3 filtered measured results in accordance with the *reportConfig* for this *measId*, ordered as follows:
 - 6> if the *measObject* associated with this *measId* concerns NR:
 - 7> if *rsType* in the associated *reportConfig* is set to *ssb*:
 - 8> set *resultsSSB-Cell* within the *measResult* to include the SS/PBCH block based quantity(ies) indicated in the *reportQuantityCell* within the concerned *reportConfig*, in decreasing order of the sorting quantity, determined as specified in 5.5.5.3, i.e. the best cell is included first;
 - ...
 - 1> increment the *numberOfReportsSent* as defined within the *VarMeasReportList* for this *measId* by 1;
 - 1> stop the periodical reporting timer, if running;
 - 1> if the *numberOfReportsSent* as defined within the *VarMeasReportList* for this *measId* is less than the *reportAmount* as defined within the corresponding *reportConfig* for this *measId*:
 - 2> start the periodical reporting timer with the value of *reportInterval* as defined within the corresponding *reportConfig* for this *measId*;
 - ...
 - 1> if the UE is configured with EN-DC:
 - ...
 - 1> else:
 - 2> submit the *MeasurementReport* message to lower layers for transmission, upon which the procedure ends.

8.1.3.1.11.3 Test description

8.1.3.1.11.3.1 Pre-test conditions

System Simulator:

- NR Cell 1 is the serving cell, NR Cell 2 is the intra-frequency neighbour cell, and NR Cell 3 is the inter-frequency neighbour cell.
- NR Cell 1 NR Cell 2 and NR Cell3 are configured to operate in FR1 bands as defined in TS 38.508-1 [4] clause 6.2.3.
- System information combination NR-5 as defined in TS 38.508-1 [4] clause 4.4.3.1.2 is used in NR cells.

UE:

- None.

Preamble:

- The UE is in state 3N-A as defined in TS 38.508-1 [4], subclause 4.4A on NR Cell 1.

8.1.3.1.11.3.2 Test procedure sequence

Table 8.1.3.1.11.3.2-1 illustrate the downlink power levels to be applied for NR Cell 1, NR Cell 2 and NR Cell 3 at various time instants of the test execution for FR1. Row marked "T0" denotes the conditions after the preamble, while

rows marked "T1" and "T2" are to be applied subsequently. The exact instants on which these values shall be applied are described in the texts in this clause.

Table 8.1.3.1.11.3.2-1: Time instances of cell power level and parameter changes in FR1

	Parameter	Unit	NR Cell 1	NR Cell 2	NR Cell 3	Remark
T0	SS/PBCH SSS EPRE	dBm/S CS	-88	-100	"Off"	Power levels are such that entry condition for event A3 (<i>measId 1 & 2</i>) is not satisfied: $Mn + Ofn + Ocn - Hys < Mp + Ofp + Ocp + Off$
	SS-RSRQ	dB	-11.74	-17.74	-	
	Noc	dBm/S CS	-94		-	
T1	SS/PBCH SSS EPRE	dBm/S CS	-88	-88	"Off"	Power levels are such that entry condition for event A3 (<i>measId 1</i>) is satisfied: $Mn + Ofn + Ocn - Hys > Mp + Ofp + Ocp + Off$
	SS-RSRQ	dB	-11.74	-11.74	-	
	Noc	dBm/S CS	-94		-	
T2	SS/PBCH SSS EPRE	dBm/S CS	-88	"Off"	-88	Power levels are such that entry condition for event A3 (<i>measId 2</i>) is satisfied: $Mn + Ofn + Ocn - Hys > Mp + Ofp + Ocp + Off$
	SS-RSRQ	dB	-11.74	-	-11.74	
	Noc	dBm/S CS	-94		-94	

NOTE 1: The total tolerance used is the sum of downlink signal level uncertainty (TS 38.508-1 Table 6.2.2.1-4) and absolute UE measurement accuracy (TS 38.133 clause 10).

Table 8.1.3.1.11.3.2-2: Void

Table 8.1.3.1.11.3.2-3: Main behaviour

St	Procedure	Message Sequence		TP	Verdict
		U - S	Message		
1	The SS transmits an <i>RRCReconfiguration</i> message on NR Cell 1 including <i>MeasConfig</i> to setup NR measurement and reporting for two event A3 (<i>measId 1</i> and <i>measId 2</i>) (intra and inter frequency measurement).	<--	NR RRC: <i>RRCReconfiguration</i>	-	-
2	The UE transmits an <i>RRCReconfigurationComplete</i> message on NR Cell 1.	-->	NR RRC: <i>RRCReconfigurationComplete</i>	-	-
3	Check: Does the UE transmit a <i>MeasurementReport</i> message on NR Cell 1 within the next 10s?	-->	NR RRC: <i>MeasurementReport</i>	1	F
4	The SS re-adjusts the cell-specific reference signal level according to row "T1" in Table 8.1.3.1.11.3.2-1.	-	-	-	-
5	Check: Does the UE transmit a <i>MeasurementReport</i> message on NR Cell 1 to report event A3 (<i>measId 1</i>) with the measured RSRP and RSRQ values for NR Cell 2?	-->	NR RRC: <i>MeasurementReport</i>	2	P
6	The SS re-adjusts the cell-specific reference signal level according to row "T2" in Table 8.1.3.1.11.3.2-1.	-	-	-	-
7	Check: Does the UE transmit a <i>MeasurementReport</i> message on NR Cell 1 to report event A3 (<i>measId 2</i>) with the measured RSRP and RSRQ values for NR Cell 3?	-->	NR RRC: <i>MeasurementReport</i>	2	P

8.1.3.1.11.3.3 Specific message contents

Table 8.1.3.1.11.3.3-1: RRCReconfiguration (step 1, Table 8.1.3.1.11.3.2-3)

Derivation Path: TS 38.508-1 [4] table 4.6.1-13 with condition NR_MEAS

Table 8.1.3.1.11.3.3-2: MeasConfig (step 1, Table 8.1.3.1.11.3.2-3)

Derivation Path: TS 38.508-1[4] table 4.6.3-69			
Information Element	Value/Remark	Comment	Condition
MeasConfig ::= SEQUENCE {			
measObjectToAddModList SEQUENCE (SIZE (1..maxNrofMeasId)) OF MeasObjectToAddMod {	2 entries		
MeasObjectToAddMod[1] SEQUENCE {		entry 1	
measObjectId	1		
measObject CHOICE {			
measObjectNR	MeasObjectNR-f1	Table 8.1.3.1.11.3.3-3	
}			
}			
MeasObjectToAddMod[2] SEQUENCE {		entry 2	
measObjectId	2		
measObject CHOICE {			
measObjectNR	MeasObjectNR-f2	Table 8.1.3.1.11.3.3-4	
}			
}			
reportConfigToAddModList SEQUENCE (SIZE (1..maxReportConfigId)) OF ReportConfigToAddMod {	1 entry		
ReportConfigToAddMod[1] SEQUENCE {		entry 1	
reportConfigId	ReportConfigId		
reportConfig CHOICE {			
reportConfigNR	ReportConfigNR-A3	Table 8.1.3.1.11.3.3-5	
}			
}			
measIdToAddModList SEQUENCE (SIZE (1..maxNrofMeasId)) OF MeasIdToAddMod {	2 entries		
MeasIdToAddMod[1] SEQUENCE {		entry 1	
measId	1		
measObjectId	1		
reportConfigId	ReportConfigId		
}			
MeasIdToAddMod[2] SEQUENCE {		entry 2	
measId	2		
measObjectId	2		
reportConfigId	ReportConfigId		
}			
}			
measGapConfig	MeasGapConfig		
}			

Table 8.1.3.1.11.3.3-3: MeasObjectNR-f1 (Table 8.1.3.1.11.3.2-3)

Derivation Path: TS 38.508-1 [4], Table 4.6.3-76			
Information Element	Value/remark	Comment	Condition
MeasObjectNR ::= SEQUENCE {			
ssbFrequency	Downlink ARFCN of NR Cell 1 SSB		

absThreshSS-BlocksConsolidation	Not present		
}			

Table 8.1.3.1.11.3.3-4: MeasObjectNR-f2 (Table 8.1.3.1.11.3.3-2)

Derivation Path: TS 38.508-1 [4], Table 4.6.3-76			
Information Element	Value/remark	Comment	Condition
MeasObjectNR ::= SEQUENCE {			
ssbFrequency	Downlink ARFCN of NR Cell 3 SSB		
absThreshSS-BlocksConsolidation	Not present		
}			

Table 8.1.3.1.11.3.3-5: ReportConfigNR-A3 (Table 8.1.3.1.11.3.3-2)

Derivation Path: TS 38.508-1 [4] table 4.6.3-142 with condition EVENT_A3			
Information Element	Value/remark	Comment	Condition
ReportConfigNR ::= SEQUENCE {			
reportType CHOICE {			
eventTriggered SEQUENCE {			
eventId CHOICE {			
eventA3 SEQUENCE {			
a3-Offset CHOICE {			
rsrq	-6	Actual value = -3dB	
}			
hysteresis	0	Actual value = 0dB	
}			
}			
reportAmount	r1		
}			
}			

Table 8.1.3.1.11.3.3-6: Void

Table 8.1.3.1.11.3.3-7: MeasurementReport (steps 5 and 7, Table 8.1.3.1.11.3.2-3)

Derivation Path: TS 38.508-1 [4], table 4.6.1-5A			
Information Element	Value/remark	Comment	Condition
MeasurementReport ::= SEQUENCE {			
criticalExtensions CHOICE {			
measurementReport SEQUENCE {			
measResults SEQUENCE {			
measId	1		Step 5
	2		Step 7
measResultServingMOList SEQUENCE (SIZE (1..maxNrofServingCells)) OF MeasResultServMO {	1 entry		Step 5
MeasResultServMO[1] SEQUENCE {		entry 1	
servCellId	ServCellIndex of NR Cell 1		
measResultServingCell SEQUENCE {			
physCellId	PhysCellId of NR Cell 1		
measResult SEQUENCE {			
cellResults SEQUENCE {			
resultsSSB-Cell SEQUENCE {			
rsrp	(0..127)		
rsrq	(0..127)		
sinr	(0..127)		pc_ss_SINR_Meas
}	Not present		
}			
}			
}			
}			
}			

[TS 38.331, clause 5.3.5.3]

The UE shall perform the following actions upon reception of the *RRCReconfiguration*:

...

- 1> if the *RRCReconfiguration* message includes the *measConfig*:
 - 2> perform the measurement configuration procedure as specified in 5.5.2;

...

[TS 38.331, clause 5.5.2.1]

The UE shall:

...

- 1> if the received *measConfig* includes the *measObjectToAddModList*:
 - 2> perform the measurement object addition/modification procedure as specified in 5.5.2.5;

...

- 1> if the received *measConfig* includes the *reportConfigToAddModList*:
 - 2> perform the reporting configuration addition/modification procedure as specified in 5.5.2.7;

- 1> if the received *measConfig* includes the *quantityConfig*:
 - 2> perform the quantity configuration procedure as specified in 5.5.2.8;

...

- 1> if the received *measConfig* includes the *measIdToAddModList*:
 - 2> perform the measurement identity addition/modification procedure as specified in 5.5.2.3;

- 1> if the received *measConfig* includes the *measGapConfig*:
 - 2> perform the measurement gap configuration procedure as specified in 5.5.2.9;

...

[TS 38.331, clause 5.5.2.9]

The UE shall:

...

- 1> if *gapUE* is set to setup:
 - 2> if a per UE measurement gap configuration is already setup, release the per UE measurement gap configuration;
 - 2> setup the per UE measurement gap configuration indicated by the *measGapConfig* in accordance with the received *gapOffset*, i.e., the first subframe of each gap occurs at an SFN and subframe meeting the following condition:
 - $SFN \bmod T = \text{FLOOR}(gapOffset/10)$;
 - subframe = $gapOffset \bmod 10$;
 - with $T = \text{MGRP}/10$ as defined in TS 38.133 [14];
 - 2> if *mgta* is configured, apply the specified timing advance to the gap occurrences calculated above (i.e. the UE starts the measurement *mgta* ms before the gap subframe occurrences);

[TS 38.331, clause 5.5.4.1]

If security has been activated successfully, the UE shall:

- 1> for each *measId* included in the *measIdList* within *VarMeasConfig*:
 - 2> if the corresponding *reportConfig* includes a *reportType* set to *eventTriggered* or *periodical*;
 - 3> if the corresponding *measObject* concerns NR;
 - 4> if the *eventA1* or *eventA2* is configured in the corresponding *reportConfig*:
 - ...
 - 4> else:
 - 5> for events involving a serving cell associated with a *measObjectNR* and neighbours associated with another *measObjectNR*, consider any serving cell associated with the other *measObjectNR* to be a neighbouring cell as well;
 - 5> if *useWhiteCellList* is set to TRUE:
 - ...
 - 5> else:
 - 6> consider any neighbouring cell detected based on parameters in the associated *measObjectNR* to be applicable when the concerned cell is not included in the *blackCellsToAddModList* defined within the *VarMeasConfig* for this *measId*;
 - ...
 - 2> if the *reportType* is set to *eventTriggered* and if the entry condition applicable for this event, i.e. the event corresponding with the *eventId* of the corresponding *reportConfig* within *VarMeasConfig*, is fulfilled for one or more applicable cells for all measurements after layer 3 filtering taken during *timeToTrigger* defined for this event within the *VarMeasConfig*, while the *VarMeasReportList* does not include a measurement reporting entry for this *measId* (a first cell triggers the event):
 - 3> include a measurement reporting entry within the *VarMeasReportList* for this *measId*;
 - 3> set the *numberOfReportsSent* defined within the *VarMeasReportList* for this *measId* to 0;
 - 3> include the concerned cell(s) in the *cellsTriggeredList* defined within the *VarMeasReportList* for this *measId*;
 - 3> initiate the measurement reporting procedure, as specified in 5.5.5;
 - 2> if the *reportType* is set to *eventTriggered* and if the entry condition applicable for this event, i.e. the event corresponding with the *eventId* of the corresponding *reportConfig* within *VarMeasConfig*, is fulfilled for one or more applicable cells not included in the *cellsTriggeredList* for all measurements after layer 3 filtering taken during *timeToTrigger* defined for this event within the *VarMeasConfig* (a subsequent cell triggers the event):
 - 3> set the *numberOfReportsSent* defined within the *VarMeasReportList* for this *measId* to 0;
 - 3> include the concerned cell(s) in the *cellsTriggeredList* defined within the *VarMeasReportList* for this *measId*;
 - 3> initiate the measurement reporting procedure, as specified in 5.5.5;
 - 2> if the *reportType* is set to *eventTriggered* and if the leaving condition applicable for this event is fulfilled for one or more of the cells included in the *cellsTriggeredList* defined within the *VarMeasReportList* for this *measId* for all measurements after layer 3 filtering taken during *timeToTrigger* defined within the *VarMeasConfig* for this event:
 - 3> remove the concerned cell(s) in the *cellsTriggeredList* defined within the *VarMeasReportList* for this *measId*;
 - ...

- 3> if the *cellsTriggeredList* defined within the *VarMeasReportList* for this *measId* is empty:
 - 4> remove the measurement reporting entry within the *VarMeasReportList* for this *measId*;
 - 4> stop the periodical reporting timer for this *measId*, if running;
 - ...

[TS 38.331, clause 5.5.4.4]

The UE shall:

- 1> consider the entering condition for this event to be satisfied when both condition A5-1 and condition A5-2, as specified below, are fulfilled;
- 1> consider the leaving condition for this event to be satisfied when condition A5-3 or condition A5-4, i.e. at least one of the two, as specified below, is fulfilled;
- 1> use the SpCell for *Mp*.

NOTE: The parameters of the reference signal(s) of the cell(s) that triggers the event are indicated in the *measObjectNR* associated to the event which may be different from the *measObjectNR* of the NR SpCell.

Inequality A5-1 (Entering condition 1)

$$M_p + H_{ys} < Thresh1$$

Inequality A5-2 (Entering condition 2)

$$M_n + O_{fn} + O_{cn} - H_{ys} > Thresh2$$

Inequality A5-3 (Leaving condition 1)

$$M_p - H_{ys} > Thresh1$$

Inequality A5-4 (Leaving condition 2)

$$M_n + O_{fn} + O_{cn} + H_{ys} < Thresh2$$

The variables in the formula are defined as follows:

Mp is the measurement result of the NR SpCell, not taking into account any offsets.

Mn is the measurement result of the neighbouring cell/SCell, not taking into account any offsets.

Ofn is the measurement object specific offset of the neighbour/SCell cell (i.e. *offsetMO* as defined within *measObjectNR* corresponding to the neighbour cell/SCell).

Ocn is the cell specific offset of the neighbour cell/SCell (i.e. *cellIndividualOffset* as defined within *measObjectNR* corresponding to the neighbour cell/SCell), and set to zero if not configured for the neighbour cell.

Hys is the hysteresis parameter for this event (i.e. *hysteresis* as defined within *reportConfigNR* for this event).

Thresh1 is the threshold parameter for this event (i.e. *a5-Threshold1* as defined within *reportConfigNR* for this event).

Thresh2 is the threshold parameter for this event (i.e. *a5-Threshold2* as defined within *reportConfigNR* for this event).

Mn, Mp are expressed in dBm in case of RSRP, or in dB in case of RSRQ and RS-SINR.

Ofn, Ocn, Hys are expressed in dB.

Thresh1 is expressed in the same unit as ***Mp***.

Thresh2 is expressed in the same unit as ***Mn***.

[TS 38.331, clause 5.5.5.1]



Figure 5.5.5.1-1: Measurement reporting

The purpose of this procedure is to transfer measurement results from the UE to the network. The UE shall initiate this procedure only after successful security activation.

For the *measId* for which the measurement reporting procedure was triggered, the UE shall set the *measResults* within the *MeasurementReport* message as follows:

- 1> set the *measId* to the measurement identity that triggered the measurement reporting;
- 1> set the *measResultServingCell* within *measResultServingMOList* to include RSRP, RSRQ and the available SINR for each configured serving cell derived based on the *rsType* indicated in the associated *reportConfig*;
- 1> set the *measResultServingCell* within *measResultServingMOList* to include for each NR serving cell that is configured with *servingCellMO*, if any, the *servCellId*;
- 1> if there is at least one applicable neighbouring cell to report:
 - 2> if the *reportType* is set to *eventTriggered* or *periodical*:
 - 3> set the *measResultNeighCells* to include the best neighbouring cells up to *maxReportCells* in accordance with the following:
 - 4> if the *reportType* is set to *eventTriggered*:
 - 5> include the cells included in the *cellsTriggeredList* as defined within the *VarMeasReportList* for this *measId*;
 - 4> for each cell that is included in the *measResultNeighCells*, include the *physCellId*;
 - 4> if the *reportType* is set to *eventTriggered* or *periodical*:
 - 5> for each included cell, include the layer 3 filtered measured results in accordance with the *reportConfig* for this *measId*, ordered as follows:
 - 6> if the *measObject* associated with this *measId* concerns NR:
 - 7> if *rsType* in the associated *reportConfig* is set to *ssb*:
 - 8> set *resultsSSB-Cell* within the *measResult* to include the SS/PBCH block based quantity(ies) indicated in the *reportQuantityCell* within the concerned *reportConfig*, in decreasing order of the sorting quantity, determined as specified in 5.5.5.3, i.e. the best cell is included first;
- 1> increment the *numberOfReportsSent* as defined within the *VarMeasReportList* for this *measId* by 1;
- 1> stop the periodical reporting timer, if running;
- 1> if the *numberOfReportsSent* as defined within the *VarMeasReportList* for this *measId* is less than the *reportAmount* as defined within the corresponding *reportConfig* for this *measId*:
 - 2> start the periodical reporting timer with the value of *reportInterval* as defined within the corresponding *reportConfig* for this *measId*;

...

2> if the UE is configured with EN-DC:

...

1> else:

2> submit the *MeasurementReport* message to lower layers for transmission, upon which the procedure ends.

8.1.3.1.12.3 Test description

8.1.3.1.12.3.1 Pre-test conditions

System Simulator:

- NR Cell 1 is the serving cell, NR Cell 2 is the intra-frequency neighbour cell, and NR Cell 3 is the inter-frequency neighbour cell.
- NR Cell 1 NR Cell 2 and NR Cell3 are configured to operate in FR1 bands as defined in TS 38.508-1 [4] clause 6.2.3.
- System information combination NR-5 as defined in TS 38.508-1 [4] clause 4.4.3.1.2 is used in NR cells.

UE:

- None.

Preamble:

- The UE is in state 3N-A as defined in TS 38.508-1 [4], subclause 4.4A on NR Cell 1.

8.1.3.1.12.3.2 Test procedure sequence

Table 8.1.3.1.12.3.2-1 illustrates the downlink power levels to be applied for NR Cell 1, NR Cell 2 and NR Cell 3 at various time instants of the test execution for FR1. Row marked "T0" denotes the conditions after the preamble, while rows marked "T1" and "T2" are to be applied subsequently. The exact instants on which these values shall be applied are described in the texts in this clause.

Table 8.1.3.1.12.3.2-1: Void

Table 8.1.3.1.12.3.2-2: Time instances of cell power level and parameter changes in FR2

	Parameter	Unit	Cell 1	Cell 2	Cell 10	Remark
T0	SS/PBCH SSS EPRE	dBm/S CS	FFS	FFS	"Off"	Power levels are such that either one entry condition for event A5 (<i>measId</i> 1 & 2) is not satisfied: $Mp + Hys > Thresh1$ or $Mn + Ofn + Ocn - Hys < Thresh2$
	SINR	dB	FFS	FFS	-	
	Noc	dBm/S CS	FFS		FFS	
T1	SS/PBCH SSS EPRE	dBm/S CS	FFS	FFS	"Off"	Power levels are such that both entry conditions for event A5 (<i>measId</i> 1) is satisfied: $Mp + Hys < Thresh1$ and $Mn + Ofn + Ocn - Hys > Thresh2$
	SINR	dB	FFS	FFS	-	
	Noc	dBm/S CS	FFS		FFS	
T2	SS/PBCH SSS EPRE	dBm/S CS	FFS	"Off"	FFS	Power levels are such that both entry conditions for event A5 (<i>measId</i> 2) is satisfied: $Mp + Hys < Thresh1$ and $Mn + Ofn + Ocn - Hys > Thresh2$
	SINR	dB	FFS	-	FFS	
	Noc	dBm/S CS	FFS		FFS	
NOTE 1: The total tolerance used is the sum of downlink signal level uncertainty (TS 38.508-1 Table 6.2.2.2-TBD) and absolute UE measurement accuracy (TS 38.133 clause 10).						

Table 8.1.3.1.12.3.2-3: Main behaviour

St	Procedure	Message Sequence		TP	Verdict
		U - S	Message		
1	The SS transmits an <i>RRCReconfiguration</i> message on NR Cell 1 including <i>MeasConfig</i> to setup NR measurement and reporting for two event A5 (<i>measId 1</i> and <i>measId 2</i>) (intra and inter frequency measurement).	<--	NR RRC: <i>RRCReconfiguration</i>	-	-
2	The UE transmits an <i>RRCReconfigurationComplete</i> message on NR Cell 1.	-->	NR RRC: <i>RRCReconfigurationComplete</i>	-	-
3	Check: Does the UE transmit a <i>MeasurementReport</i> message on NR Cell 1 within the next 10s?	-->	NR RRC: <i>MeasurementReport</i>	1	F
4	The SS re-adjusts the cell-specific reference signal level according to row "T1" in table 8.1.3.1.12.3.2-1.	-	-	-	-
5	Check: Does the UE transmit a <i>MeasurementReport</i> message on NR Cell 1 to report event A3 (<i>measId 1</i>) with the measured SINR values for NR Cell 2?	-->	NR RRC: <i>MeasurementReport</i>	2	P
6	The SS re-adjusts the cell-specific reference signal level according to row "T2" in table 8.1.3.1.12.3.2-1.	-	-	-	-
7	Check: Does the UE transmit a <i>MeasurementReport</i> message on NR Cell 1 to report event A5 (<i>measId 2</i>) with the measured SINR values for NR Cell 3?	-->	NR RRC: <i>MeasurementReport</i>	2	P

8.1.3.1.12.3.3 Specific message contents

Table 8.1.3.1.12.3.3-1: *RRCReconfiguration* (step 1, Table 8.1.3.1.12.3.2-3)

Derivation Path: TS 38.508-1 [4] table 4.6.1-13 with condition NR_MEAS

Table 8.1.3.1.12.3.3-2: *MeasConfig* (step 1, Table 8.1.3.1.12.3.2-3)

Derivation Path: TS 38.508-1 [4] table 4.6.3-69			
Information Element	Value/Remark	Comment	Condition
<i>MeasConfig</i> ::= SEQUENCE {			
<i>measObjectToAddModList</i> SEQUENCE (SIZE (1..maxNrofMeasId)) OF <i>MeasObjectToAddMod</i> {	2 entries		
<i>MeasObjectToAddMod</i> [1] SEQUENCE {		entry 1	
<i>measObjectId</i>	1		
<i>measObject</i> CHOICE {			
<i>measObjectNR</i>	<i>MeasObjectNR</i> -f1	Table 8.1.3.1.12.3.3-3	
}			
}			
<i>MeasObjectToAddMod</i> [2] SEQUENCE {		entry 2	
<i>measObjectId</i>	2		
<i>measObject</i> CHOICE {			
<i>measObjectNR</i>	<i>MeasObjectNR</i> -f2	Table 8.1.3.1.12.3.3-3A	
}			
}			
<i>reportConfigToAddModList</i> SEQUENCE(SIZE (1..maxReportConfigId)) OF <i>ReportConfigToAddMod</i> {	1 entry		

ReportConfigToAddMod[1] SEQUENCE {		entry 1	
reportConfigId	ReportConfigId		
reportConfig CHOICE {			
reportConfigNR	ReportConfigNR-A5	Table 8.1.3.1.12.3.3-5	
}			
}			
}			
measIdToAddModList SEQUENCE (SIZE (1..maxNrofMeasId)) OF MeasIdToAddMod {	2 entries		
MeasIdToAddMod[1] SEQUENCE {		entry 1	
measId	1		
measObjectId	1		
reportConfigId	ReportConfigId		
}			
MeasIdToAddMod[2] SEQUENCE {		entry 2	
measId	2		
measObjectId	2		
reportConfigId	ReportConfigId		
}			
}			
measGapConfig	MeasGapConfig		
}			

Table 8.1.3.1.12.3.3-3: MeasObjectNR-f1 (Table 8.1.3.1.12.3.3-2)

Derivation Path: TS 38.508-1 [4], Table 4.6.3-76			
Information Element	Value/remark	Comment	Condition
MeasObjectNR ::= SEQUENCE {			
ssbFrequency	Downlink ARFCN of NR Cell 1 SSB		
absThreshSS-BlocksConsolidation	Not present		
}			

Table 8.1.3.1.12.3.3-3A: MeasObjectNR-f2 (Table 8.1.3.1.12.3.3-2)

Derivation Path: TS 38.508-1 [4], Table 4.6.3-76			
Information Element	Value/remark	Comment	Condition
MeasObjectNR ::= SEQUENCE {			
ssbFrequency	Downlink ARFCN of NR Cell 3 SSB		
absThreshSS-BlocksConsolidation	Not present		
}			

Table 8.1.3.1.12.3.3-4: Void

Table 8.1.3.1.12.3.3-5: ReportConfigNR-A5 (Table 8.1.3.1.12.3.3-2)

Derivation Path: TS 38.508-1 [4] table 4.6.3-142 with condition EVENT_A5			
Information Element	Value/remark	Comment	Condition
ReportConfigNR ::= SEQUENCE {			
reportType CHOICE {			
eventTriggered SEQUENCE {			
eventId CHOICE {			
eventA5 SEQUENCE {			
a5-Threshold1 CHOICE {			
sinr	68	11 dB	
}			
}			
}			
}			
}			

sinr	47	0.5 dB	
}			
}			
reportQuantityCell SEQUENCE {			
rsrp	false		
rsrq	false		
sinr	true		
}			
reportAmount	r1		
}			
}			
}			

Table 8.1.3.1.12.3.3-6: MeasurementReport (steps 5 and 7, Table 8.1.3.1.12.3.2-3)

Derivation Path: TS 38.508-1 [4], Table 4.6.1-5A			
Information Element	Value/remark	Comment	Condition
MeasurementReport ::= SEQUENCE {			
criticalExtensions CHOICE {			
measurementReport SEQUENCE {			
measResults SEQUENCE {			
measId	1		Step 5
	2		Step 7
measResultServingMOList SEQUENCE (SIZE (1..maxNrofServingCells)) OF MeasResultServMO {	1 entry		Step 5
MeasResultServMO[1] SEQUENCE {		entry 1	
servCellId	ServCellIndex of NR Cell 1		
measResultServingCell SEQUENCE {			
physCellId	PhysCellId of NR Cell 1		
measResult SEQUENCE {			
cellResults SEQUENCE {			
resultsSSB-Cell SEQUENCE {			
rsrp	(0..127)		
rsrq	(0..127)		
sinr	(0..127)		
}			
}			
}			
}			
}			
}			
}			
measResultNeighCells CHOICE {			
measResultListNR SEQUENCE (SIZE (1..maxCellReport)) OF MeasResultNR {	1 entry		
MeasResultNR[1] SEQUENCE {		entry 1	
physCellId	PhysCellId of NR Cell 2		Step 5
	PhysCellId of NR Cell 3		Step 7
measResult SEQUENCE {			
cellResults SEQUENCE {			
resultsSSB-Cell SEQUENCE {			
rsrp	Not Present		
rsrq	Not Present		
sinr	(0..127)		
}			
resultsCSI-RS-Cell	Not present		
}			
rsIndexResults	Not present		
}			
}			
cgi-Info	Not present		

}			
}			
}			
}			
}			
}			
}			
}			

8.1.3.1.13 Measurement configuration control and reporting / SS/PBCH block based / CSI-RS based intra-frequency measurements / Measurement of Neighbour NR cell

8.1.3.1.13.1 Test Purpose (TP)

(1)

```
with { UE in NR RRC_CONNECTED state and measurement configured for SS/PBCH measurement reporting of
intra-frequency on specified frequency}
ensure that {
  when { SS/PBCH block sorting quantity is above absThreshSS-BlocksConsolidation for each beam of
Neighbour Cell}
  then { UE sends MeasurementReport message containing rsIndexResults with resultsSSB-Indexes}
}
```

(2)

```
with { UE in NR RRC_CONNECTED state and measurement configured for SS/PBCH measurement reporting of
intra-frequency on specified frequency }
ensure that {
  when { SS/PBCH block sorting quantity is below absThreshSS-BlocksConsolidation for one beam of
Neighbour Cell and another beam(s) is above absThreshSS-BlocksConsolidation}
  then { UE sends MeasurementReport message containing rsIndexResults with resultsSSB-Indexes
includes RsIndex above absThreshSS-BlocksConsolidation and excludes RsIndex below absThreshSS-
BlocksConsolidation }
}
```

(3)

```
with { UE in NR RRC_CONNECTED state and measurement configured for CSI-RS measurement reporting of
intra frequency on specified frequency }
ensure that {
  when { CSI-RS sorting quantity is above absThreshCSI-RS-Consolidation for each beam of Neighbour
Cell}
  then { UE sends MeasurementReport message containing rsIndexResults with results CSI-RS-Indexes}
}
```

(4)

```
with { UE in NR RRC_CONNECTED state and measurement configured for CSI-RS measurement reporting of
intra frequency on specified frequency }
ensure that {
  when { CSI-RS sorting quantity is below absThreshCSI-RS-Consolidation for one beam of Neighbour
Cell and another beam(s) is above absThreshCSI-RS-Consolidation }
  then { UE sends MeasurementReport message containing rsIndexResults with results CSI-RS-Indexes
includes RsIndex above absThreshCSI-RS-Consolidation and excludes RsIndex below absThreshCSI-RS-
Consolidation }
}
```

8.1.3.1.13.2 Conformance requirements

References: The conformance requirements covered in the present TC are specified in: TS 38.331, clauses 5.5.5.1 and 5.5.5.2]. Unless otherwise stated these are Rel-15 requirements.

[TS 38.331, clause 5.5.5.1]

The purpose of this procedure is to transfer measurement results from the UE to the network. The UE shall initiate this procedure only after successful security activation.

For the *measId* for which the measurement reporting procedure was triggered, the UE shall set the *measResults* within the *MeasurementReport* message as follows:

- 1> set the *measId* to the measurement identity that triggered the measurement reporting;
- 1> for each serving cell configured with *servingCellMO*:
 - 2> if the *reportConfig* associated with the *measId* that triggered the measurement reporting includes *rsType*:
 - 3> if the serving cell measurements based on the *rsType* included in the *reportConfig* that triggered the measurement report are available:
 - 4> set the *measResultServingCell* within *measResultServingMOList* to include RSRP, RSRQ and the available SINR of the serving cell, derived based on the *rsType* included in the *reportConfig* that triggered the measurement report;
 - 2> else:
 - 3> if SSB based serving cell measurements are available:
 - 4> set the *measResultServingCell* within *measResultServingMOList* to include RSRP, RSRQ and the available SINR of the serving cell, derived based on SSB;
 - 3> else if CSI-RS based serving cell measurements are available:
 - 4> set the *measResultServingCell* within *measResultServingMOList* to include RSRP, RSRQ and the available SINR of the serving cell, derived based on CSI-RS;
 - 1> set the *ServingCellId* within *measResultServingMOList* to include for each NR serving cell that is configured with *servingCellMO*, if any;
 - 1> if there is at least one applicable neighbouring cell to report:
 - 2> if the *reportType* is set to *eventTriggered* or *periodical*:
 - 3> set the *measResultNeighCells* to include the best neighbouring cells up to *maxReportCells* in accordance with the following:
 - 4> if the *reportType* is set to *eventTriggered*:
 - 5> include the cells included in the *cellsTriggeredList* as defined within the *VarMeasReportList* for this *measId*;
 - 4> for each cell that is included in the *measResultNeighCells*, include the *physCellId*;
 - 4> if the *reportType* is set to *eventTriggered* or *periodical*:
 - 5> for each included cell, include the layer 3 filtered measured results in accordance with the *reportConfig* for this *measId*, ordered as follows:
 - 6> if the *measObject* associated with this *measId* concerns NR:
 - 7> if *rsType* in the associated *reportConfig* is set to *ssb*:
 - 8> set *resultsSSB-Cell* within the *measResult* to include the SS/PBCH block based quantity(ies) indicated in the *reportQuantityCell* within the concerned *reportConfig*, in decreasing order of the sorting quantity, determined as specified in 5.5.5.3, i.e. the best cell is included first;
 - 8> if *reportQuantityRS-Indexes* and *maxNrofRS-IndexesToReport* are configured, include beam measurement information as described in 5.5.5.2;
 - 7> else if *rsType* in the associated *reportConfig* is set to *csi-rs*:
 - 8> set *resultsCSI-RS-Cell* within the *measResult* to include the CSI-RS based quantity(ies) indicated in the *reportQuantityCell* within the concerned *reportConfig*, in decreasing

order of the sorting quantity, determined as specified in 5.5.5.3, i.e. the best cell is included first;

- 8> if *reportQuantityRS-Indexes* and *maxNrofRS-IndexesToReport* are configured, include beam measurement information as described in 5.5.5.2;

[TS 38.331, clause 5.5.5.1]

- 1> increment the *numberOfReportsSent* as defined within the *VarMeasReportList* for this *measId* by 1;
- 1> stop the periodical reporting timer, if running;
- 1> if the *numberOfReportsSent* as defined within the *VarMeasReportList* for this *measId* is less than the *reportAmount* as defined within the corresponding *reportConfig* for this *measId*:
 - 2> start the periodical reporting timer with the value of *reportInterval* as defined within the corresponding *reportConfig* for this *measId*;
- 1> else:
 - 2> if the *reportType* is set to *periodical*:
 - 3> remove the entry within the *VarMeasReportList* for this *measId*;
 - 3> remove this *measId* from the *measIdList* within *VarMeasConfig*;
- 1> if the UE is configured with EN-DC:
 - 2> if SRB3 is configured:
 - 3> submit the *MeasurementReport* message via SRB3 to lower layers for transmission, upon which the procedure ends;
 - 2> else:
 - 3> submit the *MeasurementReport* message via the EUTRA MCG embedded in E-UTRA RRC message *ULInformationTransferMRDC* as specified in TS 36.331 [10].
- 1> else:
 - 2> submit the *MeasurementReport* message to lower layers for transmission, upon which the procedure ends.

[TS 38.331, clause 5.5.5.2]

For beam measurement information to be included in a measurement report the UE shall:

- 1> if *reportType* is set to *eventTriggered*:
 - 2> consider the trigger quantity as the sorting quantity if available, otherwise RSRP as sorting quantity if available, otherwise RSRQ as sorting quantity if available, otherwise SINR as sorting quantity;
- 1> if *reportType* is set to *periodical*:
 - 2> if a single reporting quantity is set to TRUE in *reportQuantityRs-Indexes*;
 - 3> consider the configured single quantity as the sorting quantity;
 - 2> else:
 - 3> if *rsrp* is set to TRUE;
 - 4> consider RSRP as the sorting quantity;
 - 3> else:
 - 4> consider RSRQ as the sorting quantity;

- 1> set *rsIndexResults* to include up to *maxNrofRs-IndexesToReport* SS/PBCH block indexes or CSI-RS indexes in order of decreasing sorting quantity as follows:
 - 2> if the measurement information to be included is based on SS/PBCH block:
 - 3> include within *resultsSSB-Indexes* the index associated to the best beam for that SS/PBCH block sorting quantity and the remaining beams whose sorting quantity is above *absThreshSS-BlocksConsolidation* defined in the *VarMeasConfig* for the corresponding *measObject*;
 - 3> if *includeBeamMeasurements* is configured, include the SS/PBCH based measurement results for the quantities in *reportQuantity-RsIndexes* set to TRUE for each SS/PBCH blockindex;
 - 2> else if the beam measurement information to be included is based on CSI-RS:
 - 3> include within *resultsCSI-RS-Indexes* the index associated to the best beam for that CSI-RS sorting quantity and the remaining beams whose sorting quantity is above *absThreshCSI-RS-Consolidation* defined in the *VarMeasConfig* for the corresponding *measObject*;
 - 3> if *includeBeamMeasurements* is configured, include the CSI-RS based measurement results for the quantities in *reportQuantity-RsIndexes* set to TRUE for each CSI-RS index.

8.1.3.1.13.3 Test description

8.1.3.1.13.3.1 Pre-test conditions

System Simulator:

- NR Cell 1 is the Serving Cell.
- NR Cell 2 is the intra-frequency neighbour cell of NR Cell 1. NR Cell2 has two beams: SSB/CSI-RS index#0 and SSB/CSI-RS index#1.

UE:

- None

Preamble:

- The UE is in state 3N-A as defined in TS 38.508-1 [4], subclause 4.4A on NR Cell 1.

8.1.3.1.13.3.2 Test procedure sequence

Table 8.1.3.1.13.3.2-1 and Table 8.1.3.1.13.3.2-1A illustrates the downlink power levels to be applied for NR Cell 1 and NR Cell 2 at various time instants of the test execution. Row marked "T0" denotes the conditions after the preamble, while rows marked "T1" and "T2" are to be applied subsequently. The exact instants on which these values shall be applied are described in the texts in this clause.

Table 8.1.3.1.13.3.2-1: Time instances of cell power level and parameter changes for FR1

	Parameter	Unit	NR Cell 1	NR Cell 2	NR Cell 2 Beam 0 (NOTE)	NR Cell 2 Beam 1 (NOTE)	Remark
T0	SS/PBCH SSS EPRE	dBm/SC S	-94	-	-	-	
	Reference Power	dBm/SC S	-	-90	-	-	
	SS/PBCH SSS EPRE,	dB	-	-	-4	-4	

	CSI-RS EPRE offset						
T1	SS/PBCH SSS EPRE	dBm/SC S	-106	-	-	-	$Mn + Ofn + Ocn - Hys > Mp + Ofp + Ocp + Off$ Power level is such that SS/PBCH quality and CSI-RS quality for both beams of NR Cell 2 are above <i>absThreshSS-BlocksConsolidation</i> .
	Reference Power	dBm/SC S	-	-90	-	-	
	SS/PBCH SSS EPRE, CSI-RS EPRE offset	dB	-	-	-4	-4	
T2	SS/PBCH SSS EPRE	dBm/SC S	-94	-	-	-	$Mn + Ofn + Ocn + Hys < Mp + Ofp + Ocp + Off$ Power level is such that SS/PBCH quality and CSI-RS quality for both beams of NR Cell 2 are below <i>absThreshSS-BlocksConsolidation</i> .
	Reference Power	dBm/SC S	-	-90	-	-	
	SS/PBCH SSS EPRE, CSI-RS EPRE offset	dB	-	-	-12	-12	
T3	SS/PBCH SSS EPRE	dBm/SC S	-106	-	-	-	Power level is such that SS/PBCH quality and CSI-RS quality for beam 0 of NR Cell 2 is above <i>absThreshSS-BlocksConsolidation</i> and for beam 1 of NR Cell 2 is below <i>absThreshSS-BlocksConsolidation</i> .
	Reference Power	dBm/SC S	-	-90	-	-	
	SS/PBCH SSS EPRE, CSI-RS EPRE offset	dB	-	-	-4	-12	

Table 8.1.3.1.13.3.2-1A: Time instances of cell power level and parameter changes for FR2

	Parameter	Unit	NR Cell 1	NR Cell 2	NR Cell 2 Beam 0 (NOTE)	NR Cell 2 Beam 1 (NOTE)	Remark
T0	SS/PBCH SSS EPRE	dBm/SC S	-82	-	-	-	
	Reference Power	dBm/SC S	-	-90	-	-	
	SS/PBCH SSS EPRE, CSI-RS EPRE offset	dB	-	-	-1	-1	
T1	SS/PBCH SSS EPRE	dBm/SC S	-100	-	-	-	$Mn + Ofn + Ocn - Hys > Mp + Ofp + Ocp + Off$ Power level is such that SS/PBCH quality and CSI-RS quality for both beams of NR Cell 2 are above <i>absThreshSS-BlocksConsolidation</i> .
	Reference Power	dBm/SC S	-	-90	-	-	
	SS/PBCH SSS EPRE,	dB	-	-	-1	-1	

	CSI-RS EPRE offset						
T2	SS/PBCH SSS EPRE	dBm/SC S	-100	-	-	-	$Mn + Ofn + Ocn + Hys < Mp + Ofp + Ocp + Off$ Power level is such that SS/PBCH quality and CSI-RS quality for both beams of NR Cell 2 are below <i>absThreshSS-BlocksConsolidation</i>
	Reference Power	dBm/SC S	-	-90	-	-	
	SS/PBCH SSS EPRE, CSI-RS EPRE offset	dB	-	-	-10	-10	
T3	SS/PBCH SSS EPRE	dBm/SC S	-100	-	-	-	Power level is such that SS/PBCH quality and CSI-RS quality for beam 0 of NR Cell 2 is above <i>absThreshSS-BlocksConsolidation</i> and for beam 1 of NR Cell 2 is below <i>absThreshSS-BlocksConsolidation</i> .
	Reference Power	dBm/SC S	-	-90	-	-	
	SS/PBCH SSS EPRE, CSI-RS EPRE offset	dB	-	-	-1	-10	

Table 8.1.3.1.13.3.2-2: Main behaviour

St	Procedure	Message Sequence		TP	Verdict
		U - S	Message		
1	The SS transmits an NR <i>RRCReconfiguration</i> message including <i>measConfig</i> to setup SS/PBCH block based intra- frequency NR measurement for NR Cell 1 and reporting for event A3.	<--	NR RRC: <i>RRCReconfiguration</i>	-	-
2	The UE transmits an <i>RRCReconfigurationComplete</i> message.	-->	NR RRC: <i>RRCReconfigurationComplete</i>	-	-
3	The SS re-adjusts the cell-specific reference signal level according to row "T1".	-	-	-	-
4	Check: Does the UE transmit a <i>MeasurementReport</i> message to report event A3 with the measured results for NR Cell 2 with beam information containing <i>RsIndex[0]</i> and <i>RsIndex[1]</i> ?	-->	NR RRC: <i>MeasurementReport</i>	1	P
4A	The SS re-adjusts the cell-specific reference signal level according to the row "T2".	-	-	-	-
4AA	Wait and ignore <i>MeasurementReport</i> messages for 10s to allow change of power levels for NR Cell 2 and UE measurement.	-	-	-	-
4B	Check: Does the UE transmit a <i>MeasurementReport</i> message on NR Cell 1 to report the event A3 during the next 1s?	-	-	1	F
5	The SS re-adjusts the cell-specific reference signal level according to row "T3".	-	-	-	-
6	Check: Does the UE transmit a <i>MeasurementReport</i> message to report event A3 with the measured results for NR Cell 2 with beam information containing <i>RsIndex[0]</i> and excludes <i>RsIndex[1]</i> ?	-->	NR RRC: <i>MeasurementReport</i>	2	P
7-8	Void	-	-	-	-
9	The SS transmits an NR <i>RRCReconfiguration</i> including <i>measConfig</i> to setup CSI-RS based intra- frequency NR measurement for NR Cell 1 and reporting for event A3.	<--	NR RRC: <i>RRCReconfiguration</i>	-	-

10	The UE transmits an <i>RRCConfigurationComplete</i> .	-->	NR RRC: <i>RRCReconfigurationComplete</i>	-	-
11	The SS re-adjusts the cell-specific reference signal level according to row "T1".	-	-	-	-
12	Check: Does the UE transmit a <i>MeasurementReport</i> message to report event A3 with the measured results for NR Cell 2 with beam information containing <i>RsIndex[0]</i> and <i>RsIndex[1]</i> ?	-->	NR RRC: <i>MeasurementReport</i>	3	P
12A	The SS re-adjusts the cell-specific reference signal level according to the row "T2".	-	-	-	-
12A A	Wait and ignore <i>MeasurementReport</i> messages for 10s to allow change of power levels for NR Cell 2 and UE measurement.	-	-	-	-
12B	Check: Does the UE transmit a <i>MeasurementReport</i> message on NR Cell 1 to report the event A3 during the next 1s?	-	-	1	F
13	The SS re-adjusts the cell-specific reference signal level according to row "T3".	-	-	-	-
14	Check: Does the UE transmit a <i>MeasurementReport</i> message to report event A3 with the measured results for NR Cell 2 with beam information containing <i>RsIndex[0]</i> and excludes <i>RsIndex[1]</i> ?	-->	NR RRC: <i>MeasurementReport</i>	4	P
15	The SS transmits an NR <i>RRCReconfiguration</i> including <i>measConfig</i> to release CSI-RS based intra-frequency NR measurement.	<--	NR RRC: <i>RRCReconfiguration</i>	-	-
16	The UE transmits an <i>RRCConfigurationComplete</i> .	-->	NR RRC: <i>RRCReconfigurationComplete</i>	-	-

8.1.3.1.13.3.3 Specific message contents

Table 8.1.3.1.13.3.3-1: RRCReconfiguration (steps 1, 9 and 15, Table 8.1.3.1.13.3.2-2)

Derivation Path: TS 38.508-1 [4] Table 4.6.1-13 with condition NR_MEAS

Table 8.1.3.1.13.3.3-2: MeasConfig (Table 8.1.3.1.13.3.3-1)

Derivation Path: TS 38.508-1 [4], Table 4.6.3-69			
Information Element	Value/remark	Comment	Condition
<i>MeasConfig</i> ::= SEQUENCE {			
<i>measObjectToAddModList</i>	<i>IdMeasObjectToAdd</i>		Step 1
	Not present		Step 9, Step 15
<i>reportConfigToAddModList</i>	<i>IdReportConfigToAdd</i>		Step 1
	Not present		Step 9, Step 15
<i>measIdToRemoveList</i> SEQUENCE (SIZE (1..maxNrofObjectId)) OF <i>MeasObjectId</i> {	1 entry		Step 15
<i>MeasObjectId</i> [1]	1		
}			
<i>measIdToAddModList</i>	<i>IdMeasIdToAdd</i>		Step 1, Step 9
	Not present		Step 15
}			

Table 8.1.3.1.13.3.3-3: IdMeasObjectToAdd (Table 8.1.3.1.13.3.3-2)

Derivation Path: TS 38.331 [6], clause 6.3.2			
Information Element	Value/remark	Comment	Condition
<i>MeasObjectToAddModList</i> ::= SEQUENCE (SIZE (1..maxNrofMeasId)) OF <i>MeasObjectToAddMod</i> {	1 entry		

MeasObjectToAddMod[1] SEQUENCE {		entry 1	
measObjectId	1		
measObject CHOICE {			
measObjectNR	Id-MeasObjectNR		
}			
}			

Table 8.1.3.1.13.3.3-4: Id-MeasObjectNR (Table 8.1.3.1.13.3.3-3)

Derivation Path: TS 38.508-1 [4], Table 4.6.3-76			
Information Element	Value/remark	Comment	Condition
MeasObjectNR ::= SEQUENCE {			
ssbFrequency	Downlink ARFCN of NR Cell1		
refFreqCSI-RS	Same as "Point A" defined for the downlink of NR Cell1		
referenceSignalConfig SEQUENCE {			
ssb-ConfigMobility SEQUENCE {			
ssb-ToMeasure CHOICE {			
setup CHOICE {			
shortBitmap	1100		(FREQ<=3G Hz AND (FR1_FDD OR NOT CASE_C)) OR (FREQ<=2.4 GHz AND FR1_TDD)
mediumBitmap	11000000		(FREQ>3G Hz AND FR1) OR (FREQ>2.4 GHz AND FR1_TDD AND CASE_C)
longBitmap	11000000 00000000 00000000 00000000 00000000 00000000 00000000 00000000		FR2
}			
}			
}			
csi-rs-ResourceConfigMobility CHOICE {			
setup SEQUENCE {			
subcarrierSpacing	SubcarrierSpacing		
csi-RS-CellList-Mobility SEQUENCE (SIZE (1..maxNrofCSI-RS-CellsRRM)) OF CSI-RS-CellMobility {	2 entries		
CSI-RS-CellMobility[1] SEQUENCE {		entry 1	
cellId	Physical CellID of the NR Cell 1		
csi-rs-MeasurementBW SEQUENCE {			
nrofPRBs	size24		
startPRB	same value as 'offsetToCarrier' as defined for the DL frequency of NR Cell 1		
}			
density	d3		
csi-rs-ResourceList-Mobility SEQUENCE (SIZE (1..maxNrofCSI-RS-ResourcesRRM)) OF CSI-RS-Resource-Mobility {	1 entry		

RS-Resource-Mobility[1] SEQUENCE {		entry 1	
csi-RS-Index	0		
slotConfig CHOICE {			
ms20	0	To avoid collision with CSI-RS of NR Cell 2	
}			
associatedSSB	Not present		
associatedSSB SEQUENCE {			pc_csi_RSR P_AndRSR Q_MeasWit hSSB
ssb-Index	0		
isQuasiColocated	false		
}			
frequencyDomainAllocation CHOICE {			
row1	1000		
}			
firstOFDMSymbolInTimeDomain	4		
sequenceGenerationConfig	24		
}			
}			
CSI-RS-CellMobility[2] SEQUENCE {		entry 2	
cellId	Physical CellID of the NR Cell 2		
csi-rs-MeasurementBW SEQUENCE {			
nrofPRBs	size24		
startPRB	same value as 'offsetToCarrier' as defined for the DL frequency of the cell		
}			
density	d3		
csi-rs-ResourceList-Mobility SEQUENCE (SIZE (1..maxNrofCSI-RS-ResourcesRRM)) OF CSI-RS-Resource-Mobility {	2 entries		
RS-Resource-Mobility[1] SEQUENCE {		entry 1	
csi-RS-Index	0	CSI-RS with Index 0	
slotConfig CHOICE {			
ms20	$10 * 2^\mu$	μ is numerology index (SCS=15kHz: 0, SCS=30kHz: 1, etc.)	
}			
associatedSSB	Not present		
associatedSSB SEQUENCE {			pc_csi_RSR P_AndRSR Q_MeasWit hSSB
ssb-Index	0		
isQuasiColocated	false		
}			
frequencyDomainAllocation CHOICE {			
row1	1000		
}			
firstOFDMSymbolInTimeDomain	4		
sequenceGenerationConfig	24		
}			
RS-Resource-Mobility[2] SEQUENCE {		entry 2	
csi-RS-Index	1	CSI-RS with Index 1	
slotConfig CHOICE {			

ms20	10 * 2 ^μ	μ: numerology index (SCS=15kHz: 0, SCS=30kHz: 1, etc.)	
}			
associatedSSB	Not present		
associatedSSB SEQUENCE {			pc_csi_RSR P_AndRSR Q_MeasWit hSSB
ssb-Index	1		
isQuasiColocated	false		
}			
frequencyDomainAllocation CHOICE {			
row1	0001		
}			
firstOFDMSymbolInTimeDomain	0		
sequenceGenerationConfig	24		
}			
}			
}			
}			
}			
}			
absThreshSS-BlocksConsolidation SEQUENCE {			
thresholdRSRP	57	corresponding to -100dBm	FR1
	66 +Delta(NRf1)	corresponding to -91dBm	FR2
}			
}			
NOTE 1: delta(NRf1) is derived based on calibration procedure defined in the TS 38.508-1 [4], clause 6.1.3.3 on NR Cell1			

Table 8.1.3.1.13.3.3-5: IdReportConfigToAdd (Table 8.1.3.1.13.3.3-2)

Derivation Path: TS 38.331 [6], clause 6.3.2			
Information Element	Value/remark	Comment	Condition
ReportConfigToAddModList ::= SEQUENCE(SIZE (1..maxReportConfigId)) OF ReportConfigToAddMod {	2 entries		
ReportConfigToAddMod[1] SEQUENCE {		entry 1	
reportConfigId	1		
reportConfig CHOICE {			
reportConfigNR	IdReportConfig-A3-SSB		
}			
ReportConfigToAddMod[2] SEQUENCE {		entry 2	
reportConfigId	2		
reportConfig CHOICE {			
reportConfigNR	IdReportConfig-A3-CSI-RS		
}			
}			
}			

Table 8.1.3.1.13.3.3-6: IdReportConfig-A3-SSB (Table 8.1.3.1.13.3.3-5)

Derivation Path: TS 38.508-1 [4], Table 4.6.3-142 with condition EVENT_A3			
Information Element	Value/remark	Comment	Condition
ReportConfigNR ::= SEQUENCE {			
reportType CHOICE {			

eventTriggered SEQUENCE {			
eventId CHOICE {			
eventA3 SEQUENCE {			
a3-Offset CHOICE {			
rsrp	2		
}			
}			
}			
reportAmount	infinity		
reportQuantityRS-Indexes SEQUENCE {			
rsrp	true		
rsrq	false		
sinr	false		
}			
maxNrofRS-IndexesToReport	2		
includeBeamMeasurements	true		
}			
}			
}			

Table 8.1.3.1.13.3.3-6A: IdReportConfig-A3-CSI-RS (Table 8.1.3.1.13.3.3-5)

Derivation Path: TS 38.508-1 [4], Table 4.6.3-142 with condition EVENT_A3			
Information Element	Value/remark	Comment	Condition
ReportConfigNR ::= SEQUENCE {			
reportType CHOICE {			
eventTriggered SEQUENCE {			
eventId CHOICE {			
eventA3 SEQUENCE {			
a3-Offset CHOICE {			
rsrp	2		
}			
}			
}			
rsType	csi-rs		
reportAmount	infinity		
reportQuantityCell SEQUENCE {			
sinr	false		
}			
reportQuantityRS-Indexes SEQUENCE {			
rsrp	true		
rsrq	false		
sinr	false		
}			
maxNrofRS-IndexesToReport	2		
includeBeamMeasurements	true		
}			
}			
}			

Table 8.1.3.1.13.3.3-7: IdMeasIdToAdd (Table 8.1.3.1.13.3.3-2)

Derivation Path: TS 38.331 [6], clause 6.3.2			
Information Element	Value/remark	Comment	Condition
MeasIdToAddModList ::= SEQUENCE (SIZE (1..maxNrofMeasId)) OF MeasIdToAddMod {	1 entry		
MeasIdToAddMod			
measId	1		
measObjectId	1		
reportConfigId	1		Step 1
}	2		Step 9
}			
}			

Table 8.1.3.1.13.3.3-8: MeasurementReport (step 4, Table 8.1.3.1.13.3.2-2)

Derivation Path: TS 38.508-1 [4], Table 4.6.1-7			
Information Element	Value/remark	Comment	Condition
MeasurementReport ::= SEQUENCE {			
criticalExtensions CHOICE {			
measurementReport SEQUENCE {			
measResults	MeasResults		
}			
}			
}			

Table 8.1.3.1.13.3.3-9: MeasResults (Table 8.1.3.1.13.3.3-8)

Derivation Path: TS 38.508-1 [4], Table 4.6.3-79			
Information Element	Value/remark	Comment	Condition
MeasResults ::= SEQUENCE {			
measId	1		
measResultServingMOList SEQUENCE (SIZE (1..maxNrofServingCells)) OF MeasResultServMO {	1 entry		
MeasResultServMO[1] SEQUENCE {		entry 1	
servCellId	ServCellIndex of NR Cell 1		
measResultServingCell SEQUENCE {			
physCellId	Physical CellID of the NR Cell 1		
measResult SEQUENCE {			
cellResults SEQUENCE {			
resultsSSB-Cell SEQUENCE {			
rsrp	(0..127)		
rsrq	(0..127)		
sinr	(0..127)		pc_ss_SINR_Meas
	Not present		
}			
rsIndexResults SEQUENCE {			
resultsSSB-Indexes SEQUENCE (SIZE (1..maxNrofIndexesToReport2)) OF ResultsPerSSB-Index {	1 entry		
ResultsPerSSB-Index[1] SEQUENCE {		entry 1	
ssb-Index	Not checked		
ssb-Results SEQUENCE {			
rsrp	(0..127)		
rsrq	Not present		
sinr	Not present		
}			
}			
}			
resultsCSI-RS-Indexes	Not present		
}			
}			
}			
measResultNeighCells CHOICE {			
measResultListNR SEQUENCE (SIZE (1..maxCellReport)) OF MeasResultNR {	1 entry		
MeasResultNR[1] SEQUENCE {		entry 1	
physCellId	Physical CellID of the NR Cell 2		
measResult SEQUENCE {			
cellResults SEQUENCE {			
resultsSSB-Cell SEQUENCE {			
rsrp	(0..127)		

rsrq	(0..127)		
sinr	(0..127)		pc_ss_SINR Meas
	Not present		
}			
resultsCSI-RS-Cell	Not present		
}			
rsIndexResults SEQUENCE {			
resultsSSB-Indexes SEQUENCE (SIZE (1..maxNrofIndexesToReport2)) OF ResultsPerSSB-Index {	2 entries that may appear in an arbitrary order		
ResultsPerSSB-Index [1] SEQUENCE {		entry 1	
ssb-Index	SSB index 0		
ssb-Results SEQUENCE {			
rsrp	(0..127)		
rsrq	Not present		
sinr	Not present		
}			
}			
ResultsPerSSB-Index [2] SEQUENCE {		entry 2	
ssb-Index	SSB index 1		
ssb-Results SEQUENCE {			
rsrp	(0..127)		
rsrq	Not present		
sinr	Not present		
}			
}			
}			
resultsCSI-RS-Indexes	Not present		
}			
}			
}			
cgi-Info	Not present		
}			
}			
}			

Table 8.1.3.1.13.3.3-10: MeasurementReport (step 6, Table 8.1.3.1.13.3.2-2)

Derivation Path: TS 38.508-1 [4], Table 4.6.1-7			
Information Element	Value/remark	Comment	Condition
MeasurementReport ::= SEQUENCE {			
criticalExtensions CHOICE {			
measurementReport SEQUENCE {			
measResults	MeasResults		
}			
}			
}			

Table 8.1.3.1.13.3.3-11: MeasResults (Table 8.1.3.1.13.3.3-10)

Derivation Path: TS 38.508-1 [4], Table 4.6.3-79			
Information Element	Value/remark	Comment	Condition
MeasResults ::= SEQUENCE {			
measId	1		
measResultServingMOList SEQUENCE (SIZE (1..maxNrofServingCells)) OF MeasResultServMO {	1 entry		
MeasResultServMO[1] SEQUENCE {		entry 1	
servCellId	ServCellIndex of NR Cell 1		
measResultServingCell SEQUENCE {			
physCellId	Physical CellID of the NR Cell 1		
}			
}			
}			

Table 8.1.3.1.13.3.3-12: Void

Table 8.1.3.1.13.3.3-13: Void

Table 8.1.3.1.13.3.3-14: Void

Table 8.1.3.1.13.3.3-15: Void

Table 8.1.3.1.13.3.3-16: Void

Table 8.1.3.1.13.3.3-17: Void

Table 8.1.3.1.13.3.3-18: MeasurementReport (step 12, Table 8.1.3.1.13.3.2-2)

Derivation Path: TS 38.508-1 [4], Table 4.6.1-7			
Information Element	Value/remark	Comment	Condition
MeasurementReport ::= SEQUENCE {			
criticalExtensions CHOICE {			
measurementReport SEQUENCE {			
measResults	MeasResults		
}			
}			
}			

Table 8.1.3.1.13.3.3-19: MeasResults (Table 8.1.3.1.13.3.3-18)

Derivation Path: TS 38.508-1 [4], Table 4.6.3-79			
Information Element	Value/remark	Comment	Condition
MeasResults ::= SEQUENCE {			
measId	1		
measResultServingMOList SEQUENCE {(SIZE (1..maxNrofServingCells)) OF MeasResultServMO {	1 entry		
MeasResultServMO[1] SEQUENCE {		entry 1	
servCellId	ServCellIndex of NR Cell 1		
measResultServingCell SEQUENCE {			
physCellId	Physical CellID of the NR Cell 1		
measResult SEQUENCE {			
cellResults SEQUENCE {			
resultsSSB-Cell	Not present		
resultsCSI-RS-Cell SEQUENCE {			
rsrp	(0..127)		
rsrq	(0..127)		
sinr	Not present		
}	Not checked		pc_ss_SINR_Meas
}			
}			
rsIndexResults SEQUENCE {			
resultsSSB-Indexes	Not present		
resultsCSI-RS-Indexes SEQUENCE (SIZE (1..maxNrofIndexesToReport2)) OF ResultsPerSSB-Index {	1 entry		
ResultsPerSSB-Index[1] SEQUENCE {		entry 1	
csi-RS-Index	Not checked		
csi-RS-Results SEQUENCE {			
rsrp	(0..127)		
rsrq	(0..127)		
sinr	Not present		
}			
}			
}			

}			
}			
}			
}			
}			
}			
measResultNeighCells CHOICE {			
measResultListNR SEQUENCE (SIZE (1..maxCellReport)) OF MeasResultNR {	1 entry		
MeasResultNR[1] SEQUENCE {		entry 1	
physCellId	Physical CellID of the NR Cell 2		
measResult SEQUENCE {			
cellResults SEQUENCE {			
resultsSSB-Cell	Not present		
resultsCSI-RS-Cell SEQUENCE {			
rsrp	(0..127)		
rsrq	(0..127)		
sinr	Not present		
}			
}			
rsIndexResults SEQUENCE {			
resultsSSB-Indexes	Not Present		
resultsCSI-RS-Indexes SEQUENCE (SIZE (1..maxNrofIndexesToReport2)) OF ResultsPerCSI-RS-Index {	2 entries that may appear in an arbitrary order		
ResultsPerCSI-RS-Index[1] SEQUENCE {		entry 1	
csi-RS-Index	CSI-RS-index 0		
csi-RS-Results SEQUENCE {			
rsrp	Not checked		
rsrq	Not present		
sinr	Not present		
}			
ResultsPerCSI-RS-Index[2] SEQUENCE {		entry 2	
csi-RS-Index	CSI-RS-index 1		
csi-RS-Results SEQUENCE {			
rsrp	Not checked		
rsrq	Not present		
sinr	Not present		
}			
}			
}			
}			
}			
cgi-Info	Not present		
}			
}			
}			
}			
}			

Table 8.1.3.1.13.3.3-20: MeasurementReport (step 14, Table 8.1.3.1.13.3.2-2)

Derivation Path: TS 38.508-1 [4], Table 4.6.1-7			
Information Element	Value/remark	Comment	Condition
MeasurementReport ::= SEQUENCE {			
criticalExtensions CHOICE {			
measurementReport SEQUENCE {			
measResults	MeasResults		
}			
}			
}			

Table 8.1.3.1.13.3.3-21: MeasResults (Table 8.1.3.1.13.3.3-20)

Derivation Path: TS 38.508-1 [4], Table 4.6.3-79			
Information Element	Value/remark	Comment	Condition
MeasResults ::= SEQUENCE {			
measId	1		
measResultServingMOList SEQUENCE (SIZE (1..maxNrofServingCells)) OF MeasResultServMO {	1 entry		
MeasResultServMO[1] SEQUENCE {		entry 1	
servCellId	ServCellIndex of NR Cell 1		
measResultServingCell SEQUENCE {			
physCellId	Physical CellID of the NR Cell 1		
measResult SEQUENCE {			
cellResults SEQUENCE{			
resultsSSB-Cell	Not present		
resultsCSI-RS-Cell SEQUENCE {			
rsrp	(0..127)		
rsrq	(0..127)		
sinr	Not present		
	Not checked		pc_ss_SINR_Meas
}			
}			
rsIndexResults SEQUENCE {			
resultsSSB-Indexes	Not present		
resultsCSI-RS-Indexes SEQUENCE (SIZE (1..maxNrofIndexesToReport2)) OF ResultsPerSSB-Index {	1 entry		
ResultsPerSSB-Index[1] SEQUENCE {		entry 1	
csi-RS-Index	Not checked		
csi-RS-Results SEQUENCE {			
rsrp	(0..127)		
rsrq	Not present		
sinr	Not present		
}			
}			
}			
}			
}			
}			
measResultNeighCells CHOICE {			
measResultListNR SEQUENCE (SIZE (1..maxCellReport)) OF MeasResultNR {	1 entry		
MeasResultNR[1] SEQUENCE {		entry 1	
physCellId	Physical CellID of the NR Cell 2		
measResult SEQUENCE {			
cellResults SEQUENCE {			
resultsSSB-Cell	Not present		
resultsCSI-RS-Cell SEQUENCE {			
rsrp	(0..127)		
rsrq	(0..127)		
sinr	Not present		
}			
}			
rsIndexResults SEQUENCE {			
resultsSSB-Indexes	Not Present		
resultsCSI-RS-Indexes SEQUENCE (SIZE (1..maxNrofIndexesToReport2)) OF ResultsPerSSB-Index {	1 entry		
ResultsPerSSB-Index[1] SEQUENCE {		entry 1	

8.1.3.1.14A.2 Conformance requirements

Same as TC 8.1.3.1.13

8.1.3.1.14A.3 Test description

8.1.3.1.14A.3.1 Pre-test conditions

Same as TC 8.1.3.1.13 with the following differences:

- Cells configuration: NR Cell 3 replaces NR Cell 2.
- System information combination NR-4 as defined in TS 38.508-1[4] clause 4.4.3.1.2 is used in NR cells.

8.1.3.1.14A.3.2 Test procedure sequence

Same as TC 8.1.3.1.13 with the following differences:

- Cells configuration: NR Cell 3 replaces NR Cell 2

8.1.3.1.14A.3.3 Specific message contents

Same as TC 8.1.3.1.13 with the following differences:

- Cells configuration: NR Cell 3 replaces NR Cell 2

Table 8.1.3.1.14A.3.3-1: IdMeasObjectToAdd (Table 8.1.3.1.13.3.3-2)

Derivation Path: TS 38.331 [6], clause 6.3.2			
Information Element	Value/remark	Comment	Condition
MeasObjectToAddModList ::= SEQUENCE (SIZE (1..maxNrofMeasId)) OF MeasObjectToAddMod {	2 entries		
MeasObjectToAddMod[1] SEQUENCE {		entry 1	
measObjectId	1		
measObject CHOICE {			
measObjectNR	Id-MeasObjectNR-f1		
}			
}			
MeasObjectToAddMod[2] SEQUENCE {		entry 2	
measObjectId	2		
measObject CHOICE {			
measObjectNR	Id-MeasObjectNR-f2		
}			
}			
}			

Table 8.1.3.1.14A.3.3-1A: Id-MeasObjectNR-f1 (Table 8.1.3.1.14A.3.3-1)

Derivation Path: TS 38.508-1 [4], Table 4.6.3-76			
Information Element	Value/remark	Comment	Condition
MeasObjectNR ::= SEQUENCE {			
ssbFrequency	Downlink ARFCN of NR Cell 1		
refFreqCSI-RS	Same as "Point A" defined for the downlink of NR Cell1		
referenceSignalConfig SEQUENCE {			
csi-rs-ResourceConfigMobility CHOICE {			
setup SEQUENCE {			
subcarrierSpacing	SubcarrierSpacing		
csi-RS-CellList-Mobility SEQUENCE (SIZE (1..maxNrofCSI-RS-CellsRRM)) OF CSI-RS-CellMobility {	1 entry		
CSI-RS-CellMobility[1] SEQUENCE {		entry 1	

cellId	Physical CellID of the NR Cell 1		
csi-rs-MeasurementBW SEQUENCE {			
nrofPRBs	size24		
startPRB	same value as 'offsetToCarrier' as defined for the DL frequency of NR Cell 1		
}			
density	d3		
csi-rs-ResourceList-Mobility SEQUENCE (SIZE (1..maxNrofCSI-RS-ResourcesRRM)) OF CSI-RS-Resource-Mobility {	1 entry		
CSI-RS-Resource-Mobility[1] SEQUENCE {		entry 1	
csi-RS-Index	0		
slotConfig CHOICE {			
ms20	0		
}			
associatedSSB	Not present		
associatedSSB SEQUENCE {			pc_csi_RSR P_AndRSR Q_MeasWit hSSB
ssb-Index	0		
isQuasiColocated	false		
}			
frequencyDomainAllocation CHOICE {			
row1	1000		
}			
firstOFDMSymbolInTimeDomain	4		
sequenceGenerationConfig	24		
}			
}			
absThreshSS-BlocksConsolidation SEQUENCE {			
thresholdRSRP	57	corresponding to -99dBm	FR1
	66	corresponding to -90dBm	FR2
}			
absThreshCSI-RS-Consolidation SEQUENCE {			
thresholdRSRP	57	corresponding to -99dBm	FR1
	66	corresponding to -90dBm	FR2
thresholdRSRQ	Not Present		
thresholdSINR	Not Present		
}			
nrofCSI-RS-ResourcesToAverage	2		
}			

Table 8.1.3.1.14A.3.3-2: Id-MeasObjectNR-f2 (Table 8.1.3.1.14A.3.3-1)

Derivation Path: TS 38.508-1 [4], Table 4.6.3-76			
Information Element	Value/remark	Comment	Condition
MeasObjectNR ::= SEQUENCE {			
ssbFrequency	Downlink ARFCN of NR Cell3		
refFreqCSI-RS	Same as "Point A" defined for the downlink of NR Cell3		

referenceSignalConfig SEQUENCE {			
ssb-ConfigMobility SEQUENCE {			
ssb-ToMeasure CHOICE {			
setup CHOICE {			
shortBitmap	1100		(FREQ<=3G Hz AND (FR1_FDD OR NOT CASE_C)) OR (FREQ<=2.4 GHz AND FR1_TDD)
mediumBitmap	11000000		(FREQ>3G Hz AND FR1) OR (FREQ>2.4 GHz AND FR1_TDD AND CASE_C)
longBitmap	11000000 00000000 00000000 00000000 00000000 00000000 00000000 00000000		FR2
}			
}			
}			
csi-rs-ResourceConfigMobility CHOICE {			
setup SEQUENCE {			
subcarrierSpacing	SubcarrierSpacing		
csi-RS-CellList-Mobility SEQUENCE (SIZE (1..maxNrofCSI-RS-CellsRRM)) OF CSI-RS-CellMobility {	1 entry		
CSI-RS-CellMobility[1] SEQUENCE {		entry 1	
cellId	Physical CellID of the NR Cell 3		
csi-rs-MeasurementBW SEQUENCE {			
nrofPRBs	size24		
startPRB	same value as 'offsetToCarrier' as defined for the DL frequency of the cell		
}			
density	d3		
csi-rs-ResourceList-Mobility SEQUENCE (SIZE (1.. maxNrofCSI-RS-ResourcesRRM)) OF CSI-RS-Resource-Mobility {	2 entries		
CSI-RS-Resource-Mobility[1] SEQUENCE {		entry 1	
csi-RS-Index	0	CSI-RS with Index 0	
slotConfig CHOICE {			
ms20	10 * 2 ^μ	μ is numerology index (SCS=15kHz: 0, SCS=30kHz: 1, etc.)	
}			
associatedSSB	Not present		
associatedSSB SEQUENCE {			pc_csi_RSR P_AndRSR Q_MeasWit hSSB
ssb-Index	0		
isQuasiColocated	false		
}			
frequencyDomainAllocation CHOICE {			

row1	1000		
}			
firstOFDMSymbolInTimeDomain	4		
sequenceGenerationConfig	24		
}			
CSI-RS-Resource-Mobility[2] SEQUENCE {		entry 2	
csi-RS-Index	1	CSI-RS with Index 1	
slotConfig CHOICE {			
ms20	$10 * 2^\mu$	μ : numerology index (SCS=15kHz: 0, SCS=30kHz: 1, etc.)	
}			
associatedSSB	Not present		
associatedSSB SEQUENCE {			pc_csi_RSR P_AndRSR Q_MeasWit hSSB
ssb-Index	1		
isQuasiColocated	false		
}			
frequencyDomainAllocation CHOICE {			
row1	0001		
}			
firstOFDMSymbolInTimeDomain	0		
sequenceGenerationConfig	24		
}			
}			
}			
}			
}			
}			
absThreshSS-BlocksConsolidation SEQUENCE {			
thresholdRSRP	57	corresponding to -909dBm	FR1
	66 +Delta(NRf2)	corresponding to -90dBm	FR2
}			
absThreshCSI-RS-Consolidation SEQUENCE {			
thresholdRSRP	57	corresponding to -99dBm	FR1
	66	corresponding to -90dBm	FR2
thresholdRSRQ	Not Present		
thresholdSINR	Not Present		
}			
nrofCSI-RS-ResourcesToAverage	2		
}			
NOTE 1: Delta(NRf2) is derived based on calibration procedure defined in the TS 38.508-1 [4], clause 6.1.3.3 on NR Cell3			

Table 8.1.3.1.14A.3.3-3: Void

Table 8.1.3.1.14A.3.3-4: IdMeasIdToAdd (Table 8.1.3.1.13.3.3-2)

Derivation Path: TS 38.331 [6], clause 6.3.2			
Information Element	Value/remark	Comment	Condition
MeasIdToAddModList ::= SEQUENCE (SIZE (1..maxNrofMeasId)) OF MeasIdToAddMod {	1 entry		
MeasIdToAddMod[1] SEQUENCE {		entry 1	

measId	1		
measObjectId	2		
reportConfigId	1		Step 1
	2		Step 9
}			
}			

Table 8.1.3.1.14A.3.3-5: Void

Table 8.1.3.1.14A.3.3-6: Void

8.1.3.1.15 Void

8.1.3.1.15A Measurement configuration control and reporting / Intra NR measurements / Blacklisting

8.1.3.1.15A.1 Test Purpose (TP)

(1)

```
with { UE in NR RRC_CONNECTED state and measurement configured for event A3 reporting }
ensure that {
  when { Blacklisted neighbour cell satisfies entry condition for event A3 }
  then { It is not considered in event evaluation and UE does not send MeasurementReport message }
}
```

(2)

```
with { UE in NR RRC_CONNECTED state and measurement reporting triggered by event A3 is ongoing and
no neighbour cells are blacklisted }
ensure that {
  when { Neighbour cells satisfies entry condition for event A3 }
  then { Neighbour cells are considered in measurement reporting }
}
```

8.1.3.1.15A.2 Conformance requirements

References: The conformance requirements covered in the current TC are specified in: TS 38.331, clauses 5.5.1, 5.5.4.1, and 5.5.5. Unless otherwise stated these are Rel-15 requirements.

[TS 38.331, clause 5.5.1]

The network may configure an RRC_CONNECTED UE to perform measurements and report them in accordance with the measurement configuration. The measurement configuration is provided by means of dedicated signalling i.e. using the *RRCReconfiguration*

...

- For intra-frequency and inter-frequency measurements a measurement object indicates the frequency/time location and subcarrier spacing of reference signals to be measured. Associated with this measurement object, the network may configure a list of cell specific offsets, a list of 'blacklisted' cells and a list of 'whitelisted' cells. Blacklisted cells are not applicable in event evaluation or measurement reporting. Whitelisted cells are the only ones applicable in event evaluation or measurement reporting.

...

[TS 38.331, clause 5.5.4.1]

The UE shall:

- 1> for each measId included in the measIdList within VarMeasConfig:

...

- 2> if the corresponding reportConfig includes a reportType set to eventTriggered or periodical;
 - 3> if the corresponding measObject concerns NR;
 - 3> if the corresponding measObject concerns EUTRA:
 - 4> consider any neighbouring cell detected based on parameters in the associated measObjectNR to be applicable when the concerned cell is not included in the blackCellsToAddModList defined within the VarMeasConfig for this measId;

...

- 2> if the reportType is set to eventTriggered and if the entry condition applicable for this event, i.e. the event corresponding with the eventId of the corresponding reportConfig within VarMeasConfig, is fulfilled for one or more applicable cells for all measurements after layer 3 filtering taken during timeToTrigger defined for this event within the VarMeasConfig, while the VarMeasReportList does not include a measurement reporting entry for this measId (a first cell triggers the event):
 - 3> include a measurement reporting entry within the VarMeasReportList for this measId;
 - 3> set the numberOfReportsSent defined within the VarMeasReportList for this measId to 0;
 - 3> include the concerned cell(s) in the cellsTriggeredList defined within the VarMeasReportList for this measId;
 - 3> initiate the measurement reporting procedure, as specified in 5.5.5;
- 2> else if the reportType is set to eventTriggered and if the entry condition applicable for this event, i.e. the event corresponding with the eventId of the corresponding reportConfig within VarMeasConfig, is fulfilled for one or more applicable cells not included in the cellsTriggeredList for all measurements after layer 3 filtering taken during timeToTrigger defined for this event within the VarMeasConfig (a subsequent cell triggers the event):
 - 3> set the numberOfReportsSent defined within the VarMeasReportList for this measId to 0;
 - 3> include the concerned cell(s) in the cellsTriggeredList defined within the VarMeasReportList for this measId;
 - 3> initiate the measurement reporting procedure, as specified in 5.5.5;
- 2> else if the reportType is set to eventTriggered and if the leaving condition applicable for this event is fulfilled for one or more of the cells included in the cellsTriggeredList defined within the VarMeasReportList for this measId for all measurements after layer 3 filtering taken during timeToTrigger defined within the VarMeasConfig for this event:
 - 3> remove the concerned cell(s) in the cellsTriggeredList defined within the VarMeasReportList for this measId;
 - 3> if reportOnLeave is set to TRUE for the corresponding reporting configuration:
 - 4> initiate the measurement reporting procedure, as specified in 5.5.5;
 - 3> if the cellsTriggeredList defined within the VarMeasReportList for this measId is empty:
 - 4> remove the measurement reporting entry within the VarMeasReportList for this measId;
 - 4> stop the periodical reporting timer for this measId, if running;

...

[TS 38.331, clause 5.5.5.1]

The purpose of this procedure is to transfer measurement results from the UE to the network. The UE shall initiate this procedure only after successful security activation.

For the *measId* for which the measurement reporting procedure was triggered, the UE shall set the *measResults* within the *MeasurementReport* message as follows:

- 1> set the *measId* to the measurement identity that triggered the measurement reporting;
- 1> for each serving cell configured with *-servingCellMO*:
 - 2> if the *reportConfig* associated with the *measId* that triggered the measurement reporting includes *rsType*:
 - 3> if the serving cell measurements based on the *rsType* included in the *reportConfig* that triggered the measurement report are available:
 - 4> set the *measResultServingCell* within *measResultServingMOList* to include RSRP, RSRQ and the available SINR of the serving cell, derived based on the *rsType* included in the *reportConfig* that triggered the measurement report;
- ...
- 1> set the *servCellId* within *measResultServingMOList* to include each NR serving cell that is configured with *-servingCellMO*, if any;
- ...
- 1> if there is at least one applicable neighbouring cell to report:
 - 2> set the *measResultNeighCells* to include the best neighbouring cells up to *maxReportCells* in accordance with the following:
 - 3> if the *reportType* is set to *eventTriggered*:
 - 4> include the cells included in the *cellsTriggeredList* as defined within the *VarMeasReportList* for this *measId*;
 - 3> else:
 - ...
 - 3> for each cell that is included in the *measResultNeighCells*, include the *physCellId*;
 - 3> if the *reportType* is set to *eventTriggered*:
 - 4> for each included cell, include the layer 3 filtered measured results in accordance with the *reportConfig* for this *measId*, ordered as follows:
 - 5> if the *measObject* associated with this *measId* concerns NR:
 - 6> if *rsType* in the associated *reportConfig* is set to *ssb*:
 - 7> set *resultsSSB-Cell* within the *measResult* to include the SS/PBCH block based quantity(ies) indicated in the *reportQuantityCell* within the concerned *reportConfig*, in order of decreasing trigger quantity, i.e. the best cell is included first;
 - 8> if *reportQuantityRsIndexes* and *maxNrofRSIndexesToReport* are configured, include beam measurement information as described in 5.5.5.2;
 - 1> increment the *numberOfReportsSent* as defined within the *VarMeasReportList* for this *measId* by 1;
 - 1> stop the periodical reporting timer, if running;
 - 1> if the *numberOfReportsSent* as defined within the *VarMeasReportList* for this *measId* is less than the *reportAmount* as defined within the corresponding *reportConfig* for this *measId*:
 - 2> start the periodical reporting timer with the value of *reportInterval* as defined within the corresponding *reportConfig* for this *measId*;
 - ...

1> if the UE is configured with EN-DC:

...

1> else:

2> submit the *MeasurementReport* message to lower layers for transmission, upon which the procedure ends.

[TS 38.331, clause 5.5.2.5]

The UE shall:

1> for each *measObjectId* included in the received *measObjectToAddModList*:

2> if an entry with the matching *measObjectId* exists in the *measObjectList* within the *VarMeasConfig*, for this entry:

3> reconfigure the entry with the value received for this *measObject*, except for the fields *cellsToAddModList*, *blackCellsToAddModList*, *whiteCellsToAddModList*, *cellsToRemoveList*, *blackCellsToRemoveList* and *whiteCellsToRemoveList*;

3> if the received *measObject* includes the *cellsToRemoveList*:

4> for each *physCellId* included in the *cellsToRemoveList*:

5> remove the entry with the matching *physCellId* from the *cellsToAddModList*;

3> if the received *measObject* includes the *cellsToAddModList*:

4> for each *physCellId* value included in the *cellsToAddModList*:

5> if an entry with the matching *physCellId* exists in the *cellsToAddModList*:

6> replace the entry with the value received for this *physCellId*;

5> else:

6> add a new entry for the received *physCellId* to the *cellsToAddModList*;

3> if the received *measObject* includes the *blackCellsToRemoveList*:

4> for each *pci-RangeIndex* included in the *blackCellsToRemoveList*:

5> remove the entry with the matching *pci-RangeIndex* from the *blackCellsToAddModList*;

NOTE: For each *pci-RangeIndex* included in the *blackCellsToRemoveList* that concerns overlapping ranges of cells, a cell is removed from the black list of cells only if all cell indexes containing it are removed.

3> if the received *measObject* includes the *blackCellsToAddModList*:

4> for each *pci-RangeIndex* included in the *blackCellsToAddModList*:

5> if an entry with the matching *pci-RangeIndex* is included in the *blackCellsToAddModList*:

6> replace the entry with the value received for this *pci-RangeIndex*;

5> else:

6> add a new entry for the received *pci-RangeIndex* to the *blackCellsToAddModList*;

3> for each *measId* associated with this *measObjectId* in the *measIdList* within the *VarMeasConfig*, if any:

4> remove the measurement reporting entry for this *measId* from the *VarMeasReportList*, if included;

4> stop the periodical reporting timer or timer T321, whichever one is running, and reset the associated information (e.g. *timeToTrigger*) for this *measId*;

2> else:

3> add a new entry for the received *measObject* to the *measObjectList* within *VarMeasConfig*.

[TS 38.331, clause 5.5.4.4]

The UE shall:

- 1> consider the entering condition for this event to be satisfied when condition A3-1, as specified below, is fulfilled;
- 1> consider the leaving condition for this event to be satisfied when condition A3-2, as specified below, is fulfilled;
- 1> use the SpCell for *Mp*, *Ofp* and *Ocp*.

NOTE The cell(s) that triggers the event has reference signals indicated in the *measObjectNR* associated to this event which may be different from the NR SpCell *measObjectNR*.

Inequality A3-1 (Entering condition)

$$Mn + Ofn + Ocn - Hys > Mp + Ofp + Ocp + Off$$

Inequality A3-2 (Leaving condition)

$$Mn + Ofn + Ocn + Hys < Mp + Ofp + Ocp + Off$$

The variables in the formula are defined as follows:

Mn is the measurement result of the neighbouring cell, not taking into account any offsets.

Ofn is the measurement object specific offset of the reference signal of the neighbour cell (i.e. *offsetMO* as defined within *measObjectNR* corresponding to the neighbour cell).

Ocn is the cell specific offset of the neighbour cell (i.e. *cellIndividualOffset* as defined within *measObjectNR* corresponding to the frequency of the neighbour cell), and set to zero if not configured for the neighbour cell.

Mp is the measurement result of the SpCell, not taking into account any offsets.

Ofp is the measurement object specific offset of the SpCell (i.e. *offsetMO* as defined within *measObjectNR* corresponding to the SpCell).

Ocp is the cell specific offset of the SpCell (i.e. *cellIndividualOffset* as defined within *measObjectNR* corresponding to the SpCell), and is set to zero if not configured for the SpCell.

Hys is the hysteresis parameter for this event (i.e. *hysteresis* as defined within *reportConfigNR* for this event).

Off is the offset parameter for this event (i.e. *a3-Offset* as defined within *reportConfigNR* for this event).

Mn*, *Mp are expressed in dBm in case of RSRP, or in dB in case of RSRQ and RS-SINR.

Ofn*, *Ocn*, *Ofp*, *Ocp*, *Hys*, *Off are expressed in dB.

8.1.3.1.15.3A Test description

8.1.3.1.15.3A.1 Pre-test conditions

System Simulator:

- NR Cell 1, Cell 3 and Cell 12:
- NR Cell 1 is the serving cell
- NR Cell 3 and Cell 12 are inter-frequency neighbour cells
- System information combination NR-4 as defined in TS 38.508-1[4] clause 4.4.3.1.2 is used in NR cells.

UE:

- None

Preamble:

- The UE is in state NR RRC_CONNECTED in Established (state 3) according to [18].

8.1.3.1.15A.3.2 Test procedure sequence

Table 8.1.3.1.15A.3.2-1 illustrates the downlink power levels to be applied for NR Cell 1, Cell 3 and Cell 12 at various time instants of the test execution. Row marked "T0" denotes the conditions after the preamble, while rows marked "T1" and "T2" are to be applied subsequently. The exact instants on which these values shall be applied are described in the texts in this clause.

Table 8.1.3.1.15A.3.2-1: Time instances of cell power level and parameter changes for FR1

	Parameter	Unit	NR Cell 1	NR Cell 3	NR Cell 12	Remark
T0	SS/PBCH SSS EPRE	dBm/ SCS	-85	-97	-97	Power levels are such that leaving condition for event A3 is satisfied for all neighbour NR cells: $Mn + Ofn + Ocn + Hys < Mp + Ofp + Ocp + Off$
T1	SS/PBCH SSS EPRE	dBm/ SCS	-85	-79	-97	Power levels are such that entry condition for event A3 is satisfied for inter-frequency neighbour NR cell 3 [<i>measId 1</i>] $Mn + Ofn + Ocn - Hys > Ms + OfS + Ocs + Off$
T2	SS/PBCH SSS EPRE	dBm/ SCS	-85	-79	-79	Power levels are such that entry condition for event A3 is satisfied for inter-frequency neighbour NR cell 3 and NR Cell 12 [<i>measId 2</i>] $Mn + Ofn + Ocn - Hys > Ms + OfS + Ocs + Off$

Table 8.1.3.1.15A.3.2-1A: Time instances of cell power level and parameter changes for FR2

	Parameter	Unit	NR Cell 1	NR Cell 3	NR Cell 12	Remark
T0	SS/PBCH SSS EPRE	dBm/ SCS	FFS	FFS	FFS	Power levels are such that leaving condition for event A3 is satisfied for all neighbour NR cells: $Mn + Ofn + Ocn + Hys < Mp + Ofp + Ocp + Off$
T1	SS/PBCH SSS EPRE	dBm/ SCS	FFS	FFS	FFS	Power levels are such that entry condition for event A3 is satisfied for inter-frequency neighbour NR cell 3 [<i>measId 1</i>] $Mn + Ofn + Ocn - Hys > Ms + OfS + Ocs + Off$
T2	SS/PBCH SSS EPRE	dBm/ SCS	FFS	FFS	FFS	Power levels are such that entry condition for event A3 is satisfied for inter-frequency neighbour NR cell 3 and NR Cell 12 [<i>measId 2</i>] $Mn + Ofn + Ocn - Hys > Ms + OfS + Ocs + Off$

Table 8.1.3.1.15A.3.2-2: Main behaviour

St	Procedure	Message Sequence		TP	Verdict
		U - S	Message		
1	SS transmits an <i>RRCReconfiguration</i> message including <i>measConfig</i> to setup intra NR measurement and reporting for event A3.	<--	NR RRC: <i>RRCReconfiguration</i>	-	-
2	The UE transmits an <i>RRCReconfigurationComplete</i> message.	-->	NR RRC: <i>RRCReconfigurationComplete</i>	-	-
3	SS re-adjusts the cell-specific reference signal levels according to row "T1" in table 8.1.3.1.15A.3.2.-1/1A.	-	-	-	-
4	Check: does the UE transmit a <i>MeasurementReport</i> messages within the next 10s?	-	NR RRC: <i>MeasurementReport</i>	1	F
5	SS re-adjusts the cell-specific reference signal levels according to row "T2" in table 8.1.3.1.15A.3.2.-1/1A.	-	-	-	-

6	Check: does the UE transmit a <i>MeasurementReport</i> message to report event A3 with the measured RSRP values for Cell 1 and Cell 12 without Cell 3 results?	-->	NR RRC: <i>MeasurementReport</i>	1	P
7	SS transmits an <i>RRCReconfiguration</i> message including <i>measConfig</i> to remove Cell 3 from the blacklisted cell list.	<--	NR RRC: <i>RRCReconfiguration</i>	-	-
8	The UE transmits an <i>RRCReconfigurationComplete</i> message	-->	NR RRC: <i>RRCReconfigurationComplete</i>	-	-
-	EXCEPTION: Steps 8Aa1 to 8Ab1 describe a transaction that depends on the UE behaviour; the "lower case letter" identifies a step sequence that takes place if a specific behaviour happens.	-	-	-	-
8A a1	IF the UE detects event A3 for Cell 12 before event A3 for Cell 3 THEN the UE may transmit <i>MeasurementReport</i> message to report event A3 with the measured RSRP values for Cell 1 and Cell 12.	-->	NR RRC: <i>MeasurementReport</i>	-	-
8A b1	IF the UE detects event A3 for Cell 3 before event A3 for Cell 12 THEN the UE may transmit <i>MeasurementReport</i> message to report event A3 with the measured RSRP values for Cell 1 and Cell 3.	-->	NR RRC: <i>MeasurementReport</i>	-	-
9	Check: does the UE transmit a <i>MeasurementReport</i> message to report event A3 with the measured RSRP values for Cell 1, Cell 3 and Cell 12?	-->	NR RRC: <i>MeasurementReport</i>	2	P
10	SS transmits an <i>RRCReconfiguration</i> message including <i>measConfig</i> to release intra NR measurement and reporting for event A3.	<--	NR RRC: <i>RRCReconfiguration</i>	-	-
11	The UE transmits an <i>RRCReconfigurationComplete</i> message	-->	NR RRC: <i>RRCReconfigurationComplete</i>	-	-

8.1.3.1.15A.3.3 Specific message contents

Table 8.1.3.1.15A.3.3-1: *RRCReconfiguration* (step 1 and Step 7 Table 8.1.3.1.15A.3.2-2)

Derivation Path: TS 38.508-1 [4] Table 4.6.1-13 with condition NR_MEAS

Table 8.1.3.1.15A.3.3-2: *MeasConfig* (Table 8.1.3.1.15A.3.3-1)

Derivation Path: TS 38.508 clause 4.6.3 table 4.6.3-69 with condition EVENT_A3			
Information Element	Value/remark	Comment	Condition
<i>MeasConfig</i> ::= SEQUENCE {			
<i>measObjectToAddModList</i> SEQUENCE (SIZE (1..maxNrofMeasId)) OF <i>MeasObjectToAddMod</i> {	2 entries		Step 1 of Table 8.1.3.1.15A.3.3-1
<i>MeasObjectToAddMod</i> [1] SEQUENCE {		entry 1	
<i>measObjectId</i>	1		
<i>measObject</i> CHOICE {			
<i>measObjectNR</i>	<i>MeasObjectNR</i> -f1	Table 8.1.3.1.15A.3.3-2A	
}			
}			
<i>MeasObjectToAddMod</i> [2] SEQUENCE {		entry 2	
<i>measObjectId</i>	2		
<i>measObject</i> CHOICE {			
<i>measObjectNR</i>	<i>MeasObjectNR</i> -f2	Table 8.1.3.1.15A.3.3-3	
}			
}			
}			

}			
measObjectToAddModList SEQUENCE (SIZE (1..maxNrofMeasId)) OF MeasObjectToAddMod {	1 entry		Step 7 of Table 8.1.3.1.15A.3.3-1
MeasObjectToAddMod[1] SEQUENCE {		entry 1	
measObjectId	2		
measObject CHOICE {			
measObjectNR	MeasObjectNR-f2	Table 8.1.3.1.15A.3.3-5	
}			
}			
measObjectToAddModList	Not present		Step 10 of Table 8.1.3.1.15A.3.3-1
reportConfigToAddModList SEQUENCE(SIZE (1..maxReportConfigId)) OF ReportConfigToAddMod {	1 entry		Step 1 of Table 8.1.3.1.15A.3.3-1
ReportConfigToAddMod[1] SEQUENCE {		entry 1	
reportConfigId	ReportConfigId		
reportConfig CHOICE {			
reportConfigNR	ReportConfigNR(2) Same as TS 38.508-1 Table 4.6.3-142 except for reportAmount set to 'r1'	a3-Offset value set to 1 dB (2*0.5 dB)	
}			
}			
reportConfigToAddModList	Not present		Step 7 or 10 of Table 8.1.3.1.15A.3.3-1
measIdToRemoveList SEQUENCE (SIZE (1..maxNrofMeasId)) OF MeasId {	1 entry		Step 10 of Table 8.1.3.1.15A.3.3-1
MeasId[1]	1	entry 1	
}			
measIdToAddModList SEQUENCE (SIZE (1..maxNrofMeasId)) OF MeasIdToAddMod {	1 entry		Step 1 of Table 8.1.3.1.15A.3.3-1
MeasIdToAddMod[1] SEQUENCE {			
measId	1		
measObjectId	2		
reportConfigId	ReportConfigId		
}			
}			
measIdToAddModList	Not present		Step 7 or 10 of Table 8.1.3.1.15A.3.3-1
measGapConfig	MeasGapConfig with condition INTER-FREQ_ODD		
}			

Table 8.1.3.1.15A.3.3-2A: MeasObjectNR-f1 (Table 8.1.3.1.15A.3.3-2)

Derivation Path: TS 38.508-1 [4], Table 4.6.3-76			
Information Element	Value/remark	Comment	Condition

MeasObjectNR ::= SEQUENCE {			
ssbFrequency	ARFCN-ValueNR for SSB of NR Cell 1		
absThreshSS-BlocksConsolidation	Not present		
nrofSS-BlocksToAverage	Not present		
}			

Table 8.1.3.1.15A.3.3-3: MeasObjectNR-f2 (Table 8.1.3.1.15A.3.3-2)

Derivation path: TS 38.508-1 [4], Table 4.6.3-76			
Information Element	Value/remark	Comment	Condition
MeasObjectNR ::= SEQUENCE {			
ssbFrequency	ARFCN-ValueNR for SSB of NR Cell 3		
smtc1	SSB-MTC with condition INTER-FREQ_ODD		
absThreshSS-BlocksConsolidation	Not present		
nrofSS-BlocksToAverage	Not present		
blackCellsToAddModList SEQUENCE (SIZE (1..maxNrofPCI-Ranges)) OF PCI-RangeElement {	1 entry	Add Cell 3	
PCI-RangeElement[1] SEQUENCE {		entry 1	
PCI-RangeIndex	1		
pci-Range SEQUENCE {			
start	physicalCellIdentity-Cell3		
range	Not present		
}			
}			
}			
}			

Table 8.1.3.1.15A.3.3-4: MeasurementReport (step 6, Table 8.1.3.1.15A.3.2-2)

Derivation Path: TS 38.508-1 [4] clause 4.6.1 table 4.6.1-5A			
Information Element	Value/remark	Comment	Condition
MeasurementReport ::= SEQUENCE {			
criticalExtensions CHOICE {			
c1 CHOICE {			
measurementReport SEQUENCE {			
measResults SEQUENCE {			
measId	1		
measResultServingMOList SEQUENCE (SIZE (1..maxNrofServingCells)) OF MeasResultServMO {	1 entry		
MeasResultServMO[1] SEQUENCE {		entry 1	
servCellId	ServCellIndex - Cell1		
measResultServingCell SEQUENCE {		Report Cell 1	
physCellId	physicalCellIdentity-Cell1		
measResult SEQUENCE {			
cellResults SEQUENCE {			
resultsSSB-Cell SEQUENCE {			
rsrp	(0..127)		
rsrq	(0..127)		
sinr	(0..127)		pc_ss_SINR_Meas
}	Not present		
}			
}			
}			
}			
}			
}			
}			
}			
}			
measResultNeighCells CHOICE {			
measResultListNR SEQUENCE (SIZE (1..maxCellReport)) OF MeasResultNR {	1 entry	Report Cell 12	

MeasResultNR[1] SEQUENCE {		entry 1	
physCellId	physicalCellIdentity-Cell 12		
measResult SEQUENCE {			
cellResults SEQUENCE {			
resultsSSB-Cell SEQUENCE {			
rsrp	(0..127)		
rsrq	(0..127)		
sinr	(0..127)		pc_ss_SIN R_Meas
	Not present		
}			
resultsCSI-RS-Cell	Not present		
}			
rsIndexResults	Not present		
}			
cgi-Info	Not present		
}			
}			
}			
}			
}			
}			
}			
}			
}			

Table 8.1.3.1.15A.3.3-5: MeasObjectNR-f2 (Step 7 Table 8.1.3.1.15A.3.3-2)

Derivation path: TS 38.508-1 [4], Table 4.6.3-76			
Information Element	Value/remark	Comment	Condition
MeasObjectNR ::= SEQUENCE {			
ssbFrequency	ARFCN-ValueNR for SSB of NR Cell 3		
smtc1	SSB-MTC with condition INTER-FREQ_ODD		
absThreshSS-BlocksConsolidation	Not present		
nrofSS-BlocksToAverage	Not present		
blackCellsToRemoveList SEQUENCE (SIZE (1.. maxNrofPCI-Ranges)) OF PCI-RangeElement {	1 entry	Remove Cell 3	
PCI-RangeIndex [1]	physicalCellIdentity-Cell3	entry 1	
}			
}			

Table 8.1.3.1.15A.3.3-6: MeasurementReport (step 8Aa1, Table 8.1.3.1.15A.3.2-2)

Derivation Path: TS 38.508-1 [4] clause 4.6.1 table 4.6.1-5A			
Information Element	Value/remark	Comment	Condition
MeasurementReport ::= SEQUENCE {			
criticalExtensions CHOICE {			
c1 CHOICE {			
measurementReport SEQUENCE {			
measResults SEQUENCE {			
measId	1		
measResultServingMOList SEQUENCE (SIZE (1.. maxNrofServingCells)) OF MeasResultServMO {	1 entry		
MeasResultServMO[1] SEQUENCE {		entry 1	
servCellId	ServCellIndex – Cell1		
measResultServingCell SEQUENCE {		Report Cell 1	
physCellId	physicalCellIdentity-Cell1		
measResult SEQUENCE {			
cellResults SEQUENCE {			
resultsSSB-Cell SEQUENCE {			
rsrp	(0..127)		
rsrq	(0..127)		
}			
}			
}			
}			
}			
}			
}			
}			

```

then { Neighbour cells are considered in measurement reporting }
}

```

8.1.3.1.16.2 Conformance requirements

References: The conformance requirements covered in the current TC are specified in: TS 38.331, clauses 5.3.5.3, 5.5.2.1, 5.5.2.9, 5.5.4.1, 5.5.4.6 and 5.5.5. Unless otherwise stated these are Rel-15 requirements.

[TS 38.331, clause 5.3.5.3]

The UE shall perform the following actions upon reception of the *RRCReconfiguration*:

...

1> if the *RRCReconfiguration* message includes the *measConfig*:

2> perform the measurement configuration procedure as specified in 5.5.2;

...

1> if the UE is configured with E-UTRA *nr-SecondaryCellGroupConfig* (MCG is E-UTRA):

...

1> else:

2> submit the *RRCReconfigurationComplete* message via SRB1 to lower layers for transmission using the new configuration;

...

[TS 38.331, clause 5.5.2.1]

...

The UE shall:

...

1> if the received *measConfig* includes the *measObjectToAddModList*:

2> perform the measurement object addition/modification procedure as specified in 5.5.2.5;

...

1> if the received *measConfig* includes the *reportConfigToAddModList*:

2> perform the reporting configuration addition/modification procedure as specified in 5.5.2.7;

...

1> if the received *measConfig* includes the *measIdToAddModList*:

2> perform the measurement identity addition/modification procedure as specified in 5.5.2.3;

...

[TS 38.331, clause 5.5.4.1]

If AS security has been activated successfully, the UE shall:

1> for each *measId* included in the *measIdList* within *VarMeasConfig*:

2> if the corresponding *reportConfig* includes a *reportType* set to *eventTriggered* or *periodical*:

3> if the corresponding *measObject* concerns NR:

...

- 4> if the *eventA3* or *eventA5* is configured in the corresponding *reportConfig*:
 - 5> if a serving cell is associated with a *measObjectNR* and neighbours are associated with another *measObjectNR*, consider any serving cell associated with the other *measObjectNR* to be a neighbouring cell as well;
- ...
- 2> if the *reportType* is set to *eventTriggered* and if the entry condition applicable for this event, i.e. the event corresponding with the *eventId* of the corresponding *reportConfig* within *VarMeasConfig*, is fulfilled for one or more applicable cells for all measurements after layer 3 filtering taken during *timeToTrigger* defined for this event within the *VarMeasConfig*, while the *VarMeasReportList* does not include a measurement reporting entry for this *measId* (a first cell triggers the event):
 - 3> include a measurement reporting entry within the *VarMeasReportList* for this *measId*;
 - 3> set the *numberOfReportsSent* defined within the *VarMeasReportList* for this *measId* to 0;
 - 3> include the concerned cell(s) in the *cellsTriggeredList* defined within the *VarMeasReportList* for this *measId*;
 - 3> initiate the measurement reporting procedure, as specified in 5.5.5;
- 2> else if the *reportType* is set to *eventTriggered* and if the entry condition applicable for this event, i.e. the event corresponding with the *eventId* of the corresponding *reportConfig* within *VarMeasConfig*, is fulfilled for one or more applicable cells not included in the *cellsTriggeredList* for all measurements after layer 3 filtering taken during *timeToTrigger* defined for this event within the *VarMeasConfig* (a subsequent cell triggers the event):
 - 3> set the *numberOfReportsSent* defined within the *VarMeasReportList* for this *measId* to 0;
 - 3> include the concerned cell(s) in the *cellsTriggeredList* defined within the *VarMeasReportList* for this *measId*;
 - 3> initiate the measurement reporting procedure, as specified in 5.5.5;
- 2> else if the *reportType* is set to *eventTriggered* and if the leaving condition applicable for this event is fulfilled for one or more of the cells included in the *cellsTriggeredList* defined within the *VarMeasReportList* for this *measId* for all measurements after layer 3 filtering taken during *timeToTrigger* defined within the *VarMeasConfig* for this event:
 - 3> remove the concerned cell(s) in the *cellsTriggeredList* defined within the *VarMeasReportList* for this *measId*;
- ...
- 3> if the *cellsTriggeredList* defined within the *VarMeasReportList* for this *measId* is empty:
 - 4> remove the measurement reporting entry within the *VarMeasReportList* for this *measId*;
 - 4> stop the periodical reporting timer for this *measId*, if running;
- ...
- 2> upon expiry of the periodical reporting timer for this *measId*:
 - 3> initiate the measurement reporting procedure, as specified in 5.5.5.
- ...

[TS 38.331, clause 5.5.4.4]

The UE shall:

- 1> consider the entering condition for this event to be satisfied when condition A3-1, as specified below, is fulfilled;
- 1> consider the leaving condition for this event to be satisfied when condition A3-2, as specified below, is fulfilled;

1> use the SpCell for M_p , O_{fp} and O_{cp} .

NOTE The cell(s) that triggers the event has reference signals indicated in the *measObjectNR* associated to this event which may be different from the NR SpCell *measObjectNR*.

Inequality A3-1 (Entering condition)

$$M_n + O_{fn} + O_{cn} - H_{ys} > M_p + O_{fp} + O_{cp} + O_{ff}$$

Inequality A3-2 (Leaving condition)

$$M_n + O_{fn} + O_{cn} + H_{ys} < M_p + O_{fp} + O_{cp} + O_{ff}$$

The variables in the formula are defined as follows:

M_n is the measurement result of the neighbouring cell, not taking into account any offsets.

O_{fn} is the measurement object specific offset of the reference signal of the neighbour cell (i.e. *offsetMO* as defined within *measObjectNR* corresponding to the neighbour cell).

O_{cn} is the cell specific offset of the neighbour cell (i.e. *cellIndividualOffset* as defined within *measObjectNR* corresponding to the frequency of the neighbour cell), and set to zero if not configured for the neighbour cell.

M_p is the measurement result of the SpCell, not taking into account any offsets.

O_{fp} is the measurement object specific offset of the SpCell (i.e. *offsetMO* as defined within *measObjectNR* corresponding to the SpCell).

O_{cp} is the cell specific offset of the SpCell (i.e. *cellIndividualOffset* as defined within *measObjectNR* corresponding to the SpCell), and is set to zero if not configured for the SpCell.

H_{ys} is the hysteresis parameter for this event (i.e. *hysteresis* as defined within *reportConfigNR* for this event).

O_{ff} is the offset parameter for this event (i.e. *a3-Offset* as defined within *reportConfigNR* for this event).

M_n , M_p are expressed in dBm in case of RSRP, or in dB in case of RSRQ and RS-SINR.

O_{fn} , O_{cn} , O_{fp} , O_{cp} , H_{ys} , O_{ff} are expressed in dB.

[TS 38.331, clause 5.5.5.1]



Figure 5.5.5.1-1: Measurement reporting

The purpose of this procedure is to transfer measurement results from the UE to the network. The UE shall initiate this procedure only after successful AS security activation.

For the *measId* for which the measurement reporting procedure was triggered, the UE shall set the *measResults* within the *MeasurementReport* message as follows:

1> set the *measId* to the measurement identity that triggered the measurement reporting;

1> set the *measResultServingCell* within *measResultServingMOList* to include, for each NR serving cell that is configured with *servingCellMO*, RSRP, RSRQ and the available SINR, derived based on the *rsType* if indicated in the associated *reportConfig*, otherwise based on SSB if available, otherwise based on CSI-RS;

1> set the *servCellId* within *measResultServingMOList* to include each NR serving cell that is configured with *servingCellMO*, if any;

...

1> if there is at least one applicable neighbouring cell to report:

2> if the *reportType* is set to *eventTriggered* or *periodical*:

3> set the *measResultNeighCells* to include the best neighbouring cells up to *maxReportCells* in accordance with the following:

4> if the *reportType* is set to *eventTriggered*:

5> include the cells included in the *cellsTriggeredList* as defined within the *VarMeasReportList* for this *measId*;

...

4> for each cell that is included in the *measResultNeighCells*, include the *physCellId*;

4> if the *reportType* is set to *eventTriggered* or *periodical*:

5> for each included cell, include the layer 3 filtered measured results in accordance with the *reportConfig* for this *measId*, ordered as follows:

6> if the *measObject* associated with this *measId* concerns NR:

7> if *rsType* in the associated *reportConfig* is set to *ssb*:

8> set *resultsSSB-Cell* within the *measResult* to include the SS/PBCH block based quantity(ies) indicated in the *reportQuantityCell* within the concerned *reportConfig*, in decreasing order of the sorting quantity, determined as specified in 5.5.5.3, i.e. the best cell is included first;

...

1> increment the *numberOfReportsSent* as defined within the *VarMeasReportList* for this *measId* by 1;

1> stop the periodical reporting timer, if running;

1> if the *numberOfReportsSent* as defined within the *VarMeasReportList* for this *measId* is less than the *reportAmount* as defined within the corresponding *reportConfig* for this *measId*:

2> start the periodical reporting timer with the value of *reportInterval* as defined within the corresponding *reportConfig* for this *measId*;

...

1> else:

2> submit the *MeasurementReport* message to lower layers for transmission, upon which the procedure ends.

8.1.3.1.16.3 Test description

8.1.3.1.16.3.1 Pre-test conditions

System Simulator:

- NR Cell 1 is the PCell, NR Cell 2 and NR Cell 4 are the intra-frequency neighbour cells of NR Cell 1.
- System information combination NR-2 as defined in TS 38.508-1 [4] clause 4.4.3.1.2 is used in NR cells.

UE:

- None.

Preamble:

- The UE is in state 3N-A as defined in TS 38.508-1 [4], subclause 4.4A.

8.1.3.1.16.3.2 Test procedure sequence

Table 8.1.3.1.16.3.2-1 and 8.1.3.1.16.3.2-2 illustrates the downlink power levels to be applied for NR Cell 1, NR Cell 2 and NR Cell 4 at various time instants of the test execution. Row marked "T0" denotes the conditions after the preamble, while the configuration marked "T1" is applied at the point indicated in the Main behaviour description in Table 8.1.3.1.16.3.2-3.

Table 8.1.3.1.16.3.2-1: Time instances of cell power level and parameter changes for NR Cell 1, 2, 4 in FR1

	Parameter	Unit	NR Cell 1	NR Cell 2	NR Cell 4	Remark
T0	SS/PBCH SSS EPRE	dBm/ SCS	-85	-91	-91	Power levels are such that entry condition for event A3 (measId 1) is not satisfied: $Mn + Ofn + Ocn - Hys \leq Mp + Ofp + Ocp + Off$
T1	SS/PBCH SSS EPRE	dBm/ SCS	-85	-78	-91	Power levels are such that entry condition for event A3 (measId 1) is satisfied: $Mn + Ofn + Ocn - Hys > Mp + Ofp + Ocp + Off$
T2	SS/PBCH SSS EPRE	dBm/ SCS	-85	-91	-91	Power levels are such that entry condition for event A3 (measId 1) is not satisfied: $Mn + Ofn + Ocn - Hys \leq Mp + Ofp + Ocp + Off$

Table 8.1.3.1.16.3.2-2: Time instances of cell power level and parameter changes for NR Cell 1, 2, 4 in FR2

	Parameter	Unit	NR Cell 1	NR Cell 2	NR Cell 4	Remark
T0	SS/PBCH SSS EPRE	dBm/ SCS	FFS	FFS	FFS	Power levels are such that entry condition for event A3 (measId 1) is not satisfied: $Mn + Ofn + Ocn - Hys \leq Mp + Ofp + Ocp + Off$
T1	SS/PBCH SSS EPRE	dBm/ SCS	FFS	FFS	FFS	Power levels are such that entry condition for event A3 (measId 1) is satisfied: $Mn + Ofn + Ocn - Hys > Mp + Ofp + Ocp + Off$
T2	SS/PBCH SSS EPRE	dBm/ SCS	FFS	FFS	FFS	Power levels are such that entry condition for event A3 (measId 1) is not satisfied: $Mn + Ofn + Ocn - Hys \leq Mp + Ofp + Ocp + Off$

Table 8.1.3.1.16.3.2-3: Main behaviour

St	Procedure	Message Sequence		TP	Verdict
		U - S	Message		
1	The SS transmits an <i>RRCReconfiguration</i> message including <i>MeasConfig</i> to setup NR measurement and reporting for intra-frequency event A3 (<i>measId 1</i>)	<--	NR RRC: <i>RRCReconfiguration</i>	-	-
2	The UE transmits an <i>RRCReconfigurationComplete</i> message.	-->	NR RRC: <i>RRCReconfigurationComplete</i>	-	-

3	SS re-adjusts the cell-specific reference signal level according to row "T1" in table 8.1.3.1.16.3.2-1/2.	-	-	-	-
4	Check: Does the UE transmit a <i>MeasurementReport</i> message within the next 30s?	-->	NR RRC: <i>MeasurementReport</i>	1	F
5	The SS transmits an <i>RRCReconfiguration</i> message including both NR Cell 2 and NR Cell 4 in <i>whiteCellsToAddModList</i>	<--	NR RRC: <i>RRCReconfiguration</i>	-	-
6	The UE transmits an <i>RRCReconfigurationComplete</i> message.	-->	NR RRC: <i>RRCReconfigurationComplete</i>	-	-
7	Wait and ignore <i>MeasurementReport</i> messages for 10s to allow UE measurement	-	-	-	-
8	Check: Does the UE transmit a <i>MeasurementReport</i> message to report event A3 (<i>measId</i> 1) with the measured RSRP value for NR Cell 2?	-->	NR RRC: <i>MeasurementReport</i>	2	P
9	SS re-adjusts the cell-specific reference signal level according to row "T2" in table 8.1.3.1.16.3.2-1/2.	-	-	-	-
10	Wait and ignore <i>MeasurementReport</i> messages for 10s to allow change of power levels for NR Cell 2 and UE measurement	-	-	-	-
11	Check: Does the UE transmit a <i>MeasurementReport</i> message within the next 10s?	-	-	2	F

8.1.3.1.16.3.3 Specific message contents

Table 8.1.3.1.16.3.3-1: *RRCReconfiguration* (step 1 and 5, Table 8.1.3.1.16.3.2-3)

Derivation Path: TS 38.508-1 [4] Table 4.6.1-13 with condition NR_MEAS

Table 8.1.3.1.16.3.3-2: *MeasConfig* (Table 8.1.3.1.16.3.3-1)

Derivation Path: TS 38.508-1 [4] Table 4.6.3-69			
Information Element	Value/remark	Comment	Condition
<i>MeasConfig</i> ::= SEQUENCE {			
<i>measObjectToAddModList</i> SEQUENCE (SIZE (1..maxNrofMeasId)) OF <i>MeasObjectToAddMod</i> {	1 entry		
<i>MeasObjectToAddMod</i> [1] SEQUENCE {		entry 1	
<i>measObjectId</i>	1		
<i>measObject</i> CHOICE {			
<i>measObjectNR</i>	<i>MeasObjectNR-f1</i>		Step 1
	<i>MeasObjectNR-whitelist</i>		Step 5
}			
}			
<i>reportConfigToAddModList</i>	Not present		Step 5
<i>reportConfigToAddModList</i> SEQUENCE (SIZE (1..maxReportConfigId)) OF <i>ReportConfigToAddMod</i> {	1 entry		Step 1
<i>ReportConfigToAddMod</i> [1] SEQUENCE {		entry 1	
<i>reportConfigId</i>	1		
<i>reportConfig</i> CHOICE {			
<i>reportConfigNR</i>	<i>ReportConfigNR-EventA3</i>		
}			
}			
}			
<i>measIdToAddModList</i>	Not present		Step 5
<i>measIdToAddModList</i> SEQUENCE (SIZE (1..maxNrofMeasId)) OF <i>MeasIdToAddMod</i> {	1 entry		Step 1
<i>MeasIdToAddMod</i> [1] SEQUENCE {		entry 1	
<i>measId</i>	1		

measObjectId	1		
reportConfigId	1		
}			
}			
}			

Table 8.1.3.1.16.3.3-3: MeasObjectNR-f1 (Table 8.1.3.1.16.3.3-2)

Derivation Path: TS 38.508-1 [4], Table 4.6.3-76			
Information Element	Value/remark	Comment	Condition
MeasObjectNR ::= SEQUENCE {			
ssbFrequency	ARFCN-ValueNR for SSB of NR Cell 1		
absThreshSS-BlocksConsolidation	Not present		
nrofSS-BlocksToAverage	Not present		
whiteCellsToAddModList SEQUENCE(SIZE (1..maxNrofPCI-Ranges)) OF PCI-RangeElement {	1 entry		
PCI-RangeElement[1] SEQUENCE {		entry 1	
pci-RangeIndex	1		
pci-Range SEQUENCE {			
start	900		
range	Not present		
}			
}			
}			
}			

Table 8.1.3.1.16.3.3-4: MeasObjectNR-whitelist (Table 8.1.3.1.16.3.3-2)

Derivation Path: TS 38.508-1 [4], Table 4.6.3-76			
Information Element	Value/remark	Comment	Condition
MeasObjectNR ::= SEQUENCE {			
ssbFrequency	ARFCN-ValueNR for SSB of NR Cell 1		
absThreshSS-BlocksConsolidation	Not present		
nrofSS-BlocksToAverage	Not present		
whiteCellsToAddModList SEQUENCE (SIZE (1..maxNrofPCI-Ranges)) OF PCI-RangeElement {	2 entries		
PCI-RangeElement[1] SEQUENCE {		entry 1	
pci-RangeIndex	1		
pci-Range SEQUENCE {			
start	PhyCellId of NR Cell 2		
range	n4		
}			
PCI-RangeElement[2] SEQUENCE {		entry 2	
pci-RangeIndex	2		
pci-Range SEQUENCE {			
start	PhyCellId of NR Cell 4		
range	n4		
}			
}			
}			
}			

Table 8.1.3.1.16.3.3-5: ReportConfigNR-EventA3 (Table 8.1.3.1.16.3.3-2)

Derivation Path: TS 38.508-1 [4] Table 4.6.3-142 with condition EVENT_A3			
Information Element	Value/remark	Comment	Condition
ReportConfigNR ::= SEQUENCE {			
reportType CHOICE {			
eventTriggered SEQUENCE {			

eventId CHOICE {			
eventA3 SEQUENCE {			
a3-Offset CHOICE {			
rsrp	0	0dB	FR1
}	FFS		FR2
}			
useWhiteCellList	TRUE		
}			
reportInterval	ms10240		
reportAmount	infinity		
reportQuantityCell SEQUENCE {			
rsrp	true		
rsrq	false		
sinr	false		
}			
}			
}			
}			

Table 8.1.3.1.16.3.3-6: MeasurementReport (step 8, Table 8.1.3.1.16.3.2-3)

Derivation Path: TS 38.508-1 [4] Table 4.6.1-5A			
Information Element	Value/remark	Comment	Condition
MeasurementReport ::= SEQUENCE {			
criticalExtensions CHOICE {			
measurementReport SEQUENCE {			
measResults SEQUENCE {			
measId	1		
measResultServingMOList SEQUENCE (SIZE (1..maxNrofServingCells)) OF MeasResultServMO {	1 entry	Measurement report for NR Cell 1	
MeasResultServMO[1] SEQUENCE {		entry 1	
servCellId	ServCellIndex of NR Cell 1		
measResultServingCell SEQUENCE {			
physCellId	PhysCellId of NR Cell 1		
measResult SEQUENCE {			
cellResults SEQUENCE {			
resultsSSB-Cell SEQUENCE {			
rsrp	(0..127)		
rsrq	(0..127)		
sinr	Not present		
}	Not checked		pc_ss_SINR_Meas
}			
}			
}			
}			
}			
}			
}			
measResultNeighCells CHOICE {			
measResultListNR SEQUENCE (SIZE (1..maxCellReport)) OF MeasResultNR {	1 entry	Measurement report for NR Cell 2	
MeasResultNR[1] SEQUENCE {		entry 1	
physCellId	PhysCellId of NR Cell 2		
measResult SEQUENCE {			
cellResults SEQUENCE {			
resultsSSB-Cell SEQUENCE {			
rsrp	(0..127)		
rsrq	Not present		
sinr	Not present		
}			
}			
}			
}			
}			
}			
resultsCSI-RS-Cell	Not present		

}			
rsIndexResults	Not present		
}			
cgi-Info	Not present		
}			
}			
}			
}			
}			
}			
}			
}			

8.1.3.1.17 NR CA / Measurement configuration control and reporting / Intra NR measurements / Event A6

8.1.3.1.17.1 NR CA / Measurement configuration control and reporting / Intra NR measurements / Event A6 / Intra-band Contiguous CA

8.1.3.1.17.1.1 Test Purpose (TP)

(1)

```
with { UE in NR RRC_CONNECTED state and measurements configured for event A6 }
ensure that {
  when { Entry condition for event A6 is not met }
  then { UE does not send MeasurementReport }
}
```

(2)

```
with { UE in NR RRC_CONNECTED state and measurements configured for event A6 }
ensure that {
  when { Intra-frequency neighbour becomes offset better than SCell }
  then { UE sends MeasurementReport with correct measId for event A6 }
}
```

(3)

```
with { UE in NR RRC_CONNECTED state and measurements configured for event A6 }
ensure that {
  when { UE receives a RRCReconfiguration message containing sCellToReleaseList with a sCellIndex
equal to one of the current UE SCell configuration }
  then { UE stops sending MeasurementReport message }
}
```

8.1.3.1.17.1.2 Conformance requirements

References: The conformance requirements covered in the current TC are specified in: TS 38.331, clauses 5.3.5.3, 5.3.5.5.9, 5.5.2.1, 5.5.4.1, 5.5.4.7 and 5.5.5. Unless otherwise stated these are Rel-15 requirements.

[TS 38.331, clause 5.3.5.3]

The UE shall perform the following actions upon reception of the *RRCReconfiguration*:

...

1> if the *RRCReconfiguration* includes the *masterCellGroup*:

2> perform the cell group configuration for the received *masterCellGroup* according to 5.3.5.5;

...

1> if the *RRCReconfiguration* message includes the *measConfig*:

2> perform the measurement configuration procedure as specified in 5.5.2;

...

1> if the UE is configured with E-UTRA *nr-SecondaryCellGroupConfig* (MCG is E-UTRA):

...

1> else:

2> submit the *RRCReconfigurationComplete* message via SRB1 to lower layers for transmission using the new configuration;

...

[TS 38.331, clause 5.3.5.5.9]

The UE shall:

1> for each *sCellIndex* value included in the *sCellToAddModList* that is not part of the current UE configuration (SCell addition):

2> add the SCell, corresponding to the *sCellIndex*, in accordance with the *sCellConfigCommon* and *sCellConfigDedicated*;

2> configure lower layers to consider the SCell to be in deactivated state;

Editor's Note: FFS Check automatic measurement handling for SCells.

2> for each *measId* included in the *measIdList* within *VarMeasConfig*:

3> if SCells are not applicable for the associated measurement; and

3> if the concerned SCell is included in *cellsTriggeredList* defined within the *VarMeasReportList* for this *measId*:

4> remove the concerned SCell from *cellsTriggeredList* defined within the *VarMeasReportList* for this *measId*;

1> for each *sCellIndex* value included in the *sCellToAddModList* that is part of the current UE configuration (SCell modification):

2> modify the SCell configuration in accordance with the *sCellConfigDedicated*.

[TS 38.331, clause 5.5.2.1]

...

The UE shall:

...

1> if the received *measConfig* includes the *measObjectToAddModList*:

2> perform the measurement object addition/modification procedure as specified in 5.5.2.5;

...

1> if the received *measConfig* includes the *reportConfigToAddModList*:

2> perform the reporting configuration addition/modification procedure as specified in 5.5.2.7;

...

1> if the received *measConfig* includes the *measIdToRemoveList*:

2> perform the measurement identity removal procedure as specified in 5.5.2.2;

1> if the received *measConfig* includes the *measIdToAddModList*:

2> perform the measurement identity addition/modification procedure as specified in 5.5.2.3;

...

[TS 38.331, clause 5.5.4.1]

If security has been activated successfully, the UE shall:

1> for each *measId* included in the *measIdList* within *VarMeasConfig*:

2> if the corresponding *reportConfig* includes a *reportType* set to *eventTriggered* or *periodical*;

3> if the corresponding *measObject* concerns NR;

4> if the *eventA1* or *eventA2* is configured in the corresponding *reportConfig*;

...

4> else:

5> for events involving a serving cell associated with a *measObjectNR* and neighbours associated with another *measObjectNR*, consider any serving cell associated with the other *measObjectNR* to be a neighbouring cell as well;

...

2> if the *reportType* is set to *eventTriggered* and if the entry condition applicable for this event, i.e. the event corresponding with the *eventId* of the corresponding *reportConfig* within *VarMeasConfig*, is fulfilled for one or more applicable cells for all measurements after layer 3 filtering taken during *timeToTrigger* defined for this event within the *VarMeasConfig*, while the *VarMeasReportList* does not include a measurement reporting entry for this *measId* (a first cell triggers the event):

3> include a measurement reporting entry within the *VarMeasReportList* for this *measId*;

3> set the *numberOfReportsSent* defined within the *VarMeasReportList* for this *measId* to 0;

3> include the concerned cell(s) in the *cellsTriggeredList* defined within the *VarMeasReportList* for this *measId*;

3> initiate the measurement reporting procedure, as specified in 5.5.5;

2> if the *reportType* is set to *eventTriggered* and if the entry condition applicable for this event, i.e. the event corresponding with the *eventId* of the corresponding *reportConfig* within *VarMeasConfig*, is fulfilled for one or more applicable cells not included in the *cellsTriggeredList* for all measurements after layer 3 filtering taken during *timeToTrigger* defined for this event within the *VarMeasConfig* (a subsequent cell triggers the event):

3> set the *numberOfReportsSent* defined within the *VarMeasReportList* for this *measId* to 0;

3> include the concerned cell(s) in the *cellsTriggeredList* defined within the *VarMeasReportList* for this *measId*;

3> initiate the measurement reporting procedure, as specified in 5.5.5;

2> if the *reportType* is set to *eventTriggered* and if the leaving condition applicable for this event is fulfilled for one or more of the cells included in the *cellsTriggeredList* defined within the *VarMeasReportList* for this *measId* for all measurements after layer 3 filtering taken during *timeToTrigger* defined within the *VarMeasConfig* for this event:

3> remove the concerned cell(s) in the *cellsTriggeredList* defined within the *VarMeasReportList* for this *measId*;

3> if *reportOnLeave* is set to *TRUE* for the corresponding reporting configuration:

4> initiate the measurement reporting procedure, as specified in 5.5.5;

3> if the *cellsTriggeredList* defined within the *VarMeasReportList* for this *measId* is empty:

4> remove the measurement reporting entry within the *VarMeasReportList* for this *measId*;

4> stop the periodical reporting timer for this *measId*, if running;

...

2> upon expiry of the periodical reporting timer for this *measId*:

3> initiate the measurement reporting procedure, as specified in 5.5.5.

...

[TS 38.331, clause 5.5.4.7]

The UE shall:

1> consider the entering condition for this event to be satisfied when condition A6-1, as specified below, is fulfilled;

1> consider the leaving condition for this event to be satisfied when condition A6-2, as specified below, is fulfilled;

1> for this measurement, consider the (secondary) cell corresponding to the *measObjectNR* associated to this event to be the serving cell.

NOTE: The reference signal(s) of the neighbour(s) and the reference signal(s) of the SCell are both indicated in the associated *measObjectNR*.

Inequality A6-1 (Entering condition)

$$Mn + Ocn - Hys > Ms + Ocs + Off$$

Inequality A6-2 (Leaving condition)

$$Mn + Ocn + Hys < Ms + Ocs + Off$$

The variables in the formula are defined as follows:

Mn is the measurement result of the neighbouring cell, not taking into account any offsets.

Ocn is the cell specific offset of the neighbour cell (i.e. *cellIndividualOffset* as defined within the associated *measObjectNR*), and set to zero if not configured for the neighbour cell.

Ms is the measurement result of the serving cell, not taking into account any offsets.

Ocs is the cell specific offset of the serving cell (i.e. *cellIndividualOffset* as defined within the associated *measObjectNR*), and is set to zero if not configured for the serving cell.

Hys is the hysteresis parameter for this event (i.e. *hysteresis* as defined within *reportConfigNR* for this event).

Off is the offset parameter for this event (i.e. *a6-Offset* as defined within *reportConfigNR* for this event).

Mn*, *Ms are expressed in dBm in case of RSRP, or in dB in case of RSRQ and RS-SINR.

Ocn*, *Ocs*, *Hys*, *Off are expressed in dB.

[TS 38.331, clause 5.5.5]



Figure 5.5.5-1: Measurement reporting

The purpose of this procedure is to transfer measurement results from the UE to the network. The UE shall initiate this procedure only after successful security activation.

For the *measId* for which the measurement reporting procedure was triggered, the UE shall set the *measResults* within the *MeasurementReport* message as follows:

- 1> set the *measId* to the measurement identity that triggered the measurement reporting;
- 1> set the *measResultServingCell* within *measResultServingMOList* to include RSRP, RSRQ and the available SINR for each configured serving cell derived based on the *rsType* indicated in the associated *reportConfig*;
- 1> set the *measResultServingCell* within *measResultServingMOList* to include for each NR serving cell that is configured with *servingCellMO*, if any, the *servCellId*;
- ...
- 1> if there is at least one applicable neighbouring cell to report:
 - 2> set the *measResultNeighCells* to include the best neighbouring cells up to *maxReportCells* in accordance with the following:
 - 3> if the *reportType* is set to *eventTriggered*:
 - 4> include the cells included in the *cellsTriggeredList* as defined within the *VarMeasReportList* for this *measId*;
 - ...
 - 3> for each cell that is included in the *measResultNeighCells*, include the *physCellId*;
 - 3> if the *reportType* is set to *eventTriggered*:
 - 4> for each included cell, include the layer 3 filtered measured results in accordance with the *reportConfig* for this *measId*, ordered as follows:
 - 5> if the *measObject* associated with this *measId* concerns NR:
 - 6> if *rsType* in the associated *reportConfig* is set to *ssb*:
 - 7> set *resultsSSB-Cell* within the *measResult* to include the SS/PBCH block based quantity(ies) indicated in the *reportQuantityCell* within the concerned *reportConfig*, in order of decreasing trigger quantity, i.e. the best cell is included first:
 - ...
 - 1> increment the *numberOfReportsSent* as defined within the *VarMeasReportList* for this *measId* by 1;
 - 1> stop the periodical reporting timer, if running;
 - 1> if the *numberOfReportsSent* as defined within the *VarMeasReportList* for this *measId* is less than the *reportAmount* as defined within the corresponding *reportConfig* for this *measId*:
 - 2> start the periodical reporting timer with the value of *reportInterval* as defined within the corresponding *reportConfig* for this *measId*;
 - ...
 - 1> if the UE is configured with EN-DC:
 - ...
 - 1> else:
 - 2> submit the *MeasurementReport* message to lower layers for transmission, upon which the procedure ends.

8.1.3.1.17.1.3 Test description

8.1.3.1.17.1.3.1 Pre-test conditions

System Simulator:

- NR Cell 1 is the PCell, NR Cell 3 is the SCell to be added, and NR Cell 12 is the intra-frequency neighbour cell of NR Cell 3.
- NR Cell 3 is an Inactive SCell according to TS 38.508-1 [4] clause 6.3.1.
- System information combination NR-4 as defined in TS 38.508-1 [4] clause 4.4.3.1.2 is used in NR cells.

UE:

- None.

Preamble:

- The UE is in state 3N-A as defined in TS 38.508-1 [4], subclause 4.4A.

8.1.3.1.17.1.3.2 Test procedure sequence

Table 8.1.3.1.17.1.3.2-1 and 8.1.3.1.17.1.3.2-2 illustrates the downlink power levels to be applied for NR Cell 1, NR Cell 3 and NR Cell 12 at various time instants of the test execution. Row marked "T0" denotes the conditions after the preamble, while the configuration marked "T1" is applied at the point indicated in the Main behaviour description in Table 8.1.3.1.17.1.3.2-3.

Table 8.1.3.1.17.1.3.2-1: Time instances of cell power level and parameter changes in conducted test environment

	Parameter	Unit	NR Cell 1	NR Cell 3	NR Cell 12	Remark
T0	SS/PBCH SSS EPRE	dBm/SCS	-82	-88	-94	Power levels are such that entry condition for event A6 (measId 1) is not satisfied: $Mn + Ocn + Hys < Ms + Ocs + Off$
T1	SS/PBCH SSS EPRE	dBm/SCS	-82	-88	-78	Power levels are such that entry condition for event A6 (measId 1) is satisfied: $Mn + Ocn - Hys > Ms + Ocs + Off$

Table 8.1.3.1.17.1.3.2-2: Time instances of cell power level and parameter changes in OTA test environment

	Parameter	Unit	NR Cell 1	NR Cell 3	NR Cell 12	Remark
T0	SS/PBCH SSS EPRE	dBm/SCS	FFS	FFS	FFS	Power levels are such that entry condition for event A6 (measId 1) is not satisfied: $Mn + Ocn + Hys < Ms + Ocs + Off$
T1	SS/PBCH SSS EPRE	dBm/SCS	FFS	FFS	FFS	Power levels are such that entry condition for event A6 (measId 1) is satisfied: $Mn + Ocn - Hys > Ms + Ocs + Off$

Table 8.1.3.1.17.1.3.2-3: Main behaviour

St	Procedure	Message Sequence		TP	Verdict
		U - S	Message		
1	The SS transmits an <i>RRCReconfiguration</i> message including <i>sCellToAddModList</i> with NR Cell 3 as SCell addition.	<--	NR RRC: <i>RRCReconfiguration</i>	-	-
2	The UE transmits an <i>RRCReconfigurationComplete</i> message.	-->	NR RRC: <i>RRCReconfigurationComplete</i>	-	-

3	The SS transmits an <i>RRCReconfiguration</i> message including <i>measConfig</i> to setup intra NR measurement and reporting for event A6.	<--	NR RRC: <i>RRCReconfiguration</i>	-	-
4	The UE transmits an <i>RRCReconfigurationComplete</i> message.	-->	NR RRC: <i>RRCReconfigurationComplete</i>	-	-
5	Check: Does the UE transmit a <i>MeasurementReport</i> message within the next 10s?	-->	NR RRC: <i>MeasurementReport</i>	1	F
6	The SS re-adjusts the SS/PBCH EPRE level according to row "T1" in table 8.1.3.1.17.1.3.2-1/2.	-	-	-	-
7	Check: Does the UE transmit a <i>MeasurementReport</i> message to report event A6 with the measured RSRP value for NR Cell 12?	-->	NR RRC: <i>MeasurementReport</i>	2	P
8	The SS transmits an <i>RRCReconfiguration</i> message including <i>sCellToReleaseList</i> with NR Cell 3 as SCell release.	<--	NR RRC: <i>RRCReconfiguration</i>	-	-
9	The UE transmits an <i>RRCReconfigurationComplete</i> message.	-->	NR RRC: <i>RRCReconfigurationComplete</i>	-	-
10	Check: Does the UE attempt to transmit an uplink message for the next 15s?	-	-	3	F

8.1.3.1.17.1.3.3 Specific message contents

Table 8.1.3.1.17.1.3.3-1: *RRCReconfiguration* (step 1, Table 8.1.3.1.17.1.3.2-3)

Derivation Path: TS 38.508-1 [4] Table 4.6.1-13 with condition SCell_add
--

Table 8.1.3.1.17.1.3.3-2: Void**Table 8.1.3.1.17.1.3.3-3: Void****Table 8.1.3.1.17.1.3.3-4: *RRCReconfiguration* (step 3, Table 8.1.3.1.17.1.3.2-3)**

Derivation Path: TS 38.508-1 [4] Table 4.6.1-13 with condition NR_MEAS
--

Table 8.1.3.1.17.1.3.3-5: *MeasConfig* (Table 8.1.3.1.17.1.3.3-4)

Derivation Path: TS 38.508-1 [4] Table 4.6.3-69			
Information Element	Value/remark	Comment	Condition
<i>MeasConfig</i> ::= SEQUENCE {			
<i>measObjectToAddModList</i> SEQUENCE (SIZE (1..maxNrofMeasId)) OF <i>MeasObjectToAddMod</i> {	2 entries		
<i>MeasObjectToAddMod</i> [1] SEQUENCE {		entry 1	
<i>measObjectId</i>	1	<i>MeasObjectIdNR-f1</i>	
<i>measObject</i> CHOICE {			
<i>measObjectNR</i> SEQUENCE {			
<i>ssbFrequency</i>	<i>ssbFrequency</i> IE equals the ARFCN for NR Cell 1		
<i>absThreshSS-BlocksConsolidation</i>	Not present		
}			
}			
<i>MeasObjectToAddMod</i> [2] SEQUENCE {		entry 2	
<i>measObjectId</i>	2	<i>MeasObjectIdNR-f2</i>	
<i>measObject</i> CHOICE {			
<i>measObjectNR</i> SEQUENCE {			
<i>ssbFrequency</i>	<i>ssbFrequency</i> IE equals the ARFCN for NR Cell 3		

absThreshSS-BlocksConsolidation	Not present		
}			
}			
reportConfigToAddModList SEQUENCE(SIZE (1..maxReportConfigId)) OF ReportConfigToAddMod {	1 entry		
ReportConfigToAddMod[1] SEQUENCE {		entry 1	
reportConfigId[1]	1		
reportConfig[1] CHOICE {			
reportConfigNR	ReportConfigNR-EventA6	Table 8.1.3.1.17.1.3.3-6	
}			
}			
}			
measIdToAddModList SEQUENCE (SIZE (1..maxNrofMeasId)) OF MeasIdToAddMod {	1 entry		
MeasIdToAddMod[1] SEQUENCE {		entry 1	
measId[1]	1		
measObjectId[1]	2		
reportConfigId[1]	1		
}			
}			
}			

Table 8.1.3.1.17.1.3.3-6: ReportConfigNR-EventA6 (Table 8.1.3.1.17.1.3.3-5)

Derivation Path: TS 38.508-1 [4] Table 4.6.3-142 with condition EVENT_A6			
Information Element	Value/remark	Comment	Condition
ReportConfigNR ::= SEQUENCE {			
reportType CHOICE {			
eventTriggered SEQUENCE {			
eventId CHOICE {			
eventA6 SEQUENCE {			
a6-Offset CHOICE {			
rsrp	0		
}			
}			
}			
}			
reportInterval	ms10240		
reportQuantityCell SEQUENCE {			
rsrp	true		
rsrq	false		
sinr	false		
}			
}			

Table 8.1.3.1.17.1.3.3-7: MeasurementReport (step 7, Table 8.1.3.1.17.1.3.2-3)

Derivation Path: TS 38.508-1 [4] Table 4.6.1-5A			
Information Element	Value/remark	Comment	Condition
MeasurementReport ::= SEQUENCE {			
criticalExtensions CHOICE {			
measurementReport SEQUENCE {			
measResults	MeasResults		
}			
}			
}			

Table 8.1.3.1.17.1.3.3-8: MeasResults (Table 8.1.3.1.17.1.3.3-7)

Derivation Path: TS 38.508-1 [4] Table 4.6.3-79			
Information Element	Value/remark	Comment	Condition
MeasResults ::= SEQUENCE {			
measId	1		
measResultServingMOList SEQUENCE (SIZE (1..maxNrofServingCells)) OF MeasResultServMO {	2 entries		
MeasResultServMO[1] SEQUENCE {		entry 1	
servCellId	ServCellIndex of NR Cell 1		
measResultServingCell SEQUENCE {			
physCellId	Physical layer cell identity of NR Cell 1		
measResult SEQUENCE {			
cellResults SEQUENCE {			
resultsSSB-Cell SEQUENCE {			
rsrp	(0..127)		
rsrq	(0..127)		
sinr	Not present		
	Not checked		pc_ss_SINR_Meas
}			
}			
}			
}			
MeasResultServMO[2] SEQUENCE {		entry 2	
servCellId	ServCellIndex of NR Cell 3		
measResultServingCell SEQUENCE {			
physCellId	Physical layer cell identity of NR Cell 3		
measResult SEQUENCE {			
cellResults SEQUENCE {			
resultsSSB-Cell SEQUENCE {			
rsrp	(0..127)		
rsrq	(0..127)		
sinr	Not present		
	Not checked		pc_ss_SINR_Meas
}			
}			
}			
measResultNeighCells CHOICE {			
measResultListNR SEQUENCE (SIZE (1..maxCellReport)) OF MeasResultNR {	1 entry	Report NR Cell 12	
MeasResultNR[1] SEQUENCE {		entry 1	
physCellId	Physical layer cell identity of NR Cell 12		
measResult SEQUENCE {			
cellResults SEQUENCE {			
resultsSSB-Cell SEQUENCE {			
rsrp	(0..127)		
rsrq	Not present		
sinr	Not present		
}			
resultsCSI-RS-Cell	Not present		
}			
rsIndexResults	Not present		
}			
cgi-Info	Not present		
}			
}			
}			

}			
---	--	--	--

Table 8.1.3.1.17.1.3.3-9: RRCReconfiguration (step 8, Table 8.1.3.1.17.1.3.2-3)

Derivation Path: TS 38.508-1 [4] Table 4.6.1-13 with condition SCell_add			
Information Element	Value/remark	Comment	Condition
RRCReconfiguration ::= SEQUENCE {			
criticalExtensions CHOICE {			
rrcReconfiguration SEQUENCE {			
nonCriticalExtension SEQUENCE{			
masterCellGroup	CellGroupConfig	Table 8.1.3.1.17.1.3.3-10	SCell release for NR Cell 3
dedicatedSIB1-Delivery	Not present	SCell release	
}			
}			
}			
}			

Table 8.1.3.1.17.1.3.3-10: CellGroupConfig (Table 8.1.3.1.17.1.3.3-9)

Derivation Path: TS 38.508-1 [4] Table 4.6.3-19 with condition SCell_add			
Information Element	Value/remark	Comment	Condition
CellGroupConfig ::= SEQUENCE {			
sCellToAddModList	Not present		
sCellToReleaseList SEQUENCE (SIZE (1..maxNrofSCells)) OF SCellIndex {	1 entry		
SCellIndex[1]	1	entry 1	SCell release for NR Cell 3
}			
}			

8.1.3.1.17.2 NR CA / Measurement configuration control and reporting / Intra NR measurements / Event A6 / Inter-band CA

8.1.3.1.17.2.1 Test Purpose (TP)

Same as TC 8.1.3.1.17.1 but applied to Inter-band CA case.

8.1.3.1.17.2.2 Conformance requirements

Same as TC 8.1.3.1.17.1 but applied to Inter-band CA case.

8.1.3.1.17.2.3 Test description

8.1.3.1.17.2.3.1 Pre-test conditions

Same as test case 8.1.3.1.17.1 with the following differences:

- CA configuration: Inter-band CA replaces Intra-band Contiguous CA.
- Cells configuration: NR Cell 10 replaces NR Cell 3, NR Cell 30 replaces NR Cell 12.
- NR Cell 10 is an Inactive SCell according to TS 38.508-1 [4] clause 6.3.1.

8.1.3.1.17.2.3.2 Test procedure sequence

Same as test case 8.1.3.1.17.1 with the following differences:

- CA configuration: Inter-band CA replaces Intra-band Contiguous CA.
- Cells configuration: NR Cell 10 replaces NR Cell 3, NR Cell 30 replaces NR Cell 12.

8.1.3.1.17.2.3.3 Specific message contents

Same as test case 8.1.3.1.17.1 with the following differences.

NOTE: For simplicity the steps referred below are steps in test case 8.1.3.1.17.1.

Table 8.1.3.1.17.2.3.3-1: MeasConfig (Table 8.1.3.1.17.1.3.3-5)

Derivation Path: TS 38.508-1 [4] Table 4.6.3-69			
Information Element	Value/remark	Comment	Condition
MeasConfig ::= SEQUENCE {			
measObjectToAddModList SEQUENCE (SIZE (1..maxNrofMeasId)) OF MeasObjectToAddMod {	2 entries		
MeasObjectToAddMod[1] SEQUENCE {		entry 1	
measObjectId	1	MeasObjectIdNR-f1	
measObject CHOICE {			
measObjectNR SEQUENCE {			
ssbFrequency	ssbFrequency IE equals the ARFCN for NR Cell 1		
absThreshSS-BlocksConsolidation	Not present		
}			
}			
}			
MeasObjectToAddMod[2] SEQUENCE {		entry 2	
measObjectId	2	MeasObjectIdNR-f5	
measObject CHOICE {			
measObjectNR SEQUENCE {			
ssbFrequency	ssbFrequency IE equals the ARFCN for NR Cell 10		
absThreshSS-BlocksConsolidation	Not present		
}			
}			
}			
reportConfigToAddModList SEQUENCE (SIZE (1..maxReportConfigId)) OF ReportConfigToAddMod {	1 entry		
ReportConfigToAddMod[1] SEQUENCE {		entry 1	
reportConfigId	1		
reportConfig CHOICE {			
reportConfigNR	ReportConfigNR-EventA6		
}			
}			
}			
measIdToAddModList SEQUENCE (SIZE (1..maxNrofMeasId)) OF MeasIdToAddMod {	1 entry		
MeasIdToAddMod[1] SEQUENCE {		entry 1	
measId	1		
measObjectId	2		
reportConfigId	1		
}			
}			
}			

8.1.3.1.17.3 NR CA / Measurement configuration control and reporting / Intra NR measurements / Event A6 / Intra-band non Contiguous CA

8.1.3.1.17.3.1 Test Purpose (TP)

Same as TC 8.1.3.1.17.1 but applied to Intra-band non Contiguous CA case.

8.1.3.1.17.3.2 Conformance requirements

Same as TC 8.1.3.1.17.1 but applied to Intra-band non Contiguous CA case.

8.1.3.1.17.3.3 Test description

8.1.3.1.17.3.3.1 Pre-test conditions

Same as test case 8.1.3.1.17.1 with the following differences:

- CA configuration: Intra-band non Contiguous CA replaces Intra-band Contiguous CA.

8.1.3.1.17.3.3.2 Test procedure sequence

Same as test case 8.1.3.1.17.1 with the following differences:

- CA configuration: Intra-band non Contiguous CA replaces Intra-band Contiguous CA.

8.1.3.1.17.3.3.3 Specific message contents

Same as test case 8.1.3.1.17.1 but applied to Intra-band non Contiguous CA case..

NOTE: For simplicity the steps referred below are steps in test case 8.1.3.1.17.1.

8.1.3.1.18 NR CA / Measurement configuration control and reporting / Intra NR measurements / Additional measurement reporting

8.1.3.1.18.1 NR CA / Measurement configuration control and reporting / Intra NR measurements / Additional measurement reporting / Intra-band Contiguous CA

8.1.3.1.18.1.1 Test Purpose (TP)

(1)

```
with { UE in NR RRC_CONNECTED state and measurements configured for event A2 reporting include
reportAddNeighMeas }
ensure that {
  when { Entry condition for event A2 of the concerned frequency that triggered measurement
reporting is met }
  then { UE sends MeasurementReport that does not include the best non-serving cell of the
concerned frequency in the measResultBestNeighCell }
}
```

(2)

```
with { UE in NR RRC_CONNECTED state and measurements configured for event A2 reporting include
reportAddNeighMeas }
ensure that {
  when { Entry condition for event A2 of other than the concerned frequency that triggered
measurement reporting is met }
  then { UE sends MeasurementReport that includes the best non-serving cell of the concerned
frequency in the measResultBestNeighCell }
}
```

8.1.3.1.18.1.2 Conformance requirements

References: The conformance requirements covered in the current TC are specified in: TS 38.331, clauses 5.3.5.3, 5.3.5.5.9, 5.5.2.1, 5.5.4.1, 5.5.4.7 and 5.5.5. Unless otherwise stated these are Rel-15 requirements.

[TS 38.331, clause 5.3.5.3]

The UE shall perform the following actions upon reception of the *RRCReconfiguration*:

...

1> if the *RRCReconfiguration* includes the *masterCellGroup*:

2> perform the cell group configuration for the received *masterCellGroup* according to 5.3.5.5;

...

1> if the *RRCReconfiguration* message includes the *measConfig*:

2> perform the measurement configuration procedure as specified in 5.5.2;

...

1> if the UE is configured with E-UTRA *nr-SecondaryCellGroupConfig* (MCG is E-UTRA):

...

1> else:

2> submit the *RRCReconfigurationComplete* message via SRB1 to lower layers for transmission using the new configuration;

...

[TS 38.331, clause 5.3.5.5.9]

The UE shall:

1> for each *sCellIndex* value included in the *sCellToAddModList* that is not part of the current UE configuration (SCell addition):

2> add the SCell, corresponding to the *sCellIndex*, in accordance with the *sCellConfigCommon* and *sCellConfigDedicated*;

2> configure lower layers to consider the SCell to be in deactivated state;

Editor's Note: FFS Check automatic measurement handling for SCells.

2> for each *measId* included in the *measIdList* within *VarMeasConfig*:

3> if SCells are not applicable for the associated measurement; and

3> if the concerned SCell is included in *cellsTriggeredList* defined within the *VarMeasReportList* for this *measId*:

4> remove the concerned SCell from *cellsTriggeredList* defined within the *VarMeasReportList* for this *measId*;

1> for each *sCellIndex* value included in the *sCellToAddModList* that is part of the current UE configuration (SCell modification):

2> modify the SCell configuration in accordance with the *sCellConfigDedicated*.

[TS 38.331, clause 5.5.2.1]

...

The UE shall:

...

- 1> if the received *measConfig* includes the *measObjectToAddModList*:
 - 2> perform the measurement object addition/modification procedure as specified in 5.5.2.5;

...

- 1> if the received *measConfig* includes the *reportConfigToAddModList*:
 - 2> perform the reporting configuration addition/modification procedure as specified in 5.5.2.7;

...

- 1> if the received *measConfig* includes the *measIdToAddModList*:
 - 2> perform the measurement identity addition/modification procedure as specified in 5.5.2.3;

[TS 38.331, clause 5.5.4.1]

If security has been activated successfully, the UE shall:

- 1> for each *measId* included in the *measIdList* within *VarMeasConfig*:
 - 2> if the corresponding *reportConfig* includes a *reportType* set to *eventTriggered* or *periodical*;
 - 3> if the corresponding *measObject* concerns NR;
 - 4> if the *eventA1* or *eventA2* is configured in the corresponding *reportConfig*:
 - 5> consider only the serving cell to be applicable;
 - ...
 - 2> if the *reportType* is set to *eventTriggered* and if the entry condition applicable for this event, i.e. the event corresponding with the *eventId* of the corresponding *reportConfig* within *VarMeasConfig*, is fulfilled for one or more applicable cells for all measurements after layer 3 filtering taken during *timeToTrigger* defined for this event within the *VarMeasConfig*, while the *VarMeasReportList* does not include a measurement reporting entry for this *measId* (a first cell triggers the event):
 - 3> include a measurement reporting entry within the *VarMeasReportList* for this *measId*;
 - 3> set the *numberOfReportsSent* defined within the *VarMeasReportList* for this *measId* to 0;
 - 3> include the concerned cell(s) in the *cellsTriggeredList* defined within the *VarMeasReportList* for this *measId*;
 - 3> initiate the measurement reporting procedure, as specified in 5.5.5;
 - 2> if the *reportType* is set to *eventTriggered* and if the entry condition applicable for this event, i.e. the event corresponding with the *eventId* of the corresponding *reportConfig* within *VarMeasConfig*, is fulfilled for one or more applicable cells not included in the *cellsTriggeredList* for all measurements after layer 3 filtering taken during *timeToTrigger* defined for this event within the *VarMeasConfig* (a subsequent cell triggers the event):
 - 3> set the *numberOfReportsSent* defined within the *VarMeasReportList* for this *measId* to 0;
 - 3> include the concerned cell(s) in the *cellsTriggeredList* defined within the *VarMeasReportList* for this *measId*;
 - 3> initiate the measurement reporting procedure, as specified in 5.5.5;
 - 2> if the *reportType* is set to *eventTriggered* and if the leaving condition applicable for this event is fulfilled for one or more of the cells included in the *cellsTriggeredList* defined within the *VarMeasReportList* for this *measId* for all measurements after layer 3 filtering taken during *timeToTrigger* defined within the *VarMeasConfig* for this event:

- 3> remove the concerned cell(s) in the *cellsTriggeredList* defined within the *VarMeasReportList* for this *measId*;
- 3> if *reportOnLeave* is set to *TRUE* for the corresponding reporting configuration:
 - 4> initiate the measurement reporting procedure, as specified in 5.5.5;
- 3> if the *cellsTriggeredList* defined within the *VarMeasReportList* for this *measId* is empty:
 - 4> remove the measurement reporting entry within the *VarMeasReportList* for this *measId*;
 - 4> stop the periodical reporting timer for this *measId*, if running;
- ...
- 2> upon expiry of the periodical reporting timer for this *measId*:
 - 3> initiate the measurement reporting procedure, as specified in 5.5.5.
- ...

[TS 38.331, clause 5.5.4.7]

The UE shall:

- 1> consider the entering condition for this event to be satisfied when condition A2-1, as specified below, is fulfilled;
- 1> consider the leaving condition for this event to be satisfied when condition A2-2, as specified below, is fulfilled;
- 1> for this measurement, consider the serving cell indicated by the *measObjectNR* associated to this event.

Inequality A2-1 (Entering condition)

$$Ms + Hys < Thresh$$

Inequality A2-2 (Leaving condition)

$$Ms - Hys > Thresh$$

The variables in the formula are defined as follows:

Ms is the measurement result of the serving cell, not taking into account any offsets.

Hys is the hysteresis parameter for this event (i.e. *hysteresis* as defined within *reportConfigNR* for this event).

Thresh is the threshold parameter for this event (i.e. *a2-Threshold* as defined within *reportConfigNR* for this event).

Ms is expressed in dBm in case of RSRP, or in dB in case of RSRQ and RS-SINR.

Hys is expressed in dB.

Thresh is expressed in the same unit as ***Ms***.

[TS 38.331, clause 5.5.5]



Figure 5.5.5-1: Measurement reporting

The purpose of this procedure is to transfer measurement results from the UE to the network. The UE shall initiate this procedure only after successful security activation.

For the *measId* for which the measurement reporting procedure was triggered, the UE shall set the *measResults* within the *MeasurementReport* message as follows:

- 1> set the *measId* to the measurement identity that triggered the measurement reporting;
- 1> set the *measResultServingCell* within *measResultServingMOList* to include RSRP, RSRQ and the available SINR for each configured serving cell derived based on the *rsType* indicated in the associated *reportConfig*;
- 1> set the *measResultServingCell* within *measResultServingMOList* to include for each NR serving cell that is configured with *servingCellMO*, if any, the *servCellId*;
- ...
- 1> if the *reportConfig* associated with the *measId* that triggered the measurement reporting includes *reportAddNeighMeas*:
 - 2> for each serving cell *measObjectId* referenced in the *measIdList*, other than the *measObjectId* corresponding with the *measId* that triggered the measurement reporting:
 - 3> set the *measResultBestNeighCell* within *measResultServingMOList* to include the *physCellId* and the available measurement quantities based on the *reportQuantityCell* and *rsType* indicated in *reportConfig* of the non-serving cell corresponding to the concerned *measObjectNR* with the highest measured RSRP if RSRP measurement results are available for cells corresponding to this *measObjectNR*, otherwise with the highest measured RSRQ if RSRQ measurement results are available for cells corresponding to this *measObjectNR*, otherwise with the highest measured SINR;
 - ...
 - 1> if there is at least one applicable neighbouring cell to report:
 - 2> set the *measResultNeighCells* to include the best neighbouring cells up to *maxReportCells* in accordance with the following:
 - 3> if the *reportType* is set to *eventTriggered*:
 - 4> include the cells included in the *cellsTriggeredList* as defined within the *VarMeasReportList* for this *measId*;
 - ...
 - 3> for each cell that is included in the *measResultNeighCells*, include the *physCellId*;
 - 3> if the *reportType* is set to *eventTriggered*:
 - 4> for each included cell, include the layer 3 filtered measured results in accordance with the *reportConfig* for this *measId*, ordered as follows:
 - 5> if the *measObject* associated with this *measId* concerns NR:
 - 6> if *rsType* in the associated *reportConfig* is set to *ssb*:
 - 7> set *resultsSSB-Cell* within the *measResult* to include the SS/PBCH block based quantity(ies) indicated in the *reportQuantityCell* within the concerned *reportConfig*, in order of decreasing trigger quantity, i.e. the best cell is included first;
 - ...
 - 1> increment the *numberOfReportsSent* as defined within the *VarMeasReportList* for this *measId* by 1;
 - 1> stop the periodical reporting timer, if running;
 - 1> if the *numberOfReportsSent* as defined within the *VarMeasReportList* for this *measId* is less than the *reportAmount* as defined within the corresponding *reportConfig* for this *measId*:

2> start the periodical reporting timer with the value of *reportInterval* as defined within the corresponding *reportConfig* for this *measId*;

...

1> if the UE is configured with EN-DC:

...

1> else:

2> submit the *MeasurementReport* message to lower layers for transmission, upon which the procedure ends.

8.1.3.1.18.1.3 Test description

8.1.3.1.18.1.3.1 Pre-test conditions

System Simulator:

- NR Cell 1 is the PCell, NR Cell 3 is the SCell to be added, NR Cell 12 and NR Cell 23 is the intra-frequency neighbour cell of NR Cell 3.
- NR Cell 3 is an Inactive SCell according to TS 38.508-1 [4] clause 6.3.1.
- Relative SS signal level uncertainty between Intra-freq cells is +/-1 dB for FR1 and FFS for FR2.
- System information combination NR-4 as defined in TS 38.508-1 [4] clause 4.4.3.1.2 is used in NR cells.

UE:

- None.

Preamble:

- The UE is in state 3N-A as defined in TS 38.508-1 [4], subclause 4.4A.

8.1.3.1.18.1.3.2 Test procedure sequence

Table 8.1.3.1.18.1.3.2-1 and 8.1.3.1.18.1.3.2-2 illustrates the downlink power levels to be applied for NR Cell 1, NR Cell 3, NR Cell 12 and NR Cell 23 at various time instants of the test execution. Row marked "T0" denotes the conditions after the preamble, while the configuration marked "T1" and "T2" are applied at the point indicated in the Main behaviour description in Table 8.1.3.1.18.1.3.2-3.

Table 8.1.3.1.18.1.3.2-1: Time instances of cell power level and parameter changes in conducted test environment

	Parameter	Unit	NR Cell 1	NR Cell 3	NR Cell 12	NR Cell 23	Remark
T0	SS/PBCH SSS EPRE	dBm/SCS	-82	-82	-91	Off	Power levels are such that entry condition for event A2 is not satisfied: $Ms + Hys > Thresh$ for NR Cell 1 and NR Cell 3
T1	SS/PBCH SSS EPRE	dBm/SCS	-82	-98	-91	-88	Power levels are such that entry condition for event A2 in NR Cell 3 is satisfied: $Ms + Hys < Thresh$
T2	SS/PBCH SSS EPRE	dBm/SCS	-82	-82	-78	-82	Power levels are such that entry condition for event A2 is not satisfied: $Ms + Hys > Thresh$ for NR Cell 1 and NR Cell 3
T3	SS/PBCH SSS EPRE	dBm/SCS	-98	-82	-78	-82	Power levels are such that entry condition for event A2 in NR Cell 1 is satisfied: $Ms + Hys < Thresh$

Table 8.1.3.1.18.1.3.2-2: Time instances of cell power level and parameter changes in OTA test environment

	Parameter	Unit	NR Cell 1	NR Cell 3	NR Cell 12	NR Cell 23	Remark
T0	SS/PBCH SSS EPRE	dBm/SCS	FFS	FFS	FFS	Off	Power levels are such that entry condition for event A2 is not satisfied: $Ms + Hys > Thresh$ for NR Cell 1 and NR Cell 3
T1	SS/PBCH SSS EPRE	dBm/SCS	FFS	FFS	FFS	Off	Power levels are such that entry condition for event A2 in NR Cell 3 is satisfied: $Ms + Hys < Thresh$
T2	SS/PBCH SSS EPRE	dBm/SCS	FFS	FFS	FFS	Off	Power levels are such that entry condition for event A2 is not satisfied: $Ms + Hys > Thresh$ for NR Cell 1 and NR Cell 3
T3	SS/PBCH SSS EPRE	dBm/SCS	FFS	FFS	FFS	FFS	Power levels are such that entry condition for event A2 in NR Cell 1 is satisfied: $Ms + Hys < Thresh$

Table 8.1.3.1.18.1.3.2-3: Main behaviour

St	Procedure	Message Sequence		TP	Verdict
		U - S	Message		
1	The SS transmits an <i>RRCReconfiguration</i> message including <i>sCellToAddModList</i> with NR Cell 3 as SCell addition.	<--	NR RRC: <i>RRCReconfiguration</i>	-	-
2	The UE transmits an <i>RRCReconfigurationComplete</i> message.	-->	NR RRC: <i>RRCReconfigurationComplete</i>	-	-
3	The SS transmits an <i>RRCReconfiguration</i> message including <i>measConfig</i> to setup intra NR measurement and for event A2 reporting configuration and include <i>reportAddNeighMeas</i> .	<--	NR RRC: <i>RRCReconfiguration</i>	-	-
4	The UE transmits an <i>RRCReconfigurationComplete</i> message.	-->	NR RRC: <i>RRCReconfigurationComplete</i>	-	-
5	The SS re-adjusts the SS/PBCH EPRE level according to row "T1" in table 8.1.3.1.18.1.3.2-1/2.	-	-	-	-
6	Check: Does the UE transmit a <i>MeasurementReport</i> message that does not include the RSRP value of the best non-serving cell on the concerned serving frequency in <i>measResultBestNeighCell</i> ?	-->	NR RRC: <i>MeasurementReport</i>	1	P
7	The SS re-adjusts the cell-specific reference signal level according to row "T2" in table 8.1.3.1.18.1.3.2-1/2.	-	-	-	-
7A	30 seconds after step 7, SS re-adjusts the cell-specific reference signal level according to row "T3" in table 8.1.3.1.18.1.3.2-1/2.	-	-	-	-
8	Check: Does the UE transmit a <i>MeasurementReport</i> message included the RSRP value of the best non-serving cell (NR Cell 12) on the concerned serving frequency in <i>measResultBestNeighCell</i> ?	-->	NR RRC: <i>MeasurementReport</i>	2	P
9	The SS transmits an <i>RRCReconfiguration</i> message containing an <i>sCellToReleaseList</i> with SCell NR Cell 3.	<--	NR RRC: <i>RRCReconfiguration</i>	-	-
10	The UE transmits an <i>RRCReconfigurationComplete</i> message.	-->	NR RRC: <i>RRCReconfigurationComplete</i>	-	-

8.1.3.1.18.1.3.3 Specific message contents

Table 8.1.3.1.18.1.3.3-1: RRCReconfiguration (step 1, Table 8.1.3.1.18.1.3.2-3)

Derivation Path: TS 38.508-1 [4] Table 4.6.1-13 with condition SCell_add

Table 8.1.3.1.18.1.3.3-2: Void**Table 8.1.3.1.18.1.3.3-3: Void****Table 8.1.3.1.18.1.3.3-4: RRCReconfiguration (step 3, Table 8.1.3.1.18.1.3.2-3)**

Derivation Path: TS 38.508-1 [4] Table 4.6.1-13 with condition NR_MEAS

Table 8.1.3.1.18.1.3.3-5: MeasConfig (Table 8.1.3.1.18.1.3.3-4)

Derivation Path: TS 38.508-1 [4] Table 4.6.3-69			
Information Element	Value/remark	Comment	Condition
MeasConfig ::= SEQUENCE {			
measObjectToAddModList SEQUENCE (SIZE (1..maxNrofMeasId)) OF MeasObjectToAddMod {	2 entries		
MeasObjectToAddMod[1] SEQUENCE {		entry 1	
measObjectId	1	MeasObjectIdNR-f1	
measObject CHOICE {			
measObjectNR SEQUENCE {			
ssbFrequency	ssbFrequency IE equals the ARFCN for NR Cell 1		
absThreshSS-BlocksConsolidation	Not present		
}			
}			
MeasObjectToAddMod[2] SEQUENCE {		entry 2	
measObjectId	2	MeasObjectIdNR-f2	
measObject CHOICE {			
measObjectNR SEQUENCE {			
ssbFrequency	ssbFrequency IE equals the ARFCN for NR Cell 3		
absThreshSS-BlocksConsolidation	Not present		
}			
}			
reportConfigToAddModList SEQUENCE(SIZE (1..maxReportConfigId)) OF ReportConfigToAddMod {	1 entry		
ReportConfigToAddMod[1] SEQUENCE {		entry 1	
reportConfigId	1		
reportConfig CHOICE {			
reportConfigNR	ReportConfigNR-EventA2	Table 8.1.3.1.18.1.3.3-6	
}			
}			
}			
measIdToAddModList SEQUENCE (SIZE (1..maxNrofMeasId)) OF MeasIdToAddMod {	2 entries		
MeasIdToAddMod[1] SEQUENCE {		entry 1	
measId	1		
measObjectId	1		
reportConfigId	1		
}			
MeasIdToAddMod[2] SEQUENCE {		entry 2	
measId	2		
measObjectId	2		
reportConfigId	1		

}			
}			
}			

Table 8.1.3.1.18.1.3.3-6: ReportConfigNR-EventA2 (Table 8.1.3.1.18.1.3.3-5)

Derivation Path: TS 38.508-1 [4] Table 4.6.3-142 with condition EVENT_A2			
Information Element	Value/remark	Comment	Condition
ReportConfigNR ::= SEQUENCE {			
reportType CHOICE {			
eventTriggered SEQUENCE {			
eventId CHOICE {			
eventA2 SEQUENCE {			
a2-Threshold SEQUENCE {			
rsrp	67	-89dBm	FR1
	FFS		FR2
}			
}			
}			
}			
reportAmount	r1		
reportQuantityCell SEQUENCE {			
rsrp	true		
rsrq	false		
sinr	false		
}			
reportAddNeighMeas	setup		
}			
}			

Table 8.1.3.1.18.1.3.3-7: MeasurementReport (step 6, step 8, Table 8.1.3.1.18.1.3.2-3)

Derivation Path: TS 38.508-1 [4] Table 4.6.1-5A			
Information Element	Value/remark	Comment	Condition
MeasurementReport ::= SEQUENCE {			
criticalExtensions CHOICE {			
measurementReport SEQUENCE {			
measResults	MeasResults1	Table 8.1.3.1.18.1.3.3-8	Step 6
	MeasResults2	Table 8.1.3.1.18.1.3.3-9	Step 8
}			
}			
}			

Table 8.1.3.1.18.1.3.3-8: MeasResults1 (Table 8.1.3.1.18.1.3.3-7)

Derivation Path: TS 38.508-1 [4] Table 4.6.3-79 with Condition A2			
Information Element	Value/remark	Comment	Condition
MeasResults ::= SEQUENCE {		Step 6	
measId	2		
measResultServingMOList SEQUENCE (SIZE (1..maxNrofServingCells)) OF MeasResultServMO {	2 entries		
MeasResultServMO[1] SEQUENCE {		entry 1	
servCellId	ServCellIndex of NR Cell 1		
measResultServingCell SEQUENCE {			
physCellId	Physical layer cell identity of NR Cell 1		
measResult SEQUENCE {			
cellResults SEQUENCE {			

resultsSSB-Cell SEQUENCE {			
rsrp	(0..127)		
rsrq	(0..127)		
sinr	Not present		
	Not checked		pc_ss_SINR _Meas
}			
}			
}			
}			
MeasResultServMO[2] SEQUENCE {		entry 2	
servCellId	ServCellIndex of NR Cell 3		
measResultServingCell SEQUENCE {			
physCellId	Physical layer cell identity of NR Cell 3		
measResult SEQUENCE {			
cellResults SEQUENCE {			
resultsSSB-Cell SEQUENCE {			
rsrp	(0..127)		
rsrq	(0..127)		
sinr	Not present		
	Not checked		pc_ss_SINR _Meas
}			
}			
}			
}			
}			
}			
}			
}			

Table 8.1.3.1.18.1.3.3-9: MeasResults2 (Table 8.1.3.1.18.1.3.3-7)

Derivation Path: TS 38.508-1 [4] Table 4.6.3-79 with Condition A2			
Information Element	Value/remark	Comment	Condition
MeasResults ::= SEQUENCE {		Step 8	
measId	1		
measResultServingMOList SEQUENCE (SIZE (1..maxNrofServingCells)) OF MeasResultServMO {	2 entries		
MeasResultServMO[1] SEQUENCE {		entry 1	
servCellId	ServCellIndex of NR Cell 1		
measResultServingCell SEQUENCE {			
physCellId	Physical layer cell identity of NR Cell 1		
measResult SEQUENCE {			
cellResults SEQUENCE {			
resultsSSB-Cell SEQUENCE {			
rsrp	(0..127)		
rsrq	(0..127)		
sinr	Not present		
	Not checked		pc_ss_SINR _Meas
}			
}			
}			
}			
MeasResultServMO[2] SEQUENCE {		entry 2	
servCellId	ServCellIndex of NR Cell 3		
measResultServingCell SEQUENCE {			
physCellId	Physical layer cell identity of NR Cell 3		
measResult SEQUENCE {			
cellResults SEQUENCE {			

resultsSSB-Cell SEQUENCE {			
rsrp	(0..127)		
rsrq	(0..127)		
sinr	Not present		
	Not checked		pc_ss_SINR_Meas
}			
}			
}			
measResultBestNeighCell SEQUENCE {		Report NR Cell 12	
physCellId	Physical layer cell identity of NR Cell 12		
measResult SEQUENCE {			
cellResults SEQUENCE {			
resultsSSB-Cell SEQUENCE {			
rsrp	(0..127)		
rsrq	Not present		
sinr	Not present		
}			
}			
}			
resultsCSI-RS-Cell	Not present		
}			
rsIndexResults	Not present		
}			
cgi-Info	Not present		
}			
}			
}			
}			

Table 8.1.3.1.18.1.3.3-10: RRCReconfiguration (step 9, Table 8.1.3.1.18.1.3.2-3)

Derivation Path: TS 38.508-1 [4] Table 4.6.1-13 with condition SCell_add			
Information Element	Value/remark	Comment	Condition
RRCReconfiguration ::= SEQUENCE {			
criticalExtensions CHOICE {			
rrcReconfiguration SEQUENCE {			
nonCriticalExtension SEQUENCE{			
masterCellGroup	CellGroupConfig		
}			
}			
}			
}			

Table 8.1.3.1.18.1.3.3-11: CellGroupConfig (Table 8.1.3.1.18.1.3.3-10)

Derivation Path: TS 38.508-1 [4] Table 4.6.3-19 with condition SCell_add			
Information Element	Value/remark	Comment	Condition
CellGroupConfig ::= SEQUENCE {			
sCellToAddModList	Not present		
sCellToReleaseList SEQUENCE (SIZE (1..maxNrofSCells)) OF SCellIndex {	1 entry		
SCellIndex[1]	1	entry 1	
}			
}			

8.1.3.1.18.2 NR CA / Measurement configuration control and reporting / Intra NR measurements / Additional measurement reporting / Inter-band CA

8.1.3.1.18.2.1 Test Purpose (TP)

Same as TC 8.1.3.1.18.1 but applied to Inter-band CA case.

8.1.3.1.18.2.2 Conformance requirements

Same as TC 8.1.3.1.18.1 but applied to Inter-band CA case.

8.1.3.1.18.2.3 Test description

8.1.3.1.18.2.3.1 Pre-test conditions

Same as test case 8.1.3.1.18.1 with the following differences:

- CA configuration: Inter-band CA replaces Intra-band Contiguous CA.
- Cells configuration: NR Cell 10 replaces NR Cell 3, NR Cell 30 replaces NR Cell 12 and NR Cell 31 replaces NR Cell 23.
- NR Cell 10 is an Inactive SCell according to TS 38.508-1 [4] clause 6.3.1.

8.1.3.1.18.2.3.2 Test procedure sequence

Same as test case 8.1.3.1.18.1 with the following differences:

- CA configuration: Inter-band CA replaces Inter-band Contiguous CA
- Cells configuration: NR Cell 10 replaces NR Cell 3, NR Cell 30 replaces NR Cell 12 and NR Cell 31 replaces NR Cell 23.

8.1.3.1.18.2.3.3 Specific message contents

Same as test case 8.1.3.1.18.1 with the following differences.

NOTE: For simplicity the steps referred below are steps in test case 8.1.3.1.18.1.

Table 8.1.3.1.18.2.3.3-1: MeasConfig (Table 8.1.3.1.18.1.3.3-5)

Derivation Path: TS 38.508-1 [4] Table 4.6.3-69			
Information Element	Value/remark	Comment	Condition
MeasConfig ::= SEQUENCE {			
measObjectToAddModList SEQUENCE (SIZE (1..maxNrofMeasId)) OF MeasObjectToAddMod {	2 entries		
MeasObjectToAddMod[1] SEQUENCE {		entry 1	
measObjectId	1	MeasObjectIdNR-f1	
measObject CHOICE {			
measObjectNR SEQUENCE {			
ssbFrequency	ssbFrequency IE equals the ARFCN for NR Cell 1		
absThreshSS-BlocksConsolidation	Not present		
}			
}			
}			
MeasObjectToAddMod[2] SEQUENCE {		entry 2	
measObjectId[2]	2	MeasObjectIdNR-f5	
measObject[2] CHOICE {			
measObjectNR SEQUENCE {			

ssbFrequency	ssbFrequency IE equals the ARFCN for NR Cell 10		
absThreshSS-BlocksConsolidation	Not present		
}			
}			
}			
reportConfigToAddModList SEQUENCE(SIZE (1..maxReportConfigId)) OF ReportConfigToAddMod {	1 entry		
ReportConfigToAddMod[1] SEQUENCE {		entry 1	
reportConfigId	1		
reportConfig CHOICE {			
reportConfigNR	ReportConfigNR-EventA2		
}			
}			
measIdToAddModList SEQUENCE (SIZE (1..maxNrofMeasId)) OF MeasIdToAddMod {	2 entries		
MeasIdToAddMod[1] SEQUENCE {		entry 1	
measId	1		
measObjectId	1		
reportConfigId	1		
}			
MeasIdToAddMod[2] SEQUENCE {		entry 2	
measId	2		
measObjectId	2		
reportConfigId	1		
}			
}			
}			

8.1.3.1.18.3 NR CA / Measurement configuration control and reporting / Intra NR measurements / Additional measurement reporting / Intra-band non Contiguous CA

8.1.3.1.18.3.1 Test Purpose (TP)

Same as TC 8.1.3.1.18.1 but applied to Intra-band non Contiguous CA case.

8.1.3.1.18.3.2 Conformance requirements

Same as TC 8.1.3.1.18.1 but applied to Intra-band non Contiguous CA case.

8.1.3.1.18.3.3 Test description

8.1.3.1.18.3.3.1 Pre-test conditions

Same as test case 8.1.3.1.18.1 with the following differences:

- CA configuration: Intra-band non Contiguous CA replaces Intra-band Contiguous CA.

8.1.3.1.18.3.3.2 Test procedure sequence

Same as test case 8.1.3.1.18.1 with the following differences:

- CA configuration: Intra-band non Contiguous CA replaces Inter-band Contiguous CA.

8.1.3.1.18.3.3.3 Specific message contents

Same as test case 8.1.3.1.18.1 but applied to Intra-band non Contiguous CA case.

8.1.3.1.19 Measurement configuration control and reporting / Inter-frequency measurements/ SFTD

8.1.3.1.19.1 Test Purpose (TP)

(1)

```
with { UE in NR RRC_CONNECTED state with reportSFTD-NeighMeas configured }
ensure that {
  when { The sfn-OffsetResult and frameBoundaryOffsetResult results become available }
  then { UE transmits a MeasurementReport message including the MeasResultCellListSFTD-NR IE }
}
```

8.1.3.1.19.2 Conformance requirements

References: The conformance requirements covered in the current TC are specified in: TS 38.331, clauses 5.3.5.3, 5.5.2.1, 5.5.3.1, 5.5.4.1, and 5.5.5.1. Unless otherwise stated these are Rel-15 requirements.

[TS 38.331, clause 5.3.5.3]

The UE shall perform the following actions upon reception of the *RRCReconfiguration*:

...

1> if the *RRCReconfiguration* message includes the *measConfig*:

2> perform the measurement configuration procedure as specified in 5.5.2;

...

1> else (*RRCReconfiguration* was received via SRB1):

2> submit the *RRCReconfigurationComplete* message via SRB1 to lower layers for transmission using the new configuration;

...

[TS 38.331, clause 5.5.2.1]

The network applies the procedure as follows:

- to ensure that, whenever the UE has a *measConfig* associated with a CG, it includes a *measObject* for the SpCell and for each NR SCell of the CG to be measured;

...

- when the UE is in NE-DC, NR-DC, or NR standalone, to configure at most one measurement identity across all CGs using a reporting configuration with the *reportType* set to *reportSFTD*;

...

The UE shall:

...

1> if the received *measConfig* includes the *measObjectToAddModList*:

2> perform the measurement object addition/modification procedure as specified in 5.5.2.5;

...

1> if the received *measConfig* includes the *reportConfigToAddModList*:

2> perform the reporting configuration addition/modification procedure as specified in 5.5.2.7;

...

- 1> if the received *measConfig* includes the *measIdToAddModList*:
 - 2> perform the measurement identity addition/modification procedure as specified in 5.5.2.3;
- 1> if the received *measConfig* includes the *measGapConfig*:
 - 2> perform the measurement gap configuration procedure as specified in 5.5.2.9;

...

[TS 38.331, clause 5.5.3.1]

The UE shall:

- 1> whenever the UE has a *measConfig*, perform RSRP and RSRQ measurements for each serving cell for which *servingCellMO* is configured as follows:
 - 2> if the *reportConfig* associated with at least one *measId* included in the *measIdList* within *VarMeasConfig* contains an *rsType* set to *ssb* and *ssb-ConfigMobility* is configured in the *measObject* indicated by the *servingCellMO*:
 - ...
 - 3> derive serving cell measurement results based on SS/PBCH block, as described in 5.5.3.3;
 - ...
 - 1> for each *measId* included in the *measIdList* within *VarMeasConfig*:
 - ...
 - 2> if the *reportType* for the associated *reportConfig* is set to *reportSFTD* and the *numberOfReportsSent* as defined within the *VarMeasReportList* for this *measId* is less than one:
 - ...
 - 3> else if the *reportSFTD-NeighMeas* is included:
 - 4> if the *measObject* is associated to NR:
 - 5> if the *drx-SFTD-NeighMeas* is included:
 - 6> perform SFTD measurements between the PCell and the NR neighbouring cell(s) detected based on parameters in the associated *measObject* using available idle periods;
 - 5> else:
 - 6> perform SFTD measurements between the PCell and the NR neighbouring cell(s) detected based on parameters in the associated *measObject*;
 - 5> if the *reportRSRP* is set to *true*:
 - 6> perform RSRP measurements based on SSB for the NR neighbouring cell(s) detected based on parameters in the associated *measObject*;
 - 2> perform the evaluation of reporting criteria as specified in 5.5.4.

[TS 38.331, clause 5.5.4.1]

If AS security has been activated successfully, the UE shall:

- 1> for each *measId* included in the *measIdList* within *VarMeasConfig*:
 - ...
 - 2> else if the corresponding *reportConfig* includes a *reportType* set to *reportSFTD*:
 - 3> if the corresponding *measObject* concerns NR:

...

4> else if the *reportSFTD-NeighMeas* is included:

5> if *cellsForWhichToReportSFTD* is configured in the corresponding *reportConfig*:

6> consider any NR neighbouring cell detected on the associated *measObjectNR* which has a physical cell identity that is included in the *cellsForWhichToReportSFTD* to be applicable;

5> else:

6> consider up to 3 strongest NR neighbouring cells detected based on parameters in the associated *measObjectNR* to be applicable when the concerned cells are not included in the *blackCellsToAddModList* defined within the *VarMeasConfig* for this *measId*;

...

2> if the corresponding *reportConfig* includes a *reportType* is set to *reportSFTD*:

3> if the corresponding *measObject* concerns NR:

...

4> else

5> initiate the measurement reporting procedure, as specified in 5.5.5, immediately after the quantity to be reported becomes available for each requested pair of PCell and NR cell or the maximal measurement reporting delay as specified in TS 38.133 [14];

...

[TS 38.331, clause 5.5.5.1]



Figure 5.5.5.1-1: Measurement reporting

For the *measId* for which the measurement reporting procedure was triggered, the UE shall set the *measResults* within the *MeasurementReport* message as follows:

1> set the *measId* to the measurement identity that triggered the measurement reporting;

...

1> if the corresponding *measObject* concerns NR:

...

2> else if the *reportSFTD-NeighMeas* is included within the corresponding *reportConfigNR* for this *measId*:

3> for each applicable cell which measurement results are available, include an entry in the *measResultCellListSFTD-NR* and set the contents as follows:

4> set *physCellId* to the physical cell identity of the concerned NR neighbour cell.

4> set *sfn-OffsetResult* and *frameBoundaryOffsetResult* to the measurement results provided by lower layers;

4> if the *reportRSRP* is set to *true*:

5> set *rsrp-Result* to the RSRP of the concerned cell derived based on SSB;

...

1> increment the *numberOfReportsSent* as defined within the *VarMeasReportList* for this *measId* by 1;

1> stop the periodical reporting timer, if running;

...

1> else:

2> submit the *MeasurementReport* message to lower layers for transmission, upon which the procedure ends.

8.1.3.1.19.3 Test description

8.1.3.1.19.3.1 Pre-test conditions

System Simulator:

- NR Cell 1 is the PCell, NR Cell 10 is the inter-frequency neighbour cell.
- System information combination NR-4 as defined in TS 38.508-1 [4] clause 4.4.3.1.2 is used in NR PCell.

UE:

- None.

Preamble:

- The UE is in state RRC_CONNECTED using generic procedure parameter Connectivity (NR) established according to TS 38.508-1 [4], clause 4.5.4.

8.1.3.1.19.3.2 Test procedure sequence

Table 8.1.3.1.19.3.2-1: Main behaviour

St	Procedure	Message Sequence		TP	Verdict
		U - S	Message		
1	The SS transmits an <i>RRCReconfiguration</i> message including <i>MeasConfig</i> to setup inter-frequency SFTD measurement on NR neighbour cell (NR Cell 10)	<--	NR RRC: <i>RRCReconfiguration</i>	-	-
2	The UE transmits an <i>RRCReconfigurationComplete</i> message.	-->	NR RRC: <i>RRCReconfigurationComplete</i>	-	-
3	Check: Does the UE transmit a <i>MeasurementReport</i> message including <i>measResultCellListSFTD-NR</i> within the next 5s? NOTE 1	-->	NR RRC: <i>MeasurementReport</i>	1	P
NOTE 1: Time limit is chosen based on the inter-frequency SFTD measurement reporting delay requirements specified in TS 38.133 [30] clause 9.3.8.					

8.1.3.1.19.3.3 Specific message contents

Table 8.1.3.1.19.3.3-1: *RRCReconfiguration* (step 1, Table 8.1.3.1.19.3.2-1)

Derivation Path: TS 38.508-1 [4] Table 4.6.1-13 with condition NR_MEAS

Table 8.1.3.1.19.3.3-2: *MeasConfig* (Table 8.1.3.1.19.3.3-1)

Derivation Path: TS 38.508-1 [4] Table 4.6.3-69			
Information Element	Value/remark	Comment	Condition
MeasConfig ::= SEQUENCE {			

measObjectToAddModList SEQUENCE (SIZE (1..maxNrofMeasId)) OF MeasObjectToAddMod {	2 entries		
MeasObjectToAddMod[1] SEQUENCE {		entry 1	
measObjectId	1		
measObject CHOICE {			
measObjectNR	MeasObjectNR-1	for NR Cell 1	
}			
}			
MeasObjectToAddMod[2] SEQUENCE {		entry 2	
measObjectId	2		
measObject CHOICE {			
measObjectNR	MeasObjectNR-2	for NR Cell 10	
}			
}			
reportConfigToAddModList SEQUENCE (SIZE (1..maxReportConfigId)) OF ReportConfigToAddMod {	1 entry		
ReportConfigToAddMod[1] SEQUENCE {		entry 1	
reportConfigId	1		
reportConfig CHOICE {			
reportConfigNR	ReportConfigNR	Table 8.1.3.1.19.3.3-5	
}			
}			
measIdToAddModList SEQUENCE (SIZE (1..maxMeasId)) OF MeasIdToAddMod {	1 entry		
MeasIdToAddMod[1] SEQUENCE {		entry 1	
measId	1		
measObjectId	2		
reportConfigId	1		
}			
}			
measGapConfig	MeasGapConfig specified in 38.508-1 [4] Table 4.6.3-70		
}			

Table 8.1.3.1.19.3.3-3: MeasObjectNR-1 (Table 8.1.3.1.19.3.3-2)

Derivation Path: TS 38.508-1 [4], Table 4.6.3-76			
Information Element	Value/remark	Comment	Condition
MeasObjectNR ::= SEQUENCE {			
ssbFrequency	ARFCN-ValueNR of NR Cell 1		
absThreshSS-BlocksConsolidation	Not present		
}			

Table 8.1.3.1.19.3.3-4: MeasObjectNR-2 (Table 8.1.3.1.19.3.3-2)

Derivation Path: TS 38.508-1 [4], Table 4.6.3-76			
Information Element	Value/remark	Comment	Condition
MeasObjectNR ::= SEQUENCE {			
ssbFrequency	ARFCN-ValueNR of NR Cell 10		
absThreshSS-BlocksConsolidation	Not present		
}			

Table 8.1.3.1.19.3.3-5: ReportConfigNR (Table 8.1.3.1.19.3.3-2)

Derivation Path: TS 38.508-1 [4], Table 4.6.3-142 with condition SFTD_NEIGHBOUR			
Information Element	Value/remark	Comment	Condition
ReportConfigNR ::= SEQUENCE {			

reportType CHOICE {			
reportSFTD SEQUENCE {			
reportRSRP	true		
reportSFTD-NeighMeas	true		
}			
}			

Table 8.1.3.1.19.3.3-6: MeasResults (step 3, Table 8.1.3.1.19.3.2-1)

Derivation Path: TS 38.508-1 [4], Table 4.6.3-79 with condition SFTD_NEIGHBOUR			
Information Element	Value/remark	Comment	Condition
MeasResults ::= SEQUENCE {			
measId	1		
measResultCellListSFTD-NR SEQUENCE (SIZE (1..maxCellsFTD)) OF MeasResultCellsFTD-NR {	1 entry		
MeasResultCellsFTD-NR[1] SEQUENCE {		entry 1	
physCellId	PhysCellId of NR Cell 10		
sfn-OffsetResult	(0..1023)		
frameBoundaryOffsetResult	(-30720..30719)		
rsrp-Result	(0..127)		
}			
}			
}			

8.1.3.1.20 Measurement configuration control and reporting / Measurement Gaps / gapFR1

8.1.3.1.20.1 Test Purpose (TP)

(1)

```
with { UE in NR RRC_CONNECTED state }
ensure that {
  when { UE receives RRCReconfiguration message containing MeasConfig to setup gapFR1 and report
periodical measurements for neighbour cell on FR1 frequency }
  then { UE applies gapFR1 and sends periodical measurements for neighbour cell on FR1 frequency }
}
```

8.1.3.1.20.2 Conformance requirements

References: The conformance requirements covered in the current TC are specified in: TS 38.331, clauses 5.3.5.3, 5.5.2.1, 5.5.2.9, 5.5.4.1, 5.5.4.5 and 5.5.5.1. Unless otherwise stated these are Rel-15 requirements.

[TS 38.331, clause 5.3.5.3]

The UE shall perform the following actions upon reception of the *RRCReconfiguration*:

...

1> if the *RRCReconfiguration* message includes the *measConfig*:

 2> perform the measurement configuration procedure as specified in 5.5.2;

...

1> else:

 2> submit the *RRCReconfigurationComplete* message via SRB1 to lower layers for transmission using the new configuration;

...

[TS 38.331, clause 5.5.2.1]

...

The UE shall:

...

- 1> if the received *measConfig* includes the *measObjectToAddModList*:
 - 2> perform the measurement object addition/modification procedure as specified in 5.5.2.5;
- ...
- 1> if the received *measConfig* includes the *reportConfigToAddModList*:
 - 2> perform the reporting configuration addition/modification procedure as specified in 5.5.2.7;
- ...
- 1> if the received *measConfig* includes the *measIdToAddModList*:
 - 2> perform the measurement identity addition/modification procedure as specified in 5.5.2.3;
- ...
- 1> if the received *measConfig* includes the *measGapConfig*:
 - 2> perform the measurement gap configuration procedure as specified in 5.5.2.9;

...

[TS 38.331, clause 5.5.2.9]

The UE shall:

- 1> if *gapFR1* is set to *setup*:
 - 2> if an FR1 measurement gap configuration is already setup, release the FR1 measurement gap configuration;
 - 2> setup the FR1 measurement gap configuration indicated by the *measGapConfig* in accordance with the received *gapOffset*, i.e., the first subframe of each gap occurs at an SFN and subframe meeting the following condition:

$$\text{SFN mod } T = \text{FLOOR}(\text{gapOffset}/10);$$

$$\text{subframe} = \text{gapOffset mod } 10;$$
 with $T = \text{MGRP}/10$ as defined in TS 38.133 [14];
 - 2> if *mgta* is configured, apply the specified timing advance to the gap occurrences calculated above (i.e. the UE starts the measurement *mgta* ms before the gap subframe occurrences);

...

[TS 38.331, clause 5.5.4.1]

If AS security has been activated successfully, the UE shall:

- 1> for each *measId* included in the *measIdList* within *VarMeasConfig*:
 - 2> if the corresponding *reportConfig* includes a *reportType* set to *eventTriggered* or *periodical*:
 - 3> if the corresponding *measObject* concerns NR:
 - ...
 - 4> for measurement events other than *eventA1* or *eventA2*:
 - 5> else:

- 6> consider any neighbouring cell detected based on parameters in the associated *measObjectNR* to be applicable when the concerned cell is not included in the *blackCellsToAddModList* defined within the *VarMeasConfig* for this *measId*;

...

- 2> if *reportType* is set to *periodical* and if a (first) measurement result is available:
 - 3> include a measurement reporting entry within the *VarMeasReportList* for this *measId*;
 - 3> set the *numberOfReportsSent* defined within the *VarMeasReportList* for this *measId* to 0;
 - 3> if the *reportAmount* exceeds 1:
 - 4> initiate the measurement reporting procedure, as specified in 5.5.5, immediately after the quantity to be reported becomes available for the NR SpCell;
 - 3> else (i.e. the *reportAmount* is equal to 1):
 - 4> initiate the measurement reporting procedure, as specified in 5.5.5, immediately after the quantity to be reported becomes available for the NR SpCell and for the strongest cell among the applicable cells;
- 2> upon expiry of the periodical reporting timer for this *measId*:
 - 3> initiate the measurement reporting procedure, as specified in 5.5.5.

...

[TS 38.331, clause 5.5.5.1]



Figure 5.5.5.1-1: Measurement reporting

The purpose of this procedure is to transfer measurement results from the UE to the network. The UE shall initiate this procedure only after successful AS security activation.

For the *measId* for which the measurement reporting procedure was triggered, the UE shall set the *measResults* within the *MeasurementReport* message as follows:

- 1> set the *measId* to the measurement identity that triggered the measurement reporting;
 - 1> set the *measResultServingCell* within *measResultServingMOList* to include, for each NR serving cell that is configured with *servingCellMO*, RSRP, RSRQ and the available SINR, derived based on the *rsType* if indicated in the associated *reportConfig*, otherwise based on SSB if available, otherwise based on CSI-RS;
 - 1> set the *servCellId* within *measResultServingMOList* to include each NR serving cell that is configured with *servingCellMO*, if any;
- ...
- 1> if there is at least one applicable neighbouring cell to report:
 - 2> if the *reportType* is set to *eventTriggered* or *periodical*:
 - 3> set the *measResultNeighCells* to include the best neighbouring cells up to *maxReportCells* in accordance with the following:

...

- 4> else:
 - 5> include the applicable cells for which the new measurement results became available since the last periodical reporting or since the measurement was initiated or reset;
 - 4> for each cell that is included in the *measResultNeighCells*, include the *physCellId*;
 - 4> if the *reportType* is set to *eventTriggered* or *periodical*:
 - 5> for each included cell, include the layer 3 filtered measured results in accordance with the *reportConfig* for this *measId*, ordered as follows:
 - 6> if the *measObject* associated with this *measId* concerns NR:
 - 7> if *rsType* in the associated *reportConfig* is set to *ssb*:
 - 8> set *resultsSSB-Cell* within the *measResult* to include the SS/PBCH block based quantity(ies) indicated in the *reportQuantityCell* within the concerned *reportConfig*, in decreasing order of the sorting quantity, determined as specified in 5.5.5.3, i.e. the best cell is included first;
 - ...
 - 1> increment the *numberOfReportsSent* as defined within the *VarMeasReportList* for this *measId* by 1;
 - 1> stop the periodical reporting timer, if running;
 - 1> if the *numberOfReportsSent* as defined within the *VarMeasReportList* for this *measId* is less than the *reportAmount* as defined within the corresponding *reportConfig* for this *measId*:
 - 2> start the periodical reporting timer with the value of *reportInterval* as defined within the corresponding *reportConfig* for this *measId*;
 - 1> else:
 - 2> if the *reportType* is set to *periodical*:
 - 3> remove the entry within the *VarMeasReportList* for this *measId*;
 - 3> remove this *measId* from the *measIdList* within *VarMeasConfig*;
 - ...
 - 1> else:
 - 2> submit the *MeasurementReport* message to lower layers for transmission, upon which the procedure ends.

8.1.3.1.20.3 Test description

8.1.3.1.20.3.1 Pre-test conditions

System Simulator:

- NR Cell 1 is the serving cell, NR Cell 3 is the inter-frequency neighbour cell of NR Cell 1.
- System information combination NR-4 as defined in TS 38.508-1 [4] clause 4.4.3.1.2 is used in NR cells.

UE:

- None.

Preamble:

- The UE is in state 3N-A as defined in TS 38.508-1 [4], subclause 4.4A.

8.1.3.1.20.3.2 Test procedure sequence

Table 8.1.3.1.20.3.2-1 illustrates the downlink power levels to be applied for NR Cell 1 and NR Cell 3 at various time instants of the test execution. Row marked "T1" are applied at the point indicated in the Main behaviour description in Table 8.1.3.1.20.3.2-3.

Table 8.1.3.1.20.3.2-1: Time instances of cell power level and parameter changes in FR1

	Parameter	Unit	NR Cell 1	NR Cell3	Remark
T1	SS/PBCH SSS EPRE	dBm/ SCS	-85	-79	

Table 8.1.3.1.20.3.2-3: Main behaviour

St	Procedure	Message Sequence		TP	Verdict
		U - S	Message		
0	SS re-adjusts the cell-specific reference signal level according to row "T1" in table 8.1.3.1.20.3.2-1.	-	-	-	-
1	The SS transmits an <i>RRCReconfiguration</i> message to setup FR1 independent gap (pattern #0) and inter-frequency measurement on NR Cell 3.	<--	NR RRC: <i>RRCReconfiguration</i>	-	-
2	The UE transmits an <i>RRCReconfigurationComplete</i> message.	-->	NR RRC: <i>RRCReconfigurationComplete</i>	-	-
3	Check: Does the UE transmit at least 10 <i>MeasurementReport</i> messages to periodically report the measured RSRP value for NR Cell 3 within the next 30 seconds?	-->	NR RRC: <i>MeasurementReport</i>	1	P
3A	The SS waits and ignores <i>MeasurementReport</i> messages for 3s to allow UE to measure NR Cell 3.	-	-	-	-
4	The SS transmits an <i>RRCReconfiguration</i> to change gap pattern to pattern #1.	<--	NR RRC: <i>RRCReconfiguration</i>	-	-
5	The UE transmits an <i>RRCReconfigurationComplete</i> message to confirm the change of pattern.	-->	NR RRC: <i>RRCReconfigurationComplete</i>	-	-
6	Check: Does the UE transmit at least 10 <i>MeasurementReport</i> messages to periodically report the measured RSRP value for NR Cell 3 within the next 30 seconds?	-->	NR RRC: <i>MeasurementReport</i>	1	P
-	EXCEPTION: Steps 7 to 9 shall be repeated for each gap pattern among #2 - #11 and supported by UE (indicated in <i>supportedGapPattern</i>).				
7	The SS transmits an <i>RRCReconfiguration</i> to change gap pattern to the next pattern supported by UE.	<--	NR RRC: <i>RRCReconfiguration</i>	-	-
8	The UE transmits an <i>RRCReconfigurationComplete</i> message to confirm the change of gap pattern.	-->	NR RRC: <i>RRCReconfigurationComplete</i>	-	-
9	Check: Does the UE transmit at least 10 <i>MeasurementReport</i> messages to periodically report the measured RSRP value for NR Cell 3 within the next 30 seconds?	-->	NR RRC: <i>MeasurementReport</i>	1	P

8.1.3.1.20.3.3 Specific message contents

Table 8.1.3.1.20.3.3-1: *RRCReconfiguration* (steps 1, 4 and 7, Table 8.1.3.1.20.3.2-3)

Derivation Path: TS 38.508-1 [4] Table 4.6.1-13 with condition NR_MEAS
--

Table 8.1.3.1.20.3.3-2: *MeasConfig* (Table 8.1.3.1.20.3.3-1)

Derivation Path: TS 38.508-1 [4] Table 4.6.3-69			
Information Element	Value/remark	Comment	Condition
MeasConfig ::= SEQUENCE {			
measObjectToAddModList	Not present		Step 4 OR Step 7
measObjectToAddModList SEQUENCE (SIZE (1..maxNrofMeasId)) OF MeasObjectToAddMod {	2 entries		Step 1
MeasObjectToAddMod[1] SEQUENCE {		entry 1	
measObjectId	1		
measObject CHOICE {			
measObjectNR	MeasObjectNR-f1	Table 8.1.3.1.20.3.3-3	
}			
}			
MeasObjectToAddMod[2] SEQUENCE {		entry 2	
measObjectId	2		
measObject CHOICE {			
measObjectNR	MeasObjectNR-f2	Table 8.1.3.1.20.3.3-4	
}			
}			
reportConfigToAddModList	Not present		Step 4 OR Step 7
reportConfigToAddModList SEQUENCE(SIZE (1..maxReportConfigId)) OF ReportConfigToAddMod {	1 entry		Step 1
ReportConfigToAddMod[1] SEQUENCE {		entry 1	
reportConfigId	1		
reportConfig CHOICE {			
reportConfigNR	ReportConfigNR with condition PERIODICAL		
}			
}			
}			
measIdToAddModList	Not present		Step 4 OR Step 7
measIdToAddModList SEQUENCE (SIZE (1..maxNrofMeasId)) OF MeasIdToAddMod {	1 entry		Step 1
MeasIdToAddMod[1] SEQUENCE {		entry 1	
measId	1		
measObjectId	2		
reportConfigId	1		
}			
}			
measGapConfig	MeasGapConfig-gapFR1	Table 8.1.3.1.20.3.3-5	
}			

Table 8.1.3.1.20.3.3-3: *MeasObjectNR-f1* (Table 8.1.3.1.20.3.3-2)

Derivation Path: TS 38.508-1 [4], Table 4.6.3-76			
Information Element	Value/remark	Comment	Condition
MeasObjectNR ::= SEQUENCE {			
ssbFrequency	ARFCN-ValueNR for SSB of NR Cell 1		
smtc1 SEQUENCE {			
periodicityAndOffset CHOICE {			
sf20	0	To make sure SMTc for intra- frequency measurement is non-overlapping with MG	

}			
}			
absThreshSS-BlocksConsolidation	Not present		
nrofSS-BlocksToAverage	Not present		
}			

Table 8.1.3.1.20.3.3-4: MeasObjectNR-f2 (Table 8.1.3.1.20.3.3-2)

Derivation Path: TS 38.08-1 [4], Table 4.6.3-76			
Information Element	Value/remark	Comment	Condition
MeasObjectNR ::= SEQUENCE {			
ssbFrequency	ARFCN-ValueNR for SSB of NR Cell 3		
smtc1 SEQUENCE {			
periodicityAndOffset CHOICE {			
sf20	10		
}			
}			
absThreshSS-BlocksConsolidation	Not present		
nrofSS-BlocksToAverage	Not present		
}			

Table 8.1.3.1.20.3.3-5: MeasGapConfig-gapFR1 (Table 8.1.3.1.20.3.3-2)

Derivation Path: TS 38.508-1 [4], Table 4.6.3-70 with condition GAP_FR1			
Information Element	Value/remark	Comment	Condition
MeasGapConfig ::= SEQUENCE {			
gapFR1 CHOICE {			
setup SEQUENCE {			
gapOffset	9		
mgl	ms3		Pattern #2, #3, #10 or #11
	ms4		Pattern #6, #7, #8 or #9
	ms6		Pattern #0, #1, #4 or #5
mgrp	ms20		Pattern #4, #6 or #10
	ms40		Pattern #0, #2 or #7
	ms80		Pattern #1, #3 or #8
	ms160		Pattern #5, #9 or #11
mgta	ms0		
}			
}			
}			

Table 8.1.3.1.20.3.3-6: MeasurementReport (steps 3, 6 and 9, Table 8.1.3.1.20.3.2-3)

Derivation Path: TS 38.508-1 [4] Table 4.6.1-5A			
Information Element	Value/remark	Comment	Condition
MeasurementReport ::= SEQUENCE {			
criticalExtensions CHOICE {			
measurementReport SEQUENCE {			
measResults SEQUENCE {			
measId	1		
measResultServingMOList SEQUENCE (SIZE (1..maxNrofServingCells)) OF MeasResultServMO {	1 entry	Measurement report for NR Cell 1	
MeasResultServMO[1] SEQUENCE {		entry 1	
servCellId	ServCellIndex of NR Cell 1		
measResultServingCell SEQUENCE {			
physCellId	PCI of NR Cell 1		
measResult SEQUENCE {			
cellResults SEQUENCE {			
resultsSSB-Cell SEQUENCE {			
rsrp	(0..127)		

rsrq	(0..127)		
sinr	(0..127)		pc_ss_SINR_Meas
	Not present		
}			
}			
}			
}			
}			
measResultNeighCells CHOICE {			
measResultListNR SEQUENCE (SIZE (1..maxCellReport)) OF MeasResultNR {	1 entry	Measurement report for NR Cell 3	
MeasResultNR[1] SEQUENCE {		entry 1	
physCellId	Physical layer cell identity of NR Cell 3		
measResult SEQUENCE {			
cellResults SEQUENCE {			
resultsSSB-Cell SEQUENCE {			
rsrp	(0..127)		
rsrq	(0..127)		
sinr	(0..127)		pc_ss_SINR_Meas
	Not present		
}			
resultsCSI-RS-Cell	Not present		
}			
rsIndexResults	Not present		
}			
cgi-Info	Not present		
}			
}			
}			
}			
}			
}			
}			
}			

8.1.3.1.21 Measurement configuration control and reporting / Measurement Gaps / gapFR2

8.1.3.1.21.1 Test Purpose (TP)

(1)

```

with { UE in NR RRC_CONNECTED state }
ensure that {
  when { UE receives RRCReconfiguration message containing MeasConfig to setup gapFR2 and report
periodical measurements for neighbor cell on FR2 frequency }
  then { UE applies gapFR2 and sends periodical measurements for neighbor cell on FR2 frequency }
}
    
```

8.1.3.1.21.2 Conformance requirements

References: The conformance requirements covered in the current TC are specified in: TS 38.331, clauses 5.3.5.3, 5.5.2.1, 5.5.2.9, 5.5.4.1, 5.5.4.5 and 5.5.5.1. Unless otherwise stated these are Rel-15 requirements.

[TS 38.331, clause 5.3.5.3]

The UE shall perform the following actions upon reception of the *RRCReconfiguration*:

...

1> if the *RRCReconfiguration* message includes the *measConfig*:

2> perform the measurement configuration procedure as specified in 5.5.2;

...

1> else:

2> submit the *RRCReconfigurationComplete* message via SRB1 to lower layers for transmission using the new configuration;

...

[TS 38.331, clause 5.5.2.1]

...

The UE shall:

...

1> if the received *measConfig* includes the *measObjectToAddModList*:

2> perform the measurement object addition/modification procedure as specified in 5.5.2.5;

...

1> if the received *measConfig* includes the *reportConfigToAddModList*:

2> perform the reporting configuration addition/modification procedure as specified in 5.5.2.7;

...

1> if the received *measConfig* includes the *measIdToAddModList*:

2> perform the measurement identity addition/modification procedure as specified in 5.5.2.3;

...

1> if the received *measConfig* includes the *measGapConfig*:

2> perform the measurement gap configuration procedure as specified in 5.5.2.9;

...

[TS 38.331, clause 5.5.2.9]

The UE shall:

...

1> if *gapFR2* is set to *setup*:

2> if an FR2 measurement gap configuration is already setup, release the FR2 measurement gap configuration;

2> setup the FR2 measurement gap configuration indicated by the *measGapConfig* in accordance with the received *gapOffset*, i.e., the first subframe of each gap occurs at an SFN and subframe meeting the following condition:

$$\text{SFN mod } T = \text{FLOOR}(\text{gapOffset}/10);$$

$$\text{subframe} = \text{gapOffset mod } 10;$$

with $T = \text{MGRP}/10$ as defined in TS 38.133 [14];

2> if *mgta* is configured, apply the specified timing advance to the gap occurrences calculated above (i.e. the UE starts the measurement *mgta* ms before the gap subframe occurrences);

...

[TS 38.331, clause 5.5.4.1]

If AS security has been activated successfully, the UE shall:

- 1> for each *measId* included in the *measIdList* within *VarMeasConfig*:
 - 2> if the corresponding *reportConfig* includes a *reportType* set to *eventTriggered* or *periodical*:
 - 3> if the corresponding *measObject* concerns NR:
 - ...
 - 4> for measurement events other than *eventA1* or *eventA2*:
 - 5> else:
 - 6> consider any neighbouring cell detected based on parameters in the associated *measObjectNR* to be applicable when the concerned cell is not included in the *blackCellsToAddModList* defined within the *VarMeasConfig* for this *measId*;
 - ...
 - 2> if *reportType* is set to *periodical* and if a (first) measurement result is available:
 - 3> include a measurement reporting entry within the *VarMeasReportList* for this *measId*;
 - 3> set the *numberOfReportsSent* defined within the *VarMeasReportList* for this *measId* to 0;
 - 3> if the *reportAmount* exceeds 1:
 - 4> initiate the measurement reporting procedure, as specified in 5.5.5, immediately after the quantity to be reported becomes available for the NR SpCell;
 - 3> else (i.e. the *reportAmount* is equal to 1):
 - 4> initiate the measurement reporting procedure, as specified in 5.5.5, immediately after the quantity to be reported becomes available for the NR SpCell and for the strongest cell among the applicable cells;
 - 2> upon expiry of the periodical reporting timer for this *measId*:
 - 3> initiate the measurement reporting procedure, as specified in 5.5.5.
 - ...

[TS 38.331, clause 5.5.5.1]



Figure 5.5.5.1-1: Measurement reporting

The purpose of this procedure is to transfer measurement results from the UE to the network. The UE shall initiate this procedure only after successful AS security activation.

For the *measId* for which the measurement reporting procedure was triggered, the UE shall set the *measResults* within the *MeasurementReport* message as follows:

- 1> set the *measId* to the measurement identity that triggered the measurement reporting;
- 1> set the *measResultServingCell* within *measResultServingMOList* to include, for each NR serving cell that is configured with *servingCellMO*, RSRP, RSRQ and the available SINR, derived based on the *rsType* if indicated in the associated *reportConfig*, otherwise based on SSB if available, otherwise based on CSI-RS;

1> set the *servCellId* within *measResultServingMOList* to include each NR serving cell that is configured with *servingCellMO*, if any;

...

1> if there is at least one applicable neighbouring cell to report:

2> if the *reportType* is set to *eventTriggered* or *periodical*:

3> set the *measResultNeighCells* to include the best neighbouring cells up to *maxReportCells* in accordance with the following:

...

4> else:

5> include the applicable cells for which the new measurement results became available since the last periodical reporting or since the measurement was initiated or reset;

4> for each cell that is included in the *measResultNeighCells*, include the *physCellId*;

4> if the *reportType* is set to *eventTriggered* or *periodical*:

5> for each included cell, include the layer 3 filtered measured results in accordance with the *reportConfig* for this *measId*, ordered as follows:

6> if the *measObject* associated with this *measId* concerns NR:

7> if *rsType* in the associated *reportConfig* is set to *ssb*:

8> set *resultsSSB-Cell* within the *measResult* to include the SS/PBCH block based quantity(ies) indicated in the *reportQuantityCell* within the concerned *reportConfig*, in decreasing order of the sorting quantity, determined as specified in 5.5.5.3, i.e. the best cell is included first;

...

1> increment the *numberOfReportsSent* as defined within the *VarMeasReportList* for this *measId* by 1;

1> stop the periodical reporting timer, if running;

1> if the *numberOfReportsSent* as defined within the *VarMeasReportList* for this *measId* is less than the *reportAmount* as defined within the corresponding *reportConfig* for this *measId*:

2> start the periodical reporting timer with the value of *reportInterval* as defined within the corresponding *reportConfig* for this *measId*;

1> else:

2> if the *reportType* is set to *periodical*:

3> remove the entry within the *VarMeasReportList* for this *measId*;

3> remove this *measId* from the *measIdList* within *VarMeasConfig*;

...

1> else:

2> submit the *MeasurementReport* message to lower layers for transmission, upon which the procedure ends.

8.1.3.1.21.3 Test description

8.1.3.1.21.3.1 Pre-test conditions

System Simulator:

- NR Cell 1 is the serving cell, NR Cell 3 is the inter-frequency neighbour cell of NR Cell 1.
- System information combination NR-4 as defined in TS 38.508-1 [4] clause 4.4.3.1.2 is used in NR cells.

UE:

- None.

Preamble:

- The UE is in state 3N-A as defined in TS 38.508-1 [4], subclause 4.4A.

8.1.3.1.21.3.2 Test procedure sequence

Table 8.1.3.1.21.3.2-1: Main behaviour

St	Procedure	Message Sequence		TP	Verdict
		U - S	Message		
1	The SS transmits an <i>RRCReconfiguration</i> message to setup FR2 independent gap (pattern #13) and inter-frequency measurement on NR Cell 3.	<--	NR RRC: <i>RRCReconfiguration</i>	-	-
2	The UE transmits an <i>RRCReconfigurationComplete</i> message.	-->	NR RRC: <i>RRCReconfigurationComplete</i>	-	-
3	Check: Does the UE transmit at least 3 <i>MeasurementReport</i> messages to periodically report the measured RSRP value for NR Cell 3 within the next 30 seconds?	-->	NR RRC: <i>MeasurementReport</i>	1	P
4	The SS transmits an <i>RRCReconfiguration</i> to change gap pattern to pattern #14.	<--	NR RRC: <i>RRCReconfiguration</i>	-	-
5	The UE transmits an <i>RRCReconfigurationComplete</i> message to confirm the change of pattern.	-->	NR RRC: <i>RRCReconfigurationComplete</i>	-	-
6	Check: Does the UE transmit at least 3 <i>MeasurementReport</i> messages to periodically report the measured RSRP value for NR Cell 3 within the next 30 seconds?	-->	NR RRC: <i>MeasurementReport</i>	1	P
-	EXCEPTION: Steps 7 to 9 shall be repeated for each gap pattern among #12 and #15 - #23 and supported by UE (indicated in <i>supportedGapPattern</i>).				
7	The SS transmits an <i>RRCReconfiguration</i> to change gap pattern to the next pattern supported by UE.	<--	NR RRC: <i>RRCReconfiguration</i>	-	-
8	The UE transmits an <i>RRCReconfigurationComplete</i> message to confirm the change of gap pattern.	-->	NR RRC: <i>RRCReconfigurationComplete</i>	-	-
9	Check: Does the UE transmit at least 3 <i>MeasurementReport</i> messages to periodically report the measured RSRP value for NR Cell 3 within the next 30 seconds?	-->	NR RRC: <i>MeasurementReport</i>	1	P

8.1.3.1.21.3.3 Specific message contents

Table 8.1.3.1.21.3.3-1: *RRCReconfiguration* (step 1, 4 and 7, Table 8.1.3.1.21.3.2-2)

Derivation Path: TS 38.508-1 [4] Table 4.6.1-13 with condition NR_MEAS

Table 8.1.3.1.21.3.3-2: *MeasConfig* (Table 8.1.3.1.21.3.3-1)

Derivation Path: TS 38.508-1 [4] Table 4.6.3-69			
Information Element	Value/remark	Comment	Condition
MeasConfig ::= SEQUENCE {			
measObjectToAddModList	Not present		Step 4 OR Step 7
measObjectToAddModList SEQUENCE (SIZE (1..maxNrofMeasId)) OF MeasObjectToAddMod {	2 entries		Step 1
MeasObjectToAddMod[1] SEQUENCE {		entry 1	
measObjectId	1		
measObject CHOICE {			
measObjectNR	MeasObjectNR-f1	Table 8.1.3.1.21.3.3-3	
}			
}			
MeasObjectToAddMod[2] SEQUENCE {		entry 2	
measObjectId	2		
measObject CHOICE {			
measObjectNR	MeasObjectNR-f2	Table 8.1.3.1.21.3.3-4	
}			
}			
reportConfigToAddModList	Not present		Step 4 OR Step 7
reportConfigToAddModList SEQUENCE(SIZE (1..maxReportConfigId)) OF ReportConfigToAddMod {	1 entry		Step 1
ReportConfigToAddMod[1] SEQUENCE {		entry 1	
reportConfigId	1		
reportConfig CHOICE {			
reportConfigNR	ReportConfigNR with condition PERIODICAL		
}			
}			
}			
measIdToAddModList SEQUENCE (SIZE (1..maxNrofMeasId)) OF MeasIdToAddMod {	Not present		Step 4 OR Step 7
MeasIdToAddMod[1] SEQUENCE {	1 entry		Step 1
measId		entry 1	
measObjectId	1		
measObjectId	2		
reportConfigId	1		
}			
}			
measGapConfig	MeasGapConfig-gapFR2	Table 8.1.3.1.21.3.3-5	
}			

Table 8.1.3.1.21.3.3-3: *MeasObjectNR-f1* (Table 8.1.3.1.21.3.3-2)

Derivation Path: TS 38.508-1 [4], Table 4.6.3-76			
Information Element	Value/remark	Comment	Condition
MeasObjectNR ::= SEQUENCE {			
ssbFrequency	ARFCN-ValueNR for SSB of NR Cell 1		
smtc1 SEQUENCE {			
periodicityAndOffset CHOICE {			
sf20	10	To make sure SMTc for intra- frequency measurement is	

		non-overlapping with MG	
}			
}			
absThreshSS-BlocksConsolidation	Not present		
nrofSS-BlocksToAverage	Not present		
}			

Table 8.1.3.1.21.3.3-4: *MeasObjectNR-f2* (Table 8.1.3.1.21.3.3-2)

Derivation Path: TS 38.508-1 [4], Table 4.6.3-76			
Information Element	Value/remark	Comment	Condition
MeasObjectNR ::= SEQUENCE {			
ssbFrequency	ARFCN-ValueNR for SSB of NR Cell 3		
smtc1 SEQUENCE {			
periodicityAndOffset CHOICE {			
sf20	0		
}			
}			
absThreshSS-BlocksConsolidation	Not present		
nrofSS-BlocksToAverage	Not present		
}			

Table 8.1.3.1.21.3.3-5: *MeasGapConfig-gapFR2* (Table 8.1.3.1.21.3.3-2)

Derivation Path: TS 38.508-1 [4], Table 4.6.3-70 with Condition GAP_FR2			
Information Element	Value/remark	Comment	Condition
MeasGapConfig ::= SEQUENCE {			
gapFR2 CHOICE {			
setup SEQUENCE {			
gapOffset	0		
mgl	ms1dot5		Pattern #20, #21, #22 or #23
	ms3dot5		Pattern #16, #17, #18 or #19
	ms5dot5		Pattern #12, #13, #14 or #15
mgrp	ms20		Pattern #12, #16 or #20
	ms40		Pattern #13, #17 or #21
	ms80		Pattern #14, #18 or #22
	ms160		Pattern #15, #19 or #23
mgta	ms0		
}			
}			
}			

Table 8.1.3.1.21.3.3-6: *MeasurementReport* (step 1, Table 8.1.3.1.21.3.2-4)

Derivation Path: TS 38.508-1 [4] Table 4.6.1-5A			
Information Element	Value/remark	Comment	Condition
MeasurementReport ::= SEQUENCE {			
criticalExtensions CHOICE {			
measurementReport SEQUENCE {			
measResults SEQUENCE {			
measId	1		
measResultServingMOList SEQUENCE (SIZE (1..maxNrofServingCells)) OF MeasResultServMO {	1 entry	Measurement report for NR Cell 1	
MeasResultServMO[1] SEQUENCE {		entry 1	
servCellId	ServCellIndex of NR Cell 1		
measResultServingCell SEQUENCE {			
physCellId	PCI of NR Cell 1		
measResult SEQUENCE {			
cellResults SEQUENCE {			

resultsSSB-Cell SEQUENCE {			
rsrp	(0..127)		
rsrq	(0..127)		
sinr	(0..127)		pc_ss_SINR_Meas
	Not present		
}			
}			
}			
}			
}			
measResultNeighCells CHOICE {			
measResultListNR SEQUENCE (SIZE (1..maxCellReport)) OF MeasResultNR {	1 entry	Measurement report for NR Cell 3	
MeasResultNR[1] SEQUENCE {		entry 1	
physCellId	Physical layer cell identity of NR Cell 3		
measResult SEQUENCE {			
cellResults SEQUENCE {			
resultsSSB-Cell SEQUENCE {			
rsrp	(0..127)		
rsrq	(0..127)		
sinr	(0..127)		pc_ss_SINR_Meas
	Not present		
}			
}			
}	Not present		
}			
rsIndexResults	Not present		
}			
cgi-Info	Not present		
}			
}			
}			
}			
}			
}			
}			

8.1.3.1.22 Void

8.1.3.1.23 Measurement configuration control and reporting / Intra NR measurements / Periodic reporting / Continuation of the measurements after RRC Resume

8.1.3.1.23.1 Test Purpose (TP)

(1)

```
with { UE in NR RRC_CONNECTED state }
ensure that {
  when { UE receives RRCReconfiguration including measConfig to setup periodical measurement reporting }
  then { UE sends RRCReconfigurationComplete and starts sending periodic measurement reports }
}
```

(2)

```
with { UE in NR RRC_INACTIVE state and measurement configured for periodical reporting }
ensure that {
  when { UE receives RRCResume message without including measconfig }
  then { UE resumes RRC connection and performs periodic measurements as per the measurement configuration }
}
```

}

(3)

```
with { UE in NR RRC_INACTIVE state and measurement configured for periodical reporting }
ensure that {
  when { UE receives RRCResume message including the measconfig }
  then { UE resumes RRC connection and performs periodic measurements as per the received
measconfig in RRCResume message }
}
```

8.1.3.1.23.2 Conformance requirements

References: The conformance requirements covered in the present TC are specified in: TS 38.331, clause 5.3.13.4, 5.5.2 and 5.5.4.1.

[TS 38.331, clause 5.3.13.4]

The UE shall:

...

1> release the *suspendConfig* except the *ran-NotificationAreaInfo*;

...

1> resume SRB2 and all DRBs;

...

1> if the *RRCResume* message includes the *measConfig*:

2> perform the measurement configuration procedure as specified in 5.5.2;

1> resume measurements if suspended;

...

1> enter RRC_CONNECTED;

1> indicate to upper layers that the suspended RRC connection has been resumed;

...

1> consider the current cell to be the PCell;

...

1> submit the *RRCResumeComplete* message to lower layers for transmission;

1> the procedure ends.

[TS 38.331, clause 5.3.13.4]

The UE shall:

...

1> if the received *measConfig* includes the *measObjectToAddModList*:

2> perform the measurement object addition/modification procedure as specified in 5.5.2.5;

...

1> if the received *measConfig* includes the *reportConfigToAddModList*:

2> perform the reporting configuration addition/modification procedure as specified in 5.5.2.7;

- 1> if the received *measConfig* includes the *quantityConfig*:
 - 2> perform the quantity configuration procedure as specified in 5.5.2.8;
- 1> if the received *measConfig* includes the *measIdToRemoveList*:
 - 2> perform the measurement identity removal procedure as specified in 5.5.2.2;
- 1> if the received *measConfig* includes the *measIdToAddModList*:
 - 2> perform the measurement identity addition/modification procedure as specified in 5.5.2.3;

[TS 38.331, clause 5.5.4.1]

If AS security has been activated successfully, the UE shall:

- 1> for each *measId* included in the *measIdList* within *VarMeasConfig*:
 - 2> if the corresponding *reportConfig* includes a *reportType* set to *eventTriggered* or *periodical*:
 - 3> if the corresponding *measObject* concerns NR:
 - ...
 - 4> if corresponding *reportConfig* includes *reportType* set to *periodical*; or
 - 4> for measurement events other than *eventA1* or *eventA2*:
 - 5> if *useWhiteCellList* is set to *true*:
 - 6> consider any neighbouring cell detected based on parameters in the associated *measObjectNR* to be applicable when the concerned cell is included in the *whiteCellsToAddModList* defined within the *VarMeasConfig* for this *measId*;
 - 5> else:
 - 6> consider any neighbouring cell detected based on parameters in the associated *measObjectNR* to be applicable when the concerned cell is not included in the *blackCellsToAddModList* defined within the *VarMeasConfig* for this *measId*;
 - ...
 - 2> if *reportType* is set to *periodical* and if a (first) measurement result is available:
 - 3> include a measurement reporting entry within the *VarMeasReportList* for this *measId*;
 - 3> set the *numberOfReportsSent* defined within the *VarMeasReportList* for this *measId* to 0;
 - 3> if the *reportAmount* exceeds 1:
 - 4> initiate the measurement reporting procedure, as specified in 5.5.5, immediately after the quantity to be reported becomes available for the NR SpCell;
 - 3> else (i.e. the *reportAmount* is equal to 1):
 - 4> initiate the measurement reporting procedure, as specified in 5.5.5, immediately after the quantity to be reported becomes available for the NR SpCell and for the strongest cell among the applicable cells;
 - 2> upon expiry of the periodical reporting timer for this *measId*:
 - 3> initiate the measurement reporting procedure, as specified in 5.5.5.

8.1.3.1.23.3 Test description

8.1.3.1.23.3.1 Pre-test conditions

System Simulator:

- NR Cell 1 is the serving cell, NR Cell 2 is the intra-frequency neighbour cell of NR Cell 1.
- System information combination NR-2 as defined in TS 38.508-1 [4] clause 4.4.3.1.2 is used in NR cells.

UE:

- None.

Preamble:

- The UE is in state 3N-A in NR Cell 1 as defined in TS 38.508-1 [4], subclause 4.4A.

8.1.3.1.23.3.2 Test procedure sequence

Tables 8.1.3.1.23.3.2-1 and 8.1.3.1.23.3.2-2 illustrate the downlink power levels to be applied for NR Cell 1 and NR Cell 2 at various time instants of the test execution. Row marked "T0" denotes the conditions after the preamble.

Table 8.1.3.1.23.3.2-1: Power levels in FR1

	Parameter	Unit	NR Cell 1	NR Cell 2	Remark
T0	SS/PBCH SSS EPRE	dBm/ SCS	-85	-91	

Table 8.1.3.1.23.3.2-2: Power levels in FR2

	Parameter	Unit	NR Cell 1	NR Cell 2	Remark
T0	SS/PBCH SSS EPRE	dBm/ SCS	FFS	FFS	

Table 8.1.3.1.23.3.2-3: Main behaviour

St	Procedure	Message Sequence		TP	Verdict
		U - S	Message		
1	The SS transmits an <i>RRCReconfiguration</i> message including <i>MeasConfig</i> to setup intra NR periodic measurement reporting.	<--	NR RRC: <i>RRCReconfiguration</i>	-	-
2	The UE transmits an <i>RRCReconfigurationComplete</i> message.	-->	NR RRC: <i>RRCReconfigurationComplete</i>	-	-
2A	The SS waits and ignores <i>MeasurementReport</i> messages for 3s to allow UE to measure NR Cell 2.	-->	NR RRC: <i>MeasurementReport</i>	-	-
3	Check: Does the UE transmit at least 10 <i>MeasurementReport</i> messages within the next 30 seconds?	-->	NR RRC: <i>MeasurementReport</i>	1	P
-	EXCEPTION: Steps 4a1-4a14 describe behaviour that depends on UE configuration; the "lower case letter" identifies a step sequence that takes place if <i>inactiveState</i> is configured	-	-	-	-
4a1	IF <i>pc_inactiveState</i> THEN the SS transmits an <i>RRCRelease</i> message with <i>suspendConfig</i> .	<--	NR RRC: <i>RRCRelease</i>	-	-
4a2	The SS waits for 5 sec and transmits a <i>Paging</i> message including a matched identity (correct <i>fullI-RNTI</i>).	-	NR RRC: <i>Paging</i>	-	-
4a3	UE transmits <i>RRCResumeRequest</i> message	-->	NR RRC: <i>RRCResumeRequest</i>	-	-

4a4	The SS transmits an <i>RRCResume</i> message without including <i>MeasConfig</i> .	<--	NR RRC: <i>RRCResume</i>	-	-
4a5	The UE transmits an <i>RRCResumeComplete</i> message.	-->	NR RRC: <i>RRCResumeComplete</i>	-	-
4a6	The SS waits and ignores <i>MeasurementReport</i> messages for 3s to allow UE to measure NR Cell 2.	-->	NR RRC: <i>MeasurementReport</i>	-	-
4a7	Check: Does the UE transmit at least 10 <i>MeasurementReport</i> messages within the next 30 seconds?	-->	NR RRC: <i>MeasurementReport</i>	2	P
4a8	The SS transmits an <i>RRCRelease</i> message with <i>suspendConfig</i> .	<--	NR RRC: <i>RRCRelease</i>	-	-
4a9	The SS waits for 5 sec and transmits a Paging message including a matched identity (correct full-RNTI).	-	NR RRC: Paging	-	-
4a10	UE transmits <i>RRCResumeRequest</i> message	-->	NR RRC: <i>RRCResumeRequest</i>	-	-
4a11	The SS transmits an <i>RRCResume</i> message including <i>MeasConfig</i> .	<--	NR RRC: <i>RRCResume</i>	-	-
4a12	The UE transmits an <i>RRCResumeComplete</i> message.	-->	NR RRC: <i>RRCResumeComplete</i>	-	-
4a13	The SS waits and ignores <i>MeasurementReport</i> messages for 3s to allow UE to measure NR Cell 2.	-->	NR RRC: <i>MeasurementReport</i>	-	-
4a14	Check: Does the UE transmit at least 10 <i>MeasurementReport</i> messages within the next 30 seconds?	-->	NR RRC: <i>MeasurementReport</i>	3	P
5-16	Void	-	-	-	-
17	The SS transmits an <i>RRCRelease</i> message	<--	NR RRC: <i>RRCRelease</i>	-	-

8.1.3.1.23.3.3 Specific message contents

Table 8.1.3.1.23.3.3-1: *RRCReconfiguration* (step 1, Table 8.1.3.1.23.3.2-3)

Derivation Path: TS 38.508-1 [4] Table 4.6.1-13 with condition NR_MEAS

Table 8.1.3.1.23.3.3-2: *MeasConfig* (Table 8.1.3.1.23.3.3-1)

Derivation Path: TS 38.508-1 [4] Table 4.6.3-69			
Information Element	Value/remark	Comment	Condition
<i>MeasConfig</i> ::= SEQUENCE {			
<i>measObjectToAddModList</i> SEQUENCE (SIZE (1..maxNrofMeasId)) OF <i>MeasObjectToAddMod</i> {	1 entry		
<i>MeasObjectToAddMod</i> [1] SEQUENCE {		entry 1	
<i>measObjectId</i>	1	<i>MeasObjectIdNR-f1</i>	
<i>measObject</i> CHOICE {			
<i>measObjectNR</i> SEQUENCE {			
<i>ssbFrequency</i>	<i>ssbFrequency</i> IE equals the ARFCN for NR Cell 2		
<i>absThreshSS-BlocksConsolidation</i>	Not present		
}			
}			
}			
<i>reportConfigToAddModList</i> SEQUENCE (SIZE (1..maxReportConfigId)) OF <i>ReportConfigToAddMod</i> {	1 entry		
<i>ReportConfigToAddMod</i> [1] SEQUENCE {		entry 1	
<i>reportConfigId</i>	1		
<i>reportConfig</i> CHOICE {			
<i>reportConfigNR</i>	<i>ReportConfigNR</i> with condition PERIODICAL		
}			
}			

}			
}			
measIdToAddModList SEQUENCE (SIZE (1..maxNrofMeasId)) OF MeasIdToAddMod {	1 entry		
MeasIdToAddMod[1] SEQUENCE {		entry 1	
measId	1		
measObjectId	1		
reportConfigId	1		
}			
}			
}			
}			

Table 8.1.3.1.23.3.3-3: MeasurementReport (step 3 and step 4a7, Table 8.1.3.1.23.3.2-3)

Derivation Path: TS 38.508-1 [4] Table 4.6.1-5A			
Information Element	Value/remark	Comment	Condition
MeasurementReport ::= SEQUENCE {			
criticalExtensions CHOICE {			
measurementReport SEQUENCE {			
measResults SEQUENCE {			
measId	1		
measResultServingMOList SEQUENCE (SIZE (1..maxNrofServingCells)) OF MeasResultServMO {	1 entry		
MeasResultServMO[1] SEQUENCE {		entry 1	
servCellId	Cell index corresponding to NR Cell 1		
measResultServingCell SEQUENCE {			
physCellId	Physical layer cell identity of NR Cell 1		
}			
}			
}			
}			
measResultNeighCells CHOICE {			
measResultListNR SEQUENCE (SIZE (1..maxCellReport)) OF MeasResultNR {	1 entry		
MeasResultNR[1] SEQUENCE {		entry 1	
physCellId	Physical layer cell identity of NR Cell 2		
measResult	Not Checked		
}			
}			
}			
}			

Table 8.1.3.1.23.3.3-4: RRCRelease (step 4a1 and step 4a8, Table 8.1.3.1.23.3.2-3)

Derivation Path: TS 38.508-1 [4] Table 4.6.1-16 with condition NR_RRC_INACTIVE

Table 8.1.3.1.23.3.3-5: Paging (step 4a2 and step 4a9, Table 8.1.3.1.23.3.2-3)

Derivation Path: TS 38.508-1 [4] Table 4.6.1-9 with condition NR_RRC_RESUME

Table 8.1.3.1.23.3.3-6: RRCResumeRequest (step 4a3 and step 4a10, Table 8.1.3.1.23.3.2-3)

Derivation Path: TS 38.331 [6], clause 6.2.2			
Information Element	Value/remark	Comment	Condition
RRCResumeRequest ::= SEQUENCE {			
rrcResumeRequest SEQUENCE {			

resumeCause	mt-Access		
}			
}			

Table 8.1.3.1.23.3.3-7: RRCResume (step 4a11, Table 8.1.3.1.23.3.2-3)

Derivation Path: TS 38.331 [6], clause 6.2.2			
Information Element	Value/remark	Comment	Condition
RRCResume ::= SEQUENCE {			
criticalExtensions CHOICE {			
rrcResume SEQUENCE {			
measConfig	MeasConfigResume		
}			
}			
}			

Table 8.1.3.1.23.3.3-8: MeasConfigResume (Table 8.1.3.1.23.3.3-7)

Derivation Path: TS 38.508-1 [4] Table 4.6.3-69			
Information Element	Value/remark	Comment	Condition
MeasConfig ::= SEQUENCE {			
measObjectToAddModList SEQUENCE (SIZE (1..maxNrofMeasId)) OF MeasObjectToAddMod {	1 entry		
MeasObjectToAddMod[1] SEQUENCE {		entry 1	
measObjectId	1	MeasObjectIdNR-f1	
measObject CHOICE {			
measObjectNR SEQUENCE {			
ssbFrequency	ssbFrequency IE equals the ARFCN for NR Cell 2		
absThreshSS-BlocksConsolidation	Not present		
}			
}			
}			
reportConfigToAddModList SEQUENCE (SIZE (1..maxReportConfigId)) OF ReportConfigToAddMod {	1 entry		
ReportConfigToAddMod[1] SEQUENCE {		entry 1	
reportConfigId	1		
reportConfig CHOICE {			
reportConfigNR	ReportConfigNR with condition PERIODICAL		
}			
}			
}			
measIdToRemoveList SEQUENCE (SIZE (1..maxNrofMeasId)) OF MeasId {	1 entry		
measId[1]	1		
}			
measIdToAddModList SEQUENCE (SIZE (1..maxNrofMeasId)) OF MeasIdToAddMod {	1 entry		
MeasIdToAddMod[1] SEQUENCE {		entry 1	
measId	2		
measObjectId	1		
reportConfigId	1		
}			
}			
}			

Table 8.1.3.1.23.3.3-9: MeasurementReport (step 4a14, Table 8.1.3.1.23.3.2-3)

Derivation Path: TS 38.508-1 [4] Table 4.6.1-5A			
---	--	--	--

Information Element	Value/remark	Comment	Condition
MeasurementReport ::= SEQUENCE {			
criticalExtensions CHOICE {			
measurementReport SEQUENCE {			
measResults SEQUENCE {			
measId	2		
measResultServingMOList SEQUENCE (SIZE (1..maxNrofServingCells)) OF MeasResultServMO {	1 entry		
MeasResultServMO[1] SEQUENCE {		entry 1	
servCellId	Cell index corresponding to NR Cell 1		
measResultServingCell SEQUENCE {			
physCellId	Physical layer cell identity of NR Cell 1		
}			
}			
}			
measResultNeighCells CHOICE {			
measResultListNR SEQUENCE (SIZE (1..maxCellReport)) OF MeasResultNR {	1 entry		
MeasResultNR[1] SEQUENCE {		entry 1	
physCellId	Physical layer cell identity of NR Cell 2		
measResult	Not Checked		
}			
}			
}			
}			
}			
}			

8.1.3.2 Inter-RAT measurements

8.1.3.2.1 Measurement configuration control and reporting / Inter-RAT measurements / Event B1 / Measurement of E-UTRA cells

8.1.3.2.1.1 Test Purpose (TP)

(1)

```
with { UE is NR RRC_CONNECTED state and inter-RAT measurement event B1 to measure neighbour E-UTRA cell is configured }
ensure that {
  when { Entering condition for the event B1 is not met }
  then { UE does not transmit any MeasurementReport }
}
```

(2)

```
with { UE is NR RRC_CONNECTED state and inter-RAT measurement event B1 to measure neighbour E-UTRA cell is configured }
ensure that {
  when { Entering condition for the event B1 is met }
  then { UE transmits a MeasurementReport }
}
```

8.1.3.2.1.2 Conformance requirements

References: The conformance requirements covered in the current TC are specified in: TS 38.331, clauses 5.3.5.3, 5.5.2, 5.5.4.1, 5.5.4.8 and 5.5.5. Unless otherwise stated these are Rel-15 requirements.

[TS 38.331, clause 5.3.5.3]

The UE shall perform the following actions upon reception of the *RRCReconfiguration*:

...

1> if the *RRCReconfiguration* message includes the *measConfig*:

2> perform the measurement configuration procedure as specified in 5.5.2;

...

1> if the UE is configured with E-UTRA *nr-SecondaryCellGroupConfig* (MCG is E-UTRA):

2> if *RRCReconfiguration* was received via SRB1:

3> submit the *RRCReconfigurationComplete* via the EUTRA MCG embedded in E-UTRA RRC message *RRCConnectionReconfigurationComplete* as specified in TS 36.331 [10];

3> if *reconfigurationWithSync* was included in *spCellConfig* of an SCG:

4> initiate the random access procedure on the SpCell, as specified in TS 38.321 [3];

3> else:

4> the procedure ends;

NOTE: The order the UE sends the *RRCConnectionReconfigurationComplete* message and performs the Random Access procedure towards the SCG is left to UE implementation.

2> else (*RRCReconfiguration* was received via SRB3):

3> submit the *RRCReconfigurationComplete* message via SRB3 to lower layers for transmission using the new configuration;

NOTE: For EN-DC, in the case *RRCReconfiguration* is received via SRB1, the random access is triggered by RRC layer itself as there is not necessarily other UL transmission. In the case *RRCReconfiguration* is received via SRB3, the random access is triggered by the MAC layer due to arrival of *RRCReconfigurationComplete*.

1> else:

2> submit the *RRCReconfigurationComplete* message via SRB1 to lower layers for transmission using the new configuration;

2> if this is the first *RRCReconfiguration* message after successful completion of the RRC re-establishment procedure;

3> resume SRB1 and DRBs that are suspended;

...

[TS 38.331, clause 5.5.2.1]

...

The UE shall:

...

1> if the received *measConfig* includes the *measObjectToAddModList*:

2> perform the measurement object addition/modification procedure as specified in 5.5.2.5;

...

1> if the received *measConfig* includes the *reportConfigToAddModList*:

2> perform the reporting configuration addition/modification procedure as specified in 5.5.2.7;

...

- 1> if the received *measConfig* includes the *measIdToAddModList*:
 - 2> perform the measurement identity addition/modification procedure as specified in 5.5.2.3;
- 1> if the received *measConfig* includes the *measGapConfig*:
 - 2> perform the measurement gap configuration procedure as specified in 5.5.2.9;

...

[TS 38.331, clause 5.5.2.9]

The UE shall:

...

- 1> else if *gapUE* is set to release:
 - 2> release the per UE measurement gap configuration.

NOTE 1: For *gapFR2* configuration, the SFN and subframe of a serving cell on FR2 frequency is used in the gap calculation

NOTE 2: For *gapFR1* or *gapUE* configuration, the SFN and subframe of the PCell is used in the gap calculation.

[TS 38.331, clause 5.5.4.1]

If security has been activated successfully, the UE shall:

- 1> for each *measId* included in the *measIdList* within *VarMeasConfig*:
 - 2> if the corresponding *reportConfig* includes a *reportType* set to *eventTriggered* or *periodical*;
 - 3> if the corresponding *measObject* concerns NR;
 - ...
 - 4> for measurement events other than *eventA1* or *eventA2*:
 - 5> if *useWhiteCellList* is set to TRUE:
 - 6> consider any neighbouring cell detected based on parameters in the associated *measObjectNRto* be applicable when the concerned cell is included in the *whiteCellsToAddModList* defined within the *VarMeasConfig* for this *measId*;
 - 5> else:
 - 6> consider any neighbouring cell detected based on parameters in the associated *measObjectNRto* be applicable when the concerned cell is not included in the *blackCellsToAddModList* defined within the *VarMeasConfig* for this *measId*;
 - 3> else if the corresponding *measObject* concerns E-UTRA;
 - 4> consider any neighbouring cell detected on the associated frequency to be applicable when the concerned cell is not included in the *blackCellsToAddModListEUTRAN* defined within the *VarMeasConfig* for this *measId*;
 - ...
 - 2> if the *reportType* is set to *eventTriggered* and if the entry condition applicable for this event, i.e. the event corresponding with the *eventId* of the corresponding *reportConfig* within *VarMeasConfig*, is fulfilled for one or more applicable cells for all measurements after layer 3 filtering taken during *timeToTrigger* defined for this event within the *VarMeasConfig*, while the *VarMeasReportList* does not include a measurement reporting entry for this *measId* (a first cell triggers the event):
 - 3> include a measurement reporting entry within the *VarMeasReportList* for this *measId*;

- 3> set the *numberOfReportsSent* defined within the *VarMeasReportList* for this *measId* to 0;
- 3> include the concerned cell(s) in the *cellsTriggeredList* defined within the *VarMeasReportList* for this *measId*;
- 3> initiate the measurement reporting procedure, as specified in 5.5.5;
- 2> else if the *reportType* is set to *eventTriggered* and if the entry condition applicable for this event, i.e. the event corresponding with the *eventId* of the corresponding *reportConfig* within *VarMeasConfig*, is fulfilled for one or more applicable cells not included in the *cellsTriggeredList* for all measurements after layer 3 filtering taken during *timeToTrigger* defined for this event within the *VarMeasConfig* (a subsequent cell triggers the event):
 - 3> set the *numberOfReportsSent* defined within the *VarMeasReportList* for this *measId* to 0;
 - 3> include the concerned cell(s) in the *cellsTriggeredList* defined within the *VarMeasReportList* for this *measId*;
 - 3> initiate the measurement reporting procedure, as specified in 5.5.5;
- 2> else if the *reportType* is set to *eventTriggered* and if the leaving condition applicable for this event is fulfilled for one or more of the cells included in the *cellsTriggeredList* defined within the *VarMeasReportList* for this *measId* for all measurements after layer 3 filtering taken during *timeToTrigger* defined within the *VarMeasConfig* for this event:
 - 3> remove the concerned cell(s) in the *cellsTriggeredList* defined within the *VarMeasReportList* for this *measId*;
 - 3> if *reportOnLeave* is set to *TRUE* for the corresponding reporting configuration:
 - 4> initiate the measurement reporting procedure, as specified in 5.5.5;
 - 3> if the *cellsTriggeredList* defined within the *VarMeasReportList* for this *measId* is empty:
 - 4> remove the measurement reporting entry within the *VarMeasReportList* for this *measId*;
 - 4> stop the periodical reporting timer for this *measId*, if running;
- ...
- 2> upon the expiry of T321 for this *measId*:
 - 3> include a measurement reporting entry within the *VarMeasReportList* for this *measId*;
 - 3> set the *numberOfReportsSent* defined within the *VarMeasReportList* for this *measId* to 0;
 - 3> initiate the measurement reporting procedure, as specified in 5.5.5.

[TS 38.331, clause 5.5.4.8]

The UE shall:

- 1> consider the entering condition for this event to be satisfied when condition B1-1, as specified below, is fulfilled;
- 1> consider the leaving condition for this event to be satisfied when condition B1-2, as specified below, is fulfilled;

Inequality B1-1 (Entering condition)

$$Mn + Ofn + Ocn - Hys > Thresh$$

Inequality B1-2 (Leaving condition)

$$Mn + Ofn + Ocn + Hys < Thresh$$

The variables in the formula are defined as follows:

Mn is the measurement result of the inter-RAT neighbour cell, not taking into account any offsets.

Ofn is the measurement object specific offset of the frequency of the inter-RAT neighbour cell (i.e. *eutra-Q-OffsetRange* as defined within the *measObjectEUTRA* corresponding to the frequency of the neighbour inter-RAT cell).

Ocn is the cell specific offset of the inter-RAT neighbour cell (i.e. *cellIndividualOffset* as defined within the *measObjectEUTRA* corresponding to the neighbour inter-RAT cell), and set to zero if not configured for the neighbour cell.

Hys is the hysteresis parameter for this event (i.e. *hysteresis* as defined within *reportConfigInterRAT* for this event).

Thresh is the threshold parameter for this event (i.e. *b1-ThresholdEUTRA* as defined within *reportConfigInterRAT* for this event).

Mn is expressed in dBm or in dB, depending on the measurement quantity of the inter-RAT neighbour cell.

Ofn, Ocn, Hys are expressed in dB.

Thresh is expressed in the same unit as **Mn**.

[TS 38.331, clause 5.5.5]



Figure 5.5.5-1: Measurement reporting

The purpose of this procedure is to transfer measurement results from the UE to the network. The UE shall initiate this procedure only after successful security activation.

For the *measId* for which the measurement reporting procedure was triggered, the UE shall set the *measResults* within the *MeasurementReport* message as follows:

- 1> set the *measId* to the measurement identity that triggered the measurement reporting;
- 1> set the *measResultServingCell* within *measResultServingMOList* to include, for each NR serving cell that is configured with *servingCellMO*, RSRP, RSRQ and the available SINR, derived based on the *rsType* if indicated in the associated *reportConfig*, otherwise based on SSB if available, otherwise based on CSI-RS;
- 1> set the *measResultServingCell* within *measResultServingMOList* to include for each NR serving cell that is configured with *servingCellMO*, if any, the *servCellId*;
- 1> if the *reportConfig* associated with the *measId* that triggered the measurement reporting includes *reportQuantityRsIndexes* and *maxNrofRSIndexesToReport*:
 - 2> for each serving cell configured with *servingCellMO*, include beam measurement information according to the associated *reportConfig* as described in 5.5.5.2;
- ...
- 1> if there is at least one applicable neighbouring cell to report:
 - 2> if the *reportType* is set to *eventTriggered* or *periodical*:
 - 3> set the *measResultNeighCells* to include the best neighbouring cells up to *maxReportCells* in accordance with the following:
 - 4> if the *reportType* is set to *eventTriggered*:

5> include the cells included in the *cellsTriggeredList* as defined within the *VarMeasReportList* for this *measId*;

...

4> for each cell that is included in the *measResultNeighCells*, include the *physCellId*;

4> if the *reportType* is set to *eventTriggered* or *periodical*:

5> for each included cell, include the layer 3 filtered measured results in accordance with the *reportConfig* for this *measId*, ordered as follows:

6> if the *measObject* associated with this *measId* concerns NR:

7> if *rsType* in the associated *reportConfig* is set to *ssb*:

8> set *resultsSSB-Cell* within the *measResult* to include the SS/PBCH block based quantity(ies) indicated in the *reportQuantityCell* within the concerned *reportConfig*, in decreasing order of the sorting quantity, determined as specified in 5.5.5.3, i.e. the best cell is included first:

9> if *reportQuantityRsIndexes* and *maxNrofRSIndexesToReport* are configured, include beam measurement information as described in 5.5.5.2;

...

6> if the *measObject* associated with this *measId* concerns E-UTRA:

7> set the *measResult* to include the quantity(ies) indicated in the *reportQuantity* within the concerned *reportConfigInterRAT* in decreasing order of the sorting quantity, determined as specified in 5.5.5.3, i.e. the best cell is included first;

...

1> increment the *numberOfReportsSent* as defined within the *VarMeasReportList* for this *measId* by 1;

1> stop the periodical reporting timer, if running;

...

1> if the UE is configured with EN-DC:

2> if SRB3 is configured:

3> submit the *MeasurementReport* message via SRB3 to lower layers for transmission, upon which the procedure ends;

2> else:

3> submit the *MeasurementReport* message via the EUTRA MCG embedded in E-UTRA RRC message *ULInformationTransferMRDC* as specified in TS 36.331 [10].

1> else:

2> submit the *MeasurementReport* message to lower layers for transmission, upon which the procedure ends.

8.1.3.2.1.3 Test description

8.1.3.2.1.3.1 Pre-test conditions

System Simulator:

- NR Cell 1 is the PCell, E-UTRA Cell 1 is the inter-RAT neighbour cell of NR Cell 1.
- NR Cell 1 is configured to operate in FR1 bands as defined in TS 38.508-1 [4] clause 6.2.3.

- System information combination NR-6 as defined in TS 38.508-1 [4] clause 4.4.3.1.2.

UE:

- None.

Preamble:

- The UE is in state 3N-A as defined in TS 38.508-1 [4], subclause 4.4A.

8.1.3.2.1.3.2 Test procedure sequence

Table 8.1.3.2.1.3.2-1 illustrates the downlink power levels to be applied for NR Cell 1, and E-UTRA Cell 1 at various time instants of the test execution. Row marked "T0" denotes the conditions after the preamble, while the configuration marked "T1" is applied at the point indicated in the Main behaviour description in Table 8.1.3.2.1.3.2-3.

Table 8.1.3.2.1.3.2-1: Time instances of cell power level and parameter changes for conducted test environment

	Parameter	Unit	NR Cell 1	E-UTRA Cell 1	Remark
T0	SS/PBCH SSS EPRE	dBm/SCS	-85	-	Power levels are such that entry condition for event B1 is not satisfied: $Mn + Ofn + Ocn + Hys < Thresh$
	Cell-specific RS EPRE	dBm/15 kHz		-93	
T1	SS/PBCH SSS EPRE	dBm/SCS	-85	-	Power levels are such that entry condition for event B1 is satisfied: $Mn + Ofn + Ocn - Hys > Thresh$
	Cell-specific RS EPRE	dBm/15 kHz		-73	

Table 8.1.3.2.1.3.2-2: Void

Table 8.1.3.2.1.3.2-3: Main behaviour

St	Procedure	Message Sequence		TP	Verdict
		U - S	Message		
1	The SS transmits an <i>RRCReconfiguration</i> message including <i>MeasConfig</i> to setup inter-RAT measurement and reporting for event B1.	<--	NR RRC: <i>RRCReconfiguration</i>	-	-
2	The UE transmits an <i>RRCReconfigurationComplete</i> message.	-->	NR RRC: <i>RRCReconfigurationComplete</i>	-	-
3	Check: Does the UE transmit a <i>MeasurementReport</i> message within the next 10s?	-->	NR RRC: <i>MeasurementReport</i>	2	F
4	SS re-adjusts the cell-specific reference signal level according to row "T1" in table 8.1.3.2.1.3.2-1.	-	-	-	-
5	Check: Does the UE transmit a <i>MeasurementReport</i> message to report event B1 with the measured RSRP value for NR Cell 1?	-->	NR RRC: <i>MeasurementReport</i>	1	P

8.1.3.2.1.3.3 Specific message contents

Table 8.1.3.2.1.3.3-1: *RRCReconfiguration* (step 1, Table 8.1.3.2.1.3.2-3)

Derivation Path: TS 38.508-1 [4] Table 4.6.1-13with condition NR_MEAS

Table 8.1.3.2.1.3.3-2: MeasConfig (Table 8.1.3.2.1.3.3-1)

Derivation Path: TS 38.508-1 [4] Table 4.6.3-69			
Information Element	Value/remark	Comment	Condition
MeasConfig ::= SEQUENCE {			
measObjectToAddModList SEQUENCE (SIZE (1..maxNrofMeasId)) OF MeasObjectToAddMod {	2 entries		
MeasObjectToAddMod[1] SEQUENCE {		entry 1	
measObjectId	1	MeasObjectIdNR-f1	
measObject CHOICE {			
measObjectNR SEQUENCE {			
ssbFrequency	ssbFrequency IE equals the ARFCN for NR Cell 1		
absThreshSS-BlocksConsolidation	Not present		
}			
}			
MeasObjectToAddMod[2] SEQUENCE {		entry 2	
measObjectId	2	MeasObjectIdE-UTRA-f1	
measObject CHOICE {			
measObjectEUTRA SEQUENCE {			
carrierFreq	ARFCN-ValueEUTRA for E-UTRA Cell 1		
}			
}			
}			
reportConfigToAddModList SEQUENCE (SIZE (1..maxReportConfigId)) OF ReportConfigToAddMod {	1 entry		
ReportConfigToAddMod[1] SEQUENCE {		entry 1	
reportConfigId	1		
reportConfig CHOICE {			
reportConfigInterRAT	ReportConfigInterRAT-EventB1	Table 8.1.3.2.1.3.3-3	
}			
}			
}			
measIdToAddModList SEQUENCE (SIZE (1..maxNrofMeasId)) OF MeasIdToAddMod {	1 entry		
MeasIdToAddMod[1] SEQUENCE {		entry 1	
measId	1		
measObjectId	2		
reportConfigId	1		
}			
}			
quantityConfig	QuantityConfig with condition INTER-RAT		
measGapConfig	MeasGapConfig		
}			

Table 8.1.3.2.1.3.3-3: ReportConfigInterRAT-EventB1 (Table 8.1.3.2.1.3.3-2)

Derivation Path: TS 38.508-1 [4] Table 4.6.3-141 with condition EVENT_B1			
Information Element	Value/remark	Comment	Condition
ReportConfigNR ::= SEQUENCE {			
reportType CHOICE {			
eventTriggered SEQUENCE {			
eventId CHOICE {			
eventB1 SEQUENCE {			
b1-ThresholdEUTRA SEQUENCE {			
rsrp	61	-80dBm	FR1
}			
}			
}			
}			
}			

}			
reportAmount	r1		
}			
}			
}			

Table 8.1.3.2.1.3.3-4: MeasurementReport (step 5, Table 8.1.3.2.1.3.2-3)

Derivation Path: TS 38.508-1 [4] Table 4.6.1-5A			
Information Element	Value/remark	Comment	Condition
MeasurementReport ::= SEQUENCE {			
criticalExtensions CHOICE {			
measurementReport SEQUENCE {			
measResults SEQUENCE {			
measId	1		Step 5
measResultServingMOList SEQUENCE (SIZE (1..maxNrofServingCells)) OF MeasResultServMO {	1 entry	Report NR Cell 1	
MeasResultServMO[1] SEQUENCE {		entry 1	
servCellId	ServCellIndex of NR Cell 1		
measResultServingCell SEQUENCE {			
physCellId	Physical layer cell identity of NR Cell 1		
measResult SEQUENCE {			
cellResults SEQUENCE {			
resultsSSB-Cell SEQUENCE {			
rsrp	(0..127)		
rsrq	(0..127)		
sinr	Not present		
}	Not checked		pc_ss_SINR_Meas
}			
}			
}			
}			
}			
}			
}			
measResultNeighCells CHOICE {			
measResultListEUTRA SEQUENCE (SIZE (1..maxCellReport)) OF MeasResultEUTRA {	1 entry	Report E-UTRA neighbour cell	
MeasResultEUTRA[1] SEQUENCE {		entry 1	
eutra-PhysCellId	Physical layer cell identity of E-UTRA Cell 1		Step 5
measResult SEQUENCE {			
rsrp	(0..97)		
rsrq	(0..34)		
sinr	Not present		
}			
cgi-Info	Not present		
}			
}			

8.1.3.2.2 Measurement configuration control and reporting / Inter-RAT measurements / Event B2 / Measurement of E-UTRA cells

8.1.3.2.2.1 Test Purpose (TP)

(1)

```
with { UE is NR RRC_CONNECTED state and inter-RAT measurement event B2 to measure neighbor E-UTRA cell is configured }
ensure that {
  when { Entering condition 1 for event B2 is not met but Entering condition 2 is met }
  then { UE does not transmit any MeasurementReport }
}
```

(2)

```
with { UE is NR RRC_CONNECTED state and inter-RAT measurement event B2 to measure neighbor E-UTRA cell is configured }
ensure that {
  when { Entering condition 1 and 2 for event B2 is met }
  then { UE transmits a MeasurementReport }
}
```

8.1.3.2.2.2 Conformance requirements

References: The conformance requirements covered in the current TC are specified in: TS 38.331, clauses 5.3.5.3, 5.5.2, 5.5.4.1, 5.5.4.9 and 5.5.5. Unless otherwise stated these are Rel-15 requirements.

[TS 38.331, clause 5.3.5.3]

The UE shall perform the following actions upon reception of the *RRCReconfiguration*:

...

1> if the *RRCReconfiguration* message includes the *measConfig*:

2> perform the measurement configuration procedure as specified in 5.5.2;

...

1> if the UE is configured with E-UTRA *nr-SecondaryCellGroupConfig* (MCG is E-UTRA):

2> if *RRCReconfiguration* was received via SRB1:

3> submit the *RRCReconfigurationComplete* via the EUTRA MCG embedded in E-UTRA RRC message *RRCConnectionReconfigurationComplete* as specified in TS 36.331 [10];

3> if *reconfigurationWithSync* was included in *spCellConfig* of an SCG:

4> initiate the random access procedure on the SpCell, as specified in TS 38.321 [3];

3> else:

4> the procedure ends;

NOTE: The order the UE sends the *RRCConnectionReconfigurationComplete* message and performs the Random Access procedure towards the SCG is left to UE implementation.

2> else (*RRCReconfiguration* was received via SRB3):

3> submit the *RRCReconfigurationComplete* message via SRB3 to lower layers for transmission using the new configuration;

NOTE: For EN-DC, in the case *RRCReconfiguration* is received via SRB1, the random access is triggered by RRC layer itself as there is not necessarily other UL transmission. In the case *RRCReconfiguration* is received via SRB3, the random access is triggered by the MAC layer due to arrival of *RRCReconfigurationComplete*.

1> else:

- 2> submit the *RRCReconfigurationComplete* message via SRB1 to lower layers for transmission using the new configuration;
- 2> if this is the first *RRCReconfiguration* message after successful completion of the RRC re-establishment procedure;
- 3> resume SRB2 and DRBs that are suspended;

...

[TS 38.331, clause 5.5.2.1]

...

The UE shall:

...

- 1> if the received *measConfig* includes the *measObjectToAddModList*:
 - 2> perform the measurement object addition/modification procedure as specified in 5.5.2.5;

...

- 1> if the received *measConfig* includes the *reportConfigToAddModList*:
 - 2> perform the reporting configuration addition/modification procedure as specified in 5.5.2.7;

...

- 1> if the received *measConfig* includes the *measIdToAddModList*:
 - 2> perform the measurement identity addition/modification procedure as specified in 5.5.2.3;

- 1> if the received *measConfig* includes the *measGapConfig*:
 - 2> perform the measurement gap configuration procedure as specified in 5.5.2.9;

...

[TS 38.331, clause 5.5.2.9]

The UE shall:

- 1> if *gapUE* is set to setup:
 - 2> if a per UE measurement gap configuration is already setup, release the per UE measurement gap configuration;
 - 2> setup the per UE measurement gap configuration indicated by the *measGapConfig* in accordance with the received *gapOffset*, i.e., the first subframe of each gap occurs at an SFN and subframe meeting the following condition:

$$\text{SFN mod } T = \text{FLOOR}(\text{gapOffset}/10);$$

$$\text{subframe} = \text{gapOffset mod } 10;$$

with $T = \text{MGRP}/10$ as defined in TS 38.133 [14];

- 2> if *mgta* is configured, apply the specified timing advance to the gap occurrences calculated above (i.e. the UE starts the measurement *mgta* ms before the gap subframe occurrences);

1> else if *gapUE* is set to release:

- 2> release the per UE measurement gap configuration.

[TS 38.331, clause 5.5.4.1]

If security has been activated successfully, the UE shall:

- 1> for each *measId* included in the *measIdList* within *VarMeasConfig*:
 - 2> if the corresponding *reportConfig* includes a *reportType* set to *eventTriggered* or *periodical*;
 - 3> if the corresponding *measObject* concerns NR;
 - ...
 - 4> for measurement events other than *eventA1* or *eventA2*:
 - 5> if *useWhiteCellList* is set to TRUE:
 - 6> consider any neighbouring cell detected based on parameters in the associated *measObjectNRto* be applicable when the concerned cell is included in the *whiteCellsToAddModList* defined within the *VarMeasConfig* for this *measId*;
 - 5> else:
 - 6> consider any neighbouring cell detected based on parameters in the associated *measObjectNRto* be applicable when the concerned cell is not included in the *blackCellsToAddModList* defined within the *VarMeasConfig* for this *measId*;
 - 3> else if the corresponding *measObject* concerns E-UTRA;
 - 4> consider any neighbouring cell detected on the associated frequency to be applicable when the concerned cell is not included in the *blackCellsToAddModListEUTRAN* defined within the *VarMeasConfig* for this *measId*;
 - ...
 - 2> if the *reportType* is set to *eventTriggered* and if the entry condition applicable for this event, i.e. the event corresponding with the *eventId* of the corresponding *reportConfig* within *VarMeasConfig*, is fulfilled for one or more applicable cells for all measurements after layer 3 filtering taken during *timeToTrigger* defined for this event within the *VarMeasConfig*, while the *VarMeasReportList* does not include a measurement reporting entry for this *measId* (a first cell triggers the event):
 - 3> include a measurement reporting entry within the *VarMeasReportList* for this *measId*;
 - 3> set the *numberOfReportsSent* defined within the *VarMeasReportList* for this *measId* to 0;
 - 3> include the concerned cell(s) in the *cellsTriggeredList* defined within the *VarMeasReportList* for this *measId*;
 - 3> initiate the measurement reporting procedure, as specified in 5.5.5;
 - 2> else if the *reportType* is set to *eventTriggered* and if the entry condition applicable for this event, i.e. the event corresponding with the *eventId* of the corresponding *reportConfig* within *VarMeasConfig*, is fulfilled for one or more applicable cells not included in the *cellsTriggeredList* for all measurements after layer 3 filtering taken during *timeToTrigger* defined for this event within the *VarMeasConfig* (a subsequent cell triggers the event):
 - 3> set the *numberOfReportsSent* defined within the *VarMeasReportList* for this *measId* to 0;
 - 3> include the concerned cell(s) in the *cellsTriggeredList* defined within the *VarMeasReportList* for this *measId*;
 - 3> initiate the measurement reporting procedure, as specified in 5.5.5;
 - 2> else if the *reportType* is set to *eventTriggered* and if the leaving condition applicable for this event is fulfilled for one or more of the cells included in the *cellsTriggeredList* defined within the *VarMeasReportList* for this *measId* for all measurements after layer 3 filtering taken during *timeToTrigger* defined within the *VarMeasConfig* for this event:

3> remove the concerned cell(s) in the *cellsTriggeredList* defined within the *VarMeasReportList* for this *measId*;

3> if *reportOnLeave* is set to *TRUE* for the corresponding reporting configuration:

4> initiate the measurement reporting procedure, as specified in 5.5.5;

3> if the *cellsTriggeredList* defined within the *VarMeasReportList* for this *measId* is empty:

4> remove the measurement reporting entry within the *VarMeasReportList* for this *measId*;

4> stop the periodical reporting timer for this *measId*, if running;

...

2> upon the expiry of T321 for this *measId*:

3> include a measurement reporting entry within the *VarMeasReportList* for this *measId*;

3> set the *numberOfReportsSent* defined within the *VarMeasReportList* for this *measId* to 0;

3> initiate the measurement reporting procedure, as specified in 5.5.5.

[TS 38.331, clause 5.5.4.9]

The UE shall:

1> consider the entering condition for this event to be satisfied when both condition B2-1 and condition B2-2, as specified below, are fulfilled;

1> consider the leaving condition for this event to be satisfied when condition B2-3 or condition B2-4, i.e. at least one of the two, as specified below, is fulfilled;

Inequality B2-1 (Entering condition 1)

$$M_p + H_{ys} < Thresh1$$

Inequality B2-2 (Entering condition 2)

$$M_n + O_{fn} + O_{cn} - H_{ys} > Thresh2$$

Inequality B2-3 (Leaving condition 1)

$$M_p - H_{ys} > Thresh1$$

Inequality B2-4 (Leaving condition 2)

$$M_n + O_{fn} + O_{cn} + H_{ys} < Thresh2$$

The variables in the formula are defined as follows:

M_p is the measurement result of the PCell, not taking into account any offsets.

M_n is the measurement result of the inter-RAT neighbour cell, not taking into account any offsets.

O_{fn} is the measurement object specific offset of the frequency of the inter-RAT neighbour cell (i.e. *eutra-Q-OffsetRange* as defined within the *measObjectEUTRA* corresponding to the frequency of the inter-RAT neighbour cell).

O_{cn} is the cell specific offset of the inter-RAT neighbour cell (i.e. *cellIndividualOffset* as defined within the *measObjectEUTRA* corresponding to the neighbour inter-RAT cell), and set to zero if not configured for the neighbour cell.

H_{ys} is the hysteresis parameter for this event (i.e. *hysteresis* as defined within *reportConfigInterRAT* for this event).

Thresh1 is the threshold parameter for this event (i.e. *b2-Threshold1* as defined within *reportConfigInterRAT* for this event).

Thresh2 is the threshold parameter for this event (i.e. *b2-Threshold2EUTRA* as defined within *reportConfigInterRAT* for this event).

Mp is expressed in dBm in case of RSRP, or in dB in case of RSRQ and SINR.

Mn is expressed in dBm or dB, depending on the measurement quantity of the inter-RAT neighbour cell.

Ofn, Ocn, Hys are expressed in dB.

Thresh1 is expressed in the same unit as **Mp**.

Thresh2 is expressed in the same unit as **Mn**.

[TS 38.331, clause 5.5.5]



Figure 5.5.5-1: Measurement reporting

The purpose of this procedure is to transfer measurement results from the UE to the network. The UE shall initiate this procedure only after successful security activation.

For the *measId* for which the measurement reporting procedure was triggered, the UE shall set the *measResults* within the *MeasurementReport* message as follows:

- 1> set the *measId* to the measurement identity that triggered the measurement reporting;
- 1> set the *measResultServingCell* within *measResultServingMOList* to include, for each NR serving cell that is configured with *servingCellMO*, RSRP, RSRQ and the available SINR, derived based on the *rsType* if indicated in the associated *reportConfig*, otherwise based on SSB if available, otherwise based on CSI-RS;
- 1> set the *measResultServingCell* within *measResultServingMOList* to include for each NR serving cell that is configured with *servingCellMO*, if any, the *servCellId*;
- 1> if the *reportConfig* associated with the *measId* that triggered the measurement reporting includes *reportQuantityRSIndexes* and *maxNrofRSIndexesToReport*:
 - 2> for each serving cell configured with *servingCellMO*, include beam measurement information according to the associated *reportConfig* as described in 5.5.5.2;
- ...
- 1> if there is at least one applicable neighbouring cell to report:
 - 2> if the *reportType* is set to *eventTriggered* or *periodical*:
 - 3> set the *measResultNeighCells* to include the best neighbouring cells up to *maxReportCells* in accordance with the following:
 - 4> if the *reportType* is set to *eventTriggered*:
 - 5> include the cells included in the *cellsTriggeredList* as defined within the *VarMeasReportList* for this *measId*;
 - ...
 - 4> for each cell that is included in the *measResultNeighCells*, include the *physCellId*;
 - 4> if the *reportType* is set to *eventTriggered* or *periodical*:

5> for each included cell, include the layer 3 filtered measured results in accordance with the *reportConfig* for this *measId*, ordered as follows:

6> if the *measObject* associated with this *measId* concerns NR:

7> if *rsType* in the associated *reportConfig* is set to *ssb*:

8> set *resultsSSB-Cell* within the *measResult* to include the SS/PBCH block based quantity(ies) indicated in the *reportQuantityCell* within the concerned *reportConfig*, in decreasing order of the sorting quantity, determined as specified in 5.5.5.3, i.e. the best cell is included first:

9> if *reportQuantityRsIndexes* and *maxNrofRSIndexesToReport* are configured, include beam measurement information as described in 5.5.5.2;

...

6> if the *measObject* associated with this *measId* concerns E-UTRA:

7> set the *measResult* to include the quantity(ies) indicated in the *reportQuantity* within the concerned *reportConfigInterRAT* in decreasing order of the sorting quantity, determined as specified in 5.5.5.3, i.e. the best cell is included first;

...

1> increment the *numberOfReportsSent* as defined within the *VarMeasReportList* for this *measId* by 1;

1> stop the periodical reporting timer, if running;

...

1> if the UE is configured with EN-DC:

2> if SRB3 is configured:

3> submit the *MeasurementReport* message via SRB3 to lower layers for transmission, upon which the procedure ends;

2> else:

3> submit the *MeasurementReport* message via the EUTRA MCG embedded in E-UTRA RRC message *ULInformationTransferMRDC* as specified in TS 36.331 [10].

1> else:

2> submit the *MeasurementReport* message to lower layers for transmission, upon which the procedure ends.

8.1.3.2.2.3 Test description

8.1.3.2.2.3.1 Pre-test conditions

System Simulator:

- NR Cell 1 is the PCell, E-UTRA Cell 1 is the inter-RAT neighbour cell of NR Cell 1.
- NR Cell 1 is configured to operate in FR1 bands as defined in TS 38.508-1 [4] clause 6.2.3.
- System information combination NR-6 as defined in TS 38.508-1 [4] clause 4.4.3.1.2.

UE:

- None.

Preamble:

- The UE is in state 3N-A as defined in TS 38.508-1 [4], subclause 4.4A.

8.1.3.2.2.3.2 Test procedure sequence

Table 8.1.3.2.2.3.2-1 illustrates the downlink power levels to be applied for NR Cell 1, and E-UTRA Cell 1 at various time instants of the test execution. Row marked "T0" denotes the conditions after the preamble, while the configuration marked "T1" is applied at the point indicated in the Main behaviour description in Table 8.1.3.2.2.3.2-3.

Table 8.1.3.2.2.3.2-1: Time instances of cell power level and parameter changes for conducted test environment

	Parameter	Unit	NR Cell 1	E-UTRA Cell 1	Remark
T0	SS/PBCH SSS EPRE	dBm/SCS	-78	-	Power levels are such that entry condition 1 for event B2 is not satisfied and entry condition 2 is satisfied: $M_p + H_{ys} > Thresh1$ and $M_n + O_{fn} + O_{cn} - H_{ys} > Thresh2$
	Cell-specific RS EPRE	dBm/15 kHz		-73	
T1	SS/PBCH SSS EPRE	dBm/SCS	-90	-	Power levels are such that entry condition for event B2 is satisfied: $M_p + H_{ys} < Thresh1$ and $M_n + O_{fn} + O_{cn} - H_{ys} > Thresh2$
	Cell-specific RS EPRE	dBm/15 kHz		-73	

Table 8.1.3.2.2.3.2-2: Void

Table 8.1.3.2.2.3.2-3: Main behaviour

St	Procedure	Message Sequence		TP	Verdict
		U - S	Message		
1	The SS transmits an <i>RRCReconfiguration</i> message including <i>MeasConfig</i> to setup inter-RAT measurement and reporting for event B2.	<--	NR RRC: <i>RRCReconfiguration</i>	-	-
2	The UE transmits an <i>RRCReconfigurationComplete</i> message.	-->	NR RRC: <i>RRCReconfigurationComplete</i>	-	-
3	Check: Does the UE transmit a <i>MeasurementReport</i> message within the next 10s?	-->	NR RRC: <i>MeasurementReport</i>	1	F
4	SS re-adjusts the cell-specific reference signal level according to row "T1" in table 8.1.3.2.2.3.2-1.	-	-	-	-
5	Check: Does the UE transmit a <i>MeasurementReport</i> message to report event B2 with the measured RSRP value for NR Cell 1?	-->	NR RRC: <i>MeasurementReport</i>	2	P

8.1.3.2.2.3.3 Specific message contents

Table 8.1.3.2.2.3.3-1: *RRCReconfiguration* (step 1, Table 8.1.3.2.2.3.2-3)

Derivation Path: TS 38.508-1 [4] Table 4.6.1-13 with condition NR_MEAS
--

Table 8.1.3.2.2.3.3-2: *MeasConfig* (Table 8.1.3.2.2.3.3-1)

Derivation Path: TS 38.508-1 [4] Table 4.6.3-69			
Information Element	Value/remark	Comment	Condition
MeasConfig ::= SEQUENCE {			

measObjectToAddModList SEQUENCE (SIZE (1..maxNrofMeasId)) OF MeasObjectToAddMod {	2 entries		
MeasObjectToAddMod[1] SEQUENCE {		entry 1	
measObjectId	1	MeasObjectIdNR-f1	
measObject CHOICE {			
measObjectNR SEQUENCE {			
ssbFrequency	ssbFrequency IE equals the ARFCN for NR Cell 1		
absThreshSS-BlocksConsolidation	Not present		
}			
}			
MeasObjectToAddMod[2] SEQUENCE {		entry 2	
measObjectId	2	MeasObjectIdE-UTRA-f1	
measObject CHOICE {			
measObjectEUTRA SEQUENCE {			
carrierFreq	ARFCN-ValueEUTRA for E-UTRA Cell 1		
}			
}			
}			
reportConfigToAddModList SEQUENCE(SIZE (1..maxReportConfigId)) OF ReportConfigToAddMod {	1 entry		
ReportConfigToAddMod[1] SEQUENCE {		entry 1	
reportConfigId	1		
reportConfig CHOICE {			
reportConfigInterRAT	ReportConfigInterRAT-EventB2	Table 8.1.3.2.2.3.3-3	
}			
}			
measIdToAddModList SEQUENCE (SIZE (1..maxNrofMeasId)) OF MeasIdToAddMod {	1 entry		
MeasIdToAddMod[1] SEQUENCE {		entry 1	
measId	1		
measObjectId	2		
reportConfigId	1		
}			
quantityConfig	QuantityConfig with Condition INTER-RAT		
measGapConfig	MeasGapConfig		
}			

Table 8.1.3.2.2.3.3-3: ReportConfigInterRAT-EventB2 (Table 8.1.3.2.2.3.3-2)

Derivation Path: TS 38.508-1 [4] Table 4.6.3-141 with condition EVENT_B2			
Information Element	Value/remark	Comment	Condition
ReportConfigNR ::= SEQUENCE {			
reportType CHOICE {			
eventTriggered SEQUENCE {			
eventId CHOICE {			
eventB2 SEQUENCE {			
b2-Threshold1 SEQUENCE {			
rsrp	73	-83dBm	
}			
b2-Threshold2EUTRA SEQUENCE {			
rsrp	58	-83dBm	
}			
}			
}			
}			
}			
reportAmount	r1		

}			
}			
}			

Table 8.1.3.2.2.3.3-4: MeasurementReport (step 5, Table 8.1.3.2.2.3.2-3)

Derivation Path: TS 38.508-1 [4] Table 4.6.1-5A			
Information Element	Value/remark	Comment	Condition
MeasurementReport ::= SEQUENCE {			
criticalExtensions CHOICE {			
measurementReport SEQUENCE {			
measResults SEQUENCE {			
measId	1		
measResultServingMOList SEQUENCE (SIZE (1..maxNrofServingCells)) OF MeasResultServMO {	1 entry	Report NR Cell 1	
MeasResultServMO[1] SEQUENCE {		entry 1	
servCellId	ServCellIndex of NR Cell 1		
measResultServingCell SEQUENCE {			
physCellId	Physical layer cell identity of NR Cell 1		
measResult SEQUENCE {			
cellResults SEQUENCE {			
resultsSSB-Cell SEQUENCE {			
rsrp	(0..127)		
rsrq	(0..127)		
sinr	Not present		
}	Not checked		pc_ss_SINR_Meas
}			
}			
}			
}			
}			
}			
}			
}			
measResultNeighCells CHOICE {			
measResultListEUTRA SEQUENCE (SIZE (1..maxCellReport)) OF MeasResultEUTRA {	1 entry	Report E-UTRA neighbour cell	
MeasResultEUTRA[1] SEQUENCE {		entry 1	
eutra-PhysCellId	Physical layer cell identity of E-UTRA Cell 1		
measResult SEQUENCE {			
rsrp	(0..97)		
rsrq	(0..34)		
sinr	Not present		
}			
cgi-Info	Not present		
}			
}			
}			

8.1.3.2.3 Measurement configuration control and reporting / Inter-RAT measurements / Event B2 / Measurement of E-UTRA cells / RSRQ based measurements

8.1.3.2.3.1 Test Purpose (TP)

(1)

with { UE is NR RRC_CONNECTED state and inter-RAT measurement event B2 to measure neighbor E-UTRA cell is configured and triggerQuantity set to rsrq }

```

ensure that {
  when { Entering condition 1 and 2 for event B2 is not met }
    then { UE does not send MeasurementReport }
}

```

(2)

```

with { UE is NR RRC_CONNECTED state and inter-RAT measurement event B2 to measure neighbor E-UTRA
cell is configured and triggerQuantity set to rsrq }
ensure that {
  when { Entering condition 1 and 2 for event B2 is met }
    then { UE transmits a MeasurementReport }
}

```

8.1.3.2.3.2 Conformance requirements

References: The conformance requirements covered in the present TC are specified in: TS 38.331, clause 5.3.5.3, 5.5.2.1, 5.5.4.1, 5.5.4.9 and 5.5.5.

[TS 38.331, clause 5.3.5.3]

The UE shall perform the following actions upon reception of the *RRCReconfiguration*:

...

- 1> if the *RRCReconfiguration* message includes the *measConfig*:
 - 2> perform the measurement configuration procedure as specified in 5.5.2;

...

[TS 38.331, clause 5.5.2.1]

The UE shall:

- 1> if the received *measConfig* includes the *measObjectToRemoveList*:
 - 2> perform the measurement object removal procedure as specified in 5.5.2.4;
- 1> if the received *measConfig* includes the *measObjectToAddModList*:
 - 2> perform the measurement object addition/modification procedure as specified in 5.5.2.5;
- 1> if the received *measConfig* includes the *reportConfigToRemoveList*:
 - 2> perform the reporting configuration removal procedure as specified in 5.5.2.6;
- 1> if the received *measConfig* includes the *reportConfigToAddModList*:
 - 2> perform the reporting configuration addition/modification procedure as specified in 5.5.2.7;
- 1> if the received *measConfig* includes the *quantityConfig*:
 - 2> perform the quantity configuration procedure as specified in 5.5.2.8;
- 1> if the received *measConfig* includes the *measIdToRemoveList*:
 - 2> perform the measurement identity removal procedure as specified in 5.5.2.2;
- 1> if the received *measConfig* includes the *measIdToAddModList*:
 - 2> perform the measurement identity addition/modification procedure as specified in 5.5.2.3;
- 1> if the received *measConfig* includes the *measGapConfig*:
 - 2> perform the measurement gap configuration procedure as specified in 5.5.2.9;
- 1> if the received *measConfig* includes the *measGapSharingConfig*:

- 2> perform the measurement gap sharing configuration procedure as specified in 5.5.2.11;
- 1> if the received *measConfig* includes the *s-MeasureConfig*:
 - 2> if *s-MeasureConfig* is set to *ssb-RSRP*, set parameter *ssb-RSRP* of *s-MeasureConfig* within *VarMeasConfig* to the lowest value of the RSRP ranges indicated by the received value of *s-MeasureConfig*;
 - 2> else, set parameter *csi-RSRP* of *s-MeasureConfig* within *VarMeasConfig* to the lowest value of the RSRP ranges indicated by the received value of *s-MeasureConfig*.

[TS 38.331, clause 5.5.4.1]

If security has been activated successfully, the UE shall:

- 1> for each *measId* included in the *measIdList* within *VarMeasConfig*:
 - 2> if the corresponding *reportConfig* includes a *reportType* set to *eventTriggered* or *periodical*;
 - ...
 - 3> else if the corresponding *measObject* concerns E-UTRA;
 - 4> consider any neighbouring cell detected on the associated frequency to be applicable when the concerned cell is not included in the *blackCellsToAddModListEUTRAN* defined within the *VarMeasConfig* for this *measId*;
 - ...
 - 2> if the *reportType* is set to *eventTriggered* and if the entry condition applicable for this event, i.e. the event corresponding with the *eventId* of the corresponding *reportConfig* within *VarMeasConfig*, is fulfilled for one or more applicable cells for all measurements after layer 3 filtering taken during *timeToTrigger* defined for this event within the *VarMeasConfig*, while the *VarMeasReportList* does not include a measurement reporting entry for this *measId* (a first cell triggers the event):
 - 3> include a measurement reporting entry within the *VarMeasReportList* for this *measId*;
 - 3> set the *numberOfReportsSent* defined within the *VarMeasReportList* for this *measId* to 0;
 - 3> include the concerned cell(s) in the *cellsTriggeredList* defined within the *VarMeasReportList* for this *measId*;
 - 3> initiate the measurement reporting procedure, as specified in 5.5.5;
 - 2> else if the *reportType* is set to *eventTriggered* and if the entry condition applicable for this event, i.e. the event corresponding with the *eventId* of the corresponding *reportConfig* within *VarMeasConfig*, is fulfilled for one or more applicable cells not included in the *cellsTriggeredList* for all measurements after layer 3 filtering taken during *timeToTrigger* defined for this event within the *VarMeasConfig* (a subsequent cell triggers the event):
 - 3> set the *numberOfReportsSent* defined within the *VarMeasReportList* for this *measId* to 0;
 - 3> include the concerned cell(s) in the *cellsTriggeredList* defined within the *VarMeasReportList* for this *measId*;
 - 3> initiate the measurement reporting procedure, as specified in 5.5.5;
 - 2> else if the *reportType* is set to *eventTriggered* and if the leaving condition applicable for this event is fulfilled for one or more of the cells included in the *cellsTriggeredList* defined within the *VarMeasReportList* for this *measId* for all measurements after layer 3 filtering taken during *timeToTrigger* defined within the *VarMeasConfig* for this event:
 - 3> remove the concerned cell(s) in the *cellsTriggeredList* defined within the *VarMeasReportList* for this *measId*;
 - 3> if *reportOnLeave* is set to *TRUE* for the corresponding reporting configuration:
 - 4> initiate the measurement reporting procedure, as specified in 5.5.5;

- 3> if the *cellsTriggeredList* defined within the *VarMeasReportList* for this *measId* is empty:
 - 4> remove the measurement reporting entry within the *VarMeasReportList* for this *measId*;
 - 4> stop the periodical reporting timer for this *measId*, if running;
- ...
- 2> upon the expiry of T321 for this *measId*:
 - 3> include a measurement reporting entry within the *VarMeasReportList* for this *measId*;
 - 3> set the *numberOfReportsSent* defined within the *VarMeasReportList* for this *measId* to 0;
 - 3> initiate the measurement reporting procedure, as specified in 5.5.5.

[TS 38.331, clause 5.5.4.9]

The UE shall:

- 1> consider the entering condition for this event to be satisfied when both condition B2-1 and condition B2-2, as specified below, are fulfilled;
- 1> consider the leaving condition for this event to be satisfied when condition B2-3 or condition B2-4, i.e. at least one of the two, as specified below, is fulfilled;

Inequality B2-1 (Entering condition 1)

$$Mp + Hys < Thresh1$$

Inequality B2-2 (Entering condition 2)

$$Mn + Ofn + Ocn - Hys > Thresh2$$

Inequality B2-3 (Leaving condition 1)

$$Mp - Hys > Thresh1$$

Inequality B2-4 (Leaving condition 2)

$$Mn + Ofn + Ocn + Hys < Thresh2$$

The variables in the formula are defined as follows:

Mp is the measurement result of the PCell, not taking into account any offsets.

Mn is the measurement result of the inter-RAT neighbour cell, not taking into account any offsets.

Ofn is the measurement object specific offset of the frequency of the inter-RAT neighbour cell (i.e. *eutra-Q-OffsetRange* as defined within the *measObjectEUTRA* corresponding to the frequency of the inter-RAT neighbour cell).

Ocn is the cell specific offset of the inter-RAT neighbour cell (i.e. *cellIndividualOffset* as defined within the *measObjectEUTRA* corresponding to the neighbour inter-RAT cell), and set to zero if not configured for the neighbour cell.

Hys is the hysteresis parameter for this event (i.e. *hysteresis* as defined within *reportConfigInterRAT* for this event).

Thresh1 is the threshold parameter for this event (i.e. *b2-Threshold1* as defined within *reportConfigInterRAT* for this event).

Thresh2 is the threshold parameter for this event (i.e. *b2-Threshold2EUTRA* as defined within *reportConfigInterRAT* for this event).

Mp is expressed in dBm in case of RSRP, or in dB in case of RSRQ and SINR.

Mn is expressed in dBm or dB, depending on the measurement quantity of the inter-RAT neighbour cell.

Ofn, *Ocn*, *Hys* are expressed in dB.

Thresh1 is expressed in the same unit as *Mp*.

Thresh2 is expressed in the same unit as *Mn*.

[TS 38.331, clause 5.5.5.1]



Figure 5.5.5.1-1: Measurement reporting

For the *measId* for which the measurement reporting procedure was triggered, the UE shall set the *measResults* within the *MeasurementReport* message as follows:

- 1> set the *measId* to the measurement identity that triggered the measurement reporting;
- 1> set the *measResultServingCell* within *measResultServingMOList* to include, for each NR serving cell that is configured with *servingCellMO*, RSRP, RSRQ and the available SINR, derived based on the *rsType* if indicated in the associated *reportConfig*, otherwise based on SSB if available, otherwise based on CSI-RS;
- 1> set the *servCellId* within *measResultServingMOList* to include each NR serving cell that is configured with *servingCellMO*, if any;
- 1> if the *reportConfig* associated with the *measId* that triggered the measurement reporting includes *reportQuantityRS-Indexes* and *maxNrofRS-IndexesToReport*:
 - 2> for each serving cell configured with *servingCellMO*, include beam measurement information according to the associated *reportConfig* as described in 5.5.5.2;
- ...
- 1> if there is at least one applicable neighbouring cell to report:
 - 2> if the *reportType* is set to *eventTriggered* or *periodical*:
 - 3> set the *measResultNeighCells* to include the best neighbouring cells up to *maxReportCells* in accordance with the following:
 - 4> if the *reportType* is set to *eventTriggered*:
 - 5> include the cells included in the *cellsTriggeredList* as defined within the *VarMeasReportList* for this *measId*;
 - ...
 - 4> for each cell that is included in the *measResultNeighCells*, include the *physCellId*;
 - 4> if the *reportType* is set to *eventTriggered* or *periodical*:
 - 5> for each included cell, include the layer 3 filtered measured results in accordance with the *reportConfig* for this *measId*, ordered as follows:
 - ...
 - 6> if the *measObject* associated with this *measId* concerns E-UTRA:

- 7> set the *measResult* to include the quantity(ies) indicated in the *reportQuantity* within the concerned *reportConfigInterRAT* in decreasing order of the sorting quantity, determined as specified in 5.5.5.3, i.e. the best cell is included first;

...

1> increment the *numberOfReportsSent* as defined within the *VarMeasReportList* for this *measId* by 1;

1> stop the periodical reporting timer, if running;

1> if the *numberOfReportsSent* as defined within the *VarMeasReportList* for this *measId* is less than the *reportAmount* as defined within the corresponding *reportConfig* for this *measId*:

2> start the periodical reporting timer with the value of *reportInterval* as defined within the corresponding *reportConfig* for this *measId*;

...

1> else:

2> submit the *MeasurementReport* message to lower layers for transmission, upon which the procedure ends.

8.1.3.2.3.3 Test description

8.1.3.2.3.3.1 Pre-test conditions

System Simulator:

- Cell 1 is the NR serving cell, E-UTRA Cell 1 is the inter-RAT neighbour cell.
- NR Cell 1 is configured to operate in FR1 bands as defined in TS 38.508-1 [4] clause 6.2.3.
- System information combination NR-6 as defined in TS 38.508-1 [4] clause 4.4.3.1.2, and message contents defined in clause 4.6.1 and clause 4.6.2 with QBASED condition is used in NR cells.

UE:

- None.

Preamble:

- The UE is in state 3N-A as defined in TS 38.508-1 [4], subclause 4.4A on NR Cell 1.

8.1.3.2.3.3.2 Test procedure sequence

Table 8.1.3.2.3.3.2-1 illustrates the downlink power levels to be applied for NR Cell 1 and E-UTRA Cell 1 at various time instants of the test execution for FR1. Row marked "T0" denotes the conditions after the preamble, while rows marked "T1" and "T2" are to be applied subsequently. The exact instants on which these values shall be applied are described in the texts in this clause.

Table 8.1.3.2.3.3.2-1: Time instances of cell power level and parameter changes for conducted test environment

	Parameter	Unit	NR Cell 1	E-UTRA Cell	Remark
T0	SS/PBCH SSS EPRE	dBm/SCS	-88	-	Power levels are such that entry condition for event B2 is not satisfied: $Mp + Hys \geq Thresh1$ or $Mn + Ofn + Ocn - Hys \leq Thresh2$
	SS-RSRQ	dB	-11.74	-	
	Cell-specific RS EPRE	dBm/15kHz	-	-94	
	RSRQ	dB	-	-11.46	
	Noc	dBm/SCS	-94	-	
	Noc	dBm/15kHz	-	-94	

T1	SS/PBCH SSS EPRE	dBm/SCS	-88	-	Power levels are such that entry condition for event B2 is satisfied: $Mp + Hys < Thresh1$ and $Mn + Ofn + Ocn - Hys > Thresh2$
	SS-RSRQ	dB	-11.74	-	
	Cell-specific RS EPRE	dBm/15kHz	-	-80	
	RSRQ	dB	-	-3.94	

Table 8.1.3.2.3.3.2-2: Void

Table 8.1.3.2.3.3.2-3: Main behaviour

St	Procedure	Message Sequence		TP	Verdict
		U - S	Message		
1	The SS transmits an <i>RRCReconfiguration</i> message on NR Cell 1 including <i>MeasConfig</i> to setup inter-RAT measurement and reporting for event B2	<--	NR RRC: <i>RRCReconfiguration</i>	-	-
2	The UE transmits an <i>RRCReconfigurationComplete</i> message on NR Cell 1.	-->	NR RRC: <i>RRCReconfigurationComplete</i>	-	-
3	Check: Does the UE transmit a <i>MeasurementReport</i> message on NR Cell 1 within the next 10s?	-->	NR RRC: <i>MeasurementReport</i>	1	F
4	The SS re-adjusts the cell-specific reference signal level according to row "T1" in Table 8.1.3.2.3.3.2-1.	-	-	-	-
5	Check: Does the UE transmit a <i>MeasurementReport</i> message on Cell 1 to report event B2 with the measured RSRP and RSRQ values for E-UTRA Cell 1?	-->	NR RRC: <i>MeasurementReport</i>	2	P

8.1.3.2.3.3.3 Specific message contents

Table 8.1.3.2.3.3.3-1: *RRCReconfiguration* (step 1, Table 8.1.3.2.3.3.2-3)

Derivation Path: TS 38.508-1 [4] table 4.6.1-13 with condion NR_MEAS

Table 8.1.3.2.3.3.3-2: *MeasConfig* (step 1, Table 8.1.3.2.3.3.2-3)

Derivation Path: TS 38.508-1 [4] table 4.6.3-69			
Information Element	Value/Remark	Comment	Condition
<i>MeasConfig</i> ::= SEQUENCE {			
<i>measObjectToAddModList</i> SEQUENCE (SIZE (1..maxNrofMeasId)) OF <i>MeasObjectToAddMod</i> {	2 entries		
<i>MeasObjectToAddMod</i> [1] SEQUENCE {		entry 1	
<i>measObjectId</i>	1		
<i>measObject</i> CHOICE {			
<i>measObjectNR</i>	<i>MeasObjectNR</i> -f1	Table 8.1.3.2.3.3.3-3	
}			
}			
<i>MeasObjectToAddMod</i> [2] SEQUENCE {		entry 2	
<i>measObjectId</i>	2		
<i>measObject</i> CHOICE {			
<i>measObjectEUTRA</i>	<i>MeasObjectEUTRA</i> -f2	Table 8.1.3.2.3.3.3-4	
}			
}			

}			
}			
}			
reportConfigToAddModList SEQUENCE(SIZE (1..maxReportConfigId)) OF ReportConfigToAddMod {	1 entry		
ReportConfigToAddMod[1] SEQUENCE {		entry 1	
reportConfigId	ReportConfigId		
reportConfig CHOICE {			
reportConfigInterRAT	ReportConfigInterRAT-B2	Table 8.1.3.2.3.3.3-5	
}			
}			
}			
measIdToAddModList SEQUENCE (SIZE (1..maxNrofMeasId)) OF MeasIdToAddMod {	1 entry		
MeasIdToAddMod[1] SEQUENCE {		entry 1	
measId	1		
measObjectId	2		
reportConfigId	ReportConfigId		
}			
}			
quantityConfig	QuantityConfig with condition INTER-RAT		
measGapConfig	MeasGapConfig	Table 8.1.3.2.3.3.3-6	
}			

Table 8.1.3.2.3.3.3-3: MeasObjectNR-f1 (Table 8.1.3.2.3.3.3-2)

Derivation Path: TS 38.508-1 [4], Table 4.6.3-76			
Information Element	Value/remark	Comment	Condition
MeasObjectNR ::= SEQUENCE {			
ssbFrequency	Downlink ARFCN of NR cell 1 SSB		
absThreshSS-BlocksConsolidation	Not present		
}			

Table 8.1.3.2.3.3.3-4: MeasObjectEUTRA-f2 (Table 8.1.3.2.3.3.3-2)

Derivation Path: TS 38.508-1 [4], Table 4.6.3-74			
Information Element	Value/remark	Comment	Condition
MeasObjectEUTRA ::= SEQUENCE {			
carrierFreq	Downlink ARFCN of E-UTRA Cell 1		
}			

Table 8.1.3.2.3.3.3-5: ReportConfigInterRAT-B2 (Table 8.1.3.2.3.3.3-2)

Derivation Path: TS 38.508-1 [4], Table 4.6.3-141 with condition EVENT_B2			
Information Element	Value/remark	Comment	Condition
ReportConfigInterRAT ::= SEQUENCE {			
reportType CHOICE {			
eventTriggered SEQUENCE {			
eventId CHOICE {			
eventB2 SEQUENCE {			
b2-Threshold1 CHOICE {			
rsrq	79	Actual value = -4dB	
}			
b2-Threshold2EUTRA CHOICE {			
rsrq	23	Actual value = -8dB	
}			
}			
}			

}			
hysteresis	Hysteresis		
timeToTrigger	ms0		
}			
reportInterval	ReportInterval		
}			
}			
}			

Table 8.1.3.2.3.3.3-6: MeasGapConfig (Table 8.1.3.2.3.3.3-2)

Derivation Path: TS 38.508-1 [4], Table 4.6.3-70			
Information Element	Value/remark	Comment	Condition
MeasGapConfig ::= SEQUENCE {			
gapUE CHOICE {			
setup SEQUENCE {			
gapOffset	0		
mgl	ms6		
mgrp	ms40		
mgta	ms0		
}			
}			
}			

Table 8.1.3.2.3.3.3-7: MeasurementReport (steps 5, Table 8.1.3.2.3.3.3-2)

Derivation Path: TS 38.508-1 [4], table 4.6.1-5A			
Information Element	Value/remark	Comment	Condition
MeasurementReport ::= SEQUENCE {			
criticalExtensions CHOICE {			
measurementReport SEQUENCE {			
measResults SEQUENCE {			
measId	1	Step 5	
measResultServingMOList SEQUENCE (SIZE (1..maxNrofServingCells)) OF MeasResultServMO {			
MeasResultServMO[1] SEQUENCE {	1 entry	entry 1	
servCellId	ServCellIndex of NR serving cell		
measResultServingCell SEQUENCE {			
physCellId	PhysCellId of NR serving cell		
measResult SEQUENCE {			
cellResults SEQUENCE {			
resultsSSB-Cell SEQUENCE {			
rsrp	(0..127)		
rsrq	(0..127)		
sinr	Not present		
}	Not checked		pc_ss_SINR_Meas
}			
}			
}			
}			
}			
}			
}			
}			
measResultNeighCells CHOICE {			
MeasResultListEUTRA SEQUENCE (SIZE (1..maxCellReport)) OF MeasResultEUTRA {	1 entry		
MeasResultEUTRA[1] SEQUENCE {		entry 1	
eutra-PhysCellId	PhysCellId of E-UTRA Cell 1	Step 5	
measResult SEQUENCE {			
rsrp	(0..97)		

rsrq	(0..34)		
sinr	Not present		
}			
cgi-Info	Not present		
}			
}			
}			
}			
}			
}			

8.1.3.2.4 Measurement configuration control and reporting / Inter-RAT measurements / Event B2 / Measurement of E-UTRA cells / SINR based measurements

8.1.3.2.4.1 Test Purpose (TP)

(1)

```
with { UE is NR RRC_CONNECTED state and inter-RAT measurement event B2 to measure neighbor E-UTRA
cell is configured and triggerQuantity set to sinr }
ensure that {
  when { Entering condition 1 and 2 for event B2 is not met }
    then { UE does not transmit any MeasurementReport }
}
```

(2)

```
with { UE is NR RRC_CONNECTED state and inter-RAT measurement event B2 to measure neighbor E-UTRA
cell is configured and triggerQuantity set to sinr }
ensure that {
  when { Entering condition 1 and 2 for event B2 is met }
    then { UE transmits a MeasurementReport }
}
```

8.1.3.2.4.2 Conformance requirements

References: The conformance requirements covered in the current TC are specified in: TS 38.331, clauses 5.3.5.3, 5.5.2.1, 5.5.2.9, 5.5.4.1, 5.5.4.9 and 5.5.5.1. Unless otherwise stated these are Rel-15 requirements.

[TS 38.331, clause 5.3.5.3]

The UE shall perform the following actions upon reception of the *RRCReconfiguration*:

...

1> if the *RRCReconfiguration* message includes the *measConfig*:

2> perform the measurement configuration procedure as specified in 5.5.2;

...

1> if the UE is configured with E-UTRA *nr-SecondaryCellGroupConfig* (MCG is E-UTRA):

...

1> else:

2> submit the *RRCReconfigurationComplete* message via SRB1 to lower layers for transmission using the new configuration;

...

[TS 38.331, clause 5.5.2.1]

...

The UE shall:

...

1> if the received *measConfig* includes the *measObjectToAddModList*:

2> perform the measurement object addition/modification procedure as specified in 5.5.2.5;

...

1> if the received *measConfig* includes the *reportConfigToAddModList*:

2> perform the reporting configuration addition/modification procedure as specified in 5.5.2.7;

...

1> if the received *measConfig* includes the *measIdToAddModList*:

2> perform the measurement identity addition/modification procedure as specified in 5.5.2.3;

...

1> if the received *measConfig* includes the *measGapConfig*:

2> perform the measurement gap configuration procedure as specified in 5.5.2.9;

...

[TS 38.331, clause 5.5.2.9]

The UE shall:

...

1> if *gapUE* is set to *setup*:

2> if a per UE measurement gap configuration is already setup, release the per UE measurement gap configuration;

2> setup the per UE measurement gap configuration indicated by the *measGapConfig* in accordance with the received *gapOffset*, i.e., the first subframe of each gap occurs at an SFN and subframe meeting the following condition:

$$\text{SFN mod } T = \text{FLOOR}(\text{gapOffset}/10);$$

$$\text{subframe} = \text{gapOffset mod } 10;$$

with $T = \text{MGRP}/10$ as defined in TS 38.133 [14];

2> if *mgta* is configured, apply the specified timing advance to the gap occurrences calculated above (i.e. the UE starts the measurement *mgta* ms before the gap subframe occurrences);

...

[TS 38.331, clause 5.5.4.1]

If AS security has been activated successfully, the UE shall:

1> for each *measId* included in the *measIdList* within *VarMeasConfig*:

2> if the corresponding *reportConfig* includes a *reportType* set to *eventTriggered* or *periodical*:

...

3> else if the corresponding *measObject* concerns E-UTRA:

- 4> consider any neighbouring cell detected on the associated frequency to be applicable when the concerned cell is not included in the *blackCellsToAddModListEUTRAN* defined within the *VarMeasConfig* for this *measId*;

...

- 2> if the *reportType* is set to *eventTriggered* and if the entry condition applicable for this event, i.e. the event corresponding with the *eventId* of the corresponding *reportConfig* within *VarMeasConfig*, is fulfilled for one or more applicable cells for all measurements after layer 3 filtering taken during *timeToTrigger* defined for this event within the *VarMeasConfig*, while the *VarMeasReportList* does not include a measurement reporting entry for this *measId* (a first cell triggers the event):
 - 3> include a measurement reporting entry within the *VarMeasReportList* for this *measId*;
 - 3> set the *numberOfReportsSent* defined within the *VarMeasReportList* for this *measId* to 0;
 - 3> include the concerned cell(s) in the *cellsTriggeredList* defined within the *VarMeasReportList* for this *measId*;
 - 3> initiate the measurement reporting procedure, as specified in 5.5.5;
 - 2> else if the *reportType* is set to *eventTriggered* and if the entry condition applicable for this event, i.e. the event corresponding with the *eventId* of the corresponding *reportConfig* within *VarMeasConfig*, is fulfilled for one or more applicable cells not included in the *cellsTriggeredList* for all measurements after layer 3 filtering taken during *timeToTrigger* defined for this event within the *VarMeasConfig* (a subsequent cell triggers the event):
 - 3> set the *numberOfReportsSent* defined within the *VarMeasReportList* for this *measId* to 0;
 - 3> include the concerned cell(s) in the *cellsTriggeredList* defined within the *VarMeasReportList* for this *measId*;
 - 3> initiate the measurement reporting procedure, as specified in 5.5.5;
 - 2> else if the *reportType* is set to *eventTriggered* and if the leaving condition applicable for this event is fulfilled for one or more of the cells included in the *cellsTriggeredList* defined within the *VarMeasReportList* for this *measId* for all measurements after layer 3 filtering taken during *timeToTrigger* defined within the *VarMeasConfig* for this event:
 - 3> remove the concerned cell(s) in the *cellsTriggeredList* defined within the *VarMeasReportList* for this *measId*;
 - 3> if *reportOnLeave* is set to *true* for the corresponding reporting configuration:
 - 4> initiate the measurement reporting procedure, as specified in 5.5.5;
 - 3> if the *cellsTriggeredList* defined within the *VarMeasReportList* for this *measId* is empty:
 - 4> remove the measurement reporting entry within the *VarMeasReportList* for this *measId*;
 - 4> stop the periodical reporting timer for this *measId*, if running;
- ...
- 2> upon expiry of the periodical reporting timer for this *measId*:
 - 3> initiate the measurement reporting procedure, as specified in 5.5.5.
- ...

[TS 38.331, clause 5.5.4.9]

The UE shall:

- 1> consider the entering condition for this event to be satisfied when both condition B2-1 and condition B2-2, as specified below, are fulfilled;

1> consider the leaving condition for this event to be satisfied when condition B2-3 or condition B2-4, i.e. at least one of the two, as specified below, is fulfilled;

Inequality B2-1 (Entering condition 1)

$$M_p + H_{ys} < Thresh1$$

Inequality B2-2 (Entering condition 2)

$$M_n + Ofn + Ocn - H_{ys} > Thresh2$$

Inequality B2-3 (Leaving condition 1)

$$M_p - H_{ys} > Thresh1$$

Inequality B2-4 (Leaving condition 2)

$$M_n + Ofn + Ocn + H_{ys} < Thresh2$$

The variables in the formula are defined as follows:

M_p is the measurement result of the PCell, not taking into account any offsets.

M_n is the measurement result of the inter-RAT neighbour cell, not taking into account any offsets.

Ofn is the measurement object specific offset of the frequency of the inter-RAT neighbour cell (i.e. *extra-Q-OffsetRange* as defined within the *measObjectEUTRA* corresponding to the frequency of the inter-RAT neighbour cell).

Ocn is the cell specific offset of the inter-RAT neighbour cell (i.e. *cellIndividualOffset* as defined within the *measObjectEUTRA* corresponding to the neighbour inter-RAT cell), and set to zero if not configured for the neighbour cell.

H_{ys} is the hysteresis parameter for this event (i.e. *hysteresis* as defined within *reportConfigInterRAT* for this event).

Thresh1 is the threshold parameter for this event (i.e. *b2-Threshold1* as defined within *reportConfigInterRAT* for this event).

Thresh2 is the threshold parameter for this event (i.e. *b2-Threshold2EUTRA* as defined within *reportConfigInterRAT* for this event).

M_p is expressed in dBm in case of RSRP, or in dB in case of RSRQ and SINR.

M_n is expressed in dBm or dB, depending on the measurement quantity of the inter-RAT neighbour cell.

Ofn, Ocn, H_{ys} are expressed in dB.

Thresh1 is expressed in the same unit as ***M_p***.

Thresh2 is expressed in the same unit as ***M_n***.

[TS 38.331, clause 5.5.5.1]



Figure 5.5.5.1-1: Measurement reporting

The purpose of this procedure is to transfer measurement results from the UE to the network. The UE shall initiate this procedure only after successful AS security activation.

For the *measId* for which the measurement reporting procedure was triggered, the UE shall set the *measResults* within the *MeasurementReport* message as follows:

- 1> set the *measId* to the measurement identity that triggered the measurement reporting;
- 1> set the *measResultServingCell* within *measResultServingMOList* to include, for each NR serving cell that is configured with *servingCellMO*, RSRP, RSRQ and the available SINR, derived based on the *rsType* if indicated in the associated *reportConfig*, otherwise based on SSB if available, otherwise based on CSI-RS;
- 1> set the *servCellId* within *measResultServingMOList* to include each NR serving cell that is configured with *servingCellMO*, if any;
- ...
- 1> if there is at least one applicable neighbouring cell to report:
 - 2> if the *reportType* is set to *eventTriggered* or *periodical*:
 - 3> set the *measResultNeighCells* to include the best neighbouring cells up to *maxReportCells* in accordance with the following:
 - 4> if the *reportType* is set to *eventTriggered*:
 - 5> include the cells included in the *cellsTriggeredList* as defined within the *VarMeasReportList* for this *measId*;
 - ...
 - 4> for each cell that is included in the *measResultNeighCells*, include the *physCellId*;
 - 4> if the *reportType* is set to *eventTriggered* or *periodical*:
 - 5> for each included cell, include the layer 3 filtered measured results in accordance with the *reportConfig* for this *measId*, ordered as follows:
 - ...
 - 6> if the *measObject* associated with this *measId* concerns E-UTRA:
 - 7> set the *measResult* to include the quantity(ies) indicated in the *reportQuantity* within the concerned *reportConfigInterRAT* in decreasing order of the sorting quantity, determined as specified in 5.5.5.3, i.e. the best cell is included first;
 - ...
 - 1> increment the *numberOfReportsSent* as defined within the *VarMeasReportList* for this *measId* by 1;
 - 1> stop the periodical reporting timer, if running;
 - 1> if the *numberOfReportsSent* as defined within the *VarMeasReportList* for this *measId* is less than the *reportAmount* as defined within the corresponding *reportConfig* for this *measId*:
 - 2> start the periodical reporting timer with the value of *reportInterval* as defined within the corresponding *reportConfig* for this *measId*;
 - ...
 - 1> else:
 - 2> submit the *MeasurementReport* message to lower layers for transmission, upon which the procedure ends.

8.1.3.2.4.3 Test description

8.1.3.2.4.3.1 Pre-test conditions

System Simulator:

- NR Cell 1 is the serving cell, EUTRA Cell 1 is the inter-RAT neighbour cell of NR Cell 1.
- NR Cell 1 is configured to operate in FR1 bands as defined in TS 38.508-1 [4] clause 6.2.3.
- System information combination NR-7 as defined in TS 38.508-1 [4] clause 4.4.3.1.2, and message contents defined in clause 4.6.1 and clause 4.6.2 with QBASED condition is used in NR cells.

UE:

- None.

Preamble:

- The UE is in state 3N-A as defined in TS 38.508-1 [4], subclause 4.4A.

8.1.3.2.4.3.2 Test procedure sequence

Table 8.1.3.2.4.3.2-1 illustrates the downlink power levels to be applied for NR Cell 1 and EUTRA Cell 1 at various time instants of the test execution. Row marked "T0" denotes the conditions after the preamble, while the configuration marked "T1", is applied at the point indicated in the Main behaviour description in Table 8.1.3.2.4.3.2-3.

Table 8.1.3.2.4.3.2-1: Time instances of cell power level and parameter changes for NR Cell 1 and E-UTRA Cell 1 in conducted test environment

	Parameter	Unit	NR Cell 1	E-UTRA Cell 1	Remark
T0	SS/PBCH SSS EPRE	dBm/SCS	-79	-	Power levels are such that entry conditions for event B2 are not satisfied: 1) $Mp + Hys \geq Thresh1$ and 2) $Mn + Ofn + Ocn - Hys \leq Thresh2$
	Cell-specific RS EPRE	dBm/15 kHz	-	-91	
	Noc	dBm/15 kHz	-	-82	
	Noc	dBm/SCS	-94	-	
	SINR	-	15	-9	
T1	SS/PBCH SSS EPRE	dBm/SCS	-91	-	Power levels are such that entry condition for event B2 are satisfied: 1) $Mp + Hys < Thresh1$ and $Mn + Ofn + Ocn - Hys > Thresh2$
	Cell-specific RS EPRE	dBm/15 kHz	-	-73	
	Noc	dBm/15 kHz	-	-82	
	Noc	dBm/SCS	-94	-	
	SINR	-	3	9	

Table 8.1.3.2.4.3.2-2: Void

Table 8.1.3.2.4.3.2-3: Main behaviour

St	Procedure	Message Sequence		TP	Verdict
		U - S	Message		
1	The SS transmits an <i>RRCReconfiguration</i> message including <i>MeasConfig</i> to setup EUTRA measurement and reporting for inter-RAT event B2.	<--	NR RRC: <i>RRCReconfiguration</i>	-	-

2	The UE transmits an <i>RRCReconfigurationComplete</i> message.	-->	NR RRC: <i>RRCReconfigurationComplete</i>	-	-
3	Check: Does the UE transmit a <i>MeasurementReport</i> message with event B2 for EUTRA Cell 1 within the next 10s?	-	-	1	F
4	SS re-adjusts the cell-specific reference signal level according to row "T1" in table 8.1.3.2.4.3.2-1.	-	-	-	-
5	Check: Does the UE transmit a <i>MeasurementReport</i> message with event B2 for EUTRA Cell 1 within the next 10s?	-->	NR RRC: <i>MeasurementReport</i>	2	P

8.1.3.2.4.3.3 Specific message contents

Table 8.1.3.2.4.3.3-1: *RRCReconfiguration* (step 1, Table 8.1.3.2.4.3.2-3)

Derivation Path: TS 38.508-1 [4] Table 4.6.1-13 with condition NR_MEAS

Table 8.1.3.2.4.3.3-2: *MeasConfig* (Table 8.1.3.2.4.3.3-1)

Derivation Path: TS 38.508-1 [4] Table 4.6.3-69			
Information Element	Value/remark	Comment	Condition
<i>MeasConfig</i> ::= SEQUENCE {			
<i>measObjectToAddModList</i> SEQUENCE (SIZE (1..maxNrofMeasId)) OF <i>MeasObjectToAddMod</i> {	2 entries		
<i>MeasObjectToAddMod</i> [1] SEQUENCE {		entry 1	
<i>measObjectId</i>	1		
<i>measObject</i> CHOICE {			
<i>measObjectNR</i>	<i>MeasObjectNR</i> -f1	Table 8.1.3.2.4.3.3-3	
}			
}			
<i>MeasObjectToAddMod</i> [2] SEQUENCE {		entry 2	
<i>measObjectId</i>	2		
<i>measObject</i> CHOICE {			
<i>measObjectEUTRA</i>	<i>MeasObjectEUTRA</i> -f2	Table 8.1.3.2.4.3.3-4	
}			
}			
<i>reportConfigToAddModList</i> SEQUENCE(SIZE (1..maxReportConfigId)) OF <i>ReportConfigToAddMod</i> {	1 entry		
<i>ReportConfigToAddMod</i> [1] SEQUENCE {		entry 1	
<i>reportConfigId</i>	1		
<i>reportConfig</i> CHOICE {			
<i>reportConfigInterRAT</i>	<i>ReportConfigInterRAT</i> -EventB2	Table 8.1.3.2.4.3.3-5	
}			
}			
<i>measIdToAddModList</i> SEQUENCE (SIZE (1..maxNrofMeasId)) OF <i>MeasIdToAddMod</i> {	1 entry		
<i>MeasIdToAddMod</i> [1] SEQUENCE {		entry 1	
<i>measId</i>	1		
<i>measObjectId</i>	2		
<i>reportConfigId</i>	1		
}			
}			
<i>quantityConfig</i>	<i>QuantityConfig</i> with condition INTER-RAT		
<i>measGapConfig</i>	<i>MeasGapConfig</i>		
}			

Table 8.1.3.2.4.3.3-3: MeasObjectNR-f1 (Table 8.1.3.2.4.3.3-2)

Derivation Path: TS 38.508-1 [4], Table 4.6.3-76			
Information Element	Value/remark	Comment	Condition
MeasObjectNR ::= SEQUENCE {			
ssbFrequency	ARFCN-ValueNR for SSB of NR Cell 1		
absThreshSS-BlocksConsolidation	Not present		
nrofSS-BlocksToAverage	Not present		
}			

Table 8.1.3.2.4.3.3-4: MeasObjectEUTRA-f2 (Table 8.1.3.2.4.3.3-2)

Derivation Path: TS 38.508-1 [4], Table 4.6.3-74			
Information Element	Value/remark	Comment	Condition
MeasObjectEUTRA ::= SEQUENCE {			
carrierFreq	ARFCN-ValueEUTRA for CRS of E-UTRA Cell 1		
}			

Table 8.1.3.2.4.3.3-5: ReportConfigInterRAT-EventB2 (Table 8.1.3.2.4.3.3-2)

Derivation Path: TS 38.508-1 [4] Table 4.6.3-141 with condition EVENT_B2			
Information Element	Value/remark	Comment	Condition
ReportConfigInterRAT ::= SEQUENCE {			
reportType CHOICE {			
eventTriggered SEQUENCE {			
eventId CHOICE {			
eventB2 SEQUENCE {			
b2-Threshold1 CHOICE {			
sinr	64	Actual value = 9dB	
}			
b2-Threshold2EUTRA CHOICE {			
sinr	46	0 dB	
}			
hysteresis	4	2 dB	
}			
}			
reportAmount	r1		
reportQuantity SEQUENCE {			
rsrp	true		
rsrq	true		
sinr	true		
}			
}			
}			

Table 8.1.3.2.4.3.3-6: MeasurementReport (step 5, Table 8.1.3.2.4.3.2-3)

Derivation Path: TS 38.508-1 [4] Table 4.6.1-5A			
Information Element	Value/remark	Comment	Condition
MeasurementReport ::= SEQUENCE {			
criticalExtensions CHOICE {			
measurementReport SEQUENCE {			
measResults SEQUENCE {			
measId	1		
measResultServingMOList SEQUENCE (SIZE (1..maxNrofServingCells)) OF MeasResultServMO {	1 entry	Measurement report for NR Cell 1	
MeasResultServMO[1] SEQUENCE {		entry 1	

[TS 38.331, clause 5.5.4.1]

If AS security has been activated successfully, the UE shall:

- 1> for each *measId* included in the *measIdList* within *VarMeasConfig*:
 - 2> if the corresponding *reportConfig* includes a *reportType* set to *eventTriggered* or *periodical*:
 - ...
 - 3> else if the corresponding *measObject* concerns UTRA-FDD:
 - 4> if *eventB1-UTRA-FDD* or *eventB2-UTRA-FDD* is configured in the corresponding *reportConfig*; or
 - 4> if corresponding *reportConfig* includes *reportType* set to *periodical*:
 - 5> consider a neighbouring cell on the associated frequency to be applicable when the concerned cell is included in the *cellsToAddModList* defined within the *VarMeasConfig* for this *measId*;

...

- 2> if the *reportType* is set to *eventTriggered* and if the entry condition applicable for this event, i.e. the event corresponding with the *eventId* of the corresponding *reportConfig* within *VarMeasConfig*, is fulfilled for one or more applicable cells for all measurements after layer 3 filtering taken during *timeToTrigger* defined for this event within the *VarMeasConfig*, while the *VarMeasReportList* does not include a measurement reporting entry for this *measId* (a first cell triggers the event):
 - 3> include a measurement reporting entry within the *VarMeasReportList* for this *measId*;
 - 3> set the *numberOfReportsSent* defined within the *VarMeasReportList* for this *measId* to 0;
 - 3> include the concerned cell(s) in the *cellsTriggeredList* defined within the *VarMeasReportList* for this *measId*;
 - 3> if *useT312* is set to *true* in *reportConfig* for this event:
 - 4> if T310 for the corresponding SpCell is running; and
 - 4> if T312 is not running for corresponding SpCell:
 - 5> start timer T312 for the corresponding SpCell with the value of T312 configured in the corresponding *measObjectNR*;
 - 3> initiate the measurement reporting procedure, as specified in 5.5.5;

[TS 38.331, clause 5.5.4.8]

The UE shall:

- 1> consider the entering condition for this event to be satisfied when condition B1-1, as specified below, is fulfilled;
- 1> consider the leaving condition for this event to be satisfied when condition B1-2, as specified below, is fulfilled.

Inequality B1-1 (Entering condition)

$$Mn + Ofn + Ocn - Hys > Thresh$$

Inequality B1-2 (Leaving condition)

$$Mn + Ofn + Ocn + Hys < Thresh$$

The variables in the formula are defined as follows:

Mn is the measurement result of the inter-RAT neighbour cell, not taking into account any offsets.

Ofn is the measurement object specific offset of the frequency of the inter-RAT neighbour cell (i.e. *eutra-Q-OffsetRange* as defined within the *measObjectEUTRA* corresponding to the frequency of the neighbour inter-

RAT cell, *utra-FDD-Q-OffsetRange* as defined within the *measObjectUTRA-FDD* corresponding to the frequency of the neighbour inter-RAT cell).

Ocn is the cell specific offset of the inter-RAT neighbour cell (i.e. *cellIndividualOffset* as defined within the *measObjectEUTRA* corresponding to the neighbour inter-RAT cell), and set to zero if not configured for the neighbour cell.

Hys is the hysteresis parameter for this event (i.e. *hysteresis* as defined within *reportConfigInterRAT* for this event).

Thresh is the threshold parameter for this event (i.e. *b1-ThresholdEUTRA* as defined within *reportConfigInterRAT* for this event, *b1-ThresholdUTRA-FDD* as defined for UTRA-FDD within *reportConfigInterRAT* for this event).

Mn is expressed in dBm or in dB, depending on the measurement quantity of the inter-RAT neighbour cell.

Ofn, Ocn, Hys are expressed in dB.

Thresh is expressed in the same unit as **Mn**.

[TS 38.331, clause 5.5.5.1]

1> if there is at least one applicable neighbouring cell to report:

2> if the *reportType* is set to *eventTriggered* or *periodical*:

3> set the *measResultNeighCells* to include the best neighbouring cells up to *maxReportCells* in accordance with the following:

4> if the *reportType* is set to *eventTriggered*:

5> include the cells included in the *cellsTriggeredList* as defined within the *VarMeasReportList* for this *measId*;

4> else:

5> include the applicable cells for which the new measurement results became available since the last periodical reporting or since the measurement was initiated or reset;

4> for each cell that is included in the *measResultNeighCells*, include the *physCellId*;

4> if the *reportType* is set to *eventTriggered* or *periodical*:

5> for each included cell, include the layer 3 filtered measured results in accordance with the *reportConfig* for this *measId*, ordered as follows:

6> if the *measObject* associated with this *measId* concerns NR:

7> if *rsType* in the associated *reportConfig* is set to *ssb*:

8> set *resultsSSB-Cell* within the *measResult* to include the SS/PBCH block based quantity(ies) indicated in the *reportQuantityCell* within the concerned *reportConfig*, in decreasing order of the sorting quantity, determined as specified in 5.5.5.3, i.e. the best cell is included first;

8> if *reportQuantityRS-Indexes* and *maxNrofRS-IndexesToReport* are configured, include beam measurement information as described in 5.5.5.2;

7> else if *rsType* in the associated *reportConfig* is set to *csi-rs*:

8> set *resultsCSI-RS-Cell* within the *measResult* to include the CSI-RS based quantity(ies) indicated in the *reportQuantityCell* within the concerned *reportConfig*, in decreasing order of the sorting quantity, determined as specified in 5.5.5.3, i.e. the best cell is included first;

8> if *reportQuantityRS-Indexes* and *maxNrofRS-IndexesToReport* are configured, include beam measurement information as described in 5.5.5.2;

6> if the *measObject* associated with this *measId* concerns E-UTRA:

7> set the *measResult* to include the quantity(ies) indicated in the *reportQuantity* within the concerned *reportConfigInterRAT* in decreasing order of the sorting quantity, determined as specified in 5.5.5.3, i.e. the best cell is included first;

6> if the *measObject* associated with this *measId* concerns UTRA-FDD and if *ReportConfigInterRAT* includes the *reportQuantityUTRA-FDD*:

7> set the *measResult* to include the quantity(ies) indicated in the *reportQuantityUTRA-FDD* within the concerned *reportConfigInterRAT* in decreasing order of the sorting quantity, determined as specified in 5.5.5.3, i.e. the best cell is included first;

8.1.3.2.6.3 Test description

8.1.3.2.6.3.1 Pre-test conditions

System Simulator:

- NR Cell 1 is the PCell, UTRA Cell 5 is the inter-RAT neighbour cell of NR Cell 1.
- System information combination NR-1 as defined in TS 38.508-1 [4] clause 4.4.3.1.2.

UE:

- None.

Preamble:

- The UE is in state 3N-A as defined in TS 38.508-1 [4], subclause 4.4A.

8.1.3.2.6.3.2 Test procedure sequence

Table 8.1.3.2.6.3.2-1 and 8.1.3.2.6.3.2-2 illustrates the downlink power levels to be applied for NR Cell 1, and UTRA Cell 5 at various time instants of the test execution. Row marked "T0" denotes the conditions after the preamble, while the configuration marked "T1" is applied at the point indicated in the Main behaviour description in Table 8.1.3.2.6.3.2-3.

Table 8.1.3.2.6.3.2-1: Time instances of cell power level and parameter changes for FR1

	Parameter	Unit	NR Cell 1	UTRA Cell 5	Remark
T0	SS/PBCH SSS EPRE	dBm/SCS	-85	-	Power levels are such that entry condition for event B1 is not satisfied: $Mn + Ofn + Ocn + Hys < Thresh$
	Cell-specific CPICH_Ec	dBm/3.84 MHz	-	-93	
T1	SS/PBCH SSS EPRE	dBm/SCS	-85	-	Power levels are such that entry condition for event B1 is satisfied: $Mn + Ofn + Ocn - Hys > Thresh$
	Cell-specific CPICH_Ec	dBm/3.84 MHz	-	-73	

Table 8.1.3.2.6.3.2-2: Time instances of cell power level and parameter changes for FR2

	Parameter	Unit	NR Cell 1	UTRA Cell 5	Remark
T0	SS/PBCH SSS EPRE	dBm/SCS	-85	-	Power levels are such that entry condition for event B1 is not satisfied: $Mn + Ofn + Ocn + Hys < Thresh$
	Cell-specific CPICH_Ec	dBm/3.84 MHz	-	Off	
T1	SS/PBCH SSS EPRE	dBm/SCS	-85	-	Power levels are such that entry condition for event B1 is satisfied: $Mn + Ofn + Ocn - Hys > Thresh$
	Cell-specific CPICH_Ec	dBm/3.84 MHz	-	-60	

Table 8.1.3.2.6.3.2-3: Main behaviour

St	Procedure	Message Sequence		TP	Verdict
		U - S	Message		
1	The SS transmits an RRCReconfiguration message including MeasConfig to setup inter-RAT measurement and reporting for event B1.	<--	NR RRC: RRCReconfiguration	-	-
2	The UE transmits an RRCReconfigurationComplete message.	-->	NR RRC: RRCReconfigurationComplete	-	-
3	Check: Does the UE transmit a MeasurementReport message within the next 10s?	-->	NR RRC: MeasurementReport	1	F
4	SS re-adjusts the cell-specific reference signal level according to row "T1" in table 8.1.3.2.6.3.2-1/2.	-	-	-	-
5	Check: Does the UE transmit a MeasurementReport message to report event B1 with the measured RSRP value for NR Cell 1 and measured RSCP value for UTRA cell 5?	-->	NR RRC: MeasurementReport	2	P

8.1.3.2.6.3.3 Specific message contents

Table 8.1.3.2.6.3.3-1: RRCReconfiguration (step 1, Table 8.1.3.2.6.3.2-3)

Derivation Path: TS 38.508-1 [4], Table 4.6.1-13, condition NR_MEAS

Table 8.1.3.2.6.3.3-2: MeasConfig (Table 8.1.3.2.6.3.3-1)

Derivation Path: TS 38.508-1 [4] Table 4.6.3-69			
Information Element	Value/remark	Comment	Condition
MeasConfig ::= SEQUENCE {			
measObjectToAddModList SEQUENCE (SIZE (1..maxNrofMeasId)) OF MeasObjectToAddMod {	2 entries		
MeasObjectToAddMod[1] SEQUENCE {		entry 1	
measObjectId	1	MeasObjectIdNR-f1	
measObject CHOICE {			
measObjectNR SEQUENCE {			
ssbFrequency	ssbFrequency IE equals the ARFCN for NR Cell 1		
absThreshSS-BlocksConsolidation	Not present		
}			
}			
MeasObjectToAddMod[2] SEQUENCE {		entry 2	
measObjectId	2	MeasObjectIdUTRA-FDD-r16	
measObject CHOICE {			
measObjectUTRA-FDD-r16	MeasObjectUTRA-FDD	Table 8.1.3.2.6.3.3-2A	
}			
}			
reportConfigToAddModList SEQUENCE (SIZE (1..maxReportConfigId)) OF ReportConfigToAddMod {	1 entry		
ReportConfigToAddMod[1] SEQUENCE {		entry 1	
reportConfigId	1		
reportConfig CHOICE {			
reportConfigInterRAT	ReportConfigInterRAT	Table 8.1.3.2.6.3.3-3	
}			
}			
}			
}			

measIdToAddModList SEQUENCE (SIZE (1..maxNrofMeasId)) OF MeasIdToAddMod {	1 entry		
MeasIdToAddMod[1] SEQUENCE {		entry 1	
measId	1		
measObjectId	2		
reportConfigId	1		
}			
}			
quantityConfig	QuantityConfig with condition INTER-RAT_UTRA		
measGapConfig	MeasGapConfig		
}			

Table 8.1.3.2.6.3.3-2A: MeasObjectUTRA-FDD (Table 8.1.3.2.6.3.3-2)

Derivation Path: TS 38.508-1 [4], Table 4.6.3-77A			
Information Element	Value/remark	Comment	Condition
MeasObjectUTRA-FDD-r16 ::= SEQUENCE {			
carrierFreq-r16	ARFCN-ValueUTRA-FDD-r16 for UTRA Cell 5		
}			

Table 8.1.3.2.6.3.3-3: ReportConfigInterRAT (Table 8.1.3.2.6.3.3-2)

Derivation Path: TS 38.508-1 [4] Table 4.6.3-141 with condition EVENT_B1_UTRA			
Information Element	Value/remark	Comment	Condition
ReportConfigInterRAT ::= SEQUENCE {			
reportType CHOICE {			
eventTriggered SEQUENCE {			
eventId CHOICE {			
eventB1-UTRA-FDD-r16 SEQUENCE {			
b1-ThresholdUTRA-FDD-r16 CHOICE {			
utra-FDD-RSCP-r16	61	-80dBm	
}			
}			
}			
}			
reportAmount	r1		
reportQuantityUTRA-FDD-r16 SEQUENCE {			
cpich-RSCP	true		
cpich-EcN0	false		
}			
}			

Table 8.1.3.2.6.3.3-4: MeasurementReport (step 5, Table 8.1.3.2.6.3.2-3)

Derivation Path: TS 38.508-1 [4] Table 4.6.1-5A			
Information Element	Value/remark	Comment	Condition
MeasurementReport ::= SEQUENCE {			
criticalExtensions CHOICE {			
measurementReport SEQUENCE {			
measResults	MeasResults	Table 8.1.3.2.6.3.3-5	
}			
}			
}			

Table 8.1.3.2.6.3.3-5: *MeasResults* (Table 8.1.3.2.6.3.3-4)

Derivation Path: TS 38.508-1 [4], Table 4.6.3-79 with condition B1_UTRA			
Information Element	Value/remark	Comment	Condition
MeasResults ::= SEQUENCE {			
measId	1		
measResultNeighCells CHOICE {			
measResultListUTRA-FDD-r16 SEQUENCE (SIZE (1..maxCellReport)) OF MeasResultUTRA-FDD-r16 {	1 entry		
MeasResultUTRA-FDD-r16[1] SEQUENCE {		entry 1	
physCellId-r16	PhysCellIdUTRA-FDD-r16 of UTRA Cell 5		
measResult-r16 SEQUENCE {			
ultra-FDD-RSCP-r16	INTEGER (-5..91)		
ultra-FDD-EcN0-r16	Not present		
}			
}			
}			
}			

8.1.3.2.7 Measurement configuration control and reporting / Inter-RAT measurements / Event B2 / NR to UTRA

8.1.3.2.7.1 Test Purpose (TP)

(1)

```
with { UE is NR RRC_CONNECTED state and inter-RAT measurement event B2 to measure neighbour UTRA cell is configured }
ensure that {
  when { Entering condition 1 for event B2 is not met but Entering condition 2 is met }
  then { UE does not transmit any MeasurementReport }
}
```

(2)

```
with { UE is NR RRC_CONNECTED state and inter-RAT measurement event B2 to measure neighbour UTRA cell is configured }
ensure that {
  when { Entering condition 1 and 2 for event B2 is met }
  then { UE transmits a MeasurementReport }
}
```

8.1.3.2.7.2 Conformance requirements

References: The conformance requirements covered in the current TC are specified in: TS 38.331, clauses 5.3.5.3, 5.5.2.1, 5.5.4.1, 5.5.4.9 and 5.5.5.1. Unless otherwise stated these are Rel-16 requirements.

[TS 38.331, clause 5.3.5.3]

The UE shall perform the following actions upon reception of the *RRCReconfiguration*, or upon execution of the conditional reconfiguration (CHO or CPC):

...

1> if the *RRCReconfiguration* message includes the *measConfig*:

2> perform the measurement configuration procedure as specified in 5.5.2;

[TS 38.331, clause 5.5.2.1]

The UE shall:

...

- 1> if the received *measConfig* includes the *measObjectToAddModList*:
 - 2> perform the measurement object addition/modification procedure as specified in 5.5.2.5;

...

- 1> if the received *measConfig* includes the *reportConfigToAddModList*:
 - 2> perform the reporting configuration addition/modification procedure as specified in 5.5.2.7;

...

- 1> if the received *measConfig* includes the *measIdToAddModList*:
 - 2> perform the measurement identity addition/modification procedure as specified in 5.5.2.3;

- 1> if the received *measConfig* includes the *measGapConfig*:
 - 2> perform the measurement gap configuration procedure as specified in 5.5.2.9;

[TS 38.331, clause 5.5.2.9]

- 1> if *gapFR1* is set to *setup*:
 - 2> if an FR1 measurement gap configuration is already setup, release the FR1 measurement gap configuration;
 - 2> setup the FR1 measurement gap configuration indicated by the *measGapConfig* in accordance with the received *gapOffset*, i.e., the first subframe of each gap occurs at an SFN and subframe meeting the following condition:
 - SFN mod $T = \text{FLOOR}(\text{gapOffset}/10)$;
 - subframe = $\text{gapOffset} \bmod 10$;
 - with $T = \text{MGRP}/10$ as defined in TS 38.133 [14];
 - 2> apply the specified timing advance *mgta* to the gap occurrences calculated above (i.e. the UE starts the measurement *mgta* ms before the gap subframe occurrences);

- 1> else if *gapFR1* is set to *release*:
 - 2> release the FR1 measurement gap configuration;

- 1> if *gapFR2* is set to *setup*:
 - 2> if an FR2 measurement gap configuration is already setup, release the FR2 measurement gap configuration;
 - 2> setup the FR2 measurement gap configuration indicated by the *measGapConfig* in accordance with the received *gapOffset*, i.e., the first subframe of each gap occurs at an SFN and subframe meeting the following condition:
 - SFN mod $T = \text{FLOOR}(\text{gapOffset}/10)$;
 - subframe = $\text{gapOffset} \bmod 10$;
 - with $T = \text{MGRP}/10$ as defined in TS 38.133 [14];
 - 2> apply the specified timing advance *mgta* to the gap occurrences calculated above (i.e. the UE starts the measurement *mgta* ms before the gap subframe occurrences);

- 1> else if *gapFR2* is set to *release*:
 - 2> release the FR2 measurement gap configuration;

- 1> if *gapUE* is set to *setup*:
 - 2> if a per UE measurement gap configuration is already setup, release the per UE measurement gap configuration;

- 2> setup the per UE measurement gap configuration indicated by the *measGapConfig* in accordance with the received *gapOffset*, i.e., the first subframe of each gap occurs at an SFN and subframe meeting the following condition:

SFN mod $T = \text{FLOOR}(\text{gapOffset}/10)$;

subframe = *gapOffset* mod 10;

with $T = \text{MGRP}/10$ as defined in TS 38.133 [14];

- 2> apply the specified timing advance *mgta* to the gap occurrences calculated above (i.e. the UE starts the measurement *mgta* ms before the gap subframe occurrences);

- 1> else if *gapUE* is set to *release*:

- 2> release the per UE measurement gap configuration.

[TS 38.331, clause 5.5.4.1]

- 3> else if the corresponding *measObject* concerns UTRA-FDD:

- 4> if *eventB1-UTRA-FDD* or *eventB2-UTRA-FDD* is configured in the corresponding *reportConfig*; or

- 4> if corresponding *reportConfig* includes *reportType* set to *periodical*:

- 5> consider a neighbouring cell on the associated frequency to be applicable when the concerned cell is included in the *cellsToAddModList* defined within the *VarMeasConfig* for this *measId*;

...

- 2> if the *reportType* is set to *eventTriggered* and if the entry condition applicable for this event, i.e. the event corresponding with the *eventId* of the corresponding *reportConfig* within *VarMeasConfig*, is fulfilled for one or more applicable cells for all measurements after layer 3 filtering taken during *timeToTrigger* defined for this event within the *VarMeasConfig*, while the *VarMeasReportList* does not include a measurement reporting entry for this *measId* (a first cell triggers the event):

- 3> include a measurement reporting entry within the *VarMeasReportList* for this *measId*;

- 3> set the *numberOfReportsSent* defined within the *VarMeasReportList* for this *measId* to 0;

- 3> include the concerned cell(s) in the *cellsTriggeredList* defined within the *VarMeasReportList* for this *measId*;

- 3> if *useT312* is set to *true* in *reportConfig* for this event:

- 4> if T310 for the corresponding SpCell is running; and

- 4> if T312 is not running for corresponding SpCell:

- 5> start timer T312 for the corresponding SpCell with the value of T312 configured in the corresponding *measObjectNR*;

- 3> initiate the measurement reporting procedure, as specified in 5.5.5;

- 2> else if the *reportType* is set to *eventTriggered* and if the entry condition applicable for this event, i.e. the event corresponding with the *eventId* of the corresponding *reportConfig* within *VarMeasConfig*, is fulfilled for one or more applicable cells not included in the *cellsTriggeredList* for all measurements after layer 3 filtering taken during *timeToTrigger* defined for this event within the *VarMeasConfig* (a subsequent cell triggers the event):

- 3> set the *numberOfReportsSent* defined within the *VarMeasReportList* for this *measId* to 0;

- 3> include the concerned cell(s) in the *cellsTriggeredList* defined within the *VarMeasReportList* for this *measId*;

- 3> if *useT312* is set to *true* in *reportConfig* for this event:

- 4> if T310 for the corresponding SpCell is running; and
- 4> if T312 is not running for corresponding SpCell:
 - 5> start timer T312 for the corresponding SpCell with the value of T312 configured in the corresponding *measObjectNR*;
- 3> initiate the measurement reporting procedure, as specified in 5.5.5;
- 2> else if the *reportType* is set to *eventTriggered* and if the leaving condition applicable for this event is fulfilled for one or more of the cells included in the *cellsTriggeredList* defined within the *VarMeasReportList* for this *measId* for all measurements after layer 3 filtering taken during *timeToTrigger* defined within the *VarMeasConfig* for this event:
 - 3> remove the concerned cell(s) in the *cellsTriggeredList* defined within the *VarMeasReportList* for this *measId*;
 - 3> if *reportOnLeave* is set to *true* for the corresponding reporting configuration:
 - 4> initiate the measurement reporting procedure, as specified in 5.5.5;
 - 3> if the *cellsTriggeredList* defined within the *VarMeasReportList* for this *measId* is empty:
 - 4> remove the measurement reporting entry within the *VarMeasReportList* for this *measId*;
 - 4> stop the periodical reporting timer for this *measId*, if running;
- 2> else if the *reportType* is set to *eventTriggered* and if the entry condition applicable for this event, i.e. the event corresponding with the *eventId* of the corresponding *reportConfig* within *VarMeasConfig*, is fulfilled for one or more applicable transmission resource pools for all measurements taken during *timeToTrigger* defined for this event within the *VarMeasConfig*, while the *VarMeasReportList* does not include an measurement reporting entry for this *measId* (a first transmission resource pool triggers the event):
 - 3> include a measurement reporting entry within the *VarMeasReportList* for this *measId*;
 - 3> set the *numberOfReportsSent* defined within the *VarMeasReportList* for this *measId* to 0;
 - 3> include the concerned transmission resource pool(s) in the *poolsTriggeredList* defined within the *VarMeasReportList* for this *measId*;
 - 3> initiate the measurement reporting procedure, as specified in 5.5.5;
- 2> else if the *reportType* is set to *eventTriggered* and if the entry condition applicable for this event, i.e. the event corresponding with the *eventId* of the corresponding *reportConfig* within *VarMeasConfig*, is fulfilled for one or more applicable transmission resource pools not included in the *poolsTriggeredList* for all measurements taken during *timeToTrigger* defined for this event within the *VarMeasConfig* (a subsequent transmission resource pool triggers the event):
 - 3> set the *numberOfReportsSent* defined within the *VarMeasReportList* for this *measId* to 0;
 - 3> include the concerned transmission resource pool(s) in the *poolsTriggeredList* defined within the *VarMeasReportList* for this *measId*;
 - 3> initiate the measurement reporting procedure, as specified in 5.5.5;
- 2> else if the *reportType* is set to *eventTriggered* and if the leaving condition applicable for this event is fulfilled for one or more applicable transmission resource pools included in the *poolsTriggeredList* defined within the *VarMeasReportList* for this *measId* for all measurements taken during *timeToTrigger* defined within the *VarMeasConfig* for this event:
 - 3> remove the concerned transmission resource pool(s) in the *poolsTriggeredList* defined within the *VarMeasReportList* for this *measId*;
 - 3> if the *poolsTriggeredList* defined within the *VarMeasReportList* for this *measId* is empty:
 - 4> remove the measurement reporting entry within the *VarMeasReportList* for this *measId*;

4> stop the periodical reporting timer for this *measId*, if running

[TS 38.331, clause 5.5.4.9]

The UE shall:

1> consider the entering condition for this event to be satisfied when both condition B2-1 and condition B2-2, as specified below, are fulfilled;

1> consider the leaving condition for this event to be satisfied when condition B2-3 or condition B2-4, i.e. at least one of the two, as specified below, is fulfilled;

Inequality B2-1 (Entering condition 1)

$$M_p + H_{ys} < Thresh1$$

Inequality B2-2 (Entering condition 2)

$$M_n + O_{fn} + O_{cn} - H_{ys} > Thresh2$$

Inequality B2-3 (Leaving condition 1)

$$M_p - H_{ys} > Thresh1$$

Inequality B2-4 (Leaving condition 2)

$$M_n + O_{fn} + O_{cn} + H_{ys} < Thresh2$$

The variables in the formula are defined as follows:

M_p is the measurement result of the PCell, not taking into account any offsets.

M_n is the measurement result of the inter-RAT neighbour cell, not taking into account any offsets.

O_{fn} is the measurement object specific offset of the frequency of the inter-RAT neighbour cell (i.e. *eutra-Q-OffsetRange* as defined within the *measObjectEUTRA* corresponding to the frequency of the inter-RAT neighbour cell, *utra-FDD-Q-OffsetRange* as defined within the *measObjectUTRA-FDD* corresponding to the frequency of the neighbour inter-RAT cell).

O_{cn} is the cell specific offset of the inter-RAT neighbour cell (i.e. *cellIndividualOffset* as defined within the *measObjectEUTRA* corresponding to the neighbour inter-RAT cell), and set to zero if not configured for the neighbour cell.

H_{ys} is the hysteresis parameter for this event (i.e. *hysteresis* as defined within *reportConfigInterRAT* for this event).

Thresh1 is the threshold parameter for this event (i.e. *b2-Threshold1* as defined within *reportConfigInterRAT* for this event).

Thresh2 is the threshold parameter for this event (i.e. *b2-Threshold2EUTRA* as defined within *reportConfigInterRAT* for this event, *b2-Threshold2UTRA-FDD* as defined for UTRA-FDD within *reportConfigInterRAT* for this event).

M_p is expressed in dBm in case of RSRP, or in dB in case of RSRQ and SINR.

M_n is expressed in dBm or dB, depending on the measurement quantity of the inter-RAT neighbour cell.

O_{fn}*, ***O_{cn}*, ***H_{ys} are expressed in dB.****

Thresh1 is expressed in the same unit as ***M_p***.

Thresh2 is expressed in the same unit as ***M_n***.

[TS 38.331, clause 5.5.5.1]

1> if there is at least one applicable neighbouring cell to report:

2> if the *reportType* is set to *eventTriggered* or *periodical*:

3> set the *measResultNeighCells* to include the best neighbouring cells up to *maxReportCells* in accordance with the following:

...

4> if the *reportType* is set to *eventTriggered* or *periodical*:

5> for each included cell, include the layer 3 filtered measured results in accordance with the *reportConfig* for this *measId*, ordered as follows:

...

6> if the *measObject* associated with this *measId* concerns UTRA-FDD and if *ReportConfigInterRAT* includes the *reportQuantityUTRA-FDD*:

7> set the *measResult* to include the quantity(ies) indicated in the *reportQuantityUTRA-FDD* within the concerned *reportConfigInterRAT* in decreasing order of the sorting quantity, determined as specified in 5.5.5.3, i.e. the best cell is included first;

8.1.3.2.7.3 Test description

8.1.3.2.7.3.1 Pre-test conditions

System Simulator:

- NR Cell 1 is the PCell, UTRA Cell 5 is the inter-RAT neighbour cell of NR Cell 1.
- System information combination NR-1 as defined in TS 38.508-1 [4] clause 4.4.3.1.2.

UE:

- None.

Preamble:

- The UE is in state 3N-A as defined in TS 38.508-1 [4], subclause 4.4A.

8.1.3.2.7.3.2 Test procedure sequence

Table 8.1.3.2.7.3.2-1 and 8.1.3.2.7.3.2-2 illustrates the downlink power levels to be applied for NR Cell 1, and UTRA Cell 5 at various time instants of the test execution. Row marked "T0" denotes the conditions after the preamble, while the configuration marked "T1" is applied at the point indicated in the Main behaviour description in Table 8.1.3.2.7.3.2-3.

Table 8.1.3.2.7.3.2-1: Time instances of cell power level and parameter changes for FR1

	Parameter	Unit	NR Cell 1	UTRA Cell 5	Remark
T0	SS/PBCH SSS EPRE	dBm/SCS	-78	-	Power levels are such that entry condition 1 for event B2 is not satisfied and entry condition 2 is satisfied: $M_p + H_{ys} > Thresh1$ and $M_n + O_{fn} + O_{cn} - H_{ys} > Thresh2$
	Cell-specific CPICH_Ec	dBm/3.84 MHz	-	-73	
T1	SS/PBCH SSS EPRE	dBm/SCS	-85	-	Power levels are such that entry condition for event B2 is satisfied: $M_p + H_{ys} < Thresh1$ and $M_n + O_{fn} + O_{cn} - H_{ys} > Thresh2$
	Cell-specific CPICH_Ec	dBm/3.84 MHz	-	-73	

Table 8.1.3.2.7.3.2-2: Time instances of cell power level and parameter changes for FR2

	Parameter	Unit	NR Cell 1	UTRA Cell 5	Remark
T0	SS/PBCH SSS EPRE	dBm/SCS	FFS	-	Power levels are such that entry condition 1 for event B2 is not satisfied and entry condition 2 is satisfied: $Mp + Hys > Thresh1$ and $Mn + Ofn + Ocn - Hys > Thresh2$
	Cell-specific CPICH_Ec	dBm/3.84 MHz	-	FFS	
T1	SS/PBCH SSS EPRE	dBm/SCS	FFS	-	Power levels are such that entry condition for event B2 is satisfied: $Mp + Hys < Thresh1$ and $Mn + Ofn + Ocn - Hys > Thresh2$
	Cell-specific CPICH_Ec	dBm/3.84 MHz	-	FFS	

Table 8.1.3.2.7.3.2-3: Main behaviour

St	Procedure	Message Sequence		TP	Verdict
		U - S	Message		
1	The SS transmits an RRCReconfiguration message including MeasConfig to setup inter-RAT measurement and reporting for event B2.	<--	NR RRC: RRCReconfiguration	-	-
2	The UE transmits an RRCReconfigurationComplete message.	-->	NR RRC: RRCReconfigurationComplete	-	-
3	Check: Does the UE transmit a MeasurementReport message within the next 10s?	-->	NR RRC: MeasurementReport	1	F
4	SS re-adjusts the cell-specific reference signal level according to row "T1" in table 8.1.3.2.7.3.2-1/2.	-	-	-	-
5	Check: Does the UE transmit a MeasurementReport message to report event B2 with the measured RSRP value for NR Cell 1 and measured RSCP value for UTRA cell 5?	-->	NR RRC: MeasurementReport	2	P

8.1.3.2.7.3.3 Specific message contents

Table 8.1.3.2.7.3.3-1: RRCReconfiguration (step 1, Table 8.1.3.2.7.3.2-3)

Derivation Path: TS 38.508-1 [4], Table 4.6.1-13, condition NR_MEAS

Table 8.1.3.2.7.3.3-2: MeasConfig (Table 8.1.3.2.7.3.3-1)

Derivation Path: TS 38.508-1 [4] Table 4.6.3-69			
Information Element	Value/remark	Comment	Condition
MeasConfig ::= SEQUENCE {			
measObjectToAddModList SEQUENCE (SIZE (1..maxNrofMeasId)) OF MeasObjectToAddMod {	2 entries		
MeasObjectToAddMod[1] SEQUENCE {		entry 1	
measObjectId	1	MeasObjectIdNR-f1	
measObject CHOICE {			
measObjectNR SEQUENCE {			
ssbFrequency	ssbFrequency IE equals the ARFCN for NR Cell 1		
absThreshSS-BlocksConsolidation	Not present		
}			
}			
}			
MeasObjectToAddMod[2] SEQUENCE {		entry 2	
measObjectId	2	MeasObjectIdUT-RA-FDD-r16	
measObject CHOICE {			

measObjectUTRA-FDD-r16	MeasObjectUTRA-FDD	Table 8.1.3.2.7.3.3-2A	
}			
}			
reportConfigToAddModList SEQUENCE(SIZE (1..maxReportConfigId)) OF ReportConfigToAddMod {	1 entry		
ReportConfigToAddMod[1] SEQUENCE {		entry 1	
reportConfigId	1		
reportConfig CHOICE {			
reportConfigInterRAT	ReportConfigInterRAT	Table 8.1.3.2.7.3.3-3	
}			
}			
}			
measIdToAddModList SEQUENCE (SIZE (1..maxNrofMeasId)) OF MeasIdToAddMod {	1 entry		
MeasIdToAddMod[1] SEQUENCE {		entry 1	
measId	1		
measObjectId	2		
reportConfigId	1		
}			
}			
quantityConfig	QuantityConfig with condition INTER-RAT_UTRA		
measGapConfig	MeasGapConfig		
}			

Table 8.1.3.2.7.3.3-2A: MeasObjectUTRA-FDD (Table 8.1.3.2.7.3.3-2)

Derivation Path: TS 38.508-1 [4], Table 4.6.3-77A			
Information Element	Value/remark	Comment	Condition
MeasObjectUTRA-FDD-r16 ::= SEQUENCE {			
carrierFreq-r16	ARFCN-ValueUTRA-FDD-r16 for UTRA Cell 5		
}			

Table 8.1.3.2.7.3.3-3: ReportConfigInterRAT (Table 8.1.3.2.7.3.3-2)

Derivation Path: TS 38.508-1 [4] Table 4.6.3-141 with condition EVENT_B2_UTRA			
Information Element	Value/remark	Comment	Condition
ReportConfigInterRAT ::= SEQUENCE {			
reportType CHOICE {			
eventTriggered SEQUENCE {			
eventId CHOICE {			
eventB2-UTRA-FDD-r16 SEQUENCE {			
b2-Threshold1-r16 SEQUENCE {			
rsrp	73	-83dBm	
}			
b2-Threshold2UTRA-FDD-r16 SEQUENCE {			
utra-FDD-RSCP-r16	58 FFS	-83dBm FFS	FR1 FR2
}			
}			
}			
}			
reportAmount	r1		
reportQuantityUTRA-FDD-r16 SEQUENCE {			
cpich-RSCP	true		
cpich-EcN0	false		
}			
}			

}		
---	--	--

Table 8.1.3.2.7.3.3-4: MeasurementReport (step 5, Table 8.1.3.2.7.3.2-3)

Derivation Path: TS 38.508-1 [4] Table 4.6.1-5A			
Information Element	Value/remark	Comment	Condition
MeasurementReport ::= SEQUENCE {			
criticalExtensions CHOICE {			
measurementReport SEQUENCE {			
measResults	MeasResults	Table 8.1.3.2.7.3.3-5	
}			
}			
}			

Table 8.1.3.2.7.3.3-5: MeasResults (Table 8.1.3.2.7.3.3-4)

Derivation Path: TS 38.508-1 [4], Table 4.6.3-79 with condition B2_UTRA			
Information Element	Value/remark	Comment	Condition
MeasResults ::= SEQUENCE {			
measId	1		
measResultNeighCells CHOICE {			
measResultListUTRA-FDD-r16 SEQUENCE (SIZE (1..maxCellReport)) OF MeasResultUTRA-FDD-r16 {	1 entry		
MeasResultUTRA-FDD-r16[1] SEQUENCE {		entry 1	
physCellId-r16	PhysCellIdUTRA-FDD-r16 of UTRA Cell 5		
measResult-r16 SEQUENCE {			
utra-FDD-RSCP-r16	INTEGER (-5..91)		
utra-FDD-EcN0-r16	Not present		
}			
}			
}			
}			

8.1.3.2.8 Measurement configuration control and reporting / Inter-RAT measurements / Periodic reporting / NR to UTRA

8.1.3.2.8.1 Test Purpose (TP)

(1)

```
with { UE is NR RRC_CONNECTED state and periodic inter-RAT measurement reporting of neighbour UTRA cells is configured }
ensure that {
  when { The UE receives reference signal power of UTRA cell where measurements are configured }
  then { UE sends MeasurementReport message at regular intervals }
}
```

(2)

```
with { UE is NR RRC_CONNECTED state with periodic measurement reporting of UTRA cells ongoing }
ensure that {
  when { The UE receives a RRCConnectionReconfiguration message removing the measId of periodic reporting of NR cells }
  then { UE stops sending MeasurementReport message for UTRA cells }
}
```

8.1.3.2.8.2 Conformance requirements

References: The conformance requirements covered in the current TC are specified in: TS 38.331, clauses 5.3.5.3, 5.5.2.1, 5.5.4.1 and 5.5.5.1. Unless otherwise stated these are Rel-16 requirements.

[TS 38.331, clause 5.3.5.3]

The UE shall perform the following actions upon reception of the *RRCReconfiguration*, or upon execution of the conditional reconfiguration (CHO or CPC):

...

- 1> if the *RRCReconfiguration* message includes the *measConfig*:
 - 2> perform the measurement configuration procedure as specified in 5.5.2;

[TS 38.331, clause 5.5.2.1]

The UE shall:

...

- 1> if the received *measConfig* includes the *measObjectToAddModList*:
 - 2> perform the measurement object addition/modification procedure as specified in 5.5.2.5;

...

- 1> if the received *measConfig* includes the *reportConfigToAddModList*:
 - 2> perform the reporting configuration addition/modification procedure as specified in 5.5.2.7;

...

- 1> if the received *measConfig* includes the *measIdToAddModList*:
 - 2> perform the measurement identity addition/modification procedure as specified in 5.5.2.3;

- 1> if the received *measConfig* includes the *measGapConfig*:
 - 2> perform the measurement gap configuration procedure as specified in 5.5.2.9;

[TS 38.331, clause 5.5.2.9]

- 1> if *gapFR1* is set to *setup*:
 - 2> if an FR1 measurement gap configuration is already setup, release the FR1 measurement gap configuration;
 - 2> setup the FR1 measurement gap configuration indicated by the *measGapConfig* in accordance with the received *gapOffset*, i.e., the first subframe of each gap occurs at an SFN and subframe meeting the following condition:
 - SFN mod $T = \text{FLOOR}(\text{gapOffset}/10)$;
 - subframe = $\text{gapOffset} \bmod 10$;
 - with $T = \text{MGRP}/10$ as defined in TS 38.133 [14];
 - 2> apply the specified timing advance *mgta* to the gap occurrences calculated above (i.e. the UE starts the measurement *mgta* ms before the gap subframe occurrences);

- 1> else if *gapFR1* is set to *release*:

- 2> release the FR1 measurement gap configuration;

- 1> if *gapFR2* is set to *setup*:

- 2> if an FR2 measurement gap configuration is already setup, release the FR2 measurement gap configuration;

- 2> setup the FR2 measurement gap configuration indicated by the *measGapConfig* in accordance with the received *gapOffset*, i.e., the first subframe of each gap occurs at an SFN and subframe meeting the following condition:

$$\text{SFN mod } T = \text{FLOOR}(\text{gapOffset}/10);$$

$$\text{subframe} = \text{gapOffset mod } 10;$$

with $T = \text{MGRP}/10$ as defined in TS 38.133 [14];

- 2> apply the specified timing advance *mgta* to the gap occurrences calculated above (i.e. the UE starts the measurement *mgta* ms before the gap subframe occurrences);

- 1> else if *gapFR2* is set to *release*:

- 2> release the FR2 measurement gap configuration;

- 1> if *gapUE* is set to *setup*:

- 2> if a per UE measurement gap configuration is already setup, release the per UE measurement gap configuration;

- 2> setup the per UE measurement gap configuration indicated by the *measGapConfig* in accordance with the received *gapOffset*, i.e., the first subframe of each gap occurs at an SFN and subframe meeting the following condition:

$$\text{SFN mod } T = \text{FLOOR}(\text{gapOffset}/10);$$

$$\text{subframe} = \text{gapOffset mod } 10;$$

with $T = \text{MGRP}/10$ as defined in TS 38.133 [14];

- 2> apply the specified timing advance *mgta* to the gap occurrences calculated above (i.e. the UE starts the measurement *mgta* ms before the gap subframe occurrences);

- 1> else if *gapUE* is set to *release*:

- 2> release the per UE measurement gap configuration.

[TS 38.331, clause 5.5.4.1]

- 3> else if the corresponding *measObject* concerns UTRA-FDD:

- 4> if *eventB1-UTRA-FDD* or *eventB2-UTRA-FDD* is configured in the corresponding *reportConfig*; or

- 4> if corresponding *reportConfig* includes *reportType* set to *periodical*:

- 5> consider a neighbouring cell on the associated frequency to be applicable when the concerned cell is included in the *cellsToAddModList* defined within the *VarMeasConfig* for this *measId*;

...

- 2> else if the *purpose* is included and set to *reportStrongestCells*, *reportStrongestCellsForSON*, *reportLocation* or *sidelink* and if a (first) measurement result is available:

- 3> include a measurement reporting entry within the *VarMeasReportList* for this *measId*;

- 3> set the *numberOfReportsSent* defined within the *VarMeasReportList* for this *measId* to 0;

- 3> if the *purpose* is set to *reportStrongestCells* and *reportStrongestCSI-RSs* is not included:

- 4> if the *triggerType* is set to *periodical* and the corresponding *reportConfig* includes the *ul-DelayConfig*:

- 5> initiate the measurement reporting procedure, as specified in 5.5.5, immediately after a first measurement result is provided by lower layers;

...

4> else if the *reportAmount* exceeds 1:

5> initiate the measurement reporting procedure, as specified in 5.5.5, immediately after the quantity to be reported becomes available for the PCell;

4> else (i.e. the *reportAmount* is equal to 1):

5> initiate the measurement reporting procedure, as specified in 5.5.5, immediately after the quantity to be reported becomes available for the PCell and for the strongest cell among the applicable cells, or becomes available for the pair of PCell and the PSCell in case of SSTD measurements, or becomes available for each requested pair of PCell and NR cell or the maximal measurement reporting delay as specified in TS 38.133 [X, 8.17.2.3] in case of SFTD measurements;

...

3> else:

4> initiate the measurement reporting procedure, as specified in 5.5.5, when it has determined the strongest cells on the associated frequency;

2> upon expiry of the periodical reporting timer for this *measId*:

3> initiate the measurement reporting procedure, as specified in 5.5.5;

...

2> upon expiry of the T321 for this *measId*:

3> include a measurement reporting entry within the *VarMeasReportList* for this *measId*;

3> set the *numberOfReportsSent* defined within the *VarMeasReportList* for this *measId* to 0;

3> initiate the measurement reporting procedure, as specified in 5.5.5;

NOTE 2: The UE does not stop the periodical reporting with *triggerType* set to *event* or to *periodical* while the corresponding measurement is not performed due to the PCell RSRP being equal to or better than *s-Measure* or due to the measurement gap not being setup.

NOTE 3: If the UE is configured with DRX, the UE may delay the measurement reporting for event triggered and periodical triggered measurements until the Active Time, which is defined in TS 36.321 [6].

[TS 38.331, clause 5.5.5.1]

1> if there is at least one applicable neighbouring cell to report:

2> if the *reportType* is set to *eventTriggered* or *periodical*:

3> set the *measResultNeighCells* to include the best neighbouring cells up to *maxReportCells* in accordance with the following:

...

4> if the *reportType* is set to *eventTriggered* or *periodical*:

5> for each included cell, include the layer 3 filtered measured results in accordance with the *reportConfig* for this *measId*, ordered as follows:

...

6> if the *measObject* associated with this *measId* concerns UTRA-FDD and if *ReportConfigInterRAT* includes the *reportQuantityUTRA-FDD*:

7> set the *measResult* to include the quantity(ies) indicated in the *reportQuantityUTRA-FDD* within the concerned *reportConfigInterRAT* in decreasing order of the sorting quantity, determined as specified in 5.5.5.3, i.e. the best cell is included first;

8.1.3.2.8.3 Test description

8.1.3.2.8.3.1 Pre-test conditions

System Simulator:

- NR Cell 1 is the PCell, UTRA Cell 5 is the inter-RAT neighbour cell of NR Cell 1.
- System information combination NR-1 as defined in TS 38.508-1 [4] clause 4.4.3.1.2.

UE:

- None.

Preamble:

- The UE is in state 3N-A as defined in TS 38.508-1 [4], subclause 4.4A.

8.1.3.2.8.3.2 Test procedure sequence

Table 8.1.3.2.8.3.2-1 and 8.1.3.2.8.3.2-2 illustrates the downlink power levels to be applied for NR Cell 1, and UTRA Cell 5 at various time instants of the test execution. Row marked "T0" denotes the conditions after the preamble, while the configuration marked "T1" is applied at the point indicated in the Main behaviour description in Table 8.1.3.2.8.3.2-3.

Table 8.1.3.2.8.3.2-1: Time instances of cell power level and parameter changes for FR1

	Parameter	Unit	NR Cell 1	UTRA Cell 5	Remark
T0	SS/PBCH SSS EPRE	dBm/ SCS	-78	-	
	Cell-specific CPICH_Ec	dBm/3.84 MkHz	-	Off	
T1	SS/PBCH SSS EPRE	dBm/ SCS	-78	-	
	Cell-specific CPICH_Ec	dBm/3.84 MkHz	-	-85	

Table 8.1.3.2.8.3.2-2: Time instances of cell power level and parameter changes for FR2

	Parameter	Unit	NR Cell 1	UTRA Cell 5	Remark
T0	SS/PBCH SSS EPRE	dBm/ SCS	-82	-	
	Cell-specific CPICH_Ec	dBm/3.84 MkHz	-	Off	
T1	SS/PBCH SSS EPRE	dBm/ SCS	-82	-	
	Cell-specific CPICH_Ec	dBm/3.84 MkHz	-	-60	

Table 8.1.3.2.8.3.2-3: Main behaviour

St	Procedure	Message Sequence		TP	Verdict
		U - S	Message		
1	The SS transmits an RRCReconfiguration message including measConfig to setup inter RAT measurements and reporting for UTRA cells.	<--	NR RRC: RRCReconfiguration	-	-

2	The UE transmits an RRCReconfigurationComplete message.	-->	NR RRC: RRCReconfigurationComplete	-	-
3	The SS changes UTRA Cell 5 parameters according to the row "T1".	-	-	-	-
4	Void	-	-	-	-
5	Check: Does the UE transmit at least 3 MeasurementReport messages on NR Cell 1 to perform periodical reporting for UTRA Cell 5?	-->	NR RRC: MeasurementReport	1	P
6	The SS transmits an RRCConnectionReconfiguration message including measConfig to remove the measId of periodic reporting of UTRA cell 5.	<--	NR RRC: RRCReconfiguration	-	-
7	The UE transmits an RRCReconfigurationComplete message.	-->	NR RRC: RRCReconfigurationComplete	-	-
8	Check: Does the UE transmit a MeasurementReport message in the next 10s?	-	-	2	F

8.1.3.2.8.3.3 Specific message contents

Table 8.1.3.2.8.3.3-1: RRCReconfiguration (step 1, Table 8.1.3.2.8.3.2-3)

Derivation path: TS 38.508-1 [4], Table 4.6.1-13, condition NR_MEAS

Table 8.1.3.2.8.3.3-2: MeasConfig (Table 8.1.3.2.8.3.3-1)

Derivation Path: TS 38.508-1 [4] Table 4.6.3-69			
Information Element	Value/remark	Comment	Condition
MeasConfig ::= SEQUENCE {			
measObjectToAddModList SEQUENCE (SIZE (1..maxNrofMeasId)) OF MeasObjectToAddMod {	2 entries		
MeasObjectToAddMod[1] SEQUENCE {		entry 1	
measObjectId	1	MeasObjectIdNR-f1	
measObject CHOICE {			
measObjectNR SEQUENCE {			
ssbFrequency	ssbFrequency IE equals the ARFCN for NR Cell 1		
absThreshSS-BlocksConsolidation	Not present		
}			
}			
MeasObjectToAddMod[2] SEQUENCE {		entry 2	
measObjectId	2	MeasObjectIdUTRA-FDD-r16	
measObject CHOICE {			
measObjectUTRA-FDD-r16	MeasObjectUTRA-FDD-r16		
}			
}			
reportConfigToAddModList SEQUENCE(SIZE (1..maxReportConfigId)) OF ReportConfigToAddMod {	1 entry		
ReportConfigToAddMod[1] SEQUENCE {		entry 1	
reportConfigId	1		
reportConfig	ReportConfigInterRAT specified in TS 38.508-1 [4] Table 4.6.3-141 with condition PERIODICAL_UTRA		
}			
}			
measIdToAddModList SEQUENCE (SIZE (1..maxNrofMeasId)) OF MeasIdToAddMod {	1 entry		

MeasIdToAddMod[1] SEQUENCE {		entry 1	
measId	1		
measObjectId	2		
reportConfigId	1		
}			
}			
quantityConfig	QuantityConfig with condition INTER- RAT_UTRA		
measGapConfig	MeasGapConfig		
}			

Table 8.1.3.2.8.3.3-3: Void

Table 8.2.3.3.1.3.3-4: Void

Table 8.1.3.2.8.3.3-5: *MeasurementReport* (step 5, Table 8.1.3.2.8.3.2-3)

Derivation Path: TS 38.508-1 [4] Table 4.6.1-5A			
Information Element	Value/remark	Comment	Condition
MeasurementReport ::= SEQUENCE {			
criticalExtensions CHOICE {			
measurementReport SEQUENCE {			
measResults	MeasResults	Table 8.1.3.2.8.3.3-5A	
}			
}			
}			

Table 8.1.3.2.8.3.3-5A: *MeasResults* (Table 8.1.3.2.8.3.3-5)

Derivation Path: TS 38.508-1 [4], Table 4.6.3-79			
Information Element	Value/remark	Comment	Condition
MeasResults ::= SEQUENCE {			
measId	1		
measResultNeighCells CHOICE {			
measResultListUTRA-FDD-r16 SEQUENCE (SIZE (1..maxCellReport)) OF MeasResultUTRA-FDD-r16 {	1 entry		
MeasResultUTRA-FDD-r16[1] SEQUENCE {		entry 1	
physCellId-r16	PhysCellIdUTRA-FDD- r16 of UTRA Cell 5		
measResult-r16 SEQUENCE {			
utra-FDD-RSCP-r16	INTEGER (-5..91)		
utra-FDD-EcN0-r16	Not present		
}			
}			
}			
}			

Table 8.1.3.2.8.3.3-6: *MeasConfig* (step 6, Table 8.1.3.2.8.3.2-3)

Derivation Path: TS 38.508-1 [4], Table 4.6.3-69			
Information Element	Value/remark	Comment	Condition
MeasConfig ::= SEQUENCE {			
measObjectToAddModList	Not present		
reportConfigToAddModList	Not present		
measIdToRemoveList SEQUENCE (SIZE (1..maxMeasId)) OF MeasId {	1 entry		
measId[1]	1	entry 1	

}			
quantityConfig	Not present		
}			

8.1.3.3 Measurement for self-optimized networks

8.1.3.3.1 Measurement configuration control and reporting / CGI reporting of NR cell

8.1.3.3.1.1 Test Purpose (TP)

(1)

```
with { UE in NR RRC_CONNECTED state }
ensure that {
  when { Neighbour NR cell becomes offset better than serving }
  then { UE sends MeasurementReport for event A3 }
}
```

(2)

```
with { UE in NR RRC_CONNECTED state }
ensure that {
  when { UE is commanded to report the global cell identity of the neighbour NR cell }
  then { UE determines the global cell identity of the cell included in the associated measurement
object by acquiring the relevant system information from the concerned cell and reports the global
cell identity in the MeasurementReport }
}
```

8.1.3.3.1.2 Conformance requirements

References: The conformance requirements covered in the current TC are specified in: TS 38.331, clauses 5.3.5.3, 5.5.2.3, 5.5.3.1, 5.5.4.8 and 5.5.5. Unless otherwise stated these are Rel-15 requirements.

[TS 38.331, clause 5.3.5.3]

The UE shall perform the following actions upon reception of the *RRCReconfiguration*:

...

1> if the *RRCReconfiguration* message includes the *measConfig*:

2> perform the measurement configuration procedure as specified in 5.5.2;

...

1> else (MCG *RRCReconfiguration*):

2> submit the *RRCReconfigurationComplete* message via SRB1 to lower layers for transmission using the new configuration;

...

[TS 38.331, clause 5.5.2.1]

...

The UE shall:

...

1> if the received *measConfig* includes the *measObjectToAddModList*:

2> perform the measurement object addition/modification procedure as specified in 5.5.2.5;

...

- 1> if the received *measConfig* includes the *reportConfigToAddModList*:
 - 2> perform the reporting configuration addition/modification procedure as specified in 5.5.2.7;

...

- 1> if the received *measConfig* includes the *measIdToAddModList*:
 - 2> perform the measurement identity addition/modification procedure as specified in 5.5.2.3;

...

[TS 38.331, clause 5.5.2.3]

...

The UE shall:

- 1> for each *measId* included in the received *measIdToAddModList*:
 - 2> if an entry with the matching *measId* exists in the *measIdList* within the *VarMeasConfig*:
 - 3> replace the entry with the value received for this *measId*;
 - 2> else:
 - 3> add a new entry for this *measId* within the *VarMeasConfig*;
 - 2> remove the measurement reporting entry for this *measId* from the *VarMeasReportList*, if included;
 - 2> stop the periodical reporting timer or timer T321, whichever one is running, and reset the associated information (e.g. *timeToTrigger*) for this *measId*;
 - 2> if the *reportType* is set to *reportCGI* in the *reportConfig* associated with this *measId*:
 - ...
 - 3> if the *measObject* associated with this *measId* concerns NR:
 - 4> if the *measObject* associated with this *measId* concerns FR1:
 - 5> start timer T321 with the timer value set to 2 seconds for this *measId*;
 - 4> if the *measObject* associated with this *measId* concerns FR2:
 - 5> start timer T321 with the timer value set to 16 seconds for this *measId*.

[TS 38.331, clause 5.5.3.1]

The UE shall:

- 1> whenever the UE has a *measConfig*, perform RSRP and RSRQ measurements for each serving cell for which *servingCellMO* is configured as follows:
 - 2> if the *reportConfig* associated with at least one *measId* included in the *measIdList* within *VarMeasConfig* contains an *rsType* set to *ssb* and *ssb-ConfigMobility* is configured in the *measObject* indicated by the *servingCellMO*:
 - ...
 - 3> derive serving cell measurement results based on SS/PBCH block, as described in 5.5.3.3;
 - ...
- 1> for each *measId* included in the *measIdList* within *VarMeasConfig*:
 - 2> if the *reportType* for the associated *reportConfig* is set to *reportCGI* and timer T321 is running:

- 3> perform the corresponding measurements on the frequency and RAT indicated in the associated *measObject* using available idle periods;
- 3> if the cell indicated by *reportCGI* field for the associated *measObject* is an NR cell and that indicated cell is broadcasting *SIB1* (see TS 38.213 [13], clause 13):
 - 4> try to acquire *SIB1* in the concerned cell;

...

- 2> if the *reportType* for the associated *reportConfig* is *periodical* or *eventTriggered*:

...

- 3> if the UE does not require measurement gaps to perform the concerned measurements:

- 4> if *s-MeasureConfig* is not configured

...

- 5> if the *measObject* is associated to NR and the *rsType* is set to *ssb*:

- 6> if *reportQuantityRS-Indexes* and *maxNrofRS-IndexesToReport* for the associated *reportConfig* are configured:

- 7> derive layer 3 beam measurements only based on SS/PBCH block for each measurement quantity indicated in *reportQuantityRS-Indexes*, as described in 5.5.3.3a;

- 6> derive cell measurement results based on SS/PBCH block for the trigger quantity and each measurement quantity indicated in *reportQuantityCell* using parameters from the associated *measObject*, as described in 5.5.3.3;

...

- 2> perform the evaluation of reporting criteria as specified in 5.5.4.

[TS 38.331, clause 5.5.4.1]

If AS security has been activated successfully, the UE shall:

- 1> for each *measId* included in the *measIdList* within *VarMeasConfig*:

- 2> if the corresponding *reportConfig* includes a *reportType* set to *eventTriggered* or *periodical*:

- 3> if the corresponding *measObject* concerns NR:

...

- 4> if the *eventA3* or *eventA5* is configured in the corresponding *reportConfig*:

- 5> if a serving cell is associated with a *measObjectNR* and neighbours are associated with another *measObjectNR*, consider any serving cell associated with the other *measObjectNR* to be a neighbouring cell as well;

- 4> if corresponding *reportConfig* includes *reportType* set to *periodical*; or

- 4> for measurement events other than *eventA1* or *eventA2*:

...

- 5> else:

- 6> consider any neighbouring cell detected based on parameters in the associated *measObjectNR* to be applicable when the concerned cell is not included in the *blackCellsToAddModList* defined within the *VarMeasConfig* for this *measId*;

...

- 2> else if the corresponding *reportConfig* includes a *reportType* set to *reportCGI*:
 - 3> consider the cell detected on the associated *measObject* which has a physical cell identity matching the value of the *cellForWhichToReportCGI* included in the corresponding *reportConfig* within the *VarMeasConfig* to be applicable;
 - ...
 - 2> if the *reportType* is set to *eventTriggered* and if the entry condition applicable for this event, i.e. the event corresponding with the *eventId* of the corresponding *reportConfig* within *VarMeasConfig*, is fulfilled for one or more applicable cells for all measurements after layer 3 filtering taken during *timeToTrigger* defined for this event within the *VarMeasConfig*, while the *VarMeasReportList* does not include a measurement reporting entry for this *measId* (a first cell triggers the event):
 - 3> include a measurement reporting entry within the *VarMeasReportList* for this *measId*;
 - 3> set the *numberOfReportsSent* defined within the *VarMeasReportList* for this *measId* to 0;
 - 3> include the concerned cell(s) in the *cellsTriggeredList* defined within the *VarMeasReportList* for this *measId*;
 - 3> initiate the measurement reporting procedure, as specified in 5.5.5;
 - ...
 - 2> upon expiry of the periodical reporting timer for this *measId*:
 - 3> initiate the measurement reporting procedure, as specified in 5.5.5.
 - ...
 - 2> if *reportType* is set to *reportCGI*:
 - 3> if the UE acquired the *SIB1* or *SystemInformationBlockType1* for the requested cell; or
 - 3> if the UE detects that the requested NR cell is not transmitting *SIB1* (see TS 38.213 [13], clause 13):
 - 4> stop timer T321;
 - 4> include a measurement reporting entry within the *VarMeasReportList* for this *measId*;
 - 4> set the *numberOfReportsSent* defined within the *VarMeasReportList* for this *measId* to 0;
 - 4> initiate the measurement reporting procedure, as specified in 5.5.5;
 - 2> upon the expiry of T321 for this *measId*:
 - 3> include a measurement reporting entry within the *VarMeasReportList* for this *measId*;
 - 3> set the *numberOfReportsSent* defined within the *VarMeasReportList* for this *measId* to 0;
 - 3> initiate the measurement reporting procedure, as specified in 5.5.5.

[TS 38.331, clause 5.5.4.4]

The UE shall:

- 1> consider the entering condition for this event to be satisfied when condition A3-1, as specified below, is fulfilled;
- 1> consider the leaving condition for this event to be satisfied when condition A3-2, as specified below, is fulfilled;
- 1> use the SpCell for *Mp*, *Ofp* and *Ocp*.

NOTE The cell(s) that triggers the event has reference signals indicated in the *measObjectNR* associated to this event which may be different from the NR SpCell *measObjectNR*.

Inequality A3-1 (Entering condition)

$$Mn + Ofn + Ocn - Hys > Mp + Ofp + Ocp + Off$$

Inequality A3-2 (Leaving condition)

$$Mn + Ofn + Ocn + Hys < Mp + Ofp + Ocp + Off$$

The variables in the formula are defined as follows:

Mn is the measurement result of the neighbouring cell, not taking into account any offsets.

Ofn is the measurement object specific offset of the reference signal of the neighbour cell (i.e. *offsetMO* as defined within *measObjectNR* corresponding to the neighbour cell).

Ocn is the cell specific offset of the neighbour cell (i.e. *cellIndividualOffset* as defined within *measObjectNR* corresponding to the frequency of the neighbour cell), and set to zero if not configured for the neighbour cell.

Mp is the measurement result of the SpCell, not taking into account any offsets.

Ofp is the measurement object specific offset of the SpCell (i.e. *offsetMO* as defined within *measObjectNR* corresponding to the SpCell).

Ocp is the cell specific offset of the SpCell (i.e. *cellIndividualOffset* as defined within *measObjectNR* corresponding to the SpCell), and is set to zero if not configured for the SpCell.

Hys is the hysteresis parameter for this event (i.e. *hysteresis* as defined within *reportConfigNR* for this event).

Off is the offset parameter for this event (i.e. *a3-Offset* as defined within *reportConfigNR* for this event).

Mn, Mp are expressed in dBm in case of RSRP, or in dB in case of RSRQ and RS-SINR.

Ofn, Ocn, Ofp, Ocp, Hys, Off are expressed in dB.

[TS 38.331, clause 5.5.5]



Figure 5.5.5.1-1: Measurement reporting

The purpose of this procedure is to transfer measurement results from the UE to the network. The UE shall initiate this procedure only after successful AS security activation.

For the *measId* for which the measurement reporting procedure was triggered, the UE shall set the *measResults* within the *MeasurementReport* message as follows:

- 1> set the *measId* to the measurement identity that triggered the measurement reporting;
- 1> for each serving cell configured with *-servingCellMO*:
 - 2> if the *reportConfig* associated with the *measId* that triggered the measurement reporting includes *rsType*:
 - 3> if the serving cell measurements based on the *rsType* included in the *reportConfig* that triggered the measurement report are available:
 - 4> set the *measResultServingCell* within *measResultServingMOList* to include RSRP, RSRQ and the available SINR of the serving cell, derived based on the *rsType* included in the *reportConfig* that triggered the measurement report;
 - 2> else:

- 3> if SSB based serving cell measurements are available:
 - 4> set the *measResultServingCell* within *measResultServingMOList* to include RSRP, RSRQ and the available SINR of the serving cell, derived based on SSB;
- 3> else if CSI-RS based serving cell measurements are available:
 - 4> set the *measResultServingCell* within *measResultServingMOList* to include RSRP, RSRQ and the available SINR of the serving cell, derived based on CSI-RS;
- 1> set the *servCellId* within *measResultServingMOList* to include each NR serving cell that is configured with *servingCellMO*, if any;
- ...
- 1> if there is at least one applicable neighbouring cell to report:
 - 2> if the *reportType* is set to *eventTriggered* or *periodical*:
 - 3> set the *measResultNeighCells* to include the best neighbouring cells up to *maxReportCells* in accordance with the following:
 - 4> if the *reportType* is set to *eventTriggered*:
 - 5> include the cells included in the *cellsTriggeredList* as defined within the *VarMeasReportList* for this *measId*;
 - ...
 - 4> for each cell that is included in the *measResultNeighCells*, include the *physCellId*;
 - 4> if the *reportType* is set to *eventTriggered* or *periodical*:
 - 5> for each included cell, include the layer 3 filtered measured results in accordance with the *reportConfig* for this *measId*, ordered as follows:
 - 6> if the *measObject* associated with this *measId* concerns NR:
 - 7> if *rsType* in the associated *reportConfig* is set to *ssb*:
 - 8> set *resultsSSB-Cell* within the *measResult* to include the SS/PBCH block based quantity(ies) indicated in the *reportQuantityCell* within the concerned *reportConfig*, in decreasing order of the sorting quantity, determined as specified in 5.5.5.3, i.e. the best cell is included first;
 - ...
 - 2> else:
 - 3> if the cell indicated by *cellForWhichToReportCGI* is an NR cell:
 - 4> if *plmn-IdentityInfoList* of the *cgi-Info* for the concerned cell has been obtained:
 - 5> include the *plmn-IdentityInfoList* including *plmn-IdentityList*, *trackingAreaCode* (if available), *ranac* (if available) and *cellIdentity* for each entry of the *plmn-IdentityInfoList*;
 - 5> include *frequencyBandList* if available;
 - 4> else if *MIB* indicates the *SIB1* is not broadcast:
 - 5> include the *noSIB1* including the *ssb-SubcarrierOffset* and *pdcc-ConfigSIB1* obtained from *MIB* of the concerned cell;
 - ...
 - 1> increment the *numberOfReportsSent* as defined within the *VarMeasReportList* for this *measId* by 1;
 - 1> stop the periodical reporting timer, if running;

- 1> if the *numberOfReportsSent* as defined within the *VarMeasReportList* for this *measId* is less than the *reportAmount* as defined within the corresponding *reportConfig* for this *measId*:
- 2> start the periodical reporting timer with the value of *reportInterval* as defined within the corresponding *reportConfig* for this *measId*;
- ...
- 1> else:
- 2> submit the *MeasurementReport* message to lower layers for transmission, upon which the procedure ends.

8.1.3.3.1.3 Test description

8.1.3.3.1.3.1 Pre-test conditions

System Simulator:

- NR Cell 1 is the PCell, NR Cell 2 is the intra-frequency neighbour cell of NR Cell 1.
- System information combination NR-2 as defined in TS 38.508-1 [4] clause 4.4.3.1.2.

UE:

- None.

Preamble:

- The UE is in state 3N-A as defined in TS 38.508-1 [4], subclause 4.4A.

8.1.3.3.1.3.2 Test procedure sequence

Table 8.1.3.3.1.3.2-1 and 8.1.3.3.1.3.2-2 illustrates the downlink power levels to be applied for NR Cell 1, and NR Cell 2 at various time instants of the test execution. Row marked "T0" denotes the conditions after the preamble, while the configuration marked "T1" is applied at the point indicated in the Main behaviour description in Table 8.1.3.3.1.3.2-3.

Table 8.1.3.3.1.3.2-1: Time instances of cell power level and parameter changes for FR1

	Parameter	Unit	NR Cell 1	NR Cell 2	Remark
T0	SS/PBCH SSS EPRE	dBm/ SCS	-85	-91	Power levels are such that entry condition for event A3 is not satisfied: $Mn + Ofn + Ocn - Hys < Mp + Ofp + Ocp + Off$
T1	SS/PBCH SSS EPRE	dBm/ SCS	-85	-79	Power levels are such that entry condition for event A3 is satisfied: $Mn + Ofn + Ocn - Hys > Mp + Ofp + Ocp + Off$

Table 8.1.3.3.1.3.2-2: Time instances of cell power level and parameter changes for FR2

	Parameter	Unit	NR Cell 1	NR Cell 2	Remark
T0	SS/PBCH SSS EPRE	dBm/ SCS	FFS	FFS	Power levels are such that entry condition for event A3 is not satisfied: $Mn + Ofn + Ocn - Hys < Mp + Ofp + Ocp + Off$
T1	SS/PBCH SSS EPRE	dBm/ SCS	FFS	FFS	Power levels are such that entry condition for event A3 is satisfied: $Mn + Ofn + Ocn - Hys > Mp + Ofp + Ocp + Off$

Table 8.1.3.3.1.3.2-3: Main behaviour

St	Procedure	Message Sequence		TP	Verdict
		U - S	Message		
1	The SS transmits an <i>RRCReconfiguration</i> message including <i>MeasConfig</i> to setup intra-frequency measurement and reporting for event A3.	<--	NR RRC: <i>RRCReconfiguration</i>	-	-
2	The UE transmits an <i>RRCReconfigurationComplete</i> message.	-->	NR RRC: <i>RRCReconfigurationComplete</i>	-	-
3	SS re-adjusts the cell-specific reference signal level according to row "T1" in table 8.1.3.3.1.3.2-1/2.	-	-	-	-
4	Check: Does the UE transmit a <i>MeasurementReport</i> message to report event A3 with the measured RSRP value for NR Cell 2?	-->	NR RRC: <i>MeasurementReport</i>	1	P
5	The SS transmits an <i>RRCReconfiguration</i> message including <i>measConfig</i> including <i>reportCGI</i> for Cell 2 and sufficient idle periods for UE to acquire the relevant system information from Cell 2	<--	NR RRC: <i>RRCReconfiguration</i>	-	-
6	The UE transmits an <i>RRCReconfigurationComplete</i> message.	-->	NR RRC: <i>RRCReconfigurationComplete</i>	-	-
7	Check: Does the UE transmit a <i>MeasurementReport</i> message with CGI of Cell 2 within 2 sec if Cell 2 is in FR1 (or within 16 sec if Cell 2 is in FR2)?	-->	NR RRC: <i>MeasurementReport</i>	2	P

8.1.3.3.1.3.3 Specific message contents

Table 8.1.3.3.1.3.3-1: *RRCReconfiguration* (step 1, Table 8.1.3.3.1.3.2-3)

Derivation Path: TS 38.508-1 [4] Table 4.6.1-13 with condition NR_MEAS
--

Table 8.1.3.3.1.3.3-2: *CellGroupConfig-DRX* (Table 8.1.3.3.1.3.3-1)

Derivation Path: TS 508-1 [4], Table 4.6.3-19 with condition MEAS			
Information Element	Value/remark	Comment	Condition
CellGroupConfig ::= SEQUENCE {			
mac-CellGroupConfig	MAC-CellGroupConfig	Table 8.1.3.3.1.3.3-9	
}			

Table 8.1.3.3.1.3.3-3: *MeasConfig-A3* (Table 8.1.3.3.1.3.3-1)

Derivation Path: TS 38.508-1 [4] Table 4.6.3-69			
Information Element	Value/remark	Comment	Condition
MeasConfig ::= SEQUENCE {			
measObjectToAddModList SEQUENCE (SIZE (1..maxNrofMeasId)) OF MeasObjectToAddMod {	1 entry		
MeasObjectToAddMod[1] SEQUENCE {		entry 1	
measObjectId	1		
measObject CHOICE {			
measObjectNR SEQUENCE {			
ssbFrequency	ssbFrequency IE equals the ARFCN for NR Cell 1		
absThreshSS-BlocksConsolidation	Not present		
}			
}			
}			
}			

}			
reportConfigToAddModList SEQUENCE (SIZE (1..maxReportConfigId)) OF ReportConfigToAddMod {	2 entries		
ReportConfigToAddMod[1] SEQUENCE {		entry 1	
reportConfigId	1		
reportConfig CHOICE {			
reportConfigNR	ReportConfigNR-A3	Table 8.1.3.3.1.3.3-4	
}			
}			
ReportConfigToAddMod[2] SEQUENCE {		entry 2	
reportConfigId	2		
reportConfig CHOICE {			
reportConfigNR	ReportConfigNR-CGI	Table 8.1.3.3.1.3.3-5	
}			
}			
}			
measIdToAddModList SEQUENCE (SIZE (1..maxNrofMeasId)) OF MeasIdToAddMod {	1 entry		
MeasIdToAddMod[1] SEQUENCE {		entry 1	
measId	1		
measObjectId	1		
reportConfigId	1	reportConfigId for event A3	
}			
}			
}			
}			

Table 8.1.3.3.1.3.3-4: ReportConfigNR-A3 (Table 8.1.3.3.1.3.3-2)

Derivation Path: TS 38.508-1 [4] Table 4.6.3-142 with Condition EVENT_A3			
Information Element	Value/remark	Comment	Condition
ReportConfigNR ::= SEQUENCE {			
reportType CHOICE {			
eventTriggered SEQUENCE {			
eventId CHOICE {			
eventA3 SEQUENCE {			
a3-Offset CHOICE {			
rsrp	2	1 dB (2*0.5 dB)	
}			
}			
}			
}			
reportAmount	r1		
}			
}			
}			

Table 8.1.3.3.1.3.3-5: ReportConfigNR-CGI (Table 8.1.3.3.1.3.3-2)

Derivation Path: TS 38.508-1 [4] Table 4.6.3-142 with Condition CGI			
Information Element	Value/remark	Comment	Condition
ReportConfigNR ::= SEQUENCE {			
reportType CHOICE {			
reportCGI SEQUENCE {			
cellForWhichToReportCGI	PhysCellId of NR Cell 2		
}			
}			
}			
}			

Table 8.1.3.3.1.3.3-6: RRCReconfiguration (step 5, Table 8.1.3.3.1.3.2-3)

Derivation Path: TS 38.508-1 [4] Table 4.6.1-13			
Information Element	Value/remark	Comment	Condition
RRCReconfiguration ::= SEQUENCE {			
criticalExtensions CHOICE {			
rrcReconfiguration SEQUENCE {			
measConfig	MeasConfig-CGI	Table 8.1.3.3.1.3.3-7	
nonCriticalExtension SEQUENCE {			
masterCellGroup	CellGroupConfig-DRX	Table 8.1.3.3.1.3.3-2	
}			
}			
}			

Table 8.1.3.3.1.3.3-7: MeasConfig-CGI (Table 8.1.3.3.1.3.3-6)

Derivation Path: TS 38.508-1 [4] Table 4.6.3-69			
Information Element	Value/remark	Comment	Condition
MeasConfig ::= SEQUENCE {			
measObjectToAddModList	Not present		
reportConfigToAddModList	Not present		
measIdToAddModList SEQUENCE (SIZE (1..maxNrofMeasId)) OF MeasIdToAddMod {	1 entry		
MeasIdToAddMod[1] SEQUENCE {		entry 1	
measId	1		
measObjectId	1		
reportConfigId	2	reportConfigId for CGI measurement	
}			
}			
}			

Table 8.1.3.3.1.3.3-8: MeasurementReport (step 4 and step 7, Table 8.1.3.3.1.3.2-3)

Derivation Path: TS 38.508-1 [4] Table 4.6.1-5A			
Information Element	Value/remark	Comment	Condition
MeasurementReport ::= SEQUENCE {			
criticalExtensions CHOICE {			
measurementReport SEQUENCE {			
measResults SEQUENCE {			
measId	1		
measResultServingMOList SEQUENCE (SIZE (1..maxNrofServingCells)) OF MeasResultServMO {	1 entry		
MeasResultServMO[1] SEQUENCE {		entry 1	
servCellId	ServCellIndex of NR Cell 1		
measResultServingCell SEQUENCE {			
physCellId	Physical layer cell identity of NR Cell 1		
measResult SEQUENCE {			
cellResults SEQUENCE {			
resultsSSB-Cell	Not Checked		Step 7
resultsSSB-Cell SEQUENCE {			Step 4
rsrp	(0..127)		
rsrq	(0..127)		
sinr	(0..127)		pc_ss_SIN R_Meas
}	Not present		
}			
}			
}			
}			
}			
}			

}

(2)

```
with { UE in NR RRC_CONNECTED state }
ensure that {
  when { UE is commanded to report the global cell identity of the neighbour E-UTRA cell }
  then { UE determines the global cell identity of the cell included in the associated measurement
object by acquiring the relevant system information from the concerned cell and reports the global
cell identity in the MeasurementReport }
}
```

8.1.3.3.2.2 Conformance requirements

References: The conformance requirements covered in the current TC are specified in: TS 38.331, clauses 5.3.5.3, 5.5.2.3, 5.5.3.1, 5.5.4.8 and 5.5.5. Unless otherwise stated these are Rel-15 requirements.

[TS 38.331, clause 5.3.5.3]

The UE shall perform the following actions upon reception of the *RRCReconfiguration*:

...

1> if the *RRCReconfiguration* message includes the *measConfig*:

2> perform the measurement configuration procedure as specified in 5.5.2;

...

1> else (MCG *RRCReconfiguration*):

2> submit the *RRCReconfigurationComplete* message via SRB1 to lower layers for transmission using the new configuration;

...

[TS 38.331, clause 5.5.2.1]

...

The UE shall:

...

1> if the received *measConfig* includes the *measObjectToAddModList*:

2> perform the measurement object addition/modification procedure as specified in 5.5.2.5;

...

1> if the received *measConfig* includes the *reportConfigToAddModList*:

2> perform the reporting configuration addition/modification procedure as specified in 5.5.2.7;

...

1> if the received *measConfig* includes the *measIdToAddModList*:

2> perform the measurement identity addition/modification procedure as specified in 5.5.2.3;

1> if the received *measConfig* includes the *measGapConfig*:

2> perform the measurement gap configuration procedure as specified in 5.5.2.9;

...

[TS 38.331, clause 5.5.2.3]

...

The UE shall:

- 1> for each *measId* included in the received *measIdToAddModList*:
 - 2> if an entry with the matching *measId* exists in the *measIdList* within the *VarMeasConfig*:
 - 3> replace the entry with the value received for this *measId*;
 - 2> else:
 - 3> add a new entry for this *measId* within the *VarMeasConfig*;
 - 2> remove the measurement reporting entry for this *measId* from the *VarMeasReportList*, if included;
 - 2> stop the periodical reporting timer or timer T321, whichever one is running, and reset the associated information (e.g. *timeToTrigger*) for this *measId*;
 - 2> if the *reportType* is set to *reportCGI* in the *reportConfig* associated with this *measId*:
 - 3> if the *measObject* associated with this *measId* concerns E-UTRA:
 - 4> start timer T321 with the timer value set to 1 second for this *measId*;
- ...

[TS 38.331, clause 5.5.2.9]

The UE shall:

- ...
- 1> if *gapUE* is set to *setup*:
 - 2> if a per UE measurement gap configuration is already setup, release the per UE measurement gap configuration;
 - 2> setup the per UE measurement gap configuration indicated by the *measGapConfig* in accordance with the received *gapOffset*, i.e., the first subframe of each gap occurs at an SFN and subframe meeting the following condition:

$$\text{SFN mod } T = \text{FLOOR}(\text{gapOffset}/10);$$

$$\text{subframe} = \text{gapOffset mod } 10;$$
 with $T = \text{MGRP}/10$ as defined in TS 38.133 [14];
 - 2> apply the specified timing advance *mgta* to the gap occurrences calculated above (i.e. the UE starts the measurement *mgta* ms before the gap subframe occurrences);
 - 1> else if *gapUE* is set to *release*:
 - 2> release the per UE measurement gap configuration.

[TS 38.331, clause 5.5.3.1]

The UE shall:

- 1> whenever the UE has a *measConfig*, perform RSRP and RSRQ measurements for each serving cell for which *servingCellMO* is configured as follows:
 - 2> if the *reportConfig* associated with at least one *measId* included in the *measIdList* within *VarMeasConfig* contains an *rsType* set to *ssb* and *ssb-ConfigMobility* is configured in the *measObject* indicated by the *servingCellMO*:
 - 3> derive serving cell measurement results based on SS/PBCH block, as described in 5.5.3.3;
- ...

...

- 1> for each *measId* included in the *measIdList* within *VarMeasConfig*:
 - 2> if the *reportType* for the associated *reportConfig* is set to *reportCGI* and timer T321 is running:
 - 3> perform the corresponding measurements on the frequency and RAT indicated in the associated *measObject* using available idle periods;
 - ...
 - 3> if the cell indicated by *reportCGI* field is an E-UTRA cell:
 - 4> try to acquire *SystemInformationBlockType1* in the concerned cell;
 - 2> if the *reportType* for the associated *reportConfig* is *periodical* or *eventTriggered*:
 - 3> if a measurement gap configuration is setup
 - ...
 - 4> if *s-MeasureConfig* is not configured
 - ...
 - 5> if the *measObject* is associated to E-UTRA:
 - 6> perform the corresponding measurements associated to neighbouring cells on the frequencies indicated in the concerned *measObject*, as described in 5.5.3.2;
 - ...
 - 2> perform the evaluation of reporting criteria as specified in 5.5.4.

[TS 38.331, clause 5.5.4.1]

If AS security has been activated successfully, the UE shall:

- 1> for each *measId* included in the *measIdList* within *VarMeasConfig*:
 - 2> if the corresponding *reportConfig* includes a *reportType* set to *eventTriggered* or *periodical*:
 - ...
 - 3> else if the corresponding *measObject* concerns E-UTRA:
 - 4> if *eventB1* or *eventB2* is configured in the corresponding *reportConfig*:
 - 5> consider a serving cell, if any, on the associated E-UTRA frequency as neighbour cell;
 - 4> else:
 - 5> consider any neighbouring cell detected on the associated frequency to be applicable when the concerned cell is not included in the *blackCellsToAddModListEUTRAN* defined within the *VarMeasConfig* for this *measId*;
 - ...
 - 2> else if the corresponding *reportConfig* includes a *reportType* set to *reportCGI*:
 - 3> consider the cell detected on the associated *measObject* which has a physical cell identity matching the value of the *cellForWhichToReportCGI* included in the corresponding *reportConfig* within the *VarMeasConfig* to be applicable;
 - ...
 - 2> if the *reportType* is set to *eventTriggered* and if the entry condition applicable for this event, i.e. the event corresponding with the *eventId* of the corresponding *reportConfig* within *VarMeasConfig*, is fulfilled for one

or more applicable cells for all measurements after layer 3 filtering taken during *timeToTrigger* defined for this event within the *VarMeasConfig*, while the *VarMeasReportList* does not include a measurement reporting entry for this *measId* (a first cell triggers the event):

- 3> include a measurement reporting entry within the *VarMeasReportList* for this *measId*;
- 3> set the *numberOfReportsSent* defined within the *VarMeasReportList* for this *measId* to 0;
- 3> include the concerned cell(s) in the *cellsTriggeredList* defined within the *VarMeasReportList* for this *measId*;
- 3> initiate the measurement reporting procedure, as specified in 5.5.5;

...

- 2> upon expiry of the periodical reporting timer for this *measId*:

- 3> initiate the measurement reporting procedure, as specified in 5.5.5.

...

- 2> if *reportType* is set to *reportCGI*:

- 3> if the UE acquired the *SIB1* or *SystemInformationBlockType1* for the requested cell

...

- 4> stop timer T321;
 - 4> include a measurement reporting entry within the *VarMeasReportList* for this *measId*;
 - 4> set the *numberOfReportsSent* defined within the *VarMeasReportList* for this *measId* to 0;
 - 4> initiate the measurement reporting procedure, as specified in 5.5.5;

- 2> upon the expiry of T321 for this *measId*:

- 3> include a measurement reporting entry within the *VarMeasReportList* for this *measId*;
 - 3> set the *numberOfReportsSent* defined within the *VarMeasReportList* for this *measId* to 0;

- 3> initiate the measurement reporting procedure, as specified in 5.5.5.

[TS 38.331, clause 5.5.4.9]

The UE shall:

- 1> consider the entering condition for this event to be satisfied when both condition B2-1 and condition B2-2, as specified below, are fulfilled;
- 1> consider the leaving condition for this event to be satisfied when condition B2-3 or condition B2-4, i.e. at least one of the two, as specified below, is fulfilled;

Inequality B2-1 (Entering condition 1)

$$M_p + H_{ys} < Thresh1$$

Inequality B2-2 (Entering condition 2)

$$M_n + O_{fn} + O_{cn} - H_{ys} > Thresh2$$

Inequality B2-3 (Leaving condition 1)

$$M_p - H_{ys} > Thresh1$$

Inequality B2-4 (Leaving condition 2)

$$M_n + O_{fn} + O_{cn} + H_{ys} < Thresh2$$

The variables in the formula are defined as follows:

M_p is the measurement result of the PCell, not taking into account any offsets.

M_n is the measurement result of the inter-RAT neighbour cell, not taking into account any offsets.

O_{fn} is the measurement object specific offset of the frequency of the inter-RAT neighbour cell (i.e. *eutra-Q-OffsetRange* as defined within the *measObjectEUTRA* corresponding to the frequency of the inter-RAT neighbour cell).

O_{cn} is the cell specific offset of the inter-RAT neighbour cell (i.e. *cellIndividualOffset* as defined within the *measObjectEUTRA* corresponding to the neighbour inter-RAT cell), and set to zero if not configured for the neighbour cell.

Hys is the hysteresis parameter for this event (i.e. *hysteresis* as defined within *reportConfigInterRAT* for this event).

Thresh1 is the threshold parameter for this event (i.e. *b2-Threshold1* as defined within *reportConfigInterRAT* for this event).

Thresh2 is the threshold parameter for this event (i.e. *b2-Threshold2EUTRA* as defined within *reportConfigInterRAT* for this event).

M_p is expressed in dBm in case of RSRP, or in dB in case of RSRQ and SINR.

M_n is expressed in dBm or dB, depending on the measurement quantity of the inter-RAT neighbour cell.

O_{fn}*, *O_{cn}*, *Hys are expressed in dB.

Thresh1 is expressed in the same unit as ***M_p***.

Thresh2 is expressed in the same unit as ***M_n***.

[TS 38.331, clause 5.5.5]



Figure 5.5.5.1-1: Measurement reporting

The purpose of this procedure is to transfer measurement results from the UE to the network. The UE shall initiate this procedure only after successful AS security activation.

For the *measId* for which the measurement reporting procedure was triggered, the UE shall set the *measResults* within the *MeasurementReport* message as follows:

- 1> set the *measId* to the measurement identity that triggered the measurement reporting;
- 1> for each serving cell configured with *servingCellMO*:
 - 2> if the *reportConfig* associated with the *measId* that triggered the measurement reporting includes *rsType*:
 - 3> if the serving cell measurements based on the *rsType* included in the *reportConfig* that triggered the measurement report are available:
 - 4> set the *measResultServingCell* within *measResultServingMOList* to include RSRP, RSRQ and the available SINR of the serving cell, derived based on the *rsType* included in the *reportConfig* that triggered the measurement report;

...

1> set the *servCellId* within *measResultServingMOList* to include each NR serving cell that is configured with *servCellMO*, if any;

...

1> if there is at least one applicable neighbouring cell to report:

2> if the *reportType* is set to *eventTriggered* or *periodical*:

3> set the *measResultNeighCells* to include the best neighbouring cells up to *maxReportCells* in accordance with the following:

4> if the *reportType* is set to *eventTriggered*:

5> include the cells included in the *cellsTriggeredList* as defined within the *VarMeasReportList* for this *measId*;

...

4> for each cell that is included in the *measResultNeighCells*, include the *physCellId*;

4> if the *reportType* is set to *eventTriggered* or *periodical*:

5> for each included cell, include the layer 3 filtered measured results in accordance with the *reportConfig* for this *measId*, ordered as follows:

...

6> if the *measObject* associated with this *measId* concerns E-UTRA:

7> set the *measResult* to include the quantity(ies) indicated in the *reportQuantity* within the concerned *reportConfigInterRAT* in decreasing order of the sorting quantity, determined as specified in 5.5.5.3, i.e. the best cell is included first;

2> else:

...

3> if the cell indicated by *cellForWhichToReportCGI* is an E-UTRA cell:

4> if all mandatory fields of the *cgi-Info-EPC* for the concerned cell have been obtained:

5> include in the *cgi-Info-EPC* the fields broadcasted in E-UTRA *SystemInformationBlockType1* associated to EPC;

4> if the UE is E-UTRA/5GC capable and all mandatory fields of the *cgi-Info-5GC* for the concerned cell have been obtained:

5> include in the *cgi-Info-5GC* the fields broadcasted in E-UTRA *SystemInformationBlockType1* associated to 5GC;

4> if the mandatory present fields of the *cgi-Info* for the cell indicated by the *cellForWhichToReportCGI* in the associated *measObject* have been obtained:

5> include the *freqBandIndicator*;

5> if the cell broadcasts the *multiBandInfoList*, include the *multiBandInfoList*;

5> if the cell broadcasts the *freqBandIndicatorPriority*, include the *freqBandIndicatorPriority*;

1> increment the *numberOfReportsSent* as defined within the *VarMeasReportList* for this *measId* by 1;

1> stop the periodical reporting timer, if running;

1> if the *numberOfReportsSent* as defined within the *VarMeasReportList* for this *measId* is less than the *reportAmount* as defined within the corresponding *reportConfig* for this *measId*:

2> start the periodical reporting timer with the value of *reportInterval* as defined within the corresponding *reportConfig* for this *measId*;

...

1> else:

2> submit the *MeasurementReport* message to lower layers for transmission, upon which the procedure ends.

8.1.3.3.2.3 Test description

8.1.3.3.2.3.1 Pre-test conditions

System Simulator:

- NR Cell 1 is the PCell, E-UTRA Cell 1 is the inter-RAT neighbour cell of NR Cell 1.
- NR Cell 1 is configured to operate in FR1 bands as defined in TS 38.508-1 [4] clause 6.2.3.
- System information combination NR-6 as defined in TS 38.508-1 [4] clause 4.4.3.1.2.

UE:

- None.

Preamble:

- The UE is in state 3N-A as defined in TS 38.508-1 [4], subclause 4.4A.

8.1.3.3.2.3.2 Test procedure sequence

Table 8.1.3.3.2.3.2-1 illustrates the downlink power levels to be applied for NR Cell 1, and NR Cell 2 at various time instants of the test execution. Row marked "T0" denotes the conditions after the preamble, while the configuration marked "T1" is applied at the point indicated in the Main behaviour description in Table 8.1.3.3.2.3.2-3.

Table 8.1.3.3.2.3.2-1: Time instances of cell power level and parameter changes for conducted test environment

	Parameter	Unit	NR Cell 1	E-UTRA Cell 1 (DL only)	Remark
T0	SS/PBCH SSS EPRE	dBm/S CS	-85	-	Power levels are such that entry condition for event B2 is not satisfied: $Mp + Hys < Thresh1$ and $Mn + Ofn + Ocn - Hys < Thresh2$
	Cell-specific RS EPRE	dBm/15 kHz	-	-91	
T1	SS/PBCH SSS EPRE	dBm/S CS	-85	-	Power levels are such that entry condition for event B2 is satisfied: $Mp + Hys < Thresh1$ and $Mn + Ofn + Ocn - Hys > Thresh2$
	Cell-specific RS EPRE	dBm/15 kHz	-	-79	

Table 8.1.3.3.2.3.2-2: Void

Table 8.1.3.3.2.3.2-3: Main behaviour

St	Procedure	Message Sequence		TP	Verdict
		U - S	Message		
1	The SS transmits an <i>RRCReconfiguration</i> message including <i>MeasConfig</i> to setup inter-RAT measurement and reporting for event B2.	<--	NR RRC: <i>RRCReconfiguration</i>	-	-

2	The UE transmits an <i>RRCReconfigurationComplete</i> message.	-->	NR RRC: <i>RRCReconfigurationComplete</i>	-	-
3	SS re-adjusts the cell-specific reference signal level according to row "T1" in table 8.1.3.3.2.3.2-1.	-	-	-	-
4	Check: Does the UE transmit a <i>MeasurementReport</i> message to report event B2 with the measured RSRP value for E-UTRA Cell 1?	-->	NR RRC: <i>MeasurementReport</i>	1	P
5	The SS transmits an <i>RRCReconfiguration</i> message including <i>measConfig</i> including <i>reportCGI</i> for E-UTRA Cell 1 and sufficient idle periods for UE to acquire the relevant system information from E-UTRA Cell 1	<--	NR RRC: <i>RRCReconfiguration</i>	-	-
6	The UE transmits an <i>RRCReconfigurationComplete</i> message.	-->	NR RRC: <i>RRCReconfigurationComplete</i>	-	-
7	Check: Does the UE transmit a <i>MeasurementReport</i> message with CGI of E-UTRA Cell 1 within 1 sec?	-->	NR RRC: <i>MeasurementReport</i>	2	P

8.1.3.3.2.3.3 Specific message contents

Table 8.1.3.3.2.3.3-1: *RRCReconfiguration* (step 1, Table 8.1.3.3.2.3.2-3)

Derivation Path: TS 38.508-1 [4] Table 4.6.1-13 with condition NR_MEAS

Table 8.1.3.3.2.3.3-2: *CellGroupConfig-DRX* (Table 8.1.3.3.2.3.3-1)

Derivation Path: TS 508-1 [4], Table 4.6.3-19 with condition MEAS

Information Element	Value/remark	Comment	Condition
CellGroupConfig ::= SEQUENCE {			
mac-CellGroupConfig	MAC-CellGroupConfig	Table 8.1.3.3.2.3.3-9	
}			

Table 8.1.3.3.2.3.3-3: *MeasConfig-B2* (Table 8.1.3.3.2.3.3-1)

Derivation Path: TS 38.508-1 [4] Table 4.6.3-69

Information Element	Value/remark	Comment	Condition
MeasConfig ::= SEQUENCE {			
measObjectToAddModList SEQUENCE (SIZE (1..maxNrofMeasId)) OF MeasObjectToAddMod {	2 entries		
MeasObjectToAddMod[1] SEQUENCE {		entry 1	
measObjectId	1		
measObject CHOICE {			
measObjectNR SEQUENCE {			
ssbFrequency	ssbFrequency IE equals the ARFCN for NR Cell 1		
absThreshSS-BlocksConsolidation	Not present		
}			
}			
}			
MeasObjectToAddMod[2] SEQUENCE {		entry 2	
measObjectId	2		
measObject CHOICE {			
measObjectEUTRA	MeasObjectEUTRA	MO for E-UTRA Cell 1	
}			
}			
}			
reportConfigToAddModList SEQUENCE(SIZE (1..maxReportConfigId)) OF ReportConfigToAddMod {	2 entries		

ReportConfigToAddMod[1] SEQUENCE {		entry 1	
reportConfigId	1		
reportConfig CHOICE {			
reportConfigInterRAT	ReportConfigInterRAT-B2	Table 8.1.3.3.2.3.3-4	
}			
}			
ReportConfigToAddMod[2] SEQUENCE {		entry 2	
reportConfigId	2		
reportConfig CHOICE {			
reportConfigInterRAT	ReportConfigInterRAT-CGI	Table 8.1.3.3.2.3.3-5	
}			
}			
measIdToAddModList SEQUENCE (SIZE (1..maxNrofMeasId)) OF MeasIdToAddMod {	1 entry		
MeasIdToAddMod[1] SEQUENCE {		entry 1	
measId	1		
measObjectId	2		
reportConfigId	1	reportConfigId for event B2	
}			
}			
quantityConfig	QuantityConfig with Condition INTER-RAT		
measGapConfig	MeasGapConfig		
}			

Table 8.1.3.3.2.3.3-4: ReportConfigInterRAT-B2 (Table 8.1.3.3.2.3.3-2)

Derivation Path: TS 38.508-1 [4] Table 4.6.3-141 with Condition EVENT_B2			
Information Element	Value/remark	Comment	Condition
ReportConfigInterRAT ::= SEQUENCE {			
reportType CHOICE {			
eventTriggered SEQUENCE {			
eventId CHOICE {			
eventB2 SEQUENCE {			
b2-Threshold1 CHOICE {			
rsrp	77	-79 dBm	
}			
b2-Threshold2EUTRA CHOICE {			
rsrp	56	-85dBm	
}			
}			
}			
}			
reportAmount	r1		
}			
}			

Table 8.1.3.3.2.3.3-5: ReportConfigInterRAT-CGI (Table 8.1.3.3.2.3.3-2)

Derivation Path: TS 38.508-1 [4] Table 4.6.3-141 with Condition CGI			
Information Element	Value/remark	Comment	Condition
ReportConfigInterRAT ::= SEQUENCE {			
reportType CHOICE {			
reportCGI SEQUENCE {			
cellForWhichToReportCGI	EUTRA-PhysCellId of E-UTRA Cell 1		
}			
}			
}			

Table 8.1.3.3.2.3-6: RRCReconfiguration (step 5, Table 8.1.3.3.2.3-3)

Derivation Path: TS 38.508-1 [4] Table 4.6.1-13			
Information Element	Value/remark	Comment	Condition
RRCReconfiguration ::= SEQUENCE {			
criticalExtensions CHOICE {			
rrcReconfiguration SEQUENCE {			
measConfig	MeasConfig-CGI	Table 8.1.3.3.2.3-7	
nonCriticalExtension SEQUENCE {			
masterCellGroup	CellGroupConfig-DRX	Table 8.1.3.3.2.3-2	
}			
}			
}			

Table 8.1.3.3.2.3-7: MeasConfig-CGI (Table 8.1.3.3.2.3-6)

Derivation Path: TS 38.508-1 [4] Table 4.6.3-69			
Information Element	Value/remark	Comment	Condition
MeasConfig ::= SEQUENCE {			
measObjectToAddModList	Not present		
reportConfigToAddModList	Not present		
measIdToAddModList SEQUENCE (SIZE (1..maxNrofMeasId)) OF MeasIdToAddMod {	1 entry		
MeasIdToAddMod[1] SEQUENCE {		entry 1	
measId	1		
measObjectId	2		
reportConfigId	2	reportConfigId for CGI measurement	
}			
}			
}			

Table 8.1.3.3.2.3-8: MeasurementReport (step 4 and step 7, Table 8.1.3.3.2.3-3)

Derivation Path: TS 38.508-1 [4] Table 4.6.1-5A			
Information Element	Value/remark	Comment	Condition
MeasurementReport ::= SEQUENCE {			
criticalExtensions CHOICE {			
measurementReport SEQUENCE {			
measResults SEQUENCE {			
measId	1		
measResultServingMOList SEQUENCE (SIZE (1..maxNrofServingCells)) OF MeasResultServMO {	1 entry		
MeasResultServMO[1] SEQUENCE {		entry 1	
servCellId	ServCellIndex of NR Cell 1		
measResultServingCell SEQUENCE {			
physCellId	Physical layer cell identity of NR Cell 1		
measResult SEQUENCE {			
cellResults SEQUENCE {			
resultsSSB-Cell	Not Checked		Step 7
resultsSSB-Cell SEQUENCE {			Step 4
rsrp	(0..127)		
rsrq	(0..127)		
sinr	Not present		
}	Not checked		pc_ss_SIN R_Meas
}			
}			
}			
}			
}			
}			

8.1.3.4 Measurement relaxation

8.1.3.4.1 Measurement relaxation / Stationary criterion / Redcap

8.1.3.4.1.1 Test Purpose (TP)

(1)

```
with { UE supporting Redcap and in NR RRC_Connected state and configured RRM measurement relaxation
Stationary criterion }
ensure that {
  when { the criterion is fulfilled and the UE did not transmit a UEAssistanceInformation message
with rrm-MeasRelaxationFulfilment as true since it was configured to provide indications of RRM
measurement relaxation criterion fulfillment }
  then { the UE initiates transmission of the UEAssistanceInformation message to indicate that the
criterion for RRM measurement relaxation for connected mode is fulfilled }
}
```

(2)

```
with { UE supporting Redcap and in NR RRC_Connected state and configured RRM measurement relaxation
Stationary criterion }
ensure that {
  when { the criterion is not fulfilled and the last UEAssistanceInformation message indicated
fulfilment of the criterion with rrm-MeasRelaxationFulfilment as true}
  then { the UE initiates transmission of the UEAssistanceInformation message to indicate that the
criterion for RRM measurement relaxation for connected mode is not fulfilled }
}
```

(3)

```
with { UE supporting Redcap and in NR RRC_Connected state and configured RRM measurement relaxation
Stationary criterion }
ensure that {
  when { the criterion is fulfilled and the last UEAssistanceInformation message indicated the
criterion is not fulfilled with rrm-MeasRelaxationFulfilment as false}
  then { the UE initiates transmission of the UEAssistanceInformation message to indicate that the
criterion for RRM measurement relaxation for connected mode is fulfilled}
}
```

8.1.3.4.1.2 Conformance requirements

References: The conformance requirements covered in the present TC are specified in: TS 38.304 clause 5.2.4.9 and TS 38.331 clause 5.7.4

[TS 38.304 clause 5.2.4.9]

The relaxed measurement criterion for a stationary RedCap UE is fulfilled when:

- $(S_{rxlev}^{RefStationary} - S_{rxlev}) < S_{SearchDeltaP-Stationary}$,

Where:

- S_{rxlev} = current S_{rxlev} value of the serving cell (dB).
- $S_{rxlev}^{RefStationary}$ = reference S_{rxlev} value of the serving cell (dB), set as follows:
 - After selecting or reselecting a new cell, or
 - If $(S_{rxlev} - S_{rxlev}^{RefStationary}) > 0$, or
 - If the relaxed measurement criterion has not been met for $T_{SearchDeltaP-Stationary}$:
 - The UE shall set the value of $S_{rxlev}^{RefStationary}$ to the current S_{rxlev} value of the serving cell.

...

The relaxed measurement criterion for a stationary RedCap UE not at cell edge is fulfilled when:

- the relaxed measurement criterion in clause 5.2.4.9.3 is fulfilled for a period of $T_{\text{SearchDeltaP-Stationary}}$,
- $S_{\text{rxlev}} > S_{\text{SearchThresholdP2}}$, and,
- $S_{\text{qual}} > S_{\text{SearchThresholdQ2}}$, if $S_{\text{SearchThresholdQ2}}$ is configured.

Where:

- S_{rxlev} = current S_{rxlev} value of the serving cell (dB).
- S_{qual} = current S_{qual} value of the serving cell (dB).

[TS 38.331 clause 5.7.4]

...

The UE shall set the contents of the *UEAssistanceInformation* message as follows:

...

- 1> if transmission of the *UEAssistanceInformation* message is initiated to provide an indication about whether the criterion for RRM relaxation for connected mode is fulfilled or not fulfilled:
 - 2> if the criterion for RRM measurement relaxation for connected mode is fulfilled:
 - 3> set the *rrm-MeasRelaxationFulfilment* to *true*;
 - 2> else:
 - 3> set the *rrm-MeasRelaxationFulfilment* to *false*.

...

The relaxed measurement criterion for a stationary UE is met when:

- $(SS\text{-RSRP}_{\text{RefStationaryConnected}} - SS\text{-RSRP}) < S_{\text{SearchDeltaP-StationaryConnected}}$,

Where:

- $SS\text{-RSRP}$ = current L3 RSRP measurement of the PCell based on SSB (dB).
- $SS\text{-RSRP}_{\text{RefStationaryConnected}}$ = reference $SS\text{-RSRP}$ value of the PCell cell (dB), set as follows:
 - At the end of RRC reconfiguration procedure as specified in 5.3.5.3, when *rrm-MeasRelaxationReportingConfig* is included in the *RRCReconfiguration* message; or
 - If $(SS\text{-RSRP} - SS\text{-RSRP}_{\text{RefStationaryConnected}}) > 0$; or
 - If the relaxed measurement criterion has not been met for $T_{\text{SearchDeltaP-StationaryConnected}}$:
 - The UE shall set the value of $SS\text{-RSRP}_{\text{RefStationaryConnected}}$ to the current $SS\text{-RSRP}$ value of the serving cell.

8.1.3.4.1.3 Test description

8.1.3.4.1.3.1 Pre-test conditions

System Simulator:

- NR Cell 1

UE:

- UE supporting RedCap

Preamble:

- The UE is in state 3N-A as defined in TS 38.508-1 [4], subclause 4.4A on NR Cell 1.

8.1.3.4.1.3.2 Test procedure sequence

Table 8.1.3.4.1.3.2-1-1 illustrates the downlink power levels and other changing parameters to be applied for the cells at various time instants of the test execution. Row marked "T0" denotes the initial conditions after preamble, while columns marked "T1", "T2" and "T3", are to be applied subsequently. The exact instants on which these values shall be applied are described in the texts in this clause.

Table 8.1.3.4.1.3.2-1-1: Time instances of cell power level and parameter changes in FR1

	Parameter	Unit	NR Cell 1	Remark
T0	SS/PBCH SSS EPRE	dBm/SCS	FFS	
T1	SS/PBCH SSS EPRE	dBm/SCS	FFS	Power level is such that measurement relaxation Stationary criterion is fulfilled
T2	SS/PBCH SSS EPRE	dBm/SCS	FFS	Power level is such that measurement relaxation Stationary criterion is not fulfilled
T3	SS/PBCH SSS EPRE	dBm/SCS	FFS	Power level is such that measurement relaxation Stationary criterion is fulfilled

Table 8.1.3.4.1.3.2-2: Main behaviour

St	Procedure	Message Sequence		TP	Verdict
		U - S	Message		
1	The SS re-adjusts the cell-specific reference signal level according to row "T1".	-	-	-	-
2	Check: Does the UE transmit an <i>UEAssistanceInformation</i> message containing <i>rrm-MeasRelaxationFulfilment-r17</i> set to "true"?	-->	NR RRC: <i>UEAssistanceInformation</i>	1	P
3	The SS re-adjusts the cell-specific reference signal level according to row "T2".	-	-	-	-
4	Check: Does the UE transmit an <i>UEAssistanceInformation</i> message containing <i>rrm-MeasRelaxationFulfilment-r17</i> set to "false"?	-->	NR RRC: <i>UEAssistanceInformation</i>	2	P
5	The SS re-adjusts the cell-specific reference signal level according to row "T3".	-	-	-	-
6	Check: Does the UE transmit an <i>UEAssistanceInformation</i> message containing <i>rrm-MeasRelaxationFulfilment-r17</i> set to "true"?	-->	NR RRC: <i>UEAssistanceInformation</i>	3	P

8.1.3.4.1.3.3 Specific message contents

Table 8.1.3.4.1.3.3-1: SIB2 for NR cell 1 (preamble)

Derivation Path: TS 38.508-1 [4], table 4.6.2-1			
Information Element	Value/remark	Comment	Condition
SIB2 ::= SEQUENCE {			
relaxedMeasurement-r17 SEQUENCE {			
stationaryMobilityEvaluation-r17 SEQUENCE {			
s-SearchDeltaP-Stationary-r17	dB6		
t-SearchDeltaP-Stationary-r17	s5		
}			
}			
}			

Table 8.1.3.4.1.3.3-2: SIB4 for NR cell 1 (preamble and all steps, Table 8.1.3.4.1.3.2-2)

Derivation Path: TS 38.508-1 [4], Table 4.6.2-3			
Information Element	Value/Remark	Comment	Condition
SystemInformationBlockType4 ::= SEQUENCE {			
interFreqCarrierFreqList-v1700 SEQUENCE (SIZE (1..maxFreq)) OF InterFreqCarrierFreqInfo-v1700 {	n entries		
InterFreqCarrierFreqInfo-v1700[j] SEQUENCE {			
redCapAccessAllowed-r17	true		
}			
}			
}			

Table 8.1.3.4.1.3.3-3: UEAssistanceInformation (Steps 2 and 6, Table Table 8.1.3.4.1.3.2-2)

Derivation Path: TS 38.508-1 [4] Table 4.6.1-30			
Information Element	Value/remark	Comment	Condition
UEAssistanceInformation ::= SEQUENCE {			
criticalExtensions CHOICE {			
ueAssistanceInformation SEQUENCE {			
nonCriticalExtension SEQUENCE {			
nonCriticalExtension SEQUENCE {			
nonCriticalExtension SEQUENCE {			
rrm-MeasRelaxationFulfilment-r17	true		
}			
}			
}			
}			
}			
}			

Table 8.1.3.4.1.3.3-4: UEAssistanceInformation (Step 4, Table Table 8.1.3.4.1.3.2-2)

Derivation Path: TS 38.508-1 [4] Table 4.6.1-30			
Information Element	Value/remark	Comment	Condition
UEAssistanceInformation ::= SEQUENCE {			
criticalExtensions CHOICE {			
ueAssistanceInformation SEQUENCE {			
nonCriticalExtension SEQUENCE {			
nonCriticalExtension SEQUENCE {			
nonCriticalExtension SEQUENCE {			
rrm-MeasRelaxationFulfilment-r17	false		
}			
}			
}			
}			
}			
}			

8.1.4 Handover

8.1.4.1 Intra NR handover

8.1.4.1.1 Void

8.1.4.1.2 Intra NR handover / Success / Inter-frequency

8.1.4.1.2.1 Test Purpose (TP)

(1)

```
with { UE in NR RRC_CONNECTED state and having performed the inter-frequency measurements for the
neighbour cell }
ensure that {
  when { UE receives an RRCReconfiguration message including a reconfigurationWithSync with rach-
ConfigDedicated }
    then { UE performs handover to the target cell and transmits an RRCReconfigurationComplete
message }
}
```

(2)

```
with { UE in NR RRC_CONNECTED state and having performed the inter-frequency measurements for the
neighbour cell }
ensure that {
  when { UE receives an RRCReconfiguration message including a reconfigurationWithSync without rach-
ConfigDedicated }
    then { UE performs handover to the target cell and transmits an RRCReconfigurationComplete
message }
}
```

(3)

```
with { UE in NR RRC_CONNECTED state }
ensure that {
  when { UE receives an RRCReconfiguration message including dedicatedSIB1-Delivery containing SIB1
information with a change of trackingAreaCode }
    then { UE reads the updated SIB1 information and sends an RRCReconfigurationComplete message
followed by registration on the new tracking area }
}
```

(4)

```
with { UE in NR RRC_CONNECTED state }
ensure that {
  when { UE receives an RRCReconfiguration message including a reconfigurationWithSync and
keySetChangeIndicator set to 'true' in MasterKeyUpdate for handover to the target cell }
    then { UE performs handover to the target cell with security key update and transmits an
RRCReconfigurationComplete message }
}
```

8.1.4.1.2.2 Conformance requirements

References: The conformance requirements covered in the current TC are specified in: TS 38.331, clauses 5.3.5.3, 5.3.5.5.1, 5.3.5.5.2, 5.5.4.4, 5.2.2.4.2 and 5.3.5.7. Unless otherwise stated these are Rel-15 requirements.

[TS 38.331, clause 5.3.5.3]

The UE shall perform the following actions upon reception of the *RRCReconfiguration*:

...

1> if the *RRCReconfiguration* includes the *masterCellGroup*:

2> perform the cell group configuration for the received *masterCellGroup* according to 5.3.5.5;

- 1> if the *RRCReconfiguration* includes the *masterKeyUpdate*:
 - 2> perform security key update procedure as specified in 5.3.5.7;
- ...
- 1> if the *RRCReconfiguration* message includes the *radioBearerConfig*:
 - 2> perform the radio bearer configuration according to 5.3.5.6;
- ...
- 1> if the *RRCReconfiguration* message includes the *dedicatedSIB1-Delivery*:
 - 2> perform the action upon reception of *SIB1* as specified in 5.2.2.4.2;
- ...1> if the *RRCReconfiguration* message includes the *measConfig*:
 - 2> perform the measurement configuration procedure as specified in 5.5.2;
- ...
- 1> if *reconfigurationWithSync* was included in *spCellConfig* of an MCG or SCG, and when MAC of an NR cell group successfully completes a random access procedure triggered above:
 - 2> stop timer T304 for that cell group;
 - 2> apply the parts of the CQI reporting configuration, the scheduling request configuration and the sounding RS configuration that do not require the UE to know the SFN of the respective target SpCell, if any;
 - 2> apply the parts of the measurement and the radio resource configuration that require the UE to know the SFN of the respective target SpCell (e.g. measurement gaps, periodic CQI reporting, scheduling request configuration, sounding RS configuration), if any, upon acquiring the SFN of that target SpCell;
 - 2> if the *reconfigurationWithSync* was included in *spCellConfig* of an MCG:
 - 3> if T390 is running:
 - 4> stop timer T390 for all access categories;
 - 4> perform the actions as specified in 5.3.14.4.
 - 3> if *RRCReconfiguration* does not include *dedicatedSIB1-Delivery* and
 - 3> if the active downlink BWP, which is indicated by the *firstActiveDownlinkBWP-Id* for the target SpCell of the MCG, has a common search space configured by *searchSpaceSIB1*:
 - 4> acquire the *SIB1*, which is scheduled as specified in TS 38.213 [13], of the target SpCell of the MCG;
 - 4> upon acquiring *SIB1*, perform the actions specified in clause 5.2.2.4.2;
 - 2> the procedure ends.

NOTE: The UE is only required to acquire broadcasted *SIB1* if the UE can acquire it without disrupting unicast data reception, i.e. the broadcast and unicast beams are quasi co-located.

[TS 38.331, clause 5.3.5.5.1]

The network configures the UE with Master Cell Group (MCG), and zero or one Secondary Cell Group (SCG). In (NG)EN-DC, the MCG is configured as specified in TS 36.331 [10], and for NE-DC, the SCG is configured as specified in TS 36.331 [10]. The network provides the configuration parameters for a cell group in the *CellGroupConfig* IE.

The UE performs the following actions based on a received *CellGroupConfig* IE:

- 1> if the *CellGroupConfig* contains the *spCellConfig* with *reconfigurationWithSync*:
 - 2> perform Reconfiguration with sync according to 5.3.5.5.2;

2> resume all suspended radio bearers and resume SCG transmission for all radio bearers, if suspended;

...

1> if the *CellGroupConfig* contains the *mac-CellGroupConfig*:

2> configure the MAC entity of this cell group as specified in 5.3.5.5.5;

...

1> if the *CellGroupConfig* contains the *spCellConfig*:

2> configure the SpCell as specified in 5.3.5.5.7;

[TS 38.331, clause 5.3.5.5.2]

The UE shall perform the following actions to execute a reconfiguration with sync.

1> if the security is not activated, perform the actions upon going to RRC_IDLE as specified in 5.3.11 with the release cause 'other' upon which the procedure ends;

1> stop timer T310 for the corresponding SpCell, if running;

1> start timer T304 for the corresponding SpCell with the timer value set to *t304*, as included in the *reconfigurationWithSync*;

1> if the *frequencyInfoDL* is included:

2> consider the target SpCell to be one on the SSB frequency indicated by the *frequencyInfoDL* with a physical cell identity indicated by the *physCellId*;

1> else:

2> consider the target SpCell to be one on the SSB frequency of the source SpCell with a physical cell identity indicated by the *physCellId*;

1> start synchronising to the DL of the target SpCell;

1> apply the specified BCCH configuration defined in 9.1.1.1;

1> acquire the *MIB*, which is scheduled as specified in TS 38.213 [13];

NOTE 1: The UE should perform the reconfiguration with sync as soon as possible following the reception of the RRC message triggering the reconfiguration with sync, which could be before confirming successful reception (HARQ and ARQ) of this message.

NOTE 2: The UE may omit reading the MIB if the UE already has the required timing information, or the timing information is not needed for random access.

1> reset the MAC entity of this cell group;

1> consider the SCell(s) of this cell group, if configured, to be in deactivated state;

1> apply the value of the *newUE-Identity* as the C-RNTI for this cell group;

1> configure lower layers in accordance with the received *spCellConfigCommon*;

1> configure lower layers in accordance with any additional fields, not covered in the previous, if included in the received *reconfigurationWithSync*.

[TS 38.331, clause 5.5.4.4]

The UE shall:

1> consider the entering condition for this event to be satisfied when condition A3-1, as specified below, is fulfilled;

1> consider the leaving condition for this event to be satisfied when condition A3-2, as specified below, is fulfilled;

1> use the SpCell for M_p , O_{fp} and O_{cp} .

NOTE The cell(s) that triggers the event has reference signals indicated in the *measObjectNR* associated to this event which may be different from the NR SpCell *measObjectNR*.

Inequality A3-1 (Entering condition)

$$M_n + O_{fn} + O_{cn} - H_{ys} > M_p + O_{fp} + O_{cp} + O_{ff}$$

Inequality A3-2 (Leaving condition)

$$M_n + O_{fn} + O_{cn} + H_{ys} < M_p + O_{fp} + O_{cp} + O_{ff}$$

The variables in the formula are defined as follows:

M_n is the measurement result of the neighbouring cell, not taking into account any offsets.

O_{fn} is the measurement object specific offset of the reference signal of the neighbour cell (i.e. *offsetMO* as defined within *measObjectNR* corresponding to the neighbour cell).

O_{cn} is the cell specific offset of the neighbour cell (i.e. *cellIndividualOffset* as defined within *measObjectNR* corresponding to the frequency of the neighbour cell), and set to zero if not configured for the neighbour cell.

M_p is the measurement result of the SpCell, not taking into account any offsets.

O_{fp} is the measurement object specific offset of the SpCell (i.e. *offsetMO* as defined within *measObjectNR* corresponding to the SpCell).

O_{cp} is the cell specific offset of the SpCell (i.e. *cellIndividualOffset* as defined within *measObjectNR* corresponding to the SpCell), and is set to zero if not configured for the SpCell.

H_{ys} is the hysteresis parameter for this event (i.e. *hysteresis* as defined within *reportConfigNR* for this event).

O_{ff} is the offset parameter for this event (i.e. *a3-Offset* as defined within *reportConfigNR* for this event).

M_n , M_p are expressed in dBm in case of RSRP, or in dB in case of RSRQ and RS-SINR.

O_{fn} , O_{cn} , O_{fp} , O_{cp} , H_{ys} , O_{ff} are expressed in dB.

[TS 38.331, clause 5.2.2.4.2]

Upon receiving the *SIB1* the UE shall:

1> store the acquired *SIB1*;

1> if the *cellAccessRelatedInfo* contains an entry with the *PLMN-Identity* of the selected PLMN:

2> in the remainder of the procedures use *plmn-IdentityList*, *trackingAreaCode*, and *cellIdentity* for the cell as received in the corresponding *PLMN-IdentityInfo* containing the selected PLMN;

1> if in RRC_CONNECTED while T311 is not running:

2> disregard the *frequencyBandList*, if received, while in RRC_CONNECTED;

2> forward the *cellIdentity* to upper layers;

2> forward the *trackingAreaCode* to upper layers;

2> apply the configuration included in the *-servingCellConfigCommonSIB*;

[TS 38.331, clause 5.3.5.7]

The UE shall:

1> if UE is connected to E-UTRA/EPC:

2> upon reception of *sk-Counter* as specified in TS 36.331 [10]:

- 3> update the $S\text{-}K_{gNB}$ key based on the K_{eNB} key and using the received *sk-Counter* value, as specified in TS 33.401 [30];
- 3> derive the $K_{RRCCenc}$ and K_{UPenc} keys as specified in TS 33.401 [30];
- 3> derive the K_{RRCint} and K_{UPint} keys as specified in TS 33.401 [30].

1> else:

2> if the *nas-Container* is included in the received *masterKeyUpdate*:

3> forward the *nas-Container* to the upper layers;

2> if the *keySetChangeIndicator* is set to true:

3> derive or update the K_{gNB} key based on the K_{AMF} key, as specified in TS 33.501 [11];

2> else:

3> derive or update the K_{gNB} key based on the current K_{gNB} key or the NH, using the *nextHopChainingCount* value indicated in the received *masterKeyUpdate*, as specified in TS 33.501 [11];

2> store the *nextHopChainingCount* value;

2> derive the keys associated with the K_{gNB} key as follows:

3> if the *securityAlgorithmConfig* is included in *SecurityConfig*:

4> derive the $K_{RRCCenc}$ and K_{UPenc} keys associated with the *cipheringAlgorithm* indicated in the *securityAlgorithmConfig*, as specified in TS 33.501 [11];

4> derive the K_{RRCint} and K_{UPint} keys associated with the *integrityProtAlgorithm* indicated in the *securityAlgorithmConfig*, as specified in TS 33.501 [11];

3> else:

4> derive the $K_{RRCCenc}$ and K_{UPenc} keys associated with the current *cipheringAlgorithm*, as specified in TS 33.501 [11];

4> derive the K_{RRCint} and K_{UPint} keys associated with the current *integrityProtAlgorithm*, as specified in TS 33.501 [11].

NOTE: Ciphering and integrity protection are optional to configure for the DRBs.

8.1.4.1.2.3 Test description

8.1.4.1.2.3.1 Pre-test conditions

System Simulator:

- NR Cell 1 is the serving cell and NR Cell 3 is the inter-frequency neighbour cell of NR Cell 1.
- System information combination NR-4 as defined in TS 38.508-1 [4] clause 4.4.3.1.2 is used in NR cells.

UE:

- None.

Preamble:

- If *pc_IP_Ping* is set to TRUE then, the UE is in 5GS state 3N-A according to TS 38.508-1 [4], clause 4.4A.2 Table 4.4A.2-3.
- Else, the UE is in 5GS state 3N-A and Test Loop Function (*On*) with UE test loop mode B on NR Cell 1 according to 38.508-1[4], clause 4.4A.2 Table 4.4A.2-3.

8.1.4.1.2.3.2 Test procedure sequence

Tables 8.1.4.1.2.3.2-1 and 8.1.4.1.2.3.2-2 illustrate the downlink power levels to be applied for NR Cell 1 and NR Cell 3 at various time instants of the test execution. Row marked "T0" denotes the conditions after the preamble, while the configuration marked "T1", T2 and "T3", are applied at the point indicated in the Main behaviour description in Table 8.1.4.1.2.3.2-3.

Table 8.1.4.1.2.3.2-1: Power levels in FR1

	Parameter	Unit	NR Cell 1	NR Cell 3	Remark
T0	SS/PBCH SSS EPRE	dBm/ SCS	-85	-91	Power levels are such that entry condition for event A3 is not satisfied
T1	SS/PBCH SSS EPRE	dBm/ SCS	-85	-79	Power levels are such that entry condition for event A3 is satisfied for NR Cell 3
T2	SS/PBCH SSS EPRE	dBm/ SCS	-79	-85	Power levels are such that entry condition for event A3 is satisfied for NR Cell 1
T3	SS/PBCH SSS EPRE	dBm/ SCS	-88	-78	

Table 8.1.4.1.2.3.2-2: Power levels in FR2

	Parameter	Unit	NR Cell 1	NR Cell 3	Remark
T0	SS/PBCH SSS EPRE	dBm/ SCS	FFS	FFS	Power levels are such that entry condition for event A3 is not satisfied
T1	SS/PBCH SSS EPRE	dBm/ SCS	FFS	FFS	Power levels are such that entry condition for event A3 is satisfied for NR Cell 3
T2	SS/PBCH SSS EPRE	dBm/ SCS	FFS	FFS	Power levels are such that entry condition for event A3 is satisfied for NR Cell 1
T3	SS/PBCH SSS EPRE	dBm/ SCS	FFS	FFS	

Table 8.1.4.1.2.3.2-3: Main behaviour

St	Procedure	Message Sequence		TP	Verdict
		U - S	Message		
1	The SS transmits an <i>RRCReconfiguration</i> message including <i>MeasConfig</i> to setup intra NR measurement and reporting for inter-frequency event A3.	<--	NR RRC: <i>RRCReconfiguration</i>	-	-
2	The UE transmits an <i>RRCReconfigurationComplete</i> message.	-->	NR RRC: <i>RRCReconfigurationComplete</i>	-	-
3	SS adjusts the cell-specific reference signal level according to row "T1".	-	-	-	-
4	Check: Does the UE transmit a <i>MeasurementReport</i> message to report event A3 with the measured RSRP value for NR Cell 3?	-->	NR RRC: <i>MeasurementReport</i>	-	-
5	The SS transmits an <i>RRCReconfiguration</i> message including <i>reconfigurationWithSync</i> with <i>rach-ConfigDedicated</i> , <i>keySetChangeIndicator</i> set to <i>true</i> and including nas-Container IE to order the UE to perform inter-frequency handover to NR Cell 3	<--	NR RRC: <i>RRCReconfiguration</i>	-	-
6	Check: Does the UE transmit <i>RRCReconfigurationComplete</i> message in NR Cell 3?	-->	NR RRC: <i>RRCReconfigurationComplete</i>	1, 4	P

6A	Check: Does the test result of generic test procedure in TS 38.508-1 subclause 4.9.1 indicate that the UE is capable of exchanging IP data on DRB #n associated with the first PDU session on NR Cell 3?	-	-	1,4	-
7	The SS transmits an <i>RRCReconfiguration</i> message including <i>MeasConfig</i> to setup intra NR measurement and reporting for inter-frequency event A3.	<--	NR RRC: <i>RRCReconfiguration</i>	-	-
8	The UE transmits an <i>RRCReconfigurationComplete</i> message.	-->	NR RRC: <i>RRCReconfigurationComplete</i>	-	-
9	SS adjusts the cell-specific reference signal level according to row "T2".	-	-	-	-
10	Check: Does the UE transmit a <i>MeasurementReport</i> message to report event A3 with the measured RSRP value for NR Cell 1?	-->	NR RRC: <i>MeasurementReport</i>	-	-
11	The SS transmits an <i>RRCReconfiguration</i> message including <i>reconfigurationWithSync</i> without <i>rach-ConfigDedicated</i> , <i>keySetChangeIndicator</i> set to <i>true</i> and including nas-Container IE to order the UE to perform inter-frequency handover to NR Cell 1	<--	NR RRC: <i>RRCReconfiguration</i>	-	-
12	Check: Does the UE transmit <i>RRCReconfigurationComplete</i> message in NR Cell 1?	-->	NR RRC: <i>RRCReconfigurationComplete</i>	2, 4	P
12 A	Check: Does the test result of generic test procedure in TS 38.508-1 subclause 4.9.1 indicate that the UE is capable of exchanging IP data on DRB #n associated with the first PDU session on NR Cell 1?	-	-	2,4	-
13	SS adjusts the cell-specific reference signal level according to row "T3".	-	-	-	-
14	The SS transmits an <i>RRCReconfiguration</i> including dedicatedSIB1-Delivery containing SIB1 of NR Cell 3 to order the UE to perform handover to NR Cell 3.	<--	NR RRC: <i>RRCReconfiguration</i>	-	-
15	Check: Does the UE transmit an <i>RRCReconfigurationComplete</i> message on NR Cell 3?	-->	NR RRC: <i>RRCReconfigurationComplete</i>	3	P
16	Check: Does UE transmit a REGISTRATION REQUEST message to update the registration of the actual tracking area?	-->	NR RRC: <i>ULInformationTransfer</i> 5GMM: REGISTRATION REQUEST	3	P
-	EXCEPTION: In parallel to the events described in steps 16A to 19, the steps specified in Table 8.1.4.1.2.3.2-4 may take place.	-	-	-	-
16 A	SS transmits SIB1 with TAC=2 on NR Cell 3	-	-	-	-
17	SS responds with REGISTRATION ACCEPT message with TAC=2 in Tracking Area Identity List IE.	<--	NR RRC: <i>DLInformationTransfer</i> 5GMM: REGISTRATION ACCEPT	-	-
18	The UE sends a REGISTRATION COMPLETE message.	-->	NR RRC: <i>ULInformationTransfer</i> 5GMM: REGISTRATION COMPLETE	-	-
19	Check: Does the test result of generic test procedure in TS 38.508-1 subclause 4.9.1 indicate that the UE is capable of exchanging IP data on DRB #n associated with the first PDU session on NR Cell 3?	-	-	3	-

Table 8.1.4.1.2.3.2-4: Parallel behaviour

St	Procedure	Message Sequence		TP	Verdict
		U - S	Message		
1	The UE sends REGISTRATION REQUEST	-->	NR RRC: <i>ULInformationTransfer</i>	-	-

NOTE: This request may be to register for TAC=1 or TAC=2 depending upon when UE reads the SIB1 after step 16	5GMM: REGISTRATION REQUEST		
--	----------------------------	--	--

8.1.4.1.2.3.3 Specific message contents

Table 8.1.4.1.2.3.3-1: RRCReconfiguration (step 1, Table 8.1.4.1.2.3.2-3)

Derivation Path: TS 38.508-1 [4] Table 4.6.1-13 with condition MEAS

Table 8.1.4.1.2.3.3-2: MeasConfig (Table 8.1.4.1.2.3.3-1)

Derivation Path: TS 38.508-1 [4] Table 4.6.3-69			
Information Element	Value/remark	Comment	Condition
MeasConfig ::= SEQUENCE {			
measObjectToAddModList SEQUENCE (SIZE (1..maxNrofMeasId)) OF MeasObjectToAddMod {	2 entries		
MeasObjectToAddMod[1] SEQUENCE {		entry 1	
measObjectId	1		
measObject CHOICE {			
measObjectNR SEQUENCE {			
ssbFrequency	ssbFrequency IE equals the ARFCN for NR Cell 3		
absThreshSS-BlocksConsolidation	Not present		
}			
}			
MeasObjectToAddMod[2] SEQUENCE {		entry 2	
measObjectId	2		
measObject CHOICE {			
measObjectNR SEQUENCE {			
ssbFrequency	ssbFrequency IE equals the ARFCN for NR Cell 1		
absThreshSS-BlocksConsolidation	Not present		
}			
}			
}			
reportConfigToAddModList SEQUENCE(SIZE (1..maxReportConfigId)) OF ReportConfigToAddMod {	1 entry		
ReportConfigToAddMod[1] SEQUENCE {		entry 1	
reportConfigId	1		
reportConfig CHOICE {			
reportConfigNR	ReportConfigNR-EventA3		
}			
}			
measIdToAddModList SEQUENCE (SIZE (1..maxNrofMeasId)) OF MeasIdToAddMod {	1 entry		
MeasIdToAddMod[1] SEQUENCE {		entry 1	
measId	1		
measObjectId	1		
reportConfigId	1		
}			
}			
measGapConfig	MeasGapConfig		
}			

Table 8.1.4.1.2.3.3-3: ReportConfigNR-EventA3 (Table 8.1.4.1.2.3.3-2 and Table 8.1.4.1.2.3.3-8)

Derivation Path: TS 38.508-1 [4] Table 4.6.3-142 with condition EVENT_A3			
Information Element	Value/remark	Comment	Condition

rsrq	Not present		
sinr	Not present		
}			
resultsCSI-RS-Cell	Not present		
}			
rsIndexResults	Not present		
}			
}			
}			
}			
}			
}			
}			
}			
}			

Table 8.1.4.1.2.3.3-5: RRCReconfiguration (step 5, Table 8.1.4.1.2.3.2-3)

Derivation Path: TS 38.508-1 [4] Table 4.8.1-1A with condition RBConfig_KeyChange			
Information Element	Value/remark	Comment	Condition
RRCReconfiguration ::= SEQUENCE {			
criticalExtensions CHOICE {			
rrcReconfiguration SEQUENCE {			
nonCriticalExtension SEQUENCE {			
measConfig SEQUENCE {			
measObjectToRemoveList SEQUENCE (SIZE (1..maxNrofObjectld)) OF MeasObjectld {	2 entries		
measObjectld[1]	1	entry 1	
measObjectld[2]	2	entry 2	
}			
measldToRemoveList SEQUENCE (SIZE (1..maxNrofMeasld)) OF Measld {	1 entry		
measld[1]	1	entry 1	
}			
masterCellGroup	OCTET STRING (CONTAINING CellGroupConfig)		
masterKeyUpdate SEQUENCE {			
keySetChangeIndicator	True		
nextHopChainingCount	0		
nas-Container	NASContainer	Intra N1 mode NAS transparent container	
}			
}			
}			
}			
}			

Table 8.1.4.1.2.3.3-6: CellGroupConfig (Table 8.1.4.1.2.3.3-5)

Derivation Path: TS 38.508-1 [4], Table 4.6.3-19 with condition PCell_change and CFRA			
Information Element	Value/remark	Comment	Condition
CellGroupConfig ::= SEQUENCE {			
spCellConfig SEQUENCE {			
reconfigurationWithSync SEQUENCE {			
spCellConfigCommon SEQUENCE {	Same as default ServingCellConfigCommon		
physCellld	Physical cell Id of NR Cell 3		
}			
rach-ConfigDedicated CHOICE {			
Uplink	RACH-ConfigDedicated		

}			
}			
}			
}			

Table 8.1.4.1.2.3.3-6A: NASContainer (Table 8.1.4.1.2.3.3-5, Table 8.1.4.1.2.3.3-10)

Derivation Path: TS 24.501, table 9.11.2.6			
Information Element	Value/Remark	Comment	Condition
Message authentication code	The calculated value of MAC-I for this message.	The value of MAC-I is calculated by SS using COUNT = 0xFFFFFFFF (as per TS 33.501[20], 6.9.2.3.3)	
Type of ciphering algorithm	Set according to PIXIT px_NAS_5GC_Ciphering Algorithm for default ciphering algorithm		
Type of integrity protection algorithm	Set according to PIXIT px_NAS_5GC_IntegrityAlgorithm for default integrity protection algorithm	This value should not be equal to the null integrity algorithm.	
KACF	'1'B	a new K _{AMF} has been calculated by the network	
TSC	'0'B	native security context (for K _{SIAMF})	
Key set identifier in 5G	K _{SIAMF} that was created when the UE last registered to 5GCN		
Sequence number	The internal counter of the SS	eight least significant bits of the downlink NAS COUNT	

Table 8.1.4.1.2.3.3-7: RRCReconfiguration (step 7, Table 8.1.4.1.2.3.2-3)

Derivation Path: TS 38.508-1 [4] Table 4.6.1-13 with condition MEAS

Table 8.1.4.1.2.3.3-8: MeasConfig (Table 8.1.4.1.2.3.3-7)

Derivation Path: TS 38.508-1 [4] Table 4.6.3-69			
Information Element	Value/remark	Comment	Condition
MeasConfig ::= SEQUENCE {			
measObjectToAddModList SEQUENCE (SIZE (1..maxNrofMeasId)) OF MeasObjectToAddMod {	2 entries		
MeasObjectToAddMod[1] SEQUENCE {		entry 1	
measObjectId	1		
measObject CHOICE {			
measObjectNR SEQUENCE {			
ssbFrequency	ssbFrequency IE equals the ARFCN for NR Cell 1		
absThreshSS-BlocksConsolidation	Not present		
}			
}			
}			
MeasObjectToAddMod[2] SEQUENCE {		entry 2	
measObjectId	2		

measObject CHOICE {			
measObjectNR SEQUENCE {			
ssbFrequency	ssbFrequency IE equals the ARFCN for NR Cell 3		
absThreshSS-BlocksConsolidation	Not present		
}			
}			
}			
reportConfigToAddModList SEQUENCE(SIZE (1..maxReportConfigId)) OF ReportConfigToAddMod {	1 entry		
ReportConfigToAddMod[1] SEQUENCE {		entry 1	
reportConfigId	1		
reportConfig CHOICE {			
reportConfigNR	ReportConfigNR-EventA3		
}			
}			
}			
measIdToAddModList SEQUENCE (SIZE (1..maxNrofMeasId)) OF MeasIdToAddMod {	1 entry		
MeasIdToAddMod[1] SEQUENCE {		entry 1	
measId	1		
measObjectId	1		
reportConfigId	1		
}			
}			
}			

Table 8.1.4.1.2.3.3-9: MeasurementReport (step 10, Table 8.1.4.1.2.3.2-3)

Derivation Path: TS 38.508-1 [4] Table 4.6.1-5A			
Information Element	Value/remark	Comment	Condition
MeasurementReport ::= SEQUENCE {			
criticalExtensions CHOICE {			
measurementReport SEQUENCE {			
measResults SEQUENCE {			
measId	1		
measResultServingMOList SEQUENCE (SIZE (1..maxNrofServingCells)) OF MeasResultServMO {	1 entry		
MeasResultServMO[1] SEQUENCE {		entry 1	
servCellId	Cell index corresponding to NR Cell 3		
measResultServingCell SEQUENCE {			
physCellId	Physical layer cell identity of NR Cell 3		
measResult SEQUENCE {			
cellResults SEQUENCE {			
resultsSSB-Cell SEQUENCE {			
rsrp	(0..127)		
rsrq	(0..127)		
sinr	Not present		
}	Not checked		pc_ss SIN R_Meas
}			
}			
}			
}			
}			
}			
}			
measResultNeighCells CHOICE {			
measResultListNR SEQUENCE (SIZE (1..maxCellReport)) OF MeasResultNR {	1 entry		

MeasResultNR[1] SEQUENCE {		entry 1	
physCellId	Physical layer cell identity of NR Cell 1		
measResult SEQUENCE {			
cellResults SEQUENCE {			
resultsSSB-Cell SEQUENCE {			
rsrp	(0..127)		
rsrq	Not present		
sinr	Not present		
}			
resultsCSI-RS-Cell	Not present		
}			
rsIndexResults	Not present		
}			
}			

Table 8.1.4.1.2.3.3-10: RRCReconfiguration (step 11, Table 8.1.4.1.2.3.2-3)

Derivation Path: TS 38.508-1 [4] Table 4.8.1-1A with condition RBConfig_KeyChange			
Information Element	Value/remark	Comment	Condition
RRCReconfiguration ::= SEQUENCE {			
criticalExtensions CHOICE {			
rrcReconfiguration SEQUENCE {			
nonCriticalExtension SEQUENCE {			
measConfig SEQUENCE {			
measObjectToRemoveList SEQUENCE (SIZE (1..maxNrofObjectId)) OF MeasObjectId {	2 entries		
measObjectId[1]	1	entry 1	
measObjectId[2]	2	entry 2	
}			
measIdToRemoveList SEQUENCE (SIZE (1..maxNrofMeasId)) OF MeasId {	1 entry		
measId[1]	1	entry 1	
}			
}			
}			
}			
}			
masterCellGroup	OCTET STRING (CONTAINING CellGroupConfig)		
masterKeyUpdate SEQUENCE {			
keySetChangeIndicator	True		
nextHopChainingCount	0		
nas-Container	NASContainer	Intra N1 mode NAS transparent container	
}			
}			

Table 8.1.4.1.2.3.3-11: CellGroupConfig (Table 8.1.4.1.2.3.3-10)

Derivation Path: TS 38.508-1 [4], Table 4.6.3-19 with condition PCell_change			
Information Element	Value/remark	Comment	Condition
CellGroupConfig ::= SEQUENCE {			
spCellConfig SEQUENCE {			
reconfigurationWithSync SEQUENCE {			

spCellConfigCommon SEQUENCE {	Same as default ServingCellConfigCommon		
physCellId	Physical cell Id of NR Cell 1		
}			
rach-ConfigDedicated	Not Present		
}			
}			
}			

Table 8.1.4.1.2.3.3-12: RRCReconfiguration (step 14 Table 8.1.4.1.2.3.2-3)

Derivation Path: TS 38.508-1 [4], Table 4.8.1-1A with condition RBConfig_NoKeyChange			
Information Element	Value/remark	Comment	Condition
RRCReconfiguration ::= SEQUENCE {			
criticalExtensions CHOICE {			
rrcReconfiguration SEQUENCE {			
nonCriticalExtension SEQUENCE {			
dedicatedSIB1-Delivery	SIB1	OCTET STRING (CONTAINING SIB1)	
}			
}			
}			
}			

Table 8.1.4.1.2.3.3-13: SIB1 (Table 8.1.4.1.2.3.3-12)

Derivation Path: TS 38.508-1 [4], Table 4.6.1-28			
Information Element	Value/remark	Comment	Condition
SIB1 ::= SEQUENCE {			
cellAccessRelatedInfo SEQUENCE {			
plmn-IdentityList SEQUENCE (SIZE (1..maxPLMN)) OF PLMN-Identity {	1 entry		
plmn-Identity[1]		entry 1	
trackingAreaCode	2		
}			
}			
}			
}			

Table 8.1.4.1.2.3.3-14: REGISTRATION REQUEST (step 16 Table 8.1.4.1.2.3.2-3)

Derivation Path: TS 38.508-1 [4], Table 4.7.1-6 with condition MOBILITY			
Information Element	Value/remark	Comment	Condition
Last visited registered TAI			
tac	1		

Table 8.1.4.1.2.3.3-15: SIB1 (step 16A, Table 8.1.4.1.2.3.2-3)

Derivation Path: TS 38.508-1 [4], Table 4.6.1-28			
Information Element	Value/remark	Comment	Condition
SIB1 ::= SEQUENCE {			
cellAccessRelatedInfo SEQUENCE {			
plmn-IdentityList SEQUENCE (SIZE (1..maxPLMN)) OF PLMN-Identity {	1 entry		
plmn-Identity[1]		entry 1	
trackingAreaCode	2		
}			
}			

}			
}			

Table 8.1.4.1.2.3.3-16: REGISTRATION ACCEPT (step 17, Table 8.1.4.1.2.3.2-3)

Derivation path: TS 38.508-1 [4], Table 4.7.1-7			
Information Element	Value/remark	Comment	Condition
TAI list			
TAC 1	2		

Table 8.1.4.1.2.3.3-17: REGISTRATION REQUEST (step 1, Table 8.1.4.1.2.3.2-4)

Derivation Path: TS 38.508-1 [4], Table 4.7.1-6 with condition MOBILITY			
Information Element	Value/remark	Comment	Condition
Last visited registered TAI			
tac	Not Checked	The value may be 1 or 2, please check note for step 1 in Table 8.1.4.1.2.3.2-4	

8.1.4.1.3 Void

8.1.4.1.4 Void

8.1.4.1.5 Intra NR handover / Failure / Re-establishment successful

8.1.4.1.5.1 Test Purpose (TP)

(1)

```
with { UE in NR RRC_CONNECTED state and having received an RRCReconfiguration message including a reconfigurationWithSync for handover to the target cell }
ensure that {
  when { UE detects handover failure and the initial cell is selectable }
  then { UE performs an RRCReestablishment procedure on the source cell }
}
```

(2)

```
with { UE detects handover failure and having transmitted an RRCReestablishmentRequest message }
ensure that {
  when { UE receives an RRCReestablishment message with a nextHopChainingCount which is different from the NCC associated with the currently active KgNB }
  then { UE derives new KgNB from the nextHopChainingCount and completes RRCReestablishment procedure on the source cell }
}
```

(3)

```
with { UE detects handover failure and having transmitted an RRCReestablishmentRequest message }
ensure that {
  when { UE receives an RRCReestablishment message with a nextHopChainingCount which is same as the NCC associated with the currently active KgNB }
  then { UE derives new KgNB from the currently active KgNB and completes RRCReestablishment procedure on the source cell }
}
```

8.1.4.1.5.2 Conformance requirements

References: The conformance requirements covered in the present test case are specified in: TS 38.331, clauses 5.3.5.5.2, 5.3.5.7, 5.3.5.8.3 and 5.3.7.5. Unless otherwise stated these are Rel-15 requirements.

[TS 38.331, clause 5.3.5.5.2]

The UE shall perform the following actions to execute a reconfiguration with sync.

- 1> if the AS security is not activated, perform the actions upon going to RRC_IDLE as specified in 5.3.11 with the release cause 'other' upon which the procedure ends;
- 1> stop timer T310 for the corresponding SpCell, if running;
- 1> start timer T304 for the corresponding SpCell with the timer value set to *t304*, as included in the *reconfigurationWithSync*;
- 1> if the *frequencyInfoDL* is included:
 - 2> consider the target SpCell to be one on the SSB frequency indicated by the *frequencyInfoDL* with a physical cell identity indicated by the *physCellId*;
- 1> else:
 - 2> consider the target SpCell to be one on the SSB frequency of the source SpCell with a physical cell identity indicated by the *physCellId*;
- 1> start synchronising to the DL of the target SpCell;
- 1> apply the specified BCCH configuration defined in 9.1.1.1;
- 1> acquire the *MIB*, which is scheduled as specified in TS 38.213 [13];

NOTE 1: The UE should perform the reconfiguration with sync as soon as possible following the reception of the RRC message triggering the reconfiguration with sync, which could be before confirming successful reception (HARQ and ARQ) of this message.

NOTE 2: The UE may omit reading the *MIB* if the UE already has the required timing information, or the timing information is not needed for random access.

- 1> reset the MAC entity of this cell group;
- 1> consider the SCell(s) of this cell group, if configured, to be in deactivated state;
- 1> apply the value of the *newUE-Identity* as the C-RNTI for this cell group;
- 1> configure lower layers in accordance with the received *spCellConfigCommon*;
- 1> configure lower layers in accordance with any additional fields, not covered in the previous, if included in the received *reconfigurationWithSync*.

[TS 38.331, clause 5.3.5.7]

The UE shall:

...

- 1> else:
 - 2> if the *nas-Container* is included in the received *masterKeyUpdate*:
 - 3> forward the *nas-Container* to the upper layers;
 - 2> if the *keySetChangeIndicator* is set to *true*:
 - 3> derive or update the K_{gNB} key based on the K_{AMF} key, as specified in TS 33.501 [11];
 - 2> else:
 - 3> derive or update the K_{gNB} key based on the current K_{gNB} key or the NH, using the *nextHopChainingCount* value indicated in the received *masterKeyUpdate*, as specified in TS 33.501 [11];
 - 2> store the *nextHopChainingCount* value;

2> derive the keys associated with the K_{gNB} key as follows:

3> if the *securityAlgorithmConfig* is included in *SecurityConfig*:

4> derive the $K_{RRCCenc}$ and K_{UPenc} keys associated with the *cipheringAlgorithm* indicated in the *securityAlgorithmConfig*, as specified in TS 33.501 [11];

4> derive the K_{RRCint} and K_{UPint} keys associated with the *integrityProtAlgorithm* indicated in the *securityAlgorithmConfig*, as specified in TS 33.501 [11];

3> else:

4> derive the $K_{RRCCenc}$ and K_{UPenc} keys associated with the current *cipheringAlgorithm*, as specified in TS 33.501 [11];

4> derive the K_{RRCint} and K_{UPint} keys associated with the current *integrityProtAlgorithm*, as specified in TS 33.501 [11].

NOTE: Ciphering and integrity protection are optional to configure for the DRBs.

[TS 38.331, clause 5.3.5.8.3]

The UE shall:

1> if T304 of the MCG expires:

2> release dedicated preambles provided in *rach-ConfigDedicated* if configured;

2> revert back to the UE configuration used in the source PCell;

2> initiate the connection re-establishment procedure as specified in subclause 5.3.7.

NOTE 1: In the context above, "the UE configuration" includes state variables and parameters of each radio bearer.

1> else if T304 of a secondary cell group expires:

2> release dedicated preambles provided in *rach-ConfigDedicated*, if configured;

2> initiate the SCG failure information procedure as specified in subclause 5.7.3 to report SCG reconfiguration with sync failure, upon which the RRC reconfiguration procedure ends;

1> else if T304 expires when *RRCReconfiguration* is received via other RAT (HO to NR failure):

2> reset MAC;

2> perform the actions defined for this failure case as defined in the specifications applicable for the other RAT.

[TS 38.331, clause 5.3.7.5]

The UE shall:

1> stop timer T301;

1> consider the current cell to be the PCell;

1> store the *nextHopChainingCount* value indicated in the *RRCReestablishment* message;

1> update the K_{gNB} key based on the current K_{gNB} key or the NH, using the stored *nextHopChainingCount* value, as specified in TS 33.501 [11];

1> derive the $K_{RRCCenc}$ and K_{UPenc} keys associated with the previously configured *cipheringAlgorithm*, as specified in TS 33.501 [11];

1> derive the K_{RRCint} and K_{UPint} keys associated with the previously configured *integrityProtAlgorithm*, as specified in TS 33.501 [11].

1> request lower layers to verify the integrity protection of the *RRCReestablishment* message, using the previously configured algorithm and the K_{RRCint} key;

- 1> if the integrity protection check of the *RRCReestablishment* message fails:
 - 2> perform the actions upon going to RRC_IDLE as specified in 5.3.11, with release cause 'RRC connection failure', upon which the procedure ends;
- 1> configure lower layers to resume integrity protection for SRB1 using the previously configured algorithm and the K_{RRcInt} key immediately, i.e., integrity protection shall be applied to all subsequent messages received and sent by the UE, including the message used to indicate the successful completion of the procedure;
- 1> configure lower layers to resume ciphering for SRB1 using the previously configured algorithm and, the K_{RRcEnc} key immediately, i.e., ciphering shall be applied to all subsequent messages received and sent by the UE, including the message used to indicate the successful completion of the procedure;
- 1> release the measurement gap configuration indicated by the *measGapConfig*, if configured;
- 1> submit the *RRCReestablishmentComplete* message to lower layers for transmission;
- 1> the procedure ends.

8.1.4.1.5.3 Test Description

8.1.4.1.5.3.1 Pre-test conditions

System Simulator:

- NR Cell 1 is the Serving cell.
- NR Cell 2 is the Suitable neighbour intra-frequency cell.
- System information combination NR-2 as defined in TS 38.508-1 [4] clause 4.4.3.1.3 is used for both NR Cells.

UE:

- None.

Preamble:

- The UE is in state 3N-A as defined in TS 38.508-1 [4], subclause 4.4A on NR Cell 1.

8.1.4.1.5.3.2 Test procedure sequence

Table 8.1.4.1.5.3.2-1 and Table 8.1.4.1.5.3.2-2 illustrates the downlink power levels and other changing parameters to be applied for the cells at various time instants of the test execution. The exact instants on which these values shall be applied are described in the texts in this clause.

Table 8.1.4.1.5.3.2-1: Time instances of cell power level and parameter changes for FR1

	Parameter	Unit	NR Cell 1	NR Cell 2	Remark
T1	SS/PBCH SSS EPRE	dBm/SC S	-88	-88	
T2	SS/PBCH SSS EPRE	dBm/SC S	-88	-94	

Table 8.1.4.1.5.3.2-2: Time instances of cell power level and parameter changes for FR2

	Parameter	Unit	NR Cell 1	NR Cell 2	Remark
T1	SS/PBCH SSS EPRE	dBm/SC S	FFS	FFS	
T2	SS/PBCH SSS EPRE	dBm/SC S	FFS	FFS	

Table 8.1.4.1.5.3.2-3: Main behaviour

St	Procedure	Message Sequence		TP	Verdict
		U - S	Message		
1	The SS changes the power level setting according to the row "T1".	-	-	-	-
2	The SS transmits an RRCReconfiguration message on NR Cell 1 to order the UE to perform handover to NR Cell 2.	<--	NR RRC: <i>RRCReconfiguration</i>	-	-
-	EXCEPTION: In parallel to the events described in step 3 the steps specified in Table 8.1.4.1.5.3.2-4 should take place.	-	-	-	-
3	The SS changes the power level setting according to the row "T2".	-	-	-	-
4	Check: Does the UE transmit an RRCReestablishmentRequest message on NR Cell 1?	-->	NR RRC: <i>RRCReestablishmentRequest</i>	1	P
5	The SS transmits an RRCReestablishment message to resume SRB1 operation and re-activate security on NR Cell 1.	<--	NR RRC: <i>RRCReestablishment</i>	-	-
6	Does the UE transmit an RRCReestablishmentComplete message using the security key derived from the nextHopChainingCount on NR Cell 1?	-->	NR RRC: <i>RRCReestablishmentComplete</i>	2	P
6A	The SS transmits an RRCReconfiguration message to resume existing radio bearers on NR Cell 1.	<--	NR RRC: RRCReconfiguration	-	-
6B	The UE transmits an <i>RRCReconfigurationComplete</i> message on NR Cell 1.	-->	NR RRC: RRCReconfigurationComplete	-	-
7	The SS changes the power level setting according to the row "T1".	-	-	-	-
8	The SS transmits an RRCReconfiguration message on NR Cell 1 to order the UE to perform handover to NR Cell 2.	<--	NR RRC: <i>RRCReconfiguration</i>	-	-
-	EXCEPTION: In parallel to the events described in step 9 the steps specified in Table 8.1.4.1.5.3.2-4 should take place.	-	-	-	-
9	The SS changes the power level setting according to the row "T2".	-	-	-	-
10	Check: Does the UE transmit an RRCReestablishmentRequest message on NR Cell 1?	-->	NR RRC: <i>RRCReestablishmentRequest</i>	-	-
11	The SS transmits an RRCReestablishment message to resume SRB1 operation and re-activate security on NR Cell 1.	<--	NR RRC: <i>RRCReestablishment</i>	-	-
12	Does the UE transmit an RRCReestablishmentComplete message using the security key derived from the nextHopChainingCount on NR Cell 1?	-->	NR RRC: <i>RRCReestablishmentComplete</i>	3	P
12A	The SS transmits an RRCReconfiguration message to resume existing radio bearers on NR Cell 1.	<--	NR RRC: RRCReconfiguration	-	-
12B	The UE transmits an RRCReconfigurationComplete message on NR Cell 1.	-->	NR RRC: RRCReconfigurationComplete	-	-
13	The SS transmits an <i>RRCRelease</i> message on NR Cell 1.	<--	NR RRC: <i>RRCRelease</i>	-	-

Table 8.1.4.1.5.3.2-4: Parallel behaviour

St	Procedure	Message Sequence		TP	Verdict
		U - S	Message		

-	EXCEPTION: The steps 1 and 2 below are repeated for the duration of T304.	-	-	-	-
1	The UE attempts to perform the handover using MAC Random Access Preamble on NR Cell 2.	-	-	-	-
2	The SS does not respond.	-	-	-	-

8.1.4.1.5.3.3 Specific message contents

Table 8.1.4.1.5.3.3-1: SIB1 for NR Cell 1 and NR Cell 2 (preamble and all steps, Table 8.1.4.1.5.3.2-3)

Derivation Path: TS 38.508-1, Table 4.6.3-130			
Information Element	Value/remark	Comment	Condition
RACH-ConfigGeneric ::= SEQUENCE {			
preambleTransMax	n50		
}			

Table 8.1.4.1.5.3.3-2: RRCReconfiguration-HO (steps 2, 8, Table 8.1.4.1.5.3.2-3)

Derivation Path: TS 38.508-1 [4] Table 4.8.1-1A with condition RBConfig_KeyChange

Table 8.1.4.1.5.3.3-3: RRCReestablishmentRequest (step 4, 10, Table 8.1.4.1.5.3.2-3)

Derivation Path: TS 38.508-1, Table 4.6.1-12			
Information Element	Value/remark	Comment	Condition
RRCReestablishmentRequest ::= SEQUENCE {			
ue-Identity SEQUENCE {			
c-RNTI	the value of the C-RNTI of the UE		
physCellId	PhysicalCellId of NR Cell 1		
shortMAC-I	The same value as the 16 least significant bits of the MAC-I value calculated by SS.		
}			
reestablishmentCause	handoverFailure		
}			

Table 8.1.4.1.5.3.3-4: RRCReestablishment (step 5, 11, Table 8.1.4.1.5.3.2-3)

Derivation Path: TS 38.508-1, Table 4.6.1-10			
Information Element	Value/remark	Comment	Condition
RRCReestablishment ::= SEQUENCE {			
criticalExtensions CHOICE {			
rrcReestablishment SEQUENCE {			
nextHopChainingCount	2		
}			
}			
}			

Table 8.1.4.1.5.3.3-5: Void

Table 8.1.4.1.5.3.3-6: Void

Table 8.1.4.1.5.3.3-7: RRCReconfiguration (step 6A and 12A, Table 8.1.4.1.5.3.2-3)

Derivation Path: TS 38.508-1[4], table 4.6.1-13 with condition REEST
--

8.1.4.1.6 Intra NR handover / Failure / Re-establishment failure

8.1.4.1.6.1 Test Purpose (TP)

(1)

```
with { UE in NR RRC_CONNECTED state and having received an RRCReconfiguration message including a
reconfigurationWithSync for handover to the target cell }
ensure that {
  when { UE detects handover failure and fails an RRCReestablishment procedure }
  then { UE enters NR RRC_IDLE state }
}
```

8.1.4.1.6.2 Conformance requirements

References: The conformance requirements covered in the present test case are specified in: TS 38.331, clauses 5.3.5.5.2, 5.3.5.8.3 and 5.3.7.5 and TS 24.501, clause 5.5.1.3.2. Unless otherwise stated these are Rel-15 requirements.

[TS 38.331, clause 5.3.5.5.2]

The UE shall perform the following actions to execute a reconfiguration with sync.

- 1> if the AS security is not activated, perform the actions upon going to RRC_IDLE as specified in 5.3.11 with the release cause 'other' upon which the procedure ends;
 - 1> stop timer T310 for the corresponding SpCell, if running;
 - 1> start timer T304 for the corresponding SpCell with the timer value set to *t304*, as included in the *reconfigurationWithSync*;
 - 1> if the *frequencyInfoDL* is included:
 - 2> consider the target SpCell to be one on the SSB frequency indicated by the *frequencyInfoDL* with a physical cell identity indicated by the *physCellId*;
 - 1> else:
 - 2> consider the target SpCell to be one on the SSB frequency of the source SpCell with a physical cell identity indicated by the *physCellId*;
 - 1> start synchronising to the DL of the target SpCell;
 - 1> apply the specified BCCH configuration defined in 9.1.1.1;
 - 1> acquire the *MIB*, which is scheduled as specified in TS 38.213 [13];
- NOTE 1: The UE should perform the reconfiguration with sync as soon as possible following the reception of the RRC message triggering the reconfiguration with sync, which could be before confirming successful reception (HARQ and ARQ) of this message.
- NOTE 2: The UE may omit reading the *MIB* if the UE already has the required timing information, or the timing information is not needed for random access.
- 1> reset the MAC entity of this cell group;
 - 1> consider the SCell(s) of this cell group, if configured, to be in deactivated state;
 - 1> apply the value of the *newUE-Identity* as the C-RNTI for this cell group;
 - 1> configure lower layers in accordance with the received *spCellConfigCommon*;

1> configure lower layers in accordance with any additional fields, not covered in the previous, if included in the received *reconfigurationWithSync*.

[TS 38.331, clause 5.3.5.8.3]

The UE shall:

- 1> if T304 of the MCG expires:
 - 2> release dedicated preambles provided in *rach-ConfigDedicated* if configured;
 - 2> revert back to the UE configuration used in the source PCell;
 - 2> initiate the connection re-establishment procedure as specified in subclause 5.3.7.

NOTE 1: In the context above, "the UE configuration" includes state variables and parameters of each radio bearer.

- 1> else if T304 of a secondary cell group expires:
 - 2> release dedicated preambles provided in *rach-ConfigDedicated*, if configured;
 - 2> initiate the SCG failure information procedure as specified in subclause 5.7.3 to report SCG reconfiguration with sync failure, upon which the RRC reconfiguration procedure ends;
- 1> else if T304 expires when *RRCReconfiguration* is received via other RAT (HO to NR failure):
 - 2> reset MAC;
 - 2> perform the actions defined for this failure case as defined in the specifications applicable for the other RAT.

[TS 38.331, clause 5.3.7.5]

The UE shall:

- 1> stop timer T301;
- 1> consider the current cell to be the PCell;
- 1> store the *nextHopChainingCount* value indicated in the *RRCReestablishment* message;
- 1> update the K_{gNB} key based on the current K_{gNB} key or the NH, using the stored *nextHopChainingCount* value, as specified in TS 33.501 [11];
- 1> derive the K_{RRcenc} and K_{UPenc} keys associated with the previously configured *cipheringAlgorithm*, as specified in TS 33.501 [11];
- 1> derive the K_{RRcint} and K_{UPint} keys associated with the previously configured *integrityProtAlgorithm*, as specified in TS 33.501 [11].
- 1> request lower layers to verify the integrity protection of the *RRCReestablishment* message, using the previously configured algorithm and the K_{RRcint} key;
- 1> if the integrity protection check of the *RRCReestablishment* message fails:
 - 2> perform the actions upon going to RRC_IDLE as specified in 5.3.11, with release cause 'RRC connection failure', upon which the procedure ends;
- 1> configure lower layers to resume integrity protection for SRB1 using the previously configured algorithm and the K_{RRcint} key immediately, i.e., integrity protection shall be applied to all subsequent messages received and sent by the UE, including the message used to indicate the successful completion of the procedure;
- 1> configure lower layers to resume ciphering for SRB1 using the previously configured algorithm and, the K_{RRcenc} key immediately, i.e., ciphering shall be applied to all subsequent messages received and sent by the UE, including the message used to indicate the successful completion of the procedure;
- 1> release the measurement gap configuration indicated by the *measGapConfig*, if configured;
- 1> submit the *RRCReestablishmentComplete* message to lower layers for transmission;

1> the procedure ends.

[TS 24.501, clause 5.5.1.3.2]

The UE in state 5GMM-REGISTERED shall initiate the registration procedure for mobility and periodic registration update by sending a REGISTRATION REQUEST message to the AMF,

...

- f) when the UE receives an indication of "RRC Connection failure" from the lower layers and does not have signalling pending (i.e. when the lower layer requests NAS signalling connection recovery) except for the case specified in subclause 5.3.1.4;

8.1.4.1.6.3 Test Description

8.1.4.1.6.3.1 Pre-test conditions

System Simulator:

- NR Cell 1 is the Serving cell.
- NR Cell 2 is the Suitable neighbour intra-frequency cell.
- System information combination NR-2 as defined in TS 38.508-1 [4] clause 4.4.3.1.3 is used for both NR Cells.

UE:

- None.

Preamble:

- The UE is in state 3N-A as defined in TS 38.508-1 [4], subclause 4.4A on NR Cell 1.

8.1.4.1.6.3.2 Test procedure sequence

Table 8.1.4.1.6.3.2-1 and Table 8.1.4.1.6.3.2-2 illustrates the downlink power levels and other changing parameters to be applied for the cells at various time instants of the test execution. The exact instants on which these values shall be applied are described in the texts in this clause.

Table 8.1.4.1.6.3.2-1: Time instances of cell power level and parameter changes for FR1

	Parameter	Unit	NR Cell 1	NR Cell 2	Remark
T1	SS/PBCH SSS EPRE	dBm/SC S	-88	-88	
T2	SS/PBCH SSS EPRE	dBm/SC S	-88	-94	

Table 8.1.4.1.6.3.2-2: Time instances of cell power level and parameter changes for FR2

	Parameter	Unit	NR Cell 1	NR Cell 2	Remark
T1	SS/PBCH SSS EPRE	dBm/SC S	FFS	FFS	
T2	SS/PBCH SSS EPRE	dBm/SC S	FFS	FFS	

Table 8.1.4.1.6.3.2-3: Main behaviour

St	Procedure	Message Sequence		TP	Verdict
		U - S	Message		

1	The SS changes the power level setting according to the row "T1".	-	-	-	-
2	The SS transmits an RRCReconfiguration message on NR Cell 1 to order the UE to perform handover to NR Cell 2.	<--	NR RRC: <i>RRCReconfiguration</i>	-	-
-	EXCEPTION: In parallel to the events described in step 3 the steps specified in Table 8.1.4.1.6.3.2-4 should take place.	-	-	-	-
3	The SS changes the power level setting according to the row "T2".	-	-	-	-
4	Check: Does the UE transmit an RRCReestablishmentRequest message on NR Cell 1?	-->	NR RRC: <i>RRCReestablishmentRequest</i>	1	P
5	The SS transmits an RRCReestablishment message to resume SRB1 operation and re-activate security on NR Cell 1. Note: RRCReestablishment includes a wrong nextHopChainingCount value causing an integrity check failure.	<--	NR RRC: <i>RRCReestablishment</i>	-	-
6	Check: Does the test result of test procedure in TS 38.508-1 [4] subclause 4.9.5 indicate that the UE has performed mobility registration on NR cell 1 started in NR RRC_IDLE?	-	-	1	-

Table 8.1.4.1.6.3.2-4: Parallel behaviour

St	Procedure	Message Sequence		TP	Verdict
		U - S	Message		
-	EXCEPTION: The steps 1 and 2 below are repeated for the duration of T304.	-	-	-	-
1	The UE attempts to perform the handover using MAC Random Access Preamble on NR Cell 2.	-	-	-	-
2	The SS does not respond.	-	-	-	-

8.1.4.1.6.3.3 Specific message contents

Table 8.1.4.1.6.3.3-1: SIB1 for NR Cell 1 and NR Cell 2 (preamble and all steps, Table 8.1.4.1.6.3.2-3)

Derivation Path: TS 38.508-1, Table 4.6.3-130			
Information Element	Value/remark	Comment	Condition
RACH-ConfigGeneric ::= SEQUENCE {			
preambleTransMax	n50		
}			

Table 8.1.4.1.6.3.3-2: RRCReconfiguration-HO (step 2, Table 8.1.4.1.6.3.2-3)

Derivation Path: TS 38.508-1 [4] Table 4.8.1-1A with condition RBConfig_KeyChange

Table 8.1.4.1.6.3.3-3: RRCReestablishmentRequest (step 4, Table 8.1.4.1.6.3.2-3)

Derivation Path: TS 38.508-1, Table 4.6.1-12			
Information Element	Value/remark	Comment	Condition
RRCReestablishmentRequest ::= SEQUENCE {			
ue-Identity SEQUENCE {			
c-RNTI	the value of the C-RNTI of the UE		
physCellId	PhysicalCellId of NR Cell 1		
shortMAC-I	The same value as the 16 least significant bits of the MAC-I value		

	calculated by SS.		
}			
reestablishmentCause	handoverFailure		
}			

Table 8.1.4.1.6.3.3-4: RRCReestablishment (step 5, Table 8.1.4.1.6.3.2-3)

Derivation Path: TS 38.508-1, Table 4.6.1-10			
Information Element	Value/remark	Comment	Condition
RRCReestablishment ::= SEQUENCE {			
criticalExtensions CHOICE {			
rrcReestablishment SEQUENCE {			
nextHopChainingCount	7		
}			
}			
}			

8.1.4.1.7 NR CA / Intra NR handover / Success / PCell Change and SCell addition / SCell release

8.1.4.1.7.1 NR CA / Intra NR handover / Success / PCell Change and SCell addition / SCell release / Intra-band Contiguous CA

8.1.4.1.7.1.1 Test Purpose (TP)

(1)

```
with { UE in NR RRC_CONNECTED state and configured an SCell }
ensure that {
  when { UE receives an RRCReconfiguration message including a reconfigurationWithSync for handover
to one of the SCell and sCellToAddModList for an SCell addition }
  then { UE transmits an RRCReconfigurationComplete message }
}
```

(2)

```
with { UE in NR RRC_CONNECTED state }
ensure that {
  when { UE receives an RRCReconfiguration message including a reconfigurationWithSync for PCell
change and including sCellToReleaseList with an sCellIndex set to the configured SCell }
  then { UE sends an RRCReconfigurationComplete message }
}
```

8.1.4.1.7.1.2 Conformance requirements

References: The conformance requirements covered in the current TC are specified in: TS 38.331 clauses 5.3.5.5.2, clauses 5.3.5.5.9 and clauses 5.3.5.5.8. Unless otherwise stated these are Rel-15 requirements.

[TS 38.331, clause 5.3.5.5.2]

The UE shall perform the following actions to execute a reconfiguration with sync.

- 1> if the AS security is not activated, perform the actions upon going to RRC_IDLE as specified in 5.3.11 with the release cause 'other' upon which the procedure ends;
- 1> stop timer T310 for the corresponding SpCell, if running;
- 1> start timer T304 for the corresponding SpCell with the timer value set to *t304*, as included in the *reconfigurationWithSync*;
- 1> if the *frequencyInfoDL* is included:

2> consider the target SpCell to be one on the SSB frequency indicated by the *frequencyInfoDL* with a physical cell identity indicated by the *physCellId*;

1> else:

2> consider the target SpCell to be one on the SSB frequency of the source SpCell with a physical cell identity indicated by the *physCellId*;

1> start synchronising to the DL of the target SpCell;

1> apply the specified BCCH configuration defined in 9.1.1.1;

1> acquire the *MIB*, which is scheduled as specified in TS 38.213 [13];

NOTE 1: The UE should perform the reconfiguration with sync as soon as possible following the reception of the RRC message triggering the reconfiguration with sync, which could be before confirming successful reception (HARQ and ARQ) of this message.

NOTE 2: The UE may omit reading the *MIB* if the UE already has the required timing information, or the timing information is not needed for random access.

1> reset the MAC entity of this cell group;

1> consider the SCell(s) of this cell group, if configured, to be in deactivated state;

1> apply the value of the *newUE-Identity* as the C-RNTI for this cell group;

1> configure lower layers in accordance with the received *spCellConfigCommon*;

1> configure lower layers in accordance with any additional fields, not covered in the previous, if included in the received *reconfigurationWithSync*.

[TS 38.331, clause 5.3.5.5.9]

The UE shall:

1> for each *sCellIndex* value included in the *sCellToAddModList* that is not part of the current UE configuration (SCell addition):

2> add the SCell, corresponding to the *sCellIndex*, in accordance with the *sCellConfigCommon* and *sCellConfigDedicated*;

2> configure lower layers to consider the SCell to be in deactivated state;

2> for each *measId* included in the *measIdList* within *VarMeasConfig*:

3> if SCells are not applicable for the associated measurement; and

3> if the concerned SCell is included in *cellsTriggeredList* defined within the *VarMeasReportList* for this *measId*:

4> remove the concerned SCell from *cellsTriggeredList* defined within the *VarMeasReportList* for this *measId*;

1> for each *sCellIndex* value included in the *sCellToAddModList* that is part of the current UE configuration (SCell modification):

2> modify the SCell configuration in accordance with the *sCellConfigDedicated*.

[TS 38.331, clause 5.3.5.5.8]

The UE shall:

1> if the release is triggered by reception of the *sCellToReleaseList*:

2> for each *sCellIndex* value included in the *sCellToReleaseList*:

3> if the current UE configuration includes an SCell with value *sCellIndex*:

4> release the SCell.

8.1.4.1.7.1.3 Test description

8.1.4.1.7.1.3.1 Pre-test conditions

System Simulator:

- NR Cell 1 is the PCell, NR Cell 3 is the configured SCell and target PCell. NR Cell 2 is the active target SCell. NR Cell 12 is the target intra-frequency Cell of NR Cell 3, and also the target PCell.
- NR Cell 1 and NR Cell 3 are Intra-band Contiguous. NR Cell 2 and NR Cell 12 are Intra-band Contiguous.
- NR Cell 12 belongs to the same PLMN and TAI with NR Cell 1.
- System information combination NR-4 as defined in TS 38.508-1 [4] clause 4.4.3.1.2 is used in NR cells.

UE:

- None.

Preamble:

- If `pc_IP_Ping` is set to TRUE then, the UE is in 5GS state 3N-A according to TS 38.508-1 [4], clause 4.4A.2 Table 4.4A.2-3.
- Else, the UE is in 5GS state 3N-A and Test Loop Function (*On*) with UE test loop mode B on NR Cell 1 according to TS 38.508-1 [4], clause 4.4A.2 Table 4.4A.2-3.

8.1.4.1.7.1.3.2 Test procedure sequence

Table 8.1.4.1.7.1.3.2-1 and Table 8.1.4.1.7.1.3.2-2 illustrates the downlink power levels to be applied for NR Cell 1, NR Cell 3, NR Cell 2 and NR Cell 12 at various time instants of the test execution. Row marked "T0" denotes the conditions after the preamble, while rows marked "T1" are to be applied subsequently. The exact instants on which these values shall be applied are described in the texts in this clause.

Table 8.1.4.1.7.1.3.2-1: Time instances of cell power level and parameter changes for conducted test environment

	Parameter	Unit	NR Cell 1	NR Cell 3	NR Cell 2	NR Cell 12	Remark
T0	SS/PBCH SSS EPRE	dBm/SCS	-88	-88	-88	"Off"	NR Cell 1, NR Cell 2 and NR Cell 3 are available. NR Cell 12 is not available.
T1	SS/PBCH SSS EPRE	dBm/SCS	"Off"	-88	-88	-82	NR Cell 3, NR Cell 2 and NR Cell 12 are available. NR Cell 1 is not available.

Table 8.1.4.1.7.1.3.2-2: Time instances of cell power level and parameter changes for OTA test environment

	Parameter	Unit	NR Cell 1	NR Cell 3	NR Cell 2	NR Cell 12	Remark
T0	SS/PBCH SSS EPRE	dBm/SCS	FFS	FFS	FFS	"Off"	NR Cell 1, NR Cell 2 and NR Cell 3 are available. NR Cell 12 is not available.
T1	SS/PBCH SSS EPRE	dBm/SCS	"ff"	FFS	FFS	FFS	NR Cell 3, NR Cell 2 and NR Cell 12 are available. NR Cell 1 is not available.

Table 8.1.4.1.7.1.3.2-3: Main behaviour

St	Procedure	Message Sequence		TP	Verdict
		U - S	Message		
1	The SS changes Cell parameters according to the row "T0" in table 8.1.4.1.7.1.3.2-1/2.	-	-	-	-
2	The SS transmits an <i>RRCReconfiguration</i> message including a <i>sCellToAddModList</i> to add NR Cell 3 as a SCell.	<--	NR RRC: <i>RRCReconfiguration</i>	-	-
3	The UE transmits the <i>RRCReconfigurationComplete</i> message.	-->	NR RRC: <i>RRCReconfigurationComplete</i>	-	-
4	The SS transmits an <i>RRCReconfiguration</i> message including a <i>reconfigurationWithSync</i> for handover to NR Cell 3 and <i>sCellToAddModList</i> to add NR Cell 2 as a SCell.	<--	NR RRC: <i>RRCReconfiguration</i>	-	-
5	Check: Does UE transmit the <i>RRCReconfigurationComplete</i> message?	-->	NR RRC: <i>RRCReconfigurationComplete</i>	1	P
5A	Check: Does the test result of generic test procedure in TS 38.508-1 [4] Table 4.9.1-1A indicate that the UE is capable of exchanging IP data on DRB #n associated with the first PDU session on Cell 2?	-	-	1	-
6	The SS changes Cell parameters according to the row "T1" in table 8.1.4.1.7.1.3.2-1/2.	-	-	-	-
7	The SS transmits an <i>RRCReconfiguration</i> message including a <i>reconfigurationWithSync</i> to change PCell to NR Cell 12 and including <i>sCellToReleaseList</i> with a <i>sCellIndex</i> of NR Cell 2.	<--	NR RRC: <i>RRCReconfiguration</i>	-	-
8	Check: Does the UE transmit the <i>RRCReconfigurationComplete</i> message?	-->	NR RRC: <i>RRCReconfigurationComplete</i>	2	P
9	Check: Does the test result of generic test procedure in TS 38.508-1 [4] subclause 4.9.1 indicate that the UE is capable of exchanging IP data on DRB #n associated with the first PDU session on Cell 12?	-	-	2	-

8.1.4.1.7.1.3.3 Specific message contents

Table 8.1.4.1.7.1.3.3-1: *RRCReconfiguration* (step 2, Table 8.1.4.1.7.1.3.2-3)

Derivation Path: TS 38.508-1 [4], Table 4.6.1-13 with condition SCell_add			
Information Element	Value/remark	Comment	Condition
<i>RRCReconfiguration</i> ::= SEQUENCE {			
criticalExtensions CHOICE {			
rrcReconfiguration SEQUENCE {			
nonCriticalExtension SEQUENCE{			
masterCellGroup	CellGroupConfig	OCTET STRING (CONTAINING CellGroupConfig)	
}			
}			
}			
}			

Table 8.1.4.1.7.1.3.3-2: *CellGroupConfig* (Table 8.1.4.1.7.1.3.3-1)

Derivation Path: TS 38.508-1 [4], Table 4.6.3-19 with Condition SCell_add			
Information Element	Value/remark	Comment	Condition
<i>CellGroupConfig</i> ::= SEQUENCE {			
sCellToAddModList SEQUENCE (SIZE (1..maxNrofSCells)) OF SCellConfig {	1 entry		
SCellConfig[1] SEQUENCE {		entry 1	

sCellConfigCommon SEQUENCE {			
physCellId	Physical Cell Identity of NR Cell 3		
}			
}			
}			

Table 8.1.4.1.7.1.3.3-3: RRCReconfiguration-HO (step 4, Table 8.1.4.1.7.1.3.2-3)

Derivation Path: TS 38.508-1 [4] 4.8.1-1A with condition RBConfig_KeyChange			
Information Element	Value/remark	Comment	Condition
RRCReconfiguration ::= SEQUENCE {			
criticalExtensions CHOICE {			
rrcReconfiguration SEQUENCE {			
nonCriticalExtension SEQUENCE{			
masterCellGroup	CellGroupConfig	OCTET STRING (CONTAINING CellGroupConfig)	
}			
}			
}			
}			

Table 8.1.4.1.7.1.3.3-4: CellGroupConfig (Table 8.1.4.1.7.1.3.3-3)

Derivation Path: TS 38.508-1 [4], Table 4.6.3-19 with Condition PCell_change and SCell_add			
Information Element	Value/remark	Comment	Condition
CellGroupConfig ::= SEQUENCE {			
spCellConfig SEQUENCE {			
reconfigurationWithSync SEQUENCE {			
spCellConfigCommon SEQUENCE {			
physCellId	Physical Cell Identity of NR Cell 3		
}			
}			
}			
sCellToAddModList SEQUENCE (SIZE (1..maxNrofSCells)) OF SCellConfig {	1 entry		
SCellConfig[1] SEQUENCE {		entry 1	
sCellConfigCommon SEQUENCE {			
physCellId	Physical Cell Identity of NR Cell 2		
}			
}			
}			
sCellToReleaseList SEQUENCE (SIZE (1..maxNrofSCells)) OF SCellIndex {	1 entry		
SCellIndex[1]	1	entry 1 SCell release for NR Cell 3	
}			
}			

Table 8.1.4.1.7.1.3.3-5: RRCReconfiguration-HO (step 7, Table 8.1.4.1.7.1.3.2-3)

Derivation Path: TS 38.508-1 [4], Table 4.8.1-1A with condition RBConfig_KeyChange
--

Table 8.1.4.1.7.1.3.3-6: CellGroupConfig (Table 8.1.4.1.7.1.3.3-5)

Derivation Path: TS 38.508-1 [4], Table 4.6.3-19 with conditions PCell_change

Information Element	Value/remark	Comment	Condition
CellGroupConfig ::= SEQUENCE {			
spCellConfig SEQUENCE {			
reconfigurationWithSync SEQUENCE {			
spCellConfigCommon SEQUENCE {			
physCellId	Physical Cell Identity of NR Cell 12		
}			
}			
}			
sCellToReleaseList SEQUENCE (SIZE (1..maxNrofSCells)) OF SCellIndex {	1 entry		
SCellIndex[1]	1	entry 1 SCell release for NR Cell 2	
}			
}			

8.1.4.1.7.2 NR CA / Intra NR handover / Success / PCell Change and SCell addition / SCell release / Inter-band CA

8.1.4.1.7.2.1 Test Purpose (TP)

Same as TC 8.1.4.1.7.1 but applied to Inter-band CA case.

8.1.4.1.7.2.2 Conformance requirements

Same as TC 8.1.4.1.7.1 but applied to Inter-band CA case.

8.1.4.1.7.2.3 Test description

8.1.4.1.7.2.3.1 Pre-test conditions

Same as test case 8.1.4.1.7.1 with the following differences:

- CA configuration: Inter-band CA replaces Intra-band Contiguous CA.
- Cells configuration: NR Cell 10 replaces NR Cell 3, NR Cell 30 replaces NR Cell 12.
- NR Cell 30 belongs to the same PLMN and TAI with NR Cell 1.

8.1.4.1.7.2.3.2 Test procedure sequence

Same as TC 8.1.4.1.7.1 with the following differences:

- CA configuration: Inter-band CA replaces Intra-band Contiguous CA

8.1.4.1.7.2.3.3 Specific message contents

Same as TC 8.1.4.1.7.1 with the following differences:

- CA configuration: Inter-band CA replaces Intra-band Contiguous CA
- Cells configuration: NR Cell 10 replaces NR Cell 3, NR Cell 30 replaces NR Cell 12.

Table 8.1.4.1.7.2.3.3-1: SIB3 of NR Cell 10 (step 6, Table 8.1.4.1.7.1.3.2-3)

Derivation Path: TS 38.508-1 [4], Table 4.6.2-2			
Information Element	Value/remark	Comment	Condition
SIB3 ::= SEQUENCE {			
intraFreqNeighCellList SEQUENCE (SIZE (1..maxCellIntra)) OF IntraFreqNeighCellInfo {	1 entry		

IntraFreqNeighCellInfo [1] SEQUENCE {		entry 1	
physCellId	Physical Cell Identity of NR Cell 30		
}			
}			
}			

8.1.4.1.7.3 NR CA / Intra NR handover / Success / PCell Change and SCell addition / SCell release / Intra-band non-contiguous CA

8.1.4.1.7.3.1 Test Purpose (TP)

Same as TC 8.1.4.1.7.1 but applied to Intra-band non-Contiguous CA.

8.1.4.1.7.3.2 Conformance requirements

Same as TC 8.1.4.1.7.1 but applied to Intra-band non-Contiguous CA.

8.1.4.1.7.3.3 Test description

8.1.4.1.7.3.3.1 Pre-test conditions

Same as test case 8.1.4.1.7.1 with the following differences:

- CA configuration: Intra-band non-Contiguous CA replaces Intra-band Contiguous CA.

8.1.4.1.7.3.3.2 Test procedure sequence

Same as TC 8.1.4.1.7.1 with the following differences:

- CA configuration: Intra-band non-Contiguous CA replaces Intra-band Contiguous CA

8.1.4.1.7.3.3.3 Specific message contents

Same as TC 8.1.4.1.7.1 with the following differences:

- CA configuration: Intra-band non-Contiguous CA replaces Intra-band Contiguous CA

8.1.4.1.8 NR CA / Intra NR handover / Success / PCell Change / SCell no Change

8.1.4.1.8.1 NR CA / Intra NR handover / Success / PCell Change / SCell no Change / Intra-band Contiguous CA

8.1.4.1.8.1.1 Test Purpose (TP)

(1)

```
with { UE in NR RRC_CONNECTED state and configured an SCell }
ensure that {
  when { UE receives an RRCReconfiguration message including a reconfigurationWithSync for PCell
change and sCellToAddModList with an SCell same from configured SCell }
  then { UE transmits an RRCReconfigurationComplete message }
}
```

8.1.4.1.8.1.2 Conformance requirements

References: The conformance requirements covered in the current TC are specified in: TS 38.331 clauses 5.3.5.5.2, clauses 5.3.5.5.9. Unless otherwise stated these are Rel-15 requirements.

[TS 38.331, clause 5.3.5.5.2]

The UE shall perform the following actions to execute a reconfiguration with sync.

- 1> if the AS security is not activated, perform the actions upon going to RRC_IDLE as specified in 5.3.11 with the release cause 'other' upon which the procedure ends;
- 1> stop timer T310 for the corresponding SpCell, if running;
- 1> start timer T304 for the corresponding SpCell with the timer value set to *t304*, as included in the *reconfigurationWithSync*;
- 1> if the *frequencyInfoDL* is included:
 - 2> consider the target SpCell to be one on the SSB frequency indicated by the *frequencyInfoDL* with a physical cell identity indicated by the *physCellId*;
- 1> else:
 - 2> consider the target SpCell to be one on the SSB frequency of the source SpCell with a physical cell identity indicated by the *physCellId*;
- 1> start synchronising to the DL of the target SpCell;
- 1> apply the specified BCCH configuration defined in 9.1.1.1;
- 1> acquire the *MIB*, which is scheduled as specified in TS 38.213 [13];

NOTE 1: The UE should perform the reconfiguration with sync as soon as possible following the reception of the RRC message triggering the reconfiguration with sync, which could be before confirming successful reception (HARQ and ARQ) of this message.

NOTE 2: The UE may omit reading the *MIB* if the UE already has the required timing information, or the timing information is not needed for random access.

- 1> reset the MAC entity of this cell group;
- 1> consider the SCell(s) of this cell group, if configured, to be in deactivated state;
- 1> apply the value of the *newUE-Identity* as the C-RNTI for this cell group;
- 1> configure lower layers in accordance with the received *spCellConfigCommon*;
- 1> configure lower layers in accordance with any additional fields, not covered in the previous, if included in the received *reconfigurationWithSync*.

[TS 38.331, clause 5.3.5.5.9]

The UE shall:

- 1> for each *sCellIndex* value included in the *sCellToAddModList* that is not part of the current UE configuration (SCell addition):
 - 2> add the SCell, corresponding to the *sCellIndex*, in accordance with the *sCellConfigCommon* and *sCellConfigDedicated*;
 - 2> configure lower layers to consider the SCell to be in deactivated state;
 - 2> for each *measId* included in the *measIdList* within *VarMeasConfig*:
 - 3> if SCells are not applicable for the associated measurement; and
 - 3> if the concerned SCell is included in *cellsTriggeredList* defined within the *VarMeasReportList* for this *measId*:
 - 4> remove the concerned SCell from *cellsTriggeredList* defined within the *VarMeasReportList* for this *measId*;

- 1> for each *sCellIndex* value included in the *sCellToAddModList* that is part of the current UE configuration (SCell modification):
- 2> modify the SCell configuration in accordance with the *sCellConfigDedicated*.

8.1.4.1.8.1.3 Test description

8.1.4.1.8.1.3.1 Pre-test conditions

System Simulator:

- NR Cell 1 is the PCell, NR Cell 3 is the configured active SCell. NR Cell 2 is the target intra-frequency Cell of NR Cell 1, and also the target PCell.
- NR Cell 1 and NR Cell 3 are Intra-band Contiguous.
- System information combination NR-4 as defined in TS 38.508-1 [4] clause 4.4.3.1.2 is used in NR cells.

UE:

- None.

Preamble:

- If *pc_IP_Ping* is set to TRUE then, the UE is in 5GS state 3N-A according to TS 38.508-1 [4], clause 4.4A.2 Table 4.4A.2-3.
- Else, the UE is in 5GS state 3N-A and Test Loop Function (*On*) with UE test loop mode B on NR Cell 1 according to TS 38.508-1 [4], clause 4.4A.2 Table 4.4A.2-3.

8.1.4.1.8.1.3.2 Test procedure sequence

Table 8.1.4.1.8.1.3.2-1 and Table 8.1.4.1.8.1.3.2-2 illustrates the downlink power levels to be applied for NR Cell 1, NR Cell 3 and NR Cell 2 at various time instants of the test execution. Row marked “T0” denotes the conditions after the preamble, while rows marked “T1” are to be applied subsequently. The exact instants on which these values shall be applied are described in the texts in this clause.

Table 8.1.4.1.8.1.3.2-1: Time instances of cell power level and parameter changes for conducted test environment

	Parameter	Unit	NR Cell 1	NR Cell 3	NR Cell 2	Remark
T0	SS/PBCH SSS EPRE	dBm/ SCS	-88	-99	“Off”	NR Cell 1, NR Cell 3 are available. NR Cell 2 is not available.
T1	SS/PBCH SSS EPRE	dBm/ SCS	-88	-99	-88	NR Cell 1, NR Cell 3 and NR Cell 2 are available.

Table 8.1.4.1.8.1.3.2-2: Time instances of cell power level and parameter changes for OTA test environment

	Parameter	Unit	NR Cell 1	NR Cell 3	NR Cell 2	Remark
T0	SS/PBCH SSS EPRE	dBm/ SCS	FFS	FFS	“Off”	NR Cell 1, NR Cell 3 are available. NR Cell 2 is not available.
T1	SS/PBCH SSS EPRE	dBm/ SCS	FFS	FFS	FFS	NR Cell 1, NR Cell 3 and NR Cell 2 are available.

Table 8.1.4.1.8.1.3.2-3: Main behaviour

St	Procedure	Message Sequence		TP	Verdict
		U - S	Message		
1	The SS changes Cell parameters according to the row "T0" in table 8.1.4.1.8.1.3.2-1/2.	-	-	-	-
2	The SS transmits an <i>RRCReconfiguration</i> message including a <i>sCellToAddModList</i> to add NR Cell 3 as a SCell.	<--	NR RRC: <i>RRCReconfiguration</i>	-	-
3	The UE transmits the <i>RRCReconfigurationComplete</i> message?	-->	NR RRC: <i>RRCReconfigurationComplete</i>	-	-
3A	Check: Does the test result of generic test procedure in TS 38.508-1 [4] Table 4.9.1-1A indicate that the UE is capable of exchanging IP data on DRB1 and NR Cell 3?	-	-	1	-
4	The SS changes Cell parameters according to the row "T1" in table 8.1.4.1.8.1.3.2-1/2.	-	-	-	-
5	The SS transmits an <i>RRCReconfiguration</i> message including a <i>reconfigurationWithSync</i> to change PCell to NR Cell 2 and <i>sCellToAddModList</i> to add NR Cell 3 as the SCell.	<--	NR RRC: <i>RRCReconfiguration</i>	-	-
6	Check: Does the UE transmit the <i>RRCReconfigurationComplete</i> message?	-->	NR RRC: <i>RRCReconfigurationComplete</i>	1	P
7	Check: Does the test result of generic test procedure in TS 38.508-1 [4] Table 4.9.1-1A indicate that the UE is capable of exchanging IP data on DRB1 and NR Cell 3?	-	-	1	-
8	The SS transmits an <i>RRCReconfiguration</i> message containing an <i>sCellToReleaseList</i> with SCell NR Cell 3.	<--	NR RRC: <i>RRCReconfiguration</i>	-	-
9	The UE transmits an <i>RRCReconfigurationComplete</i> message.	-->	NR RRC: <i>RRCReconfigurationComplete</i>	-	-

8.1.4.1.8.1.3.3 Specific message contents

Table 8.1.4.1.8.1.3.3-1: *RRCReconfiguration* (step 2, Table 8.1.4.1.8.1.3.2-3)

Derivation Path: TS 38.508-1 [4], Table 4.6.1-13 with condition SCell_add			
Information Element	Value/remark	Comment	Condition
<i>RRCReconfiguration</i> ::= SEQUENCE {			
<i>criticalExtensions</i> CHOICE {			
<i>rrcReconfiguration</i> SEQUENCE {			
<i>nonCriticalExtension</i> SEQUENCE{			
<i>masterCellGroup</i>	CellGroupConfig	OCTET STRING (CONTAINING CellGroupConfig)	
}			
}			
}			
}			

Table 8.1.4.1.8.1.3.3-2: *CellGroupConfig* (Table 8.1.4.1.8.1.3.3-1)

Derivation Path: TS 38.508-1 [4], Table 4.6.3-19 with condition SCell_add			
Information Element	Value/remark	Comment	Condition
<i>CellGroupConfig</i> ::= SEQUENCE {			
<i>sCellToAddModList</i> SEQUENCE (SIZE (1..maxNrofSCells)) OF <i>SCellConfig</i> {	1 entry		
<i>SCellConfig</i> [1] SEQUENCE {		entry 1	
<i>sCellIndex</i>	1		
<i>sCellConfigCommon</i> SEQUENCE {			
<i>physCellId</i>	Physical Cell Identity of NR Cell 3		

}			
}			
}			
}			

Table 8.1.4.1.8.1.3.3-3: RRCReconfiguration-HO (step 5, Table 8.1.4.1.8.1.3.2-3)

Derivation Path: TS 38.508-1 [4], Table 4.8.1-1A with condition RBConfig_KeyChange

Table 8.1.4.1.8.1.3.3-4: CellGroupConfig (Table 8.1.4.1.8.1.3.3-3)

Derivation Path: TS 38.508-1 [4], Table 4.6.3-19 with condition PCell_change and SCell_add			
Information Element	Value/remark	Comment	Condition
CellGroupConfig ::= SEQUENCE {			
spCellConfig SEQUENCE {			
reconfigurationWithSync SEQUENCE {			
spCellConfigCommon SEQUENCE {			
physCellId	Physical Cell Identity of NR Cell 2		
}			
}			
}			
sCellToAddModList SEQUENCE (SIZE (1..maxNrofSCells)) OF SCellConfig {	1 entry		
SCellConfig[1] SEQUENCE {		entry 1	
sCellIndex	1		
sCellConfigCommon SEQUENCE {			
physCellId	Physical Cell Identity of NR Cell 3		
}			
}			
}			
sCellToReleaseList SEQUENCE (SIZE (1..maxNrofSCells)) OF SCellIndex {	1 entry		
SCellIndex[1]	1	entry 1 SCell release for NR Cell 3	
}			
}			

Table 8.1.4.1.8.1.3.3-5: RRCReconfiguration (step 8, Table 8.1.4.1.8.1.3.2-3)

Derivation Path: TS 38.508-1 [4] Table 4.6.1-13 with condition SCell_add			
Information Element	Value/remark	Comment	Condition
RRCReconfiguration ::= SEQUENCE {			
criticalExtensions CHOICE {			
rrcReconfiguration SEQUENCE {			
nonCriticalExtension SEQUENCE{			
masterCellGroup	CellGroupConfig		
}			
}			
}			
}			

Table 8.1.4.1.1.1.3.3-6: CellGroupConfig (Table 8.1.4.1.8.1.3.3-5)

Derivation Path: TS 38.508-1 [4] Table 4.6.3-19 with condition SCell_add			
Information Element	Value/remark	Comment	Condition
CellGroupConfig ::= SEQUENCE {			
sCellToAddModList	Not present		

sCellToReleaseList SEQUENCE (SIZE (1..maxNrofSCells)) OF SCellIndex {	1 entry		
SCellIndex[1]	1	entry 1	
}			
}			

8.1.4.1.8.2 NR CA / Intra NR handover / Success / PCell Change / SCell no Change / Inter-band CA

8.1.4.1.8.2.1 Test Purpose (TP)

Same as TC 8.1.4.1.8.1 but applied to Inter-band CA case.

8.1.4.1.8.2.2 Conformance requirements

Same as TC 8.1.4.1.8.1 but applied to Inter-band CA case.

8.1.4.1.8.2.3 Test description

8.1.4.1.8.2.3.1 Pre-test conditions

Same as test case 8.1.4.1.8.1 with the following differences:

- CA configuration: Inter-band CA replaces Intra-band Contiguous CA.
- Cells configuration: NR Cell 10 replaces NR Cell 3.

8.1.4.1.8.2.3.2 Test procedure sequence

Same as TC 8.1.4.1.8.1 with the following differences:

- CA configuration: Inter-band CA replaces Intra-band Contiguous CA

8.1.4.1.8.2.3.3 Specific message contents

Same as TC 8.1.4.1.8.1 with the following differences:

- CA configuration: Inter-band CA replaces Intra-band Contiguous CA
- Cells configuration: NR Cell 10 replaces NR Cell 3.

8.1.4.1.8.3 NR CA / Intra NR handover / Success / PCell Change / SCell no Change / Intra-band non-contiguous CA

8.1.4.1.8.3.1 Test Purpose (TP)

Same as TC 8.1.4.1.8.1 but applied to Intra-band non-Contiguous CA.

8.1.4.1.8.3.2 Conformance requirements

Same as TC 8.1.4.1.8.1 but applied to Intra-band non-Contiguous CA.

8.1.4.1.8.3.3 Test description

8.1.4.1.8.3.3.1 Pre-test conditions

Same as test case 8.1.4.1.8.1 with the following differences:

- CA configuration: Intra-band non-Contiguous CA replaces Intra-band Contiguous CA.

8.1.4.1.8.3.3.2 Test procedure sequence

Same as TC 8.1.4.1.8.1 with the following differences:

- CA configuration: Intra-band non-Contiguous CA replaces Intra-band Contiguous CA

8.1.4.1.8.3.3.3 Specific message contents

Same as TC 8.1.4.1.8.1 with the following differences:

- CA configuration: Intra-band non-Contiguous CA replaces Intra-band Contiguous CA

8.1.4.1.9 NR CA / Intra NR handover / Failure / Re-establishment successful

8.1.4.1.9.1 NR CA / Intra NR handover / Failure / Re-establishment successful / Intra-band Contiguous CA

8.1.4.1.9.1.1 Test Purpose (TP)

(1)

```
with { UE in NR RRC_CONNECTED state and having received an RRCReconfiguration message including a
reconfigurationWithSync for PCell change and including sCellToReleaseList with an sCellIndex set to
the configured SCell }
ensure that {
  when { UE detects handover failure and the source PCell is selectable}
  then { UE successfully performs an RRCReestablishment procedure on source Pcell}
}
```

(2)

```
with { UE in NR RRC_CONNECTED state and having received an RRCReconfiguration message including a
reconfigurationWithSync for PCell change and including sCellToReleaseList with an sCellIndex set to
the configured SCell }
ensure that {
  when { UE detects handover failure and the initial SCell is selectable}
  then { UE successfully performs an RRCReestablishment procedure on original SCell and the
original SCell becomes the PCell}
}
```

8.1.4.1.9.1.2 Conformance requirements

References: The conformance requirements covered in the present test case are specified in: TS 38.331, clause 5.3.5.5.2, 5.3.5.5.9, 5.3.5.5.8 and 5.3.7.5. Unless otherwise stated these are Rel-15 requirements.

[TS 38.331, clause 5.3.5.5.2]

The UE shall perform the following actions to execute a reconfiguration with sync.

- 1> if the AS security is not activated, perform the actions upon going to RRC_IDLE as specified in 5.3.11 with the release cause 'other' upon which the procedure ends;
- 1> stop timer T310 for the corresponding SpCell, if running;
- 1> start timer T304 for the corresponding SpCell with the timer value set to *t304*, as included in the *reconfigurationWithSync*;
- 1> if the *frequencyInfoDL* is included:
 - 2> consider the target SpCell to be one on the SSB frequency indicated by the *frequencyInfoDL* with a physical cell identity indicated by the *physCellId*;
- 1> else:
 - 2> consider the target SpCell to be one on the SSB frequency of the source SpCell with a physical cell identity indicated by the *physCellId*;

- 1> start synchronising to the DL of the target SpCell;
- 1> apply the specified BCCH configuration defined in 9.1.1.1;
- 1> acquire the *MIB*, which is scheduled as specified in TS 38.213 [13];

NOTE 1: The UE should perform the reconfiguration with sync as soon as possible following the reception of the RRC message triggering the reconfiguration with sync, which could be before confirming successful reception (HARQ and ARQ) of this message.

NOTE 2: The UE may omit reading the *MIB* if the UE already has the required timing information, or the timing information is not needed for random access.

- 1> reset the MAC entity of this cell group;
- 1> consider the SCell(s) of this cell group, if configured, to be in deactivated state;
- 1> apply the value of the *newUE-Identity* as the C-RNTI for this cell group;
- 1> configure lower layers in accordance with the received *spCellConfigCommon*;
- 1> configure lower layers in accordance with any additional fields, not covered in the previous, if included in the received *reconfigurationWithSync*.

[TS 38.331, clause 5.3.5.5.9]

The UE shall:

- 1> for each *sCellIndex* value included in the *sCellToAddModList* that is not part of the current UE configuration (SCell addition):
 - 2> add the SCell, corresponding to the *sCellIndex*, in accordance with the *sCellConfigCommon* and *sCellConfigDedicated*;
 - 2> configure lower layers to consider the SCell to be in deactivated state;
 - 2> for each *measId* included in the *measIdList* within *VarMeasConfig*:
 - 3> if SCells are not applicable for the associated measurement; and
 - 3> if the concerned SCell is included in *cellsTriggeredList* defined within the *VarMeasReportList* for this *measId*:
 - 4> remove the concerned SCell from *cellsTriggeredList* defined within the *VarMeasReportList* for this *measId*;
- 1> for each *sCellIndex* value included in the *sCellToAddModList* that is part of the current UE configuration (SCell modification):
- 2> modify the SCell configuration in accordance with the *sCellConfigDedicated*.

[TS 38.331, clause 5.3.5.5.8]

The UE shall:

- 1> if the release is triggered by reception of the *sCellToReleaseList*:
 - 2> for each *sCellIndex* value included in the *sCellToReleaseList*:
 - 3> if the current UE configuration includes an SCell with value *sCellIndex*:
 - 4> release the SCell.

[TS 38.331, clause 5.3.7.5]

The UE shall:

- 1> stop timer T301;

- 1> consider the current cell to be the PCell;
- 1> store the *nextHopChainingCount* value indicated in the *RRCReestablishment* message;
- 1> update the K_{gNB} key based on the current K_{gNB} key or the NH, using the stored *nextHopChainingCount* value, as specified in TS 33.501 [11];
- 1> derive the K_{RRCenc} and K_{UPenc} keys associated with the previously configured *cipheringAlgorithm*, as specified in TS 33.501 [11];
- 1> derive the K_{RRCint} and K_{UPint} keys associated with the previously configured *integrityProtAlgorithm*, as specified in TS 33.501 [11].
- 1> request lower layers to verify the integrity protection of the *RRCReestablishment* message, using the previously configured algorithm and the K_{RRCint} key;
- 1> if the integrity protection check of the *RRCReestablishment* message fails:
 - 2> perform the actions upon going to RRC_IDLE as specified in 5.3.11, with release cause 'RRC connection failure', upon which the procedure ends;
- 1> configure lower layers to resume integrity protection for SRB1 using the previously configured algorithm and the K_{RRCint} key immediately, i.e., integrity protection shall be applied to all subsequent messages received and sent by the UE, including the message used to indicate the successful completion of the procedure;
- 1> configure lower layers to resume ciphering for SRB1 using the previously configured algorithm and, the K_{RRCenc} key immediately, i.e., ciphering shall be applied to all subsequent messages received and sent by the UE, including the message used to indicate the successful completion of the procedure;
- 1> release the measurement gap configuration indicated by the *measGapConfig*, if configured;
- 1> submit the *RRCReestablishmentComplete* message to lower layers for transmission;
- 1> the procedure ends.

8.1.4.1.9.1.3 Test Description

8.1.4.1.9.1.3.1 Pre-test conditions

System Simulator:

- NR Cell 1 is the PCell and NR Cell 3 is the configured SCell and target PCell.
- System information combination NR-4 as defined in TS 38.508-1 [4] clause 4.4.3.1.3 is used in all NR cells.

UE:

- None.

Preamble:

- The UE is in 5GS state 3N-A as defined in TS 38.508-1 [4], clause 4.4A.2 Table 4.4A.2-3 on NR Cell 1.

8.1.4.1.9.1.3.2 Test procedure sequence

Table 8.1.4.1.9.1.3.2-1 and Table 8.1.4.1.9.1.3.2-1A illustrates the downlink power levels to be applied for NR Cell 1 and NR Cell 3 at various time instants of the test execution. Row marked "T0" denotes the conditions after the preamble, while rows marked "T1", "T2", "T3" and "T4" are to be applied subsequently. The exact instants on which these values shall be applied are described in the texts in this clause.

Table 8.1.4.1.9.1.3.2-1: Time instances of cell power level and parameter changes for conducted test environment

	Parameter	Unit	NR Cell 1	NR Cell 3	Remark
T0	SS/PBCH SSS EPRE	dBm/SC S	-85	-91	Power levels are such that entry condition for event A3 is not satisfied $Mn + Ofn + Ocn - Hys < Mp + Ofp + Ocp + Off$
T1	SS/PBCH SSS EPRE	dBm/SC S	-85	-79	Power levels are such that entry condition for event A3 is satisfied $Mn + Ofn + Ocn - Hys > Mp + Ofp + Ocp + Off$
T2	SS/PBCH SSS EPRE	dBm/SC S	-85	"Off"	Power levels are assigned to satisfy $SrxLevCell3 < 0$ such that selecting Cell 1 is guaranteed
T3	SS/PBCH SSS EPRE	dBm/SC S	-85	-79	Power levels are such that entry condition for event A3 is satisfied $Mn + Ofn + Ocn - Hys > Mp + Ofp + Ocp + Off$
T4	SS/PBCH SSS EPRE	dBm/SC S	"Off"	-79	Power levels are assigned to satisfy $SrxLevCell1 < 0$ such that selecting Cell 3 is guaranteed

Table 8.1.4.1.9.1.3.2-1A: TOTA test environment ime instances of cell power level and parameter changes for

	Parameter	Unit	NR Cell 1	NR Cell 3	Remark
T0	SS/PBCH SSS EPRE	dBm/SC S	[FFS]	[FFS]	Power levels are such that entry condition for event A3 is not satisfied $Mn + Ofn + Ocn - Hys < Mp + Ofp + Ocp + Off$
T1	SS/PBCH SSS EPRE	dBm/SC S	[FFS]	[FFS]	Power levels are such that entry condition for event A3 is satisfied $Mn + Ofn + Ocn - Hys > Mp + Ofp + Ocp + Off$
T2	SS/PBCH SSS EPRE	dBm/SC S	[FFS]	"Off"	Power levels are assigned to satisfy $SrxLevCell3 < 0$ such that selecting Cell 1 is guaranteed
T3	SS/PBCH SSS EPRE	dBm/SC S	[FFS]	[FFS]	Power levels are such that entry condition for event A3 is satisfied $Mn + Ofn + Ocn - Hys > Mp + Ofp + Ocp + Off$
T4	SS/PBCH SSS EPRE	dBm/SC S	"Off"	[FFS]	Power levels are assigned to satisfy $SrxLevCell1 < 0$ such that selecting Cell 3 is guaranteed

Table 8.1.4.1.9.1.3.2-2: Main behaviour

St	Procedure	Message Sequence		TP	Verdict
		U - S	Message		
1	The SS transmits an <i>RRCReconfiguration</i> message on NR Cell 1 to configure NR Cell 3 as an SCell	<--	NR RRC: <i>RRCReconfiguration</i>	-	-
2	The UE transmits an <i>RRCReconfigurationComplete</i> message on NR Cell 1.	-->	NR RRC: <i>RRCReconfigurationComplete</i>	-	-
3	The SS transmits an <i>RRCReconfiguration</i> message on NR Cell 1 to setup event A3 reporting configuration.	<--	NR RRC: <i>RRCReconfiguration</i>	-	-

4	The UE transmits an <i>RRCReconfigurationComplete</i> message on NR Cell 1.	-->	NR RRC: <i>RRCReconfigurationComplete</i>	-	-
5	The SS changes NR Cell 1 and NR Cell 3 parameters according to the row "T1" in table 8.1.4.1.9.1.3.2-1/1A	-	-	-	-
6	The UE transmits a <i>MeasurementReport</i> message on NR Cell 1 to report event A3 with the measured RSRP, RSRQ value for NR Cell 3.	-->	NR RRC: <i>MeasurementReport</i>	-	-
7	The SS transmits an <i>RRCReconfiguration</i> message on NR Cell 1 to order the UE to perform inter frequency handover to NR Cell 3 and to release SCell NR Cell 3.	<--	NR RRC: <i>RRCReconfiguration</i>	-	-
-	EXCEPTION: In parallel to the events described in step 8 the steps specified in Table 8.1.4.1.9.1.3.2-3 should take place.	-	-	-	-
8	The SS changes NR Cell 1 and NR Cell 3 parameters according to the row "T2" in table 8.1.4.1.9.1.3.2-1/1A	-	-	-	-
9	Check: Does the UE transmit an <i>RRCReestablishmentRequest</i> message on NR Cell 1?	-->	NR RRC: <i>RRCReestablishmentRequest</i>	1	P
10	The SS transmits an <i>RRCReestablishment</i> message to resume SRB1 operation and re-activate security on NR Cell 1.	<--	NR RRC: <i>RRCReestablishment</i>	-	-
11	The UE transmits an <i>RRCReestablishmentComplete</i> message	-->	NR RRC: <i>RRCReestablishmentComplete</i>	-	-
11A	Void	-	-	-	-
12	The SS transmits an <i>RRCReconfiguration</i> message to resume existing radio bearer on NR Cell 1	<--	NR RRC: <i>RRCReconfiguration</i>	-	-
13	The UE transmits an <i>RRCReconfigurationComplete</i> message on NR Cell 1	-->	NR RRC: <i>RRCReconfigurationComplete</i>	-	-
13A	The SS changes NR Cell 1 and NR Cell 3 parameters according to the row "T3" in table 8.1.4.1.9.1.3.2-1/1A	-	-	-	-
13B	The SS transmits an <i>RRCReconfiguration</i> message to configure NR Cell 3 as an SCell	<--	NR RRC: <i>RRCReconfiguration</i>	-	-
13C	The UE transmits an <i>RRCReconfigurationComplete</i> message on NR Cell 1	-->	NR RRC: <i>RRCReconfigurationComplete</i>	-	-
14	The SS transmits an <i>RRCReconfiguration</i> message on NR Cell 1 to setup event A3 reporting configuration.	<--	NR RRC: <i>RRCReconfiguration</i>	-	-
15	The UE transmits an <i>RRCReconfigurationComplete</i> message on NR Cell 1.	-->	NR RRC: <i>RRCReconfigurationComplete</i>	-	-
16	Void	-	-	-	-
17	The UE transmits a <i>MeasurementReport</i> message on NR Cell 1 to report event A3 with the measured RSRP, RSRQ value for NR Cell 3.	-->	NR RRC: <i>MeasurementReport</i>	-	-
18	The SS transmits an <i>RRCReconfiguration</i> message on NR Cell 1 to order the UE to perform handover to NR Cell 3 and to release SCell NR Cell3.	<--	NR RRC: <i>RRCReconfiguration</i>	-	-
-	EXCEPTION: In parallel to the events described in step 19 the steps specified in Table 8.1.4.1.9.1.3.2-3 should take place.	-	-	-	-
19	The SS changes NR Cell 1 and NR Cell 3 parameters according to the row "T4" in table 8.1.4.1.9.1.3.2-1/1A	-	-	-	-
20	Check: Does the UE transmit an <i>RRCReestablishmentRequest</i> message on NR Cell 3?	-->	NR RRC: <i>RRCReestablishmentRequest</i>	2	P

21	The SS transmits an <i>RRCReestablishment</i> message to resume SRB1 operation and re-activate security on NR Cell 3.	<--	NR RRC: <i>RRCReestablishment</i>	-	-
22	The UE transmits an <i>RRCReestablishmentComplete</i> message	-->	NR RRC: <i>RRCReestablishmentComplete</i>	-	-
23	The SS transmits an <i>RRCReconfiguration</i> message to resume existing radio bearer on NR Cell 3.	<--	NR RRC: <i>RRCReconfiguration</i>	-	-
24	The UE transmits an <i>RRCReconfigurationComplete</i> message on NR Cell 3.	-->	NR RRC: <i>RRCReconfigurationComplete</i>	-	-

Table 8.1.4.1.9.1.3.2-3: Parallel behaviour

St	Procedure	Message Sequence		TP	Verdict
		U - S	Message		
-	EXCEPTION: The steps 1 and 2 below are repeated for the duration of T304.	-	-	-	-
1	The UE attempts to perform the inter frequency handover using MAC Random Access Preamble on NR Cell 3.	-	-	-	-
2	The SS does not respond.	-	-	-	-

8.1.4.1.9.1.3.3 Specific message contents

Table 8.1.4.1.9.1.3.3-1: SIB1 for NR Cell 1 and NR Cell 3 (Preamble and all the steps in Table 8.1.4.1.9.1.3.2-2)

Derivation Path: TS 38.508-1 [4] table 4.6.1-28			
Information Element	Value/Remark	Comment	Condition
SIB1 ::= SEQUENCE {			
servingCellConfigCommon SEQUENCE {			
uplinkConfigCommon SEQUENCE {			
initialUplinkBWP SEQUENCE {			
rach-ConfigCommon SEQUENCE {			
rach-ConfigGeneric SEQUENCE {			
preambleTransMax	n50		
}			
}			
}			
}			
}			
}			

Table 8.1.4.1.9.1.3.3-2: RRCReconfiguration (step 1 and 13B, Table 8.1.4.1.9.1.3.2-2)

Derivation Path: TS 38.508-1 [4], table 4.6.1-13			
Information Element	Value/Remark	Comment	Condition
RRCReconfiguration ::= SEQUENCE {			
criticalExtensions CHOICE {			
rrcReconfiguration SEQUENCE {			
masterCellGroup	CellGroupConfig		
}			
}			
}			

Table 8.1.4.1.9.1.3.3-3: CellGroupConfig (Table 8.1.4.1.9.1.3.3-2)

Derivation path: TS 38.508-1 [4], table 4.6.3-19			
Information Element	Value/Remark	Comment	Condition
CellGroupConfig ::= SEQUENCE {			

sCellToAddModList SEQUENCE (SIZE (1..maxNrofSCells)) OF SCellConfig {	1 entry		
SCellConfig[1] SEQUENCE {		entry 1	
sCellIndex	1		
sCellConfigCommon	ServingCellConfigCommon		
sCellConfigDedicated	ServingCellConfig		
}			
}			
sCellToReleaseList	Not present		
}			

Table 8.1.4.1.9.1.3.3-4: ServingCellConfigCommon (Table 8.1.4.1.9.1.3.3-3)

Derivation Path: TS 38.508-1 [4], table 4.6.3-168			
Information Element	Value/remark	Comment	Condition
ServingCellConfigCommon ::= SEQUENCE {			
physCellId	Physical layer cell identity of NR Cell 3		
}			

Table 8.1.4.1.9.1.3.3-5: RRCReconfiguration (steps 3 and 14, Table 8.1.4.1.9.1.3.2-2)

Derivation Path: TS 38.508-1 [4], table 4.6.1-13 and condition NR_MEAS			
Information Element	Value/remark	Comment	Condition
RRCReconfiguration ::= SEQUENCE {			
criticalExtensions CHOICE {			
rrcReconfiguration SEQUENCE {			
measConfig	MeasConfig	Table 8.1.4.1.9.1.3.3-6	
nonCriticalExtension SEQUENCE {			
masterCellGroup	CellGroupConfig	Table 8.1.4.1.9.1.3.3-9A	
}			
}			
}			
}			

Table 8.1.4.1.9.1.3.3-6: MeasConfig (Table 8.1.4.1.9.1.3.3-5)

Derivation path: TS 38.508-1[4], table 4.6.3-69			
Information Element	Value/Remark	Comment	Condition
measConfig ::= SEQUENCE {			
measObjectToAddModList SEQUENCE (SIZE (1..maxNrofMeasId)) OF MeasObjectToAddMod {	2 entries		
MeasObjectToAddMod[1] SEQUENCE {		entry 1	
measObjectId	1		
measObject CHOICE {			
measObjectNR	MeasObjectNR-f1	NR Cell 1	
}			
}			
MeasObjectToAddMod[2] SEQUENCE {		entry 2	
measObjectId	2		
measObject CHOICE {			
measObjectNR	MeasObjectNR-f2	NR Cell 3	
}			
}			
reportConfigToAddModList SEQUENCE(SIZE (1..maxReportConfigId)) OF ReportConfigToAddMod {	1 entry		
ReportConfigToAddMod[1] SEQUENCE {		entry 1	

reportConfigId[1]	1		
reportConfig[1] CHOICE {			
reportConfigNR	ReportConfigNR-A3		
}			
}			
measIdToAddModList SEQUENCE (SIZE (1..maxNrofMeasId)) OF MeasIdToAddMod {	1 entry		
MeasIdToAddMod[1] SEQUENCE {		entry 1	
measId	1		
measObjectId	2		
reportConfigId	1		
}			
}			

Table 8.1.4.1.9.1.3.3-7: MeasObjectNR-f1 (Table 8.1.4.1.9.1.3.3-6)

Derivation Path: TS 38.508-1 [4], Table 4.6.3-76			
Information Element	Value/remark	Comment	Condition
MeasObjectNR ::= SEQUENCE {			
ssbFrequency	Downlink ARFCN of NR Cell 1 SSB		
absThreshSS-BlocksConsolidation	Not present		
nrofSS-BlocksToAverage	Not present		
}			

Table 8.1.4.1.9.1.3.3-8: MeasObjectNR-f2 (Table 8.1.4.1.9.1.3.3-6)

Derivation Path: TS 38.508-1 [4], Table 4.6.3-76			
Information Element	Value/remark	Comment	Condition
MeasObjectNR ::= SEQUENCE {			
ssbFrequency	Downlink ARFCN of NR Cell 3 SSB		
absThreshSS-BlocksConsolidation	Not present		
nrofSS-BlocksToAverage	Not present		
}			

Table 8.1.4.1.9.1.3.3-9: ReportConfigNR-A3 (Table 8.1.4.1.9.1.3.3-6)

Derivation Path: TS 38.508-1 [4], table 4.6.3-142 with condition EVENT_A3			
Information Element	Value/remark	Comment	Condition
ReportConfigNR ::= SEQUENCE {			
reportType CHOICE {			
eventTriggered SEQUENCE {			
eventId CHOICE {			
eventA3 SEQUENCE {			
a3-Offset CHOICE {			
rsrp	2	1 dB (2*0.5 dB)	FR1
FFS			FR2
}			
timeToTrigger	ms2560		
}			
}			
}			

Table 8.1.4.1.9.1.3.3-9A: CellGroupConfig (Table 8.1.4.1.9.1.3.3-5)

Derivation Path: TS 38.508-1 [4], Table 4.6.3-19 with condition MEAS			
Information Element	Value/remark	Comment	Condition

CellGroupConfig ::= SEQUENCE {			
sCellToAddModList SEQUENCE (SIZE (1..maxNrofSCells)) OF SCellConfig {	1 entry		
SCellConfig[1] SEQUENCE {		entry 1	
sCellIndex	SCellIndex of Cell 3		
sCellConfigDedicated	ServingCellConfig	Table 8.1.4.1.9.1.3.3-9B	
}			
}			
}			

Table 8.1.4.1.9.1.3.3-9B: ServingCellConfig (Table 8.1.4.1.9.1.3.3-9A)

Derivation Path: TS 38.331 [6], Table 4.6.3-167 with condition MEAS			
Information Element	Value/remark	Comment	Condition
ServingCellConfig ::= SEQUENCE {			
servingCellMO	2		
}			

Table 8.1.4.1.9.1.3.3-10: MeasurementReport (steps 6 and 17, Table 8.1.4.1.9.1.3.2-2)

Derivation Path: TS 38.508-1 [4], table 4.6.1-5A			
Information Element	Value/remark	Comment	Condition
MeasurementReport ::= SEQUENCE {			
criticalExtensions CHOICE {			
measurementReport SEQUENCE {			
measResults SEQUENCE {			
measResultServingMOList	Not checked		
measResultNeighCells CHOICE {	1 entry		
measResultListNR SEQUENCE (SIZE (1..maxCellReport)) OF MeasResultNR {			
MeasResultNR[1] SEQUENCE {		entry 1	
physCellId	PhysCellId of NR Cell 3		
measResult SEQUENCE {			
cellResults SEQUENCE {			
resultsSSB-Cell SEQUENCE {			
rsrp	(0..127)		
rsrp	(0..127)		
sinr	(0..127)		
}			
resultsCSI-RS-Cell	Not present		
}			
rsIndexResults	Not present		
}			
}			
}			
}			
}			
}			

Table 8.1.4.1.9.1.3.3-11: RRCReconfiguration (steps 7 and 18, Table 8.1.4.1.9.1.3.2-2)

Derivation Path: TS 38.508-1[4], table 4.6.1-13 with condition NR			
Information Element	Value/Remark	Comment	Condition
RRCReconfiguration ::= SEQUENCE {			
criticalExtensions CHOICE {			
rrcReconfiguration SEQUENCE {			

Table 8.1.4.1.9.1.3.3-14: RRCReestablishment (steps 10 and 21, Table 8.1.4.1.9.1.3.2-2)

Derivation Path: TS 38.508-1 [4], table 4.6.1-10			
Information Element	Value/remark	Comment	Condition
RRCReestablishment ::= SEQUENCE {			
criticalExtensions CHOICE {			
rrcReestablishment SEQUENCE {			
nextHopChainingCount	0		
}			
}			
}			

Table 8.1.4.1.9.1.3.3-15: RRCReconfiguration (Steps 12 and 23, Table 8.1.4.1.9.1.3.2-2)

Derivation Path: TS 38.508-1 [4], table 4.6.1-13 with condition REEST

8.1.4.1.9.2 NR CA / Intra NR handover / Failure / Re-establishment successful / Inter-band CA

8.1.4.1.9.2.1 Test Purpose (TP)

Same as TC 8.1.4.1.9.1 but applied to Inter-band CA case

8.1.4.1.9.2.2 Conformance requirements

Same as TC 8.1.4.1.9.1 but applied to Inter-band CA case

8.1.4.1.9.2.3 Test Description

8.1.4.1.9.2.3.1 Pre-test conditions

Same as test case 8.1.4.1.9.1 with the following differences:

- CA configuration: Inter-band CA replaces Intra-band Contiguous CA.
- Cells configuration: NR Cell 10 replaces NR Cell 3.
- NR Cell 10 is an Inactive SCell according to TS 38.508-1 [4] clause 6.3.1.

8.1.4.1.9.2.3.2 Test procedure sequence

Same as test case 8.1.4.1.9.1 with the following differences:

- CA configuration: Inter-band CA replaces Intra-band Contiguous CA.
- Cells configuration: NR Cell 10 replaces NR Cell 3.

8.1.4.1.9.2.3.3 Specific message contents

Same as TC 8.1.4.1.9.1 but applied to Inter-band CA case

8.1.4.1.9.3 NR CA / Intra NR handover / Failure / Re-establishment successful / Intra-band non-contiguous CA

8.1.4.1.9.3.1 Test Purpose (TP)

Same as TC 8.1.4.1.9.1 but applied to Intra-band non-contiguous CA case

8.1.4.1.9.3.2 Conformance requirements

Same as TC 8.1.4.1.9.1 but applied to Intra-band non-contiguous CA case

8.1.4.1.9.3.3 Test Description

8.1.4.1.9.3.3.1 Pre-test conditions

Same as test case 8.1.4.1.9.1 with the following differences:

- CA configuration: Intra-band Contiguous CA replaces Intra-band non-contiguous CA.

8.1.4.1.9.3.3.2 Test procedure sequence

Same as test case 8.1.4.1.9.1 with the following differences:

- CA configuration: Inter-band CA replaces Intra-band Contiguous CA.

8.1.4.1.9.3.3.3 Specific message contents

Same as TC 8.1.4.1.9.1 but applied to Intra-band non-contiguous CA case

8.1.4.1.10 eCall Only mode / Intra NR handover / Success / Inter-frequency

8.1.4.1.10.1 Test Purpose (TP)

(1)

```
with { UE in eCall Only mode and an eCall over IMS is ongoing }
ensure that {
  when { UE receives an RRCReconfiguration message including a reconfigurationWithSync for handover }
  then { UE performs handover to the target cell and transmits an RRCReconfigurationComplete message }
}
```

8.1.4.1.10.2 Conformance requirements

References: The conformance requirements covered in the present test case are specified in: TS 38.331, clauses 5.3.5.3, 5.3.5.5.1, 5.3.5.5.2, 5.5.4.4, 5.2.2.4.2 and 6.2.2.

[TS 38.331, clause 5.3.5.3]

The UE shall perform the following actions upon reception of the *RRCReconfiguration*, or upon execution of the conditional reconfiguration (CHO or CPC):

...

1> if the *RRCReconfiguration* includes the *masterCellGroup*:

2> perform the cell group configuration for the received *masterCellGroup* according to 5.3.5.5;

...

1> if the *RRCReconfiguration* message includes the *radioBearerConfig*:

2> perform the radio bearer configuration according to 5.3.5.6;

...

1> if the *RRCReconfiguration* message includes the *measConfig*:

2> perform the measurement configuration procedure as specified in 5.5.2;

...

1> if *reconfigurationWithSync* was included in *spCellConfig* of an MCG or SCG, and when MAC of an NR cell group successfully completes a Random Access procedure triggered above:

2> stop timer T304 for that cell group;

2> stop timer T310 for source SpCell if running;

...

2> apply the parts of the measurement and the radio resource configuration that require the UE to know the SFN of the respective target SpCell (e.g. measurement gaps, periodic CQI reporting, scheduling request configuration, sounding RS configuration), if any, upon acquiring the SFN of that target SpCell;

...

2> if the *reconfigurationWithSync* was included in *spCellConfig* of an MCG:

3> if T390 is running:

4> stop timer T390 for all access categories;

4> perform the actions as specified in 5.3.14.4.

3> if T350 is running:

4> stop timer T350;

3> if *RRCReconfiguration* does not include *dedicatedSIB1-Delivery* and

3> if the active downlink BWP, which is indicated by the *firstActiveDownlinkBWP-Id* for the target SpCell of the MCG, has a common search space configured by *searchSpaceSIB1*:

4> acquire the *SIB1*, which is scheduled as specified in TS 38.213 [13], of the target SpCell of the MCG;

4> upon acquiring *SIB1*, perform the actions specified in clause 5.2.2.4.2;

...

2> the procedure ends.

NOTE 3: The UE is only required to acquire broadcasted *SIB1* if the UE can acquire it without disrupting unicast data reception, i.e. the broadcast and unicast beams are quasi co-located.

[TS 38.331, clause 5.3.5.5.1]

The network configures the UE with Master Cell Group (MCG), and zero or one Secondary Cell Group (SCG). In (NG)EN-DC, the MCG is configured as specified in TS 36.331 [10], and for NE-DC, the SCG is configured as specified in TS 36.331 [10]. The network provides the configuration parameters for a cell group in the *CellGroupConfig* IE.

The UE performs the following actions based on a received *CellGroupConfig* IE:

1> if the *CellGroupConfig* contains the *spCellConfig* with *reconfigurationWithSync*:

2> perform Reconfiguration with sync according to 5.3.5.5.2;

- 2> resume all suspended radio bearers except the SRBs for the source cell group, and resume SCG transmission for all radio bearers, and resume BH RLC channels and resume SCG transmission for BH RLC channels for IAB-MT, if suspended;

...

- 1> if the *CellGroupConfig* contains the *rlc-BearerToAddModList*:

- 2> perform the RLC bearer addition/modification as specified in 5.3.5.5.4;

- 1> if the *CellGroupConfig* contains the *mac-CellGroupConfig*:

- 2> configure the MAC entity of this cell group as specified in 5.3.5.5.5;

...

- 1> if the *CellGroupConfig* contains the *spCellConfig*:

- 2> configure the SpCell as specified in 5.3.5.5.7;

[TS 38.331, clause 5.3.5.5.2]

The UE shall perform the following actions to execute a reconfiguration with sync.

- 1> if the AS security is not activated, perform the actions upon going to RRC_IDLE as specified in 5.3.11 with the release cause 'other' upon which the procedure ends;

- 1> if no DAPS bearer is configured:

- 2> stop timer T310 for the corresponding SpCell, if running;

- 1> if this procedure is executed for the MCG:

- 2> if timer T316 is running;

- 3> stop timer T316;

- 3> clear the information included in *VarRLF-Report*, if any;

- 2> resume MCG transmission, if suspended.

- 1> stop timer T312 for the corresponding SpCell, if running;

- 1> start timer T304 for the corresponding SpCell with the timer value set to *t304*, as included in the *reconfigurationWithSync*;

- 1> if the *frequencyInfoDL* is included:

- 2> consider the target SpCell to be one on the SSB frequency indicated by the *frequencyInfoDL* with a physical cell identity indicated by the *physCellId*;

- 1> else:

- 2> consider the target SpCell to be one on the SSB frequency of the source SpCell with a physical cell identity indicated by the *physCellId*;

- 1> start synchronising to the DL of the target SpCell;

- 1> apply the specified BCCH configuration defined in 9.1.1.1 for the target SpCell;

- 1> acquire the *MIB* of the target SpCell, which is scheduled as specified in TS 38.213 [13];

NOTE 1: The UE should perform the reconfiguration with sync as soon as possible following the reception of the RRC message triggering the reconfiguration with sync, which could be before confirming successful reception (HARQ and ARQ) of this message.

NOTE 2: The UE may omit reading the *MIB* if the UE already has the required timing information, or the timing information is not needed for random access.

...

1> else:

- 2> reset the MAC entity of this cell group;
- 2> consider the SCell(s) of this cell group, if configured, that are not included in the *SCellToAddModList* in the *RRCReconfiguration* message, to be in deactivated state;
- 2> apply the value of the *newUE-Identity* as the C-RNTI for this cell group;
- 2> configure lower layers in accordance with the received *spCellConfigCommon*;
- 2> configure lower layers in accordance with any additional fields, not covered in the previous, if included in the received *reconfigurationWithSync*.

[TS 38.331, clause 5.5.4.4]

The UE shall:

- 1> consider the entering condition for this event to be satisfied when condition A3-1, as specified below, is fulfilled;
- 1> consider the leaving condition for this event to be satisfied when condition A3-2, as specified below, is fulfilled;
- 1> use the SpCell for *Mp*, *Ofp* and *Ocp*.

NOTE 1: The cell(s) that triggers the event has reference signals indicated in the *measObjectNR* associated to this event which may be different from the NR SpCell *measObjectNR*.

Inequality A3-1 (Entering condition)

$$Mn + Ofn + Ocn - Hys > Mp + Ofp + Ocp + Off$$

Inequality A3-2 (Leaving condition)

$$Mn + Ofn + Ocn + Hys < Mp + Ofp + Ocp + Off$$

The variables in the formula are defined as follows:

Mn is the measurement result of the neighbouring cell, not taking into account any offsets.

Ofn is the measurement object specific offset of the reference signal of the neighbour cell (i.e. *offsetMO* as defined within *measObjectNR* corresponding to the neighbour cell).

Ocn is the cell specific offset of the neighbour cell (i.e. *cellIndividualOffset* as defined within *measObjectNR* corresponding to the frequency of the neighbour cell), and set to zero if not configured for the neighbour cell.

Mp is the measurement result of the SpCell, not taking into account any offsets.

Ofp is the measurement object specific offset of the SpCell (i.e. *offsetMO* as defined within *measObjectNR* corresponding to the SpCell).

Ocp is the cell specific offset of the SpCell (i.e. *cellIndividualOffset* as defined within *measObjectNR* corresponding to the SpCell), and is set to zero if not configured for the SpCell.

Hys is the hysteresis parameter for this event (i.e. *hysteresis* as defined within *reportConfigNR* for this event).

Off is the offset parameter for this event (i.e. *a3-Offset* as defined within *reportConfigNR* for this event).

Mn*, *Mp are expressed in dBm in case of RSRP, or in dB in case of RSRQ and RS-SINR.

Ofn*, *Ocn*, *Ofp*, *Ocp*, *Hys*, *Off are expressed in dB.

NOTE 2: The definition of Event A3 also applies to CondEvent A3.

[TS 38.331, clause 5.2.2.4.2]

Upon receiving the *SIB1* the UE shall:

1> store the acquired *SIB1*;

...

4> forward the *eCallOverIMS-Support* to upper layers, if present;

[TS 38.331, clause 6.2.2]

eCallOverIMS-Support

Indicates whether the cell supports eCall over IMS services as defined in TS 23.501 [32]. If absent, eCall over IMS is not supported by the network in the cell.

8.1.4.1.10.3 Test description

8.1.4.1.10.3.1 Pre-test conditions

System Simulator:

- NR Cell 1 is the serving cell and NR Cell 3 is the inter-frequency neighbour cell of NR Cell 1.
- System information combination NR-4 as defined in TS 38.508-1 [4] clause 4.4.3.1.2 is used in NR cells.

UE:

- the eCall capable UE is equipped with 'eCall only' enabled USIM configured as per TS 38.508-1 [4] Table 6.4.1-24.

Preamble:

- An automatic eCall is established by following the test procedure as defined in TS 38.508-1 [4], subclause 4.9.29.

8.1.4.1.10.3.2 Test procedure sequence

Table 8.1.4.1.10.3.2-1 illustrate the downlink power levels to be applied for NR Cell 1 and NR Cell 3 at various time instants of the test execution. Row marked "T0" denotes the conditions after the preamble, while the configuration marked "T1" is applied at the point indicated in the Main behaviour description in Table 8.1.4.1.10.3.2-2.

Table 8.1.4.1.10.3.2-1: Power levels in FR1

	Parameter	Unit	NR Cell 1	NR Cell 3	Remark
T0	SS/PBCH SSS EPRE	dBm/SCS	-85	-91	Power levels are such that entry condition for event A3 is not satisfied
T1	SS/PBCH SSS EPRE	dBm/SCS	-85	-79	Power levels are such that entry condition for event A3 is satisfied for NR Cell 3

Editor's Note: FR2 power levels are FFS

Table 8.1.4.1.10.3.2-2: Main behaviour

St	Procedure	Message Sequence		TP	Verdict
		U - S	Message		
1	The SS transmits an <i>RRCReconfiguration</i> message including <i>MeasConfig</i> to setup intra NR measurement and reporting for inter-frequency event A3.	<--	NR RRC: <i>RRCReconfiguration</i>	-	-
2	The UE transmits an <i>RRCReconfigurationComplete</i> message.	-->	NR RRC: <i>RRCReconfigurationComplete</i>	-	-

3	SS adjusts the cell-specific reference signal level according to row "T1".	-	-	-	-
4	The UE transmits a <i>MeasurementReport</i> message to report event A3 with the measured RSRP value for NR Cell 3.	-->	NR RRC: <i>MeasurementReport</i>	-	-
5	The SS transmits an <i>RRCReconfiguration</i> message including <i>reconfigurationWithSync</i> to order the UE to perform inter-frequency handover to NR Cell 3.	<--	NR RRC: <i>RRCReconfiguration</i>	-	-
6	Check: Does the UE transmit <i>RRCReconfigurationComplete</i> message on NR Cell 3?	-->	NR RRC: <i>RRCReconfigurationComplete</i>	1	P
7	Release eCall over IMS using the generic procedure described in TS 34.229-5 [41] subclause A.8.	-	-	-	-

8.1.4.1.10.3.3 Specific message contents

Table 8.1.4.1.10.3.3-1: SIB1 for NR Cell 1, NR Cell 3 (All steps, Table 8.1.4.1.10.3.2-2)

Derivation path: TS 38.508-1 [4] table 4.6.1-28 Condition eCalloverIMSforNR

Table 8.1.4.1.10.3.3-2: RRCReconfiguration (step 1, Table 8.1.4.1.10.3.2-2)

Derivation Path: TS 38.508-1 [4] Table 4.6.1-13 with condition MEAS

Table 8.1.4.1.10.3.3-3: MeasConfig (Table 8.1.4.1.10.3.3-2)

Derivation Path: TS 38.508-1 [4] Table 4.6.3-69			
Information Element	Value/remark	Comment	Condition
MeasConfig ::= SEQUENCE {			
measObjectToAddModList SEQUENCE (SIZE (1..maxNrofMeasId)) OF MeasObjectToAddMod {	2 entries		
MeasObjectToAddMod[1] SEQUENCE {		entry 1	
measObjectId	1		
measObject CHOICE {			
measObjectNR SEQUENCE {			
ssbFrequency	ssbFrequency IE equals the ARFCN for NR Cell 3		
absThreshSS-BlocksConsolidation	Not present		
}			
}			
MeasObjectToAddMod[2] SEQUENCE {		entry 2	
measObjectId	2		
measObject CHOICE {			
measObjectNR SEQUENCE {			
ssbFrequency	ssbFrequency IE equals the ARFCN for NR Cell 1		
absThreshSS-BlocksConsolidation	Not present		
}			
}			
}			
reportConfigToAddModList SEQUENCE (SIZE (1..maxReportConfigId)) OF ReportConfigToAddMod {	1 entry		
ReportConfigToAddMod[1] SEQUENCE {		entry 1	
reportConfigId	1		
reportConfig CHOICE {			
reportConfigNR	ReportConfigNR-EventA3		
}			
}			
}			

}			
measIdToAddModList SEQUENCE (SIZE (1..maxNrofMeasId)) OF MeasIdToAddMod {	1 entry		
MeasIdToAddMod[1] SEQUENCE {		entry 1	
measId	1		
measObjectId	1		
reportConfigId	1		
}			
}			
measGapConfig	MeasGapConfig		
}			

Table 8.1.4.1.10.3.3-4: ReportConfigNR-EventA3 (Table 8.1.4.1.10.3.3-3)

Derivation Path: TS 38.508-1 [4] Table 4.6.3-142 with condition EVENT_A3			
Information Element	Value/remark	Comment	Condition
ReportConfigNR ::= SEQUENCE {			
reportType CHOICE {			
eventTriggered SEQUENCE {			
eventId CHOICE {			
eventA3 SEQUENCE {			EVENT_A3
a3-Offset CHOICE {			
rsrp	6	3dB	
}			
hysteresis	0	0 dB	
timeToTrigger	ms640		
}			
}			
reportAmount	r1		
reportQuantityCell SEQUENCE {			
rsrp	true		
rsrq	false		
sinr	false		
}			
}			
}			

Table 8.1.4.1.10.3.3-5: MeasurementReport (step 4, Table 8.1.4.1.10.3.2-2)

Derivation Path: TS 38.508-1 [4] Table 4.6.1-5A			
Information Element	Value/remark	Comment	Condition
MeasurementReport ::= SEQUENCE {			
criticalExtensions CHOICE {			
measurementReport SEQUENCE {			
measResults SEQUENCE {			
measId	1		
measResultServingMOList SEQUENCE (SIZE (1..maxNrofServingCells)) OF MeasResultServMO {	1 entry		
MeasResultServMO[1] SEQUENCE {		entry 1	
servCellId	Cell index corresponding to NR Cell 1		
measResultServingCell SEQUENCE {			
physCellId	Physical layer cell identity of NR Cell 1		
measResult SEQUENCE {			
cellResults SEQUENCE {			
resultsSSB-Cell SEQUENCE {			
rsrp	(0..127)		
rsrq	(0..127)		
sinr	Not present		
}	Not checked		pc_ss_SIN R_Meas
}			
}			
}			
}			
}			

}			
}			
}			
}			
}			
measResultNeighCells CHOICE {			
measResultListNR SEQUENCE (SIZE (1..maxCellReport)) OF MeasResultNR {	1 entry		
MeasResultNR[1] SEQUENCE {		entry 1	
physCellId	Physical layer cell identity of NR Cell 3		
measResult SEQUENCE {			
cellResults SEQUENCE {			
resultsSSB-Cell SEQUENCE {			
rsrp	(0..127)		
rsrq	Not present		
sinr	Not present		
}			
resultsCSI-RS-Cell	Not present		
}			
rsIndexResults	Not present		
}			
}			
}			
}			
}			
}			
}			
}			
}			
}			

Table 8.1.4.1.10.3.3-6: RRCReconfiguration (step 5, Table 8.1.4.1.10.3.2-2)

Derivation Path: TS 38.508-1 [4] Table 4.8.1-1A with condition RBConfig_KeyChange			
Information Element	Value/remark	Comment	Condition
RRCReconfiguration ::= SEQUENCE {			
criticalExtensions CHOICE {			
rrcReconfiguration SEQUENCE {			
nonCriticalExtension SEQUENCE {			
measConfig SEQUENCE {			
measObjectToRemoveList SEQUENCE (SIZE (1..maxNrofObjectId)) OF MeasObjectId {	2 entries		
measObjectId[1]	1	entry 1	
measObjectId[2]	2	entry 2	
}			
measIdToRemoveList SEQUENCE (SIZE (1..maxNrofMeasId)) OF MeasId {	1 entry		
measId[1]	1	entry 1	
}			
}			
masterCellGroup	OCTET STRING (CONTAINING CellGroupConfig)		
masterKeyUpdate SEQUENCE {			
keySetChangeIndicator	True		
nextHopChainingCount	0		
nas-Container	NASContainer	Intra N1 mode NAS transparent container	
}			
}			
}			
}			

Table 8.1.4.1.10.3.3-7: CellGroupConfig (Table 8.1.4.1.10.3.3-6)

Derivation Path: TS 38.508-1 [4], Table 4.6.3-19 with condition PCell_change and CFRA			
Information Element	Value/remark	Comment	Condition
CellGroupConfig ::= SEQUENCE {			
spCellConfig SEQUENCE {			
reconfigurationWithSync SEQUENCE {			
spCellConfigCommon SEQUENCE {	Same as default ServingCellConfigCommon		
physCellId	Physical cell Id of NR Cell 3		
}			
}			
}			

Table 8.1.4.1.10.3.3-8: NASContainer (Table 8.1.4.1.10.3.3-6)

Derivation Path: TS 24.501, table 9.11.2.6			
Information Element	Value/Remark	Comment	Condition
Message authentication code	The calculated value of MAC-I for this message.	The value of MAC-I is calculated by SS using COUNT = 0xFFFFFFFF (as per TS 33.501[20], 6.9.2.3.3)	
Type of ciphering algorithm	Set according to PIXIT px_NAS_5GC_Ciphering Algorithm for default ciphering algorithm		
Type of integrity protection algorithm	Set according to PIXIT px_NAS_5GC_IntegrityAl gorithm for default integrity protection algorithm	This value should not be equal to the null integrity algorithm.	
KACF	'1'B	a new K _{AMF} has been calculated by the network	
TSC	'0'B	native security context (for K _{SIAMF})	
Key set identifier in 5G	K _{SIAMF} that was created when the UE last registered to 5GCN		
Sequence number	The internal counter of the SS	eight least significant bits of the downlink NAS COUNT	

8.1.4.2 Inter-RAT handover

8.1.4.2.1 Inter-RAT handover from NR

8.1.4.2.1.1 Inter-RAT handover / From NR to E-UTRA / Success

8.1.4.2.1.1.1 Test Purpose (TP)

(1)

```
with { UE in NR RRC_CONNECTED state }
ensure that {
  when { UE receives a MobilityFromNRCommand message }
  then { UE transmits an RRCConnectionReconfigurationComplete message on the E-UTRA cell }
}
```

8.1.4.2.1.1.2 Conformance requirements

References: The conformance requirements covered in the present TC are specified in: TS 38.331, clause 5.4.3.2, clause 5.4.3.3 and clause 5.4.3.4 and TS 36.331, clause 5.4.2.2 and clause 5.4.2.3.

[TS.38.331, clause 5.4.3.2]

The network initiates the mobility from NR procedure to a UE in RRC_CONNECTED, possibly in response to a MeasurementReport message, by sending a MobilityFromNRCommand message. The network applies the procedure as follows:

- the procedure is initiated only when AS-security has been activated, and SRB2 with at least one DRB are setup and not suspended.

[TS 38.331, clause 5.4.3.3]

The UE shall:

- 1> if the targetRAT-Type is set to eutra:
 - 2> consider inter-RAT mobility as initiated towards E-UTRA;
 - 2> forward the nas-SecurityParamFromNR to the upper layers, if included;
- 1> access the target cell indicated in the inter-RAT message in accordance with the specifications of the target RAT.

[TS.38.331, clause 5.4.3.4]

Upon successfully completing the handover, at the source side the UE shall:

- 1> reset MAC;
- 1> stop all timers that are running;
- 1> release *ran-NotificationAreaInfo*, if stored;
- 1> release the AS security context including the $K_{RRCCenc}$ key, the K_{RRCint} , the K_{UPint} key and the K_{UPenc} key, if stored;
- 1> release all radio resources, including release of the RLC entity and the MAC configuration;
- 1> release the associated PDCP entity and SDAP entity for all established RBs;

NOTE : PDCP and SDAP configured by the source RAT prior to the handover that are reconfigured and re-used by target RAT when delta signalling (i.e., during inter-RAT intra-system handover when *fullConfig* is not present) is used, are not released as part of this procedure.

- 1> indicate the release of the RRC connection to upper layers together with the release cause 'other'.

[TS 36.331, clause 5.4.2.2]

The RAN using another RAT or the E-UTRA connected to a different type of CN initiates the handover to E-UTRA procedure, in accordance with the specifications applicable for the other RAT or for the E-UTRA connected to a different type of CN, by sending the *RRConnectionReconfiguration* message via the radio access technology from which the inter-RAT handover is performed.

E-UTRAN applies the procedure as follows:

- to activate ciphering, possibly using NULL algorithm, if not yet activated in the other RAT or in the E-UTRA connected to a different type of CN;
- to establish SRB1, SRB2 and one or more DRBs, i.e. at least the DRB associated with the default EPS bearer is established if the target CN is EPC and at least one DRB is established if the target CN is 5GC.

[TS 36.331, clause 5.4.2.3]

If the UE is able to comply with the configuration included in the *RRConnectionReconfiguration* message, the UE shall:

- 1> if the *RRConnectionReconfiguration* message includes the *fullConfig* and the source RAT was E-UTRA (i.e., intra-RAT inter-system handover):
 - ...
 - 1> apply the default physical channel configuration as specified in 9.2.4;
 - 1> apply the default semi-persistent scheduling configuration as specified in 9.2.3;
 - 1> apply the default MAC main configuration as specified in 9.2.2;
 - 1> start timer T304 with the timer value set to *t304*, as included in the *mobilityControlInfo*;
 - 1> consider the target PCell to be one on the frequency indicated by the *carrierFreq* with a physical cell identity indicated by the *targetPhysCellId*;
 - 1> start synchronising to the DL of the target PCell;
 - 1> set the C-RNTI to the value of the *newUE-Identity*;
 - 1> for the target PCell, apply the downlink bandwidth indicated by the *dl-Bandwidth*;
 - 1> for the target PCell, apply the uplink bandwidth indicated by (the absence or presence of) the *ul-Bandwidth*;
 - 1> configure lower layers in accordance with the received *radioResourceConfigCommon*;
 - 1> configure lower layers in accordance with any additional fields, not covered in the previous, if included in the received *mobilityControlInfo*;
 - 1> perform the radio resource configuration procedure as specified in 5.3.10;
 - 1> if the *handoverType* in *securityConfigHO* is set to *fivegc-ToEPC*:
 - 2> indicate to higher layer that the CN has changed from 5GC to EPC;
 - 2> derive the key *KeNB* based on the mapped KASME key as specified for interworking between EPS and 5GS in TS 33.501 [86];
 - 2> store the *nextHopChainingCount-r15* value;
 - 1> else if the *handoverType* in *securityConfigHO* is set to *intra5GC*:
 - ...
 - 1> derive the *KRRCint* key associated with the *integrityProtAlgorithm*, as specified in TS 33.401 [32];
 - 1> derive the *KRRCenc* key and the *KUPenc* key associated with the *cipheringAlgorithm*, as specified in TS 33.401 [32];
 - ...

- 1> if the handoverType in securityConfigHO is set to fivegc-ToEPC or if the handoverType-v1530 is not present:
 - 2> configure lower layers to apply the indicated integrity protection algorithm and the KRRCint key immediately, i.e. the indicated integrity protection configuration shall be applied to all subsequent messages received and sent by the UE, including the message used to indicate the successful completion of the procedure;
 - 2> configure lower layers to apply the indicated ciphering algorithm, the KRRCenc key and the KUPenc key immediately, i.e. the indicated ciphering configuration shall be applied to all subsequent messages received and sent by the UE, including the message used to indicate the successful completion of the procedure;
 - 1> if the received RRCConnectionReconfiguration includes the sCellToAddModList:
 - ...
 - 1> if the RRCConnectionReconfiguration message includes the measConfig:
 - 2> perform the measurement configuration procedure as specified in 5.5.2;
 - ...
 - 1> submit the RRCConnectionReconfigurationComplete message to lower layers for transmission using the new configuration;
 - 1> if the RRCConnectionReconfiguration message does not include rlf-TimersAndConstants set to setup:
 - 2> use the default values specified in 9.2.5 for timer T310, T311 and constant N310, N311;
 - 1> if MAC successfully completes the random access procedure:
 - 2> stop timer T304;
 - 2> apply the parts of the CQI reporting configuration, the scheduling request configuration and the sounding RS configuration that do not require the UE to know the SFN of the target PCell, if any;
 - 2> apply the parts of the measurement and the radio resource configuration that require the UE to know the SFN of the target PCell (e.g. measurement gaps, periodic CQI reporting, scheduling request configuration, sounding RS configuration), if any, upon acquiring the SFN of the target PCell;
- NOTE 1: Whenever the UE shall setup or reconfigure a configuration in accordance with a field that is received it applies the new configuration, except for the cases addressed by the above statements.
- 2> enter E-UTRA RRC_CONNECTED, upon which the procedure ends;

8.1.4.2.1.1.3 Test description

8.1.4.2.1.1.3.1 Pre-test conditions

System Simulator:

- NR Cell 1 and E-UTRA Cell 1.
- System information Combination NR-6 as defined in TS 38.508 [4] clause 4.4.3.1 is used in NR cells.

UE:

- None

Preamble:

- The UE is in 5GS state 3N-A and Test Loop Function (*On*) with UE test loop mode B on NR Cell 1 according to 38.508-1[4], clause 4.4A.2 Table 4.4A.2-3.

8.1.4.2.1.1.3.2 Test procedure sequence

Table 8.1.4.2.1.1.3.2-1: Main behaviour

St	Procedure	Message Sequence		TP	Verdict
		U - S	Message		
1	The SS transmits a MobilityFromNRCommand message on NR Cell 1.	<--	MobilityFromNRCommand	-	-
2	Check: Does the UE transmit an RRCConnectionReconfigurationComplete message on E-UTRA Cell 1 using the security key derived from the new KeNB?	-->	RRCConnectionReconfigurationComplete	1	P
3	The UE transmits an ULInformationTransfer message on the cell specified in the test case. This message includes a TRACKING AREA UPDATE REQUEST message.	-->	RRC: ULInformationTransfer NAS: TRACKING AREA UPDATE REQUEST	-	-
4	The SS transmits a DLInformationTransfer message on the cell specified in the test case. This message includes a TRACKING AREA UPDATE ACCEPT message.	<--	RRC: DLInformationTransfer NAS: TRACKING AREA UPDATE ACCEPT	-	-
5	The UE transmits an ULInformationTransfer message on the cell specified in the test case. This message includes a TRACKING AREA UPDATE COMPLETE message.	-->	RRC: ULInformationTransfer NAS: TRACKING AREA UPDATE COMPLETE	-	-
6	Void	-	-	-	-
7	The SS sends one IP Packet to the UE on the default DRB associated with the first PDU session.	-	-	-	-
8	The UE loop backs the IP packet received in step 7.	-	-	1	P

8.1.4.2.1.1.3.3 Specific message contents

Table 8.1.4.2.1.1.3.3-1: MobilityFromNRCommand (step 1, Table 8.1.4.2.1.1.3.2-1)

Derivation Path: TS 38.508-1 [4], Table 4.6.1-8			
Information Element	Value/remark	Comment	Condition
MobilityFromNRCommand ::= SEQUENCE {			
rrc-TransactionIdentifier	RRC-TransactionIdentifier		
criticalExtensions CHOICE {			
mobilityFromNRCommand SEQUENCE {			
targetRAT-Type	eutra		
targetRAT-MessageContainer	DL-DCCH message containing RRCConnectionReconfiguration		
nas-SecurityParamFromNR	8 LSB of the downlink NAS COUNT		
}			
}			
}			

Table 8.1.4.2.1.1.3.3-2: RRCConnectionReconfiguration (Table 8.1.4.2.1.1.3.3-1)

Derivation Path: TS 36.508, Table 4.6.1-8, condition HO-TO-EUTRA(1,0)

Table 8.1.4.2.1.1.3.3-3: MobilityControllInfo (Table 8.1.4.2.1.1.3.3-1)

Derivation Path: TS 36.508 [7], Table 4.6.5-1, condition HO-TO-EUTRA			
Information Element	Value/remark	Comment	Condition
MobilityControllInfo ::= SEQUENCE {			

targetPhysCellId	PhysicalCellIdentity of E-UTRA Cell 1		
carrierFreq SEQUENCE {			
dl-CarrierFreq	Same downlink EARFCN as used for E-UTRA Cell 1		
}			
carrierFreq	Not present		Band > 64
carrierBandwidth SEQUENCE {			
dl-Bandwidth	Downlink system bandwidth under test.		
ul-Bandwidth	Uplink Bandwidth under test.		FDD
ul-Bandwidth	Not present		TDD
}			
carrierFreq-v9e0 SEQUENCE {			Band > 64
dl-CarrierFreq-v9e0	Same downlink EARFCN as used for E-UTRA Cell 1		
}			
}			

Condition	Explanation
FDD	FDD cell environment
TDD	TDD cell environment
Band > 64	If band > 64 is selected

Table 8.1.4.2.1.1.3.3-4: SecurityConfigHO (Table 8.1.4.2.1.1.3.3-1)

Derivation Path: TS 36.508, Table 4.6.4-1			
Information Element	Value/remark	Comment	Condition
SecurityConfigHO-v1530 ::= SEQUENCE {			
handoverType-v1530 CHOICE {			
fivegc-ToEPC-r15 SEQUENCE {			
securityAlgorithmConfig-r15 SEQUENCE {			
cipheringAlgorithm	Set according to PIXIT parameter for default ciphering algorithm		
integrityProtAlgorithm	Set according to PIXIT parameter for default integrity protection algorithm		
}			
}			
nextHopChainingCount-r15	2		
}			
}			

Table 8.1.4.2.1.1.3.3-5: Void

Table 8.1.4.2.1.1.3.3-6: TRACKING AREA UPDATE REQUEST (step 3, Table 8.1.4.2.1.1.3.2-1)

Derivation Path: TS 38.508-1 table 4.9.7.2.3-1			
Information Element	Value/remark	Comment	Condition
EPS update type			
EPS update type Value	'000'B	TA updating	TA_only
	'001'B	Combined TA/LA updating	combined_TA_LA_without_IMSI

	'010'B	Combined TA/LA updating with IMSI attach	combined_TA_LA
NAS key set identifier			
NAS Key Set Identifier	The value of ngKSI assigned in preamble		
Type of security context flag	'1'B	Mapped security context	
Non-current native NAS key set identifier	Not present or any allowed value		
Old GUTI	Mapped 5G-GUTI		
EPS bearer context status	Not checked		

Condition	Explanation
TA_only	The UE is configured to initiate EPS attach
combined_TA_LA	The UE is configured to initiate combined EPS/IMSI attach
combined_TA_LA_without_IMSI	The UE is configured to initiate combined attach

Table 8.1.4.2.1.1.3.3-7: Void

8.1.4.2.1.2 Inter-RAT handover / From NR to EN-DC / Success

8.1.4.2.1.2.1 Test Purpose (TP)

(1)

```

with { UE in NR RRC_CONNECTED state }
ensure that {
  when { UE receives a MobilityFromNRCommand message with the embedded RRCConnectionReconfiguration
message including nr-SecondaryCellGroupConfig }
  then { UE transmits an RRCConnectionReconfigurationComplete message embedding an
RRCReconfigurationComplete message on the E-UTRA cell }
}

```

8.1.4.2.1.2.2 Conformance requirements

Same as TC 8.1.4.2.1.1 with the addition of: Rel-16 TS 36.331, clause 5.3.5.4 and Rel-16 TS 37.340, clause 10.16.1.

[TS 36.331, clause 5.3.5.4]

If the *RRCConnectionReconfiguration* message includes the *mobilityControlInfo* and the UE is able to comply with the configuration included in this message, the UE shall:

1> if the *RRCConnectionReconfiguration* message includes the *fullConfig*:

...

1> if the received *RRCConnectionReconfiguration* includes the *sk-Counter*:

2> perform key update procedure as specified in in TS 38.331 [82], clause 5.3.5.7;

1> if the received *RRCConnectionReconfiguration* includes the *nr-SecondaryCellGroupConfig*:

2> perform NR RRC Reconfiguration as specified in TS 38.331 [82], clause 5.3.5.3.

...

1> set the content of *RRCConnectionReconfigurationComplete* message as follows:

...

2> if the received *RRCConnectionReconfiguration* message included *nr-SecondaryCellGroupConfig*:

3> include *scg-ConfigResponseNR* in accordance with TS 38.331 [82], clause 5.3.5.3;

1> submit the *RRCConnectionReconfigurationComplete* message to lower layers for transmission;

[TS 37.340, clause 10.16.1]

Inter-system HO from NR to E-UTRA with EN-DC configuration is supported in this version of the specification. N26 based inter-system HO will be executed between source RAN and gNB.

8.1.4.2.1.2.3 Test description

8.1.4.2.1.2.3.1 Pre-test conditions

System Simulator:

- NR Cell 1 is the serving cell. System information combination NR-6 as defined in TS 38.508-1 [4] clause 4.4.3.1.2 is used in NR Cell 1.
- E-UTRA Cell 1 (PCell) and NR Cell 3 (PSCell) are the target cells. System information combination 31 as defined in TS 36.508 [7] clause 4.4.3.1 is used in the E-UTRA cell. Only NR MIB is broadcasted on NR Cell 3.

UE:

- None

Preamble:

- If *pc_IP_Ping* is set to TRUE then, the UE is in 5GS state 3N-A according to TS 38.508-1 [4], clause 4.4A.2 Table 4.4A.2-3.
- Else, the UE is in 5GS state 3N-A and Test Loop Function (*On*) with UE test loop mode B on NR Cell 1 according to 38.508-1[4], clause 4.4A.2 Table 4.4A.2-3.

8.1.4.2.1.2.3.2 Test procedure sequence

Table 8.1.4.2.1.2.3.2-1: Main behaviour

St	Procedure	Message Sequence		TP	Verdict
		U - S	Message		
0A	The SS transmits an <i>RRCReconfiguration</i> message and a PDU SESSION MODIFICATION COMMAND to add DRB#a associated with a new QoS Flow.	<--	NR RRC: <i>RRCReconfiguration</i> 5GMM: DL NAS TRANSPORT 5GSM: PDU SESSION MODIFICATION COMMAND	-	-
0B	The UE transmits an <i>RRCReconfigurationComplete</i> message	-->	NR RRC: <i>RRCReconfigurationComplete</i>	-	-
0C	The UE transmits a <i>ULInformationTransfer</i> message, an UL NAS TRANSPORT message and an PDU SESSION MODIFICATION COMPLETE message	-->	NR RRC: <i>ULInformationTransfer</i> 5GMM: UL NAS TRANSPORT 5GSM: PDU SESSION MODIFICATION COMPLETE	-	-
1	The SS transmits a <i>MobilityFromNRCommand</i> message on NR Cell 1, and embedded <i>RRCConnectionReconfiguration</i> message contains <i>nr-SecondaryCellGroupConfig</i> with the configuration of NR Cell 3	<--	<i>MobilityFromNRCommand</i> (<i>RRCConnectionReconfiguration</i>)	-	-
2	Check: Does the UE transmit an <i>RRCConnectionReconfigurationComplete</i> containing NR <i>RRCReconfigurationComplete</i> message on E-UTRA Cell 1 using the security key derived from the new KeNB and sk-Counter?	-->	<i>RRCConnectionReconfigurationC</i> <i>omplete</i> (<i>RRCReconfigurationComplete</i>)	1	P
3	The UE transmits an <i>ULInformationTransfer</i> message on the cell specified in the test case. This message includes a TRACKING AREA UPDATE REQUEST message.	-->	RRC: <i>ULInformationTransfer</i> NAS: TRACKING AREA UPDATE REQUEST	-	-

4	The SS transmits a <i>DLInformationTransfer</i> message on the cell specified in the test case. This message includes a TRACKING AREA UPDATE ACCEPT message.	<--	RRC: <i>DLInformationTransfer</i> NAS: TRACKING AREA UPDATE ACCEPT	-	-
5	The UE transmits an <i>ULInformationTransfer</i> message on the cell specified in the test case. This message includes a TRACKING AREA UPDATE COMPLETE message.	-->	RRC: <i>ULInformationTransfer</i> NAS: TRACKING AREA UPDATE COMPLETE	-	-
6	Check: Does the test result of generic test procedure in TS 38.508-1 [4] subclause 4.9.1 indicate that the UE is capable of exchanging IP data on DRB#b associated with the default EPS bearer in E-UTRA Cell 1	-	-	1	P
7	Check: Does the test result of generic test procedure in TS 38.508-1 [4] subclause 4.9.1 indicate that the UE is capable of exchanging IP data on the SCG DRB#a in NR Cell 3	-	-	1	P

Tables 8.1.4.2.1.2.3.2-1a and 8.1.4.2.1.2.3.2-1b illustrate the downlink power levels to be applied for NR Cell 3, and E-UTRA Cell 1 at various time instants of the test execution. Row marked "T0" denotes the conditions after the preamble.

Table 8.1.4.2.1.2.3.2-1a: Time instances of cell power level and parameter changes for conducted test environment

	Parameter	Unit	NR Cell 3	E-UTRA Cell 1	Remark
T0	SS/PBCH SSS EPRE	dBm/SCS	-91	-	
	Cell-specific RS EPRE	dBm/15 kHz		-85	

Table 8.1.4.2.1.2.3.2-1b: Time instances of cell power level and parameter changes for OTA test environment

	Parameter	Unit	NR Cell 3	E-UTRA Cell 1	Remark
T0	SS/PBCH SSS EPRE	dBm/SCS	FFS	-	
	Cell-specific RS EPRE	dBm/15 kHz		FFS	

8.1.4.2.1.2.3.3 Specific message contents

Table 8.1.4.2.1.2.3.3-0A: PDU SESSION MODIFICATION COMMAND (step 0A, Table 8.1.4.2.1.2.3.2-1)

Derivation Path: TS 38.508-1 [4], Table 4.7.2-9.			
Information Element	Value/remark	Comment	Condition
PDU session ID	The same as the PDU session ID in PDU SESSION ESTABLISHMENT REQUEST associated with the Internet PDU session if available or with the first PDU session		
Mapped EPS bearer contexts			
Mapped EPS bearer context			
EPS bearer identity	(DRB#a + 4)		
Operation code	'001'B	Create new EPS bearer	
E bit	'1'B	Parameters list is included	
Number of EPS parameters	'0010'B	2 parameters	

Mapped EPS QoS parameters	EPC dedicated bearer context of the entry in TS 38.508-1 [4] Table 4.8.4-1 which has been determined by the DNN IE in the UL NAS TRANSPORT message which carried the corresponding PDU SESSION ESTABLISHMENT REQUEST or by pc-APN-Default-Configuration if the DNN IE was not present		
TFT	EPC dedicated bearer context of the entry in TS 38.508-1 [4] Table 4.8.4-1 which has been determined by the DNN IE in the UL NAS TRANSPORT message which carried the corresponding PDU SESSION ESTABLISHMENT REQUEST or by pc-APN-Default-Configuration if the DNN IE was not present. Reference dedicated EPS bearer context #1 as specified in TS 36.508 [10], Table 6.6.2-1.		
Authorized QoS rules	One entry		
QoS rule [1]	Reference QoS rule #5 as defined in TS 38.508-1 [4] Table 4.8.2.1-1.	QFI=5	
Authorized QoS flow descriptions	One entry		
QoS flow [1]	Dedicated QoS Flow	QFI=5	
NOTE: The mapped EPS bearer will become the Dedicated EPS Bearer after handover.			

Table 8.1.4.2.1.2.3.3-0B: Dedicated QoS Flow (step 0A, Table 8.1.4.2.1.2.3.2-1)

Derivation Path: TS 24.501, table 9.11.4.12			
Information Element	Value/remark	Comment	Condition
QoS flow descriptions			
QoS flow description			
QFI	'00 0101'B	QFI 5	
Operation code	'001'B	Create new QoS flow description	
E bit	'1'B	Parameters list is included	
Number of parameters	'00 0010'B	2 parameters	
5QI	5QI 1	5QI 1	
EPS bearer identity	(DRB#a + 4)	EBI related to NR DRB#a	

Table 8.1.4.2.1.2.3.3-0C: RRCReconfiguration (step 0A, Table 8.1.4.2.1.2.3.2-1)

Derivation Path: TS xx?? Table 4.6.1-13 with condition NR.			
Information Element	Value/remark	Comment	Condition
RRCReconfiguration ::= SEQUENCE {			
criticalExtensions CHOICE {			

nr-SecondaryCellGroupConfig-r15	OCTET STRING including the <i>RRCReconfiguration</i> message and <i>CellGroupConfig_EN-DC</i>		
nr-RadioBearerConfig1-r15	OCTET STRING including <i>RadioBearerConfig_EN-DC</i>		
NOTE: x is equal to the number of PDU sessions established on NR Cell 1. These are all included in the HO to E-UTRA.			

Table 8.1.4.2.1.2.3.3-2A: CellGroupConfig_EN-DC (Table 8.1.4.2.1.2.3.3-2)

Derivation Path: TS 38.508-1 [4], Table 4.6.3-19 with condition EN-DC			
Information Element	Value/remark	Comment	Condition
rlc-BearerToAddModList SEQUENCE (SIZE(1..maxLCH)) OF RLC-BearerConfig {	1 entry		
RLC-BearerConfig[1]	RLC-BearerConfig with conditions AM and DRB#a	entry 1	
}			
}			
NOTE: DRB#a is the SCG DRB on NR Cell 3 after Handover			

Table 8.1.4.2.1.2.3.3-2B: RadioBearerConfig_EN-DC (Table 8.1.4.2.1.2.3.3-2)

Derivation Path: TS 38.508-1 [4], Table 4.6.3-132			
Information Element	Value/remark	Comment	Condition
drb-ToAddModList SEQUENCE (SIZE (1..maxDRB)) OF DRB-ToAddMod {	1 entry		
DRB-ToAddMod[1] SEQUENCE {		entry 1	
cnAssociation CHOICE {			
eps-BearerIdentity	(DRB#a + 4)		
}			
drb-Identity	DRB-Identity using condition DRB#a		
reestablishPDCP	true		
recoverPDCP	Not present		
pdcpc-Config	PDCP-Config		
}			
}			
NOTE: DRB#a is the SCG DRB on NR Cell associated with the Dedicated EPS Bearer after handover.			

Table 8.1.4.2.1.2.3.3-3: MobilityControllInfo_EN-DC (Table 8.1.4.2.1.2.3.3-1)

Derivation Path: TS 36.508 [7], Table 4.6.5-1, condition HO-TO-EN-DC			
Information Element	Value/remark	Comment	Condition
MobilityControllInfo ::= SEQUENCE {			
targetPhysCellId	PhysicalCellId of E-UTRA Cell 1		
carrierFreq SEQUENCE {			
dl-CarrierFreq	Same downlink EARFCN as used for E-UTRA Cell 1		
}			
carrierFreq	Not present		Band > 64
carrierBandwidth SEQUENCE {			
dl-Bandwidth	Downlink system bandwidth under test.		

ul-Bandwidth	Uplink Bandwidth under test.		FDD
ul-Bandwidth	Not present		TDD
}			
carrierFreq-v9e0 SEQUENCE {			Band > 64
dl-CarrierFreq-v9e0	Same downlink EARFCN as used for E-UTRA Cell 1		
}			
}			

Condition	Explanation
FDD	FDD cell environment
TDD	TDD cell environment
Band > 64	If band > 64 is selected

Table 8.1.4.2.1.2.3.3-4: SecurityConfigHO (Table 8.1.4.2.1.2.3.3-1)

Derivation Path: TS 36.508 [7], Table 4.6.4-1			
Information Element	Value/remark	Comment	Condition
SecurityConfigHO-v1530 ::= SEQUENCE {			
handoverType-v1530 CHOICE {			
fivegc-ToEPC-r15 SEQUENCE {			
securityAlgorithmConfig-r15 SEQUENCE {			
cipheringAlgorithm	Set according to PIXIT parameter for default ciphering algorithm		
integrityProtAlgorithm	Set according to PIXIT parameter for default integrity protection algorithm		
}			
}			
nextHopChainingCount-r15	2		
}			
}			

Table 8.1.4.2.1.2.3.3-5: Void

Table 8.1.4.2.1.2.3.3-6: RRCConnectionReconfigurationComplete (step 2, Table 8.1.4.2.1.2.3.2-1)

Derivation Path: TS 36.508 [7], Table 4.6.1-9, condition HO-TO-EN-DC(1,0)

Table 8.1.4.2.1.2.3.3-7: TRACKING AREA UPDATE REQUEST (step 3, Table 8.1.4.2.1.2.3.2-1)

Derivation Path: TS 36.508 [7] clause 4.7.2-27			
Information Element	Value/remark	Comment	Condition
EPS update type			
EPS update type Value	'000'B	TA updating	TA_only
	'001'B	Combined TA/LA updating	combined_TA_LA_without_IMSI
	'010'B	Combined TA/LA updating with IMSI attach	combined_TA_LA
NAS key set identifier			
NAS Key Set Identifier	The value of ngKSI assigned in preamble		
Type of security context flag	'1'B	Mapped security context	

Non-current native NAS key set identifier	Not present or any allowed value		
Old GUTI	Mapped 5G-GUTI		
GUTI type	Native		
Additional GUTI	Any value or not present		
UE status	UE is in 5GMM-REGISTERED state		

Condition	Explanation
TA_only	The UE is configured to initiate EPS attach
combined_TA_LA	The UE is configured to initiate combined EPS/IMSI attach
combined_TA_LA_without_IMSI	The UE is configured to initiate combined attach

8.1.4.2.2 Inter-RAT handover to NR

8.1.4.2.2.1 Inter-RAT handover / From E-UTRA to NR / Success

8.1.4.2.2.1.1 Test Purpose (TP)

(1)

```
with { UE in E-UTRA RRC_CONNECTED state }
ensure that {
  when { UE receives a MobilityFromEUTRACommand message }
  then { UE transmits a RRCReconfigurationComplete message on the NR cell }
}
```

8.1.4.2.2.1.2 Conformance requirements

References: The conformance requirements covered in the current TC are specified in: TS 38.331, clause 5.4.2.2, 5.4.2.3, TS 36.331, clause 5.4.3.2, 5.4.3.3, 5.4.3.4. Unless otherwise stated these are Rel-15 requirements.

[TS 38.331, clause 5.4.2.2]

The RAN using another RAT initiates the handover to NR procedure, in accordance with the specifications applicable for the other RAT, by sending the *RRCReconfiguration* message via the radio access technology from which the inter-RAT handover is performed.

The network applies the procedure as follows:

- to activate ciphering, possibly using NULL algorithm, if not yet activated in the other RAT;
- to re-establish SRBs and one or more DRBs;

[TS 38.331, clause 5.4.2.3]

The UE shall:

- 1> perform RRC reconfiguration procedure as specified in 5.3.5;

NOTE: If the UE is connected to 5GC of the source E-UTRA cell, the delta configuration for PDCP and SDAP can be used for intra-system inter-RAT handover.

[TS 36.331, clause 5.4.3.2]

E-UTRAN initiates the mobility from E-UTRA procedure to a UE in RRC_CONNECTED, possibly in response to a *MeasurementReport* message or in response to reception of CS fallback indication for the UE from MME, by sending a *MobilityFromEUTRACommand* message. E-UTRAN applies the procedure as follows:

- the procedure is initiated only when AS-security has been activated, and SRB2 with at least one DRB are setup and not suspended;

[TS 36.331, clause 5.4.3.3]

The UE shall be able to receive a *MobilityFromEUTRACommand* message and perform a cell change order to GERAN, even if no prior UE measurements have been performed on the target cell.

The UE shall:

- 1> stop timer T310, if running;
- 1> stop timer T312, if running;
- 1> if T309 is running:
 - 2> stop timer T309 for all access categories;
 - 2> perform the actions as specified in 5.3.16.4.
- 1> if the *MobilityFromEUTRACommand* message includes the *purpose* set to *handover*:
 - ...
 - 2> else if the *targetRAT-Type* is set to *nr*:
 - 3> consider inter-RAT mobility as initiated towards NR;
 - 3> access the target cell indicated in the inter-RAT message in accordance with the specifications in TS 38.331 [82];

[TS 36.331, clause 5.4.3.4]

Upon successfully completing the handover, the cell change order or enhanced 1xRTT CS fallback, the UE shall:

- ...
- 1> else if the UE is connected to 5GC prior to the reception of the *MobilityFromEUTRACommand* and the *targetRAT-Type* in the received *MobilityFromEUTRACommand* is set to *nr*:
 - 2> reset MAC;
 - 2> stop all timers that are running;
 - 2> release *ran-NotificationAreaInfo*, if stored;
 - 2> release the AS security context including the $K_{RRCCenc}$ key, the K_{RRCint} , the K_{UPint} key and the K_{UPenc} key, if stored;
 - 2> release all radio resources, including release of the RLC entity and the MAC configuration and the associated PDCP entity and SDAP entity for all established RBs;

NOTE 1: PDCP and SDAP configured by the source configurations RAT prior to the handover that are reconfigured and re-used by target RAT when delta signalling (i.e., during inter-RAT intra-system handover when *fullConfig* is not present) is used, are not released as part of this procedure.

1> else:

- 2> perform the actions upon leaving RRC_CONNECTED as specified in 5.3.12, with release cause 'other';

NOTE 2: If the UE performs enhanced 1xRTT CS fallback along with concurrent mobility to CDMA2000 HRPD and the connection to either CDMA2000 1xRTT or CDMA2000 HRPD succeeds, then the mobility from E-UTRA is considered successful.

8.1.4.2.2.1.3 Test description

8.1.4.2.2.1.3.1 Pre-test conditions

System Simulator:

- E-UTRA Cell 1 "Serving cell" and NR Cell 1 "Non-suitable "Off" cell".

- System information combination 31 as defined in TS 36.508 [7] clause 4.4.3.1 is used in the E-UTRA cell.
- System information combination NR-6 as defined in TS 38.508-1 [4] clause 4.4.3.1.2 is used in the NR cell.

UE:

- None.

Preamble:

- The UE is brought to state RRC_CONNECTED using generic procedure parameters Connectivity (*E-UTRA/EPC*), Unrestricted nr PDN (*On*), Test Loop Function (*On*) with UE test loop mode B, on E-UTRA Cell 1 according to the procedure described in TS 38.508-1 [4], clause 4.5.4.

8.1.4.2.2.1.3.2 Test procedure sequence

Table 8.1.4.2.2.1.3.2-1: Main behaviour

St	Procedure	Message Sequence		TP	Verdict
		U - S	Message		
0	The SS configures NR Cell 1 as the "Serving cell" and wait 5s.	-	-	-	-
1	The SS transmits a <i>MobilityFromEUTRACommand</i> message on E-UTRA Cell 1.	<--	E-UTRA RRC: <i>MobilityFromEUTRACommand</i>	-	-
2	Check: Does the UE transmit a <i>RRCReconfigurationComplete</i> message on NR Cell 1?	-->	NR RRC: <i>RRCReconfigurationComplete</i>	1	P
3	The UE transmits a <i>ULInformationTransfer</i> message and a REGISTRATION REQUEST message indicating "mobility registration updating" is sent to update the registration of the actual tracking area.	-->	NR RRC: <i>ULInformationTransfer</i> 5GMM: REGISTRATION REQUEST	-	-
4	SS sends an <i>DLInformationTransfer</i> message and a REGISTRATION ACCEPT message containing a 5G-GUTI.	<--	NR RRC: <i>DLInformationTransfer</i> 5GMM: REGISTRATION ACCEPT	-	-
5	The UE transmits an <i>ULInformationTransfer</i> message and a REGISTRATION COMPLETE message.	-->	NR RRC: <i>ULInformationTransfer</i> 5GMM: REGISTRATION COMPLETE	-	-
6	The procedure in table 4.5A.2C.2.2-1 in TS 38.508-1 [4] is performed.	-	-	-	-
7	Void	-	-	-	-
8	The SS sends one IP Packet to the UE on the default DRB associated with the first PDU session.	-	-	-	-
9	The UE loops back the IP packet received in step 8.	-	-	-	-

Table 8.1.4.2.2.1.3.2-2: Void

8.1.4.2.2.1.3.3 Specific message contents

Table 8.1.4.2.2.1.3.3-1: *MobilityFromEUTRACommand* (step 1, Table 8.1.4.2.2.1.3.2-1)

Derivation Path: TS 36.508 [7] table 4.6.1-6			
Information Element	Value/remark	Comment	Condition
<i>MobilityFromEUTRACommand</i> ::= SEQUENCE {			
criticalExtensions CHOICE {			
c1 CHOICE {			
<i>mobilityFromEUTRACommand-r8</i> SEQUENCE {			
purpose CHOICE {			

handover SEQUENCE {			
targetRAT-Type	nr		
targetRAT-MessageContainer	RRCReconfiguration		
nas-SecurityParamFromEUTRA	Not present		
systemInformation	Not present		
}			
}			
}			
}			
}			
}			

Table 8.1.4.2.2.1.3.3-2: RRCReconfiguration (Table 8.1.4.2.2.1.3.3-1)

Derivation Path: TS 38.508-1 [4] Table 4.6.1-13			
Information Element	Value/remark	Comment	Condition
RRCReconfiguration ::= SEQUENCE {			
criticalExtensions CHOICE {			
rrcReconfiguration SEQUENCE {			
radioBearerConfig	RadioBearerConfig as per table 4.6.3-132 in TS 38.508-1 [4] with conditions SRB1,SRB2 and DRB1		
nonCriticalExtension SEQUENCE {			
masterCellGroup	CellGroupConfig with conditions SRB1,SRB2 and DRB1	OCTET STRING (CONTAINING CellGroupConfig)	
fullConfig	true		
masterKeyUpdate	MasterKeyUpdate		
}			
}			
}			
}			

Table 8.1.4.2.2.1.3.3-3: Void

Table 8.1.4.2.2.1.3.3-4: CellGroupConfig (Table 8.1.4.2.2.1.3.3-2)

Derivation Path: TS 38.508-1 [4] Table 4.6.3-19			
Information Element	Value/remark	Comment	Condition
CellGroupConfig ::= SEQUENCE {			
rlc-BearerToAddModList SEQUENCE (SIZE(1..maxLC-ID)) OF RLC-BearerConfig {	3 entries		
RLC-Bearer-Config[1]	RLC-Bearer-Config with condition SRB1	entry 1	
RLC-Bearer-Config[2]	RLC-Bearer-Config with condition SRB2	entry 2	
RLC-Bearer-Config[3]	RLC-Bearer-Config with condition DRB1	entry 3	
}			
mac-CellGroupConfig	MAC-CellGroupConfig		
physicalCellGroupConfig	PhysicalCellGroupConfig		
spCellConfig SEQUENCE {			
reconfigurationWithSync SEQUENCE {			
spCellConfigCommon	ServingCellConfigCommon		
newUE-Identity	RNTI-Value		
t304	ms1000		
rachConfigDedicated CHOICE {			
uplink	RACH-ConfigDedicated		
supplementaryUplink	Not present		

}			
}			
rlf-TimersAndConstants CHOICE {			
setup	RLF-TimersAndConstants		
}			
spCellConfigDedicated	ServingCellConfig		
}			
}			

Table 8.1.4.2.2.1.3.3-5: ServingCellConfigCommon (Table 8.1.4.2.2.1.3.3-4)

Derivation Path: TS 38.508-1 [4] Table 4.6.3-168			
Information Element	Value/remark	Comment	Condition
ServingCellConfigCommon ::= SEQUENCE {			
physCellId	Physical CellID of the NR Cell 1		
}			

Table 8.1.4.2.2.1.3.3-6: MasterKeyUpdate (Table 8.1.4.2.2.1.3.3-2)

Derivation Path: TS 38.331 [12], clause 6.2.2			
Information Element	Value/remark	Comment	Condition
MasterKeyUpdate ::= SEQUENCE {			
keySetChangeIndicator	True		
nextHopChainingCount	NextHopChainingCount	38.508-1 [4] Table 4.6.3-83	
nas-Container	<p>Octets 1 to 4 are Message authentication code(MAC) IE using {NH, NCC=2}</p> <p>Bits 1 to 4 of octet 5 are set according to PIXIT parameter for default integrity protection algorithm.</p> <p>Bits 5 to 8 of octet 5 are set according to PIXIT parameter for default ciphering algorithm.</p> <p>Bits 1 to 3 of octet 6 contains the Key set identifier in 5G.</p> <p>Bit 4 of octet 6 contains the type of security context flag(TSC). Bits 5 to 7 of octet 6 contains the 3bit Next hop chaining counter.</p> <p>Bit 8 of octet 6 is Spare.</p> <p>Octets 7 and 8 are spare and shall be coded as zero.</p>	24.501 [22] 9.11.2.9 The value part of S1 mode to N1 mode NAS transparent container	
}			

8.1.4.3 DAPS handover

8.1.4.3.1 DAPS handover with key change / Success / Intra-frequency

8.1.4.3.1.1 Test Purpose (TP)

(1)

```
with { UE in NR RRC_CONNECTED state and supporting DAPS handover }
ensure that {
  when { UE receives an RRCReconfiguration message including a reconfigurationWithSync for handover
with key change and dapsConfig is configured for a DRB }
  then { UE performs DAPS handover to the target cell and keeps DL/UL reception/transmission with
the source gNB for the DRB configured with dapsConfig }
}
```

(2)

```
with { UE in NR RRC_CONNECTED state and supporting DAPS handover and having received an
RRCReconfiguration message including a reconfigurationWithSync for handover to the neighbour cell
and a dapsConfig configured for any DRB }
ensure that {
  when { UE has performed random access procedure to the target cell successfully }
  then { UE transmits an RRCReconfigurationComplete message to the target gNB }
}
```

(3)

```
with { UE in NR RRC_CONNECTED state and supporting DAPS handover and having received an
RRCReconfiguration message including a reconfigurationWithSync for handover to the neighbour cell
and a dapsConfig configured for any DRB }
ensure that {
  when { UE receives an RRCReconfiguration message including a daps-SourceRelease }
  then { UE releases the radio link with the source cell }
}
```

(4)

```
with { UE in NR RRC_CONNECTED state and supporting DAPS handover and having received an
RRCReconfiguration message including a reconfigurationWithSync for handover to the neighbour cell
and a dapsConfig configured for any DRB }
ensure that {
  when { UE has performed random access procedure to the target cell successfully }
  then { UE continues the downlink user data reception from the source gNB until releasing the
source cell }
}
```

8.1.4.3.1.2 Conformance requirements

References: The conformance requirements covered in the present TC are specified in: TS 38.300 9.2.3.1 and 9.2.3.2.1 and TS 38.331 clause 5.3.5.3 and 5.3.5.5.2. Unless otherwise stated these are Rel-16 requirements.

[TS 38.300, clause 9.2.3.1]

Network controlled mobility applies to UEs in RRC_CONNECTED and is categorized into two types of mobility: cell level mobility and beam level mobility.

Cell Level Mobility requires explicit RRC signalling to be triggered, i.e. handover. For inter-gNB handover, the signalling procedures consist of at least the following elemental components illustrated in Figure 9.2.3.1-1:

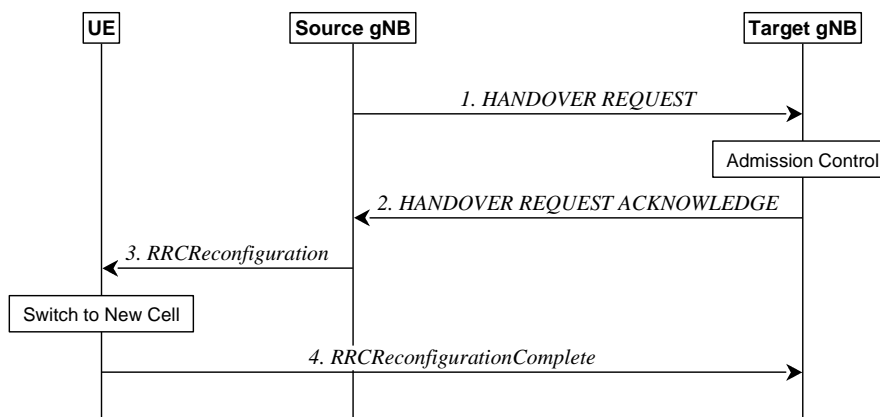

Figure 9.2.3.1-1: Inter-gNB handover procedures

1. The source gNB initiates handover and issues a HANDOVER REQUEST over the Xn interface.
2. The target gNB performs admission control and provides the new RRC configuration as part of the HANDOVER REQUEST ACKNOWLEDGE.
3. The source gNB provides the RRC configuration to the UE by forwarding the *RRCReconfiguration* message received in the HANDOVER REQUEST ACKNOWLEDGE. The *RRCReconfiguration* message includes at least cell ID and all information required to access the target cell so that the UE can access the target cell without reading system information. For some cases, the information required for contention-based and contention-free random access can be included in the *RRCReconfiguration* message. The access information to the target cell may include beam specific information, if any.
4. The UE moves the RRC connection to the target gNB and replies with the *RRCReconfigurationComplete*.

NOTE 1: User Data can also be sent in step 4 if the grant allows.

In case of DAPS handover, the UE continues the downlink user data reception from the source gNB until releasing the source cell and continues the uplink user data transmission to the source gNB until successful random access procedure to the target gNB.

Only source and target PCell are used during DAPS handover. CA, DC, SUL, multi-TRP, NR sidelink configurations and V2X sidelink configurations are released by the source gNB before the handover command is sent to the UE and are not configured by the target gNB until the DAPS handover has completed (i.e. at source cell release).

The handover mechanism triggered by RRC requires the UE at least to reset the MAC entity and re-establish RLC, except for DAPS handover, where upon reception of the handover command, the UE:

- Creates a MAC entity for target;
- Establishes the RLC entity and an associated DTCH logical channel for target for each DRB configured with DAPS;
- For each DRB configured with DAPS, reconfigures the PDCP entity with separate security and ROHC functions for source and target and associates them with the RLC entities configured by source and target respectively;
- Retains the rest of the source configurations until release of the source.

NOTE 2: The handling on RLC and PDCP for DRBs not configured with DAPS is the same as in normal handover.

NOTE 3: Void.

RRC managed handovers with and without PDCP entity re-establishment are both supported. For DRBs using RLC AM mode, PDCP can either be re-established together with a security key change or initiate a data recovery procedure without a key change. For DRBs using RLC UM mode and for SRBs, PDCP can either be re-established together with a security key change or remain as it is without a key change.

Data forwarding, in-sequence delivery and duplication avoidance at handover can be guaranteed when the target gNB uses the same DRB configuration as the source gNB.

Timer based handover failure procedure is supported in NR. RRC connection re-establishment procedure is used for recovering from handover failure except in certain CHO or DAPS handover scenarios:

- When DAPS handover fails, the UE falls back to the source cell configuration, resumes the connection with the source cell, and reports DAPS handover failure via the source without triggering RRC connection re-establishment if the source link has not been released.
- When initial CHO execution attempt fails or HO fails, the UE performs cell selection, and if the selected cell is a CHO candidate and if network configured the UE to try CHO after handover/CHO failure, then the UE attempts CHO execution once, otherwise re-establishment is performed.

DAPS handover for FR2 to FR2 case is not supported in this release of the specification.

[TS 38.300, clause 9.2.3.2.1]

The intra-NR RAN handover performs the preparation and execution phase of the handover procedure performed without involvement of the 5GC, i.e. preparation messages are directly exchanged between the gNBs. The release of the resources at the source gNB during the handover completion phase is triggered by the target gNB. The figure below depicts the basic handover scenario where neither the AMF nor the UPF changes:

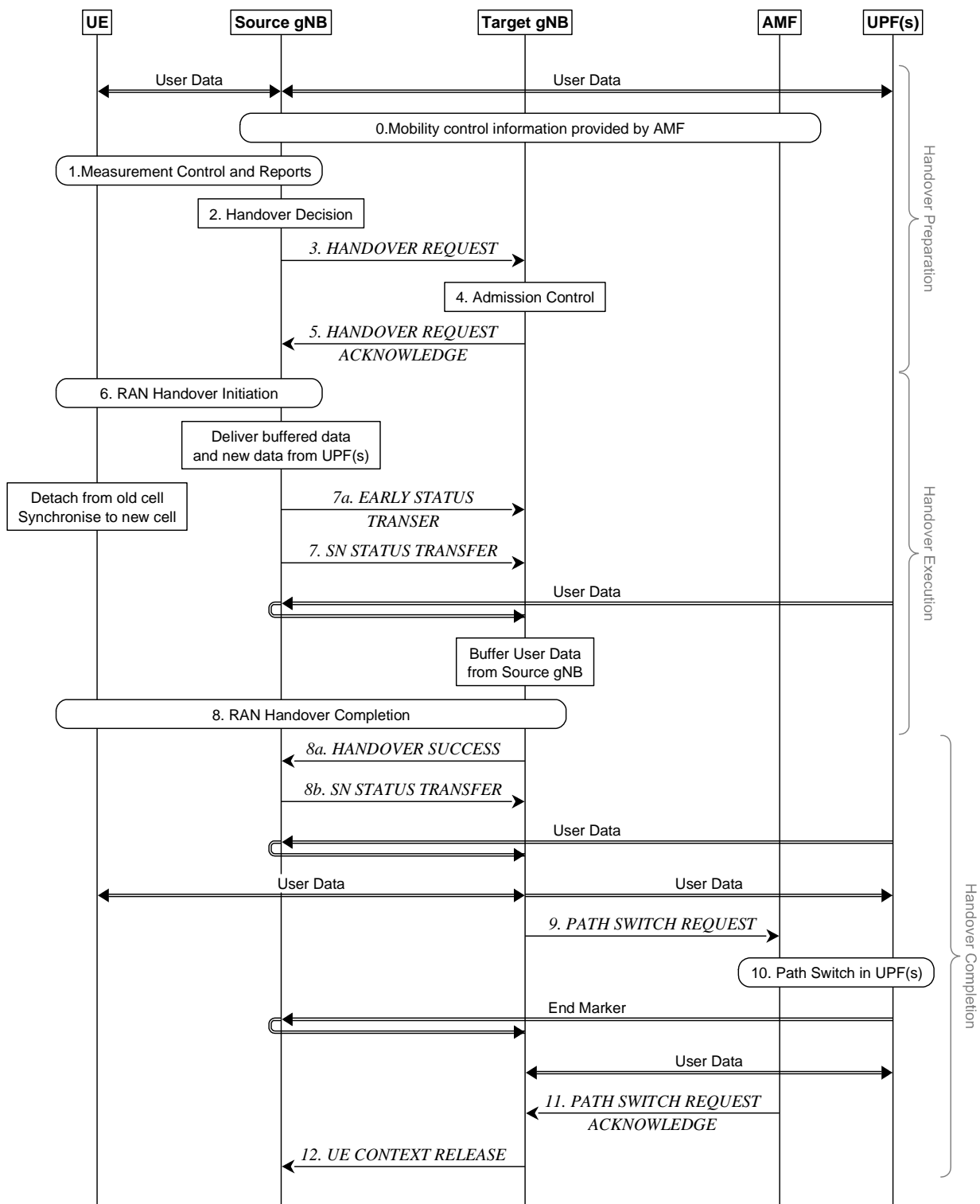

<http://msc-generator.sourceforge.net> v6.3.7

Figure 9.2.3.2.1-1: Intra-AMF/UPF Handover

0. The UE context within the source gNB contains information regarding roaming and access restrictions which were provided either at connection establishment or at the last TA update.
1. The source gNB configures the UE measurement procedures and the UE reports according to the measurement configuration.
2. The source gNB decides to handover the UE, based on *MeasurementReport* and RRM information.

3. The source gNB issues a Handover Request message to the target gNB passing a transparent RRC container with necessary information to prepare the handover at the target side. The information includes at least the target cell ID, KgNB*, the C-RNTI of the UE in the source gNB, RRM-configuration including UE inactive time, basic AS-configuration including *antenna Info and DL Carrier Frequency*, the current QoS flow to DRB mapping rules applied to the UE, the SIB1 from source gNB, the UE capabilities for different RATs, PDU session related information, and can include the UE reported measurement information including beam-related information if available. The PDU session related information includes the slice information and QoS flow level QoS profile(s). The source gNB may also request a DAPS handover for one or more DRBs.

NOTE 1: After issuing a Handover Request, the source gNB should not reconfigure the UE, including performing Reflective QoS flow to DRB mapping.

4. Admission Control may be performed by the target gNB. Slice-aware admission control shall be performed if the slice information is sent to the target gNB. If the PDU sessions are associated with non-supported slices the target gNB shall reject such PDU Sessions.
5. The target gNB prepares the handover with L1/L2 and sends the HANOVER REQUEST ACKNOWLEDGE to the source gNB, which includes a transparent container to be sent to the UE as an RRC message to perform the handover. The target gNB also indicates if a DAPS handover is accepted.

NOTE 2: As soon as the source gNB receives the HANOVER REQUEST ACKNOWLEDGE, or as soon as the transmission of the handover command is initiated in the downlink, data forwarding may be initiated.

NOTE 3: For DRBs configured with DAPS, downlink PDCP SDUs are forwarded with SN assigned by the source gNB, until SN assignment is handed over to the target gNB in step 8b, for which the normal data forwarding follows as defined in 9.2.3.2.3.

6. The source gNB triggers the Uu handover by sending an *RRCReconfiguration* message to the UE, containing the information required to access the target cell: at least the target cell ID, the new C-RNTI, the target gNB security algorithm identifiers for the selected security algorithms. It can also include a set of dedicated RACH resources, the association between RACH resources and SSB(s), the association between RACH resources and UE-specific CSI-RS configuration(s), common RACH resources, and system information of the target cell, etc.

NOTE 4: For DRBs configured with DAPS, the source gNB does not stop transmitting downlink packets until it receives the HANOVER SUCCESS message from the target gNB in step 8a.

NOTE 4a: CHO cannot be configured simultaneously with DAPS handover.

- 7a. For DRBs configured with DAPS, the source gNB sends the EARLY STATUS TRANSFER message. The DL COUNT value conveyed in the EARLY STATUS TRANSFER message indicates PDCP SN and HFN of the first PDCP SDU that the source gNB forwards to the target gNB. The source gNB does not stop assigning SNs to downlink PDCP SDUs until it sends the SN STATUS TRANSFER message to the target gNB in step 8b.
7. For DRBs not configured with DAPS, the source gNB sends the SN STATUS TRANSFER message to the target gNB to convey the uplink PDCP SN receiver status and the downlink PDCP SN transmitter status of DRBs for which PDCP status preservation applies (i.e. for RLC AM). The uplink PDCP SN receiver status includes at least the PDCP SN of the first missing UL PDCP SDU and may include a bit map of the receive status of the out of sequence UL PDCP SDUs that the UE needs to retransmit in the target cell, if any. The downlink PDCP SN transmitter status indicates the next PDCP SN that the target gNB shall assign to new PDCP SDUs, not having a PDCP SN yet.

NOTE 5: In case of DAPS handover, the uplink PDCP SN receiver status and the downlink PDCP SN transmitter status for a DRB with RLC-AM and not configured with DAPS may be transferred by the SN STATUS TRANSFER message in step 8b instead of step 7.

NOTE 6: For DRBs configured with DAPS, the source gNB may additionally send the EARLY STATUS TRANSFER message(s) between step 7 and step 8b, to inform discarding of already forwarded PDCP SDUs. The target gNB does not transmit forwarded downlink PDCP SDUs to the UE, whose COUNT is less than the conveyed DL COUNT value and discards them if transmission has not been attempted already.

8. The UE synchronises to the target cell and completes the RRC handover procedure by sending *RRCReconfigurationComplete* message to target gNB. In case of DAPS handover, the UE does not detach from the source cell upon receiving the *RRCReconfiguration* message. The UE releases the source resources and

configurations and stops DL/UL reception/transmission with the source upon receiving an explicit release from the target node.

NOTE 6a: From RAN point of view, the DAPS handover is considered to only be completed after the UE has released the source cell as explicitly requested from the target node. RRC suspend, a subsequent handover or inter-RAT handover cannot be initiated until the source cell has been released.

8a/b In case of DAPS handover, the target gNB sends the HANDOVER SUCCESS message to the source gNB to inform that the UE has successfully accessed the target cell. In return, the source gNB sends the SN STATUS TRANSFER message for DRBs configured with DAPS for which the description in step 7 applies, and the normal data forwarding follows as defined in 9.2.3.2.3.

NOTE 7: The uplink PDCP SN receiver status and the downlink PDCP SN transmitter status are also conveyed for DRBs with RLC-UM in the SN STATUS TRANSFER message in step 8b, if configured with DAPS.

NOTE 8: For DRBs configured with DAPS, the source gNB does not stop delivering uplink QoS flows to the UPF until it sends the SN STATUS TRANSFER message in step 8b. The target gNB does not forward QoS flows of the uplink PDCP SDUs successfully received in-sequence to the UPF until it receives the SN STATUS TRANSFER message, in which UL HFN and the first missing SN in the uplink PDCP SN receiver status indicates the start of uplink PDCP SDUs to be delivered to the UPF. The target gNB does not deliver any uplink PDCP SDUs which has an UL COUNT lower than the provided.

NOTE 9: Void.

9. The target gNB sends a PATH SWITCH REQUEST message to AMF to trigger 5GC to switch the DL data path towards the target gNB and to establish an NG-C interface instance towards the target gNB.
10. 5GC switches the DL data path towards the target gNB. The UPF sends one or more "end marker" packets on the old path to the source gNB per PDU session/tunnel and then can release any U-plane/TNL resources towards the source gNB.
11. The AMF confirms the PATH SWITCH REQUEST message with the PATH SWITCH REQUEST ACKNOWLEDGE message.
12. Upon reception of the PATH SWITCH REQUEST ACKNOWLEDGE message from the AMF, the target gNB sends the UE CONTEXT RELEASE to inform the source gNB about the success of the handover. The source gNB can then release radio and C-plane related resources associated to the UE context. Any ongoing data forwarding may continue.

...

Upon receiving a handover command requesting DAPS handover, the UE suspends source cell SRBs, stops sending and receiving any RRC control plane signalling toward the source cell, and establishes SRBs for the target cell. The UE releases the source cell SRBs configuration upon receiving source cell release indication from the target cell after successful DAPS handover execution. When DAPS handover to the target cell fails and if the source cell link is available, then the UE reverts back to the source cell configuration and resumes source cell SRBs for control plane signalling transmission.

[TS 38.331, clause 5.3.5.3]

The UE shall perform the following actions upon reception of the *RRCReconfiguration*, or upon execution of the conditional reconfiguration (CHO or CPC):

- 1> if the *RRCReconfiguration* is applied due to a conditional reconfiguration execution upon cell selection while timer T311 is running, as defined in 5.3.7.3:
 - 2> remove all the entries within *VarConditionalReconfig*, if any;
- 1> if the *RRCReconfiguration* includes the *daps-SourceRelease*:
 - 2> reset the source MAC and release the source MAC configuration;
 - 2> for each DAPS bearer:
 - 3> release the RLC entity or entities as specified in TS 38.322 [4], clause 5.1.3, and the associated logical channel for the source SpCell;

- 3> reconfigure the PDCP entity to release DAPS as specified in TS 38.323 [5];
- 2> for each SRB:
 - 3> release the PDCP entity for the source SpCell;
 - 3> release the RLC entity as specified in TS 38.322 [4], clause 5.1.3, and the associated logical channel for the source SpCell;
 - 2> release the physical channel configuration for the source SpCell;
 - 2> discard the keys used in the source SpCell (the K_{gNB} key, the K_{RRCenc} key, the K_{RRCint} key, the K_{UPint} key and the K_{UPenc} key), if any;
- ...
- 1> if *reconfigurationWithSync* was included in *spCellConfig* of an MCG or SCG, and when MAC of an NR cell group successfully completes a Random Access procedure triggered above:
 - 2> stop timer T304 for that cell group;
 - 2> stop timer T310 for source SpCell if running;
 - 2> apply the parts of the CSI reporting configuration, the scheduling request configuration and the sounding RS configuration that do not require the UE to know the SFN of the respective target SpCell, if any;
 - 2> apply the parts of the measurement and the radio resource configuration that require the UE to know the SFN of the respective target SpCell (e.g. measurement gaps, periodic CQI reporting, scheduling request configuration, sounding RS configuration), if any, upon acquiring the SFN of that target SpCell;
 - 2> for each DRB configured as DAPS bearer, request uplink data switching to the PDCP entity, as specified in TS 38.323 [5];
- ...

NOTE 3: The UE is only required to acquire broadcasted *SIB1* if the UE can acquire it without disrupting unicast data reception, i.e. the broadcast and unicast beams are quasi co-located.

NOTE 4: The UE sets the content of *UEAssistanceInformation* according to latest configuration (i.e. the configuration after applying the *RRCReconfiguration* message) and latest UE preference. The UE may include more than the concerned UE assistance information within the *UEAssistanceInformation* according to 5.7.4.2. Therefore, the content of *UEAssistanceInformation* message may not be similar to the original one.

[TS 38.331, clause 5.3.5.5.2]

The UE shall perform the following actions to execute a reconfiguration with sync.

- 1> if the AS security is not activated, perform the actions upon going to RRC_IDLE as specified in 5.3.11 with the release cause 'other' upon which the procedure ends;
- 1> if no DAPS bearer is configured:
 - 2> stop timer T310 for the corresponding SpCell, if running;
- 1> if this procedure is executed for the MCG:
 - 2> if timer T316 is running;
 - 3> stop timer T316;
 - 3> clear the information included in *VarRLF-Report*, if any;
 - 2> resume MCG transmission, if suspended.
- 1> stop timer T312 for the corresponding SpCell, if running;

1> start timer T304 for the corresponding SpCell with the timer value set to $t304$, as included in the *reconfigurationWithSync*;

1> if the *frequencyInfoDL* is included:

2> consider the target SpCell to be one on the SSB frequency indicated by the *frequencyInfoDL* with a physical cell identity indicated by the *physCellId*;

1> else:

2> consider the target SpCell to be one on the SSB frequency of the source SpCell with a physical cell identity indicated by the *physCellId*;

1> start synchronising to the DL of the target SpCell;

1> apply the specified BCCH configuration defined in 9.1.1.1 for the target SpCell;

1> acquire the *MIB* of the target SpCell, which is scheduled as specified in TS 38.213 [13];

NOTE 1: The UE should perform the reconfiguration with sync as soon as possible following the reception of the RRC message triggering the reconfiguration with sync, which could be before confirming successful reception (HARQ and ARQ) of this message.

NOTE 2: The UE may omit reading the *MIB* if the UE already has the required timing information, or the timing information is not needed for random access.

NOTE 2a: A UE with DAPS bearer does not monitor for system information updates in the source PCell.

1> If any DAPS bearer is configured:

2> create a MAC entity for the target cell group with the same configuration as the MAC entity for the source cell group;

2> for each DAPS bearer:

3> establish an RLC entity or entities for the target cell group, with the same configurations as for the source cell group;

3> establish the logical channel for the target cell group, with the same configurations as for the source cell group;

NOTE 2b: In order to understand if a DAPS bearer is configured, the UE needs to check the presence of the field *daps-Config* within the *RadioBearerConfig* IE received in *radioBearerConfig* or *radioBearerConfig2*.

2> for each SRB:

3> establish an RLC entity for the target cell group, with the same configurations as for the source cell group;

3> establish the logical channel for the target cell group, with the same configurations as for the source cell group;

3> suspend SRBs for the source cell group;

NOTE 3: Void

2> apply the value of the *newUE-Identity* as the C-RNTI in the target cell group;

2> configure lower layers for the target SpCell in accordance with the received *spCellConfigCommon*;

2> configure lower layers for the target SpCell in accordance with any additional fields, not covered in the previous, if included in the received *reconfigurationWithSync*.

8.1.4.3.1.3 Test description

8.1.4.3.1.3.1 Pre-test conditions

System Simulator:

- NR Cell 1 is the Serving cell and the power level is configured to "Serving Cell" defined in TS 38.508-1 [4] Table 6.2.2.1-3.
- NR Cell 2 is the Suitable neighbour intra-frequency cell and the power level is configured to " Suitable neighbour intra-frequency cell" defined in TS 38.508-1 [4] Table 6.2.2.1-3
- System information combination NR-2 as defined in TS 38.508-1 [4] clause 4.4.3.1.3 is used for both NR Cells

UE:

- None.

Preamble:

- If `pc_IP_Ping` is set to TRUE then, the UE is in 5GS state 3N-A according to TS 38.508-1 [4], clause 4.4A.2 Table 4.4A.2-3.
- Else, the UE is in 5GS state 3N-A and Test Loop Function (*On*) with UE test loop mode B on NR Cell 1 according to 38.508-1[4], clause 4.4A.2 Table 4.4A.2-3.

8.1.4.3.1.3.2 Test procedure sequence

Table 8.1.4.3.1.3.2-1: Main behaviour

St	Procedure	Message Sequence		TP	Verdict
		U - S	Message		
1	The SS transmits an <i>RRCReconfiguration</i> message containing <i>reconfigurationWithSync</i> to order UE to perform DAPS handover to NR Cell 2. DRB#n of the first PDU session is configured as DAPS bearer.	<--	NR RRC: <i>RRCReconfiguration</i>	-	-
-	EXCEPTION: In parallel with step 2-3, parallel behaviour defined in table 8.1.4.3.1.3.2-2 is executed repeatedly.	-	-	-	-
2	Check: Does the test result of generic test procedure in TS 38.508-1 [4] Table 4.9.1-1 indicate that the UE is capable of exchanging IP data on DRB#n of the first PDU session on NR Cell 1?	<--	-	1	P
3	Void	-	-	-	-
4	The SS transmits Random Access Response to respond to the latest preamble on NR Cell 2.	<--	Random Access Response	-	-
5	Check: Does UE transmit an <i>RRCReconfigurationComplete</i> message in NR Cell 2?	-->	NR RRC: <i>RRCReconfigurationComplete</i>	1,2	P
5A	The SS transmits one IP Packet to verify data path on DRB#n of the first PDU session on NR Cell 1	-	-	-	-
5B	Check: Does the UE transmit HARQ feedback after step 5A?	-	-	4	P
6	The SS transmits an <i>RRCReconfiguration</i> message with condition <i>DAPS_HO_ReleaseSource</i> in NR Cell 2.	<--	NR RRC: <i>RRCReconfiguration</i>	-	-
7	Check: Does the UE transmit an <i>RRCReconfigurationComplete</i> message in NR Cell 2?	-->	NR RRC: <i>RRCReconfigurationComplete</i>	3	P
8	Check: Does the test result of generic test procedure in TS 38.508-1 Table 4.9.1-1	-	-	2	P

	indicate that the UE is capable of exchanging IP data on DRB#n of the first PDU session on NR Cell 2?				
9	The SS transmits one IP Packet to verify data path on DRB#n of the first PDU session on NR Cell 1.	-	-	-	-
10	Check: Does UE send the IP Packet on DRB#n of the first PDU session in the uplink on NR Cell 1 within the next 1s?	-	-	3	F

Table 8.1.4.3.1.3.2-2: Parallel behaviour

St	Procedure	Message Sequence		TP	Verdict
		U - S	Message		
1	The UE transmits preamble to NR Cell 2.	->	(PRACH Preamble)	-	-

8.1.4.3.1.3.3 Specific message contents

Table 8.1.4.3.1.3.3-1: RRCReconfiguration (step 1, Table 8.1.4.3.1.3.2-1)

Derivation Path: TS 38.508-1 [4], Table 4.8.1-1A with Condition RBConfig_KeyChange			
Information Element	Value/remark	Comment	Condition
RRCReconfiguration ::= SEQUENCE {			
criticalExtensions CHOICE {			
rrcReconfiguration SEQUENCE {			
radioBearerConfig	RadioBearerConfig with conditions SRB_NR_PDCP and (DRBn AND DAPS_PDCP)		
nonCriticalExtension SEQUENCE{			
masterCellGroup	CellGroupConfig	OCTET STRING (CONTAINING CellGroupConfig)	
}			
}			
}			
}			

Table 8.1.4.3.1.3.3-2: CellGroupConfig (Table 8.1.4.3.1.3.3-1)

Derivation Path: TS 38.508-1 [4], Table 4.6.3-19			
Information Element	Value/remark	Comment	Condition
CellGroupConfig ::= SEQUENCE {			
rlc-BearerToAddModList SEQUENCE (SIZE(1..maxLCH)) OF RLC-BearerConfig {	3 entries		
RLC-BearerConfig[1]	RLC-BearerConfig with conditions SRB1	entry 1	
RLC-BearerConfig[2]	RLC-BearerConfig with conditions SRB2	entry 2	
RLC-BearerConfig[3]	RLC-BearerConfig with conditions AM, DRBn	entry 3	
}			
spCellConfig SEQUENCE {			
reconfigurationWithSync SEQUENCE {			
spCellConfigCommon SEQUENCE {			
physCellId	Physical Cell Identity of NR Cell 2		
}			
rach-ConfigDedicated CHOICE {			
uplink	RACH-ConfigDedicated	Table 8.1.4.3.1.3.3-3	

}			
}			
}			
}			

Table 8.1.4.3.1.3.3-3: RACH-ConfigDedicated (Table 8.1.4.3.1.3.3-2)

Derivation Path: TS 38.508-1 [4], Table 4.6.3-129			
Information Element	Value/remark	Comment	Condition
RACH-ConfigDedicated ::= SEQUENCE {			
cfra SEQUENCE {			
occasions SEQUENCE {			
rach-ConfigGeneric	RACH-ConfigGeneric	Table 8.1.4.3.1.3.3-4	
}			
}			
}			

Table 8.1.4.3.1.3.3-4: RACH-ConfigGeneric (Table 8.1.4.3.1.3.3-3)

Derivation Path: TS 38.508-1 [4], Table 4.6.3-130			
Information Element	Value/remark	Comment	Condition
RACH-ConfigGeneric ::= SEQUENCE {			
preambleTransMax	n200		
}			

Table 8.1.4.3.1.3.3-5: RRCReconfiguration (step 6, Table 8.1.4.3.1.3.2-1)

Derivation Path: TS 38.508-1 [4], Table 4.8.1-13 with Condition DAPS_HO_ReleaseSource

8.1.4.3.2 DAPS handover / HO Failure and source link available / HO Success and RLF in source / Intra-frequency

8.1.4.3.2.1 Test Purpose (TP)

(1)

```
with { UE in NR RRC_CONNECTED state and having received an RRCReconfiguration message including a reconfigurationWithSync for handover to the neighbour cell and a dapsConfig configured for a DRB }
ensure that {
  when { T304 of the MCG expires and the source link has not been released }
  then { UE falls back to source cell configuration, resumes the connection with source cell, and reports DAPS HO failure via the source without triggering RRC connection re-establishment }
}
```

(2)

```
with { UE in NR RRC_CONNECTED state and having received an RRCReconfiguration message including a reconfigurationWithSync for handover to the neighbour cell and a dapsConfig configured for a DRB }
ensure that {
  when { Radio link failure is detected for the source MCG }
  then { UE suspends all DRBs in the source, releases the source connection and continues the handover procedure to target }
}
```

8.1.4.3.2.2 Conformance requirements

References: The conformance requirements covered in the present TC are specified in: TS 38.300 9.2.3.1 and 9.2.3.2.1 and TS 38.331 clause 5.3.5.3, 5.3.5.5.2, 5.3.5.5.6, 5.3.5.5.7, 5.3.5.8.3, 5.3.10.3 and 5.7.5.3. Unless otherwise stated these are Rel-16 requirements.

[TS 38.300, clause 9.2.3.1]

Network controlled mobility applies to UEs in RRC_CONNECTED and is categorized into two types of mobility: cell level mobility and beam level mobility.

Cell Level Mobility requires explicit RRC signalling to be triggered, i.e. handover. For inter-gNB handover, the signalling procedures consist of at least the following elemental components illustrated in Figure 9.2.3.1-1:

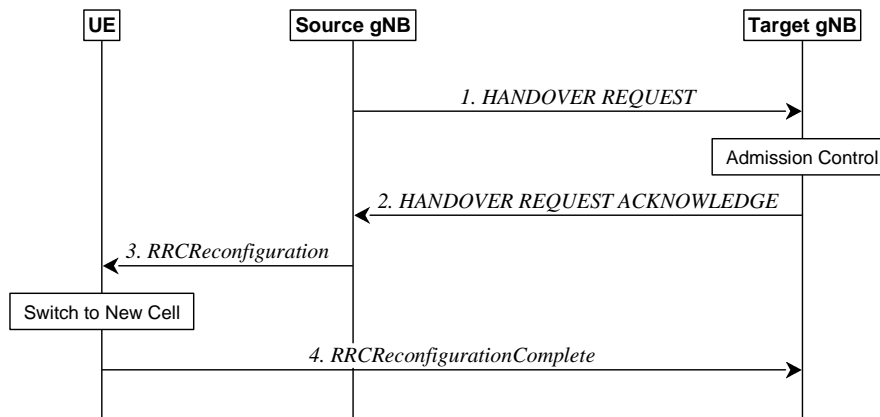

Figure 9.2.3.1-1: Inter-gNB handover procedures

1. The source gNB initiates handover and issues a **HANDOVER REQUEST** over the Xn interface.
2. The target gNB performs admission control and provides the new RRC configuration as part of the **HANDOVER REQUEST ACKNOWLEDGE**.
3. The source gNB provides the RRC configuration to the UE by forwarding the *RRCReconfiguration* message received in the **HANDOVER REQUEST ACKNOWLEDGE**. The *RRCReconfiguration* message includes at least cell ID and all information required to access the target cell so that the UE can access the target cell without reading system information. For some cases, the information required for contention-based and contention-free random access can be included in the *RRCReconfiguration* message. The access information to the target cell may include beam specific information, if any.
4. The UE moves the RRC connection to the target gNB and replies with the *RRCReconfigurationComplete*.

NOTE 1: User Data can also be sent in step 4 if the grant allows.

In case of DAPS handover, the UE continues the downlink user data reception from the source gNB until releasing the source cell and continues the uplink user data transmission to the source gNB until successful random access procedure to the target gNB.

Only source and target PCell are used during DAPS handover. CA, DC, SUL, multi-TRP, NR sidelink configurations and V2X sidelink configurations are released by the source gNB before the handover command is sent to the UE and are not configured by the target gNB until the DAPS handover has completed (i.e. at source cell release).

The handover mechanism triggered by RRC requires the UE at least to reset the MAC entity and re-establish RLC, except for DAPS handover, where upon reception of the handover command, the UE:

- Creates a MAC entity for target;
- Establishes the RLC entity and an associated DTCH logical channel for target for each DRB configured with DAPS;
- For each DRB configured with DAPS, reconfigures the PDCP entity with separate security and ROHC functions for source and target and associates them with the RLC entities configured by source and target respectively;
- Retains the rest of the source configurations until release of the source.

NOTE 2: The handling on RLC and PDCP for DRBs not configured with DAPS is the same as in normal handover.

NOTE 3: Void.

RRC managed handovers with and without PDCP entity re-establishment are both supported. For DRBs using RLC AM mode, PDCP can either be re-established together with a security key change or initiate a data recovery procedure without a key change. For DRBs using RLC UM mode and for SRBs, PDCP can either be re-established together with a security key change or remain as it is without a key change.

Data forwarding, in-sequence delivery and duplication avoidance at handover can be guaranteed when the target gNB uses the same DRB configuration as the source gNB.

Timer based handover failure procedure is supported in NR. RRC connection re-establishment procedure is used for recovering from handover failure except in certain CHO or DAPS handover scenarios:

- When DAPS handover fails, the UE falls back to the source cell configuration, resumes the connection with the source cell, and reports DAPS handover failure via the source without triggering RRC connection re-establishment if the source link has not been released.
- When initial CHO execution attempt fails or HO fails, the UE performs cell selection, and if the selected cell is a CHO candidate and if network configured the UE to try CHO after handover/CHO failure, then the UE attempts CHO execution once, otherwise re-establishment is performed.

DAPS handover for FR2 to FR2 case is not supported in this release of the specification.

[TS 38.300, clause 9.2.3.2.1]

The intra-NR RAN handover performs the preparation and execution phase of the handover procedure performed without involvement of the 5GC, i.e. preparation messages are directly exchanged between the gNBs. The release of the resources at the source gNB during the handover completion phase is triggered by the target gNB. The figure below depicts the basic handover scenario where neither the AMF nor the UPF changes:

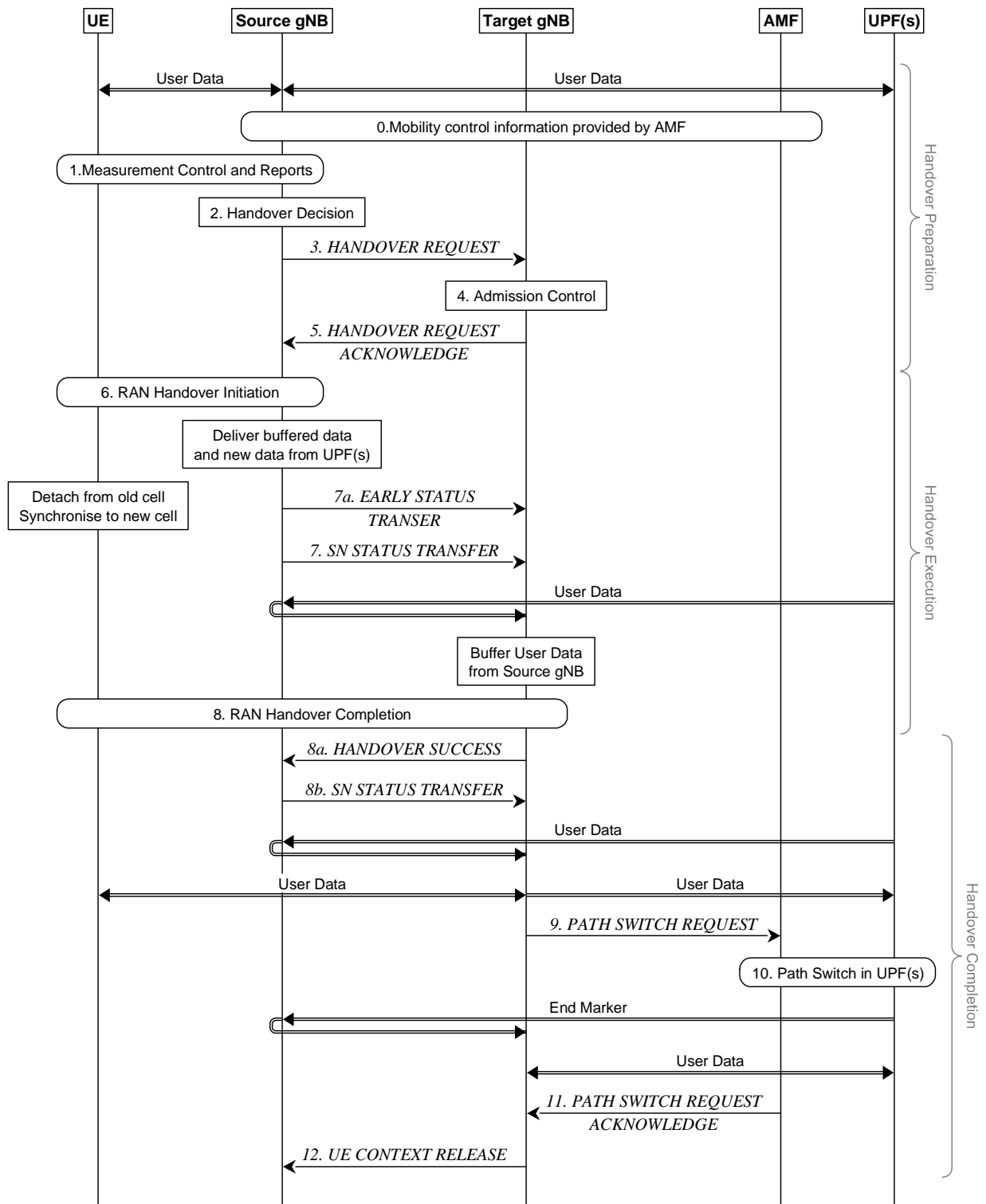

<http://msc-generator.sourceforge.net> v6.3.7

Figure 9.2.3.2.1-1: Intra-AMF/UPF Handover

0. The UE context within the source gNB contains information regarding roaming and access restrictions which were provided either at connection establishment or at the last TA update.
1. The source gNB configures the UE measurement procedures and the UE reports according to the measurement configuration.
2. The source gNB decides to handover the UE, based on *MeasurementReport* and RRM information.

3. The source gNB issues a Handover Request message to the target gNB passing a transparent RRC container with necessary information to prepare the handover at the target side. The information includes at least the target cell ID, KgNB*, the C-RNTI of the UE in the source gNB, RRM-configuration including UE inactive time, basic AS-configuration including *antenna Info and DL Carrier Frequency*, the current QoS flow to DRB mapping rules applied to the UE, the SIB1 from source gNB, the UE capabilities for different RATs, PDU session related information, and can include the UE reported measurement information including beam-related information if available. The PDU session related information includes the slice information and QoS flow level QoS profile(s). The source gNB may also request a DAPS handover for one or more DRBs.

NOTE 1: After issuing a Handover Request, the source gNB should not reconfigure the UE, including performing Reflective QoS flow to DRB mapping.

4. Admission Control may be performed by the target gNB. Slice-aware admission control shall be performed if the slice information is sent to the target gNB. If the PDU sessions are associated with non-supported slices the target gNB shall reject such PDU Sessions.
5. The target gNB prepares the handover with L1/L2 and sends the HANOVER REQUEST ACKNOWLEDGE to the source gNB, which includes a transparent container to be sent to the UE as an RRC message to perform the handover. The target gNB also indicates if a DAPS handover is accepted.

NOTE 2: As soon as the source gNB receives the HANOVER REQUEST ACKNOWLEDGE, or as soon as the transmission of the handover command is initiated in the downlink, data forwarding may be initiated.

NOTE 3: For DRBs configured with DAPS, downlink PDCP SDUs are forwarded with SN assigned by the source gNB, until SN assignment is handed over to the target gNB in step 8b, for which the normal data forwarding follows as defined in 9.2.3.2.3.

6. The source gNB triggers the Uu handover by sending an *RRCReconfiguration* message to the UE, containing the information required to access the target cell: at least the target cell ID, the new C-RNTI, the target gNB security algorithm identifiers for the selected security algorithms. It can also include a set of dedicated RACH resources, the association between RACH resources and SSB(s), the association between RACH resources and UE-specific CSI-RS configuration(s), common RACH resources, and system information of the target cell, etc.

NOTE 4: For DRBs configured with DAPS, the source gNB does not stop transmitting downlink packets until it receives the HANOVER SUCCESS message from the target gNB in step 8a.

NOTE 4a: CHO cannot be configured simultaneously with DAPS handover.

- 7a. For DRBs configured with DAPS, the source gNB sends the EARLY STATUS TRANSFER message. The DL COUNT value conveyed in the EARLY STATUS TRANSFER message indicates PDCP SN and HFN of the first PDCP SDU that the source gNB forwards to the target gNB. The source gNB does not stop assigning SNs to downlink PDCP SDUs until it sends the SN STATUS TRANSFER message to the target gNB in step 8b.
7. For DRBs not configured with DAPS, the source gNB sends the SN STATUS TRANSFER message to the target gNB to convey the uplink PDCP SN receiver status and the downlink PDCP SN transmitter status of DRBs for which PDCP status preservation applies (i.e. for RLC AM). The uplink PDCP SN receiver status includes at least the PDCP SN of the first missing UL PDCP SDU and may include a bit map of the receive status of the out of sequence UL PDCP SDUs that the UE needs to retransmit in the target cell, if any. The downlink PDCP SN transmitter status indicates the next PDCP SN that the target gNB shall assign to new PDCP SDUs, not having a PDCP SN yet.

NOTE 5: In case of DAPS handover, the uplink PDCP SN receiver status and the downlink PDCP SN transmitter status for a DRB with RLC-AM and not configured with DAPS may be transferred by the SN STATUS TRANSFER message in step 8b instead of step 7.

NOTE 6: For DRBs configured with DAPS, the source gNB may additionally send the EARLY STATUS TRANSFER message(s) between step 7 and step 8b, to inform discarding of already forwarded PDCP SDUs. The target gNB does not transmit forwarded downlink PDCP SDUs to the UE, whose COUNT is less than the conveyed DL COUNT value and discards them if transmission has not been attempted already.

8. The UE synchronises to the target cell and completes the RRC handover procedure by sending *RRCReconfigurationComplete* message to target gNB. In case of DAPS handover, the UE does not detach from the source cell upon receiving the *RRCReconfiguration* message. The UE releases the source resources and

configurations and stops DL/UL reception/transmission with the source upon receiving an explicit release from the target node.

NOTE 6a: From RAN point of view, the DAPS handover is considered to only be completed after the UE has released the source cell as explicitly requested from the target node. RRC suspend, a subsequent handover or inter-RAT handover cannot be initiated until the source cell has been released.

8a/b In case of DAPS handover, the target gNB sends the HANDOVER SUCCESS message to the source gNB to inform that the UE has successfully accessed the target cell. In return, the source gNB sends the SN STATUS TRANSFER message for DRBs configured with DAPS for which the description in step 7 applies, and the normal data forwarding follows as defined in 9.2.3.2.3.

NOTE 7: The uplink PDCP SN receiver status and the downlink PDCP SN transmitter status are also conveyed for DRBs with RLC-UM in the SN STATUS TRANSFER message in step 8b, if configured with DAPS.

NOTE 8: For DRBs configured with DAPS, the source gNB does not stop delivering uplink QoS flows to the UPF until it sends the SN STATUS TRANSFER message in step 8b. The target gNB does not forward QoS flows of the uplink PDCP SDUs successfully received in-sequence to the UPF until it receives the SN STATUS TRANSFER message, in which UL HFN and the first missing SN in the uplink PDCP SN receiver status indicates the start of uplink PDCP SDUs to be delivered to the UPF. The target gNB does not deliver any uplink PDCP SDUs which has an UL COUNT lower than the provided.

NOTE 9: Void.

9. The target gNB sends a PATH SWITCH REQUEST message to AMF to trigger 5GC to switch the DL data path towards the target gNB and to establish an NG-C interface instance towards the target gNB.
10. 5GC switches the DL data path towards the target gNB. The UPF sends one or more "end marker" packets on the old path to the source gNB per PDU session/tunnel and then can release any U-plane/TNL resources towards the source gNB.
11. The AMF confirms the PATH SWITCH REQUEST message with the PATH SWITCH REQUEST ACKNOWLEDGE message.
12. Upon reception of the PATH SWITCH REQUEST ACKNOWLEDGE message from the AMF, the target gNB sends the UE CONTEXT RELEASE to inform the source gNB about the success of the handover. The source gNB can then release radio and C-plane related resources associated to the UE context. Any ongoing data forwarding may continue.

...

Upon receiving a handover command requesting DAPS handover, the UE suspends source cell SRBs, stops sending and receiving any RRC control plane signalling toward the source cell, and establishes SRBs for the target cell. The UE releases the source cell SRBs configuration upon receiving source cell release indication from the target cell after successful DAPS handover execution. When DAPS handover to the target cell fails and if the source cell link is available, then the UE reverts back to the source cell configuration and resumes source cell SRBs for control plane signalling transmission.

[TS 38.331, clause 5.3.5.3]

The UE shall perform the following actions upon reception of the *RRCReconfiguration*, or upon execution of the conditional reconfiguration (CHO or CPC):

- 1> if the *RRCReconfiguration* is applied due to a conditional reconfiguration execution upon cell selection while timer T311 is running, as defined in 5.3.7.3:
 - 2> remove all the entries within *VarConditionalReconfig*, if any;
- 1> if the *RRCReconfiguration* includes the *daps-SourceRelease*:
 - 2> reset the source MAC and release the source MAC configuration;
 - 2> for each DAPS bearer:
 - 3> release the RLC entity or entities as specified in TS 38.322 [4], clause 5.1.3, and the associated logical channel for the source SpCell;

- 3> reconfigure the PDCP entity to release DAPS as specified in TS 38.323 [5];
- 2> for each SRB:
 - 3> release the PDCP entity for the source SpCell;
 - 3> release the RLC entity as specified in TS 38.322 [4], clause 5.1.3, and the associated logical channel for the source SpCell;
 - 2> release the physical channel configuration for the source SpCell;
 - 2> discard the keys used in the source SpCell (the K_{gNB} key, the K_{RRCenc} key, the K_{RRCint} key, the K_{UPint} key and the K_{UPenc} key), if any;
- ...
- 1> if *reconfigurationWithSync* was included in *spCellConfig* of an MCG or SCG, and when MAC of an NR cell group successfully completes a Random Access procedure triggered above:
 - 2> stop timer T304 for that cell group;
 - 2> stop timer T310 for source SpCell if running;
 - 2> apply the parts of the CSI reporting configuration, the scheduling request configuration and the sounding RS configuration that do not require the UE to know the SFN of the respective target SpCell, if any;
 - 2> apply the parts of the measurement and the radio resource configuration that require the UE to know the SFN of the respective target SpCell (e.g. measurement gaps, periodic CQI reporting, scheduling request configuration, sounding RS configuration), if any, upon acquiring the SFN of that target SpCell;
 - 2> for each DRB configured as DAPS bearer, request uplink data switching to the PDCP entity, as specified in TS 38.323 [5];
- ...

NOTE 3: The UE is only required to acquire broadcasted *SIB1* if the UE can acquire it without disrupting unicast data reception, i.e. the broadcast and unicast beams are quasi co-located.

NOTE 4: The UE sets the content of *UEAssistanceInformation* according to latest configuration (i.e. the configuration after applying the *RRCReconfiguration* message) and latest UE preference. The UE may include more than the concerned UE assistance information within the *UEAssistanceInformation* according to 5.7.4.2. Therefore, the content of *UEAssistanceInformation* message may not be similar to the original one.

[TS 38.331, clause 5.3.5.5.2]

The UE shall perform the following actions to execute a reconfiguration with sync.

- 1> if the AS security is not activated, perform the actions upon going to RRC_IDLE as specified in 5.3.11 with the release cause 'other' upon which the procedure ends;
- 1> if no DAPS bearer is configured:
 - 2> stop timer T310 for the corresponding SpCell, if running;
- 1> if this procedure is executed for the MCG:
 - 2> if timer T316 is running;
 - 3> stop timer T316;
 - 3> clear the information included in *VarRLF-Report*, if any;
 - 2> resume MCG transmission, if suspended.
- 1> stop timer T312 for the corresponding SpCell, if running;

1> start timer T304 for the corresponding SpCell with the timer value set to t_{304} , as included in the *reconfigurationWithSync*;

1> if the *frequencyInfoDL* is included:

2> consider the target SpCell to be one on the SSB frequency indicated by the *frequencyInfoDL* with a physical cell identity indicated by the *physCellId*;

1> else:

2> consider the target SpCell to be one on the SSB frequency of the source SpCell with a physical cell identity indicated by the *physCellId*;

1> start synchronising to the DL of the target SpCell;

1> apply the specified BCCH configuration defined in 9.1.1.1 for the target SpCell;

1> acquire the *MIB* of the target SpCell, which is scheduled as specified in TS 38.213 [13];

NOTE 1: The UE should perform the reconfiguration with sync as soon as possible following the reception of the RRC message triggering the reconfiguration with sync, which could be before confirming successful reception (HARQ and ARQ) of this message.

NOTE 2: The UE may omit reading the *MIB* if the UE already has the required timing information, or the timing information is not needed for random access.

NOTE 2a: A UE with DAPS bearer does not monitor for system information updates in the source PCell.

1> If any DAPS bearer is configured:

2> create a MAC entity for the target cell group with the same configuration as the MAC entity for the source cell group;

2> for each DAPS bearer:

3> establish an RLC entity or entities for the target cell group, with the same configurations as for the source cell group;

3> establish the logical channel for the target cell group, with the same configurations as for the source cell group;

NOTE 2b: In order to understand if a DAPS bearer is configured, the UE needs to check the presence of the field *daps-Config* within the *RadioBearerConfig* IE received in *radioBearerConfig* or *radioBearerConfig2*.

2> for each SRB:

3> establish an RLC entity for the target cell group, with the same configurations as for the source cell group;

3> establish the logical channel for the target cell group, with the same configurations as for the source cell group;

3> suspend SRBs for the source cell group;

NOTE 3: Void

2> apply the value of the *newUE-Identity* as the C-RNTI in the target cell group;

2> configure lower layers for the target SpCell in accordance with the received *spCellConfigCommon*;

2> configure lower layers for the target SpCell in accordance with any additional fields, not covered in the previous, if included in the received *reconfigurationWithSync*.

[TS 38.331, clause 5.3.5.5.6]

The UE shall:

- 1> if the received *rlf-TimersAndConstants* is set to *release*:
 - 2> if any DAPS bearer is configured:
 - 3> use values for timers T301, T310, T311 and constants N310, N311 for the target cell group, as included in *ue-TimersAndConstants* received in *SIB1*;
 - 2> else:
 - 3> use values for timers T301, T310, T311 and constants N310, N311, as included in *ue-TimersAndConstants* received in *SIB1*;
- 1> else:
 - 2> if any DAPS bearer is configured:
 - 3> configure the value of timers and constants for the target cell group in accordance with received *rlf-TimersAndConstants*;
 - 2> else:
 - 3> (re-)configure the value of timers and constants in accordance with received *rlf-TimersAndConstants*;
 - 3> stop timer T310 for this cell group, if running;
 - 3> stop timer T312 for this cell group, if running;
 - 3> reset the counters N310 and N311.

[TS 38.331, clause 5.3.5.5.7]

The UE shall:

- 1> if the *SpCellConfig* contains the *rlf-TimersAndConstants*:
 - 2> configure the RLF timers and constants for this cell group as specified in 5.3.5.5.6;
 - 1> else if *rlf-TimersAndConstants* is not configured for this cell group:
 - 2> if any DAPS bearer is configured:
 - 3> use values for timers T301, T310, T311 and constants N310, N311 for the target cell group, as included in *ue-TimersAndConstants* received in *SIB1*;
 - 2> else
 - 3> use values for timers T301, T310, T311 and constants N310, N311, as included in *ue-TimersAndConstants* received in *SIB1*;
- ...

[TS 38.331, clause 5.3.5.8.3]

The UE shall:

- 1> if T304 of the MCG expires:
 - 2> release dedicated preambles provided in *rach-ConfigDedicated* if configured;
 - 2> release dedicated msgA PUSCH resources provided in *rach-ConfigDedicated* if configured;
- 2> if any DAPS bearer is configured, and radio link failure is not detected in the source PCell, according to subclause 5.3.10.3:
 - 3> reset MAC for the target PCell and release the MAC configuration for the target PCell;
 - 3> for each DAPS bearer:

- 4> release the RLC entity or entities as specified in TS 38.322 [4], clause 5.1.3, and the associated logical channel for the target PCell;
- 4> reconfigure the PDCP entity to release DAPS as specified in TS 38.323 [5];
- 3> for each SRB:
 - 4> if the *masterKeyUpdate* was not received:
 - 5> configure the PDCP entity for the source PCell with state variables continuation as specified in TS 38.323 [5], the state variables as the PDCP entity for the target PCell;
 - 4> release the PDCP entity for the target PCell;
 - 4> release the RLC entity as specified in TS 38.322 [4], clause 5.1.3, and the associated logical channel for the target PCell;
 - 4> trigger the PDCP entity for the source PCell to perform SDU discard as specified in TS 38.323 [5];
 - 4> re-establish the RLC entity for the source PCell;
- 3> release the physical channel configuration for the target PCell;
- 3> revert back to the SDAP configuration used in the source PCell;
- 3> discard the keys used in target PCell (the K_{gNB} key, the K_{RRCenc} key, the K_{RRCint} key, the K_{UPint} key and the K_{UPenc} key), if any;
- 3> resume suspended SRBs in the source PCell;
- 3> for each non DAPS bearer:
 - 4> revert back to the UE configuration used for the DRB in the source PCell, includes PDCP, RLC states variables, the security configuration and the data stored in transmission and reception buffers in PDCP and RLC entities ;
- 3> revert back to the UE measurement configuration used in the source PCell;
- 3> initiate the failure information procedure as specified in subclause 5.7.5 to report DAPS handover failure.
- ...

NOTE 2: In this clause, the term 'handover failure' has been used to refer to 'reconfiguration with sync failure'.

[TS 38.331, clause 5.3.10.3]

The UE shall:

- 1> if any DAPS bearer is configured and T304 is running:
 - 2> upon T310 expiry in source SpCell; or
 - 2> upon random access problem indication from source MCG MAC; or
 - 2> upon indication from source MCG RLC that the maximum number of retransmissions has been reached; or
 - 2> upon consistent uplink LBT failure indication from source MCG MAC:
 - 3> consider radio link failure to be detected for the source MCG i.e. source RLF;
 - 3> suspend the transmission and reception of all DRBs in the source MCG;
 - 3> reset MAC for the source MCG;
 - 3> release the source connection.

[TS 38.331, clause 5.7.5.3]

The UE shall:

...

- 1> if initiated to provide DAPS failure information, set *FailureInfoDAPS* as follows:
 - 2> set the *failureType* as *daps-failure*;
- 1> if used to inform the network about a failure for an MCG RLC bearer or DAPS failure information:
 - 2> submit the *FailureInformation* message to lower layers for transmission via SRB1;

8.1.4.3.2.3 Test description

8.1.4.3.2.3.1 Pre-test conditions

System Simulator:

- NR Cell 1 is the Serving cell and NR Cell 2 is the Suitable neighbour intra-frequency cell.
- System information combination NR-2 as defined in TS 38.508-1 [4] clause 4.4.3.1.3 is used for NR Cells

UE:

- None.

Preamble:

- If *pc_IP_Ping* is set to TRUE then, the UE is in 5GS state 3N-A on NR Cell 1 according to TS 38.508-1 [4], clause 4.4A.2 Table 4.4A.2-3.
- Else, the UE is in 5GS state 3N-A and Test Loop Function (*On*) with UE test loop mode B on NR Cell 1 according to 38.508-1[4], clause 4.4A.2 Table 4.4A.2-3.

8.1.4.3.2.3.2 Test procedure sequence

Table 8.1.4.3.2.3.2-1 illustrates the downlink power levels and other changing parameters to be applied for the NR cells at various time instants of the test execution. The exact instants on which these values shall be applied are described in the texts in this clause. The configuration "T0" indicates the initial conditions. Subsequent configurations marked "T1", "T2" and "T3" are applied at the points indicated in the Main behaviour description in Table 8.1.4.3.2.3.2-2.

Table 8.1.4.3.2.3.2-1: Time instances of cell power level and parameter changes for FR1

	Parameter	Unit	NR Cell 1	NR Cell 2	Remark
T0	SS/PBCH SSS EPRE	dBm/SC S	-88	-94	
T1	SS/PBCH SSS EPRE	dBm/SC S	-88	off	
T2	SS/PBCH SSS EPRE	dBm/SC S	-88	-88	
T3	SS/PBCH SSS EPRE	dBm/SC S	off	-88	

Table 8.1.4.3.2.3.2-2: Main behaviour

St	Procedure	Message Sequence		TP	Verdict
		U - S	Message		
1	The SS transmits an <i>RRCReconfiguration</i> message containing <i>reconfigurationWithSync</i> to order UE to perform DAPS handover to NR Cell 2. DRB#n of the first PDU session is configured as DAPS bearer.	<--	NR RRC: <i>RRCReconfiguration</i>	-	-

-	EXCEPTION: In parallel with step 2, parallel behaviour defined in table 8.1.4.3.2.3.2-3 is executed repeatedly.	-	-	-	-
2	The SS changes the power level setting according to the row "T1".	-	-	-	-
3	Check: Does the UE transmit an <i>RRCReestablishmentRequest</i> message on NR Cell 1 within 5s?	-->	NR RRC: <i>RRCReestablishmentRequest</i>	1	F
4	Check: Does the UE transmit a <i>FailureInformation</i> message with <i>failureType-r16</i> set to <i>daps-failure</i> on NR Cell 1 within 5s?	-->	NR RRC: <i>FailureInformation</i>	1	P
5	Check: Does the test result of generic test procedure in TS 38.508-1 [4] Table 4.9.1-1 indicate that the UE revert back to the configuration used in the source PCell on DRB#n of the first PDU session on NR Cell 1?	-	-	1	P
6	The SS changes the power level setting according to the row "T2".	-	-	-	-
7	The SS transmits an <i>RRCReconfiguration</i> message containing <i>reconfigurationWithSync</i> to order UE to perform DAPS handover to NR Cell 2. DRB#n of the first PDU session is configured as DAPS bearer.	<--	NR RRC: <i>RRCReconfiguration</i>	-	-
-	EXCEPTION: In parallel with step 8, parallel behaviour defined in table 8.1.4.3.2.3.2-3 is executed repeatedly.	-	-	-	-
8	The SS changes the power level setting according to the row "T3" and waits 300ms to ensure T310 expires in NR Cell 1.	-	-	-	-
9	The SS transmits Random Access Response to respond to the latest preamble on NR Cell 2.	<--	Random Access Response	-	-
10	Check: Does UE transmit an <i>RRCReconfigurationComplete</i> message in NR Cell 2?	-->	NR RRC: <i>RRCReconfigurationComplete</i>	2	P
11	Check: Does the test result of generic test procedure in TS 38.508-1 [4] Table 4.9.1-1 indicate that the UE is capable of exchanging IP data on DRB#n of the first PDU session on NR Cell 2?	-	-	2	P
12	The SS transmits an <i>RRCReconfiguration</i> message with condition <i>DAPS_HO_ReleaseSource</i> in NR Cell 2.	<--	NR RRC: <i>RRCReconfiguration</i>	-	-
13	Check: Does the UE transmits an <i>RRCReconfigurationComplete</i> message in NR Cell 2.	-->	NR RRC: <i>RRCReconfigurationComplete</i>	-	-

Table 8.1.4.3.2.3.2-3: Parallel behaviour

St	Procedure	Message Sequence		TP	Verdict
		U - S	Message		
1	The UE transmits preamble to NR Cell 2.	->	(PRACH Preamble)	-	-
2	The SS does not respond.	-	-	-	-

8.1.4.3.2.3.3 Specific message contents

Table 8.1.5.6.1.3.3-1: SIB1 for NR Cell 1 (all steps)

Derivation Path: TS 38.508-1 [4] table 4.6.1-28			
Information Element	Value/Remark	Comment	Condition
SIB1 ::= SEQUENCE {			
ue-TimersAndConstants SEQUENCE {			
t310	ms0	0 ms	
}			

}		
---	--	--

Table 8.1.4.3.2.3.3-2: RRCReconfiguration (step 1 and step 7, Table 8.1.4.3.2.3.2-2)

Derivation Path: TS 38.508-1 [4], Table 4.8.1-1A with Condition RBConfig_KeyChange			
Information Element	Value/remark	Comment	Condition
RRCReconfiguration ::= SEQUENCE {			
criticalExtensions CHOICE {			
rrcReconfiguration SEQUENCE {			
radioBearerConfig	RadioBearerConfig with conditions (SRB_NR_PDCP) and (DRBn AND DAPS_PDCP)		
nonCriticalExtension SEQUENCE{			
masterCellGroup	CellGroupConfig	OCTET STRING (CONTAINING CellGroupConfig) Table 8.1.4.3.2.3.3-3	
}			
}			
}			
}			

Table 8.1.4.3.2.3.3-3: CellGroupConfig (Table 8.1.4.3.2.3.3-2)

Derivation Path: TS 38.508-1 [4], Table 4.6.3-19 with condition PCell_change and CFRA			
Information Element	Value/remark	Comment	Condition
CellGroupConfig ::= SEQUENCE {			
rlc-BearerToAddModList SEQUENCE (SIZE(1..maxLCH)) OF RLC-BearerConfig {	3 entries		
RLC-BearerConfig[1]	RLC-BearerConfig with conditions SRB1	entry 1	
RLC-BearerConfig[2]	RLC-BearerConfig with conditions SRB2	entry 2	
RLC-BearerConfig[3]	RLC-BearerConfig with conditions AM, DRBn	entry 3	
}			
spCellConfig SEQUENCE {			
reconfigurationWithSync SEQUENCE {			
spCellConfigCommon SEQUENCE {			
physCellId	Physical Cell Identity of NR Cell 2		
}			
rach-ConfigDedicated CHOICE {			
uplink	RACH-ConfigDedicated	Table 8.1.4.3.2.3.3-4	
}			
}			
}			

Table 8.1.4.3.2.3.3-4: RACH-ConfigDedicated (Table 8.1.4.3.2.3.3-3)

Derivation Path: TS 38.508-1 [4], Table 4.6.3-129			
Information Element	Value/remark	Comment	Condition
RACH-ConfigDedicated ::= SEQUENCE {			
cfra SEQUENCE {			
occasions SEQUENCE {			
rach-ConfigGeneric	RACH-ConfigGeneric	Table 8.1.4.3.2.3.3-5	
}			

}			
}			

Table 8.1.4.3.2.3.3-5: RACH-ConfigGeneric (Table 8.1.4.3.2.3.3-4)

Derivation Path: TS 38.508-1 [4], Table 4.6.3-130			
Information Element	Value/remark	Comment	Condition
RACH-ConfigGeneric ::= SEQUENCE {			
preambleTransMax	n200		
}			

Table 8.1.4.3.2.3.3-6: FailureInformation (step 4, Table 8.1.4.3.2.3.2-2)

Derivation Path: TS 38.508-1 [4], Table 4.6.1-4 with Condition DAPS_HOF

Table 8.1.4.3.2.3.3-7: RRCReconfiguration (step 12, Table 8.1.4.3.2.3.2-2)

Derivation Path: TS 38.508-1 [4], Table 4.8.1-13 with Condition DAPS_HO_ReleaseSource

8.1.4.3.3

8.1.4.3.4 DAPS handover with key change / Success / Inter-frequency

8.1.4.3.4.1 Test Purpose (TP)

(1)

```

with { UE in NR RRC_CONNECTED state and supporting DAPS handover }
ensure that {
  when { UE receives an RRCReconfiguration message including a reconfigurationWithSync for handover
with key change and dapsConfig is configured for a DRB }
  then { UE performs DAPS handover to the target cell and keeps DL/UL reception/transmission with
the source gNB for the DRB configured with dapsConfig }
}

```

(2)

```

with { UE in NR RRC_CONNECTED state and supporting DAPS handover and having received an
RRCReconfiguration message including a reconfigurationWithSync for handover to the neighbour cell
and a dapsConfig configured for any DRB }
ensure that {
  when { UE has performed random access procedure to the target cell successfully }
  then { UE transmits an RRCReconfigurationComplete message to the target gNB }
}

```

(3)

```

with { UE in NR RRC_CONNECTED state and supporting DAPS handover and having received an
RRCReconfiguration message including a reconfigurationWithSync for handover to the neighbour cell
and a dapsConfig configured for any DRB }
ensure that {
  when { UE receives an RRCReconfiguration message including a daps-SourceRelease }
  then { UE releases the radio link with the source cell }
}

```

(4)

```

with { UE in NR RRC_CONNECTED state and supporting DAPS handover and having received an
RRCReconfiguration message including a reconfigurationWithSync for handover to the neighbour cell
and a dapsConfig configured for any DRB }
ensure that {

```

```

when { UE has performed random access procedure to the target cell successfully }
then { UE continues the downlink user data reception from the source gNB until releasing the
source cell }

```

8.1.4.3.4.2 Conformance requirements

Same as test case 8.1.4.3.1.

8.1.4.3.4.3 Test description

8.1.4.3.4.3.1 Pre-test conditions

Same as test case 8.1.4.3.1 with the following differences:

- Cells configuration: NR Cell 3 replaces NR Cell 2.
- System information combination: NR-4 replaces NR-2.

8.1.4.3.4.3.2 Test procedure sequence

Same as test case 8.1.4.3.1 with the following differences:

- Cells configuration: NR Cell 3 replaces NR Cell 2.

8.1.4.3.4.3.3 Specific message contents

Same as test case 8.1.4.3.1 with the following difference:

- Cells configuration: NR Cell 3 replaces NR Cell 2.

8.1.4.3.5 DAPS handover / HO Failure and source link available / HO Success and RLF in source / Inter-frequency

8.1.4.3.5.1 Test Purpose (TP)

(1)

```

with { UE in NR RRC_CONNECTED state and having received an RRCReconfiguration message including a
reconfigurationWithSync for handover to the neighbour cell and a dapsConfig configured for a DRB }
ensure that {
  when { T304 of the MCG expires and the source link has not been released }
  then { UE falls back to source cell configuration, resumes the connection with source cell, and
reports DAPS HO failure via the source without triggering RRC connection re-establishment }
}

```

(2)

```

with { UE in NR RRC_CONNECTED state and having received an RRCReconfiguration message including a
reconfigurationWithSync for handover to the neighbour cell and a dapsConfig configured for a DRB }
ensure that {
  when { Radio link failure is detected for the source MCG }
  then { UE suspends all DRBs in the source, releases the source connection and continues the
handover procedure to target }
}

```

8.1.4.3.5.2 Conformance requirements

Same as test case 8.1.4.3.2.

8.1.4.3.5.3 Test description

8.1.4.3.5.3.1 Pre-test conditions

Same as test case 8.1.4.3.2 with the following differences:

- Cells configuration: NR Cell 3 replaces NR Cell 2.
- System information combination: NR-4 replaces NR-2.

8.1.4.3.5.3.2 Test procedure sequence

Same as test case 8.1.4.3.2 with the following differences:

- Cells configuration: NR Cell 3 replaces NR Cell 2.

8.1.4.3.5.3.3 Specific message contents

Same as test case 8.1.4.3.2 with the following differences:

- Cells configuration: NR Cell 3 replaces NR Cell 2.

8.1.4.4 Conditional handover

8.1.4.4.1 Conditional handover / Success / A3 / A5 / A3+A5

8.1.4.4.1.1 Test Purpose (TP)

(1)

```
with { UE in NR RRC_CONNECTED state and supporting conditional handover and receiving an
RRCReconfiguration message including ConditionalReconfiguration }
ensure that {
  when { any CHO execution condition is not satisfied }
  then { UE maintains connection with source gNB and starts evaluating the CHO execution
conditions for the candidate cell(s) }
}
```

(2)

```
with { UE in NR RRC_CONNECTED state and supporting conditional handover }
ensure that {
  when { UE receives an RRCReconfiguration message including ConditionalReconfiguration and only
event A3 is configured as conditional handover trigger event }
  then { UE starts evaluating the CHO execution condition A3 and perform conditional handover to
the neighbour cell triggered in conditional configuration execution }
}
```

(3)

```
with { UE in NR RRC_CONNECTED state and supporting conditional handover }
ensure that {
  when { UE receives an RRCReconfiguration message including ConditionalReconfiguration and only
event A5 is configured as conditional handover trigger event }
  then { UE starts evaluating the CHO execution condition A5 and perform conditional handover to
the neighbour cell triggered in conditional configuration execution }
}
```

(4)

```
with { UE in NR RRC_CONNECTED state and supporting conditional handover }
ensure that {
  when { UE receives an RRCReconfiguration message including ConditionalReconfiguration and both
event A3 and event A5 are configured as conditional handover trigger events }
  then { UE starts evaluating the CHO execution condition A3 and A5 and perform conditional
handover to the neighbour cell triggered in conditional configuration execution }
}
```

(5)

```
with { UE in NR RRC_CONNECTED state and supporting conditional handover }
ensure that {
  when { UE perform conditional handover procedure successfully }
  then { UE releases stored CHO configurations }
}
```

8.1.4.4.1.2 Conformance requirements

References: The conformance requirements covered in the present TC are specified in: TS 38.300 9.2.3.4.1, and 9.2.3.4.2 and TS 38.331 clause 5.3.5.1, 5.3.5.13.1, 5.3.5.13.4 and 5.3.5.13.5. Unless otherwise stated these are Rel-16 requirements.

[TS 38.300, clause 9.2.3.4.1]

A Conditional Handover (CHO) is defined as a handover that is executed by the UE when one or more handover execution conditions are met. The UE starts evaluating the execution condition(s) upon receiving the CHO configuration, and stops evaluating the execution condition(s) once a handover is executed (legacy handover or conditional handover execution).

The following principles apply to CHO:

- The CHO configuration contains the configuration of CHO candidate cell(s) generated by the candidate gNB(s) and execution condition(s) generated by the source gNB.
- An execution condition may consist of one or two trigger condition(s) (CHO events A3/A5, as defined in [12]). Only single RS type is supported and at most two different trigger quantities (e.g. RSRP and RSRQ, RSRP and SINR, etc.) can be configured simultaneously for the evaluation of CHO execution condition of a single candidate cell.
- Before any CHO execution condition is satisfied, upon reception of HO command (without CHO configuration), the UE executes the HO procedure as described in clause 9.2.3.2, regardless of any previously received CHO configuration.
- While executing CHO, i.e. from the time when the UE starts synchronization with target cell, UE does not monitor source cell.

CHO is not supported for NG-C based handover in this release of the specification.

[TS 38.300, clause 9.2.3.4.2]

As in intra-NR RAN handover, in intra-NR RAN CHO, the preparation and execution phase of the conditional handover procedure is performed without involvement of the 5GC; i.e. preparation messages are directly exchanged between gNBs. The release of the resources at the source gNB during the conditional handover completion phase is triggered by the target gNB. The figure below depicts the basic conditional handover scenario where neither the AMF nor the UPF changes:

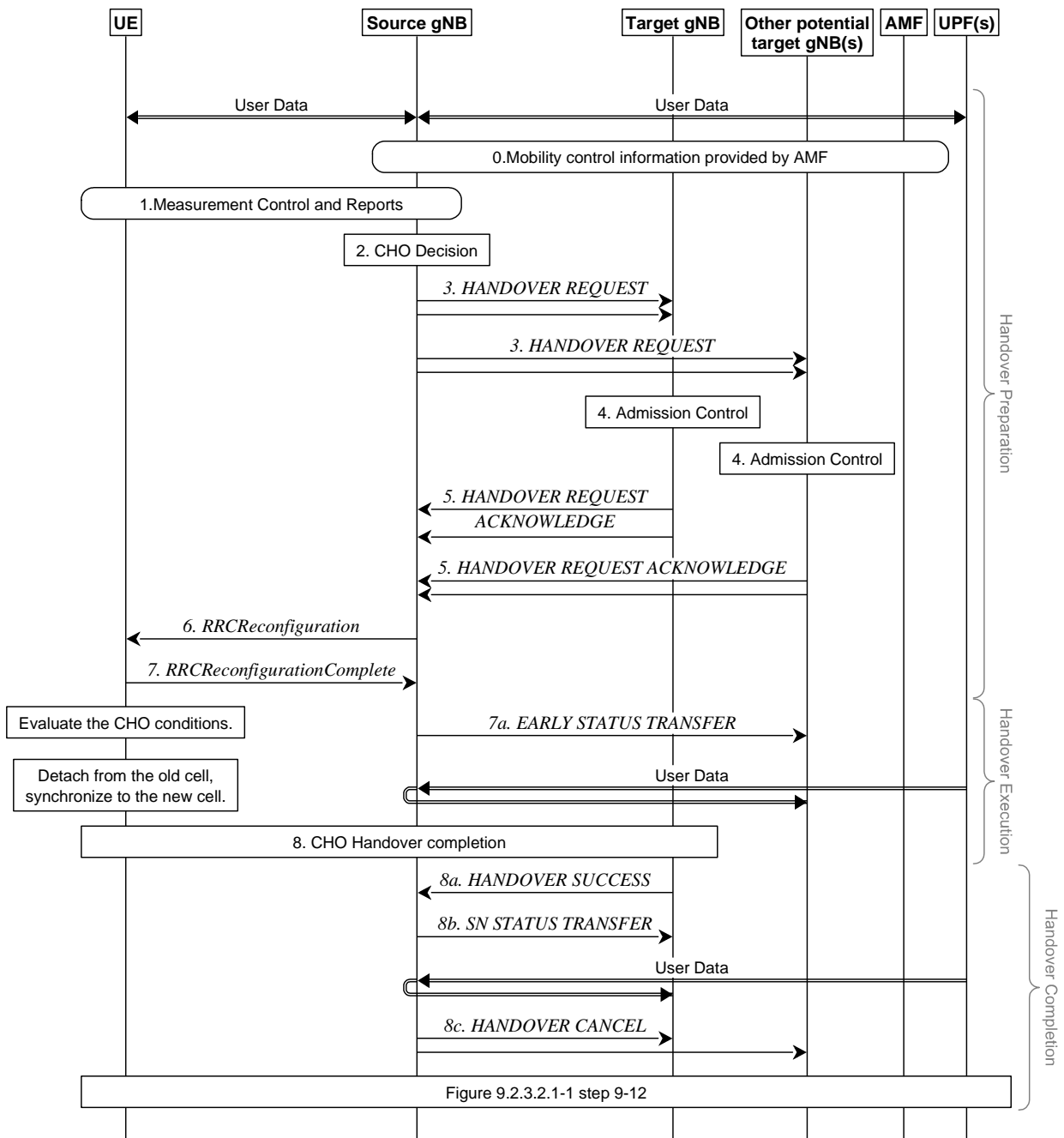

Figure 9.2.3.4.2-1: Intra-AMF/UPF Conditional Handover

- 0/1. Same as step 0, 1 in Figure 9.2.3.2.1-1 of clause 9.2.3.2.1.
- 2. The source gNB decides to use CHO.
- 3. The source gNB requests CHO for one or more candidate cells belonging to one or more candidate gNBs. A CHO request message is sent for each candidate cell.
- 4. Same as step 4 in Figure 9.2.3.2.1-1 of clause 9.2.3.2.1.
- 5. The candidate gNB(s) sends CHO response (HO REQUEST ACKNOWLEDGE) including configuration of CHO candidate cell(s) to the source gNB. The CHO response message is sent for each candidate cell.
- 6. The source gNB sends an *RRCReconfiguration* message to the UE, containing the configuration of CHO candidate cell(s) and CHO execution condition(s).

NOTE 1: CHO configuration of candidate cells can be followed by other reconfiguration from the source gNB.

NOTE 1a: A configuration of a CHO candidate cell cannot contain a DAPS handover configuration.

7. The UE sends an *RRCReconfigurationComplete* message to the source gNB.

7a If early data forwarding is applied, the source gNB sends the EARLY STATUS TRANSFER message.

8. The UE maintains connection with the source gNB after receiving CHO configuration, and starts evaluating the CHO execution conditions for the candidate cell(s). If at least one CHO candidate cell satisfies the corresponding CHO execution condition, the UE detaches from the source gNB, applies the stored corresponding configuration for that selected candidate cell, synchronises to that candidate cell and completes the RRC handover procedure by sending *RRCReconfigurationComplete* message to the target gNB. The UE releases stored CHO configurations after successful completion of RRC handover procedure.

8a/b The target gNB sends the HANDOVER SUCCESS message to the source gNB to inform that the UE has successfully accessed the target cell. In return, the source gNB sends the SN STATUS TRANSFER message following the principles described in step 7 of Intra-AMF/UPF Handover in clause 9.2.3.2.1.

NOTE 2: Late data forwarding may be initiated as soon as the source gNB receives the HANDOVER SUCCESS message.

8c. The source gNB sends the HANDOVER CANCEL message toward the other signalling connections or other candidate target gNBs, if any, to cancel CHO for the UE.

[TS 38.331, clause 5.3.5.1]

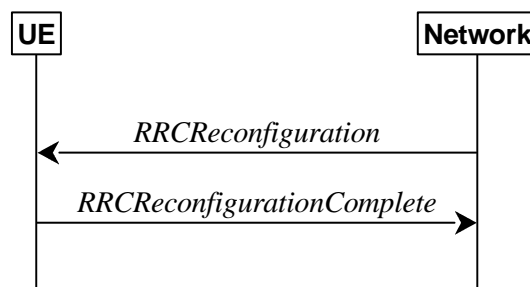

Figure 5.3.5.1-1: RRC reconfiguration, successful

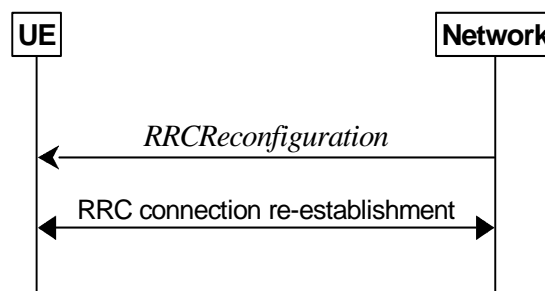

Figure 5.3.5.1-2: RRC reconfiguration, failure

The purpose of this procedure is to modify an RRC connection, e.g. to establish/modify/release RBs, to perform reconfiguration with sync, to setup/modify/release measurements, to add/modify/release SCells and cell groups, to add/modify/release conditional handover configuration, to add/modify/release conditional PSCell change configuration. As part of the procedure, NAS dedicated information may be transferred from the Network to the UE.

[TS 38.331, clause 5.3.5.13.1]

The network configures the UE with one or more candidate target SpCells in the conditional reconfiguration. The UE evaluates the condition of each configured candidate target SpCell. The UE applies the conditional reconfiguration associated with one of the target SpCells which fulfils associated execution condition. The network provides the configuration parameters for the target SpCell in the *ConditionalReconfiguration* IE.

The UE performs the following actions based on a received *ConditionalReconfiguration* IE:

- 1> if the *ConditionalReconfiguration* contains the *condReconfigToRemoveList*:
 - 2> perform conditional reconfiguration removal procedure as specified in 5.3.5.13.2;
- 1> if the *ConditionalReconfiguration* contains the *condReconfigToAddModList*:
 - 2> perform conditional reconfiguration addition/modification as specified in 5.3.5.13.3;

[TS 38.331, clause 5.3.5.13.4]

The UE shall:

- 1> for each *condReconfigId* within the *VarConditionalReconfig*:
 - 2> consider the cell which has a physical cell identity matching the value indicated in the *ServingCellConfigCommon* included in the *reconfigurationWithSync* in the received *condRRCReconfig* to be applicable cell;
 - 2> for each *measId* included in the *measIdList* within *VarMeasConfig* indicated in the *condExecutionCond* associated to *condReconfigId*:
 - 3> if the entry condition(s) applicable for this event associated with the *condReconfigId*, i.e. the event corresponding with the *condEventId(s)* of the corresponding *condTriggerConfig* within *VarConditionalReconfig*, is fulfilled for the applicable cells for all measurements after layer 3 filtering taken during the corresponding *timeToTrigger* defined for this event within the *VarConditionalReconfig*:
 - 4> consider the event associated to that *measId* to be fulfilled;
 - 3> if the leaving condition(s) applicable for this event associated with the *condReconfigId*, i.e. the event corresponding with the *condEventId(s)* of the corresponding *condTriggerConfig* within *VarConditionalReconfig*, is fulfilled for the applicable cells for all measurements after layer 3 filtering taken during the corresponding *timeToTrigger* defined for this event within the *VarConditionalReconfig*:
 - 4> consider the event associated to that *measId* to be not fulfilled;
 - 2> if event(s) associated to all *measId(s)* within *condTriggerConfig* for a target candidate cell within the stored *condRRCReconfig* are fulfilled:
 - 3> consider the target candidate cell within the stored *condRRCReconfig*, associated to that *condReconfigId*, as a triggered cell;
 - 3> initiate the conditional reconfiguration execution, as specified in 5.3.5.13.5;

NOTE: Up to 2 *MeasId* can be configured for each *condReconfigId*. The conditional reconfiguration event of the 2 *MeasId* may have the same or different event conditions, triggering quantity, time to trigger, and triggering threshold.

[TS 38.331, clause 5.3.5.13.5]

The UE shall:

- 1> if more than one triggered cell exists:
 - 2> select one of the triggered cells as the selected cell for conditional reconfiguration execution;
- 1> for the selected cell of conditional reconfiguration execution:
 - 2> apply the stored *condRRCReconfig* of the selected cell and perform the actions as specified in 5.3.5.3;

NOTE: If multiple NR cells are triggered in conditional reconfiguration execution, it is up to UE implementation which one to select, e.g. the UE considers beams and beam quality to select one of the triggered cells for execution.

8.1.4.4.1.3 Test description

8.1.4.4.1.3.1 Pre-test conditions

System Simulator:

- NR Cell 1, NR Cell 2 and NR Cell 4.
- System information combination NR-2 as defined in TS 38.508-1 [4] clause 4.4.3.1.3 is used for NR cells

UE:

- None.

Preamble:

- If `pc_IP_Ping` is set to TRUE then, the UE is in 5GS state 3N-A on NR Cell 1 according to TS 38.508-1 [4], clause 4.4A.2 Table 4.4A.2-3.
- Else, the UE is in 5GS state 3N-A and Test Loop Function (*On*) with UE test loop mode B on NR Cell 1 according to 38.508-1[4], clause 4.4A.2 Table 4.4A.2-3.

8.1.4.4.1.3.2 Test procedure sequence

Tables 8.1.4.4.1.3.2-1 and 8.1.4.4.1.3.2-2 illustrate the downlink power levels to be applied for NR Cells at various time instants of the test execution. Row marked "T0" denotes the conditions after the preamble, while the configuration marked "T1", T2 and "T3", are applied at the point indicated in the Main behaviour description in Table 8.1.4.4.1.3.2-3.

Table 8.1.4.4.1.3.2-1: Power levels in FR1

	Parameter	Unit	NR Cell 1	NR Cell 2	NR Cell 4	Remark
T0	SS/PBCH SSS EPRE	dBm/ SCS	-82	-91	-91	Power levels are such that UE registered on NR Cell 1 and entry condition for event A3 is not satisfied
T1	SS/PBCH SSS EPRE	dBm/ SCS	-91	-79	-91	Power levels are such that entry condition for event A3 is satisfied for NR Cell 2
T2	SS/PBCH SSS EPRE	dBm/ SCS	-91	-91	-79	Power levels are such that entry condition for event A5 is satisfied for NR Cell 4
T3	SS/PBCH SSS EPRE	dBm/ SCS	-79	-91	-91	Power levels are such that entry condition for event A3 and event A5 are satisfied for NR Cell 1

Table 8.1.4.4.1.3.2-2: Power levels in FR2

	Parameter	Unit	NR Cell 1	NR Cell 2	NR Cell 4	Remark
T0	SS/PBCH SSS EPRE	dBm/ SCS	FFS	FFS	FFS	Power levels are such that UE registered on NR Cell 1 and entry condition for event A3 is not satisfied
T1	SS/PBCH SSS EPRE	dBm/ SCS	FFS	FFS	FFS	Power levels are such that entry condition for event A3 is satisfied for NR Cell 2
T2	SS/PBCH SSS EPRE	dBm/ SCS	FFS	FFS	FFS	Power levels are such that entry condition for event A5 is satisfied for NR Cell 4
T3	SS/PBCH SSS EPRE	dBm/ SCS	FFS	FFS	FFS	Power levels are such that entry condition for event A3 and event A5 are satisfied for NR Cell 1

Table 8.1.4.4.1.3.2-3: Main behaviour

St	Procedure	Message Sequence		TP	Verdict
		U - S	Message		
1	The SS transmits an <i>RRCReconfiguration</i> message including <i>MeasConfig</i> and <i>ConditionalReconfiguration</i> to set NR Cell 2 and NR Cell 4 as target candidate cells and configure event A3 as trigger event in NR cell 1.	<--	NR RRC: <i>RRCReconfiguration</i>	-	-
2	The UE transmits an <i>RRCReconfigurationComplete</i> message in NR cell 1.	-->	NR RRC: <i>RRCReconfigurationComplete</i>	-	-
3	Check: Does the UE initiate a random access procedure transmitting Preamble in NR Cell 2 or in NR cell 4 within 10s?	-->	(PRACH Preamble)	1	F
4	SS adjusts the cell-specific reference signal level according to row "T1".	-	-	-	-
5	Check: Does the UE initiate a random access procedure by transmitting Preamble in NR Cell 2 within 10s?	-->	(PRACH Preamble)	2	P
6	The SS transmits Random Access Response.	<--	Random Access Response	-	-
7	The UE transmits <i>RRCReconfigurationComplete</i> message in NR Cell 2.	-->	NR RRC: <i>RRCReconfigurationComplete</i>	-	-
8	Check: Does the test result of generic test procedure in TS 38.508-1 Table 4.9.1-1 indicate that the UE is capable of exchanging IP data on DRB1 and NR Cell 2?	-	-	2	P
9	The SS transmits an <i>RRCReconfiguration</i> message including <i>MeasConfig</i> and <i>ConditionalReconfiguration</i> to set NR Cell 1 and NR Cell 4 as target candidate cells and configure event A5 as trigger event in NR cell 2.	<--	NR RRC: <i>RRCReconfiguration</i>	-	-
10	The UE transmits an <i>RRCReconfigurationComplete</i> message in NR cell 2.	-->	NR RRC: <i>RRCReconfigurationComplete</i>	-	-
11	SS adjusts the cell-specific reference signal level according to row "T2".	-	-	-	-
12	Check: Does the UE initiate a random access procedure by transmitting Preamble in NR Cell 4 within 10s?	-->	(PRACH Preamble)	3	P
13	The SS transmits Random Access Response.	<--	Random Access Response	-	-
14	The UE transmits <i>RRCReconfigurationComplete</i> message in NR Cell 4.	-->	NR RRC: <i>RRCReconfigurationComplete</i>	-	-
15	Check: Does the test result of generic test procedure in TS 38.508-1 Table 4.9.1-1 indicate that the UE is capable of exchanging IP data on DRB1 and NR Cell 4?	-	-	3	P
16	The SS transmits an <i>RRCReconfiguration</i> message including <i>MeasConfig</i> and <i>ConditionalReconfiguration</i> for intra-frequency event A3 and A5 in NR cell 4.	<--	NR RRC: <i>RRCReconfiguration</i>	-	-
17	The UE transmits an <i>RRCReconfigurationComplete</i> message in NR cell 4.	-->	NR RRC: <i>RRCReconfigurationComplete</i>	-	-
18	SS adjusts the cell-specific reference signal level according to row "T3".	-	-	-	-
19	Check: Does the UE initiate a random access procedure by transmitting Preamble in NR Cell 1 within 10s?	-->	(PRACH Preamble)	4	P
20	The SS transmits Random Access Response.	<--	Random Access Response	-	-
21	The UE transmits <i>RRCReconfigurationComplete</i> message in NR Cell 1.	-->	NR RRC: <i>RRCReconfigurationComplete</i>	-	-

22	Check: Does the test result of generic test procedure in TS 38.508-1 Table 4.9.1-1 indicate that the UE is capable of exchanging IP data on DRB1 and NR Cell 1?	-	-	4	P
23	SS adjusts the cell-specific reference signal level according to row "T1".	-	-	-	-
24	Check: Does the UE transmit <i>RRCReconfigurationComplete</i> message in NR Cell 2 within 10s?	-->	NR RRC: <i>RRCReconfigurationComplete</i>	5	F

8.1.4.4.1.3.3 Specific message contents

Table 8.1.4.4.1.3.3-1: *RRCReconfiguration* (Step 1, step 9 and step 16, Table 8.1.4.4.1.3.2-3)

Derivation Path: TS 38.508-1 [4], Table 4.6.1-13 with condition NR_MEAS and CHO			
Information Element	Value/remark	Comment	Condition
<i>RRCReconfiguration</i> ::= SEQUENCE {			
criticalExtensions CHOICE {			
rrcReconfiguration SEQUENCE {			
measConfig	MeasConfig	Table 8.1.4.4.1.3.3-2	
nonCriticalExtension SEQUENCE {			
nonCriticalExtension SEQUENCE {			
nonCriticalExtension SEQUENCE {			
nonCriticalExtension SEQUENCE {			
conditionalReconfiguration-r16	ConditionalReconfiguration	Table 8.1.4.4.1.3.3-6	
}			
}			
}			
}			
}			
}			
}			
}			

Table 8.1.4.4.1.3.3-2: *MeasConfig* (Table 8.1.4.4.1.3.3-1)

Derivation Path: TS 38.508-1 [4] Table 4.6.3-69			
Information Element	Value/remark	Comment	Condition
<i>MeasConfig</i> ::= SEQUENCE {			
measObjectToAddModList SEQUENCE (SIZE (1..maxNrofMeasId)) OF MeasObjectToAddMod {	1 entry		
MeasObjectToAddMod[1] SEQUENCE {		entry 1	
measObjectId	1		
measObject CHOICE {			
measObjectNR	MeasObjectNR	Table 8.1.4.4.1.3.3-3	
}			
}			
reportConfigToAddModList SEQUENCE(SIZE (1..maxReportConfigId)) OF ReportConfigToAddMod {	2 entries		
ReportConfigToAddMod[1] SEQUENCE {		entry 1	
reportConfigId	1		
reportConfig CHOICE {			
reportConfigNR	<i>ReportConfigNR-condEventA3</i>	Table 8.1.4.4.1.3.3-4	
}			
}			
ReportConfigToAddMod[2] SEQUENCE {		entry 2	
reportConfigId	2		
reportConfig CHOICE {			

reportConfigNR	ReportConfigNR-condEventA5	Table 8.1.4.4.1.3.3-5	
}			
}			
measIdToAddModList SEQUENCE (SIZE (1..maxNrofMeasId)) OF MeasIdToAddMod {	1 entry		Step 1, Step 9
MeasIdToAddMod[1] SEQUENCE {		entry 1	
measId	1		
measObjectId	1		
reportConfigId	1		Step 1
}	2		Step 9
}			
measIdToAddModList SEQUENCE (SIZE (1..maxNrofMeasId)) OF MeasIdToAddMod {	2 entries		Step 16
MeasIdToAddMod[1] SEQUENCE {		entry 1	
measId	1		
measObjectId	1		
reportConfigId	1		
}			
MeasIdToAddMod[2] SEQUENCE {		entry 2	
measId	2		
measObjectId	1		
reportConfigId	2		
}			
}			
}			

Table 8.1.4.4.1.3.3-3: MeasObjectNR (Table 8.1.4.4.1.3.3-2)

Derivation Path: TS 38.508-1 [4] Table 4.6.3-76			
Information Element	Value/remark	Comment	Condition
MeasObjectNR ::= SEQUENCE {			
ssbFrequency	ARFCN-ValueNR for SSB of NR Cell 1	The SSB of NR cell 1, NR Cell 2 and NR cell 4 have the same ARFCN value as specified in TS 38.508-1 [4] clause 6.2.3	
absThreshSS-BlocksConsolidation	Not present		
nrofSS-BlocksToAverage	Not present		
}			

Table 8.1.4.4.1.3.3-4: ReportConfigNR-condEventA3 (Table 8.1.4.4.1.3.3-2)

Derivation Path: TS 38.508-1 [4] Table 4.6.3-142 with condition CHO AND EVENT_A3			
Information Element	Value/remark	Comment	Condition
ReportConfigNR ::= SEQUENCE {			
reportType CHOICE {			
condTriggerConfig SEQUENCE {			
condEventId CHOICE {			
condEventA3 SEQUENCE {			
a3-Offset CHOICE {			
rsrp	2	1 dB (2*0.5 dB)	FR1
}	FFS		FR2
}			
}			
}			
}			
}			

Table 8.1.4.4.1.3.3-5: ReportConfigNR-condEventA5 (Table 8.1.4.4.1.3.3-2)

Derivation Path: TS 38.508-1 [4] Table 4.6.3-142 with condition CHO AND EVENT_A3			
Information Element	Value/remark	Comment	Condition
ReportConfigNR ::= SEQUENCE {			
reportType CHOICE {			
condTriggerConfig SEQUENCE {			
condEventId CHOICE {			
condEventA5 SEQUENCE {			
a5-Threshold1 CHOICE {			
rsrp	76	-80dBm	FR1
	FFS		FR2
}			
a5-Threshold2 CHOICE {			
rsrp	70	-86dBm	FR1
	FFS		FR2
}			
}			
}			
}			
}			
}			

Table 8.1.4.4.1.3.3-6: ConditionalReconfiguration (Table 8.1.4.4.1.3.3-1)

Derivation Path: TS 38.508-1 [4] Table 4.6.3-25D			
Information Element	Value/remark	Comment	Condition
ConditionalReconfiguration-r16 ::= SEQUENCE {			
condReconfigToRemoveList-r16	Not present		
condReconfigToAddModList-r16	CondReconfigToAddMod List-r16 (Step 1 and step 9)	Table 8.1.4.4.1.3.3-7	Step 1, Step 9
	CondReconfigToAddMod List-r16 (Step 16)	Table 8.1.4.4.1.3.3-10	Step 16
}			

Table 8.1.4.4.1.3.3-7: CondReconfigToAddModList-r16 (Step 1 and step 9, Table 8.1.4.4.1.3.3-6)

Derivation Path: TS 38.508-1 [4] Table 4.6.3-25C			
Information Element	Value/remark	Comment	Condition
CondReconfigToAddModList-r16 ::= SEQUENCE (SIZE (1.. maxNrofCondCells-r16)) OF CondReconfigToAddMod-r16 {	2 entries		
CondReconfigToAddMod-r16[1] ::= SEQUENCE {		entry 1	
condReconfigId-r16	1		
condExecutionCond-r16 ::= SEQUENCE {			
MeasId [1]	1		
}			
condRRCReconfig-r16	RRCReconfiguration-HO with condition HO_NR cell 2	Table 8.1.4.4.1.3.3-8	Step 1
	RRCReconfiguration-HO with condition HO_NR cell 1	Table 8.1.4.4.1.3.3-8	Step 9
}			
CondReconfigToAddMod-r16[2] ::= SEQUENCE {		entry 2	
condReconfigId-r16	2		
condExecutionCond-r16 ::= SEQUENCE {			
MeasId [1]	1		
}			
}			

condRRCReconfig-r16	RRCReconfiguration-HO with condition HO_NR cell 4	Table 8.1.4.4.1.3.3-8	
}			
}			

Table 8.1.4.4.1.3.3-8: RRCReconfiguration-HO (Table 8.1.4.4.1.3.3-7)

Derivation Path: TS 38.508-1 [4] Table 4.8.1-1A with condition RBCConfig_KeyChange			
Information Element	Value/remark	Comment	Condition
RRCReconfiguration ::= SEQUENCE {			
criticalExtensions CHOICE {			
rrcReconfiguration SEQUENCE {			
nonCriticalExtension SEQUENCE{			
masterCellGroup	CellGroupConfig with condition PCI_NR cell 1	Table 8.1.4.4.1.3.3-9	HO_NR cell 1
	CellGroupConfig with condition PCI_NR cell 2	Table 8.1.4.4.1.3.3-9	HO_NR cell 2
	CellGroupConfig with condition PCI_NR cell 4	Table 8.1.4.4.1.3.3-9	HO_NR cell 4
}			
}			
}			
}			

8.1.4.4.1.3.3-9: CellGroupConfig (Table 8.1.4.4.1.3.3-8)

Derivation Path: TS 38.508-1 [4], Table 4.6.3-19 with Condition PCell_change and CFRA			
Information Element	Value/remark	Comment	Condition
CellGroupConfig ::= SEQUENCE {			
spCellConfig SEQUENCE {			
reconfigurationWithSync SEQUENCE {			
spCellConfigCommon SEQUENCE {			
physCellId	Physical Cell Identity of NR Cell 1		PCI_NR cell 1
	Physical Cell Identity of NR Cell 2		PCI_NR Cell 2
	Physical Cell Identity of NR Cell 4		PCI_NR Cell 4
}			
}			
}			
}			

Table 8.1.4.4.1.3.3-10: CondReconfigToAddModList-r16 (Step 16, Table 8.1.4.4.1.3.3-6)

Derivation Path: TS 38.508-1 [4] Table 4.6.3-25C			
Information Element	Value/remark	Comment	Condition
CondReconfigToAddModList-r16 ::= SEQUENCE (SIZE (1.. maxNrofCondCells-r16)) OF CondReconfigToAddMod-r16 {	2 entries		
CondReconfigToAddMod-r16[1] ::= SEQUENCE {		entry 1	
condReconfigId-r16	1		
condExecutionCond-r16 ::= SEQUENCE {			
MeasId [1]	1		
MeasId [2]	2		
}			
condRRCReconfig-r16	RRCReconfiguration-HO with condition HO_NR cell 1	Table 8.1.4.4.1.3.3-8	
}			
CondReconfigToAddMod-r16[2] ::= SEQUENCE {		entry 2	
condReconfigId-r16	2		

condExecutionCond-r16::= SEQUENCE {			
MeasId [1]	1		
}			
condRRCReconfig-r16	RRCReconfiguration-HO with condition HO_NR cell 2	Table 8.1.4.4.1.3.3-8	
}			
}			

8.1.4.4.2 Conditional handover / modify conditional handover configuration

8.1.4.4.2.1 Test Purpose (TP)

(1)

```
with { UE in NR RRC_CONNECTED state and supporting conditional handover and receiving an
RRCReconfiguration message including a ConditionalReconfiguration }
ensure that {
  when { UE received another RRCReconfiguration message with adding a new entry in the
CondReconfigToAddModList before any CHO execution condition is satisfied }
  then { UE add the new entry within the VarConditionalReconfig and apply the latest conditional
handover configurations }
}
```

(2)

```
with { UE in NR RRC_CONNECTED state and supporting conditional handover and receiving an
RRCReconfiguration message including a ConditionalReconfiguration }
ensure that {
  when { UE received another RRCReconfiguration message with modifying an existing entry in the
CondReconfigToAddModList before any CHO execution condition is satisfied }
  then { UE replace the existing entry with the value received and apply the latest conditional
handover configurations }
}
```

(3)

```
with { UE in NR RRC_CONNECTED state and supporting conditional handover and receiving an
RRCReconfiguration message including a ConditionalReconfiguration }
ensure that {
  when { UE received another RRCReconfiguration message with condConfigToRemoveList before any CHO
execution condition is satisfied }
  then { UE removes the entry with the matching condConfigId included in the
condConfigToRemoveList and apply the latest conditional handover configurations }
}
```

8.1.4.4.2.2 Conformance requirements

References: The conformance requirements covered in the present TC are specified in: TS 38.300 9.2.3.4.1, and 9.2.3.4.2 and TS 38.331 clause 5.3.5.1, 5.3.5.13.2 and 5.3.5.13.3. Unless otherwise stated these are Rel-16 requirements.

[TS 38.300, clause 9.2.3.4.1]

A Conditional Handover (CHO) is defined as a handover that is executed by the UE when one or more handover execution conditions are met. The UE starts evaluating the execution condition(s) upon receiving the CHO configuration, and stops evaluating the execution condition(s) once a handover is executed (legacy handover or conditional handover execution).

The following principles apply to CHO:

- The CHO configuration contains the configuration of CHO candidate cell(s) generated by the candidate gNB(s) and execution condition(s) generated by the source gNB.
- An execution condition may consist of one or two trigger condition(s) (CHO events A3/A5, as defined in [12]). Only single RS type is supported and at most two different trigger quantities (e.g. RSRP and RSRQ, RSRP and

SINR, etc.) can be configured simultaneously for the evaluation of CHO execution condition of a single candidate cell.

- Before any CHO execution condition is satisfied, upon reception of HO command (without CHO configuration), the UE executes the HO procedure as described in clause 9.2.3.2, regardless of any previously received CHO configuration.
- While executing CHO, i.e. from the time when the UE starts synchronization with target cell, UE does not monitor source cell.

CHO is not supported for NG-C based handover in this release of the specification.

[TS 38.300, clause 9.2.3.4.2]

As in intra-NR RAN handover, in intra-NR RAN CHO, the preparation and execution phase of the conditional handover procedure is performed without involvement of the 5GC; i.e. preparation messages are directly exchanged between gNBs. The release of the resources at the source gNB during the conditional handover completion phase is triggered by the target gNB. The figure below depicts the basic conditional handover scenario where neither the AMF nor the UPF changes:

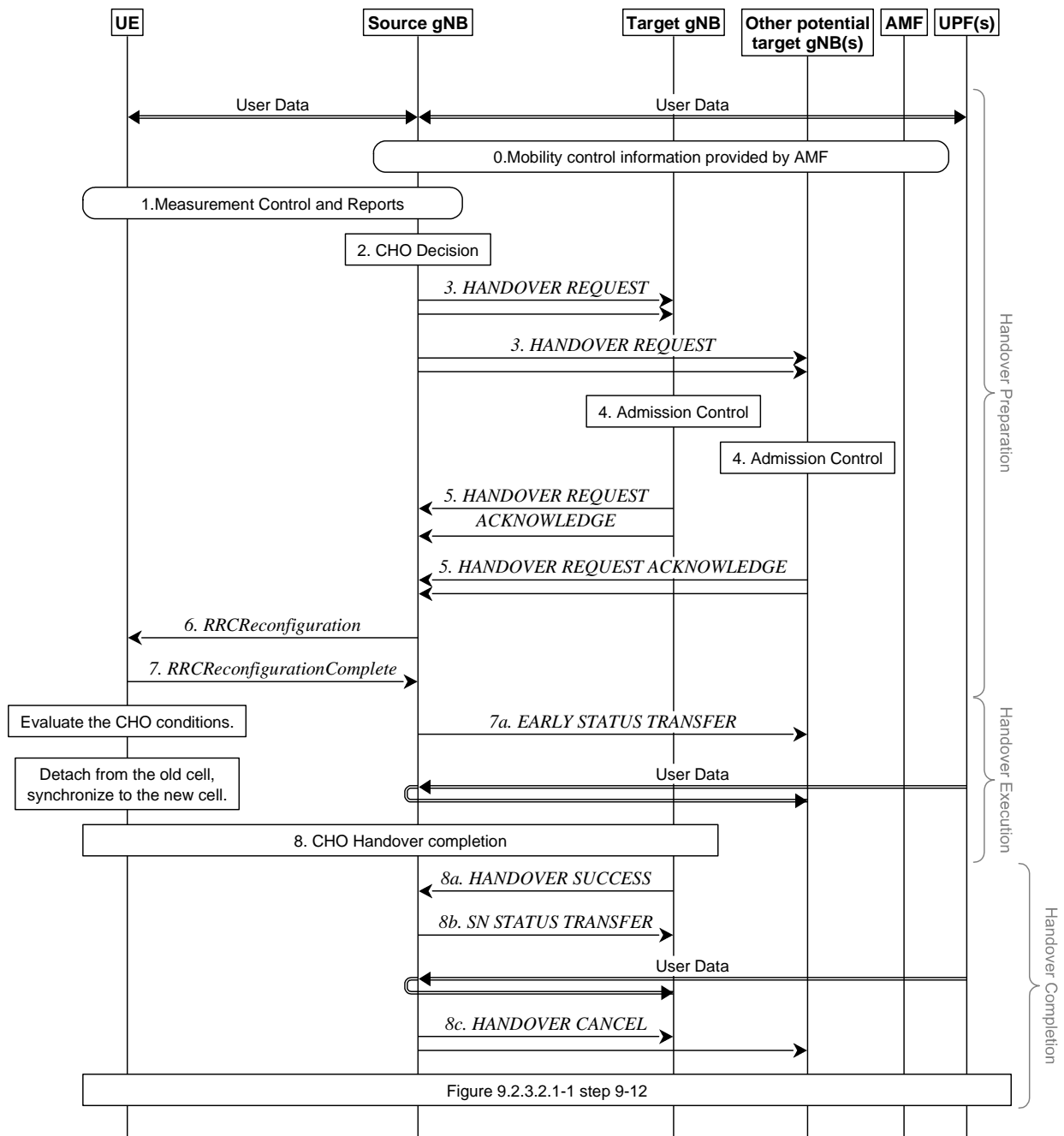

<http://msc-generator.sourceforge.net v6.3.7>

Figure 9.2.3.4.2-1: Intra-AMF/UPF Conditional Handover

- 0/1. Same as step 0, 1 in Figure 9.2.3.2.1-1 of clause 9.2.3.2.1.
- 2. The source gNB decides to use CHO.
- 3. The source gNB requests CHO for one or more candidate cells belonging to one or more candidate gNBs. A CHO request message is sent for each candidate cell.
- 4. Same as step 4 in Figure 9.2.3.2.1-1 of clause 9.2.3.2.1.
- 5. The candidate gNB(s) sends CHO response (HO REQUEST ACKNOWLEDGE) including configuration of CHO candidate cell(s) to the source gNB. The CHO response message is sent for each candidate cell.
- 6. The source gNB sends an *RRCReconfiguration* message to the UE, containing the configuration of CHO candidate cell(s) and CHO execution condition(s).

NOTE 1: CHO configuration of candidate cells can be followed by other reconfiguration from the source gNB.

NOTE 1a: A configuration of a CHO candidate cell cannot contain a DAPS handover configuration.

7. The UE sends an *RRCReconfigurationComplete* message to the source gNB.

7a If early data forwarding is applied, the source gNB sends the EARLY STATUS TRANSFER message.

8. The UE maintains connection with the source gNB after receiving CHO configuration, and starts evaluating the CHO execution conditions for the candidate cell(s). If at least one CHO candidate cell satisfies the corresponding CHO execution condition, the UE detaches from the source gNB, applies the stored corresponding configuration for that selected candidate cell, synchronises to that candidate cell and completes the RRC handover procedure by sending *RRCReconfigurationComplete* message to the target gNB. The UE releases stored CHO configurations after successful completion of RRC handover procedure.

8a/b The target gNB sends the HANOVER SUCCESS message to the source gNB to inform that the UE has successfully accessed the target cell. In return, the source gNB sends the SN STATUS TRANSFER message following the principles described in step 7 of Intra-AMF/UPF Handover in clause 9.2.3.2.1.

NOTE 2: Late data forwarding may be initiated as soon as the source gNB receives the HANOVER SUCCESS message.

8c. The source gNB sends the HANOVER CANCEL message toward the other signalling connections or other candidate target gNBs, if any, to cancel CHO for the UE.

[TS 38.331, clause 5.3.5.1]

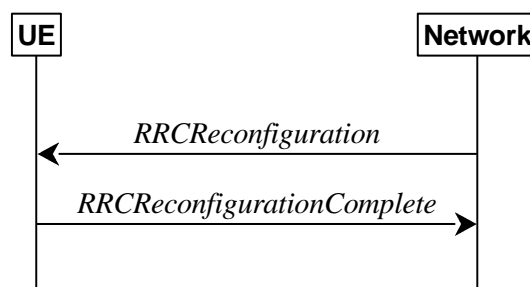

Figure 5.3.5.1-1: RRC reconfiguration, successful

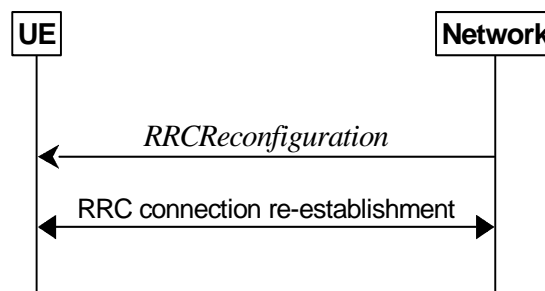

Figure 5.3.5.1-2: RRC reconfiguration, failure

The purpose of this procedure is to modify an RRC connection, e.g. to establish/modify/release RBs, to perform reconfiguration with sync, to setup/modify/release measurements, to add/modify/release SCells and cell groups, to add/modify/release conditional handover configuration, to add/modify/release conditional PSCell change configuration. As part of the procedure, NAS dedicated information may be transferred from the Network to the UE.

[TS 38.331, clause 5.3.5.13.2]

The UE shall:

- 1> for each *condReconfigId* value included in the *condReconfigToRemoveList* that is part of the current UE conditional reconfiguration in *VarConditionalReconfig*:
- 2> remove the entry with the matching *condReconfigId* from the *VarConditionalReconfig*;

NOTE: The UE does not consider the message as erroneous if the *condReconfigToRemoveList* includes any *condReconfigId* value that is not part of the current UE configuration.

[TS 38.331, clause 5.3.5.13.3]

For each *condReconfigId* received in the *condReconfigToAddModList* IE the UE shall:

- 1> if an entry with the matching *condReconfigId* exists in the *condReconfigToAddModList* within the *VarConditionalReconfig*:
 - 2> if the entry in *condReconfigToAddModList* includes an *condExecutionCond*;
 - 3> replace the entry with the value received for this *condReconfigId*;
 - 2> if the entry in *condReconfigToAddModList* includes an *condRRCReconfig*;
 - 2> replace the entry with the value received for this *condReconfigId*;
- 1> else:
 - 2> add a new entry for this *condReconfigId* within the *VarConditionalReconfig*;
- 1> perform conditional reconfiguration evaluation as specified in 5.3.5.13.4;

8.1.4.4.2.3 Test description

8.1.4.4.2.3.1 Pre-test conditions

System Simulator:

- NR Cell 1, NR Cell 2 and NR Cell 4.
- System information combination NR-2 as defined in TS 38.508-1 [4] clause 4.4.3.1.3 is used for NR cells

UE:

- None.

Preamble:

- If *pc_IP_Ping* is set to TRUE then, the UE is in 5GS state 3N-A on NR Cell 1 according to TS 38.508-1 [4], clause 4.4A.2 Table 4.4A.2-3.
- Else, the UE is in 5GS state 3N-A and Test Loop Function (*On*) with UE test loop mode B on NR Cell 1 according to 38.508-1[4], clause 4.4A.2 Table 4.4A.2-3.

8.1.4.4.2.3.2 Test procedure sequence

Tables 8.1.4.4.2.3.2-1 and 8.1.4.4.2.3.2-2 illustrate the downlink power levels to be applied for NR cells at various time instants of the test execution. Row marked "T0" denotes the conditions after the preamble, while the configuration marked "T1", T2 and "T3", are applied at the point indicated in the Main behaviour description in Table 8.1.4.4.2.3.2-3.

Table 8.1.4.4.2.3.2-1: Power levels in FR1

	Parameter	Unit	NR Cell 1	NR Cell 2	NR Cell 4	Remark
T0	SS/PBCH SSS EPRE	dBm/ SCS	-82	-91	-91	Power levels are such that UE registered on NR Cell 1 and entry condition for event A3 is not satisfied

T1	SS/PBCH SSS EPRE	dBm/ SCS	-91	-79	-91	Power levels are such that entry condition for event A3 is satisfied for NR Cell 2
T2	SS/PBCH SSS EPRE	dBm/ SCS	-91	-91	-79	Power levels are such that entry condition for event A3 is satisfied for NR Cell 4
T3	SS/PBCH SSS EPRE	dBm/ SCS	-91	-91	-91	Power levels are such that entry condition for NR Cell 4 is not satisfied
T4	SS/PBCH SSS EPRE	dBm/ SCS	-85	-91	-79	Power levels are such that entry condition for event A3 is satisfied for NR Cell 1 and NR Cell 4

Table 8.1.4.4.2.3.2-2: Power levels in FR2

	Parameter	Unit	NR Cell 1	NR Cell 2	NR Cell 4	Remark
T0	SS/PBCH SSS EPRE	dBm/ SCS	FFS	FFS	FFS	Power levels are such that UE registered on NR Cell 1 and entry condition for event A3 is not satisfied
T1	SS/PBCH SSS EPRE	dBm/ SCS	FFS	FFS	FFS	Power levels are such that entry condition for event A3 is satisfied for NR Cell 2
T2	SS/PBCH SSS EPRE	dBm/ SCS	FFS	FFS	FFS	Power levels are such that entry condition for event A3 is satisfied for NR Cell 4
T3	SS/PBCH SSS EPRE	dBm/ SCS	FFS	FFS	FFS	Power levels are such that entry condition for NR Cell 4 is not satisfied
T4	SS/PBCH SSS EPRE	dBm/ SCS	FFS	FFS	FFS	Power levels are such that entry condition for event A3 is satisfied for NR Cell 1 and NR Cell 4

Table 8.1.4.4.2.3.2-3: Main behaviour

St	Procedure	Message Sequence		TP	Verdict
		U - S	Message		
1	The SS transmits an <i>RRCReconfiguration</i> message including <i>MeasConfig</i> and <i>ConditionalReconfiguration</i> to set NR Cell 4 as a target candidate cell.	<--	NR RRC: <i>RRCReconfiguration</i>	-	-
2	The UE transmits an <i>RRCReconfigurationComplete</i> message in NR Cell 1.	-->	NR RRC: <i>RRCReconfigurationComplete</i>	-	-
3	The SS transmits an <i>RRCReconfiguration</i> message including <i>ConditionalReconfiguration</i> to add NR Cell 2 as another target candidate cell.	<--	NR RRC: <i>RRCReconfiguration</i>	-	-
4	The UE transmits an <i>RRCReconfigurationComplete</i> message in NR Cell 1.	-->	NR RRC: <i>RRCReconfigurationComplete</i>	-	-
5	SS adjusts the cell-specific reference signal level according to row "T1".	-	-	-	-
6	Check: Does the UE initiate a random access procedure by transmitting Preamble in NR Cell 2 within 10s?	-->	(PRACH Preamble)	1	P
7	The SS transmits Random Access Response.	<--	Random Access Response	-	-
8	The UE transmits <i>RRCReconfigurationComplete</i> message in NR Cell 2.	-->	NR RRC: <i>RRCReconfigurationComplete</i>	-	-
9	Check: Does the test result of generic test procedure in TS 38.508-1 [4] Table 4.9.1-1 indicate that the UE is capable of exchanging IP data on DRB1 and NR Cell 2?	-	-	1	P
10	The SS transmits an <i>RRCReconfiguration</i> message including <i>MeasConfig</i> and <i>ConditionalReconfiguration</i> to set NR Cell 1 and NR Cell 4 as target candidate cells.	<--	NR RRC: <i>RRCReconfiguration</i>	-	-
11	The UE transmits an <i>RRCReconfigurationComplete</i> message in NR Cell 2.	-->	NR RRC: <i>RRCReconfigurationComplete</i>	-	-
12	The SS transmits an <i>RRCReconfiguration</i> message including <i>ConditionalReconfiguration</i>	<--	NR RRC: <i>RRCReconfiguration</i>	-	-

	with <i>condConfigToRemoveList</i> to remove NR Cell 4 from the target candidate cell list.				
13	The UE transmits an <i>RRCReconfigurationComplete</i> message in NR Cell 2.	-->	NR RRC: <i>RRCReconfigurationComplete</i>	-	-
14	SS adjusts the cell-specific reference signal level according to row "T2".	-	-	-	-
15	Check: Does the UE initiate a random access procedure by transmitting Preamble in NR Cell 4 within 10s?	-->	(<i>PRACH Preamble</i>)	3	F
15A	SS adjusts the cell-specific reference signal level according to row "T3".				
16	The SS transmits an <i>RRCReconfiguration</i> message including <i>ConditionalReconfiguration</i> to replace NR Cell 1 with NR Cell 4 as the target candidate cell.	<--	NR RRC: <i>RRCReconfiguration</i>	-	-
16A	The UE transmits <i>RRCReconfigurationComplete</i> message in NR Cell 2.	-->	NR RRC: <i>RRCReconfigurationComplete</i>	-	-
17	SS adjusts the cell-specific reference signal level according to row "T4".	-	-	-	-
18	Check: Does the UE initiate a random access procedure by transmitting Preamble in NR Cell 4 within 10s?	-->	(<i>PRACH Preamble</i>)	3	P
19	The SS transmits Random Access Response.	<--	Random Access Response	-	-
20	The UE transmits <i>RRCReconfigurationComplete</i> message in NR Cell 4.	-->	NR RRC: <i>RRCReconfigurationComplete</i>	-	-
21	Check: Does the test result of generic test procedure in TS 38.508-1 [4] Table 4.9.1-1 indicate that the UE is capable of exchanging IP data on DRB1 and NR Cell 4?	-	-	2	P

8.1.4.4.2.3.3 Specific message contents

Table 8.1.4.4.2.3.3-1: *RRCReconfiguration* (Step 1, step 3, step 10, step 12 and step 16, Table 8.1.4.4.2.3.2-3)

Derivation Path: TS 38.508-1 [4], Table 4.6.1-13 with condition NR_MEAS and CHO			
Information Element	Value/remark	Comment	Condition
<i>RRCReconfiguration</i> ::= SEQUENCE {			
criticalExtensions CHOICE {			
rrcReconfiguration SEQUENCE {			
measConfig	Not present		Step 3, Step 12, Step 16
	MeasConfig	Table 8.1.4.4.2.3.3-2	Step 1, Step 10
nonCriticalExtension SEQUENCE {			
nonCriticalExtension SEQUENCE {			
nonCriticalExtension SEQUENCE {			
nonCriticalExtension SEQUENCE {			
conditionalReconfiguration-r16	ConditionalReconfiguration	Table 8.1.4.4.2.3.3-5	
}			
}			
}			
}			
}			
}			
}			

Table 8.1.4.4.2.3.3-2: *MeasConfig* (Table 8.1.4.4.2.3.3-1)

Derivation Path: TS 38.508-1 [4] Table 4.6.3-69

Information Element	Value/remark	Comment	Condition
MeasConfig ::= SEQUENCE {			
measObjectToAddModList SEQUENCE (SIZE (1..maxNrofMeasId)) OF MeasObjectToAddMod {	1 entry		
MeasObjectToAddMod[1] SEQUENCE {		entry 1	
measObjectId	1		
measObject CHOICE {			
measObjectNR	MeasObjectNR	Table 8.1.4.4.2.3.3-3	
}			
}			
}			
reportConfigToAddModList SEQUENCE (SIZE (1..maxReportConfigId)) OF ReportConfigToAddMod {	1 entry		
ReportConfigToAddMod[1] SEQUENCE {		entry 1	
reportConfigId	1		
reportConfig CHOICE {			
reportConfigNR	ReportConfigNR-condEventA3	Table 8.1.4.4.2.3.3-4	
}			
}			
}			
measIdToAddModList SEQUENCE (SIZE (1..maxNrofMeasId)) OF MeasIdToAddMod {	1 entry		
MeasIdToAddMod[1] SEQUENCE {		entry 1	
measId	1		
measObjectId	1		
reportConfigId	1		
}			
}			
}			

Table 8.1.4.4.2.3.3-3: MeasObjectNR (Table 8.1.4.4.2.3.3-2)

Derivation Path: TS 38.508-1 [4] Table 4.6.3-76			
Information Element	Value/remark	Comment	Condition
MeasObjectNR ::= SEQUENCE {			
ssbFrequency	ARFCN-ValueNR for SSB of NR Cell 1	The SSB of NR Cell 1, NR Cell 2 and NR Cell 4 have the same ARFCN value as specified in TS 38.508-1 [4] clause 6.2.3	
absThreshSS-BlocksConsolidation	Not present		
nrofSS-BlocksToAverage	Not present		
}			

Table 8.1.4.4.2.3.3-4: ReportConfigNR-condEventA3 (Table 8.1.4.4.2.3.3-2)

Derivation Path: TS 38.508-1 [4] Table 4.6.3-142 with condition CHO AND EVENT_A3			
Information Element	Value/remark	Comment	Condition
ReportConfigNR ::= SEQUENCE {			
reportType CHOICE {			
condTriggerConfig SEQUENCE {			
condEventId CHOICE {			
condEventA3 SEQUENCE {			
a3-Offset CHOICE {			
rsrp	2 FFS	1 dB (2*0.5 dB)	FR1 FR2
}			
}			
}			
}			
}			

}			
}			
}			

Table 8.1.4.4.2.3.3-5: ConditionalReconfiguration (Table 8.1.4.4.2.3.3-1)

Derivation Path: TS 38.508-1 [4] Table 4.6.3-25D			
Information Element	Value/remark	Comment	Condition
ConditionalReconfiguration-r16 ::= SEQUENCE {			
condReconfigToRemoveList-r16	Not present		
condReconfigToRemoveList-r16 SEQUENCE (SIZE (1.. maxNrofCondCells-r16)) OF CondReconfigId-r16	1 entry		Step 12
{			
condReconfigId-r16[1]	2	entry 1	
}			
condReconfigToAddModList-r16	CondReconfigToAddMod List-r16 (Step 1 and step 16)	Table 8.1.4.4.2.3.3-6	Step 1, Step 16
	CondReconfigToAddMod List-r16 (Step 3)	Table 8.1.4.4.2.3.3-9	Step 3
	CondReconfigToAddMod List-r16 (Step 10)	Table 8.1.4.4.2.3.3-10	Step 10
}			

Table 8.1.4.4.2.3.3-6: CondReconfigToAddModList-r16 (Step 1 and step 16, Table 8.1.4.4.2.3.3-6)

Derivation Path: TS 38.508-1 [4] Table 4.6.3-25C			
Information Element	Value/remark	Comment	Condition
CondReconfigToAddModList-r16 ::= SEQUENCE (SIZE (1.. maxNrofCondCells-r16)) OF CondReconfigToAddMod-r16 {	1 entry		
CondReconfigToAddMod-r16[1] ::= SEQUENCE {		entry 1	
condReconfigId-r16	1		
condExecutionCond-r16 ::= SEQUENCE {			
MeasId [1]	1		
}			
condRRCReconfig-r16	OCTETSTRING (Containing RRCReconfiguration-HO with condition HO_NR Cell 4)	Table 8.1.4.4.2.3.3-7	Step 1, Step 16
}			
}			

Table 8.1.4.4.2.3.3-7: RRCReconfiguration-HO (Table 8.1.4.4.2.3.3-7)

Derivation Path: TS 38.508-1 [4] Table 4.8.1-1A with condition RBConfig_KeyChange			
Information Element	Value/remark	Comment	Condition
RRCReconfiguration ::= SEQUENCE {			
criticalExtensions CHOICE {			
rrcReconfiguration SEQUENCE {			
nonCriticalExtension SEQUENCE{			
masterCellGroup	CellGroupConfig with condition PCI_NR Cell 1	Table 8.1.4.4.2.3.3-8	HO_NR Cell 1
	CellGroupConfig with condition PCI_NR Cell 2	Table 8.1.4.4.2.3.3-8	HO_NR Cell 2
	CellGroupConfig with condition PCI_NR Cell 4	Table 8.1.4.4.2.3.3-8	HO_NR Cell 4
}			
}			
}			
}			

8.1.4.4.2.3.3-8: CellGroupConfig (Table 8.1.4.4.2.3.3-8)

Derivation Path: TS 38.508-1 [4], Table 4.6.3-19 with Condition PCell_change and CFRA			
Information Element	Value/remark	Comment	Condition
CellGroupConfig ::= SEQUENCE {			
spCellConfig SEQUENCE {			
reconfigurationWithSync SEQUENCE {			
spCellConfigCommon SEQUENCE {			
physCellId	Physical Cell Identity of NR Cell 1		PCI_NR Cell 1
	Physical Cell Identity of NR Cell 2		PCI_NR Cell 2
	Physical Cell Identity of NR Cell 4		PCI_NR Cell 4
}			
}			
}			
}			

Table 8.1.4.4.2.3.3-9: CondReconfigToAddModList-r16 (Step 3, Table 8.1.4.4.2.3.3-6)

Derivation Path: TS 38.508-1 [4] Table 4.6.3-25C			
Information Element	Value/remark	Comment	Condition
CondReconfigToAddModList-r16 ::= SEQUENCE (SIZE (1.. maxNrofCondCells-r16)) OF CondReconfigToAddMod-r16 {	1 entry		
CondReconfigToAddMod-r16[1] ::= SEQUENCE {		entry 1	
condReconfigId-r16	2		
condExecutionCond-r16 ::= SEQUENCE {			
MeasId [1]	1		
}			
condRRCReconfig-r16	OCTETSTRING (Containing RRCReconfiguration-HO with condition HO_NR Cell 2)	Table 8.1.4.4.2.3.3-7	
}			
}			

Table 8.1.4.4.2.3.3-10: CondReconfigToAddModList-r16 (Step 10, Table 8.1.4.4.2.3.3-6)

Derivation Path: TS 38.508-1 [4] Table 4.6.3-25C			
Information Element	Value/remark	Comment	Condition
CondReconfigToAddModList-r16 ::= SEQUENCE (SIZE (1.. maxNrofCondCells-r16)) OF CondReconfigToAddMod-r16 {	2 entries		
CondReconfigToAddMod-r16[1] ::= SEQUENCE {		entry 1	
condReconfigId-r16	1		
condExecutionCond-r16 ::= SEQUENCE {			
MeasId [1]	1		
}			
condRRCReconfig-r16	OCTETSTRING (Containing RRCReconfiguration-HO with condition HO_NR Cell 1)	Table 8.1.4.4.2.3.3-8	
}			
CondReconfigToAddMod-r16[2] ::= SEQUENCE {		entry 2	
condReconfigId-r16	2		
condExecutionCond-r16 ::= SEQUENCE {			
MeasId [1]	1		
}			
condRRCReconfig-r16	OCTETSTRING (Containing	Table 8.1.4.4.2.3.3-8	

	RRCReconfiguration-HO with condition HO_NR Cell 4)		
}			
}			

8.1.4.4.3 Conditional handover / Failure

8.1.4.4.3.1 Test Purpose (TP)

(1)

```
with { UE in NR RRC_CONNECTED state and supporting conditional handover and receiving a
RRCReconfiguration message including ConditionalReconfiguration }
ensure that {
  when { UE detects conditional handover failure and finds a selectable cell which is the candidate
cell included in ConditionalReconfiguration before T311 expires }
  then { UE applies the stored condRRCReconfig associated to the selected cell and perform
conditional handover to the selected cell }
}
```

(2)

```
with { UE in NR RRC_CONNECTED state and supporting conditional handover and receiving a
RRCReconfiguration message including ConditionalReconfiguration }
ensure that {
  when { UE detects conditional handover failure and cannot find any selectable cell before T311
expires }
  then { UE goes to RRC_IDLE and release the stored conditional handover configurations }
}
```

8.1.4.4.3.2 Conformance requirements

References: The conformance requirements covered in the present TC are specified in: TS 38.300 9.2.3.4.1, and 9.2.3.4.2 and TS 38.331 clause 5.3.7.3, 5.3.7.6 and 5.3.11. Unless otherwise stated these are Rel-16 requirements.

[TS 38.300, clause 9.2.3.4.1]

A Conditional Handover (CHO) is defined as a handover that is executed by the UE when one or more handover execution conditions are met. The UE starts evaluating the execution condition(s) upon receiving the CHO configuration, and stops evaluating the execution condition(s) once a handover is executed (legacy handover or conditional handover execution).

The following principles apply to CHO:

- The CHO configuration contains the configuration of CHO candidate cell(s) generated by the candidate gNB(s) and execution condition(s) generated by the source gNB.
- An execution condition may consist of one or two trigger condition(s) (CHO events A3/A5, as defined in [12]). Only single RS type is supported and at most two different trigger quantities (e.g. RSRP and RSRQ, RSRP and SINR, etc.) can be configured simultaneously for the evaluation of CHO execution condition of a single candidate cell.
- Before any CHO execution condition is satisfied, upon reception of HO command (without CHO configuration), the UE executes the HO procedure as described in clause 9.2.3.2, regardless of any previously received CHO configuration.
- While executing CHO, i.e. from the time when the UE starts synchronization with target cell, UE does not monitor source cell.

CHO is not supported for NG-C based handover in this release of the specification.

[TS 38.300, clause 9.2.3.4.2]

As in intra-NR RAN handover, in intra-NR RAN CHO, the preparation and execution phase of the conditional handover procedure is performed without involvement of the 5GC; i.e. preparation messages are directly exchanged between gNBs. The release of the resources at the source gNB during the conditional handover completion phase is triggered by the target gNB. The figure below depicts the basic conditional handover scenario where neither the AMF nor the UPF changes:

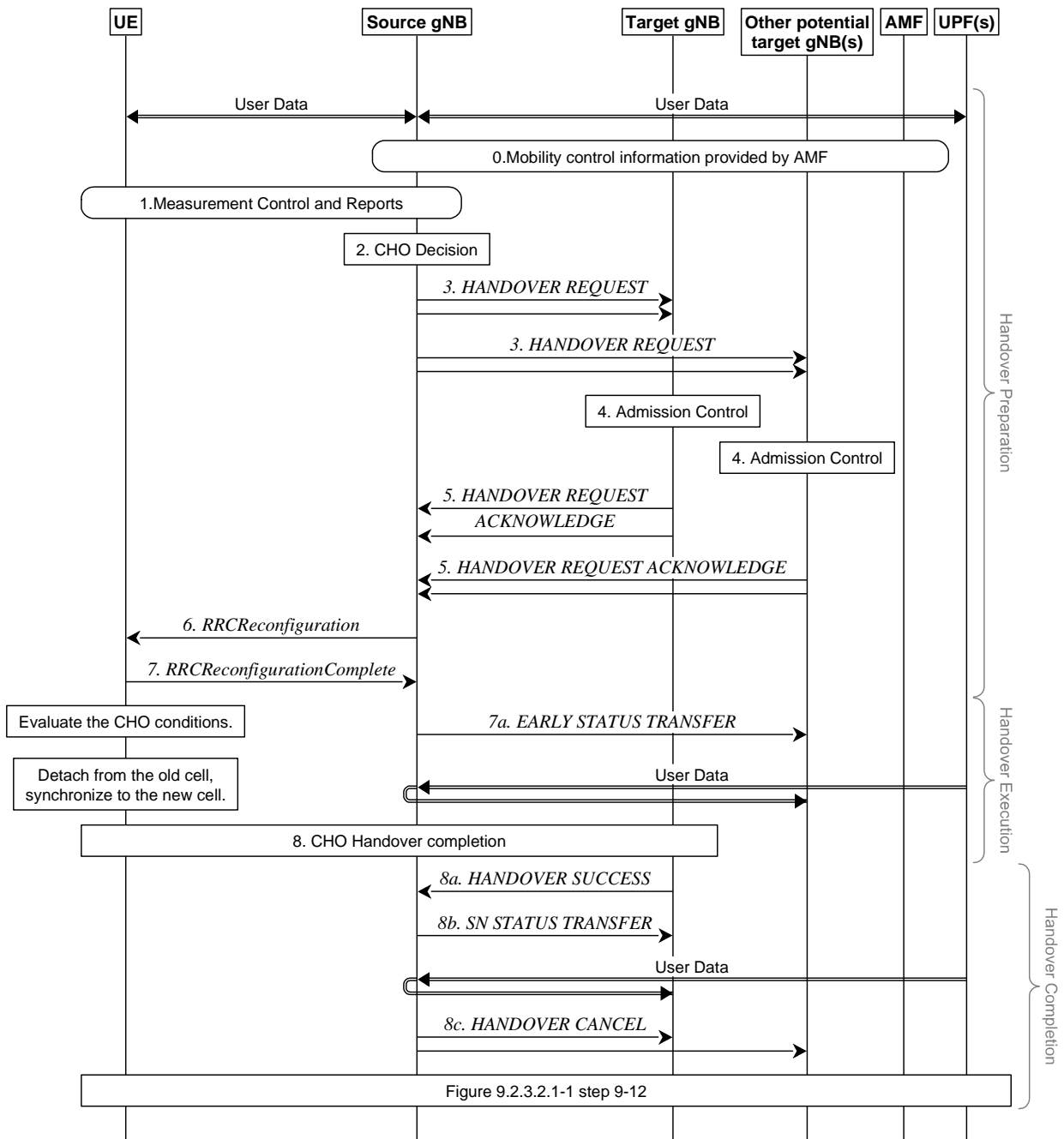

Figure 9.2.3.4.2-1: Intra-AMF/UPF Conditional Handover

- 0/1. Same as step 0, 1 in Figure 9.2.3.2.1-1 of clause 9.2.3.2.1.
- 2. The source gNB decides to use CHO.
- 3. The source gNB requests CHO for one or more candidate cells belonging to one or more candidate gNBs. A CHO request message is sent for each candidate cell.

4. Same as step 4 in Figure 9.2.3.2.1-1 of clause 9.2.3.2.1.
5. The candidate gNB(s) sends CHO response (HO REQUEST ACKNOWLEDGE) including configuration of CHO candidate cell(s) to the source gNB. The CHO response message is sent for each candidate cell.
6. The source gNB sends an *RRCReconfiguration* message to the UE, containing the configuration of CHO candidate cell(s) and CHO execution condition(s).

NOTE 1: CHO configuration of candidate cells can be followed by other reconfiguration from the source gNB.

NOTE 1a: A configuration of a CHO candidate cell cannot contain a DAPS handover configuration.

7. The UE sends an *RRCReconfigurationComplete* message to the source gNB.

7a If early data forwarding is applied, the source gNB sends the EARLY STATUS TRANSFER message.

8. The UE maintains connection with the source gNB after receiving CHO configuration, and starts evaluating the CHO execution conditions for the candidate cell(s). If at least one CHO candidate cell satisfies the corresponding CHO execution condition, the UE detaches from the source gNB, applies the stored corresponding configuration for that selected candidate cell, synchronises to that candidate cell and completes the RRC handover procedure by sending *RRCReconfigurationComplete* message to the target gNB. The UE releases stored CHO configurations after successful completion of RRC handover procedure.

8a/b The target gNB sends the HANOVER SUCCESS message to the source gNB to inform that the UE has successfully accessed the target cell. In return, the source gNB sends the SN STATUS TRANSFER message following the principles described in step 7 of Intra-AMF/UPF Handover in clause 9.2.3.2.1.

NOTE 2: Late data forwarding may be initiated as soon as the source gNB receives the HANOVER SUCCESS message.

- 8c. The source gNB sends the HANOVER CANCEL message toward the other signalling connections or other candidate target gNBs, if any, to cancel CHO for the UE.

[TS 38.331, clause 5.3.7.3]

Upon selecting a suitable NR cell, the UE shall:

- 1> ensure having valid and up to date essential system information as specified in clause 5.2.2.2;
- 1> stop timer T311;
- ...
- 1> if *attemptCondReconfig* is configured; and
- 1> if the selected cell is one of the candidate cells for which the *reconfigurationWithSync* is included in the *masterCellGroup* in *VarConditionalReconfig*:
 - 2> apply the stored *condRRCReconfig* associated to the selected cell and perform actions as specified in 5.3.5.3;
- 1> else:
 - 2> if UE is configured with *conditionalReconfiguration*:
 - 3> reset MAC;
 - 3> release *spCellConfig*, if configured;
 - 3> release the MCG SCell(s), if configured;
 - 3> release *delayBudgetReportingConfig*, if configured and stop timer T342, if running;
 - 3> release *overheatingAssistanceConfig*, if configured and stop timer T345, if running;
 - 3> if MR-DC is configured:
 - 4> perform MR-DC release, as specified in clause 5.3.5.10;

- 3> release *idc-AssistanceConfig*, if configured;
- 3> release *btNameList*, if configured;
- 3> release *wlanNameList*, if configured;
- 3> release *sensorNameList*, if configured;
- 3> release *drx-PreferenceConfig* for the MCG, if configured and stop timer T346a associated with the MCG, if running;
- 3> release *maxBW-PreferenceConfig* for the MCG, if configured and stop timer T346b associated with the MCG, if running;
- 3> release *maxCC-PreferenceConfig* for the MCG, if configured and stop timer T346c associated with the MCG, if running;
- 3> release *maxMIMO-LayerPreferenceConfig* for the MCG, if configured and stop timer T346d associated with the MCG, if running;
- 3> release *minSchedulingOffsetPreferenceConfig* for the MCG, if configured and stop timer T346e associated with the MCG, if running;
- 3> release *releasePreferenceConfig*, if configured and stop timer T346f, if running;
- 3> release *onDemandSIB-Request* if configured, and stop timer T350, if running;
- 3> suspend all RBs, except SRB0;
- 2> remove all the entries within *VarConditionalReconfig*, if any;
- 2> for each *measId*, if the associated *reportConfig* has a *reportType* set to *condTriggerConfig*:
 - 3> for the associated *reportConfigId*:
 - 4> remove the entry with the matching *reportConfigId* from the *reportConfigList* within the *VarMeasConfig*;
 - 3> if the associated *measObjectId* is only associated to a *reportConfig* with *reportType* set to *condTriggerConfig*:
 - 4> remove the entry with the matching *measObjectId* from the *measObjectList* within the *VarMeasConfig*;
 - 3> remove the entry with the matching *measId* from the *measIdList* within the *VarMeasConfig*;
- 2> start timer T301;
- 2> apply the default L1 parameter values as specified in corresponding physical layer specifications except for the parameters for which values are provided in *SIB1*;
- 2> apply the default MAC Cell Group configuration as specified in 9.2.2;
- 2> apply the CCCH configuration as specified in 9.1.1.2;
- 2> apply the *timeAlignmentTimerCommon* included in *SIB1*;
- 2> initiate transmission of the *RRCReestablishmentRequest* message in accordance with 5.3.7.4;

NOTE: This procedure applies also if the UE returns to the source PCell.

Upon selecting an inter-RAT cell, the UE shall:

- 1> perform the actions upon going to RRC_IDLE as specified in 5.3.11, with release cause 'RRC connection failure'.

[TS 38.331, clause 5.3.7.6]

Upon T311 expiry, the UE shall:

- 1> if the procedure was initiated due to radio link failure or handover failure:
 - 2> set the *noSuitableCellFound* in the *VarRLF-Report* to *true*;
- 1> perform the actions upon going to RRC_IDLE as specified in 5.3.11, with release cause 'RRC connection failure'.

[TS 38.331, clause 5.3.11]

The UE shall:

- 1> reset MAC;
- ...
- 1> remove all the entries within *VarConditionalReconfig*, if any;
- 1> for each *measId*, if the associated *reportConfig* has a *reportType* set to *condTriggerConfig*:
 - 2> for the associated *reportConfigId*:
 - 3> remove the entry with the matching *reportConfigId* from the *reportConfigList* within the *VarMeasConfig*;
 - 2> if the associated *measObjectId* is only associated to a *reportConfig* with *reportType* set to *condTriggerConfig*:
 - 3> remove the entry with the matching *measObjectId* from the *measObjectList* within the *VarMeasConfig*;
 - 2> remove the entry with the matching *measId* from the *measIdList* within the *VarMeasConfig*;
- 1> discard the K_{gNB} key, the $S-K_{gNB}$ key, the $S-K_{eNB}$ key, the K_{RRCenc} key, the K_{RRCint} key, the K_{UPint} key and the K_{UPenc} key, if any;
- 1> release all radio resources, including release of the RLC entity, the BAP entity, the MAC configuration and the associated PDCP entity and SDAP for all established RBs;
- 1> indicate the release of the RRC connection to upper layers together with the release cause;
- 1> except if going to RRC_IDLE was triggered by inter-RAT cell reselection while the UE is in RRC_INACTIVE or RRC_IDLE or when selecting an inter-RAT cell while T311 was running or when selecting an E-UTRA cell for EPS fallback for IMS voice as specified in 5.4.3.5:
 - 2> enter RRC_IDLE and perform cell selection as specified in TS 38.304 [20];

8.1.4.4.3.3 Test description

8.1.4.4.3.3.1 Pre-test conditions

System Simulator:

- NR Cell 1, NR Cell 2 and NR Cell 4.
- System information combination NR-2 as defined in TS 38.508-1 [4] clause 4.4.3.1.3 is used for NR cells

UE:

- None.

Preamble:

- If *pc_IP_Ping* is set to TRUE then, the UE is in 5GS state 3N-A on NR Cell 1 according to TS 38.508-1 [4], clause 4.4A.2 Table 4.4A.2-3.

- Else, the UE is in 5GS state 3N-A and Test Loop Function (*On*) with UE test loop mode B on NR Cell 1 according to 38.508-1[4], clause 4.4A.2 Table 4.4A.2-3.

8.1.4.4.3.3.2 Test procedure sequence

Tables 8.1.4.4.3.3.2-1 and 8.1.4.4.3.3.2-2 illustrate the downlink power levels to be applied for NR cells at various time instants of the test execution. Row marked "T0" denotes the conditions after the preamble, while the configuration marked "T1", T2 and "T3", are applied at the point indicated in the Main behaviour description in Table 8.1.4.4.3.3.2-3.

Table 8.1.4.4.3.3.2-1: Power levels in FR1

	Parameter	Unit	NR Cell 1	NR Cell 2	NR Cell 4	Remark
T0	SS/PBCH SSS EPRE	dBm/ SCS	-85	-113	-113	Power levels are such that UE registered on NR Cell 1
T1	SS/PBCH SSS EPRE	dBm/ SCS	-91	-79	-91	Power levels are such that entry condition for event A3 is satisfied for NR Cell 2
T2	SS/PBCH SSS EPRE	dBm/ SCS	-113	-113	-79	The power level is such that only $Srxlev_{NR\ Cell\ 4} > 0$
T3	SS/PBCH SSS EPRE	dBm/ SCS	-79	-91	-91	Power levels are such that entry condition for event A3 is satisfied for NR Cell 1
T4	SS/PBCH SSS EPRE	dBm/ SCS	-113	-113	-113	Power levels are such that all $Srxlev_{NR\ Cell} < 0$
T5	SS/PBCH SSS EPRE	dBm/ SCS	-113	-79	-113	The power level is such that only $Srxlev_{NR\ Cell\ 2} > 0$

Table 8.1.4.4.3.3.2-2: Power levels in FR2

	Parameter	Unit	NR Cell 1	NR Cell 2	NR Cell 4	Remark
T0	SS/PBCH SSS EPRE	dBm/ SCS	FFS	FFS	FFS	Power levels are such that UE registered on NR Cell 1
T1	SS/PBCH SSS EPRE	dBm/ SCS	FFS	FFS	FFS	Power levels are such that entry condition for event A3 is satisfied for NR Cell 2
T2	SS/PBCH SSS EPRE	dBm/ SCS	FFS	FFS	FFS	The power level is such that only $Srxlev_{NR\ Cell\ 4} > 0$
T3	SS/PBCH SSS EPRE	dBm/ SCS	FFS	FFS	FFS	Power levels are such that entry condition for event A3 is satisfied for NR Cell 1
T4	SS/PBCH SSS EPRE	dBm/ SCS	FFS	FFS	FFS	Power levels are such that all $Srxlev_{NR\ Cell} < 0$
T5	SS/PBCH SSS EPRE	dBm/ SCS	FFS	FFS	FFS	The power level is such that only $Srxlev_{NR\ Cell\ 2} > 0$

Table 8.1.4.4.3.3.2-3: Main behaviour

St	Procedure	Message Sequence		TP	Verdict
		U - S	Message		
1	The SS transmits an <i>RRCReconfiguration</i> message including <i>MeasConfig</i> and <i>ConditionalReconfiguration</i> to set NR Cell 2 and NR Cell 4 as the target candidate cells.	<--	NR RRC: <i>RRCReconfiguration</i>	-	-
2	The UE transmits an <i>RRCReconfigurationComplete</i> message in NR Cell 1.	-->	NR RRC: <i>RRCReconfigurationComplete</i>	-	-
3	SS adjusts the cell-specific reference signal level according to row "T1".	-	-	-	-
-	EXCEPTION: The steps 4 and 5 below are repeated for the duration of T304.	-	-	-	-
4	The UE attempts to perform the intra frequency handover using MAC Random Access Preamble on NR Cell 2.	-	-	-	-
5	The SS does not respond.	-	-	-	-

6	SS adjusts the cell-specific reference signal level according to row "T2" right before T304 expire.	-	-	-	-
7	Check: Does the UE initiate a random access procedure by transmitting Preamble in NR Cell 4 within 10s?	-->	(PRACH Preamble)	1	P
8	The SS transmits Random Access Response.	<--	Random Access Response	-	-
9	The UE transmits RRCReconfigurationComplete message in NR Cell 4.	-->	NR RRC: RRCReconfigurationComplete	-	-
10	Check: Does the test result of generic test procedure in TS 38.508-1 [4] Table 4.9.1-1 indicate that the UE is capable of exchanging IP data on DRB1 and NR Cell 4?	-	-	1	P
11	The SS transmits an RRCReconfiguration message including MeasConfig and ConditionalReconfiguration to set NR Cell 1 and NR Cell 2 as the target candidate cells.	<--	NR RRC: RRCReconfiguration	-	-
12	The UE transmits an RRCReconfigurationComplete message in NR Cell 4.	-->	NR RRC: RRCReconfigurationComplete	-	-
13	SS adjusts the cell-specific reference signal level according to row "T3".	-	-	-	-
-	EXCEPTION: The steps 14 and 15 below are repeated for the duration of T304.	-	-	-	-
14	The UE attempts to perform the intra frequency handover using MAC Random Access Preamble on NR Cell 1.	-	-	-	-
15	The SS does not respond.	-	-	-	-
16	SS adjusts the cell-specific reference signal level according to row "T4".	-	-	-	-
17	Wait 5s to ensure that T304 and T311 expire. (Note 1)				
18	SS adjusts the cell-specific reference signal level according to row "T5".	-	-	-	-
19	Check: Is the generic mobility registration updating procedure described in TS 38.508-1 [4] Table 4.9.5.2.2-1 performed on NR Cell 2?	-	-	2	P
Note 1: The wait time is selected to cover T304 (1000ms) + T311 (1000ms) to ensure that UE goes to RRC_IDLE.					

8.1.4.4.3.3.3 Specific message contents

Table 8.1.4.4.3.3.3-1: SIB1 for NR Cell 2 (preamble and all steps, Table 8.1.4.4.3.3.2-3)

Derivation Path: TS 38.508-1 [4], Table 4.6.1-28			
Information Element	Value/remark	Comment	Condition
SIB1 ::= SEQUENCE {			
cellAccessRelatedInfo SEQUENCE {			
PLMN-IdentityInfoList SEQUENCE {			
trackingAreaCode	2		
}			
}			
}			

Table 8.1.4.4.3.3.3-2: RRCReconfiguration (Step1 and step 11, Table 8.1.4.4.3.3.2-3)

Derivation Path: TS 38.508-1 [4], Table 4.6.1-13 with condition NR_MEAS and CHO			
Information Element	Value/remark	Comment	Condition
RRCReconfiguration ::= SEQUENCE {			
criticalExtensions CHOICE {			
rrcReconfiguration SEQUENCE {			
measConfig	MeasConfig	Table 8.1.4.4.3.3.3-3	
nonCriticalExtension SEQUENCE {			

nonCriticalExtension SEQUENCE {			
nonCriticalExtension SEQUENCE {			
nonCriticalExtension SEQUENCE {			
conditionalReconfiguration-r16	ConditionalReconfigurati on	Table 8.1.4.4.3.3.3-6	
}			
}			
}			
}			
}			
}			
}			

Table 8.1.4.4.3.3-3: MeasConfig (Table 8.1.4.4.3.3-2)

Derivation Path: TS 38.508-1 [4] Table 4.6.3-69			
Information Element	Value/remark	Comment	Condition
MeasConfig ::= SEQUENCE {			
measObjectToAddModList SEQUENCE (SIZE (1..maxNrofMeasId)) OF MeasObjectToAddMod {	1 entry		
MeasObjectToAddMod[1] SEQUENCE {		entry 1	
measObjectId	1		
measObject CHOICE {			
measObjectNR	MeasObjectNR	Table 8.1.4.4.3.3.3-4	
}			
}			
}			
reportConfigToAddModList SEQUENCE(SIZE (1..maxReportConfigId)) OF ReportConfigToAddMod {	1 entry		
ReportConfigToAddMod[1] SEQUENCE {		entry 1	
reportConfigId	1		
reportConfig CHOICE {			
reportConfigNR	<i>ReportConfigNR- condEventA3</i>	Table 8.1.4.4.3.3.3-5	
}			
}			
}			
measIdToAddModList SEQUENCE (SIZE (1..maxNrofMeasId)) OF MeasIdToAddMod {	1 entry		
MeasIdToAddMod[1] SEQUENCE {		entry 1	
measId	1		
measObjectId	1		
reportConfigId	1		
}			
}			
}			

Table 8.1.4.4.3.3-4: MeasObjectNR (Table 8.1.4.4.3.3-3)

Derivation Path: TS 38.508-1 [4] Table 4.6.3-76			
Information Element	Value/remark	Comment	Condition
MeasObjectNR ::= SEQUENCE {			
ssbFrequency	ARFCN-ValueNR for SSB of NR Cell 1	The SSB of NR Cell 1, NR Cell 2 and NR Cell 4 have the same ARFCN value as specified in TS 38.508-1 [4] clause 6.2.3	
absThreshSS-BlocksConsolidation	Not present		
nrofSS-BlocksToAverage	Not present		
}			

Table 8.1.4.4.3.3-5: ReportConfigNR-condEventA3 (Table 8.1.4.4.3.3-3)

Derivation Path: TS 38.508-1 [4] Table 4.6.3-142 with condition CHO AND EVENT_A3			
Information Element	Value/remark	Comment	Condition
ReportConfigNR ::= SEQUENCE {			
reportType CHOICE {			
condTriggerConfig SEQUENCE {			
condEventId CHOICE {			
condEventA3 SEQUENCE {			
a3-Offset CHOICE {			
rsp	2	1 dB (2*0.5 dB)	FR1
	FFS		FR2
}			
}			
}			
}			
}			

Table 8.1.4.4.3.3-6: ConditionalReconfiguration (Table 8.1.4.4.3.3-2)

Derivation Path: TS 38.508-1 [4] Table 4.6.3-25D			
Information Element	Value/remark	Comment	Condition
ConditionalReconfiguration-r16 ::= SEQUENCE {			
condReconfigToAddModList-r16	CondReconfigToAddModList-r16	Table 8.1.4.4.3.3-7	
}			

Table 8.1.4.4.3.3-7: CondReconfigToAddModList-r16 (Table 8.1.4.4.3.3-6)

Derivation Path: TS 38.508-1 [4] Table 4.6.3-25C			
Information Element	Value/remark	Comment	Condition
CondReconfigToAddModList-r16 ::= SEQUENCE (SIZE (1.. maxNrofCondCells-r16)) OF CondReconfigToAddMod-r16 {	2 entries		
CondReconfigToAddMod-r16[1] ::= SEQUENCE {		entry 1	
condReconfigId-r16	1		
condExecutionCond-r16 ::= SEQUENCE {			
MeasId [1]	1		
}			
condRRCReconfig-r16	RRCReconfiguration-HO with condition HO_NR Cell 2	Table 8.1.4.4.3.3-8	Step 1
	RRCReconfiguration-HO with condition HO_NR Cell 1	Table 8.1.4.4.3.3-8	Step 11
}			
CondReconfigToAddMod-r16[2] ::= SEQUENCE {		entry 2	
condReconfigId-r16	2		
condExecutionCond-r16 ::= SEQUENCE {			
MeasId [1]	1		
}			
condRRCReconfig-r16	RRCReconfiguration-HO with condition HO_NR Cell 4	Table 8.1.4.4.3.3-8	Step 1
	RRCReconfiguration-HO with condition HO_NR Cell 2	Table 8.1.4.4.3.3-8	Step 11
}			
}			

Table 8.1.4.4.3.3-8: RRCReconfiguration-HO (Table 8.1.4.4.3.3-7)

Derivation Path: TS 38.508-1 [4] Table 4.8.1-1A with condition RBCConfig_KeyChange			
Information Element	Value/remark	Comment	Condition
RRCReconfiguration ::= SEQUENCE {			
criticalExtensions CHOICE {			
rrcReconfiguration SEQUENCE {			
nonCriticalExtension SEQUENCE{			
masterCellGroup	CellGroupConfig with condition PCI_NR Cell 1	Table 8.1.4.4.3.3-9	HO_NR Cell 1
	CellGroupConfig with condition PCI_NR Cell 2	Table 8.1.4.4.3.3-9	HO_NR Cell 2
	CellGroupConfig with condition PCI_NR Cell 4	Table 8.1.4.4.3.3-9	HO_NR Cell 4
}			
}			
}			

8.1.4.4.3.3-9: CellGroupConfig (Table 8.1.4.4.3.3-8)

Derivation Path: TS 38.508-1 [4], Table 4.6.3-19 with Condition PCell_change and CFRA			
Information Element	Value/remark	Comment	Condition
CellGroupConfig ::= SEQUENCE {			
spCellConfig SEQUENCE {			
reconfigurationWithSync SEQUENCE {			
spCellConfigCommon SEQUENCE {			
physCellId	Physical Cell Identity of NR Cell 1		PCI_NR Cell 1
	Physical Cell Identity of NR Cell 2		PCI_NR Cell 2
	Physical Cell Identity of NR Cell 4		PCI_NR Cell 4
}			
}			
}			
}			

8.1.4.4.4 Conditional handover / legacy Handover / legacy Handover Failure

8.1.4.4.4.1 Test Purpose (TP)

(1)

```
with { UE in NR RRC_CONNECTED state and supporting conditional handover and having received an
RRCReconfiguration message including a ConditionalReconfiguration }
ensure that {
  when { UE receives an RRCReconfiguration message including a reconfigurationWithSync for legacy
handover to a neighbour cell }
  then { UE performs handover procedure }
}
```

(2)

```
with { UE having stored ConditionalReconfiguration and having received another RRCReconfiguration
message including a reconfigurationWithSync for legacy handover to a neighbour cell }
ensure that {
  when { UE detects handover failure and find a selectable cell which is the candidate cell included
in ConditionalReconfiguration before T311 expires }
  then { UE applies the stored condRRCReconfig associated to the selected cell and performs
conditional handover to the selected cell }
}
```

(3)

```

with { UE having stored ConditionalReconfiguration and having received another RRCReconfiguration
message including a reconfigurationWithSync for handover to a neighbour cell }
ensure that {
  when { UE detects handover failure and can not find any selectable cell before T311 expires }
  then { UE goes to RRC_IDLE and releases the stored conditional handover configurations }
}
    
```

8.1.4.4.2 Conformance requirements

References: The conformance requirements covered in the present TC are specified in: TS 38.300 9.2.3.4.1 and 9.2.3.1 and 38.331 clause 5.3.7.3 and 5.3.11. Unless otherwise stated these are Rel-16 requirements.

[TS 38.300, clause 9.2.3.4.1]

A Conditional Handover (CHO) is defined as a handover that is executed by the UE when one or more handover execution conditions are met. The UE starts evaluating the execution condition(s) upon receiving the CHO configuration, and stops evaluating the execution condition(s) once a handover is executed (legacy handover or conditional handover execution).

The following principles apply to CHO:

- The CHO configuration contains the configuration of CHO candidate cell(s) generated by the candidate gNB(s) and execution condition(s) generated by the source gNB.
- An execution condition may consist of one or two trigger condition(s) (CHO events A3/A5, as defined in [12]). Only single RS type is supported and at most two different trigger quantities (e.g. RSRP and RSRQ, RSRP and SINR, etc.) can be configured simultaneously for the evaluation of CHO execution condition of a single candidate cell.
- Before any CHO execution condition is satisfied, upon reception of HO command (without CHO configuration), the UE executes the HO procedure as described in clause 9.2.3.2, regardless of any previously received CHO configuration.
- While executing CHO, i.e. from the time when the UE starts synchronization with target cell, UE does not monitor source cell.

CHO is not supported for NG-C based handover in this release of the specification.

[TS 38.300, clause 9.2.3.1]

Network controlled mobility applies to UEs in RRC_CONNECTED and is categorized into two types of mobility: cell level mobility and beam level mobility.

Cell Level Mobility requires explicit RRC signalling to be triggered, i.e. handover. For inter-gNB handover, the signalling procedures consist of at least the following elemental components illustrated in Figure 9.2.3.1-1:

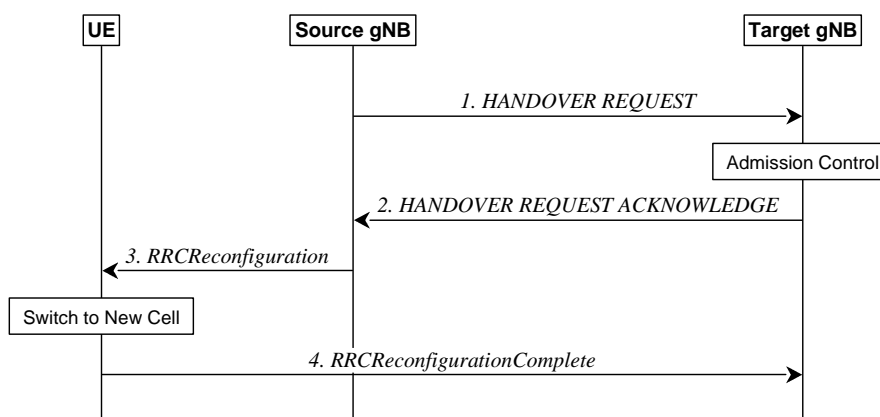

Figure 9.2.3.1-1: Inter-gNB handover procedures

1. The source gNB initiates handover and issues a HANOVER REQUEST over the Xn interface.
2. The target gNB performs admission control and provides the new RRC configuration as part of the HANOVER REQUEST ACKNOWLEDGE.
3. The source gNB provides the RRC configuration to the UE by forwarding the *RRCReconfiguration* message received in the HANOVER REQUEST ACKNOWLEDGE. The *RRCReconfiguration* message includes at least cell ID and all information required to access the target cell so that the UE can access the target cell without reading system information. For some cases, the information required for contention-based and contention-free random access can be included in the *RRCReconfiguration* message. The access information to the target cell may include beam specific information, if any.
4. The UE moves the RRC connection to the target gNB and replies with the *RRCReconfigurationComplete*.

NOTE 1: User Data can also be sent in step 4 if the grant allows.

...

NOTE 2: Void.

NOTE 3: Void.

RRC managed handovers with and without PDCP entity re-establishment are both supported. For DRBs using RLC AM mode, PDCP can either be re-established together with a security key change or initiate a data recovery procedure without a key change. For DRBs using RLC UM mode, PDCP can either be re-established together with a security key change or remain as it is without a key change. For SRBs, PDCP can either remain as it is, discard its stored PDCP PDUs/SDUs without a key change or be re-established together with a security key change.

Data forwarding, in-sequence delivery and duplication avoidance at handover can be guaranteed when the target gNB uses the same DRB configuration as the source gNB.

Timer based handover failure procedure is supported in NR. RRC connection re-establishment procedure is used for recovering from handover failure except in certain CHO or DAPS handover scenarios:

- When DAPS handover fails, the UE falls back to the source cell configuration, resumes the connection with the source cell, and reports DAPS handover failure via the source without triggering RRC connection re-establishment if the source link has not been released.
- When initial CHO execution attempt fails or HO fails, the UE performs cell selection, and if the selected cell is a CHO candidate and if network configured the UE to try CHO after handover/CHO failure, then the UE attempts CHO execution once, otherwise re-establishment is performed.

DAPS handover for FR2 to FR2 case is not supported in this release of the specification.

The handover of the IAB-MT in SA mode follows the same procedure as described for the UE. After the backhaul has been established, the handover of the IAB-MT is part of the intra-CU topology adaptation procedure defined in TS 38.401 [4]. Modifications to the configuration of BAP sublayer and higher protocol layers above the BAP sublayer are described in TS 38.401 [4].

Beam Level Mobility does not require explicit RRC signalling to be triggered. The gNB provides via RRC signalling the UE with measurement configuration containing configurations of SSB/CSI resources and resource sets, reports and trigger states for triggering channel and interference measurements and reports. Beam Level Mobility is then dealt with at lower layers by means of physical layer and MAC layer control signalling, and RRC is not required to know which beam is being used at a given point in time.

SSB-based Beam Level Mobility is based on the SSB associated to the initial DL BWP and can only be configured for the initial DL BWPs and for DL BWPs containing the SSB associated to the initial DL BWP. For other DL BWPs, Beam Level Mobility can only be performed based on CSI-RS.

[TS 38.331, clause 5.3.7.3]

Upon selecting a suitable NR cell, the UE shall:

- 1> ensure having valid and up to date essential system information as specified in clause 5.2.2.2;
- 1> stop timer T311;

...

- 1> if *attemptCondReconfig* is configured; and
- 1> if the selected cell is one of the candidate cells for which the *reconfigurationWithSync* is included in the *masterCellGroup* in *VarConditionalReconfig*:
 - 2> apply the stored *condRRCReconfig* associated to the selected cell and perform actions as specified in 5.3.5.3;
- 1> else:
 - 2> if UE is configured with *conditionalReconfiguration*:
 - 3> reset MAC;
 - 3> release *spCellConfig*, if configured;
 - 3> release the MCG SCell(s), if configured;
 - 3> release *delayBudgetReportingConfig*, if configured and stop timer T342, if running;
 - 3> release *overheatingAssistanceConfig*, if configured and stop timer T345, if running;
 - 3> if MR-DC is configured:
 - 4> perform MR-DC release, as specified in clause 5.3.5.10;
 - 3> release *idc-AssistanceConfig*, if configured;
 - 3> release *btNameList*, if configured;
 - 3> release *wlanNameList*, if configured;
 - 3> release *sensorNameList*, if configured;
 - 3> release *drx-PreferenceConfig* for the MCG, if configured and stop timer T346a associated with the MCG, if running;
 - 3> release *maxBW-PreferenceConfig* for the MCG, if configured and stop timer T346b associated with the MCG, if running;
 - 3> release *maxCC-PreferenceConfig* for the MCG, if configured and stop timer T346c associated with the MCG, if running;
 - 3> release *maxMIMO-LayerPreferenceConfig* for the MCG, if configured and stop timer T346d associated with the MCG, if running;
 - 3> release *minSchedulingOffsetPreferenceConfig* for the MCG, if configured and stop timer T346e associated with the MCG, if running;
 - 3> release *releasePreferenceConfig*, if configured and stop timer T346f, if running;
 - 3> release *onDemandSIB-Request* if configured, and stop timer T350, if running;
 - 3> suspend all RBs, except SRB0;
 - 2> remove all the entries within *VarConditionalReconfig*, if any;
 - 2> for each *measId*, if the associated *reportConfig* has a *reportType* set to *condTriggerConfig*:
 - 3> for the associated *reportConfigId*:
 - 4> remove the entry with the matching *reportConfigId* from the *reportConfigList* within the *VarMeasConfig*;
 - 3> if the associated *measObjectId* is only associated to a *reportConfig* with *reportType* set to *condTriggerConfig*:

- 4> remove the entry with the matching *measObjectId* from the *measObjectList* within the *VarMeasConfig*;
- 3> remove the entry with the matching *measId* from the *measIdList* within the *VarMeasConfig*;
- 2> start timer T301;
- 2> apply the default L1 parameter values as specified in corresponding physical layer specifications except for the parameters for which values are provided in *SIB1*;
- 2> apply the default MAC Cell Group configuration as specified in 9.2.2;
- 2> apply the CCCH configuration as specified in 9.1.1.2;
- 2> apply the *timeAlignmentTimerCommon* included in *SIB1*;
- 2> initiate transmission of the *RRCReestablishmentRequest* message in accordance with 5.3.7.4;

NOTE: This procedure applies also if the UE returns to the source PCell.

Upon selecting an inter-RAT cell, the UE shall:

- 1> perform the actions upon going to RRC_IDLE as specified in 5.3.11, with release cause 'RRC connection failure'.

[TS 38.331, clause 5.3.11]

The UE shall:

- 1> reset MAC;
- ...
- 1> remove all the entries within *VarConditionalReconfig*, if any;
- 1> for each *measId*, if the associated *reportConfig* has a *reportType* set to *condTriggerConfig*:
 - 2> for the associated *reportConfigId*:
 - 3> remove the entry with the matching *reportConfigId* from the *reportConfigList* within the *VarMeasConfig*;
 - 2> if the associated *measObjectId* is only associated to a *reportConfig* with *reportType* set to *condTriggerConfig*:
 - 3> remove the entry with the matching *measObjectId* from the *measObjectList* within the *VarMeasConfig*;
 - 2> remove the entry with the matching *measId* from the *measIdList* within the *VarMeasConfig*;
- 1> discard the K_{gNB} key, the $S-K_{gNB}$ key, the $S-K_{eNB}$ key, the K_{RRcenc} key, the K_{RRcint} key, the K_{UPint} key and the K_{UPenc} key, if any;
- 1> release all radio resources, including release of the RLC entity, the BAP entity, the MAC configuration and the associated PDCP entity and SDAP for all established RBs;
- 1> indicate the release of the RRC connection to upper layers together with the release cause;
- 1> except if going to RRC_IDLE was triggered by inter-RAT cell reselection while the UE is in RRC_INACTIVE or RRC_IDLE or when selecting an inter-RAT cell while T311 was running or when selecting an E-UTRA cell for EPS fallback for IMS voice as specified in 5.4.3.5:
 - 2> enter RRC_IDLE and perform cell selection as specified in TS 38.304 [20];

8.1.4.4.4.3 Test description

8.1.4.4.4.3.1 Pre-test conditions

System Simulator:

- NR Cell 1, NR Cell 2 and NR Cell 4.
- System information combination NR-2 as defined in TS 38.508-1 [4] clause 4.4.3.1.3 is used for NR cells.

UE:

- None.

Preamble:

- If `pc_IP_Ping` is set to TRUE then, the UE is in 5GS state 3N-A on NR Cell 1 according to TS 38.508-1 [4], clause 4.4A.2 Table 4.4A.2-3.
- Else, the UE is in 5GS state 3N-A and Test Loop Function (*On*) with UE test loop mode B on NR Cell 1 according to 38.508-1[4], clause 4.4A.2 Table 4.4A.2-3.

8.1.4.4.4.3.2 Test procedure sequence

Tables 8.1.4.4.4.3.2-1 and 8.1.4.4.4.3.2-2 illustrate the downlink power levels to be applied for NR cells at various time instants of the test execution. Row marked "T0" denotes the conditions after the preamble, while the configuration marked "T1", "T2", "T3", and "T4" are applied at the point indicated in the Main behaviour description in Table 8.1.4.4.4.3.2-3.

Table 8.1.4.4.4.3.2-1: Power levels in FR1

	Parameter	Unit	NR Cell 1	NR Cell 2	NR Cell 4	Remark
T0	SS/PBCH SSS EPRE	dBm/ SCS	-79	-113	-85	Power levels are such that UE registered on NR Cell 1
T1	SS/PBCH SSS EPRE	dBm/ SCS	-85	-113	-79	Power levels are such that UE successfully handovers to NR Cell 4
T2	SS/PBCH SSS EPRE	dBm/ SCS	-85	-79	-113	Power levels are such that entry condition for event A3 is satisfied for NR Cell 2
T3	SS/PBCH SSS EPRE	dBm/ SCS	- 113	-113	- 113	Power levels are such that all $Srxlev_{NR\ Cell} < 0$
T4	SS/PBCH SSS EPRE	dBm/ SCS	-113	-113	-79	Power levels are such that entry condition for event A3 is satisfied for NR Cell 4

Table 8.1.4.4.4.3.2-2: Power levels in FR2

	Parameter	Unit	NR Cell 1	NR Cell 2	NR Cell 4	Remark
T0	SS/PBCH SSS EPRE	dBm/ SCS	FFS	FFS	FFS	Power levels are such that UE registered on NR Cell 1
T1	SS/PBCH SSS EPRE	dBm/ SCS	FFS	FFS	FFS	Power levels are such that UE successfully handovers to NR Cell 4
T2	SS/PBCH SSS EPRE	dBm/ SCS	FFS	FFS	FFS	Power levels are such that entry condition for event A3 is satisfied for NR Cell 2
T3	SS/PBCH SSS EPRE	dBm/ SCS	FFS	FFS	FFS	Power levels are such that all $Srxlev_{NR\ Cell} < 0$
T4	SS/PBCH SSS EPRE	dBm/ SCS	FFS	FFS	FFS	Power levels are such that entry condition for event A3 is satisfied for NR Cell 4

Table 8.1.4.4.4.3.2-3: Main behaviour

St	Procedure	Message Sequence	TP	Verdict
----	-----------	------------------	----	---------

		U - S	Message		
1	The SS transmits an <i>RRCReconfiguration</i> message including <i>MeasConfig</i> and <i>ConditionalReconfiguration</i> to set NR Cell 2 as the target candidate cell.	<--	NR RRC: <i>RRCReconfiguration</i>	-	-
2	The UE transmits an <i>RRCReconfigurationComplete</i> message in NR Cell 1.	-->	NR RRC: <i>RRCReconfigurationComplete</i>	-	-
2A	SS adjusts the cell-specific reference signal level according to row "T1".				
3	The SS transmits an <i>RRCReconfiguration</i> message including a <i>reconfigurationWithSync</i> for handover to NR Cell 4.	<--	NR RRC: <i>RRCReconfiguration</i>	-	-
4	Check: Does UE transmit the <i>RRCReconfigurationComplete</i> message in NR Cell 4 within 10s?	-->	NR RRC: <i>RRCReconfigurationComplete</i>	1	P
4A	Check: Does the test result of generic test procedure in TS 38.508-1 Table 4.9.1-1 indicate that the UE is capable of exchanging IP data on NR Cell 4?	-	-	1	-
-	EXCEPTION: Steps 5-15 describe behaviour that depends on UE configuration; the "lower case letter" identifies a step sequence that takes place if <i>inactiveState</i> is configured	-	-	-	-
5	IF <i>pc_condHandoverFailure-r16</i> THEN the SS transmits an <i>RRCReconfiguration</i> message including <i>MeasConfig</i> and <i>ConditionalReconfiguration</i> to set NR Cell 2 as the target candidate cell.	<--	NR RRC: <i>RRCReconfiguration</i>	-	-
6	The UE transmits an <i>RRCReconfigurationComplete</i> message in NR Cell 4.	-->	NR RRC: <i>RRCReconfigurationComplete</i>	-	-
7	The SS transmits an <i>RRCReconfiguration</i> message including a <i>reconfigurationWithSync</i> for handover to NR Cell 1?	<--	NR RRC: <i>RRCReconfiguration</i>	-	-
-	EXCEPTION: In parallel to the events described in step 8 the steps specified in Table 8.1.4.4.4.3.2-4 should take place.	-	-	-	-
8	SS adjusts the cell-specific reference signal level according to row "T2".	-	-	-	-
9	Check: Does UE transmit the <i>RRCReconfigurationComplete</i> message in NR Cell 2 within 10s?	-->	NR RRC: <i>RRCReconfigurationComplete</i>	2	P
9A	Check: Does the test result of generic test procedure in TS 38.508-1 Table 4.9.1-1 indicate that the UE is capable of exchanging IP data on NR Cell 2?	-	-	2	-
10	The SS transmits an <i>RRCReconfiguration</i> message including <i>MeasConfig</i> and <i>ConditionalReconfiguration</i> to set NR Cell 4 as the target candidate cell.	<--	NR RRC: <i>RRCReconfiguration</i>	-	-
11	The UE transmits an <i>RRCReconfigurationComplete</i> message in NR Cell 2.	-->	NR RRC: <i>RRCReconfigurationComplete</i>	-	-
12	The SS transmits an <i>RRCReconfiguration</i> message including a <i>reconfigurationWithSync</i> for handover to NR Cell 1?	<--	NR RRC: <i>RRCReconfiguration</i>	-	-
12A	SS adjusts the cell-specific reference signal level according to row "T3".	-	-	-	-
-	EXCEPTION: In parallel to the events described in step 13 the steps specified in Table 8.1.4.4.4.3.2-4 should take place until T304 expiry.	-	-	-	-
13	SS waits 5s to make sure that the UE is in idle state. (Note 1)				

14	SS adjusts the cell-specific reference signal level according to row "T4".	-	-	-	-
15	Check: Is the generic mobility registration updating procedure described in TS 38.508-1 [4] Table 4.9.5.2.2-1 performed on NR Cell 4?	-	-	3	-P
Note 1: The wait time is selected to cover T304 (1000ms) + T311 (1000ms) to ensure that UE goes to RRC_IDLE.					

Table 8.1.4.4.3.2-4: Parallel behaviour

St	Procedure	Message Sequence		TP	Verdict
		U - S	Message		
-	EXCEPTION: The steps 1 and 2 below are repeated for the duration of T304.	-	-	-	-
1	The UE attempts to perform the intra frequency handover using MAC Random Access Preamble on NR Cell 1.	-	-	-	-
2	The SS does not respond.	-	-	-	-

8.1.4.4.3.3 Specific message contents

Table 8.1.4.4.3.3-1: RRCReconfiguration (Step1, step 5 and step 10, Table 8.1.4.4.3.2-3)

Derivation Path: TS 38.508-1 [4], Table 4.6.1-13 with condition NR_MEAS and CHO			
Information Element	Value/remark	Comment	Condition
RRCReconfiguration ::= SEQUENCE {			
criticalExtensions CHOICE {			
rrcReconfiguration SEQUENCE {			
measConfig	MeasConfig	Table 8.1.4.4.3.3-2	
nonCriticalExtension SEQUENCE {			
nonCriticalExtension SEQUENCE {			
nonCriticalExtension SEQUENCE {			
nonCriticalExtension SEQUENCE {			
conditionalReconfiguration-r16	ConditionalReconfiguration	Table 8.1.4.4.3.3-5	
}			
}			
}			
}			
}			
}			
}			

Table 8.1.4.4.3.3-2: MeasConfig (Table 8.1.4.4.3.3-1)

Derivation Path: TS 38.508-1 [4] Table 4.6.3-69			
Information Element	Value/remark	Comment	Condition
MeasConfig ::= SEQUENCE {			
measObjectToAddModList SEQUENCE (SIZE (1..maxNrofMeasId)) OF MeasObjectToAddMod {	1 entry		
MeasObjectToAddMod[1] SEQUENCE {		entry 1	
measObjectId	1		
measObject CHOICE {			
measObjectNR	MeasObjectNR	Table 8.1.4.4.3.3-3	
}			
}			
reportConfigToAddModList SEQUENCE(SIZE (1..maxReportConfigId)) OF ReportConfigToAddMod {	1 entry		
ReportConfigToAddMod[1] SEQUENCE {		entry 1	
reportConfigId	1		

reportConfig CHOICE {			
reportConfigNR	<i>ReportConfigNR-condEventA3</i>	Table 8.1.4.4.4.3.3-4	
}			
}			
measIdToAddModList SEQUENCE (SIZE (1..maxNrofMeasId)) OF MeasIdToAddMod {	1 entry		
MeasIdToAddMod[1] SEQUENCE {		entry 1	
measId	1		
measObjectId	1		
reportConfigId	1		
}			
}			
}			

Table 8.1.4.4.4.3.3-3: MeasObjectNR (Table 8.1.4.4.4.3.3-2)

Derivation Path: TS 38.508-1 [4] Table 4.6.3-76			
Information Element	Value/remark	Comment	Condition
MeasObjectNR ::= SEQUENCE {			
ssbFrequency	ARFCN-ValueNR for SSB of NR Cell 1	The SSB of NR Cell 1, NR Cell 2 and NR Cell 4 have the same ARFCN value as specified in TS 38.508-1 [4] clause 6.2.3	
absThreshSS-BlocksConsolidation	Not present		
nrofSS-BlocksToAverage	Not present		
}			

Table 8.1.4.4.4.3.3-4: ReportConfigNR-condEventA3 (Table 8.1.4.4.4.3.3-2)

Derivation Path: TS 38.508-1 [4] Table 4.6.3-142 with condition CHO AND EVENT_A3			
Information Element	Value/remark	Comment	Condition
ReportConfigNR ::= SEQUENCE {			
reportType CHOICE {			
condTriggerConfig SEQUENCE {			
condEventId CHOICE {			
condEventA3 SEQUENCE {			
a3-Offset CHOICE {			
rsrp	2	1 dB (2*0.5 dB)	FR1
	FFS		FR2
}			
}			
}			
}			
}			

Table 8.1.4.4.4.3.3-5: ConditionalReconfiguration (Table 8.1.4.4.4.3.3-1)

Derivation Path: TS 38.508-1 [4] Table 4.6.3-25D			
Information Element	Value/remark	Comment	Condition
ConditionalReconfiguration-r16 ::= SEQUENCE {			
condReconfigToAddModList-r16	CondReconfigToAddModList-r16	Table 8.1.4.4.4.3.3-6	
}			

Table 8.1.4.4.3.3-6: CondReconfigToAddModList-r16 (Table 8.1.4.4.3.3-5)

Derivation Path: TS 38.508-1 [4] Table 4.6.3-25C			
Information Element	Value/remark	Comment	Condition
CondReconfigToAddModList-r16 ::= SEQUENCE (SIZE (1.. maxNrofCondCells-r16)) OF CondReconfigToAddMod-r16 {	1 entry		
CondReconfigToAddMod-r16[1] ::= SEQUENCE {		entry 1	
condReconfigId-r16	1		
condExecutionCond-r16 ::= SEQUENCE {			
MeasId [1]	1		
}			
condRRCReconfig-r16	OCTET STRING (CONTAINING RRCReconfiguration-HO with condition HO_NR Cell 2)	Table 8.1.4.4.3.3-7	Step 1, Step 5
	OCTET STRING (CONTAINING RRCReconfiguration-HO with condition HO_NR Cell 4)	Table 8.1.4.4.3.3-7	Step 10
}			
}			

Table 8.1.4.4.3.3-7: RRCReconfiguration-HO (Table 8.1.4.4.3.3-6)

Derivation Path: TS 38.508-1 [4] Table 4.8.1-1A with condition RBConfig_KeyChange			
Information Element	Value/remark	Comment	Condition
RRCReconfiguration ::= SEQUENCE {			
criticalExtensions CHOICE {			
rrcReconfiguration SEQUENCE {			
nonCriticalExtension SEQUENCE{			
masterCellGroup	OCTET STRING (CONTAINING CellGroupConfig with condition PCI_NR Cell 2)	Table 8.1.4.4.3.3-8	HO_NR Cell 2
	OCTET STRING (CONTAINING CellGroupConfig with condition PCI_NR Cell 4)	Table 8.1.4.4.3.3-8	HO_NR Cell 4
}			
}			
}			
}			

8.1.4.4.3.3-8: CellGroupConfig (Table 8.1.4.4.3.3-7)

Derivation Path: TS 38.508-1 [4], Table 4.6.3-19 with Condition PCell_change and CFRA			
Information Element	Value/remark	Comment	Condition
CellGroupConfig ::= SEQUENCE {			
spCellConfig SEQUENCE {			
reconfigurationWithSync SEQUENCE {			
spCellConfigCommon SEQUENCE {			
physCellId	Physical Cell Identity of NR Cell 2		PCI_NR Cell 2
	Physical Cell Identity of NR Cell 4		PCI_NR Cell 4
}			
}			
}			
}			

Table 8.1.4.4.3.3-9: RRCReconfiguration-HO (Step 3, step 7 and step 12, Table 8.1.4.4.3.2-3)

Derivation Path: TS 38.508-1 [4] Table 4.8.1-1A with condition RBCConfig_KeyChange			
Information Element	Value/remark	Comment	Condition
RRCReconfiguration ::= SEQUENCE {			
criticalExtensions CHOICE {			
rrcReconfiguration SEQUENCE {			
nonCriticalExtension SEQUENCE{			
masterCellGroup	OCTET STRING (CONTAINING CellGroupConfig with condition PCI_NR Cell 4)	Table 8.1.4.4.3.3-8	Step 3
	OCTET STRING (CONTAINING CellGroupConfig with condition PCI_NR Cell 1)	Table 8.1.4.4.3.3-8	Step 7, Step 12
}			
}			
}			

8.1.5 RRC others

8.1.5.1 UE capability transfer

8.1.5.1.1 UE capability transfer / Success

8.1.5.1.1.1 Test Purpose (TP)

(1)

```
with { UE in NR RRC_CONNECTED state }
ensure that {
  when { UE receives an UECapabilityEnquiry message }
  then { UE transmits an UECapabilityInformation message including UE radio access capability
information corresponding to the ue-CapabilityRequest variable }
}
```

8.1.5.1.1.2 Conformance requirements

References: The conformance requirements covered in the present test case are specified in: TS 38.331, clauses 5.6.1.3, 5.6.1.4, 5.7.7.2 and 5.7.7.3.

[TS 38.331, clause 5.6.1.3]

The UE shall set the contents of *UECapabilityInformation* message as follows:

- 1> if the ue-CapabilityRAT-RequestList contains a UE-CapabilityRAT-Request with rat-Type set to nr:
 - 2> include in the ue-CapabilityRAT-ContainerList a UE-CapabilityRAT-Container of the type UE-NR-Capability and with the rat-Type set to nr;
 - 2> include the supportedBandCombinationList, featureSets and featureSetCombinations as specified in clause 5.6.1.4;

...

- 1> submit the *UECapabilityInformation* message to lower layers for transmission, upon which the procedure ends.

[TS 38.331, clause 5.6.1.4]

The UE invokes the procedures in this clause if the NR or E-UTRA network requests UE capabilities for *nr*, *eutra-nr* or *eutra*. This procedure is invoked once per requested *rat-Type* (see clause 5.6.1.3 for capability enquiry by the NR

network; see TS 36.331 [10], clause 5.6.3.3 for capability enquiry by the E-UTRA network). The UE shall ensure that the feature set IDs are consistent across feature sets, feature set combinations and band combinations in all three UE capability containers that the network queries with the same fields with the same values, i.e. *UE-CapabilityRequestFilterNR* and fields in *UECapabilityEnquiry* message (i.e. *requestedFreqBandsNR-MRDC*, *requestedCapabilityNR* and *eutra-nr-only* flag) as defined in TS 36.331, where applicable.

NOTE 1: Capability enquiry without *frequencyBandListFilter* is not supported.

[TS 38.331, clause 5.7.7.2]

A UE capable of UL RRC message segmentation in RRC_CONNECTED will initiate the procedure when the following conditions are met:

- 1> if the RRC message segmentation is enabled based on the field *rrc-SegAllowed* received, and
- 1> if the encoded RRC message is larger than the maximum supported size of a PDCP SDU specified in TS 38.323 [5];

Upon initiating the procedure, the UE shall:

- 1> initiate transmission of the *ULDedicatedMessageSegment* message as specified in 5.7.7.3;

[TS 38.331, clause 5.7.7.3]

The UE shall segment the encoded RRC PDU based on the maximum supported size of a PDCP SDU specified in TS 38.323 [5]. UE shall minimize the number of segments and set the contents of the *ULDedicatedMessageSegment* messages as follows:

- 1> For each new UL DCCH message, set the *segmentNumber* to 0 for the first message segment and increment the *segmentNumber* for each subsequent RRC message segment;
- 1> set *rrc-MessageSegmentContainer* to include the segment of the UL DCCH message corresponding to the *segmentNumber*;
- 1> if the segment included in the *rrc-MessageSegmentContainer* is the last segment of the UL DCCH message:
 - 2> set the *rrc-MessageSegmentType* to *lastSegment*;
- 1> else:
 - 2> set the *rrc-MessageSegmentType* to *notLastSegment*;
- 1> submit all the *ULDedicatedMessageSegment* messages generated for the segmented RRC message to lower layers for transmission in ascending order based on the *segmentNumber*, upon which the procedure ends.

8.1.5.1.1.3 Test Description

8.1.5.1.1.3.1 Pre-test conditions

System Simulator:

- NR Cell 1
- System information combination NR-1 as defined in TS 38.508-1 [4] clause 4.4.3.1.3 is used in NR cell.

UE:

- None.

Preamble:

- The UE is in 5GS state 3N-A according to TS 38.508-1 [4], clause 4.4A on NR Cell 1.

8.1.5.1.1.3.2 Test procedure sequence

Table 8.1.5.1.1.3.2-1: Main behaviour

St	Procedure	Message Sequence		TP	Verdict
		U - S	Message		
1	The SS transmits a <i>UECapabilityEnquiry</i> message including <i>nr</i> and <i>rrc-segAllowed-r16</i> set to enabled.	<--	<i>UECapabilityEnquiry</i>	-	-
-	EXCEPTION: The "lower case letter" identifies a step sequence that takes place depending on the size of UE capability message. IF <i>pc_NR_UL_Segmentation</i> and UE's encoded <i>UECapabilityInformation</i> message >= Max PDCP SDU size then steps 2a1 and 2a2 will be performed else step 2b1 will be performed	-	-	-	-
-	EXCEPTION: Step 2a1 is repeated a maximum of 16 times or till <i>rrc-MessageSegmentType-16</i> IE within the <i>UIDedicatedMessageSegment</i> message indicates <i>rrc-MessageSegmentType-r16</i> = <i>lastSegment</i> .	-	-	-	-
2a1	The UE sends segments of <i>UECapabilityInformation</i> message contained within the <i>rrc-MessageSegmentContainer-r16</i> IE of the <i>UIDedicatedMessageSegment</i> message?	-->	<i>ULDedicatedMessageSegment</i>	-	-
2a2	Check: Is the received UE radio access capability information as per the <i>ue-CapabilityRequest</i> variable?	-	-	1	P
2b1	Check: Does the UE transmit a <i>UECapabilityInformation</i> message including UE radio access capability information as per the <i>ue-CapabilityRequest</i> variable?	-->	<i>UECapabilityInformation</i>	1	P

8.1.5.1.1.3.3 Specific message contents

Table 8.1.5.1.1.3.3-1: *UECapabilityEnquiry* (step 1, Table 8.1.5.1.1.3.2-1)

Derivation Path: TS 38.508-1 [4], Table 4.6.1-31			
Information Element	Value/remark	Comment	Condition
<i>UECapabilityEnquiry</i> ::= SEQUENCE {			
<i>rrc-TransactionIdentifier</i>	RRC-TransactionIdentifier		
criticalExtensions CHOICE {			
<i>ueCapabilityEnquiry</i> SEQUENCE {			
<i>ue-CapabilityRAT-RequestList</i> SEQUENCE (SIZE (1.. <i>maxRAT-CapabilityContainers</i>)) OF <i>CapabilityRAT-Request</i> {	-		
<i>UE-CapabilityRAT-Request</i> [1] SEQUENCE {		entry 1	
<i>rat-Type</i>	nr		
}			
}			
<i>lateNonCriticalExtension</i>	Not present		
<i>ue-CapabilityEnquiryExt</i>	OCTET STRING Containing <i>UECapabilityEnquiry-v1560</i> -IEs		
}			
criticalExtensionsFuture			
}			
}			

Table 8.1.5.1.1.3.3-2: *UECapabilityInformation* (steps 2a2 and 2b1, Table 8.1.5.1.1.3.2-1)

Derivation Path: TS 38.508-1 [4], Table 4.6.1-32			
Information Element	Value/remark	Comment	Condition

UECapabilityInformation ::= SEQUENCE {			
rrc-TransactionIdentifier	RRC-TransactionIdentifier		
criticalExtensions CHOICE {			
ueCapabilityInformation SEQUENCE {			
ue-CapabilityRAT-ContainerList SEQUENCE (SIZE (0..maxRAT-CapabilityContainers)) OF CapabilityRAT-Request {			
UE-CapabilityRAT-Request[1] SEQUENCE {		entry 1	
rat-Type	nr		
ueCapabilityRAT-Container	UE-NR-Capability	Encoded as per TS 38.331 [12] clause 5.6.1	
}			
}			
lateNonCriticalExtension	Not checked		
nonCriticalExtension	Not checked		
}			
criticalExtensionsFuture	Not checked		
}			
}			

Table 8.1.5.1.1.3.3-3: UE-NR-Capability (Table 8.1.5.1.1.3.3-2)

Derivation Path: TS 38.331 [12], clause 6.3.3			
Information Element	Value/remark	Comment	Condition
UE-NR-Capability ::= SEQUENCE {			
accessStratumRelease	Checked	"rel-15" or higher	
pdcp-Parameters SEQUENCE {			
supportedROHC-Profiles SEQUENCE {			
profile0x0000	Not checked		
profile0x0001	Not checked		
profile0x0002	Not checked		
profile0x0003	Not checked		
profile0x0004	Not checked		
profile0x0006	Not checked		
profile0x0101	Not checked		
profile0x0102	Not checked		
profile0x0103	Not checked		
profile0x0104	Not checked		
}			
maxNumberROHC-ContextSessions	Not checked		
uplinkOnlyROHC-Profiles	Not checked		
continueROHC-Context	Not checked		
outOfOrderDelivery	Checked		pc_outOfOrderDelivery
shortSN	Checked		pc_shortSN
pdcp-DuplicationSRB	Checked		pc_pdcpl_DuplicationSplitSRB
pdcp-DuplicationMCG-OrSCG-DRB	Checked		pc_pdcpl_DuplicationMCG-OrSCG-DRB
drb-IAB-r16	Not checked		
non-DRB-IAB-r16	Not checked		
extendedDiscardTimer-r16	Not checked		
continueEHC-Context-r16	Not checked		
ehc-r16	Checked		pc_NR_ehc_r16
maxNumberEHC-Contexts-r16	Not checked		
jointEHC-ROHC-Config-r16	Not checked		
pdcp-DuplicationMoreThanTwoRLC-r16	Checked		pc_pdcpl_DuplicationMore

			eThanTwoR LC_r16
}			
rlc-Parameters SEQUENCE {			
am-WithShortSN	Checked		pc_am_With ShortSN
um-WithShortSN	Checked		pc_um_With ShortSN
um-WithLongSN	Checked		pc_um_With LongSN
}			
mac-Parameters SEQUENCE {			
mac-ParametersCommon SEQUENCE {			
lcp-Restriction	Checked		pc_lcp_Restr iction
dummy	Not checked		
lch-ToSCellRestriction	Not checked		
recommendedBitRate	Checked		pc_recomme ndedBitRate
recommendedBitRateQuery	Checked		pc_recomme ndedBitRate Query
recommendedBitRateMultiplier-r16	Not checked		
preEmptiveBSR-r16	Not checked		
autonomousTransmission-r16	Not checked		
lch-PriorityBasedPrioritization-r16	Checked		pc_lch_Prior ityBasedPrior itization_r16
lch-ToConfiguredGrantMapping-r16	Not checked		
lch-ToGrantPriorityRestriction-r16	Checked		pc_lch_ToGr antPriorityRe striction_r16
singlePHR-P-r16	Not checked		
ul-LBT-FailureDetectionRecovery-r16	Not checked		
tdd-MPE-P-MPR-Reporting-r16	Not checked		
lcid-ExtensionIAB-r16	Not checked		
spCell-BFR-CBRA-r16	Not checked		
srs-ResourceId-Ext-r16	Not checked		
}			
mac-ParametersXDD-Diff SEQUENCE {			
skipUplinkTxDynamic	Checked (NOTE 4)		pc_skipUplin kTxDynamic
logicalChannelSR-DelayTimer	Checked (NOTE 5)		pc_logicalCh annelSR_De layTimer
longDRX-Cycle	Checked (NOTE 6)		pc_longDRX _Cycle
shortDRX-Cycle	Checked (NOTE 7)		pc_shortDR X_Cycle
multipleSR-Configurations	Not checked		
multipleConfiguredGrants	Checked (NOTE 12)		pc_multipleC onfiguredGra nts_r16
}			
}			
phy-Parameters SEQUENCE {			
phy-ParametersCommon SEQUENCE {			
csi-RS-CFRA-ForHO	Checked		pc_csi_RS_ CFRA_ForH O
dynamicPRB-BundlingDL	Not checked		
sp-CSI-ReportPUCCH	Not checked		
sp-CSI-ReportPUSCH	Not checked		
nzp-CSI-RS-IntefMgmt	Not checked		
type2-SP-CSI-Feedback-LongPUCCH	Not checked		
precoderGranularityCORESET	Not checked		

dynamicHARQ-ACK-Codebook	supported		
semiStaticHARQ-ACK-Codebook	Not checked		
spatialBundlingHARQ-ACK	Checked		pc_spatialBundlingHARQ_ACK
dynamicBetaOffsetInd-HARQ-ACK-CSI	Not checked		
pucch-Repetition-F1-3-4	Not checked		
ra-Type0-PUSCH	Checked		pc_ra_Type0_PUSCH
dynamicSwitchRA-Type0-1-PDSCH	Checked		pc_dynamicSwitchRA_Type0_1_PDSCH
dynamicSwitchRA-Type0-1-PUSCH	Checked		pc_dynamicSwitchRA_Type0_1_PUSCH
pdsch-MappingTypeA	supported		pc_pdsch_MappingTypeA
pdsch-MappingTypeB	Checked		pc_pdsch_MappingTypeB
interleavingVRB-ToPRB-PDSCH	Checked		pc_interleavingVRB_ToPRB_PDSCH
interSlotFreqHopping-PUSCH	Not checked		
type1-PUSCH-RepetitionMultiSlots	Not checked		
type2-PUSCH-RepetitionMultiSlots	Not checked		
pusch-RepetitionMultiSlots	Checked		pc_pusch_RepetitionMultiSlots
pdsch-RepetitionMultiSlots	Checked		pc_pdsch_RepetitionMultiSlots
downlinkSPS	Checked		pc_downlinkSPS
configuredUL-GrantType1	Checked		pc_configuredUL_GrantType1
configuredUL-GrantType2	Checked		pc_configuredUL_GrantType2
pre-EmptIndication-DL	Not checked		
cbg-TransIndication-DL	Not checked		
cbg-TransIndication-UL	Not checked		
cbg-FlushIndication-DL	Not checked		
dynamicHARQ-ACK-CodeB-CBG-Retx-DL	Not checked		
rateMatchingResrcSetSemi-Static	Not checked		
rateMatchingResrcSetDynamic	Not checked		
bwp-SwitchingDelay	Checked	38.306, 4.2.7.10: It is mandatory to report type 1 or type 2. This capability is not applicable to IAB-MT	pc_bwp_SwitchingDelay_Type1 or pc_bwp_SwitchingDelay_Type2
dummy	Not checked		
maxNumberSearchSpaces	n10		
rateMatchingCtrlResrsSetDynamic	Not checked		
maxLayersMIMO-Indication	Not checked		
spCellPlacement	Not checked		
twoStepRACH-r16	Not checked		
dci-Format1-2And0-2-r16	Checked		pc_dci_Format1_2And0_2_r16
monitoringDCI-SameSearchSpace-r16	Not checked		

type2-CG-ReleaseDCI-0-1-r16	Not checked		
type2-CG-ReleaseDCI-0-2-r16	Not checked		
sps-ReleaseDCI-1-1-r16	Not checked		
sps-ReleaseDCI-1-2-r16	Not checked		
csi-TriggerStateNon-ActiveBWP-r16	Not checked		
seperateSMTC-InterIAB-Support-r16	Not checked		
seperateRACH-IAB-Support-r16	Not checked		
ul-flexibleDL-SlotFormatSemiStatic-IAB-r16	Not checked		
ul-flexibleDL-SlotFormatDynamics-IAB-r16	Not checked		
dft-S-OFDM-WaveformUL-IAB-r16	Not checked		
dci-25-AI-RNTI-Support-IAB-r16	Not checked		
t-DeltaReceptionSupport-IAB-r16	Not checked		
guardSymbolReportReception-IAB-r16	Not checked		
harqACK-CB-SpatialBundlingPUCCH-Group-r16	Not checked		
crossSlotScheduling-r16	Not checked		
maxNumberSRS- PosPathLossEstimateAllServingCells-r16	Not checked		
extendedCG-Periodicities-r16	Not checked		
extendedSPS-Periodicities-r16	Not checked		
codebookVariantsList-r16	Not checked		
pusch-RepetitionTypeA-r16	Not checked		
dci-DL-PriorityIndicator-r16	Checked		pc_dci_DL_ PriorityIndica tor_r16
dci-UL-PriorityIndicator-r16	Checked		pc_dci_UL_ PriorityIndica tor_r16
maxNumberPathlossRS-Update-r16	Not checked		
type2-HARQ-ACK-Codebook-r16	Not checked		
maxTotalResourcesForAcrossFreqRanges-r16	Not checked		
harqACK-separateMultiDCI-MultiTRP-r16	Not checked		
harqACK-jointMultiDCI-MultiTRP-r16	Not checked		
bwp-SwitchingMultiCCs-r16	Not checked		
targetSMTC-SCG-r16	Not checked		
supportRepetitionZeroOffsetRV-r16	Not checked		
cbg-TransInOrderPUSCH-UL-r16	Not checked		
bwp-SwitchingMultiDormancyCCs-r16	Not checked		
supportRetx-Diff-CoresetPool-Multi-DCI-TRP-r16	Not checked		
pdccch- MonitoringAnyOccasionsWithSpanGapCrossCarrierS ch-r16	Not checked		
newBeamIdentifications2PortCSI-RS-r16	Not checked		
pathlossEstimation2PortCSI-RS-r16	Not checked		
}			
phy-ParametersXDD-Diff SEQUENCE {			
dynamicSFI	Not checked		
twoPUCCH-F0-2-ConsecSymbols	Not checked		
twoDifferentTPC-Loop-PUSCH	Not checked		
twoDifferentTPC-Loop-PUCCH	Not checked		
dl-SchedulingOffset-PDSCH-TypeA	Not checked		
dl-SchedulingOffset-PDSCH-TypeB	Not checked		
ul-SchedulingOffset	Not checked		
}			
phy-ParametersFRX-Diff SEQUENCE {			
dynamicSFI	Not checked		
dummy1	Not checked		
twoFL-DMRS	Not checked		
dummy2	Not checked		
dummy3	Not checked		
supportedDMRS-TypeDL	Not checked		
supportedDMRS-TypeUL	Not checked		
semiOpenLoopCSI	Not checked		
csi-ReportWithoutPMI	Not checked		
csi-ReportWithoutCQI	Not checked		
onePortsPTRS	Not checked		
twoPUCCH-F0-2-ConsecSymbols	Not checked		

pucch-F2-WithFH	supported		
pucch-F3-WithFH	supported		
pucch-F4-WithFH	Not checked		
freqHoppingPUCCH-F0-2	Not checked		
freqHoppingPUCCH-F1-3-4	Not checked		
mux-SR-HARQ-ACK-CSI-PUCCH-MultiPerSlot	Not checked		
uci-CodeBlockSegmentation	Not checked		
onePUCCH-LongAndShortFormat	Not checked		
twoPUCCH-AnyOthersInSlot	Not checked		
intraSlotFreqHopping-PUSCH	Not checked		
pusch-LBRM	Not checked		
pdccch-BlindDetectionCA	Not checked		
tpc-PUSCH-RNTI	Not checked		
tpc-PUCCH-RNTI	Not checked		
tpc-SRS-RNTI	Not checked		
absoluteTPC-Command	Not checked		
twoDifferentTPC-Loop-PUSCH	Not checked		
twoDifferentTPC-Loop-PUCCH	Not checked		
pusch-HalfPi-BPSK	Not checked		
pucch-F3-4-HalfPi-BPSK	Not checked		
almostContiguousCP-OFDM-UL	Not checked		
sp-CSI-RS	Not checked		
sp-CSI-IM	Not checked		
tdd-MultiDL-UL-SwitchPerSlot	Not checked		
multipleCORESET	Not checked		
csi-RS-IM-ReceptionForFeedback	Not checked	CSI-RS-IM-ReceptionForFeedback	
csi-RS-ProcFrameworkForSRS	Not checked	CSI-RS-ProcFrameworkForSRS	
csi-ReportFramework	Not checked	CSI-ReportFramework	
mux-SR-HARQ-ACK-CSI-PUCCH-OncePerSlot			
SEQUENCE {			
sameSymbol	Not checked		
diffSymbol	Not checked		
}			
mux-SR-HARQ-ACK-PUCCH	Not checked		
mux-MultipleGroupCtrlCH-Overlap	Not checked		
dl-SchedulingOffset-PDSCH-TypeA	Not checked		
dl-SchedulingOffset-PDSCH-TypeB	Not checked		
ul-SchedulingOffset	Not checked		
dl-64QAM-MCS-TableAlt	Not checked		
ul-64QAM-MCS-TableAlt	Not checked		
cqi-TableAlt	Not checked		
oneFL-DMRS-TwoAdditionalDMRS-UL	Not checked		
twoFL-DMRS-TwoAdditionalDMRS-UL	Not checked		
oneFL-DMRS-ThreeAdditionalDMRS-UL	Not checked		
}			
phy-ParametersFR1 SEQUENCE {			
pdccchMonitoringSingleOccasion	Not checked		
scs-60kHz	Not checked		
pdsch-256QAM-FR1	Checked		pc_pdsch_256QAM_FR1
pdsch-RE-MappingFR1-PerSymbol	Not checked		
pdsch-RE-MappingFR1-PerSlot	Not checked		
}			
phy-ParametersFR2 SEQUENCE {			
dummy	Not checked		
pdsch-RE-MappingFR2-PerSymbol	Not checked		
pCell-FR2	Not checked		
pdsch-RE-MappingFR2-PerSlot	Not checked		
}			
rf-Parameters SEQUENCE {			

supportedBandListNR SEQUENCE (SIZE (1..maxBands)) OF BandNR {			
BandNR[i] SEQUENCE {			
bandNR	Checked	Checked for 'maxBands' entries of FreqBandIndicator NR[i]	pc_nrBandx ('x' being the band number/type related PICS listed in TS 38.508-2)
modifiedMPR-Behaviour	Not checked		
mimo-ParametersPerBand	Not checked	MIMO-ParametersPerBand[i]	
extendedCP	Not checked		
multipleTCI	supported		
bwp-WithoutRestriction	Checked		pc_bwp_WithoutRestriction
bwp-SameNumerology	Not checked		
bwp-DiffNumerology	Not checked		
crossCarrierScheduling-SameSCS	Not checked		
pdsch-256QAM-FR2	Checked	Note 8	pc_pdsch_256QAM_FR2
pusch-256QAM	Checked	Note 9	pc_pusch_256QAM_FR1 OR pc_pusch_256QAM_FR2
ue-PowerClass	Not checked		
rateMatchingLTE-CRS	Not checked		
channelBWs-DL-v1530 CHOICE {			
fr1 SEQUENCE {			
scs-15kHz	Not checked		
scs-30kHz	Not checked		
scs-60kHz	Not checked		
}			
fr2 SEQUENCE {			
scs-60kHz	Not checked		
scs-120kHz	Not checked		
}			
}			
channelBWs-UL-v1530[i] CHOICE {			
fr1 SEQUENCE {			
scs-15kHz	Not checked		
scs-30kHz	Not checked		
scs-60kHz	Not checked		
}			
fr2 SEQUENCE {			
scs-60kHz	Not checked		
scs-120kHz	Not checked		
}			
maxUplinkDutyCycle-PC2-FR1	Not checked		
pucch-SpatialRelInfoMAC-CE	Not checked		
powerBoosting-pi2BPSK	Not checked		
maxUplinkDutyCycle-PC1dot5-MPE-FR1-r16	Checked		pc_nrBandx_maxUplinkDutyCycle_PC1dot5_MPE_FR1_r16 ('x' being the band number related PICS listed in Table

			A.4.3.1-4h of TS 38.508-2)
maxUplinkDutyCycle-FR2	Not checked		
channelBWs-DL-v1590	Not checked		
channelBWs-UL-v1590	Not checked		
asymmetricBandwidthCombinationSet	Not checked		
sharedSpectrumChAccessParamsPerBand-r16	Not checked		
cancelOverlappingPUSCH-r16	Not checked		
multipleRateMatchingEUTRA-CRS-r16	Not checked		
overlapRateMatchingEUTRA-CRS-r16	Not checked		
pdsch-MappingTypeB-Alt-r16	Not checked		
oneSlotPeriodicTRS-r16	Not checked		
olpc-SRS-Pos-r16	Not checked		
spatialRelationsSRS-Pos-r16	Not checked		
simulSRS-MIMO-TransWithinBand-r16	Not checked		
channelBW-DL-IAB-r16	Not checked		
channelBW-UL-IAB-r16	Not checked		
rasterShift7dot5-IAB-r16	Not checked		
ue-PowerClass-v1610	Not checked		
condHandover-r16	Checked		pc_condHandover_r16
condHandoverFailure-r16	Checked		pc_condHandoverFailure_r16
condHandoverTwoTriggerEvents-r16	Checked		pc_condHandoverTwoTriggerEvents_r16
condPSCellChange-r16	Checked		pc_condPSCellChange_r16
condPSCellChangeTwoTriggerEvents-r16	Not checked		
mpr-PowerBoost-FR2-r16	Not checked		
activeConfiguredGrant-r16	Not checked		
jointReleaseConfiguredGrantType2-r16	Not checked		
sps-r16	Not checked		
jointReleaseSPS-r16	Not checked		
simulSRS-TransWithinBand-r16	Not checked		
trs-AdditionalBandwidth-r16	Not checked		
handoverIntraF-IAB-r16	Not checked		
simulTX-SRS-AntSwitchingIntraBandUL-CA-r16	Not checked		
sharedSpectrumChAccessParamsPerBand-v1630	Not checked		
handoverUTRA-FDD-r16	Not checked		
enhancedUL-TransientPeriod-r16	Not checked		
sharedSpectrumChAccessParamsPerBand-v1640	Not checked		
type1-PUSCH-RepetitionMultiSlots-v1650	Not checked		
type2-PUSCH-RepetitionMultiSlots-v1650	Not checked		
pusch-RepetitionMultiSlots-v1650	Not checked		
configuredUL-GrantType1-v1650	Not checked		
configuredUL-GrantType2-v1650	Not checked		
sharedSpectrumChAccessParamsPerBand-v1650	Not checked		
enhancedSkipUplinkTxConfigured-v1660	Not checked		
enhancedSkipUplinkTxDynamic-v1660	Not checked		
}			
}			
supportedBandCombinationList SEQUENCE (SIZE (1..maxBandComb)) OF BandCombination {			
BandCombinationSEQUENCE {			
bandList SEQUENCE (SIZE (1..maxSimultaneousBands)) OF BandParameters {			
BandParameters CHOICE			
eutra SEQUENCE {			
bandEUTRA	Not checked	FreqBandIndicator EUTRA	

ca-BandwidthClassDL-EUTRA	Not checked	CA-BandwidthClassEUTRA	
ca-BandwidthClassUL-EUTRA	Not checked	CA-BandwidthClassEUTRA	
}			
nr SEQUENCE {			
bandNR	Not checked	FreqBandIndicatorNR	
ca-BandwidthClassDL-NR	Not checked	CA-BandwidthClassNR	
ca-BandwidthClassUL-NR	Not checked	CA-BandwidthClassNR	
}			
}			
}			
}			
featureSetCombination	Not checked	FeatureSetCombinationId	
ca-ParametersEUTRA	Not checked	CA-ParametersEUTRA	
ca-ParametersNR	Not checked	CA-ParametersNR	
mrdc-Parameters	Not checked	MRDC-Parameters	
supportedBandwidthCombinationSet	Not checked		
powerClass-v1530	Not checked		
}			
appliedFreqBandListFilter	Not checked	FreqBandList	
supportedBandCombinationList-v1540 SEQUENCE (SIZE (1..maxBandComb)) OF BandCombination-v1540 {		BandCombinationList-v1540	
BandCombination-v1540 SEQUENCE {			
bandList-v1540 SEQUENCE (SIZE (1..maxSimultaneousBands)) OF BandParameters-v1540 {	Not checked	BandParameters-v1540	
BandParameters-v1540 SEQUENCE {			
srs-CarrierSwitch CHOICE {			
nr SEQUENCE [NR bands	
srs-SwitchingTimesListNR SEQUENCE (SIZE (1..maxSimultaneousBands)) OF SRS-SwitchingTimeNR	Not checked		
}			
eutra SEQUENCE {		EUTRA bands	
srs-SwitchingTimesListEUTRA SEQUENCE (SIZE (1..maxSimultaneousBands)) OF SRS-SwitchingTimeEUTRA	Not checked		
}			
}			
srs-TxSwitch-v1540 SEQUENCE {			
supportedSRS-TxPortSwitch	Not checked		
txSwitchImpactToRx	Not checked		
txSwitchWithAnotherBand	Not checked		
}			
}			
}			
ca-ParametersNR-v1540[i]	Not checked	CA-ParametersNR-v1540	
}			
}			
srs-SwitchingTimeRequested	Not checked		

supportedBandCombinationList-v1550	Not checked	BandCombination List-v1550	
supportedBandCombinationList-v1560	Not checked	BandCombination List-v1560	
supportedBandCombinationList-v1610 SEQUENCE (SIZE (1..maxBandComb)) OF BandCombination-v1610 {		BandCombination List-v1610	
BandCombination-v1610 SEQUENCE {			
bandList-v1610 SEQUENCE (SIZE (1..maxSimultaneousBands)) OF BandParameters-v1610 {			
ca-ParametersNR-v1610	Checked	CA-ParametersNR-v1610 (Table 8.1.5.1.1.3.3-8	
ca-ParametersNRDC-v1610	Not checked	CA-ParametersNRDC-v1610	
powerClass-v1610	Not checked		
powerClassNRPart-r16	Not checked		
featureSetCombinationDAPS-r16	Not checked	FeatureSetCombinationId	
mrdc-Parameters-v1620	Not checked	MRDC-Parameters-v1620	
}			
}			
}			
supportedBandCombinationListSidelinkEUTRA-NR-r16	Not checked	BandCombination ListSidelinkEUTRA-NR-r16	
supportedBandCombinationList-UplinkTxSwitch-r16	Not checked	BandCombination List-UplinkTxSwitch-r16	
supportedBandCombinationList-v1630	Not checked	BandCombination List-v1630	
supportedBandCombinationListSidelinkEUTRA-NR-v1630	Not checked	BandCombination ListSidelinkEUTRA-NR-v1630	
supportedBandCombinationList-UplinkTxSwitch-v1630	Not checked	BandCombination List-UplinkTxSwitch-v1630	
supportedBandCombinationList-v1640	Not checked	BandCombination List-v1640	
supportedBandCombinationList-UplinkTxSwitch-v1640	Not checked	BandCombination List-UplinkTxSwitch-v1640	
supportedBandCombinationList-v1650	Not checked	BandCombination List-v1650	
supportedBandCombinationList-UplinkTxSwitch-v1650	Not checked	BandCombination List-UplinkTxSwitch-v1650	
extendedBand-n77-r16	Not checked		
}			
measAndMobParameters SEQUENCE {			
measAndMobParametersCommon SEQUENCE {			
supportedGapPattern	Not checked		
ssb-RLM	supported		
ssb-AndCSI-RS-RLM	Not checked		
eventB-MeasAndReport	Checked		pc_eventB-MeasAndReport
handoverFDD-TDD	Not checked		

eutra-CGI-Reporting	Checked		pc_eutra_CGI_Reporting
nr-CGI-Reporting	Checked		pc_nr_CGI_Reporting
independentGapConfig	Checked		pc_independentGapConfig
periodicEUTRA-MeasAndReport	Checked		pc_periodicEUTRA_MeasAndReport
handoverFR1-FR2	Not checked		
maxNumberCSI-RS-RRM-RS-SINR	Not checked		
nr-CGI-Reporting-ENDC	Not checked		
eutra-CGI-Reporting-NEDC	Not checked		
eutra-CGI-Reporting-NRDC	Not checked		
nr-CGI-Reporting-NEDC	Not checked		
nr-CGI-Reporting-NRDC	Not checked		
reportAddNeighMeasForPeriodic-r16	Not checked		
condHandoverParametersCommon-r16	Not checked		
nr-NeedForGap-Reporting-r16	Not checked		
supportedGapPattern-NRonly-r16	Not checked		
supportedGapPattern-NRonly-NEDC-r16	Not checked		
maxNumberCLI-RSSI-r16	Not checked		
maxNumberCLI-SRS-RSRP-r16	Not checked		
maxNumberPerSlotCLI-SRS-RSRP-r16	Not checked		
mfbI-IAB-r16	Not checked		
dummy	Not checked		
nr-CGI-Reporting-NPN-r16	Checked		pc_nr_CGI_Reporting_NPN_r16
idleInactiveEUTRA-MeasReport-r16	Not checked		
idleInactive-ValidityArea-r16	Not checked		
eutra-AutonomousGaps-r16	Not checked		
eutra-AutonomousGaps-NEDC-r16	Not checked		
eutra-AutonomousGaps-NRDC-r16	Not checked		
pCellT312-r16	Not checked		
supportedGapPattern-r16	Not checked		
}			
measAndMobParametersXDD-Diff SEQUENCE {			
intraAndInterF-MeasAndReport	Checked (NOTE 1)		pc_intraAndInterF-MeasAndReport
eventA-MeasAndReport	Checked (NOTE 2)		pc_eventA-MeasAndReport
handoverInterF	Checked (NOTE 15)		pc_handoverInterF
handoverLTE-EPC	Not checked		
handoverLTE-5GC	Not checked		
sftd-MeasNR-Neigh	Checked (NOTE 13)		pc_SFTD_MeasNR_Neigh_FDD and/or pc_SFTD_MeasNR_Neigh_TDD
sftd-MeasNR-Neigh-DRX	Not checked		
dummy	Not checked		
}			
measAndMobParametersFRX-Diff SEQUENCE {			
ss-SINR-Meas	Checked (NOTE 10)		pc_ss_SINR_Meas

csi-RSRP-AndRSRQ-MeasWithSSB	Checked (NOTE 3)		pc_csi-RSRP-AndRSRQ-MeasWithSSB
csi-RSRP-AndRSRQ-MeasWithoutSSB	Checked (NOTE 11)		pc_csi_RSRP_AndRSRQ_MeasWithoutSSB
csi-SINR-Meas	Not checked		
csi-RS-RLM	Not checked		
handoverInterF	Checked (NOTE 14)		pc_handoverInterF
handoverLTE-EPC	Not checked		
handoverLTE-5GC	Not checked		
maxNumberResource-CSI-RS-RLM	Not checked		
simultaneousRxDataSSB-DiffNumerology	Not checked		
nr-AutonomousGaps-r16	Not checked		
nr-AutonomousGaps-ENDC-r16	Not checked		
nr-AutonomousGaps-NEDC-r16	Not checked		
nr-AutonomousGaps-NRDC-r16	Not checked		
dummy	Not checked		
cli-RSSI-Meas-r16	Not checked		
cli-SRS-RSRP-Meas-r16	Not checked		
interFrequencyMeas-NoGap-r16	Not checked		
simultaneousRxDataSSB-DiffNumerology-Inter-r16	Not checked		
idleInactiveNR-MeasReport-r16	Not checked		
idleInactiveNR-MeasBeamReport-r16	Not checked		
increasedNumberOfCSIRSPerMO-r16	Not checked		
}			
}			
fdd-Add-UE-NR-Capabilities SEQUENCE {			
phy-ParametersXDD-Diff SEQUENCE {			
dynamicSFI	Not checked		
twoPUCCH-F0-2-ConsecSymbols	Not checked		
twoDifferentTPC-Loop-PUSCH	Not checked		
twoDifferentTPC-Loop-PUCCH	Not checked		
dl-SchedulingOffset-PDSCH-TypeA	Not checked		
dl-SchedulingOffset-PDSCH-TypeB	Not checked		
ul-SchedulingOffset	Not checked		
}			
mac-ParametersXDD-Diff SEQUENCE {			
skipUplinkTxDynamic	Checked (NOTE 4)		pc_skipUplinkTxDynamic
logicalChannelSR-DelayTimer	Checked (NOTE 5)		pc_logicalChannelSR-DelayTimer
longDRX-Cycle	Checked (NOTE 6)		pc_longDRX-Cycle
shortDRX-Cycle	Checked (NOTE 7)		pc_shortDRX-Cycle
multipleSR-Configurations	Not checked		
multipleConfiguredGrants	Checked (NOTE 12)		pc_multipleConfiguredGrants_r16
}			
measAndMobParametersXDD-Diff SEQUENCE {			
intraAndInterF-MeasAndReport	Checked (NOTE 1)		pc_intraAndInterF-MeasAndReport
eventA-MeasAndReport	Checked (NOTE 2)		pc_eventA-MeasAndReport

handoverInterF	Checked (NOTE 15)		pc_ handoverInterF
handoverLTE-EPC	Not checked		
handoverLTE-5GC	Not checked		
sftd-MeasNR-Neigh	Checked (NOTE 13)		pc_SFTD_M easNR_Neigh_FDD and/or pc_SFTD_M easNR_Neigh_TDD
sftd-MeasNR-Neigh-DRX	Not checked		
dummy	Not checked		
}			
}			
tdd-Add-UE-NR-Capabilities SEQUENCE {			
phy-ParametersXDD-Diff SEQUENCE {			
dynamicSFI	Not checked		
twoPUCCH-F0-2-ConsecSymbols	Not checked		
twoDifferentTPC-Loop-PUSCH	Not checked		
twoDifferentTPC-Loop-PUCCH	Not checked		
dl-SchedulingOffset-PDSCH-TypeA	Not checked		
dl-SchedulingOffset-PDSCH-TypeB	Not checked		
ul-SchedulingOffset	Not checked		
}			
mac-ParametersXDD-Diff SEQUENCE {			
skipUplinkTxDynamic	Checked (NOTE 4)		pc_skipUplinkTxDynamic
logicalChannelSR-DelayTimer	Checked (NOTE 5)		pc_logicalChannelSR_DelayTimer
longDRX-Cycle	Checked (NOTE 6)		pc_longDRX_Cycle
shortDRX-Cycle	Checked (NOTE 7)		pc_shortDRX_Cycle
multipleSR-Configurations	Not checked		
multipleConfiguredGrants	Checked (NOTE 12)		pc_multipleConfiguredGrants_r16
}			
measAndMobParametersXDD-Diff SEQUENCE {			
intraAndInterF-MeasAndReport	Checked (NOTE 1)		pc_intraAndInterF-MeasAndReport
eventA-MeasAndReport	Checked (NOTE 2)		pc_eventA-MeasAndReport
handoverInterF	Checked (NOTE 15)		pc_ handoverInterF
handoverLTE-EPC	Not checked		
handoverLTE-5GC	Not checked		
sftd-MeasNR-Neigh	Checked (NOTE 13)		pc_SFTD_M easNR_Neigh_FDD and/or pc_SFTD_M easNR_Neigh_TDD
sftd-MeasNR-Neigh-DRX	Not checked		
dummy	Not checked		
}			
fr1-Add-UE-NR-Capabilities SEQUENCE {			
phy-ParametersFRX-Diff SEQUENCE {			
dynamicSFI	Not checked		

dummy1	Not checked		
twoFL-DMRS	Not checked		
dummy2	Not checked		
dummy3	Not checked		
supportedDMRS-TypeDL	Not checked		
supportedDMRS-TypeUL	Not checked		
semiOpenLoopCSI	Not checked		
csi-ReportWithoutPMI	Not checked		
csi-ReportWithoutCQI	Not checked		
onePortsPTRS	Not checked		
twoPUCCH-F0-2-ConsecSymbols	Not checked		
pucch-F2-WithFH	Not checked		
pucch-F3-WithFH	Not checked		
pucch-F4-WithFH	Not checked		
freqHoppingPUCCH-F0-2	Not checked		
freqHoppingPUCCH-F1-3-4	Not checked		
mux-SR-HARQ-ACK-CSI-PUCCH-MultiPerSlot	Not checked		
uci-CodeBlockSegmentation	Not checked		
onePUCCH-LongAndShortFormat	Not checked		
twoPUCCH-AnyOthersInSlot	Not checked		
intraSlotFreqHopping-PUSCH	Not checked		
pusch-LBRM	Not checked		
pdccch-BlindDetectionCA	Not checked		
tpc-PUSCH-RNTI	Not checked		
tpc-PUCCH-RNTI	Not checked		
tpc-SRS-RNTI	Not checked		
absoluteTPC-Command	Not checked		
twoDifferentTPC-Loop-PUSCH	Not checked		
twoDifferentTPC-Loop-PUCCH	Not checked		
pusch-HalfPi-BPSK	Not checked		
pucch-F3-4-HalfPi-BPSK	Not checked		
almostContiguousCP-OFDM-UL	Not checked		
sp-CSI-RS	Not checked		
sp-CSI-IM	Not checked		
tdd-MultiDL-UL-SwitchPerSlot	Not checked		
multipleCORESET	Not checked		
csi-RS-IM-ReceptionForFeedback	Not checked		
csi-RS-ProcFrameworkForSRS	Not checked		
csi-ReportFramework	Not checked		
mux-SR-HARQ-ACK-CSI-PUCCH-OncePerSlot			
SEQUENCE {			
sameSymbol	Not checked		
diffSymbol	Not checked		
}			
mux-SR-HARQ-ACK-PUCCH	Not checked		
mux-MultipleGroupCtrlCH-Overlap	Not checked		
dl-SchedulingOffset-PDSCH-TypeA	Not checked		
dl-SchedulingOffset-PDSCH-TypeB	Not checked		
ul-SchedulingOffset	Not checked		
dl-64QAM-MCS-TableAlt	Not checked		
ul-64QAM-MCS-TableAlt	Not checked		
cqi-TableAlt	Not checked		
oneFL-DMRS-TwoAdditionalDMRS-UL	Not checked		
twoFL-DMRS-TwoAdditionalDMRS-UL	Not checked		
oneFL-DMRS-ThreeAdditionalDMRS-UL	Not checked		
}			
measAndMobParametersFRX-Diff SEQUENCE {			
ss-SINR-Meas	Checked (NOTE 10)		pc_ss_SINR_Meas
csi-RSRP-AndRSRQ-MeasWithSSB	Checked (NOTE 3)		pc_csi-RSRP-AndRSRQ-MeasWithSSB
csi-RSRP-AndRSRQ-MeasWithoutSSB	Checked (NOTE 11)		pc_csi_RSRP_AndRSR

			Q_MeasWith outSSB
csi-SINR-Meas	Not checked		
csi-RS-RLM	Not checked		
handoverInterF	Checked (NOTE 14)		pc_ handoverInte rF
handoverLTE-EPC	Not checked		
handoverLTE-5GC	Not checked		
maxNumberResource-CSI-RS-RLM	Not checked		
simultaneousRxDataSSB-DiffNumerology	Not checked		
nr-AutonomousGaps-r16	Not checked		
nr-AutonomousGaps-ENDC-r16	Not checked		
nr-AutonomousGaps-NEDC-r16	Not checked		
nr-AutonomousGaps-NRDC-r16	Not checked		
dummy	Not checked		
cli-RSSI-Meas-r16	Not checked		
cli-SRS-RSRP-Meas-r16	Not checked		
interFrequencyMeas-NoGap-r16	Not checked		
simultaneousRxDataSSB-DiffNumerology-Inter- r16	Not checked		
idleInactiveNR-MeasReport-r16	Not checked		
idleInactiveNR-MeasBeamReport-r16	Not checked		
increasedNumberOfCSIRSPerMO-r16	Not checked		
}			
}			
fr2-Add-UE-NR-Capabilities SEQUENCE {			
phy-ParametersFRX-Diff SEQUENCE {	Not checked		
dynamicSFI	Not checked		
dummy1	Not checked		
twoFL-DMRS	Not checked		
dummy2	Not checked		
dummy3	Not checked		
supportedDMRS-TypeDL	Not checked		
supportedDMRS-TypeUL	Not checked		
semiOpenLoopCSI	Not checked		
csi-ReportWithoutPMI	Not checked		
csi-ReportWithoutCQI	Not checked		
onePortsPTRS	Not checked		
twoPUCCH-F0-2-ConsecSymbols	Not checked		
pucch-F2-WithFH	Not checked		
pucch-F3-WithFH	Not checked		
pucch-F4-WithFH	Not checked		
freqHoppingPUCCH-F0-2	Not checked		
freqHoppingPUCCH-F1-3-4	Not checked		
mux-SR-HARQ-ACK-CSI-PUCCH-MultiPerSlot	Not checked		
uci-CodeBlockSegmentation	Not checked		
onePUCCH-LongAndShortFormat	Not checked		
twoPUCCH-AnyOthersInSlot	Not checked		
intraSlotFreqHopping-PUSCH	Not checked		
pusch-LBRM	Not checked		
pdcch-BlindDetectionCA	Not checked		
tpc-PUSCH-RNTI	Not checked		
tpc-PUCCH-RNTI	Not checked		
tpc-SRS-RNTI	Not checked		
absoluteTPC-Command	Not checked		
twoDifferentTPC-Loop-PUSCH	Not checked		
twoDifferentTPC-Loop-PUCCH	Not checked		
pusch-HalfPi-BPSK	Not checked		
pucch-F3-4-HalfPi-BPSK	Not checked		
almostContiguousCP-OFDM-UL	Not checked		
sp-CSI-RS	Not checked		
sp-CSI-IM	Not checked		
tdd-MultiDL-UL-SwitchPerSlot	Not checked		
multipleCORESET	Not checked		

csi-RS-IM-ReceptionForFeedback	Not checked		
csi-RS-ProcFrameworkForSRS	Not checked		
csi-ReportFramework	Not checked		
mux-SR-HARQ-ACK-CSI-PUCCH-OncePerSlot SEQUENCE {			
sameSymbol	Not checked		
diffSymbol	Not checked		
}			
mux-SR-HARQ-ACK-PUCCH	Not checked		
mux-MultipleGroupCtrlCH-Overlap	Not checked		
dl-SchedulingOffset-PDSCH-TypeA	Not checked		
dl-SchedulingOffset-PDSCH-TypeB	Not checked		
ul-SchedulingOffset	Not checked		
dl-64QAM-MCS-TableAlt	Not checked		
ul-64QAM-MCS-TableAlt	Not checked		
cqi-TableAlt	Not checked		
oneFL-DMRS-TwoAdditionalDMRS-UL	Not checked		
twoFL-DMRS-TwoAdditionalDMRS-UL	Not checked		
oneFL-DMRS-ThreeAdditionalDMRS-UL	Not checked		
}			
measAndMobParametersFRX-Diff SEQUENCE {			
ss-SINR-Meas	Checked (NOTE 10)		pc_ss_SINR_Meas
csi-RSRP-AndRSRQ-MeasWithSSB	Checked (NOTE 3)		pc_csi-RSRP-AndRSRQ-MeasWithSSB
csi-RSRP-AndRSRQ-MeasWithoutSSB	Checked (NOTE 11)		pc_csi_RSRP-AndRSRQ-MeasWithoutSSB
csi-SINR-Meas	Not checked		
csi-RS-RLM	Not checked		
handoverInterF	Checked (NOTE 14)		pc_handoverInterF
handoverLTE-EPC	Not checked		
handoverLTE-5GC	Not checked		
maxNumberResource-CSI-RS-RLM	Not checked		
simultaneousRxDataSSB-DiffNumerology	Not checked		
nr-AutonomousGaps-r16	Not checked		
nr-AutonomousGaps-ENDC-r16	Not checked		
nr-AutonomousGaps-NEDC-r16	Not checked		
nr-AutonomousGaps-NRDC-r16	Not checked		
dummy	Not checked		
cli-RSSI-Meas-r16	Not checked		
cli-SRS-RSRP-Meas-r16	Not checked		
interFrequencyMeas-NoGap-r16	Not checked		
simultaneousRxDataSSB-DiffNumerology-Inter-r16	Not checked		
idleInactiveNR-MeasReport-r16	Not checked		
idleInactiveNR-MeasBeamReport-r16	Not checked		
increasedNumberOfCSIRSPerMO-r16	Not checked		
}			
}			
featureSets SEQUENCE {			
featureSetsDownlink SEQUENCE (SIZE (1..maxDownlinkFeatureSets)) OF FeatureSetDownlink {			
FeatureSetDownlink SEQUENCE {	Not checked		
featureSetListPerDownlinkCC	Not checked		
intraBandFreqSeparationDL	Not checked		
scalingFactor	Not checked		
crossCarrierScheduling-OtherSCS	Not checked		
scellWithoutSSB	Not checked		

csi-RS-MeasSCellWithoutSSB	Not checked		
dummy1	Not checked		
type1-3-CSS	Not checked		
pdccch-MonitoringAnyOccasions	Not checked		
dummy2	Not checked		
ue-SpecificUL-DL-Assignment	Not checked		
searchSpaceSharingCA-DL	Not checked		
timeDurationForQCL SEQUENCE {			
scs-60kHz	Not checked		
scs-120kHz	Not checked		
}			
pdsch-ProcessingType1-DifferentTB-PerSlot SEQUENCE {			
scs-15kHz	Not checked		
scs-30kHz	Not checked		
scs-60kHz	Not checked		
scs-120kHz	Not checked		
}			
dummy3	Not checked		
dummy4	Not checked		
dummy5	Not checked		
dummy6	Not checked		
dummy7	Not checked		
}			
featureSetsDownlinkPerCC SEQUENCE (SIZE (1..maxPerCC-FeatureSets)) OF FeatureSetDownlinkPerCC {			
FeatureSetDownlinkPerCCSEQUENCE {			
supportedSubcarrierSpacingDL	Not checked	SubcarrierSpacing	
supportedBandwidthDL	Not checked	SupportedBandwidth	
channelBW-90mhz	Not checked		
maxNumberMIMO-LayersPDSCH	Not checked	MIMO-LayersDL	
supportedModulationOrderDL	Not checked	ModulationOrder	
}			
featureSetsUplink SEQUENCE (SIZE (1..maxUplinkFeatureSets)) OF FeatureSetUplink {			
FeatureSetUplink SEQUENCE {			
featureSetListPerUplinkCC	Not checked		
scalingFactor	Not checked		
crossCarrierScheduling-OtherSCS	Not checked		
intraBandFreqSeparationUL	Not checked		
searchSpaceSharingCA-UL	Not checked		
dummy1	Not checked		
supportedSRS-Resources	Not checked	SRS-Resources	
twoPUCCH-Group	Not checked		
dynamicSwitchSUL	Checked		pc_dynamic Switch_SUL
simultaneousTxSUL-NonSUL	Not checked		
pusch-ProcessingType1-DifferentTB-PerSlot SEQUENCE {			
scs-15kHz	Not checked		
scs-30kHz	Not checked		
scs-60kHz	Not checked		
scs-120kHz	Not checked		
}			
dummy2	Not checked		
}			
featureSetsUplinkPerCC SEQUENCE (SIZE (1..maxPerCC-FeatureSets)) OF FeatureSetUplinkPerCC {			
FeatureSetUplinkPerCCSEQUENCE {			
supportedSubcarrierSpacingUL	Not checked	SubcarrierSpacing	

supportedBandwidthUL	Not checked	SupportedBandwidth	
channelBW-90mHz	Not checked		
mimo-CB-PUSCH SEQUENCE {			
maxNumberMIMO-LayersCB-PUSCH	Not checked		
maxNumberSRS-ResourcePerSet	Not checked		
}			
maxNumberMIMO-LayersNonCB-PUSCH	Not checked		
supportedModulationOrderUL	Not checked	ModulationOrder	
}			
}			
featureSetsDownlink-v1540 SEQUENCE (SIZE (1..maxDownlinkFeatureSets)) OF FeatureSetDownlink-v1540 {			
FeatureSetDownlink-v1540 SEQUENCE {			
oneFL-DMRS-TwoAdditionalDMRS-DL	Not checked		
additionalDMRS-DL-Alt	Not checked		
twoFL-DMRS-TwoAdditionalDMRS-DL	Not checked		
oneFL-DMRS-ThreeAdditionalDMRS-DL	Not checked		
pdcch-MonitoringAnyOccasionsWithSpanGap			
SEQUENCE {			
scs-15kHz	Not checked		
scs-30kHz	Not checked		
scs-60kHz	Not checked		
scs-120kHz	Not checked		
}			
pdsch-SeparationWithGap	Not checked		
pdsch-ProcessingType2 SEQUENCE {			
scs-15kHz	Not checked		
scs-30kHz	Not checked		
scs-60kHz	Not checked		
}			
pdsch-ProcessingType2-Limited SEQUENCE {			
differentTB-PerSlot-SCS-30kHz	Not checked		
}			
dl-MCS-TableAlt-DynamicIndication	Not checked		
}			
}			
featureSetsUplink-v1540 SEQUENCE (SIZE (1..maxUplinkFeatureSets)) OF FeatureSetUplink-v1540 {			
FeatureSetUplink-v1540 SEQUENCE {			
zeroSlotOffsetAperiodicSRS	Not checked		
pa-PhaseDiscontinuityImpacts	Not checked		
pusch-SeparationWithGap	Not checked		
pusch-ProcessingType2 SEQUENCE {			
scs-15kHz	Not checked		
scs-30kHz	Not checked		
scs-60kHz	Not checked		
}			
ul-MCS-TableAlt-DynamicIndication	Not checked		
}			
}			
featureSetsUplinkPerCC-v1540 SEQUENCE (SIZE (1..maxPerCC-FeatureSets)) OF FeatureSetUplinkPerCC-v1540 {			
FeatureSetUplinkPerCC-v1540 SEQUENCE {			
mimo-NonCB-PUSCH SEQUENCE {			
maxNumberSRS-ResourcePerSet	Not checked		
maxNumberSimultaneousSRS-ResourceTx	Not checked		
}			
}			
}			
}			

nr-HO-ToEN-DC-r16	Checked		pc_interRAT_NR_ToENDC
}			
eutra-ParametersXDD-Diff SEQUENCE {			
rsrqMeasWidebandEUTRA	Not checked		
}			
}			
inactiveState	Checked		pc_inactiveState
delayBudgetReporting	Not checked		
nonCriticalExtension SEQUENCE {			
sdap-Parameters SEQUENCE {			
as-ReflectiveQoS	Checked		pc_as_ReflectiveQoS
}			
overheatingInd	Not checked		
ims-Parameters SEQUENCE {			
ims-ParametersCommon SEQUENCE {			
voiceOverEUTRA-5GC	Not checked		
voiceOverSCG-BearerEUTRA-5GC	Not checked		
voiceFallbackIndicationEPS-r16	Checked		pc_voiceFallbackIndication
}			
ims-ParametersFRX-Diff SEQUENCE {			
voiceOverNR	Checked (NOTE 16)		pc_voiceOverNR
}			
}			
fr1-Add-UE-NR-Capabilities-v1540 SEQUENCE {			
ims-ParametersFRX-Diff SEQUENCE {			
voiceOverNR	Checked (NOTE 16)		pc_voiceOverNR
}			
}			
fr2-Add-UE-NR-Capabilities-v1540 SEQUENCE {			
ims-ParametersFRX-Diff SEQUENCE {			
voiceOverNR	Checked (NOTE 16)		pc_voiceOverNR
}			
}			
fr1-fr2-Add-UE-NR-Capabilities SEQUENCE {			
phy-ParametersFRX-Diff SEQUENCE {			
dynamicSFI	Not checked		
dummy1	Not checked		
twoFL-DMRS	Not checked		
dummy2	Not checked		
dummy3	Not checked		
supportedDMRS-TypeDL	Not checked		
supportedDMRS-TypeUL	Not checked		
semiOpenLoopCSI	Not checked		
csi-ReportWithoutPMI	Not checked		
csi-ReportWithoutCQI	Not checked		
onePortsPTRS	Not checked		
twoPUCCH-F0-2-ConsecSymbols	Not checked		
pucch-F2-WithFH	Not checked		
pucch-F3-WithFH	Not checked		
pucch-F4-WithFH	Not checked		
freqHoppingPUCCH-F0-2	Not checked		
freqHoppingPUCCH-F1-3-4	Not checked		
mux-SR-HARQ-ACK-CSI-PUCCH-MultiPerSlot	Not checked		
uci-CodeBlockSegmentation	Not checked		
onePUCCH-LongAndShortFormat	Not checked		
twoPUCCH-AnyOthersInSlot	Not checked		

intraSlotFreqHopping-PUSCH	Not checked		
pusch-LBRM	Not checked		
pdccch-BlindDetectionCA	Not checked		
tpc-PUSCH-RNTI	Not checked		
tpc-PUCCH-RNTI	Not checked		
tpc-SRS-RNTI	Not checked		
absoluteTPC-Command	Not checked		
twoDifferentTPC-Loop-PUSCH	Not checked		
twoDifferentTPC-Loop-PUCCH	Not checked		
pusch-HalfPi-BPSK	Not checked		
pucch-F3-4-HalfPi-BPSK	Not checked		
almostContiguousCP-OFDM-UL	Not checked		
sp-CSI-RS	Not checked		
sp-CSI-IM	Not checked		
tdd-MultiDL-UL-SwitchPerSlot	Not checked		
multipleCORESET	Not checked		
csi-RS-IM-ReceptionForFeedback	Not checked	CSI-RS-IM-ReceptionForFeedback	
csi-RS-ProcFrameworkForSRS	Not checked	CSI-RS-ProcFrameworkForSRS	
csi-ReportFramework	Not checked	CSI-ReportFramework	
mux-SR-HARQ-ACK-CSI-PUCCH-OncePerSlot SEQUENCE {			
sameSymbol	Not checked		
diffSymbol	Not checked		
}			
mux-SR-HARQ-ACK-PUCCH	Not checked		
mux-MultipleGroupCtrlCH-Overlap	Not checked		
dl-SchedulingOffset-PDSCH-TypeA	Not checked		
dl-SchedulingOffset-PDSCH-TypeB	Not checked		
ul-SchedulingOffset	Not checked		
dl-64QAM-MCS-TableAlt	Not checked		
ul-64QAM-MCS-TableAlt	Not checked		
cqi-TableAlt	Not checked		
oneFL-DMRS-TwoAdditionalDMRS-UL	Not checked		
twoFL-DMRS-TwoAdditionalDMRS-UL	Not checked		
oneFL-DMRS-ThreeAdditionalDMRS-UL	Not checked		
}			
measAndMobParametersFRX-Diff SEQUENCE {			
ss-SINR-Meas	Checked (NOTE 10)		pc_ss_SINR_Meas
csi-RSRP-AndRSRQ-MeasWithSSB	Checked (NOTE 3)		pc_csi-RSRP-AndRSRQ-MeasWithSSB
csi-RSRP-AndRSRQ-MeasWithoutSSB	Checked (NOTE 11)		pc_csi_RSRP-AndRSRQ-MeasWithoutSSB
csi-SINR-Meas	Not checked		
csi-RS-RLM	Not checked		
handoverInterF	Checked (NOTE 14)		pc_handoverInterF
handoverLTE-EPC	Not checked		
handoverLTE-5GC	Not checked		
maxNumberResource-CSI-RS-RLM	Not checked		
simultaneousRxDataSSB-DiffNumerology	Not checked		
nr-AutonomousGaps-r16	Not checked		
nr-AutonomousGaps-ENDC-r16	Not checked		
nr-AutonomousGaps-NEDC-r16	Not checked		
nr-AutonomousGaps-NRDC-r16	Not checked		

dummy	Not checked		
cli-RSSI-Meas-r16	Not checked		
cli-SRS-RSRP-Meas-r16	Not checked		
interFrequencyMeas-NoGap-r16	Not checked		
simultaneousRxDataSSB-DiffNumerology-Inter-r16	Not checked		
idleInactiveNR-MeasReport-r16	Not checked		
idleInactiveNR-MeasBeamReport-r16	Not checked		
increasedNumberOfCSIRSPerMO-r16	Not checked		
}			
}			
nonCriticalExtension SEQUENCE {		UE-NR-Capability-v1550	
reducedCP-Latency	Checked		pc_reduced CP_Latency
nonCriticalExtension SEQUENCE {		UE-NR-Capability-v1560	
nrdc-Parameters	Not checked	NRDC-Parameters	
receivedFilters	Not checked		
nonCriticalExtension SEQUENCE {		UE-NR-Capability-v1570	
nrdc-Parameters-v1570	Not checked	NRDC-Parameters-v1570	
nonCriticalExtension SEQUENCE {		UE-NR-Capability-v1610	
inDeviceCoexInd-r16	Not checked		
dl-DedicatedMessageSegmentation-r16	Not checked		
nrdc-Parameters-v1610	Not checked		
powSav-Parameters-r16	Checked	PowSav-Parameters-r16 (Table 8.1.5.1.1.3.3-9)	
fr1-Add-UE-NR-Capabilities-v1610	Not checked		
fr2-Add-UE-NR-Capabilities-v1610	Not checked		
bh-RLF-Indication-r16	Not checked		
directSN-AdditionFirstRRC-IAB-r16	Not checked		
bap-Parameters-r16	Not checked		
referenceTimeProvision-r16	Not checked		
sidelinkParameters-r16 SEQUENCE {			
sidelinkParametersNR-r16 {			
rlc-ParametersSidelink-r16	Not checked		
mac-ParametersSidelink-r16	Not checked		
fdd-Add-UE-Sidelink-Capabilities-r16	Not checked		
tdd-Add-UE-Sidelink-Capabilities-r16	Not checked		
supportedBandListSidelink-r16 SEQUENCE (SIZE (1..maxBands)) OF BandSidelink-r16 {			
freqBandSidelink-r16	Not checked		
sl-Reception-r16	Not checked		
sl-TransmissionMode1-r16	Not checked		
sync-Sidelink-r16	Not checked		
sl-Tx-256QAM-r16	Not checked		
psfch-FormatZeroSidelink-r16	Not checked		
lowSE-64QAM-MCS-TableSidelink-r16	Not checked		
enb-sync-Sidelink-r16	Not checked		
sl-TransmissionMode2-r16	Checked	38.306, 4.2.16.1.6: Support of this feature is mandatory if UE supports NR sidelink	pc_NR_sl_Tr ansmissionM ode2_r16
congestionControlSidelink-r16	Not checked		
fewerSymbolSlotSidelink-r16	Not checked		
sl-openLoopPC-RSRP-ReportSidelink-r16	Not checked		
sl-Rx-256QAM-r16	Not checked		

}			
}			
sidelinkParametersEUTRA-r16	Not checked		
}			
highSpeedParameters-r16	Not checked		
mac-Parameters-v1610	Not checked		
mcgRLF-RecoveryViaSCG-r16	Not checked		
resumeWithStoredMCG-SCells-r16	Not checked		
resumeWithStoredSCG-r16	Not checked		
resumeWithSCG-Config-r16	Not checked		
ue-BasedPerfMeas-Parameters-r16	Checked	UE- BasedPerfMeas- Parameters-r16 (Table 8.1.5.1.1.3.3-10)	
son-Parameters-r16 {			
rach-Report-r16	Checked		pc_rachRep ort_r16
}			
onDemandSIB-Connected-r16	Not checked		
nonCriticalExtension SEQUENCE {}	Not checked		
}			
}			
}			
}			
}			
nonCriticalExtension SEQUENCE {}	Not checked		
}			
}			

Note 1: If the UE is single mode (FDD or TDD), or the UE is dual mode (FDD and TDD) and *intraAndInterF-MeasAndReport* is supported in both modes, then support of *intraAndInterF-MeasAndReport* will be signaled in *measAndMobParameters/measAndMobParametersXDD-Diff*.
If the UE is dual mode (FDD + TDD) and *intraAndInterF-MeasAndReport* is only supported in one mode, then support of *intraAndInterF-MeasAndReport* will be signaled in one of *fdd-Add-UE-NR-Capabilities/measAndMobParametersXDD-Diff* or *tdd-Add-UE-NR-Capabilities/measAndMobParametersXDD-Diff* as appropriate.)

Note 2: If the UE is single mode (FDD or TDD), or the UE is dual mode (FDD and TDD) and *eventA-MeasAndReport* is supported in both modes, then support of *eventA-MeasAndReport* will be signaled in *measAndMobParameters/measAndMobParametersXDD-Diff*.
If the UE is dual mode (FDD + TDD) and *eventA-MeasAndReport* is only supported in one mode, then support of *eventA-MeasAndReport* will be signaled in one of *fdd-Add-UE-NR-Capabilities/measAndMobParametersXDD-Diff* or *tdd-Add-UE-NR-Capabilities/measAndMobParametersXDD-Diff* as appropriate.

Note 3: If the UE supports single frequency range (FR1 or FR2), or the UE supports both frequency ranges (FR1 and FR2) and *csi-RSRP-AndRSRQ-MeasWithSSB* is supported in both frequency ranges, then support of *csi-RSRP-AndRSRQ-MeasWithSSB* will be signaled in *measAndMobParameters/MeasAndMobParametersFRX-Diff*.
If the UE supports both frequency ranges (FR1 + FR2) and *csi-RSRP-AndRSRQ-MeasWithSSB* is only supported in one frequency range, then support of *csi-RSRP-AndRSRQ-MeasWithSSB* will be signaled in one of *fr1-Add-UE-NR-Capabilities/measAndMobParametersFRX-Diff* or *fr2-Add-UE-NR-Capabilities/measAndMobParametersFRX-Diff* as appropriate.)

Note 4: If the UE is single mode (FDD or TDD), or the UE is dual mode (FDD and TDD) and *skipUplinkTxDynamic* is supported in both modes, then support of *skipUplinkTxDynamic* will be signaled in *mac-Parameters/mac-ParametersXDD-Diff*.
If the UE is dual mode (FDD + TDD) and *skipUplinkTxDynamic* is only supported in one mode, then *skipUplinkTxDynamic* will be signaled in one of *fdd-Add-UE-NR-Capabilities/mac-ParametersXDD-Diff* or *tdd-Add-UE-NR-Capabilities/mac-ParametersXDD-Diff* as appropriate.

Note 5: If the UE is single mode (FDD or TDD), or the UE is dual mode (FDD and TDD) and *logicalChannelSR-DelayTimer* is supported in both modes, then support of *logicalChannelSR-DelayTimer* will be signaled in *mac-Parameters/mac-ParametersXDD-Diff*.
If the UE is dual mode (FDD + TDD) and *logicalChannelSR-DelayTimer* is only supported in one mode, then support of *logicalChannelSR-DelayTimer* will be signaled in one of *fdd-Add-UE-NR-Capabilities/mac-ParametersXDD-Diff* or *tdd-Add-UE-NR-Capabilities/mac-ParametersXDD-Diff* as appropriate.

Note 6: If the UE is single mode (FDD or TDD), or the UE is dual mode (FDD and TDD) and *longDRX_Cycle* is supported in both modes, then support of *longDRX_Cycle* will be signaled in *mac-Parameters/mac-*

	ParametersXDD-Diff. If the UE is dual mode (FDD + TDD) and <i>longDRX_Cycle</i> is only supported in one mode, then support of <i>longDRX_Cycle</i> will be signaled in one of fdd-Add-UE-NR-Capabilities/mac-ParametersXDD-Diff or tdd-Add-UE-NR-Capabilities/mac-ParametersXDD-Diff as appropriate.
Note 7:	If the UE is single mode (FDD or TDD), or the UE is dual mode (FDD and TDD) and <i>shortDRX_Cycle</i> is supported in both modes, then support of <i>shortDRX_Cycle</i> will be signaled in mac-Parameters/mac-ParametersXDD-Diff. If the UE is dual mode (FDD + TDD) and <i>shortDRX_Cycle</i> is only supported in one mode, then support of <i>shortDRX_Cycle</i> will be signaled in one of fdd-Add-UE-NR-Capabilities/mac-ParametersXDD-Diff or tdd-Add-UE-NR-Capabilities/mac-ParametersXDD-Diff as appropriate.
Note 8:	If the UE supports FR2 and pc_pdsch_256QAM_FR2 is supported, then support of pdsch_256QAM_FR2 will be signaled in at least one entry of supportedBandListNR as appropriate.
Note 9:	If pc_pusch_256QAM_FR1 or pc_pusch_256QAM_FR2 is supported, then support of pusch-256QAM will be signaled in at least one entry of supportedBandListNR as appropriate.
Note 10:	If the UE supports single frequency range (FR1 or FR2), or the UE supports both frequency ranges (FR1 and FR2) and ss-SINR-Meas is supported in both frequency ranges, then support of ss-SINR-Meas will be signaled in measAndMobParameters/MeasAndMobParametersFRX-Diff. If the UE supports both frequency ranges (FR1 + FR2) and ss-SINR-Meas is only supported in one frequency range, then support of ss-SINR-Meas will be signaled in one of fr1-Add-UE-NR-Capabilities/measAndMobParametersFRX-Diff or fr2-Add-UE-NR-Capabilities/measAndMobParametersFRX-Diff as appropriate.)
Note 11:	If the UE supports single frequency range (FR1 or FR2), or the UE supports both frequency ranges (FR1 and FR2) and csi-RSRP-AndRSRQ-MeasWithoutSSB is supported in both frequency ranges, then support of csi-RSRP-AndRSRQ-MeasWithoutSSB will be signaled in measAndMobParameters/MeasAndMobParametersFRX-Diff. If the UE supports both frequency ranges (FR1 + FR2) and csi-RSRP-AndRSRQ-MeasWithoutSSB is only supported in one frequency range, then support of csi-RSRP-AndRSRQ-MeasWithoutSSB will be signaled in one of fr1-Add-UE-NR-Capabilities/measAndMobParametersFRX-Diff or fr2-Add-UE-NR-Capabilities/measAndMobParametersFRX-Diff as appropriate.)
Note 12:	If the UE is single mode (FDD or TDD), or the UE is dual mode (FDD and TDD) and multipleConfiguredGrants is supported in both modes, then support of multipleConfiguredGrants will be signaled in mac-Parameters/mac-ParametersXDD-Diff. If the UE is dual mode (FDD + TDD) and multipleConfiguredGrants is only supported in one mode, then support of multipleConfiguredGrants will be signaled in one of fdd-Add-UE-NR-Capabilities/mac-ParametersXDD-Diff or tdd-Add-UE-NR-Capabilities/mac-ParametersXDD-Diff as appropriate.
Note 13:	If the UE is single mode (FDD or TDD), or the UE is dual mode (FDD and TDD) and <i>sftd-MeasNR-Neigh</i> is supported in both modes, then support of <i>sftd-MeasNR-Neigh</i> will be signaled in measAndMobParameters/measAndMobParametersXDD-Diff. If the UE is dual mode (FDD + TDD) and <i>sftd-MeasNR-Neigh</i> is only supported in one mode, then support of <i>sftd-MeasNR-Neigh</i> will be signaled in one of fdd-Add-UE-NR-Capabilities/measAndMobParametersXDD-Diff or tdd-Add-UE-NR-Capabilities/measAndMobParametersXDD-Diff as appropriate.)
Note 14:	If the UE supports single frequency range (FR1 or FR2), or the UE supports both frequency ranges (FR1 and FR2) and handoverInterF is supported in both frequency ranges, then support of handoverInterF will be signaled in measAndMobParameters/MeasAndMobParametersFRX-Diff. If the UE supports both frequency ranges (FR1 + FR2) and handoverInterF is only supported in one frequency range, then support of handoverInterF will be signaled in one of fr1-Add-UE-NR-Capabilities/measAndMobParametersFRX-Diff or fr2-Add-UE-NR-Capabilities/measAndMobParametersFRX-Diff as appropriate.)
Note 15:	If the UE is single mode (FDD or TDD), or the UE is dual mode (FDD and TDD) and <i>handoverInterF</i> is supported in both modes, then support of <i>handoverInterF</i> will be signaled in measAndMobParameters/measAndMobParametersXDD-Diff. If the UE is dual mode (FDD + TDD) and <i>handoverInterF</i> is only supported in one mode, then support of <i>handoverInterF</i> will be signaled in one of fdd-Add-UE-NR-Capabilities/measAndMobParametersXDD-Diff or tdd-Add-UE-NR-Capabilities/measAndMobParametersXDD-Diff as appropriate.
Note 16:	If the UE supports single frequency range (FR1 or FR2), or the UE supports both frequency ranges (FR1 and FR2) and voiceOverNR is supported in both frequency ranges, then support of voiceOverNR will be signaled in ims-Parameters/ims-ParametersFRX-Diff. If the UE supports both frequency ranges (FR1 + FR2) and voiceOverNR is only supported in one frequency range, then support of voiceOverNR will be signaled in one of fr1-Add-UE-NR-Capabilities-v1540/ims-ParametersFRX-Diff or fr2-Add-UE-NR-Capabilities-v1540/ims-ParametersFRX-Diff as appropriate.)

Table 8.1.5.1.1.3.3-4: UECapabilityEnquiry-v1560-IEs (Table 8.1.5.1.1.3.3-1)

Information Element	Value/remark	Comment	Condition
UECapabilityEnquiry-v1560-IEs ::= SEQUENCE {			
capabilityRequestFilterCommon	Not present		
nonCriticalExtension SEQUENCE {			

rrc-SegAllowed-r16	enabled		
nonCriticalExtension	Not present		
}			
}			

Table 8.1.5.1.1.3.3-5: ULDedicatedMessageSegment (step 2a1, Table 8.1.5.1.1.3.2-1)

Derivation Path: 38.508-1 [4], Table 4.6.1-32C			
Information Element	Value/remark	Comment	Condition
ULDedicatedMessageSegment-r16 ::= SEQUENCE {			
criticalExtensions CHOICE {			
segmentNumber-r16	0 for first segment, and incremented by 1 for each subsequent segment		
rrc-MessageSegmentContainer-r16	Not Checked	OCTET STRING including segmented UE Capability Information message	
rrc-MessageSegmentType-r16	<i>notLastSegment</i> for all segments except the last segment. <i>lastSegment</i> for the last segment		
lateNonCriticalExtension	Not present		
nonCriticalExtension	Not present		
}			
}			

Table 8.1.5.1.1.3.3-6: FeatureSetDownlink-v1610 (Table 8.1.5.1.1.3.3-3)

Information Element	Value/remark	Comment	Condition
FeatureSetDownlink-v1610 ::= SEQUENCE {			
cbgPDSCH-ProcessingType1-DifferentTB-PerSlot-r16	Not checked		
cbgPDSCH-ProcessingType2-DifferentTB-PerSlot-r16	Not checked		
intraFreqDAPS-r16	Checked		pc_intraFreqDAPS_r16
intraBandFreqSeparationDL-v1620	Not checked		
intraBandFreqSeparationDL-Only-r16	Not checked		
pdccch-Monitoring-r16	Not checked		
pdccch-MonitoringMixed-r16	Not checked		
crossCarrierSchedulingProcessing-DiffSCS-r16	Not checked		
singleDCI-SDM-scheme-r16	Not checked		
}			

Table 8.1.5.1.1.3.3-7: FeatureSetUplink-v1610 (Table 8.1.5.1.1.3.3-3)

Information Element	Value/remark	Comment	Condition
FeatureSetUplink-v1610 ::= SEQUENCE {			
pusch-RepetitionTypeB-r16	Checked		pc_pusch_RepetitionTypeB_r16
ul-CancellationSelfCarrier-r16	Not checked		
ul-CancellationCrossCarrier-r16	Not checked		
ul-FullPwrMode2-MaxSRS-ResInSet-r16	Not checked		
cbgPUSCH-ProcessingType1-DifferentTB-PerSlot-r16	Not checked		

cbgPUSCH-ProcessingType2-DifferentTB-PerSlot-r16	Not checked		
supportedSRS-PosResources-r16	Not checked		
intraFreqDAPS-UL-r16	Not checked		
intraBandFreqSeparationUL-v1620	Not checked		
multiPUCCH-r16	Not checked		
twoPUCCH-Type1-r16	Not checked		
twoPUCCH-Type2-r16	Not checked		
twoPUCCH-Type3-r16	Not checked		
twoPUCCH-Type4-r16	Not checked		
mux-SR-HARQ-ACK-r16	Not checked		
dummy1	Not checked		
dummy2	Not checked		
twoPUCCH-Type5-r16	Not checked		
twoPUCCH-Type6-r16	Not checked		
twoPUCCH-Type7-r16	Not checked		
twoPUCCH-Type8-r16	Not checked		
twoPUCCH-Type9-r16	Not checked		
twoPUCCH-Type10-r16	Not checked		
twoPUCCH-Type11-r16	Not checked		
ul-IntraUE-Mux-r16	Not checked		
ul-FullPwrMode-r16	Not checked		
crossCarrierSchedulingProcessing-DiffSCS-r16	Not checked		
ul-FullPwrMode1-r16	Not checked		
ul-FullPwrMode2-SRSCConfig-diffNumSRSPorts-r16	Not checked		
ul-FullPwrMode2-TPMIGroup-r16	Not checked		
}			

Table 8.1.5.1.1.3.3-8: CA-ParametersNR-v1610 (Table 8.1.5.1.1.3.3-3)

Information Element	Value/remark	Comment	Condition
CA-ParametersNR-v1610 ::= SEQUENCE {			
parallelTxMsgA-SRS-PUCCH-PUSCH-r16	Not checked		
msgA-SUL-r16	Not checked		
jointSearchSpaceSwitchAcrossCells-r16	Not checked		
half-DuplexTDD-CA-SameSCS-r16	Not checked		
scellDormancyWithinActiveTime-r16	Not checked		
scellDormancyOutsideActiveTime-r16	Checked		pc_scellDormancyOutsideActiveTime_r16
crossCarrierA-CSI-trigDiffSCS-r16	Not checked		
defaultQCL-CrossCarrierA-CSI-Trig-r16	Not checked		
interCA-NonAlignedFrame-r16	Not checked		
simul-SRS-Trans-BC-r16	Not checked		
interFreqDAPS-r16	Checked		pc_interFreqDAPS_r16
codebookParametersPerBC-r16	Not checked		
blindDetectFactor-r16	Not checked		
pdccch-MonitoringCA-r16	Not checked		
pdccch-BlindDetectionCA-Mixed-r16	Not checked		
pdccch-BlindDetectionMCG-UE-r16	Not checked		
pdccch-BlindDetectionSCG-UE-r16	Not checked		
pdccch-BlindDetectionMCG-UE-Mixed-r16	Not checked		
pdccch-BlindDetectionSCG-UE-Mixed-r16	Not checked		
crossCarrierSchedulingDL-DiffSCS-r16	Not checked		
crossCarrierSchedulingDefaultQCL-r16	Not checked		
crossCarrierSchedulingUL-DiffSCS-r16	Not checked		
simul-SRS-MIMO-Trans-BC-r16	Not checked		
codebookParametersAdditionPerBC-r16	Not checked		
codebookComboParametersAdditionPerBC-r16	Not checked		
}			

Table 8.1.5.1.1.3.3-9: PowSav-Parameters-r16 (Table 8.1.5.1.1.3.3-3)

Information Element	Value/remark	Comment	Condition
PowSav-Parameters-r16 ::= SEQUENCE {			
powSav-ParametersCommon-r16 SEQUENCE {			
drx-Preference-r16	Not checked		
maxCC-Preference-r16	Not checked		
releasePreference-r16	Checked		pc_releaseP reference_r1 6
minSchedulingOffsetPreference-r16	Not checked		
}			
powSav-ParametersFRX-Diff-r16	Not checked		
}			

Table 8.1.5.1.1.3.3-10: UE-BasedPerfMeas-Parameters-r16 (Table 8.1.5.1.1.3.3-3)

Information Element	Value/remark	Comment	Condition
UE-BasedPerfMeas-Parameters-r16 ::= SEQUENCE {			
barometerMeasReport-r16	Checked		pc_baromete r_r16
immMeasBT-r16	Not checked		
immMeasWLAN-r16	Checked		pc_immMea sWLAN_r16
loggedMeasBT-r16	Not checked		
loggedMeasurements-r16	Checked		pc_loggedM easurements _r16
loggedMeasWLAN-r16	Checked		pc_loggedM easWLAN_r 16
orientationMeasReport-r16	Checked		pc_orientatio n_r16
speedMeasReport-r16	Checked		pc_speed_r1 6
gnss-Location-r16	Checked		pc_GNSS_lo cation_r16
ulPDCP-Delay-r16	Checked		pc_PDCP_D elay_r16
}			

8.1.5.2 SI change / On-demand SIB

8.1.5.2.1 Void

8.1.5.2.2 SI change / Notification of BCCH modification / Short message for SI update in NR RRC_CONNECTED state

8.1.5.2.2.1 Test Purpose (TP)

(1)

```

with { UE in NR RRC_CONNECTED state }
ensure that {
  when { UE receives a short message transmitted on PDCCH using P-RNTI indicating a
systemInfoModification }
  then { UE re-acquires the SIB1 }
}

```

8.1.5.2.2.2 Conformance requirements

References: The conformance requirements covered in the present test case are specified in: TS 38.331, clause 5.2.2.2.2, 5.2.2.3.1, 5.2.2.4.2 and 6.5. Unless otherwise stated these are Rel-15 requirements.

[TS 38.331, clause 5.2.2.2.2]

A modification period is used, i.e. updated SI (other than for ETWS and CMAS) is broadcasted in the modification period following the one where SI change indication is transmitted. The modification period boundaries are defined by SFN values for which $SFN \bmod m = 0$, where m is the number of radio frames comprising the modification period. The modification period is configured by system information. The UE receives indications about SI modifications and/or PWS notifications using Short Message transmitted with P-RNTI over DCI (see clause 6.5). Repetitions of SI change indication may occur within preceding modification period.

UEs in RRC_IDLE or in RRC_INACTIVE shall monitor for SI change indication in its own paging occasion every DRX cycle. UEs in RRC_CONNECTED shall monitor for SI change indication in any paging occasion at least once per modification period if the UE is provided with common search space on the active BWP to monitor paging, as specified in TS 38.213 [13], clause 13.

...

If the UE receives a Short Message, the UE shall:

...

1> if the *systemInfoModification* bit of Short Message is set:

2> apply the SI acquisition procedure as defined in sub-clause 5.2.2.3 from the start of the next modification.

[TS 38.331, clause 5.2.2.3.1]

The UE shall:

1> apply the specified BCCH configuration defined in 9.1.1.1;

...

1> if the UE is in RRC_CONNECTED with an active BWP with common search space configured by *searchSpaceSIB1* and *pagingSearchSpace* and has received an indication about change of system information; or

...

NOTE: The UE in RRC_CONNECTED is only required to acquire broadcasted *SIB1* if the UE can acquire it without disrupting unicast data reception, i.e. the broadcast and unicast beams are quasi co-located.

[TS 38.331, clause 5.2.2.4.2]

Upon receiving the *SIB1* the UE shall:

...

3> if the UE has a stored valid version of a SIB, in accordance with sub-clause 5.2.2.2.1, that the UE requires to operate within the cell in accordance with sub-clause 5.2.2.1:

4> use the stored version of the required SIB;

3> if the UE has not stored a valid version of a SIB, in accordance with sub-clause 5.2.2.2.1, of one or several required SIB(s), in accordance with sub-clause 5.2.2.1:

4> for the SI message(s) that, according to the *si-SchedulingInfo*, contain at least one required SIB and for which *si-BroadcastStatus* is set to broadcasting:

5> acquire the SI message(s) as defined in sub-clause 5.2.2.3.2;

[TS 38.331, clause 6.5]

Short messages can be transmitted on PDCCH using P-RNTI with or without associated *Paging* message using Short Message field in DCI format 1_0 (see TS 38.212 [17, 7.3.1.2.1]).

Table 6.5-1 defines Short Messages. Bit 1 is the most significant bit.

Table 6.5-1: Short messages

Bit	Short message
1	systemInfoModification If set to 1: indication of a BCCH modification other than SIB6, SIB7 and SIB8.
2	etwsAndCmasIndication If set to 1: indication of an ETWS primary notification and/or an ETWS secondary notification and/or a CMAS notification.
3 – [8]	Not used in this release of the specification, and shall be ignored by UE if received.

8.1.5.2.2.3 Test Description

8.1.5.2.2.3.1 Pre-test conditions

System Simulator:

- NR Cell 1
- System information combination NR-1 as defined in TS 38.508-1 [4] clause 4.4.3.1.3 is used in NR cell.

UE:

- None.

Preamble:

- The UE is in 5GS state 3N-A and Test Loop Function (ON) with UE test loop mode B established according to TS 38.508-1 [4], clause 4.4A.2 Table 4.4A.2-3 with the exception that Short_DCI condition is applied in NR Serving cell configuration.

8.1.5.2.2.3.2 Test procedure sequence

Table 8.1.5.2.2.3.2-1: Main behaviour

St	Procedure	Message Sequence		TP	Verdict
		U - S	Message		
1	The SS sends one IP Packet to the UE.	-	-	-	-
1A	The SS waits 0.5 second and then ignores scheduling requests and does not allocate any uplink grant.	-	-	-	-
2	The SS changes the prach-ConfigurationIndex and ra-ResponseWindow in the system information.	-	-	-	-
3	The SS transmits a Short message on PDCCH using P-RNTI indicating a systemInfoModification.	-	PDCCH (DCI 1_0): Short Message	-	-
4	Void	-	-	-	-
5	Check: Does the UE initiate a random access using prach-ConfigurationIndex given in step 3 to send pending Uplink data?	-	-	1	P
6	The SS transmits Random Access Response with RAPID corresponding to preamble in step 5. (Note 1)	-	-	-	-
7	The UE loop backs the IP packets received in step 1	-	-	-	-
8	The SS starts the UL default grant transmissions.				

Note 1: The resource allocation for Msg3 shall be enough to accommodate all of the DRB data that UE will loop back at step 7. To be more specific, resource allocation shall be no less than: TB size = IP packet (64 bytes) + SDAP header (1 bytes) + PDCP header (3 bytes) + RLC header (3 bytes) + MAC header (2 bytes) + padding or BSR (2 bytes) + C-RNTI MAC CE (3 Bytes) + PHR (3 bytes) = 81 bytes.

8.1.5.2.2.3.3 Specific message contents

Table 8.1.5.2.2.3.3-1: CLOSE UE TEST LOOP (Preamble, Table 8.1.5.2.2.3.2-1)

Derivation Path: TS 36.508-1 [7] table 4.7A-3 condition UE test loop mode B			
Information Element	Value/Remark	Comment	Condition
UE test loop mode B LB setup			
IP PDU delay	'0000 1111'B	15 seconds	

Table 8.1.5.2.2.3.3-2: SIB1 (step 2, Table 8.1.5.2.2.3.2-1)

Derivation Path: TS 38.508-1 [4] table 4.6.1-28			
Information Element	Value/Remark	Comment	Condition
SIB1 ::= SEQUENCE {			
servingCellConfigCommon SEQUENCE {			
uplinkConfigCommon SEQUENCE {			
initialUplinkBWP SEQUENCE {			
rach-ConfigCommon SEQUENCE {			
rach-ConfigGeneric SEQUENCE {			
prach-ConfigurationIndex	119	.	FR1 FDD
	91		FR1 TDD
	6		FR2
ra-ResponseWindow	sl20		
}			
}			
}			
}			
}			

8.1.5.3 PWS notification

8.1.5.3.1 PWS notification / PWS reception in NR RRC_IDLE state

8.1.5.3.1.1 Test Purpose (TP)

(1)

```
with { UE in NR RRC_IDLE state }
ensure that {
  when { an ETWS capable UE receives a short message transmitted on PDCCH using P-RNTI indicating an
etwsAndCmasIndication and the si-SchedulingInfo includes scheduling information for SIB6 }
  then { the UE is able to retrieve the PWS message from SIB6 and alert the user }
}
```

(2)

```
with { UE in NR RRC_IDLE state }
ensure that {
  when { an ETWS capable UE receives a short message transmitted on PDCCH using P-RNTI indicating an
etwsAndCmasIndication and the si-SchedulingInfo includes scheduling information for SIB7 }
  then { the UE is able to retrieve all the PWS message segments from SIB7, reassemble the message
and alert the user }
}
```

(3)

```

with { UE in NR RRC_IDLE state }
ensure that {
  when { a CMAS capable UE receives a short message transmitted on PDCCH using P-RNTI indicating an
etwsAndCmasIndication and the si-SchedulingInfo includes scheduling information for SIB8 }
  then { the UE is able to retrieve all the PWS message segments from SIB8, reassemble the message
and alert the user }
}

```

8.1.5.3.1.2 Conformance requirements

References: The conformance requirements covered in the current TC are specified in: TS 38.331 clause 5.2.2.2.2.

[TS 38.331 clause 5.2.2.2.2]

...

ETWS or CMAS capable UEs in RRC_IDLE or in RRC_INACTIVE shall monitor for indications about PWS notification in its own paging occasion every DRX cycle. ETWS or CMAS capable UEs in RRC_CONNECTED shall monitor for indication about PWS notification in any paging occasion at least once every *defaultPagingCycle* if the UE is provided with common search space on the active BWP to monitor paging.

For Short Message reception in a paging occasion, the UE monitors the PDCCH monitoring occasion(s) for paging as specified in TS 38.304 [20] and TS 38.213 [13].

If the UE receives a Short Message, the UE shall:

- 1> if the UE is ETWS capable or CMAS capable, the *etwsAndCmasIndication* bit of Short Message is set, and the UE is provided with *searchSpaceOtherSystemInformation* on the active BWP:
 - 2> immediately re-acquire the *SIB1*;
 - 2> if the UE is ETWS capable and *si-SchedulingInfo* includes scheduling information for *SIB6*:
 - 3> acquire *SIB6*, as specified in sub-clause 5.2.2.3.2, immediately;
 - 2> if the UE is ETWS capable and *si-SchedulingInfo* includes scheduling information for *SIB7*:
 - 3> acquire *SIB7*, as specified in sub-clause 5.2.2.3.2, immediately;
 - 2> if the UE is CMAS capable and *si-SchedulingInfo* includes scheduling information for *SIB8*:
 - 3> acquire *SIB8*, as specified in sub-clause 5.2.2.3.2, immediately;
- 1> if the *systemInfoModification* bit of Short Message is set:
 - 2> apply the SI acquisition procedure as defined in sub-clause 5.2.2.3 from the start of the next modification period.

8.1.5.3.1.3 Test description

8.1.5.3.1.3.1 Pre-test conditions

System Simulator:

- NR Cell 1.

UE:

- None.

Preamble:

- The UE is in test state 1N-A according to TS 38.508-1 [4].

8.1.5.3.1.3.2 Test procedure sequence

Table 8.1.5.3.1.3.2-1: Main behaviour

St	Procedure	Message Sequence		TP	Verdict
		U - S	Message		
-	If pc_ETWS_NR is true, step1-8 will be excuted.	-	-	-	-
1	The SS indicates an etwsAndCmasIndication by Short Message field in DCI format 1_0 and transmitted on PDCCH using P-RNTI. The SS starts transmitting SIB1 with the si-SchedulingInfo including scheduling information for SIB6 on NR Cell 1.	<--	PDCCH (DCI 1_0): Short Message	-	-
2	The SS includes an ETWS message with new <i>messageIdentifier</i> and <i>serialNumber</i> in SIB6. (Note 1)	-	-	-	-
3	Check: Does the UE alert or activate alerting the user (NOTE 2)?	-	-	1	P
4	The SS waits for 10s.	-	-	-	-
5	The SS indicates an etwsAndCmasIndication by Short Message field in DCI format 1_0 and transmitted on PDCCH using P-RNTI. The SS starts transmitting SIB1 with the si-SchedulingInfo including scheduling information for SIB7 on NR Cell 1.	<--	PDCCH (DCI 1_0): Short Message	-	-
6	The SS includes an ETWS message with new <i>messageIdentifier</i> and <i>serialNumber</i> in SIB7. (NOTE 3).	-	-	-	-
7	Check: Does the UE indicate the contents of the "warning message" to the user, and alert or activate alerting the user (NOTE 2)?	-	-	2	P
8	The SS waits for 10s.	-	-	-	-
-	If pc_CMAS_NR is true, step9-11 will be excuted.	-	-	-	-
9	The SS indicates an etwsAndCmasIndication by Short Message field in DCI format 1_0 and transmitted on PDCCH using P-RNTI. The SS starts transmitting SIB1 with the si-SchedulingInfo including scheduling information for SIB8 on NR Cell 1.	<--	PDCCH (DCI 1_0): Short Message	-	-
10	The SS includes a CMAS message with new <i>messageIdentifier</i> and <i>serialNumber</i> in SIB8. (NOTE 4).	-	-	-	-
11	Check: Does the UE indicate the contents of the "warning message" to the user, and alert or activate alerting the user (NOTE 2)?	-	-	3	P
NOTE 1: The NR-10 in Table 4.4.3.1.2-1 Combinations of system information blocks of TS 38.508-1 [4] is used.					
NOTE 2: The data indication and user alerting are the UE implementation issues.					
NOTE 3: The NR-11 in Table 4.4.3.1.2-1 Combinations of system information blocks of TS 38.508-1 [4] is used.					
NOTE 4: The NR-9 in Table 4.4.3.1.2-1 Combinations of system information blocks of TS 38.508-1 [4] is used.					

8.1.5.3.1.3.3 Specific message contents

None

8.1.5.3.2 PWS notification / PWS reception in NR RRC_INACTIVE state

8.1.5.3.2.1 Test Purpose (TP)

(1)

```
with { UE in NR RRC_INACTIVE state }
ensure that {
```



```

when { an ETWS capable UE receives a short message transmitted on PDCCH using P-RNTI indicating an
etwsAndCmasIndication and the si-SchedulingInfo includes scheduling information for SIB6 }
  then { the UE is able to retrieve the PWS message from SIB6 and alert the user }
}

```

(2)

```

with { UE in NR RRC_INACTIVE state }
ensure that {
  when { an ETWS capable UE receives a short message transmitted on PDCCH using P-RNTI indicating an
etwsAndCmasIndication and the si-SchedulingInfo includes scheduling information for SIB7 }
    then { the UE is able to retrieve all the PWS message segments from SIB7, reassemble the message
and alert the user }
}

```

(3)

```

with { UE in NR RRC_INACTIVE state }
ensure that {
  when { a CMAS capable UE receives a short message transmitted on PDCCH using P-RNTI indicating an
etwsAndCmasIndication and the si-SchedulingInfo includes scheduling information for SIB8 }
    then { the UE is able to retrieve all the PWS message segments from SIB8, reassemble the message
and alert the user }
}

```

8.1.5.3.2.2 Conformance requirements

Same as test case 8.1.5.3.1.

8.1.5.3.2.3 Test description

8.1.5.3.2.3.1 Pre-test conditions

System Simulator:

- NR Cell 1.

UE:

None.

Preamble:

- The UE is in state Registered, Inactive mode (state 2N-A) according to TS 38.508-1 [4].

8.1.5.3.2.3.2 Test procedure sequence

Same as test case 8.1.5.3.1

8.1.5.3.2.3.3 Specific message contents

Same as test case 8.1.5.3.1.

8.1.5.3.3 PWS notification / PWS reception in NR RRC_CONNECTED state

8.1.5.3.3.1 Test Purpose (TP)

(1)

```

with { UE in NR RRC_CONNECTED state }
ensure that {
  when { an ETWS capable UE receives a short message transmitted on PDCCH using P-RNTI indicating an
etwsAndCmasIndication and the si-SchedulingInfo includes scheduling information for SIB6 }
    then { the UE is able to retrieve all the PWS message segments from SIB6, reassemble the message
and alert the user }
}

```

```
    }
```

(2)

```
with { UE in NR RRC_CONNECTED state }
ensure that {
  when { an ETWS capable UE receives a short message transmitted on PDCCH using P-RNTI indicating an
etwsAndCmasIndication and the si-SchedulingInfo includes scheduling information for SIB7 }
  then { the UE is able to retrieve all the PWS message segments from SIB7, reassemble the message
and alert the user }
}
```

(3)

```
with { UE in NR RRC_CONNECTED state }
ensure that {
  when { a CMAS capable UE receives a short message transmitted on PDCCH using P-RNTI indicating an
etwsAndCmasIndication and the si-SchedulingInfo includes scheduling information for SIB8 }
  then { the UE is able to retrieve all the PWS message segments from SIB8, reassemble the message
and alert the user }
}
```

8.1.5.3.3.2 Conformance requirements

Same as test case 8.1.5.3.1.

8.1.5.3.3.3 Test description

8.1.5.3.3.3.1 Pre-test conditions

System Simulator:

- NR Cell 1.

UE:

None.

Preamble:

- The UE is in test state 3N-A according to TS 38.508-1 [4].

8.1.5.3.3.3.2 Test procedure sequence

Same as test case 8.1.5.3.1 except PDCCH (DCI 1_0): Short Message is sent on active BWP.

8.1.5.3.3.3.3 Specific message contents

Same as test case 8.1.5.3.1.

8.1.5.3.4 PWS notification / PWS reception using dedicatedSystemInformationDelivery

8.1.5.3.4.1 Test Purpose (TP)

(1)

```
with { UE in NR RRC_CONNECTED state }
ensure that {
  when { UE receives an RRCReconfiguration message including dedicatedSystemInformationDelivery
containing SIB6 }
  then { UE reads the SIB6 to alert the user and sends an RRCReconfigurationComplete message }
}
```

(2)

```

with { UE in NR RRC_CONNECTED state }
ensure that {
  when { UE receives an RRCReconfiguration message including dedicatedSystemInformationDelivery
containing SIB7 }
  then { UE reads the SIB7 to alert the user and sends an RRCReconfigurationComplete message }
}

```

(3)

```

with { UE in NR RRC_CONNECTED state }
ensure that {
  when { UE receives an RRCReconfiguration message including dedicatedSystemInformationDelivery
containing SIB8 }
  then { UE reads the SIB8 to alert the user and sends an RRCReconfigurationComplete message }
}

```

8.1.5.3.4.2 Conformance requirements

References: The conformance requirements covered in the present TC are specified in: TS 38.331, clauses 5.2.2.4.7, 5.2.2.4.8, 5.2.2.4.9, 5.3.5.3. Unless otherwise stated these are Rel-15 requirements.

[TS 38.331, clause 5.3.5.3]

The UE shall perform the following actions upon reception of the *RRCReconfiguration*:

- 1> if the *RRCReconfiguration* message includes the *dedicatedSIB1-Delivery*:
 - 2> perform the action upon reception of *SIB1* as specified in 5.2.2.4.2;
- 1> if the *RRCReconfiguration* message includes the *dedicatedSystemInformationDelivery*:
 - 2> perform the action upon reception of System Information as specified in 5.2.2.4;

[TS 38.331, clause 5.2.2.4.7]

Upon receiving the *SIB6* the UE shall:

- 1> forward the received *warningType*, *messageIdentifier* and *serialNumber* to upper layers;

[TS 38.331, clause 5.2.2.4.8]

Upon receiving the *SIB7* the UE shall:

- 1> if there is no current value for *messageIdentifier* and *serialNumber* for *SIB7*; or
- 1> if either the received value of *messageIdentifier* or of *serialNumber* or of both are different from the current values of *messageIdentifier* and *serialNumber* for *SIB7*:
 - 2> use the received values of *messageIdentifier* and *serialNumber* for *SIB7* as the current values of *messageIdentifier* and *serialNumber* for *SIB7*;
 - 2> discard any previously buffered *warningMessageSegment*;
 - 2> if all segments of a warning message have been received:
 - 3> assemble the warning message from the received *warningMessageSegment*;
 - 3> forward the received warning message, *messageIdentifier*, *serialNumber* and *dataCodingScheme* to upper layers;
 - 3> stop reception of *SIB7*;
 - 3> discard the current values of *messageIdentifier* and *serialNumber* for *SIB7*;
- 2> else:
 - 3> store the received *warningMessageSegment*;

- 3> continue reception of *SIB7*;
- 1> else if all segments of a warning message have been received:
 - 2> assemble the warning message from the received *warningMessageSegment*;
 - 2> forward the received complete warning message, *messageIdentifier*, *serialNumber* and *dataCodingScheme* to upper layers;
 - 2> stop reception of *SIB7*;
 - 2> discard the current values of *messageIdentifier* and *serialNumber* for *SIB7*;
- 1> else:
 - 2> store the received *warningMessageSegment*;
 - 2> continue reception of *SIB7*;

The UE should discard any stored *warningMessageSegment* and the current value of *messageIdentifier* and *serialNumber* for *SIB7* if the complete warning message has not been assembled within a period of 3 hours.

[TS 38.331, clause 5.2.2.4.9]

Upon receiving the *SIB8* the UE shall:

- 1> if the *SIB8* contains a complete warning message and the complete geographical area coordinates (if any):
 - 2> forward the received warning message, *messageIdentifier*, *serialNumber*, *dataCodingScheme* and the geographical area coordinates (if any) to upper layers;
 - 2> continue reception of *SIB8*;
- 1> else:
 - 2> if the received values of *messageIdentifier* and *serialNumber* are the same (each value is the same) as a pair for which a warning message and the geographical area coordinates (if any) are currently being assembled:
 - 3> store the received *warningMessageSegment*;
 - 3> store the received *warningAreaCoordinatesSegment* (if any);
 - 3> if all segments of a warning message and geographical area coordinates (if any) have been received:
 - 4> assemble the warning message from the received *warningMessageSegment*;
 - 4> assemble the geographical area coordinates from the received *warningAreaCoordinatesSegment* (if any);
 - 4> forward the received warning message, *messageIdentifier*, *serialNumber*, *dataCodingScheme* and geographical area coordinates (if any) to upper layers;
 - 4> stop assembling a warning message and geographical area coordinates (if any) for this *messageIdentifier* and *serialNumber* and delete all stored information held for it;
 - 3> continue reception of *SIB8*;
 - 2> else if the received values of *messageIdentifier* and/or *serialNumber* are not the same as any of the pairs for which a warning message is currently being assembled:
 - 3> start assembling a warning message for this *messageIdentifier* and *serialNumber* pair;
 - 3> start assembling the geographical area coordinates (if any) for this *messageIdentifier* and *serialNumber* pair;
 - 3> store the received *warningMessageSegment*;
 - 3> store the received *warningAreaCoordinatesSegment* (if any);

3> continue reception of *SIB8*;

The UE should discard *warningMessageSegment* and *warningAreaCoordinatesSegment* (if any) and the associated values of *messageIdentifier* and *serialNumber* for *SIB8* if the complete warning message and the geographical area coordinates (if any) have not been assembled within a period of 3 hours.

NOTE: The number of warning messages that a UE can re-assemble simultaneously is a function of UE implementation.

8.1.5.3.4.3 Test description

8.1.5.3.4.3.1 Pre-test conditions

System Simulator:

- NR Cell 1.

UE:

- None

Preamble:

- The UE is in 5GS state 3N-A according to TS 38.508-1 [4], clause 4.4A.2 Table 4.4A.2-1

8.1.5.3.4.3.2 Test procedure sequence

Table 8.1.5.3.4.3.2-1: Main behaviour

St	Procedure	Message Sequence		TP	Verdict
		U - S	Message		
-	If <i>pc_ETWS_NR</i> is true, steps 1-6 will be executed.	-	-	-	-
1	The SS transmits an <i>RRCReconfiguration</i> message containing <i>dedicatedSystemInformationDelivery</i> containing <i>SIB6</i> .	<--	NR RRC: <i>RRCReconfiguration</i>	-	-
2	Check: Does the UE transmit an <i>RRCReconfigurationComplete</i> message?	-->	NR RRC: <i>RRCReconfigurationComplete</i>	-	-
3	Check: Does the UE alert or activate alerting the user (NOTE 1)?	-	-	1	P
4	The SS transmits an <i>RRCReconfiguration</i> message containing <i>dedicatedSystemInformationDelivery</i> containing <i>SIB7</i> .	<--	NR RRC: <i>RRCReconfiguration</i>	-	-
5	Check: Does the UE transmit an <i>RRCReconfigurationComplete</i> message?	-->	NR RRC: <i>RRCReconfigurationComplete</i>	-	-
6	Check: Does the UE indicate the "warning message" to the user, and alert or activate alerting the user (NOTE 1)?	-	-	2	P
-	If <i>pc_CMAS_NR</i> is true, steps 7-9 will be executed.	-	-	-	-
7	The SS transmits an <i>RRCReconfiguration</i> message containing <i>dedicatedSystemInformationDelivery</i> containing <i>SIB8</i> .	<--	NR RRC: <i>RRCReconfiguration</i>	-	-
8	Check: Does the UE transmit an <i>RRCReconfigurationComplete</i> message?	-->	NR RRC: <i>RRCReconfigurationComplete</i>	-	-
9	Check: Does the UE alert or activate alerting the user (NOTE 1)?	-	-	3	P

NOTE 1: The data indication and user alerting are the UE implementation issues.

8.1.5.3.4.3.3 Specific message contents

Table 8.1.5.3.4.3.3-1: RRCReconfiguration (Steps 1, 4 and 7 Table 8.1.5.3.4.3.2-1)

Derivation Path: TS 38.508-1 [4], Table 4.6.1-13			
Information Element	Value/remark	Comment	Condition
RRCReconfiguration ::= SEQUENCE {			
criticalExtensions CHOICE {			
rrcReconfiguration SEQUENCE {			
nonCriticalExtension SEQUENCE {			
masterCellGroup	Not present		
dedicatedNAS-MessageList	Not present		
dedicatedSystemInformationDelivery	SystemInformation	OCTET STRING (CONTAINING SystemInformatio n)	
}			
}			
}			
}			

Table 8.1.5.3.4.3.3-2: SystemInformation (Steps 1, 4 and 7 Table 8.1.5.3.4.3.2-1)

Derivation Path: TS 38.508-1 [4], Table 4.6.1-29			
Information Element	Value/remark	Comment	Condition
SystemInformation ::= SEQUENCE {			
criticalExtensions CHOICE {			
systemInformation-r15 SEQUENCE {			
sib-TypeAndInfo SEQUENCE (SIZE (1..maxSIB))	1 entry		
OF CHOICE {			
sib6	SIB6	Acc to 38.508-1 [4] Table 4.6.2-5: SIB6	Step 1
sib7	SIB7		Step 4
sib8	SIB8		Step 7
}			
lateNonCriticalExtension	Not present		
nonCriticalExtension SEQUENCE {}	Not present		
}			
}			
}			

Table 8.1.5.3.4.3.3-3: SIB7 (Step 4 in Table 8.1.5.3.4.3.2-1)

Derivation Path: TS 38.331 [6], clause 6.3.1			
Information Element	Value/remark	Comment	Condition
SIB7 ::= SEQUENCE {			
messageIdentifier	'0001 0001 0000 0010'B	ETWS message identifier for earthquake and tsunami message (see TS 23.041 [25])	
serialNumber	'0011 0000 0000 0000'B	Note 1.	
warningMessageSegmentType	lastSegment		
warningMessageSegmentNumber	0		
warningMessageSegment	Octetstring of N	Containing the complete ETWS message	
dataCodingScheme	Bitstring (8) ID of the alphabet/coding and the applied language	see TS 23.041 [25].	
lateNonCriticalExtension	Not present		
}			

Note 1: Geographical Scope (Octet 1 bit 7 ~ 6) set to 'Cell wide',
 Emergency User Alert (Octet 1 bit 5) set to 'Activate emergency user alert',
 Popup (Octet 1 bit 4) set to 'Activate popup',
 Update Number (Octet 2 bits 3~0) for each update, incremented by one, See TS 23.041 [25].

Table 8.1.5.3.4.3.3-4: SIB8 (Step 7 in Table 8.1.5.3.4.3.2-1)

Derivation Path: TS 38.331 [6], clause 6.3.1			
Information Element	Value/remark	Comment	Condition
SIB8 ::= SEQUENCE {			
messageIdentifier	'0001 0001 0001 0010'B	CMAS CBS Message Identifier for CMAS Presidential Level Alerts (see TS 23.041 [25])	
serialNumber	'0011 0000 0000 0000'B	Note 1	
warningMessageSegmentType	lastSegment		
warningMessageSegmentNumber	0		
warningMessageSegment	Octetstring of N		
dataCodingScheme	Bitstring (8) ID of the alphabet/coding and the applied language	Containing the complete CMAS message	
warningAreaCoordinatesSegment	Not present		
lateNonCriticalExtension	Not present		
}			
Note 1: Geographical Scope (Octet 1 bit 7 ~ 6) set to 'Cell wide', Emergency User Alert (Octet 1 bit 5) set to 'Activate emergency user alert', Popup (Octet 1 bit 4) set to 'Activate popup', Update Number (Octet 2 bits 3~0) for each update, incremented by one, See TS 23.041 [25].			

8.1.5.4 Counter check

8.1.5.4.1 Counter check / Reception of CounterCheck message by the UE

8.1.5.4.1.1 Test Purpose (TP)

(1)

```
with { UE in NR RRC_CONNECTED state with two DRBs established and having received 10 data packets on
each DRB }
ensure that {
  when { UE receives CounterCheck message with drb-CountMSB-InfoList included for DRB3(not
established) and DRB1 (with the most significant bits of the count different from the actual COUNT) }
  then { UE sends CounterCheckResponse message by including the drb-Identity, the count-Uplink and
the count-Downlink set to the value of TX_NEXT - 1 and RX_NEXT - 1 in drb-CountInfoList IE for each
DRB established, and by including the drb-Identity, the count-Uplink and the count-Downlink with the
most significant bits set identical to the corresponding values in the drb-CountMSB-InfoList and the
least significant bits set to zero for the DRB that is not established }
}
```

8.1.5.4.1.2 Conformance requirements

References: The conformance requirements covered in the current TC are specified in: TS 38.331, clause 5.3.6.3.
 Unless otherwise stated these are Rel-15 requirements.
 [TS 38.331, clause 5.3.6.3]

Upon receiving the *CounterCheck* message, the UE shall:

- 1> for each DRB that is established:

- 2> if no COUNT exists for a given direction (uplink or downlink) because it is a uni-directional bearer configured only for the other direction:
 - 3> assume the COUNT value to be 0 for the unused direction;
- 2> if the *drb-Identity* is not included in the *drb-CountMSB-InfoList*:
 - 3> include the DRB in the *drb-CountInfoList* in the *CounterCheckResponse* message by including the *drb-Identity*, the *count-Uplink* and the *count-Downlink* set to the value of TX_NEXT – 1 and RX_NEXT – 1 (specified in TS 38.323 [5]), respectively;
- 2> else if, for at least one direction, the most significant bits of the COUNT are different from the value indicated in the *drb-CountMSB-InfoList*:
 - 3> include the DRB in the *drb-CountInfoList* in the *CounterCheckResponse* message by including the *drb-Identity*, the *count-Uplink* and the *count-Downlink* set to the value of TX_NEXT – 1 and RX_NEXT – 1 (specified in TS 38.323 [5]), respectively;
- 1> for each DRB that is included in the *drb-CountMSB-InfoList* in the *CounterCheck* message that is not established:
 - 2> include the DRB in the *drb-CountInfoList* in the *CounterCheckResponse* message by including the *drb-Identity*, the *count-Uplink* and the *count-Downlink* with the most significant bits set identical to the corresponding values in the *drb-CountMSB-InfoList* and the least significant bits set to zero;
- 1> submit the *CounterCheckResponse* message to lower layers for transmission upon which the procedure ends.

8.1.5.4.1.3 Test description

8.1.5.4.1.3.1 Pre-test conditions

System Simulator:

- NR Cell 1.
- System information combination NR-1 as defined in TS 38.508-1 [4] clause 4.4.3.1.3 is used in the NR cell.

UE:

- None.

Preamble:

- The UE is in 5GS state 3N-A on NR Cell 1 with at least one PDU session active according to TS 38.508-1 [4], clause 4.4A.3 Table 4.4A.3-1 and Test Loop Function (On) with UE test loop mode B is established. 2 DRBs are configured where DRB1 is defined as default DRB.

8.1.5.4.1.3.2 Test procedure sequence

Table 8.1.5.4.1.3.2-1: Main behaviour

St	Procedure	Message Sequence		TP	Verdict
		U - S	Message		
1	The SS transmits 10 IP packets on each DRB (using QFI2 for DRB1 and QFI5 for DRB2)	-	-	-	-
2	The UE loops back the IP packets received in step 1 (Note 1)	-	-	-	-
3	The SS transmits CounterCheck message with <i>drb-Identity</i> not included in the <i>drb-CountMSB-InfoList</i>	<--	NR RRC: <i>CounterCheck</i>	-	-
4	Check: Does the UE send CounterCheckResponse message by including the <i>drb-Identity</i> , the <i>count-Uplink</i> and the	-->	NR RRC: <i>CounterCheckResponse</i>	1	P

	count-Downlink set to the value of TX_NEXT – 1 and RX_NEXT – 1 in drb-CountInfoList IE for each DRB established?				
Note 1: IP packets at step 2 may be received by the SS in the same slot or in multiple slots					

8.1.5.4.1.3.3 Specific message contents

Table 8.1.5.4.1.3.3-1: RRCReconfiguration (Preamble, Table 8.1.5.4.1.3.2-1)

Derivation Path: TS 38.508-1 [4], table 4.6.1-13 with condition NR			
Information Element	Value/remark	Comment	Condition
RRCReconfiguration ::= SEQUENCE {			
criticalExtensions CHOICE {			
rrcReconfiguration SEQUENCE {			
radioBearerConfig	RadioBearerConfig-2DRBs		
nonCriticalExtension SEQUENCE {			
masterCellGroup	CellGroupConfig-2DRBs	OCTET STRING (CONTAINING CellGroupConfig)	
}			
}			
}			
}			

Table 8.1.5.4.1.3.3-2: RadioBearerConfig-2DRBs (Preamble, Table 8.1.5.4.1.3.3-1)

Derivation Path: TS 38.508-1 [4], table 4.6.3-132 and condition SRB2 and DRB1			
Information Element	Value/remark	Comment	Condition
RadioBearerConfig ::= SEQUENCE {			
drb-ToAddModList SEQUENCE (SIZE (1..maxDRB)) OF DRB-ToAddMod {	2 entries		
DRB-ToAddMod[1] SEQUENCE {		entry 1	
cnAssociation CHOICE {			
sdap-Config ::= SEQUENCE {			
pdu-Session	PDU session ID	Same as the PDU session ID in PDU SESSION ESTABLISHMENT REQUEST	
defaultDRB	true		
mappedQoS-FlowsToAdd SEQUENCE {			
QFI	2		
}			
}			
drb-Identity	DRB-Identity with Condition DRB1		
}			
}			
DRB-ToAddMod[2] SEQUENCE		entry 2	
cnAssociation CHOICE {			
sdap-Config SEQUENCE {			
pdu-Session	PDU session ID	Same as the PDU session ID in PDU SESSION ESTABLISHMENT REQUEST	
defaultDRB	false		
mappedQoS-FlowsToAdd SEQUENCE {			
QFI	5		
}			
}			

}			
drb-Identity	DRB-Identity with Condition DRB2		
}			
}			
}			

Table 8.1.5.4.1.3.3-3: CellGroupConfig-2DRBs (Preamble, Table 8.1.5.4.1.3.3-1)

Derivation Path: TS 38.508-1 [4], table 4.6.3-19 and condition SRB2_DRB1			
Information Element	Value/remark	Comment	Condition
CellGroupConfig ::= SEQUENCE {			
rlc-BearerToAddModList SEQUENCE (SIZE(1..maxLC-ID)) OF RLC-BearerConfig {	3 entries		
RLC-BearerConfig[1]	RLC-BearerConfig with condition SRB2	entry 1	
RLC-BearerConfig[2]	RLC-BearerConfig with conditions AM and DRB1	entry 2	
RLC-BearerConfig[3]	RLC-BearerConfig with conditions AM and DRB2	entry 3	
}			
}			

Table 8.1.5.4.1.3.3-4: PDU SESSION ESTABLISHMENT ACCEPT (Preamble) (Table 8.1.5.4.1.3.2-1)

Derivation Path: TS 38.508-1, table 4.7.2-2			
Information Element	Value/remark	Comment	Condition
PDU session ID	The same as the PDU session ID in PDU SESSION ESTABLISHMENT REQUEST		
Authorized QoS rules	3 entries		
QoS rule [1]	Reference QoS rule #1 as defined in Table 4.8.2.1-1.	QFI=1	
QoS rule [2]	Reference QoS rule #4 as defined in Table 4.8.2.1-4 except DQR bit set to '0'B.	QFI=2	
QoS rule [3]	Reference QoS rule #5 as defined in Table 4.8.2.1-5.	QFI=5	
Mapped EPS Bearer contexts	Not Present		
Authorized QoS flow descriptions	3 entries		
QoS flow [1]	Reference QoS flow #1 as defined in Table 8.1.5.4.1.3.3-7.	QFI=1	
QoS flow [2]	Reference QoS flow #2 as defined in Table 8.1.5.4.1.3.3-8.	QFI=2	
QoS flow [3]	Reference QoS flow #3 as defined in Table 4.8.2.3-3.	QFI=5	

Table 8.1.5.4.1.3.3-5: CounterCheck (step 3, Table 8.1.5.4.1.3.2-1)

Derivation Path: TS 38.508-1 [4] table 4.6.1-1			
Information Element	Value/Remark	Comment	Condition
CounterCheck ::= SEQUENCE {			
criticalExtensions CHOICE {			
counterCheck SEQUENCE {			

drb-CountMSB-InfoList SEQUENCE (SIZE (1..maxDRB)) OF DRB-CountMSB-Info {	2 entries		
DRB-CountMSB-Info[1] SEQUENCE {		entry 1	
drb-Identity	DRB-Identity with Condition DRB1	DRB established	
countMSB-Uplink	1		
countMSB-Downlink	1		
}			
DRB-CountMSB-Info[2] SEQUENCE {		entry 2	
drb-Identity	DRB-Identity with Condition DRB3	DRB not established	
countMSB-Uplink	3		
countMSB-Downlink	3		
}			
}			
}			
}			
}			

Table 8.1.5.4.1.3.3-6: CounterCheckResponse (step 4, Table 8.1.5.4.1.3.2-1)

Derivation Path: TS 38.508-1 [4] table 4.6.1-2			
Information Element	Value/Remark	Comment	Condition
CounterCheckResponse ::= SEQUENCE {			
criticalExtensions CHOICE {			
counterCheckResponse SEQUENCE {			
drb-CountInfoList SEQUENCE (SIZE (0..maxDRB)) OF DRB-CountInfo {	3 entries		
DRB-CountInfo[1] SEQUENCE {		entry 1	
drb-Identity	DRB-Identity with Condition DRB1	DRB established	
count-Uplink	9		
count-Downlink	9		
}			
DRB-CountInfo[2] SEQUENCE {		entry 2	
drb-Identity	DRB-Identity with Condition DRB2	DRB established but not requested	
count-Uplink	9		
count-Downlink	9		
}			
DRB-CountInfo[3] SEQUENCE {		entry 3	
drb-Identity	DRB-Identity with Condition DRB3	DRB not established	
count-Uplink]	384	MSB 3 and LSB 0	
count-Downlink	384	MSB 3 and LSB 0	
}			
}			
}			
}			
}			

Table 8.1.5.4.1.3.3-7: Reference QoS flow #1 (Preamble)

Derivation Path: TS 38.508-1, table 4.8.2.3-1			
Information Element	Value/remark	Comment	Condition
QoS flow descriptions			
QFI	'00 0001'B	QFI 1	
Operation code	'001'B	Create new QoS flow description	
E bit	'1'B	Parameters list is included	
Number of parameters	'00 0001'B	1 parameter	
5QI	'0000 1001'B	5QI 9	

Table 8.1.5.4.1.3.3-8: Reference QoS flow #2 (Preamble)

Derivation Path: TS 38.508-1, table 4.8.2.3-2			
Information Element	Value/remark	Comment	Condition
QoS flow descriptions			
QoS flow description			
QFI	'00 0010'B	QFI 2	
Operation code	'001'B	Create new QoS flow description	
E bit	'1'B	Parameters list is included	
Number of parameters	'00 0001'B	1 parameter	
5QI	'0000 0101'B	5QI 5	

8.1.5.5 Redirection to NR

8.1.5.5.1 Redirection to NR / From E-UTRA / Success

8.1.5.5.1.1 Test Purpose (TP)

(1)

```
with { UE in E-UTRA RRC_CONNECTED state }
ensure that {
  when { UE receives an RRCConnectionRelease message including a redirectedCarrierInfo for
redirection to an NR cell }
  then { UE enters E-UTRA RRC_IDLE state and performs redirection to NR cell }
}
```

8.1.5.5.1.2 Conformance requirements

References: The conformance requirements covered in the current TC is specified in: TS 36.331 clause 5.3.8.3. Unless otherwise stated these are Rel-15 requirements.

[TS 36.331, clause 5.3.8.3]

The UE shall:

- 1> except for NB-IoT, BL UEs or UEs in CE, delay the following actions defined in this sub-clause 60 ms from the moment the *RRCConnectionRelease* message was received or optionally when lower layers indicate that the receipt of the *RRCConnectionRelease* message has been successfully acknowledged, whichever is earlier;
- 1> for BL UEs or UEs in CE, delay the following actions defined in this sub-clause 1.25 seconds from the moment the *RRCConnectionRelease* message was received or optionally when lower layers indicate that the receipt of the *RRCConnectionRelease* message has been successfully acknowledged, whichever is earlier;
- 1> for NB-IoT, delay the following actions defined in this sub-clause 10 seconds from the moment the *RRCConnectionRelease* message was received or optionally when lower layers indicate that the receipt of the *RRCConnectionRelease* message has been successfully acknowledged, whichever is earlier.

NOTE: For BL UEs, UEs in CE and NB-IoT, when STATUS reporting, as defined in TS 36.322 [7], has not been triggered and the UE has sent positive HARQ feedback (ACK), as defined in TS 36.321 [6], the lower layers can be considered to have indicated that the receipt of the *RRCConnectionRelease* message has been successfully acknowledged.

1> stop T380, if running;

1> if T309 is running:

2> stop timer T309 for all access categories;

- 2> perform the actions as specified in 5.3.16.4.
 - 1> if the *RRCConnectionRelease* message is received in response to an *RRCConnectionResumeRequest* for EDT:
 - 2> indicate to upper layers that the suspended RRC connection has been resumed;
 - 2> discard the stored UE AS context and *resumeIdentity*;
 - 2> stop timer T300;
 - 2> stop timer T302, if running;
 - 2> stop timer T303, if running;
 - 2> stop timer T305, if running;
 - 2> stop timer T306, if running;
 - 2> stop timer T308, if running;
 - 2> perform the actions as specified in 5.3.3.7;
 - 2> stop timer T320, if running;
 - 2> stop timer T322, if running;
 - 1> if the security is not activated and if UE is connected to 5GC:
 - 2> perform the actions upon leaving RRC_CONNECTED or RRC_INACTIVE as specified in 5.3.12 with the release cause 'other' upon which the procedure ends;
 - 1> if the *RRCConnectionRelease* message includes *redirectedCarrierInfo* indicating redirection to *geran*; or
 - 1> if the *RRCConnectionRelease* message includes *idleModeMobilityControlInfo* including *freqPriorityListGERAN*:
 - 2> if AS security has not been activated; and
 - 2> if upper layers indicate that redirect to GERAN without AS security is not allowed:
 - 3> ignore the content of the *RRCConnectionRelease*;
 - 3> perform the actions upon leaving RRC_CONNECTED or RRC_INACTIVE as specified in 5.3.12, with release cause 'other', upon which the procedure ends;
 - 1> if AS security has not been activated:
 - 2> ignore the content of *redirectedCarrierInfo*, if included and indicating redirection to *nr*;
 - 2> ignore the content of *idleModeMobilityControlInfo*, if included and including *freqPriorityListNR*;
 - 2> if the UE ignores the content of *redirectedCarrierInfo* or of *idleModeMobilityControlInfo*:
 - 3> perform the actions upon leaving RRC_CONNECTED as specified in 5.3.12, with release cause 'other', upon which the procedure ends;
 - 1> if the *RRCConnectionRelease* message includes *redirectedCarrierInfo* indicating redirection to *eutra* and if UE is connected to 5GC:
 - 2> if *cn-Type* is included:
 - 3> after the cell selection, indicate the available CN Type(s) and the received *cn-Type* to upper layers;
- NOTE 1: Handling the case if the E-UTRA cell selected after the redirection does not support the core network type specified by the *cn-Type*, is up to UE implementation.
- 1> if the *RRCConnectionRelease* message includes the *idleModeMobilityControlInfo*:
 - 2> store the cell reselection priority information provided by the *idleModeMobilityControlInfo*;

- 2> if the *t320* is included:
 - 3> start timer T320, with the timer value set according to the value of *t320*;
 - 1> else:
 - 2> apply the cell reselection priority information broadcast in the system information;
 - 1> if the *RRCConnectionRelease* message includes the *measIdleConfig*:
 - 2> clear *VarMeasIdleConfig* and *VarMeasIdleReport*;
 - 2> store the received *measIdleDuration* in *VarMeasIdleConfig*;
 - 2> start T331 with the value of *measIdleDuration*;
 - 2> if the *measIdleConfig* contains *measIdleCarrierListEUTRA*:
 - 3> store the received *measIdleCarrierListEUTRA* in *VarMeasIdleConfig*;
 - 3> start performing idle mode measurements as specified in 5.6.20;
- NOTE 2: If the *measIdleConfig* does not contain *measIdleCarrierListEUTRA*, UE may receive *measIdleCarrierListEUTRA* as specified in 5.2.2.12.
- 1> for NB-IoT, if the *RRCConnectionRelease* message includes the *redirectedCarrierInfo*:
 - 2> if the *redirectedCarrierOffsetDedicated* is included in the *redirectedCarrierInfo*:
 - 3> store the dedicated offset for the frequency in *redirectedCarrierInfo*;
 - 3> start timer T322, with the timer value set according to the value of *T322* in *redirectedCarrierInfo*;
 - 1> if the *releaseCause* received in the *RRCConnectionRelease* message indicates *loadBalancingTAURequired*:
 - 2> perform the actions upon leaving RRC_CONNECTED as specified in 5.3.12, with release cause 'load balancing TAU required';
 - 1> else if the *releaseCause* received in the *RRCConnectionRelease* message indicates *cs-FallbackHighPriority*:
 - 2> perform the actions upon leaving RRC_CONNECTED as specified in 5.3.12, with release cause 'CS Fallback High Priority';
 - 1> else:
 - 2> if the *waitTime* is present:
 - 3> start timer T302, with the timer value set according to the *waitTime*;
 - 3> inform the upper layer that access barring is applicable for all access categories except categories '0' and '2';
 - 2> if the *extendedWaitTime* is present; and
 - 2> if the UE supports delay tolerant access or the UE is a NB-IoT UE:
 - 3> forward the *extendedWaitTime* to upper layers;
 - 2> if the *extendedWaitTime-CPdata* is present and the NB-IoT UE only supports the Control Plane CIoT EPS optimisation:
 - 3> forward the *extendedWaitTime-CPdata* to upper layers;
 - 2> if the *releaseCause* received in the *RRCConnectionRelease* message indicates *rrc-Suspend*:
 - 3> perform the actions upon leaving RRC_CONNECTED as specified in 5.3.12, with release cause 'RRC suspension';

2> else if *rrc-InactiveConfig* is included:

3> perform the actions upon entering RRC_INACTIVE as specified in 5.3.8.7;

2> else:

3> perform the actions upon leaving RRC_CONNECTED or RRC_INACTIVE as specified in 5.3.12, with release cause 'other';

8.1.5.5.1.3 Test Description

8.1.5.5.1.3.1 Pre-test conditions

System Simulator:

- E-UTRA Cell 1 is the serving cell and NR Cell 1 is the suitable neighbour cell.
- System information combination 31 as defined in TS 36.508 [7] clause 4.4.3.1 is used in the E-UTRA cell.
- System information combination NR-6 as defined in TS 38.508-1 [4] clause 4.4.3.1.2 is used in the NR cell.

UE:

- In E-UTRA RRC_CONNECTED state using generic procedure parameters Connectivity (E-UTRA/EPC) and Unrestricted nr PDN (*On*) in accordance with the procedure described in TS 38.508-1 [4], clause 4.5.4.

Preamble:

- With NR Cell 1 "Serving cell" and E-UTRA Cell 1 "Non-suitable "Off" cell", the UE is brought to state 1N-A, RRC_IDLE Connectivity (NR), in accordance with the procedure described in TS 38.508-1 [4], Table 4.5.2.2-2. 5G-GUTI and ngKSI are assigned and security context established.
- the UE is switched-off
- With E-UTRA Cell 1 and NR Cell 1 power levels set according to T0, the UE is brought to state Generic RB Established (state 3) according to TS 36.508 [7] clause 4.5.3. 4G GUTI and eKSI are assigned and security context established

8.1.5.5.1.3.2 Test procedure sequence

Tables 8.1.5.5.1.3.2-0/ 8.1.5.5.1.3.2-0A illustrates the downlink power levels to be applied for NR Cell 1, E-UTRA Cell 1 for the test execution.

Table 8.1.5.5.1.3.2-0: Time instances of cell power level and parameter changes for FR1

	Parameter	Unit	NR Cell 1	E-UTRA Cell 1	Remark
T0	Cell-specific RS EPRE	dBm/15 kHz		-85	The power levels are such that reselection to NR Cell 1 does not happen.
	SS/PBCH SSS EPRE	dBm/S CS	-91	-	

Table 8.1.5.5.1.3.2-0A: Time instances of cell power level and parameter changes for FR2

	Parameter	Unit	NR Cell 1	E-UTRA Cell 1	Remark
T0	Cell-specific RS EPRE	dBm/15 kHz		-85	The power levels are such that reselection to NR Cell 1 does not happen.
	SS/PBCH SSS EPRE	dBm/S CS	-94	-	

Table 8.1.5.5.1.3.2-1: Main behaviour

St	Procedure	Message Sequence		TP	Verdict
		U - S	Message		
1	The SS transmits an <i>RRCConnectionRelease</i> message indicating redirection to NR Cell 1.	-	E-UTRA RRC: <i>RRCConnectionRelease</i>	-	-
2-14a1	Check: Does the test result of generic test procedure in TS 38.508-1 subclause 4.9.9 indicate that the UE has performed mobility registration updating when it camps on NR Cell 1?	-	-	1	P

8.1.5.5.1.3.3 Specific message contents

Table 8.1.5.5.1.3.3-1: RRCConnectionRelease (step 1, Table 8.1.5.5.1.3.2-1)

Derivation Path: TS 36.508 table 4.6.1-15			
Information Element	Value/remark	Comment	Condition
RRCConnectionRelease ::= SEQUENCE {			
criticalExtensions CHOICE {			
c1 CHOICE {			
rrcConnectionRelease-r8 SEQUENCE {			
redirectedCarrierInfo CHOICE {			
nr-r15 SEQUENCE {			
carrierFreq-r15	ARFCN of NR Cell 1		
}			
}			
}			
}			
}			

8.1.5.6 Radio link failure

8.1.5.6.1 Radio link failure / RRC connection re-establishment success

8.1.5.6.1.1 Test Purpose (TP)

(1)

```
with { UE in NR RRC_CONNECTED state }
ensure that {
  when { UE detecting physical layer recovery while T310 was running }
  then { UE resumes the RRC connection without explicit signalling }
}
```

(2)

```
with { UE in NR RRC_CONNECTED state }
ensure that {
  when { UE detecting physical layer problems }
  then { UE shall start timer T310 and UE does not initiate any RRC connection re-establishment procedure before expiring of timer T310 }
}
```

(3)

```
with { UE in NR RRC_CONNECTED state }
ensure that {
  when { UE detecting radio link failure on expiring of timer T310 }
  then { UE starts timer T311 and UE initiates the RRC connection re-establishment procedure }
}
```

(4)

```

with { UE having initiated RRC connection re-establishment procedure and timer T311 running }
ensure that {
  when { UE successfully completes the RRC connection re-establishment procedure }
  then { UE is in NR RRC_CONNECTED state }
}

```

(5)

```

with { UE in NR RRC_CONNECTED state and upon detecting radio link failure UE sends
RRCReestablishmentRequest message }
ensure that {
  when { UE receives a RRCSetup message }
  then { UE completes RRC setup procedure by sending RRCSetupComplete message }
}

```

8.1.5.6.1.2 Conformance requirements

References: The conformance requirements covered in the current TC are specified in: TS 38.331 clauses 5.3.3.4, 5.3.7.2, 5.3.7.8, 5.3.10.1, 5.3.10.2 and 5.3.10.3.

[TS 38.331 clause 5.3.3.4]

The UE shall perform the following actions upon reception of the *RRCSetup*:

- 1> if the *RRCSetup* is received in response to an *RRCReestablishmentRequest*; or
- 1> if the *RRCSetup* is received in response to an *RRCResumeRequest* or *RRCResumeRequest1*:
 - 2> discard any stored UE Inactive AS context and *suspendConfig*;
 - 2> discard any current AS security context including the $K_{RRCCenc}$ key, the $K_{RRCCint}$ key, the K_{UPint} key and the K_{UPenc} key;
 - 2> release radio resources for all established RBs except SRB0, including release of the RLC entities, of the associated PDCP entities and of SDAP;
 - 2> release the RRC configuration except for the default L1 parameter values, default MAC Cell Group configuration and CCCH configuration;
 - 2> indicate to upper layers fallback of the RRC connection;
 - 2> stop timer T380, if running;
- 1> perform the cell group configuration procedure in accordance with the received *masterCellGroup* and as specified in 5.3.5.5;
- 1> perform the radio bearer configuration procedure in accordance with the received *radioBearerConfig* and as specified in 5.3.5.6;
- 1> if stored, discard the cell reselection priority information provided by the *cellReselectionPriorities* or inherited from another RAT;
- 1> stop timer T300, T301 or T319 if running;
- 1> if T390 is running:
 - 2> stop timer T390 for all access categories;
 - 2> perform the actions as specified in 5.3.14.4;
- 1> if T302 is running:
 - 2> stop timer T302;
 - 2> perform the actions as specified in 5.3.14.4;

- 1> stop timer T320, if running;
 - 1> if the *RRCSetup* is received in response to an *RRCResumeRequest*, *RRCResumeRequest1* or *RRCSetupRequest*:
 - 2> enter RRC_CONNECTED;
 - 2> stop the cell re-selection procedure;
 - 1> consider the current cell to be the PCell;
 - 1> set the content of *RRCSetupComplete* message as follows:
 - 2> if upper layers provide a 5G-S-TMSI:
 - 3> if the *RRCSetup* is received in response to an *RRCSetupRequest*:
 - 4> set the *ng-5G-S-TMSI-Value* to *ng-5G-S-TMSI-Part2*;
 - 3> else:
 - 4> set the *ng-5G-S-TMSI-Value* to *ng-5G-S-TMSI*;
 - 2> set the *selectedPLMN-Identity* to the PLMN selected by upper layers (TS 24.501 [23]) from the PLMN(s) included in the *plmn-IdentityList* in *SIB1*;
 - 2> if upper layers provide the 'Registered AMF':
 - 3> include and set the *registeredAMF* as follows:
 - 4> if the PLMN identity of the 'Registered AMF' is different from the PLMN selected by the upper layers:
 - 5> include the *plmnIdentity* in the *registeredAMF* and set it to the value of the PLMN identity in the 'Registered AMF' received from upper layers;
 - 4> set the *amf-Identifier* to the value received from upper layers;
 - 3> include and set the *guami-Type* to the value provided by the upper layers;
 - 2> if upper layers provide one or more S-NSSAI (see TS 23.003 [21]):
 - 3> include the *s-NSSAI-List* and set the content to the values provided by the upper layers;
 - 2> set the *dedicatedNAS-Message* to include the information received from upper layers;
 - 1> submit the *RRCSetupComplete* message to lower layers for transmission, upon which the procedure ends
- [TS 38.331 clause 5.3.7.2]

The UE initiates the procedure when one of the following conditions is met:

- 1> upon detecting radio link failure of the MCG, in accordance with 5.3.10; or
- 1> upon re-configuration with sync failure of the MCG, in accordance with sub-clause 5.3.5.8.3; or
- 1> upon mobility from NR failure, in accordance with sub-clause 5.4.3.5; or
- 1> upon integrity check failure indication from lower layers concerning SRB1 or SRB2, except if the integrity check failure is detected on the *RRCReestablishment* message; or
- 1> upon an RRC connection reconfiguration failure, in accordance with sub-clause 5.3.5.8.2.

Upon initiation of the procedure, the UE shall:

- 1> stop timer T310, if running;
- 1> stop timer T304, if running;
- 1> start timer T311;

- 1> suspend all RBs, except SRB0;
- 1> reset MAC;
- 1> release the MCG SCell(s), if configured;
- 1> release *spCellConfig*;
- 1> release *delayBudgetReportingConfig*, if configured, and stop timer T342, if running;
- 1> release *overheatingAssistanceConfig*, if configured, and stop timer T345, if running;
- 1> perform cell selection in accordance with the cell selection process as specified in TS 38.304 [20], clause 5.2.6.

[TS 38.331 clause 5.3.7.8]

The UE shall:

- 1> perform the RRC connection establishment procedure as specified in 5.3.3.4.

[TS 38.331 clause 5.3.10.1]

The UE shall:

- 1> upon receiving N310 consecutive "out-of-sync" indications for the SpCell from lower layers while neither T300, T301, T304, T311 nor T319 are running:
 - 2> start timer T310 for the corresponding SpCell.

[TS 38.331 clause 5.3.10.2]

Upon receiving N311 consecutive "in-sync" indications for the SpCell from lower layers while T310 is running, the UE shall:

- 1> stop timer T310 for the corresponding SpCell.

NOTE 1: In this case, the UE maintains the RRC connection without explicit signalling, i.e. the UE maintains the entire radio resource configuration.

NOTE 2: Periods in time where neither "in-sync" nor "out-of-sync" is reported by L1 do not affect the evaluation of the number of consecutive "in-sync" or "out-of-sync" indications.

[TS 38.331 clause 5.3.10.3]

The UE shall:

- 1> upon T310 expiry in PCell; or
- 1> upon random access problem indication from MCG MAC while neither T300, T301, T304, T311 nor T319 are running; or
- 1> upon indication from MCG RLC that the maximum number of retransmissions has been reached:
 - 2> if the indication is from MCG RLC and CA duplication is configured and activated, and for the corresponding logical channel *allowedServingCells* only includes SCell(s):
 - 3> initiate the failure information procedure as specified in 5.7.5 to report RLC failure.
 - 2> else:
 - 3> consider radio link failure to be detected for the MCG i.e. RLF;
 - 3> if AS security has not been activated:
 - 4> perform the actions upon going to RRC_IDLE as specified in 5.3.11, with release cause 'other';-
 - 3> else if AS security has been activated but SRB2 and at least one DRB have not been setup:

4> perform the actions upon going to RRC_IDLE as specified in 5.3.11, with release cause 'RRC connection failure';

3> else:

4> initiate the connection re-establishment procedure as specified in 5.3.7.

8.1.5.6.1.3 Test description

8.1.5.6.1.3.1 Pre-test conditions

System Simulator:

- 3 NR Cells. NR Cell 1 is the serving cell, NR Cell 2 and NR Cell 4 are the intra-frequency neighbour cell.

None.

Preamble:

- The UE is in state 3N-A as defined in TS 38.508-1 [4], subclause 4.4A on NR Cell 1.

8.1.5.6.1.3.2 Test procedure sequence

Table 8.1.5.6.1.3.2-1: Time instances of cell power level and parameter changes for FR1

	Parameter	Unit	NR Cell 1	NR Cell 2	NR Cell 4
T0	SS/PBCH SSS EPRE	dBm/SCS	"Off"	"Off"	"Off"
T0 A	SS/PBCH SSS EPRE	dBm/SCS	-88	"Off"	"Off"
T1	SS/PBCH SSS EPRE	dBm/SCS	"Off"	-88	-94
T2	SS/PBCH SSS EPRE	dBm/SCS	"Off"	"Off"	-88
Power level "Off" is defined in TS 38.508-1 [4] Table 6.2.2.1-3.					

Table 8.1.5.6.1.3.2-2: Time instances of cell power level and parameter changes for FR2

	Parameter	Unit	NR Cell 1	NR Cell 2	NR Cell 4
T0	SS/PBCH SSS EPRE	dBm/SCS	"Off"	"Off"	"Off"
T0 A	SS/PBCH SSS EPRE	dBm/SCS	-82	"Off"	"Off"
T1	SS/PBCH SSS EPRE	dBm/SCS	"Off"	-82	-91
T2	SS/PBCH SSS EPRE	dBm/SCS	"Off"	"Off"	-82
Power level "Off" is defined in TS 38.508-1 [4] Table 6.2.2.2-2.					

Table 8.1.5.6.1.3.2-3: Main behaviour

St	Procedure	Message Sequence		TP	Verdict
		U - S	Message		
0A	The SS changes NR Cell 1 parameters according to the row "T0" in table Table 8.1.5.6.1.3.2-1/2 to set NR Cell 1 to Non-suitable "Off".	-	-	-	-
0B	The SS wait for 1,5 s (T310 (2s) is transmitted in SIB1).	-	-	-	-

0C	The SS changes NR Cell 1 parameters according to the row "TOA" in table 8.1.5.6.1.3.2-1/2 making NR Cell 1 serving cell.	-	-	-	-
0D	Check: For the next 5 s does the UE transmit any signalling message?	-	-	1	F
0E	Check: Does the test result of generic test procedure in TS 38.508-1 [4] subclause 4.9.10 indicate that the UE is in NR RRC_CONNECTED state on NR Cell 1?	-	-	1	P
1	The SS changes NR Cell 1, NR Cell 2 and NR Cell 4 parameters according to the row "T1" in table 8.1.5.6.1.3.2-1/2 in order that the radio link quality of NR Cell 1 is degraded, and NR Cell 2 is suitable for camping.	-	-	-	-
2	Check: Does the UE initiate an RRC connection re-establishment procedure on Cell 1 or Cell 2. This is checked during the time T=T310?	-	-	2	F
3	Check: Does the UE send <i>RRCReestablishmentRequest</i> message on NR Cell 2?	-->	NR RRC: <i>RRCReestablishmentRequest</i>	3	P
4	The SS transmits <i>RRCReestablishment</i> message.	<--	NR RRC: <i>RRCReestablishment</i>	-	-
5	The UE transmits <i>RRCReestablishmentComplete</i> message.	-->	NR RRC: <i>RRCReestablishmentComplete</i>	-	-
6	The SS transmits an <i>RRCReconfiguration</i> message to resume existing radio bearer.	<--	NR RRC: <i>RRCReconfiguration</i>	-	-
7	Check: Does the UE transmit an <i>RRCReconfigurationComplete</i> message?	-->	NR RRC: <i>RRCReconfigurationComplete</i>	4	P
8	The SS changes NR Cell 2 and NR Cell 4 parameters according to the row "T2" in table 8.1.5.6.1.3.2-1/2 in order that the radio link quality of NR Cell 2 is degraded and cell 4 is suitable for camping.	-	-	-	-
9	Check: Does the UE send <i>RRCReestablishmentRequest</i> message on NR Cell 4?	-->	NR RRC: <i>RRCReestablishmentRequest</i>	-	-
10	The SS transmits <i>RRCSetup</i> message.	<--	NR RRC: <i>RRCSetup</i>	-	-
11	Check: Does the UE transmit a <i>RRCSetupComplete</i> message and a REGISTRATION REQUEST message indicating "mobility registration updating"?	-->	NR RRC: <i>RRCSetupComplete</i> 5GMM: REGISTRATION REQUEST	5	P
11A	The SS transmits a <i>DLInformationTransfer</i> message and an AUTHENTICATION REQUEST message.	<--	RRC: <i>DLInformationTransfer</i> NAS: AUTHENTICATION REQUEST	-	-
11B	The UE transmits an <i>ULInformationTransfer</i> message and an AUTHENTICATION RESPONSE message.	-->	RRC: <i>ULInformationTransfer</i> NAS: AUTHENTICATION RESPONSE	-	-
11C	The SS transmits a NAS SECURITY MODE COMMAND message to activate NAS security.	<--	RRC: <i>DLInformationTransfer</i> NAS: SECURITY MODE COMMAND	-	-
11D	The UE transmits a NAS SECURITY MODE COMPLETE message and establishes the initial security configuration.	-->	RRC: <i>ULInformationTransfer</i> NAS: SECURITY MODE COMPLETE	-	-
12	The SS transmits a <i>SecurityModeCommand</i> message.	<--	NR RRC: <i>SecurityModeCommand</i>	-	-
13	The UE transmits a <i>SecurityModeComplete</i> message.	-->	NR RRC: <i>SecurityModeComplete</i>	-	-
14	The SS transmits an <i>RRCReconfiguration</i> message to establish SRB2 and DRB and a REGISTRATION ACCEPT message.	<--	NR RRC: <i>RRCReconfiguration</i> 5GMM: REGISTRATION ACCEPT	-	-
15	The UE transmits an <i>RRCReconfigurationComplete</i> message.	-->	NR RRC: <i>RRCReconfigurationComplete</i>	-	-
16	The UE sends a REGISTRATION COMPLETE.	-->	NR RRC: <i>ULInformationTransfer</i>	-	-

			5GMM: REGISTRATION COMPLETE		
--	--	--	-----------------------------	--	--

8.1.5.6.1.3.3 Specific message contents

Table 8.1.5.6.1.3.3-0: SIB1 for Cell 1 (all steps)

Derivation Path: TS 38.508-1 [4] table 4.6.1-28			
Information Element	Value/Remark	Comment	Condition
SIB1 ::= SEQUENCE {			
ue-TimersAndConstants SEQUENCE {			
t310	ms2000		
}			
}			

Table 8.1.5.6.1.3.3-0A: RLF-TimersAndConstants(preamble)

Derivation Path: TS 38.508-1 [4] Table 4.6.1-150			
Information Element	Value/remark	Comment	Condition
RLF-TimersAndConstants ::= SEQUENCE {			
t310	ms2000		
}			

Table 8.1.5.6.1.3.3-0B: RRCSetup (preamble)

Derivation Path: TS 38.508-1 [4], Table 4.6.1-21			
Information Element	Value/remark	Comment	Condition
RRCSetup ::= SEQUENCE {			
criticalExtensions CHOICE {			
rrcSetup SEQUENCE {			
masterCellGroup SEQUENCE {			
spCellConfig SEQUENCE {			
rlf-TimersAndConstants CHOICE {			
setup	RLF-TimersAndConstants	Table 8.1.5.6.1.3.3-0A	
}			
spCellConfigDedicated SEQUENCE {			
initialDownlinkBWP SEQUENCE {			
radioLinkMonitoringConfig CHOICE {			
setup	RadioLinkMonitoringConfig specified in TS 38.508-1[4] Table 4.6.3-133		
}			
}			
}			
}			
}			
}			
}			

Table 8.1.5.6.1.3.3-1: RRCReestablishmentRequest (step 3, Table 8.1.5.6.1.3.2-3)

Derivation Path: TS 38.508-1 [4] table 4.6.1-12			
Information Element	Value/remark	Comment	Condition
RRCReestablishmentRequest ::= SEQUENCE {			
ue-Identity SEQUENCE {			
c-RNTI	the value of the C-RNTI of the UE		
physCellId	PhysicalCellIdentity of NR Cell 1		

shortMAC-I	The same value as the 16 least significant bits of the XMAC-I value calculated by SS		
}			
reestablishmentCause	otherFailure		
}			

Table 8.1.5.6.1.3.3-1A: RRCReconfiguration (step 6, Table 8.1.5.6.1.3.2-3)

Derivation Path: TS 38.508-1[4], table 4.6.1-13 with condition REEST			
Information Element	Value/remark	Comment	Condition
RRCReconfiguration ::= SEQUENCE {			
criticalExtensions CHOICE {			
rrcReconfiguration SEQUENCE {			
nonCriticalExtension SEQUENCE {			
masterCellGroup SEQUENCE {			
spCellConfig SEQUENCE {			
spCellConfigDedicated SEQUENCE {			
initialDownlinkBWP SEQUENCE {			
radioLinkMonitoringConfig CHOICE {			
setup	RadioLinkMonitoringConfig specified in TS 38.508-1[4] Table 4.6.3-133		
}			
}			
}			
}			
}			
}			
}			
}			
}			
}			
}			

Table 8.1.5.6.1.3.3-2: RRCReestablishmentRequest (step 9, Table 8.1.5.6.1.3.2-3)

Derivation Path: TS 38.508-1 [4] table 4.6.1-12			
Information Element	Value/remark	Comment	Condition
RRCReestablishmentRequest ::= SEQUENCE {			
ue-Identity SEQUENCE {			
c-RNTI	the value of the C-RNTI of the UE		
physCellId	PhysicalCellIdentity of NR Cell 2		
shortMAC-I	The same value as the 16 least significant bits of the XMAC-I value calculated by SS		
}			
reestablishmentCause	otherFailure		
}			

Table 8.1.5.6.1.3.3-3: RRCReconfiguration (step 14, Table 8.1.5.6.1.3.2-3)

Derivation Path: TS 38.508-1[4], table 4.6.1-13 with condition NR

8.1.5.6.2 Void

8.1.5.6.3 Radio link failure / T311 expiry

8.1.5.6.3.1 Test Purpose (TP)

(1)

```
with { UE in NR RRC_CONNECTED state and radio link failure was detected and UE attempts to select a
suitable NR cell to re-establish the RRC connection }
ensure that {
  when { UE cannot find a suitable NR cell within T311 }
    then { UE does not try to re-establish the RRC connection and goes to NR RRC_IDLE state after
T311 expired }
}
```

8.1.5.6.3.2 Conformance requirements

References: The conformance requirements covered in the current TC are specified in: TS 38.331 clauses 5.3.7.2, 5.3.7.6, 5.3.7.8, 5.3.10.1, 5.3.10.3 and 5.3.5.5.7.

[TS 38.331 clause 5.3.7.2]

The UE initiates the procedure when one of the following conditions is met:

- 1> upon detecting radio link failure of the MCG, in accordance with 5.3.10; or
- 1> upon re-configuration with sync failure of the MCG, in accordance with sub-clause 5.3.5.8.3; or
- 1> upon mobility from NR failure, in accordance with sub-clause 5.4.3.5; or
- 1> upon integrity check failure indication from lower layers concerning SRB1 or SRB2, except if the integrity check failure is detected on the *RRCReestablishment* message; or
- 1> upon an RRC connection reconfiguration failure, in accordance with sub-clause 5.3.5.8.2.

Upon initiation of the procedure, the UE shall:

- 1> stop timer T310, if running;
- 1> stop timer T304, if running;
- 1> start timer T311;
- 1> suspend all RBs, except SRB0;
- 1> reset MAC;
- 1> release the MCG SCell(s), if configured;
- 1> release *spCellConfig*;
- 1> release *delayBudgetReportingConfig*, if configured, and stop timer T342, if running;
- 1> release *overheatingAssistanceConfig*, if configured, and stop timer T345, if running;
- 1> perform cell selection in accordance with the cell selection process as specified in TS 38.304 [20], clause 5.2.6.

[TS 38.331 clause 5.3.7.7]

Upon T311 expiry, the UE shall:

- 1> perform the actions upon going to RRC_IDLE as specified in 5.3.11, with release cause 'RRC connection failure'.

[TS 38.331 clause 5.3.7.8]

The UE shall:

- 1> perform the RRC connection establishment procedure as specified in 5.3.3.4.

[TS 38.331 clause 5.3.10.1]

The UE shall:

- 1> upon receiving N310 consecutive "out-of-sync" indications for the SpCell from lower layers while neither T300, T301, T304, T311 nor T319 are running:
 - 2> start timer T310 for the corresponding SpCell.

[TS 38.331 clause 5.3.10.3]

The UE shall:

- 1> upon T310 expiry in PCell; or
- 1> upon random access problem indication from MCG MAC while neither T300, T301, T304, T311 nor T319 are running; or
- 1> upon indication from MCG RLC that the maximum number of retransmissions has been reached:
 - 2> if the indication is from MCG RLC and CA duplication is configured and activated, and for the corresponding logical channel *allowedServingCells* only includes SCell(s):
 - 3> initiate the failure information procedure as specified in 5.7.5 to report RLC failure.
 - 2> else:
 - 3> consider radio link failure to be detected for the MCG i.e. RLF;
 - 3> if AS security has not been activated:
 - 4> perform the actions upon going to RRC_IDLE as specified in 5.3.11, with release cause 'other';-
 - 3> else if AS security has been activated but SRB2 and at least one DRB have not been setup:
 - 4> perform the actions upon going to RRC_IDLE as specified in 5.3.11, with release cause 'RRC connection failure';
 - 3> else:
 - 4> initiate the connection re-establishment procedure as specified in 5.3.7.

[TS 38.331, 5.3.5.5.7]

The UE shall:

- 1> if the *SpCellConfig* contains the *rlf-TimersAndConstants*:
 - 2> configure the RLF timers and constants for this cell group as specified in 5.3.5.5.6;
- 1> else if *rlf-TimersAndConstants* is not configured for this cell group:
 - 2> use values for timers T301, T310, T311 and constants N310, N311, as included in *ue-TimersAndConstants* received in *SIB1*;

8.1.5.6.3.3 Test description

8.1.5.6.3.3.1 Pre-test conditions

System Simulator:

- NR Cell 1

None.

Preamble:

- The UE is in state 3N-A as defined in TS 38.508-1 [4], subclause 4.4A on NR Cell 1.

8.1.5.6.3.3.2 Test procedure sequence

Table 8.1.5.6.3.3.2-1: Time instances of cell power level and parameter changes for FR1

	Parameter	Unit	NR Cell 1
T1	SS/PBCH SSS EPRE	dBm/SCS	"Off"
T2	SS/PBCH SSS EPRE	dBm/SCS	-88
Power level "Off" is defined in TS 38.508-1 [4] Table 6.2.2.1-3.			

Table 8.1.5.6.3.3.2-2: Time instances of cell power level and parameter changes for FR2

	Parameter	Unit	NR Cell 1
T1	SS/PBCH SSS EPRE	dBm/SCS	"Off"
T2	SS/PBCH SSS EPRE	dBm/SCS	-82
Power level "Off" is defined in TS 38.508-1 [4] Table 6.2.2.2-2.			

Table 8.1.5.6.3.3.2-3: Main behaviour

St	Procedure	Message Sequence		TP	Verdict
		U - S	Message		
1	The SS changes NR Cell 1 parameters according to the row "T1" in table 8.1.5.6.3.3.2-1 in order that the radio link quality of NR Cell 1 is degraded.	-	-	-	-
2	Wait for 12s (T311 (10s) is transmitted in RRCSetup).	-	-	-	-
3	The SS changes NR Cell 1 parameters according to the row "T2" in table 8.1.5.6.3.3.2-1 making NR Cell 1 is suitable for camping.	-	-	-	-
4	Check: Does the test result of generic test procedure in TS 38.508-1 [4] subclause 4.9.5 indicate that the UE is camped on NR Cell 1?	-	-	1	P

8.1.5.6.3.3.3 Specific message contents

Table 8.1.5.6.3.3.3-1: RRCSetup(Preamble)

Derivation Path: TS 38.508-1 [4] table 4.6.1-21			
Information Element	Value/remark	Comment	Condition

RRCSetup ::= SEQUENCE {			
criticalExtensions CHOICE {			
rrcSetup SEQUENCE {			
masterCellGroup	CellGroupConfig with condition SRB1	OCTET STRING (CONTAINING CellGroupConfig)	
}			
}			
}			

Table 8.1.5.6.3.3.3-2: CellGroupConfig (Table 8.1.5.6.3.3.3-1)

Derivation Path: TS 38.508-1 [4], Table 4.6.3-19			
Information Element	Value/remark	Comment	Condition
CellGroupConfig ::= SEQUENCE {			
rfl-TimersAndConstants SEQUENCE {			
t311-v1530	ms10000		
}			
spCellConfigDedicated	ServingCellConfig		
}			

Table 8.1.5.6.3.3.3-3: ServingCellConfig (Table 8.1.5.6.3.3.3-2: CellGroupConfig)

Derivation Path: TS 38.508-1 [4], Table 4.6.3-167			
Information Element	Value/remark	Comment	Condition
ServingCellConfig ::= SEQUENCE {			
initialDownlinkBWP	BWP-DownlinkDedicated		
}			

Table 8.1.5.6.3.3.3-4: BWP-DownlinkDedicated (Table 8.1.5.6.3.3.3-3: ServingCellConfig)

Derivation Path: TS 38.508-1 [4], Table 4.6.3-11			
Information Element	Value/remark	Comment	Condition
BWP-DownlinkDedicated ::= SEQUENCE {			
radioLinkMonitoringConfig	RadioLinkMonitoringConfig		
}			

8.1.5.6.4 Void

8.1.5.6.5 NR CA / No Radio Link Failure on SCell / RRC Connection Continues on PCell

8.1.5.6.5.1 NR CA / No Radio Link Failure on SCell / RRC Connection Continues on PCell / Intra-band Contiguous CA

8.1.5.6.5.1.1 Test Purpose (TP)

(1)

```
with { UE in NR RRC_CONNECTED, security activated and SCell configured }
ensure that {
  when { the SCell becomes out of coverage for the UE }
  then { UE does not consider radio link failure to be detected and stay in NR RRC_CONNECTED state }
}
```

8.1.5.6.5.1.2 Conformance requirements

References: The conformance requirements covered in the present TC are specified in: TS 38.331, clauses 5.3.5.5.6, 5.3.10.1 and 5.3.10.3. Unless otherwise stated these are Rel-15 requirements.

[TS 38.331, clause 5.3.5.5.6]

The UE shall:

- 1> if the received *rlf-TimersAndConstants* is set to *release*:
 - 2> use values for timers T301, T310, T311 and constants N310, N311, as included in *ue-TimersAndConstants* received in *SIB1*;
- 1> else:
 - 2> (re-)configure the value of timers and constants in accordance with received *rlf-TimersAndConstants*;
 - 2> stop timer T310 for this cell group, if running;
 - 2> reset the counters N310 and N311.

[TS 38.331, clause 5.3.10.1]

The UE shall:

- 1> upon receiving N310 consecutive "out-of-sync" indications for the SpCell from lower layers while neither T300, T301, T304, T311 nor T319 are running:
- 2> start timer T310 for the corresponding SpCell.

[TS 38.331, clause 5.3.10.3]

The UE shall:

- 1> upon T310 expiry in PCell; or
- 1> upon random access problem indication from MCG MAC while neither T300, T301, T304, T311 nor T319 are running; or
- 1> upon indication from MCG RLC that the maximum number of retransmissions has been reached:
 - 2> if the indication is from MCG RLC and CA duplication is configured and activated, and for the corresponding logical channel *allowedServingCells* only includes SCell(s):
 - 3> initiate the failure information procedure as specified in 5.7.5 to report RLC failure.
 - 2> else:
 - 3> consider radio link failure to be detected for the MCG, i.e. MCG RLF;
 - 3> if AS security has not been activated:
 - 4> perform the actions upon going to RRC_IDLE as specified in 5.3.11, with release cause 'other';-
 - 3> else if AS security has been activated but SRB2 and at least one DRB have not been setup:
 - 4> perform the actions upon going to RRC_IDLE as specified in 5.3.11, with release cause 'RRC connection failure';
 - 3> else:
 - 4> initiate the connection re-establishment procedure as specified in 5.3.7.

The UE shall:

- 1> upon T310 expiry in PSCell; or

- 1> upon random access problem indication from SCG MAC; or
- 1> upon indication from SCG RLC that the maximum number of retransmissions has been reached:
 - 2> if the indication is from SCG RLC and CA duplication is configured and activated, and for the corresponding logical channel *allowedServingCells* only includes SCell(s):
 - 3> initiate the failure information procedure as specified in 5.7.5 to report RLC failure.
 - 2> else:
 - 3> consider radio link failure to be detected for the SCG, i.e. SCG RLF;
 - 3> initiate the SCG failure information procedure as specified in 5.7.3 to report SCG radio link failure.

8.1.5.6.5.1.3 Test description

8.1.5.6.5.1.3.1 Pre-test conditions

System Simulator:

- NR Cell 1, and NR Cell 3
- NR Cell 1 is PCell
- NR Cell 3 is SCell
- System information combination NR-4 as defined in TS 38.508-1 [4] clause 4.4.3.1.2 is used in NR cells.

UE:

None.

Preamble:

- The UE is in 5GS state 3N-A with UE test loop mode B active if *pc_IP_Ping* is set to FALSE according to TS 38.508-1 [4], clause 4.4A.2 Table 4.4A.2-3 on NR Cell 1.

8.1.5.6.5.1.3.2 Test procedure sequence

Table 8.5.1.7.1.3.2-1 illustrates the downlink power levels and other changing parameters to be applied for the cells at various time instants of the test execution. Row marked "T0" denotes the initial conditions after preamble, while columns marked "T1" is to be applied subsequently. The exact instants on which these values shall be applied are described in the texts in this clause.

Table 8.1.5.6.5.1.3.2-1: Time instances of cell power level and parameter changes for FR1

	Parameter	Unit	NR Cell 1	NR Cell 3	Remark
T0	SS/PBCH SSS EPRE	dBm/SCS	-88	-88	NR Cell1 and NR Cell 3 are available
T1	SS/PBCH SSS EPRE	dBm/SCS	-88	"Off"	Only NR Cell 1 is available.

Table 8.1.5.6.5.1.3.2-1A: Time instances of cell power level and parameter changes for FR2

	Parameter	Unit	NR Cell 1	NR Cell 3	Remark
T0	SS/PBCH SSS EPRE	dBm/SCS	-95	-95	NR Cell1 and NR Cell 3 are available
T1	SS/PBCH SSS EPRE	dBm/SCS	-95	"Off"	Only NR Cell 1 is available.

Table 8.1.5.6.5.1.3.2-2: Main behaviour

St	Procedure	Message Sequence		TP	Verdict
		U - S	Message		
1	The SS transmits an <i>RRCReconfiguration</i> message on NR Cell 1 to configure NR Cell 3 as SCell.	<--	<i>RRCReconfiguration</i>	-	-
2	The UE transmits an <i>RRCReconfigurationComplete</i> message on NR Cell 1.	-->	<i>RRCReconfigurationComplete</i>	-	-
2A	The SS transmits an Activation MAC control element to activate SCell.	<--	MAC PDU (SCell Activation/Deactivation MAC CE of one octet (C ₁ =1))	-	-
3	Wait for 1s.	-	-	-	-
4	The SS changes power levels according to row "T1" in Table 8.1.5.6.5.1.3.2-1/1A.	-	-	-	-
5	Wait for 1s.	-	-	-	-
6	Check: Does the UE transmit an <i>RRCReestablishmentRequest</i> message on NR Cell 1 within next 2 seconds?	-->	<i>RRCReestablishmentRequest</i>	1	F
7	The SS changes power levels according to row "T0" in Table 8.1.5.6.5.1.3.2-1/1A.	-	-	-	-
8	Check: Does the test result of generic test procedure in TS 38.508-1 subclause 4.9.1 indicate that the UE is capable of exchanging IP data on NR Cell 3?	-	-	1	P
9	The SS transmits an <i>RRCReconfiguration</i> message containing an <i>sCellToReleaseList</i> with SCell NR Cell 3.	<--	NR RRC: <i>RRCReconfiguration</i>	-	-
10	The UE transmits an <i>RRCReconfigurationComplete</i> message.	-->	NR RRC: <i>RRCReconfigurationComplete</i>	-	-

8.1.5.6.5.1.3.3 Specific message contents

Table 8.1.5.6.5.1.3.3-1: *RRCReconfiguration* (step 1, Table 8.1.5.6.5.1.3.2-2)

Derivation Path: TS 38.508-1 [4] Table 4.6.1-13 with condition SCell_add

Table 8.1.5.6.5.1.3.3-2: Void

Table 8.1.5.6.5.1.3.3-3: Void

Table 8.1.5.6.5.1.3.3-4: *RRCReconfiguration* (Step 9, Table 8.1.5.6.5.1.3.2-2)

Derivation Path: TS 38.508-1 [4], Table 4.6.1-13 with Condition SCell_Add			
Information Element	Value/remark	Comment	Condition
<i>RRCReconfiguration</i> ::= SEQUENCE {			
criticalExtensions CHOICE {			
rrcReconfiguration SEQUENCE {			
nonCriticalExtension SEQUENCE {			
masterCellGroup SEQUENCE {			
sCellToAddModList	Not present		
sCellToReleaseList SEQUENCE (SIZE (1..maxNrofSCells)) OF SCellIndex {	1 entry		
SCellIndex[1]	SCellIndex of Cell 3	entry 1	
}			
}			
}			
}			
}			

8.1.5.6.5.2 NR CA / No Radio Link Failure on SCell / RRC Connection Continues on PCell / Inter-band CA

8.1.5.6.5.2.1 Test Purpose (TP)

Same as TC 8.1.5.6.5.1 but applied to Inter-band CA Test Case.

8.1.5.6.5.2.2 Conformance Requirements

Same as TC 8.1.5.6.5.1 but applied to Inter-band CA Test Case.

8.1.5.6.5.2.3 Test Description

8.1.5.6.5.2.3.1 Pre-test conditions

Same as TC 8.1.5.6.5.1 but with the following differences:

- CA configuration: Inter-band CA replaces Intra-band Contiguous CA.
- Cells configuration: Cell 10 replaces Cell 3.
- Cell 10 is an Inactive SCell according to TS 38.508-1 [4] clause 6.3.1.

8.1.5.6.5.2.3.2 Test procedure sequence

Same as TC 8.1.5.6.5.1 with the following differences:

- CA configuration: Inter-band CA replaces Intra-band Contiguous CA.
- Cells configuration: Cell 10 replaces Cell 3.

8.1.5.6.5.2.3.3 Specific message contents

Same as TC 8.1.5.6.5.1 but applied to Inter-band CA Test Case.

8.1.5.6.5.3 NR CA / No Radio Link Failure on SCell / RRC Connection Continues on PCell / Intra-band non-Contiguous CA

8.1.5.6.5.3.1 Test Purpose (TP)

Same as TC 8.1.5.6.5.1 but applied to Intra-band non-Contiguous CA Test Case.

8.1.5.6.5.3.2 Conformance Requirements

Same as TC 8.1.5.6.5.1 but applied to Intra-band non-Contiguous CA Test Case.

8.1.5.6.5.3.3 Test Description

8.1.5.6.5.3.3.1 Pre-test conditions

Same as TC 8.1.5.6.5.1 but with the following differences:

- CA configuration: Intra-band non-Contiguous CA replaces Intra-band Contiguous CA.

8.1.5.6.5.3.3.2 Test procedure sequence

Same as TC 8.1.5.6.5.1 with the following differences:

- CA configuration: Intra-band non-Contiguous CA replaces Intra-band Contiguous CA.

8.1.5.6.5.3.3.3 Specific message contents

Same as TC 8.1.5.6.5.1 but applied to Intra-band non-Contiguous CA Test Case.

8.1.5.7 Failure information

8.1.5.7.1 Failure information / RLC failure / MCG

8.1.5.7.1.1 Failure information / RLC failure / MCG / Intra-band Contiguous CA

8.1.5.7.1.1.1 Test Purpose (TP)

(1)

```
with { UE in NR RRC_CONNECTED state }
ensure that {
  when { an indication from MCG RLC that the maximum number of retransmissions has been reached and
when CA duplication is configured and activated and for the corresponding logical channel
allowedServingCells only includes SCell(s) }
  then { UE initiates the failure information procedure to report RLC failure via SRB1 }
}
```

8.1.5.7.1.1.2 Conformance requirements

References: The conformance requirements covered in the current TC are specified in: TS 38.331, clauses 5.7.5.2 and 5.7.5.3. Unless otherwise stated these are Rel-15 requirements.

[TS 38.331, clause 5.3.10.3]

The UE shall:

...

- 1> upon indication from MCG RLC that the maximum number of retransmissions has been reached:
- 2> if the indication is from MCG RLC and CA duplication is configured and activated, and for the corresponding logical channel *allowedServingCells* only includes SCell(s):
- 3> initiate the failure information procedure as specified in 5.7.5 to report RLC failure.

...

[TS 38.331, clause 5.7.5.2]

A UE initiates the procedure when there is a need inform the network about a failure detected by the UE. In particular, the UE initiates the procedure when the following condition is met:

- 1> upon detecting failure for an RLC bearer, in accordance with 5.3.10.3;

Upon initiating the procedure, the UE shall:

- 1> initiate transmission of the *FailureInformation* message as specified in 5.7.5.3;

[TS 38.331, clause 5.7.5.3]

The UE shall:

- 1> if initiated to provide RLC failure information, set *FailureInfoRLC-Bearer* as follows:
 - 2> set *logicalChannelIdentity* to the logical channel identity of the failing RLC bearer;
 - 2> set *cellGroupId* to the cell group identity of the failing RLC bearer;
 - 2> set the *failureType* as *rlc-failure*;
- 1> if used to inform the network about a failure for an MCG RLC bearer:

2> submit the *FailureInformation* message to lower layers for transmission via SRB1;

...

8.1.5.7.1.1.3 Test description

8.1.5.7.1.1.3.1 Pre-test conditions

System Simulator:

- NR Cell 1 is the PCell, NR Cell 3 is the SCell.

UE:

- None.

Preamble:

Same Pre-Test conditions as in clause 7.1.3.0 except the following:

- 2 NR cells (NR Cell 1 as Pcell and NR Cell 3 as Scell)
- NR Cell 1 is configured with DRBs in RLC AM mode

8.1.5.7.1.1.3.2 Test procedure sequence

Table 8.1.5.7.1.1.3.2-1: Main behaviour

St	Procedure	Message Sequence		TP	Verdict
		U - S	Message		
1	The SS transmits an <i>RRCReconfiguration</i> message to add SCell (NR Cell 3) for the UE.	<--	NR RRC: <i>RRCReconfiguration</i>	-	-
2	The UE transmits an <i>RRCReconfigurationComplete</i> message	-->	NR RRC: <i>RRCReconfigurationComplete</i>	-	-
2A	The SS transmits a SCell Activation/Deactivation MAC-CE to activate SCell (NR Cell 3).	<--	MAC PDU (SCell Activation/Deactivation MAC CE of one octet (C ₁ =1))	-	-
3	The SS transmits an <i>RRCReconfiguration</i> message to reconfigure DRB #j for the UE	<--	NR RRC: <i>RRCReconfiguration</i>	-	-
4	The UE transmits an <i>RRCReconfigurationComplete</i> message	-->	NR RRC: <i>RRCReconfigurationComplete</i>	-	-
5	Void	-	-	-	-
6	Void	-	-	-	-
7	The SS stops sending MCG RLC acknowledgmentson PCell (NR Cell 1) and SCell (NR Cell 3)	-	-	-	-
8	SS transmits a periodic UL Grant on SCell (as PUCCH is not configured in the SCell), allowing the UE to loop back the PDCP PDU on SCell.	-	-	-	-
8A	The SS transmits one PDCP PDU to the UE on DRB #j.	<-	PDCP PDU	-	-
-	EXCEPTION: Steps 9-9A occur in any sequence.	-	-	-	-
9	The UE loops back the PDCP PDU on PCell (NR Cell 1) on DRB #j	-->	PDCP PDU	-	-
9A	The UE loops back the PDCP PDU on SCell (NR Cell 3) on DRB #j	-->	PDCP PDU	-	-
10	Check: Does the UE transmit a <i>FailureInformation</i> message with failureType set to 'rlc-failure'?	-->	NR RRC: <i>FailureInformation</i>	1	P
10 A	SS resumes sending MCG RLC acknowledgments	-	-	-	-

11	The SS transmits an <i>RRCReconfiguration</i> message containing an <i>sCellToReleaseList</i> with <i>SCell NR Cell 3</i> .	<--	NR RRC: <i>RRCReconfiguration</i>	-	-
12	The UE transmits an <i>RRCReconfigurationComplete</i> message.	-->	NR RRC: <i>RRCReconfigurationComplete</i>	-	-

8.1.5.7.1.1.3.3 Specific message contents

Table 8.1.5.7.1.1.3.3-1: *RRCReconfiguration* (Step 1, Table 8.1.5.7.1.1.3.2-1)

Derivation Path: TS 38.508-1 [4], Table 4.6.1-13 with condition <i>SCell_add</i>			
Information Element	Value/remark	Comment	Condition
<i>RRCReconfiguration</i> ::= SEQUENCE {			
<i>criticalExtensions</i> CHOICE {			
<i>rrcReconfiguration</i> SEQUENCE {			
<i>nonCriticalExtension</i> SEQUENCE {			
<i>masterCellGroup</i> SEQUENCE {			
<i>sCellToAddModList</i> SEQUENCE (SIZE (1..maxNrofSCells)) OF <i>SCellConfig</i> {	1 entry		
<i>SCellConfig</i> [1] SEQUENCE {		entry 1	
<i>sCellIndex</i>	<i>SCellIndex</i> for NR Cell 3		
<i>sCellConfigCommon</i>	<i>ServingCellConfigCommon</i>		
<i>sCellConfigDedicated</i>	<i>ServingCellConfig</i>		
}			
}			
}			
}			
}			
}			

Table 8.1.5.7.1.1.3.3-1A: *ServingCellConfig* (Table 8.1.5.7.1.1.3.3-1)

Derivation Path: TS 38.508-1 [4], Table 4.6.3-167.			
Information Element	Value/remark	Comment	Condition
<i>ServingCellConfig</i> ::= SEQUENCE {			
<i>uplinkConfig</i> SEQUENCE {			
<i>initialUplinkBWP</i>	<i>BWP-UplinkDedicated</i>		
}			
}			

Table 8.1.5.7.1.1.3.3-1B: *BWP-UplinkDedicated* (Table 8.1.5.7.1.1.3.3-1A)

Derivation Path: TS 38.508-1 [4], Table 4.6.3-15			
Information Element	Value/remark	Comment	Condition
<i>BWP-UplinkDedicated</i> ::= SEQUENCE {			
<i>pucch-Config</i>	Not present		
}			

Table 8.1.5.7.1.1.3.3-1C: *ServingCellConfigCommon* (Table 8.1.5.7.1.1.3.3-1)

Derivation Path: TS 38.508-1 [4], Table 4.6.3-168.			
Information Element	Value/remark	Comment	Condition
<i>ServingCellConfigCommon</i> ::= SEQUENCE {			
<i>physCellId</i>	Physical Cell Identity of NR Cell 3		
<i>uplinkConfigCommon</i>	<i>UplinkConfigCommon</i>		
}			

Table 8.1.5.7.1.1.3.3-1D: UplinkConfigCommon (Table 8.1.5.7.1.1.3.3-1C)

Derivation Path: TS 38.331 [6], clause 6.3.2			
Information Element	Value/remark	Comment	Condition
UplinkConfigCommon ::= SEQUENCE {			
initialUplinkBWP	BWP-UplinkCommon		
}			

Table 8.1.5.7.1.1.3.3-1E: BWP-UplinkCommon (Table 8.1.5.7.1.1.3.3-1D)

Derivation Path: TS 38.331 [6], clause 6.3.2			
Information Element	Value/remark	Comment	Condition
BWP-UplinkCommon ::= SEQUENCE {			
pucch-ConfigCommon	Not present		
}			

Table 8.1.5.7.1.1.3.3-2: RRCReconfiguration (Step 3, Table 8.1.5.7.1.1.3.2-1)

Derivation Path: TS 38.508-1[4], Table 4.6.1-13 with condition NR			
Information Element	Value/remark	Comment	Condition
RRCReconfiguration ::= SEQUENCE {			
criticalExtensions CHOICE {			
rrcReconfiguration SEQUENCE {			
radioBearerConfig	RadioBearerConfig-DRB	Table 8.1.5.7.1.1.3.3-3	
nonCriticalExtension SEQUENCE {			
masterCellGroup	CellGroupConfig-DRB	Table 8.1.5.7.1.1.3.3-4	
}			
}			
}			

Table 8.1.5.7.1.1.3.3-3: RadioBearerConfig-DRB (Table 8.1.5.7.1.1.3.3-2)

Derivation Path: TS 508-1 [4], Table 4.6.3-132 with condition DRB2			
Information Element	Value/remark	Comment	Condition
RadioBearerConfig ::= SEQUENCE {			
drb-ToAddModList SEQUENCE (SIZE (1..maxDRB)) OF DRB-ToAddMod {	1 entry		
DRB-ToAddMod[1] SEQUENCE {		entry 1	
drb-Identity	DRB-Identity with condition DRB j	j is the ID of the DRB established during the preamble which is allocated according to internal TTCN mapping	
pdcp-Config	PDCCP-Config		
}			
}			

Table 8.1.5.7.1.1.3.3-4: PDCCP-Config (Table 8.1.5.7.1.1.3.3-3)

Derivation Path: TS 38.508-1 [4], Table 4.6.3-99 with condition Split			
Information Element	Value/remark	Comment	Condition
PDCCP-Config ::= SEQUENCE {			
moreThanOneRLC SEQUENCE {			
primaryPath SEQUENCE {			

logicalChannel	LogicalChannelIdentity with Condition DRB j		
}			
pdcp-Duplication	True		
}			
}			

Table 8.1.5.7.1.1.3.3-5: CellGroupConfig-DRB

Derivation Path: TS 38.508-1 [4], Table 4.6.3-19 with Condition DRB j			
Information Element	Value/remark	Comment	Condition
CellGroupConfig ::= SEQUENCE {			
rlc-BearerToAddModList SEQUENCE (SIZE(1..maxLC-ID)) OF RLC-BearerConfig {	2 entries		
RLC-BearerConfig[1]	RLC-BearerConfig-1	entry 1 Table 8.1.5.7.1.1.3.3-6 Primary RLC	
RLC-BearerConfig[2]	RLC-BearerConfig-2	entry 1 Table 8.1.5.7.1.1.3.3-7 Secondary RLC	
}			
spCellConfig	Not present		
}			

Table 8.1.5.7.1.1.3.3-6: RLC-BearerConfig-1 (Table 8.1.5.7.1.1.3.3-5)

Derivation Path: TS 38.508-1 [4], Table 4.6.3-148 with Condition AM			
Information Element	Value/remark	Comment	Condition
RLC-BearerConfig ::= SEQUENCE {			
logicalChannelIdentity	LogicalChannelIdentity with condition DRB j	ID of primary logical channel	
servedRadioBearer CHOICE {			
drb-Identity	DRB-Identity with condition DRB j		
}			
rlc-Config CHOICE {			
am SEQUENCE {			
ul-AM-RLC SEQUENCE {			
maxRetxThreshold	t32	To ensure RLC failure happens before RLF	
}			
}			
}			
mac-LogicalChannelConfig SEQUENCE {			
ul-SpecificParameters SEQUENCE {			
allowedServingCells SEQUENCE (SIZE (1..maxNrofServingCells-1)) OF ServCellIndex {	1 entry		
ServCellIndex[1]	ServCellIndex of NR Cell 1	entry 1	
}			
}			
}			
}			

Table 8.1.5.7.1.1.3.3-7: RLC-BearerConfig-2 (Table 8.1.5.7.1.1.3.3-5)

Derivation Path: TS 38.508-1 [4], Table 4.6.3-148 with Condition AM			
Information Element	Value/remark	Comment	Condition
RLC-BearerConfig ::= SEQUENCE {			

logicalChannelIdentity	LogicalChannelIdentity with condition DRB j+1	To ensure ID of secondary logical channel ID is different with existing logical channel and the primary logical channel defined in Table 8.1.5.7.1.1.3.3-6	
servedRadioBearer CHOICE {			
drb-Identity	DRB-Identity with condition DRB j		
}			
rlc-Config CHOICE {			
am SEQUENCE {			
ul-AM-RLC SEQUENCE {			
maxRetxThreshold	t1	To ensure RLC failure happens before RLF	
}			
}			
}			
mac-LogicalChannelConfig SEQUENCE {			
ul-SpecificParameters SEQUENCE {			
allowedServingCells SEQUENCE (SIZE (1..maxNrofServingCells-1)) OF ServCellIndex {	1 entry		
ServCellIndex[1]	ServCellIndex of NR Cell 3	entry 1	
}			
}			
}			
}			
}			

Table 8.1.5.7.1.1.3.3-8: FailureInformation (Step 10, Table 8.1.5.7.1.1.3.2-3)

Derivation Path: TS 38.508-1 [4], Table 4.6.1-4			
Information Element	Value/remark	Comment	Condition
FailureInformation ::= SEQUENCE {			
criticalExtensions CHOICE {			
failureInformation SEQUENCE {			
failureInfoRLC-Bearer SEQUENCE {			
cellGroupld	CellGroupld as per TS 38.508-1 [4] Table 4.6.3-20		
logicalChannelIdentity	LogicalChannelIdentity with condition DRB j+1		
failureType	rlc-failure		
}			
}			
}			
}			
}			

Table 8.1.5.7.1.1.3.3-9: RRCReconfiguration (step 11, Table 8.1.5.7.1.1.3.2-1)

Derivation Path: TS 38.508-1 [4] Table 4.6.1-13 with condition SCell_add			
Information Element	Value/remark	Comment	Condition
RRCReconfiguration ::= SEQUENCE {			
criticalExtensions CHOICE {			
rrcReconfiguration SEQUENCE {			
nonCriticalExtension SEQUENCE{			
masterCellGroup	CellGroupConfig		
}			
}			
}			

}			
}			

Table 8.1.5.7.1.1.3.3-10: CellGroupConfig (Table 8.1.5.7.1.1.3.3-9)

Derivation Path: TS 38.508-1 [4] Table 4.6.3-19 with condition SCell_add			
Information Element	Value/remark	Comment	Condition
CellGroupConfig ::= SEQUENCE {			
sCellToAddModList	Not present		
sCellToReleaseList SEQUENCE (SIZE (1..maxNrofSCells)) OF SCellIndex {	1 entry		
SCellIndex[1]	1	entry 1	
}			
}			

8.1.5.7.1.2 Failure information / RLC failure / MCG / Inter-band CA

8.1.5.7.1.2.1 Test Purpose (TP)

Same as TC 8.1.5.7.1.1 but applied to Inter-band CA case.

8.1.5.7.1.2.2 Conformance requirements

Same as TC 8.1.5.7.1.1 but applied to Inter-band CA case.

8.1.5.7.1.2.3 Test description

8.1.5.7.1.2.3.1 Pre-test conditions

Same as test case 8.1.5.7.1.1 with the following differences:

- CA configuration: Inter-band CA replaces Intra-band Contiguous CA.
- Cells configuration: NR Cell 10 replaces NR Cell 3.

8.1.5.7.1.2.3.2 Test procedure sequence

Same as test case 8.1.5.7.1.1 with the following differences:

- CA configuration: Inter-band CA replaces Intra-band Contiguous CA.
- Cells configuration: NR Cell 10 replaces NR Cell 3.

8.1.5.7.1.2.3.3 Specific message contents

Same as test case 8.1.5.7.1.1 with the following differences.

- CA configuration: Inter-band CA replaces Intra-band Contiguous CA.
- Cells configuration: NR Cell 10 replaces NR Cell 3.

8.1.5.7.1.3 Failure information / RLC failure / MCG / Intra-band non Contiguous CA

8.1.5.7.1.3.1 Test Purpose (TP)

Same as TC 8.1.5.7.1.1 but applied to Intra-band non Contiguous CA case.

8.1.5.7.1.3.2 Conformance requirements

Same as TC 8.1.5.7.1.1 but applied to Intra-band non Contiguous CA case.

8.1.5.7.1.3.3 Test description

8.1.5.7.1.3.3.1 Pre-test conditions

Same as test case 8.1.5.7.1.1 with the following differences:

- CA configuration: Intra-band non Contiguous CA replaces Intra-band Contiguous CA.

8.1.5.7.1.3.3.2 Test procedure sequence

Same as test case 8.1.5.7.1.1 with the following differences:

- CA configuration: Intra-band non Contiguous CA replaces Intra-band Contiguous CA.

8.1.5.7.1.3.3.3 Specific message contents

Same as test case 8.1.5.7.1.1 but applied to Intra-band non Contiguous CA case.

8.1.5.8 Processing delay

8.1.5.8.1 Processing delay / RRC_Idle to RRC_Connected / RRC_Inactive to RRC_Connected / Success / Latency check

8.1.5.8.1.1 Test Purpose (TP)

(1)

```
with { UE in NR RRC_IDLE state and has sent an RRCSetupRequest message }
ensure that {
  when { UE receives RRCSetup message and after 10ms receives an UL grant }
  then { UE successfully transmits RRCSetupComplete message }
}
```

(2)

```
with { UE in NR RRC_CONNECTED state }
ensure that {
  when { UE receive a SecurityModeCommand message and after 5ms receives an UL grant }
  then { UE successfully transmits SecurityModeComplete }
}
```

(3)

```
with { UE in NR RRC_CONNECTED state }
ensure that {
  when { UE receive a RRCReconfiguration message to establish DRB that is not part of the current UE
configuration and after 10ms receives an UL grant }
  then { UE successfully transmits RRCReconfigurationComplete message }
}
```

(4)

```
with { UE in NR RRC_CONNECTED state }
ensure that {
  when { UE receives an UECapabilityEnquiry message and after 80ms receives an UL grant }
  then { UE successfully transmits an UECapabilityInformation message }
}
```

(5)

```
with { UE in NR RRC_INACTIVE state and has sent an RRCResumeRequest message }
ensure that {
  when { UE receives RRCResume message and after 6 or 10ms receives an UL grant depending on UE
capability }
  then { UE successfully transmits RRCResumeComplete message }
}
```

(6)

Void

(7)

```

with { UE in NR RRC_CONNECTED state and has sent an RRCReestablishmentRequest message after
detecting radio link failure on expiring of timer T310 }
ensure that {
  when { UE receives RRCReestablishment message and after 10ms receives an UL grant }
  then { UE successfully transmits RRCReestablishmentComplete message }
}

```

(8)

Void

(9)

```

with { UE in NR RRC_CONNECTED state }
ensure that {
  when { UE receives CounterCheck message and after 5ms receives an UL grant }
  then { UE successfully transmits an CounterCheckResponse message }
}

```

8.1.5.8.1.2 Conformance requirements

References: The conformance requirements covered in the present TC are specified in: TS 38.331, clauses 5.3.3.4, 5.3.4.3, 5.3.5.3, 5.3.6.3, 5.3.7.4, 5.3.13.4, 5.6.1.3 and 12. Unless otherwise stated these are Rel-15 requirements.

[TS 38.331, clause 5.3.3.4]

The UE shall perform the following actions upon reception of the *RRCSetup*:

...

- 1> submit the *RRCSetupComplete* message to lower layers for transmission, upon which the procedure ends.

[TS 38.331, clause 5.3.4.3]

The UE shall:

...

- 1> if the *SecurityModeCommand* message passes the integrity protection check:

...

- 2> submit the *SecurityModeComplete* message to lower layers for transmission, upon which the procedure ends;

[TS 38.331, clause 5.3.5.3]

The UE shall perform the following actions upon reception of the *RRCReconfiguration*:

...

- 1> if the *RRCReconfiguration* includes the *masterCellGroup*:
 - 2> perform the cell group configuration for the received *masterCellGroup* according to 5.3.5.5;

...

- 1> if the *RRCReconfiguration* message includes the *radioBearerConfig*:

- 2> perform the radio bearer configuration according to 5.3.5.6;

...

1> else (*RRCReconfiguration* was received via SRB1):

2> submit the *RRCReconfigurationComplete* message via SRB1 to lower layers for transmission using the new configuration;

...

[38.331, clause 5.3.6.3]

Upon receiving the *CounterCheck* message, the UE shall:

...

1> submit the *CounterCheckResponse* message to lower layers for transmission upon which the procedure ends.

[38.331, clause 5.3.7.4]

The UE shall set the contents of *RRCReestablishmentRequest* message as follows:

...

1> submit the *RRCReestablishmentRequest* message to lower layers for transmission.

[38.331, clause 5.3.13.4]

The UE shall:

...

1> if the *RRCResume* includes the *masterCellGroup*:

2> perform the cell group configuration for the received *masterCellGroup* according to 5.3.5.5;

...

1> submit the *RRCResumeComplete* message to lower layers for transmission;

...

[38.331, clause 5.6.1.3]

The UE shall set the contents of *UECapabilityInformation* message as follows:

1> if the *ue-CapabilityRAT-RequestList* contains a *UE-CapabilityRAT-Request* with *rat-Type* set to *nr*:

2> include in the *ue-CapabilityRAT-ContainerList* a *UE-CapabilityRAT-Container* of the type *UE-NR-Capability* and with the *rat-Type* set to *nr*;

2> include the *supportedBandCombinationList*, *featureSets* and *featureSetCombinations* as specified in clause 5.6.1.4;

...

1> submit the *UECapabilityInformation* message to lower layers for transmission, upon which the procedure ends.

[TS 38.331, clause 12]

The UE performance requirements for RRC procedures are specified in the following tables. The performance requirement is expressed as the time in [ms] from the end of reception of the network -> UE message on the UE physical layer up to when the UE shall be ready for the reception of uplink grant for the UE -> network response message with no access delay other than the TTI-alignment (e.g. excluding delays caused by scheduling, the random access procedure or physical layer synchronisation). In case the RRC procedure triggers BWP switching, the RRC procedure delay is the value defined in the following table plus the BWP switching delay defined in TS 38.133 [14], clause 8.6.3.

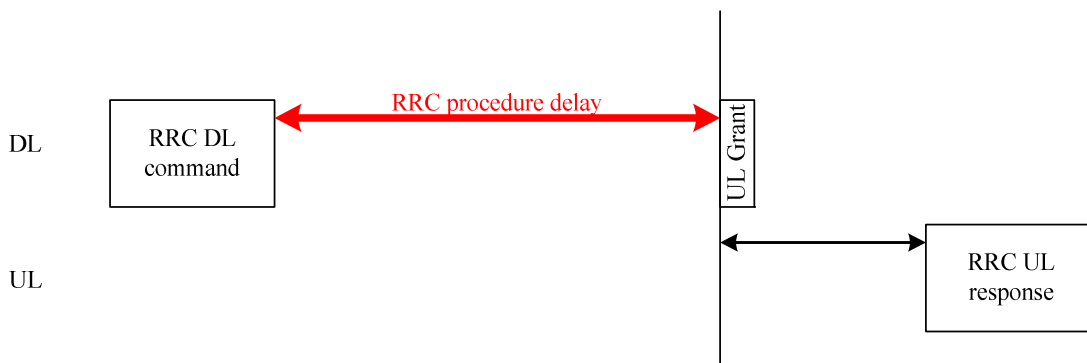

Figure 12.1-1: Illustration of RRC procedure delay

Table 12.1-1: UE performance requirements for RRC procedures for UEs

Procedure title:	Network -> UE	UE -> Network	Value [ms]	Notes
RRC Connection Control Procedures				
RRC reconfiguration	<i>RRCReconfiguration</i>	<i>RRCReconfigurationComplete</i>	10	
RRC reconfiguration (scell addition/release)	<i>RRCReconfiguration</i>	<i>RRCReconfigurationComplete</i>	16	
RRC setup	<i>RRCSetup</i>	<i>RRCSetupComplete</i>	10	
RRC re-establishment	<i>RRCReestablishment</i>	<i>RRCReestablishmentComplete</i>	10	
RRC resume	<i>RRCResume</i>	<i>RRCResumeComplete</i>	6 or 10	Value=6 applies for a UE supporting reduced CP latency for the case of RRCResume message only including MAC and PHY configuration, reestablishPDCP and reestablishRLC for SRB2 and DRB(s), and no DRX, SPS, configured grant, CA or MIMO re-configuration will be triggered by this message. Further, the UL grant for transmission of <i>RRCResumeComplete</i> and the data is transmitted over common search space with DCI format 0_0. In this scenario, the RRC procedure delay [ms] can extend beyond the reception of the UL grant, up to 7 ms. For other cases, Value = 10 applies.
RRC resume (scell addition)	<i>RRCResume</i>	<i>RRCResumeComplete</i>	16	

Procedure title:	Network -> UE	UE -> Network	Value [ms]	Notes
Initial AS security activation	<i>SecurityModeCommand</i>	<i>SecurityModeComplete/SecurityModeFailure</i>	5	
Other procedures				
UE capability transfer	<i>UECapabilityEnquiry</i>	<i>UECapabilityInformation</i>	80	
Counter check	<i>CounterCheck</i>	<i>CounterCheckResponse</i>	5	

8.1.5.8.1.3 Test description

8.1.5.8.1.3.1 Pre-test conditions

System Simulator:

- NR Cell 1 and NR Cell 2.
- System information combination NR-2 as defined in TS 38.508-1 [4] clause 4.4.3.1.3 is used in NR cells.
- Test frequency NRf1 is as specified in TS 38.508-1 [4] clause 4.3.1 using the common highest UL and DL channel bandwidth and using the default subcarrier spacing specified in TS 38.508-1 [4] clause 6.2.3.1.

UE:

- None.

Preamble:

- The UE is in state RRC_IDLE using generic procedure parameter Connectivity (NR) according to TS 38.508-1 [4], clause 4.5.4.

8.1.5.8.1.3.2 Test procedure sequence

Table 8.1.5.8.1.3.2-1/2 illustrates the downlink power levels and other changing parameters to be applied for the cells at various time instants of the test execution. Row marked "T0" denotes the initial conditions after preamble, while column marked "T1", is to be applied subsequently. The exact instants on which these values shall be applied are described in the texts in this clause.

Table 8.1.5.8.1.3.2-1: Time instances of cell power level and parameter changes in FR1

	Parameter	Unit	NR Cell 1	NR Cell 2
T0	SS/PBCH SSS EPRE	dBm/SCS	-88	-96
T1	SS/PBCH SSS EPRE	dBm/SCS	"Off"	-88

Table 8.1.5.8.1.3.2-2: Time instances of cell power level and parameter changes in FR2

	Parameter	Unit	NR Cell 1	NR Cell 2
T0	SS/PBCH SSS EPRE	dBm/SCS	FFS	FFS
T1	SS/PBCH SSS EPRE	dBm/SCS	"Off"	FFS

Table 8.1.5.8.1.3.2-3: Main behaviour

St	Procedure	Message Sequence		TP	Verdict
		U - S	Message		
1	The SS transmits a <i>Paging</i> message including a matched ng-5G-S-TMSI.	<--	NR RRC: <i>Paging</i>	-	-
2	The UE transmits an <i>RRCSetupRequest</i> message.	-->	NR RRC: <i>RRCSetupRequest</i>	-	-

3	The SS transmits an <i>RRCSetup</i> message.	<--	NR RRC: <i>RRCSetup</i>	-	-
3A	The SS starts transmitting a periodic DCI from $(10 \cdot 2^{\mu} + 1 + T_{DL})$ slots after step 3 to schedule PUSCH. (Note 1, Note 2)				
4	Check: Does the UE transmit an <i>RRCSetupComplete</i> message piggybacked with SERVICE REQUEST message within $(10 \cdot 2^{\mu} + 1 + T_{DL} + K_2)$ slots after successful completion of step 3? (Note 1, Note 2, Note 3)	-->	NR RRC: <i>RRCSetupComplete</i> NR 5GMM: SERVICE REQUEST	1	P
5	The SS transmits a <i>SecurityModeCommand</i> message.	<--	NR RRC: <i>SecurityModeCommand</i>	-	-
5A	The SS starts transmitting a periodic DCI from $(5 \cdot 2^{\mu} + 1 + T_{DL})$ slots after step 5 to schedule PUSCH. (Note 1, Note 2)				
6	Check: Does the UE transmit a <i>SecurityModeComplete</i> message within $(5 \cdot 2^{\mu} + 1 + T_{DL} + K_2)$ slots after successful completion of step 5? (Note 1, Note 2, Note 3)	-->	NR RRC: <i>SecurityModeComplete</i>	2	P
7	The SS transmits a <i>UECapabilityEnquiry</i> message.	<--	NR RRC: <i>UECapabilityEnquiry</i>	-	-
7A	The SS starts transmitting a periodic DCI with the maximum grant allowed by the carrier bandwidth from $(80 \cdot 2^{\mu} + 1 + T_{DL})$ slots after step 7 to schedule PUSCH. (Note 1, Note 2)				
8	Check: Does the UE transmit a <i>UECapabilityInformation</i> message within $(80 \cdot 2^{\mu} + 1 + T_{DL} + K_2)$ slots after successful completion of step 7? (Note 1, Note 2, Note 3)	-->	NR RRC: <i>UECapabilityInformation</i>	4	P
9	The SS transmits an <i>RRCReconfiguration</i> message to establish SRB2 and DRB #n for the UE piggybacked with SERVICE ACCEPT message.	<--	NR RRC: <i>RRCReconfiguration</i> NR 5GMM: SERVICE ACCEPT	-	-
9A	The SS starts transmitting a periodic DCI from $(10 \cdot 2^{\mu} + 1 + T_{DL})$ slots after step 9 to schedule PUSCH. (Note 1, Note 2)				
10	Check: Does the UE transmit an <i>RRCReconfigurationComplete</i> message within $(10 \cdot 2^{\mu} + 1 + T_{DL} + K_2)$ slots after successful completion of step 9? (Note 1, Note 2, Note 3)	-->	NR RRC: <i>RRCReconfigurationComplete</i>	3	P
11	The SS transmits a <i>CounterCheck</i> message.	<--	NR RRC: <i>CounterCheck</i>	-	-
11A	The SS starts transmitting a periodic DCI from $(5 \cdot 2^{\mu} + 1 + T_{DL})$ slots after step 11 to schedule PUSCH. (Note 1, Note 2)				
12	Check: Does the UE transmit a <i>CounterCheckResponse</i> message within $(5 \cdot 2^{\mu} + 1 + T_{DL} + K_2)$ slots after successful completion of step 11? (Note 1, Note 2, Note 3)	-->	NR RRC: <i>CounterCheckResponse</i>	9	P
13	Void	-	-	-	-
-	EXCEPTION: Steps 14a1 to 14a7 describe behaviour that depends on the UE capability; the "lower case letter" identifies a step sequence that take place if a capability is supported	-	-	-	-
14a1	IF <i>pc_inactiveState</i> THEN the SS transmits an <i>RRCRelease</i> message with <i>suspendConfig</i> .	<--	NR RRC: <i>RRCRelease</i>	-	-

14a 2	Wait 1s to let UE enter RRC_INACTIVE state.	-	-	-	-
14a 3	The SS transmits a <i>Paging</i> message including a matched ng-5G-S-TMSI.	<--	NR RRC: <i>Paging</i>	-	-
14a 4	The UE transmits an <i>RRCResumeRequest</i> message.	-->	NR RRC: <i>RRCResumeRequest</i>	-	-
14a 5	The SS transmits an <i>RRCResume</i> message for the UE	<--	NR RRC: <i>RRCResume</i>	-	-
-	EXCEPTION: Steps 14a5Aa1 to 14a5Ab2 describe behaviour that depends on the UE capability; the "lower case letter" identifies a step sequence that take place if a capability is supported	-	-	-	-
14a 5A a1	IF <i>pc_reducedCP_Latency</i> THEN the SS starts transmitting a periodic DCI from $(6 \cdot 2^\mu + 1 + T_{DL})$ slots after step 14a5 to schedule PUSCH. (Note 1, Note 2)				
14a 5A a2	Check: Does the UE transmit an <i>RRCResumeComplete</i> message within $(6 \cdot 2^\mu + 1 + T_{DL} + K_2)$ slots after successful completion of step 14a5? (Note 1, Note 2, Note 3)	-->	NR RRC: <i>RRCResumeComplete</i>	5	P
14a 5A b1	ELSE the SS starts transmitting a periodic DCI from $(10 \cdot 2^\mu + 1 + T_{DL})$ slots after step 14a5 to schedule PUSCH. (Note 1, Note 2)				
14a 5A b2	Check: Does the UE transmit an <i>RRCResumeComplete</i> message within $(10 \cdot 2^\mu + 1 + T_{DL} + K_2)$ slots after successful completion of step 14a5? (Note 1, Note 2, Note 3)	-->	NR RRC: <i>RRCResumeComplete</i>	5	P
14a 6- 14a 7	Void	-	-	-	-
14- 21	Void	-	-	-	-
22	The SS re-adjusts the SS levels according to row "T1" in table 8.1.5.8.1.3.2-1/2 in order that the radio link quality of NR Cell 1 is degraded, and NR Cell 2 is suitable for camping	-	-	-	-
23	Wait 1s to let T310 expire	-	-	-	-
24	The UE transmits an <i>RRCReestablishmentRequest</i> message on Cell 2	-->	NR RRC: <i>RRCReestablishmentRequest</i>	-	-
25	The SS transmits an <i>RRCReestablishment</i> message on slot #i in the radio frame, where: i = 1 for $\mu=0,1$ i = 21 for $\mu=3$ (Note 2)	<--	NR RRC: <i>RRCReestablishment</i>	-	-
25 A	The SS starts transmitting a periodic DCI from $(10 \cdot 2^\mu + 1 + T_{DL})$ slots after step 25 to schedule PUSCH. IF UE transmits a Random Access Preamble, then SS sends RAR. (Note 1, Note 2)	-	-	-	-
26	Check: Does the UE transmit an <i>RRCReestablishmentComplete</i> message within $(10 \cdot 2^\mu + 1 + T_{DL} + K_2)$ slots after successful completion of step 25? (Note 1, Note 2, Note 3)	-->	NR RRC: <i>RRCReestablishmentComplete</i>	7	P
26 A	The SS transmits an <i>RRCReconfiguration</i> message to resume existing radio bearer.	<--	NR RRC: <i>RRCReconfiguration</i>	-	-
26 B	The UE transmit an <i>RRCReconfigurationComplete</i> message.	-->	NR RRC: <i>RRCReconfigurationComplete</i>	-	-

27-35	Void	-	-	-	-
<p>Note 1: T_{DL} is the delay in slots to the next available DL slot suitable for the transmission of a DCI if the UL grant is provided by DCI, and it is the delay in slots to the DL slot used for the transmission of RAR if the UL grant is provided by RAR.</p> <p>Note 2: μ is the SCS index. $\mu = 0/1/2/3$ for SCS = 15kHz/30kHz/60kHz/120kHz respectively.</p> <p>Note 3: K_2 is the offset (in slots) between UL grant and the PUSCH it scheduled</p>					

8.1.5.8.1.3.3 Specific message contents

Table 8.1.5.8.1.3.3-1: RRCReconfiguration (Step 9, Table 8.1.5.8.1.3.2-3)

Derivation Path: TS 38.508-1[4], table 4.6.1-13 with condition NR			
Information Element	Value/remark	Comment	Condition
RRCReconfiguration ::= SEQUENCE {			
criticalExtensions CHOICE {			
c1 CHOICE {			
rrcReconfiguration SEQUENCE {			
radioBearerConfig	RadioBearerConfig-SRB2-DRB(1,0)	TS 38.508-1 [4] Table 4.8.1-4	
}			
nonCriticalExtension SEQUENCE {			
masterCellGroup	CellGroupConfig-SRB2-DRB(1,0)	TS 38.508-1 [4] Table 4.8.1-2B	
dedicatedNAS-MessageList	Not present		
}			
}			
}			
}			

Table 8.1.5.8.1.3.3-2: CounterCheck (Step 11, Table 8.1.5.8.1.3.2-3)

Derivation Path: TS 38.508-1[4], Table 4.6.1-1			
Information Element	Value/remark	Comment	Condition
CounterCheck ::= SEQUENCE {			
criticalExtensions CHOICE {			
counterCheck SEQUENCE {			
drb-CountMSB-InfoList SEQUENCE (SIZE (1..maxDRB)) OF DRB-CountMSB-Info {	1 entry		
drb-Identity[1]	DRB-Identity with Condition DRBn	entry 1 n is the index of the DRB established in step 9 of Table 8.1.5.8.1.3.2-3, which is allocated according to internal TTCN mapping	
}			
}			
}			
}			

Table 8.1.5.8.1.3.3-3: CounterCheckResponse (Step 12, Table 8.1.5.8.1.3.2-3)

Derivation Path: TS 38.508-1[4], Table 4.6.1-2			
Information Element	Value/remark	Comment	Condition
CounterCheckResponse ::= SEQUENCE {			
criticalExtensions CHOICE {			
counterCheckResponse SEQUENCE {			

drb-CountInfoList SEQUENCE (SIZE (0..maxDRB)) OF DRB-CountInfo {	1 entry		
drb-Identity[1]	DRB-Identity with Condition DRBn	entry 1 n is the index of the DRB established in step 9 of Table 8.1.5.8.1.3.2-3, which is allocated according to internal TTCN mapping	
}			
}			
}			
}			

Table 8.1.5.8.1.3.3-4: RRCRelease (Step 14a1, Table 8.1.5.8.1.3.2-3)

Derivation Path: TS 38.508-1 [4], Table 4.6.1-16 with Condition NR_RRC_INACTIVE

Table 8.1.5.8.1.3.3-5: RRCResume (Step 14a5, Table 8.1.5.8.1.3.2-3)

Derivation Path: TS 38.508-1[4], Table 4.6.1-17

Table 8.1.5.8.1.3.3-6 to Table 8.1.5.8.1.3.3-10: Void

Table 8.1.5.8.1.3.3-11: Physical layer parameters for DCI format 1_0 (Steps 25, Table 8.1.5.8.1.3.2-3)

Derivation Path: TS 38.508-1 [4], Table 4.3.6.1.2.1-1

Parameter	Value	Value in binary	Condition
PDSCH-to-HARQ_feedback timing indicator	K ₁ slots as specified in 9.2.3 in TS 38.213 μ=0 (SCS=15kHz): K ₁ =3 μ=1 (SCS=30kHz): K ₁ =7 μ=3 (SCS=120kHz): K ₁ =3	'010'B '110'B '010'B	

Table 8.1.5.8.1.3.3-12: SIB1 (Preamble, and all steps of Table 8.1.5.8.1.3.2-3)

Derivation Path: TS 38.508-1 [4], Table 4.6.1-28

Information Element	Value/remark	Comment	Condition
SIB1 ::= SEQUENCE {			
cellSelectionInfo SEQUENCE {			
servingCellConfigCommon SEQUENCE {			
uplinkConfigCommon SEQUENCE {			
initialUplinkBWP SEQUENCE {			
rach-ConfigCommon CHOICE {			
setup SEQUENCE {			
rach-ConfigGeneric SEQUENCE {			
prach-ConfigurationIndex	159		FR2
}			
}			
}			
}			
}			
}			
}			

Table 8.1.5.8.1.3.3-13: RRCReconfiguration (Step 26A, Table 8.1.5.8.1.3.2-3)

Derivation Path: TS 38.508-1 [4], Table 4.6.1-13 with condition REEST

8.1.5.8.2 Processing delay / RRC_Inactive to RRC_Connected / Success / Latency check / SCell addition

8.1.5.8.2.1 Processing delay / RRC_Inactive to RRC_Connected / Success / Latency check / SCell addition / Intra-band Contiguous CA

8.1.5.8.2.1.1 Test Purpose (TP)

(1)

```
with { UE in NR RRC_CONNECTED state }
ensure that {
  when { UE receives an RRCReconfiguration message containing sCellToAddModList with a SCell
  addition and after 16ms receives an UL grant }
  then { UE successfully transmits RRCReconfigurationComplete message }
}
```

(2)

```
with { UE in NR RRC_INACTIVE state and has sent an RRCResumeRequest message }
ensure that {
  when { UE receives RRCResume message containing sCellToAddModList with a SCell addition and after
  16ms receives an UL grant }
  then { UE successfully transmits RRCResumeComplete message }
}
```

8.1.5.8.2.1.2 Conformance requirements

References: The conformance requirements covered in the present TC are specified in: TS 38.331, clauses 5.3.3.4, 5.3.4.3, 5.3.5.3, 5.3.6.3, 5.3.7.4, 5.3.13.4, 5.6.1.3 and 12. Unless otherwise stated these are Rel-15 requirements.

[TS 38.331, clause 5.3.5.3]

The UE shall perform the following actions upon reception of the *RRCReconfiguration*:

...

1> if the *RRCReconfiguration* includes the *masterCellGroup*:

2> perform the cell group configuration for the received *masterCellGroup* according to 5.3.5.5;

...

1> if the *RRCReconfiguration* message includes the *radioBearerConfig*:

2> perform the radio bearer configuration according to 5.3.5.6;

...

1> else (*RRCReconfiguration* was received via SRB1):

2> submit the *RRCReconfigurationComplete* message via SRB1 to lower layers for transmission using the new configuration;

...

[38.331, clause 5.3.13.4]

The UE shall:

...

- 1> if the *RRCResume* includes the *masterCellGroup*:
 - 2> perform the cell group configuration for the received *masterCellGroup* according to 5.3.5.5;
 - ...
- 1> submit the *RRCResumeComplete* message to lower layers for transmission;
- ...

[TS 38.331, clause 12]

The UE performance requirements for RRC procedures are specified in the following tables. The performance requirement is expressed as the time in [ms] from the end of reception of the network -> UE message on the UE physical layer up to when the UE shall be ready for the reception of uplink grant for the UE -> network response message with no access delay other than the TTI-alignment (e.g. excluding delays caused by scheduling, the random access procedure or physical layer synchronisation). In case the RRC procedure triggers BWP switching, the RRC procedure delay is the value defined in the following table plus the BWP switching delay defined in TS 38.133 [14], clause 8.6.3.

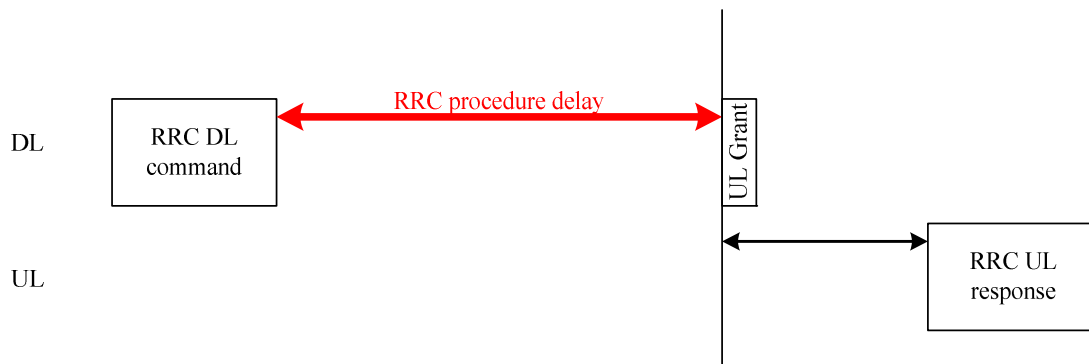

Figure 12.1-1: Illustration of RRC procedure delay

Table 12.1-1: UE performance requirements for RRC procedures for UEs

Procedure title:	Network -> UE	UE -> Network	Value [ms]	Notes
RRC Connection Control Procedures				
RRC reconfiguration (scell addition/release)	<i>RRCReconfiguration</i>	<i>RRCReconfigurationComplete</i>	16	
RRC resume (scell addition)	<i>RRCResume</i>	<i>RRCResumeComplete</i>	16	

8.1.5.8.2.1.3 Test description

8.1.5.8.2.1.3.1 Pre-test conditions

System Simulator:

- NR Cell 1 is the PCell and NR Cell 3 is the SCell.
- System information combination NR-4 as defined in TS 38.508-1 [4] clause 4.4.3.1.3 is used in NR cells.

UE:

- None.

Preamble:

- The UE is in 5GS state 3N-A on NR Cell 1 according to TS 38.508-1 [4], clause 4.5.4.

8.1.5.8.2.1.3.2 Test procedure sequence

Table 8.1.5.8.2.1.3.2-1/2 illustrates the downlink power levels and other changing parameters to be applied for the cells at various time instants of the test execution. Row marked "T0" denotes the initial conditions after preamble.

Table 8.1.5.8.2.1.3.2-1: Time instances of cell power level and parameter changes in FR1

	Parameter	Unit	NR Cell 1	NR Cell 3
T0	SS/PBCH SSS EPRE	dBm/SCS	-88	-88

Table 8.1.5.8.2.1.3.2-2: Time instances of cell power level and parameter changes in FR2

	Parameter	Unit	NR Cell 1	NR Cell 3
T0	SS/PBCH SSS EPRE	dBm/SCS	FFS	FFS

Table 8.1.5.8.2.1.3.2-3: Main behaviour

St	Procedure	Message Sequence		TP	Verdict
		U - S	Message		
1	The SS transmits an <i>RRCReconfiguration</i> message with <i>sCellToAddModList</i> to add <i>SCell(Cell 3)</i>	<--	NR RRC: <i>RRCReconfiguration</i>	-	-
2	The SS starts transmitting a periodic DCI from $(16 \cdot 2^{\mu} + 1 + T_{DL})$ slots after step 1 to schedule PUSCH. (Note 1, Note 2)				
3	Check: Does the UE transmit an <i>RRCReconfigurationComplete</i> message within $(16 \cdot 2^{\mu} + 1 + T_{DL} + K_2)$ slots after successful completion of step 1? (Note 1, Note 2, Note 3)	-->	NR RRC: <i>RRCReconfigurationComplete</i>	1	P
4	The SS transmits an <i>RRCReconfiguration</i> message to release <i>SCell(Cell 3)</i>	<--	NR RRC: <i>RRCReconfiguration</i>	-	-
5	UE transmits an <i>RRCReconfigurationComplete</i> message	-->	NR RRC: <i>RRCReconfigurationComplete</i>	-	-
-	EXCEPTION: Steps 6a1 to 6a9 describe behaviour that depends on UE configuration; the "lower case letter" identifies a step sequence that takes place if a capability is configured	-	-	-	-
6a1	IF <i>pc_inactiveState</i> THEN the SS transmits an <i>RRCRelease</i> message with <i>suspendConfig</i> .	<--	NR RRC: <i>RRCRelease</i>	-	-
6a2	Wait 1s to let UE enter <i>RRC_INACTIVE</i> state.	-	-	-	-
6a3	The SS transmits a <i>Paging</i> message including a matched <i>ng-5G-S-TMSI</i> .	<--	NR RRC: <i>Paging</i>	-	-
6a4	The UE transmits an <i>RRCResumeRequest</i> message.	-->	NR RRC: <i>RRCResumeRequest</i>	-	-
6a5	The SS transmits an <i>RRCResume</i> message with <i>sCellToAddModList</i> to add <i>SCell(Cell 3)</i>	<--	NR RRC: <i>RRCResume</i>	-	-
6a6	The SS starts transmitting a periodic DCI from $(16 \cdot 2^{\mu} + 1 + T_{DL})$ slots after step 10 to schedule PUSCH. (Note 1, Note 2)				
6a7	Check: Does the UE transmit an <i>RRCResumeComplete</i> message within	-->	NR RRC: <i>RRCResumeComplete</i>	2	P

	($16 \cdot 2^{\mu} + 1 + T_{DL} + K_2$) slots after successful completion of step 9? (Note 1, Note 2, Note 3)				
6a8	The SS transmits an <i>RRCReconfiguration</i> message containing an <i>sCellToReleaseList</i> with SCell NR Cell 3.	<--	NR RRC: <i>RRCReconfiguration</i>	-	-
6a9	The UE transmits an <i>RRCReconfigurationComplete</i> message.	-->	NR RRC: <i>RRCReconfigurationComplete</i>	-	-
Note 1: T_{DL} is the delay in slots to the next available DL slot suitable for the transmission of a DCI Note 2: μ is the SCS index. $\mu = 0/1/2/3$ for SCS = 15kHz/30kHz/60kHz/120kHz respectively. Note 3: K_2 is the offset (in slots) between DCI and the PUSCH it scheduled					

8.1.5.8.2.1.3.3 Specific message contents

Table 8.1.5.8.2.1.3.3-1: *RRCReconfiguration* (Step 1, Table 8.1.5.8.2.1.3.2-3)

Derivation Path: TS 38.508-1 [4], Table 4.6.1-13 with Condition SCell_Add			
Information Element	Value/remark	Comment	Condition
<i>RRCReconfiguration</i> ::= SEQUENCE {			
criticalExtensions CHOICE {			
rrcReconfiguration SEQUENCE {			
nonCriticalExtension SEQUENCE {			
masterCellGroup	CellGroupConfig	Table 8.1.5.8.2.1.3.3-2	
}			
}			
}			
}			

Table 8.1.5.8.2.1.3.3-2: *CellGroupConfig* (Table 8.1.5.8.2.1.3.3-1)

Derivation Path: TS 38.508-1 [4], Table 4.6.3-19 with Condition SCell_Add			
Information Element	Value/remark	Comment	Condition
<i>CellGroupConfig</i> ::= SEQUENCE {			
sCellToAddModList SEQUENCE (SIZE (1..maxNrofSCells)) OF SCellConfig {	1 entry		
SCellConfig[1] SEQUENCE {		entry 1	
sCellConfigCommon SEQUENCE {			
physCellId	physCellId of Cell 3		
}			
}			
}			
}			

Table 8.1.5.8.2.1.3.3-3: *RRCReconfiguration* (Steps 4 and 6a8, Table 8.1.5.8.2.1.3.2-3)

Derivation Path: TS 38.508-1 [4], Table 4.6.1-13 with Condition SCell_Add			
Information Element	Value/remark	Comment	Condition
<i>RRCReconfiguration</i> ::= SEQUENCE {			
criticalExtensions CHOICE {			
rrcReconfiguration SEQUENCE {			
nonCriticalExtension SEQUENCE {			
masterCellGroup SEQUENCE {			
sCellToAddModList	Not present		
sCellToReleaseList SEQUENCE (SIZE (1..maxNrofSCells)) OF SCellIndex {	1 entry		
SCellIndex[1]	SCellIndex of Cell 3	entry 1	
}			
}			
}			
}			

}		
---	--	--

Table 8.1.5.8.2.1.3.3-4: RRCRelease (Step 6a1, Table 8.1.5.8.2.1.3.2-3)

Derivation Path: TS 38.508-1 [4], Table 4.6.1-16 with Condition NR_RRC_INACTIVE

Table 8.1.5.8.2.1.3.3-5: RRCResume (Step 6a5, Table 8.1.5.8.2.1.3.2-3)

Derivation Path: TS 38.508-1[4],Table 4.6.1-17			
Information Element	Value/remark	Comment	Condition
RRCResume ::= SEQUENCE {			
criticalExtensions CHOICE {			
rrcResume SEQUENCE {			
masterCellGroup	CellGroupConfig	Table 8.1.5.8.2.1.3.3-6	
}			
}			
}			

Table 8.1.5.8.2.1.3.3-6: CellGroupConfig (Table 8.1.5.8.2.1.3.3-5)

Derivation Path: TS 38.508-1 [4], Table 4.6.3-19 with Condition SCell_Add and RESUME			
Information Element	Value/remark	Comment	Condition
CellGroupConfig ::= SEQUENCE {			
sCellToAddModList SEQUENCE (SIZE (1..maxNrofSCells)) OF SCellConfig {	1 entry		
SCellConfig[1] SEQUENCE {		entry 1	
sCellConfigCommon SEQUENCE {			
physCellId	physCellId of Cell 3		
}			
}			
}			
}			

8.1.5.8.2.2 Processing delay / RRC_Inactive to RRC_Connected / Success / Latency check / SCell addition / Inter-band CA

8.1.5.8.2.2.1 Test Purpose (TP)

Same as TC 8.1.5.8.2.1 but applied to Inter-band CA Test Case

8.1.5.8.2.2.2 Conformance requirements

Same as TC 8.1.5.8.2.1 but applied to Inter-band CA Test Case

8.1.5.8.2.2.3 Test description

8.1.5.8.2.2.3.1 Pre-test conditions

Same as TC 8.1.5.8.2.1 but with the following differences :

- CA configuration: Inter-band CA replaces Intra-band Contiguous CA.
- Cells configuration: Cell 10 replaces Cell 3.

8.1.5.8.2.2.3.2 Test procedure sequence

Same as TC 8.1.5.8.2.1 but with the following differences :

- Cells configuration: Cell 10 replaces Cell 3.

8.1.5.8.2.2.3.3 Specific message contents

Same as TC 8.1.5.8.2.1 but with the following differences:

- Cells configuration: Cell 10 replaces Cell 3.

8.1.5.8.2.3 Processing delay / RRC_Inactive to RRC_Connected / Success / Latency check / SCell addition / Intra-band non-Contiguous CA

8.1.5.8.2.3.1 Test Purpose (TP)

Same as TC 8.1.5.8.2.1 but applied to Intra-band non-Contiguous CA Test Case

8.1.5.8.2.3.2 Conformance requirements

Same as TC 8.1.5.8.2.1 but applied to Intra-band non-Contiguous CA Test Case

8.1.5.8.2.3.3 Test description

8.1.5.8.2.3.3.1 Pre-test conditions

Same as TC 8.1.5.8.2.1 but with the following differences:

- CA configuration: Intra-band non-Contiguous CA replaces Intra-band Contiguous CA.

8.1.5.8.2.3.3.2 Test procedure sequence

Same as TC 8.1.5.8.2.1.

8.1.5.8.2.3.3.3 Specific message contents

Same as TC 8.1.5.8.2.1.

8.1.5.9 Message Segment transfer

8.1.5.9.1 RACS / UL Message Segment transfer / UECapabilityInformation

8.1.5.9.1.1 Test Purpose (TP)

(1)

```
with { UE in NR RRC_CONNECTED state }
ensure that {
  when { UE receives UECapabilityEnquiry message with rrc-segAllowed-r16 enabled }
  then { UE successfully segments UECapabilityInformation message at RRC layer and sends
  ULDedicatedMessageSegment messages with rrc-MessageSegmentType set accordingly for the first and
  last segment and rrc-MessageSegmentContainer containing the segments of UECapabilityInformation
  message }
}
```

(2)

```
with { UE in NR RRC_CONNECTED state and UE having received UECapabilityEnquiry message with rrc-
segAllowed-r16 enabled and having transmitted the firstSegment of UECapabilityInformation message
within the ULDedicatedMessageSegment message }
ensure that {
  when { UE detects radio link failure on expiry of timer T310 }
  then { UE successfully completes RRC re-establishment procedure and discards the remaining
  segments of UECapabilityInformation message }
}
```

8.1.5.9.1.2 Conformance requirements

References: The conformance requirements covered in the present TC are specified in: TS 38.331 clause 5.6.1.3, 5.7.7.2, 5.7.7.3 and 5.3.7.2. Unless otherwise stated these are Rel-16 requirements.

[TS 38.331, clause 5.6.1.3]

The UE shall set the contents of *UECapabilityInformation* message as follows:

- 1> if the RRC message segmentation is enabled based on the field *rrc-SegAllowed* received, and the encoded RRC message is larger than the maximum supported size of a PDCP SDU specified in TS 38.323 [5]:
 - 2> initiate the UL message segment transfer procedure as specified in clause 5.7.7;
- 1> else:
 - 2> submit the *UECapabilityInformation* message to lower layers for transmission, upon which the procedure ends.

[TS 38.331, clause 5.7.7.2]

A UE capable of UL RRC message segmentation in RRC_CONNECTED will initiate the procedure when the following conditions are met:

- 1> if the RRC message segmentation is enabled based on the field *rrc-SegAllowed* received, and
- 1> if the encoded RRC message is larger than the maximum supported size of a PDCP SDU specified in TS 38.323 [5];

Upon initiating the procedure, the UE shall:

- 1> initiate transmission of the *ULDedicatedMessageSegment* message as specified in 5.7.7.3;

[TS 38.331, clause 5.7.7.3]

The UE shall segment the encoded RRC PDU based on the maximum supported size of a PDCP SDU specified in TS 38.323 [5]. UE shall minimize the number of segments and set the contents of the *ULDedicatedMessageSegment* messages as follows:

- 1> For each new UL DCCH message, set the *segmentNumber* to 0 for the first message segment and increment the *segmentNumber* for each subsequent RRC message segment;
- 1> set *rrc-MessageSegmentContainer* to include the segment of the UL DCCH message corresponding to the *segmentNumber*;
- 1> if the segment included in the *rrc-MessageSegmentContainer* is the last segment of the UL DCCH message:
 - 2> set the *rrc-MessageSegmentType* to *lastSegment*;
- 1> else:
 - 2> set the *rrc-MessageSegmentType* to *notLastSegment*;
- 1> submit all the *ULDedicatedMessageSegment* messages generated for the segmented RRC message to lower layers for transmission in ascending order based on the *segmentNumber*, upon which the procedure ends.

[TS 38.331, clause 5.3.7.2]

Upon initiation of the procedure, the UE shall:

...

- 1> if UE is not configured with *conditionalReconfiguration*:
 - 2> reset MAC;
 - 2> release *spCellConfig*, if configured;

2> suspend all RBs, except SRB0;

8.1.5.9.1.3 Test description

8.1.5.9.1.3.1 Pre-test conditions

System Simulator:

- NR Cell 1

UE:

- None.

Preamble:

- The UE is in state 3N-A as defined in TS 38.508-1 [4], subclause 4.4A on NR Cell 1.

8.1.5.9.1.3.2 Test procedure sequence

Table 8.1.5.9.1.3.2-1: Time instances of cell power level and parameter changes for FR1

	Parameter	Unit	NR Cell 1
T1	SS/PBCH SSS EPRE	dBm/SCS	"Off"
T2	SS/PBCH SSS EPRE	dBm/SCS	-88
Power level "Off" is defined in TS 38.508-1 [4] Table 6.2.2.1-3.			

Table 8.1.5.9.1.3.2-2: Time instances of cell power level and parameter changes for FR2

	Parameter	Unit	NR Cell 1
T1	SS/PBCH SSS EPRE	dBm/SCS	"Off"
T2	SS/PBCH SSS EPRE	dBm/SCS	-82
Power level "Off" is defined in TS 38.508-1 [4] Table 6.2.2.2-2.			

Table 8.1.5.9.1.3.2-3: Main behaviour

St	Procedure	Message Sequence		TP	Verdict
		U - S	Message		
1	The SS transmits a <i>UECapabilityEnquiry</i> message to enquire max capability and with <i>rrc-segAllowed-r16</i> set to enabled.	<--	<i>UECapabilityEnquiry</i>	-	-
-	EXCEPTION: Steps 2a1 to 2b7 describe behaviour that depends on the size of UEs capability container; the "lower case letter" identifies a step sequence that takes place depending on the size of UE capability message. IF UE's encoded <i>UECapabilityInformation</i> message \geq Max PDCP SDU size then step 2a1 will be performed else step 2b1 to 2b7 will be performed.	-	-	-	-
-	EXCEPTION: Step 2a1 is repeated a maximum of 16 times or till <i>rrc-MessageSegmentType-16</i> IE within the	-	-	-	-

	ULDedicatedMessageSegment message indicates rrc-MessageSegmentType-r16 = lastSegment.				
2a1	Check: Does the UE send segments of UECapabilityInformation message contained within the rrc-MessageSegmentContainer-r16 IE of the ULDedicatedMessageSegment message? NOTE: The SS shall ensure that the concatenated segments decode into a valid UECapabilityInformation message (specific capability content is not checked).	-->	<i>ULDedicatedMessageSegment</i>	1	P
2b1	Check: Does the UE send UECapabilityInformation Message?	-->	<i>UECapabilityInformation</i>	-	-
3a1-4a13	Void	-	-	-	-
2b2	The SS transmits a SET UL MESSAGE REQUEST message.	<--	SET UL MESSAGE REQUEST	-	-
2b3	The UE transmits a SET UL MESSAGE RESPONSE message.	-->	SET UL MESSAGE RESPONSE	-	-
2b4	The SS transmits a <i>UECapabilityEnquiry</i> message with rrc-segAllowed-r16 set to enabled.	<--	<i>UECapabilityEnquiry</i>	-	-
-	EXCEPTION: Step 2b5 is repeated a maximum of 2 times.	-	-	-	-
2b5	Check: Does the UE send segments of UECapabilityInformation message contained within the rrc-MessageSegmentContainer-r16 IE of the ULDedicatedMessageSegment message? NOTE: The SS shall ensure that the concatenated segments decode into a valid UECapabilityInformation message (specific capability content is not checked).	-->	<i>ULDedicatedMessageSegment</i>	1	P
2b6	The SS transmits a SET UL MESSAGE REQUEST message.	<--	SET UL MESSAGE REQUEST	-	-
2b7	The UE transmits a SET UL MESSAGE RESPONSE message.	-->	SET UL MESSAGE RESPONSE	-	-
3	SS stops regular grant transmission upon scheduling request.	-	-	-	-
4	The SS transmits a <i>UECapabilityEnquiry</i> message to enquire max capability and with rrc-segAllowed-r16 set to enabled.	<--	<i>UECapabilityEnquiry</i>	-	-
5	The SS transmits periodic grant from $(80 \cdot 2^{\mu} + 1 + T_{DL})$ slots after step 4 to schedule PUSCH till the ULDedicatedMessageSegment at step 6 is received. (Note 1, Note 2)	-	-	-	-
6	The UE sends 1st segment of UECapabilityInformation message contained within the rrc-MessageSegmentContainer-r16 IE of the ULDedicatedMessageSegment message.	-->	<i>ULDedicatedMessageSegment</i>	-	-
7	The SS changes NR Cell 1 parameters according to the row "T1" in table 8.1.5.9.1.3.2-1/2 in order that the radio link quality of NR Cell 1 is degraded.	-	-	-	-
8	Wait for T310 to expire	-	-	-	-
9	The SS changes NR Cell 1 parameters according to the row "T2" in table 8.1.5.9.1.3.2-1/2.	-	-	-	-
10	The UE sends an <i>RRCReestablishmentRequest</i> message on NR Cell 1.	-->	<i>RRCReestablishmentRequest</i>	-	-

11	The SS transmits an RRCReestablishment message to resume SRB1 operation on NR Cell 1.	<--	RRCReestablishment	-	-
12	The UE transmits an RRCReestablishmentComplete message on NR Cell 1?	-->	RRCReestablishmentComplete	-	-
13	SS resumes regular UL grant transmission.	-	-	-	-
14	Check: Upon successful completion of RRC re-establishment procedure, does the UE discards remaining segments of UECapabilityInformation message and does not send any ULDedicatedMessageSegment message in the next 5 seconds?	-	-	2	P
Note 1: T_{DL} is the delay in slots to the next available DL slot suitable for the transmission of a DCI.					
Note 2: μ is the SCS index. $\mu = 0/1/2/3$ for SCS = 15kHz/30kHz/60kHz/120kHz respectively.					

8.1.5.9.1.3.3 Specific message contents

Table 8.1.5.9.1.3.3-0: CellGroupConfig (preamble)

Derivation Path: TS 38.508-1 [4], Table 4.6.3-19			
Information Element	Value/remark	Comment	Condition
CellGroupConfig ::= SEQUENCE {			
rlf-TimersAndConstants SEQUENCE {			
t311-v1530	ms10000		
}			
}			

Table 8.1.5.9.1.3.3-1: UECapabilityEnquiry (step 1, 2b4 and step 4, Table 8.1.5.9.1.3.2-1)

Derivation Path: TS 38.508-1 [4], Table 4.6.1-31			
Information Element	Value/remark	Comment	Condition
UECapabilityEnquiry ::= SEQUENCE {			
rrc-TransactionIdentifier	RRC-TransactionIdentifier		
criticalExtensions CHOICE {			
ueCapabilityEnquiry SEQUENCE {			
ue-CapabilityRAT-RequestList SEQUENCE (SIZE (1.. maxRAT-CapabilityContainers)) OF UE-CapabilityRAT-Request {	2 entries		
UE-CapabilityRAT-Request[1] SEQUENCE {		entry 1	
rat-Type	nr		
capabilityRequestFilter	UE-CapabilityRequestFilterNR	OCTET STRING (CONTAINING UE-CapabilityRequestFilterNR)	
}			
UE-CapabilityRAT-Request[2] SEQUENCE {		entry 2	
rat-Type	eutra-nr		
capabilityRequestFilter	UE-CapabilityRequestFilterNR	OCTET STRING (CONTAINING UE-CapabilityRequestFilterNR)	
}			
}			
lateNonCriticalExtension	Not present		
ue-CapabilityEnquiryExt	OCTET STRING Containing UECapabilityEnquiry-v1560-IEs		
}			

}		
---	--	--

Table 8.1.5.9.1.3.3-2: UE-CapabilityRequestFilterNR (Table 8.1.5.9.1.3.3-1)

Derivation Path: TS 38.508-1 [4], Table 4.6.1-47			
Information Element	Value/remark	Comment	Condition
UE-CapabilityRequestFilterNR ::= SEQUENCE {			
frequencyBandListFilter	FreqBandList		
nonCriticalExtension SEQUENCE {	Not present		
srs-SwitchingTimeRequest	Not present		
nonCriticalExtension SEQUENCE {			
srs-SwitchingTimeRequest	Not present		
nonCriticalExtension	Not present		
}			
}			
}			

Table 8.1.5.9.1.3.3-3: FreqBandList (Table 8.1.5.9.1.3.3-2)

Derivation Path: TS 38.508-1 [4], Table 4.6.4-21			
Information Element	Value/remark	Comment	Condition
FreqBandList ::= SEQUENCE (SIZE (1..maxBandsMRDC)) OF FreqBandInformation {	43 entries	FreqBandIndicator NR = n1, n2, n3, n5, n7, n8, n12, n14, n20, n25, n26, n28, n29, n30, n34, n38, n39, n40, n41, n48, n50, n51, n53, n65, n66, n70, n71, n74, n75, n76, n77, n78, n79, n80, n81, n82, n83, n84, n86, n257, n258, n260, n261.	
FreqBandInformation[n] CHOICE {		entry n	
bandInformationNR SEQUENCE {			
bandNR	FreqBandIndicatorNR		
maxBandwidthRequestedDL	Not present		
maxBandwidthRequestedUL	Not present		
maxCarriersRequestedDL	Not present		
maxCarriersRequestedUL	Not present		
}			
}			
}			

Table 8.1.5.9.1.3.3-4: UECapabilityEnquiry-v1560-IEs (Table 8.1.5.9.1.3.3-1)

Information Element	Value/remark	Comment	Condition
UECapabilityEnquiry-v1560-IEs ::= SEQUENCE {			
capabilityRequestFilterCommon	Not present		
nonCriticalExtension SEQUENCE {			
rrc-SegAllowed-r16	enabled		
nonCriticalExtension	Not present		
}			
}			

Table 8.1.5.9.1.3.3-5: ULDedicatedMessageSegment (step 2a1, 2b5 and step 6, Table 8.1.5.9.1.3.2-1)

Derivation Path: TS 38.508-1 [4], Table 4.6.1-32C			
Information Element	Value/remark	Comment	Condition

ULDedicatedMessageSegment-r16 ::= SEQUENCE {			
criticalExtensions CHOICE {			
segmentNumber-r16	0 for first segment, and incremented by 1 for each subsequent segment		
rrc-MessageSegmentContainer-r16	Not Checked	OCTET STRING Includes a segment of the encoded UL DCCH message. The size of the included segment in this container should be small enough so the resulting encoded RRC message PDU is less than or equal to the PDCP SDU size limit	
rrc-MessageSegmentType-r16	<i>notLastSegment</i> for all segments except the last segment. <i>lastSegment</i> for the last segment		
lateNonCriticalExtension	Not present		
nonCriticalExtension	Not present		
}			
}			

8.1.5.9.2 RRC reconfiguration / DL segment transfer

8.1.5.9.2.1 Test Purpose (TP)

(1)

```
with { UE having completed the RRC connection establishment procedure }
ensure that {
  when { SS initiates the DL Dedicated Message Segment transfer procedure to send an
  RRCReconfiguration message to establish a DRB and SRB2 }
  then { UE successfully completes the reconfiguration }
}
```

(2)

```
with { UE in NR RRC_CONNECTED state with SRB2 and has previously received the first and second
segment of an RRCReconfiguration message including SRB2 configuration }
ensure that {
  when { SS releases the RRC connection }
  then { UE discards all segments }
}
```

8.1.5.9.2.2 Conformance requirements

References: The conformance requirements covered in the present TC are specified in: TS 38.331, clauses 5.3.11 and 5.7.6.3. Unless otherwise stated these are Rel-16 requirements.

[TS 38.331, clause 5.3.11]

The UE shall:

...

1> discard any segments of segmented RRC messages stored according to 5.7.6.3;

[TS 38.331, clause 5.7.6.3]

Upon receiving *DL DedicatedMessageSegment* message, the UE shall:

- 1> store the segment included in *rrc-MessageSegmentContainer*;
- 1> if all segments of the message have been received:
 - 2> assemble the message from the received segments and process the message according to 5.3.5.3 for the *RRCReconfiguration* message or 5.3.13.4 for the *RRCResume* message;
 - 2> discard all segments.

8.1.5.9.2.3 Test description

8.1.5.9.2.3.1 Pre-test conditions

System Simulator:

- NR Cell 1

UE:

- None

Preamble:

- If *pc_IP_Ping* is set to TRUE then the UE is in 5GS state 1N-A, PDU SESSION ACTIVE according to TS 38.508-1 [4], clause 4.4A.2 Table 4.4A.2-1
- Else, the UE is in 5GS state 1N-A and Test Loop Function (*On*) with UE test loop mode B on NR Cell 1 according to 38.508-1[4], clause 4.4A.2 Table 4.4A.2-3.

8.1.5.9.2.3.2 Test procedure sequence

Table 8.1.5.9.2.3.2-1: Main behaviour

St	Procedure	Message Sequence		TP	Verdict
		U - S	Message		
1	SS transmits a <i>Paging</i> message to the UE on the appropriate paging block, and including the UE identity in one entry of the IE <i>pagingRecordList</i> .	<--	NR RRC: <i>Paging</i>	-	-
2	UE transmits an <i>RRCSetupRequest</i> message.	-->	NR RRC: <i>RRCSetupRequest</i>	-	-
3	SS transmits an <i>RRCSetup</i> message	<--	NR RRC: <i>RRCSetup</i>	-	-
4	The UE transmits an <i>RRCSetupComplete</i> to confirm the successful completion of the connection establishment.	-->	NR RRC: <i>RRCSetupComplete</i>	-	-
5	SS transmits a <i>SecurityModeCommand</i> message to activate AS security.	<--	NR RRC: <i>SecurityModeCommand</i>	-	-
6	Using the same slot as the <i>SecurityModeCommand</i> message in step 5, the SS transmits an <i>DL DedicatedMessageSegment</i> containing the first segment of the <i>RRCReconfiguration</i> message to establish a data radio bearer, DRB1 and signalling radio bearer, SRB2.	<--	NR RRC: <i>DL DedicatedMessageSegment</i>	-	-
7	The UE transmits a <i>SecurityModeComplete</i> message.	-->	NR RRC: <i>SecurityModeComplete</i>	-	-
8	The SS transmits a <i>DL DedicatedMessageSegment</i> containing the second(last) segment of the <i>RRCReconfiguration</i> message.	<--	NR RRC: <i>DL DedicatedMessageSegment</i>	-	-

9	Check: Does the UE transmit an <i>RRCReconfigurationComplete</i> message to confirm the establishment of data radio bearer, DRB1 and signalling radio bearer, SRB2?	-->	NR RRC: <i>RRCReconfigurationComplete</i>	1	P
10	Check: Does the test result of generic test procedure in TS 38.508-1 [4] subclause 4.9.1 indicate that the UE is capable of exchanging IP data on DRB#1 established in Step 8?	-	-	1	-
11	The SS transmits a <i>DLDedicatedMessageSegment</i> containing the first segment of the <i>RRCReconfiguration</i> message to modify SRB and DRB configuration.	<--	NR RRC: <i>DLDedicatedMessageSegment</i>		
12	The SS transmits the second segment of the <i>RRCReconfiguration</i> message to modify SRB and DRB configuration.	<--	NR RRC: <i>DLDedicatedMessageSegment</i>	-	-
13	The SS releases the RRC connection.	-	-	-	-
14	Step 1-8 of generic test procedure in TS 38.508-1 [4] subclause 4.5.4 to bring the UE in RRC_CONNECTED mode.	-	-	-	-
15	The SS transmits the third(last) segment of the <i>RRCReconfiguration</i> message to modify SRB2 and DRB configuration.	<--	NR RRC: <i>DLDedicatedMessageSegment</i>	-	-
16	Check: Does the UE transmit an <i>RRCReconfigurationComplete</i> message in the next 3s?	-->	NR RRC: <i>RRCReconfigurationComplete</i>	2	F
17	The SS releases the RRC connection.	-	-	-	-
18	Step 1-8 of generic test procedure in TS 38.508-1 [4] subclause 4.5.4 to bring the UE in RRC_CONNECTED mode.	-	-	-	-
19	The SS transmits a <i>DLDedicatedMessageSegment</i> containing the first segment of the <i>RRCReconfiguration</i> message to modify SRB and DRB configuration.		NR RRC: <i>DLDedicatedMessageSegment</i>		
20	The SS transmits the second segment of the <i>RRCReconfiguration</i> message to modify SRB and DRB configuration.	<--	NR RRC: <i>DLDedicatedMessageSegment</i>	-	-
21	The SS transmits the third(last) segment of the <i>RRCReconfiguration</i> message to modify SRB2 and DRB configuration.	<--	NR RRC: <i>DLDedicatedMessageSegment</i>	-	-
22	Check: Does the UE transmit an <i>RRCReconfigurationComplete</i> message in the next 3s?	-->	NR RRC: <i>RRCReconfigurationComplete</i>	1	P
23	Check: Does the test result of generic test procedure in TS 38.508-1 [4] subclause 4.9.1 indicate that the UE is capable of exchanging IP data on DRB#1 established in Steps 12-21?	-	-	1	
24	The SS transmits an OPEN UE TEST LOOP Message.	<--	OPEN UE TEST LOOP	-	-
25	The UE transmits an OPEN UE TEST LOOP COMPLETE Message.	-->	OPEN UE TEST LOOP COMPLETE	-	-
26	The SS transmits DEACTIVATE TEST MODE message.	<--	DEACTIVATE TEST MODE	-	-
27	The UE transmits DEACTIVATE TEST MODE COMPLETE message.	-->	DEACTIVATE TEST MODE COMPLETE	-	-
NOTE 1: The request to establish a PDU session may be performed by MMI or AT Command.					

8.1.5.9.2.3.3 Specific message contents

Table 8.1.5.9.2.3.3-1: *DLDedicatedMessageSegment* (Step 6, 8, 11, 12, 15, 19, 20 and 21, Table 8.1.5.9.2.3.2-1)

Derivation Path: TS 38.508-1[4], table 4.6.1-2B			
Information Element	Value/remark	Comment	Condition
<i>DLDedicatedMessageSegment-r16</i> ::= SEQUENCE {			
criticalExtensions CHOICE {			

dIDedicatedMessageSegment-r16 SEQUENCE {			
segmentNumber-r16	0		Step 6, Step 11, Step 19
segmentNumber-r16	1		Step 8, Step 12, Step 20
segmentNumber-r16	2		Step 15, Step 21
rrc-MessageSegmentContainer-r16	OCTET STRING (CONTAINING First segment of the RRCReconfiguration message)	Table 8.1.5.9.2.3.3-2	Step 6
rrc-MessageSegmentContainer-r16	OCTET STRING (CONTAINING Last segment of the RRCReconfiguration message)	Table 8.1.5.9.2.3.3-2	Step 8
rrc-MessageSegmentContainer-r16	OCTET STRING (CONTAINING First segment of the RRCReconfiguration message)	Table 8.1.5.9.2.3.3-4	Step 11, Step 19
rrc-MessageSegmentContainer-r16	OCTET STRING (CONTAINING Second segment of the RRCReconfiguration message)	Table 8.1.5.9.2.3.3-4	Step 12, Step 20
rrc-MessageSegmentContainer-r16	OCTET STRING (CONTAINING Last (third) segment of the RRCReconfiguration message)	Table 8.1.5.9.2.3.3-4	Step 15, Step 21
rrc-MessageSegmentType-r16	notLastSegment		Step 6, Step 11, Step 19, Step 12, Step 20
rrc-MessageSegmentType-r16	LastSegment		Step 8, Step 15, Step 21
}			
}			
}			

Table 8.1.5.9.2.3.3-2: RRCReconfiguration (Step 6 and 8, Table 8.1.5.9.2.3.3-1)

Derivation Path: TS 38.508-1[4], table 4.6.1-13			
Information Element	Value/remark	Comment	Condition
RRCReconfiguration ::= SEQUENCE {			
criticalExtensions CHOICE {			
rrcReconfiguration SEQUENCE {			
radioBearerConfig	RadioBearerConfig with conditions SRB2 and DRB1		
nonCriticalExtension SEQUENCE {			
masterCellGroup	CellGroupConfig	OCTET STRING (CONTAINING CellGroupConfig Table 8.1.5.9.2.3.3-3)	
lateNonCriticalExtension	'00,,,'00'O	Add enough padding so that: maximum PDCP SDU size < encoded DLdedicatedMessageSegment size < 2 x maximum PDCP SDU size	
}			
}			

}		
---	--	--

Table 8.1.5.9.2.3.3-3: CellGroupConfig (Table 8.1.5.9.2.3.3-2)

Derivation Path: TS 38.508-1[4], table 4.6.3-19			
Information Element	Value/remark	Comment	Condition
CellGroupConfig ::= SEQUENCE {			
rlc-BearerToAddModList SEQUENCE	2 entries		
(SIZE(1..maxLC-ID)) OF RLC-BearerConfig {			
RLC-Bearer-Config[1] SEQUENCE {		entry 1	
logicalChannelIdentity	LogicalChannelIdentity		
servedRadioBearer CHOICE {			
drb-Identity	DRB-Identity with condition DRB1		
}			
reestablishRLC	Not present		
RLC-Config	RLC-Config with condition AM according to 38.508-1 [4], table 4.6.3-149		
mac-LogicalChannelConfig	LogicalChannelConfig according to 38.508-1 [4], table 4.6.3-66		
}			
RLC-Bearer-Config[2] SEQUENCE {		entry 2	
logicalChannelIdentity	LogicalChannelIdentity		
servedRadioBearer CHOICE {			
srb-Identity	SRB-Identity with condition SRB2		
}			
reestablishRLC	Not present		
RLC-Config	Not present		
mac-LogicalChannelConfig	LogicalChannelConfig according to 38.508-1 [4], table 4.6.3-66		
}			
}			
mac-CellGroupConfig	Not present		
physicalCellGroupConfig	Not present		
spCellConfig SEQUENCE	Not present		
}			

Table 8.1.5.9.2.3.3-4: RRCReconfiguration (Step 11, 12, 15, 19, 20 and 21, Table 8.1.5.9.2.3.2-1)

Derivation Path: TS 38.508-1[4], table 4.6.1-13			
Information Element	Value/remark	Comment	Condition
RRCReconfiguration ::= SEQUENCE {			
criticalExtensions CHOICE {			
rrcReconfiguration SEQUENCE {			
nonCriticalExtension SEQUENCE {			
masterCellGroup	CellGroupConfig	OCTET STRING (CONTAINING CellGroupConfig Table 8.1.5.9.2.3.3-5)	
}			
lateNonCriticalExtension	'00,,,00'O	Add enough padding so that the size of the encoded DL Dedicated Message Segment = 3 x maximum PDCP SDU size	

}			
}			
}			

Table 8.1.5.9.2.3.3-5: CellGroupConfig (Table 8.1.5.9.2.3.3-3)

Derivation Path: TS 38.508-1, table 4.6.3-19			
Information Element	Value/remark	Comment	Condition
CellGroupConfig ::= SEQUENCE {			
rlc-BearerToAddModList SEQUENCE	2 entries		
(SIZE(1..maxLC-ID)) OF RLC-BearerConfig {			
RLC-Bearer-Config[1] SEQUENCE {		entry 1	
logicalChannelIdentity	LogicalChannelIdentity		
servedRadioBearer CHOICE {			
srb-Identity	SRB-Identity with condition SRB2		
}			
reestablishRLC	true		
RLC-Config	RLC-Config with condition AM according to 38.508-1 [4], table 4.6.3-149		
mac-LogicalChannelConfig	LogicalChannelConfig according to 38.508-1 [4], table 4.6.3-66		
}			
RLC-Bearer-Config[2] SEQUENCE {		entry 2	
logicalChannelIdentity	LogicalChannelIdentity		
servedRadioBearer CHOICE {			
drb-Identity	DRB-Identity with condition DRB1		
}			
reestablishRLC	true		
RLC-Config	Not present		
mac-LogicalChannelConfig	LogicalChannelConfig according to 38.508-1 [4], table 4.6.3-66		
}			
}			
mac-CellGroupConfig	Not present		
physicalCellGroupConfig	Not present		
spCellConfig SEQUENCE	Not present		
}			

8.1.5.10 UE Assistance Information

8.1.5.10.1 UE Assistance Information/ Release Preference

8.1.5.10.1.1 Test Purpose (TP)

(1)

```
with { UE in NR RRC_CONNECTED state }
ensure that {
  when { UE configured to provide its release preference and a Preferred RRC State is provided (UE determines that it would prefer to transition out of RRC_CONNECTED) and timer T346f is not running }
  then { the UE transmits a UEAssistanceInformation message }
}
```

(2)

```
with { UE in NR RRC_CONNECTED state }
ensure that {
```



```

when { UE configured to provide its release preference and a Preferred RRC State is provided (UE
determines that it would prefer to transition out of RRC_CONNECTED) and timer T346f is running }
  then { the UE does not transmit a UEAssistanceInformation message }
}

```

(3)

```

with { UE in NR RRC_CONNECTED state and is configured with connectedReporting and having transmitted
a UEAssistanceInformation message to indicate preference to transition out of RRC_CONNECTED state }
ensure that {
  when { UE determines that it would prefer to remain in RRC_CONNECTED state and timer T346f is not
running }
    then { the UE transmits a UEAssistanceInformation message }
}

```

8.1.5.10.1.2 Conformance requirements

References: The conformance requirements covered in the current TC is specified in: TS 38.331 clause 5.3.5.9, 5.7.4.2 and 5.7.4.3. Unless state explicitly these are Rel-16 requirements.

[TS 38.331, clause 5.3.5.9]

The UE shall:

...

- 1> if the received *otherConfig* includes the *releasePreferenceConfig*:
 - 2> if *releasePreferenceConfig* is set to *setup*:
 - 3> consider itself to be configured to provide assistance information to transition out of RRC_CONNECTED in accordance with 5.7.4;
 - 2> else:
 - 3> consider itself not to be configured to provide assistance information to transition out of RRC_CONNECTED and stop timer T346f, if running.

[TS 38.331, clause 5.7.4.2]

A UE capable of providing assistance information to transition out of RRC_CONNECTED state may initiate the procedure if it was configured to do so, upon determining that it prefers to transition out of RRC_CONNECTED state, or upon change of its preferred RRC state.

...

Upon initiating the procedure, the UE shall:

- 1> if configured to provide its release preference and timer T346f is not running:
 - 2> if the UE determines that it would prefer to transition out of RRC_CONNECTED state; or
 - 2> if the UE is configured with *connectedReporting* and the UE determines that it would prefer to revert an earlier indication to transition out of RRC_CONNECTED state:
 - 3> start timer T346f with the timer value set to the *releasePreferenceProhibitTimer*;
 - 3> initiate transmission of the *UEAssistanceInformation* message in accordance with 5.7.4.3 to provide the release preference;

[TS 38.331, clause 5.7.4.3]

The UE shall set the contents of the *UEAssistanceInformation* message as follows:

...

- 1> if transmission of the *UEAssistanceInformation* message is initiated to provide a release preference according to 5.7.4.2 or 5.3.5.3:

2> include *releasePreference* in the *UEAssistanceInformation* message;

2> set *preferredRRC-State* to the desired RRC state on transmission of the *UEAssistanceInformation* message;

8.1.5.10.1.3 Test Description

8.1.5.10.1.3.1 Pre-test conditions

System Simulator:

- NR Cell 1.
- System information combination NR-1 as defined in TS 38.508-1 [4] clause 4.4.3.1.2 is used for NR cell 1.

UE:

- None.

Preamble:

- The UE is in 5GS state 3N-A on NR Cell 1 according to TS 38.508-1 [4], clause 4.4A.2 Table 4.4A.2-3.

8.1.5.10.1.3.2 Test procedure sequence

Table 8.1.5.10.1.3.2-1: Main behaviour

St	Procedure	Message Sequence		TP	Verdict
		U - S	Message		
1	The SS transmits an RRCReconfiguration message to configure <i>releasePreferenceConfig</i> with <i>releasePreferenceProhibitTimer</i> IE.	<--	NR RRC: <i>RRCReconfiguration</i>	-	-
2	The UE transmits an RRCReconfigurationComplete message.	-->	NR RRC: <i>RRCReconfigurationComplete</i>	-	-
3	The SS transmits an SET UAI REQUEST message indicating Preferred RRC State = 'idle'.	<--	SET UAI REQUEST	-	-
-	EXCEPTION: Step 4 and 5 can be performed in any order.	-	-	-	-
4	The UE transmits an SET UAI RESPONSE message.	-->	SET UAI RESPONSE	-	-
5	Check: Does the UE transmits an <i>UEAssistanceInformation</i> message to indicate IE <i>preferredRRC-State-r16</i> = 'idle' within the <i>ReleasePreference-r16</i> IE?	-->	NR RRC: <i>UEAssistanceInformation</i>	1	P
6	SS starts timer T346f = 30s.	-	-	-	-
7	The SS transmits an SET UAI REQUEST message indicating Preferred RRC State = 'inactive'.	<--	SET UAI REQUEST	-	-
8	The UE transmits an SET UAI RESPONSE message.	-->	SET UAI RESPONSE	-	-
9	Check: Does the UE transmit an <i>UEAssistanceInformation</i> message to indicate IE <i>preferredRRC-State-r16</i> = 'inactive' within the <i>ReleasePreference-r16</i> IE?	-->	NR RRC: <i>UEAssistanceInformation</i>	2	F
10	SS waits for timer T346f expiry.	-	-	-	-
-	EXCEPTION: Step 10a may be performed if the UE cached the <i>preferredRRC-State</i> indication from upper layers.				

10a	The UE transmit an <i>UEAssistanceInformation</i> message to indicate IE preferredRRC-State-r16 = 'inactive' within the ReleasePreference-r16 IE.	-->	NR RRC: <i>UEAssistanceInformation</i>	-	-
11	The SS transmits an SET UAI REQUEST message indicating Preferred RRC State = connected.	<--	SET UAI REQUEST	-	-
12	The UE transmits an SET UAI RESPONSE message.	-->	SET UAI RESPONSE	-	-
13	Check: Does the UE transmits an <i>UEAssistanceInformation</i> message to indicate IE preferredRRC-State-r16 = 'connected' within the ReleasePreference-r16 IE?	-->	NR RRC: <i>UEAssistanceInformation</i>	3	F
14	The SS transmits an RRCReconfiguration message to configure <i>releasePreferenceConfig</i> with <i>connectedReporting</i> .	<--	NR RRC: <i>RRCReconfiguration</i>	-	-
15	The UE transmits an RRCReconfigurationComplete message.	-->	NR RRC: <i>RRCReconfigurationComplete</i>	-	-
16	The SS transmits an SET UAI REQUEST message indicating Preferred RRC State = 'connected'.	<--	SET UAI REQUEST	-	-
-	EXCEPTION: Step 18 and 19 can be performed in any order.	-	-	-	-
17	The UE transmits an SET UAI RESPONSE message.	-->	SET UAI RESPONSE	-	-
18	Check: Does the UE transmits an <i>UEAssistanceInformation</i> message to indicate IE preferredRRC-State-r16 = 'connected' within the ReleasePreference-r16?	-->	NR RRC: <i>UEAssistanceInformation</i>	3	P

8.1.5.10.1.3.3 Specific message contents

Table 8.1.5.10.1.3.3-1: RRCReconfiguration (step 1, Table 8.1.5.10.1.3.2-1)

Derivation Path: TS 38.508-1 [4] Table 4.6.1-13			
Information Element	Value/remark	Comment	Condition
RRCReconfiguration ::= SEQUENCE {			
criticalExtensions CHOICE {			
rrcReconfiguration SEQUENCE {			
nonCriticalExtension SEQUENCE {			
nonCriticalExtension SEQUENCE {			
nonCriticalExtension SEQUENCE {			
nonCriticalExtension SEQUENCE {			
otherConfig-v1610 SEQUENCE {			
releasePreferenceConfig-r16 CHOICE {			
setup SEQUENCE {			
releasePreferenceProhibitTimer-r16	s30		
connectedReporting	Not present		
}			
}			
}			
}			
}			
}			
}			
}			
}			
}			
}			

Table 8.1.5.10.1.3.3-2: UEAssistanceInformation (Step 5, step 10a and step 18, Table 8.1.5.10.1.3.2-1)

Derivation Path: TS 38.508-1 [4] Table 4.6.1-30			
Information Element	Value/remark	Comment	Condition
UEAssistanceInformation ::= SEQUENCE {			
criticalExtensions CHOICE {			
ueAssistanceInformation SEQUENCE {			
nonCriticalExtension SEQUENCE {			
nonCriticalExtension SEQUENCE {			
releasePreference-r16 SEQUENCE {			
preferredRRC-State-r16	idle		Step 5
	inactive		Step 10a
	connected		Step 18
}			
}			
}			
}			
}			
}			
}			

Table 8.1.5.10.1.3.3-3: RRCReconfiguration (step 14, Table 8.1.5.10.1.3.2-1)

Derivation Path: TS 38.508-1 [4] Table 4.6.1-13			
Information Element	Value/remark	Comment	Condition
RRCReconfiguration ::= SEQUENCE {			
criticalExtensions CHOICE {			
rrcReconfiguration SEQUENCE {			
nonCriticalExtension SEQUENCE {			
nonCriticalExtension SEQUENCE {			
nonCriticalExtension SEQUENCE {			
nonCriticalExtension SEQUENCE {			
otherConfig-v1610 SEQUENCE {			
releasePreferenceConfig-r16 CHOICE {			
setup SEQUENCE {			
releasePreferenceProhibitTimer-r16	s30		
connectedReporting	true		
}			
}			
}			
}			
}			
}			
}			
}			
}			
}			
}			

8.1.5.11 Idle/Inactive measurements

8.1.5.11.1 Idle/Inactive measurements / Idle mode / SIB11 configuration / Measurement of NR cells

8.1.5.11.1.1 Test Purpose (TP)

(1)

with { UE in NR RRC_CONNECTED state }
 ensure that {

```

when { UE receives a RRCRelease message including measIdleConfig and SIB11 including
measIdleCarrierListNR with ssb-MeasConfig }
then { UE enters RRC_IDLE state, performs cell measurements and reports measurement results in
RRC_CONNECTED state }
}

```

(2)

```

with { UE in NR RRC_CONNECTED state }
ensure that {
when { UE receives a RRCRelease message including measIdleConfig, SIB11 including
measIdleCarrierListNR without ssb-MeasConfig and ssb-MeasConfig parameters derived from SIB4 }
then { UE enters RRC_IDLE state, performs cell measurements and reports measurement results in
RRC_CONNECTED state }
}

```

(3)

```

with { UE in NR RRC_CONNECTED state }
ensure that {
when { UE receives a RRCRelease message including measIdleConfig, SIB11 including
measIdleCarrierListNR without ssb-MeasConfig and ssb-MeasConfig parameters derived from SIB4 and
T331 expires }
then { UE enters RRC_IDLE state, UE does not report measurement results in RRC_CONNECTED state
after T331 expiration }
}

```

(4)

```

with { UE in NR RRC_CONNECTED state }
ensure that {
when { UE receives a RRCRelease message including measIdleConfig and SIB11 does not include
measIdleCarrierListNR }
then { UE enters RRC_IDLE state, UE does not report measurement results in RRC_CONNECTED state }
}

```

8.1.5.11.1.2 Conformance requirements

References: The conformance requirements covered in the current TC is specified in: TS 38.331 clause 5.3.2.3.

[TS 38.331, clause 5.7.8.1]

This procedure specifies the measurements to be performed and stored by a UE in RRC_IDLE and RRC_INACTIVE when it has an idle/inactive measurement configuration.

[TS 38.331, clause 5.7.8.1a]

The purpose of this procedure is to update the idle/inactive measurement configuration.

The UE initiates this procedure while T331 is running and one of the following conditions is met:

- 1> upon selecting a cell when entering RRC_IDLE or RRC-INACTIVE from RRC_CONNECTED or RRC_INACTIVE; or
- 1> upon update of system information (*SIB4*, or *SIB11*), e.g. due to intra-RAT cell (re)selection;

While in RRC_IDLE or RRC_INACTIVE, and T331 is running, the UE shall:

- 1> if *VarMeasIdleConfig* includes neither a *measIdleCarrierListEUTRA* nor a *measIdleCarrierListNR* received from the *RRCRelease* message:
 - 2> if the UE supports *idleInactiveNR-MeasReport*:
 - 3> if *SIB11* includes the *measIdleConfigSIB* and contains *measIdleCarrierListNR*:
 - 4> store or replace the *measIdleCarrierListNR* of *measIdleConfigSIB* of *SIB11* within *VarMeasIdleConfig*;
 - 3> else:

- 4> remove the *measIdleCarrierListNR* in *VarMeasIdleConfig*, if stored;
- 1> for each entry in the *measIdleCarrierListNR* within *VarMeasIdleConfig* that does not contain an *ssb-MeasConfig* received from the *RRCRelease* message:
 - 2> if there is an entry in *measIdleCarrierListNR* in *measIdleConfigSIB* of *SIB11* that has the same carrier frequency and subcarrier spacing as the entry in the *measIdleCarrierListNR* within *VarMeasIdleConfig* and that contains *ssb-MeasConfig*:
 - 3> delete the *ssb-MeasConfig* of the corresponding entry in the *measIdleCarrierListNR* within *VarMeasIdleConfig*;
 - 3> store the SSB measurement configuration from *SIB11* into *nrofSS-BlocksToAverage*, *absThreshSS-BlocksConsolidation*, *smtc*, *ssb-ToMeasure*, *deriveSSB-IndexFromCell*, and *ss-RSSI-Measurement* within *ssb-MeasConfig* of the corresponding entry in the *measIdleCarrierListNR* within *VarMeasIdleConfig*;
 - 2> else if there is an entry in *interFreqCarrierFreqList* of *SIB4* with the same carrier frequency and subcarrier spacing as the entry in *measIdleCarrierListNR* within *VarMeasIdleConfig*:
 - 3> delete the *ssb-MeasConfig* of the corresponding entry in the *measIdleCarrierListNR* within *VarMeasIdleConfig*;
 - 3> store the SSB measurement configuration from *SIB4* into *nrofSS-BlocksToAverage*, *absThreshSS-BlocksConsolidation*, *smtc*, *ssb-ToMeasure*, *deriveSSB-IndexFromCell*, and *ss-RSSI-Measurement* within *ssb-MeasConfig* of the corresponding entry in the *measIdleCarrierListNR* within *VarMeasIdleConfig*;
 - 2> else:
 - 3> remove the *ssb-MeasConfig* of the corresponding entry in the *measIdleCarrierListNR* within *VarMeasIdleConfig*, if stored;
- 1> perform measurements according to 5.7.8.2a.

[TS 38.331, clause 5.7.8.2a]

When performing measurements on NR carriers according to this clause, the UE shall derive the cell quality as specified in 5.5.3.3 and consider the beam quality to be the value of the measurement results of the concerned beam, where each result is averaged as described in TS 38.215 [9].

While in *RRC_IDLE* or *RRC_INACTIVE*, and T331 is running, the UE shall:

- 1> perform the measurements in accordance with the following:
 - 2> if the *VarMeasIdleConfig* includes the *measIdleCarrierListNR* and the *SIB1* contains *idleModeMeasurementsNR*:
 - 3> for each entry in *measIdleCarrierListNR* within *VarMeasIdleConfig* that contains *ssb-MeasConfig*:
 - 4> if UE supports carrier aggregation or NR-DC between serving carrier and the carrier frequency and subcarrier spacing indicated by *carrierFreq* and *ssbSubCarrierSpacing* within the corresponding entry:
 - 5> perform measurements in the carrier frequency and subcarrier spacing indicated by *carrierFreq* and *ssbSubCarrierSpacing* within the corresponding entry;
 - 5> if the *reportQuantities* is set to *rsrq*:
 - 6> consider *RSRQ* as the cell sorting quantity;
 - 5> else:
 - 6> consider *RSRP* as the cell sorting quantity;
 - 5> if the *measCellListNR* is included:

- 6> consider cells identified by each entry within the *measCellListNR* to be applicable for idle/inactive measurement reporting;
- 5> else:
 - 6> consider up to *maxCellMeasIdle* strongest identified cells, according to the sorting quantity, to be applicable for idle/inactive measurement reporting;
 - 5> for all cells applicable for idle/inactive measurement reporting, derive cell measurement results for the measurement quantities indicated by *reportQuantities*;
 - 5> store the derived cell measurement results as indicated by *reportQuantities* for cells applicable for idle/inactive measurement reporting within *measResultsPerCarrierListIdleNR* in the *measReportIdleNR* in *VarMeasIdleReport* in decreasing order of the cell sorting quantity, i.e. the best cell is included first, as follows:
 - 6> if *qualityThreshold* is configured:
 - 7> include the measurement results from the cells applicable for idle/inactive measurement reporting whose RSRP/RSRQ measurement results are above the value(s) provided in *qualityThreshold*;
 - 6> else:
 - 7> include the measurement results from all cells applicable for idle/inactive measurement reporting;
 - 5> if *beamMeasConfigIdle* is included in the associated entry in *measIdleCarrierListNR* and if UE supports *idleInactiveNR-MeasBeamReport* for the FR of the carrier frequency indicated by *carrierFreq* within the associated entry, for each cell in the measurement results:
 - 6> derive beam measurements based on SS/PBCH block for each measurement quantity indicated in *reportQuantityRS-Indexes*, as described in TS 38.215 [9];
 - 6> if the *reportQuantityRS-Indexes* is set to *rsrq*:
 - 7> consider RSRQ as the beam sorting quantity;
 - 6> else:
 - 7> consider RSRP as the beam sorting quantity;
 - 6> set *resultsSSB-Indexes* to include up to *maxNrofRS-IndexesToReport* SS/PBCH block indexes in order of decreasing beam sorting quantity as follows:
 - 7> include the index associated to the best beam for the sorting quantity and if *absThreshSS-BlocksConsolidation* is included, the remaining beams whose sorting quantity is above *absThreshSS-BlocksConsolidation*;
 - 6> if the *includeBeamMeasurements* is set to *true*:
 - 7> include the beam measurement results as indicated by *reportQuantityRS-Indexes*;
- 2> if, as a result of the procedure in this subclause, the UE performs measurements in one or more carrier frequency indicated by *measIdleCarrierListNR* or *measIdleCarrierListEUTRA*:
 - 3> store the cell measurement results for RSRP and RSRQ for the serving cell within *measResultServingCell* in the *measReportIdleNR* in *VarMeasIdleReport*.
 - 3> if the *VarMeasIdleConfig* includes the *measIdleCarrierListNR* and it contains an entry with *carrierFreq* set to the value of the serving frequency:
 - 4> if *beamMeasConfigIdle* is included in that entry, and if the UE supports *idleInactiveNR-MeasBeamReport* for the FR of the serving cell:
 - 5> derive beam measurements based on SS/PBCH block for each measurement quantity indicated in *reportQuantityRS-Indexes*, as described in TS 38.215 [9];

- 5> if the *reportQuantityRS-Indexes* is set to *rsrq*:
 - 6> consider RSRQ as the beam sorting quantity;
- 5> else:
 - 6> consider RSRP as the beam sorting quantity;
- 5> set *resultsSSB-Indexes* to include up to *maxNrofRS-IndexesToReport* SS/PBCH block indexes in order of decreasing beam sorting quantity as follows:
 - 6> include the index associated to the best beam for the sorting quantity and if *absThreshSS-BlocksConsolidation* is included in *SIB2* of serving cell, the remaining beams whose sorting quantity is above *absThreshSS-BlocksConsolidation*;
- 5> if the *includeBeamMeasurements* is set to true:
 - 6> include the beam measurement results as indicated by *reportQuantityRS-Indexes*;

NOTE 1: How the UE performs idle/inactive measurements is up to UE implementation as long as the requirements in TS 38.133 [14] are met for measurement reporting.

NOTE 2: The UE is not required to perform idle/inactive measurements on a given carrier if the SSB configuration of that carrier provided via dedicated signalling is different from the SSB configuration broadcasted in the serving cell, if any.

NOTE 3: How the UE prioritizes which frequencies to measure or report (in case it is configured with more frequencies than it can measure or report) is left to UE implementation.

[TS 38.331, clause 5.3.8.3]

The UE shall:

- 1> if the *RRCRelease* includes the *measIdleConfig*:
 - 2> if T331 is running:
 - 3> stop timer T331;
 - 3> perform the actions as specified in 5.7.8.3;
 - 2> if the *measIdleConfig* is set to *setup*:
 - 3> store the received *measIdleDuration* in *VarMeasIdleConfig*;
 - 3> start timer T331 with the value set to *measIdleDuration*;

[TS 38.331, clause 5.7.8.3]

The UE shall:

- 1> if T331 expires or is stopped:
 - 2> release the *VarMeasIdleConfig*.

NOTE: It is up to UE implementation whether to continue idle/inactive measurements according to SIB11 and SIB4 configurations or according to E-UTRA SIB5 and E-UTRA SIB24 configurations as specified in TS 36.331 [10] upon inter-RAT cell reselection to E-UTRA, after T331 has expired or stopped.

[TS 38.331, clause 5.7.10.3]

Upon receiving the *UEInformationRequest* message, the UE shall, only after successful security activation:

- 1> if the *idleModeMeasurementReq* is included in the *UEInformationRequest* and the UE has stored *VarMeasIdleReport* that contains measurement information concerning cells other than the PCell:
 - 2> set the *measResultIdleNR* in the *UEInformationResponse* message to the value of *measReportIdleNR* in the *VarMeasIdleReport*, if available;

8.1.5.11.1.3 Test Description

8.1.5.11.1.3.1 Pre-test conditions

System Simulator:

- NR Cell 1
- NR Cell 3, suitable for inter-frequency measurements

UE:

- None.

Preamble:

- The UE is in 5GS state 3N-A according to TS 38.508-1 [4], clause 4.4A.2 Table 4.4A.2-1.

8.1.5.11.1.3.2 Test procedure sequence

Table 8.1.5.11.1.3.2-1: Main behaviour

St	Procedure	Message Sequence		TP	Verdict
		U - S	Message		
1	The SS transmits <i>RRCRelease</i> message including <i>measIdleConfig</i> to the UE.	<-	NR RRC: <i>RRCRelease</i>	-	-
2	Wait for 5 s for UE to enter RRC_IDLE mode and to perform measurements.	-	-	-	-
3-10	Steps 1 to 8 of procedure described in TS 38.508-1 table 4.5.4.2-3: NR RRC_CONNECTED are performed.	-	-	-	-
11	The SS transmits <i>UEInformationRequest</i> message including <i>idleModeMeasurementReq</i> to the UE.	<-	NR RRC: <i>UEInformationRequest</i>	-	-
12	Check: Does the UE transmit <i>UEInformationResponse</i> including <i>measResultIdleNR</i> ?	->	NR RRC: <i>UEInformationResponse</i>	1	P
13	The SS removes <i>ssb-MeasConfig</i> in SIB11.	-	-	-	-
14	The SS transmits a Short message on PDCCH using P-RNTI indicating a <i>systemInfoModification</i> .	-	PDCCH (DCI 1_0): Short Message	-	-
15	Wait for 2.1* modification period to allow the new system information to take effect.	-	-	-	-
16	The SS transmits <i>RRCRelease</i> message including <i>measIdleConfig</i> to the UE.	<-	NR RRC: <i>RRCRelease</i>	-	-
17	Wait for 5 s for UE to enter RRC_IDLE mode and to perform measurements.	-	-	-	-
18-25	Steps 1 to 8 of procedure described in TS 38.508-1 table 4.5.4.2-3: NR RRC_CONNECTED are performed.	-	-	-	-
26	The SS transmits <i>UEInformationRequest</i> message including <i>idleModeMeasurementReq</i> to the UE.	<-	NR RRC: <i>UEInformationRequest</i>	-	-
27	Check: Does the UE transmit <i>UEInformationResponse</i> including <i>measResultIdleNR</i> ?	->	NR RRC: <i>UEInformationResponse</i>	2	P
28	The SS transmits <i>RRCRelease</i> message including <i>measIdleConfig</i> to the UE.	<-	NR RRC: <i>RRCRelease</i>	-	-
29	Wait for 11 s for UE to enter RRC_IDLE mode and to perform measurements.	-	-	-	-
30-37	Steps 1 to 8 of procedure described in TS 38.508-1 table 4.5.4.2-3: NR RRC_CONNECTED are performed.	-	-	-	-

38	The SS transmits <i>UEInformationRequest</i> message including <i>idleModeMeasurementReq</i> to the UE.	<-	NR RRC: <i>UEInformationRequest</i>	-	-
39	Check: Does the UE transmit <i>UEInformationResponse</i> including <i>measResultIdleNR</i> ?	->	NR RRC: <i>UEInformationResponse</i>	3	F
40	The SS removes <i>measIdleCarrierListNR</i> in SIB11.	-	-	-	-
41	The SS transmits a Short message on PDCCH using P-RNTI indicating a <i>systemInfoModification</i> .	-	PDCCH (DCI 1_0): Short Message	-	-
42	Wait for 2.1* modification period to allow the new system information to take effect.	-	-	-	-
43	The SS transmits <i>RRCRelease</i> message including <i>measIdleConfig</i> to the UE.	<-	NR RRC: <i>RRCRelease</i>	-	-
44	Wait for 5 s for UE to enter RRC_IDLE mode and to perform measurements.	-	-	-	-
45-52	Steps 1 to 8 of procedure described in TS 38.508-1 table 4.5.4.2-3: NR RRC_CONNECTED are performed.	-	-	-	-
53	The SS transmits <i>UEInformationRequest</i> message including <i>idleModeMeasurementReq</i> to the UE.	<-	NR RRC: <i>UEInformationRequest</i>	-	-
54	Check: Does the UE transmit <i>UEInformationResponse</i> including <i>measResultIdleNR</i> ?	->	NR RRC: <i>UEInformationResponse</i>	4	F

8.1.5.11.1.3.3 Specific message contents

TBD

8.1.5.11.2 Void

8.1.5.11.2 Idle/Inactive measurements / Idle mode / RRCRelease configuration / Measurement of NR cells

8.1.5.11.2.1 Test Purpose (TP)

(1)

```
with { UE in NR RRC_CONNECTED state }
ensure that {
  when { UE receives a RRCRelease message including measIdleConfig with ssb-MeasConfig }
  then { UE enters RRC_IDLE state, performs cell measurements and reports measurement results in RRC_CONNECTED state }
}
```

(2)

```
with { UE in NR RRC_CONNECTED state }
ensure that {
  when { UE receives a RRCRelease message including measIdleConfig, ssb-MeasConfig from SIB11 }
  then { UE enters RRC_IDLE state, performs cell measurements and reports measurement results }
}
```

(3)

```
with { UE in NR RRC_CONNECTED state }
ensure that {
  when { UE receives a RRCRelease message including measIdleConfig, ssb-MeasConfig parameters derived from SIB4 }
  then { UE enters RRC_IDLE state, performs cell measurements and reports measurement results }
}
```

(4)

```

with { UE in NR RRC_CONNECTED state }
ensure that {
  when { UE receives a RRCRelease message including measIdleConfig with ssb-MeasConfig, T331 expires }
  then { UE enters RRC_IDLE state, UE does not report measurement results in RRC_CONNECTED state after T331 expiration }
}

```

(5)

```

with { UE in NR RRC_CONNECTED state }
ensure that {
  when { UE receives a RRCRelease message including measIdleConfig without measIdleCarrierListNR }
  then { UE does not report measurement results }
}

```

8.1.5.11.2.2 Conformance requirements

References: The conformance requirements covered in the current TC is specified in: TS 38.331 clause 5.3.8.3, 5.7.8 and 5.7.10.3.

[TS 38.331, clause 5.3.8.3]

The UE shall:

- 1> if the *RRCRelease* includes the *measIdleConfig*:
 - 2> if T331 is running:
 - 3> stop timer T331;
 - 3> perform the actions as specified in 5.7.8.3;
 - 2> if the *measIdleConfig* is set to *setup*:
 - 3> store the received *measIdleDuration* in *VarMeasIdleConfig*;
 - 3> start timer T331 with the value set to *measIdleDuration*;

[TS 38.331, clause 5.7.8.1]

This procedure specifies the measurements to be performed and stored by a UE in RRC_IDLE and RRC_INACTIVE when it has an idle/inactive measurement configuration.

[TS 38.331, clause 5.7.8.1a]

The purpose of this procedure is to update the idle/inactive measurement configuration.

The UE initiates this procedure while T331 is running and one of the following conditions is met:

- 1> upon selecting a cell when entering RRC_IDLE or RRC-INACTIVE from RRC_CONNECTED or RRC_INACTIVE; or
- 1> upon update of system information (*SIB4*, or *SIB11*), e.g. due to intra-RAT cell (re)selection;

While in RRC_IDLE or RRC_INACTIVE, and T331 is running, the UE shall:

- 1> for each entry in the *measIdleCarrierListNR* within *VarMeasIdleConfig* that does not contain an *ssb-MeasConfig* received from the *RRCRelease* message:
 - 2> if there is an entry in *measIdleCarrierListNR* in *measIdleConfigSIB* of *SIB11* that has the same carrier frequency and subcarrier spacing as the entry in the *measIdleCarrierListNR* within *VarMeasIdleConfig* and that contains *ssb-MeasConfig*:
 - 3> delete the *ssb-MeasConfig* of the corresponding entry in the *measIdleCarrierListNR* within *VarMeasIdleConfig*;

- 3> store the SSB measurement configuration from *SIB11* into *nrofSS-BlocksToAverage*, *absThreshSS-BlocksConsolidation*, *smtc*, *ssb-ToMeasure*, *deriveSSB-IndexFromCell*, and *ss-RSSI-Measurement* within *ssb-MeasConfig* of the corresponding entry in the *measIdleCarrierListNR* within *VarMeasIdleConfig*;
- 2> else if there is an entry in *interFreqCarrierFreqList* of *SIB4* with the same carrier frequency and subcarrier spacing as the entry in *measIdleCarrierListNR* within *VarMeasIdleConfig*:
 - 3> delete the *ssb-MeasConfig* of the corresponding entry in the *measIdleCarrierListNR* within *VarMeasIdleConfig*;
 - 3> store the SSB measurement configuration from *SIB4* into *nrofSS-BlocksToAverage*, *absThreshSS-BlocksConsolidation*, *smtc*, *ssb-ToMeasure*, *deriveSSB-IndexFromCell*, and *ss-RSSI-Measurement* within *ssb-MeasConfig* of the corresponding entry in the *measIdleCarrierListNR* within *VarMeasIdleConfig*;
- 2> else:
 - 3> remove the *ssb-MeasConfig* of the corresponding entry in the *measIdleCarrierListNR* within *VarMeasIdleConfig*, if stored;
- 1> perform measurements according to 5.7.8.2a.

[TS 38.331, clause 5.7.8.2a]

When performing measurements on NR carriers according to this clause, the UE shall derive the cell quality as specified in 5.5.3.3 and consider the beam quality to be the value of the measurement results of the concerned beam, where each result is averaged as described in TS 38.215 [9].

While in RRC_IDLE or RRC_INACTIVE, and T331 is running, the UE shall:

- 1> perform the measurements in accordance with the following:
 - 2> if the *VarMeasIdleConfig* includes the *measIdleCarrierListNR* and the SIB1 contains *idleModeMeasurementsNR*:
 - 3> for each entry in *measIdleCarrierListNR* within *VarMeasIdleConfig* that contains *ssb-MeasConfig*:
 - 4> if UE supports carrier aggregation or NR-DC between serving carrier and the carrier frequency and subcarrier spacing indicated by *carrierFreq* and *ssbSubCarrierSpacing* within the corresponding entry:
 - 5> perform measurements in the carrier frequency and subcarrier spacing indicated by *carrierFreq* and *ssbSubCarrierSpacing* within the corresponding entry;
 - 5> if the *reportQuantities* is set to *rsrq*:
 - 6> consider RSRQ as the cell sorting quantity;
 - 5> else:
 - 6> consider RSRP as the cell sorting quantity;
 - 5> if the *measCellListNR* is included:
 - 6> consider cells identified by each entry within the *measCellListNR* to be applicable for idle/inactive measurement reporting;
 - 5> else:
 - 6> consider up to *maxCellMeasIdle* strongest identified cells, according to the sorting quantity, to be applicable for idle/inactive measurement reporting;
 - 5> for all cells applicable for idle/inactive measurement reporting, derive cell measurement results for the measurement quantities indicated by *reportQuantities*;
 - 5> store the derived cell measurement results as indicated by *reportQuantities* for cells applicable for idle/inactive measurement reporting within *measResultsPerCarrierListIdleNR* in the

measReportIdleNR in *VarMeasIdleReport* in decreasing order of the cell sorting quantity, i.e. the best cell is included first, as follows:

- 6> if *qualityThreshold* is configured:
 - 7> include the measurement results from the cells applicable for idle/inactive measurement reporting whose RSRP/RSRQ measurement results are above the value(s) provided in *qualityThreshold*;
- 6> else:
 - 7> include the measurement results from all cells applicable for idle/inactive measurement reporting;
- 5> if *beamMeasConfigIdle* is included in the associated entry in *measIdleCarrierListNR* and if UE supports *idleInactiveNR-MeasBeamReport* for the FR of the carrier frequency indicated by *carrierFreq* within the associated entry, for each cell in the measurement results:
 - 6> derive beam measurements based on SS/PBCH block for each measurement quantity indicated in *reportQuantityRS-Indexes*, as described in TS 38.215 [9];
 - 6> if the *reportQuantityRS-Indexes* is set to *rsrq*:
 - 7> consider RSRQ as the beam sorting quantity;
 - 6> else:
 - 7> consider RSRP as the beam sorting quantity;
 - 6> set *resultsSSB-Indexes* to include up to *maxNrofRS-IndexesToReport* SS/PBCH block indexes in order of decreasing beam sorting quantity as follows:
 - 7> include the index associated to the best beam for the sorting quantity and if *absThreshSS-BlocksConsolidation* is included, the remaining beams whose sorting quantity is above *absThreshSS-BlocksConsolidation*;
 - 6> if the *includeBeamMeasurements* is set to *true*:
 - 7> include the beam measurement results as indicated by *reportQuantityRS-Indexes*;
- 2> if, as a result of the procedure in this subclause, the UE performs measurements in one or more carrier frequency indicated by *measIdleCarrierListNR* or *measIdleCarrierListEUTRA*:
 - 3> store the cell measurement results for RSRP and RSRQ for the serving cell within *measResultServingCell* in the *measReportIdleNR* in *VarMeasIdleReport*.
 - 3> if the *VarMeasIdleConfig* includes the *measIdleCarrierListNR* and it contains an entry with *carrierFreq* set to the value of the serving frequency:
 - 4> if *beamMeasConfigIdle* is included in that entry, and if the UE supports *idleInactiveNR-MeasBeamReport* for the FR of the serving cell:
 - 5> derive beam measurements based on SS/PBCH block for each measurement quantity indicated in *reportQuantityRS-Indexes*, as described in TS 38.215 [9];
 - 5> if the *reportQuantityRS-Indexes* is set to *rsrq*:
 - 6> consider RSRQ as the beam sorting quantity;
 - 5> else:
 - 6> consider RSRP as the beam sorting quantity;
 - 5> set *resultsSSB-Indexes* to include up to *maxNrofRS-IndexesToReport* SS/PBCH block indexes in order of decreasing beam sorting quantity as follows:

6> include the index associated to the best beam for the sorting quantity and if *absThreshSS-BlocksConsolidation* is included in *SIB2* of serving cell, the remaining beams whose sorting quantity is above *absThreshSS-BlocksConsolidation*;

5> if the *includeBeamMeasurements* is set to true:

6> include the beam measurement results as indicated by *reportQuantityRS-Indexes*;

NOTE 1: How the UE performs idle/inactive measurements is up to UE implementation as long as the requirements in TS 38.133 [14] are met for measurement reporting.

NOTE 2: The UE is not required to perform idle/inactive measurements on a given carrier if the SSB configuration of that carrier provided via dedicated signalling is different from the SSB configuration broadcasted in the serving cell, if any.

NOTE 3: How the UE prioritizes which frequencies to measure or report (in case it is configured with more frequencies than it can measure or report) is left to UE implementation.

[TS 38.331, clause 5.7.8.3]

The UE shall:

1> if T331 expires or is stopped:

2> release the *VarMeasIdleConfig*.

NOTE: It is up to UE implementation whether to continue idle/inactive measurements according to SIB11 and SIB4 configurations or according to E-UTRA SIB5 and E-UTRA SIB24 configurations as specified in TS 36.331 [10] upon inter-RAT cell reselection to E-UTRA, after T331 has expired or stopped.

[TS 38.331, clause 5.7.10.3]

Upon receiving the *UEInformationRequest* message, the UE shall, only after successful security activation:

1> if the *idleModeMeasurementReq* is included in the *UEInformationRequest* and the UE has stored *VarMeasIdleReport* that contains measurement information concerning cells other than the PCell:

2> set the *measResultIdleNR* in the *UEInformationResponse* message to the value of *measReportIdleNR* in the *VarMeasIdleReport*, if available;

8.1.5.11.2.3 Test Description

8.1.5.11.2.3.1 Pre-test conditions

System Simulator:

- NR Cell 1
- NR Cell 3, suitable for inter-frequency measurements

UE:

- None.

Preamble:

- The UE is in 5GS state 3N-A according to TS 38.508-1 [4], clause 4.4A.2 Table 4.4A.2-1.

8.1.5.11.2.3.2 Test procedure sequence

Table 8.1.5.11.2.3.2-1: Main behaviour

St	Procedure	Message Sequence		TP	Verdict
		U - S	Message		

1	The SS transmits <i>RRCRelease</i> message with <i>measIdleConfig</i> to the UE.	<-	NR RRC: <i>RRCRelease</i>	-	-
2	Wait for 5 s for UE to enter RRC_IDLE mode and to perform measurements.	-	-	-	-
3-10	Steps 1 to 8 of procedure described in TS 38.508-1 table 4.5.4.2-3: NR RRC_CONNECTED are performed.	-	-	-	-
11	The SS transmits <i>UEInformationRequest</i> message including <i>idleModeMeasurementReq</i> to the UE.	<-	NR RRC: <i>UEInformationRequest</i>	-	-
12	Check: Does the UE transmit <i>UEInformationResponse</i> including <i>measResultIdleNR</i> ?	->	NR RRC: <i>UEInformationResponse</i>	1	P
13	The SS transmits <i>RRCRelease</i> message with <i>measIdleConfig</i> not including <i>ssb-MeasConfig</i> to the UE.	<-	NR RRC: <i>RRCRelease</i>	-	-
14	Wait for 5 s for UE to enter RRC_IDLE mode and to perform measurements.	-	-	-	-
15-22	Steps 1 to 8 of procedure described in TS 38.508-1 table 4.5.4.2-3: NR RRC_CONNECTED are performed.	-	-	-	-
23	The SS transmits <i>UEInformationRequest</i> message including <i>idleModeMeasurementReq</i> to the UE.	<-	NR RRC: <i>UEInformationRequest</i>	-	-
24	Check: Does the UE transmit <i>UEInformationResponse</i> including <i>measResultIdleNR</i> ?	->	NR RRC: <i>UEInformationResponse</i>	2	P
25	The SS removes <i>measIdleCarrierListNR</i> in SIB11.	-	-	-	-
26	The SS transmits a Short message on PDCCH using P-RNTI indicating a <i>systemInfoModification</i> .	-	PDCCH (DCI 1_0): Short Message	-	-
27	Wait for 2.1* modification period to allow the new system information to take effect.	-	-	-	-
28	The SS transmits <i>RRCRelease</i> message with <i>measIdleConfig</i> not including <i>ssb-MeasConfig</i> to the UE.	<-	NR RRC: <i>RRCRelease</i>	-	-
29	Wait for 5 s for UE to enter RRC_IDLE mode and to perform measurements.	-	-	-	-
30-37	Steps 1 to 8 of procedure described in TS 38.508-1 table 4.5.4.2-3: NR RRC_CONNECTED are performed.	-	-	-	-
38	The SS transmits <i>UEInformationRequest</i> message including <i>idleModeMeasurementReq</i> to the UE.	<-	NR RRC: <i>UEInformationRequest</i>	-	-
39	Check: Does the UE transmit <i>UEInformationResponse</i> including <i>measResultIdleNR</i> ?	->	NR RRC: <i>UEInformationResponse</i>	3	P
40	The SS transmits <i>RRCRelease</i> message including <i>measIdleConfig</i> to the UE.	<-	NR RRC: <i>RRCRelease</i>	-	-
41	Wait for 11 s for UE to enter RRC_IDLE mode and to perform measurements.	-	-	-	-
42-49	Steps 1 to 8 of procedure described in TS 38.508-1 table 4.5.4.2-3: NR RRC_CONNECTED are performed.	-	-	-	-
50	The SS transmits <i>UEInformationRequest</i> message including <i>idleModeMeasurementReq</i> to the UE.	<-	NR RRC: <i>UEInformationRequest</i>	-	-
51	Check: Does the UE transmit <i>UEInformationResponse</i> including <i>measResultIdleNR</i> ?	->	NR RRC: <i>UEInformationResponse</i>	4	F
52	The SS transmits <i>RRCRelease</i> message with <i>measIdleConfig</i> not including <i>measIdleCarrierListNR</i> to the UE.	<-	NR RRC: <i>RRCRelease</i>	-	-
53	Wait for 5 s for UE to enter RRC_IDLE mode and to perform measurements.	-	-	-	-

54-61	Steps 1 to 8 of procedure described in TS 38.508-1 table 4.5.4.2-3: NR RRC_CONNECTED are performed.	-	-	-	-
62	The SS transmits <i>UEInformationRequest</i> message including <i>idleModeMeasurementReq</i> to the UE.	<-	NR RRC: <i>UEInformationRequest</i>	-	-
63	Check: Does the UE transmit <i>UEInformationResponse</i> including <i>measResultIdleNR</i> ?	->	NR RRC: <i>UEInformationResponse</i>	5	F

8.1.5.11.2.3.3 Specific message contents

TBD

8.1.5.11.3 Idle/Inactive measurements / Inactive mode / SIB11 configuration / Measurement of NR cells

8.1.5.11.3.1 Test Purpose (TP)

(1)

```
with { UE in NR RRC_CONNECTED state }
ensure that {
  when { UE receives a RRCRelease message including measIdleConfig and suspendConfig, SIB11
including measIdleCarrierListNR with ssb-MeasConfig }
  then { UE enters RRC_INACTIVE state, performs cell measurements and reports measurement results
in RRC_CONNECTED state }
}
```

(2)

```
with { UE in NR RRC_CONNECTED state }
ensure that {
  when { UE receives a RRCRelease message including measIdleConfig and suspendConfig, SIB11
including measIdleCarrierListNR without ssb-MeasConfig and ssb-MeasConfig parameters derived from
SIB4 }
  then { UE enters RRC_INACTIVE state, performs cell measurements and reports measurement results
in RRC_CONNECTED state }
}
```

(3)

```
with { UE in NR RRC_CONNECTED state }
ensure that {
  when { UE receives a RRCRelease message including measIdleConfig and suspendConfig, SIB11
including measIdleCarrierListNR without ssb-MeasConfig, ssb-MeasConfig parameters derived from SIB4
and T331 expires }
  then { UE enters RRC_INACTIVE state, UE does not report measurement results in RRC_CONNECTED
state after T331 expiration }
}
```

(4)

```
with { UE in NR RRC_CONNECTED state }
ensure that {
  when { UE receives a RRCRelease message including measIdleConfig and suspendConfig, SIB11 does not
include measIdleCarrierListNR }
  then { UE enters RRC_INACTIVE state, UE does not report measurement results in RRC_CONNECTED
state }
}
```

8.1.5.11.3.2 Conformance requirements

References: The conformance requirements covered in the current TC is specified in: TS 38.331 clause 5.3.8.3, 5.7.8 and 5.7.10.3. Unless otherwise stated, these are Rel-16 requirements.

[TS 38.331, clause 5.3.8.3]

- 1> if the *RRCRelease* includes the *measIdleConfig*:
 - 2> if T331 is running:
 - 3> stop timer T331;
 - 3> perform the actions as specified in 5.7.8.3;
 - 2> if the *measIdleConfig* is set to *setup*:
 - 3> store the received *measIdleDuration* in *VarMeasIdleConfig*;
 - 3> start timer T331 with the value set to *measIdleDuration*;
 - 3> if the *measIdleConfig* contains *measIdleCarrierListNR*:
 - 4> store the received *measIdleCarrierListNR* in *VarMeasIdleConfig*;

[TS 38.331, clause 5.7.8.1a]

While in RRC_IDLE or RRC_INACTIVE, and T331 is running, the UE shall:

- 1> if *VarMeasIdleConfig* includes neither a *measIdleCarrierListEUTRA* nor a *measIdleCarrierListNR* received from the *RRCRelease* message:
 - 2> if the UE supports *idleInactiveNR-MeasReport*:
 - 3> if *SIB11* includes the *measIdleConfigSIB* and contains *measIdleCarrierListNR*:
 - 4> store or replace the *measIdleCarrierListNR* of *measIdleConfigSIB* of *SIB11* within *VarMeasIdleConfig*;
 - 3> else:
 - 4> remove the *measIdleCarrierListNR* in *VarMeasIdleConfig*, if stored;
- 1> for each entry in the *measIdleCarrierListNR* within *VarMeasIdleConfig* that does not contain an *ssb-MeasConfig* received from the *RRCRelease* message:
 - 2> if there is an entry in *measIdleCarrierListNR* in *measIdleConfigSIB* of *SIB11* that has the same carrier frequency and subcarrier spacing as the entry in the *measIdleCarrierListNR* within *VarMeasIdleConfig* and that contains *ssb-MeasConfig*:
 - 3> delete the *ssb-MeasConfig* of the corresponding entry in the *measIdleCarrierListNR* within *VarMeasIdleConfig*;
 - 3> store the SSB measurement configuration from *SIB11* into *nrofSS-BlocksToAverage*, *absThreshSS-BlocksConsolidation*, *smtc*, *ssb-ToMeasure*, *deriveSSB-IndexFromCell*, and *ss-RSSI-Measurement* within *ssb-MeasConfig* of the corresponding entry in the *measIdleCarrierListNR* within *VarMeasIdleConfig*;
 - 2> else if there is an entry in *interFreqCarrierFreqList* of *SIB4* with the same carrier frequency and subcarrier spacing as the entry in *measIdleCarrierListNR* within *VarMeasIdleConfig*:
 - 3> delete the *ssb-MeasConfig* of the corresponding entry in the *measIdleCarrierListNR* within *VarMeasIdleConfig*;
 - 3> store the SSB measurement configuration from *SIB4* into *nrofSS-BlocksToAverage*, *absThreshSS-BlocksConsolidation*, *smtc*, *ssb-ToMeasure*, *deriveSSB-IndexFromCell*, and *ss-RSSI-Measurement* within *ssb-MeasConfig* of the corresponding entry in the *measIdleCarrierListNR* within *VarMeasIdleConfig*;
 - 2> else:
 - 3> remove the *ssb-MeasConfig* of the corresponding entry in the *measIdleCarrierListNR* within *VarMeasIdleConfig*, if stored;
- 1> perform measurements according to 5.7.8.2a.

[TS 38.331, clause 5.7.8.2a]

While in RRC_IDLE or RRC_INACTIVE, and T331 is running, the UE shall:

- 1> perform the measurements in accordance with the following:
 - 2> if the *VarMeasIdleConfig* includes the *measIdleCarrierListNR* and the SIB1 contains *idleModeMeasurementsNR*:
 - 3> for each entry in *measIdleCarrierListNR* within *VarMeasIdleConfig* that contains *ssb-MeasConfig*:
 - 4> if UE supports carrier aggregation or NR-DC between serving carrier and the carrier frequency and subcarrier spacing indicated by *carrierFreq* and *ssbSubCarrierSpacing* within the corresponding entry:
 - 5> perform measurements in the carrier frequency and subcarrier spacing indicated by *carrierFreq* and *ssbSubCarrierSpacing* within the corresponding entry;
 - 5> if the *reportQuantities* is set to *rsrq*:
 - 6> consider RSRQ as the cell sorting quantity;
 - 5> else:
 - 6> consider RSRP as the cell sorting quantity;
 - 5> if the *measCellListNR* is included:
 - 6> consider cells identified by each entry within the *measCellListNR* to be applicable for idle/inactive measurement reporting;
 - 5> else:
 - 6> consider up to *maxCellMeasIdle* strongest identified cells, according to the sorting quantity, to be applicable for idle/inactive measurement reporting;
 - 5> for all cells applicable for idle/inactive measurement reporting, derive cell measurement results for the measurement quantities indicated by *reportQuantities*;
 - 5> store the derived cell measurement results as indicated by *reportQuantities* for cells applicable for idle/inactive measurement reporting within *measResultsPerCarrierListIdleNR* in the *measReportIdleNR* in *VarMeasIdleReport* in decreasing order of the cell sorting quantity, i.e. the best cell is included first, as follows:
 - 6> if *qualityThreshold* is configured:
 - 7> include the measurement results from the cells applicable for idle/inactive measurement reporting whose RSRP/RSRQ measurement results are above the value(s) provided in *qualityThreshold*;
 - 6> else:
 - 7> include the measurement results from all cells applicable for idle/inactive measurement reporting;
- 2> if, as a result of the procedure in this subclause, the UE performs measurements in one or more carrier frequency indicated by *measIdleCarrierListNR* or *measIdleCarrierListEUTRA*:
 - 3> store the cell measurement results for RSRP and RSRQ for the serving cell within *measResultServingCell* in the *measReportIdleNR* in *VarMeasIdleReport*.

NOTE 1: How the UE performs idle/inactive measurements is up to UE implementation as long as the requirements in TS 38.133 [14] are met for measurement reporting.

NOTE 2: The UE is not required to perform idle/inactive measurements on a given carrier if the SSB configuration of that carrier provided via dedicated signalling is different from the SSB configuration broadcasted in the serving cell, if any.

NOTE 3: How the UE prioritizes which frequencies to measure or report (in case it is configured with more frequencies than it can measure or report) is left to UE implementation.

[TS 38.331, clause 5.7.8.3]

1> if T331 expires or is stopped:

2> release the *VarMeasIdleConfig*.

NOTE: It is up to UE implementation whether to continue idle/inactive measurements according to SIB11 and SIB4 configurations or according to E-UTRA SIB5 and E-UTRA SIB24 configurations as specified in TS 36.331 [10] upon inter-RAT cell reselection to E-UTRA, after T331 has expired or stopped.

[TS 38.331, clause 5.7.10.3]

Upon receiving the *UEInformationRequest* message, the UE shall, only after successful security activation:

1> if the *idleModeMeasurementReq* is included in the *UEInformationRequest* and the UE has stored *VarMeasIdleReport* that contains measurement information concerning cells other than the PCell:

2> set the *measResultIdleNR* in the *UEInformationResponse* message to the value of *measReportIdleNR* in the *VarMeasIdleReport*, if available;

2> discard the *VarMeasIdleReport* upon successful delivery of the *UEInformationResponse* message confirmed by lower layers;

8.1.5.11.3.3 Test Description

8.1.5.11.3.3.1 Pre-test conditions

System Simulator:

- NR Cell 1, serving cell. System information combination NR-7 defined in TS 38.508-1 [4] clause 4.4.3.1.2 together with SIB11 defined in specific message contents
- NR Cell 3, suitable for inter-frequency measurements. System information combination NR-4 defined in TS 38.508-1 [4] clause 4.4.3.1.2.

UE:

- None.

Preamble:

- The UE is in 5GS state 3N-A according to TS 38.508-1 [4], clause 4.4A.2 Table 4.4A.2-1.

8.1.5.11.3.3.2 Test procedure sequence

Table 8.1.5.11.3.3.2-1: Main behaviour

St	Procedure	Message Sequence		TP	Verdict
		U - S	Message		
1	The SS transmits <i>RRCRelease</i> message including <i>measIdleConfig</i> and <i>suspendConfig</i> to the UE.	<--	NR RRC: <i>RRCRelease</i>	-	-
2	Wait for 15 s for UE to enter RRC_INACTIVE mode and to perform measurements.	-	-	-	-
3	SS transmits <i>Paging</i> message to UE.	<--	NR RRC: <i>Paging</i>	-	-
4	UE transmits <i>RRCResumeRequest</i> message to SS.	-->	NR RRC: <i>RRCResumeRequest</i>	-	-
5	SS transmits <i>RRCResume</i> message to UE.	<--	NR RRC: <i>RRCResume</i>	-	-
6	UE transmits <i>RRCResumeComplete</i> message to SS.		NR RRC: <i>RRCResumeComplete</i>	-	-

7	The SS transmits <i>UEInformationRequest</i> message including <i>idleModeMeasurementReq</i> to the UE.	<--	NR RRC: <i>UEInformationRequest</i>	-	-
8	Check: Does the UE transmit <i>UEInformationResponse</i> including <i>measResultIdleNR</i> ?	-->	NR RRC: <i>UEInformationResponse</i>	1	P
9	The SS removes <i>ssb-MeasConfig</i> in SIB11.	-	-	-	-
10	The SS transmits a Short message on PDCCH using P-RNTI indicating a <i>systemInfoModification</i> .	<--	PDCCH (DCI 1_0): Short Message	-	-
11	Wait for 2.1* modification period to allow the new system information to take effect.	-	-	-	-
12	The SS transmits <i>RRCRelease</i> message including <i>measIdleConfig</i> and <i>suspendConfig</i> to the UE.	<--	NR RRC: <i>RRCRelease</i>	-	-
13	Wait for 15 s for UE to enter RRC_INACTIVE mode and to perform measurements.	-	-	-	-
14	SS transmits <i>Paging</i> message to UE.	<--	NR RRC: <i>Paging</i>	-	-
15	UE transmits <i>RRCResumeRequest</i> message to SS.	-->	NR RRC: <i>RRCResumeRequest</i>	-	-
16	SS transmits <i>RRCResume</i> message to UE.	<--	NR RRC: <i>RRCResume</i>	-	-
17	UE transmits <i>RRCResumeComplete</i> message to SS.		NR RRC: <i>RRCResumeComplete</i>	-	-
18	The SS transmits <i>UEInformationRequest</i> message including <i>idleModeMeasurementReq</i> to the UE.	<--	NR RRC: <i>UEInformationRequest</i>	-	-
19	Check: Does the UE transmit <i>UEInformationResponse</i> including <i>measResultIdleNR</i> ?	-->	NR RRC: <i>UEInformationResponse</i>	2	P
20	The SS transmits <i>RRCRelease</i> message including <i>measIdleConfig</i> and <i>suspendConfig</i> to the UE.	<-	NR RRC: <i>RRCRelease</i>	-	-
21	Wait for 15 s for UE to enter RRC_INACTIVE mode and to perform measurements.	-	-	-	-
22	SS transmits <i>Paging</i> message to UE.	<--	NR RRC: <i>Paging</i>	-	-
23	UE transmits <i>RRCResumeRequest</i> message to SS.	-->	NR RRC: <i>RRCResumeRequest</i>	-	-
24	SS transmits <i>RRCResume</i> message to UE.	<--	NR RRC: <i>RRCResume</i>	-	-
25	UE transmits <i>RRCResumeComplete</i> message to SS.		NR RRC: <i>RRCResumeComplete</i>	-	-
26	The SS transmits <i>UEInformationRequest</i> message including <i>idleModeMeasurementReq</i> to the UE.	<-	NR RRC: <i>UEInformationRequest</i>	-	-
27	Check: Does the UE transmit <i>UEInformationResponse</i> without <i>measResultIdleNR</i> ?	-->	NR RRC: <i>UEInformationResponse</i>	3	P
28	The SS removes <i>measIdleCarrierListNR</i> in SIB11.	-	-	-	-
29	The SS transmits a Short message on PDCCH using P-RNTI indicating a <i>systemInfoModification</i> .	<--	PDCCH (DCI 1_0): Short Message	-	-
30	Wait for 2.1* modification period to allow the new system information to take effect.	-	-	-	-
31	The SS transmits <i>RRCRelease</i> message including <i>measIdleConfig</i> and <i>suspendConfig</i> to the UE.	<--	NR RRC: <i>RRCRelease</i>	-	-
32	Wait for 15 s for UE to enter RRC_INACTIVE mode and to perform measurements.	-	-	-	-
33	SS transmits <i>Paging</i> message to UE.	<--	NR RRC: <i>Paging</i>	-	-
34	UE transmits <i>RRCResumeRequest</i> message to SS.	-->	NR RRC: <i>RRCResumeRequest</i>	-	-
35	SS transmits <i>RRCResume</i> message to UE.	<--	NR RRC: <i>RRCResume</i>	-	-
36	UE transmits <i>RRCResumeComplete</i> message to SS.		NR RRC: <i>RRCResumeComplete</i>	-	-
37	The SS transmits <i>UEInformationRequest</i> message including <i>idleModeMeasurementReq</i> to the UE.	<--	NR RRC: <i>UEInformationRequest</i>	-	-

38	Check: Does the UE transmit <i>UEInformationResponse</i> without <i>measResultIdleNR</i> ?	-->	NR RRC: <i>UEInformationResponse</i>	4	P
----	--	-----	--------------------------------------	---	---

8.1.5.11.3.3.3 Specific message contents

Table 8.1.5.11.3.3.3-1: RRCRelease (steps 1, 13 and 28, Table 8.1.5.11.3.3.2-1)

Derivation Path: TS 38.508-1 [4] Table 4.6.1-16			
Information Element	Value/remark	Comment	Condition
RRCRelease ::= SEQUENCE {			
rrc-TransactionIdentifier	RRC-TransactionIdentifier		
criticalExtensions CHOICE {			
rrcRelease SEQUENCE {			
suspendConfig	SuspendConfig		
nonCriticalExtensions SEQUENCE {			
nonCriticalExtensions SEQUENCE {			
measIdleConfig-r16 SetupRelease {			
setup	MeasIdleConfigDedicated-r16		
}			
}			
}			

Table 8.1.5.11.3.3.3-2: SuspendConfig (Table 8.1.5.11.3.3.3-1)

Derivation Path: TS 38.331 [12] Chapter 6.2.2 Message definitions - RRCRelease			
Information Element	Value/remark	Comment	Condition
SuspendConfig ::= SEQUENCE {			
fullI-RNTI	I-RNTI-Value	38.508-1[4] Table 4.6.3-64	
shortI-RNTI	ShortI-RNTI-Value	38.508-1[4] Table 4.6.3-170	
ran-PagingCycle	rf32		
ran-NotificationAreaInfo CHOICE {			
cellList SEQUENCE (SIZE (1..maxPLMNIdentities)) OF PLMN-RAN-AreaCell {	2 entries		
PLMN-RAN-AreaCellList[1] SEQUENCE {		entry 1	
plmn-Identity	PLMN1		
ran-AreaCells SEQUENCE (SIZE (1..32)) OF CellIdentity {	1 entry		
CellIdentity[1]	CellIdentity of NR Cell 1	entry 1	
}			
}			
PLMN-RAN-AreaCellList[2] SEQUENCE {		entry 2	
plmn-Identity	PLMN2		
ran-AreaCells SEQUENCE (SIZE (1..32)) OF CellIdentity {	1 entry		
CellIdentity[1]	CellIdentity of NR Cell 3	entry 1	
}			
}			
}			
}			
t380	Not present		
nextHopChainingCount	NextHopChainingCount	38.508-1[4] Table 4.6.3-83	
}			

Table 8.1.5.11.3.3.3-3: MeasIdleConfigDedicated (Table 8.1.5.11.3.3.3-1)

Derivation Path: TS 38.331 [12] Chapter 6.3.2 Radio resource control information elements - MeasIdleConfig			
--	--	--	--

Information Element	Value/remark	Comment	Condition
MeasIdleConfigDedicated-r16 ::= SEQUENCE {			
measIdleCarrierListNR-r16	Not present		
measIdleCarrierListEUTRA-r16	Not present		
measIdleDuration-r16	sec120		
validityAreaList-r16	Not present		
}			

Table 8.1.5.11.3.3.3-4: RRCResumeRequest (Table 8.1.5.11.3.3.2-1)

Derivation Path: TS 38.508 [4], clause 4.6.1 table 4.6.1-19

Table 8.1.5.11.3.3.3-5: RRCResume (Table 8.1.5.11.3.3.2-1)

Derivation Path: TS 38.508 [4], clause 4.6.1 table 4.6.1-17

Table 8.1.5.11.3.3.3-6: RRCResumeComplete (Table 8.1.5.11.3.3.2-1)

Derivation Path: TS 38.508 [4], clause 4.6.1 table 4.6.1-18

Table 8.1.5.11.3.3.3-7: SIB11 (Table 8.1.5.11.3.3.2-1, steps 1 to 12)

Derivation Path: TS 38.331 [12Z] Chapter 6.3.1 System information blocks – SIB11			
Information Element	Value/remark	Comment	Condition
SIB11-r16 ::= SEQUENCE {			
measIdleConfigSIB-r16 SEQUENCE {			
measIdleCarrierListNR-r16 SEQUENCE (SIZE (1..maxFreqIdle-r16)) OF MeasIdleCarrierNR-r16 {	1 entry		
MeasIdleCarrierNR-r16 SEQUENCE {			
carrierFreq-r16	ARFCN value corresponding NR cell 3		
ssbSubcarrierSpacing-r16	kHz15		
frequencyBandList	Not present		
measCellListNR-r16			
reportQuantities-r16	both		
qualityThreshold-r16	Not present		
ssb-MeasConfig-r16 SEQUENCE {			
nrofSS-BlocksToAverage-r16	2		
absThreshSS-BlocksConsolidation-r16 SEQUENCE {			
thresholdRSRP	RSRP-Range	38.508-1[4] Table 4.6.3-152	
thresholdRSRQ	Not present		
thresholdSINR	Not present		
}			
smtc-r16	SSB-MTC	38.508-1[4] Table 4.6.3-185	
ssb-ToMeasure-r16	SSB-ToMeasure	38.508-1[4] Table 4.6.3-187	
deriveSSB-IndexFromCell-r16	false true		FR1_TDD, FR2_TDD
ss-RSSI-Measurement-r16	Not present		
}			
measIdleCarrierListEUTRA-r16	Not present		
}			
}			

Table 8.1.5.11.3.3.3-8: SIB11 (Table 8.1.5.11.3.3.2-1, steps 13 to 39)

Derivation Path: TS 38.331 [XYZ] Chapter 6.3.1 System information blocks – SIB11			
Information Element	Value/remark	Comment	Condition
SIB11-r16 ::= SEQUENCE {			
measIdleConfigSIB-r16 SEQUENCE {			
measIdleCarrierListNR-r16 SEQUENCE (SIZE (1..maxFreqIdle-r16)) OF MeasIdleCarrierNR-r16 {	1 entry		
MeasIdleCarrierNR-r16 SEQUENCE {			
carrierFreq-r16	ARFCN value corresponding NR cell 3		
ssbSubcarrierSpacing-r16	kHz15		
frequencyBandList	Not present		
measCellListNR-r16			
reportQuantities-r16	both		
qualityThreshold-r16	Not present		
ssb-MeasConfig-r16	Not present		
measIdleCarrierListEUTRA-r16	Not present		
}			
}			
}			
}			

Table 8.1.5.11.3.3.3-9: SIB11 (Table 8.1.5.11.3.3.2-1, steps 25 to 39)

Derivation Path: TS 38.331 [XYZ] Chapter 6.3.1 System information blocks – SIB11			
Information Element	Value/remark	Comment	Condition
SIB11-r16 ::= SEQUENCE {			
measIdleConfigSIB-r16 SEQUENCE {			
measIdleCarrierListNR-r16	Not present		
measIdleCarrierListEUTRA-r16	Not present		
}			
}			

Table 8.1.5.11.3.3.3-10: UEInformationRequest (Table 8.1.5.11.3.3.2-1)

Derivation Path: TS 38.508-1 [4], clause 4.6.1 table 4.6.1-32A with condition IDLE
--

Table 8.1.5.11.3.3.3-11: UEInformationResponse (Table 8.1.5.11.3.3.2-1)

Derivation Path: TS 38.508-1 [4], clause 4.6.1 table 4.6.1-32B			
Information Element	Value/remark	Comment	Condition
UEInformationResponse-r16 ::= SEQUENCE {			
criticalExtensions CHOICE {			
ueInformationResponse-r16 SEQUENCE {			
measResultIdleNR-r16 SEQUENCE {			
measResultServingCell-r16 SEQUENCE {			
rsrp-Result-r16	INTEGER (0..127)		
rsrq-Result-r16	INTEGER (0..127)		
resultsSSB-Indexes-r16 SEQUENCE {			
ssb-Index-r16	INTEGER (0..maxNrofSSBs-1)		
ssb-Results-r16 SEQUENCE {			
ssb-RSRP-Result-r16	INTEGER (0..127)		
ssb-RSRQ-Result-r16	INTEGER (0..127)		
}			
}			
}			
}			
measResultsPerCarrierListIdleNR-r16 SEQUENCE (SIZE (1.. maxFreqIdle-r16)) OF MeasResultsPerCarrierIdleNR-r16	1 entry		
MeasResultsPerCarrierIdleNR-r16[1] SEQUENCE {		entry 1	

(4)

```

with { UE in NR RRC_CONNECTED state }
ensure that {
  when { UE receives a RRCRelease message including measIdleConfig with ssb-MeasConfig and
suspendConfig, T331 expires }
  then { UE enters RRC_INACTIVE state, UE does not report measurement results in RRC_CONNECTED
state after T331 expiration }
}

```

(5)

```

with { UE in NR RRC_CONNECTED state }
ensure that {
  when { UE receives a RRCRelease message including measIdleConfig and suspendConfig without
measIdleCarrierListNR }
  then { UE does not report measurement results }
}

```

8.1.5.11.4.2 Conformance requirements

References: The conformance requirements covered in the current TC is specified in: TS 38.331 clause 5.3.8.3, 5.7.8 and 5.7.10.3. Unless otherwise stated, these are Rel-16 requirements.

[TS 38.331, clause 5.3.8.3]

The UE shall:

- 1> if the *RRCRelease* includes the *measIdleConfig*:
 - 2> if T331 is running:
 - 3> stop timer T331;
 - 3> perform the actions as specified in 5.7.8.3;
 - 2> if the *measIdleConfig* is set to *setup*:
 - 3> store the received *measIdleDuration* in *VarMeasIdleConfig*;
 - 3> start timer T331 with the value set to *measIdleDuration*;

[TS 38.331, clause 5.7.8.1]

This procedure specifies the measurements to be performed and stored by a UE in RRC_IDLE and RRC_INACTIVE when it has an idle/inactive measurement configuration.

[TS 38.331, clause 5.7.8.1a]

The purpose of this procedure is to update the idle/inactive measurement configuration.

The UE initiates this procedure while T331 is running and one of the following conditions is met:

- 1> upon selecting a cell when entering RRC_IDLE or RRC-INACTIVE from RRC_CONNECTED or RRC_INACTIVE; or
- 1> upon update of system information (*SIB4*, or *SIB11*), e.g. due to intra-RAT cell (re)selection;

While in RRC_IDLE or RRC_INACTIVE, and T331 is running, the UE shall:

- 1> for each entry in the *measIdleCarrierListNR* within *VarMeasIdleConfig* that does not contain an *ssb-MeasConfig* received from the *RRCRelease* message:
 - 2> if there is an entry in *measIdleCarrierListNR* in *measIdleConfigSIB* of *SIB11* that has the same carrier frequency and subcarrier spacing as the entry in the *measIdleCarrierListNR* within *VarMeasIdleConfig* and that contains *ssb-MeasConfig*:

- 3> delete the *ssb-MeasConfig* of the corresponding entry in the *measIdleCarrierListNR* within *VarMeasIdleConfig*;
- 3> store the SSB measurement configuration from *SIB11* into *nrofSS-BlocksToAverage*, *absThreshSS-BlocksConsolidation*, *smtc*, *ssb-ToMeasure*, *deriveSSB-IndexFromCell*, and *ss-RSSI-Measurement* within *ssb-MeasConfig* of the corresponding entry in the *measIdleCarrierListNR* within *VarMeasIdleConfig*;
- 2> else if there is an entry in *interFreqCarrierFreqList* of *SIB4* with the same carrier frequency and subcarrier spacing as the entry in *measIdleCarrierListNR* within *VarMeasIdleConfig*:
 - 3> delete the *ssb-MeasConfig* of the corresponding entry in the *measIdleCarrierListNR* within *VarMeasIdleConfig*;
 - 3> store the SSB measurement configuration from *SIB4* into *nrofSS-BlocksToAverage*, *absThreshSS-BlocksConsolidation*, *smtc*, *ssb-ToMeasure*, *deriveSSB-IndexFromCell*, and *ss-RSSI-Measurement* within *ssb-MeasConfig* of the corresponding entry in the *measIdleCarrierListNR* within *VarMeasIdleConfig*;
- 2> else:
 - 3> remove the *ssb-MeasConfig* of the corresponding entry in the *measIdleCarrierListNR* within *VarMeasIdleConfig*, if stored;
- 1> perform measurements according to 5.7.8.2a.

[TS 38.331, clause 5.7.8.2a]

When performing measurements on NR carriers according to this clause, the UE shall derive the cell quality as specified in 5.5.3.3 and consider the beam quality to be the value of the measurement results of the concerned beam, where each result is averaged as described in TS 38.215 [9].

While in RRC_IDLE or RRC_INACTIVE, and T331 is running, the UE shall:

- 1> perform the measurements in accordance with the following:
 - 2> if the *VarMeasIdleConfig* includes the *measIdleCarrierListNR* and the SIB1 contains *idleModeMeasurementsNR*:
 - 3> for each entry in *measIdleCarrierListNR* within *VarMeasIdleConfig* that contains *ssb-MeasConfig*:
 - 4> if UE supports carrier aggregation or NR-DC between serving carrier and the carrier frequency and subcarrier spacing indicated by *carrierFreq* and *ssbSubCarrierSpacing* within the corresponding entry:
 - 5> perform measurements in the carrier frequency and subcarrier spacing indicated by *carrierFreq* and *ssbSubCarrierSpacing* within the corresponding entry;
 - 5> if the *reportQuantities* is set to *rsrq*:
 - 6> consider RSRQ as the cell sorting quantity;
 - 5> else:
 - 6> consider RSRP as the cell sorting quantity;
 - 5> if the *measCellListNR* is included:
 - 6> consider cells identified by each entry within the *measCellListNR* to be applicable for idle/inactive measurement reporting;
 - 5> else:
 - 6> consider up to *maxCellMeasIdle* strongest identified cells, according to the sorting quantity, to be applicable for idle/inactive measurement reporting;
 - 5> for all cells applicable for idle/inactive measurement reporting, derive cell measurement results for the measurement quantities indicated by *reportQuantities*;

- 5> store the derived cell measurement results as indicated by *reportQuantities* for cells applicable for idle/inactive measurement reporting within *measResultsPerCarrierListIdleNR* in the *measReportIdleNR* in *VarMeasIdleReport* in decreasing order of the cell sorting quantity, i.e. the best cell is included first, as follows:
 - 6> if *qualityThreshold* is configured:
 - 7> include the measurement results from the cells applicable for idle/inactive measurement reporting whose RSRP/RSRQ measurement results are above the value(s) provided in *qualityThreshold*;
 - 6> else:
 - 7> include the measurement results from all cells applicable for idle/inactive measurement reporting;
- 5> if *beamMeasConfigIdle* is included in the associated entry in *measIdleCarrierListNR* and if UE supports *idleInactiveNR-MeasBeamReport* for the FR of the carrier frequency indicated by *carrierFreq* within the associated entry, for each cell in the measurement results:
 - 6> derive beam measurements based on SS/PBCH block for each measurement quantity indicated in *reportQuantityRS-Indexes*, as described in TS 38.215 [9];
 - 6> if the *reportQuantityRS-Indexes* is set to *rsrq*:
 - 7> consider RSRQ as the beam sorting quantity;
 - 6> else:
 - 7> consider RSRP as the beam sorting quantity;
 - 6> set *resultsSSB-Indexes* to include up to *maxNrofRS-IndexesToReport* SS/PBCH block indexes in order of decreasing beam sorting quantity as follows:
 - 7> include the index associated to the best beam for the sorting quantity and if *absThreshSS-BlocksConsolidation* is included, the remaining beams whose sorting quantity is above *absThreshSS-BlocksConsolidation*;
 - 6> if the *includeBeamMeasurements* is set to *true*:
 - 7> include the beam measurement results as indicated by *reportQuantityRS-Indexes*;
- 2> if, as a result of the procedure in this subclause, the UE performs measurements in one or more carrier frequency indicated by *measIdleCarrierListNR* or *measIdleCarrierListEUTRA*:
 - 3> store the cell measurement results for RSRP and RSRQ for the serving cell within *measResultServingCell* in the *measReportIdleNR* in *VarMeasIdleReport*.
 - 3> if the *VarMeasIdleConfig* includes the *measIdleCarrierListNR* and it contains an entry with *carrierFreq* set to the value of the serving frequency:
 - 4> if *beamMeasConfigIdle* is included in that entry, and if the UE supports *idleInactiveNR-MeasBeamReport* for the FR of the serving cell:
 - 5> derive beam measurements based on SS/PBCH block for each measurement quantity indicated in *reportQuantityRS-Indexes*, as described in TS 38.215 [9];
 - 5> if the *reportQuantityRS-Indexes* is set to *rsrq*:
 - 6> consider RSRQ as the beam sorting quantity;
 - 5> else:
 - 6> consider RSRP as the beam sorting quantity;
 - 5> set *resultsSSB-Indexes* to include up to *maxNrofRS-IndexesToReport* SS/PBCH block indexes in order of decreasing beam sorting quantity as follows:

6> include the index associated to the best beam for the sorting quantity and if *absThreshSS-BlocksConsolidation* is included in *SIB2* of serving cell, the remaining beams whose sorting quantity is above *absThreshSS-BlocksConsolidation*;

5> if the *includeBeamMeasurements* is set to true:

6> include the beam measurement results as indicated by *reportQuantityRS-Indexes*;

NOTE 1: How the UE performs idle/inactive measurements is up to UE implementation as long as the requirements in TS 38.133 [14] are met for measurement reporting.

NOTE 2: The UE is not required to perform idle/inactive measurements on a given carrier if the SSB configuration of that carrier provided via dedicated signalling is different from the SSB configuration broadcasted in the serving cell, if any.

NOTE 3: How the UE prioritizes which frequencies to measure or report (in case it is configured with more frequencies than it can measure or report) is left to UE implementation.

[TS 38.331, clause 5.7.8.3]

The UE shall:

1> if T331 expires or is stopped:

2> release the *VarMeasIdleConfig*.

NOTE: It is up to UE implementation whether to continue idle/inactive measurements according to SIB11 and SIB4 configurations or according to E-UTRA SIB5 and E-UTRA SIB24 configurations as specified in TS 36.331 [10] upon inter-RAT cell reselection to E-UTRA, after T331 has expired or stopped.

[TS 38.331, clause 5.7.10.3]

Upon receiving the *UEInformationRequest* message, the UE shall, only after successful security activation:

1> if the *idleModeMeasurementReq* is included in the *UEInformationRequest* and the UE has stored *VarMeasIdleReport* that contains measurement information concerning cells other than the PCell:

2> set the *measResultIdleNR* in the *UEInformationResponse* message to the value of *measReportIdleNR* in the *VarMeasIdleReport*, if available;

2> discard the *VarMeasIdleReport* upon successful delivery of the *UEInformationResponse* message confirmed by lower layers;

8.1.5.11.4.3 Test Description

8.1.5.11.4.3.1 Pre-test conditions

System Simulator:

- NR Cell 1, serving cell. System information combination NR-7 defined in TS 38.508-1 [4] clause 4.4.3.1.2.
- NR Cell 3, suitable for inter-frequency measurements. System information combination NR-4 defined in TS 38.508-1 [4] clause 4.4.3.1.2.

UE:

- None.

Preamble:

- The UE is in 5GS state 3N-A according to TS 38.508-1 [4], clause 4.4A.2 Table 4.4A.2-1.

8.1.5.11.4.3.2 Test procedure sequence

Table 8.1.5.11.4.3.2-1: Main behaviour

St	Procedure	Message Sequence		TP	Verdict
		U - S	Message		
1	The SS transmits <i>RRCRelease</i> message with <i>measIdleConfig</i> and <i>suspendConfig</i> to the UE.	<-	NR RRC: <i>RRCRelease</i>	-	-
2	Wait for 5 s for UE to enter RRC_INACTIVE mode and to perform measurements.	-	-	-	-
3	SS transmits <i>Paging</i> message to UE.	<--	NR RRC: <i>Paging</i>	-	-
4	UE transmits <i>RRCResumeRequest</i> message to SS.	-->	NR RRC: <i>RRCResumeRequest</i>	-	-
5	SS transmits <i>RRCResume</i> message to UE.	<--	NR RRC: <i>RRCResume</i>	-	-
6	UE transmits <i>RRCResumeComplete</i> message to SS.		NR RRC: <i>RRCResumeComplete</i>	-	-
7	The SS transmits <i>UEInformationRequest</i> message including <i>idleModeMeasurementReq</i> to the UE.	<-	NR RRC: <i>UEInformationRequest</i>	-	-
8	Check: Does the UE transmit <i>UEInformationResponse</i> including <i>measResultIdleNR</i> ?	->	NR RRC: <i>UEInformationResponse</i>	1	P
9	The SS transmits <i>RRCRelease</i> message with <i>measIdleConfig</i> and <i>suspendConfig</i> not including <i>ssb-MeasConfig</i> to the UE.	<-	NR RRC: <i>RRCRelease</i>	-	-
10	Wait for 15 s for UE to enter RRC_INACTIVE mode and to perform measurements.	-	-	-	-
11	SS transmits <i>Paging</i> message to UE.	<--	NR RRC: <i>Paging</i>	-	-
12	UE transmits <i>RRCResumeRequest</i> message to SS.	-->	NR RRC: <i>RRCResumeRequest</i>	-	-
13	SS transmits <i>RRCResume</i> message to UE.	<--	NR RRC: <i>RRCResume</i>	-	-
14	UE transmits <i>RRCResumeComplete</i> message to SS.		NR RRC: <i>RRCResumeComplete</i>	-	-
15	The SS transmits <i>UEInformationRequest</i> message including <i>idleModeMeasurementReq</i> to the UE.	<-	NR RRC: <i>UEInformationRequest</i>	-	-
16	Check: Does the UE transmit <i>UEInformationResponse</i> including <i>measResultIdleNR</i> ?	->	NR RRC: <i>UEInformationResponse</i>	2	P
17	The SS removes <i>measIdleCarrierListNR</i> in SIB11.	-	-	-	-
18	The SS transmits a Short message on PDCCH using P-RNTI indicating a <i>systemInfoModification</i> .	-	PDCCH (DCI 1_0): Short Message	-	-
19	Wait for 2.1* modification period to allow the new system information to take effect.	-	-	-	-
20	The SS transmits <i>RRCRelease</i> message with <i>measIdleConfig</i> and <i>suspendConfig</i> not including <i>ssb-MeasConfig</i> to the UE.	<-	NR RRC: <i>RRCRelease</i>	-	-
21	Wait for 15 s for UE to enter RRC_INACTIVE mode and to perform measurements.	-	-	-	-
22	SS transmits <i>Paging</i> message to UE.	<--	NR RRC: <i>Paging</i>	-	-
23	UE transmits <i>RRCResumeRequest</i> message to SS.	-->	NR RRC: <i>RRCResumeRequest</i>	-	-
24	SS transmits <i>RRCResume</i> message to UE.	<--	NR RRC: <i>RRCResume</i>	-	-
25	UE transmits <i>RRCResumeComplete</i> message to SS.		NR RRC: <i>RRCResumeComplete</i>	-	-
26	The SS transmits <i>UEInformationRequest</i> message including <i>idleModeMeasurementReq</i> to the UE.	<-	NR RRC: <i>UEInformationRequest</i>	-	-
27	Check: Does the UE transmit <i>UEInformationResponse</i> including <i>measResultIdleNR</i> ?	->	NR RRC: <i>UEInformationResponse</i>	3	P
28	The SS transmits <i>RRCRelease</i> message including <i>measIdleConfig</i> and <i>suspendConfig</i> to the UE.	<-	NR RRC: <i>RRCRelease</i>	-	-

29	Wait for 11 s for UE to enter RRC_INACTIVE mode and to perform measurements.	-	-	-	-
30	SS transmits <i>Paging</i> message to UE.	<--	NR RRC: <i>Paging</i>	-	-
31	UE transmits <i>RRCResumeRequest</i> message to SS.	-->	NR RRC: <i>RRCResumeRequest</i>	-	-
32	SS transmits <i>RRCResume</i> message to UE.	<--	NR RRC: <i>RRCResume</i>	-	-
33	UE transmits <i>RRCResumeComplete</i> message to SS.		NR RRC: <i>RRCResumeComplete</i>	-	-
34	The SS transmits <i>UEInformationRequest</i> message including <i>idleModeMeasurementReq</i> to the UE.	<-	NR RRC: <i>UEInformationRequest</i>	-	-
35	Check: Does the UE transmit <i>UEInformationResponse</i> without <i>measResultIdleNR</i> ?	->	NR RRC: <i>UEInformationResponse</i>	4	P
36	The SS transmits <i>RRCRelease</i> message with <i>measIdleConfig</i> and <i>suspendConfig</i> not including <i>measIdleCarrierListNR</i> to the UE.	<-	NR RRC: <i>RRCRelease</i>	-	-
37	Wait for 5 s for UE to enter RRC_INACTIVE mode and to perform measurements.	-	-	-	-
38	SS transmits <i>Paging</i> message to UE.	<--	NR RRC: <i>Paging</i>	-	-
39	UE transmits <i>RRCResumeRequest</i> message to SS.	-->	NR RRC: <i>RRCResumeRequest</i>	-	-
40	SS transmits <i>RRCResume</i> message to UE.	<--	NR RRC: <i>RRCResume</i>	-	-
41	UE transmits <i>RRCResumeComplete</i> message to SS.		NR RRC: <i>RRCResumeComplete</i>	-	-
42	The SS transmits <i>UEInformationRequest</i> message including <i>idleModeMeasurementReq</i> to the UE.	<-	NR RRC: <i>UEInformationRequest</i>	-	-
43	Check: Does the UE transmit <i>UEInformationResponse</i> without <i>measResultIdleNR</i> ?	->	NR RRC: <i>UEInformationResponse</i>	5	P

8.1.5.11.4.3.3 Specific message contents

TBD

8.1.6 SON and MDT support for NR

8.1.6.1 Intra NR MDT

8.1.6.1.1 Immediate MDT

8.1.6.1.1.1 Immediate MDT / Measurement reporting / Location information

8.1.6.1.1.1.1 Test Purpose (TP)

(1)

```
with { UE in RRC_CONNECTED state and measurement with event A2 configured with includeLocationInfo
included in the reportConfig }
ensure that {
  when { Entry condition for event A2 is met and detailed location information that has not been
reported is available }
  then { UE sends MeasurementReport message with locationInfo included }
}
```

(2)

```
with { UE in RRC_CONNECTED state and measurement configured for event A2 }
ensure that {
  when { Exit condition for event A2 is met }
  then { UE stops sending MeasurementReport message }
}
```

8.1.6.1.1.1.2 Conformance requirements

References: The conformance requirements covered in the current TC is specified in: TS 38.331 clause 5.3.5.3, 5.5.4.1, 5.5.4.3, 5.5.5.1.

[TS 38.331, clause 5.3.5.3]

The UE shall perform the following actions upon reception of the *RRCReconfiguration*, or upon execution of the conditional reconfiguration (CHO or CPC):

...

- 1> if the *RRCReconfiguration* message includes the *measConfig*:
 - 2> perform the measurement configuration procedure as specified in 5.5.2;

...

[TS 38.331, clause 5.5.4.1]

If AS security has been activated successfully, the UE shall:

- 1> for each *measId* included in the *measIdList* within *VarMeasConfig*:
 - 2> if the corresponding *reportConfig* includes a *reportType* set to *eventTriggered* or *periodical*:
 - 3> if the corresponding *measObject* concerns NR:
 - 4> if the *eventA1* or *eventA2* is configured in the corresponding *reportConfig*:
 - 5> consider only the serving cell to be applicable;
 - 4> if the *eventA3* or *eventA5* is configured in the corresponding *reportConfig*:
 - 5> if a serving cell is associated with a *measObjectNR* and neighbours are associated with another *measObjectNR*, consider any serving cell associated with the other *measObjectNR* to be a neighbouring cell as well;
 - 4> if corresponding *reportConfig* includes *reportType* set to *periodical*; or
 - 4> for measurement events other than *eventA1* or *eventA2*:
 - 5> if *useWhiteCellList* is set to *true*:
 - 6> consider any neighbouring cell detected based on parameters in the associated *measObjectNR* to be applicable when the concerned cell is included in the *whiteCellsToAddModList* defined within the *VarMeasConfig* for this *measId*;
 - 5> else:
 - 6> consider any neighbouring cell detected based on parameters in the associated *measObjectNR* to be applicable when the concerned cell is not included in the *blackCellsToAddModList* defined within the *VarMeasConfig* for this *measId*;

...

- 2> if the *reportType* is set to *eventTriggered* and if the entry condition applicable for this event, i.e. the event corresponding with the *eventId* of the corresponding *reportConfig* within *VarMeasConfig*, is fulfilled for one or more applicable cells for all measurements after layer 3 filtering taken during *timeToTrigger* defined for this event within the *VarMeasConfig*, while the *VarMeasReportList* does not include a measurement reporting entry for this *measId* (a first cell triggers the event):
 - 3> include a measurement reporting entry within the *VarMeasReportList* for this *measId*;
 - 3> set the *numberOfReportsSent* defined within the *VarMeasReportList* for this *measId* to 0;

- 3> include the concerned cell(s) in the *cellsTriggeredList* defined within the *VarMeasReportList* for this *measId*;
- 3> if *useT312* is set to *true* in *reportConfig* for this event:
 - 4> if T310 for the corresponding SpCell is running; and
 - 4> if T312 is not running for corresponding SpCell:
 - 5> start timer T312 for the corresponding SpCell with the value of T312 configured in the corresponding *measObjectNR*;
- 3> initiate the measurement reporting procedure, as specified in 5.5.5;
- 2> else if the *reportType* is set to *eventTriggered* and if the entry condition applicable for this event, i.e. the event corresponding with the *eventId* of the corresponding *reportConfig* within *VarMeasConfig*, is fulfilled for one or more applicable cells not included in the *cellsTriggeredList* for all measurements after layer 3 filtering taken during *timeToTrigger* defined for this event within the *VarMeasConfig* (a subsequent cell triggers the event):
 - 3> set the *numberOfReportsSent* defined within the *VarMeasReportList* for this *measId* to 0;
 - 3> include the concerned cell(s) in the *cellsTriggeredList* defined within the *VarMeasReportList* for this *measId*;
 - 3> if *useT312* is set to *true* in *reportConfig* for this event:
 - 4> if T310 for the corresponding SpCell is running; and
 - 4> if T312 is not running for corresponding SpCell:
 - 5> start timer T312 for the corresponding SpCell with the value of T312 configured in the corresponding *measObjectNR*;
 - 3> initiate the measurement reporting procedure, as specified in 5.5.5;
- 2> else if the *reportType* is set to *eventTriggered* and if the leaving condition applicable for this event is fulfilled for one or more of the cells included in the *cellsTriggeredList* defined within the *VarMeasReportList* for this *measId* for all measurements after layer 3 filtering taken during *timeToTrigger* defined within the *VarMeasConfig* for this event:
 - 3> remove the concerned cell(s) in the *cellsTriggeredList* defined within the *VarMeasReportList* for this *measId*;
 - 3> if *reportOnLeave* is set to *true* for the corresponding reporting configuration:
 - 4> initiate the measurement reporting procedure, as specified in 5.5.5;
 - 3> if the *cellsTriggeredList* defined within the *VarMeasReportList* for this *measId* is empty:
 - 4> remove the measurement reporting entry within the *VarMeasReportList* for this *measId*;
 - 4> stop the periodical reporting timer for this *measId*, if running;
- 2> else if the *reportType* is set to *eventTriggered* and if the entry condition applicable for this event, i.e. the event corresponding with the *eventId* of the corresponding *reportConfig* within *VarMeasConfig*, is fulfilled for one or more applicable transmission resource pools for all measurements taken during *timeToTrigger* defined for this event within the *VarMeasConfig*, while the *VarMeasReportList* does not include a measurement reporting entry for this *measId* (a first transmission resource pool triggers the event):
 - 3> include a measurement reporting entry within the *VarMeasReportList* for this *measId*;
 - 3> set the *numberOfReportsSent* defined within the *VarMeasReportList* for this *measId* to 0;
 - 3> include the concerned transmission resource pool(s) in the *poolsTriggeredList* defined within the *VarMeasReportList* for this *measId*;

- 3> initiate the measurement reporting procedure, as specified in 5.5.5;
- 2> else if the *reportType* is set to *eventTriggered* and if the entry condition applicable for this event, i.e. the event corresponding with the *eventId* of the corresponding *reportConfig* within *VarMeasConfig*, is fulfilled for one or more applicable transmission resource pools not included in the *poolsTriggeredList* for all measurements taken during *timeToTrigger* defined for this event within the *VarMeasConfig* (a subsequent transmission resource pool triggers the event):
 - 3> set the *numberOfReportsSent* defined within the *VarMeasReportList* for this *measId* to 0;
 - 3> include the concerned transmission resource pool(s) in the *poolsTriggeredList* defined within the *VarMeasReportList* for this *measId*;
 - 3> initiate the measurement reporting procedure, as specified in 5.5.5;
 - 2> else if the *reportType* is set to *eventTriggered* and if the leaving condition applicable for this event is fulfilled for one or more applicable transmission resource pools included in the *poolsTriggeredList* defined within the *VarMeasReportList* for this *measId* for all measurements taken during *timeToTrigger* defined within the *VarMeasConfig* for this event:
 - 3> remove the concerned transmission resource pool(s) in the *poolsTriggeredList* defined within the *VarMeasReportList* for this *measId*;
 - 3> if the *poolsTriggeredList* defined within the *VarMeasReportList* for this *measId* is empty:
 - 4> remove the measurement reporting entry within the *VarMeasReportList* for this *measId*;
 - 4> stop the periodical reporting timer for this *measId*, if running

...

[TS 38.331, clause 5.5.4.3]

The UE shall:

- 1> consider the entering condition for this event to be satisfied when condition A2-1, as specified below, is fulfilled;
- 1> consider the leaving condition for this event to be satisfied when condition A2-2, as specified below, is fulfilled;
- 1> for this measurement, consider the serving cell indicated by the *measObjectNR* associated to this event.

Inequality A2-1 (Entering condition)

$$Ms + Hys < Thresh$$

Inequality A2-2 (Leaving condition)

$$Ms - Hys > Thresh$$

The variables in the formula are defined as follows:

Ms is the measurement result of the serving cell, not taking into account any offsets.

Hys is the hysteresis parameter for this event (i.e. *hysteresis* as defined within *reportConfigNR* for this event).

Thresh is the threshold parameter for this event (i.e. *a2-Threshold* as defined within *reportConfigNR* for this event).

Ms is expressed in dBm in case of RSRP, or in dB in case of RSRQ and RS-SINR.

Hys is expressed in dB.

Thresh is expressed in the same unit as ***Ms***.

[TS 38.331, clause 5.5.5.1]

...

For the *measId* for which the measurement reporting procedure was triggered, the UE shall set the *measResults* within the *MeasurementReport* message as follows:

1> set the *measId* to the measurement identity that triggered the measurement reporting;

...

1> if there is at least one applicable neighbouring cell to report:

...

1> if the *includeCommonLocationInfo* is configured in the corresponding *reportConfig* for this *measId* and detailed location information that has not been reported is available, set the content of *commonLocationInfo* of the *locationInfo* as follows:

2> include the *locationTimestamp*;

2> include the *locationCoordinate*, if available;

2> include the *velocityEstimate*, if available;

2> include the *locationError*, if available;

2> include the *locationSource*, if available;

2> if available, include the *gnss-TOD-msec*,

...

1> increment the *numberOfReportsSent* as defined within the *VarMeasReportList* for this *measId* by 1;

1> stop the periodical reporting timer, if running;

1> if the *numberOfReportsSent* as defined within the *VarMeasReportList* for this *measId* is less than the *reportAmount* as defined within the corresponding *reportConfig* for this *measId*:

2> start the periodical reporting timer with the value of *reportInterval* as defined within the corresponding *reportConfig* for this *measId*;

1> else:

2> if the *reportType* is set to *periodical* or *cli-Periodical*:

3> remove the entry within the *VarMeasReportList* for this *measId*;

3> remove this *measId* from the *measIdList* within *VarMeasConfig*;

8.1.6.1.1.1.3 Test description

8.1.6.1.1.1.3.1 Pre-test conditions

System Simulator:

- NR Cell 1

Preamble:

- The UE's positioning engine (e.g. standalone GNSS receiver) should be provided with any necessary stimulus to allow it to provide the position. This shall be done by use of the test function Update UE Location Information defined in TS 38.509 [6], if supported by the UE according to *pc_UpdateUE_LocationInformation*. Otherwise, or in addition any other suitable method may also be used.
- The UE is in state 3N-A as defined in TS 38.508-1 [4], subclause 4.4A on NR Cell 1.

8.1.6.1.1.3.2 Test procedure sequence

Table 8.1.6.1.1.3.2-1 and Table 8.1.6.1.1.3.2-1a illustrate the downlink power levels to be applied for NR Cell 1 at various time instants of the test execution. Row marked "T0" denotes the initial conditions after the preamble, while rows marked "T1" and "T2" are to be applied subsequently. The exact instants on which these values shall be applied are described in the texts in this clause.

Table 8.1.6.1.1.3.2-1: Time instances of cell power level and parameter changes for FR1

	Parameter	Unit	NR Cell 1	Remark
T0	SS/PBCH SSS EPRE	dBm/SCS	-78	Power level is such that $M_s > Thresh + Hys$
T1	SS/PBCH SSS EPRE	dBm/SCS	-98	Power level is such that entry condition for event A2 is satisfied $M_s + Hys < Thresh$
T2	SS/PBCH SSS EPRE	dBm/SCS	-78	Power level is such that exit condition for event A2 is satisfied $M_s - Hys > Thresh$

Table 8.1.6.1.1.3.2-1a: Time instances of cell power level and parameter changes for FR2

	Parameter	Unit	NR Cell 1	Remark
T0	SS/PBCH SSS EPRE	dBm/SCS	-82	Power level is such that $M_s > Thresh + Hys$
T1	SS/PBCH SSS EPRE	dBm/SCS	-96	Power level is such that entry condition for event A2 is satisfied $M_s + Hys < Thresh$
T2	SS/PBCH SSS EPRE	dBm/SCS	-82	Power level is such that exit condition for event A2 is satisfied $M_s - Hys > Thresh$

Table 8.1.6.1.1.3.2-2: Main behaviour

St	Procedure	Message Sequence		TP	Verdict
		U - S	Message		
1	The SS transmits an <i>RRCReconfiguration</i> message including <i>measConfig</i> to setup intra NR measurement and reporting for event A2 with <i>includeLocationInfo</i> configured.	<--	NR RRC: <i>RRCReconfiguration</i>	-	-
2	The UE transmits an <i>RRCReconfigurationComplete</i> message.	-->	NR RRC: <i>RRCReconfigurationComplete</i>	-	-
3	SS re-adjusts the SS/PBCH EPRE level according to row "T1" in Table 8.1.6.1.1.3.2-1 or Table 8.1.6.1.1.3.2-1a.	-	-	-	-
4	Check: Does the UE transmit a <i>MeasurementReport</i> message to report event A2 with the UE <i>commonLocationInfo</i> included?	-->	NR RRC: <i>MeasurementReport</i>	1	P
5	SS re-adjusts the SS/PBCH EPRE level according to row "T2" in Table 8.1.6.1.1.3.2-1 or Table 8.1.6.1.1.3.2-1a.	-	-	-	-
6	Wait and ignore <i>MeasurementReport</i> messages for 5 s to allow change of power levels for NR Cell 1.	-	-	-	-
7	Check: Does the UE attempt to transmit <i>MeasurementReport</i> message within the next 10s??	-	-	2	F

8.1.6.1.1.3.3 Specific message contents

Table 8.1.6.1.1.3.3-1: RRCReconfiguration (step 1 Table 8.1.6.1.1.3.2-2)

Derivation Path: TS 38.508-1 [4], Table 4.6.1-13 with condition NR_MEAS

Table 8.1.6.1.1.3.3-2: MeasConfig (Table 8.1.6.1.1.3.3-1)

Derivation Path: TS 38.508-1 [4] Table 4.6.3-69			
Information Element	Value/Remark	Comment	Condition
measConfig ::= SEQUENCE {			
measObjectToAddModList SEQUENCE (SIZE (1..maxNrofObjectId)) OF MeasObjectToAddMod {	1 entry		
MeasObjectToAddMod[1] SEQUENCE {		entry 1	
measObjectId	1		
measObject CHOICE {			
measObjectNR	MeasObjectNR(57)	Thres=57(-100dBm ≤ SS-RSRP < -99dBm)	
}			
}			
reportConfigToAddModList SEQUENCE (SIZE (1..maxReportConfigId)) OF ReportConfigToAddMod {	1 entry		
ReportConfigToAddMod[1] SEQUENCE {		entry 1	
reportConfigId	1		
reportConfig	ReportConfigNR-EventA2		
}			
}			
measIdToAddModList SEQUENCE (SIZE (1..maxNrofMeasId)) OF MeasIdToAddMod {	1 entry		
MeasIdToAddMod[1] SEQUENCE {		entry 1	
measId	1		
measObjectId	1		
reportConfigId	1		
}			
}			
}			

Table 8.1.6.1.1.3.3-3: ReportConfigNR-EventA2 (Table 8.1.6.1.1.3.3-2)

Derivation Path: TS 38.508-1 [4], Table 4.6.3-142 with condition EVENT_A2			
Information Element	Value/remark	Comment	Condition
ReportConfigNR ::= SEQUENCE {			
reportType CHOICE {			
eventTriggered SEQUENCE {			
eventId CHOICE {			
eventA2 SEQUENCE {			EVENT_A2
a2-Threshold CHOICE {			
rsrp	69	-88dBm ≤ SS-RSRP < -87dBm	FR1/FR2
}			
hysteresis	0	0 dB	FR1/FR2
}			
}			
}			
reportAmount	r1		
includeCommonLocationInfo-r16	True		
}			
}			

Table 8.1.6.1.1.3.3-4: MeasurementReport (steps 4, Table 8.1.6.1.1.3.2-2)

Derivation Path: TS 38.508-1 [4], Table 4.6.1-5A			
Information Element	Value/remark	Comment	Condition
MeasurementReport ::= SEQUENCE {			

}

8.1.6.1.1.2.2 Conformance requirements

References: The conformance requirements covered in the present TC are specified in: TS 38.331, clause 5.5.3.1, 5.5.4.1, 5.5.5.1 & TS 38.314, clause 4.3.1.1

[TS 38.331, clause 5.5.3.1]

...

The UE shall:

...

1> for each *measId* included in the *measIdList* within *VarMeasConfig*:

...

2> if the *ul-DelayValueConfig* is configured for the associated *reportConfig*:

3> ignore the *measObject*;

3> for each of the configured DRBs, configure the PDCP layer to perform corresponding average UL PDCP packet delay measurement per DRB;

...

[TS 38.331, clause 5.5.4.1]

If AS security has been activated successfully, the UE shall:

1> for each *measId* included in the *measIdList* within *VarMeasConfig*:

...

2> if the corresponding *reportConfig* includes the *ul-DelayValueConfig*:

3> initiate the measurement reporting procedure, as specified in 5.5.5, immediately after a first measurement result is provided by all lower layers of the associated DRB identity;

...

[TS 38.331, clause 5.5.5.1]

...

For the *measId* for which the measurement reporting procedure was triggered, the UE shall set the *measResults* within the *MeasurementReport* message as follows:

...

1> if average uplink PDCP delay values are available:

2> set the *ul-PDCP-DelayValueResultList* to include the corresponding average uplink PDCP delay values;

...

[TS 38.314, clause 4.3.1.1]

The objective of this measurement performed by UE is to measure Packet Delay in Layer PDCP for QoS verification of MDT or for the QoS monitoring as defined in TS 23.501.

Protocol Layer: PDCP

Table 4.3.1.1-1: Definition for UL PDCP Packet Average Delay per DRB per UE

Definition	<p>PDCP Packet Delay in the UL per DRB. This measurement refers to PDCP queuing delay for DRBs in the UE, which captures the delay from packet arrival at PDCP upper SAP until the UL grant to transmit the packet is available, which has included the delay the UE gets resources granted (from sending SR/RACH to get the first grant). The measurement is done separately per DRB.</p> <p>Detailed Definition: $M(T, drbid) = \left\lfloor \frac{\sum_{vi} t_{Deliv}(i, drbid) - t_{Arrival}(i, drbid)}{I(T)} \right\rfloor$, where explanations can be found in the table 4.3.1.1-2 below.</p>
------------	--

NOTE: UE measures UL PDCP queuing delay at DRB level. It is up to gNB to convert DRB level delay to QoS level delay with the assumption that all QoS flows mapped to the same DRB get the same QoS treatment, and it is up to gNB to calculate QoS level delay if multiple DRBs mapped with the same QoS.

Table 4.3.1.1-2: Parameter description for UL PDCP Packet Average Delay per DRB per UE

$M(T, drbid)$	PDCP average delay in the UL per DRB, averaged during time period T . Unit: 0.1 ms. PDCP average delay in the UL per DRB is 1s if the actual value is larger than 1s.
$t_{Arrival}(i)$	The point in time when the UL PDCP SDU i arrives at PDCP upper SAP.
$t_{Deliv}(i)$	The point in time when the UL MAC PDU k including the first part of UL PDCP SDU i is scheduled for transmission.
i	A UL PDCP SDU that is received by the PDCP during time period T .
$I(T)$	Total number of UL PDCP SDUs received during time period T .
T	Time Period during which the measurement is performed
$drbid$	The identity of the measured DRB.

8.1.6.1.1.2.3 Test description

8.1.6.1.1.2.3.1 Pre-test conditions

System Simulator:

- NR Cell 1

UE:

- None

Preamble:

- The UE is in 5GS state 3N-A with one PDU session active according to TS 38.508-1 [4], clause 4.4A.3 Table 4.4A.3-1 and using the message condition UE TEST LOOP MODE A active. 3 DRBs are configured where DRB#j1 is defined as default DRB.

8.1.6.1.1.2.3.2 Test procedure sequence

Table 8.1.6.1.1.2.3.2-1: Main behaviour

St	Procedure	Message Sequence		TP	Verdict
		U - S	Message		
1	The SS transmits an <i>RRCReconfiguration</i> message including <i>MeasConfig</i> to setup <i>ul-DelayValueConfig</i>	<--	NR RRC: <i>RRCReconfiguration</i>	-	-

2	The UE transmits an <i>RRCReconfigurationComplete</i> message	-->	NR RRC: <i>RRCReconfigurationComplete</i>	1	P
	EXCEPTION: In parallel with steps 3-9, parallel behaviour defined in table 8.1.6.1.1.2.3.2-3 is executed to receive periodic measurement report.				
3	The SS transmits UL grant to the UE at every 5ms in PDCCH occasion				
4	The SS transmits an IP Packet on the data radio bearer associated with the dedicated 5GC bearer context #2				
5	The UE loop backs the IP packet received in step 4 on DRB#j+1				
5A	Check: Does the UE transmit a <i>MeasurementReport</i> message containing UL-PDCP-DelayValueResult with averageDelay set to non zero value for DRB#j+1 and DRB#j+2?	-->	NR RRC: <i>MeasurementReport</i>	2	P
6	The SS transmits an IP Packet on the data radio bearer associated with the dedicated 5GC bearer context #3				
7	The UE loop backs the IP packet received in step 6 on DRB# j+2				
8	Check: Does the UE transmit a <i>MeasurementReport</i> message containing UL-PDCP-DelayValueResult for DRB# j+1 and with with averageDelay set to non zero value DRB#j+2?2 and DRB#3?	-->	<i>MeasurementReport</i>	2	P
9	The SS transmits an <i>RRCReconfiguration</i> message including MeasConfig to release the <i>ul-DelayValueConfig</i> measurement	<--	NR RRC: <i>RRCReconfiguration</i>	-	-
10	The UE transmits an <i>RRCReconfigurationComplete</i> message.	-->	NR RRC: <i>RRCReconfigurationComplete</i>		
-	EXCEPTION: In parallel with steps 11-14, parallel behaviour defined in table 8.1.6.1.1.2.3.2-2 is executed.	-	-	-	-
11	The SS transmits an IP Packet on the data radio bearer associated with the dedicated 5GC bearer context #2				
12	The UE loop backs the IP packet received in step 11 on DRB# j+1				
13	The SS transmits an IP Packet on the data radio bearer associated with the dedicated 5GC bearer context #3				
14	The UE loop backs the IP packet received in step 13 on DRB#j+2				
15	Void	-	-	-	-

Table 8.1.6.1.1.2.3.2-2: Parallel behaviour

St	Procedure	Message Sequence		TP	Verdict
		U - S	Message		
1	Check: Does the UE transmit a <i>MeasurementReport</i> message containing UL-PDCP-DelayValueResult?	-->	<i>MeasurementReport</i>	3	F

Table 8.1.6.1.1.2.3.2-3: Parallel behaviour

St	Procedure	Message Sequence		TP	Verdict
		U - S	Message		
1	The UE transmit a <i>MeasurementReport</i> message	-->	<i>MeasurementReport</i>	-	-

8.1.6.1.1.2.3.3 Specific message contents

Table 8.1.6.1.1.2.3.3-1: RRCReconfiguration (step 1 and 9, Table 8.1.6.1.1.2.3.2-1)

Derivation Path: TS 38.508-1 [4], Table 4.6.1-13 with condition NR_MEAS

Table 8.1.6.1.1.2.3.3-2: MeasConfig (Table 8.1.6.1.1.2.3.3-1)

Derivation Path: TS 38.508-1 [4] Table 4.6.3-69			
Information Element	Value/Remark	Comment	Condition
measConfig ::= SEQUENCE {			
measObjectToAddModList SEQUENCE (SIZE (1..maxNrofObjectId)) OF MeasObjectToAddMod {	1 entry		
MeasObjectToAddMod[1] SEQUENCE {		entry 1	
measObjectId	1		
measObject CHOICE {			
measObjectNR	MeasObjectNR(57)	Thres=57(-100dBm ≤ SS-RSRP < -99dBm)	
}			
}			
}			
reportConfigToAddModList SEQUENCE (SIZE (1..maxReportConfigId)) OF ReportConfigToAddMod {	1 entry		
ReportConfigToAddMod[1] SEQUENCE {		entry 1	
reportConfigId	1		
reportConfig	ReportConfigNR-PERIODICAL		
}			
}			
measIdToAddModList SEQUENCE (SIZE (1..maxNrofMeasId)) OF MeasIdToAddMod {	1 entry		
MeasIdToAddMod[1] SEQUENCE {		entry 1	
measId	1		
measObjectId	1		
reportConfigId	1		
}			
}			
}			

Table 8.1.6.1.1.2.3.3-3: ReportConfigNR- PERIODICAL (Table 8.1.6.1.1.2.3.3-2)

Derivation Path: TS 38.508-1 [4], Table 4.6.3-142 with condition PERIODICAL, MDT_DELAY			
Information Element	Value/remark	Comment	Condition
ReportConfigNR ::= SEQUENCE {			
reportType CHOICE {			
periodical SEQUENCE {			
ul-DelayValueConfig-r16 CHOICE {			
setup SEQUENCE {			Step1
delay-DRBlist SEQUENCE (SIZE(1..maxDRB)) OF DRB-Identity {	2 entries		
DRB-Identity[1]	j+1	entry 1	
DRB-Identity[2]	j+2	entry 2	
}			
}			
Release	NULL		Step9
}			
}			

}			
}			
}			
}			

Table 8.1.6.1.1.2.3.3-6: RadioBearerConfig-3DRBs (Table 8.1.6.1.1.2.3.3-4)

Derivation Path: TS 38.508-1 [4], table 4.6.3-132 and condition SRB2 and DRB1			
Information Element	Value/remark	Comment	Condition
RadioBearerConfig ::= SEQUENCE {			
drb-ToAddModList SEQUENCE (SIZE (1..maxDRB))	3 entries		
OF DRB-ToAddMod {			
DRB-ToAddMod[1] SEQUENCE {		entry 1	
cnAssociation CHOICE {			
sdap-Config ::= SEQUENCE {			
pdu-Session	PDU session ID	Same as the PDU session ID in PDU SESSION ESTABLISHMENT REQUEST	
defaultDRB	true		
mappedQoS-FlowsToAdd SEQUENCE {			
QFI	1		
}			
}			
}			
drb-Identity	DRB-Identity with Condition DRBj	j is the ID of the DRB established during the preamble which is allocated according to internal TTCN mapping	
}			
}			
DRB-ToAddMod[2] SEQUENCE		entry 2	
cnAssociation CHOICE {			
sdap-Config SEQUENCE {			
pdu-Session	PDU session ID	Same as the PDU session ID in PDU SESSION ESTABLISHMENT REQUEST	
defaultDRB	false		
mappedQoS-FlowsToAdd SEQUENCE {			
QFI	5		
}			
}			
}			
drb-Identity	DRB-Identity with Condition DRBj+1		
}			
}			
DRB-ToAddMod[3] SEQUENCE		entry 3	
cnAssociation CHOICE {			
sdap-Config SEQUENCE {			
pdu-Session	PDU session ID	Same as the PDU session ID in PDU SESSION ESTABLISHMENT REQUEST	
defaultDRB	false		
mappedQoS-FlowsToAdd SEQUENCE {			

QFI	2		
}			
}			
drb-Identity	DRB-Identity with Condition DRBj+2		
}			
}			
}			
}			

Table 8.1.6.1.1.2.3.3-7: CellGroupConfig-3DRBs (Table 8.1.6.1.1.2.3.3-4)

Derivation Path: TS 38.508-1 [4], table 4.6.3-19 and condition SRB2_DRB1			
Information Element	Value/remark	Comment	Condition
CellGroupConfig ::= SEQUENCE {			
rlc-BearerToAddModList SEQUENCE (SIZE(1..maxLC-ID)) OF RLC-BearerConfig {	4 entries		
RLC-BearerConfig[1]	RLC-BearerConfig with condition SRB2	entry 1	
RLC-BearerConfig[2]	RLC-BearerConfig with conditions AM and DRBj	entry 2	
RLC-BearerConfig[3]	RLC-BearerConfig with conditions AM and DRBj+1	entry 3	
RLC-BearerConfig[3]	RLC-BearerConfig with conditions AM and DRBj+2	entry 4	
}			
}			

Table 8.1.6.1.1.2.3.3-8: PDU SESSION ESTABLISHMENT ACCEPT (Preamble) (Table 8.1.6.1.1.2.3.3-1)

Derivation Path: TS 38.508-1, table 4.7.2-2			
Information Element	Value/remark	Comment	Condition
PDU session ID	The same as the PDU session ID in PDU SESSION ESTABLISHMENT REQUEST		
Authorized QoS rules	3 entries		
QoS rule [1]	Reference QoS rule #1 as defined in Table 4.8.2.1-1.	QFI=1	
QoS rule [2]	Reference QoS rule #4 as defined in Table 4.8.2.1-4 except DQR bit set to '0'B.	QFI=2	
QoS rule [3]	Reference QoS rule #5 as defined in Table 4.8.2.1-5.	QFI=5	
Mapped EPS Bearer contexts	Not Present		
Authorized QoS flow descriptions	3 entries		
QoS flow [1]	Reference QoS flow #1 as defined in Table 8.1.5.4.1.3.3-7.	QFI=1	
QoS flow [2]	Reference QoS flow #2 as defined in Table 8.1.5.4.1.3.3-8.	QFI=2	
QoS flow [3]	Reference QoS flow #3 as defined in Table 4.8.2.3-3.	QFI=5	

8.1.6.1.2 Logged MDT

8.1.6.1.2.1 Logged MDT / RRC_IDLE / Logging and reporting / Intra-frequency measurement

8.1.6.1.2.1.1 Test Purpose (TP)

(1)

```
with { UE in NR RRC_IDLE state camping normally on an NR cell where logged measurement is configured
without areaConfiguration and the UE is able to detect an NR intra-frequency cell }
ensure that {
  when { T330 is running }
  then { UE is logging serving cell idle mode measurements and Intra-frequency neighbouring cell
measurements }
}
```

(2)

```
with { UE in NR RRC_IDLE state and UE has one or more logged Intra-frequency neighbouring cell
measurement entries stored in VarLogMeasReport }
ensure that {
  when { receiving RRCSetup message }
  then { UE includes the logMeasAvailable IE in the RRCSetupComplete message }
}
```

(3)

```
with { UE in NR RRC_CONNECTED state and UE has one or more logged Intra-frequency neighbouring cell
measurement entries stored in VarLogMeasReport }
ensure that {
  when { receiving UEInformationRequest message }
  then { UE transmits UEInformationResponse messages with absoluteTimeStamp set equal to the value
configured when the logged measurement configuration was received and a relativeTimeStamp for each
logged measurement indicating the elapsed time since the logged measurement configuration was
received }
}
```

(4)

```
with { UE in NR RRC_CONNECTED state and UE has one or more logged Intra-frequency neighbouring cell
measurement entries stored in VarLogMeasReport }
ensure that {
  when { receiving UEInformationRequest message }
  then { UE transmits UEInformationResponse messages with traceReference, traceRecordingSessionRef
and tce-Id being set to same values as configured when the logged measurement configuration was
received }
}
```

8.1.6.1.2.1.2 Conformance requirements

References: The conformance requirements covered in the current TC are specified in: TS 38.331, clauses 5.3.3.4, 5.5a.1.3, 5.5a.3.2, 5.7.10.3 and 6.2.2. Unless otherwise stated these are Rel-16 requirements.

[TS 38.331, clause 5.3.3.4]

The UE shall perform the following actions upon reception of the *RRCSetup*:

...

1> set the content of *RRCSetupComplete* message as follows:

...

2> if the UE has logged measurements available for NR and if the RPLMN is included in *plmn-IdentityList* stored in *VarLogMeasReport*:

- 3> include the *logMeasAvailable* in the *RRCSetupComplete* message;
- 2> if the UE has Bluetooth logged measurements available and if the RPLMN is included in *plmn-IdentityList* stored in *VarLogMeasReport*:
 - 3> include the *logMeasAvailableBT* in the *RRCSetupComplete* message;
- 2> if the UE has WLAN logged measurements available and if the RPLMN is included in *plmn-IdentityList* stored in *VarLogMeasReport*:
 - 3> include the *logMeasAvailableWLAN* in the *RRCSetupComplete* message;
- ...

[TS 38.331, clause 5.5a.1.3]

Upon receiving the *LoggedMeasurementConfiguration* message the UE shall:

- 1> discard the logged measurement configuration as well as the logged measurement information as specified in 5.5a.2;
- 1> store the received *loggingDuration*, *reportType* and *areaConfiguration*, if included, in *VarLogMeasConfig*;
- 1> if the *LoggedMeasurementConfiguration* message includes *plmn-IdentityList*:
 - 2> set *plmn-IdentityList* in *VarLogMeasReport* to include the RPLMN as well as the PLMNs included in *plmn-IdentityList*;
- 1> else:
 - 2> set *plmn-IdentityList* in *VarLogMeasReport* to include the RPLMN;
- 1> store the received *absoluteTimeInfo*, *traceReference*, *traceRecordingSessionRef*, and *tce-Id* in *VarLogMeasReport*;
- 1> store the received *bt-NameList*, if included, in *VarLogMeasConfig*;
- 1> store the received *wlan-Namelist*, if included, in *VarLogMeasConfig*;
- 1> store the received *sensor-Namelist*, if included, in *VarLogMeasConfig*;
- 1> start timer T330 with the timer value set to the *loggingDuration*;

[TS 38.331, clause 5.5a.3.2]

While T330 is running, the UE shall:

- 1> perform the logging in accordance with the following:
 - 2> if the *reportType* is set to *periodical* in the *VarLogMeasConfig*:
 - 3> if the UE is camping normally on an NR cell and if the RPLMN is included in *plmn-IdentityList* stored in *VarLogMeasReport* and, if the cell is part of the area indicated by *areaConfiguration* if configured in *VarLogMeasConfig*:
 - 4> perform the logging at regular time intervals, as defined by the *loggingInterval* in the *VarLogMeasConfig*;
 - 2> else if the *reportType* is set to *eventTriggered*, and *eventType* is set to *outOfCoverage*:
 - 3> perform the logging at regular time intervals as defined by the *loggingInterval* in *VarLogMeasConfig* only when the UE is in any cell selection state;
 - 3> perform the logging immediately upon transitioning from the any cell selection state to the camped normally state;
 - 2> else if the *reportType* is set to *eventTriggered* and *eventType* is set to *eventL1*:

- 3> if the UE is camping normally on an NR cell and if the RPLMN is included in *plmn-IdentityList* stored in *VarLogMeasReport* and, if the cell is part of the area indicated by *areaConfiguration* if configured in *VarLogMeasConfig*;
- 4> perform the logging at regular time intervals as defined by the *loggingInterval* in *VarLogMeasConfig* only when the conditions indicated by the *eventLI* are met;
- 2> when performing the logging:
 - 3> set the *relativeTimeStamp* to indicate the elapsed time since the moment at which the logged measurement configuration was received;
 - 3> if detailed location information became available during the last logging interval, set the content of the *locationInfo* as in 5.3.3.7;
 - 3> if the UE is in any cell selection state (as specified in TS 38.304 [20]):
 - 4> set *anyCellSelectionDetected* to indicate the detection of no suitable or no acceptable cell found;
 - 4> set the *servCellIdentity* to indicate global cell identity of the last logged cell that the UE was camping on;
 - 4> set the *measResultServingCell* to include the quantities of the last logged cell the UE was camping on;
 - 3> else:
 - 4> set the *servCellIdentity* to indicate global cell identity of the cell the UE is camping on;
 - 4> set the *measResultServingCell* to include the quantities of the cell the UE is camping on;
 - 4> if available, set the *measResultNeighCells*, in order of decreasing ranking-criterion as used for cell reselection, to include neighbouring cell measurements that became available during the last logging interval for at most the following number of neighbouring cells: 6 intra-frequency and 3 inter-frequency neighbours per frequency as well as 3 inter-RAT neighbours, per frequency/ set of frequencies per RAT and according to the following:
 - 5> for each neighbour cell included, include the optional fields that are available;

NOTE: The UE includes the latest results of the available measurements as used for cell reselection evaluation in RRC_IDLE or RRC_INACTIVE, which are performed in accordance with the performance requirements as specified in TS 38.133 [14].

- 2> when the memory reserved for the logged measurement information becomes full, stop timer T330 and perform the same actions as performed upon expiry of T330, as specified in 5.5a.1.4.

[TS 38.331, clause 5.7.10.3]

Upon receiving the *UEInformationRequest* message, the UE shall, only after successful security activation:

...

- 1> if the *logMeasReportReq* is present and if the RPLMN is included in *plmn-IdentityList* stored in *VarLogMeasReport*:
- 2> if *VarLogMeasReport* includes one or more logged measurement entries, set the contents of the *logMeasReport* in the *UEInformationResponse* message as follows:
 - 3> include the *absoluteTimeStamp* and set it to the value of *absoluteTimeInfo* in the *VarLogMeasReport*;
 - 3> include the *traceReference* and set it to the value of *traceReference* in the *VarLogMeasReport*;
 - 3> include the *traceRecordingSessionRef* and set it to the value of *traceRecordingSessionRef* in the *VarLogMeasReport*;
 - 3> include the *tce-Id* and set it to the value of *tce-Id* in the *VarLogMeasReport*;

- 3> include the *logMeasInfoList* and set it to include one or more entries from *VarLogMeasReport* starting from the entries logged first;
- 3> if the *VarLogMeasReport* includes one or more additional logged measurement entries that are not included in the *logMeasInfoList* within the *UEInformationResponse* message:
 - 4> include the *logMeasAvailable*;
- 3> if the *VarLogMeasReport* includes one or more additional logged Bluetooth measurement entries that are not included in the *logMeasInfoList* within the *UEInformationResponse* message:
 - 4> include the *logMeasAvailableBT*;
- 3> if the *VarLogMeasReport* includes one or more additional logged WLAN measurement entries that are not included in the *logMeasInfoList* within the *UEInformationResponse* message:
 - 4> include the *logMeasAvailableWLAN*;

...

- 1> if the *logMeasReport* is included in the *UEInformationResponse*:
 - 2> submit the *UEInformationResponse* message to lower layers for transmission via SRB2;
 - 2> discard the logged measurement entries included in the *logMeasInfoList* from *VarLogMeasReport* upon successful delivery of the *UEInformationResponse* message confirmed by lower layers;
- 1> else:
 - 2> submit the *UEInformationResponse* message to lower layers for transmission via SRB1.

[TS 38.331, clause 6.2.2]

– LoggedMeasurementConfiguration

The *LoggedMeasurementConfiguration* message is used to perform logging of measurement results while in RRC_IDLE or RRC_INACTIVE. It is used to transfer the logged measurement configuration for network performance optimisation.

Signalling radio bearer: SRB1

RLC-SAP: AM

Logical channel: DCCH

Direction: Network to UE

LoggedMeasurementConfiguration message

```
-- ASN1START
-- TAG-LOGGEDMEASUREMENTCONFIGURATION-START

LoggedMeasurementConfiguration-r16 ::= SEQUENCE {
    criticalExtensions          CHOICE {
        loggedMeasurementConfiguration-r16    LoggedMeasurementConfiguration-r16-IEs,
        criticalExtensionsFuture              SEQUENCE {}
    }
}

LoggedMeasurementConfiguration-r16-IEs ::= SEQUENCE {
    traceReference-r16          TraceReference-r16,
    traceRecordingSessionRef-r16 OCTET STRING (SIZE (2)),
    tce-Id-r16                  OCTET STRING (SIZE (1)),
    absoluteTimeInfo-r16       AbsoluteTimeInfo-r16,
    areaConfiguration-r16      AreaConfiguration-r16                OPTIONAL,
--Need R
    plmn-IdentityList-r16      PLMN-IdentityList2-r16            OPTIONAL,
--Need R
    bt-NameList-r16           SetupRelease {BT-NameList-r16}     OPTIONAL,
--Need M
}
```



```

    wlan-NameList-r16          SetupRelease {WLAN-NameList-r16}          OPTIONAL,
--Need M
    sensor-NameList-r16       SetupRelease {Sensor-NameList-r16}         OPTIONAL,
--Need M
    loggingDuration-r16       LoggingDuration-r16,
    reportType                 CHOICE {
        periodical             LoggedPeriodicalReportConfig-r16,
        eventTriggered         LoggedEventTriggerConfig-r16,
        ...
    },
    lateNonCriticalExtension   OCTET STRING                      OPTIONAL,
    nonCriticalExtension       SEQUENCE {}                          OPTIONAL
}

LoggedPeriodicalReportConfig-r16 ::=
    loggingInterval-r16
    ...
}

LoggedEventTriggerConfig-r16 ::=
    eventType-r16
    loggingInterval-r16
    ...
}

EventType-r16 ::= CHOICE {
    outOfCoverage             NULL,
    eventL1                   SEQUENCE {
        l1-Threshold          MeasTriggerQuantity,
        hysteresis            Hysteresis,
        timeToTrigger         TimeToTrigger
    },
    ...
}

-- TAG-LOGGEDMEASUREMENTCONFIGURATION-STOP
-- ASN1STOP

```

LoggedMeasurementConfiguration field descriptions

absoluteTimeInfo	Indicates the absolute time in the current cell.
areaConfiguration	Used to restrict the area in which the UE performs measurement logging to cells broadcasting either one of the included cell identities or one of the included tracking area codes/ frequencies.
eventType	The value outOfCoverage indicates the UE to perform logging of measurements when the UE enters any cell selection state, and the value eventL1 indicates the UE to perform logging of measurements when the triggering condition (similar as event A2 as specified in 5.5.4.3) as configured in the event is met for the camping cell in camped normally state.
plmn-IdentityList	Indicates a set of PLMNs defining when the UE performs measurement logging as well as the associated status indication and information retrieval i.e. the UE performs these actions when the RPLMN is part of this set of PLMNs.
tce-Id	Parameter Trace Collection Entity Id: See TS 32.422 [52].
traceRecordingSessionRef	Parameter Trace Recording Session Reference: See TS 32.422 [52].
reportType	Parameter configures the type of MDT configuration, specifically Periodic MDT configuration or Event Triggered MDT configuration.

8.1.6.1.2.1.3 Test description

8.1.6.1.2.1.3.1 Pre-test conditions

System Simulator:

- NR Cell 1 and NR Cell 11.
- System information combination NR-2 as defined in TS 38.508-1[4] clause 4.4.3.1.2 is used in NR cells.

UE:

- None.

Preamble:

- The UE is in state 3N-A on NR Cell 1 according to TS 38.508-1 [4], clause 4.4A.2 Table 4.4A.2-3.

8.1.6.1.2.1.3.2 Test procedure sequence

Table 8.1.6.1.2.1.3.2-1/2 illustrate the downlink power levels and other changing parameters to be applied for the cell at various time instants of the test execution. The configuration "T0" indicates the initial conditions. The exact instants on which these values shall be applied are described in the texts in this clause.

Table 8.1.6.1.2.1.3.2-1: Time instances of cell power level for FR1

	Parameter	Unit	NR Cell 1	NR Cell 11	Remark
T0	SS/PBCH SSS EPRE	dBm/ SCS	-78	-85	NR Cell 1 becomes the highest ranked cell.
T1	SS/PBCH SSS EPRE	dBm/ SCS	-85	-78	NR Cell 11 becomes the highest ranked cell.

Table 8.1.6.1.2.1.3.2-2: Time instances of cell power level for FR2

	Parameter	Unit	NR Cell 1	NR Cell 11	Remark
T0	SS/PBCH SSS EPRE	dBm/ SCS	-82	-91	NR Cell 1 becomes the highest ranked cell.
T1	SS/PBCH SSS EPRE	dBm/ SCS	-91	-82	NR Cell 11 becomes the highest ranked cell.

Table 8.1.6.1.2.1.3.2-3: Main behaviour

St	Procedure	Message Sequence		TP	Verdict
		U - S	Message		
1	SS transmits a <i>LoggedMeasurementConfiguration</i> message to configure the UE to perform logging of measurement results while in RRC_IDLE.	<--	<i>LoggedMeasurementConfiguration</i>	-	-
2	The SS transmits an <i>RRCRelease</i> message.	<--	<i>NR RRC:RRCRelease</i>	-	-
3	Wait 5s to allow UE to activate logging.	-	-	-	-
4	The SS changes NR Cell 1 and NR Cell 11 levels according to the row "T1" in table 8.1.6.1.2.1.3.2-1/2. (Note 1)	-	-	-	-
5	The UE transmits an <i>RRCSetupRequest</i> message on NR Cell 11 to initiate a tracking area update procedure.	-->	NR RRC: <i>RRCSetupRequest</i>	-	-
6	SS transmits an <i>RRCSetup</i> message.	<--	NR RRC: <i>RRCSetup</i>	-	-
7	Check: Does the UE include the IE <i>logMeasAvailable</i> in the <i>RRCSetupComplete</i> message?	-->	NR RRC: <i>RRCSetupComplete</i> 5GMM: <i>REGISTRATION REQUEST</i>	2	P
8-10	Steps 4 to 6a1 of generic test procedure in TS 38.508-1[4] Table 4.9.5.2.2-1 are performed on NR Cell 11. NOTE: The UE performs a REGISTRATION procedure update the registration of the actual tracking area and the RRC connection is released.	-	-	-	-
11-18	Steps 1 to 8 of the generic radio bearer establishment procedure in TS 38.508-1 [4], Table 4.5.4.2-3 are executed to successfully complete the service request procedure on NR Cell 11.	-	-	-	-

19	The SS transmits a <i>UEInformationRequest</i> message on NR Cell 11.	<--	<i>UEInformationRequest</i>	-	-
20	Check: Does the UE transmit a <i>UEInformationResponse</i> message with the IEs <i>absoluteTimeStamp</i> , <i>traceReference</i> , <i>traceRecordingSessionRef</i> and <i>tce-Id</i> set to same value as received in the <i>LoggedMeasurementConfiguration</i> message in step 1; and a <i>LogMeasInfoList</i> with at least two entries with serving cell idle mode measurements and where in at least one of the entries the IE <i>measResultListNR</i> include a neighbouring cell measurement of NR Cell 11; and where the <i>relativeTimeStamp</i> is increased between the subsequent <i>LogMeasInfoList</i> entries by at least the value of configured <i>loggingInterval</i> in the received <i>LoggedMeasurementConfiguration</i> message in step 1.	-->	<i>UEInformationResponse</i>	1, 3, 4	P
Note 1: The change of power levels is to trigger a cell re-selection procedure to make sure that the UE is logging neighbouring cell measurements (logging interval=2.56 seconds) of Cell NR 11 while t-Reselection timer is running (7 seconds).					

8.1.6.1.2.1.3.3 Specific message contents

Table 8.1.6.1.2.1.3.3-1: SIB2 for NR cell 1 (preamble)

Derivation Path: TS 38.508-1 [4], table 4.6.2-1			
Information Element	Value/remark	Comment	Condition
SIB2 ::= SEQUENCE {			
intraFreqCellReselectionInfo SEQUENCE {			
t-ReselectionNR	7	seconds	
}			
}			

Table 8.1.6.1.2.1.3.3-2: LoggedMeasurementConfiguration (step 1, Table 8.1.6.1.2.1.3.2-3)

Derivation path: TS 38.508-1 [4], table 4.6.1-5AA with condition PERIODICAL

Table 8.1.6.1.2.1.3.3-3: RRCSetupComplete (steps 7 and 14, Table 8.1.6.1.2.1.3.2-3)

Derivation path: TS 38.508-1 [4], table 4.6.1-22			
Information Element	Value/remark	Comment	Condition
RRCSetupComplete ::= SEQUENCE {			
criticalExtensions CHOICE {			
rrcSetupComplete SEQUENCE {			
nonCriticalExtension SEQUENCE {			
ue-MeasurementsAvailable-r16	UE-MeasurementsAvailable-r16 with condition LOG		
}			
}			
}			
}			

Table 8.1.6.1.2.1.3.3-4: UEInformationRequest (step 19, Table 8.1.6.1.2.1.3.2-3)

Derivation path: TS 38.508-1 [4], table 4.6.1-32A with condition LOG
--

Table 8.1.6.1.2.1.3.3-5: *UEInformationResponse* (step 20, Table 8.1.6.1.2.1.3.2-3)

Derivation path: TS 38.508-1 [4], table 4.6.1-32B			
Information Element	Value/remark	Comment	Condition
UEInformationResponse-r16 ::= SEQUENCE {			
criticalExtensions CHOICE {			
ueInformationResponse-r16 SEQUENCE {			
logMeasReport-r16 SEQUENCE {			
absoluteTimeStamp-r16	Same value as sent by SS in LoggedMeasurementConfiguration in step 1		
traceReference-r16 SEQUENCE {			
plmn-Identity-r16 SEQUENCE {			
mcc SEQUENCE (SIZE (3)) OF MCC-NMC-Digit	Same value as sent by SS in LoggedMeasurementConfiguration in step 1		
mnc SEQUENCE (SIZE (2..3)) OF MCC-NMC-Digit	Same value as sent by SS in LoggedMeasurementConfiguration in step 1		
}			
traceId-r16	Same value as sent by SS in LoggedMeasurementConfiguration in step 1		
}			
traceRecordingSessionRef-r16	Same value as sent by SS in LoggedMeasurementConfiguration in step 1		
tce-Id-r16	Same value as sent by SS in LoggedMeasurementConfiguration in step 1		
logMeasInfoList-r16 SEQUENCE (SIZE (1..maxLogMeasReport-r16)) OF LogMeasInfo-r16 SEQUENCE {	At least 2 entries where at least one entry complies to entry with index 'x' below. SS records the relativeTimeStamp value for each entry		
LogMeasInfo-r16[x] SEQUENCE {		entry x	
locationInfo-r16	Not checked		
relativeTimeStamp-r16	SS record the value		
servCellIdentity-r16	Same as NR Cell 1		
measResultServCell-16 SEQUENCE {			
resultsSSB-Cell-r16	MeasQuantityResults of NR Cell 1		
resultsSSB SEQUENCE {			
best-ssb-Index	Not checked		
best-ssb-Results	Not checked		
numberOfGoodSSB	Not checked		
}			
}			
measResultNeighCells-r16 SEQUENCE {			
measResultNeighCellListNR SEQUENCE (SIZE (1..maxFreq)) OF MeasResultLogging2NR-r16 SEQUENCE {	1 entry		
carrierFreq-r16	Same as NR Cell 11		
measResultListLoggingNR-r16 SEQUENCE (SIZE (1..maxCellReport)) OF MeasResultLoggingNR-r16 SEQUENCE {	1 entry		
MeasResultLoggingNR-r16[1] SEQUENCE {		entry 1	
physCellId-r16	Same as NR Cell 11		

resultsSSB-Cell-r16	MeasQuantityResults of NR Cell 11		
numberOfGoodSSB-r16	Not checked		
}			
}			
}			
measResultNeighCellListEUTRA	Not present		
}			
anyCellSelectionDetected-r16	Not present		
}			
logMeasAvailable-r16	Not present		
}			
}			
}			
}			

8.1.6.1.2.2 Logged MDT / RRC_INACTIVE / Logging and reporting / Inter-frequency measurement

8.1.6.1.2.2.1 Test Purpose (TP)

(1)

```
with { UE in NR RRC_INACTIVE state camping normally on an NR cell where logged measurement is
configured without areaConfiguration and the UE is able to detect an NR inter-frequency cell }
ensure that {
  when { T330 is running }
  then { UE is logging serving cell measurements and Inter-frequency neighbouring cell
measurements }
}
```

(2)

```
with { UE in NR RRC_INACTIVE state and has sent RRCResumeRequest message and UE has one or more
logged Inter-frequency neighbouring cell measurement entries stored in VarLogMeasReport }
ensure that {
  when { receiving RRCResume message }
  then { UE includes the logMeasAvailable IE in the RRCResumeComplete message }
}
```

(3)

```
with { UE in NR RRC_CONNECTED state and UE has one or more logged Inter-frequency neighbouring cell
measurement entries stored in VarLogMeasReport }
ensure that {
  when { receiving UEInformationRequest message }
  then { UE transmits UEInformationResponse messages with a logMeasReport with Inter-frequency
neighbouring cell measurements }
}
```

(4)

```
with { UE in NR RRC_CONNECTED state and UE has one or more logged Inter-frequency neighbouring cell
measurement entries stored in VarLogMeasReport }
ensure that {
  when { receiving UEInformationRequest message and the UE has not transferred the total log in the
UEInformationResponse message }
  then { UE transmits UEInformationResponse messages with the logMeasAvailable IE }
}
```

8.1.6.1.2.2.2 Conformance requirements

References: The conformance requirements covered in the current TC are specified in: TS 38.331, clauses 5.3.13.4, 5.5a.1.3, 5.5a.3.2, 5.7.10.3 and 6.2.2. Unless otherwise stated these are Rel-16 requirements. [TS 38.331, clause 5.3.13.4]

The UE shall:

1> stop timer T319;

1> stop timer T380, if running;

...

1> set the content of the of *RRCResumeComplete* message as follows:

2> if the upper layer provides NAS PDU, set the *dedicatedNAS-Message* to include the information received from upper layers;

...

2> if the UE has logged measurements available for NR and if the RPLMN is included in *plmn-IdentityList* stored in *VarLogMeasReport*:

3> include the *logMeasAvailable* in the *RRCResumeComplete* message;

2> if the UE has Bluetooth logged measurements available and if the RPLMN is included in *plmn-IdentityList* stored in *VarLogMeasReport*:

3> include the *logMeasAvailableBT* in the *RRCResumeComplete* message;

2> if the UE has WLAN logged measurements available and if the RPLMN is included in *plmn-IdentityList* stored in *VarLogMeasReport*:

3> include the *logMeasAvailableWLAN* in the *RRCResumeComplete* message;

...

[TS 38.331, clause 5.5a.1.3]

Upon receiving the *LoggedMeasurementConfiguration* message the UE shall:

1> discard the logged measurement configuration as well as the logged measurement information as specified in 5.5a.2;

1> store the received *loggingDuration*, *reportType* and *areaConfiguration*, if included, in *VarLogMeasConfig*;

1> if the *LoggedMeasurementConfiguration* message includes *plmn-IdentityList*:

2> set *plmn-IdentityList* in *VarLogMeasReport* to include the RPLMN as well as the PLMNs included in *plmn-IdentityList*;

1> else:

2> set *plmn-IdentityList* in *VarLogMeasReport* to include the RPLMN;

1> store the received *absoluteTimeInfo*, *traceReference*, *traceRecordingSessionRef*, and *tce-Id* in *VarLogMeasReport*;

1> store the received *bt-NameList*, if included, in *VarLogMeasConfig*;

1> store the received *wlan-NameList*, if included, in *VarLogMeasConfig*;

1> store the received *sensor-NameList*, if included, in *VarLogMeasConfig*;

1> start timer T330 with the timer value set to the *loggingDuration*;

[TS 38.331, clause 5.5a.3.2]

While T330 is running, the UE shall:

- 1> perform the logging in accordance with the following:
 - 2> if the *reportType* is set to *periodical* in the *VarLogMeasConfig*:
 - 3> if the UE is camping normally on an NR cell and if the RPLMN is included in *plmn-IdentityList* stored in *VarLogMeasReport* and, if the cell is part of the area indicated by *areaConfiguration* if configured in *VarLogMeasConfig*:
 - 4> perform the logging at regular time intervals, as defined by the *loggingInterval* in the *VarLogMeasConfig*;
 - 2> else if the *reportType* is set to *eventTriggered*, and *eventType* is set to *outOfCoverage*:
 - 3> perform the logging at regular time intervals as defined by the *loggingInterval* in *VarLogMeasConfig* only when the UE is in any cell selection state;
 - 3> perform the logging immediately upon transitioning from the any cell selection state to the camped normally state;
 - 2> else if the *reportType* is set to *eventTriggered* and *eventType* is set to *eventLI*:
 - 3> if the UE is camping normally on an NR cell and if the RPLMN is included in *plmn-IdentityList* stored in *VarLogMeasReport* and, if the cell is part of the area indicated by *areaConfiguration* if configured in *VarLogMeasConfig*:
 - 4> perform the logging at regular time intervals as defined by the *loggingInterval* in *VarLogMeasConfig* only when the conditions indicated by the *eventLI* are met;
 - 2> when performing the logging:
 - 3> set the *relativeTimeStamp* to indicate the elapsed time since the moment at which the logged measurement configuration was received;
 - 3> if detailed location information became available during the last logging interval, set the content of the *locationInfo* as in 5.3.3.7;
 - 3> if the UE is in any cell selection state (as specified in TS 38.304 [20]):
 - 4> set *anyCellSelectionDetected* to indicate the detection of no suitable or no acceptable cell found;
 - 4> set the *servCellIdentity* to indicate global cell identity of the last logged cell that the UE was camping on;
 - 4> set the *measResultServingCell* to include the quantities of the last logged cell the UE was camping on;
 - 3> else:
 - 4> set the *servCellIdentity* to indicate global cell identity of the cell the UE is camping on;
 - 4> set the *measResultServingCell* to include the quantities of the cell the UE is camping on;
 - 4> if available, set the *measResultNeighCells*, in order of decreasing ranking-criterion as used for cell reselection, to include neighbouring cell measurements that became available during the last logging interval for at most the following number of neighbouring cells: 6 intra-frequency and 3 inter-frequency neighbours per frequency as well as 3 inter-RAT neighbours, per frequency/ set of frequencies per RAT and according to the following:
 - 5> for each neighbour cell included, include the optional fields that are available;
 - 2> when the memory reserved for the logged measurement information becomes full, stop timer T330 and perform the same actions as performed upon expiry of T330, as specified in 5.5a.1.4.

NOTE: The UE includes the latest results of the available measurements as used for cell reselection evaluation in RRC_IDLE or RRC_INACTIVE, which are performed in accordance with the performance requirements as specified in TS 38.133 [14].

[TS 38.331, clause 5.7.10.3]

Upon receiving the *UEInformationRequest* message, the UE shall, only after successful security activation:

...

- 1> if the *logMeasReportReq* is present and if the RPLMN is included in *plmn-IdentityList* stored in *VarLogMeasReport*:
 - 2> if *VarLogMeasReport* includes one or more logged measurement entries, set the contents of the *logMeasReport* in the *UEInformationResponse* message as follows:
 - 3> include the *absoluteTimeStamp* and set it to the value of *absoluteTimeInfo* in the *VarLogMeasReport*;
 - 3> include the *traceReference* and set it to the value of *traceReference* in the *VarLogMeasReport*;
 - 3> include the *traceRecordingSessionRef* and set it to the value of *traceRecordingSessionRef* in the *VarLogMeasReport*;
 - 3> include the *tce-Id* and set it to the value of *tce-Id* in the *VarLogMeasReport*;
 - 3> include the *logMeasInfoList* and set it to include one or more entries from *VarLogMeasReport* starting from the entries logged first;
 - 3> if the *VarLogMeasReport* includes one or more additional logged measurement entries that are not included in the *logMeasInfoList* within the *UEInformationResponse* message:
 - 4> include the *logMeasAvailable*;
 - 3> if the *VarLogMeasReport* includes one or more additional logged Bluetooth measurement entries that are not included in the *logMeasInfoList* within the *UEInformationResponse* message:
 - 4> include the *logMeasAvailableBT*;
 - 3> if the *VarLogMeasReport* includes one or more additional logged WLAN measurement entries that are not included in the *logMeasInfoList* within the *UEInformationResponse* message:
 - 4> include the *logMeasAvailableWLAN*;

...

- 1> if the *logMeasReport* is included in the *UEInformationResponse*:
 - 2> submit the *UEInformationResponse* message to lower layers for transmission via SRB2;
 - 2> discard the logged measurement entries included in the *logMeasInfoList* from *VarLogMeasReport* upon successful delivery of the *UEInformationResponse* message confirmed by lower layers;
- 1> else:
 - 2> submit the *UEInformationResponse* message to lower layers for transmission via SRB1.

[TS 38.331, clause 6.2.2]

– LoggedMeasurementConfiguration

The *LoggedMeasurementConfiguration* message is used to perform logging of measurement results while in RRC_IDLE or RRC_INACTIVE. It is used to transfer the logged measurement configuration for network performance optimisation.

Signalling radio bearer: SRB1

RLC-SAP: AM

Logical channel: DCCH

Direction: Network to UE

LoggedMeasurementConfiguration message

```

-- ASN1START
-- TAG-LOGGEDMEASUREMENTCONFIGURATION-START

LoggedMeasurementConfiguration-r16 ::= SEQUENCE {
    criticalExtensions          CHOICE {
        loggedMeasurementConfiguration-r16  LoggedMeasurementConfiguration-r16-IEs,
        criticalExtensionsFuture             SEQUENCE {}
    }
}

LoggedMeasurementConfiguration-r16-IEs ::= SEQUENCE {
    traceReference-r16          TraceReference-r16,
    traceRecordingSessionRef-r16 OCTET STRING (SIZE (2)),
    tce-Id-r16                  OCTET STRING (SIZE (1)),
    absoluteTimeInfo-r16       AbsoluteTimeInfo-r16,
    areaConfiguration-r16      AreaConfiguration-r16                OPTIONAL,
--Need R
    plmn-IdentityList-r16      PLMN-IdentityList2-r16            OPTIONAL,
--Need R
    bt-NameList-r16           SetupRelease {BT-NameList-r16}     OPTIONAL,
--Need M
    wlan-NameList-r16         SetupRelease {WLAN-NameList-r16}   OPTIONAL,
--Need M
    sensor-NameList-r16       SetupRelease {Sensor-NameList-r16}  OPTIONAL,
--Need M
    loggingDuration-r16       LoggingDuration-r16,
    reportType                 CHOICE {
        periodical             LoggedPeriodicalReportConfig-r16,
        eventTriggered         LoggedEventTriggerConfig-r16,
        ...
    },
    lateNonCriticalExtension   OCTET STRING                OPTIONAL,
    nonCriticalExtension       SEQUENCE {}                  OPTIONAL
}

LoggedPeriodicalReportConfig-r16 ::= SEQUENCE {
    loggingInterval-r16       LoggingInterval-r16,
    ...
}

LoggedEventTriggerConfig-r16 ::= SEQUENCE {
    eventType-r16             EventType-r16,
    loggingInterval-r16       LoggingInterval-r16,
    ...
}

EventType-r16 ::= CHOICE {
    outOfCoverage             NULL,
    eventL1                   SEQUENCE {
        l1-Threshold           MeasTriggerQuantity,
        hysteresis             Hysteresis,
        timeToTrigger          TimeToTrigger
    },
    ...
}

-- TAG-LOGGEDMEASUREMENTCONFIGURATION-STOP
-- ASN1STOP

```

LoggedMeasurementConfiguration field descriptions
absoluteTimeInfo Indicates the absolute time in the current cell.
areaConfiguration Used to restrict the area in which the UE performs measurement logging to cells broadcasting either one of the included cell identities or one of the included tracking area codes/ frequencies.
eventType The value outOfCoverage indicates the UE to perform logging of measurements when the UE enters any cell selection state, and the value eventL1 indicates the UE to perform logging of measurements when the triggering condition (similar as event A2 as specified in 5.5.4.3) as configured in the event is met for the camping cell in camped normally state.
plmn-IdentityList Indicates a set of PLMNs defining when the UE performs measurement logging as well as the associated status indication and information retrieval i.e. the UE performs these actions when the RPLMN is part of this set of PLMNs.
tce-Id Parameter Trace Collection Entity Id: See TS 32.422 [52].
traceRecordingSessionRef Parameter Trace Recording Session Reference: See TS 32.422 [52].
reportType Parameter configures the type of MDT configuration, specifically Periodic MDT configuration or Event Triggered MDT configuration.

8.1.6.1.2.2.3 Test description

8.1.6.1.2.2.3.1 Pre-test conditions

System Simulator:

- NR Cell 1 is the serving cell and NR Cell 3 is a suitable neighbour inter-frequency cell.
- System information combination NR-4 as defined in TS 38.508-1 [4] clause 4.4.3.1.2 is used in NR cells.

UE:

- None.

Preamble:

- The UE is in state 3N-A on NR Cell 1 according to TS 38.508-1 [4], clause 4.4A.2 Table 4.4A.2-3.

8.1.6.1.2.2.3.2 Test procedure sequence

Table 8.1.6.1.2.2.3.2-1: Main behaviour

St	Procedure	Message Sequence		TP	Verdict
		U - S	Message		
1	SS transmits a <i>LoggedMeasurementConfiguration</i> message with loggingInterval is set to '320ms' to configure the UE to perform logging of measurement results while in RRC_INACTIVE.	<--	NR RRC: <i>LoggedMeasurementConfiguration</i>	-	-
2	The SS transmits an <i>RRCRelease</i> message.	<--	NR RRC: <i>RRCRelease</i>	-	-
3	Wait 5 minutes to allow UE to activate logging. Note: Make the UE to log more than 520 entries of LogMeasInfo, and UE can't transfer the total log in one UEInformationResponse message.	-	-	-	-
4	The SS transmits a <i>Paging</i> message including a matched identity (correct fullI-RNTI).	<--	NR RRC: <i>Paging</i>	-	-
5	The UE transmits an <i>RRCResumeRequest</i> message by setting <i>resumIdentity</i> to the stored <i>shortI-RNTI</i> value.	-->	NR RRC: <i>RRCResumeRequest</i>	-	-

6	The SS transmits an <i>RRCResume</i> message.	<--	NR RRC: <i>RRCResume</i>	-	-
7	Check: Does the UE include the IE <i>logMeasAvailable</i> in the <i>RRCResumeComplete</i> message?	-->	NR RRC: <i>RRCResumeComplete</i>	2	P
8	The SS transmits a <i>UEInformationRequest</i> message on NR Cell 1.	<--	NR RRC: <i>UEInformationRequest</i>	-	-
9	Check: Does the UE transmit a <i>UEInformationResponse</i> message with a <i>LogMeasInfoList</i> with at least one neighbouring cell measurement of NR Cell 3 and the <i>logMeasAvailable</i> IE?	-->	NR RRC: <i>UEInformationResponse</i>	1, 3, 4	P
10	The SS sends an <i>UEInformationRequest</i> message to get <i>logMeasReport</i> .	<--	NR RRC: <i>UEInformationRequest</i>	-	-
11	The UE sends an <i>UEInformationResponse</i> message including <i>logMeasReport</i> .	-->	NR RRC: <i>UEInformationResponse</i>	-	-

8.1.6.1.2.2.3.3 Specific message contents

Table 8.1.6.1.2.2.3.3-1: *LoggedMeasurementConfiguration* (step 1, Table 8.1.6.1.2.2.3.2-1)

Derivation path: TS 38.508-1 [4], Table 4.6.1-5AA			
Information Element	Value/remark	Comment	Condition
LoggedMeasurementConfiguration-r16 ::= SEQUENCE {			
criticalExtensions CHOICE {			
loggedMeasurementConfiguration-r16 SEQUENCE {			
reportType CHOICE {			
periodical SEQUENCE {			
loggingInterval-r16	ms320	0.32 seconds	
}			
}			
}			
}			
}			

Table 8.1.6.1.2.2.3.3-2: *RRCRelease* (step 2, Table 8.1.6.1.2.2.3.2-1)

Derivation Path: TS 38.508-1 [4], Table 4.6.1-16 with condition NR_RRC_INACTIVE

Table 8.1.6.1.2.2.3.3-3: *RRCResumeComplete* (step 7, Table 8.1.6.1.2.2.3.2-1)

Derivation path: TS 38.508-1 [4], Table 4.6.1-18			
Information Element	Value/remark	Comment	Condition
RRCResumeComplete ::= SEQUENCE {			
criticalExtensions CHOICE {			
rrcResumeComplete SEQUENCE {			
nonCriticalExtension SEQUENCE {			
ue-MeasurementsAvailable-r16	UE-MeasurementsAvailable-r16 with condition LOG		
}			
}			
}			
}			

Table 8.1.6.1.2.2.3.3-4: *UEInformationRequest* (steps 8 and 10, Table 8.1.6.1.2.2.3.2-1)

Derivation path: TS 38.508-1 [4], Table 4.6.1-32A with condition LOG

Table 8.1.6.1.2.2.3.3-5: UEInformationResponse (steps 9 and 11, Table 8.1.6.1.2.2.3.2-1)

Derivation path: TS 38.508-1 [4], Table 4.6.1-32B			
Information Element	Value/remark	Comment	Condition
criticalExtensions CHOICE {			
ueInformationResponse-r16 SEQUENCE {			
UEInformationResponse-r16 ::= SEQUENCE {			
logMeasReport-r16 SEQUENCE {			
absoluteTimeStamp-r16	Same value as sent by SS in <i>LoggedMeasurementConfiguration</i> in step 1		
traceReference-r16 SEQUENCE {			
plmn-Identity-r16 SEQUENCE {			
mcc SEQUENCE (SIZE (3)) OF MCC-NMC-Digit	Same value as sent by SS in <i>LoggedMeasurementConfiguration</i> in step 1		
mnc SEQUENCE (SIZE (2..3)) OF MCC-NMC-Digit	Same value as sent by SS in <i>LoggedMeasurementConfiguration</i> in step 1		
}			
traceId-r16	Same value as sent by SS in <i>LoggedMeasurementConfiguration</i> in step 1		
}			
traceRecordingSessionRef-r16	Same value as sent by SS in <i>LoggedMeasurementConfiguration</i> in step 1		
tce-Id-r16	Same value as sent by SS in <i>LoggedMeasurementConfiguration</i> in step 1		
logMeasInfoList-r16 SEQUENCE (SIZE (1..maxLogMeasReport-r16)) OF LogMeasInfo-r16 SEQUENCE {	Total number of entries in step 9 and 11 exceeds 520 and all entries complies to entry with index 'x' below.		
LogMeasInfo-r16[x] SEQUENCE {		entry x	
locationInfo-r16	Not checked		
relativeTimeStamp-r16	SS record the value		
servCellIdentity-r16	Same as NR Cell 1		
measResultServCell-16 SEQUENCE {			
resultsSSB-Cell-r16	MeasQuantityResults of NR Cell 1		
resultsSSB SEQUENCE {			
best-ssb-Index	Not checked		
best-ssb-Results	Not checked		
numberOfGoodSSB	Not checked		
}			
}			
measResultNeighCells-r16 SEQUENCE {			
measResultNeighCellListNR SEQUENCE (SIZE (1..maxFreq)) OF MeasResultLogging2NR-r16 SEQUENCE {	1 entry		
MeasResultLogging2NR-r16[1] SEQUENCE {		entry 1	
carrierFreq-r16	Same as NR Cell 3		
measResultListLoggingNR-r16 SEQUENCE (SIZE (1..maxCellReport)) OF MeasResultLoggingNR-r16 SEQUENCE {	1 entry		
MeasResultLoggingNR-r16[1] SEQUENCE {		entry 1	
physCellId-r16	Same as NR Cell 3		

resultsSSB-Cell-r16	MeasQuantityResults of NR Cell 3		
numberOfGoodSSB-r16	Not checked		
}			
}			
}			
measResultNeighCellListEUTRA	Not present		
}			
anyCellSelectionDetected-r16	Not present		
}			
}			
logMeasAvailable-r16	True		Step 9
	Not checked		Step 11
}			
}			
}			

8.1.6.1.2.3 Logged MDT / Intra-frequency measurement, logging and reporting

8.1.6.1.2.3.1 Test Purpose (TP)

(1)

```
with { UE received LoggedMeasurementConfiguration message with a cellGlobalIdList on a NR cell }
ensure that {
  when { UE camps on a NR cell in the cellGlobalIdList }
  then { UE performs logged measurements }
}
```

(2)

```
with { UE received LoggedMeasurementConfiguration message with a cellGlobalIdList on a NR cell }
ensure that {
  when { UE camps on a NR cell not in the cellGlobalIdList }
  then { UE does not perform logged measurements }
}
```

(3)

```
with { UE received LoggedMeasurementConfiguration message with a trackingAreaCodeList on a NR cell }
ensure that {
  when { UE camps on a NR cell in the trackingAreaCodeList }
  then { UE performs logged measurements }
}
```

(4)

```
with { UE received LoggedMeasurementConfiguration message with a trackingAreaCodeList on a NR cell }
ensure that {
  when { UE camps on a NR cell not in the trackingAreaCodeList }
  then { UE does not perform logged measurements }
}
```

8.1.6.1.2.3.2 Conformance requirements

References: The conformance requirements covered in the current TC are specified in: TS 38.331, clauses 5.3.3.4, 5.5a.1.3, 5.5a.3.2, and 5.7.10.3. Unless otherwise stated these are Rel-16 requirements.

[TS 38.331, clause 5.3.3.4]

The UE shall perform the following actions upon reception of the *RRCSetup*:

...

2> set the content of *RRCSetupComplete* message as follows:

...

2> if the UE has logged measurements available for NR and if the RPLMN is included in *plmn-IdentityList* stored in *VarLogMeasReport*:

3> include the *logMeasAvailable* in the *RRCSetupComplete* message;

2> if the UE has Bluetooth logged measurements available and if the RPLMN is included in *plmn-IdentityList* stored in *VarLogMeasReport*:

3> include the *logMeasAvailableBT* in the *RRCSetupComplete* message;

2> if the UE has WLAN logged measurements available and if the RPLMN is included in *plmn-IdentityList* stored in *VarLogMeasReport*:

3> include the *logMeasAvailableWLAN* in the *RRCSetupComplete* message;

...

[TS 38.331, clause 5.7.10.3]

Upon receiving the *UEInformationRequest* message, the UE shall, only after successful security activation:

...

1> if the *logMeasReportReq* is present and if the RPLMN is included in *plmn-IdentityList* stored in *VarLogMeasReport*:

2> if *VarLogMeasReport* includes one or more logged measurement entries, set the contents of the *logMeasReport* in the *UEInformationResponse* message as follows:

3> include the *absoluteTimeStamp* and set it to the value of *absoluteTimeInfo* in the *VarLogMeasReport*;

3> include the *traceReference* and set it to the value of *traceReference* in the *VarLogMeasReport*;

3> include the *traceRecordingSessionRef* and set it to the value of *traceRecordingSessionRef* in the *VarLogMeasReport*;

3> include the *tce-Id* and set it to the value of *tce-Id* in the *VarLogMeasReport*;

3> include the *logMeasInfoList* and set it to include one or more entries from *VarLogMeasReport* starting from the entries logged first;

3> if the *VarLogMeasReport* includes one or more additional logged measurement entries that are not included in the *logMeasInfoList* within the *UEInformationResponse* message:

4> include the *logMeasAvailable*;

3> if the *VarLogMeasReport* includes one or more additional logged Bluetooth measurement entries that are not included in the *logMeasInfoList* within the *UEInformationResponse* message:

4> include the *logMeasAvailableBT*;

3> if the *VarLogMeasReport* includes one or more additional logged WLAN measurement entries that are not included in the *logMeasInfoList* within the *UEInformationResponse* message:

4> include the *logMeasAvailableWLAN*;

...

1> if the *logMeasReport* is included in the *UEInformationResponse*:

2> submit the *UEInformationResponse* message to lower layers for transmission via SRB2;

2> discard the logged measurement entries included in the *logMeasInfoList* from *VarLogMeasReport* upon successful delivery of the *UEInformationResponse* message confirmed by lower layers;

1> else:

2> submit the *UEInformationResponse* message to lower layers for transmission via SRB1.

[TS 38.331, clause 5.5a.1.3]

Upon receiving the *LoggedMeasurementConfiguration* message the UE shall:

1> discard the logged measurement configuration as well as the logged measurement information as specified in 5.5a.2;

1> store the received *loggingDuration*, *reportType* and *areaConfiguration*, if included, in *VarLogMeasConfig*;

1> if the *LoggedMeasurementConfiguration* message includes *plmn-IdentityList*:

2> set *plmn-IdentityList* in *VarLogMeasReport* to include the RPLMN as well as the PLMNs included in *plmn-IdentityList*;

1> else:

2> set *plmn-IdentityList* in *VarLogMeasReport* to include the RPLMN;

1> store the received *absoluteTimeInfo*, *traceReference*, *traceRecordingSessionRef*, and *tce-Id* in *VarLogMeasReport*;

1> store the received *bt-NameList*, if included, in *VarLogMeasConfig*;

1> store the received *wlan-NameList*, if included, in *VarLogMeasConfig*;

1> store the received *sensor-NameList*, if included, in *VarLogMeasConfig*;

1> start timer T330 with the timer value set to the *loggingDuration*;

[TS 38.331, clause 5.5a.3.2]

While T330 is running, the UE shall:

1> perform the logging in accordance with the following:

2> if the *reportType* is set to *periodical* in the *VarLogMeasConfig*:

3> if the UE is camping normally on an NR cell and if the RPLMN is included in *plmn-IdentityList* stored in *VarLogMeasReport* and, if the cell is part of the area indicated by *areaConfiguration* if configured in *VarLogMeasConfig*:

4> perform the logging at regular time intervals, as defined by the *loggingInterval* in the *VarLogMeasConfig*;

2> else if the *reportType* is set to *eventTriggered*, and *eventType* is set to *outOfCoverage*:

3> perform the logging at regular time intervals as defined by the *loggingInterval* in *VarLogMeasConfig* only when the UE is in any cell selection state;

3> perform the logging immediately upon transitioning from the any cell selection state to the camped normally state;

2> else if the *reportType* is set to *eventTriggered* and *eventType* is set to *eventLI*:

3> if the UE is camping normally on an NR cell and if the RPLMN is included in *plmn-IdentityList* stored in *VarLogMeasReport* and, if the cell is part of the area indicated by *areaConfiguration* if configured in *VarLogMeasConfig*;

4> perform the logging at regular time intervals as defined by the *loggingInterval* in *VarLogMeasConfig* only when the conditions indicated by the *eventLI* are met;

2> when performing the logging:

- 3> set the *relativeTimeStamp* to indicate the elapsed time since the moment at which the logged measurement configuration was received;
- 3> if detailed location information became available during the last logging interval, set the content of the *locationInfo* as in 5.3.3.7:
- 3> if the UE is in any cell selection state (as specified in TS 38.304 [20]):
 - 4> set *anyCellSelectionDetected* to indicate the detection of no suitable or no acceptable cell found;
 - 4> set the *servCellIdentity* to indicate global cell identity of the last logged cell that the UE was camping on;
 - 4> set the *measResultServingCell* to include the quantities of the last logged cell the UE was camping on;
- 3> else:
 - 4> set the *servCellIdentity* to indicate global cell identity of the cell the UE is camping on;
 - 4> set the *measResultServingCell* to include the quantities of the cell the UE is camping on;
 - 4> if available, set the *measResultNeighCells*, in order of decreasing ranking-criterion as used for cell reselection, to include neighbouring cell measurements that became available during the last logging interval for at most the following number of neighbouring cells: 6 intra-frequency and 3 inter-frequency neighbours per frequency as well as 3 inter-RAT neighbours, per frequency/ set of frequencies per RAT and according to the following:
 - 5> for each neighbour cell included, include the optional fields that are available;

NOTE: The UE includes the latest results of the available measurements as used for cell reselection evaluation in RRC_IDLE or RRC_INACTIVE, which are performed in accordance with the performance requirements as specified in TS 38.133 [14].

- 2> when the memory reserved for the logged measurement information becomes full, stop timer T330 and 8.1.6.1.2.3.3 Test description

8.1.6.1.2.3.3.1 Pre-test conditions

System Simulator:

- NR Cell 1, NR Cell 2 and NR Cell 11.
- System information combination NR-2 as defined in TS 38.508-1 [4] clause 4.4.3.1.2 is used in NR cells.

UE:

- None.

Preamble:

- The UE is in state 3N-A according to TS 38.508-1 [4], clause 4.4A.2 Table 4.4A.2-3 on NR Cell 1.

8.1.6.1.2.3.3.2 Test procedure sequence

Table 8.1.6.1.2.3.3.2-1/2 illustrate the downlink power levels and other changing parameters to be applied for the cell at various time instants of the test execution. The configuration "T0" indicates the initial conditions. The exact instants on which these values shall be applied are described in the texts in this clause.

Table 8.1.6.1.2.3.3.2-1: Time instances of cell power level for FR1

	Parameter	Unit	NR Cell 1	NR Cell 2	NR Cell 11	Remark
T0	SS/PBCH SSS EPRE	dBm/ SCS	-78	"Off"	"Off"	NR Cell 1 becomes the highest ranked cell.
T1	SS/PBCH	dBm/	-85	"Off"	-78	NR Cell 11 becomes the highest ranked cell.

	SSS EPRE	SCS				
T2	SS/PBCH SSS EPRE	dBm/ SCS	-85	-78	"Off"	NR Cell 2 becomes the highest ranked cell.
T3	SS/PBCH SSS EPRE	dBm/ SCS	-85	"Off"	-78	NR Cell 11 becomes the highest ranked cell.
T4	SS/PBCH SSS EPRE	dBm/ SCS	-78	"Off"	-85	NR Cell 1 becomes the highest ranked cell.
Note: The downlink signal level uncertainty is specified in TS 38.508-1 [4] clause 6.2.2.1.						

Table 8.1.6.1.2.3.3.2-2: Time instances of cell power level for FR2

	Parameter	Unit	NR Cell 1	NR Cell 2	NR Cell 11	Remark
T0	SS/PBCH SSS EPRE	dBm/ SCS	-82	-91	-91	NR Cell 1 becomes the highest ranked cell.
T1	SS/PBCH SSS EPRE	dBm/ SCS	-91	-91	-82	NR Cell 11 becomes the highest ranked cell.
T2	SS/PBCH SSS EPRE	dBm/ SCS	-91	-82	-91	NR Cell 2 becomes the highest ranked cell.
T3	SS/PBCH SSS EPRE	dBm/ SCS	-91	-91	-82	NR Cell 11 becomes the highest ranked cell.
T4	SS/PBCH SSS EPRE	dBm/ SCS	-82	-91	-91	NR Cell 1 becomes the highest ranked cell.
Note: The downlink signal level uncertainty is specified in TS 38.508-1 [4] clause 6.2.2.2.						

Table 8.1.6.1.2.3.3.2-3: Main behaviour

St	Procedure	Message Sequence		TP	Verdict
		U - S	Message		
1	The SS transmits a <i>LoggedMeasurementConfiguration</i> message with a <i>cellGlobalIdList</i> on NR Cell 1.	<--	NR RRC: <i>LoggedMeasurementConfiguration</i>	-	-
2	SS transmits a <i>RRCRelease</i> message to release the RRC connection.	<--	NR RRC: <i>RRCRelease</i>	-	-
3	The SS changes NR Cell 1, NR Cell 2 and NR Cell 11 level according to the row "T1" in Table 8.1.6.1.2.3.3.2-1/2.	-	-	-	-
4-9	Steps 1 to 6a1 of generic test procedure in TS 38.508-1 [4] subclause 4.9.5.2.2-1 are performed on NR Cell 11.	-	-	-	-
10	Wait 30 seconds for UE logging interval timer to expire at least once.	-	-	-	-
11-18	Steps 1 to 8 of the generic radio bearer establishment procedure in TS 38.508-1 [4] Table 4.5.4.2-3 are executed to successfully complete the service request procedure on NR Cell 11.	-	-	-	-
19	Void	-	-	-	-
20	The SS sends a <i>UEInformationRequest</i> message to get <i>logMeasReport</i> .	<--	NR RRC: <i>UEInformationRequest</i>	-	-
21	Check: Does the UE send a <i>UEInformationResponse</i> message including at least one <i>logMeasReport</i> with serving cell measurements for NR Cell 11?	-->	NR RRC: <i>UEInformationResponse</i>	1	P
22	SS transmits a <i>RRCRelease</i> message to release the RRC connection.	<--	NR RRC: <i>RRCRelease</i>	-	-
23	The SS changes NR Cell 1, NR Cell 2 and NR Cell 11 level according to the row "T2" in Table 8.1.6.1.2.3.3.2-1/2.	-	-	-	-
24-29	Steps 1 to 6a1 of generic test procedure in TS 38.508-1 [4] subclause 4.9.5.2.2-1 are performed on NR Cell 2.	-	-	-	-
30	Wait 30 seconds for UE logging interval timer to expire at least once.	-	-	-	-

31	The SS transmits a <i>Paging</i> message.	<--	NR RRC: <i>Paging</i>	-	-
32	The UE transmits an <i>RRCSetupRequest</i> message.	-->	NR RRC: <i>RRCSetupRequest</i>	-	-
33	The SS transmits an <i>RRCSetup</i> message.	<--	NR RRC: <i>RRCSetup</i>	-	-
-	EXCEPTION: In case the UE had performed a logging before the cell re-selection to NR Cell 2 then the steps 34a1-34a7 are executed.				
34a1	The UE transmits an <i>RRCSetupComplete</i> message including <i>logMeasAvailable</i> IE set it to <i>true</i> .	-->	NR RRC: <i>RRCSetupComplete</i>	-	-
34a2 - 34a5	Steps 5 to 8 of the generic procedure in TS 38.508-1 [4] Table 4.5.4.2-3 are executed to successfully complete the service request procedure.	-	-	-	-
34a6	The SS sends a <i>UEInformationRequest</i> message to get <i>logMeasReport</i> .	<--	NR RRC: <i>UEInformationRequest</i>	-	-
34a7	Check: Does the UE send a <i>UEInformationResponse</i> message with logged serving cell measurements of NR Cell 2?	-->	NR RRC: <i>UEInformationResponse</i>	2	F
-	EXCEPTION: In case the UE had not performed any logging before the cell re-selection to NR Cell 2 then the step 34b1 is executed.	-	-	-	-
34b1	Check: Does UE transmit an <i>RRCSetupComplete</i> message with <i>logMeasAvailable</i> IE not present?	-->	NR RRC: <i>RRCSetupComplete</i>	2	P
35	The SS transmits a <i>LoggedMeasurementConfiguration</i> message with a trackingAreaCodeList on NR Cell 2.	<--	NR RRC: <i>LoggedMeasurementConfiguration</i>	-	-
36	The SS transmits an <i>RRCRelease</i> message to release RRC connection and move to RRC_IDLE on NR Cell 2.	<--	NR RRC: <i>RRCRelease</i>	-	-
37	The SS changes NR Cell 1, NR Cell 2 and NR Cell 11 level according to the row "T3" in Table 8.1.6.1.2.3.3.2-1/2.	-	-	-	-
38- 43	Steps 1 to 6a1 of generic test procedure in TS 38.508-1 [4] subclause 4.9.5.2.2-1 are performed on NR Cell 11.	-	-	-	-
44	The SS transmits a <i>Paging</i> message on NR Cell 11.	<--	NR RRC: <i>Paging</i>	-	-
45	The UE transmits an <i>RRCSetupRequest</i> message on NR Cell 11.	-->	NR RRC: <i>RRCSetupRequest</i>	-	-
46	The SS transmits an <i>RRCSetup</i> message on NR Cell 11.	<--	NR RRC: <i>RRCSetup</i>	-	-
-	EXCEPTION: In case the UE had performed a logging before the cell re-selection to NR Cell 11 then the steps 47a1-47a7 are executed.	-	-	-	-
47a1	The UE transmits an <i>RRCSetupComplete</i> message including <i>logMeasAvailable</i> IE set it to <i>true</i> .	-->	NR RRC: <i>RRCSetupComplete</i>	-	-
47a2 - 47a5	Steps 5 to 8 of the generic procedure in TS 38.508-1 [4] Table 4.5.4.2-3 are executed to successfully complete the service request procedure.	-	-	-	-
47a6	The SS sends a <i>UEInformationRequest</i> message to get <i>logMeasReport</i> .	<--	NR RRC: <i>UEInformationRequest</i>	-	-
47a7	Check: Does the UE send a <i>UEInformationResponse</i> message with logged serving cell measurements of NR Cell 11?	-->	NR RRC: <i>UEInformationResponse</i>	4	F
-	EXCEPTION: In case the UE had not performed any logging before the cell re-selection to NR Cell 11 then the step 47b1-47b5 are executed.	-	-	-	-
47b1	Check: Does UE transmit an <i>RRCSetupComplete</i> message with <i>logMeasAvailable</i> IE not present?	-->	NR RRC: <i>RRCSetupComplete</i>	4	P

47b2 - 47b5	Steps 5 to 8 of the generic procedure in TS 38.508-1 [4] Table 4.5.4.2-3 are executed to successfully complete the service request procedure.	-	-	-	-
48	The SS transmits an <i>RRCRelease</i> message to release the RRC connection.	<--	NR RRC: <i>RRCRelease</i>	-	-
49	The SS changes NR Cell 1, NR Cell 2 and NR Cell 11 level according to the row "T4" in Table 8.1.6.1.2.3.3.2-1/2.	-	-	-	-
50- 55	Steps 1 to 6a1 of generic test procedure in TS 38.508-1 [4] subclause 4.9.5.2.2-1 are performed on NR Cell 1.	-	-	-	-
56	Wait 30 seconds for UE logging interval timer to expire at least once.	-	-	-	-
57- 64	Steps 1 to 8 of the generic procedure in TS 38.508-1 [4] Table 4.5.4.2-3 are executed to successfully complete the service request procedure.	-	-	-	-
65	Void	-	-	-	-
66	The SS sends a <i>UEInformationRequest</i> message to get <i>logMeasReport</i> .	<--	NR RRC: <i>UEInformationRequest</i>		
67	Check: Does the UE send a <i>UEInformationResponse</i> include <i>logMeasReport</i> with logged serving cell measurements of NR Cell 1?	-->	NR RRC: <i>UEInformationResponse</i>	3	P

8.1.6.1.2.3.3.3 Specific message contents

Table 8.1.6.1.2.3.3-1: *LoggedMeasurementConfiguration* (step 1, Table 8.1.6.1.2.3.3.2-3)

Derivation path: TS 38.508-1 [4], Table 4.6.1-5AA with condition PERIODICAL			
Information Element	Value/remark	Comment	Condition
LoggedMeasurementConfiguration-r16 ::= SEQUENCE {			
criticalExtensions CHOICE {			
loggedMeasurementConfiguration-r16 SEQUENCE {			
areaConfiguration-r16 SEQUENCE {			
areaConfig-r16 CHOICE {			
CellGlobalIdList-r16 SEQUENCE (SIZE (1)) OF CGI-Info-Logging-r16 {			
plmn-Identity-r16	Set to the same Mobile Country Code and Mobile Network Code stored in EFIMSI on the test USIM card		
cellIdentity-r16	Same as NR Cell 11		
trackingAreaCode-r16	2		
}			
}			
}			
}			
}			
}			

Table 8.1.6.1.2.3.3-2: *LoggedMeasurementConfiguration* (step 35, Table 8.1.6.1.2.3.3.2-3)

Derivation path: TS 38.508-1 [4], Table 4.6.1-5AA with condition PERIODICAL			
Information Element	Value/remark	Comment	Condition
LoggedMeasurementConfiguration-r16 ::= SEQUENCE {			
criticalExtensions CHOICE {			
loggedMeasurementConfiguration-r16 SEQUENCE {			

areaConfiguration-r16 SEQUENCE {			
areaConfig-r16 CHOICE {			
trackingAreaCodeList-r16 SEQUENCE (SIZE (1...)) OF TrackingAreaCode {	1 entry		
TrackingAreaCode	1	Entry 1	
}			
}			
}			

Table 8.1.6.1.2.3.3.3-3: RRCSetupComplete (steps 34b1 and 47b1, Table 8.1.6.1.2.3.3.2-3)

Derivation path: TS 38.508-1 [4], Table 4.6.1-22			
Information Element	Value/remark	Comment	Condition
RRCSetupComplete ::= SEQUENCE {			
criticalExtensions CHOICE {			
rrcSetupComplete SEQUENCE {			
nonCriticalExtension	Not present		
}			
}			
}			

Table 8.1.6.1.2.3.3.3-4: RRCSetupComplete (steps 14, 34a1, 47a1, and 60, Table 8.1.6.1.2.3.3.2-3)

Derivation path: TS 38.508-1 [4], Table 4.6.1-22			
Information Element	Value/remark	Comment	Condition
RRCSetupComplete ::= SEQUENCE {			
criticalExtensions CHOICE {			
rrcSetupComplete SEQUENCE {			
nonCriticalExtension SEQUENCE {			
ue-MeasurementsAvailable-r16	UE-MeasurementsAvailable-r16 with condition LOG		
}			
}			
}			
}			

Table 8.1.6.1.2.3.3.3-5: UEInformationRequest (steps 20, 34a6, 47a6, and 66, Table 8.1.6.1.2.3.3.2-3)

Derivation path: TS 38.508-1 [4], Table 4.6.1-32A with condition LOG			
--	--	--	--

Table 8.1.6.1.2.3.3.3-6: UEInformationResponse (steps 21 and 34a7, Table 8.1.6.1.2.3.3.2-3)

Derivation path: TS 38.508-1 [4], Table 4.6.1-32B			
Information Element	Value/remark	Comment	Condition
UEInformationResponse-r16 ::= SEQUENCE {			
criticalExtensions CHOICE {			
ueInformationResponse-r16 SEQUENCE {			
logMeasReport-r16 SEQUENCE {			
absoluteTimeStamp-r16	Same value as sent by SS in LoggedMeasurementConfiguration in step 1		
traceReference-r16 SEQUENCE {			
plmn-Identity-r16 SEQUENCE {			
mcc SEQUENCE (SIZE (3)) OF MCC-NMC-Digit	Same value as sent by SS in		

	<i>LoggedMeasurementCon</i> <i>figuration</i> in step 1		
mnc SEQUENCE (SIZE (2..3)) OF MCC-NMC-Digit	Same value as sent by SS in <i>LoggedMeasurementCon</i> <i>figuration</i> in step 1		
}			
traceId-r16	Same value as sent by SS in <i>LoggedMeasurementCon</i> <i>figuration</i> in step 1		
}			
traceRecordingSessionRef-r16	Same value as sent by SS in <i>LoggedMeasurementCon</i> <i>figuration</i> in step 1		
tce-Id-r16	Same value as sent by SS in <i>LoggedMeasurementCon</i> <i>figuration</i> in step 1		
logMeasInfoList-r16 SEQUENCE (SIZE (1..maxLogMeasReport-r16)) OF LogMeasInfo-r16 SEQUENCE {	At least one entry and all entries complies to entry with index 'x' below.		
LogMeasInfo-r16[x] SEQUENCE {		entry x	
locationInfo-r16	Not checked		
relativeTimeStamp-r16	SS record the value		
servCellIdentity-r16	Same as NR Cell 11	No logged serving cell measurement of NR Cell 2	
measResultServCell-16 SEQUENCE {			
resultsSSB-Cell-r16	MeasQuantityResults of NR Cell 11		
resultsSSB SEQUENCE {			
best-ssb-Index	Not checked		
best-ssb-Results	Not checked		
numberOfGoodSSB	Not checked		
}			
}			
measResultNeighCells-r16	Any allowed value		
anyCellSelectionDetected-r16	Not present		
}			
}			
logMeasAvailable-r16	Not present		
}			
}			
}			
}			

Table 8.1.6.1.2.3.3.3-7: UEInformationResponse (step 47a7, Table 8.1.6.1.2.3.3.2-3)

Derivation path: TS 38.508-1 [4], Table 4.6.1-32B			
Information Element	Value/remark	Comment	Condition
UEInformationResponse-r16 ::= SEQUENCE {			
criticalExtensions CHOICE {			
ueInformationResponse-r16 SEQUENCE {			
logMeasReport-r16 SEQUENCE {			
absoluteTimeStamp-r16	Same value as sent by SS in <i>LoggedMeasurementCon</i> <i>figuration</i> in step 35		
traceReference-r16 SEQUENCE {			
plmn-Identity-r16 SEQUENCE {			
mcc SEQUENCE (SIZE (3)) OF MCC-NMC-Digit	Same value as sent by SS in		

	<i>LoggedMeasurementCon</i> <i>figuration</i> in step 35		
mnc SEQUENCE (SIZE (2..3)) OF MCC-NMC-Digit	Same value as sent by SS in <i>LoggedMeasurementCon</i> <i>figuration</i> in step 35		
}			
traceId-r16	Same value as sent by SS in <i>LoggedMeasurementCon</i> <i>figuration</i> in step 35		
}			
traceRecordingSessionRef-r16	Same value as sent by SS in <i>LoggedMeasurementCon</i> <i>figuration</i> in step 35		
tce-Id-r16	Same value as sent by SS in <i>LoggedMeasurementCon</i> <i>figuration</i> in step 1		
logMeasInfoList-r16 SEQUENCE (SIZE (1..maxLogMeasReport-r16)) OF LogMeasInfo-r16 SEQUENCE {	At least one entry and all entries complies to entry with index 'x' below.		
LogMeasInfo-r16[x] SEQUENCE {		entry x	
locationInfo-r16	Not checked		
relativeTimeStamp-r16	SS record the value		
servCellIdentity-r16	Same as NR Cell 2	No logged serving cell measurement of NR Cell 11	
measResultServCell-16 SEQUENCE {			
resultsSSB-Cell-r16	MeasQuantityResults of NR Cell 2		
resultsSSB SEQUENCE {			
best-ssb-Index	Not checked		
best-ssb-Results	Not checked		
numberOfGoodSSB	Not checked		
}			
}			
measResultNeighCells-r16	Any allowed value		
anyCellSelectionDetected-r16	Not present		
}			
}			
logMeasAvailable-r16	Not present		
}			
}			
}			
}			

Table 8.1.6.1.2.3.3.3-8: UEInformationResponse (step 67, Table 8.1.6.1.2.3.3.2-3)

Derivation path: TS 38.508-1 [4], Table 4.6.1-32B			
Information Element	Value/remark	Comment	Condition
UEInformationResponse-r16 ::= SEQUENCE {			
criticalExtensions CHOICE {			
ueInformationResponse-r16 SEQUENCE {			
logMeasReport-r16 SEQUENCE {			
absoluteTimeStamp-r16	Same value as sent by SS in <i>LoggedMeasurementCon</i> <i>figuration</i> in step 35		
traceReference-r16 SEQUENCE {			
plmn-Identity-r16 SEQUENCE {			
mcc SEQUENCE (SIZE (3)) OF MCC-NMC-Digit	Same value as sent by SS in		

8.1.6.1.2.4.2 Conformance requirements

References: The conformance requirements covered in the current TC are specified in: TS 38.331, clauses 5.3.3.4, 5.5a.1.3, 5.5a.3.2, 5.7.10.3 and 6.2.2. Unless otherwise stated these are Rel-16 requirements.

[TS 38.331, clause 5.3.3.4]

The UE shall perform the following actions upon reception of the *RRCSetup*:

...

3> set the content of *RRCSetupComplete* message as follows:

...

2> if the UE has logged measurements available for NR and if the RPLMN is included in *plmn-IdentityList* stored in *VarLogMeasReport*:

3> include the *logMeasAvailable* in the *RRCSetupComplete* message;

2> if the UE has Bluetooth logged measurements available and if the RPLMN is included in *plmn-IdentityList* stored in *VarLogMeasReport*:

3> include the *logMeasAvailableBT* in the *RRCSetupComplete* message;

2> if the UE has WLAN logged measurements available and if the RPLMN is included in *plmn-IdentityList* stored in *VarLogMeasReport*:

3> include the *logMeasAvailableWLAN* in the *RRCSetupComplete* message;

...

[TS 38.331, clause 5.7.10.3]

Upon receiving the *UEInformationRequest* message, the UE shall, only after successful security activation:

...

1> if the *logMeasReportReq* is present and if the RPLMN is included in *plmn-IdentityList* stored in *VarLogMeasReport*:

2> if *VarLogMeasReport* includes one or more logged measurement entries, set the contents of the *logMeasReport* in the *UEInformationResponse* message as follows:

3> include the *absoluteTimeStamp* and set it to the value of *absoluteTimeInfo* in the *VarLogMeasReport*;

3> include the *traceReference* and set it to the value of *traceReference* in the *VarLogMeasReport*;

3> include the *traceRecordingSessionRef* and set it to the value of *traceRecordingSessionRef* in the *VarLogMeasReport*;

3> include the *tce-Id* and set it to the value of *tce-Id* in the *VarLogMeasReport*;

3> include the *logMeasInfoList* and set it to include one or more entries from *VarLogMeasReport* starting from the entries logged first;

3> if the *VarLogMeasReport* includes one or more additional logged measurement entries that are not included in the *logMeasInfoList* within the *UEInformationResponse* message:

4> include the *logMeasAvailable*;

3> if the *VarLogMeasReport* includes one or more additional logged Bluetooth measurement entries that are not included in the *logMeasInfoList* within the *UEInformationResponse* message:

4> include the *logMeasAvailableBT*;

3> if the *VarLogMeasReport* includes one or more additional logged WLAN measurement entries that are not included in the *logMeasInfoList* within the *UEInformationResponse* message:

4> include the *logMeasAvailableWLAN*;

...

1> if the *logMeasReport* is included in the *UEInformationResponse*:

2> submit the *UEInformationResponse* message to lower layers for transmission via SRB2;

2> discard the logged measurement entries included in the *logMeasInfoList* from *VarLogMeasReport* upon successful delivery of the *UEInformationResponse* message confirmed by lower layers;

1> else:

2> submit the *UEInformationResponse* message to lower layers for transmission via SRB1.

[TS 38.331, clause 5.5a.1.3]

Upon receiving the *LoggedMeasurementConfiguration* message the UE shall:

1> discard the logged measurement configuration as well as the logged measurement information as specified in 5.5a.2;

1> store the received *loggingDuration*, *reportType* and *areaConfiguration*, if included, in *VarLogMeasConfig*;

1> if the *LoggedMeasurementConfiguration* message includes *plmn-IdentityList*:

2> set *plmn-IdentityList* in *VarLogMeasReport* to include the RPLMN as well as the PLMNs included in *plmn-IdentityList*;

1> else:

2> set *plmn-IdentityList* in *VarLogMeasReport* to include the RPLMN;

1> store the received *absoluteTimeInfo*, *traceReference*, *traceRecordingSessionRef*, and *tce-Id* in *VarLogMeasReport*;

1> store the received *bt-NameList*, if included, in *VarLogMeasConfig*;

1> store the received *wlan-NameList*, if included, in *VarLogMeasConfig*;

1> store the received *sensor-NameList*, if included, in *VarLogMeasConfig*;

1> start timer T330 with the timer value set to the *loggingDuration*;

[TS 38.331, clause 5.5a.3.2]

While T330 is running, the UE shall:

1> perform the logging in accordance with the following:

2> if the *reportType* is set to *periodical* in the *VarLogMeasConfig*:

3> if the UE is camping normally on an NR cell and if the RPLMN is included in *plmn-IdentityList* stored in *VarLogMeasReport* and, if the cell is part of the area indicated by *areaConfiguration* if configured in *VarLogMeasConfig*:

4> perform the logging at regular time intervals, as defined by the *loggingInterval* in the *VarLogMeasConfig*;

2> else if the *reportType* is set to *eventTriggered*, and *eventType* is set to *outOfCoverage*:

3> perform the logging at regular time intervals as defined by the *loggingInterval* in *VarLogMeasConfig* only when the UE is in any cell selection state;

3> perform the logging immediately upon transitioning from the any cell selection state to the camped normally state;

2> else if the *reportType* is set to *eventTriggered* and *eventType* is set to *eventL1*:

- 3> if the UE is camping normally on an NR cell and if the RPLMN is included in *plmn-IdentityList* stored in *VarLogMeasReport* and, if the cell is part of the area indicated by *areaConfiguration* if configured in *VarLogMeasConfig*;
 - 4> perform the logging at regular time intervals as defined by the *loggingInterval* in *VarLogMeasConfig* only when the conditions indicated by the *eventLI* are met;
 - 2> when performing the logging:
 - 3> set the *relativeTimeStamp* to indicate the elapsed time since the moment at which the logged measurement configuration was received;
 - 3> if detailed location information became available during the last logging interval, set the content of the *locationInfo* as in 5.3.3.7:
 - 3> if the UE is in any cell selection state (as specified in TS 38.304 [20]):
 - 4> set *anyCellSelectionDetected* to indicate the detection of no suitable or no acceptable cell found;
 - 4> set the *servCellIdentity* to indicate global cell identity of the last logged cell that the UE was camping on;
 - 4> set the *measResultServingCell* to include the quantities of the last logged cell the UE was camping on;
 - 3> else:
 - 4> set the *servCellIdentity* to indicate global cell identity of the cell the UE is camping on;
 - 4> set the *measResultServingCell* to include the quantities of the cell the UE is camping on;
 - 4> if available, set the *measResultNeighCells*, in order of decreasing ranking-criterion as used for cell reselection, to include neighbouring cell measurements that became available during the last logging interval for at most the following number of neighbouring cells: 6 intra-frequency and 3 inter-frequency neighbours per frequency as well as 3 inter-RAT neighbours, per frequency/ set of frequencies per RAT and according to the following:
 - 5> for each neighbour cell included, include the optional fields that are available;
- NOTE: The UE includes the latest results of the available measurements as used for cell reselection evaluation in RRC_IDLE or RRC_INACTIVE, which are performed in accordance with the performance requirements as specified in TS 38.133 [14].
- 2> when the memory reserved for the logged measurement information becomes full, stop timer T330 and perform the same actions as performed upon expiry of T330, as specified in 5.5a.1.4.

[TS 38.331, clause 6.2.2]

– LoggedMeasurementConfiguration

The *LoggedMeasurementConfiguration* message is used to perform logging of measurement results while in RRC_IDLE or RRC_INACTIVE. It is used to transfer the logged measurement configuration for network performance optimisation.

Signalling radio bearer: SRB1

RLC-SAP: AM

Logical channel: DCCH

Direction: Network to UE

LoggedMeasurementConfiguration message

```
-- ASN1START
-- TAG-LOGGEDMEASUREMENTCONFIGURATION-START
LoggedMeasurementConfiguration-r16 ::= SEQUENCE {
```

```

criticalExtensions CHOICE {
  loggedMeasurementConfiguration-r16 LoggedMeasurementConfiguration-r16-IEs,
  criticalExtensionsFuture SEQUENCE {}
}
}

LoggedMeasurementConfiguration-r16-IEs ::= SEQUENCE {
  traceReference-r16 TraceReference-r16,
  traceRecordingSessionRef-r16 OCTET STRING (SIZE (2)),
  tce-Id-r16 OCTET STRING (SIZE (1)),
  absoluteTimeInfo-r16 AbsoluteTimeInfo-r16,
  areaConfiguration-r16 AreaConfiguration-r16 OPTIONAL,
--Need R
  plmn-IdentityList-r16 PLMN-IdentityList2-r16 OPTIONAL,
--Need R
  bt-NameList-r16 SetupRelease {BT-NameList-r16} OPTIONAL,
--Need M
  wlan-NameList-r16 SetupRelease {WLAN-NameList-r16} OPTIONAL,
--Need M
  sensor-NameList-r16 SetupRelease {Sensor-NameList-r16} OPTIONAL,
--Need M
  loggingDuration-r16 LoggingDuration-r16,
  reportType CHOICE {
    periodical LoggedPeriodicalReportConfig-r16,
    eventTriggered LoggedEventTriggerConfig-r16,
    ...
  },
  lateNonCriticalExtension OCTET STRING OPTIONAL,
  nonCriticalExtension SEQUENCE {} OPTIONAL
}

LoggedPeriodicalReportConfig-r16 ::= SEQUENCE {
  loggingInterval-r16 LoggingInterval-r16,
  ...
}

LoggedEventTriggerConfig-r16 ::= SEQUENCE {
  eventType-r16 EventType-r16,
  loggingInterval-r16 LoggingInterval-r16,
  ...
}

EventType-r16 ::= CHOICE {
  outOfCoverage NULL,
  eventL1 SEQUENCE {
    l1-Threshold MeasTriggerQuantity,
    hysteresis Hysteresis,
    timeToTrigger TimeToTrigger
  },
  ...
}

-- TAG-LOGGEDMEASUREMENTCONFIGURATION-STOP
-- ASN1STOP

```

LoggedMeasurementConfiguration field descriptions	
absoluteTimeInfo	Indicates the absolute time in the current cell.
areaConfiguration	Used to restrict the area in which the UE performs measurement logging to cells broadcasting either one of the included cell identities or one of the included tracking area codes/ frequencies.
eventType	The value outOfCoverage indicates the UE to perform logging of measurements when the UE enters any cell selection state, and the value eventL1 indicates the UE to perform logging of measurements when the triggering condition (similar as event A2 as specified in 5.5.4.3) as configured in the event is met for the camping cell in camped normally state.
plmn-IdentityList	Indicates a set of PLMNs defining when the UE performs measurement logging as well as the associated status indication and information retrieval i.e. the UE performs these actions when the RPLMN is part of this set of PLMNs.
tce-Id	Parameter Trace Collection Entity Id: See TS 32.422 [52].
traceRecordingSessionRef	Parameter Trace Recording Session Reference: See TS 32.422 [52].
reportType	Parameter configures the type of MDT configuration, specifically Periodic MDT configuration or Event Triggered MDT configuration.

8.1.6.1.2.4.3 Test description

8.1.6.1.2.4.3.1 Pre-test conditions

System Simulator:

- NR Cell 1 and NR Cell 11.
- System information combination NR-2 as defined in TS 38.508-1[4] clause 4.4.3.1.2 is used in NR cells.

UE:

- None.

Preamble:

- The UE is in state 3N-A according to TS 38.508-1 [4], clause 4.4A.2 Table 4.4A.2-3 on NR Cell 1.

8.1.6.1.2.4.3.2 Test procedure sequence

Table 8.1.6.1.2.4.3.2-1/2 illustrate the downlink power levels and other changing parameters to be applied for the cell at various time instants of the test execution. Row marked "T0" denotes the initial conditions after preamble, while columns marked "T1" is to be applied subsequently. The exact instants on which these values shall be applied are described in the texts in this clause.

Table 8.1.6.1.2.4.3.2-1: Time instances of cell power level and parameter changes for FR1

	Parameter	Unit	NR Cell 1	NR Cell 11	Remark
T0	SS/PBCH SSS EPRE	dBm/ SCS	-78	-85	NR Cell 1 becomes the highest ranked cell.
T1	SS/PBCH SSS EPRE	dBm/ SCS	-85	-78	NR Cell 11 becomes the highest ranked cell.

Table 8.1.6.1.2.4.3.2-2: Time instances of cell power level and parameter changes for FR2

	Parameter	Unit	NR Cell 1	NR Cell 11	Remark
T0	SS/PBCH SSS EPRE	dBm/ SCS	-82	-91	NR Cell 1 becomes the highest ranked cell.
T1	SS/PBCH SSS EPRE	dBm/ SCS	-91	-82	NR Cell 11 becomes the highest ranked cell.

Table 8.1.6.1.2.4.3.2-3: Main behaviour

St	Procedure	Message Sequence		TP	Verdict
		U - S	Message		
1	SS transmits a <i>LoggedMeasurementConfiguration</i> message with reportType is set to 'periodical' and LoggingInterval is set to 'ms10240', to configure the UE to perform logging of measurement results while in RRC_IDLE.	<--	<i>LoggedMeasurementConfiguration</i>	-	-
2	The SS transmits an <i>RRCRelease</i> message.	<--	<i>NR RRC:RRCRelease</i>	-	-
3	Wait 5s and the LoggingInterval will not be expired.	-	-	-	-
4	The SS changes NR Cell 1 and NR Cell 11 levels according to the row "T1" in table 8.1.6.1.2.4.3.2-1/2.	-	-	-	-
5	The UE transmits an <i>RRCSetupRequest</i> message on NR Cell 11 to initiate a tracking area update procedure.	-->	<i>NR RRC: RRCSetupRequest</i>	-	-
6	SS transmits an <i>RRCSetup</i> message.	<--	<i>NR RRC: RRCSetup</i>	-	-
7	Check: Does the UE include the IE <i>logMeasAvailable</i> in the <i>RRCSetupComplete</i> message?	-->	<i>NR RRC: RRCSetupComplete</i> <i>5GMM: REGISTRATION REQUEST</i>	1	F
8-10	Steps 4 to 6a1 of generic test procedure in TS 38.508-1 [4] subclause 4.9.5.2.2-1 are performed on NR Cell 11.	-	-	-	-
11	Wait 30s to allow UE to activate logging.	-	-	-	-
12-14	Steps 1 to 3 of the generic procedure in TS 38.508-1 [4] Table 4.5.4.2-3 are executed to successfully complete the service request procedure.	-	-	-	-
15	Check: Does the UE include the IE <i>logMeasAvailable</i> in the <i>RRCSetupComplete</i> message?	-->	<i>NR RRC: RRCSetupComplete</i> <i>5GMM: SERVICE REQUEST</i>	1	P
16-19	Steps 5 to 8 of the generic procedure in TS 38.508-1 [4] Table 4.5.4.2-3 are executed to successfully complete the service request procedure.	-	-	-	-
20	The SS transmits a <i>UEInformationRequest</i> message on NR Cell 11.	<--	<i>UEInformationRequest</i>	-	-
21	Check: Does the UE transmit a <i>UEInformationResponse</i> message?	-->	<i>UEInformationResponse</i>	1	P

8.1.6.1.2.4.3.3 Specific message contents

Table 8.1.6.1.2.4.3.3-1: *LoggedMeasurementConfiguration* (step 1, Table 8.1.6.1.2.4.3.2-3)

Derivation path: TS 38.508-1 [4], Table 4.6.1-5AA			
Information Element	Value/remark	Comment	Condition
LoggedMeasurementConfiguration-r16 ::= SEQUENCE {			
criticalExtensions CHOICE {			
loggedMeasurementConfiguration-r16 SEQUENCE {			
reportType CHOICE {			
periodical SEQUENCE {			
loggingInterval-r16	ms10240	10.24 seconds	
}			
}			
}			
}			
}			

Table 8.1.6.1.2.4.3.3-2: Void

Table 8.1.6.1.2.4.3.3-3: *RRCSetupComplete* (steps 7 and 15, Table 8.1.6.1.2.4.3.2-3)

Derivation path: TS 38.508-1 [4], Table 4.6.1-22			
Information Element	Value/remark	Comment	Condition
RRCSetupComplete ::= SEQUENCE {			
criticalExtensions CHOICE {			
rrcSetupComplete SEQUENCE {			
nonCriticalExtension {			
ue-MeasurementsAvailable-r16 SEQUENCE {			
logMeasAvailable-r16	true		Step 15
	Not Present		Step 7
logMeasAvailableBT-r16	Not Present		
logMeasAvailableWLAN-r16	Not Present		
connEstFailInfoAvailable-r16	Not Checked		
rlf-InfoAvailable-r16	Not Checked		
}			
}			
}			
}			
}			

Table 8.1.6.1.2.4.3.3-4: *UEInformationRequest* (step 20, Table 8.1.6.1.2.4.3.2-3)

Derivation path: TS 38.508-1 [4], Table 4.6.1-32A with condition LOG			

Table 8.1.6.1.2.4.3.3-5: *UEInformationResponse* (step 21, Table 8.1.6.1.2.4.3.2-3)

Derivation path: TS 38.508-1 [4], Table 4.6.1-32B			
Information Element	Value/remark	Comment	Condition
UEInformationResponse-r16 ::= SEQUENCE {			
criticalExtensions CHOICE {			
ueInformationResponse-r16 SEQUENCE {			
logMeasReport-r16 SEQUENCE {			
absoluteTimeStamp-r16	Same value as sent by SS in <i>LoggedMeasurementConfiguration</i> in step 1		
traceReference-r16 SEQUENCE {			
plmn-Identity-r16 SEQUENCE {			
mcc SEQUENCE (SIZE (3)) OF MCC-NMC-Digit	Same value as sent by SS in <i>LoggedMeasurementConfiguration</i> in step 1		
mnc SEQUENCE (SIZE (2..3)) OF MCC-NMC-Digit	Same value as sent by SS in <i>LoggedMeasurementConfiguration</i> in step 1		
}			
traceId-r16	Same value as sent by SS in <i>LoggedMeasurementConfiguration</i> in step 1		
}			
traceRecordingSessionRef-r16	Same value as sent by SS in <i>LoggedMeasurementConfiguration</i> in step 1		
tce-Id-r16	Same value as sent by SS in		

	<i>LoggedMeasurementCon</i> <i>figuration</i> in step 1		
logMeasInfoList-r16 SEQUENCE (SIZE (1..maxLogMeasReport-r16)) OF LogMeasInfo-r16 SEQUENCE {	At least 2 entries where at least one entry complies to entry with index 'x' below. SS records the relativeTimeStamp value for each entry		
LogMeasInfo-r16[x] SEQUENCE {		entry x	
locationInfo-r16	Not checked		
relativeTimeStamp-r16	SS record the value		
servCellIdentity-r16	Same as NR Cell 11		
measResultServCell-16 SEQUENCE {			
resultsSSB-Cell-r16	MeasQuantityResults of NR Cell 11		
resultsSSB SEQUENCE {			
best-ssb-Index	Not checked		
best-ssb-Results	Not checked		
numberOfGoodSSB	Not checked		
}			
}			
measResultNeighCells-r16 SEQUENCE {			
measResultNeighCellListNR SEQUENCE (SIZE (1..maxFreq)) OF MeasResultLogging2NR-r16 SEQUENCE {	1 entry		
MeasResultLogging2NR-r16[1] SEQUENCE {		entry 1	
carrierFreq-r16	Same as NR Cell 1		
measResultListLoggingNR-r16 SEQUENCE (SIZE (1..maxCellReport)) OF MeasResultLoggingNR-r16 SEQUENCE {	1 entry		
MeasResultLoggingNR-r16[1] SEQUENCE {		entry 1	
physCellId-r16	Same as NR Cell 1		
resultsSSB-Cell-r16	MeasQuantityResults of NR Cell 1		
numberOfGoodSSB-r16	Not checked		
}			
}			
}			
measResultNeighCellListEUTRA	Not present		
}			
anyCellSelectionDetected-r16	Not present		
}			
}			
logMeasAvailable-r16	Not present		
}			
}			
}			
}			

8.1.6.1.2.5 Logged MDT/ RRC_IDLE / Logging and reporting / event-based trigger

8.1.6.1.2.5.1 Test Purpose (TP)

(1)

```
with { UE in NR RRC_IDLE state camping normally on an NR cell where reportType is set to eventTriggered and eventType is set to eventL1 }
ensure that {
  when { T330 is running }
  then { UE is logging serving cell idle mode measurements only when the conditions indicated by the eventL1 are met }
```

}

8.1.6.1.2.5.2 Conformance requirements

References: The conformance requirements covered in the current TC are specified in: TS 38.331, clauses 5.3.3.4, 5.5a.1.3, 5.5a.3.2, 5.7.10.3 and 6.2.2. Unless otherwise stated these are Rel-16 requirements.

[TS 38.331, clause 5.3.3.4]

The UE shall perform the following actions upon reception of the *RRCSetup*:

...

4> set the content of *RRCSetupComplete* message as follows:

...

2> if the UE has logged measurements available for NR and if the RPLMN is included in *plmn-IdentityList* stored in *VarLogMeasReport*:

3> include the *logMeasAvailable* in the *RRCSetupComplete* message;

2> if the UE has Bluetooth logged measurements available and if the RPLMN is included in *plmn-IdentityList* stored in *VarLogMeasReport*:

3> include the *logMeasAvailableBT* in the *RRCSetupComplete* message;

2> if the UE has WLAN logged measurements available and if the RPLMN is included in *plmn-IdentityList* stored in *VarLogMeasReport*:

3> include the *logMeasAvailableWLAN* in the *RRCSetupComplete* message;

...

[TS 38.331, clause 5.5a.1.3]

Upon receiving the *LoggedMeasurementConfiguration* message the UE shall:

1> discard the logged measurement configuration as well as the logged measurement information as specified in 5.5a.2;

1> store the received *loggingDuration*, *reportType* and *areaConfiguration*, if included, in *VarLogMeasConfig*;

1> if the *LoggedMeasurementConfiguration* message includes *plmn-IdentityList*:

2> set *plmn-IdentityList* in *VarLogMeasReport* to include the RPLMN as well as the PLMNs included in *plmn-IdentityList*;

1> else:

2> set *plmn-IdentityList* in *VarLogMeasReport* to include the RPLMN;

1> store the received *absoluteTimeInfo*, *traceReference*, *traceRecordingSessionRef*, and *tce-Id* in *VarLogMeasReport*;

1> store the received *bt-NameList*, if included, in *VarLogMeasConfig*;

1> store the received *wlan-NameList*, if included, in *VarLogMeasConfig*;

1> store the received *sensor-NameList*, if included, in *VarLogMeasConfig*;

1> start timer T330 with the timer value set to the *loggingDuration*;

[TS 38.331, clause 5.5a.3.2]

While T330 is running, the UE shall:

1> perform the logging in accordance with the following:

- 2> if the *reportType* is set to *periodical* in the *VarLogMeasConfig*:
 - 3> if the UE is camping normally on an NR cell and if the RPLMN is included in *plmn-IdentityList* stored in *VarLogMeasReport* and, if the cell is part of the area indicated by *areaConfiguration* if configured in *VarLogMeasConfig*:
 - 4> perform the logging at regular time intervals, as defined by the *loggingInterval* in the *VarLogMeasConfig*;
 - 2> else if the *reportType* is set to *eventTriggered*, and *eventType* is set to *outOfCoverage*:
 - 3> perform the logging at regular time intervals as defined by the *loggingInterval* in *VarLogMeasConfig* only when the UE is in any cell selection state;
 - 3> perform the logging immediately upon transitioning from the any cell selection state to the camped normally state;
 - 2> else if the *reportType* is set to *eventTriggered* and *eventType* is set to *eventLI*:
 - 3> if the UE is camping normally on an NR cell and if the RPLMN is included in *plmn-IdentityList* stored in *VarLogMeasReport* and, if the cell is part of the area indicated by *areaConfiguration* if configured in *VarLogMeasConfig*:
 - 4> perform the logging at regular time intervals as defined by the *loggingInterval* in *VarLogMeasConfig* only when the conditions indicated by the *eventLI* are met;
 - 2> when performing the logging:
 - 3> set the *relativeTimeStamp* to indicate the elapsed time since the moment at which the logged measurement configuration was received;
 - 3> if detailed location information became available during the last logging interval, set the content of the *locationInfo* as in 5.3.3.7:
 - 3> if the UE is in any cell selection state (as specified in TS 38.304 [20]):
 - 4> set *anyCellSelectionDetected* to indicate the detection of no suitable or no acceptable cell found;
 - 4> set the *servCellIdentity* to indicate global cell identity of the last logged cell that the UE was camping on;
 - 4> set the *measResultServingCell* to include the quantities of the last logged cell the UE was camping on;
 - 3> else:
 - 4> set the *servCellIdentity* to indicate global cell identity of the cell the UE is camping on;
 - 4> set the *measResultServingCell* to include the quantities of the cell the UE is camping on;
 - 4> if available, set the *measResultNeighCells*, in order of decreasing ranking-criterion as used for cell reselection, to include neighbouring cell measurements that became available during the last logging interval for at most the following number of neighbouring cells: 6 intra-frequency and 3 inter-frequency neighbours per frequency as well as 3 inter-RAT neighbours, per frequency/ set of frequencies per RAT and according to the following:
 - 5> for each neighbour cell included, include the optional fields that are available;
- NOTE: The UE includes the latest results of the available measurements as used for cell reselection evaluation in RRC_IDLE or RRC_INACTIVE, which are performed in accordance with the performance requirements as specified in TS 38.133 [14].
- 2> when the memory reserved for the logged measurement information becomes full, stop timer T330 and perform the same actions as performed upon expiry of T330, as specified in 5.5a.1.4.

[TS 38.331, clause 5.7.10.3]

Upon receiving the *UEInformationRequest* message, the UE shall, only after successful security activation:

...

- 1> if the *logMeasReportReq* is present and if the RPLMN is included in *plmn-IdentityList* stored in *VarLogMeasReport*:
 - 2> if *VarLogMeasReport* includes one or more logged measurement entries, set the contents of the *logMeasReport* in the *UEInformationResponse* message as follows:
 - 3> include the *absoluteTimeStamp* and set it to the value of *absoluteTimeInfo* in the *VarLogMeasReport*;
 - 3> include the *traceReference* and set it to the value of *traceReference* in the *VarLogMeasReport*;
 - 3> include the *traceRecordingSessionRef* and set it to the value of *traceRecordingSessionRef* in the *VarLogMeasReport*;
 - 3> include the *tce-Id* and set it to the value of *tce-Id* in the *VarLogMeasReport*;
 - 3> include the *logMeasInfoList* and set it to include one or more entries from *VarLogMeasReport* starting from the entries logged first;
 - 3> if the *VarLogMeasReport* includes one or more additional logged measurement entries that are not included in the *logMeasInfoList* within the *UEInformationResponse* message:
 - 4> include the *logMeasAvailable*;
 - 3> if the *VarLogMeasReport* includes one or more additional logged Bluetooth measurement entries that are not included in the *logMeasInfoList* within the *UEInformationResponse* message:
 - 4> include the *logMeasAvailableBT*;
 - 3> if the *VarLogMeasReport* includes one or more additional logged WLAN measurement entries that are not included in the *logMeasInfoList* within the *UEInformationResponse* message:
 - 4> include the *logMeasAvailableWLAN*;

...

- 1> if the *logMeasReport* is included in the *UEInformationResponse*:
 - 2> submit the *UEInformationResponse* message to lower layers for transmission via SRB2;
 - 2> discard the logged measurement entries included in the *logMeasInfoList* from *VarLogMeasReport* upon successful delivery of the *UEInformationResponse* message confirmed by lower layers;
- 1> else:
 - 2> submit the *UEInformationResponse* message to lower layers for transmission via SRB1.

[TS 38.331, clause 6.2.2]

– LoggedMeasurementConfiguration

The *LoggedMeasurementConfiguration* message is used to perform logging of measurement results while in RRC_IDLE or RRC_INACTIVE. It is used to transfer the logged measurement configuration for network performance optimisation.

Signalling radio bearer: SRB1

RLC-SAP: AM

Logical channel: DCCH

Direction: Network to UE

LoggedMeasurementConfiguration message

-- ASN1START

```

-- TAG-LOGGEDMEASUREMENTCONFIGURATION-START

LoggedMeasurementConfiguration-r16 ::= SEQUENCE {
    criticalExtensions          CHOICE {
        loggedMeasurementConfiguration-r16  LoggedMeasurementConfiguration-r16-IEs,
        criticalExtensionsFuture             SEQUENCE {}
    }
}

LoggedMeasurementConfiguration-r16-IEs ::= SEQUENCE {
    traceReference-r16          TraceReference-r16,
    traceRecordingSessionRef-r16 OCTET STRING (SIZE (2)),
    tce-Id-r16                  OCTET STRING (SIZE (1)),
    absoluteTimeInfo-r16       AbsoluteTimeInfo-r16,
    areaConfiguration-r16      AreaConfiguration-r16 OPTIONAL,
--Need R
    plmn-IdentityList-r16      PLMN-IdentityList2-r16 OPTIONAL,
--Need R
    bt-NameList-r16           SetupRelease {BT-NameList-r16} OPTIONAL,
--Need M
    wlan-NameList-r16         SetupRelease {WLAN-NameList-r16} OPTIONAL,
--Need M
    sensor-NameList-r16       SetupRelease {Sensor-NameList-r16} OPTIONAL,
--Need M
    loggingDuration-r16        LoggingDuration-r16,
    reportType                 CHOICE {
        periodical              LoggedPeriodicalReportConfig-r16,
        eventTriggered          LoggedEventTriggerConfig-r16,
        ...
    },
    lateNonCriticalExtension    OCTET STRING OPTIONAL,
    nonCriticalExtension        SEQUENCE {} OPTIONAL
}

LoggedPeriodicalReportConfig-r16 ::= SEQUENCE {
    loggingInterval-r16        LoggingInterval-r16,
    ...
}

LoggedEventTriggerConfig-r16 ::= SEQUENCE {
    eventType-r16              EventType-r16,
    loggingInterval-r16        LoggingInterval-r16,
    ...
}

EventType-r16 ::= CHOICE {
    outOfCoverage              NULL,
    eventL1                    SEQUENCE {
        l1-Threshold            MeasTriggerQuantity,
        hysteresis              Hysteresis,
        timeToTrigger           TimeToTrigger
    },
    ...
}

-- TAG-LOGGEDMEASUREMENTCONFIGURATION-STOP
-- ASN1STOP

```

<i>LoggedMeasurementConfiguration</i> field descriptions
absoluteTimeInfo Indicates the absolute time in the current cell.
areaConfiguration Used to restrict the area in which the UE performs measurement logging to cells broadcasting either one of the included cell identities or one of the included tracking area codes/ frequencies.
eventType The value outOfCoverage indicates the UE to perform logging of measurements when the UE enters any cell selection state, and the value eventL1 indicates the UE to perform logging of measurements when the triggering condition (similar as event A2 as specified in 5.5.4.3) as configured in the event is met for the camping cell in camped normally state.
plmn-IdentityList Indicates a set of PLMNs defining when the UE performs measurement logging as well as the associated status indication and information retrieval i.e. the UE performs these actions when the RPLMN is part of this set of PLMNs.
tce-Id Parameter Trace Collection Entity Id: See TS 32.422 [52].
traceRecordingSessionRef Parameter Trace Recording Session Reference: See TS 32.422 [52].
reportType Parameter configures the type of MDT configuration, specifically Periodic MDT configuration or Event Triggered MDT configuration.

8.1.6.1.2.5.3 Test description

8.1.6.1.2.5.3.1 Pre-test conditions

System Simulator:

- NR Cell 1.

UE:

- None.

Preamble:

- The UE is in state 3N-A according to TS 38.508-1 [4], clause 4.4A.2 Table 4.4A.2-3.

8.1.6.1.2.5.3.2 Test procedure sequence

Table 8.1.6.1.2.5.3.2-1/2 illustrate the downlink power levels and other changing parameters to be applied for the cell at various time instants of the test execution. Row marked "T0" denotes the initial conditions, while columns marked "T1" is to be applied subsequently. The exact instants on which these values shall be applied are described in the texts in this clause.

Table 8.1.6.1.2.5.3.2-1: Time instances of cell power level in FR1

	Parameter	Unit	NR Cell 1	Remark
T0	SS/PBCH SSS EPRE	dBm/SCS	-85	
T1	SS/PBCH SSS EPRE	dBm/SCS	-98	Power level is such that entry condition for eventL1 is satisfied $M_s + H_{ys} < Thresh$

Table 8.1.6.1.2.5.3.2-2: Time instances of cell power level in FR2

	Parameter	Unit	NR Cell 1	Remark
T0	SS/PBCH SSS EPRE	dBm/SCS	FFS	

T1	SS/PBCH SSS EPRE	dBm/SCS	FFS	Power level is such that entry condition for eventL1 is satisfied $M_s + H_{ys} < Thresh$
----	---------------------	---------	-----	---

Table 8.1.6.1.2.5.3.2-3: Main behaviour

St	Procedure	Message Sequence		TP	Verdict
		U - S	Message		
1	SS transmits a <i>LoggedMeasurementConfiguration</i> message with reportType is set to eventTriggered and eventType is set to eventL1, to configure the UE to perform logging of measurement results while in RRC_IDLE.	<--	NR RRC: <i>LoggedMeasurementConfiguration</i>	-	-
2	The SS transmits an <i>RRCRelease</i> message.	<--	NR RRC: <i>RRCRelease</i>	-	-
3	Wait 30s to allow UE to activate logging.	-	-	-	-
4-6	Steps 1 to 3 of the generic procedure in TS 38.508-1 [4] Table 4.5.4.2-3 are executed to successfully complete the service request procedure.	-	-	-	-
7	Check: Does the UE include the IE logMeasAvailable in the <i>RRCSetupComplete</i> message?	-->	NR RRC: <i>RRCSetupComplete</i> 5GMM: SERVICE REQUEST	1	F
8-11	Steps 5 to 8 of the generic procedure in TS 38.508-1 [4] Table 4.5.4.2-3 are executed to successfully complete the service request procedure.	-	-	-	-
12	The SS transmits a <i>UEInformationRequest</i> message with <i>logMeasReportReq</i> present.	<--	NR RRC: <i>UEInformationRequest</i>	-	-
13	Check: Does the UE transmit a <i>UEInformationResponse</i> message on SRB1 including <i>logMeasReport</i> ?	-->	NR RRC: <i>UEInformationResponse</i>	1	F
14	The SS transmits an <i>RRCRelease</i> message.	<--	NR RRC: <i>RRCRelease</i>	-	-
15	The SS changes NR Cell 1 levels according to the row "T1" in table 8.1.6.1.2.5.3.2-1/2.	-	-	-	-
16	Wait 30s to allow UE to activate logging.	-	-	-	-
17-19	Steps 1 to 3 of the generic procedure in TS 38.508-1 [4] Table 4.5.4.2-3 are executed.	-	-	-	-
20	Check: Does the UE include the IE logMeasAvailable in the <i>RRCSetupComplete</i> message?	-->	NR RRC: <i>RRCSetupComplete</i> 5GMM: SERVICE REQUEST	1	P
21-24	Steps 5 to 8 of of the generic procedure in TS 38.508-1 [4] Table 4.5.4.2-3 are executed to successfully complete the service request procedure.	-	-	-	-
25	The SS transmits a <i>UEInformationRequest</i> message.	<--	NR RRC: <i>UEInformationRequest</i>	-	-
26	Check: Does the UE transmit a <i>UEInformationResponse</i> message on SRB2?	-->	NR RRC: <i>UEInformationResponse</i>	1	P

8.1.6.1.2.5.3.3 Specific message contents

Table 8.1.6.1.2.5.3.3-1: *LoggedMeasurementConfiguration* (step 1, Table 8.1.6.1.2.5.3.2-3)

Derivation path: TS 38.508-1 [4], Table 4.6.1-5AA with condition EVENTL1			
Information Element	Value/remark	Comment	Condition
LoggedMeasurementConfiguration-r16 ::= SEQUENCE {			
criticalExtensions CHOICE {			
loggedMeasurementConfiguration-r16 SEQUENCE {			
reportType CHOICE {			
eventTriggered SEQUENCE {			
eventType-r16 CHOICE {			

eventL1 SEQUENCE {			
l1-Threshold CHOICE {			
rsrp	69	-87dBm	FR1
	FFS		FR2
}			
hysteresis	0		
timeToTrigger	ms100	0.1s	
}			
loggingInterval-r16	ms2560	2.56s	
}			
}			
}			
}			
}			
}			

Table 8.1.6.1.2.5.3.3-2: Void

Table 8.1.6.1.2.5.3.3-3: UEInformationRequest (step 12 and step 25, Table 8.1.6.1.2.5.3.2-3)

Derivation path: TS 38.508-1 [4], Table 4.6.1-32A with condition LOG

Table 8.1.6.1.2.5.3.3-4: UEInformationResponse (step 13, Table 8.1.6.1.2.5.3.2-3)

Derivation path: TS 38.508-1 [4], Table 4.6.1-32B			
Information Element	Value/remark	Comment	Condition
UEInformationResponse-r16 ::= SEQUENCE {			
criticalExtensions CHOICE {			
ueInformationResponse-r16 SEQUENCE {			
logMeasReport-r16	Not present		
}			
}			
}			

Table 8.1.6.1.2.5.3.3-5: RRCSetupComplete (steps 7 and 20, Table 8.1.6.1.2.5.3.2-3)

Derivation path: TS 38.508-1 [4], Table 4.6.1-22			
Information Element	Value/remark	Comment	Condition
RRCSetupComplete ::= SEQUENCE {			
criticalExtensions CHOICE {			
rrcSetupComplete SEQUENCE {			
nonCriticalExtension {			
ue-MeasurementsAvailable-r16 SEQUENCE {			
logMeasAvailable-r16	true		Step 20
	Not Present		Step 7
logMeasAvailableBT-r16	Not Present		
logMeasAvailableWLAN-r16	Not Present		
connEstFailInfoAvailable-r16	Not Checked		
rlf-InfoAvailable-r16	Not Checked		
}			
}			
}			
}			

Table 8.1.6.1.2.5.3.3-6: UEInformationResponse (step 26, Table 8.1.6.1.2.5.3.2-3)

Derivation path: TS 38.508-1[4], Table 4.6.1-32B			
Information Element	Value/remark	Comment	Condition

UEInformationResponse-r16 ::= SEQUENCE {			
criticalExtensions CHOICE {			
ueInformationResponse-r16 SEQUENCE {			
logMeasReport-r16 SEQUENCE {			
absoluteTimeStamp-r16	Same value as sent by SS in <i>LoggedMeasurementConfiguration</i> in step 1		
traceReference-r16 SEQUENCE {			
plmn-Identity-r16 SEQUENCE {			
mcc SEQUENCE (SIZE (3)) OF MCC-NMC-Digit	Same value as sent by SS in <i>LoggedMeasurementConfiguration</i> in step 1		
mnc SEQUENCE (SIZE (2..3)) OF MCC-NMC-Digit	Same value as sent by SS in <i>LoggedMeasurementConfiguration</i> in step 1		
}			
traceId-r16	Same value as sent by SS in <i>LoggedMeasurementConfiguration</i> in step 1		
}			
traceRecordingSessionRef-r16	Same value as sent by SS in <i>LoggedMeasurementConfiguration</i> in step 1		
tce-Id-r16	Same value as sent by SS in <i>LoggedMeasurementConfiguration</i> in step 1		
logMeasInfoList-r16 SEQUENCE (SIZE (1..maxLogMeasReport-r16)) OF LogMeasInfo-r16 SEQUENCE {	At least 2 entries where at least one entry complies to entry with index 'x' below. SS records the relativeTimeStamp value for each entry		
LogMeasInfo-r16[x] SEQUENCE {		entry x	
locationInfo-r16	Not checked		
relativeTimeStamp-r16	SS record the value		
servCellIdentity-r16	Same as NR Cell 1		
measResultServCell-16 SEQUENCE {			
resultsSSB-Cell-r16	MeasQuantityResults of NR Cell 1		
resultsSSB SEQUENCE {			
best-ssb-Index	Not checked		
best-ssb-Results	Not checked		
numberOfGoodSSB	Not checked		
}			
}			
measResultNeighCells-r16	Any allowed value		
anyCellSelectionDetected-r16	Not present		
}			
logMeasAvailable-r16	Not present		
}			
}			
}			

8.1.6.1.2.6 Logged MDT/ RRC_IDLE / Logging and reporting / event-based trigger/ out-of-coverage

8.1.6.1.2.6.1 Test Purpose (TP)

(1)

```
with {UE has received LoggedMeasurementConfiguration message with reportType is set to
eventTriggered and eventType is set to outOfCoverage }
ensure that {
  when { T330 is running }
  then { UE performs the logging at regular time intervals as defined by the loggingInterval in
VarLogMeasConfig only when the UE is in any cell selection state }
}
```

(2)

```
with {UE has received LoggedMeasurementConfiguration message with reportType is set to
eventTriggered and eventType is set to outOfCoverage }
ensure that {
  when { T330 is running }
  then { UE performs the logging immediately upon transitioning from the any cell selection state
to the camped normally state }
}
```

8.1.6.1.2.6.2 Conformance requirements

References: The conformance requirements covered in the current TC are specified in: TS 38.331, clauses 5.3.3.4, 5.5a.1.3, 5.5a.3.2, 5.7.10.3 and 6.2.2. Unless otherwise stated these are Rel-16 requirements.

[TS 38.331, clause 5.3.3.4]

The UE shall perform the following actions upon reception of the *RRCSetup*:

...

5> set the content of *RRCSetupComplete* message as follows:

...

2> if the UE has logged measurements available for NR and if the RPLMN is included in *plmn-IdentityList* stored in *VarLogMeasReport*:

3> include the *logMeasAvailable* in the *RRCSetupComplete* message;

2> if the UE has Bluetooth logged measurements available and if the RPLMN is included in *plmn-IdentityList* stored in *VarLogMeasReport*:

3> include the *logMeasAvailableBT* in the *RRCSetupComplete* message;

2> if the UE has WLAN logged measurements available and if the RPLMN is included in *plmn-IdentityList* stored in *VarLogMeasReport*:

3> include the *logMeasAvailableWLAN* in the *RRCSetupComplete* message;

...

[TS 38.331, clause 5.5a.1.3]

Upon receiving the *LoggedMeasurementConfiguration* message the UE shall:

1> discard the logged measurement configuration as well as the logged measurement information as specified in 5.5a.2;

1> store the received *loggingDuration*, *reportType* and *areaConfiguration*, if included, in *VarLogMeasConfig*;

1> if the *LoggedMeasurementConfiguration* message includes *plmn-IdentityList*:

2> set *plmn-IdentityList* in *VarLogMeasReport* to include the RPLMN as well as the PLMNs included in *plmn-IdentityList*;

1> else:

2> set *plmn-IdentityList* in *VarLogMeasReport* to include the RPLMN;

1> store the received *absoluteTimeInfo*, *traceReference*, *traceRecordingSessionRef*, and *tce-Id* in *VarLogMeasReport*;

1> store the received *bt-NameList*, if included, in *VarLogMeasConfig*;

1> store the received *wlan-NameList*, if included, in *VarLogMeasConfig*;

1> store the received *sensor-NameList*, if included, in *VarLogMeasConfig*;

1> start timer T330 with the timer value set to the *loggingDuration*;

[TS 38.331, clause 5.5a.3.2]

While T330 is running, the UE shall:

1> perform the logging in accordance with the following:

2> if the *reportType* is set to *periodical* in the *VarLogMeasConfig*:

3> if the UE is camping normally on an NR cell and if the RPLMN is included in *plmn-IdentityList* stored in *VarLogMeasReport* and, if the cell is part of the area indicated by *areaConfiguration* if configured in *VarLogMeasConfig*:

4> perform the logging at regular time intervals, as defined by the *loggingInterval* in the *VarLogMeasConfig*;

2> else if the *reportType* is set to *eventTriggered*, and *eventType* is set to *outOfCoverage*:

3> perform the logging at regular time intervals as defined by the *loggingInterval* in *VarLogMeasConfig* only when the UE is in any cell selection state;

3> perform the logging immediately upon transitioning from the any cell selection state to the camped normally state;

2> else if the *reportType* is set to *eventTriggered* and *eventType* is set to *eventLI*:

3> if the UE is camping normally on an NR cell and if the RPLMN is included in *plmn-IdentityList* stored in *VarLogMeasReport* and, if the cell is part of the area indicated by *areaConfiguration* if configured in *VarLogMeasConfig*;

4> perform the logging at regular time intervals as defined by the *loggingInterval* in *VarLogMeasConfig* only when the conditions indicated by the *eventLI* are met;

2> when performing the logging:

3> set the *relativeTimeStamp* to indicate the elapsed time since the moment at which the logged measurement configuration was received;

3> if detailed location information became available during the last logging interval, set the content of the *locationInfo* as in 5.3.3.7;

3> if the UE is in any cell selection state (as specified in TS 38.304 [20]):

4> set *anyCellSelectionDetected* to indicate the detection of no suitable or no acceptable cell found;

4> set the *servCellIdentity* to indicate global cell identity of the last logged cell that the UE was camping on;

4> set the *measResultServingCell* to include the quantities of the last logged cell the UE was camping on;

3> else:

- 4> set the *servCellIdentity* to indicate global cell identity of the cell the UE is camping on;
- 4> set the *measResultServingCell* to include the quantities of the cell the UE is camping on;
- 4> if available, set the *measResultNeighCells*, in order of decreasing ranking-criterion as used for cell re-selection, to include neighbouring cell measurements that became available during the last logging interval for at most the following number of neighbouring cells: 6 intra-frequency and 3 inter-frequency neighbours per frequency as well as 3 inter-RAT neighbours, per frequency/ set of frequencies per RAT and according to the following:
 - 5> for each neighbour cell included, include the optional fields that are available;

NOTE: The UE includes the latest results of the available measurements as used for cell reselection evaluation in RRC_IDLE or RRC_INACTIVE, which are performed in accordance with the performance requirements as specified in TS 38.133 [14].

- 2> when the memory reserved for the logged measurement information becomes full, stop timer T330 and perform the same actions as performed upon expiry of T330, as specified in 5.5a.1.4.

[TS 38.331, clause 5.7.10.3]

Upon receiving the *UEInformationRequest* message, the UE shall, only after successful security activation:

...

- 1> if the *logMeasReportReq* is present and if the RPLMN is included in *plmn-IdentityList* stored in *VarLogMeasReport*:
 - 2> if *VarLogMeasReport* includes one or more logged measurement entries, set the contents of the *logMeasReport* in the *UEInformationResponse* message as follows:
 - 3> include the *absoluteTimeStamp* and set it to the value of *absoluteTimeInfo* in the *VarLogMeasReport*;
 - 3> include the *traceReference* and set it to the value of *traceReference* in the *VarLogMeasReport*;
 - 3> include the *traceRecordingSessionRef* and set it to the value of *traceRecordingSessionRef* in the *VarLogMeasReport*;
 - 3> include the *tce-Id* and set it to the value of *tce-Id* in the *VarLogMeasReport*;
 - 3> include the *logMeasInfoList* and set it to include one or more entries from *VarLogMeasReport* starting from the entries logged first;
 - 3> if the *VarLogMeasReport* includes one or more additional logged measurement entries that are not included in the *logMeasInfoList* within the *UEInformationResponse* message:
 - 4> include the *logMeasAvailable*;
 - 3> if the *VarLogMeasReport* includes one or more additional logged Bluetooth measurement entries that are not included in the *logMeasInfoList* within the *UEInformationResponse* message:
 - 4> include the *logMeasAvailableBT*;
 - 3> if the *VarLogMeasReport* includes one or more additional logged WLAN measurement entries that are not included in the *logMeasInfoList* within the *UEInformationResponse* message:
 - 4> include the *logMeasAvailableWLAN*;

...

- 1> if the *logMeasReport* is included in the *UEInformationResponse*:
 - 2> submit the *UEInformationResponse* message to lower layers for transmission via SRB2;

- 2> discard the logged measurement entries included in the *logMeasInfoList* from *VarLogMeasReport* upon successful delivery of the *UEInformationResponse* message confirmed by lower layers;

1> else:

- 2> submit the *UEInformationResponse* message to lower layers for transmission via SRB1.

[TS 38.331, clause 6.2.2]

– LoggedMeasurementConfiguration

The *LoggedMeasurementConfiguration* message is used to perform logging of measurement results while in RRC_IDLE or RRC_INACTIVE. It is used to transfer the logged measurement configuration for network performance optimisation.

Signalling radio bearer: SRB1

RLC-SAP: AM

Logical channel: DCCH

Direction: Network to UE

LoggedMeasurementConfiguration message

```
-- ASN1START
-- TAG-LOGGEDMEASUREMENTCONFIGURATION-START

LoggedMeasurementConfiguration-r16 ::= SEQUENCE {
    criticalExtensions          CHOICE {
        loggedMeasurementConfiguration-r16 LoggedMeasurementConfiguration-r16-IEs,
        criticalExtensionsFuture          SEQUENCE {}
    }
}

LoggedMeasurementConfiguration-r16-IEs ::= SEQUENCE {
    traceReference-r16          TraceReference-r16,
    traceRecordingSessionRef-r16 OCTET STRING (SIZE (2)),
    tce-Id-r16                  OCTET STRING (SIZE (1)),
    absoluteTimeInfo-r16       AbsoluteTimeInfo-r16,
    areaConfiguration-r16      AreaConfiguration-r16 OPTIONAL,
--Need R
    plmn-IdentityList-r16      PLMN-IdentityList2-r16 OPTIONAL,
--Need R
    bt-NameList-r16           SetupRelease {BT-NameList-r16} OPTIONAL,
--Need M
    wlan-NameList-r16         SetupRelease {WLAN-NameList-r16} OPTIONAL,
--Need M
    sensor-NameList-r16       SetupRelease {Sensor-NameList-r16} OPTIONAL,
--Need M
    loggingDuration-r16        LoggingDuration-r16,
    reportType                 CHOICE {
        periodical              LoggedPeriodicalReportConfig-r16,
        eventTriggered          LoggedEventTriggerConfig-r16,
        ...
    },
    lateNonCriticalExtension    OCTET STRING OPTIONAL,
    nonCriticalExtension        SEQUENCE {} OPTIONAL
}

LoggedPeriodicalReportConfig-r16 ::= SEQUENCE {
    loggingInterval-r16        LoggingInterval-r16,
    ...
}

LoggedEventTriggerConfig-r16 ::= SEQUENCE {
    eventType-r16              EventType-r16,
    loggingInterval-r16        LoggingInterval-r16,
    ...
}

EventType-r16 ::= CHOICE {
    outOfCoverage              NULL,
    eventL1                    SEQUENCE {
```

```

        l1-Threshold      MeasTriggerQuantity,
        hysteresis       Hysteresis,
        timeToTrigger    TimeToTrigger
    },
    ...
}

-- TAG-LOGGEDMEASUREMENTCONFIGURATION-STOP
-- ASN1STOP
    
```

<i>LoggedMeasurementConfiguration</i> field descriptions
absoluteTimeInfo Indicates the absolute time in the current cell.
areaConfiguration Used to restrict the area in which the UE performs measurement logging to cells broadcasting either one of the included cell identities or one of the included tracking area codes/ frequencies.
eventType The value outOfCoverage indicates the UE to perform logging of measurements when the UE enters any cell selection state, and the value eventL1 indicates the UE to perform logging of measurements when the triggering condition (similar as event A2 as specified in 5.5.4.3) as configured in the event is met for the camping cell in camped normally state.
plmn-IdentityList Indicates a set of PLMNs defining when the UE performs measurement logging as well as the associated status indication and information retrieval i.e. the UE performs these actions when the RPLMN is part of this set of PLMNs.
tce-Id Parameter Trace Collection Entity Id: See TS 32.422 [52].
traceRecordingSessionRef Parameter Trace Recording Session Reference: See TS 32.422 [52].
reportType Parameter configures the type of MDT configuration, specifically Periodic MDT configuration or Event Triggered MDT configuration.

8.1.6.1.2.6.3 Test description

8.1.6.1.2.6.3.1 Pre-test conditions

System Simulator:

- NR Cell 1.

UE:

- None.

Preamble:

- The UE is in state 3N-A according to TS 38.508-1 [4], clause 4.4A.2 Table 4.4A.2-3.

8.1.6.1.2.6.3.2 Test procedure sequence

Table 8.1.6.1.2.6.3.2-1/2 illustrate the downlink power levels and other changing parameters to be applied for the cell at various time instants of the test execution. Row marked "T0" denotes the initial conditions, while columns marked "T1" is to be applied subsequently. The exact instants on which these values shall be applied are described in the texts in this clause.

Table 8.1.6.1.2.6.3.2-1: Time instances of cell power level in FR1

	Parameter	Unit	NR Cell 1	Remark
T0	SS/PBCH SSS EPRE	dBm/SCS	-85	
T1	SS/PBCH SSS EPRE	dBm/SCS	Off	Make UE go to any cell selection state

T2	SS/PBCH SSS EPRE	dBm/SCS	-85	Cell 1 become suitable cell
----	---------------------	---------	-----	-----------------------------

Table 8.1.6.1.2.6.3.2-2: Time instances of cell power level in FR2

	Parameter	Unit	NR Cell 1	Remark
T0	SS/PBCH SSS EPRE	dBm/SCS	-82	
T1	SS/PBCH SSS EPRE	dBm/SCS	Off	Make UE go to any cell selection state
T2	SS/PBCH SSS EPRE	dBm/SCS	-82	Cell 1 become suitable cell

Table 8.1.6.1.2.6.3.2-3: Main behaviour

St	Procedure	Message Sequence		TP	Verdict
		U - S	Message		
1	SS transmits a <i>LoggedMeasurementConfiguration</i> message with reportType is set to eventTriggered and eventType is set to outOfCoverage, to configure the UE to perform logging of measurement results.	<--	NR RRC: <i>LoggedMeasurementConfiguration</i>	-	-
2	The SS transmits an <i>RRCRelease</i> message.	<--	NR RRC: <i>RRCRelease</i>	-	-
3	Wait 30s to allow UE to activate logging.	-	-	-	-
4-6	Steps 1 to 3 of the generic procedure in TS 38.508-1 [4], Table 4.5.4.2-3 are executed.	-	-	-	-
7	Check: Does the UE include the IE logMeasAvailable in the <i>RRCSetupComplete</i> message?	-->	NR RRC: <i>RRCSetupComplete</i> 5GMM: SERVICE REQUEST	1	F
8-11	Steps 5 to 8 of the generic procedure in TS 38.508-1 [4], Table 4.5.4.2-3 are executed to successfully complete the service request procedure.	-	-	-	-
12	The SS transmits a <i>UEInformationRequest</i> message with <i>logMeasReportReq</i> present.	<--	NR RRC: <i>UEInformationRequest</i>	-	-
13	Check: Does the UE transmit a <i>UEInformationResponse</i> message on SRB1 including <i>logMeasReport</i> ?	-->	NR RRC: <i>UEInformationResponse</i>	1	F
14	The SS transmits an <i>RRCRelease</i> message.	<--	NR RRC: <i>RRCRelease</i>	-	-
15	The SS changes NR Cell 1 level according to the row "T1" in table 8.1.6.1.2.6.3.2-1/2.	-	-	-	-
16	Wait 30s to allow UE to activate logging.	-	-	-	-
17	The SS changes NR Cell 1 level according to the row "T2" in table 8.1.6.1.2.6.3.2-1/2.	-	-	-	-
18	Wait 10s to allow UE to go to camp normaly state and activate logging.	-	-	-	-
19	Steps 1 to 3 of the generic procedure in TS 38.508-1 [4], Table 4.5.4.2-3 are executed.	-	-	-	-
20	Check: Does the UE include the IE logMeasAvailable in the <i>RRCSetupComplete</i> message?	-->	NR RRC: <i>RRCSetupComplete</i> 5GMM: SERVICE REQUEST	1, 2	P
21-24	Steps 5 to 8 of the generic procedure in TS 38.508-1 [4], Table 4.5.4.2-3 are executed to successfully complete the service request procedure.	-	-	-	-
25	The SS transmits a <i>UEInformationRequest</i> message to get logMeasReport.	<--	NR RRC: <i>UEInformationRequest</i>	-	-
26	Check: Does the UE transmit a <i>UEInformationResponse</i> message on SRB2 with logMeasReport including at least one LogMeasInfo for any cell selection state and one LogMeasInfo for transitioning from the any	-->	NR RRC: <i>UEInformationResponse</i>	1, 2	P

	cell selection state to the camped normally state?				
--	--	--	--	--	--

8.1.6.1.2.6.3.3 Specific message contents

Table 8.1.6.1.2.6.3.3-1: *LoggedMeasurementConfiguration* (step 1, Table 8.1.6.1.2.6.3.2-3)

Derivation path: TS 38.508-1 [4], Table 4.6.1-5AA with condition EVENT and OUT-OF-COVERAGE

Table 8.1.6.1.2.6.3.3-2: Void

Table 8.1.6.1.2.6.3.3-3: *UEInformationRequest* (steps 12 and 25, Table 8.1.6.1.2.6.3.2-3)

Derivation path: TS 38.508-1 [4], Table 4.6.1-32A with condition LOG

Table 8.1.6.1.2.6.3.3-4: *UEInformationResponse* (step 13, Table 8.1.6.1.2.6.3.2-3)

Derivation path: TS 38.508-1 [4], Table 4.6.1-32B			
Information Element	Value/remark	Comment	Condition
UEInformationResponse-r16 ::= SEQUENCE {			
criticalExtensions CHOICE {			
ueInformationResponse-r16 SEQUENCE {			
logMeasReport-r16	Not present		
}			
}			
}			

Table 8.1.6.1.2.6.3.3-5: *RRCSetupComplete* (steps 7 and 20, Table 8.1.6.1.2.6.3.2-3)

Derivation path: TS 38.508-1 [4], Table 4.6.1-22			
Information Element	Value/remark	Comment	Condition
RRCSetupComplete ::= SEQUENCE {			
criticalExtensions CHOICE {			
rrcSetupComplete SEQUENCE {			
nonCriticalExtension {			
ue-MeasurementsAvailable-r16 SEQUENCE {			
logMeasAvailable-r16	true		Step 20
	Not Present		Step 7
logMeasAvailableBT-r16	Not Present		
logMeasAvailableWLAN-r16	Not Present		
connEstFailInfoAvailable-r16	Not Checked		
rlf-InfoAvailable-r16	Not Checked		
}			
}			
}			
}			

Table 8.1.6.1.2.6.3.3-6: *UEInformationResponse* (step 26, Table 8.1.6.1.2.6.3.2-3)

Derivation path: TS 38.508-1 [4], Table 4.6.1-32B			
Information Element	Value/remark	Comment	Condition
UEInformationResponse-r16 ::= SEQUENCE {			
criticalExtensions CHOICE {			
ueInformationResponse-r16 SEQUENCE {			
logMeasReport-r16 SEQUENCE {			

absoluteTimeStamp-r16	Same value as sent by SS in <i>LoggedMeasurementConfiguration</i> in step 1		
traceReference-r16 SEQUENCE {			
plmn-Identity-r16 SEQUENCE {			
mcc SEQUENCE (SIZE (3)) OF MCC-NMC-Digit	Same value as sent by SS in <i>LoggedMeasurementConfiguration</i> in step 1		
mnc SEQUENCE (SIZE (2..3)) OF MCC-NMC-Digit	Same value as sent by SS in <i>LoggedMeasurementConfiguration</i> in step 1		
}			
traceId-r16	Same value as sent by SS in <i>LoggedMeasurementConfiguration</i> in step 1		
}			
traceRecordingSessionRef-r16	Same value as sent by SS in <i>LoggedMeasurementConfiguration</i> in step 1		
tce-Id-r16	Same value as sent by SS in <i>LoggedMeasurementConfiguration</i> in step 1		
logMeasInfoList-r16 SEQUENCE (SIZE (1..maxLogMeasReport-r16)) OF LogMeasInfo-r16 SEQUENCE {	At least 2 entries where at least one entry complies to entry with index 'x' below. SS records the relativeTimeStamp value for each entry. And the relative TimeStamp of first entry is more than 10s before the last one.		
LogMeasInfo-r16[x] SEQUENCE {		entry x	
locationInfo-r16	Not checked		
relativeTimeStamp-r16	SS record the value		
servCellIdentity-r16	Same as NR Cell 1		
measResultServCell-16 SEQUENCE {			
resultsSSB-Cell-r16	MeasQuantityResults of NR Cell 1		
resultsSSB SEQUENCE {			
best-ssb-Index	Not checked		
best-ssb-Results	Not checked		
numberOfGoodSSB	Not checked		
}			
}			
measResultNeighCells-r16	Any allowed value		
anyCellSelectionDetected-r16	Not checked		
}			
logMeasAvailable-r16	Not present		
}			
}			
}			
}			

8.1.6.1.2.7 Logged MDT / Logging and reporting / Indication of logged measurements at NR reestablishment

8.1.6.1.2.7.1 Test Purpose (TP)

(1)

```
with { UE has one or more logged measurement entries stored in VarLogMeasReport }
ensure that {
  when { receiving RRCReestablishment message }
  then { UE includes the logMeasAvailable IE in the RRCReestablishmentComplete message }
}
```

8.1.6.1.2.7.2 Conformance requirements

References: The conformance requirements covered in the current TC are specified in: TS 38.331, clauses 5.3.7.5. Unless otherwise stated these are Rel-16 requirements.

[TS 38.331, clause 5.3.7.5]

The UE shall:

- 1> stop timer T301;
- 1> consider the current cell to be the PCell;
- 1> store the *nextHopChainingCount* value indicated in the *RRCReestablishment* message;
- 1> update the K_{gNB} key based on the current K_{gNB} key or the NH, using the stored *nextHopChainingCount* value, as specified in TS 33.501 [11];
- 1> derive the K_{RRcenc} and K_{UPenc} keys associated with the previously configured *cipheringAlgorithm*, as specified in TS 33.501 [11];
- 1> derive the K_{RRcint} and K_{UPint} keys associated with the previously configured *integrityProtAlgorithm*, as specified in TS 33.501 [11].
- 1> request lower layers to verify the integrity protection of the *RRCReestablishment* message, using the previously configured algorithm and the K_{RRcint} key;
- 1> if the integrity protection check of the *RRCReestablishment* message fails:
 - 2> perform the actions upon going to RRC_IDLE as specified in 5.3.11, with release cause 'RRC connection failure', upon which the procedure ends;
- 1> configure lower layers to resume integrity protection for SRB1 using the previously configured algorithm and the K_{RRcint} key immediately, i.e., integrity protection shall be applied to all subsequent messages received and sent by the UE, including the message used to indicate the successful completion of the procedure;
- 1> configure lower layers to resume ciphering for SRB1 using the previously configured algorithm and, the K_{RRcenc} key immediately, i.e., ciphering shall be applied to all subsequent messages received and sent by the UE, including the message used to indicate the successful completion of the procedure;
- 1> release the measurement gap configuration indicated by the *measGapConfig*, if configured;
- 1> set the content of *RRCReestablishmentComplete* message as follows:
 - 2> if the UE has logged measurements available for NR and if the RPLMN is included in *plmn-IdentityList* stored in *VarLogMeasReport*:
 - 3> include the *logMeasAvailable* in the *RRCReestablishmentComplete* message;
 - 3> if Bluetooth measurement results are included in the logged measurements the UE has available for NR and if the RPLMN is included in *plmn-IdentityList* stored in *VarLogMeasReport*:
 - 4> include the *logMeasAvailableBT* in the *RRCReestablishmentComplete* message;

- 3> if WLAN measurement results are included in the logged measurements the UE has available for NR and if the RPLMN is included in *plmn-IdentityList* stored in *VarLogMeasReport*:
- 4> include the *logMeasAvailableWLAN* in the *RRCReestablishmentComplete* message;
- 2> if the UE has connection establishment failure or connection resume failure information available in *VarConnEstFailReport* and if the RPLMN is equal to *plmn-Identity* stored in *VarConnEstFailReport*:
- 3> include *connEstFailInfoAvailable* in the *RRCReestablishmentComplete* message;
- 2> if the UE has radio link failure or handover failure information available in *VarRLF-Report* and if the RPLMN is included in *plmn-IdentityList* stored in *VarRLF-Report*; or
- 2> if the UE has radio link failure or handover failure information available in *VarRLF-Report* of TS 36.331 [10] and if the UE is capable of cross-RAT RLF reporting and if the RPLMN is included in *plmn-IdentityList* stored in *VarRLF-Report* of TS 36.331 [10]:
- 3> include *rlf-InfoAvailable* in the *RRCReestablishmentComplete* message;
- 1> submit the *RRCReestablishmentComplete* message to lower layers for transmission;
- 1> the procedure ends.

8.1.6.1.2.7.3 Test description

8.1.6.1.2.7.3.1 Pre-test conditions

System Simulator:

- NR Cell 1 and NR Cell 2.
- System information combination NR-2 as defined in TS 38.508-1 [4] clause 4.4.3.1.2 is used in NR cells.

UE:

- None.

Preamble:

- The UE is in state 3N-A on NR Cell 1 according to TS 38.508-1 [4], clause 4.4A.2 Table 4.4A.2-3.

8.1.6.1.2.7.3.2 Test procedure sequence

Table 8.1.6.1.2.7.3.2-1/2 illustrate the downlink power levels and other changing parameters to be applied for the cell at various time instants of the test execution. The exact instants on which these values shall be applied are described in the texts in this clause.

Table 8.1.6.1.2.7.3.2-1: Time instances of cell power level for FR1

	Parameter	Unit	NR Cell 1	NR Cell 2
T0	SS/PBCH SSS EPRE	dBm/ SCS	-85	-91
T1	SS/PBCH SSS EPRE	dBm/ SCS	Off	-85

Table 8.1.6.1.2.7.3.2-2: Time instances of cell power level for FR2

	Parameter	Unit	NR Cell 1	NR Cell 2
T0	SS/PBCH SSS EPRE	dBm/ SCS	-82	-91
T1	SS/PBCH SSS EPRE	dBm/ SCS	Off	-82

Table 8.1.6.1.2.7.3.2-3: Main behaviour

St	Procedure	Message Sequence		TP	Verdict
		U - S	Message		
1	SS transmits a <i>LoggedMeasurementConfiguration</i> message with reportType is set to 'periodical' and LoggingInterval is set to 'ms10240', to configure the UE to perform logging of measurement results while in RRC_IDLE.	<--	<i>LoggedMeasurementConfiguration</i>	-	-
2	The SS transmits an <i>RRCRelease</i> message.	<--	NR RRC: <i>RRCRelease</i>	-	-
3	Wait 30s to allow UE to activate logging.	-	-	-	-
4-11	Steps 1 to 8 of the generic procedure in TS 38.508-1 [4] Table 4.5.4.2-3 are executed to successfully complete the service request procedure on NR Cell 1.	-	-	-	-
12	The SS changes NR Cell 1 and NR Cell 2 levels according to the row "T1" in table 8.1.6.1.2.7.3.2-1 for FR1 or table 8.1.6.1.2.7.3.2-2 for FR2.	-	-	-	-
13	The UE sends <i>RRCReestablishmentRequest</i> message on NR Cell 2.	-->	NR RRC: <i>RRCReestablishmentRequest</i>	-	-
14	The SS transmits <i>RRCReestablishment</i> message.	<--	NR RRC: <i>RRCReestablishment</i>	-	-
15	Check: Does the UE transmit <i>RRCReestablishmentComplete</i> message including logMeasAvailable IE?	-->	NR RRC: <i>RRCReestablishmentComplete</i>	1	P
16	The SS transmits an <i>RRCReconfiguration</i> message to resume existing radio bearer.	<--	NR RRC: <i>RRCReconfiguration</i>	-	-
17	The UE transmits an <i>RRCReconfigurationComplete</i> message.	-->	NR RRC: <i>RRCReconfigurationComplete</i>	-	-
18	The SS sends an <i>UEInformationRequest</i> message to get logMeasReport and rlf-Report.	<--	NR RRC: <i>UEInformationRequest</i>	-	-
19	The UE sends an <i>UEInformationResponse</i> message including logMeasReport and rlf-Report.	-->	NR RRC: <i>UEInformationResponse</i>	-	-

8.1.6.1.2.7.3.3 Specific message contents

Table 8.1.6.1.2.7.3.3-1: *LoggedMeasurementConfiguration* (step 1, Table 8.1.6.1.2.7.3.2-3)

Derivation path: TS 38.508-1 [4], Table 4.6.1-5AA			
Information Element	Value/remark	Comment	Condition
<i>LoggedMeasurementConfiguration</i> -r16 ::= SEQUENCE {			
criticalExtensions CHOICE {			
loggedMeasurementConfiguration-r16 SEQUENCE {			
reportType CHOICE {			
periodical SEQUENCE {			
loggingInterval-r16	ms10240	10.24 seconds	
}			
}			
}			
}			

Table 8.1.6.1.2.7.3.3-2: *RRCReestablishmentComplete* (step 15, Table 8.1.6.1.2.7.3.2-3)

Derivation path: TS 38.508-1 [4], Table 4.6.1-11			
Information Element	Value/remark	Comment	Condition
<i>RRCReestablishmentComplete</i> ::= SEQUENCE {			
criticalExtensions CHOICE {			

rrcReestablishmentComplete SEQUENCE {			
nonCriticalExtension SEQUENCE {			
ue-MeasurementsAvailable-r16	UE-MeasurementsAvailable-r16 with condition LOG and RLF		
}			
}			
}			
}			

Table 8.1.6.1.2.7.3.3-3: UEInformationRequest (step 18, Table 8.1.6.1.2.7.3.2-3)

Derivation Path: TS 38.508-1 [4], Table 4.6.1-32A with condition LOG and RLF

8.1.6.1.2.8 Logged MDT / Logging and reporting / Reporting at RRC reconfiguration

8.1.6.1.2.8.1 Test Purpose (TP)

(1)

```
with { UE received LoggedMeasurementConfiguration message and has stored logMeasReport in
VarLogMeasReport }
ensure that {
  when { UE receives an RRCReconfiguration message including a reconfigurationWithSyn }
  then { UE transmits an RRCReconfigurationComplete message with logMeasAvailable set to true }
}
```

(2)

```
with { UE having indicated availability of logged measurements in RRCReconfigurationComplete message }
ensure that {
  when { UE has completed intra NR handover procedure and receives a UEInformationRequest message
with logMeasReportReq present }
  then { UE transmits an UEInformationResponse message including logMeasReport }
}
```

8.1.6.1.2.8.2 Conformance requirements

References: The conformance requirements covered in the current TC are specified in: TS 38.331, clauses 5.3.5.3 and 5.7.10.3. Unless otherwise stated these are Rel-16 requirements.

[TS 38.331, clause 5.3.5.3]

The UE shall perform the following actions upon reception of the *RRCReconfiguration*, or upon execution of the conditional reconfiguration (CHO or CPC):

1> if the *RRCReconfiguration* is applied due to a conditional reconfiguration execution upon cell selection while timer T311 is running, as defined in 5.3.7.3:

2> remove all the entries within *VarConditionalReconfig*, if any;

...

1> set the content of the *RRCReconfigurationComplete* message as follows:

2> if the *RRCReconfiguration* includes the *masterCellGroup* containing the *reportUplinkTxDirectCurrent*:

3> include the *uplinkTxDirectCurrentList* for each MCG serving cell with UL;

- 3> include *uplinkDirectCurrentBWP-SUL* for each MCG serving cell configured with SUL carrier, if any, within the *uplinkTxDirectCurrentList*;
- 2> if the *RRCReconfiguration* includes the *secondaryCellGroup* containing the *reportUplinkTxDirectCurrent*:
 - 3> include the *uplinkTxDirectCurrentList* for each SCG serving cell with UL;
 - 3> include *uplinkDirectCurrentBWP-SUL* for each SCG serving cell configured with SUL carrier, if any, within the *uplinkTxDirectCurrentList*;
- 2> if the *RRCReconfiguration* message includes the *mrdc-SecondaryCellGroupConfig* with *mrdc-SecondaryCellGroup* set to *eutra-SCG*:
 - 3> include in the *eutra-SCG-Response* the E-UTRA *RRCConnectionReconfigurationComplete* message in accordance with TS 36.331 [10] clause 5.3.5.3;
- 2> if the *RRCReconfiguration* message includes the *mrdc-SecondaryCellGroupConfig* with *mrdc-SecondaryCellGroup* set to *nr-SCG*:
 - 3> include in the *nr-SCG-Response* the *RRCReconfigurationComplete* message;
- 2> if the *RRCReconfiguration* message was included in an *RRCResume* message:
 - 3> include the *RRCReconfigurationComplete* message in the *nr-SCG-Response* within the *scg-Response* in the *RRCResumeComplete* message;
- 2> if the *RRCReconfiguration* message was included in E-UTRA *RRCConnectionResume* message:
 - 3> include the *RRCReconfigurationComplete* message in the E-UTRA MCG RRC message *RRCConnectionResumeComplete* in accordance with TS 36.331 [10], clause 5.3.3.4a;
- 2> if the UE has logged measurements available for NR and if the RPLMN is included in *plmn-IdentityList* stored in *VarLogMeasReport*:
 - 3> include the *logMeasAvailable* in the *RRCReconfigurationComplete* message;
 - 3> if Bluetooth measurement results are included in the logged measurements the UE has available for NR and if the RPLMN is included in *plmn-IdentityList* stored in *VarLogMeasReport*:
 - 4> include the *logMeasAvailableBT* in the *RRCReconfigurationComplete* message;
 - 3> if WLAN measurement results are included in the logged measurements the UE has available for NR and if the RPLMN is included in *plmn-IdentityList* stored in *VarLogMeasReport*:
 - 4> include the *logMeasAvailableWLAN* in the *RRCReconfigurationComplete* message;

...

[TS 38.331, clause 5.7.10.3]

Upon receiving the *UEInformationRequest* message, the UE shall, only after successful security activation:

...

- 1> if the *logMeasReportReq* is present and if the RPLMN is included in *plmn-IdentityList* stored in *VarLogMeasReport*:
- 2> if *VarLogMeasReport* includes one or more logged measurement entries, set the contents of the *logMeasReport* in the *UEInformationResponse* message as follows:

- 3> include the *absoluteTimeStamp* and set it to the value of *absoluteTimeInfo* in the *VarLogMeasReport*;
- 3> include the *traceReference* and set it to the value of *traceReference* in the *VarLogMeasReport*;
- 3> include the *traceRecordingSessionRef* and set it to the value of *traceRecordingSessionRef* in the *VarLogMeasReport*;
- 3> include the *tce-Id* and set it to the value of *tce-Id* in the *VarLogMeasReport*;
- 3> include the *logMeasInfoList* and set it to include one or more entries from *VarLogMeasReport* starting from the entries logged first;
- 3> if the *VarLogMeasReport* includes one or more additional logged measurement entries that are not included in the *logMeasInfoList* within the *UEInformationResponse* message:
 - 4> include the *logMeasAvailable*;
- 3> if the *VarLogMeasReport* includes one or more additional logged Bluetooth measurement entries that are not included in the *logMeasInfoList* within the *UEInformationResponse* message:
 - 4> include the *logMeasAvailableBT*;
- 3> if the *VarLogMeasReport* includes one or more additional logged WLAN measurement entries that are not included in the *logMeasInfoList* within the *UEInformationResponse* message:
 - 4> include the *logMeasAvailableWLAN*;

...

- 1> if the *logMeasReport* is included in the *UEInformationResponse*:
 - 2> submit the *UEInformationResponse* message to lower layers for transmission via SRB2;
 - 2> discard the logged measurement entries included in the *logMeasInfoList* from *VarLogMeasReport* upon successful delivery of the *UEInformationResponse* message confirmed by lower layers;
- 1> else:
 - 2> submit the *UEInformationResponse* message to lower layers for transmission via SRB1.

8.1.6.1.2.8.3 Test description

8.1.6.1.2.8.3.1 Pre-test conditions

System Simulator:

- NR Cell 1 and NR Cell 2
- System information combination NR-2 as defined in TS 38.508-1 [4] clause 4.4.3.1.2 is used in NR cells.

UE:

- None.

Preamble:

- The UE is in state 3N-A according to TS 38.508-1 [4], clause 4.4A.2 Table 4.4A.2-3 on NR Cell 1.

8.1.6.1.2.8.3.2 Test procedure sequence

Table 8.1.6.1.2.8.3.2-1/2 illustrate the downlink power levels and other changing parameters to be applied for the cell at various time instants of the test execution. Row marked "T0" denotes the conditions after the preamble, while the configuration marked "T1" shall be applied as described in the texts in this clause.

Table 8.1.6.1.2.8.3.2-1: Power levels in FR1

	Parameter	Unit	NR Cell 1	NR Cell 2	Remark
T0	SS/PBCH SSS EPRE	dBm/SCS	-85	-91	Power levels are such that entry condition for event A3 is not satisfied for NR Cell 2
T1	SS/PBCH SSS EPRE	dBm/SCS	-85	-79	Power levels are such that entry condition for event A3 is satisfied for NR Cell 2

Table 8.1.6.1.2.8.3.2-2: Power levels in FR2

	Parameter	Unit	NR Cell 1	NR Cell 2	Remark
T0	SS/PBCH SSS EPRE	dBm/SCS	FFS	FFS	Power levels are such that entry condition for event A3 is not satisfied for NR Cell 2
T1	SS/PBCH SSS EPRE	dBm/SCS	FFS	FFS	Power levels are such that entry condition for event A3 is satisfied for NR Cell 2

Table 8.1.6.1.2.8.3.2-3: Main behaviour

St	Procedure	Message Sequence		TP	Verdict
		U - S	Message		
1	The SS transmits a <i>LoggedMeasurementConfiguration</i> message on NR Cell 1.	<--	NR RRC: <i>LoggedMeasurementConfiguration</i>	-	-
2	The SS transmits a <i>RRCRelease</i> message to release the RRC connection.	<--	NR RRC: <i>RRCRelease</i>	-	-
3	Wait 30 seconds for the UE to perform the logging at regular time intervals.	-	-	-	-
4-11	Steps 1 to 8 of the generic procedure in TS 38.508-1 [4] Table 4.5.4.2-3 are executed to successfully complete the service request procedure.	-	-	-	-
12	The SS transmits an <i>RRCReconfiguration</i> message including <i>MeasConfig</i> to setup intra NR measurement and reporting for intra-frequency event A3.	<--	NR RRC: <i>RRCReconfiguration</i>	-	-
13	The UE transmits an <i>RRCReconfigurationComplete</i> message.	-->	NR RRC: <i>RRCReconfigurationComplete</i>	-	-
14	The SS changes NR Cell 1 and NR Cell 2 parameters according to the row "T1" in tables 8.1.6.1.2.8.3.2-1/2.	-	-	-	-
15	The UE transmits a <i>MeasurementReport</i> message to report event A3 with the measured RSRP value for NR Cell 2.	-->	NR RRC: <i>MeasurementReport</i>	-	-
16	The SS transmits an <i>RRCReconfiguration</i> message on NR Cell 1 to order the UE to perform intra frequency handover to NR Cell 2.	<--	NR RRC: <i>RRCReconfiguration</i>	-	-
17	Check: Does the UE transmit an <i>RRCReconfigurationComplete</i> message on NR Cell 2 with <i>logMeasAvailable</i> set to true to confirm the successful completion of the intra frequency handover?	-->	NR RRC: <i>RRCReconfigurationComplete</i>	1	P
18	The SS sends an <i>UEInformationRequest</i> message to get <i>logMeasReport</i> .	<--	NR RRC: <i>UEInformationRequest</i>	-	-
19	Check: Does the UE send an <i>UEInformationResponse</i> message including <i>logMeasReport</i> ?	-->	NR RRC: <i>UEInformationResponse</i>	2	P

8.1.6.1.2.8.3.3 Specific message contents

Table 8.1.6.1.2.8.3.3-1: LoggedMeasurementConfiguration (step 1, Table 8.1.6.1.2.8.3.2-3)

Derivation path: TS 38.508-1 [4], Table 4.6.1-5AA			
Information Element	Value/remark	Comment	Condition
LoggedMeasurementConfiguration-r16 ::= SEQUENCE {			
criticalExtensions CHOICE {			
loggedMeasurementConfiguration-r16 SEQUENCE {			
reportType CHOICE {			
periodical SEQUENCE {			
loggingInterval-r16	ms10240	10.24 seconds	
}			
}			
}			
}			
}			

Table 8.1.6.1.2.8.3.3-2: RRCReconfiguration (step 12, Table Table 8.1.6.1.2.8.3.2-3)

Derivation Path: TS 38.508-1 [4], Table 4.6.1-13, condition NR_MEAS

Table 8.1.6.1.2.8.3.3-3: MeasConfig (Table 8.1.6.1.2.8.3.3-2)

Derivation Path: TS 38.508-1 [4], Table 4.6.3-69			
Information Element	Value/remark	Comment	Condition
MeasConfig ::= SEQUENCE {			
measObjectToAddModList SEQUENCE (SIZE (1..maxObjectld)) OF MeasObjectToAddMod {	1 entry		
MeasObjectToAddMod[1] SEQUENCE {		entry 1	
measObjectld	1		
measObject CHOICE {			
measObjectNR SEQUENCE {			
ssbFrequency	ssbFrequency IE equals the ARFCN for NR Cell 1		
absThreshSS-BlocksConsolidation	Not present		
}			
}			
}			
reportConfigToAddModList SEQUENCE (SIZE (1..maxReportConfigld)) OF ReportConfigToAddMod {	1 entry		
ReportConfigToAddMod[1] SEQUENCE {		entry 1	
reportConfigld	1		
reportConfig CHOICE {			
reportConfigNR	ReportConfigNR-EventA3		
}			
}			
measldToAddModList ::= SEQUENCE (SIZE (1..maxNrofMeasld)) OF MeasldToAddMod {	1 entry		
MeasldToAddMod[1] SEQUENCE {		entry 1	
measld	1		
measObjectld	1		
reportConfigld	1		
}			
}			
}			

absoluteTimeStamp-r16	Same value as sent by SS in <i>LoggedMeasurementConfiguration</i> in step 1		
traceReference-r16 SEQUENCE {			
plmn-Identity-r16 SEQUENCE {			
mcc SEQUENCE (SIZE (3)) OF MCC-NMC-Digit	Same value as sent by SS in <i>LoggedMeasurementConfiguration</i> in step 1		
mnc SEQUENCE (SIZE (2..3)) OF MCC-NMC-Digit	Same value as sent by SS in <i>LoggedMeasurementConfiguration</i> in step 1		
}			
traceId-r16	FFS		
}			
traceRecordingSessionRef-r16	Same value as sent by SS in <i>LoggedMeasurementConfiguration</i> in step 1		
tce-Id-r16	Same value as sent by SS in <i>LoggedMeasurementConfiguration</i> in step 1		
logMeasInfoList-r16 SEQUENCE (SIZE (1..maxLogMeasReport-r16)) OF LogMeasInfo-r16 SEQUENCE {	At least 2 entries where at least one entry complies to entry with index 'x' below. SS records the relativeTimeStamp value for each entry		
LogMeasInfo-r16[x] SEQUENCE {		entry x	
locationInfo-r16	Not checked		
relativeTimeStamp-r16	SS record the value		
servCellIdentity-r16	Same as NR Cell 1		
measResultServCell-16 SEQUENCE {			
resultsSSB-Cell-r16	MeasQuantityResults of NR Cell 1		
resultsSSB SEQUENCE {			
best-ssb-Index	Not checked		
best-ssb-Results	Not checked		
numberOfGoodSSB	Not checked		
}			
}			
measResultNeighCells-r16 SEQUENCE {			
measResultNeighCellListNR SEQUENCE (SIZE (1..maxFreq)) OF MeasResultLogging2NR-r16 SEQUENCE {	1 entry		
MeasResultLogging2NR-r16[1] SEQUENCE {		entry 1	
carrierFreq-r16	Same as NR Cell 2		
measResultListLoggingNR-r16 SEQUENCE (SIZE (1..maxCellReport)) OF MeasResultLoggingNR-r16 SEQUENCE {	1 entry		
MeasResultLoggingNR-r16[1] SEQUENCE {		entry 1	
physCellId-r16	Same as NR Cell 2		
resultsSSB-Cell-r16	MeasQuantityResults of NR Cell 2		
numberOfGoodSSB-r16	Not checked		
}			
}			
}			
}			
measResultNeighCellListEUTRA	Not present		
}			

anyCellSelectionDetected-r16	Not present		
}			
}			
logMeasAvailable-r16	Not present		
logMeasAvailableBT-r16	Not present		
logMeasAvailableWLAN-r16	Not present		
}			
}			
}			
}			

Table 8.1.6.1.2.8.3.3-8: RRCSetupComplete (step 7, Table 8.1.6.1.2.8.3.2-3)

Derivation path: TS 38.508-1 [4], Table 4.6.1-22			
Information Element	Value/remark	Comment	Condition
RRCSetupComplete ::= SEQUENCE {			
criticalExtensions CHOICE {			
rrcSetupComplete SEQUENCE {			
nonCriticalExtension SEQUENCE {			
ue-MeasurementsAvailable-r16	UE-MeasurementsAvailable-r16 with condition LOG		
}			
}			
}			
}			

8.1.6.1.2.9 Logged MDT / Location information

8.1.6.1.2.9.1 Test Purpose (TP)

(1)

```
with { UE received LoggedMeasurementConfiguration message and has stored logMeasReport with detailed location information in VarLogMeasReport }
ensure that {
  when { receiving UEInformationRequest message }
  then { UE transmits UEInformationResponse messages with a logMeasReport with locationCoordinate in the locationInfo in the logged measurement entries }
}
```

8.1.6.1.2.9.2 Conformance requirements

References: The conformance requirements covered in the current TC are specified in: TS 38.331, clauses 5.3.3.4, 5.5a.1.3, 5.5a.3.2, 5.3.3.7 and 5.7.10.3. Unless otherwise stated these are Rel-16 requirements.

[TS 38.331, clause 5.3.3.4]

The UE shall perform the following actions upon reception of the *RRCSetup*:

...

6> set the content of *RRCSetupComplete* message as follows:

...

2> if the UE has logged measurements available for NR and if the RPLMN is included in *plmn-IdentityList* stored in *VarLogMeasReport*:

3> include the *logMeasAvailable* in the *RRCSetupComplete* message;

2> if the UE has Bluetooth logged measurements available and if the RPLMN is included in *plmn-IdentityList* stored in *VarLogMeasReport*:

- 3> include the *logMeasAvailableBT* in the *RRCSetupComplete* message;
- 2> if the UE has WLAN logged measurements available and if the RPLMN is included in *plmn-IdentityList* stored in *VarLogMeasReport*:
- 3> include the *logMeasAvailableWLAN* in the *RRCSetupComplete* message;
- ...

[TS 38.331, clause 5.5a.1.3]

Upon receiving the *LoggedMeasurementConfiguration* message the UE shall:

- 1> discard the logged measurement configuration as well as the logged measurement information as specified in 5.5a.2;
- 1> store the received *loggingDuration*, *reportType* and *areaConfiguration*, if included, in *VarLogMeasConfig*;
- 1> if the *LoggedMeasurementConfiguration* message includes *plmn-IdentityList*:
 - 2> set *plmn-IdentityList* in *VarLogMeasReport* to include the RPLMN as well as the PLMNs included in *plmn-IdentityList*;
- 1> else:
 - 2> set *plmn-IdentityList* in *VarLogMeasReport* to include the RPLMN;
- 1> store the received *absoluteTimeInfo*, *traceReference*, *traceRecordingSessionRef*, and *tce-Id* in *VarLogMeasReport*;
- 1> store the received *bt-NameList*, if included, in *VarLogMeasConfig*;
- 1> store the received *wlan-NameList*, if included, in *VarLogMeasConfig*;
- 1> store the received *sensor-NameList*, if included, in *VarLogMeasConfig*;
- 1> start timer T330 with the timer value set to the *loggingDuration*;

[TS 38.331, clause 5.5a.3.2]

While T330 is running, the UE shall:

- 1> perform the logging in accordance with the following:
 - ...
 - 2> when performing the logging:
 - 3> set the *relativeTimeStamp* to indicate the elapsed time since the moment at which the logged measurement configuration was received;
 - 3> if location information became available during the last logging interval, set the content of the *locationInfo* as in 5.3.3.7:

[TS 38.331, clause 5.3.3.7]

- 3> if available, set the *locationInfo* as follows:
 - 4> if available, set the *commonLocationInfo* to include the detailed location information;
 - 4> if available, set the *bt-LocationInfo* to include the Bluetooth measurement results, in order of decreasing RSSI for Bluetooth beacons;
 - 4> if available, set the *wlan-LocationInfo* to include the WLAN measurement results, in order of decreasing RSSI for WLAN APs;
 - 4> if available, set the *sensor-LocationInfo* to include the sensor measurement results as follows;

5> if available, include the *sensor-MeasurementInformation*;

5> if available, include the *sensor-MotionInformation*;

[TS 38.331, clause 5.7.10.3]

Upon receiving the *UEInformationRequest* message, the UE shall, only after successful security activation:

...

1> if the *logMeasReportReq* is present and if the RPLMN is included in *plmn-IdentityList* stored in *VarLogMeasReport*:

2> if *VarLogMeasReport* includes one or more logged measurement entries, set the contents of the *logMeasReport* in the *UEInformationResponse* message as follows:

3> include the *absoluteTimeStamp* and set it to the value of *absoluteTimeInfo* in the *VarLogMeasReport*;

3> include the *traceReference* and set it to the value of *traceReference* in the *VarLogMeasReport*;

3> include the *traceRecordingSessionRef* and set it to the value of *traceRecordingSessionRef* in the *VarLogMeasReport*;

3> include the *tce-Id* and set it to the value of *tce-Id* in the *VarLogMeasReport*;

3> include the *logMeasInfoList* and set it to include one or more entries from *VarLogMeasReport* starting from the entries logged first;

3> if the *VarLogMeasReport* includes one or more additional logged measurement entries that are not included in the *logMeasInfoList* within the *UEInformationResponse* message:

4> include the *logMeasAvailable*;

3> if the *VarLogMeasReport* includes one or more additional logged Bluetooth measurement entries that are not included in the *logMeasInfoList* within the *UEInformationResponse* message:

4> include the *logMeasAvailableBT*;

3> if the *VarLogMeasReport* includes one or more additional logged WLAN measurement entries that are not included in the *logMeasInfoList* within the *UEInformationResponse* message:

4> include the *logMeasAvailableWLAN*;

...

1> if the *logMeasReport* is included in the *UEInformationResponse*:

2> submit the *UEInformationResponse* message to lower layers for transmission via SRB2;

2> discard the logged measurement entries included in the *logMeasInfoList* from *VarLogMeasReport* upon successful delivery of the *UEInformationResponse* message confirmed by lower layers;

1> else:

2> submit the *UEInformationResponse* message to lower layers for transmission via SRB1.

8.1.6.1.2.9.3 Test description

8.1.6.1.2.9.3.1 Pre-test conditions

System Simulator:

- NR Cell 1 and NR Cell 11.
- System information combination NR-2 as defined in TS 38.508-1 [4] clause 4.4.3.1.2 is used in NR cells.

UE:

- None.

Preamble:

- The UE is in state 3N-A according to TS 38.508-1 [4], clause 4.4A.2 Table 4.4A.2-3 on Cell 1.
- The UE's positioning engine (e.g. standalone GNSS receiver) should be provided with any necessary stimulus to allow it to provide the position. This shall be done by use of the test function Update UE Location Information defined in TS 38.509 [6] clause 5.6.2. Or in addition any other suitable method may also be used.

8.1.6.1.2.9.3.2 Test procedure sequence

Table 8.1.6.1.2.9.3.2-1/2 illustrate the downlink power levels and other changing parameters to be applied for the cell at various time instants of the test execution. The exact instants on which these values shall be applied are described in the texts in this clause.

Table 8.1.6.1.2.9.3.2-1: Time instances of cell power level for FR1

	Parameter	Unit	NR Cell 1	NR Cell 11	Remark
T0	SS/PBCH SSS EPRE	dBm/ SCS	-78	-85	NR Cell 1 becomes the highest ranked cell.
T1	SS/PBCH SSS EPRE	dBm/ SCS	-85	-78	NR Cell 11 becomes the highest ranked cell.

Table 8.1.6.1.2.9.3.2-2: Time instances of cell power level for FR2

	Parameter	Unit	NR Cell 1	NR Cell 11	Remark
T0	SS/PBCH SSS EPRE	dBm/ SCS	-82	-91	NR Cell 1 becomes the highest ranked cell.
T1	SS/PBCH SSS EPRE	dBm/ SCS	-91	-82	NR Cell 11 becomes the highest ranked cell.

Table 8.1.6.1.2.9.3.2-3: Main behaviour

St	Procedure	Message Sequence		TP	Verdict
		U - S	Message		
1	SS transmits a <i>LoggedMeasurementConfiguration</i> message including to configure the UE to perform logging of measurement results while in RRC_IDLE.	<--	<i>LoggedMeasurementConfiguration</i>	-	-
2	The SS transmits an <i>RRCRelease</i> message.	<--	<i>NR RRC:RRCRelease</i>	-	-
3	Wait 5s to allow UE to activate logging.	-	-	-	-
4	The SS changes Cell 1 and Cell 11 levels according to the row "T1" in table 8.1.6.1.2.9.3.2-1/2.	-	-	-	-
5	The UE transmits an <i>RRCSetupRequest</i> message on Cell 11 to initiate a tracking area update procedure.	-->	<i>NR RRC: RRCSetupRequest</i>	-	-
6	SS transmit an <i>RRCSetup</i> message.	<--	<i>NR RRC: RRCSetup</i>	-	-
7	The UE includes the IE <i>logMeasAvailable</i> in the <i>RRCSetupComplete</i> message.	-->	<i>NR RRC: RRCSetupComplete</i> <i>5GMM: REGISTRATION REQUEST</i>	-	-
8-10	Steps 4 to 6a1 of generic test procedure in TS 38.508-1 [4] Table 4.9.5.2.2-1 are performed on Cell 11. NOTE: The UE performs a REGISTRATION procedure update the registration of the actual tracking area and the RRC connection is released.	-	-	-	-

11-18	Steps 1 to 8 of the generic procedure in TS 38.508-1 [4] Table 4.5.4.2-3 are executed to successfully complete the service request procedure.	-	-	-	-
19	The SS transmits a <i>UEInformationRequest</i> message on Cell 11.	<--	<i>UEInformationRequest</i>	-	-
20	Check: Does the UE transmit a <i>UEInformationResponse</i> message where the IE <i>CommonLocationInfo</i> is present?	-->	<i>UEInformationResponse</i>	1	P

8.1.6.1.2.9.3.3 Specific message contents

Table 8.1.6.1.2.9.3.3-1: *LoggedMeasurementConfiguration* (step 1, Table 8.1.6.1.2.9.3.2-3)

Derivation path: TS 38.508-1 [4], Table 4.6.1-5AA with condition PERIODICAL

Table 8.1.6.1.2.9.3.3-2: *RRCSetupComplete* (step 7, Table 8.1.6.1.2.9.3.2-3)

Derivation path: TS 38.508-1 [4], Table 4.6.1-22			
Information Element	Value/remark	Comment	Condition
<i>RRCSetupComplete</i> ::= SEQUENCE {			
<i>criticalExtensions</i> CHOICE {			
<i>rrcSetupComplete</i> SEQUENCE {			
<i>nonCriticalExtension</i> SEQUENCE {			
<i>ue-MeasurementsAvailable-r16</i>	UE-MeasurementsAvailable-r16 with condition LOG		
}			
}			
}			
}			

Table 8.1.6.1.2.9.3.3-3: *UEInformationRequest* (step 19, Table 8.1.6.1.2.9.3.2-3)

Derivation path: TS 38.508-1 [4], Table 4.6.1-32A with condition LOG
--

Table 8.1.6.1.2.9.3.3-4: *UEInformationResponse* (step 20, Table 8.1.6.1.2.9.3.2-3)

Derivation path: TS 38.508-1 [4], Table 4.6.1-32B			
Information Element	Value/remark	Comment	Condition
<i>UEInformationResponse-r16</i> ::= SEQUENCE {			
<i>criticalExtensions</i> CHOICE {			
<i>ueInformationResponse-r16</i> SEQUENCE {			
<i>logMeasReport-r16</i> SEQUENCE {			
<i>absoluteTimeStamp-r16</i>	Same value as sent by SS in <i>LoggedMeasurementConfiguration</i> in step 1		
<i>traceReference-r16</i> SEQUENCE {			
<i>plmn-Identity-r16</i> SEQUENCE {			
<i>mcc</i> SEQUENCE (SIZE (3)) OF MCC-NMC-Digit	Same value as sent by SS in <i>LoggedMeasurementConfiguration</i> in step 1		
<i>mnc</i> SEQUENCE (SIZE (2..3)) OF MCC-NMC-Digit	Same value as sent by SS in <i>LoggedMeasurementConfiguration</i> in step 1		
}			
<i>traceld-r16</i>	Same value as sent by SS in		

	LoggedMeasurementCon figuration in step 1		
}			
traceRecordingSessionRef-r16	Same value as sent by SS in <i>LoggedMeasurementCon figuration in step 1</i>		
tce-Id-r16	Same value as sent by SS in <i>LoggedMeasurementCon figuration in step 1</i>		
logMeasInfoList-r16 SEQUENCE (SIZE (1..maxLogMeasReport-r16)) OF LogMeasInfo-r16 SEQUENCE {	At least 1 entrie where at least one entry complies to entry with index 'x' below.		
LogMeasInfo-r16[x] SEQUENCE {		entry x	
locationInfo-r16 SEQUENCE {			
commonLocationInfo-r16 SEQUENCE {			
gnss-TOD-msec-r16	Not checked		
locationTimestamp-r16	Not checked		
locationCoordinate-r16	OCTET STRING including LocationCoordinates message according to TS 37.355		
locationError-r16	Not checked		
locationSource-r16	Not checked		
velocityEstimate-r16	Not checked		
}			
bt-LocationInfo-r16	Not present		
wlan-LocationInfo-r16	Not present		
sensor-LocationInfo-r16	Not present		
}			
relativeTimeStamp-r16	SS record the value		
servCellIdentity-r16	Same as Cell 1		
measResultServCell-16 SEQUENCE {			
resultsSSB-Cell-r16	MeasQuantityResults of Cell 1		
resultsSSB SEQUENCE {			
best-ssb-Index	Not checked		
best-ssb-Results	Not checked		
numberOfGoodSSB	Not checked		
}			
}			
measResultNeighCells-r16 SEQUENCE {			
measResultNeighCellListNR SEQUENCE (SIZE (1..maxFreq)) OF MeasResultLogging2NR-r16 SEQUENCE {	1 entry		
MeasResultLogging2NR-r16[1] SEQUENCE {		entry 1	
carrierFreq-r16	Same as Cell 11		
measResultListLoggingNR -r16 SEQUENCE (SIZE (1..maxCellReport)) OF MeasResultLoggingNR-r16 SEQUENCE {	1 entry		
MeasResultLoggingNR-r16[1] SEQUENCE {		entry 1	
physCellId-r16	Same as Cell 11		
resultsSSB-Cell-r16	MeasQuantityResults of Cell 11		
numberOfGoodSSB-r16	Not checked		
}			
}			
}			
}			
measResultNeighCellListEUTRA	Not present		
}			

anyCellSelectionDetected-r16	Not present		
}			
}			
logMeasAvailable-r16	Not present		
logMeasAvailableBT-r16	Not present		
logMeasAvailableWLAN-r16	Not present		
}			
}			
}			
}			

8.1.6.1.2.10 Logged MDT / Maintaining logged measurement configuration / UE mobility

8.1.6.1.2.10.1 Test Purpose (TP)

(1)

```
with { UE received LoggedMeasurementConfiguration message and has stored logMeasReport in
VarLogMeasReport }
ensure that {
  when { UE reselected to a cell belong to non MDT PLMN }
  then { UE does not indicate availability of Logged MDT measurements }
}
```

(2)

```
with { UE received LoggedMeasurementConfiguration message and has stored logMeasReport in
VarLogMeasReport }
ensure that {
  when { UE reselects to a cell belong to non MDT PLMN }
  then { UE suspends Logged MDT measurements }
}
```

(3)

```
with { UE received LoggedMeasurementConfiguration message and has reselected to a cell belong to non
MDT PLMN }
ensure that {
  when { UE returns to a cell belong to MDT PLMN }
  then { UE indicate availability of Logged MDT measurements }
}
```

(4)

```
with { UE received LoggedMeasurementConfiguration message and has reselected to a cell belong to non
MDT PLMN }
ensure that {
  when { UE returns to a cell belong to MDT PLMN }
  then { UE resumes Logged MDT measurements }
}
```

8.1.6.1.2.10.2 Conformance requirements

References: The conformance requirements covered in the current TC are specified in: TS 38.331, clauses 5.3.3.4, 5.5.a.1.3 and 5.7.10.3. Unless otherwise stated these are Rel-16 requirements.

[TS 38.331, clause 5.3.3.4]

The UE shall perform the following actions upon reception of the *RRCSetup*:

...

1> set the content of *RRCSetupComplete* message as follows:

...

- 2> if the UE has logged measurements available for NR and if the RPLMN is included in *plmn-IdentityList* stored in *VarLogMeasReport*:
 - 3> include the *logMeasAvailable* in the *RRCSetupComplete* message;
- 2> if the UE has Bluetooth logged measurements available and if the RPLMN is included in *plmn-IdentityList* stored in *VarLogMeasReport*:
 - 3> include the *logMeasAvailableBT* in the *RRCSetupComplete* message;
- 2> if the UE has WLAN logged measurements available and if the RPLMN is included in *plmn-IdentityList* stored in *VarLogMeasReport*:
 - 3> include the *logMeasAvailableWLAN* in the *RRCSetupComplete* message;
- ...

[TS 38.331, clause 5.5a.1.3]

Upon receiving the *LoggedMeasurementConfiguration* message the UE shall:

- 1> discard the logged measurement configuration as well as the logged measurement information as specified in 5.5a.2;
- 1> store the received *loggingDuration*, *reportType* and *areaConfiguration*, if included, in *VarLogMeasConfig*;
- 1> if the *LoggedMeasurementConfiguration* message includes *plmn-IdentityList*:
 - 2> set *plmn-IdentityList* in *VarLogMeasReport* to include the RPLMN as well as the PLMNs included in *plmn-IdentityList*;
- 1> else:
 - 2> set *plmn-IdentityList* in *VarLogMeasReport* to include the RPLMN;
- 1> store the received *absoluteTimeInfo*, *traceReference*, *traceRecordingSessionRef*, and *tce-Id* in *VarLogMeasReport*;
- 1> store the received *bt-NameList*, if included, in *VarLogMeasConfig*;
- 1> store the received *wlan-NameList*, if included, in *VarLogMeasConfig*;
- 1> store the received *sensor-NameList*, if included, in *VarLogMeasConfig*;
- 1> start timer T330 with the timer value set to the *loggingDuration*;

[TS 38.331, clause 5.7.10.3]

Upon receiving the *UEInformationRequest* message, the UE shall, only after successful security activation:

- ...
- 1> if the *logMeasReportReq* is present and if the RPLMN is included in *plmn-IdentityList* stored in *VarLogMeasReport*:
 - 2> if *VarLogMeasReport* includes one or more logged measurement entries, set the contents of the *logMeasReport* in the *UEInformationResponse* message as follows:
 - 3> include the *absoluteTimeStamp* and set it to the value of *absoluteTimeInfo* in the *VarLogMeasReport*;
 - 3> include the *traceReference* and set it to the value of *traceReference* in the *VarLogMeasReport*;
 - 3> include the *traceRecordingSessionRef* and set it to the value of *traceRecordingSessionRef* in the *VarLogMeasReport*;
 - 3> include the *tce-Id* and set it to the value of *tce-Id* in the *VarLogMeasReport*;

- 3> include the *logMeasInfoList* and set it to include one or more entries from *VarLogMeasReport* starting from the entries logged first;
- 3> if the *VarLogMeasReport* includes one or more additional logged measurement entries that are not included in the *logMeasInfoList* within the *UEInformationResponse* message:
 - 4> include the *logMeasAvailable*;
- 3> if the *VarLogMeasReport* includes one or more additional logged Bluetooth measurement entries that are not included in the *logMeasInfoList* within the *UEInformationResponse* message:
 - 4> include the *logMeasAvailableBT*;
- 3> if the *VarLogMeasReport* includes one or more additional logged WLAN measurement entries that are not included in the *logMeasInfoList* within the *UEInformationResponse* message:
 - 4> include the *logMeasAvailableWLAN*;

...

- 1> if the *logMeasReport* is included in the *UEInformationResponse*:
 - 2> submit the *UEInformationResponse* message to lower layers for transmission via SRB2;
 - 2> discard the logged measurement entries included in the *logMeasInfoList* from *VarLogMeasReport* upon successful delivery of the *UEInformationResponse* message confirmed by lower layers;
- 1> else:
 - 2> submit the *UEInformationResponse* message to lower layers for transmission via SRB1.

8.1.6.1.2.10.3 Test description

8.1.6.1.2.10.3.1 Pre-test conditions

System Simulator:

- NR Cell 1, NR Cell 3, NR Cell 11
- System information combination NR-4 as defined in TS 38.508-1 [4] clause 4.4.3.1.2 is used in NR cells.
- When NR Cell 3 is used its PLMN will be set to PLMN2.

UE:

- None.

Preamble:

- The UE is in state 3N-A according to TS 38.508-1 [4], clause 4.4A.2 Table 4.4A.2-3 on NR Cell 1.

8.1.6.1.2.10.3.2 Test procedure sequence

Table 8.1.6.1.2.10.3.2-1/2 illustrate the downlink power levels and other changing parameters to be applied for the cell at various time instants of the test execution. The exact instants on which these values shall be applied are described in the texts in this clause.

Table 8.1.6.1.2.10.3.2-1: Time instances of cell power level for FR1

	Parameter	Unit	NR Cell 1	NR Cell 11	NR Cell 3
T0	SS/PBCH SSS EPRE	dBm/ SCS	-85	Off	Off
T1	SS/PBCH SSS EPRE	dBm/ SCS	Off	Off	-85

T2	SS/PBCH SSS EPRE	dBm/ SCS	Off	-85	Off
Note:	The downlink signal level uncertainty is specified in TS 38.508-1 [4] clause 6.2.2.1.				

Table 8.1.6.1.2.10.3.2-2: Time instances of cell power level for FR2

	Parameter	Unit	NR Cell 1	NR Cell 11	NR Cell 3
T0	SS/PBCH SSS EPRE	dBm/ SCS	-82	Off	Off
T1	SS/PBCH SSS EPRE	dBm/ SCS	Off	Off	-82
T2	SS/PBCH SSS EPRE	dBm/ SCS	Off	-82	Off
Note:	The downlink signal level uncertainty is specified in TS 38.508-1 [4] clause 6.2.2.2.				

Table 8.1.6.1.2.10.3.2-3: Main behaviour

St	Procedure	Message Sequence		TP	Verdict
		U - S	Message		
1	The SS transmits a LoggedMeasurementConfiguration message on NR Cell 1.	<--	NR RRC: <i>LoggedMeasurementConfiguration</i>	-	-
2	The SS transmits a <i>RRCRelease</i> message to release the RRC connection.	<--	NR RRC: <i>RRCRelease</i>	-	-
3	Wait 10 seconds for UE performing the logging at regular time intervals.	-	-	-	-
4	The SS changes NR Cell 1 and NR Cell 3 level according to the row "T1" in Table 8.1.6.1.2.10.3.2-1/2.	-	-	-	-
5-10	Steps 1 to 6a1 of generic test procedure in TS 38.508-1 [4] subclause 4.9.5.2.2-1 are performed on NR Cell 3.	-	-	-	-
11	Wait 10 seconds for UE not to perform the logging at regular time intervals.	-	-	-	-
12	The SS transmits a <i>Paging</i> message.	<--	NR RRC: <i>Paging</i>	-	-
13	The UE transmits an <i>RRCRequest</i> message.	-->	NR RRC: <i>RRCRequest</i>	-	-
14	The SS transmits an <i>RRCSetup</i> message.	<--	NR RRC: <i>RRCSetup</i>	-	-
15	Check: Does UE transmit an <i>RRCSetupComplete</i> message with <i>logMeasAvailable</i> IE not present?	-->	NR RRC: <i>RRCSetupComplete</i>	1	P
15A-15D	Steps 5 to 8 of the generic procedure in TS 38.508-1 [4] Table 4.5.4.2-3 are executed to successfully complete the service request procedure.	-	-	-	-
16	The SS transmits a <i>RRCRelease</i> message to release RRC connection and move to RRC_IDLE on NR Cell 3.	<--	NR RRC: <i>RRCRelease</i>	-	-
17	The SS changes NR Cell 1, NR Cell 11 and NR Cell 3 level according to the row "T2" in Table 8.1.6.1.2.10.3.2-1/2.	-	-	-	-
18-23	Steps 1 to 6a1 of generic test procedure in TS 38.508-1 [4] subclause 4.9.5.2.2-1 are performed on NR Cell 11.	-	-	-	-
24	Wait 10 seconds for UE performing the logging at regular time intervals.	-	-	-	-
25	The SS transmits a <i>Paging</i> message.	<--	NR RRC: <i>Paging</i>	-	-
26	The UE transmits an <i>RRCRequest</i> message.	-->	NR RRC: <i>RRCRequest</i>	-	-
27	The SS transmits an <i>RRCSetup</i> message.	<--	NR RRC: <i>RRCSetup</i>	-	-
28	Check: Does UE transmit an <i>RRCSetupComplete</i> message with <i>logMeasAvailable</i> set as true?	-->	NR RRC: <i>RRCSetupComplete</i>	3	P

29-31	Steps 5 to 8 of the generic procedure in TS 38.508-1 [4] Table 4.5.4.2-3 are executed to successfully complete the service request procedure.	-	-	-	-
32	The SS send a <i>UEInformationRequest</i> message to get logMeasReport.	<--	NR RRC: <i>UEInformationRequest</i>	-	-
33	Check: Does the UE send an <i>UEInformationResponse</i> message including at least one logMeasReport with serving cell measurements for NR Cell 1 and NR Cell 11 and without serving cell measurements for NR Cell 3?	-->	NR RRC: <i>UEInformationResponse</i>	2, 4,	P

8.1.6.1.2.10.3.3 Specific message contents

Table 8.1.6.1.2.10.3.3-1: *LoggedMeasurementConfiguration* (step 1, Table 8.1.6.1.2.10.3.2-3)

Derivation path: TS 38.508-1 [4], table 4.6.1-5AA with condition PERIODICAL

Table 8.1.6.1.2.10.3.3-1A: *RRCSetupComplete* (step 15, Table 8.1.6.1.2.10.3.2-3)

Derivation path: TS 38.508-1 [4], table 4.6.1-22			
Information Element	Value/remark	Comment	Condition
RRCSetupComplete ::= SEQUENCE {			
criticalExtensions CHOICE {			
rrcSetupComplete SEQUENCE {			
nonCriticalExtension SEQUENCE {	Checked	Note 1	
ue-MeasurementsAvailable-r16 SEQUENCE {			If nonCriticalExtension is present
logMeasAvailable-r16	Not present		
}			
}			
}			
}			
}			

Condition	Explanation
If nonCriticalExtension is present	Contents of ue-MeasurementsAvailable-r16 shall be checked only if nonCriticalExtension is present
Note 1:	If the UE has no underlying information to report to the network, this information element may be absent. If this information element is present, further check on the contents of the ue-MeasurementsAvailable-r16 shall be performed

Table 8.1.6.1.2.10.3.3-2: *RRCSetupComplete* (step 28, Table 8.1.6.1.2.10.3.2-3)

Derivation path: TS 38.508-1 [4], Table 4.6.1-22			
Information Element	Value/remark	Comment	Condition
RRCSetupComplete ::= SEQUENCE {			
criticalExtensions CHOICE {			
rrcSetupComplete SEQUENCE {			
nonCriticalExtension SEQUENCE {			
ue-MeasurementsAvailable-r16	UE-MeasurementsAvailable-r16 with condition LOG		
}			
}			
}			
}			

Table 8.1.6.1.2.10.3.3-3: UEInformationRequest (step 32, Table 8.1.6.1.2.10.3.2-3)

Derivation path: TS 38.508-1 [4], Table 4.6.1-32A with condition LOG
--

Table 8.1.6.1.2.10.3.3-4: UEInformationResponse (step 33, Table 8.1.6.1.2.10.3.2-3)

Derivation path: TS 38.508-1 [4], Table 4.6.1-32B			
Information Element	Value/remark	Comment	Condition
UEInformationResponse-r16 ::= SEQUENCE {			
criticalExtensions CHOICE {			
ueInformationResponse-r16 SEQUENCE {			
logMeasReport-r16 SEQUENCE {			
absoluteTimeStamp-r16	Same value as sent by SS in <i>LoggedMeasurementConfiguration</i> in step 1		
traceReference-r16 SEQUENCE {			
plmn-Identity-r16 SEQUENCE {			
mcc SEQUENCE (SIZE (3)) OF MCC-NMC-Digit	Same value as sent by SS in <i>LoggedMeasurementConfiguration</i> in step 1		
mnc SEQUENCE (SIZE (2..3)) OF MCC-NMC-Digit	Same value as sent by SS in <i>LoggedMeasurementConfiguration</i> in step 1		
}			
traceId-r16	Same value as sent by SS in <i>LoggedMeasurementConfiguration</i> in step 1		
}			
traceRecordingSessionRef-r16	Same value as sent by SS in <i>LoggedMeasurementConfiguration</i> in step 1		
tce-Id-r16	Same value as sent by SS in <i>LoggedMeasurementConfiguration</i> in step 1		
logMeasInfoList-r16 SEQUENCE (SIZE (1..maxLogMeasReport-r16)) OF LogMeasInfo-r16 SEQUENCE {	At least 2 entries where at least one entry complies to entry with index 'x' below. At least 1 entry with "servCellIdentity-r16" set to NR Cell 1 and at least 1 entry with "servCellIdentity-r16" set to NR Cell 11.		
LogMeasInfo-r16[x] SEQUENCE {		entry x	
locationInfo-r16	Not checked		
relativeTimeStamp-r16	SS record the value		
servCellIdentity-r16	Same as NR Cell 1 or NR Cell 11		
measResultServCell-16 SEQUENCE {			
resultsSSB-Cell-r16	MeasQuantityResults of NR Cell 1 or NR Cell 11		
resultsSSB SEQUENCE {			
best-ssb-Index	Not checked		
best-ssb-Results	Not checked		
numberOfGoodSSB	Not checked		
}			

}			
measResultNeighCells-r16	Any allowed value		
anyCellSelectionDetected-r16	Not present		
}			
logMeasAvailable-r16	Not present		
logMeasAvailableBT-r16	Not present		
logMeasAvailableWLAN-r16	Not present		
}			
}			
}			
}			

8.1.6.1.2.11 Logged MDT / UE state transitions

8.1.6.1.2.11.1 Test Purpose (TP)

(1)

```
with { UE received LoggedMeasurementConfiguration message and has stored logMeasReport in
VarLogMeasReport }
ensure that {
  when { UE moves to RRC_CONNECTED state }
  then { UE maintains the Logged measurement configurations and logged measurement reports }
}
```

(2)

void

(3)

```
with { UE received LoggedMeasurementConfiguration message and is not in 'camped normally' state }
ensure that {
  when { UE is again in 'camped normally' state on an NR cell }
  then { UE performs logged MDT measurements }
}
```

8.1.6.1.2.11.2 Conformance requirements

References: The conformance requirements covered in the current TC are specified in: TS 38.331, clauses 5.3.5.3, 5.5.4.1, 5.5.4.2 and 5.5.5. Unless otherwise stated these are Rel-16 requirements.

[TS 38.331, clause 5.3.3.4]

The UE shall perform the following actions upon reception of the *RRCSetup*:

...

1> set the content of *RRCSetupComplete* message as follows:

...

2> if the UE has logged measurements available for NR and if the RPLMN is included in *plmn-IdentityList* stored in *VarLogMeasReport*:

3> include the *logMeasAvailable* in the *RRCSetupComplete* message;

2> if the UE has Bluetooth logged measurements available and if the RPLMN is included in *plmn-IdentityList* stored in *VarLogMeasReport*:

3> include the *logMeasAvailableBT* in the *RRCSetupComplete* message;

2> if the UE has WLAN logged measurements available and if the RPLMN is included in *plmn-IdentityList* stored in *VarLogMeasReport*:

3> include the *logMeasAvailableWLAN* in the *RRCSetupComplete* message;

...

[TS 38.331, clause 5.5a.1.3]

Upon receiving the *LoggedMeasurementConfiguration* message the UE shall:

- 1> discard the logged measurement configuration as well as the logged measurement information as specified in 5.5a.2;
- 1> store the received *loggingDuration*, *reportType* and *areaConfiguration*, if included, in *VarLogMeasConfig*;
- 1> if the *LoggedMeasurementConfiguration* message includes *plmn-IdentityList*:
 - 2> set *plmn-IdentityList* in *VarLogMeasReport* to include the RPLMN as well as the PLMNs included in *plmn-IdentityList*;
- 1> else:
 - 2> set *plmn-IdentityList* in *VarLogMeasReport* to include the RPLMN;
- 1> store the received *absoluteTimeInfo*, *traceReference*, *traceRecordingSessionRef*, and *tce-Id* in *VarLogMeasReport*;
- 1> store the received *bt-NameList*, if included, in *VarLogMeasConfig*;
- 1> store the received *wlan-NameList*, if included, in *VarLogMeasConfig*;
- 1> store the received *sensor-NameList*, if included, in *VarLogMeasConfig*;
- 1> start timer T330 with the timer value set to the *loggingDuration*;

[TS 38.331, clause 5.5a.3.2]

While T330 is running, the UE shall:

- 1> perform the logging in accordance with the following:
 - 2> if the *reportType* is set to *periodical* in the *VarLogMeasConfig*:
 - 3> if the UE is in any cell selection state (as specified in TS 38.304 [20]):
 - 4> perform the logging at regular time intervals, as defined by the *loggingInterval* in the *VarLogMeasConfig*;
 - 3> if the UE is in camped normally state on an NR cell and if the RPLMN is included in *plmn-IdentityList* stored in *VarLogMeasReport*:
 - 4> if *areaConfiguration* is not included in *VarLogMeasConfig*; or
 - 4> if the serving cell is part of the area indicated by *areaConfig* in *areaConfiguration* in *VarLogMeasConfig*;
 - 5> perform the logging at regular time intervals, as defined by the *loggingInterval* in the *VarLogMeasConfig*;

[TS 38.331, clause 5.7.10.3]

Upon receiving the *UEInformationRequest* message, the UE shall, only after successful security activation:

...

- 1> if the *logMeasReportReq* is present and if the RPLMN is included in *plmn-IdentityList* stored in *VarLogMeasReport*:
- 2> if *VarLogMeasReport* includes one or more logged measurement entries, set the contents of the *logMeasReport* in the *UEInformationResponse* message as follows:

- 3> include the *absoluteTimeStamp* and set it to the value of *absoluteTimeInfo* in the *VarLogMeasReport*;
- 3> include the *traceReference* and set it to the value of *traceReference* in the *VarLogMeasReport*;
- 3> include the *traceRecordingSessionRef* and set it to the value of *traceRecordingSessionRef* in the *VarLogMeasReport*;
- 3> include the *tce-Id* and set it to the value of *tce-Id* in the *VarLogMeasReport*;
- 3> include the *logMeasInfoList* and set it to include one or more entries from *VarLogMeasReport* starting from the entries logged first;
- 3> if the *VarLogMeasReport* includes one or more additional logged measurement entries that are not included in the *logMeasInfoList* within the *UEInformationResponse* message:
 - 4> include the *logMeasAvailable*;
- 3> if the *VarLogMeasReport* includes one or more additional logged Bluetooth measurement entries that are not included in the *logMeasInfoList* within the *UEInformationResponse* message:
 - 4> include the *logMeasAvailableBT*;
- 3> if the *VarLogMeasReport* includes one or more additional logged WLAN measurement entries that are not included in the *logMeasInfoList* within the *UEInformationResponse* message:
 - 4> include the *logMeasAvailableWLAN*;

...

- 1> if the *logMeasReport* is included in the *UEInformationResponse*:
 - 2> submit the *UEInformationResponse* message to lower layers for transmission via SRB2;
 - 2> discard the logged measurement entries included in the *logMeasInfoList* from *VarLogMeasReport* upon successful delivery of the *UEInformationResponse* message confirmed by lower layers;
- 1> else:
 - 2> submit the *UEInformationResponse* message to lower layers for transmission via SRB1.

8.1.6.1.2.11.3 Test description

8.1.6.1.2.11.3.1 Pre-test conditions

System Simulator:

- NR Cell 1 and NR Cell 11.
- System information combination NR-2 as defined in TS 38.508-1 [4] clause 4.4.3.1.2 is used in NR cells.

UE:

- None.

Preamble:

- The UE is in state 3N-A on NR Cell 1 according to TS 38.508-1 [4], clause 4.4A.2 Table 4.4A.2-3.

8.1.6.1.2.11.3.2 Test procedure sequence

Table 8.1.6.1.2.11.3.2-1/2 illustrate the downlink power levels and other changing parameters to be applied for the cell at various time instants of the test execution. The exact instants on which these values shall be applied are described in the texts in this clause.

Table 8.1.6.1.2.11.3.2-1: Time instances of cell power level for FR1

	Parameter	Unit	NR Cell 1	NR Cell 11
T0	SS/PBCH SSS EPRE	dBm/ SCS	-85	Off
T1	SS/PBCH SSS EPRE	dBm/ SCS	Off	Off
T2	SS/PBCH SSS EPRE	dBm/ SCS	Off	-85

Table 8.1.6.1.2.11.3.2-2: Time instances of cell power level for FR2

	Parameter	Unit	NR Cell 1	NR Cell 11
T0	SS/PBCH SSS EPRE	dBm/ SCS	-82	Off
T1	SS/PBCH SSS EPRE	dBm/ SCS	Off	Off
T2	SS/PBCH SSS EPRE	dBm/ SCS	Off	-82

Table 8.1.6.1.2.11.3.2-3: Main behaviour

St	Procedure	Message Sequence		TP	Verdict
		U - S	Message		
1	SS transmits a <i>LoggedMeasurementConfiguration</i> message including to configure the UE to perform logging of measurement results while in RRC_IDLE.	<--	<i>LoggedMeasurementConfiguration</i>	-	-
2	The SS transmits an <i>RRCRelease</i> message to move the UE to RRC_IDLE state.	<--	<i>NR RRC: RRCRelease</i>	-	-
3	Wait 10s to allow UE to activate logging.	-	-	-	-
4	The SS changes NR Cell 1 and NR Cell 11 levels according to the row "T1" in table 8.1.6.1.2.11.3.2-1/2.	-	-	-	-
5	Wait 15 seconds.	-	-	-	-
6	The SS changes NR Cell 1 and NR Cell 11 levels according to the row "T2" in table 8.1.6.1.2.11.3.2-1/2.	-	-	-	-
7-11	Steps 1 to 5 of generic test procedure in TS 38.508-1 [4] subclause 4.9.5.2.2-1 are performed on NR Cell 11.	-	-	-	-
12	Wait 15 seconds. Note: It is checked that UE does not perform the logging while in RRC_CONNECTED state.	-	-	-	-
13	The SS transmits an <i>RRCRelease</i> message to move the UE to RRC_INACTIVE state.	<--	<i>NR RRC: RRCRelease</i>	-	-
14	Wait 10s to allow UE to activate logging.	-	-	-	-
15-22	Steps 1 to 8 of the generic procedure in TS 38.508-1 [4] Table 4.5.4.2-3 are executed to successfully complete the service request procedure on NR Cell 11.	-	-	-	-
23	The SS transmits a <i>UEInformationRequest</i> message on NR Cell 11.	<--	<i>UEInformationRequest</i>	-	-
24	Check: Does the UE transmit a <i>UEInformationResponse</i> message including <i>logMeasReport</i> with serving cell measurements for NR Cell 1 and NR Cell 11?	-->	<i>UEInformationResponse</i>	1, 3	P

8.1.6.1.2.11.3.3 Specific message contents

Table 8.1.6.1.2.11.3.3-1: *LoggedMeasurementConfiguration* (step 1, Table 8.1.6.1.2.11.3.2-3)

Derivation path: TS 38.508-1 [4], Table 4.6.1-5AA with condition PERIODICAL

Table 8.1.6.1.2.11.3.3-2: *UEInformationRequest* (step 23, Table 8.1.6.1.2.11.3.2-3)

Derivation path: TS 38.508-1 [4], Table 4.6.1-32A with condition LOG
--

Table 8.1.6.1.2.11.3.3-3: *UEInformationResponse* (step 24, Table 8.1.6.1.2.11.3.2-3)

Derivation path: TS 38.508-1 [4], Table 4.6.1-32B			
Information Element	Value/remark	Comment	Condition
UEInformationResponse-r16 ::= SEQUENCE {			
rrc-TransactionIdentifier			
criticalExtensions CHOICE {			
ueInformationResponse-r16 SEQUENCE {			
logMeasReport-r16 SEQUENCE {			
absoluteTimeStamp-r16	Same value as sent by SS in LoggedMeasurementConfiguration in step 1		
traceReference-r16 SEQUENCE {			
plmn-Identity-r16 SEQUENCE {			
mcc SEQUENCE (SIZE (3)) OF MCC-NMC-Digit	Same value as sent by SS in LoggedMeasurementConfiguration in step 1		
mnc SEQUENCE (SIZE (2..3)) OF MCC-NMC-Digit	Same value as sent by SS in LoggedMeasurementConfiguration in step 1		
}			
traceId-r16	Same value as sent by SS in LoggedMeasurementConfiguration in step 1		
}			
traceRecordingSessionRef-r16	Same value as sent by SS in LoggedMeasurementConfiguration in step 1		
tce-Id-r16	Same value as sent by SS in LoggedMeasurementConfiguration in step 1		
logMeasInfoList-r16 SEQUENCE (SIZE (1..maxLogMeasReport-r16)) OF LogMeasInfo-r16 SEQUENCE {	At least 2 entries, Where at least 1 entry with servCellIdentity-r16 set to cell Identity of NR Cell 1 and at least 1 entry with servCellIdentity-r16 set to cell Identity of NR Cell 11.		
LogMeasInfo-r16[x] SEQUENCE {		entry x	
locationInfo-r16	Not checked		
relativeTimeStamp-r16	SS record the value		
servCellIdentity-r16	Same as NR Cell 1 or NR Cell 11		
measResultServCell-16 SEQUENCE {			
resultsSSB-Cell-r16	MeasQuantityResults of NR Cell 1 or NR Cell 11		

resultsSSB SEQUENCE {			
best-ssb-Index	Not checked		
best-ssb-Results	Not checked		
numberOfGoodSSB	Not checked		
}			
}			
measResultNeighCells-r16	Any allowed value		
anyCellSelectionDetected-r16	Not checked		
}			
}			
logMeasAvailable-r16	Not present		
logMeasAvailableBT-r16	Not present		
logMeasAvailableWLAN-r16	Not present		
}			
}			
}			
}			

8.1.6.1.2.12 Logged MDT / Release of logged MDT measurement configuration / Expire of duration timer

8.1.6.1.2.12.1 Test Purpose (TP)

(1)

```
with { UE received LoggedMeasurementConfiguration message and has stored logMeasReport in
VarLogMeasReport }
ensure that {
  when { The logging duration timer T330 expires }
  then { UE releases VarLogMeasConfig and will not perform logged measurements }
}
```

(2)

```
with { UE received LoggedMeasurementConfiguration message and has stored logMeasReport in
VarLogMeasReport }
ensure that {
  when { UE has released VarlogMeasConfig due to timer T330 has expired and UE receives
UEInformationRequest message with logMeasReportReq present }
  then { UE transmits an UEInformationResponse message including logMeasReport }
}
```

(3)

```
with { UE received LoggedMeasurementConfiguration message and has stored logMeasReport in
VarLogMeasReport }
ensure that {
  when { UE has transmitted all the stored logMeasReport and UE receives UEInformationRequest
message with logMeasReportReq present }
  then { UE transmits an UEInformationResponse message without logMeasReport }
}
```

8.1.6.1.2.12.2 Conformance requirements

References: The conformance requirements covered in the current TC are specified in: TS 38.331, clauses 5.3.3.4, 5.5a.1.3, 5.5a.1.4, 5.5a.3.2, and 5.7.10.3. Unless otherwise stated these are Rel-16 requirements.

[TS 38.331, clause 5.3.3.4]

The UE shall perform the following actions upon reception of the *RRCSetup*:

...

7> set the content of *RRCSetupComplete* message as follows:

...

- 2> if the UE has logged measurements available for NR and if the RPLMN is included in *plmn-IdentityList* stored in *VarLogMeasReport*:
 - 3> include the *logMeasAvailable* in the *RRCSetupComplete* message;
- 2> if the UE has Bluetooth logged measurements available and if the RPLMN is included in *plmn-IdentityList* stored in *VarLogMeasReport*:
 - 3> include the *logMeasAvailableBT* in the *RRCSetupComplete* message;
- 2> if the UE has WLAN logged measurements available and if the RPLMN is included in *plmn-IdentityList* stored in *VarLogMeasReport*:
 - 3> include the *logMeasAvailableWLAN* in the *RRCSetupComplete* message;
- ...

[TS 38.331, clause 5.5a.1.3]

Upon receiving the *LoggedMeasurementConfiguration* message the UE shall:

- 1> discard the logged measurement configuration as well as the logged measurement information as specified in 5.5a.2;
- 1> store the received *loggingDuration*, *reportType* and *areaConfiguration*, if included, in *VarLogMeasConfig*;
- 1> if the *LoggedMeasurementConfiguration* message includes *plmn-IdentityList*:
 - 2> set *plmn-IdentityList* in *VarLogMeasReport* to include the RPLMN as well as the PLMNs included in *plmn-IdentityList*;
- 1> else:
 - 2> set *plmn-IdentityList* in *VarLogMeasReport* to include the RPLMN;
- 1> store the received *absoluteTimeInfo*, *traceReference*, *traceRecordingSessionRef*, and *tce-Id* in *VarLogMeasReport*;
- 1> store the received *bt-NameList*, if included, in *VarLogMeasConfig*;
- 1> store the received *wlan-NameList*, if included, in *VarLogMeasConfig*;
- 1> store the received *sensor-NameList*, if included, in *VarLogMeasConfig*;
- 1> start timer T330 with the timer value set to the *loggingDuration*;

[TS 38.331, clause 5.5a.3.2]

While T330 is running, the UE shall:

- 1> perform the logging in accordance with the following:
 - 2> if the *reportType* is set to *periodical* in the *VarLogMeasConfig*:
 - 3> if the UE is camping normally on an NR cell and if the RPLMN is included in *plmn-IdentityList* stored in *VarLogMeasReport* and, if the cell is part of the area indicated by *areaConfiguration* if configured in *VarLogMeasConfig*:
 - 4> perform the logging at regular time intervals, as defined by the *loggingInterval* in the *VarLogMeasConfig*;
 - 2> else if the *reportType* is set to *eventTriggered*, and *eventType* is set to *outOfCoverage*:
 - 3> perform the logging at regular time intervals as defined by the *loggingInterval* in *VarLogMeasConfig* only when the UE is in any cell selection state;
 - 3> perform the logging immediately upon transitioning from the any cell selection state to the camped normally state;

- 2> else if the *reportType* is set to *eventTriggered* and *eventType* is set to *eventL1*:
 - 3> if the UE is camping normally on an NR cell and if the RPLMN is included in *plmn-IdentityList* stored in *VarLogMeasReport* and, if the cell is part of the area indicated by *areaConfiguration* if configured in *VarLogMeasConfig*;
 - 4> perform the logging at regular time intervals as defined by the *loggingInterval* in *VarLogMeasConfig* only when the conditions indicated by the *eventL1* are met;
- 2> when performing the logging:
 - 3> set the *relativeTimeStamp* to indicate the elapsed time since the moment at which the logged measurement configuration was received;
 - 3> if detailed location information became available during the last logging interval, set the content of the *locationInfo* as in 5.3.3.7;
 - 3> if the UE is in any cell selection state (as specified in TS 38.304 [20]):
 - 4> set *anyCellSelectionDetected* to indicate the detection of no suitable or no acceptable cell found;
 - 4> set the *servCellIdentity* to indicate global cell identity of the last logged cell that the UE was camping on;
 - 4> set the *measResultServingCell* to include the quantities of the last logged cell the UE was camping on;
 - 3> else:
 - 4> set the *servCellIdentity* to indicate global cell identity of the cell the UE is camping on;
 - 4> set the *measResultServingCell* to include the quantities of the cell the UE is camping on;
 - 4> if available, set the *measResultNeighCells*, in order of decreasing ranking-criterion as used for cell reselection, to include neighbouring cell measurements that became available during the last logging interval for at most the following number of neighbouring cells: 6 intra-frequency and 3 inter-frequency neighbours per frequency as well as 3 inter-RAT neighbours, per frequency/ set of frequencies per RAT and according to the following:
 - 5> for each neighbour cell included, include the optional fields that are available;

NOTE: The UE includes the latest results of the available measurements as used for cell reselection evaluation in RRC_IDLE or RRC_INACTIVE, which are performed in accordance with the performance requirements as specified in TS 38.133 [14].

- 2> when the memory reserved for the logged measurement information becomes full, stop timer T330 and perform the same actions as performed upon expiry of T330, as specified in 5.5a.1.4.

[TS 38.331, clause 5.5a.1.4]

Upon expiry of T330 the UE shall:

- 1> release *VarLogMeasConfig*;

The UE is allowed to discard stored logged measurements, i.e. to release *VarLogMeasReport*, 48 hours after T330 expiry.

[TS 38.331, clause 5.7.10.3]

Upon receiving the *UEInformationRequest* message, the UE shall, only after successful security activation:

...

- 1> if the *logMeasReportReq* is present and if the RPLMN is included in *plmn-IdentityList* stored in *VarLogMeasReport*:
- 2> if *VarLogMeasReport* includes one or more logged measurement entries, set the contents of the *logMeasReport* in the *UEInformationResponse* message as follows:

- 3> include the *absoluteTimeStamp* and set it to the value of *absoluteTimeInfo* in the *VarLogMeasReport*;
- 3> include the *traceReference* and set it to the value of *traceReference* in the *VarLogMeasReport*;
- 3> include the *traceRecordingSessionRef* and set it to the value of *traceRecordingSessionRef* in the *VarLogMeasReport*;
- 3> include the *tce-Id* and set it to the value of *tce-Id* in the *VarLogMeasReport*;
- 3> include the *logMeasInfoList* and set it to include one or more entries from *VarLogMeasReport* starting from the entries logged first;
- 3> if the *VarLogMeasReport* includes one or more additional logged measurement entries that are not included in the *logMeasInfoList* within the *UEInformationResponse* message:
 - 4> include the *logMeasAvailable*;
- 3> if the *VarLogMeasReport* includes one or more additional logged Bluetooth measurement entries that are not included in the *logMeasInfoList* within the *UEInformationResponse* message:
 - 4> include the *logMeasAvailableBT*;
- 3> if the *VarLogMeasReport* includes one or more additional logged WLAN measurement entries that are not included in the *logMeasInfoList* within the *UEInformationResponse* message:
 - 4> include the *logMeasAvailableWLAN*;

...

- 1> if the *logMeasReport* is included in the *UEInformationResponse*:
 - 2> submit the *UEInformationResponse* message to lower layers for transmission via SRB2;
 - 2> discard the logged measurement entries included in the *logMeasInfoList* from *VarLogMeasReport* upon successful delivery of the *UEInformationResponse* message confirmed by lower layers;
- 1> else:
 - 2> submit the *UEInformationResponse* message to lower layers for transmission via SRB1.

8.1.6.1.2.12.3 Test description

8.1.6.1.2.12.3.1 Pre-test conditions

System Simulator:

- NR Cell 1.

UE:

- None.

Preamble:

- The UE is in state 3N-A according to TS 38.508-1 [4], clause 4.4A.2 Table 4.4A.2-3.

8.1.6.1.2.12.3.2 Test procedure sequence

Table 8.1.6.1.2.12.3.2-1: Main behaviour

St	Procedure	Message Sequence		TP	Verdict
		U - S	Message		

1	The SS transmits a <i>LoggedMeasurementConfiguration</i> message on NR Cell 1.	<--	NR RRC: <i>LoggedMeasurementConfiguration</i>	-	-
2	The SS transmits a <i>RRCRelease</i> message to release the RRC connection.	<--	NR RRC: <i>RRCRelease</i>	-	-
3	Wait 30 seconds for the UE to perform the logging at regular time intervals.	-	-	-	-
4-11	Steps 1 to 8 of the generic procedure in TS 38.508-1 [4] Table 4.5.4.2-3 are executed to successfully complete the service request procedure.	-	-	-	-
12	Void	-	-	-	-
13	The SS sends an <i>UEInformationRequest</i> message to get <i>logMeasReport</i> .	<--	NR RRC: <i>UEInformationRequest</i>	-	-
14	The UE sends an <i>UEInformationResponse</i> message on SRB2 including <i>logMeasReport</i> .	-->	NR RRC: <i>UEInformationResponse</i>	-	-
-	EXCEPTION: In case the <i>logMeasAvailable</i> in <i>logMeasReport</i> is True, steps 14a1 and 14a2 will be executed.	-	-	-	-
14a1	The SS sends an <i>UEInformationRequest</i> message to get <i>logMeasReport</i> .	<--	NR RRC: <i>UEInformationRequest</i>	-	-
14a2	The UE sends an <i>UEInformationResponse</i> message on SRB2 including <i>logMeasReport</i> .	-->	NR RRC: <i>UEInformationResponse</i>	-	-
15	The SS sends an <i>UEInformationRequest</i> message to get <i>logMeasReport</i> .	<--	NR RRC: <i>UEInformationRequest</i>	-	-
16	Check: Does the UE send an <i>UEInformationResponse</i> message on SRB1 without <i>logMeasReport</i> ?	-->	NR RRC: <i>UEInformationResponse</i>	3	P
17	The SS transmits a <i>RRCRelease</i> message to release the RRC connection.	<--	NR RRC: <i>RRCRelease</i>	-	-
18	Wait 10 minutes for UE to perform the logging at regular time intervals as to ensure timer T330 has expired.	-	-	-	-
19-26	Steps 1 to 8 of the generic procedure in TS 38.508-1 [4] Table 4.5.4.2-3 are executed to successfully complete the service request procedure.	-	-	-	-
27	Void	-	-	-	-
28	The SS sends an <i>UEInformationRequest</i> message to get <i>logMeasReport</i> .	<--	NR RRC: <i>UEInformationRequest</i>	-	-
29	Check: Does the UE send an <i>UEInformationResponse</i> message on SRB2 including <i>logMeasReport</i> ?	-->	NR RRC: <i>UEInformationResponse</i>	2	P
-	EXCEPTION: In case the <i>logMeasAvailable</i> in <i>logMeasReport</i> is True, steps 29a1 and 29a2 will be executed until all the stored <i>logMeasReport</i> transmitted.	-	-	-	-
29a1	The SS sends an <i>UEInformationRequest</i> message to get <i>logMeasReport</i> .	<--	NR RRC: <i>UEInformationRequest</i>	-	-
29a2	UE sends an <i>UEInformationResponse</i> message on SRB2 including <i>logMeasReport</i> .	-->	NR RRC: <i>UEInformationResponse</i>	-	-
30	The SS transmits a <i>RRCRelease</i> message to release the RRC connection.	<--	NR RRC: <i>RRCRelease</i>	-	-
31	Wait 30 seconds.	-	-	-	-
32	The SS transmits a <i>Paging</i> message on NR Cell 1.	<--	NR RRC: <i>Paging</i>	-	-
33	The UE transmits an <i>RRCRequest</i> message on NR Cell 1.	-->	NR RRC: <i>RRCRequest</i>	-	-
34	The SS transmits an <i>RRCSetup</i> message on NR Cell 1.	<--	NR RRC: <i>RRCSetup</i>	-	-
35	Check: Does UE transmit an <i>RRCSetupComplete</i> message with <i>logMeasAvailable</i> IE not present?	-->	NR RRC: <i>RRCSetupComplete</i>	1	P
36-39	Steps 5 to 8 of the generic procedure in TS 38.508-1 [4] Table 4.5.4.2-3 are executed to successfully complete the service request procedure.	-	-	-	-

8.1.6.1.2.12.3.3 Specific message contents

Table 8.1.6.1.2.12.3.3-1: *LoggedMeasurementConfiguration* (step 1, Table 8.1.6.1.2.12.3.2-1)

Derivation path: TS 38.508-1 [4], Table 4.6.1-5AA with condition PERIODICAL			
Information Element	Value/remark	Comment	Condition
LoggedMeasurementConfiguration-r16 ::= SEQUENCE {			
criticalExtensions CHOICE {			
loggedMeasurementConfiguration-r16 SEQUENCE {			
loggingDuration-r16	min10	10 minutes for T330	
}			
}			
}			

Table 8.1.6.1.2.12.3.3-2: *RRCSetupComplete* (step 35, Table 8.1.6.1.2.12.3.2-1)

Derivation path: TS 38.508-1 [4], Table 4.6.1-22			
Information Element	Value/remark	Comment	Condition
RRCSetupComplete ::= SEQUENCE {			
criticalExtensions CHOICE {			
rrcSetupComplete SEQUENCE {			
nonCriticalExtension	Not Present		
}			
}			
}			

Table 8.1.6.1.2.12.3.3-3: *UEInformationRequest* (steps 13, 14a1, 15, 28 and 29a1, Table 8.1.6.1.2.12.3.2-1)

Derivation path: TS 38.508-1 [4], Table 4.6.1-32A with condition LOG			
--	--	--	--

Table 8.1.6.1.2.12.3.3-4: *UEInformationResponse* (steps 14, 14a2, 29 and 29a2, Table 8.1.6.1.2.12.3.2-1)

Derivation path: TS 38.508-1 [4], Table 4.6.1-32B			
Information Element	Value/remark	Comment	Condition
UEInformationResponse-r16 ::= SEQUENCE {			
criticalExtensions CHOICE {			
ueInformationResponse-r16 SEQUENCE {			
logMeasReport-r16 SEQUENCE {			
absoluteTimeStamp-r16	Same value as sent by SS in LoggedMeasurementConfiguration in step 1		
traceReference-r16 SEQUENCE {			
plmn-Identity-r16 SEQUENCE {			
mcc SEQUENCE (SIZE (3)) OF MCC-NMC-Digit	Same value as sent by SS in LoggedMeasurementConfiguration in step 1		
mnc SEQUENCE (SIZE (2..3)) OF MCC-NMC-Digit	Same value as sent by SS in LoggedMeasurementConfiguration in step 1		
}			
traceId-r16	Same value as sent by SS in		

	LoggedMeasurementCon figuration in step 1		
}			
traceRecordingSessionRef-r16	Same value as sent by SS in LoggedMeasurementCon figuration in step 1		
tce-Id-r16	Same value as sent by SS in LoggedMeasurementCon figuration in step 1		
logMeasInfoList-r16 SEQUENCE (SIZE (1..maxLogMeasReport-r16)) OF LogMeasInfo-r16 SEQUENCE {	At least 2 entries where at least one entry complies to entry with index 'x' below. SS records the relativeTimeStamp value for each entry		
LogMeasInfo-r16[x] SEQUENCE {		entry x	
locationInfo-r16	Not checked		
relativeTimeStamp-r16	SS record the value		
servCellIdentity-r16	Same as NR Cell 1		
measResultServCell-16 SEQUENCE {			
resultsSSB-Cell-r16	MeasQuantityResults of NR Cell 1		
resultsSSB SEQUENCE {			
best-ssb-Index	Not checked		
best-ssb-Results	Not checked		
numberOfGoodSSB	Not checked		
}			
}			
measResultNeighCells-r16	Any allowed value		
anyCellSelectionDetected-r16	Not present		
}			
}			
logMeasAvailable-r16	Not checked		
logMeasAvailableBT-r16	Not present		
logMeasAvailableWLAN-r16	Not present		
}			
}			
}			
}			

Table 8.1.6.1.2.12.3.3-5: UEInformationResponse (step 16, Table 8.1.6.1.2.12.3.2-1)

Derivation path: TS 38.508-1 [4] Table 4.6.1-32B			
Information Element	Value/remark	Comment	Condition
UEInformationResponse-r16 ::= SEQUENCE {			
rrc-TransactionIdentifier			
criticalExtensions CHOICE {			
ueInformationResponse-r16 SEQUENCE {			
logMeasReport-r16	Not present		
}			
}			
}			

Table 8.1.6.1.2.12.3.3-6: RRCSetupComplete (steps 7 and 22, Table 8.1.6.1.2.12.3.2-1)

Derivation path: TS 38.508-1 [4] Table 4.6.1-22			
Information Element	Value/remark	Comment	Condition
RRCSetupComplete ::= SEQUENCE {			
criticalExtensions CHOICE {			
rrcSetupComplete SEQUENCE {			
nonCriticalExtension SEQUENCE {			

ue-MeasurementsAvailable-r16	UE-MeasurementsAvailable-r16 with condition LOG		
}			
}			
}			
}			

8.1.6.1.2.13 Logged MDT / Release of logged MDT measurement configuration / Reception of new logged measurement configuration

8.1.6.1.2.13.1 Test Purpose (TP)

(1)

```
with { UE received LoggedMeasurementConfiguration message and has stored logMeasReport in VarLogMeasReport }
ensure that {
  when { UE receive a new LoggedMeasurementConfiguration message }
  then { UE discards the stored logMeasReport }
}
```

(2)

```
with { UE received LoggedMeasurementConfiguration message and has stored logMeasReport in VarLogMeasReport }
ensure that {
  when { UE receive a new LoggedMeasurementConfiguration message }
  then { UE discards the old logged measurement configuration }
}
```

8.1.6.1.2.13.2 Conformance requirements

References: The conformance requirements covered in the current TC are specified in: TS 38.331, clauses 5.3.3.4, 5.5.a.1.3 and 5.5.a.3.2. Unless otherwise stated these are Rel-16 requirements.

[TS 38.331, clause 5.3.3.4]

The UE shall perform the following actions upon reception of the *RRCSetup*:

...

8> set the content of *RRCSetupComplete* message as follows:

...

2> if the UE has logged measurements available for NR and if the RPLMN is included in *plmn-IdentityList* stored in *VarLogMeasReport*:

3> include the *logMeasAvailable* in the *RRCSetupComplete* message;

2> if the UE has Bluetooth logged measurements available and if the RPLMN is included in *plmn-IdentityList* stored in *VarLogMeasReport*:

3> include the *logMeasAvailableBT* in the *RRCSetupComplete* message;

2> if the UE has WLAN logged measurements available and if the RPLMN is included in *plmn-IdentityList* stored in *VarLogMeasReport*:

3> include the *logMeasAvailableWLAN* in the *RRCSetupComplete* message;

...

[TS 38.331, clause 5.7.10.3]

Upon receiving the *UEInformationRequest* message, the UE shall, only after successful security activation:

...

- 1> if the *logMeasReportReq* is present and if the RPLMN is included in *plmn-IdentityList* stored in *VarLogMeasReport*:
 - 2> if *VarLogMeasReport* includes one or more logged measurement entries, set the contents of the *logMeasReport* in the *UEInformationResponse* message as follows:
 - 3> include the *absoluteTimeStamp* and set it to the value of *absoluteTimeInfo* in the *VarLogMeasReport*;
 - 3> include the *traceReference* and set it to the value of *traceReference* in the *VarLogMeasReport*;
 - 3> include the *traceRecordingSessionRef* and set it to the value of *traceRecordingSessionRef* in the *VarLogMeasReport*;
 - 3> include the *tce-Id* and set it to the value of *tce-Id* in the *VarLogMeasReport*;
 - 3> include the *logMeasInfoList* and set it to include one or more entries from *VarLogMeasReport* starting from the entries logged first;
 - 3> if the *VarLogMeasReport* includes one or more additional logged measurement entries that are not included in the *logMeasInfoList* within the *UEInformationResponse* message:
 - 4> include the *logMeasAvailable*;
 - 3> if the *VarLogMeasReport* includes one or more additional logged Bluetooth measurement entries that are not included in the *logMeasInfoList* within the *UEInformationResponse* message:
 - 4> include the *logMeasAvailableBT*;
 - 3> if the *VarLogMeasReport* includes one or more additional logged WLAN measurement entries that are not included in the *logMeasInfoList* within the *UEInformationResponse* message:
 - 4> include the *logMeasAvailableWLAN*;

...

- 1> if the *logMeasReport* is included in the *UEInformationResponse*:
 - 2> submit the *UEInformationResponse* message to lower layers for transmission via SRB2;
 - 2> discard the logged measurement entries included in the *logMeasInfoList* from *VarLogMeasReport* upon successful delivery of the *UEInformationResponse* message confirmed by lower layers;
- 1> else:
 - 2> submit the *UEInformationResponse* message to lower layers for transmission via SRB1.

[TS 38.331, clause 5.5a.1.3]

Upon receiving the *LoggedMeasurementConfiguration* message the UE shall:

- 1> discard the logged measurement configuration as well as the logged measurement information as specified in 5.5a.2;
- 1> store the received *loggingDuration*, *reportType* and *areaConfiguration*, if included, in *VarLogMeasConfig*;
- 1> if the *LoggedMeasurementConfiguration* message includes *plmn-IdentityList*:
 - 2> set *plmn-IdentityList* in *VarLogMeasReport* to include the RPLMN as well as the PLMNs included in *plmn-IdentityList*;
- 1> else:
 - 2> set *plmn-IdentityList* in *VarLogMeasReport* to include the RPLMN;
- 1> store the received *absoluteTimeInfo*, *traceReference*, *traceRecordingSessionRef*, and *tce-Id* in *VarLogMeasReport*;

- 1> store the received *bt-NameList*, if included, in *VarLogMeasConfig*;
- 1> store the received *wlan-NameList*, if included, in *VarLogMeasConfig*;
- 1> store the received *sensor-NameList*, if included, in *VarLogMeasConfig*;
- 1> start timer T330 with the timer value set to the *loggingDuration*;

[TS 38.331, clause 5.5a.3.2]

While T330 is running, the UE shall:

- 1> perform the logging in accordance with the following:
 - 2> if the *reportType* is set to *periodical* in the *VarLogMeasConfig*:
 - 3> if the UE is camping normally on an NR cell and if the RPLMN is included in *plmn-IdentityList* stored in *VarLogMeasReport* and, if the cell is part of the area indicated by *areaConfiguration* if configured in *VarLogMeasConfig*:
 - 4> perform the logging at regular time intervals, as defined by the *loggingInterval* in the *VarLogMeasConfig*;
 - 2> else if the *reportType* is set to *eventTriggered*, and *eventType* is set to *outOfCoverage*:
 - 3> perform the logging at regular time intervals as defined by the *loggingInterval* in *VarLogMeasConfig* only when the UE is in any cell selection state;
 - 3> perform the logging immediately upon transitioning from the any cell selection state to the camped normally state;
 - 2> else if the *reportType* is set to *eventTriggered* and *eventType* is set to *eventLI*:
 - 3> if the UE is camping normally on an NR cell and if the RPLMN is included in *plmn-IdentityList* stored in *VarLogMeasReport* and, if the cell is part of the area indicated by *areaConfiguration* if configured in *VarLogMeasConfig*:
 - 4> perform the logging at regular time intervals as defined by the *loggingInterval* in *VarLogMeasConfig* only when the conditions indicated by the *eventLI* are met;
 - 2> when performing the logging:
 - 3> set the *relativeTimeStamp* to indicate the elapsed time since the moment at which the logged measurement configuration was received;
 - 3> if detailed location information became available during the last logging interval, set the content of the *locationInfo* as in 5.3.3.7;
 - 3> if the UE is in any cell selection state (as specified in TS 38.304 [20]):
 - 4> set *anyCellSelectionDetected* to indicate the detection of no suitable or no acceptable cell found;
 - 4> set the *servCellIdentity* to indicate global cell identity of the last logged cell that the UE was camping on;
 - 4> set the *measResultServingCell* to include the quantities of the last logged cell the UE was camping on;
 - 3> else:
 - 4> set the *servCellIdentity* to indicate global cell identity of the cell the UE is camping on;
 - 4> set the *measResultServingCell* to include the quantities of the cell the UE is camping on;
 - 4> if available, set the *measResultNeighCells*, in order of decreasing ranking-criterion as used for cell re-selection, to include neighbouring cell measurements that became available during the last logging interval for at most the following number of neighbouring cells: 6 intra-frequency and 3 inter-

frequency neighbours per frequency as well as 3 inter-RAT neighbours, per frequency/ set of frequencies per RAT and according to the following:

5> for each neighbour cell included, include the optional fields that are available;

NOTE: The UE includes the latest results of the available measurements as used for cell reselection evaluation in RRC_IDLE or RRC_INACTIVE, which are performed in accordance with the performance requirements as specified in TS 38.133 [14].

2> when the memory reserved for the logged measurement information becomes full, stop timer T330 and perform the same actions as performed upon expiry of T330, as specified in 5.5a.1.4.

8.1.6.1.2.13.3 Test description

8.1.6.1.2.13.3.1 Pre-test conditions

System Simulator:

- NR Cell 1.

UE:

- None.

Preamble:

- The UE is in state 3N-A according to TS 38.508-1 [4], clause 4.4A.2 Table 4.4A.2-3.

8.1.6.1.2.13.3.2 Test procedure sequence

Table 8.1.6.1.2.13.3.2-1: Main behaviour

St	Procedure	Message Sequence		TP	Verdict
		U - S	Message		
1	The SS transmits a <i>LoggedMeasurementConfiguration</i> message on NR Cell 1.	<--	NR RRC: <i>LoggedMeasurementConfiguration</i>	-	-
2	The SS transmits a <i>RRCRelease</i> message to release the RRC connection.	<--	NR RRC: <i>RRCRelease</i>	-	-
3	Wait 30 seconds for the UE to perform the logging at regular time intervals.	-	-	-	-
4-11	Steps 1 to 8 of the generic procedure in TS 38.508-1 [4], Table 4.5.4.2-3 are executed to successfully complete the service request procedure.	-	-	-	-
12	Void	-	-	-	-
13	The SS transmits a <i>LoggedMeasurementConfiguration</i> message on NR Cell 1.	<--	NR RRC: <i>LoggedMeasurementConfiguration</i>	-	-
14	The SS sends an <i>UEInformationRequest</i> message to get <i>logMeasReport</i> .	<--	NR RRC: <i>UEInformationRequest</i>	-	-
15	Check: Does the UE send an <i>UEInformationResponse</i> message on SRB1 without <i>logMeasReport</i> ?	-->	NR RRC: <i>UEInformationResponse</i>	1	P
16	The SS transmits a <i>RRCRelease</i> message to release the RRC connection.	<--	NR RRC: <i>RRCRelease</i>	-	-
17	Wait 30 seconds for the UE to perform the logging at regular time intervals.	-	-	-	-
18-25	Steps 1 to 8 of the generic procedure in TS 38.508-1 [4], Table 4.5.4.2-3 are executed to successfully complete the service request procedure.	-	-	-	-
26	Void	-	-	-	-

27	The SS sends an <i>UEInformationRequest</i> message to get <i>logMeasReport</i> .	<--	NR RRC: <i>UEInformationRequest</i>	-	-
28	Check: Does the UE send an <i>UEInformationResponse</i> message on SRB2 without <i>logMeasReport</i> based on the <i>LoggedMeasurementConfiguration</i> as in step 1, but with <i>logMeasReport</i> based on the <i>LoggedMeasurementConfiguration</i> as in step 13?	-->	NR RRC: <i>UEInformationResponse</i>	2	P

8.1.6.1.2.13.3.3 Specific message contents

Table 8.1.6.1.2.13.3.3-1: *LoggedMeasurementConfiguration* (step 1, Table 8.1.6.1.2.13.3.2-1)

Derivation path: TS 38.508-1 [4], Table 4.6.1-5AA with condition PERIODICAL

Table 8.1.6.1.2.13.3.3-1A: *LoggedMeasurementConfiguration* (step 13, Table 8.1.6.1.2.13.3.2-1)

Derivation path: TS 38.508-1 [4], Table 4.6.1-5AA			
Information Element	Value/remark	Comment	Condition
LoggedMeasurementConfiguration-r16 ::= SEQUENCE {			
criticalExtensions CHOICE {			
loggedMeasurementConfiguration-r16 SEQUENCE {			
reportType CHOICE {			
periodical SEQUENCE {			
loggingInterval-r16	ms5120	5.12 seconds	
}			
}			
}			
}			
}			

Table 8.1.6.1.2.13.3.3-2: *RRCSetupComplete* (steps 7 and 21, Table 8.1.6.1.2.13.3.2-1)

Derivation path: TS 38.508-1 [4], Table 4.6.1-22			
Information Element	Value/remark	Comment	Condition
RRCSetupComplete ::= SEQUENCE {			
criticalExtensions CHOICE {			
rrcSetupComplete SEQUENCE {			
nonCriticalExtension SEQUENCE {			
ue-MeasurementsAvailable-r16	UE-MeasurementsAvailable-r16 with condition LOG		
}			
}			
}			
}			

Table 8.1.6.1.2.13.3.3-3: *UEInformationRequest* (steps 14 and 27, Table 8.1.6.1.2.13.3.2-1)

Derivation path: TS 38.508-1 [4], Table 4.6.1-32A with condition LOG

Table 8.1.6.1.2.13.3.3-4: *UEInformationResponse* (step 15, Table 8.1.6.1.2.13.3.2-1)

Derivation path: TS 38.508-1 [4], Table 4.6.1-32B			
Information Element	Value/remark	Comment	Condition
UEInformationResponse-r16 ::= SEQUENCE {			
criticalExtensions CHOICE {			

ueInformationResponse-r16 SEQUENCE {			
logMeasReport-r16	Not present		
}			
}			
}			

Table 8.1.6.1.2.13.3.3-5: UEInformationResponse (step 28, Table 8.1.6.1.2.13.3.2-1)

Derivation path: TS 38.508-1 [4], Table 4.6.1-32B			
Information Element	Value/remark	Comment	Condition
UEInformationResponse-r16 ::= SEQUENCE {			
criticalExtensions CHOICE {			
ueInformationResponse-r16 SEQUENCE {			
logMeasReport-r16 SEQUENCE {			
absoluteTimeStamp-r16	Same value as sent by SS in LoggedMeasurementConfiguration in step 13		
traceReference-r16 SEQUENCE {			
plmn-Identity-r16 SEQUENCE {			
mcc SEQUENCE (SIZE (3)) OF MCC-NMC-Digit	Same value as sent by SS in LoggedMeasurementConfiguration in step 13		
mnc SEQUENCE (SIZE (2..3)) OF MCC-NMC-Digit	Same value as sent by SS in LoggedMeasurementConfiguration in step 13		
}			
traceId-r16	Same value as sent by SS in LoggedMeasurementConfiguration in step 13		
}			
traceRecordingSessionRef-r16	Same value as sent by SS in LoggedMeasurementConfiguration in step 13		
tce-Id-r16	Same value as sent by SS in LoggedMeasurementConfiguration in step 13		
logMeasInfoList-r16 SEQUENCE (SIZE (1..maxLogMeasReport-r16)) OF LogMeasInfo-r16 SEQUENCE {	At least 1 entries where at least one entry complies to entry with index 'x' below. SS records the relativeTimeStamp value for each entry		
LogMeasInfo-r16[x] SEQUENCE {		entry x	
locationInfo-r16	Not checked		
relativeTimeStamp-r16	SS record the value		
servCellIdentity-r16	Same as NR Cell 1		
measResultServCell-16 SEQUENCE {			
resultsSSB-Cell-r16	MeasQuantityResults of NR Cell 1		
resultsSSB SEQUENCE {			
best-ssb-Index	Not checked		
best-ssb-Results	Not checked		
numberOfGoodSSB	Not checked		
}			
}			
measResultNeighCells-r16	Any allowed value		
anyCellSelectionDetected-r16	Not present		
}			
}			

}			
logMeasAvailable-r16	Not present		
logMeasAvailableBT-r16	Not present		
logMeasAvailableWLAN-r16	Not present		
}			
}			
}			
}			

8.1.6.1.3 Radio Link Failure report

8.1.6.1.3.1 Radio Link Failure / Reporting of Intra-frequency measurements

8.1.6.1.3.1.1 Test Purpose (TP)

(1)

```
with { UE in RRC_CONNECTED having performed the intra-frequency measurement and reported that the UE
has radio link failure information available }
ensure that {
  when { UE receives the UEInformationRequest message containing rlf-ReportReq }
  then { UE sends the UEInformationResponse message containing the measurement result for intra-
frequency neighbour cell }
}
```

(2)

```
with { UE sends the UEInformationResponse message containing the measurement result for intra-
frequency neighbour cell }
ensure that {
  when { The latest radio measurement results of the serving and neighbouring cells are available }
  then { UE includes SSB index and associated measurements in the measResultLastServCell }
}
```

8.1.6.1.3.1.2 Conformance requirements

References: The conformance requirements covered in the present TC are specified in: TS 38.331, clauses 5.3.10.5, 5.3.7.4, 5.3.7.5, 5.3.10.3 and 5.7.10.3. Unless otherwise stated these are Rel-16 requirements.

[TS 38.331, clause 5.3.10.5]

The UE shall determine the content in the *VarRLF-Report* as follows:

- 1> clear the information included in *VarRLF-Report*, if any;
- 1> set the *plmn-IdentityList* to include the list of EPLMNs stored by the UE (i.e. includes the RPLMN);
- 1> set the *measResultLastServCell* to include the cell level RSRP, RSRQ and the available SINR, of the source PCell (in case HO failure) or PCell (in case RLF) based on the available SSB and CSI-RS measurements collected up to the moment the UE detected failure;
- 1> if the SS/PBCH block-based measurement quantities are available:
 - 2> set the *rsIndexResults* in *measResultLastServCell* to include all the available measurement quantities of the source PCell (in case HO failure) or PCell (in case RLF), ordered such that the highest SS/PBCH block RSRP is listed first if SS/PBCH block RSRP measurement results are available, otherwise the highest SS/PBCH block RSRQ is listed first if SS/PBCH block RSRQ measurement results are available, otherwise the highest SS/PBCH block SINR is listed first, based on the available SS/PBCH block based measurements collected up to the moment the UE detected failure;
- ...
- 1> set the *ssbRRLMConfigBitmap* and/or *csi-rsRRLMConfigBitmap* in *measResultLastServCell* to include the radio link monitoring configuration of the source PCell (in case HO failure) or PCell (in case RLF);

- 1> for each of the configured *measObjectNR* in which measurements are available:
 - 2> if the SS/PBCH block-based measurement quantities are available:
 - 3> set the *measResultListNR* in *measResultNeighCells* to include all the available measurement quantities of the best measured cells, other than the source PCell(in case HO failure) or PCell (in case RLF), ordered such that the cell with highest SS/PBCH block RSRP is listed first if SS/PBCH block RSRP measurement results are available, otherwise the cell with highest SS/PBCH block RSRQ is listed first if SS/PBCH block RSRQ measurement results are available, otherwise the cell with highest SS/PBCH block SINR is listed first, based on the available SS/PBCH block based measurements collected up to the moment the UE detected failure;
 - 4> for each neighbour cell included, include the optional fields that are available;

...

- 1> set the *c-RNTI* to the C-RNTI used in the source PCell(in case HO failure) or PCell (in case RLF);

...

- 1> else if the failure is detected due to radio link failure as described in 5.3.10.3, set the fields in *VarRLF-report* as follows:
 - 2> set the *connectionFailureType* to *rlf*;
 - 2> set the *rlf-Cause* to the trigger for detecting radio link failure in accordance with clause 5.3.10.4;
 - 2> set the *nrFailedPCellId* in *failedPCellId* to the global cell identity and the tracking area code, if available, and otherwise to the physical cell identity and carrier frequency of the PCell where radio link failure is detected;

...

- 1> if location information is available, set the content of *locationInfo* as follows:
 - 2> if available, set the *commonLocationInfo* to include the detailed location information;
 - 2> if available, set the *bt-LocationInfo* in *locationInfo* to include the Bluetooth measurement results, in order of decreasing RSSI for Bluetooth beacons;
 - 2> if available, set the *wlan-LocationInfo* in *locationInfo* to include the WLAN measurement results, in order of decreasing RSSI for WLAN APs;

- 2> if available, set the *sensor-LocationInfo* in *locationInfo* to include the sensor measurement results;

[TS 38.331, clause 5.3.7.4]

The UE shall set the contents of *RRCReestablishmentRequest* message as follows:

- 1> if the procedure was initiated due to radio link failure as specified in 5.3.10.3 or handover failure as specified in 5.3.5.8.3:
 - 2> set the *reestablishmentCellId* in the *VarRLF-Report* to the global cell identity of the selected cell;

[TS 38.331, clause 5.3.7.5]

The UE shall:

...

- 1> set the content of *RRCReestablishmentComplete* message as follows:
 - 2> if the UE has logged measurements available for NR and if the RPLMN is included in *plmn-IdentityList* stored in *VarLogMeasReport*:
 - 3> include the *logMeasAvailable* in the *RRCReestablishmentComplete* message;

...

- 2> if the UE has radio link failure or handover failure information available in *VarRLF-Report* and if the RPLMN is included in *plmn-IdentityList* stored in *VarRLF-Report*; or

...

- 3> include *rlf-InfoAvailable* in the *RRCReestablishmentComplete* message;

- 1> submit the *RRCReestablishmentComplete* message to lower layers for transmission;

[TS 38.331, clause 5.3.10.3]

The UE shall:

...

- 1> else:

- 2> during a DAPS handover: the following only applies for the target PCell;

- 2> upon T310 expiry in PCell; or

...

- 2> upon consistent uplink LBT failure indication from MCG MAC while T304 is not running:

...

- 3> else:

- 4> consider radio link failure to be detected for the MCG i.e. RLF;

- 4> discard any segments of segmented RRC messages stored according to 5.7.6.3;

NOTE: Void.

- 4> if AS security has not been activated:

- 5> perform the actions upon going to RRC_IDLE as specified in 5.3.11, with release cause 'other';-

- 4> else if AS security has been activated but SRB2 and at least one DRB or, for IAB, SRB2, have not been setup:

- 5> store the radio link failure information in the *VarRLF-Report* as described in subclause 5.3.10.5;

- 5> perform the actions upon going to RRC_IDLE as specified in 5.3.11, with release cause 'RRC connection failure';

- 4> else:

- 5> store the radio link failure information in the *VarRLF-Report* as described in subclause 5.3.10.5;

...

- 5> else:

- 6> initiate the connection re-establishment procedure as specified in 5.3.7.

The UE may discard the radio link failure information, i.e. release the UE variable *VarRLF-Report*, 48 hours after the radio link failure is detected.

[TS 38.331, clause 5.7.10.3]

Upon receiving the *UEInformationRequest* message, the UE shall, only after successful security activation:

...

- 1> if the *logMeasReportReq* is present and if the RPLMN is included in *plmn-IdentityList* stored in *VarLogMeasReport*:
 - 2> if *VarLogMeasReport* includes one or more logged measurement entries, set the contents of the *logMeasReport* in the *UEInformationResponse* message as follows:
 - 3> include the *absoluteTimeStamp* and set it to the value of *absoluteTimeInfo* in the *VarLogMeasReport*;
 - 3> include the *traceReference* and set it to the value of *traceReference* in the *VarLogMeasReport*;
 - 3> include the *traceRecordingSessionRef* and set it to the value of *traceRecordingSessionRef* in the *VarLogMeasReport*;
 - 3> include the *tce-Id* and set it to the value of *tce-Id* in the *VarLogMeasReport*;
 - 3> include the *logMeasInfoList* and set it to include one or more entries from *VarLogMeasReport* starting from the entries logged first;
 - 3> if the *VarLogMeasReport* includes one or more additional logged measurement entries that are not included in the *logMeasInfoList* within the *UEInformationResponse* message:
 - 4> include the *logMeasAvailable*;
 - ...
 - 1> if *rlf-ReportReq* is set to *true*:
 - 2> if the UE has radio link failure information or handover failure information available in *VarRLF-Report* and if the RPLMN is included in *plmn-IdentityList* stored in *VarRLF-Report*:
 - 3> set *timeSinceFailure* in *VarRLF-Report* to the time that elapsed since the last radio link or handover failure in NR;
 - 3> set the *rlf-Report* in the *UEInformationResponse* message to the value of *rlf-Report* in *VarRLF-Report*;
 - 3> discard the *rlf-Report* from *VarRLF-Report* upon successful delivery of the *UEInformationResponse* message confirmed by lower layers;
 - ...
 - 1> if the *logMeasReport* is included in the *UEInformationResponse*:
 - 2> submit the *UEInformationResponse* message to lower layers for transmission via SRB2;
 - 2> discard the logged measurement entries included in the *logMeasInfoList* from *VarLogMeasReport* upon successful delivery of the *UEInformationResponse* message confirmed by lower layers;
 - 1> else:
 - 2> submit the *UEInformationResponse* message to lower layers for transmission via SRB1.

8.1.6.1.3.1.3 Test description

8.1.6.1.3.1.3.1 Pre-test conditions

System Simulator:

- NR Cell 1 is the serving cell.
- NR Cell 2 is the intra-frequency neighbor cell.
- System information combination NR-2 as defined in TS 38.508-1 [4] clause 4.4.3.1.2 is used in NR cells.

UE:

None.

Preamble:

- The UE is in state 3N-A on NR Cell 1 according to TS 38.508-1 [4], clause 4.4A.

8.1.6.1.3.1.3.2 Test procedure sequence

Table 8.1.6.1.3.1.3.2-1/2 illustrates the downlink power levels and other changing parameters to be applied for the cells at various time instants of the test execution. Row marked "T0" denotes the initial conditions after preamble, while columns marked "T1" and "T2" are to be applied subsequently. The exact instants on which these values shall be applied are described in the texts in this clause.

Table 8.1.6.1.3.1.3.2-1: Time instances of cell power level and parameter changes for FR1

	Parameter	Unit	NR Cell 1	NR Cell 2	Remark
T0	SS/PBCH SSS EPRE	dBm/SCS	-88	-94	The power level values are such that measurement results for Cell 1 (M1) and Cell 2 (M2) satisfy exit condition for event A3 ($M2 < M1$).
T1	SS/PBCH SSS EPRE	dBm/SCS	-88	-82	The power level values are such that measurement results for Cell 1 (M1) and Cell 2 (M2) satisfy entry condition for event A3 ($M2 > M1$).
T2	SS/PBCH SSS EPRE	dBm/SCS	"Off"	-82	Only Cell 2 is available.

Table 8.1.6.1.3.1.3.2-2: Time instances of cell power level and parameter changes for FR2

	Parameter	Unit	NR Cell 1	NR Cell 2	Remark
T0	SS/PBCH SSS EPRE	dBm/SCS	FFS	FFS	The power level values are such that measurement results for Cell 1 (M1) and Cell 2 (M2) satisfy exit condition for event A3 ($M2 < M1$).
T1	SS/PBCH SSS EPRE	dBm/SCS	FFS	FFS	The power level values are such that measurement results for Cell 1 (M1) and Cell 2 (M2) satisfy entry condition for event A3 ($M2 > M1$).
T2	SS/PBCH SSS EPRE	dBm/SCS	"Off"	-73	Only Cell 2 is available.

Table 8.1.6.1.3.1.3.2-3: Main behaviour

St	Procedure	Message Sequence		TP	Verdict
		U - S	Message		
1	The SS transmits an <i>RRCReconfiguration</i> message including <i>MeasConfig</i> to setup NR measurement and reporting for intra-frequency event A3 (<i>measId 1</i>).	<--	NR RRC: <i>RRCReconfiguration</i>	-	-
2	The UE transmits an <i>RRCReconfigurationComplete</i> message.	-->	NR RRC: <i>RRCReconfigurationComplete</i>	-	-
3	The SS changes NR Cell 2 parameters according to the row "T1" in Table 8.1.6.1.3.1.3.2-1/2.	-	-	-	-
4	The UE transmit a <i>MeasurementReport</i> message to report event A3 (<i>measId 1</i>) with the measured RSRP value for NR Cell 2.	-->	NR RRC: <i>MeasurementReport</i>	-	-
5	The SS changes NR Cell 1 parameter according to the row "T2" in Table 8.1.6.1.3.1.3.2-1/2.	-	-	-	-
6	The UE transmits an <i>RRCReestablishmentRequest</i> message on NR Cell 2.	-->	NR RRC: <i>RRCReestablishmentRequest</i>	-	-
7	The SS transmits an <i>RRCReestablishment</i> message.	<--	NR RRC: <i>RRCReestablishment</i>	-	-

8	Check: Does the UE transmits an <i>RRCReestablishmentComplete</i> message with <i>rif-InfoAvailable</i> included?	-->	NR RRC: <i>RRCReestablishmentComplete</i>	1	P
9	The SS transmits an <i>RRCReconfiguration</i> message to establish SRB2 and DRB.	<--	NR RRC: <i>RRCReconfiguration</i>	-	-
10	The UE transmits an <i>RRCReconfigurationComplete</i> message.	-->	NR RRC: <i>RRCReconfigurationComplete</i>	-	-
11	The SS transmits a <i>UEInformationRequest</i> message.	<--	NR RRC: <i>UEInformationRequest</i>	-	-
12	Check: Does the UE transmit a <i>UEInformationResponse</i> message on NR Cell 2?	-->	NR RRC: <i>UEInformationResponse</i>	1, 2	P

8.1.6.1.3.1.3.3 Specific message contents

Table 8.1.6.1.3.1.3.3-1: *RRCReconfiguration* (step 1, Table 8.1.6.1.3.1.3.2-3)

Derivation Path: TS 38.508-1 [4], Table 4.6.1-13 with condition NR_MEAS

Table 8.1.6.1.3.1.3.3-2: *MeasConfig* (Table 8.1.6.1.3.1.3.3-1)

Derivation Path: TS 38.508-1 [4], Table 4.6.3-69			
Information Element	Value/remark	Comment	Condition
<i>MeasConfig</i> ::= SEQUENCE {			
<i>measObjectToAddModList</i> SEQUENCE (SIZE (1..maxNrofMeasId)) OF <i>MeasObjectToAddMod</i> {	1 entry		
<i>MeasObjectToAddMod</i> [1] SEQUENCE {		entry 1	
<i>measObjectId</i>	1		
<i>measObject</i> CHOICE {			
<i>measObjectNR</i>	<i>MeasObjectNR</i>	Table 8.1.6.1.3.1.3.3-3	
}			
}			
}			
<i>reportConfigToAddModList</i> SEQUENCE(SIZE (1..maxReportConfigId)) OF <i>ReportConfigToAddMod</i> {	1 entry		
<i>ReportConfigToAddMod</i> [1] SEQUENCE {		entry 1	
<i>reportConfigId</i>	1		
<i>reportConfig</i> CHOICE {			
<i>reportConfigNR</i>	<i>ReportConfigNR-EventA3</i>	Table 8.1.6.1.3.1.3.3-4	
}			
}			
}			
<i>measIdToAddModList</i> SEQUENCE (SIZE (1..maxNrofMeasId)) OF <i>MeasIdToAddMod</i> {	1 entry		
<i>MeasIdToAddMod</i> [1] SEQUENCE {		entry 1	
<i>measId</i>	1		
<i>measObjectId</i>	1		
<i>reportConfigId</i>	1		
}			
}			
}			

Table 8.1.6.1.3.1.3.3-3: *MeasObjectNR* (Table 8.1.6.1.3.1.3.3-2)

Derivation Path: TS 38.508-1 [4], Table 4.6.3-76			
Information Element	Value/remark	Comment	Condition
<i>MeasObjectNR</i> ::= SEQUENCE {			
<i>ssbFrequency</i>	ARFCN-ValueNR for SSB of NR Cell 1		
<i>absThreshSS-BlocksConsolidation</i>	Not present		

nrofSS-BlocksToAverage	Not present		
}			

Table 8.1.6.1.3.1.3.3-4: ReportConfigNR-EventA3 (Table 8.1.6.1.3.1.3.3-2)

Derivation Path: TS 38.508-1 [4], Table 4.6.3-142 with condition EVENT_A3			
Information Element	Value/remark	Comment	Condition
ReportConfigNR ::= SEQUENCE {			
reportType CHOICE {			
eventTriggered SEQUENCE {			
eventId CHOICE {			
eventA3 SEQUENCE {			
a3-Offset CHOICE {			
rsrp	2	1 dB (2*0.5 dB)	
}			
}			
}			
}			
reportAmount	r1		
reportQuantityCell SEQUENCE {			
rsrp	true		
rsrq	false		
sinr	false		
}			
}			

Table 8.1.6.1.3.1.3.3-5: MeasurementReport (step 4, Table 8.1.6.1.3.1.3.2-3)

Derivation Path: TS 38.508-1 [4], Table 4.6.1-5A			
Information Element	Value/remark	Comment	Condition
MeasurementReport ::= SEQUENCE {			
criticalExtensions CHOICE {			
measurementReport SEQUENCE {			
measResults SEQUENCE {			
measId	1		
measResultServingMOList SEQUENCE (SIZE (1..maxNrofServingCells)) OF MeasResultServMO {	1 entry	Measurement result for NR Cell 1	
MeasResultServMO[1] SEQUENCE {		entry 1	
servCellId	ServCellIndex of NR Cell 1		
measResultServingCell SEQUENCE {			
physCellId	PCI of NR Cell 1		
measResult SEQUENCE {			
cellResults SEQUENCE {			
resultsSSB-Cell SEQUENCE {			
rsrp	(0..127)		
rsrq	(0..127)		
sinr	Not checked		
}			
}			
}			
}			
}			
measResultNeighCells CHOICE {			
measResultListNR SEQUENCE (SIZE (1..maxCellReport)) OF MeasResultNR {	1 entry	Measurement result for NR Cell 2	
MeasResultNR[1] SEQUENCE {		entry 1	
physCellId	PCI of NR Cell 2		
measResult SEQUENCE {			
cellResults SEQUENCE {			

resultsSSB-Cell SEQUENCE {			
rsrp	(0..127)		
rsrq	Not present		
sinr	Not present		
}			
resultsCSI-RS-Cell	Not present		
}			
rsIndexResults	Not present		
}			
cgi-Info	Not present		
}			
}			
}			
}			
}			
}			
}			

Table 8.1.6.1.3.1.3.3-6: RRCReestablishmentRequest (step 6, Table 8.1.6.1.3.1.3.2-3)

Derivation Path: TS 38.508-1 [4], Table 4.6.1-12			
Information Element	Value/remark	Comment	Condition
RRCReestablishmentRequest ::= SEQUENCE {			
ue-Identity SEQUENCE {			
c-RNTI	the value of the C-RNTI of the UE		
physCellId	PCI of NR Cell 1		
shortMAC-I	The same value as the 16 least significant bits of the XMAC-I value calculated by SS		
}			
reestablishmentCause	otherFailure		
}			

Table 8.1.6.1.3.1.3.3-7: RRCReestablishmentComplete (step 8, Table 8.1.6.1.3.1.3.2-3)

Derivation Path: TS 38.508-1 [4], Table 4.6.1-11			
Information Element	Value/remark	Comment	Condition
RRCReestablishmentComplete ::= SEQUENCE {			
criticalExtensions CHOICE {			
rrcReestablishmentComplete SEQUENCE {			
nonCriticalExtension SEQUENCE {			
ue-MeasurementsAvailable-r16	UE-MeasurementsAvailable-r16 with condition RLF		
}			
}			
}			
}			

Table 8.1.6.1.3.1.3.3-8: RRCReconfiguration (step 9, Table 8.1.6.1.3.1.3.2-3)

Derivation Path: TS 38.508-1 [4], Table 4.6.1-13 with condition REEST

Table 8.1.6.1.3.1.3.3-9: UEInformationRequest (step 11, Table 8.1.6.1.3.1.3.2-3)

Derivation Path: TS 38.508-1 [4], Table 4.6.1-32A with condition RLF
--

Table 8.1.6.1.3.1.3.3-10: *UEInformationResponse* (step 12, Table 8.1.6.1.3.1.3.2-3)

Derivation Path: TS 38.508-1 [4], Table 4.6.1-32B			
Information Element	Value/remark	Comment	Condition
UEInformationResponse-r16 ::= SEQUENCE {			
criticalExtensions CHOICE {			
ueInformationResponse-r16 SEQUENCE {			
rlf-Report-r16 CHOICE {			
nr-RLF-Report-r16 SEQUENCE {			
measResultLastServCell-r16 SEQUENCE {			
measResult-r16 SEQUENCE {			
cellResults-r16 SEQUENCE {			
resultsSSB-Cell-r16 SEQUENCE {			
rsrp	(0..127)		
rsrq	(0..127)		
sinr	Not checked		
}			
resultsCSI-RS-Cell-r16	Not checked		
}			
rsIndexResults-r16 SEQUENCE {			
resultsSSB-Indexes-r16 SEQUENCE {			
ssb-Index	1		
ssb-Results SEQUENCE {			
rsrp	(0..127)		
rsrq	(0..127)		
sinr	Not checked		
}			
}			
ssbRLMConfigBitmap-r16	01000000 00000000 00000000 00000000 00000000 00000000 00000000 00000000		
resultsCSI-RS-Indexes-r16	Not present		
csi-rsRLMConfigBitmap-r16	Not present		
}			
}			
measResultNeighCells-r16 SEQUENCE {			
measResultListNR-r16 SEQUENCE {			
ssbFrequency-r16	ARFCN-ValueNR for SSB of NR Cell 2		
refFreqCSI-RS-r16	Not present		
measResultList-r16 SEQUENCE {			
physCellId	PCI of NR Cell 2		
measResult SEQUENCE {			
cellResults SEQUENCE {			
resultsSSB-Cell SEQUENCE {			
rsrp	(0..127)		
rsrq	Not checked		
sinr	Not checked		
}			
}			
rsIndexResults	Not checked		
}			
}			
}			
c-RNTI-r16	the old value of the C- RNTI of the UE used in NR Cell 1		
previousPCellId-r16	Not present		
failedPCellId-r16 CHOICE {			
nrFailedPCellId-r16	Any Allowed Value	Either pci-arfcn- r16 or cellGlobalId-r16	

		corresponding to NR Cell 1	
eutraFailedPCellId-r16	Not present		
}			
reconnectCellId-r16	Not present		
timeUntilReconnection-16	Not present		
reestablishmentCellId-r16 SEQUENCE {			
plmn-Identity-r16	PLMN ID of NR Cell 2		
cellIdentity-r16	CGI of NR Cell 2		
trackingAreaCode-r16	TAC of NR Cell 2		
}			
timeConnFailure-r16	Not present		
timeSinceFailure-r16	Any allowed value		
connectionFailureType-r16	rlf		
rlf-Cause-r16	t310-Expiry		
locationInfo-r16	Not checked		
noSuitableCellFound-r16	Not present		
ra-InformationCommon-r16	Not present		
csi-rsRLMConfigBitmap-v1650	Not present		
}			
eutra-RLF-Report-r16	Not present		
}			
}			
}			
}			

8.1.6.1.3.2 Radio Link Failure / Reporting of Inter-frequency measurements

8.1.6.1.3.2.1 Test Purpose (TP)

(1)

```
with { UE in RRC_CONNECTED having performed the inter-frequency measurement and reported that the UE
has radio link failure information available }
ensure that {
  when { UE receives the UEInformationRequest message containing rlf-ReportReq }
  then { UE sends the UEInformationResponse message containing the measurement result for inter-
frequency neighbour cell }
}
```

(2)

```
with { UE sends the UEInformationResponse message containing the measurement result for inter-
frequency neighbour cell }
ensure that {
  when { The latest radio measurement results of the serving and neighbouring cells are available }
  then { UE includes SSB index and associated measurements in the measResultLastServCell }
}
```

8.1.6.1.3.2.2 Conformance requirements

Same as test case 8.1.6.1.3.1.

8.1.6.1.3.2.3 Test description

8.1.6.1.3.2.3.1 Pre-test conditions

Same as test case 8.1.6.1.3.1 with the following differences:

- Cells configuration: NR Cell 3 replaces NR Cell 2.
- System information combination: NR-4 replaces NR-2.

8.1.6.1.3.2.3.2 Test procedure sequence

Same as test case 8.1.6.1.3.1 with the following differences:

- Cells configuration: NR Cell 3 replaces NR Cell 2.

8.1.6.1.3.2.3.3 Specific message contents

Same as test case 8.1.6.1.3.1 with the following difference:

- Cells configuration: NR Cell 3 replaces NR Cell 2.

Table 8.1.6.1.3.2.3.3-1: MeasConfig (Table 8.1.6.1.3.1.3.3-2)

Derivation Path: TS 38.508-1 [4] Table 4.6.3-69			
Information Element	Value/remark	Comment	Condition
MeasConfig ::= SEQUENCE {			
measObjectToAddModList SEQUENCE (SIZE (1..maxNrofMeasId)) OF MeasObjectToAddMod {	2 entries		
MeasObjectToAddMod[1] SEQUENCE {		entry 1	
measObjectId	1		
measObject CHOICE {			
measObjectNR	MeasObjectNR-f1	Table 8.1.6.1.3.2.3.3-2	
}			
}			
MeasObjectToAddMod[2] SEQUENCE {		entry 2	
measObjectId	2		
measObject CHOICE {			
measObjectNR	MeasObjectNR-f2	Table 8.1.6.1.3.2.3.3-3	
}			
}			
reportConfigToAddModList SEQUENCE(SIZE (1..maxReportConfigId)) OF ReportConfigToAddMod {	1 entry		
ReportConfigToAddMod[1] SEQUENCE {		entry 1	
reportConfigId	1		
reportConfig CHOICE {			
reportConfigNR	ReportConfigNR-EventA3	Table 8.1.6.1.3.1.3.3-4	
}			
}			
measIdToAddModList SEQUENCE (SIZE (1..maxNrofMeasId)) OF MeasIdToAddMod {	1 entry		
MeasIdToAddMod[1] SEQUENCE {		entry 1	
measId	1		
measObjectId	2		
reportConfigId	1		
}			
}			
measGapConfig	MeasGapConfig		
}			

Table 8.1.6.1.3.2.3.3-2: MeasObjectNR-f1 (Table 8.1.6.1.3.2.3.3-1)

Derivation Path: TS 38.508-1 [4], Table 4.6.3-76			
Information Element	Value/remark	Comment	Condition
MeasObjectNR ::= SEQUENCE {			
ssbFrequency	ARFCN-ValueNR for SSB of NR Cell 1		
absThreshSS-BlocksConsolidation	Not present		
nrofSS-BlocksToAverage	Not present		

}		
---	--	--

Table 8.1.6.1.3.2.3.3-3: MeasObjectNR-f2 (Table 8.1.6.1.3.2.3.3-1)

Derivation Path: TS 38.508-1 [4], Table 4.6.3-76			
Information Element	Value/remark	Comment	Condition
MeasObjectNR ::= SEQUENCE {			
ssbFrequency	ARFCN-ValueNR for SSB of NR Cell 3		
absThreshSS-BlocksConsolidation	Not present		
nrofSS-BlocksToAverage	Not present		
}			

Table 8.1.6.1.3.2.3.3-4: ReportConfigNR-EventA3 (Table 8.1.6.1.3.2.3.3-1)

Derivation Path: TS 38.508-1 [4], Table 4.6.3-142 with condition EVENT_A3			
Information Element	Value/remark	Comment	Condition
ReportConfigNR ::= SEQUENCE {			
reportType CHOICE {			
eventTriggered SEQUENCE {			
eventId CHOICE {			
eventA3 SEQUENCE {			
a3-Offset CHOICE {			
rsrp	2	1 dB (2*0.5 dB)	FR1
	2+ Delta(NRf ₂) - Delta(NRf ₁)	a3-Offset value set to (2+ Delta(NRf ₂) - Delta(NRf ₁)). (Note 1)	FR2
}			
}			
}			
}			
reportAmount	r1		
reportQuantityCell SEQUENCE {			
rsrp	true		
rsrq	false		
sinr	false		
}			
}			
Note 1: Delta(NRf ₂) and Delta(NRf ₁) are derived based on calibration procedure defined in the TS 38.508-1 [4], clause 6.1.3.3 where Delta(NRf ₁) is derived for the carrier of NR PCell and Delta(NRf ₂) is derived for the carrier of neighbour cell.			

8.1.6.1.3.3 Radio Link Failure / Reporting at RRC connection establishment and reestablishment

8.1.6.1.3.3.1 Test Purpose (TP)

(1)

```

with { UE in NR RRC_CONNECTED state detecting radio link failure }
ensure that {
  when { T301 expires after UE having sent an RRCReestablishmentRequest message, the UE has radio
link failure information available in VarRLF-Report and plmn-Identity stored in VarRLF-Report is
equal to the RPLMN }
  then { UE sends the RRCSetupComplete message with rlf-InfoAvailable included after receiving an
RRCSetup message }
}
    
```

(2)

```

with { UE in NR RRC_CONNECTED state detecting radio link failure }
ensure that {
  when { UE has radio link failure information available in VarRLF-Report and plmn-Identity stored
in VarRLF-Report is equal to the RPLMN }
  then { UE sends the RRCReestablishmentComplete message with rlf-InfoAvailable included after
receiving an RRCReestablishment message }
}

```

(3)

```

with { UE in NR RRC_CONNECTED state with the radio link failure information available and plmn-
Identity stored in VarRLF-Report is equal to the RPLMN }
ensure that {
  when { UE receives the UEInformationRequest message containing rlf-ReportReq set to true }
  then { UE sends the UEInformationResponse message with rlf-Report included }
}

```

8.1.6.1.3.3.2 Conformance requirements

References: The conformance requirements covered in the present TC are specified in: TS 38.331, clauses 5.3.3.4, 5.3.7.5, 5.3.10.3, 5.3.7.4 and 5.7.10.3. Unless otherwise stated these are Rel-16 requirements.

[TS 38.331, clause 5.3.3.4]

The UE shall perform the following actions upon reception of the *RRCSetup*:

- 1> if the *RRCSetup* is received in response to an *RRCReestablishmentRequest*; or
- ...
- 1> perform the cell group configuration procedure in accordance with the received *masterCellGroup* and as specified in 5.3.5.5;
- 1> perform the radio bearer configuration procedure in accordance with the received *radioBearerConfig* and as specified in 5.3.5.6;
- 1> if stored, discard the cell reselection priority information provided by the *cellReselectionPriorities* or inherited from another RAT;
- ...
- 1> set the content of *RRCSetupComplete* message as follows:
 - ...
 - 2> if the UE has logged measurements available for NR and if the RPLMN is included in *plmn-IdentityList* stored in *VarLogMeasReport*:
 - 3> include the *logMeasAvailable* in the *RRCSetupComplete* message;
 - ...
 - 2> if the UE has connection establishment failure or connection resume failure information available in *VarConnEstFailReport* and if the RPLMN is equal to *plmn-Identity* stored in *VarConnEstFailReport*:
 - 3> include *connEstFailInfoAvailable* in the *RRCSetupComplete* message;
 - 2> if the UE has radio link failure or handover failure information available in *VarRLF-Report* and if the RPLMN is included in *plmn-IdentityList* stored in *VarRLF-Report*:
 - 3> if *reconnectCellId* in *VarRLF-Report* is not set:
 - 4> set *timeUntilReconnection* in *VarRLF-Report* to the time that elapsed since the last radio link or handover failure;
 - 4> set *nrReconnectCellId* in *reconnectCellId* in *VarRLF-Report* to the global cell identity and the tracking area code of the PCell;

3> include *rlf-InfoAvailable* in the *RRCSetupComplete* message;

...

1> submit the *RRCSetupComplete* message to lower layers for transmission, upon which the procedure ends.

[TS 38.331, clause 5.3.7.5]

The UE shall:

...

1> set the content of *RRCReestablishmentComplete* message as follows:

2> if the UE has logged measurements available for NR and if the RPLMN is included in *plmn-IdentityList* stored in *VarLogMeasReport*:

3> include the *logMeasAvailable* in the *RRCReestablishmentComplete* message;

...

2> if the UE has radio link failure or handover failure information available in *VarRLF-Report* and if the RPLMN is included in *plmn-IdentityList* stored in *VarRLF-Report*; or

...

3> include *rlf-InfoAvailable* in the *RRCReestablishmentComplete* message;

1> submit the *RRCReestablishmentComplete* message to lower layers for transmission;

[TS 38.331, clause 5.3.10.3]

The UE shall:

...

1> else:

2> during a DAPS handover: the following only applies for the target PCell;

2> upon T310 expiry in PCell; or

...

2> upon consistent uplink LBT failure indication from MCG MAC while T304 is not running:

...

3> else:

4> consider radio link failure to be detected for the MCG i.e. RLF;

4> discard any segments of segmented RRC messages stored according to 5.7.6.3;

NOTE: Void.

4> if AS security has not been activated:

5> perform the actions upon going to RRC_IDLE as specified in 5.3.11, with release cause 'other';-

4> else if AS security has been activated but SRB2 and at least one DRB or, for IAB, SRB2, have not been setup:

5> store the radio link failure information in the *VarRLF-Report* as described in subclause 5.3.10.5;

5> perform the actions upon going to RRC_IDLE as specified in 5.3.11, with release cause 'RRC connection failure';

4> else:

- 5> store the radio link failure information in the *VarRLF-Report* as described in subclause 5.3.10.5;
- ...
- 5> else:

- 6> initiate the connection re-establishment procedure as specified in 5.3.7.

The UE may discard the radio link failure information, i.e. release the UE variable *VarRLF-Report*, 48 hours after the radio link failure is detected.

[TS 38.331, clause 5.3.7.4]

The UE shall set the contents of *RRCReestablishmentRequest* message as follows:

- 1> if the procedure was initiated due to radio link failure as specified in 5.3.10.3 or handover failure as specified in 5.3.5.8.3:
- 2> set the *reestablishmentCellId* in the *VarRLF-Report* to the global cell identity of the selected cell;

[TS 38.331, clause 5.7.10.3]

Upon receiving the *UEInformationRequest* message, the UE shall, only after successful security activation:

...

- 1> if the *logMeasReportReq* is present and if the RPLMN is included in *plmn-IdentityList* stored in *VarLogMeasReport*:
- 2> if *VarLogMeasReport* includes one or more logged measurement entries, set the contents of the *logMeasReport* in the *UEInformationResponse* message as follows:
 - 3> include the *absoluteTimeStamp* and set it to the value of *absoluteTimeInfo* in the *VarLogMeasReport*;
 - 3> include the *traceReference* and set it to the value of *traceReference* in the *VarLogMeasReport*;
 - 3> include the *traceRecordingSessionRef* and set it to the value of *traceRecordingSessionRef* in the *VarLogMeasReport*;
 - 3> include the *tce-Id* and set it to the value of *tce-Id* in the *VarLogMeasReport*;
 - 3> include the *logMeasInfoList* and set it to include one or more entries from *VarLogMeasReport* starting from the entries logged first;
 - 3> if the *VarLogMeasReport* includes one or more additional logged measurement entries that are not included in the *logMeasInfoList* within the *UEInformationResponse* message:
 - 4> include the *logMeasAvailable*;

...

- 1> if *rlf-ReportReq* is set to *true*:
 - 2> if the UE has radio link failure information or handover failure information available in *VarRLF-Report* and if the RPLMN is included in *plmn-IdentityList* stored in *VarRLF-Report*:
 - 3> set *timeSinceFailure* in *VarRLF-Report* to the time that elapsed since the last radio link or handover failure in NR;
 - 3> set the *rlf-Report* in the *UEInformationResponse* message to the value of *rlf-Report* in *VarRLF-Report*;
 - 3> discard the *rlf-Report* from *VarRLF-Report* upon successful delivery of the *UEInformationResponse* message confirmed by lower layers;

...

- 1> if the *logMeasReport* is included in the *UEInformationResponse*:

- 2> submit the *UEInformationResponse* message to lower layers for transmission via SRB2;
- 2> discard the logged measurement entries included in the *logMeasInfoList* from *VarLogMeasReport* upon successful delivery of the *UEInformationResponse* message confirmed by lower layers;
- 1> else:
 - 2> submit the *UEInformationResponse* message to lower layers for transmission via SRB1.

8.1.6.1.3.3.3 Test description

8.1.6.1.3.3.3.1 Pre-test conditions

System Simulator:

- NR Cell 1 (TAI-1) is the serving cell.
- NR Cell 2 and Cell 4 are the inter-frequency neighbor cells.
- System information combination NR-2 as defined in TS 38.508-1 [4] clause 4.4.3.1.2 is used in NR cells.

NOTE: For NR Cell 2 and Cell 4 TAI is set to TAI-2.

UE:

None.

Preamble:

- The UE is in state 3N-A on NR Cell 1 according to TS 38.508-1 [4], clause 4.4A.

8.1.6.1.3.3.3.2 Test procedure sequence

Table 8.1.6.1.3.3.3.2-1/2 illustrates the downlink power levels and other changing parameters to be applied for the cells at various time instants of the test execution. Row marked "T0" denotes the initial conditions after preamble, while columns marked "T1" and "T2" are to be applied subsequently. The exact instants on which these values shall be applied are described in the texts in this clause.

Table 8.1.6.1.3.3.3.2-1: Time instances of cell power level and parameter changes for FR1

	Parameter	Unit	NR Cell 1	NR Cell 2	NR Cell 4	Remark
T0	SS/PBCH SSS EPRE	dBm/SCS	-88	"Off"	"Off"	Only Cell 1 is available.
T1	SS/PBCH SSS EPRE	dBm/SCS	"Off"	-88	"Off"	Only Cell 2 is available.
T2	SS/PBCH SSS EPRE	dBm/SCS	"Off"	"Off"	-88	Only Cell 4 is available.

Table 8.1.6.1.3.3.3.2-2: Time instances of cell power level and parameter changes for FR2

	Parameter	Unit	NR Cell 1	NR Cell 2	NR Cell 4	Remark
T0	SS/PBCH SSS EPRE	dBm/SCS	-82	"Off"	"Off"	Only Cell 1 is available.
T1	SS/PBCH SSS EPRE	dBm/SCS	"Off"	-82	"Off"	Only Cell 2 is available.
T2	SS/PBCH SSS EPRE	dBm/SCS	"Off"	"Off"	-82	Only Cell 4 is available.

Table 8.1.6.1.3.3.3.2-3: Main behaviour

St	Procedure	Message Sequence		TP	Verdict
		U - S	Message		

1	The SS changes NR Cell 1 and Cell 2 parameters according to the row "T1" in Table 8.1.6.1.3.3.3.2-1/2.	-	-	-	-
2	The UE transmits an <i>RRCReestablishmentRequest</i> message on NR Cell 2.	-->	NR RRC: <i>RRCReestablishmentRequest</i>	-	-
3	The SS does not respond to any <i>RRCReestablishmentRequest</i> message and waits for 1s to ensure that T301 expires and the UE goes to NR RRC_IDLE state on NR Cell 2.	-	-	-	-
4-5	Steps 1-2 of Table 4.9.5.2.2-1 of the generic procedure in TS 38.508-1 [4] are performed on NR Cell 2.	-	-	-	-
6	Check: Does the UE transmit an <i>RRCSetupComplete</i> message with <i>rlf-InfoAvailable</i> included and a REGISTRATION REQUEST message indicating "mobility registration updating" is sent to update the registration of the actual tracking area?	-->	NR RRC: <i>RRCSetupComplete</i> 5GMM: REGISTRATION REQUEST	1	P
6A	The SS transmits a <i>SecurityModeCommand</i> message.	<--	NR RRC: <i>SecurityModeCommand</i>	-	-
6B	The UE transmits a <i>SecurityModeComplete</i> message.	-->	NR RRC: <i>SecurityModeComplete</i>	-	-
7-8	Steps 4-5 of Table 4.9.5.2.2-1 of the generic procedure in TS 38.508-1 [4] are performed.	-	-	-	-
8A	The SS transmits an <i>RRCReconfiguration</i> message to establish SRB2 and DRB.	<--	NR RRC: <i>RRCReconfiguration</i>	-	-
8B	The UE transmits an <i>RRCReconfigurationComplete</i> message.	-->	NR RRC: <i>RRCReconfigurationComplete</i>	-	-
9	The SS changes NR Cell 2 and Cell 4 parameters according to the row "T2" in Table 8.1.6.1.3.3.3.2-1/2.	-	-	-	-
10	The UE transmits an <i>RRCReestablishmentRequest</i> message on NR Cell 4.	-->	NR RRC: <i>RRCReestablishmentRequest</i>	-	-
11	The SS transmits an <i>RRCReestablishment</i> message.	<--	NR RRC: <i>RRCReestablishment</i>	-	-
12	Check: Does the UE transmit an <i>RRCReestablishmentComplete</i> message with <i>rlf-InfoAvailable</i> included?	-->	NR RRC: <i>RRCReestablishmentComplete</i>	2	P
13	The SS transmits an <i>RRCReconfiguration</i> message to establish SRB2 and DRB.	<--	NR RRC: <i>RRCReconfiguration</i>	-	-
14	The UE transmits an <i>RRCReconfigurationComplete</i> message.	-->	NR RRC: <i>RRCReconfigurationComplete</i>	-	-
15	The SS transmits a <i>UEInformationRequest</i> message with <i>rlf-ReportReq</i> set to <i>true</i> .	<--	NR RRC: <i>UEInformationRequest</i>	-	-
16	Check: Does the UE transmit a <i>UEInformationResponse</i> message on Cell 4 with <i>rlf-Report</i> included?	-->	NR RRC: <i>UEInformationResponse</i>	3	P

8.1.6.1.3.3.3.3 Specific message contents

Table 8.1.6.1.3.3.3.3-0: *RRCSetup* (preamble and step 5 in Table 8.1.6.1.3.3.3.2-3)

Derivation Path: TS 38.508-1 [4], Table 4.6.1-21			
Information Element	Value/remark	Comment	Condition
<i>RRCSetup</i> ::= SEQUENCE {			
criticalExtensions CHOICE {			
<i>rrcSetup</i> SEQUENCE {			
<i>masterCellGroup</i>	CellGroupConfig as per table 8.1.6.1.3.3.3.3-0A	OCTET STRING (CONTAINING CellGroupConfig)	
}			
}			

}			
---	--	--	--

Table 8.1.6.1.3.3.3-0A: CellGroupConfig (preamble)

Derivation Path: TS 38.508-1 [4], Table 4.6.1-19 with condition SRB1			
Information Element	Value/remark	Comment	Condition
CellGroupConfig ::= SEQUENCE {			
spCellConfig SEQUENCE {			
rlf-TimersAndConstants CHOICE {			
Setup SEQUENCE {			
t311	ms10000		
}			
}			
}			
}			

Table 8.1.6.1.3.3.3-1: RRCReestablishmentRequest (steps 2 and 10, Table 8.1.6.1.3.3.3-2-3)

Derivation Path: TS 38.508-1 [4], Table 4.6.1-12			
Information Element	Value/remark	Comment	Condition
RRCReestablishmentRequest ::= SEQUENCE {			
ue-Identity SEQUENCE {			
c-RNTI	the value of the C-RNTI of the UE		
physCellId	PCI of NR Cell 1		Step 2
	PCI of NR Cell 2		Step 10
shortMAC-I	The same value as the 16 least significant bits of the XMAC-I value calculated by SS		
}			
reestablishmentCause	otherFailure		
}			

Table 8.1.6.1.3.3.3-2: RRCSetupComplete (step 6, Table 8.1.6.1.3.3.3-2-3)

Derivation Path: TS 38.508-1 [4], Table 4.6.1-22			
Information Element	Value/remark	Comment	Condition
RRCSetupComplete ::= SEQUENCE {			
criticalExtensions CHOICE {			
rrcSetupComplete SEQUENCE {			
nonCriticalExtension SEQUENCE {			
ue-MeasurementsAvailable-r16	UE-MeasurementsAvailable-r16 with condition RLF		
}			
}			
}			
}			

Table 8.1.6.1.3.3.3-3: RRCReestablishmentComplete (step 12, Table 8.1.6.1.3.3.3-2-3)

Derivation Path: TS 38.508-1 [4], Table 4.6.1-11			
Information Element	Value/remark	Comment	Condition
RRCReestablishmentComplete ::= SEQUENCE {			
criticalExtensions CHOICE {			
rrcReestablishmentComplete SEQUENCE {			
nonCriticalExtension SEQUENCE {			
ue-MeasurementsAvailable-r16	UE-MeasurementsAvailable-r16 with condition RLF		
}			
}			
}			

}			
}			
}			
}			

Table 8.1.6.1.3.3.3-4: UEInformationRequest (step 15, Table 8.1.6.1.3.3.3.2-3)

Derivation Path: TS 38.508-1 [4], Table 4.6.1-32A with condition RLF

Table 8.1.6.1.3.3.3-5: UEInformationResponse (step 16, Table 8.1.6.1.3.3.3.2-3)

Derivation Path: TS 38.508-1 [4], Table 4.6.1-32B			
Information Element	Value/remark	Comment	Condition
UEInformationResponse-r16 ::= SEQUENCE {			
criticalExtensions CHOICE {			
ueInformationResponse-r16 SEQUENCE {			
r1f-Report-r16 CHOICE {			
nr-RLF-Report-r16 SEQUENCE {			
measResultLastServCell-r16 SEQUENCE {			
measResult-r16 SEQUENCE {			
cellResults-r16 SEQUENCE {			
resultsSSB-Cell-r16 SEQUENCE {			
rsrp	(0..127)		
rsrq	(0..127)		
sinr	Not checked		
}			
resultsCSI-RS-Cell-r16	Not checked		
}			
rsIndexResults-r16 SEQUENCE {			
resultsSSB-Indexes-r16 SEQUENCE {			
ssb-Index	0	Cell 2 SSB index	
ssb-Results SEQUENCE {			
rsrp	(0..127)		
rsrq	(0..127)		
sinr	Not checked		
}			
}			
ssbRLMConfigBitmap-r16	10000000 00000000 00000000 00000000 00000000 00000000 00000000 00000000	Radio LinkMonitoring configuration for Cell 2	
resultsCSI-RS-Indexes-r16	Not present		
csi-rsRLMConfigBitmap-r16	Not present		
}			
}			
measResultNeighCells-r16	Not present		
c-RNTI-r16	the old value of the C-RNTI of the UE used in NR Cell 2		
previousPCellId-r16	Not present		
failedPCellId-r16 CHOICE {			
nrFailedPCellId-r16	Any Allowed Value	Either pci-arfcn-r16 or cellGlobalId-r16 corresponding to NR Cell 2	
eutraFailedPCellId-r16	Not present		
}			
reconnectCellId-r16	Not present		
timeUntilReconnection-r16	Not present		
reestablishmentCellId-r16 SEQUENCE {			
plmn-Identity-r16	PLMN ID of NR Cell 4		
cellId-r16	CGI of NR Cell 4		
}			
}			
}			
}			

trackingAreaCode-r16	TAC of NR Cell 4		
}			
timeConnFailure-r16	Not present		
timeSinceFailure-r16	Not checked		
connectionFailureType-r16	rlf		
rlf-Cause-r16	t310-Expiry		
locationInfo-r16	Not checked		
noSuitableCellFound-r16	Not present		
ra-InformationCommon-r16	Not present		
csi-rsRLMConfigBitmap-v1650	Not present		
}			
extra-RLF-Report-r16	Not present		
}			
}			
}			
}			

8.1.6.1.3.4 Radio Link Failure / Reporting at NR handover

8.1.6.1.3.4.1 Test Purpose (TP)

(1)

```
with { UE in RRC_CONNECTED state with handover failure information available }
ensure that {
  when { UE receives RRCReestablishment message }
  then { UE sends the RRCReestablishmentComplete message with rlf-InfoAvailable }
}
```

(2)

```
with { UE in RRC_CONNECTED state with the handover failure information available }
ensure that {
  when { UE receives the UEInformationRequest message containing rlf-ReportReq }
  then { UE sends the UEInformationResponse message with rlf-Report included }
}
```

8.1.6.1.3.4.2 Conformance requirements

References: The conformance requirements covered in the present TC are specified in: TS 38.331, clauses 5.3.7.4, 5.3.10.5, 5.3.5.8.3, 5.3.5.3 and 5.7.10.3. Unless otherwise stated these are Rel-16 requirements.

[TS 38.331, clause 5.3.7.4]

The UE shall set the contents of *RRCReestablishmentRequest* message as follows:

1> if the procedure was initiated due to radio link failure as specified in 5.3.10.3 or reconfiguration with sync failure as specified in 5.3.5.8.3:

2> set the *reestablishmentCellId* in the *VarRLF-Report* to the global cell identity of the selected cell;

...

[TS 38.331, clause 5.3.7.4]

The UE shall:

...

...

1> set the content of *RRCReestablishmentComplete* message as follows:

...

...

2> if the UE has radio link failure or handover failure information available in *VarRLF-Report* of TS 36.331 [10] and if the UE is capable of cross-RAT RLF reporting and if the RPLMN is included in *plmn-IdentityList* stored in *VarRLF-Report* of TS 36.331 [10]:

3> include *rlf-InfoAvailable* in the *RRCReestablishmentComplete* message;

1> submit the *RRCReestablishmentComplete* message to lower layers for transmission;

[TS 38.331, clause 5.3.10.5]

The UE shall determine the content in the *VarRLF-Report* as follows:

1> clear the information included in *VarRLF-Report*, if any;

1> set the *plmn-IdentityList* to include the list of EPLMNs stored by the UE (i.e. includes the RPLMN);

1> set the *measResultLastServCell* to include the cell level RSRP, RSRQ and the available SINR, of the source PCell (in case HO failure) or PCell (in case RLF) based on the available SSB and CSI-RS measurements collected up to the moment the UE detected failure;

1> if the SS/PBCH block-based measurement quantities are available:

2> set the *rsIndexResults* in *measResultLastServCell* to include all the available measurement quantities of the source PCell (in case HO failure) or PCell (in case RLF), ordered such that the highest SS/PBCH block RSRP is listed first if SS/PBCH block RSRP measurement results are available, otherwise the highest SS/PBCH block RSRQ is listed first if SS/PBCH block RSRQ measurement results are available, otherwise the highest SS/PBCH block SINR is listed first, based on the available SS/PBCH block based measurements collected up to the moment the UE detected failure;

...

1> set the *c-RNTI* to the C-RNTI used in the source PCell (in case HO failure) or PCell (in case RLF);

1> if the failure is detected due to reconfiguration with sync failure as described in 5.3.5.8.3, set the fields in *VarRLF-report* as follows:

2> set the *connectionFailureType* to *hof*;

2> set the *nrFailedPCellId* in *failedPCellId* to the global cell identity and tracking area code, if available, and otherwise to the physical cell identity and carrier frequency of the target PCell of the failed handover;

2> include *nrPreviousCell* in *previousPCellId* and set it to the global cell identity and tracking area code of the PCell where the last *RRCReconfiguration* message including *reconfigurationWithSync* was received;

2> set the *timeConnFailure* to the elapsed time since reception of the last *RRCReconfiguration* message including the *reconfigurationWithSync*;

...

1> if available, set the *locationInfo* as in 5.3.3.7.

The UE may discard the radio link failure information or handover failure information, i.e. release the UE variable *VarRLF-Report*, 48 hours after the radio link failure/handover failure is detected.

NOTE 2: In this clause, the term 'handover failure' has been used to refer to 'reconfiguration with sync failure'.

[TS 38.331, clause 5.3.5.8.3]

The UE shall:

1> if T304 of the MCG expires:

2> release dedicated preambles provided in *rach-ConfigDedicated* if configured;

2> release dedicated msgA PUSCH resources provided in *rach-ConfigDedicated* if configured;

...

2> else:

- 3> revert back to the UE configuration used in the source PCell;
- 3> store the handover failure information in *VarRLF-Report* as described in the subclause 5.3.10.5;
- 3> initiate the connection re-establishment procedure as specified in subclause 5.3.7.

[TS 38.331, clause 5.3.5.3]

The UE shall perform the following actions upon reception of the *RRCReconfiguration*, or upon execution of the conditional reconfiguration (CHO or CPC):

...

1> set the content of the *RRCReconfigurationComplete* message as follows:

...

2> if the UE has radio link failure or handover failure information available in *VarRLF-Report* and if the RPLMN is included in *plmn-IdentityList* stored in *VarRLF-Report*; or

...

3> include *rlf-InfoAvailable* in the *RRCReconfigurationComplete* message;

...

1> else (*RRCReconfiguration* was received via SRB1):

2> submit the *RRCReconfigurationComplete* message via SRB1 to lower layers for transmission using the new configuration;

[TS 38.331, clause 5.7.10.3]

Upon receiving the *UEInformationRequest* message, the UE shall, only after successful security activation:

...

1> if *rlf-ReportReq* is set to *true*:

2> if the UE has radio link failure information or handover failure information available in *VarRLF-Report* and if the RPLMN is included in *plmn-IdentityList* stored in *VarRLF-Report*:

3> set *timeSinceFailure* in *VarRLF-Report* to the time that elapsed since the last radio link failure or handover failure in NR;

3> set the *rlf-Report* in the *UEInformationResponse* message to the value of *rlf-Report* in *VarRLF-Report*;

3> discard the *rlf-Report* from *VarRLF-Report* upon successful delivery of the *UEInformationResponse* message confirmed by lower layers;

...

1> else:

2> submit the *UEInformationResponse* message to lower layers for transmission via SRB1.

8.1.6.1.3.4.3 Test description

8.1.6.1.3.4.3.1 Pre-test conditions

System Simulator:

- NR Cell 1 is the serving cell.

- NR Cell 2 is the Suitable neighbour intra-frequency cell.
- System information combination NR-2 as defined in TS 38.508-1 [4] clause 4.4.3.1.2 is used in NR cells.

UE:

None.

Preamble:

- The UE is in state 3N-A on NR Cell 1 according to TS 38.508-1 [4], clause 4.4A.

8.1.6.1.3.4.3.2 Test procedure sequence

Table 8.1.6.1.3.4.3.2-1/2 illustrates the downlink power levels and other changing parameters to be applied for the cells at various time instants of the test execution. Row marked "T0" denotes the initial conditions after preamble, while columns marked "T1" is to be applied subsequently. The exact instants on which these values shall be applied are described in the texts in this clause.

Table 8.1.6.1.3.4.3.2-1: Time instances of cell power level and parameter changes for FR1

	Parameter	Unit	NR Cell 1	NR Cell 2	Remark
T0	SS/PBCH SSS EPRE	dBm/SCS	-88	-94	
T1	SS/PBCH SSS EPRE	dBm/SCS	-88	"Off"	Only Cell 1 is available.

Table 8.1.6.1.3.4.3.2-2: Time instances of cell power level and parameter changes for FR2

	Parameter	Unit	NR Cell 1	NR Cell 2	Remark
T0	SS/PBCH SSS EPRE	dBm/SCS	FFS	FFS	
T1	SS/PBCH SSS EPRE	dBm/SCS	-82	"Off"	Only Cell 1 is available.

Table 8.1.6.1.3.4.3.2-3: Main behaviour

St	Procedure	Message Sequence		TP	Verdict
		U - S	Message		
1	The SS transmits an <i>RRCReconfiguration</i> message on NR Cell 1 to order the UE to perform handover to NR Cell 2.	<--	NR RRC: <i>RRCReconfiguration</i>	-	-
-	EXCEPTION: In parallel to the events described in step 2 the steps specified in Table 8.1.6.1.3.4.3.2-4 should take place.	-	-	-	-
2	The SS changes the power level setting according to the row "T1".	-	-	-	-
3	The UE transmits an <i>RRCReestablishmentRequest</i> message on NR Cell 1.	-->	NR RRC: <i>RRCReestablishmentRequest</i>	-	-
4	The SS transmits an <i>RRCReestablishment</i> message to resume SRB1 operation and re-activate security on NR Cell 1.	<--	NR RRC: <i>RRCReestablishment</i>	-	-
5	Check: Does the UE transmits an <i>RRCReestablishmentComplete</i> message with <i>rif-InfoAvailable</i> included using the security key derived from the nextHopChainingCount on NR Cell 1.	-->	NR RRC: <i>RRCReestablishmentComplete</i>	1	P
6	The SS transmits an <i>RRCReconfiguration</i> message to resume existing radio bearers on NR Cell 1.	<--	NR RRC: <i>RRCReconfiguration</i>	-	-
7	The UE transmit an <i>RRCReconfigurationComplete</i> message.	-->	NR RRC: <i>RRCReconfigurationComplete</i>	-	-

8	The SS transmits a <i>UEInformationRequest</i> message.	<--	NR RRC: <i>UEInformationRequest</i>	-	-
9	Check: Does the UE transmit a <i>UEInformationResponse</i> message on NR Cell 1?	-->	NR RRC: <i>UEInformationResponse</i>	2	P

Table 8.1.6.1.3.4.3.2-4: Parallel behaviour

St	Procedure	Message Sequence		TP	Verdict
		U - S	Message		
-	EXCEPTION: The steps 1 and 2 below are repeated for the duration of T304.	-	-	-	-
1	The UE attempts to perform the handover using MAC Random Access Preamble on NR Cell 2.	-	-	-	-
2	The SS does not respond.	-	-	-	-

8.1.6.1.3.4.3.3 Specific message contents

Table 8.1.6.1.3.4.3.3-1: RRCReconfiguration-HO (step 1, Table 8.1.6.1.3.4.3.2-3)

Derivation Path: TS 38.508-1 [4], Table 4.8.1-1A with condition RBConfig_KeyChange
--

Table 8.1.6.1.3.4.3.3-2: RRCReestablishmentRequest (step 3, Table 8.1.6.1.3.4.3.2-3)

Derivation Path: TS 38.508-1, Table 4.6.1-12			
Information Element	Value/remark	Comment	Condition
RRCReestablishmentRequest ::= SEQUENCE {			
ue-Identity SEQUENCE {			
c-RNTI	the value of the C-RNTI of the UE		
physCellId	PhysicalCellId of NR Cell 1		
shortMAC-I	The same value as the 16 least significant bits of the MAC-I value calculated by SS.		
}			
reestablishmentCause	handoverFailure		
}			

Table 8.1.6.1.3.4.3.3-3: RRCReestablishment (step 4, Table 8.1.6.1.3.4.3.2-3)

Derivation Path: TS 38.508-1, Table 4.6.1-10			
Information Element	Value/remark	Comment	Condition
RRCReestablishment ::= SEQUENCE {			
criticalExtensions CHOICE {			
rrcReestablishment SEQUENCE {			
nextHopChainingCount	2		
}			
}			
}			

Table 8.1.6.1.3.4.3.3-4: RRCReestablishmentComplete (step 5, Table 8.1.6.1.3.4.3.2-3)

Derivation Path: TS 38.508-1 [4], Table 4.6.1-11			
Information Element	Value/remark	Comment	Condition
RRCReestablishmentComplete ::= SEQUENCE {			
criticalExtensions CHOICE {			
rrcReestablishmentComplete SEQUENCE {			

nonCriticalExtension SEQUENCE {			
ue-MeasurementsAvailable-r16	UE-MeasurementsAvailable-r16 with condition RLF		
}			
}			
}			
}			

Table 8.1.6.1.3.4.3.3-5: RRCReconfiguration (step 6, Table 8.1.6.1.3.4.3.2-3)

Derivation Path: TS 38.508-1 [4], Table 4.6.1-13 with condition REEST

Table 8.1.6.1.3.4.3.3-6: Void

Table 8.1.6.1.3.4.3.3-7: UEInformationRequest (step 8, Table 8.1.6.1.3.4.3.2-3)

Derivation Path: TS 38.508-1 [4], Table 4.6.1-32A with condition RLF

Table 8.1.6.1.3.4.3.3-8: UEInformationResponse (step 9, Table 8.1.6.1.3.4.3.2-3)

Derivation Path: TS 38.508-1 [4], Table 4.6.1-32B			
Information Element	Value/remark	Comment	Condition
UEInformationResponse-r16 ::= SEQUENCE {			
criticalExtensions CHOICE {			
ueInformationResponse-r16 SEQUENCE {			
rlf-Report-r16 CHOICE {			
nr-RLF-Report-r16 SEQUENCE {			
measResultLastServCell-r16 SEQUENCE {			
measResult-r16 SEQUENCE {			
cellResults-r16 SEQUENCE {			
resultsSSB-Cell-r16 SEQUENCE {			
rsrp	(0..127)		
rsrq	(0..127)		
sinr	Not checked		
}			
resultsCSI-RS-Cell-r16	Not checked		
}			
rsIndexResults-r16 SEQUENCE {			
resultsSSB-Indexes-r16 SEQUENCE {			
ssb-Index	1		
ssb-Results SEQUENCE {			
rsrp	(0..127)		
rsrq	(0..127)		
sinr	Not checked		
}			
}			
ssbRLMConfigBitmap-r16	01000000 00000000 00000000 00000000 00000000 00000000 00000000 00000000		
resultsCSI-RS-Indexes-r16	Not present		
csi-rsRLMConfigBitmap-r16	Not present		
}			
}			
measResultNeighCells-r16	Not present		
c-RNTI-r16	the old value of the C-RNTI of the UE used in NR Cell 1		

previousPCellId-r16 CHOICE {			
nrPreviousCell-r16 SEQUENCE {			
plmn-Identity-r16	PLMN ID of NR Cell 1		
cellIdentity-r16	CGI of NR Cell 1		
trackingAreaCode-r16	TAC of NR Cell 1		
}			
failedPCellId-r16 CHOICE {			
nrFailedPCellId-r16	Any Allowed Value	Either pci-arfcn-r16 or cellGlobalId-r16 corresponding to NR Cell 2	
eutraFailedPCellId-r16	Not present		
}			
reconnectCellId-r16	Not present		
timeUntilReconnection-r16	Not present		
reestablishmentCellId-r16 SEQUENCE {			
plmn-Identity-r16	PLMN ID of NR Cell 1		
cellIdentity-r16	CGI of NR Cell 1		
trackingAreaCode-r16	TAC of NR Cell 1		
}			
timeConnFailure-r16	Any allowed value		
timeSinceFailure-r16	Any allowed value		
connectionFailureType-r16	hof		
rlf-Cause-r16	Not checked		
locationInfo-r16	Not checked		
noSuitableCellFound-r16	Not present		
ra-InformationCommon-r16	Not checked		
}			
}			
}			
}			
}			

8.1.6.1.3.5 Radio Link Failure / Location information

8.1.6.1.3.5.1 Test Purpose (TP)

(1)

with { UE in RRC_CONNECTED having performed the intra-frequency measurement and reported that the UE has radio link failure information with location information available }
 ensure that {
 when { UE receives the *UEInformationRequest* message containing *rlf-ReportReq* }
 then { UE sends the *UEInformationResponse* containing the measurement result for intra-frequency neighbour cell including *locationInfo* }
 }

8.1.6.1.3.5.2 Conformance requirements

References: The conformance requirements covered in the present TC are specified in: TS 38.306 clause 4.2.18; TS 38.331, clauses 5.3.10.3, 5.3.10.5, 5.3.3.7, 5.3.7.4, 5.3.7.5, and 5.7.10.3. Unless otherwise stated these are Rel-16 requirements.

[TS 38.306, clause 4.2.18]

gnss-Location-r16 Indicates whether the UE is equipped with a GNSS or A-GNSS receiver that may be used to provide detailed location information along with SON or MDT related measurements in RRC_CONNECTED, RRC_IDLE and RRC_INACTIVE.	UE	No	No	No
---	----	----	----	----

[TS 38.331, clause 5.3.10.3]

The UE shall:

...

1> else:

2> during a DAPS handover: the following only applies for the target PCell;

2> upon T310 expiry in PCell; or

...

2> upon consistent uplink LBT failure indication from MCG MAC while T304 is not running:

...

3> else:

4> consider radio link failure to be detected for the MCG i.e. RLF;

4> discard any segments of segmented RRC messages stored according to 5.7.6.3;

NOTE: Void.

4> if AS security has not been activated:

5> perform the actions upon going to RRC_IDLE as specified in 5.3.11, with release cause 'other';-

4> else if AS security has been activated but SRB2 and at least one DRB or, for IAB, SRB2, have not been setup:

5> store the radio link failure information in the *VarRLF-Report* as described in subclause 5.3.10.5;

5> perform the actions upon going to RRC_IDLE as specified in 5.3.11, with release cause 'RRC connection failure';

4> else:

5> store the radio link failure information in the *VarRLF-Report* as described in subclause 5.3.10.5;

...

5> else:

6> initiate the connection re-establishment procedure as specified in 5.3.7.

The UE may discard the radio link failure information, i.e. release the UE variable *VarRLF-Report*, 48 hours after the radio link failure is detected.

[TS 38.331, clause 5.3.10.5]

The UE shall determine the content in the *VarRLF-Report* as follows:

1> clear the information included in *VarRLF-Report*, if any;

1> set the *plmn-IdentityList* to include the list of EPLMNs stored by the UE (i.e. includes the RPLMN);

1> set the *measResultLastServCell* to include the cell level RSRP, RSRQ and the available SINR, of the source PCell (in case HO failure) or PCell (in case RLF) based on the available SSB and CSI-RS measurements collected up to the moment the UE detected failure;

1> if the SS/PBCH block-based measurement quantities are available:

2> set the *rsIndexResults* in *measResultLastServCell* to include all the available measurement quantities of the source PCell (in case HO failure) or PCell (in case RLF), ordered such that the highest SS/PBCH block RSRP is listed first if SS/PBCH block RSRP measurement results are available, otherwise the highest SS/PBCH block RSRQ is listed first if SS/PBCH block RSRQ measurement results are available, otherwise the highest SS/PBCH block SINR is listed first, based on the available SS/PBCH block based measurements collected up to the moment the UE detected failure;

...

1> set the *ssbRLMConfigBitmap* and/or *csi-rsRLMConfigBitmap* in *measResultLastServCell* to include the radio link monitoring configuration of the source PCell(in case HO failure) or PCell (in case RLF);

...

1> set the *c-RNTI* to the C-RNTI used in the source PCell(in case HO failure) or PCell (in case RLF);

...

1> else if the failure is detected due to radio link failure as described in 5.3.10.3, set the fields in *VarRLF-report* as follows:

2> set the *connectionFailureType* to *rlf*;

2> set the *rlf-Cause* to the trigger for detecting radio link failure in accordance with clause 5.3.10.4;

2> set the *nrFailedPCellId* in *failedPCellId* to the global cell identity and the tracking area code, if available, and otherwise to the physical cell identity and carrier frequency of the PCell where radio link failure is detected;

...

1> if available, set the *locationInfo* as in 5.3.3.7.

The UE may discard the radio link failure information or handover failure information, i.e. release the UE variable *VarRLF-Report*, 48 hours after the radio link failure/handover failure is detected.

NOTE 2: In this clause, the term 'handover failure' has been used to refer to 'reconfiguration with sync failure'.

[TS 38.331, clause 5.3.3.7]

The UE shall:

1> if timer T300 expires:

2> reset MAC, release the MAC configuration and re-establish RLC for all RBs that are established;

2> if the UE supports RRC Connection Establishment failure with temporary offset and the T300 has expired a consecutive *connEstFailCount* times on the same cell for which *connEstFailureControl* is included in *SIB1*:

3> for a period as indicated by *connEstFailOffsetValidity*:

4> use *connEstFailOffset* for the parameter *Qoffsettemp* for the concerned cell when performing cell selection and reselection according to TS 38.304 [20] and TS 36.304 [27];

NOTE 1: When performing cell selection, if no suitable or acceptable cell can be found, it is up to UE implementation whether to stop using *connEstFailOffset* for the parameter *Qoffsettemp* during *connEstFailOffsetValidity* for the concerned cell.

2> if the UE has connection establishment failure informaton or connection resume failure information available in *VarConnEstFailReport* and if the RPLMN is not equal to *plmn-identity* stored in *VarConnEstFailReport*;
or

2> if the cell identity of current cell is not equal to the cell identity stored in *measResultFailedCell* in *VarConnEstFailReport*:

3> reset the *numberOfConnFail* to 0;

2> clear the content included in *VarConnEstFailReport* except for the *numberOfConnFail*, if any;

2> store the following connection establishment failure information in the *VarConnEstFailReport* by setting its fields as follows:

...

- 3> if available, set the *locationInfo* as follows:
 - 4> if available, set the *commonLocationInfo* to include the detailed location information;
 - 4> if available, set the *bt-LocationInfo* to include the Bluetooth measurement results, in order of decreasing RSSI for Bluetooth beacons;
 - 4> if available, set the *wlan-LocationInfo* to include the WLAN measurement results, in order of decreasing RSSI for WLAN APs;
 - 4> if available, set the *sensor-LocationInfo* to include the sensor measurement results as follows:
 - 5> if available, include the *sensor-MeasurementInformation*;
 - 5> if available, include the *sensor-MotionInformation*;

[TS 38.331, clause 5.3.7.4]

The UE shall set the contents of *RRCReestablishmentRequest* message as follows:

- 1> if the procedure was initiated due to radio link failure as specified in 5.3.10.3 or handover failure as specified in 5.3.5.8.3:
 - 2> set the *reestablishmentCellId* in the *VarRLF-Report* to the global cell identity of the selected cell;

[TS 38.331, clause 5.3.7.5]

The UE shall:

...

- 1> set the content of *RRCReestablishmentComplete* message as follows:
 - 2> if the UE has logged measurements available for NR and if the RPLMN is included in *plmn-IdentityList* stored in *VarLogMeasReport*:
 - 3> include the *logMeasAvailable* in the *RRCReestablishmentComplete* message;
 - ...
 - 2> if the UE has radio link failure or handover failure information available in *VarRLF-Report* and if the RPLMN is included in *plmn-IdentityList* stored in *VarRLF-Report*; or
 - ...
 - 3> include *rlf-InfoAvailable* in the *RRCReestablishmentComplete* message;
- 1> submit the *RRCReestablishmentComplete* message to lower layers for transmission;

[TS 38.331, clause 5.7.10.3]

Upon receiving the *UEInformationRequest* message, the UE shall, only after successful security activation:

- 1> if *rlf-ReportReq* is set to *true*:
 - 2> if the UE has radio link failure information or handover failure information available in *VarRLF-Report* and if the RPLMN is included in *plmn-IdentityList* stored in *VarRLF-Report*:
 - 3> set *timeSinceFailure* in *VarRLF-Report* to the time that elapsed since the last radio link failure or handover failure in NR;
 - 3> set the *rlf-Report* in the *UEInformationResponse* message to the value of *rlf-Report* in *VarRLF-Report*;
 - 3> discard the *rlf-Report* from *VarRLF-Report* upon successful delivery of the *UEInformationResponse* message confirmed by lower layers;

...

1> else:

2> submit the *UEInformationResponse* message to lower layers for transmission via SRB1.

8.1.6.1.3.5.3 Test description

8.1.6.1.3.5.3.1 Pre-test conditions

System Simulator:

- NR Cell 1 is the serving cell.
- NR Cell 2 is the Suitable neighbour intra-frequency cell.
- System information combination NR-2 as defined in TS 38.508-1 [4] clause 4.4.3.1.2 is used in NR cells.

UE:

None.

Preamble:

- The UE's positioning engine (e.g. standalone GNSS receiver) should be provided with any necessary stimulus to allow it to provide the position. This shall be done by use of the test function Update UE Location Information defined in TS 38.509 [6] or any other suitable method may also be used.
- The UE is in state 3N-A on NR Cell 1 according to TS 38.508-1 [4], clause 4.4A.

8.1.6.1.3.5.3.2 Test procedure sequence

Same test procedure as specified in 8.1.6.1.3.1.3.2 with the following exception:

- The specific message content for the *UEInformationResponse* message in Table 8.1.6.1.3.1.3.3-10 is replaced by the specific message content in Table 8.1.6.1.3.5.3.3-1.

8.1.6.1.3.5.3.3 Specific message contents

Table 8.1.6.1.3.5.3.3-1: *UEInformationResponse* (step 9, Table 8.1.6.1.3.1.3.2-3)

Derivation Path: TS 38.508-1 [4], Table 4.6.1-32B			
Information Element	Value/remark	Comment	Condition
<i>UEInformationResponse</i> -r16 ::= SEQUENCE {			
criticalExtensions CHOICE {			
<i>ueInformationResponse</i> -r16 SEQUENCE {			
r1f-Report-r16 CHOICE {			
nr-RLF-Report-r16 SEQUENCE {			
measResultLastServCell-r16 SEQUENCE {			
measResult-r16 SEQUENCE {			
cellResults-r16 SEQUENCE {			
resultsSSB-Cell-r16 SEQUENCE {			
rsrp	(0..127)		
rsrq	(0..127)		
sinr	Not checked		
}			
resultsCSI-RS-Cell-r16	Not checked		
}			
rsIndexResults-r16 SEQUENCE {			
resultsSSB-Indexes-r16 SEQUENCE {			
ssb-Index	1		
ssb-Results SEQUENCE {			
rsrp	(0..127)		
rsrq	(0..127)		
sinr	Not checked		

}			
}			
ssbRLMConfigBitmap-r16	01000000 00000000 00000000 00000000 00000000 00000000 00000000 00000000		
resultsCSI-RS-Indexes-r16	Not present		
csi-rsRLMConfigBitmap-r16	Not present		
}			
}			
}			
measResultNeighCells-r16 SEQUENCE {			
measResultListNR-r16 SEQUENCE {			
ssbFrequency-r16	ARFCN-ValueNR for SSB of NR Cell 2		
refFreqCSI-RS-r16	Not present		
measResultList-r16 SEQUENCE {			
physCellId	PCI of NR Cell 2		
measResult SEQUENCE {			
cellResults SEQUENCE {			
resultsSSB-Cell SEQUENCE {			
rsrp	(0..127)		
rsrq	Not present		
sinr	Not present		
}			
}			
}			
}			
c-RNTI-r16	the old value of the C- RNTI of the UE used in NR Cell 1		
previousPCellId-r16	Not present		
failedPCellId-r16 CHOICE {			
nrFailedPCellId-r16 CHOICE {			
pci-arfcn-r16 SEQUENCE {			
physCellId-r16	PCI of NR Cell 1		
carrierFreq-r16	NARFCN of NR Cell 1		
}			
}			
}			
reconnectCellId-r16	Not present		
timeUntilReconnection-r16	Not present		
reestablishmentCellId-r16 SEQUENCE {			
plmn-Identity-r16	PLMN ID of NR Cell 2		
cellIdentity-r16	CGI of NR Cell 2		
trackingAreaCode-r16	TAC of NR Cell 2		
}			
timeConnFailure-r16	Not present		
timeSinceFailure-r16	Any allowed value		
connectionFailureType-r16	r1f		
r1f-Cause-r16	t310-Expiry		
locationInfo-r16 SEQUENCE {			
commonLocationInfo-r16 SEQUENCE {			
gnss-TOD-msec-r16	Not checked		
locationTimestamp-r16	Any allowed value		
locationCoordinate-r16	Not checked		
locationError-r16	Not checked		
locationSource-r16	Not checked		
velocityEstimate-r16	Not checked		
}			
bt-LocationInfo-r16	Not checked		
wlan-LocationInfo-r16	Not checked		
sensor-LocationInfo-r16	Not checked		
}			

noSuitableCellFound-r16	Not present		
ra-InformationCommon-r16	Not present		
}			
}			
}			
}			
}			

8.1.6.1.3.6 Radio Link Failure / Random access problem

8.1.6.1.3.6.1 Test Purpose (TP)

(1)

```
with { UE in RRC_CONNECTED state with the radio link failure information with cause
randomAccessProblem available }
ensure that {
  when { UE receives the UEInformationRequest message containing rlf-ReportReq }
  then { UE sends the UEInformationResponse message with rlf-Report with rlf-cause
randomAccessProblem included }
}
```

8.1.6.1.3.6.2 Conformance requirements

References: The conformance requirements covered in the present TC are specified in: TS 38.331, clauses 5.3.3.7, 5.7.10.5, 5.3.10.3, 5.3.10.5 and 5.7.10.3. Unless otherwise stated these are Rel-16 requirements.

[TS 38.331, clause 5.3.3.7]

The UE shall:

1> if timer T300 expires:

...

2> store the following connection establishment failure information in the *VarConnEstFailReport* by setting its fields as follows:

3> set the *plmn-Identity* to the PLMN selected by upper layers (see TS 24.501 [23]) from the PLMN(s) included in the *plmn-IdentityList* in *SIB1*;

...

3> set *perRAInfoList* to indicate random access failure information as specified in 5.7.10.5;

...

2> inform upper layers about the failure to establish the RRC connection, upon which the procedure ends;

The UE may discard the connection establishment failure or connection resume failure information, i.e. release the UE variable *VarConnEstFailReport*, 48 hours after the last connection establishment failure is detected.

[TS 38.331, clause 5.7.10.5]

The UE shall set the content in *ra-InformationCommon* as follows:

1> set the *absoluteFrequencyPointA* to indicate the absolute frequency of the reference resource block associated to the random-access resources used in the random-access procedure;

1> set the *locationAndBandwidth* and *subcarrierSpacing* associated to the UL BWP of the random-access resources used in the random-access procedure;

1> set the *msg1-FrequencyStart*, *msg1-FDM* and *msg1-SubcarrierSpacing* associated to the contention based random-access resources if used in the random-access procedure;

- 1> set the *msg1-FrequencyStartCFRA*, *msg1-FDMCFRA* and *msg1-SubcarrierSpacingCFRA* associated to the contention free random-access resources if used in the random-access procedure;
- 1> set the parameters associated to individual random-access attempt in the chronological order of attempts in the *perRAInfoList* as follows:
 - 2> if the random-access resource used is associated to a SS/PBCH block, set the associated random-access parameters for the successive random-access attempts associated to the same SS/PBCH block for one or more random-access attempts as follows:
 - 3> set the *ssb-Index* to include the SS/PBCH block index associated to the used random-access resource;
 - 3> set the *numberOfPreamblesSentOnSSB* to indicate the number of successive random-access attempts associated to the SS/PBCH block;
 - 3> for each random-access attempt performed on the random-access resource, include the following parameters in the chronological order of the random-access attempt:
 - 4> if the random-access attempt is performed on the contention based random-access resource and if *raPurpose* is not equal to *requestForOtherSI*, include *contentionDetected* as follows:
 - 5> if contention resolution was not successful as specified in TS 38.321 [6] for the transmitted preamble:
 - 6> set the *contentionDetected* to *true*;
 - 5> else:
 - 6> set the *contentionDetected* to *false*;
 - 4> if the random-access attempt is performed on the contention based random-access resource; or
 - 4> if the random-access attempt is performed on the contention free random-access resource and if the random-access procedure was initiated due to the PDCCH ordering:
 - 5> if the SS/PBCH block RSRP of the SS/PBCH block corresponding to the random-access resource used in the random-access attempt is above *rsrp-ThresholdSSB*:
 - 6> set the *dirSRPAboveThreshold* to *true*;
 - 5> else:
 - 6> set the *dirSRPAboveThreshold* to *false*;

[TS 38.331, clause 5.3.10.3]

The UE shall:

...

1> else:

...

- 2> upon random access problem indication from MCG MAC while neither T300, T301, T304, T311 nor T319 are running; or

[TS 38.331, clause 5.3.10.5]

The UE shall determine the content in the *VarRLF-Report* as follows:

- 1> clear the information included in *VarRLF-Report*, if any;
- 1> set the *plmn-IdentityList* to include the list of EPLMNs stored by the UE (i.e. includes the RPLMN);
- 1> set the *measResultLastServCell* to include the cell level RSRP, RSRQ and the available SINR, of the source PCell (in case HO failure) or PCell (in case RLF) based on the available SSB and CSI-RS measurements collected up to the moment the UE detected failure;

- 1> if the SS/PBCH block-based measurement quantities are available:
 - 2> set the *rsIndexResults* in *measResultLastServCell* to include all the available measurement quantities of the source PCell (in case HO failure) or PCell (in case RLF), ordered such that the highest SS/PBCH block RSRP is listed first if SS/PBCH block RSRP measurement results are available, otherwise the highest SS/PBCH block RSRQ is listed first if SS/PBCH block RSRQ measurement results are available, otherwise the highest SS/PBCH block SINR is listed first, based on the available SS/PBCH block based measurements collected up to the moment the UE detected failure;
 - ...
- 1> set the *ssbRLMConfigBitmap* and/or *csi-rsRLMConfigBitmap* in *measResultLastServCell* to include the radio link monitoring configuration of the source PCell(in case HO failure) or PCell (in case RLF);
- ...
- 1> set the *c-RNTI* to the C-RNTI used in the source PCell(in case HO failure) or PCell (in case RLF);
- ...
- 1> else if the failure is detected due to radio link failure as described in 5.3.10.3, set the fields in *VarRLF-report* as follows:
 - 2> set the *connectionFailureType* to *rlf*;
 - 2> set the *rlf-Cause* to the trigger for detecting radio link failure in accordance with clause 5.3.10.4;
 - 2> set the *nrFailedPCellId* in *failedPCellId* to the global cell identity and the tracking area code, if available, and otherwise to the physical cell identity and carrier frequency of the PCell where radio link failure is detected;
 - ...
- 1> if *connectionFailureType* is *rlf* and the *rlf-Cause* is set to *randomAccessProblem* or *beamFailureRecoveryFailure*; or
- 1> if *connectionFailureType* is *hof* and if the failed handover is an intra-RAT handover:
 - 2> set the *ra-InformationCommon* to include the random-access related information as described in subclause 5.7.10.5;
- 1> if available, set the *locationInfo* as in 5.3.3.7.

[TS 38.331, clause 5.7.10.3]

Upon receiving the *UEInformationRequest* message, the UE shall, only after successful security activation:

- ...
- 1> if *rlf-ReportReq* is set to *true*:
 - 2> if the UE has radio link failure information or handover failure information available in *VarRLF-Report* and if the RPLMN is included in *plmn-IdentityList* stored in *VarRLF-Report*:
 - 3> set *timeSinceFailure* in *VarRLF-Report* to the time that elapsed since the last radio link failure or handover failure in NR;
 - 3> set the *rlf-Report* in the *UEInformationResponse* message to the value of *rlf-Report* in *VarRLF-Report*;
 - 3> discard the *rlf-Report* from *VarRLF-Report* upon successful delivery of the *UEInformationResponse* message confirmed by lower layers;
 - ...
- 1> else:
 - 2> submit the *UEInformationResponse* message to lower layers for transmission via SRB1.

8.1.6.1.3.6.3 Test description

8.1.6.1.3.6.3.1 Pre-test conditions

- NR Cell 1 is the serving cell.
- System information combination NR-2 as defined in TS 38.508-1 [4] clause 4.4.3.1.2 is used in NR cells.

UE:

None.

Preamble:

- The UE is in state 3N-A according to TS 38.508-1 [4], clause 4.4A.2 Table 4.4A.2-3.

8.1.6.1.3.6.3.2 Test procedure sequence

Table 8.1.6.1.3.6.3.2-1: Void

Table 8.1.6.1.3.6.3.2-2: Void

Table 8.1.6.1.3.6.3.2-3: Main behaviour

St	Procedure	Message Sequence		TP	Verdict
		U - S	Message		
1-11	Void				
12	The SS is configured to ignore the preambles transmitted by the UE on PRACH.	-	-	-	-
13	The SS sends a PDCCH order with ra-PreambleIndex = '000000'B.	-	-	-	-
14	The UE transmits Preamble on PRACH corresponding to ra-PreambleIndex in step 13 preambleTransMax times.	-	-	-	-
14A	The SS is configured to reply the preambles transmitted by the UE on PRACH.				
15	The UE transmits an <i>RRCReestablishmentRequest</i> message	-->	NR RRC: <i>RRCReestablishmentRequest</i>	-	-
16	The SS transmits an <i>RRCReestablishment</i> message.	<--	NR RRC: <i>RRCReestablishment</i>	-	-
17	The UE transmits an <i>RRCReestablishmentComplete</i> message.	-->	NR RRC: <i>RRCReestablishmentComplete</i>	-	-
18	The SS transmits an <i>RRCReconfiguration</i> message to establish SRB2 and DRB.	<--	NR RRC: <i>RRCReconfiguration</i>	-	-
19	The UE transmits an <i>RRCReconfigurationComplete</i> message.	-->	NR RRC: <i>RRCReconfigurationComplete</i>	-	-
20	The SS transmits a <i>UEInformationRequest</i> message with <i>rlf-ReportReq</i> set to <i>true</i> .	<--	NR RRC: <i>UEInformationRequest</i>	-	-
21	Check: Does the UE transmit a <i>UEInformationResponse</i> message with <i>rlf-Report</i> included?	-->	NR RRC: <i>UEInformationResponse</i>	2	P

8.1.6.1.3.6.3.3 Specific message contents

Table 8.1.6.1.3.6.3.3-1: *RRCReestablishmentComplete* (step 17, Table 8.1.6.1.3.6.3.2-3)

Derivation Path: TS 38.508-1 [4], Table 4.6.1-11			
Information Element	Value/remark	Comment	Condition
<i>RRCReestablishmentComplete</i> ::= SEQUENCE {			
criticalExtensions CHOICE {			
rrcReestablishmentComplete SEQUENCE {			

nonCriticalExtension SEQUENCE {			
ue-MeasurementsAvailable-r16	UE-MeasurementsAvailable-r16 with condition RLF		
}			
}			
}			
}			

Table 8.1.6.1.3.6.3.2-2: UEInformationRequest (step 20, Table 8.1.6.1.3.6.3.2-3)

Derivation Path: TS 38.508-1 [4], Table 4.6.1-32A with condition RLF

Table 8.1.6.1.3.6.3.3-3: UEInformationResponse (step 21, Table 8.1.6.1.3.6.3.2-3)

Derivation Path: TS 38.508-1 [4], Table 4.6.1-32B			
Information Element	Value/remark	Comment	Condition
UEInformationResponse-r16 ::= SEQUENCE {			
criticalExtensions CHOICE {			
ueInformationResponse-r16 SEQUENCE {			
rlf-Report-r16 CHOICE {			
nr-RLF-Report-r16 SEQUENCE {			
measResultLastServCell-r16 SEQUENCE {			
measResult-r16 SEQUENCE {			
cellResults-r16 SEQUENCE {			
resultsSSB-Cell-r16 SEQUENCE {			
rsrp	(0..127)		
rsrq	(0..127)		
sinr	Not checked		
}			
resultsCSI-RS-Cell-r16	Not checked		
}			
rsIndexResults-r16 SEQUENCE {			
resultsSSB-Indexes-r16 SEQUENCE {			
ssb-Index	1		
ssb-Results SEQUENCE {			
rsrp	(0..127)		
rsrq	(0..127)		
sinr	Not checked		
}			
}			
ssbRLMConfigBitmap-r16	01000000 00000000 00000000 00000000 00000000 00000000 00000000 00000000		
resultsCSI-RS-Indexes-r16	Not present		
csi-rsRLMConfigBitmap-r16	Not present		
}			
}			
}			
measResultNeighCells-r16	Not present		
c-RNTI-r16	the value of the C-RNTI of the UE used in the preamble		
previousPCellId-r16 CHOICE {	Not present		
failedPCellId-r16 CHOICE {			
nrFailedPCellId-r16 CHOICE {			
cellGlobalId-r16 SEQUENCE {			
plmn-Identity-r16	PLMN ID of NR Cell 1		
cellIdentity-r16	CGI of NR Cell 1		
trackingAreaCode-r16	TAC of NR Cell 1		
}			
}			
}			
}			
}			

8.1.6.1.3.7.2 Conformance requirements

References: The conformance requirements covered in the present TC are specified in: TS 38.331, clauses 5.3.5.3, 5.3.10.3, 5.3.10.5 and 5.7.10.3. Unless otherwise stated these are Rel-16 requirements.

[TS 38.331, clause 5.3.5.3]

The UE shall perform the following actions upon reception of the *RRCReconfiguration*, or upon execution of the conditional reconfiguration (CHO or CPC):

...

1> if the *RRCReconfiguration* includes the *masterCellGroup*:

2> perform the cell group configuration for the received *masterCellGroup* according to 5.3.5.5;

...

1> if the *RRCReconfiguration* message includes the *radioBearerConfig*:

2> perform the radio bearer configuration according to 5.3.5.6;

...

1> set the content of the *RRCReconfigurationComplete* message as follows:

...

2> if the UE has radio link failure or handover failure information available in *VarRLF-Report* and if the RPLMN is included in *plmn-IdentityList* stored in *VarRLF-Report*; or

2> if the UE has radio link failure or handover failure information available in *VarRLF-Report* of TS 36.331 [10] and if the UE is capable of cross-RAT RLF reporting and if the RPLMN is included in *plmn-IdentityList* stored in *VarRLF-Report* of TS 36.331 [10];

3> include *rlf-InfoAvailable* in the *RRCReconfigurationComplete* message;

[TS 38.331, clause 5.3.10.3]

The UE shall:

...

1> else:

2> during a DAPS handover: the following only applies for the target PCell;

2> upon T310 expiry in PCell; or

2> upon T312 expiry in PCell; or

2> upon random access problem indication from MCG MAC while neither T300, T301, T304, T311 nor T319 are running; or

2> upon indication from MCG RLC that the maximum number of retransmissions has been reached; or

2> if connected as an IAB-node, upon BH RLF indication received on BAP entity from the MCG; or

2> upon consistent uplink LBT failure indication from MCG MAC while T304 is not running;

...

3> else:

4> consider radio link failure to be detected for the MCG, i.e. MCG RLF;

4> discard any segments of segmented RRC messages stored according to 5.7.6.3;

NOTE: Void.

4> if AS security has not been activated:

5> perform the actions upon going to RRC_IDLE as specified in 5.3.11, with release cause 'other';-

4> else if AS security has been activated but SRB2 and at least one DRB or, for IAB, SRB2, have not been setup:

5> store the radio link failure information in the *VarRLF-Report* as described in subclause 5.3.10.5;

5> perform the actions upon going to RRC_IDLE as specified in 5.3.11, with release cause 'RRC connection failure';

4> else:

5> store the radio link failure information in the *VarRLF-Report* as described in subclause 5.3.10.5;

...

5> else:

6> initiate the connection re-establishment procedure as specified in 5.3.7.

[TS 38.331, clause 5.3.10.5]

The UE shall determine the content in the *VarRLF-Report* as follows:

1> clear the information included in *VarRLF-Report*, if any;

1> set the *plmn-IdentityList* to include the list of EPLMNs stored by the UE (i.e. includes the RPLMN);

1> set the *measResultLastServCell* to include the cell level RSRP, RSRQ and the available SINR, of the source PCell(in case HO failure) or PCell (in case RLF) based on the available SSB and CSI-RS measurements collected up to the moment the UE detected failure;

1> if the SS/PBCH block-based measurement quantities are available:

2> set the *rsIndexResults* in *measResultLastServCell* to include all the available measurement quantities of the source PCell (in case HO failure) or PCell (in case RLF), ordered such that the highest SS/PBCH block RSRP is listed first if SS/PBCH block RSRP measurement results are available, otherwise the highest SS/PBCH block RSRQ is listed first if SS/PBCH block RSRQ measurement results are available, otherwise the highest SS/PBCH block SINR is listed first, based on the available SS/PBCH block based measurements collected up to the moment the UE detected failure;

...

1> set the *ssbRLMConfigBitmap* and/or *csi-rsRLMConfigBitmap* in *measResultLastServCell* to include the radio link monitoring configuration of the source PCell(in case HO failure) or PCell (in case RLF);

...

1> set the *c-RNTI* to the C-RNTI used in the source PCell(in case HO failure) or PCell (in case RLF);

...

1> else if the failure is detected due to radio link failure as described in 5.3.10.3, set the fields in *VarRLF-report* as follows:

2> set the *connectionFailureType* to *rlf*;

2> set the *rlf-Cause* to the trigger for detecting radio link failure in accordance with clause 5.3.10.4;

2> set the *nrFailedPCellId* in *failedPCellId* to the global cell identity and the tracking area code, if available, and otherwise to the physical cell identity and carrier frequency of the PCell where radio link failure is detected;

...

1> if available, set the *locationInfo* as in 5.3.3.7.

The UE may discard the radio link failure information or handover failure information, i.e. release the UE variable *VarRLF-Report*, 48 hours after the radio link failure/handover failure is detected.

NOTE 2: In this clause, the term 'handover failure' has been used to refer to 'reconfiguration with sync failure'.

[TS 38.331, clause 5.7.10.3]

Upon receiving the *UEInformationRequest* message, the UE shall, only after successful security activation:

...

1> if *rlf-ReportReq* is set to *true*:

2> if the UE has radio link failure information or handover failure information available in *VarRLF-Report* and if the RPLMN is included in *plmn-IdentityList* stored in *VarRLF-Report*:

3> set *timeSinceFailure* in *VarRLF-Report* to the time that elapsed since the last radio link failure or handover failure in NR;

3> set the *rlf-Report* in the *UEInformationResponse* message to the value of *rlf-Report* in *VarRLF-Report*;

3> discard the *rlf-Report* from *VarRLF-Report* upon successful delivery of the *UEInformationResponse* message confirmed by lower layers;

...

1> else:

2> submit the *UEInformationResponse* message to lower layers for transmission via SRB1.

8.1.6.1.3.7.3 Test description

8.1.6.1.3.7.3.1 Pre-test conditions

System Simulator:

- NR Cell 1 is the serving cell.
- NR Cell 12 is the Suitable neighbour inter-frequency cell.
- System information combination NR-4 as defined in TS 38.508-1 [4] clause 4.4.3.1.2 is used in NR cells.
- The PLMNs are identified in the test by the identifiers in Table 8.1.6.1.3.7.3.1-1.

Table 8.1.6.1.3.7.3.1-1: PLMN identifiers

Cell	PLMN ID
1	PLMN1
12	PLMN2

UE:

None.

Preamble:

- The UE is registered on PLMN1 (NR Cell 1) using the procedure described in TS 38.508-1[4] clause 4.5.2.2-2 except that the REGISTRATION ACCEPT message indicates PLMN2 in the Equivalent PLMN list.
- The UE is in state 3N-A on NR Cell 1 according to TS 38.508-1 [4], clause 4.4A.

8.1.6.1.3.7.3.2 Test procedure sequence

Table 8.1.6.1.3.7.3.2-1/2 illustrates the downlink power levels and other changing parameters to be applied for the cells at various time instants of the test execution. Row marked "T0" denotes the initial conditions after preamble, while columns marked "T1" is to be applied subsequently. The exact instants on which these values shall be applied are described in the texts in this clause.

Table 8.1.6.1.3.7.3.2-1: Time instances of cell power level and parameter changes for FR1

	Parameter	Unit	NR Cell 1	NR Cell 12	Remark
T0	SS/PBCH SSS EPRE	dBm/SCS	-88	"Off"	
T1	SS/PBCH SSS EPRE	dBm/SCS	"Off"	"Off"	
T2	SS/PBCH SSS EPRE	dBm/SCS	-88	"Off"	Only Cell 1 is available.
T3	SS/PBCH SSS EPRE	dBm/SCS	-88	-82	

Table 8.1.6.1.3.7.3.2-2: Time instances of cell power level and parameter changes for FR2

	Parameter	Unit	NR Cell 1	NR Cell 12	Remark
T0	SS/PBCH SSS EPRE	dBm/SCS	-82	"Off"	
T1	SS/PBCH SSS EPRE	dBm/SCS	"Off"	"Off"	
T2	SS/PBCH SSS EPRE	dBm/SCS	-82	"Off"	Only Cell 1 is available.
T3	SS/PBCH SSS EPRE	dBm/SCS	-82	-73	

Table 8.1.6.1.3.7.3.2-3: Main behaviour

St	Procedure	Message Sequence		TP	Verdict
		U - S	Message		
1	The SS changes NR Cell 1 parameters according to the row "T1" in Table 8.1.6.1.3.7.3.2-1/2.	-	-	-	-
2	The SS waits for 3s to ensure that the UE detects T310 expiry.	-	-	-	-
3	The SS changes NR Cell 1 parameters according to the row "T2" in Table 8.1.6.1.3.7.3.2-1/2.	-	-	-	-
4	The UE transmits an <i>RRCReestablishmentRequest</i> message on NR Cell 1.	-->	NR RRC: <i>RRCReestablishmentRequest</i>	-	-
5	The SS transmits an <i>RRCReestablishment</i> message.	<--	NR RRC: <i>RRCReestablishment</i>	-	-
6	The UE transmits an <i>RRCReestablishmentComplete</i> message.	-->	NR RRC: <i>RRCReestablishmentComplete</i>	-	-
7	The SS transmits an <i>RRCReconfiguration</i> message to establish SRB2 and DRB.	<--	NR RRC: <i>RRCReconfiguration</i>	-	-
8	The UE transmits an <i>RRCReconfigurationComplete</i> message.	-->	NR RRC: <i>RRCReconfigurationComplete</i>	-	-
9	The SS changes NR Cell 12 parameters according to the row "T3" in Table 8.1.6.1.3.7.3.2-1/2.	-		-	-
10	The SS transmits an <i>RRCReconfiguration</i> message on Cell 1 to order the UE to perform inter frequency handover to Cell 12.	<--	NR RRC: <i>RRCReconfiguration</i>	-	-
11	Check: Does the UE send an <i>RRCReconfigurationComplete</i> message with <i>rif-InfoAvailable</i> on Cell 12?	-->	NR RRC: <i>RRCReconfigurationComplete</i>	1	P

12	The UE transmit a REGISTRATION REQUEST message with registration type value set to "mobility registration updating".	-->	NR RRC: <i>UplinkInformationTransfer</i> 5GMM: REGISTRATION REQUEST	-	-
13-14	Steps 4 to 5 of generic test procedure in TS 38.508-1 [4] subclause 4.9.5.2.2-1 are performed on Cell 12.	-	-	-	-
15	The SS transmits a <i>UEInformationRequest</i> message with <i>rlf-ReportReq</i> set to true.	<--	NR RRC: <i>UEInformationRequest</i>	-	-
16	Check: Does the UE transmit a <i>UEInformationResponse</i> message on NR Cell 12?	-->	NR RRC: <i>UEInformationResponse</i>	2	P

8.1.6.1.3.7.3.3 Specific message contents

Table 8.1.6.1.3.7.3.3-0: CellGroupConfig (preamble RRCSetup)

Derivation Path: TS 38.508-1 [4], Table 4.6.3-19			
Information Element	Value/remark	Comment	Condition
CellGroupConfig ::= SEQUENCE {			
spCellConfig SEQUENCE {			
rlf-TimersAndConstants SEQUENCE {			
t311	ms10000		
}			
}			
}			

Table 8.1.6.1.3.7.3.3-1: RRCReestablishmentRequest (step 4, Table 8.1.6.1.3.7.3.2-3)

Derivation Path: TS 38.508-1, Table 4.6.1-12			
Information Element	Value/remark	Comment	Condition
RRCReestablishmentRequest ::= SEQUENCE {			
ue-Identity SEQUENCE {			
c-RNTI	the value of the C-RNTI of the UE		
physCellId	PhysicalCellIdentity of NR Cell 1		
shortMAC-I	The same value as the 16 least significant bits of the MAC-I value calculated by SS.		
}			
reestablishmentCause	otherFailure		
}			

Table 8.1.6.1.3.7.3.3-2: RRCReconfiguration (step 7, Table 8.1.6.1.3.7.3.2-3)

Derivation Path: TS 38.508-1 [4], Table 4.6.1-13 with condition REEST

Table 8.1.6.1.3.7.3.3-3: RRCReconfiguration-HO (step 10, Table 8.1.6.1.3.7.3.2-3)

Derivation Path: TS 38.508-1 [4], Table 4.8.1-1A with condition RBConfig_KeyChange
--

Table 8.1.6.1.3.7.3.3-4: RRCReconfigurationComplete (step 11, Table 8.1.6.1.3.7.3.2-3)

Derivation Path: TS 38.508-1 [4], Table 4.6.1-14			
Information Element	Value/remark	Comment	Condition
RRCReconfigurationComplete ::= SEQUENCE {			
criticalExtensions CHOICE {			
rrcReconfigurationComplete SEQUENCE {			
nonCriticalExtension SEQUENCE {			

nonCriticalExtension SEQUENCE {			
nonCriticalExtension SEQUENCE {			
ue-MeasurementsAvailable-r16	UE-MeasurementsAvailable-r16 with condition RLF		
}			
}			
}			
}			
}			
}			

Table 8.1.6.1.3.7.3.3-5: UEInformationRequest (step 15, Table 8.1.6.1.3.7.3.2-3)

Derivation Path: TS 38.508-1 [4], Table 4.6.1-32A with condition RLF

Table 8.1.6.1.3.7.3.3-6: UEInformationResponse (step 16, Table 8.1.6.1.3.7.3.2-3)

Derivation Path: TS 38.508-1 [4], Table 4.6.1-32B			
Information Element	Value/remark	Comment	Condition
UEInformationResponse-r16 ::= SEQUENCE {			
criticalExtensions CHOICE {			
ueInformationResponse-r16 SEQUENCE {			
rlf-Report-r16 CHOICE {			
nr-RLF-Report-r16 SEQUENCE {			
measResultLastServCell-r16 SEQUENCE {			
measResult-r16 SEQUENCE {			
cellResults-r16 SEQUENCE {			
resultsSSB-Cell-r16 SEQUENCE {			
rsrp	(0..127)		
rsrq	(0..127)		
sinr	Not checked		
}			
resultsCSI-RS-Cell-r16	Not checked		
}			
rsIndexResults-r16 SEQUENCE {			
resultsSSB-Indexes-r16 SEQUENCE {			
ssb-Index	1		
ssb-Results SEQUENCE {			
rsrp	(0..127)		
rsrq	(0..127)		
sinr	Not checked		
}			
}			
ssbRLMConfigBitmap-r16	01000000 00000000 00000000 00000000 00000000 00000000 00000000 00000000		
resultsCSI-RS-Indexes-r16	Not present		
csi-rsRLMConfigBitmap-r16	Not present		
}			
}			
}			
measResultNeighCells-r16	Not present		
c-RNTI-r16	the old value of the C-RNTI of the UE used in NR Cell 1		
previousPCellId-r16	Not present		
failedPCellId-r16 CHOICE {			
nrFailedPCellId-r16 CHOICE {			
cellGlobalId-r16 SEQUENCE {			
plmn-Identity-r16	the first PLMN entry of plmn-IdentityList (in SIB1)		

...

[TS 38.331, clause 5.3.3.7]

The UE shall:

- 1> if timer T300 expires:
 - 2> reset MAC, release the MAC configuration and re-establish RLC for all RBs that are established;
 - 2> if the UE supports RRC Connection Establishment failure with temporary offset and the T300 has expired a consecutive *connEstFailCount* times on the same cell for which *connEstFailureControl* is included in *SIB1*:
 - 3> for a period as indicated by *connEstFailOffsetValidity*:
 - 4> use *connEstFailOffset* for the parameter *Qoffsettemp* for the concerned cell when performing cell selection and reselection according to TS 38.304 [20] and TS 36.304 [27];

NOTE 1: When performing cell selection, if no suitable or acceptable cell can be found, it is up to UE implementation whether to stop using *connEstFailOffset* for the parameter *Qoffsettemp* during *connEstFailOffsetValidity* for the concerned cell.

- 2> if the UE has connection establishment failure information or connection resume failure information available in *VarConnEstFailReport* and if the RPLMN is not equal to *plmn-identity* stored in *VarConnEstFailReport*; or
- 2> if the cell identity of current cell is not equal to the cell identity stored in *measResultFailedCell* in *VarConnEstFailReport*:
 - 3> reset the *numberOfConnFail* to 0;
- 2> clear the content included in *VarConnEstFailReport* except for the *numberOfConnFail*, if any;
- 2> store the following connection establishment failure information in the *VarConnEstFailReport* by setting its fields as follows:
 - 3> set the *plmn-Identity* to the PLMN selected by upper layers (see TS 24.501 [23]) from the PLMN(s) included in the *plmn-IdentityList* in *SIB1*;
 - 3> set the *measResultFailedCell* to include the global cell identity, tracking area code, the cell level and SS/PBCH block level RSRP, and RSRQ, and SS/PBCH block indexes, of the failed cell based on the available SSB measurements collected up to the moment the UE detected connection establishment failure;
 - 3> if available, set the *measResultNeighCells*, in order of decreasing ranking-criterion as used for cell reselection, to include neighbouring cell measurements for at most the following number of neighbouring cells: 6 intra-frequency and 3 inter-frequency neighbours per frequency as well as 3 inter-RAT neighbours, per frequency/ set of frequencies per RAT and according to the following:
 - 4> for each neighbour cell included, include the optional fields that are available;

NOTE 2: The UE includes the latest results of the available measurements as used for cell reselection evaluation, which are performed in accordance with the performance requirements as specified in TS 38.133 [14].

- 3> if available, set the *locationInfo* as follows:
 - 4> if available, set the *commonLocationInfo* to include the detailed location information;
 - 4> if available, set the *bt-LocationInfo* to include the Bluetooth measurement results, in order of decreasing RSSI for Bluetooth beacons;
 - 4> if available, set the *wlan-LocationInfo* to include the WLAN measurement results, in order of decreasing RSSI for WLAN APs;
 - 4> if available, set the *sensor-LocationInfo* to include the sensor measurement results as follows:
 - 5> if available, include the *sensor-MeasurementInformation*;

- 5> if available, include the *sensor-MotionInformation*;
- 3> set *perRAInfoList* to indicate random access failure information as specified in 5.7.10.5;
- 3> if the *numberOfConnFail* is smaller than 8:
 - 4> increment the *numberOfConnFail* by 1;
- 2> inform upper layers about the failure to establish the RRC connection, upon which the procedure ends;

The UE may discard the connection establishment failure or connection resume failure information, i.e. release the UE variable *VarConnEstFailReport*, 48 hours after the last connection establishment failure is detected.

[TS 38.331, clause 5.7.10.3]

Upon receiving the *UEInformationRequest* message, the UE shall, only after successful security activation:

...

- 1> if *connEstFailReportReq* is set to *true* and the UE has connection establishment failure or connection resume failure information in *VarConnEstFailReport* and if the RPLMN is equal to *plmn-Identity* stored in *VarConnEstFailReport*:
 - 2> set *timeSinceFailure* in *VarConnEstFailReport* to the time that elapsed since the last connection establishment failure or connection resume failure in NR;
 - 2> set the *connEstFailReport* in the *UEInformationResponse* message to the value of *connEstFailReport* in *VarConnEstFailReport*;
 - 2> discard the *connEstFailReport* from *VarConnEstFailReport* upon successful delivery of the *UEInformationResponse* message confirmed by lower layers;

...

8.1.6.1.4.1.3 Test description

8.1.6.1.4.1.3.1 Pre-test conditions

System Simulator:

- NR Cell 1.
- System information combination NR-1 as defined in TS 38.508-1 [4] clause 4.4.3.1.2.

UE:

- None.

Preamble:

- The UE is in state 1N-A as defined in TS 38.508-1 [4], subclause 4.4A.

8.1.6.1.4.1.3.2 Test procedure sequence

Table 8.1.6.1.4.1.3.2-1: Main behaviour

St	Procedure	Message Sequence		TP	Verdict
		U - S	Message		
1	The SS transmits a <i>Paging</i> message.	<--	NR RRC: <i>Paging</i>	-	-
2	The UE transmits an <i>RRCSetupRequest</i> message.	-->	NR RRC: <i>RRCSetupRequest</i>	-	-
3	The SS waits for 2sec to ensure that the UE detects T300 expiry.	-	-	-	-
4	The SS transmits a <i>Paging</i> message.	<--	NR RRC: <i>Paging</i>	-	-

5	The UE transmits an <i>RRCSetupRequest</i> message.	-->	NR RRC: <i>RRCSetupRequest</i>	-	-
6	The SS transmits an <i>RRCSetup</i> message.	<--	NR RRC: <i>RRCSetup</i>	-	-
7	Check: Does the UE transmit an <i>RRCSetupComplete</i> message including <i>connEstFailInfoAvailable</i> IE set it to <i>true</i> ? UE initiates the session management procedure by including the SERVICE REQUEST message.	-->	NR RRC: <i>RRCSetupComplete</i> 5GMM: SERVICE REQUEST	1	P
8-11	Steps 5 to 8 of the generic radio bearer establishment procedure in TS 38.508-1 table 4.5.4.2-3	-	-	-	-
12	The SS sends a <i>UEInformationRequest</i> message to get <i>connEstFailReportReq</i> .	<--	<i>UEInformationRequest</i>	-	-
13	Check: Does the UE send a <i>UEInformationResponse</i> message with <i>connEstFailReport</i> ?	-->	<i>UEInformationResponse</i>	2	P

8.1.6.1.4.1.3.3 Specific message contents

Table 8.1.6.1.4.1.3.3-1: *RRCSetupComplete* (step 7, Table 8.1.6.1.4.1.3.2-1)

Derivation Path: TS 38.508-1 [4], Table 4.6.1-22			
Information Element	Value/remark	Comment	Condition
<i>RRCSetupComplete</i> ::= SEQUENCE {			
criticalExtensions CHOICE {			
<i>rrcSetupComplete</i> SEQUENCE {			
nonCriticalExtension SEQUENCE {			
ue-MeasurementsAvailable-r16	UE-MeasurementsAvailable-r16 with condition CEF		
}			
}			
}			

Table 8.1.6.1.4.1.3.3-2: Void

Table 8.1.6.1.4.1.3.3-3: *UEInformationResponse* (step 13, Table 8.1.6.1.4.1.3.2-1)

Derivation Path: TS 38.508-1 [4], Table 4.6.1-32B			
Information Element	Value/remark	Comment	Condition
<i>UEInformationResponse-r16</i> ::= SEQUENCE {			
criticalExtensions CHOICE {			
ueInformationResponse-r16 SEQUENCE {			
<i>connEstFailReport-r16</i> SEQUENCE {			
<i>measResultFailedCell-r16</i> SEQUENCE {			
<i>cgi-Info</i> SEQUENCE {			
<i>plmn-Identity-r16</i>	<i>plmn-Identity</i> within SIB1 broadcasted in NR Cell 1		
<i>cellIdentity-r16</i>	<i>cellIdentity</i> within SIB1 broadcasted in NR Cell 1	BIT STRING (SIZE (36))	
<i>trackingAreaCode-r16</i>	Not present or any allowed value	BIT STRING (SIZE (24))	
}			
<i>measResult-r16</i> SEQUENCE {			
<i>cellResults-r16</i>	Not present or any allowed value		
<i>rsIndexResults-r16</i>	Not present or any allowed value		
}			
}			

}			
locationInfo-r16	Not present or any allowed value		
measResultNeighCells-r16 SEQUENCE {			
measResultNeighCellListNR	Not present		
measResultNeighCellListEUTRA	Not present		
}			
numberOfConnFail-r16	Any allowed value	INTEGER (1..8)	
perRAInfoList-r16	Any allowed value		
timeSinceFailure-r16	Any allowed value	INTEGER (0..172800)	
}			
}			
}			
}			

8.1.6.1.4.2 Connection Establishment Failure / Logging and reporting / RRC Resume

8.1.6.1.4.2.1 Test Purpose (TP)

(1)

```
with { UE having sent an RRCResumeRequest message }
ensure that {
  when { T319 is expired and random access procedure failed }
  then { UE stores the connection resume failure information }
}
```

(2)

```
with { UE having sent an RRCSetupComplete message with connEstFailInfoAvailable }
ensure that {
  when { UE receives a UEInformationRequest message with connEstFailReportReq set to true }
  then { UE sends a UEInformationResponse message with connEstFailReport }
}
```

8.1.6.1.4.2.2 Conformance requirements

References: The conformance requirements covered in the current TC is specified in: TS 38.331 clause 5.3.3.4, 5.3.13.5, 5.7.10.3.

[TS 38.331, clause 5.3.3.4]

The UE shall perform the following actions upon reception of the *RRCSetup*:

...1> set the content of *RRCSetupComplete* message as follows:

...

2> if the UE has connection establishment failure or connection resume failure information available in *VarConnEstFailReport* and if the RPLMN is equal to *plmn-Identity* stored in *VarConnEstFailReport*:

3> include *connEstFailInfoAvailable* in the *RRCSetupComplete* message;

...

[TS 38.331, clause 5.3.13.5]

The UE shall:

1> if timer T319 expires or upon receiving Integrity check failure indication from lower layers while T319 is running:

- 2> if the UE has connection establishment failure information or connection resume failure information available in *VarConnEstFailReport* and if the RPLMN is not equal to *plmn-identity* stored in *VarConnEstFailReport*; or
- 2> if the cell identity of current cell is not equal to the cell identity stored in *measResultFailedCell* in *VarConnEstFailReport*:
 - 3> reset the *numberOfConnFail* to 0;
- 2> clear the content included in *VarConnEstFailReport* except for the *numberOfConnFail*, if any;
- 2> store the following connection resume failure information in the *VarConnEstFailReport* by setting its fields as follows:
 - 3> set the *plmn-Identity* to the PLMN selected by upper layers (see TS 24.501 [23]) from the PLMN(s) included in the *plmn-IdentityList* in *SIB1*;
 - 3> set the *measResultFailedCell* to include the global cell identity, tracking area code, the cell level and SS/PBCH block level RSRP, and RSRQ, and SS/PBCH block indexes, of the failed cell based on the available SSB measurements collected up to the moment the UE detected connection resume failure;
 - 3> if available, set the *measResultNeighCells*, in order of decreasing ranking-criterion as used for cell reselection, to include neighbouring cell measurements for at most the following number of neighbouring cells: 6 intra-frequency and 3 inter-frequency neighbours per frequency as well as 3 inter-RAT neighbours, per frequency/ set of frequencies per RAT and according to the following:
 - 4> for each neighbour cell included, include the optional fields that are available;

NOTE: The UE includes the latest results of the available measurements as used for cell reselection evaluation, which are performed in accordance with the performance requirements as specified in TS 38.133 [14].

- 3> if available, set the *locationInfo* as in 5.3.3.7;
- 3> set *perRAInfoList* to indicate random access failure information as specified in 5.7.10.5;
- 3> if *numberOfConnFail* is smaller than 8:
 - 4> increment the *numberOfConnFail* by 1;
- 2> perform the actions upon going to RRC_IDLE as specified in 5.3.11 with release cause 'RRC Resume failure'.

The UE may discard the connection resume failure or connection establishment failure information, i.e. release the UE variable *VarConnEstFailReport*, 48 hours after the last connection resume failure is detected.

[TS 38.331, clause 5.7.10.3]

Upon receiving the *UEInformationRequest* message, the UE shall, only after successful security activation:

...

- 1> if *connEstFailReportReq* is set to *true* and the UE has connection establishment failure or connection resume failure information in *VarConnEstFailReport* and if the RPLMN is equal to *plmn-Identity* stored in *VarConnEstFailReport*:
 - 2> set *timeSinceFailure* in *VarConnEstFailReport* to the time that elapsed since the last connection establishment failure or connection resume failure in NR;
 - 2> set the *connEstFailReport* in the *UEInformationResponse* message to the value of *connEstFailReport* in *VarConnEstFailReport*;
 - 2> discard the *connEstFailReport* from *VarConnEstFailReport* upon successful delivery of the *UEInformationResponse* message confirmed by lower layers;

...

[TS 24.501, clause 5.3.1.4]

...

If the UE in 5GMM-CONNECTED mode with RRC inactive indication receives an indication from the lower layers that the resumption of the RRC connection has failed, and:

- a) if the lower layers indicate that access barring is applicable for all access categories except categories 0 and 2, the UE shall:
 - 1) stay in 5GMM-CONNECTED mode with RRC inactive indication;
- b) else, the UE shall:
 - 1) enter 5GMM-IDLE mode; and
 - 2) initiate the registration procedure for mobility and periodic registration update used for mobility (i.e. the 5GS registration type IE set to "mobility registration updating" in the REGISTRATION REQUEST message) for N1 NAS signalling connection recovery as specified in subclause 5.5.1.3.2.

NOTE 2: An indication from the lower layer that the RRC connection has been released with cause "RRC resume failure" can be considered as an indication that the resumption of the RRC connection has failed.

8.1.6.1.4.2.3 Test description

8.1.6.1.4.2.3.1 Pre-test conditions

System Simulator:

- NR Cell 1

UE:

- None.

Preamble:

- The UE is in state 2N-A on NR Cell 1 as defined in TS 38.508-1 [4], subclause 4.4A.

8.1.6.1.4.2.3.2 Test procedure sequence

Table 8.1.6.1.4.2.3.2-1: Void

Table 8.1.6.1.4.2.3.2-2: Void

Table 8.1.6.1.4.2.3.2-3: Main behaviour

St	Procedure	Message Sequence		TP	Verdict
		U - S	Message		
1	The SS transmits a <i>Paging</i> message on NR Cell 1.	<--	NR RRC: <i>Paging</i>	-	-
2	The UE transmits an <i>RRCResumeRequest</i> message.	-->	NR RRC: <i>RRCResumeRequest</i>	-	-
3	The SS waits for 1 sec to ensure that the UE detects T319 expiry.	-	-	-	-
3A	The UE transmits an <i>RRCSetupRequest</i> message.	-->	NR RRC: <i>RRCSetupRequest</i>		
3B	The SS transmits an <i>RRCSetup</i> message.	<--	NR RRC: <i>RRCSetup</i>		
3C	Check: Does the UE transmit an <i>RRCSetupComplete</i> message including <i>connEstFailInfoAvailable</i> IE set it to <i>true</i> ? UE initiates the mobility registration procedure by including the REGISTRATION REQUEST message.	-->	NR RRC: <i>RRCSetupComplete</i> 5GMM: REGISTRATION REQUEST	1	P

3D-3E	Steps4-5 defined in TS 38.508-1 [4] Table 4.9.5.2.2-1, indicate that the UE has performed mobility registration on NR cell 1 started in NR RRC_IDLE?	-	-	-	-
4	The SS transmits a SecurityModeCommand message.	<--	NR RRC: <i>SecurityModeCommand</i>	-	-
5	The UE transmits a SecurityModeComplete message.	-->	NR RRC: <i>SecurityModeComplete</i>	-	-
6-12	Void				
13	The SS sends a <i>UEInformationRequest</i> message to get <i>connEstFailReportReq</i> .	<--	<i>UEInformationRequest</i>	-	-
14	Check: Does the UE send a <i>UEInformationResponse</i> message with <i>connEstFailReport</i> ?	-->	<i>UEInformationResponse</i>	2	P

8.1.6.1.4.2.3.3 Specific message contents

Table 8.1.6.1.4.2.3.3-1: RRCSetupComplete (step 3C, Table 8.1.6.1.4.2.3.2-3)

Derivation Path: TS 38.508-1 [4], Table 4.6.1-22			
Information Element	Value/remark	Comment	Condition
RRCSetupComplete ::= SEQUENCE {			
criticalExtensions CHOICE {			
rrcSetupComplete SEQUENCE {			
nonCriticalExtension SEQUENCE {			
ue-MeasurementsAvailable-r16	UE-MeasurementsAvailable-r16 with condition CEF		
}			
}			
}			

Table 8.1.6.1.4.2.3.3-2: Void

Table 8.1.6.1.4.2.3.3-3: UEInformationResponse (step 14, Table 8.1.6.1.4.2.3.2-3)

Derivation Path: TS 38.508-1 [4], Table 4.6.1-32B			
Information Element	Value/remark	Comment	Condition
UEInformationResponse-r16 ::= SEQUENCE {			
criticalExtensions CHOICE {			
ueInformationResponse-r16 SEQUENCE {			
connEstFailReport-r16 SEQUENCE {			
measResultFailedCell-r16 SEQUENCE {			
cgi-Info SEQUENCE {			
plmn-Identity-r16	plmn-Identity within SIB1 broadcasted in NR Cell 1		
cellIdentity-r16	cellIdentity within SIB1 broadcasted in NR Cell 1	BIT STRING (SIZE (36))	
trackingAreaCode-r16	Not checked	BIT STRING (SIZE (24))	
}			
}			
measResult-r16 SEQUENCE {			
cellResults-r16	Not checked		
rsIndexResults-r16	Not checked		
}			
}			
locationInfo-r16	Not checked		
measResultNeighCells-r16 SEQUENCE {			
measResultNeighCellListNR	Not present		
measResultNeighCellListEUTRA	Not present		

}			
numberOfConnFail-r16	Not checked	INTEGER (1..8)	
perRAInfoList-r16	Not checked		
timeSinceFailure-r16	Not checked	INTEGER (0..172800)	
}			
}			
}			
}			

8.1.6.1.4.3 Connection Establishment Failure / Logging and reporting / Reporting at intra-NR handover

8.1.6.1.4.3.1 Test Purpose (TP)

(1)

```
with { UE has connection establishment failure information available }
ensure that {
  when { UE performs an intra-NR Handover procedure }
  then { UE sends an RRCReconfigurationComplete message with connEstFailInfoAvailable }
}
```

8.1.6.1.4.2 Conformance requirements

References: The conformance requirements covered in the current TC are specified in: TS 38.331, clauses 5.3.5.3. Unless otherwise stated these are Rel-16 requirements.

[TS 38.331, clause 5.3.5.3]

The UE shall perform the following actions upon reception of the *RRCReconfiguration*, or upon execution of the conditional reconfiguration (CHO or CPC):

...

1> set the content of the *RRCReconfigurationComplete* message as follows:

...

2> if the UE has connection establishment failure or connection resume failure information available in *VarConnEstFailReport* and if the RPLMN is equal to *plmn-Identity* stored in *VarConnEstFailReport*:

3> include *connEstFailInfoAvailable* in the *RRCReconfigurationComplete* message;

8.1.6.1.4.3.3 Test description

8.1.6.1.4.3.3.1 Pre-test conditions

System Simulator:

- NR Cell 1 and NR Cell 3.
- System information combination NR-4 as defined in TS 38.508-1 [4] clause 4.4.3.1.2.

UE:

- None.

Preamble:

- The UE is in state 1N-A as defined in TS 38.508-1 [4], subclause 4.4A.

8.1.6.1.4.3.3.2 Test procedure sequence

Table 8.1.6.1.4.3.3.2-1/2 illustrates the downlink power levels and other changing parameters to be applied for the cells at various time instants of the test execution. Row marked "T0" denotes the initial conditions after preamble, while columns marked "T1" is to be applied subsequently. The exact instants on which these values shall be applied are described in the texts in this clause.

Table 8.1.6.1.4.3.3.2-1: Time instances of cell power level and parameter changes for FR1

	Parameter	Unit	NR Cell 1	NR Cell 3	Remark
T0	SS/PBCH SSS EPRE	dBm/S CS	-85	-97	Power levels are such that entry condition for event A3 is not satisfied for the neighbour NR cell.
T1	SS/PBCH SSS EPRE	dBm/S CS	-85	-78	Power levels are such that entry condition for event A3 is satisfied for the neighbour NR cell.

Table 8.1.6.1.4.3.3.2-2: Time instances of cell power level and parameter changes for FR2

	Parameter	Unit	NR Cell 1	NR Cell 3	Remark
T0	SS/PBCH SSS EPRE	dBm/S CS	FFS	FFS	
T1	SS/PBCH SSS EPRE	dBm/S CS	FFS	FFS	

Table 8.1.6.1.4.3.3.2-3: Main behaviour

St	Procedure	Message Sequence		TP	Verdict
		U - S	Message		
1	Void	-	-	-	-
2	The SS transmits a <i>Paging</i> message.	<--	NR RRC: <i>Paging</i>	-	-
3	The UE transmits an <i>RRCSetupRequest</i> message.	-->	NR RRC: <i>RRCSetupRequest</i>	-	-
4	The SS waits for 2 sec to ensure that the UE detects T300 expiry.	-	-	-	-
5	Void	-	-	-	-
6	The SS transmits a <i>Paging</i> message.	<--	NR RRC: <i>Paging</i>	-	-
7-8	Steps 2 to 3 of the generic radio bearer establishment procedure in TS 38.508-1 table 4.5.4.2-3 on NR Cell 1.	-	-	-	-
9	The UE transmits an <i>RRCSetupComplete</i> message and a SERVICE REQUEST message.	-->	NR RRC: <i>RRCSetupComplete</i> 5GMM: SERVICE REQUEST	-	-
10-13	Steps 5 to 8 of the generic radio bearer establishment procedure in TS 38.508-1 table 4.5.4.2-3 on NR Cell 1.	-	-	-	-
14	The SS transmits an <i>RRCReconfiguration</i> message to configure measurement.	<--	NR RRC: <i>RRCReconfiguration</i>	-	-
15	UE transmit an <i>RRCReconfigurationComplete</i> message to confirm the measurement configuration.	-->	NR RRC: <i>RRCReconfigurationComplete</i>	-	-
16	The SS changes NR Cell 1 and NR Cell 3 parameters according to the row "T1" in table 8.1.6.1.4.3.3.2-1/2.	-	-	-	-
17	The UE transmits a <i>MeasurementReport</i> message.	-->	NR RRC: <i>MeasurementReport</i>	-	-
18	The SS transmits an <i>RRCReconfiguration</i> message to order the UE to perform handover to NR Cell 3.	<--	NR RRC: <i>RRCReconfiguration</i>	-	-
19	Check: Dose the UE transmit an <i>RRCReconfigurationComplete</i> message	-->	NR RRC: <i>RRCReconfigurationComplete</i>	1	P

	containing <i>connEstFailInfoAvailable</i> on NR Cell 3?				
20	The SS sends a <i>UEInformationRequest</i> message to get <i>connEstFailReport</i> .	<--	NR RRC: <i>UEInformationRequest</i>	-	-
21	The UE send a <i>UEInformationResponse</i> message with <i>connEstFailReport</i> .	-->	NR RRC: <i>UEInformationResponse</i>	-	-

8.1.6.1.4.3.3.3 Specific message contents

Table 8.1.6.1.4.3.3.3-1: Void

Table 8.1.6.1.4.3.3.3-1A: *RRCSetupComplete* (step 9, Table 8.1.6.1.4.3.3.2-3)

Derivation Path: TS 38.508-1 [4], Table 4.6.1-22			
Information Element	Value/remark	Comment	Condition
<i>RRCSetupComplete</i> ::= SEQUENCE {			
<i>criticalExtensions</i> CHOICE {			
<i>rrcSetupComplete</i> SEQUENCE {			
<i>nonCriticalExtension</i> SEQUENCE {			
<i>ue-MeasurementsAvailable-r16</i>	UE-MeasurementsAvailable-r16 with condition CEF		
}			
}			
}			
}			

Table 8.1.6.1.4.3.3.3-2: *RRCReconfiguration* (step 14, Table 8.1.6.1.4.3.3.2-3)

Derivation Path: TS 38.508-1 [4], Table 4.6.1-13, condition MEAS
--

Table 8.1.6.1.4.3.3.3-3: *MeasConfig* (Table 8.1.6.1.4.3.3.3-2)

Derivation Path: TS 38.508-1 [4], Table 4.6.3-69			
Information Element	Value/remark	Comment	Condition
<i>MeasConfig</i> ::= SEQUENCE {			
<i>measObjectToAddModList</i> SEQUENCE (SIZE (1.. <i>maxObjectId</i>)) OF <i>MeasObjectToAddMod</i> {	2 entries		
<i>MeasObjectToAddMod</i> [1] SEQUENCE {		entry 1	
<i>measObjectId</i>	1		
<i>measObject</i> CHOICE {			
<i>measObjectNR</i> SEQUENCE {			
<i>ssbFrequency</i>	<i>ssbFrequency</i> IE equals the ARFCN for NR Cell 3		
<i>absThreshSS-BlocksConsolidation</i>	Not present		
}			
}			
<i>MeasObjectToAddMod</i> [2] SEQUENCE {		entry 2	
<i>measObjectId</i>	2		
<i>measObject</i> CHOICE {			
<i>measObjectNR</i> SEQUENCE {			
<i>ssbFrequency</i>	<i>ssbFrequency</i> IE equals the ARFCN for NR Cell 1		
<i>absThreshSS-BlocksConsolidation</i>	Not present		
}			
}			
}			
<i>reportConfigToAddModList</i> SEQUENCE (SIZE (1.. <i>maxReportConfigId</i>)) OF <i>ReportConfigToAddMod</i> {	1 entry		
<i>ReportConfigToAddMod</i> [1] SEQUENCE {		entry 1	

reportConfigId	1		
reportConfig CHOICE {			
reportConfigNR	ReportConfigNR-EventA3		
}			
}			
MeasIdToAddModList ::= SEQUENCE (SIZE (1..maxNrofMeasId)) OF MeasIdToAddMod {	1 entry		
MeasIdToAddMod[1] SEQUENCE {		entry 1	
measId	1		
measObjectId	1		
reportConfigId	1		
}			
}			
}			

Table 8.1.6.1.4.3.3-3A: ReportConfigNR-EventA3 (Table 8.1.6.1.4.3.3-3)

Derivation Path: TS 38.508-1 [4] Table 4.6.3-142 with condition EVENT_A3			
Information Element	Value/remark	Comment	Condition
ReportConfigNR ::= SEQUENCE {			
reportType CHOICE {			
eventTriggered SEQUENCE {			
eventId CHOICE {			
eventA3 SEQUENCE {			
a3-Offset CHOICE {			
rsrp	2	1 dB (2*0.5 dB)	FR1
}	FFS		FR2
}			
}			
}			
}			
reportAmount	r1		
reportQuantityCell SEQUENCE {			
rsrp	true		
rsrq	false		
sinr	false		
}			
}			
}			
}			

Table 8.1.6.1.4.3.3-4: MeasurementReport (step 17, Table 8.1.6.1.4.3.3-3)

Derivation Path: TS 38.508-1 [4] Table 4.6.1-5A			
Information Element	Value/remark	Comment	Condition
MeasurementReport ::= SEQUENCE {			
criticalExtensions ::= CHOICE {			
measurementReport ::= SEQUENCE {			
measResults ::= SEQUENCE {			
measId	1		
measResultServingMOList SEQUENCE (SIZE (1.. maxNrofServingCells)) OF MeasResultServMO {	1 entry		
MeasResultServMO[1] SEQUENCE {		entry 1	
servCellId	Cell index corresponding to NR Cell 1		
measResultServingCell SEQUENCE {			
physCellId	PhysicalCellIdentity of NR Cell 1		
measResult SEQUENCE {			
cellResults SEQUENCE {			
resultsSSB-Cell SEQUENCE {			
rsrp	(0..127)		
rsrq	(0..127)		
sinr	Not checked		

}			
}			
}			
}			
}			
measResultNeighCells CHOICE {			
measResultListNR SEQUENCE (SIZE (1..	1 entry		
maxCellReport)) OF MeasResultNR {			
MeasResultNR[1] SEQUENCE {			
physCellId	Physical layer cell identity		
	of NR Cell 3		
measResult SEQUENCE {			
cellResults SEQUENCE {			
rsrp	(0..127)		
rsrq	Not present		
sinr	Not present		
}			
}			
}			
}			
}			
}			
}			
}			
}			
}			
}			
}			
}			
}			

Table 8.1.6.1.4.3.3.3-5: RRCReconfiguration (step 18, Table 8.1.6.1.4.3.3.2-3)

Derivation Path: TS 38.508-1 [4], Table 4.8.1-1A, condition RBConfig_NoKeyChange

Table 8.1.6.1.4.3.3.3-6: RRCReconfigurationComplete (step 19, Table 8.1.6.1.4.3.3.2-3)

Derivation Path: TS 38.508-1 [4] Table 4.6.1-14			
Information Element	Value/remark	Comment	Condition
RRCReconfigurationComplete ::= SEQUENCE {			
criticalExtensions CHOICE {			
rrcReconfigurationComplete SEQUENCE {			
nonCriticalExtension SEQUENCE {			
nonCriticalExtension SEQUENCE {			
nonCriticalExtension SEQUENCE {			
ue-MeasurementsAvailable-r16	UE- MeasurementsAvailable- r16 with condition CEF		
}			
}			
}			
}			
}			
}			

8.1.6.1.4.4 Connection Establishment Failure / Logging and reporting / Reporting at RRC connection re-establishment

8.1.6.1.4.4.1 Test Purpose (TP)

(1)

with { UE has connection establishment failure information available }

```
ensure that {
  when { UE performs an RRC Connection re-establishment procedure }
  then { UE sends an RRCReestablishmentComplete message with connEstFailInfoAvailable }
}
```

8.1.6.1.4.4.2 Conformance requirements

References: The conformance requirements covered in the current TC are specified in: TS 38.331, clauses 5.3.7.5. Unless otherwise stated these are Rel-16 requirements.

[TS 38.331, clause 5.3.7.5]

The UE shall:

...

- 1> set the content of *RRCReestablishmentComplete* message as follows:
 - 2> if the UE has logged measurements available for NR and if the RPLMN is included in *plmn-IdentityList* stored in *VarLogMeasReport*:
 - 3> include the *logMeasAvailable* in the *RRCReestablishmentComplete* message;

...

- 2> if the UE has connection establishment failure or connection resume failure information available in *VarConnEstFailReport* and if the RPLMN is equal to *plmn-Identity* stored in *VarConnEstFailReport*:
 - 3> include *connEstFailInfoAvailable* in the *RRCReestablishmentComplete* message;

8.1.6.1.4.4.3 Test description

8.1.6.1.4.4.3.1 Pre-test conditions

System Simulator:

- NR Cell 1 and Cell 2.
- System information combination NR-2 as defined in TS 38.508-1 [4] clause 4.4.3.1.2.

UE:

- None.

Preamble:

- The UE is in state 1N-A as defined in TS 38.508-1 [4], subclause 4.4A.

8.1.6.1.4.4.3.2 Test procedure sequence

Table 8.1.6.1.4.4.3.2-1/2 illustrates the downlink power levels and other changing parameters to be applied for the cells at various time instants of the test execution. Row marked "T0" denotes the initial conditions after preamble, while columns marked "T1" is to be applied subsequently. The exact instants on which these values shall be applied are described in the texts in this clause.

Table 8.1.6.1.4.4.3.2-1: Time instances of cell power level and parameter changes (FR1)

	Parameter	Unit	Cell 1	Cell 2	Remark
T0	SS/PBCH SSS EPRE	dBm/S CS	-80	"Off"	Only Cell 1 is available. (NOTE 1).
T1	SS/PBCH SSS EPRE	dBm/S CS	"Off"	-80	Only Cell 2 is available. (NOTE 1).
NOTE 1: Power level "Off" is defined in TS 38.508-1 Table 6.2.2.1-3.					

Table 8.1.6.1.4.4.3.2-2: Time instances of cell power level and parameter changes (FR2)

	Parameter	Unit	Cell 1	Cell 2	Remark
T0	SS/PBCH SSS EPRE	dBm/S CS	-80	"Off"	Only Cell 1 is available. (NOTE 1).
T1	SS/PBCH SSS EPRE	dBm/S CS	"Off"	-80	Only Cell 2 is available. (NOTE 1).
NOTE 1: Power level "Off" is defined in TS 38.508-1 Table 6.2.2.2.2-2.					

Table 8.1.6.1.4.4.3.2-3: Main behaviour

St	Procedure	Message Sequence		TP	Verdict
		U - S	Message		
1	The SS transmits a <i>Paging</i> message.	<--	NR RRC: <i>Paging</i>	-	-
2	The UE transmits an <i>RRCSetupRequest</i> message.	-->	NR RRC: <i>RRCSetupRequest</i>	-	-
3	The SS waits for 2 sec to ensure that the UE detects T300 expiry.	-	-	-	-
4-6	Steps 1 to 3 of the generic radio bearer establishment procedure in TS 38.508-1 table 4.5.4.2-3 on NR Cell 1.	-	-	-	-
7	The UE transmits an <i>RRCSetupComplete</i> message and a SERVICE REQUEST message.	-->	NR RRC: <i>RRCSetupComplete</i>	-	-
8-11	Steps 5 to 8 of the generic radio bearer establishment procedure in TS 38.508-1 table 4.5.4.2-3 on NR Cell 1.	-	-	-	-
12	The SS changes Cell 1 and Cell 2 parameters according to the row "T1" in table 8.1.6.1.4.4.3.2-1/2.	-	-	-	-
13	The UE transmits an <i>RRCReestablishmentRequest</i> message on Cell 2.	-->	NR RRC: <i>RRCReestablishmentRequest</i>	-	-
14	The SS transmits an <i>RRCReestablishment</i> message on Cell 2.	<--	NR RRC: <i>RRCReestablishment</i>	-	-
15	Check: Does the UE send an <i>RRCReestablishmentComplete</i> message with <i>connEstFailInfoAvailable</i> on Cell 2?	-->	NR RRC: <i>RRCReestablishmentComplete</i>	1	P
16	The SS transmits an <i>RRCReconfiguration</i> message to establish SRB2 and DRB.	<--	NR RRC: <i>RRCReconfiguration</i>	-	-
17	The UE transmits an <i>RRCReconfigurationComplete</i> message.	-->	NR RRC: <i>RRCReconfigurationComplete</i>	-	-
18	The SS sends a <i>UEInformationRequest</i> message to get <i>connEstFailReport</i> and <i>rlf-Report</i> .	<--	NR RRC: <i>UEInformationRequest</i>	-	-
19	The UE send a <i>UEInformationResponse</i> message with <i>connEstFailReport</i> and <i>rlf-Report</i> .	-->	NR RRC: <i>UEInformationResponse</i>	-	-

8.1.6.1.4.4.3.3 Specific message contents

Table 8.1.6.1.4.4.3.3-1: *RRCSetupComplete* (step 7, Table 8.1.6.1.4.4.3.2-3)

Derivation Path: TS 38.508-1 [4] Table 4.6.1-22			
Information Element	Value/remark	Comment	Condition
<i>RRCSetupComplete</i> ::= SEQUENCE {			
criticalExtensions CHOICE {			
rrcSetupComplete SEQUENCE{			
nonCriticalExtension EQUENCE{			
ue-MeasurementsAvailable-r16	UE- MeasurementsAvailable- r16 with condition CEF		
}			
}			

}		
---	--	--

Table 8.1.6.1.4.4.3.2: RRCReestablishmentRequest (step 13, Table 8.1.6.1.4.4.3.2-3)

Derivation Path: TS 38.508-1 [4] Table 4.6.1-12			
Information Element	Value/remark	Comment	Condition
RRCReestablishmentRequest ::= SEQUENCE {			
reestablishmentCause	otherFailure		

Table 8.1.6.1.4.4.3.3: RRCReestablishmentComplete (step 15, Table 8.1.6.1.4.4.3.2-3)

Derivation Path: TS 38.508-1 [4] Table 4.6.1-11			
Information Element	Value/remark	Comment	Condition
RRCReestablishmentComplete ::= SEQUENCE {			
criticalExtensions CHOICE {			
rrcReestablishmentComplete SEQUENCE {			
nonCriticalExtension SEQUENCE {			
ue-MeasurementsAvailable-r16	UE-MeasurementsAvailable-r16 with condition CEF and RLF		
}			
}			
}			
}			

Table 8.1.6.1.4.4.3.4: UEInformationRequest (step 18, Table 8.1.6.1.4.4.3.2-3)

Derivation Path: TS 38.508-1 [4], Table 4.6.1-32A with condition RLF
--

8.1.6.1.4.5 Connection Establishment Failure / Logging and reporting / Location Information

8.1.6.1.4.5.1 Test Purpose (TP)

(1)

```
with { UE has connection establishment failure information available with location information }
ensure that {
  when { UE receives the UEInformationRequest message containing connEstFailReportReq }
  then { UE sends the UEInformationResponse message containing connEstFailReport with
CommonLocationInfo }
}
```

8.1.6.1.4.5 Conformance requirements

References: The conformance requirements covered in the current TC are specified in: TS 38.331, clauses 5.3.3.7, 5.7.10.3 and 6.3.2. Unless otherwise stated these are Rel-16 requirements.

[TS 38.331, clause 5.7.10.3]

Upon receiving the *UEInformationRequest* message, the UE shall, only after successful security activation:

...

- 1> if *connEstFailReportReq* is set to *true* and the UE has connection establishment failure or connection resume failure information in *VarConnEstFailReport* and if the RPLMN is equal to *plmn-Identity* stored in *VarConnEstFailReport*:
- 2> set *timeSinceFailure* in *VarConnEstFailReport* to the time that elapsed since the last connection establishment failure or connection resume failure in NR;

- 2> set the *connEstFailReport* in the *UEInformationResponse* message to the value of *connEstFailReport* in *VarConnEstFailReport*;
- 2> discard the *connEstFailReport* from *VarConnEstFailReport* upon successful delivery of the *UEInformationResponse* message confirmed by lower layers;

[TS 38.331, clause 5.3.3.7]

The UE shall:

- 1> if timer T300 expires:

...

- 2> store the following connection establishment failure information in the *VarConnEstFailReport* by setting its fields as follows:

...

- 3> if available, set the *locationInfo* as follows:

- 4> if available, set the *commonLocationInfo* to include the detailed location information;

[TS 38.331, clause 6.3.2]

The IE *CommonLocationInfo* is used to transfer detailed location information available at the UE to correlate measurements and UE position information.

CommonLocationInfo field descriptions	
LocationTimeStamp	Parameter type DisplacementTimeStamp defined in TS 37.355 [49]. The first/leftmost bit of the first octet contains the most significant bit.
locationCoordinate	Parameter type LocationCoordinates defined in TS 37.355 [49]. The first/leftmost bit of the first octet contains the most significant bit.
locationError	Parameter LocationError defined in TS 37.355 [49]. The first/leftmost bit of the first octet contains the most significant bit.
locationSource	Parameter LocationSource defined in TS 37.355 [49]. The first/leftmost bit of the first octet contains the most significant bit.
velocityEstimate	Parameter type Velocity defined in TS 37.355 [49]. The first/leftmost bit of the first octet contains the most significant bit.

8.1.6.1.4.5.3 Test description

8.1.6.1.4.5.3.1 Pre-test conditions

System Simulator:

- NR Cell 1

UE:

- None.

Preamble:

- The UE's positioning engine (e.g. standalone GNSS receiver) should be provided with any necessary stimulus to allow it to provide the position. This shall be done by use of the test function Update UE Location Information defined in TS 38.509 [6], if supported by the UE according to *pc_UpdateUE_LocationInformation*. Otherwise, or in addition any other suitable method may also be used.

- The UE is in state 1N-A as defined in TS 38.508-1 [4], subclause 4.4A.

8.1.6.1.4.5.3.2 Test procedure sequence

Table 8.1.6.1.4.5.3.2-1: Main behaviour

St	Procedure	Message Sequence		TP	Verdict
		U - S	Message		
1	Void	-	-	-	-
2	The SS transmits a <i>Paging</i> message.	<--	NR RRC: <i>Paging</i>	-	-
3	The UE transmits an <i>RRCSetupRequest</i> message.	-->	NR RRC: <i>RRCSetupRequest</i>	-	-
4	The SS waits for 2sec to ensure that the UE detects T300 expiry.	-	-	-	-
5	Void	-	-	-	-
6-8	Steps 1 to 3 of the generic radio bearer establishment procedure in TS 38.508-1 table 4.5.4.2-3.	-	-	-	-
9	The UE transmits an <i>RRCSetupComplete</i> message and a SERVICE REQUEST message.	-->	NR RRC: <i>RRCSetupComplete</i>	-	-
10-13	Steps 5 to 8 of the generic radio bearer establishment procedure in TS 38.508-1 table 4.5.4.2-3.	-	-	-	-
14	The SS sends a <i>UEInformationRequest</i> message to get <i>connEstFailReportReq</i> .	<--	<i>UEInformationRequest</i>	-	-
15	Check: Does the UE send a <i>UEInformationResponse</i> message with <i>connEstFailReport</i> with the IE <i>commonLocationInfo-r16</i> is present?	-->	<i>UEInformationResponse</i>	1	P

8.1.6.1.4.5.3.3 Specific message contents

Table 8.1.6.1.4.5.3.3-1: *RRCSetupComplete* (step 9, Table 8.1.6.1.4.5.3.2-1)

Derivation Path: TS 38.508-1 [4], Table 4.6.1-22			
Information Element	Value/remark	Comment	Condition
<i>RRCSetupComplete</i> ::= SEQUENCE {			
<i>criticalExtensions</i> CHOICE {			
<i>rrcSetupComplete</i> SEQUENCE {			
<i>nonCriticalExtension</i> SEQUENCE {			
<i>ue-MeasurementsAvailable-r16</i>	UE-MeasurementsAvailable-r16 with condition CEF		
}			
}			
}			
}			

Table 8.1.6.1.4.5.3.3-2: Void

Table 8.1.6.1.4.5.3.3-3: *UEInformationResponse* (step 15, Table 8.1.6.1.4.5.3.2-1)

Derivation Path: TS 38.508-1 [4] Table 4.6.1-32B			
Information Element	Value/remark	Comment	Condition
<i>UEInformationResponse-r16</i> ::= SEQUENCE {			
<i>rrc-TransactionIdentifier</i>	RRC-TransactionIdentifier		
<i>criticalExtensions</i> CHOICE {			
<i>ueInformationResponse-r16</i> SEQUENCE {			

connEstFailReport-r16 SEQUENCE {			
measResultFailedCell-r16 SEQUENCE {			
cgi-Info SEQUENCE {			
plmn-Identity-r16	Any allowed value		
cellIdentity-r16	Any allowed value		
trackingAreaCode-r16	Not checked		
}			
measResult-r16 SEQUENCE {			
cellResults-r16 SEQUENCE {			
resultsSSB-Cell-r16 SEQUENCE {			
rsrp	Not checked		
rsrq	Not checked		
sinr	Not checked		
}			
}			
rsIndexResults-r16 SEQUENCE {			
resultsSSB-Indexes-r16 SEQUENCE (SIZE (1..maxNrofIndexesToReport2)) OF ResultsPerSSB-Index	1 entry		
ssb-Index	Any allowed value		
ssb-Results SEQUENCE {			
rsrp	Not checked		
rsrq	Not checked		
sinr	Not checked		
}			
}			
}			
}			
}			
}			
locationInfo-r16 SEQUENCE {			
commonLocationInfo-r16 SEQUENCE {			
gnss-TOD-msec-r16	Not checked		
locationTimestamp-r16	Any allowed value		
locationCoordinate-r16	Not checked		
locationError-r16	Not checked		
locationSource-r16	Not checked		
velocityEstimate-r16	Not checked		
}			
bt-LocationInfo-r16	Not present		
wlan-LocationInfo-r16	Not present		
sensor-LocationInfo-r16	Not present		
}			
measResultNeighCells-r16 SEQUENCE {			
measResultNeighCellListNR	Not present		
measResultNeighCellListEUTRA	Not present		
}			
numberOfConnFail-r16	Any allowed value		
perRAInfoList-r16	Any allowed value		
timeSinceFailure-r16	Any allowed value		
}			
}			
}			
}			
}			

8.1.6.1.4.6 Connection Establishment Failure / Logging and reporting / Reporting of Intra-frequency measurements

8.1.6.1.4.6.1 Test Purpose (TP)

(1)

with { UE has connection establishment failure information available with the intra-frequency measurement result }
ensure that {
 when { UE receives a UEInformationRequest message with connEstFailReportReq set to true }
}

```

    then { UE sends a UEInformationResponse message containing the measurement result for intra-
frequency neighbouring cell }
}

```

8.1.6.1.4.6.2 Conformance requirements

References: The conformance requirements covered in the current TC are specified in: TS 38.331, clauses 5.3.3.7, 5.7.10.3 and 6.2.2. Unless otherwise stated these are Rel-16 requirements.

[TS 38.331, clause 5.7.10.3]

Upon receiving the *UEInformationRequest* message, the UE shall, only after successful security activation:

...

- 1> if *connEstFailReportReq* is set to *true* and the UE has connection establishment failure or connection resume failure information in *VarConnEstFailReport* and if the RPLMN is equal to *plmn-Identity* stored in *VarConnEstFailReport*:
- 2> set *timeSinceFailure* in *VarConnEstFailReport* to the time that elapsed since the last connection establishment failure or connection resume failure in NR;
- 2> set the *connEstFailReport* in the *UEInformationResponse* message to the value of *connEstFailReport* in *VarConnEstFailReport*;
- 2> discard the *connEstFailReport* from *VarConnEstFailReport* upon successful delivery of the *UEInformationResponse* message confirmed by lower layers;

[TS 38.331, clause 5.3.3.7]

The UE shall:

- 1> if timer T300 expires:

...

- 2> store the following connection establishment failure information in the *VarConnEstFailReport* by setting its fields as follows:

...

- 3> if available, set the *measResultNeighCells*, in order of decreasing ranking-criterion as used for cell reselection, to include neighbouring cell measurements for at most the following number of neighbouring cells: 6 intra-frequency and 3 inter-frequency neighbours per frequency as well as 3 inter-RAT neighbours, per frequency/ set of frequencies per RAT and according to the following:
 - 4> for each neighbour cell included, include the optional fields that are available;

NOTE 2: The UE includes the latest results of the available measurements as used for cell reselection evaluation, which are performed in accordance with the performance requirements as specified in TS 38.133 [14].

[TS 38.331, clause 6.2.2]

– UEInformationResponse

The *UEInformationResponse* message is used by the UE to transfer information requested by the network.

...

ConnEstFailReport field descriptions
<i>measResultFailedCell</i> This field refers to the last measurement results taken in the cell, where connection establishment failure or connection resume failure happened.
<i>measResultNeighCells</i> This field refers to the neighbour cell measurements when connection establishment failure or connection resume failure happened.
<i>numberOfConnFail</i>

This field is used to indicate the latest number of consecutive failed RRCSetup or RRCResume procedures in the same cell independent of RRC state transition.
numberOfPreamblesSent This field is used to indicate the number of random access preambles that were transmitted.
timeSinceFailure This field is used to indicate the time that elapsed since the connection (establishment or resume) failure. Value in seconds. The maximum value 172800 means 172800s or longer.

8.1.6.1.4.6.3 Test description

8.1.6.1.4.6.3.1 Pre-test conditions

System Simulator:

- NR Cell 1 and Cell 2

UE:

- None.

Preamble:

- The UE is in state 1N-A as defined in TS 38.508-1 [4], subclause 4.4A, on cell 1.
- System information combination NR-2 as defined in TS 38.508-1 [4] clause 4.4.3.1.2.

8.1.6.1.4.6.3.2 Test procedure sequence

Table 8.1.6.1.4.6.3.2-1 illustrates the downlink power levels and other changing parameters to be applied for the cells at various time instants of the test execution. Row marked "T0" denotes the initial conditions after preamble, while columns marked "T1" is to be applied subsequently. The exact instants on which these values shall be applied are described in the texts in this clause.

Table 8.1.6.1.4.6.3.2-1: Time instances of cell power level and parameter changes (FR1)

	Parameter	Unit	Cell 1	Cell 2	Remark
T0	SS/PBCH SSS EPRE	dBm/S CS	-85	"Off"	Only Cell 1 is available. (NOTE 1).
T1	SS/PBCH SSS EPRE	dBm/S CS	-85	-91	The power level values are assigned to satisfy $R_{Cell\ 1} > R_{Cell\ 2}$.
NOTE 1: Power level "Off" is defined in TS 38.508-1 Table 6.2.2.1-3.					

Table 8.1.6.1.4.6.3.2-2: Time instances of cell power level and parameter changes (FR2)

	Parameter	Unit	Cell 1	Cell 2	Remark
T0	SS/PBCH SSS EPRE	dBm/S CS	FFS	"Off"	Only Cell 1 is available. (NOTE 1).
T1	SS/PBCH SSS EPRE	dBm/S CS	FFS	FFS	The power level values are assigned to satisfy $R_{Cell\ 1} > R_{Cell\ 2}$.
NOTE 1: Power level "Off" is defined in TS 38.508-1 Table 6.2.2.2-3.					

Table 8.1.6.1.4.6.3.2-3: Main behaviour

St	Procedure	Message Sequence		TP	Verdict
		U - S	Message		

1	The SS changes NR Cell 1 and NR Cell 2 parameter according to the row "T1" in Table 8.1.6.1.4.6.3.2-1/2.	-	-	-	-
2	The SS waits for 40s to ensure that the UE detects intra-frequency cell.	-	-	-	-
3	Void	-	-	-	-
4	The SS transmits a <i>Paging</i> message.	<--	NR RRC: <i>Paging</i>	-	-
5	The UE transmits an <i>RRCSetupRequest</i> message.	-->	NR RRC: <i>RRCSetupRequest</i>	-	-
6	The SS waits for 2sec to ensure that the UE detects T300 expiry.	-	-	-	-
7	Void	-	-	-	-
8-10	Steps 1 to 3 of the generic radio bearer establishment procedure in TS 38.508-1 table 4.5.4.2-3 on NR Cell 1.	-	-	-	-
11	The UE transmits an <i>RRCSetupComplete</i> message and a SERVICE REQUEST message on NR Cell 1.	-->	NR RRC: <i>RRCSetupComplete</i> 5GMM: SERVICE REQUEST	-	-
12-15	Steps 5 to 8 of the generic radio bearer establishment procedure in TS 38.508-1 table 4.5.4.2-3 on NR Cell 1.	-	-	-	-
16	The SS sends a <i>UEInformationRequest</i> message to get <i>connEstFailReportReq</i> on NR Cell 1.	<--	<i>UEInformationRequest</i>	-	-
17	Check: Does the UE send a <i>UEInformationResponse</i> message with <i>connEstFailReport</i> on NR Cell 1?	-->	<i>UEInformationResponse</i>	1	P

8.1.6.1.4.6.3.3 Specific message contents

Table 8.1.6.1.4.6.3.3-1: *RRCSetupComplete* (step 11, Table 8.1.6.1.4.6.3.2-3)

Derivation Path: TS 38.508-1 [4] Table 4.6.1-22			
Information Element	Value/remark	Comment	Condition
<i>RRCSetupComplete</i> ::= SEQUENCE {			
<i>criticalExtensions</i> CHOICE {			
<i>rrcSetupComplete</i> SEQUENCE {			
<i>nonCriticalExtension</i> SEQUENCE {			
<i>ue-MeasurementsAvailable-r16</i>	UE-MeasurementsAvailable-r16 with condition CEF		
}			
}			
}			
}			

Table 8.1.6.1.4.6.3.3-2: Void

Table 8.1.6.1.4.6.3.3-3: *UEInformationResponse* (step 17, Table 8.1.6.1.4.6.3.2-3)

Derivation Path: TS 38.508-1 [4] Table 4.6.1-32B			
Information Element	Value/remark	Comment	Condition
<i>UEInformationResponse-r16</i> ::= SEQUENCE {			
<i>criticalExtensions</i> CHOICE {			
<i>ueInformationResponse-r16</i> SEQUENCE {			
<i>connEstFailReport-r16</i> SEQUENCE {			
<i>measResultFailedCell-r16</i> SEQUENCE {			
CGI-Info-Logging-r16 SEQUENCE {		Information of NR Cell 2	
<i>plmn-Identity-r16</i>	the same MCC and MNC stored in EF _{IMSI} on the test USIM card		

sinr	Not checked		
}			
resultsCSI-RS-Cell	Not checked		
}			
rsIndexResults	Not checked		
}			
cgi-Info	Not checked		
}			
}			
}			
}			
numberOfConnFail-r16	Integer between 1-8		
perRAInfoList-r16	Not checked		
timeSinceFailure-r16	Not checked		
}			
}			
}			
}			

8.1.6.1.4.7 Connection Establishment Failure / Logging and reporting / Reporting of Inter-frequency measurements

8.1.6.1.4.7.1 Test Purpose (TP)

(1)

```
with { UE has connection establishment failure information available with the inter-frequency
measurement result }
ensure that {
  when { UE receives a UEInformationRequest message with connEstFailReportReq set to true }
  then { UE sends a UEInformationResponse message containing the measurement result for inter-
frequency neighbouring cell }
}
```

8.1.6.1.4.7.2 Conformance requirements

References: The conformance requirements covered in the current TC are specified in: TS 38.331, clauses 5.3.3.7, 5.7.10.3 and 6.2.2. Unless otherwise stated these are Rel-16 requirements.

[TS 38.331, clause 5.7.10.3]

Upon receiving the *UEInformationRequest* message, the UE shall, only after successful security activation:

...

- 1> if *connEstFailReportReq* is set to *true* and the UE has connection establishment failure or connection resume failure information in *VarConnEstFailReport* and if the RPLMN is equal to *plmn-Identity* stored in *VarConnEstFailReport*:
- 2> set *timeSinceFailure* in *VarConnEstFailReport* to the time that elapsed since the last connection establishment failure or connection resume failure in NR;
- 2> set the *connEstFailReport* in the *UEInformationResponse* message to the value of *connEstFailReport* in *VarConnEstFailReport*;
- 2> discard the *connEstFailReport* from *VarConnEstFailReport* upon successful delivery of the *UEInformationResponse* message confirmed by lower layers;

[TS 38.331, clause 5.3.3.7]

The UE shall:

- 1> if timer T300 expires:

...

- 2> store the following connection establishment failure information in the *VarConnEstFailReport* by setting its fields as follows:

...

- 3> if available, set the *measResultNeighCells*, in order of decreasing ranking-criterion as used for cell re-selection, to include neighbouring cell measurements for at most the following number of neighbouring cells: 6 intra-frequency and 3 inter-frequency neighbours per frequency as well as 3 inter-RAT neighbours, per frequency/ set of frequencies per RAT and according to the following:

- 4> for each neighbour cell included, include the optional fields that are available;

NOTE 2: The UE includes the latest results of the available measurements as used for cell reselection evaluation, which are performed in accordance with the performance requirements as specified in TS 38.133 [14].

[TS 38.331, clause 6.2.2]

– UEInformationResponse

The *UEInformationResponse* message is used by the UE to transfer information requested by the network.

...

ConnEstFailReport field descriptions	
<i>measResultFailedCell</i>	This field refers to the last measurement results taken in the cell, where connection establishment failure or connection resume failure happened.
<i>measResultNeighCells</i>	This field refers to the neighbour cell measurements when connection establishment failure or connection resume failure happened.
<i>numberOfConnFail</i>	This field is used to indicate the latest number of consecutive failed RRCSetup or RRCResume procedures in the same cell independent of RRC state transition.
<i>numberOfPreamblesSent</i>	This field is used to indicate the number of random access preambles that were transmitted.
<i>timeSinceFailure</i>	This field is used to indicate the time that elapsed since the connection (establishment or resume) failure. Value in seconds. The maximum value 172800 means 172800s or longer.

8.1.6.1.4.7.3 Test description

8.1.6.1.4.7.3.1 Pre-test conditions

System Simulator:

- NR Cell 1 and NR Cell 3
- System information combination NR-4 as defined in TS 38.508-1 [4] clause 4.4.3.1.2 is used in NR cells.

UE:

- None.

Preamble:

- The UE is in state 1N-A as defined in TS 38.508-1 [4], subclause 4.4A, on NR Cell 1.

8.1.6.1.4.7.3.2 Test procedure sequence

Tables 8.1.6.1.4.7.3.2-1/2 illustrate the downlink power levels and other changing parameters to be applied for the cells at various time instants of the test execution. Row marked "T0" denotes the initial conditions after preamble, while

columns marked "T1" is to be applied subsequently. The exact instants on which these values shall be applied are described in the texts in this clause.

Table 8.1.6.1.4.7.3.2-1: Time instances of cell power level and parameter changes (FR1)

	Parameter	Unit	NR Cell 1	NR Cell 3	Remark
T0	SS/PBCH SSS EPRE	dBm/S CS	-85	"Off"	Only NR Cell 1 is available. (NOTE 1).
T1	SS/PBCH SSS EPRE	dBm/S CS	-85	-91	The power level values are assigned to satisfy $R_{NRCell\ 1} > R_{NRCell\ 3}$.

NOTE 1: Power level "Off" is defined in TS 38.508-1 [4], Table 6.2.2.1-3.

Table 8.1.6.1.4.7.3.2-2: Time instances of cell power level and parameter changes (FR2)

	Parameter	Unit	NR Cell 1	NR Cell 3	Remark
T0	SS/PBCH SSS EPRE	dBm/S CS	FFS	"Off"	Only NR Cell 1 is available. (NOTE 1).
T1	SS/PBCH SSS EPRE	dBm/S CS	FFS	FFS	The power level values are assigned to satisfy $R_{NRCell\ 1} > R_{NRCell\ 3}$.

NOTE 1: Power level "Off" is defined in TS 38.508-1 [4], Table 6.2.2.2-2.

Table 8.1.6.1.4.7.3.2-3: Main behaviour

St	Procedure	Message Sequence		TP	Verdict
		U - S	Message		
1	The SS changes NR Cell 1 and NR Cell 3 parameter according to the row "T1" in Table 8.1.6.1.4.7.3.2-1/2.	-	-	-	-
2	The SS waits for 40s to ensure that the UE detects inter-frequency cell.	-	-	-	-
3	Void	-	-	-	-
4	The SS transmits a <i>Paging</i> message.	<--	NR RRC: <i>Paging</i>	-	-
5	The UE transmits an <i>RRCSetupRequest</i> message.	-->	NR RRC: <i>RRCSetupRequest</i>	-	-
6	The SS waits for 2 sec to ensure that the UE detects T300 expiry.	-	-	-	-
7	Void	-	-	-	-
8-10	Steps 1 to 3 of the generic radio bearer establishment procedure in TS 38.508-1 [4], table 4.5.4.2-3 on NR Cell 1.	-	-	-	-
11	The UE transmits an <i>RRCSetupComplete</i> message and a SERVICE REQUEST message on NR Cell 1.	-->	NR RRC: <i>RRCSetupComplete</i>	-	-
12-15	Steps 5 to 8 of the generic radio bearer establishment procedure in TS 38.508-1 [4], table 4.5.4.2-3 on NR Cell 1.	-	-	-	-
16	The SS sends a <i>UEInformationRequest</i> message to get <i>connEstFailReportReq</i> .	<--	<i>UEInformationRequest</i>	-	-
17	Check: Does the UE send a <i>UEInformationResponse</i> message with <i>connEstFailReport</i> on NR Cell 1?	-->	<i>UEInformationResponse</i>	1	P

8.1.6.1.4.7.3.3 Specific message contents

Table 8.1.6.1.4.7.3.3-1: RRCSetupComplete (step 11, Table 8.1.6.1.4.7.3.2-3)

Derivation Path: TS 38.508-1 [4], Table 4.6.1-22			
Information Element	Value/remark	Comment	Condition
RRCSetupComplete ::= SEQUENCE {			
criticalExtensions CHOICE {			

rrcSetupComplete SEQUENCE {			
nonCriticalExtension SEQUENCE {			
ue-MeasurementsAvailable-r16	UE-MeasurementsAvailable-r16 with condition CEF		
}			
}			
}			
}			

Table 8.1.6.1.4.7.3.3-2: Void

Table 8.1.6.1.4.7.3.3-3: UEInformationResponse (step 17, Table 8.1.6.1.4.7.3.2-3)

Derivation Path: TS 38.508-1 [4], Table 4.6.1-32B			
Information Element	Value/remark	Comment	Condition
UEInformationResponse-r16 ::= SEQUENCE {			
criticalExtensions CHOICE {			
ueInformationResponse-r16 SEQUENCE {			
connEstFailReport-r16 SEQUENCE {			
measResultFailedCell-r16 SEQUENCE {			
cgi-Info SEQUENCE {		Information of NR Cell 1	
plmn-Identity-r16	the same MCC and MNC stored in EF _{IMSI} on the test USIM card		
cellIdentity-r16	NR Cell 1		
trackingAreaCode-r16	1		
}			
measResult-r16 SEQUENCE {			
cellResults-r16 SEQUENCE {		Measurement result of NR Cell 1	
resultsSSB-Cell-r16 SEQUENCE {			
rsrp	(0..127)		
rsrq	(0..127)		
sinr	Not checked		
}			
}			
rsIndexResults-r16	Not checked		
}			
locationInfo-r16	Not checked		
measResultNeighCells-r16 SEQUENCE {			
measResultNeighCellListNR SEQUENCE (SIZE (1..maxFreq)) OF MeasResult2NR-r16 {	1 entry		
MeasResult2NR-r16[1] SEQUENCE {		entry 1	
ssbFrequency-r16	ARFCN-ValueNR for SSB of NR Cell 3		
refFreqCSI-RS-r16	Not checked		
measResultList-r16 SEQUENCE (SIZE (1..maxCellReport)) OF MeasResultNR SEQUENCE {	1 entry		
MeasResultNR[1] SEQUENCE {		entry 1	
physCellId	PCI of NR Cell 3		
measResult SEQUENCE {			
cellResults SEQUENCE {			
resultsSSB-Cell SEQUENCE {			
rsrp	(0..127)		
rsrq	Not checked		
sinr	Not checked		
}			
resultsCSI-RS-Cell	Not checked		
}			
}			

rsIndexResults	Not checked		
}			
cgi-Info	Not checked		
}			
}			
}			
numberOfConnFail-r16	Integer between 1-8		
perRAInfoList-r16	Not checked		
timeSinceFailure-r16	Any allowed value		
}			
}			
}			
}			
}			

8.1.6.1.4.8 Connection Establishment Failure / Logging and reporting / RACH failure report

8.1.6.1.4.8.1 Test Purpose (TP)

(1)

```
with { UE having previously failed the random access procedure where contention resolution was not
successful for any of the transmitted preambles }
ensure that {
  when { UE receives UEInformationRequest message with connEstFailReportReq set to true }
  then { UE transmits UEInformationResponse message with a connEstFailReport including the
perRAInfoList }
}
```

8.1.6.1.4.8.2 Conformance requirements

References: The conformance requirements covered in the current TC are specified in: TS 38.331, clauses 5.3.3.7, 5.7.10.3, 5.7.10.4, 5.7.10.5 and 6.2.2. Unless otherwise stated these are Rel-16 requirements.

[TS 38.331, clause 5.7.10.3]

1> if timer T300 expires:

...

2> store the following connection establishment failure information in the *VarConnEstFailReport* by setting its fields as follows:

...

3> set *perRAInfoList* to indicate the performed random access procedure related information as specified in 5.7.10.5;

[TS 38.331, clause 5.7.10.3]

Upon receiving the *UEInformationRequest* message, the UE shall, only after successful security activation:

...

1> if *connEstFailReportReq* is set to *true* and the UE has connection establishment failure or connection resume failure information in *VarConnEstFailReport* and if the RPLMN is equal to *plmn-Identity* stored in *VarConnEstFailReport*:

2> set *timeSinceFailure* in *VarConnEstFailReport* to the time that elapsed since the last connection establishment failure or connection resume failure in NR;

2> set the *connEstFailReport* in the *UEInformationResponse* message to the value of *connEstFailReport* in *VarConnEstFailReport*;

2> discard the *connEstFailReport* from *VarConnEstFailReport* upon successful delivery of the *UEInformationResponse* message confirmed by lower layers; [TS 38.331, clause 5.7.10.5]

The UE shall set the content in *ra-InformationCommon* as follows:

...

- 1> set the parameters associated to individual random-access attempt in the chronological order of attempts in the *perRAInfoList* as follows:
 - 2> if the random-access resource used is associated to a SS/PBCH block, set the associated random-access parameters for the successive random-access attempts associated to the same SS/PBCH block for one or more random-access attempts as follows:
 - 3> set the *ssb-Index* to include the SS/PBCH block index associated to the used random-access resource;
 - 3> set the *numberOfPreamblesSentOnSSB* to indicate the number of successive random-access attempts associated to the SS/PBCH block;
 - 3> for each random-access attempt performed on the random-access resource, include the following parameters in the chronological order of the random-access attempt:
 - 4> if the random-access attempt is performed on the contention based random-access resource and if *raPurpose* is not equal to '*requestForOtherSI*', include *contentionDetected* as follows:
 - 5> if contention resolution was not successful as specified in TS 38.321 [6] for the transmitted preamble:
 - 6> set the *contentionDetected* to true;
 - 5> else:
 - 6> set the *contentionDetected* to false;
 - 4> if the random-access attempt is performed on the contention based random-access resource; or
 - 4> if the random-access attempt is performed on the contention free random-access resource and if the random-access procedure was initiated due to the PDCCH ordering:
 - 5> if the SS/PBCH block RSRP of the SS/PBCH block corresponding to the random-access resource used in the random-access attempt is above *rsrp-ThresholdSSB*:
 - 6> set the *dIRSRPAboveThreshold* to true;
 - 5> else:
 - 6> set the *dIRSRPAboveThreshold* to false;
 - 2> else if the random-access resource used is associated to a CSI-RS, set the associated random-access parameters for the successive random-access attempts associated to the same CSI-RS for one or more random-access attempts as follows:
 - 3> set the *csi-RS-Index* to include the CSI-RS index associated to the used random-access resource;
 - 3> set the *numberOfPreamblesSentOnCSI-RS* to indicate the number of successive random-access attempts associated to the CSI-RS.

[TS 38.331, clause 6.2.2]

– UEInformationResponse

The *UEInformationResponse* message is used by the UE to transfer information requested by the network.

...

<i>UEInformationResponse</i> -IEs field descriptions
<i>logMeasReport</i>

This field is used to provide the measurement results stored by the UE associated to logged MDT.
measResultIdleEUTRA EUTRA measurement results performed during RRC_INACTIVE or RRC_IDLE.
measResultIdleNR NR measurement results performed during RRC_INACTIVE or RRC_IDLE.
ra-Report This field is used to provide the list of RA reports that is stored by the UE for the past up to maxRAReport-r16 number of successful random access procedures.
rlf-Report This field is used to indicate the RLF report related contents.

...

RA-Report field descriptions
absoluteFrequencyPointA This field indicates the absolute frequency position of the reference resource block (Common RB 0).
cellID This field indicates the CGI of the cell in which the associated random access procedure was performed.
contentionDetected This field is used to indicate that contention was detected for the transmitted preamble in the given random access attempt or not. This field is not included when the UE performs random access attempt is using contention free random-access resources or when the raPurpose is set to requestForOtherSI.
csi-RS-Index This field is used to indicate the CSI-RS index corresponding to the random access attempt.
dIRSRPAboveThreshold This field is used to indicate whether the DL beam (SSB) quality associated to the random access attempt was above or below the threshold (rsrp-ThresholdSSB in beamFailureRecoveryConfig in UL BWP configuration of UL BWP selected for random access procedure initiated for beam failure recovery; Otherwise, rsrp-ThresholdSSB in rach-ConfigCommon in UL BWP configuration of UL BWP selected for random access procedure.
locationAndBandwidth Frequency domain location and bandwidth of the bandwidth part associated to the random-access resources used by the UE.
numberOfPreamblesSentOnCSI-RS This field is used to indicate the total number of successive RA preambles that were transmitted on the corresponding CSI-RS.
numberOfPreamblesSentOnSSB This field is used to indicate the total number of successive RA preambles that were transmitted on the corresponding SS/PBCH block.
perRAAttemptInfoList This field provides detailed information about a random access attempt.
perRAInfoList This field provides detailed information about each of the random access attempts in the chronological order of the random access attempts.
perRACSI-RSInfoList This field provides detailed information about the successive random access attempts associated to the same CSI-RS.
perRASSBInfoList This field provides detailed information about the successive random access attempts associated to the same SS/PBCH block.
raPurpose This field is used to indicate the RA scenario for which the RA report entry is triggered. The RA accesses associated to Initial access from RRC_IDLE, transition from RRC-INACTIVE and the MSG3 based SI request are indicated using the indicator 'accessRelated'. The indicator beamFailureRecovery is used in case of beam failure recovery failure in the SpCell [3]. The indicator reconfigurationWithSync is used if the UE executes a reconfiguration with sync. The indicator ulUnSynchronized is used if the random access procedure is initiated in a SpCell by DL or UL data arrival during RRC_CONNECTED when the timeAlignmentTimer is not running in the PTAG or in a serving cell by a PDCCH order [3]. The indicator schedulingRequestFailure is used in case of SR failures [3]. The indicator noPUCCHResourceAvailable is used when the UE has no valid SR PUCCH resources configured [3]. The indicator requestForOtherSI is used for MSG1 based on demand SI request.
ra-InformationCommon This field is used to indicate the common random-access related information between RA-report and RLF-report. For RA report, this field is mandatory presented. For RLF-report, this field is optionally included when connectionFailureType is set to 'hof' or when connectionFailureType is set to 'rlf' and the rlf-Cause equals to 'randomAccessProblem' or 'beamRecoveryFailure'; otherwise this field is absent.
ssb-Index This field is used to indicate the SS/PBCH index of the SS/PBCH block corresponding to the random access attempt.
subcarrierSpacing Subcarrier spacing used in the BWP associated to the random-access resources used by the UE.

...

8.1.6.1.4.8.3 Test description

8.1.6.1.4.8.3.1 Pre-test conditions

System Simulator:

- NR Cell 1
- System information combination NR-1 as defined in TS 38.508-1 [4] clause 4.4.3.1.2.

UE:

- None.

Preamble:

- The UE is in state 1N-A on Cell 1 as defined in TS 38.508-1 [4], subclause 4.4A.

8.1.6.1.4.8.3.2 Test procedure sequence

Table 8.1.6.1.4.8.3.2-1: Main behaviour

St	Procedure	Message Sequence		TP	Verdict
		U - S	Message		
1	SS is configured to not transmit MAC control element and ignore subsequent RACH attempts	-	-	-	-
1A	The SS transmits a <i>Paging</i> message.	<--	NR RRC: <i>Paging</i>	-	-
1B	The UE transmits an <i>RRCSetupRequest</i> message.	-->	NR RRC: <i>RRCSetupRequest</i>	-	-
1C	The SS waits for 2sec to ensure that the UE detects T300 expiry.	-	-	-	-
1D	SS is configured to transmit MAC control element with matched UE Contention Resolution Identity	-	-	-	-
2	SS sends a <i>Paging</i> message to the UE on the appropriate paging block, and including the UE identity in one entry of the IE <i>pagingRecordList</i> .	<--	NR RRC: <i>Paging</i>	-	-
3-9	Steps 2-8 of generic test procedure in TS 38.508-1 Table 4.5.4.2-3 are performed on NR Cell 1.	-	-	-	-
10	The SS sends a <i>UEInformationRequest</i> message to get <i>connEstFailReportReq</i> .	<--	NR RRC: <i>UEInformationRequest</i>	-	-
11	Check: Does the UE send a <i>UEInformationResponse</i> message with <i>connEstFailReport</i> including the <i>perRAInfoList</i> on NR Cell 1?	-->	NR RRC: <i>UEInformationResponse</i>	1	P

8.1.6.1.4.8.3.3 Specific message contents

Table 8.1.6.1.4.8.3.3-1: Void

Table 8.1.6.1.4.8.3.3-2: *UEInformationResponse* (step 11, Table 8.1.6.1.4.8.3.2-1)

Derivation Path: TS 38.508-1 [4], Table 4.6.1-32B			
Information Element	Value/remark	Comment	Condition
<i>UEInformationResponse</i> -r16 ::= SEQUENCE {			

criticalExtensions CHOICE {			
ueInformationResponse-r16 SEQUENCE {			
connEstFailReport-r16 SEQUENCE {			
measResultFailedCell-r16 SEQUENCE {			
cgi-Info SEQUENCE {			
plmn-Identity-r16	plmn-Identity within SIB1 broadcasted in NR Cell 1		
cellIdentity-r16	cellIdentity within SIB1 broadcasted in NR Cell 1	BIT STRING (SIZE (36))	
trackingAreaCode-r16	Not checked	BIT STRING (SIZE (24))	
}			
}			
}			
}			
measResult-r16 SEQUENCE {			
cellResults-r16	Any allowed value		
rsIndexResults-r16	Any allowed value		
}			
locationInfo-r16	Not checked		
measResultNeighCells-r16 SEQUENCE {			
measResultNeighCellListNR	Not present		
measResultNeighCellListEUTRA	Not present		
}			
numberOfConnFail-r16	Any allowed value	INTEGER (1..8)	
perRAInfoList-r16 SEQUENCE (SIZE (1..200)) OF PerRAInfo-r16{	1 entry		
PerRAInfo-r16[1] CHOICE {		entry 1	
perRASSBInfoList-r16 SEQUENCE {			
ssb-Index-r16	1		
numberOfPreamblesSentOnSSB-r16	Any allowed value	total number of successive RA preambles sent by the UE before T300 expiry	
perRAAttemptInfoList-r16 SEQUENCE (SIZE (1..200)) OF PerRAAttemptInfo-r16{			
PerRAAttemptInfo-r16[x] SEQUENCE {		x ranges from 1 to numberOfPream blesSentOnSSB -r16	
contentionDetected-r16	true		
dirSRPAboveThreshold-r16	true		
}			
}			
}			
timeSinceFailure-r16	Any allowed value	INTEGER (0..172800)	
}			
}			
}			
}			

8.1.6.2 Inter-RAT MDT

8.1.6.2.1 Inter-RAT MDT / Immediate MDT / Periodic reporting of E-UTRAN/ Location information

8.1.6.2.1.1 Test Purpose (TP)

```

with { UE in NR RRC CONNECTED state and periodic inter-RAT measurement reporting of neighbour E-UTRA
cells with includeCommonLocationInfo included is configured }
ensure that {
  when { The UE receives reference signal power of E-UTRA cell where measurements are configured }
  then { UE sends MeasurementReport message with locationInfo included at regular intervals }
}

```

8.1.6.2.1.2 Conformance requirements

References: The conformance requirements covered in the current TC is specified in: TS 38.331 clause 5.3.5.3, 5.5.2.1, 5.5.2.9, 5.5.4.1, 5.5.5.1.

[TS 38.331, clause 5.3.5.3]

The UE shall perform the following actions upon reception of the *RRCReconfiguration*, or upon execution of the conditional reconfiguration (CHO or CPC):

...

- 1> if the *RRCReconfiguration* message includes the *measConfig*:
 - 2> perform the measurement configuration procedure as specified in 5.5.2;

...

[TS 38.331, clause 5.5.2.1]

The UE shall:

...

- 1> if the received *measConfig* includes the *measObjectToAddModList*:
 - 2> perform the measurement object addition/modification procedure as specified in 5.5.2.5;

...

- 1> if the received *measConfig* includes the *reportConfigToAddModList*:
 - 2> perform the reporting configuration addition/modification procedure as specified in 5.5.2.7;

...

- 1> if the received *measConfig* includes the *measIdToAddModList*:
 - 2> perform the measurement identity addition/modification procedure as specified in 5.5.2.3;

- 1> if the received *measConfig* includes the *measGapConfig*:
 - 2> perform the measurement gap configuration procedure as specified in 5.5.2.9;

[TS 38.331, clause 5.5.2.9]

- 1> if *gapFR1* is set to *setup*:
 - 2> if an FR1 measurement gap configuration is already setup, release the FR1 measurement gap configuration;

- 2> setup the FR1 measurement gap configuration indicated by the *measGapConfig* in accordance with the received *gapOffset*, i.e., the first subframe of each gap occurs at an SFN and subframe meeting the following condition:
- $$\text{SFN mod } T = \text{FLOOR}(\text{gapOffset}/10);$$
- $$\text{subframe} = \text{gapOffset mod } 10;$$
- with $T = \text{MGRP}/10$ as defined in TS 38.133 [14];
- 2> apply the specified timing advance *mgta* to the gap occurrences calculated above (i.e. the UE starts the measurement *mgta* ms before the gap subframe occurrences);
- 1> else if *gapFR1* is set to *release*:
- 2> release the FR1 measurement gap configuration;
- 1> if *gapFR2* is set to *setup*:
- 2> if an FR2 measurement gap configuration is already setup, release the FR2 measurement gap configuration;
- 2> setup the FR2 measurement gap configuration indicated by the *measGapConfig* in accordance with the received *gapOffset*, i.e., the first subframe of each gap occurs at an SFN and subframe meeting the following condition:
- $$\text{SFN mod } T = \text{FLOOR}(\text{gapOffset}/10);$$
- $$\text{subframe} = \text{gapOffset mod } 10;$$
- with $T = \text{MGRP}/10$ as defined in TS 38.133 [14];
- 2> apply the specified timing advance *mgta* to the gap occurrences calculated above (i.e. the UE starts the measurement *mgta* ms before the gap subframe occurrences);
- 1> else if *gapFR2* is set to *release*:
- 2> release the FR2 measurement gap configuration;
- 1> if *gapUE* is set to *setup*:
- 2> if a per UE measurement gap configuration is already setup, release the per UE measurement gap configuration;
- 2> setup the per UE measurement gap configuration indicated by the *measGapConfig* in accordance with the received *gapOffset*, i.e., the first subframe of each gap occurs at an SFN and subframe meeting the following condition:
- $$\text{SFN mod } T = \text{FLOOR}(\text{gapOffset}/10);$$
- $$\text{subframe} = \text{gapOffset mod } 10;$$
- with $T = \text{MGRP}/10$ as defined in TS 38.133 [14];
- 2> apply the specified timing advance *mgta* to the gap occurrences calculated above (i.e. the UE starts the measurement *mgta* ms before the gap subframe occurrences);
- 1> else if *gapUE* is set to *release*:
- 2> release the per UE measurement gap configuration.

[TS 38.331, clause 5.5.4.1]

If AS security has been activated successfully, the UE shall:

- 1> for each *measId* included in the *measIdList* within *VarMeasConfig*:
- 2> if the corresponding *reportConfig* includes a *reportType* set to *eventTriggered* or *periodical*:

- 3> if the corresponding *measObject* concerns NR:
 - 4> if the corresponding *reportConfig* includes *measRSSI-ReportConfig*:
 - 5> consider the resource indicated by the *rmtc-Config* on the associated frequency to be applicable;
 - 4> if the *eventA1* or *eventA2* is configured in the corresponding *reportConfig*:
 - 5> consider only the serving cell to be applicable;
 - 4> if the *eventA3* or *eventA5* is configured in the corresponding *reportConfig*:
 - 5> if a serving cell is associated with a *measObjectNR* and neighbours are associated with another *measObjectNR*, consider any serving cell associated with the other *measObjectNR* to be a neighbouring cell as well;
 - 4> if corresponding *reportConfig* includes *reportType* set to *periodical*; or
 - 4> for measurement events other than *eventA1* or *eventA2*:
 - 5> if *useWhiteCellList* is set to *true*:
 - 6> consider any neighbouring cell detected based on parameters in the associated *measObjectNR* to be applicable when the concerned cell is included in the *whiteCellsToAddModList* defined within the *VarMeasConfig* for this *measId*;
 - 5> else:
 - 6> consider any neighbouring cell detected based on parameters in the associated *measObjectNR* to be applicable when the concerned cell is not included in the *blackCellsToAddModList* defined within the *VarMeasConfig* for this *measId*;
- 3> else if the corresponding *measObject* concerns E-UTRA:
 - 4> if *eventB1* or *eventB2* is configured in the corresponding *reportConfig*:
 - 5> consider a serving cell, if any, on the associated E-UTRA frequency as neighbour cell;
 - 4> else:
 - 5> consider any neighbouring cell detected on the associated frequency to be applicable when the concerned cell is not included in the *blackCellsToAddModListEUTRAN* defined within the *VarMeasConfig* for this *measId*;

...

[TS 38.331, clause 5.5.5.1]

The purpose of this procedure is to transfer measurement results from the UE to the network. The UE shall initiate this procedure only after successful AS security activation.

For the *measId* for which the measurement reporting procedure was triggered, the UE shall set the *measResults* within the *MeasurementReport* message as follows:

- 1> if there is at least one applicable neighbouring cell to report:
 - 2> if the *reportType* is set to *eventTriggered* or *periodical*:
 - 3> set the *measResultNeighCells* to include the best neighbouring cells up to *maxReportCells* in accordance with the following:
 - 4> if the *reportType* is set to *eventTriggered*:
 - 5> include the cells included in the *cellsTriggeredList* as defined within the *VarMeasReportList* for this *measId*;
 - 4> else:

- 5> include the applicable cells for which the new measurement results became available since the last periodical reporting or since the measurement was initiated or reset;
- 4> for each cell that is included in the *measResultNeighCells*, include the *physCellId*;
- 4> if the *reportType* is set to *eventTriggered* or *periodical*:
 - 5> for each included cell, include the layer 3 filtered measured results in accordance with the *reportConfig* for this *measId*, ordered as follows:
 - 6> if the *measObject* associated with this *measId* concerns NR:
 - 7> if *rsType* in the associated *reportConfig* is set to *ssb*:
 - 8> set *resultsSSB-Cell* within the *measResult* to include the SS/PBCH block based quantity(ies) indicated in the *reportQuantityCell* within the concerned *reportConfig*, in decreasing order of the sorting quantity, determined as specified in 5.5.5.3, i.e. the best cell is included first;
 - 8> if *reportQuantityRS-Indexes* and *maxNrofRS-IndexesToReport* are configured, include beam measurement information as described in 5.5.5.2;
 - 7> else if *rsType* in the associated *reportConfig* is set to *csi-rs*:
 - 8> set *resultsCSI-RS-Cell* within the *measResult* to include the CSI-RS based quantity(ies) indicated in the *reportQuantityCell* within the concerned *reportConfig*, in decreasing order of the sorting quantity, determined as specified in 5.5.5.3, i.e. the best cell is included first;
 - 8> if *reportQuantityRS-Indexes* and *maxNrofRS-IndexesToReport* are configured, include beam measurement information as described in 5.5.5.2;
 - 6> if the *measObject* associated with this *measId* concerns E-UTRA:
 - 7> set the *measResult* to include the quantity(ies) indicated in the *reportQuantity* within the concerned *reportConfigInterRAT* in decreasing order of the sorting quantity, determined as specified in 5.5.5.3, i.e. the best cell is included first;

...

- 1> if the *includeCommonLocationInfo* is configured in the corresponding *reportConfig* for this *measId* and detailed location information that has not been reported is available, set the content of *commonLocationInfo* of the *locationInfo* as follows:
 - 2> include the *locationTimestamp*;
 - 2> include the *locationCoordinate*, if available;
 - 2> include the *velocityEstimate*, if available;
 - 2> include the *locationError*, if available;
 - 2> include the *locationSource*, if available;
 - 2> if available, include the *gnss-TOD-msec*,

...

- 1> increment the *numberOfReportsSent* as defined within the *VarMeasReportList* for this *measId* by 1;
- 1> stop the periodical reporting timer, if running;
- 1> if the *numberOfReportsSent* as defined within the *VarMeasReportList* for this *measId* is less than the *reportAmount* as defined within the corresponding *reportConfig* for this *measId*:
 - 2> start the periodical reporting timer with the value of *reportInterval* as defined within the corresponding *reportConfig* for this *measId*;

1> else:

2> if the *reportType* is set to *periodical* or *cli-Periodical*:

3> remove the entry within the *VarMeasReportList* for this *measId*;

3> remove this *measId* from the *measIdList* within *VarMeasConfig*;

8.1.6.2.1.3 Test description

8.1.6.2.1.3.1 Pre-test conditions

System Simulator:

- NR Cell 1 is the serving cell and E-UTRA Cell 1 is the inter-RAT neighbour cell of NR Cell 1
- System information combination NR-6 as defined in TS 38.508-1 [4] clause 4.4.3.1.2.

Preamble:

- The UE's positioning engine (e.g. standalone GNSS receiver) should be provided with any necessary stimulus to allow it to provide the position. This shall be done by use of the test function Update UE Location Information defined in TS 36.509, if supported by the UE according to *pc_UpdateUE_LocationInformation*. Otherwise, or in addition any other suitable method may also be used.
- The UE is in state 3N-A as defined in TS 38.508-1 [4], subclause 4.4A on NR Cell 1.

8.1.6.2.1.3.2 Test procedure sequence

Table 8.1.6.2.1.3.2-1 and Table 8.1.6.2.1.3.2-2 illustrate the downlink power levels and other changing parameters to be applied for the cells at various time instants of the test execution. Row marked "T0" denotes the initial conditions after preamble, while columns marked "T1" is to be applied subsequently. The exact instants on which these values shall be applied are described in the texts in this clause.

Table 8.1.6.2.1.3.2-1: Time instances of cell power level and parameter changes for FR1

	Parameter	Unit	NR Cell 1	E-UTRA Cell 1	Remark
T0	SS/PBCH SSS EPRE	dBm/S CS	-78	-	
	Cell-specific RS EPRE	dBm/15 kHz	-	Off	
T1	SS/PBCH SSS EPRE	dBm/S CS	-78	-	
	Cell-specific RS EPRE	dBm/15 kHz	-	-85	

Table 8.1.6.2.1.3.2-2: Time instances of cell power level and parameter changes for FR2

	Parameter	Unit	NR Cell 1	E-UTRA Cell 1	Remark
T0	SS/PBCH SSS EPRE	dBm/S CS	-82	-	
	Cell-specific RS EPRE	dBm/15 kHz	-	Off	
T1	SS/PBCH SSS EPRE	dBm/S CS	FFS	-	
	Cell-specific RS EPRE	dBm/15 kHz	-	FFS	

Table 8.1.6.2.1.3.2-3: Main behaviour

St	Procedure	Message Sequence		TP	Verdict
		U - S	Message		
0	The SS changes E-UTRA Cell 1 parameters according to the row "T1" in table 8.1.6.2.1.3.2-1 or 8.1.6.2.1.3.2-2.	-	-	-	-
1	The SS transmits an <i>RRCReconfiguration</i> message including <i>measConfig</i> to setup inter-RAT measurement and reporting for E-UTRA cell with <i>includeCommonLocationInfo</i> .	<--	NR RRC: <i>RRCReconfiguration</i>	-	-
2	The UE transmits an <i>RRCReconfigurationComplete</i> message on NR Cell1.	-->	NR RRC: <i>RRCReconfigurationComplete</i>	-	-
3	Void	-	-	-	-
4	Wait and ignore <i>MeasurementReport</i> messages for 8s to allow for the switching of cells and UE measurement.	-	-	-	-
5	Check: Does the UE transmit a <i>MeasurementReport</i> message on NR Cell 1 to perform periodical reporting for E-UTRA Cell 1 with <i>locationInfo</i> ?	-->	NR RRC: <i>MeasurementReport</i>	1	P
6	The SS transmits an <i>RRCReconfiguration</i> message including <i>measConfig</i> to remove inter-RAT measurement and reporting for E-UTRA cell	<--	NR RRC: <i>RRCReconfiguration</i>	-	-
7	The UE transmits an <i>RRCReconfigurationComplete</i> message on NR Cell1.	-->	NR RRC: <i>RRCReconfigurationComplete</i>	-	-

8.1.6.2.1.3.3 Specific message contents

Table 8.1.6.2.1.3.3-1: RRCReconfiguration (step 1 Table 8.1.6.2.1.3.2-3)

Derivation Path: TS 38.508-1 [4], Table 4.6.1-13 with condition NR_MEAS

Table 8.1.6.2.1.3.3-2: MeasConfig (Table 8.1.6.2.1.3.3-1)

Derivation Path: TS 38.508-1 [4] Table 4.6.3-69			
Information Element	Value/Remark	Comment	Condition
measConfig ::= SEQUENCE {			
measObjectToAddModList SEQUENCE (SIZE (1..maxNrofObjectId)) OF MeasObjectToAddMod {	2 entries		
MeasObjectToAddMod[1] SEQUENCE {		entry 1	
measObjectId	1	MeasObjectIdNR-f1	
measObject CHOICE {			
measObjectNR SEQUENCE {			
ssbFrequency	ssbFrequency IE equals the ARFCN for NR Cell 1		
absThreshSS-BlocksConsolidation	Not present		
}			
}			
MeasObjectToAddMod[2] SEQUENCE {		entry 2	
measObjectId	2	MeasObjectEUTRA-f1	
measObject CHOICE {			
measObjectEUTRA SEQUENCE {			
carrierFreq	ARFCN-ValueEUTRA for E-UTRA Cell 1		
}			
}			
}			

}			
reportConfigToAddModList SEQUENCE (SIZE (1..maxReportConfigId)) OF ReportConfigToAddMod {	1 entry		
ReportConfigToAddMod[1] SEQUENCE {		entry 1	
reportConfigId	1		
reportConfig	ReportConfigInterRAT-PERIODICAL-E-UTRA	Table 8.1.6.2.1.3.3-3	
}			
}			
measIdToAddModList SEQUENCE (SIZE (1..maxNrofMeasId)) OF MeasIdToAddMod {	1 entry		
MeasIdToAddMod[1] SEQUENCE {		entry 1	
measId	1		
measObjectId	2		
reportConfigId	1		
}			
}			
}			

Table 8.1.6.2.1.3.3-3: ReportConfigInterRAT-PERIODICAL-E-UTRA (Table 8.1.6.2.1.3.3-2)

Derivation Path: 38.508-1 [4] Table 4.6.3-141 with condition PERIODICAL			
Information Element	Value/remark	Comment	Condition
ReportConfigInterRAT ::= SEQUENCE {			
reportType CHOICE {			
PeriodicalReportConfigInterRAT SEQUENCE {			
maxReportCells	1		
includeCommonLocationInfo-r16	true		
}			
}			
}			

Table 8.1.6.2.1.3.3-4: MeasurementReport (steps 5, Table 8.1.6.2.1.3.2-3)

Derivation Path: TS 38.508-1 [4], Table 4.6.1-5A			
Information Element	Value/remark	Comment	Condition
MeasurementReport ::= SEQUENCE {			
criticalExtensions CHOICE {			
measurementReport SEQUENCE {			
measResults SEQUENCE {			
measId	1		
measResultServingMOList SEQUENCE {	1 entry		
servCellId	ServCellIndex of NR Cell 1		
measResultServingCell SEQUENCE {			
physCellId	Physical CellID of the NR Cell 1		
measResult SEQUENCE {			
cellResults SEQUENCE {			
resultsSSB-Cell SEQUENCE {			
rsrp	(0..127)		
rsrq	(0..127)		
sinr	Not present		
}			
}			
}			
}			
}			
measResultNeighCells CHOICE {			
measResultListEUTRA SEQUENCE (SIZE (1..maxCellReport)) OF MeasResultEUTRA {	1 entry		
eutra-PhysCellId	Physical layer cell identity of E-UTRA Cell 1		
}			
measResult SEQUENCE {			

rsrp	(0..97)		
rsrq	(0..34)		
sinr	Not present		
}			
}			
}			
locationInfo-r16 SEQUENCE {			
commonLocationInfo-r16 SEQUENCE {			
gnss-TOD-msec-r16	Any allowed value		
locationTimestamp-r16	Any allowed value		
locationCoordinate-r16	Any allowed value		
locationError-r16	Not checked		
locationSource-r16	Any allowed value		
velocityEstimate-r16	Any allowed value		
}			
bt-LocationInfo-r16	Not present		
wlan-LocationInfo-r16	Not present		
sensor-LocationInfo-r16	Not present		
}			
}			
}			
}			
}			
}			

Table 8.1.6.2.1.3.3-5: RRCReconfiguration (step 6 Table 8.1.6.2.1.3.2-3)

Derivation Path: TS 38.508-1 [4], Table 4.6.1-13 with condition NR_MEAS

Table 8.1.6.2.1.3.3-6: MeasConfig (Table 8.1.6.2.1.3.3-5)

Derivation Path: TS 38.508-1 [4] Table 4.6.3-69			
Information Element	Value/Remark	Comment	Condition
measConfig ::= SEQUENCE {			
measObjectToRemoveList SEQUENCE (SIZE (1..maxNrofObjectld)) OF MeasObjectld {	2 entries		
measObjectld[1]	1	entry 1	
measObjectld[2]	2	entry 2	
}			
measldToRemoveList SEQUENCE (SIZE (1..maxNrofMeasld)) OF Measld {	1 entry		
measld[1]	1	entry 1	
}			
}			

8.1.6.2.2 Inter-RAT MDT / Logged MDT / E-UTRA Inter-RAT measurement, logging and reporting

8.1.6.2.2.1 Test Purpose (TP)

(1)

```

with { UE in NR RRC_IDLE state camping normally on NR cell and the UE is able to detect a E-UTRA cell }
ensure that {
  when { T330 is running }
  then { UE is logging serving cell idle mode measurements and E-UTRA neighbouring cell measurements at regular time intervals }
}
    
```

(2)

```

with { UE in RRC_CONNECTED state and UE has logged E-UTRA neighbouring cell measurements available
and plmn-Identity stored in VarLogMeasReport is equal to the RPLMN }
ensure that {
  when { receiving UEInformationRequest message }
  then { UE transmits UEInformationResponse messages with E-UTRA neighbouring cell measurements }
}

```

8.1.6.2.2.2 Conformance requirements

References: The conformance requirements covered in the current TC are specified in: TS 38.331, clauses 5.3.3.4, 5.5a.1.3, 5.5a.3.2, 5.7.10.3. Unless otherwise stated these are Rel-16 requirements.

[TS 38.331, clause 5.3.3.4]

The UE shall perform the following actions upon reception of the *RRCSetup*:

...

1> set the content of *RRCSetupComplete* message as follows:

...

2> if the SIB1 contains *idleModeMeasurementsEUTRA* and the UE has E-UTRA idle/inactive measurement information available in *VarMeasIdleReport*:

3> include the *idleMeasAvailable*;

2> if the UE has logged measurements available for NR and if the RPLMN is included in *plmn-IdentityList* stored in *VarLogMeasReport*:

3> include the *logMeasAvailable* in the *RRCSetupComplete* message;

3> if Bluetooth measurement results are included in the logged measurements the UE has available for NR:

4> include the *logMeasAvailableBT* in the *RRCSetupComplete* message;

3> if WLAN measurement results are included in the logged measurements the UE has available for NR:

4> include the *logMeasAvailableWLAN* in the *RRCSetupComplete* message;

...

[TS 38.331, clause 5.5a.1.3]

Upon receiving the *LoggedMeasurementConfiguration* message the UE shall:

1> discard the logged measurement configuration as well as the logged measurement information as specified in 5.5a.2;

1> store the received *loggingDuration*, *reportType* and *areaConfiguration*, if included, in *VarLogMeasConfig*;

1> if the *LoggedMeasurementConfiguration* message includes *plmn-IdentityList*:

2> set *plmn-IdentityList* in *VarLogMeasReport* to include the RPLMN as well as the PLMNs included in *plmn-IdentityList*;

1> else:

2> set *plmn-IdentityList* in *VarLogMeasReport* to include the RPLMN;

1> store the received *absoluteTimeInfo*, *traceReference*, *traceRecordingSessionRef*, and *tce-Id* in *VarLogMeasReport*;

1> store the received *bt-NameList*, if included, in *VarLogMeasConfig*;

1> store the received *wlan-NameList*, if included, in *VarLogMeasConfig*;

1> store the received *sensor-NameList*, if included, in *VarLogMeasConfig*;

1> start timer T330 with the timer value set to the *loggingDuration*;

[TS 38.331, clause 5.5a.3.2]

While T330 is running, the UE shall:

1> perform the logging in accordance with the following:

2> if the *reportType* is set to *periodical* in the *VarLogMeasConfig*:

3> if the UE is in any cell selection state (as specified in TS 38.304 [20]):

4> perform the logging at regular time intervals, as defined by the *loggingInterval* in the *VarLogMeasConfig*;

3> if the UE is in camped normally state on an NR cell and if the RPLMN is included in *plmn-IdentityList* stored in *VarLogMeasReport*:

4> if *areaConfiguration* is not included in *VarLogMeasConfig*; or

4> if the serving cell is part of the area indicated by *areaConfig* in *areaConfiguration* in *VarLogMeasConfig*;

5> perform the logging at regular time intervals, as defined by the *loggingInterval* in the *VarLogMeasConfig*;

...

2> when performing the logging:

3> set the *relativeTimeStamp* to indicate the elapsed time since the moment at which the logged measurement configuration was received;

3> if location information became available during the last logging interval, set the content of the *locationInfo* as in 5.3.3.7:

3> if the UE is in any cell selection state (as specified in TS 38.304 [20]):

4> set *anyCellSelectionDetected* to indicate the detection of no suitable or no acceptable cell found;

4> if the *reportType* is set to *eventTriggered* in the *VarLogMeasConfig*; and

4> if the RPLMN at the time of entering the any cell selection state is included in *plmn-IdentityList* stored in *VarLogMeasReport*; and

4> if *areaConfiguration* is not included in *VarLogMeasConfig* or if the last cell that the UE was camping on is part of the area indicated by *areaConfig* of *areaConfiguration* in *VarLogMeasConfig*:

5> set the *servCellIdentity* to indicate global cell identity of the last cell that the UE was camping on;

5> set the *measResultServingCell* to include the quantities of the last cell the UE was camping on;

4> else if the *reportType* is set to *periodical* in the *VarLogMeasConfig*:

5> set the *servCellIdentity* to indicate global cell identity of the last logged cell that the UE was camping on;

5> set the *measResultServingCell* to include the quantities of the last logged cell the UE was camping on;

3> else:

4> set the *servCellIdentity* to indicate global cell identity of the cell the UE is camping on;

4> set the *measResultServingCell* to include the quantities of the cell the UE is camping on;

- 3> if available, set the *measResultNeighCells*, in order of decreasing ranking-criterion as used for cell reselection, to include measurements of neighbouring cell that became available during the last logging interval and according to the following:
 - 4> include measurement results for at most 6 neighbouring cells on the NR serving frequency and for at most 3 cells per NR neighbouring frequency and for the NR neighbouring frequencies in accordance with the following:
 - 5> if *interFreqTargetInfo* is included in *VarLogMeasConfig*:
 - 6> include measurement results for NR neighbouring frequencies that are included in both *interFreqTargetInfo* and *SIB4*;
 - 5> else:
 - 6> include measurement results for NR neighbouring frequencies that are included in *SIB4*;
 - 4> include measurement results for at most 3 neighbours per inter-RAT frequency that is included in *SIB5*;
 - 4> for each neighbour cell included, include the optional fields that are available;

NOTE: The UE includes the latest results of the available measurements as used for cell reselection evaluation in RRC_IDLE or RRC_INACTIVE, which are performed in accordance with the performance requirements as specified in TS 38.133 [14].

- 2> when the memory reserved for the logged measurement information becomes full, stop timer T330 and perform the same actions as performed upon expiry of T330, as specified in 5.5a.1.4.

[TS 38.331, clause 5.7.10.3]

Upon receiving the *UEInformationRequest* message, the UE shall, only after successful security activation:

- 1> if the *idleModeMeasurementReq* is included in the *UEInformationRequest* and the UE has stored *VarMeasIdleReport* that contains measurement information concerning cells other than the PCell:
 - 2> set the *measResultIdleEUTRA* in the *UEInformationResponse* message to the value of *measReportIdleEUTRA* in the *VarMeasIdleReport*, if available;
 - 2> set the *measResultIdleNR* in the *UEInformationResponse* message to the value of *measReportIdleNR* in the *VarMeasIdleReport*, if available;
 - 2> discard the *VarMeasIdleReport* upon successful delivery of the *UEInformationResponse* message confirmed by lower layers;
- 1> if the *logMeasReportReq* is present and if the RPLMN is included in *plmn-IdentityList* stored in *VarLogMeasReport*:
 - 2> if *VarLogMeasReport* includes one or more logged measurement entries, set the contents of the *logMeasReport* in the *UEInformationResponse* message as follows:
 - 3> include the *absoluteTimeStamp* and set it to the value of *absoluteTimeInfo* in the *VarLogMeasReport*;
 - 3> include the *traceReference* and set it to the value of *traceReference* in the *VarLogMeasReport*;
 - 3> include the *traceRecordingSessionRef* and set it to the value of *traceRecordingSessionRef* in the *VarLogMeasReport*;
 - 3> include the *tce-Id* and set it to the value of *tce-Id* in the *VarLogMeasReport*;
 - 3> include the *logMeasInfoList* and set it to include one or more entries from the *VarLogMeasReport* starting from the entries logged first, and for each entry of the *logMeasInfoList* that is included, include all information stored in the corresponding *logMeasInfoList* entry in *VarLogMeasReport*;
 - 3> if the *VarLogMeasReport* includes one or more additional logged measurement entries that are not included in the *logMeasInfoList* within the *UEInformationResponse* message:

4> include the *logMeasAvailable*;

4> if *bt-LocationInfo* is included in *locationInfo* of one or more of the additional logged measurement entries in *VarLogMeasReport* that are not included in the *logMeasInfoList* within the *UEInformationResponse* message:

5> include the *logMeasAvailableBT*;

4> if *wlan-LocationInfo* is included in *locationInfo* of one or more of the additional logged measurement entries in *VarLogMeasReport* that are not included in the *logMeasInfoList* within the *UEInformationResponse* message:

5> include the *logMeasAvailableWLAN*;

8.1.6.2.2.3 Test description

8.1.6.2.2.3.1 Pre-test conditions

System Simulator:

- NR Cell 1 is the serving cell and E-UTRA Cell 1 is the inter-RAT neighbour cell of NR Cell 1
- System information combination NR-6 as defined in TS 38.508-1 [4] clause 4.4.3.1.2.

Preamble:

- The UE is in state 3N-A as defined in TS 38.508-1 [4], subclause 4.4A on NR Cell 1.

8.1.6.2.2.3.2 Test procedure sequence

Table 8.1.6.2.2.3.2-1 and Table 8.1.6.2.2.3.2-2 illustrate the downlink power levels and other changing parameters to be applied for the cells at various time instants of the test execution. Row marked "T0" denotes the initial conditions after preamble, while columns marked "T1" is to be applied subsequently. The exact instants on which these values shall be applied are described in the texts in this clause.

Table 8.1.6.2.2.3.2-1: Time instances of cell power level and parameter changes for FR1

	Parameter	Unit	NR Cell 1	E-UTRA Cell 1	Remark
T0	SS/PBCH SSS EPRE	dBm/S CS	-78	-	The power level values are assigned to ensure UE registered on NR Cell 1
	Cell-specific RS EPRE	dBm/15 kHz	-	Off	
T1	SS/PBCH SSS EPRE	dBm/S CS	-78	-	The power level values are assigned to satisfy $Srxle_{VE-UTRA\ Cell\ 1} < Thresh_{x, high}$
	Cell-specific RS EPRE	dBm/15 kHz	-	-85	

Table 8.1.6.2.2.3.2-2: Time instances of cell power level and parameter changes for FR2

	Parameter	Unit	NR Cell 1	E-UTRA Cell 1	Remark
T0	SS/PBCH SSS EPRE	dBm/S CS	-82	-	The power level values are assigned to ensure UE registered on NR Cell 1
	Cell-specific RS EPRE	dBm/15 kHz	-	Off	
T1	SS/PBCH SSS EPRE	dBm/S CS	FFS	-	The power level values are assigned to satisfy $Srxle_{VE-UTRA\ Cell\ 1} < Thresh_{x, high}$
	Cell-specific RS EPRE	dBm/15 kHz	-	FFS	

Table 8.1.6.2.2.3.2-3: Main behaviour

St	Procedure	Message Sequence		TP	Verdict
		U - S	Message		
1	SS transmits a <i>LoggedMeasurementConfiguration</i> message with reportType set to 'periodical' on NR Cell 1.	<--	<i>LoggedMeasurementConfiguration</i>	-	-
2	The SS transmits a <i>RRCRelease</i> message to release the RRC connection.	<--	<i>NR RRC: RRCRelease</i>	-	-
3	The SS changes cell power levels according to the row "T1" in table 8.1.6.2.2.3.2-1/2.	-	-	-	-
4	Wait 10 seconds for UE performing the logging at regular time intervals.	-	-	-	-
5	The SS transmits a <i>Paging</i> message.	<--	<i>NR RRC: Paging</i>	-	-
6	The UE transmits an <i>RRCRequest</i> message.	-->	<i>NR RRC: RRCRequest</i>	-	-
7	The SS transmit an <i>RRCSetup</i> message.	<--	<i>NR RRC: RRCSetup</i>	-	-
8	Check: Does UE transmit an <i>RRCSetupComplete</i> message with <i>logMeasAvailable</i> set as true?	-->	<i>NR RRC: RRCSetupComplete</i>	-	-
9-11	Steps 6 to 8 of the generic procedure in TS 38.508 [4] Table 4.5.4.2-3 are executed to successfully complete the service request procedure.	-	-	-	-
12	The SS send a <i>UEInformationRequest</i> message to get logMeasReport.	<--	<i>NR RRC: UEInformationRequest</i>	-	-
13	Check: Does the UE send an <i>UEInformationResponse</i> message including logMeasReport with E-UTRAN Cell1?	-->	<i>NR RRC: UEInformationResponse</i>	1, 2	P

8.1.6.2.2.3.3 Specific message contents

Table 8.1.6.2.2.3.3-1: SIB2 of NR Cell 1(preamble and all steps, Table 8.1.6.2.2.3.2-3)

Derivation Path: TS 38.508-1 [4], Table 4.6.2-1			
Information Element	Value/remark	Comment	Condition
SIB2 ::= SEQUENCE {			
cellReselectionServingFreqInfo SEQUENCE {			
threshServingLowP	10	20 dB	
}			
}			

Table 8.1.6.2.2.3.3-2: SIB5 of NR Cell 1(preamble and all steps, Table 8.1.6.2.2.3.2-3)

Derivation Path: TS 38.508-1 [4], Table 4.6.2-4			
Information Element	Value/remark	Comment	Condition
SIB5 ::= SEQUENCE {			
carrierFreqListEUTRA SEQUENCE (SIZE (1..maxEUTRA-Carrier)) OF CarrierFreqEUTRA {	1 entry		
CarrierFreqEUTRA[1] SEQUENCE {		entry 1	
carrierFreq	Downlink EUTRA ARFCN as E-UTRA Cell 1 used		
cellReselectionPriority	5		
threshX-High	10	20 dB	
threshX-Low	20	40 dB	
}			
}			
t-ReselectionEUTRA	7	7 Seconds	
}			

Table 8.1.6.2.2.3.3-3: *LoggedMeasurementConfiguration* (step 1, Table 8.1.6.2.2.3.2-3)

Derivation path: TS 38.508-1 [4], Table 4.6.1-5AA			
Information Element	Value/remark	Comment	Condition
LoggedMeasurementConfiguration-r16 ::= SEQUENCE {			
criticalExtensions CHOICE {			
LoggedMeasurementConfiguration SEQUENCE {			
reportType CHOICE {			
periodical SEQUENCE {			
loggingInterval-r16	ms2560	2.56 seconds	
}			
}			
}			
}			
}			

Table 8.1.6.2.2.3.3-4: *RRCSetupComplete* (step 8, Table 8.1.6.2.2.3.2-3)

Derivation path: TS 38.508-1 [4], Table 4.6.1-23			
Information Element	Value/remark	Comment	Condition
RRCSetupComplete ::= SEQUENCE {			
criticalExtensions CHOICE {			
rrcSetupComplete SEQUENCE {			
nonCriticalExtension SEQUENCE {			
ue-MeasurementsAvailable-r16	UE-MeasurementsAvailable-r16 with condition LOG		
}			
}			
}			
}			

Table 8.1.6.2.2.3.3-5: *UEInformationRequest* (step 12, Table 8.1.6.2.2.3.2-3)

Derivation path: TS 38.508-1 [4], Table 4.6.1-32A with condition LOG
--

Table 8.1.6.2.2.3.3-6: *UEInformationResponse* (step 13, Table 8.1.6.2.2.3.2-3)

Derivation path: TS 38.508-1 [4], Table 4.6.1-32B			
Information Element	Value/remark	Comment	Condition
UEInformationResponse-r16 ::= SEQUENCE {			
logMeasReport-r16 SEQUENCE {			
absoluteTimeStamp-r16	Same value as sent by SS in <i>LoggedMeasurementConfiguration</i> in step 1		
traceReference-r16 SEQUENCE {			
plmn-Identity-r16 SEQUENCE {			
mcc SEQUENCE (SIZE (3)) OF MCC-NMC-Digit	Same value as sent by SS in <i>LoggedMeasurementConfiguration</i> in step 1		
mnc SEQUENCE (SIZE (2..3)) OF MCC-NMC-Digit	Same value as sent by SS in <i>LoggedMeasurementConfiguration</i> in step 1		
}			
}			
traceRecordingSessionRef-r16	Same value as sent by SS in <i>LoggedMeasurementConfiguration</i> in step 1		

1> clear the information included in *VarRLF-Report*, if any;

1> set the *plmn-IdentityList* to include the list of EPLMNs stored by the UE (i.e. includes the RPLMN);

...

1> for each of the configured *measObjectNR* in which measurements are available:

2> if the SS/PBCH block-based measurement quantities are available:

3> set the *measResultListNR* in *measResultNeighCells* to include all the available measurement quantities of the best measured cells, other than the source PCell (in case HO failure) or PCell (in case RLF), ordered such that the cell with highest SS/PBCH block RSRP is listed first if SS/PBCH block RSRP measurement results are available, otherwise the cell with highest SS/PBCH block RSRQ is listed first if SS/PBCH block RSRQ measurement results are available, otherwise the cell with highest SS/PBCH block SINR is listed first, based on the available SS/PBCH block based measurements collected up to the moment the UE detected failure;

4> for each neighbour cell included, include the optional fields that are available;

2> if the CSI-RS based measurement quantities are available:

3> set the *measResultListNR* in *measResultNeighCells* to include all the available measurement quantities of the best measured cells, other than the source PCell, ordered such that the cell with highest CSI-RS RSRP is listed first if CSI-RS RSRP measurement results are available, otherwise the cell with highest CSI-RS RSRQ is listed first if CSI-RS RSRQ measurement results are available, otherwise the cell with highest CSI-RS SINR is listed first, based on the available CSI-RS based measurements collected up to the moment the UE detected radio link failure;

4> for each neighbour cell included, include the optional fields that are available;

1> for each of the configured EUTRA frequencies in which measurements are available;

2> set the *measResultListEUTRA* in *measResultNeighCells* to include the best measured cells ordered such that the cell with highest RSRP is listed first if RSRP measurement results are available, otherwise the cell with highest RSRQ is listed first, and based on measurements collected up to the moment the UE detected failure;

3> for each neighbour cell included, include the optional fields that are available;

NOTE 1: The measured quantities are filtered by the L3 filter as configured in the mobility measurement configuration. The measurements are based on the time domain measurement resource restriction, if configured. Blacklisted cells are not required to be reported.

...

1> else if the failure is detected due to radio link failure as described in 5.3.10.3, set the fields in *VarRLF-report* as follows:

2> set the *connectionFailureType* to *rlf*;

2> set the *rlf-Cause* to the trigger for detecting radio link failure in accordance with clause 5.3.10.4;

2> set the *nrFailedPCellId* in *failedPCellId* to the global cell identity and the tracking area code, if available, and otherwise to the physical cell identity and carrier frequency of the PCell where radio link failure is detected;

2> if an *RRCReconfiguration* message including the *reconfigurationWithSync* was received before the connection failure:

3> if the last *RRCReconfiguration* message including the *reconfigurationWithSync* concerned an intra NR handover:

4> include the *nrPreviousCell* in *previousPCellId* and set it to the global cell identity and the tracking area code of the PCell where the last *RRCReconfiguration* message including *reconfigurationWithSync* was received;

- 4> set the *timeConnFailure* to the elapsed time since reception of the last *RRCReconfiguration* message including the *reconfigurationWithSync*;
- 3> else if the last *RRCReconfiguration* message including the *reconfigurationWithSync* concerned a handover to NR from E-UTRA and if the UE supports Radio Link Failure Report for Inter-RAT MRO EUTRA:
 - 4> include the *eutraPreviousCell* in *previousPCellId* and set it to the global cell identity and the tracking area code of the E-UTRA PCell where the last *RRCReconfiguration* message including *reconfigurationWithSync* was received embedded in E-UTRA RRC message *MobilityFromEUTRACommand* message as specified in TS 36.331 [10] clause 5.4.3.3;
 - 4> set the *timeConnFailure* to the elapsed time since reception of the last *RRCReconfiguration* message including the *reconfigurationWithSync* embedded in E-UTRA RRC message *MobilityFromEUTRACommand* message as specified in TS 36.331 [10] clause 5.4.3.3;

...

[TS 38.331, clause 5.4.2.3]

The UE shall:

- 1> apply the default L1 parameter values as specified in corresponding physical layer specifications except for the parameters for which values are provided in *SIB1*;
- 1> apply the default MAC Cell Group configuration as specified in 9.2.2;
- 1> perform RRC reconfiguration procedure as specified in 5.3.5;

NOTE: If the UE is connected to 5GC of the source E-UTRA cell, the delta configuration for PDCP and SDAP can be used for intra-system inter-RAT handover. For other cases, source RAT configuration is not considered when the UE applies the reconfiguration message of target RAT.

[TS 38.331, clause 5.3.5.3]

The UE shall perform the following actions upon reception of the *RRCReconfiguration*, or upon execution of the conditional reconfiguration (CHO or CPC):

...

- 1> set the content of the *RRCReconfigurationComplete* message as follows:

...

- 2> if the UE has connection establishment failure or connection resume failure information available in *VarConnEstFailReport* and if the RPLMN is equal to *plmn-Identity* stored in *VarConnEstFailReport*:
 - 3> include *connEstFailInfoAvailable* in the *RRCReconfigurationComplete* message;
- 2> if the UE has radio link failure or handover failure information available in *VarRLF-Report* and if the RPLMN is included in *plmn-IdentityList* stored in *VarRLF-Report*; or
- 2> if the UE has radio link failure or handover failure information available in *VarRLF-Report* of TS 36.331 [10] and if the UE is capable of cross-RAT RLF reporting and if the RPLMN is included in *plmn-IdentityList* stored in *VarRLF-Report* of TS 36.331 [10]:
 - 3> include *rlf-InfoAvailable* in the *RRCReconfigurationComplete* message;

...

[TS 38.331, clause 5.7.10.3]

Upon receiving the *UEInformationRequest* message, the UE shall, only after successful security activation:

...

- 1> if the *logMeasReportReq* is present and if the RPLMN is included in *plmn-IdentityList* stored in *VarLogMeasReport*:
 - 2> if *VarLogMeasReport* includes one or more logged measurement entries, set the contents of the *logMeasReport* in the *UEInformationResponse* message as follows:
 - 3> include the *absoluteTimeStamp* and set it to the value of *absoluteTimeInfo* in the *VarLogMeasReport*;
 - 3> include the *traceReference* and set it to the value of *traceReference* in the *VarLogMeasReport*;
 - 3> include the *traceRecordingSessionRef* and set it to the value of *traceRecordingSessionRef* in the *VarLogMeasReport*;
 - 3> include the *tce-Id* and set it to the value of *tce-Id* in the *VarLogMeasReport*;
 - 3> include the *logMeasInfoList* and set it to include one or more entries from *VarLogMeasReport* starting from the entries logged first;
 - 3> if the *VarLogMeasReport* includes one or more additional logged measurement entries that are not included in the *logMeasInfoList* within the *UEInformationResponse* message:
 - 4> include the *logMeasAvailable*;
 - ...
 - 1> if *rlf-ReportReq* is set to *true*:
 - 2> if the UE has radio link failure information or handover failure information available in *VarRLF-Report* and if the RPLMN is included in *plmn-IdentityList* stored in *VarRLF-Report*:
 - 3> set *timeSinceFailure* in *VarRLF-Report* to the time that elapsed since the last radio link or handover failure in NR;
 - 3> set the *rlf-Report* in the *UEInformationResponse* message to the value of *rlf-Report* in *VarRLF-Report*;
 - 3> discard the *rlf-Report* from *VarRLF-Report* upon successful delivery of the *UEInformationResponse* message confirmed by lower layers;
 - ...
 - 1> if the *logMeasReport* is included in the *UEInformationResponse*:
 - 2> submit the *UEInformationResponse* message to lower layers for transmission via SRB2;
 - 2> discard the logged measurement entries included in the *logMeasInfoList* from *VarLogMeasReport* upon successful delivery of the *UEInformationResponse* message confirmed by lower layers;
 - 1> else:
 - 2> submit the *UEInformationResponse* message to lower layers for transmission via SRB1.

8.1.6.2.3.3 Test description

8.1.6.2.3.3.1 Pre-test conditions

System Simulator:

- NR Cell 1 is the serving cell and E-UTRA Cell 1 is the inter-RAT neighbour cell of NR Cell 1
- System information combination NR-6 as defined in TS 38.508-1 [4] clause 4.4.3.1.2.
- System information combination 31 as defined in TS 36.508 [7] clause 4.4.3.1 is used in the E-UTRA cell.

Preamble:

- The UE is in state 3N-A as defined in TS 38.508-1 [4], subclause 4.4A on NR Cell 1.

8.1.6.2.3.3.2 Test procedure sequence

Table 8.1.6.2.3.3.2-1 and Table 8.1.6.2.3.3.2-2 illustrate the downlink power levels and other changing parameters to be applied for the cells at various time instants of the test execution. Configurations marked "T1", "T2" and "T3" are applied at the points indicated in the Main behaviour description in Table 8.1.6.2.3.3.2-1 and Table 8.1.6.2.3.3.2-2. The exact instants on which these values shall be applied are described in the texts in this clause.

Table 8.1.6.2.3.3.2-1: Time instances of cell power level and parameter changes for FR1

	Parameter	Unit	NR Cell 1	E-UTRA Cell 1	Remark
T0	SS/PBCH SSS EPRE	dBm/S CS	-90	-	Power levels are such that entry condition 1 for event B2 and entry condition 2 are both satisfied: Mp + Hys < Thresh1 and Mn + Ofn + Ocn - Hys > Thresh2
	Cell-specific RS EPRE	dBm/15 kHz	-	-73	
T1	SS/PBCH SSS EPRE	dBm/S CS	Off	-	Only E-UTRA Cell 1 is available.
	Cell-specific RS EPRE	dBm/15 kHz	-	-73	
T2	SS/PBCH SSS EPRE	dBm/S CS	-88	-	
	Cell-specific RS EPRE	dBm/15 kHz	-	-85	

Table 8.1.6.2.3.3.2-2: Time instances of cell power level and parameter changes for FR2

	Parameter	Unit	NR Cell 1	E-UTRA Cell 1	Remark
T0	SS/PBCH SSS EPRE	dBm/S CS	FFS	-	Power levels are such that entry condition 1 for event B2 and entry condition 2 are both satisfied: Mp + Hys < Thresh1 and Mn + Ofn + Ocn - Hys > Thresh2
	Cell-specific RS EPRE	dBm/15 kHz	-	FFS	
T1	SS/PBCH SSS EPRE	dBm/S CS	Off	-	Only E-UTRA Cell 1 is available.
	Cell-specific RS EPRE	dBm/15 kHz	-	-73	
T2	SS/PBCH SSS EPRE	dBm/S CS	FFS	-	
	Cell-specific RS EPRE	dBm/15 kHz	-	FFS	

Table 8.1.6.2.3.3.2-3: Main behaviour

St	Procedure	Message Sequence		TP	Verdict
		U - S	Message		
1	The SS transmits an <i>RRCReconfiguration</i> message including <i>measConfig</i> to setup inter-RAT measurement on NR Cell 1.	<--	NR RRC: <i>RRCReconfiguration</i>	-	-
2	The UE transmits an <i>RRCReconfigurationComplete</i> message on NR Cell1.	-->	NR RRC: <i>RRCReconfigurationComplete</i>	-	-
3	The UE transmits a <i>MeasurementReport</i> message on NR Cell 1.	-->	<i>MeasurementReport</i>	-	-
4	The SS changes NR Cell 1 and E-UTRA Cell 1 parameters according to the row "T1" in table 8.1.6.2.3.3.2-1/2.	-	-	-	-
5	Steps 1-4b2of TS 38.508-1 Table 4.9.7.2.2-1 is performed with the conditions 'connected'	-	-	-	-

	without release' & 'mapped 5G security context' on E-UTRA Cell 1.				
5A	The SS transmits a <i>SecurityModeCommand</i> message.	<--	E-UTRA RRC: <i>SecurityModeCommand</i>	-	-
5B	The UE transmits a <i>SecurityModeComplete</i> message.	-->	E-UTRA RRC: <i>SecurityModeComplete</i>	-	-
5C-5D	Steps 5-6 of TS 38.508-1 Table 4.9.7.2.2-1 is performed	-	-	-	-
5E	The SS transmits an <i>RRCConnectionReconfiguration</i> message to establish SRB2 and DRB(s).	<--	E-UTRA RRC: <i>RRCConnectionReconfiguration</i>	-	-
5F	The UE transmits an <i>RRCConnectionReconfigurationComplete</i> message.	-->	E-UTRA RRC: <i>RRCConnectionReconfigurationComplete</i>	-	-
6	The SS changes NR Cell 1 parameter according to the row "T2" in Table 8.1.6.2.3.3.2-1/2.	-	-	-	-
7	The SS transmits a <i>MobilityFromEUTRACommand</i> message on E-UTRA Cell 1.	<--	E-UTRA RRC: <i>MobilityFromEUTRACommand</i>	-	-
8	Check: Does the UE transmit a <i>RRCReconfigurationComplete</i> message containing <i>rfl-InfoAvailable</i> on NR Cell 1?	-->	NR RRC: <i>RRCReconfigurationComplete</i>	1	P
9	The UE transmits a <i>ULInformationTransfer</i> message and a REGISTRATION REQUEST message indicating "mobility registration updating" is sent to update the registration of the actual tracking area.	-->	NR RRC: <i>ULInformationTransfer</i> 5GMM: REGISTRATION REQUEST	-	-
10	SS sends an <i>DLInformationTransfer</i> message and a REGISTRATION ACCEPT message containing a 5G-GUTI.	<--	NR RRC: <i>DLInformationTransfer</i> 5GMM: REGISTRATION ACCEPT	-	-
11	The UE transmits an <i>ULInformationTransfer</i> message and a REGISTRATION COMPLETE message.	-->	NR RRC: <i>ULInformationTransfer</i> 5GMM: REGISTRATION COMPLETE	-	-
12	Void	-	-	-	-
13	The SS transmits a <i>UEInformationRequest</i> message.	<--	NR RRC: <i>UEInformationRequest</i>	-	-
14	Check: Does the UE transmit a <i>UEInformationResponse</i> message on NR Cell 1?	-->	NR RRC: <i>UEInformationResponse</i>	2	P

8.1.6.2.3.3.3 Specific message contents

Table 8.1.6.2.3.3.3-1: *RRCReconfiguration* (step 1, Table 8.1.6.2.3.3.2-3)

Derivation Path: TS 38.508-1 [4] Table 4.6.1-13 with condition NR_MEAS

Table 8.1.6.2.3.3.3-2: *MeasConfig* (Table 8.1.6.2.3.3.3-1)

Derivation Path: TS 38.508-1 [4] Table 4.6.3-69			
Information Element	Value/remark	Comment	Condition
<i>MeasConfig</i> ::= SEQUENCE {			
<i>measObjectToAddModList</i> SEQUENCE (SIZE (1.. <i>maxNrofMeasId</i>)) OF <i>MeasObjectToAddMod</i> {	2 entries		
<i>MeasObjectToAddMod</i> [1] SEQUENCE {		entry 1	
<i>measObjectId</i>	1		
<i>measObject</i> CHOICE {			
<i>measObjectNR</i> SEQUENCE {			
<i>ssbFrequency</i>	<i>ssbFrequency</i> IE equals the ARFCN for NR Cell 1		
<i>absThreshSS-BlocksConsolidation</i>	Not present		
}			
}			
}			
}			

MeasObjectToAddMod[2] SEQUENCE {		entry 2	
measObjectId	2		
measObject CHOICE {			
measObjectEUTRA SEQUENCE {			
carrierFreq	ARFCN-ValueEUTRA for E-UTRA Cell 1		
}			
}			
}			
}			
}			
reportConfigToAddModList SEQUENCE(SIZE (1..maxReportConfigId)) OF ReportConfigToAddMod {	1 entry		
ReportConfigToAddMod[1] SEQUENCE {		entry 1	
reportConfigId	1		
reportConfig CHOICE {			
reportConfigInterRAT	ReportConfigInterRAT-EventB2		
}			
}			
}			
measIdToAddModList SEQUENCE (SIZE (1..maxNrofMeasId)) OF MeasIdToAddMod {	1 entry		
MeasIdToAddMod[1] SEQUENCE {		entry 1	
measId	1		
measObjectId	2		
reportConfigId	1		
}			
}			
quantityConfig	QuantityConfig with Condition INTER-RAT		
measGapConfig	MeasGapConfig		
}			

Table 8.1.6.2.3.3.3-3: ReportConfigInterRAT-EventB2 (Table 8.1.6.2.3.3.3-2)

Derivation Path: TS 38.508-1 [4] Table 4.6.3-141 with condition EVENT_B2			
Information Element	Value/remark	Comment	Condition
ReportConfigNR ::= SEQUENCE {			
reportType CHOICE {			
eventTriggered SEQUENCE {			
eventId CHOICE {			
eventB2 SEQUENCE {			
b2-Threshold1 SEQUENCE {			
rsrp	73	-83dBm	FR1
	73	-83dBm	FR2
}			
b2-Threshold2EUTRA SEQUENCE {			
rsrp	58	-83dBm	FR1
	58	-83dBm	FR2
}			
}			
}			
}			
}			
reportAmount	r1		
}			

Table 8.1.6.2.3.3.3-4: MeasurementReport (step 3, Table 8.1.6.2.3.3.2-3)

Derivation Path: TS 38.508-1 [4] Table 4.6.1-5A			
Information Element	Value/remark	Comment	Condition
MeasurementReport ::= SEQUENCE {			
criticalExtensions CHOICE {			

Table 8.1.6.2.3.3.3-6: RRCReconfiguration (Table 8.1.6.2.3.3.3-5)

Derivation Path: TS 38.508-1 [4] Table 4.6.1-13			
Information Element	Value/remark	Comment	Condition
RRCReconfiguration ::= SEQUENCE {			
criticalExtensions CHOICE {			
rrcReconfiguration SEQUENCE {			
radioBearerConfig	RadioBearerConfig as per table 4.6.3-132 in TS 38.508-1 [4] with conditions SRB1,SRB2 and DRB1		
nonCriticalExtension SEQUENCE {			
masterCellGroup	CellGroupConfig with conditions SRB1,SRB2 and DRB1	OCTET STRING (CONTAINING CellGroupConfig)	
fullConfig	true		
masterKeyUpdate	MasterKeyUpdate		
}			
}			
}			

Table 8.1.6.2.3.3.3-6A: MasterKeyUpdate (Table 8.1.6.2.3.3.3-6)

Derivation Path: TS 38.331 [12], clause 6.2.2			
Information Element	Value/remark	Comment	Condition
MasterKeyUpdate ::= SEQUENCE {			
keySetChangeIndicator	True		
nextHopChainingCount	NextHopChainingCount	TS 38.508-1 [4] Table 4.6.3-83	
nas-Container	<p>Octets 1 to 4 are Message authentication code(MAC) IE using {NH, NCC=2}</p> <p>Bits 1 to 4 of octet 5 are set according to PIXIT parameter for default integrity protection algorithm.</p> <p>Bits 5 to 8 of octet 5 are set according to PIXIT parameter for default ciphering algorithm.</p> <p>Bits 1 to 3 of octet 6 contains the Key set identifier in 5G.</p> <p>Bit 4 of octet 6 contains the type of security context flag(TSC).</p> <p>Bits 5 to 7 of octet 6 contains the 3bit Next hop chaining counter.</p> <p>Bit 8 of octet 6 is Spare.</p> <p>Octets 7 and 8 are spare and shall be coded as zero.</p>	TS 24.501 [22] 9.11.2.9 The value part of S1 mode to N1 mode NAS transparent container	
}			

Table 8.1.6.2.3.3-7: RRCReconfigurationComplete (step 8, Table 8.1.6.2.3.2-3)

Derivation Path: TS 38.508-1 [4], Table 4.6.1-14			
Information Element	Value/remark	Comment	Condition
RRCReconfigurationComplete ::= SEQUENCE {			
criticalExtensions CHOICE {			
rrcReconfigurationComplete SEQUENCE {			
nonCriticalExtension SEQUENCE {			
nonCriticalExtension SEQUENCE {			
nonCriticalExtension SEQUENCE {			
ue-MeasurementsAvailable-r16	UE-MeasurementsAvailable-r16 with condition RLF		
}			
}			
}			
}			
}			

Table 8.1.6.2.3.3-8: UEInformationRequest (step 13, Table 8.1.6.2.3.2-3)

Derivation Path: TS 38.508-1 [4], Table 4.6.1-32A with condition RLF

Table 8.1.6.2.3.3-9: UEInformationResponse (step 14, Table 8.1.6.2.3.2-3)

Derivation Path: TS 38.508-1 [4], Table 4.6.1-32B			
Information Element	Value/remark	Comment	Condition
UEInformationResponse-r16 ::= SEQUENCE {			
criticalExtensions CHOICE {			
ueInformationResponse-r16 SEQUENCE {			
r1f-Report-r16 CHOICE {			
nr-RLF-Report-r16 SEQUENCE {			
measResultLastServCell-r16 SEQUENCE {			
measResult-r16 SEQUENCE {			
cellResults-r16 SEQUENCE {			
resultsSSB-Cell-r16 SEQUENCE {			
rsrp	(0..127)		
rsrq	(0..127)		
sinr	Not checked		
}			
resultsCSI-RS-Cell-r16	Not checked		
}			
rsIndexResults-r16 SEQUENCE {			
resultsSSB-Indexes-r16 SEQUENCE {			
ssb-Index	1		
ssb-Results SEQUENCE {			
rsrp	(0..127)		
rsrq	(0..127)		
sinr	Not checked		
}			
}			
ssbRLMConfigBitmap-r16	01000000 00000000 00000000 00000000 00000000 00000000 00000000 00000000		
resultsCSI-RS-Indexes-r16	Not present		
csi-rsRLMConfigBitmap-r16	Not present		
}			
}			
}			
measResultNeighCells-r16 SEQUENCE {			

measResultListEUTRA-r16 SEQUENCE(SIZE (1..maxFreq)) OF SEQUENCE {	1 entry		
carrierFreq-r16[1]	Same as E-UTRA Cell 1		
measResultList-r16[1] SEQUENCE (SIZE (1..maxCellReport)) OF SEQUENCE {	1 entry		
eutra-PhysCellId[1]	Same as E-UTRA Cell 1		
measResult[1]	MeasQuantityResults of E-UTRA Cell 1		
}			
}			
c-RNTI-r16	the value of the C-RNTI of the UE before RLF		
previousPCellId-r16	Not present		
failedPCellId-r16 CHOICE {			
nrFailedPCellId-r16	Any Allowed Value	Either pci-arfcn-r16 or cellGlobalId-r16 corresponding to NR Cell 1	
eutraFailedPCellId-r16	Not present		
}			
reconnectCellId-r16 CHOICE {			
nrReconnectCellId-r16	Not present		
eutraReconnectCellId-r16	Not checked		
}			
timeUntilReconnection-r16	Not checked		
reestablishmentCellId-r16	Not present		
timeConnFailure-r16	Not checked		
timeSinceFailure-r16	Any allowed value		
connectionFailureType-r16	r1f		
r1f-Cause-r16	t310-Expiry		
locationInfo-r16	Not checked		
noSuitableCellFound-r16	Not checked		
ra-InformationCommon-r16	Not present		
}			
}			
}			
}			
}			

8.1.6.2.4 Inter-RAT MDT / Connection Establishment Failure / Logging and reporting / Reporting of E-UTRA measurement

8.1.6.2.4.1 Test Purpose (TP)

(1)

```
with {UE has connection establishment failure information available with the E-UTRA measurement result }
ensure that {
  when {UE performs an RRC connection establishment procedure }
  then {UE sends an RRCSetupComplete message with connEstFailInfoAvailable }
}
```

(2)

```
with {UE having sent an RRCSetupComplete message with connEstFailInfoAvailable }
ensure that {
  when {UE receives a UEInformationRequest message with connEstFailReportReq set to true }
  then { UE sends a UEInformationResponse message containing the measurement result for E-UTRA neighbouring cell }
}
```

8.1.6.2.4.2 Conformance requirements

References: The conformance requirements covered in the current TC is specified in: TS 38.331 clause 5.3.3.4, 5.3.3.7, 5.7.10.3.

[TS 38.331, clause 5.3.3.4]

The UE shall perform the following actions upon reception of the *RRCSetup*:

...

1> set the content of *RRCSetupComplete* message as follows:

...

2> if the UE has connection establishment failure or connection resume failure information available in *VarConnEstFailReport* and if the RPLMN is equal to *plmn-Identity* stored in *VarConnEstFailReport*:

3> include *connEstFailInfoAvailable* in the *RRCSetupComplete* message;

...

[TS 38.331, clause 5.3.3.7]

The UE shall:

1> if timer T300 expires:

2> reset MAC, release the MAC configuration and re-establish RLC for all RBs that are established;

2> if the UE supports RRC Connection Establishment failure with temporary offset and the T300 has expired a consecutive *connEstFailCount* times on the same cell for which *connEstFailureControl* is included in *SIB1*:

3> for a period as indicated by *connEstFailOffsetValidity*:

4> use *connEstFailOffset* for the parameter *Qoffsettemp* for the concerned cell when performing cell selection and reselection according to TS 38.304 [20] and TS 36.304 [27];

NOTE 1: When performing cell selection, if no suitable or acceptable cell can be found, it is up to UE implementation whether to stop using *connEstFailOffset* for the parameter *Qoffsettemp* during *connEstFailOffsetValidity* for the concerned cell.

2> if the UE has connection establishment failure information or connection resume failure information available in *VarConnEstFailReport* and if the RPLMN is not equal to *plmn-identity* stored in *VarConnEstFailReport*; or

2> if the cell identity of current cell is not equal to the cell identity stored in *measResultFailedCell* in *VarConnEstFailReport*:

3> reset the *numberOfConnFail* to 0;

2> clear the content included in *VarConnEstFailReport* except for the *numberOfConnFail*, if any;

2> store the following connection establishment failure information in the *VarConnEstFailReport* by setting its fields as follows:

3> set the *plmn-Identity* to the PLMN selected by upper layers (see TS 24.501 [23]) from the PLMN(s) included in the *plmn-IdentityList* in *SIB1*;

3> set the *measResultFailedCell* to include the global cell identity, tracking area code, the cell level and SS/PBCH block level RSRP, and RSRQ, and SS/PBCH block indexes, of the failed cell based on the available SSB measurements collected up to the moment the UE detected connection establishment failure;

3> if available, set the *measResultNeighCells*, in order of decreasing ranking-criterion as used for cell reselection, to include neighbouring cell measurements for at most the following number of neighbouring

cells: 6 intra-frequency and 3 inter-frequency neighbours per frequency as well as 3 inter-RAT neighbours, per frequency/ set of frequencies per RAT and according to the following:

4> for each neighbour cell included, include the optional fields that are available;

NOTE 2: The UE includes the latest results of the available measurements as used for cell reselection evaluation, which are performed in accordance with the performance requirements as specified in TS 38.133 [14].

3> if available, set the *locationInfo* as follows:

4> if available, set the *commonLocationInfo* to include the detailed location information;

4> if available, set the *bt-LocationInfo* to include the Bluetooth measurement results, in order of decreasing RSSI for Bluetooth beacons;

4> if available, set the *wlan-LocationInfo* to include the WLAN measurement results, in order of decreasing RSSI for WLAN APs;

4> if available, set the *sensor-LocationInfo* to include the sensor measurement results as follows;

5> if available, include the *sensor-MeasurementInformation*;

5> if available, include the *sensor-MotionInformation*;

3> set *perRAInfoList* to indicate random access failure information as specified in 5.7.10.5;

3> if the *numberOfConnFail* is smaller than 8:

4> increment the *numberOfConnFail* by 1;

2> inform upper layers about the failure to establish the RRC connection, upon which the procedure ends;

The UE may discard the connection establishment failure or connection resume failure information, i.e. release the UE variable *VarConnEstFailReport*, 48 hours after the last connection establishment failure is detected.

[TS 38.331, clause 5.7.10.3]

Upon receiving the *UEInformationRequest* message, the UE shall, only after successful security activation:

...

1> if *connEstFailReportReq* is set to *true* and the UE has connection establishment failure or connection resume failure information in *VarConnEstFailReport* and if the RPLMN is equal to *plmn-Identity* stored in *VarConnEstFailReport*:

2> set *timeSinceFailure* in *VarConnEstFailReport* to the time that elapsed since the last connection establishment failure or connection resume failure in NR;

2> set the *connEstFailReport* in the *UEInformationResponse* message to the value of *connEstFailReport* in *VarConnEstFailReport*;

2> discard the *connEstFailReport* from *VarConnEstFailReport* upon successful delivery of the *UEInformationResponse* message confirmed by lower layers;

...

8.1.6.2.4.3 Test description

8.1.6.2.4.3.1 Pre-test conditions

System Simulator:

- NR Cell 1 is the serving cell and E-UTRA Cell 1 is the inter-RAT neighbour cell of NR Cell 1
- System information combination NR-6 as defined in TS 38.508-1 [4] clause 4.4.3.1.2.

Preamble:

- The UE is in state 1N-A as defined in TS 38.508-1 [4], subclause 4.4A.

8.1.6.2.4.3.2 Test procedure sequence

Table 8.1.6.2.4.3.2-1 and 8.1.6.2.4.3.2-2 illustrates the downlink power levels and other changing parameters to be applied for the cells at various time instants of the test execution. Row marked "T0" denotes the initial conditions after preamble, while columns marked "T1" is to be applied subsequently. The exact instants on which these values shall be applied are described in the texts in this clause.

Table 8.1.6.2.4.3.2-1: Time instances of cell power level and parameter changes for FR1

	Parameter	Unit	NR Cell 1	E-UTRA Cell 1	Remark
T0	SS/PBCH SSS EPRE	dBm/S CS	-78	-	Only NR Cell 1 is available.
	Cell-specific RS EPRE	dBm/15 kHz	-	Off	
T1	SS/PBCH SSS EPRE	dBm/S CS	-78	-	NR Cell 1 and E-UTRA Cell 1 are available.
	Cell-specific RS EPRE	dBm/15 kHz	-	-90	

Table 8.1.6.2.4.3.2-2: Time instances of cell power level and parameter changes for FR2

	Parameter	Unit	NR Cell 1	E-UTRA Cell 1	Remark
T0	SS/PBCH SSS EPRE	dBm/S CS	FFS	-	Only NR Cell 1 is available.
	Cell-specific RS EPRE	dBm/15 kHz	-	Off	
T1	SS/PBCH SSS EPRE	dBm/S CS	FFS	-	NR Cell 1 and E-UTRA Cell 1 are available.
	Cell-specific RS EPRE	dBm/15 kHz	-	FFS	

Table 8.1.6.2.4.3.2-3: Main behaviour

St	Procedure	Message Sequence		TP	Verdict
		U - S	Message		
1	The SS changes NR Cell 1 and E-UTRA Cell 1 parameter according to the row "T1" in Table 8.1.6.2.4.3.2-1/2.	-	-	-	-
2	The SS waits for [30s] to ensure that the UE detects E-UTRA cell.	-	-	-	-
3	The SS transmits a <i>Paging</i> message on NR Cell 1.	<--	NR RRC: <i>Paging</i>	-	-
4	The UE transmits an <i>RRCSetupRequest</i> message.	-->	NR RRC: <i>RRCSetupRequest</i>	-	-
5	The SS waits for 2sec (T300 expiry) and ignores further received Random Access Preamble.	-	-	-	-
6	The SS transmits a <i>Paging</i> message on NR Cell 1.	<--	NR RRC: <i>Paging</i>	-	-
7	The UE transmits an <i>RRCSetupRequest</i> message on NR Cell 1.	-->	NR RRC: <i>RRCSetupRequest</i>	-	-
8	The SS transmits an <i>RRCSetup</i> message on NR Cell 1.	<--	NR RRC: <i>RRCSetup</i>	-	-
9	Check: Does the UE transmit an <i>RRCSetupComplete</i> message including <i>connEstFailInfoAvailable</i> IE set it to <i>true</i> ? UE initiates the session management procedure	-->	NR RRC: <i>RRCSetupComplete</i> 5GMM: SERVICE REQUEST	1	P

	by including the SERVICE REQUEST message.				
10-13	Steps 5 to 8 of the generic radio bearer establishment procedure in TS 38.508-1 table 4.5.4.2-3	-	-	-	-
14	The SS sends a <i>UEInformationRequest</i> message to get <i>connEstFailReportReq</i> .	<--	<i>UEInformationRequest</i>	-	-
15	Check: Does the UE send a <i>UEInformationResponse</i> message with <i>connEstFailReport</i> containing the measurement result for E-UTRA Cell 1?	-->	<i>UEInformationResponse</i>	2	P

8.1.6.2.4.3.3 Specific message contents

Table 8.1.6.2.4.3.3-1: SIB2 of NR Cell 1(preamble and all steps, Table 8.1.6.2.4.3.2-3)

Derivation Path: TS 38.508-1 [4], Table 4.6.2-1			
Information Element	Value/remark	Comment	Condition
SIB2 ::= SEQUENCE {			
cellReselectionServingFreqInfo SEQUENCE {			
threshServingLowP	10	20 dB	
}			
}			

Table 8.1.6.2.4.3.3-2: SIB5 of NR Cell 1(preamble and all steps, Table 8.1.6.2.4.3.2-3)

Derivation Path: TS 38.508-1 [4], Table 4.6.2-4			
Information Element	Value/remark	Comment	Condition
SIB5 ::= SEQUENCE {			
carrierFreqListEUTRA SEQUENCE (SIZE (1..maxEUTRA-Carrier)) OF CarrierFreqEUTRA {	1 entry		
CarrierFreqEUTRA[1] SEQUENCE {		entry 1	
carrierFreq	Downlink EUTRA ARFCN as E-UTRA Cell 1 used		
}			
cellReselectionPriority	5		
threshX-High	10	20 dB	
threshX-Low	20	40 dB	
}			
}			
t-ReselectionEUTRA	7	7 Seconds	
}			

Table 8.1.6.2.4.3.3-3: RRCSetupComplete (step 9, Table 8.1.6.2.4.3.2-3)

Derivation Path: TS 38.508-1 [4], Table 4.6.1-22			
Information Element	Value/remark	Comment	Condition
RRCSetupComplete ::= SEQUENCE {			
criticalExtensions CHOICE {			
rrcSetupComplete SEQUENCE {			
nonCriticalExtension SEQUENCE {			
ue-MeasurementsAvailable-r16		UE-MeasurementsA vailable-r16 with condition FAIL	
}			
}			
}			
}			

Table 8.1.6.2.4.3.3-4: Void

Table 8.1.6.2.4.3.3-5: *UEInformationResponse* (step 15, Table 8.1.6.2.4.3.2-3)

Derivation Path: TS 38.508-1 [4], Table 4.6.1-32B			
Information Element	Value/remark	Comment	Condition
UEInformationResponse-r16 ::= SEQUENCE {			
criticalExtensions CHOICE {			
ueInformationResponse-r16 SEQUENCE {			
connEstFailReport-r16 SEQUENCE {			
measResultFailedCell-r16 SEQUENCE {			
cgi-Info SEQUENCE {			
plmn-Identity-r16	plmn-Identity within SIB1 broadcasted in NR Cell 1		
cellIdentity-r16	cellIdentity within SIB1 broadcasted in NR Cell 1	BIT STRING (SIZE (36))	
trackingAreaCode-r16	Not present or any allowed value	BIT STRING (SIZE (24))	
}			
measResult-r16 SEQUENCE {			
cellResults-r16	Not present or any allowed value		
rsIndexResults-r16	Not present or any allowed value		
}			
}			
locationInfo-r16	Not checked		
measResultNeighCells-r16 SEQUENCE {			
measResultNeighCellListNR	Not present		
measResultNeighCellListEUTRA	1 entry		
SEQUENCE(SIZE (1..maxFreq)) OF SEQUENCE {			
carrierFreq-r16[1]	Same as E-UTRA Cell 1		
measResultList-r16[1] SEQUENCE (SIZE (1..maxCellReport)) OF SEQUENCE {	1 entry		
eutra-PhysCellId[1]	Same as E-UTRA Cell 1		
measResult[1]	MeasQuantityResults of E-UTRA Cell 1		
}			
}			
}			
numberOfConnFail-r16	Not checked	INTEGER (1..8)	
perRAInfoList-r16	Not checked		
timeSinceFailure-r16	Not checked	INTEGER (0..172800)	
}			
}			
}			
}			

8.1.6.3 Inter-System MDT

8.1.6.3.1 Inter-System MDT / Immediate MDT

8.1.6.3.1.1 Inter-System MDT / Immediate MDT / Measurement reporting / Bluetooth measurement collection

8.1.6.3.1.1.1 Test Purpose (TP)

(1)

```
with { UE is in RRC_CONNECTED state and supports Bluetooth measurements and receives the
ReportConfigNR in RRCReconfiguration message with includeBT-Meas and measurement configured for
event A2 and a Bluetooth beacon is included in BT-NameList }
ensure that {
  when { Entry condition for event A2 is met and Bluetooth measurement results that has not been
reported is available }
  then { UE sends MeasurementReport message with LogMeasResultBT including Bluetooth measurement
results corresponding to BT-Name included in includeBT-Meas }
}
```

(2)

```
with { UE is in RRC_CONNECTED state and supports Bluetooth measurements and receives the
ReportConfigNR in RRCReconfiguration message with includeBT-Meas and measurement configured for
event A2 and a Bluetooth beacon is not included in BT-NameList }
ensure that {
  when { Entry condition for event A2 is met }
  then { UE sends MeasurementReport message with LogMeasResultBT not including Bluetooth
measurement results of the Bluetooth beacon not included in BT-Name }
}
```

8.1.6.3.1.1.2 Conformance requirements

References: The conformance requirements covered in the current TC is specified in: TS 38.331 clause 5.3.5.3, 5.5.4.1, 5.5.4.3, 5.5.5.1.

[TS 38.331, clause 5.3.5.3]

The UE shall perform the following actions upon reception of the *RRCReconfiguration*, or upon execution of the conditional reconfiguration (CHO or CPC):

...

- 1> if the *RRCReconfiguration* message includes the *measConfig*:
- 2> perform the measurement configuration procedure as specified in 5.5.2;

...

[TS 38.331, clause 5.5.4.1]

If AS security has been activated successfully, the UE shall:

- 1> for each *measId* included in the *measIdList* within *VarMeasConfig*:
- 2> if the corresponding *reportConfig* includes a *reportType* set to *eventTriggered* or *periodical*:
- 3> if the corresponding *measObject* concerns NR:
 - 4> if the corresponding *reportConfig* includes *measRSSI-ReportConfig*:
 - 5> consider the resource indicated by the *rmtc-Config* on the associated frequency to be applicable;
 - 4> if the *eventA1* or *eventA2* is configured in the corresponding *reportConfig*:
 - 5> consider only the serving cell to be applicable;

- 4> if the *eventA3* or *eventA5* is configured in the corresponding *reportConfig*:
 - 5> if a serving cell is associated with a *measObjectNR* and neighbours are associated with another *measObjectNR*, consider any serving cell associated with the other *measObjectNR* to be a neighbouring cell as well;
- 4> if corresponding *reportConfig* includes *reportType* set to *periodical*; or
- 4> for measurement events other than *eventA1* or *eventA2*:
 - 5> if *useWhiteCellList* is set to *true*:
 - 6> consider any neighbouring cell detected based on parameters in the associated *measObjectNR* to be applicable when the concerned cell is included in the *whiteCellsToAddModList* defined within the *VarMeasConfig* for this *measId*;
 - 5> else:
 - 6> consider any neighbouring cell detected based on parameters in the associated *measObjectNR* to be applicable when the concerned cell is not included in the *blackCellsToAddModList* defined within the *VarMeasConfig* for this *measId*;
- ...
- 2> if the *reportType* is set to *eventTriggered* and if the entry condition applicable for this event, i.e. the event corresponding with the *eventId* of the corresponding *reportConfig* within *VarMeasConfig*, is fulfilled for one or more applicable cells for all measurements after layer 3 filtering taken during *timeToTrigger* defined for this event within the *VarMeasConfig*, while the *VarMeasReportList* does not include a measurement reporting entry for this *measId* (a first cell triggers the event):
 - 3> include a measurement reporting entry within the *VarMeasReportList* for this *measId*;
 - 3> set the *numberOfReportsSent* defined within the *VarMeasReportList* for this *measId* to 0;
 - 3> include the concerned cell(s) in the *cellsTriggeredList* defined within the *VarMeasReportList* for this *measId*;
 - 3> if *useT312* is set to *true* in *reportConfig* for this event:
 - 4> if T310 for the corresponding SpCell is running; and
 - 4> if T312 is not running for corresponding SpCell:
 - 5> start timer T312 for the corresponding SpCell with the value of T312 configured in the corresponding *measObjectNR*;
 - 3> initiate the measurement reporting procedure, as specified in 5.5.5;
- 2> else if the *reportType* is set to *eventTriggered* and if the entry condition applicable for this event, i.e. the event corresponding with the *eventId* of the corresponding *reportConfig* within *VarMeasConfig*, is fulfilled for one or more applicable cells not included in the *cellsTriggeredList* for all measurements after layer 3 filtering taken during *timeToTrigger* defined for this event within the *VarMeasConfig* (a subsequent cell triggers the event):
 - 3> set the *numberOfReportsSent* defined within the *VarMeasReportList* for this *measId* to 0;
 - 3> include the concerned cell(s) in the *cellsTriggeredList* defined within the *VarMeasReportList* for this *measId*;
 - 3> if *useT312* is set to *true* in *reportConfig* for this event:
 - 4> if T310 for the corresponding SpCell is running; and
 - 4> if T312 is not running for corresponding SpCell:
 - 5> start timer T312 for the corresponding SpCell with the value of T312 configured in the corresponding *measObjectNR*;

- 3> initiate the measurement reporting procedure, as specified in 5.5.5;
- 2> else if the *reportType* is set to *eventTriggered* and if the leaving condition applicable for this event is fulfilled for one or more of the cells included in the *cellsTriggeredList* defined within the *VarMeasReportList* for this *measId* for all measurements after layer 3 filtering taken during *timeToTrigger* defined within the *VarMeasConfig* for this event:
 - 3> remove the concerned cell(s) in the *cellsTriggeredList* defined within the *VarMeasReportList* for this *measId*;
 - 3> if *reportOnLeave* is set to *true* for the corresponding reporting configuration:
 - 4> initiate the measurement reporting procedure, as specified in 5.5.5;
 - 3> if the *cellsTriggeredList* defined within the *VarMeasReportList* for this *measId* is empty:
 - 4> remove the measurement reporting entry within the *VarMeasReportList* for this *measId*;
 - 4> stop the periodical reporting timer for this *measId*, if running;
- 2> else if the *reportType* is set to *eventTriggered* and if the entry condition applicable for this event, i.e. the event corresponding with the *eventId* of the corresponding *reportConfig* within *VarMeasConfig*, is fulfilled for one or more applicable transmission resource pools for all measurements taken during *timeToTrigger* defined for this event within the *VarMeasConfig*, while the *VarMeasReportList* does not include a measurement reporting entry for this *measId* (a first transmission resource pool triggers the event):
 - 3> include a measurement reporting entry within the *VarMeasReportList* for this *measId*;
 - 3> set the *numberOfReportsSent* defined within the *VarMeasReportList* for this *measId* to 0;
 - 3> include the concerned transmission resource pool(s) in the *poolsTriggeredList* defined within the *VarMeasReportList* for this *measId*;
 - 3> initiate the measurement reporting procedure, as specified in 5.5.5;
- 2> else if the *reportType* is set to *eventTriggered* and if the entry condition applicable for this event, i.e. the event corresponding with the *eventId* of the corresponding *reportConfig* within *VarMeasConfig*, is fulfilled for one or more applicable transmission resource pools not included in the *poolsTriggeredList* for all measurements taken during *timeToTrigger* defined for this event within the *VarMeasConfig* (a subsequent transmission resource pool triggers the event):
 - 3> set the *numberOfReportsSent* defined within the *VarMeasReportList* for this *measId* to 0;
 - 3> include the concerned transmission resource pool(s) in the *poolsTriggeredList* defined within the *VarMeasReportList* for this *measId*;
 - 3> initiate the measurement reporting procedure, as specified in 5.5.5;
- 2> else if the *reportType* is set to *eventTriggered* and if the leaving condition applicable for this event is fulfilled for one or more applicable transmission resource pools included in the *poolsTriggeredList* defined within the *VarMeasReportList* for this *measId* for all measurements taken during *timeToTrigger* defined within the *VarMeasConfig* for this event:
 - 3> remove the concerned transmission resource pool(s) in the *poolsTriggeredList* defined within the *VarMeasReportList* for this *measId*;
 - 3> if the *poolsTriggeredList* defined within the *VarMeasReportList* for this *measId* is empty:
 - 4> remove the measurement reporting entry within the *VarMeasReportList* for this *measId*;
 - 4> stop the periodical reporting timer for this *measId*, if running

...

[TS 38.331, clause 5.5.4.3]

The UE shall:

- 1> consider the entering condition for this event to be satisfied when condition A2-1, as specified below, is fulfilled;
- 1> consider the leaving condition for this event to be satisfied when condition A2-2, as specified below, is fulfilled;
- 1> for this measurement, consider the serving cell indicated by the *measObjectNR* associated to this event.

Inequality A2-1 (Entering condition)

$$Ms + Hys < Thresh$$

Inequality A2-2 (Leaving condition)

$$Ms - Hys > Thresh$$

The variables in the formula are defined as follows:

Ms is the measurement result of the serving cell, not taking into account any offsets.

Hys is the hysteresis parameter for this event (i.e. *hysteresis* as defined within *reportConfigNR* for this event).

Thresh is the threshold parameter for this event (i.e. *a2-Threshold* as defined within *reportConfigNR* for this event).

Ms is expressed in dBm in case of RSRP, or in dB in case of RSRQ and RS-SINR.

Hys is expressed in dB.

Thresh is expressed in the same unit as ***Ms***.

[TS 38.331, clause 5.5.5.1]

...

For the *measId* for which the measurement reporting procedure was triggered, the UE shall set the *measResults* within the *MeasurementReport* message as follows:

- 1> set the *measId* to the measurement identity that triggered the measurement reporting;

...

- 1> if the *includeWLAN-Meas* is configured in the corresponding *reportConfig* for this *measId*, set the *wlan-LocationInfo* of the *locationInfo* in the *measResults* as follows:

- 2> if available, include the *LogMeasResultWLAN*, in order of decreasing RSSI for WLAN APs;

- 1> if the *includeBT-Meas* is configured in the corresponding *reportConfig* for this *measId*, set the *BT-LocationInfo* of the *locationInfo* in the *measResults* as follows:

- 2> if available, include the *LogMeasResultBT*, in order of decreasing RSSI for Bluetooth beacons;

- 1> if the *includeSensor-Meas* is configured in the corresponding *reportConfig* for this *measId*, set the *sensor-LocationInfo* of the *locationInfo* in the *measResults* as follows:

- 2> if available, include the *sensor-MeasurementInformation*;

- 2> if available, include the *sensor-MotionInformation*;

...

8.1.6.3.1.1.3 Test description

8.1.6.3.1.1.3.1 Pre-test conditions

System Simulator:

- NR Cell 1, Bluetooth beacon 1 (Cell 40) and Bluetooth beacon 2 (Cell 41)
- Cell 40 and Cell 41 are configured as per 38.508-1 [4] cl 4.4.1.3.2

Preamble:

- The UE is in state 3N-A as defined in TS 38.508-1 [4], subclause 4.4A on NR Cell 1.

8.1.6.3.1.1.3.2 Test procedure sequence

Table 8.1.6.3.1.1.3.2-1 and Table 8.1.6.3.1.1.3.2-1a illustrate the downlink power levels to be applied for NR Cell 1 at various time instants of the test execution. Row marked "T0" denotes the conditions after the preamble, while row marked "T1" is to be applied subsequently. The exact instants on which these values shall be applied are described in the texts in this clause.

Table 8.1.6.3.1.1.3.2-1: Time instances of cell power level and parameter changes for FR1

	Parameter	Unit	NR Cell 1	Cell 40 (Bluetooth beacon 1)	Cell 41 (Bluetooth beacon 2)	Remark
T0	SS/PBCH SSS EPRE	dBm/SC S	-78			Power level is such that $Ms > Thresh + Hys$
	BeaconRSSI	dBm		-80	-50	
T1	SS/PBCH SSS EPRE	dBm/SC S	-96			Power level is such that entry condition for event A2 is satisfied $Ms + Hys$ $< Thresh$
	BeaconRSSI	dBm		-80	-50	

Table 8.1.6.3.1.1.3.2-1a: Time instances of cell power level and parameter changes for FR2

	Parameter	Unit	NR Cell 1	Cell 40 (Bluetooth beacon 1)	Cell 41 (Bluetooth beacon 2)	Remark
T0	SS/PBCH SSS EPRE	dBm/SC S	-82			Power level is such that $Ms > Thresh + Hys$
	BeaconRSSI	dBm		-80	-50	
T1	SS/PBCH SSS EPRE	dBm/SC S	-96			Power level is such that entry condition for event A2 is satisfied $Ms + Hys$ $< Thresh$
	BeaconRSSI	dBm		-80	-50	

Table 8.1.6.3.1.1.3.2-2: Main behaviour

St	Procedure	Message Sequence		TP	Verdict
		U - S	Message		
1	The SS transmits an <i>RRCReconfiguration</i> message including <i>measConfig</i> to setup intra NR measurement and reporting for event A2 with <i>includeBT-Meas-r16</i> configured.	<--	NR RRC: <i>RRCReconfiguration</i>	-	-
2	The UE transmits an <i>RRCReconfigurationComplete</i> message.	-->	NR RRC: <i>RRCReconfigurationComplete</i>	-	-
3	The SS re-adjusts the SS/PBCH EPRE level according to row "T1" in Table 8.1.6.3.1.1.3.2-1/1a.	-	-	-	-
4	Check: Does the UE transmit a <i>MeasurementReport</i> message to report event A2 with the <i>LogMeasResultBT</i> including one entry (Bluetooth beacon 1) measurement result?	-->	NR RRC: <i>MeasurementReport</i>	1,2	P

8.1.6.3.1.1.3.3 Specific message contents

Table 8.1.6.3.1.1.3.3-1: *RRCReconfiguration* (step 1 Table 8.1.6.3.1.1.3.2-2)

Derivation Path: TS 38.508-1 [4], Table 4.6.1-13 with condition NR_MEAS

Table 8.1.6.3.1.1.3.3-2: MeasConfig (Table 8.1.6.3.1.1.3.3-1)

Derivation Path: TS 38.508-1 [4] Table 4.6.3-69			
Information Element	Value/Remark	Comment	Condition
measConfig ::= SEQUENCE {			
measObjectToAddModList SEQUENCE (SIZE (1..maxNrofObjectId)) OF MeasObjectToAddMod {	1 entry		
MeasObjectToAddMod[1] SEQUENCE {		entry 1	
measObjectId	1		
measObject CHOICE {			
measObjectNR	MeasObjectNR(57)	Thres=57(-100dBm ≤ SS-RSRP < -99dBm)	
}			
}			
reportConfigToAddModList SEQUENCE (SIZE (1..maxReportConfigId)) OF ReportConfigToAddMod {	1 entry		
ReportConfigToAddMod[1] SEQUENCE {		entry 1	
reportConfigId	1		
reportConfig	ReportConfigNR-EventA2		
}			
}			
measIdToAddModList SEQUENCE (SIZE (1..maxNrofMeasId)) OF MeasIdToAddMod {	1 entry		
MeasIdToAddMod[1] SEQUENCE {		entry 1	
measId	1		
measObjectId	1		
reportConfigId	1		
}			
}			
}			

Table 8.1.6.3.1.1.3.3-3: ReportConfigNR-EventA2 (Table 8.1.6.3.1.1.3.3-2)

Derivation Path: TS 38.508-1 [4], Table 4.6.3-142 with condition EVENT_A2			
Information Element	Value/remark	Comment	Condition
ReportConfigNR ::= SEQUENCE {			
reportType CHOICE {			
eventTriggered SEQUENCE {			
eventId CHOICE {			
eventA2 SEQUENCE {			EVENT_A2
a2-Threshold CHOICE {			
rsrp	69	-88dBm ≤ SS-RSRP < -87dBm	FR1/FR2
}			
hysteresis	0	0 dB	FR1/FR2
}			
}			
includeBT-Meas-r16 SEQUENCE (SIZE (1..maxBT-Name-r16)) OF BT-Name-r16 {	1 entry		
BT-Name-r16[1]	Set the value as per Cell 40	OCTET STRING (SIZE (1..248)) Refers to LOCAL NAME defined in Bluetooth specification	
}			
}			
}			

(2)

```

with { UE is in RRC_CONNECTED state and supports WLAN measurements and receives the ReportConfigNR
in RRCReconfiguration message with includeWLAN-Meas and measurement configured for event A2 and a
WLAN node is not included in WLAN-NameList }
ensure that {
  when { Entry condition for event A2 is met }
  then { UE sends MeasurementReport message with LogMeasResultWLAN not including WLAN measurement
results of the WLAN node not included in WLAN-NameList }
}
    
```

8.1.6.3.1.2.2 Conformance requirements

Same as test case 8.1.6.3.1.1.

8.1.6.3.1.2.3 Test description

8.1.6.3.1.2.3.1 Pre-test conditions

System Simulator:

- NR Cell 1, WLAN AP 1 (Cell 27) and WLAN AP 2 (Cell 27b)
- Cell 27 and Cell 27b are configured as per TS 38.508-1 [4] cl 4.4.1.3 with the OFFLOAD condition

Preamble:

- The UE is in state 3N-A as defined in TS 38.508-1 [4], subclause 4.4A on NR Cell 1.

8.1.6.3.1.2.3.2 Test procedure sequence

Table 8.1.6.3.1.2.3.2-1 and Table 8.1.6.3.1.2.3.2-1a illustrate the downlink power levels to be applied for NR Cell 1 at various time instants of the test execution. Row marked "T0" denotes the conditions after the preamble, while row marked "T1" is to be applied subsequently. The exact instants on which these values shall be applied are described in the texts in this clause.

Table 8.1.6.3.1.2.3.2-1: Time instances of cell power level and parameter changes for FR1

	Parameter	Unit	Cell 1	Cell 27 (WLAN AP1)	Cell 27b (WLAN AP2)	Remark
T0	SS/PBCH SSS EPRE	dBm/SC S	-78			Power level is such that $M_s > Thresh + Hys$
	BeaconRSSI	dBm		-60	-50	
T1	SS/PBCH SSS EPRE	dBm/SC S	-96			Power level is such that entry condition for event A2 is satisfied $M_s + Hys$ $< Thresh$
	BeaconRSSI	dBm		-60	-50	

Table 8.1.6.3.1.2.3.2-1a: Time instances of cell power level and parameter changes for FR2

	Parameter	Unit	Cell 1	Cell 27 (WLAN AP1)	Cell 27b (WLAN AP2)	Remark
T0	SS/PBCH SSS EPRE	dBm/SC S	-82			Power level is such that $M_s > Thresh + Hys$
	BeaconRSSI	dBm		-60	-50	
T1	SS/PBCH SSS EPRE	dBm/SC S	-96			Power level is such that entry condition for event A2 is satisfied $M_s + Hys$ $< Thresh$
	BeaconRSSI	dBm		-60	-50	

Table 8.1.6.3.1.2.3.2-2: Main behaviour

St	Procedure	Message Sequence		TP	Verdict
		U - S	Message		
1	The SS transmits an <i>RRCReconfiguration</i> message including <i>measConfig</i> to setup intra NR measurement and reporting for event A2 with <i>includeWLAN-Meas-r16</i> configured.	<--	NR RRC: <i>RRCReconfiguration</i>	-	-
2	The UE transmits an <i>RRCReconfigurationComplete</i> message.	-->	NR RRC: <i>RRCReconfigurationComplete</i>	-	-
3	The SS re-adjusts the SS/PBCH EPRE level according to row "T1" in Table 8.1.6.3.1.2.3.2-1/1a.	-	-	-	-
4	Check: Does the UE transmit a <i>MeasurementReport</i> message to report event A2 with the <i>LogMeasResultWLAN</i> including one entry (WLAN AP 1) measurement result?	-->	NR RRC: <i>MeasurementReport</i>	1,2	P

8.1.6.3.1.2.3.3 Specific message contents

Same as test case 8.1.6.3.1.1 with the following difference:

Table 8.1.6.3.1.2.3.3-1: ReportConfigNR-EventA2 (Table 8.1.6.3.1.1.3.3-2)

Derivation Path: TS 38.508-1 [4], Table 4.6.3-142 with condition EVENT_A2 and MDT_WLAN			
Information Element	Value/remark	Comment	Condition
ReportConfigNR ::= SEQUENCE {			
reportType CHOICE {			
eventTriggered SEQUENCE {			
eventId CHOICE {			
eventA2 SEQUENCE {			EVENT_A2
a2-Threshold CHOICE {			
rsrp	69	-88dBm ≤ SS-RSRP <- 87dBm	FR1/FR2
}			
hysteresis	0	0 dB	FR1/FR2
}			
}			
reportAmount	r1		
includeWLAN-Meas-r16 CHOICE {	1 entry		
Setup SEQUENCE (SIZE (1..maxWLAN-Name-r16)) OF WLAN-Name-r16 {			
WLAN-Name-r16 [1]	Set the value as per Cell 27	OCTET STRING (SIZE (1..32)) Refers to Service Set Identifier (SSID) defined in IEEE 802.11-2012	
}			
}			
}			
}			
}			

Table 8.1.6.3.1.2.3.3-2: MeasurementReport (step 4, Table 8.1.6.3.1.2.3.2-2)

Derivation Path: TS 38.508-1 [4], Table 4.6.1-5A			
Information Element	Value/remark	Comment	Condition
MeasurementReport ::= SEQUENCE {			
criticalExtensions CHOICE {			
measurementReport SEQUENCE {			
measResults SEQUENCE {			
measId	1		

measResultServingMOList SEQUENCE {	1 entry		
servCellId	ServCellIndex of NR Cell 1		
measResultServingCell SEQUENCE {			
physCellId	Physical CellID of the NR Cell 1		
measResult SEQUENCE {			
cellResults SEQUENCE {			
resultsSSB-Cell SEQUENCE {			
rsrp	(0..127)		
rsrq	(0..127)		
sinr	Not present		
	(0..127)		pc_ss_SINR_Meas
}			
}			
}			
}			
locationInfo-r16 SEQUENCE {			MDT_WLAN
commonLocationInfo-r16	Not present		
bt-LocationInfo-r16	Not present		
wlan-LocationInfo-r16 SEQUENCE (SIZE (1..maxWLAN-Id-Report-r16)) OF LogMeasResultWLAN-r16 {	1 entry	Report WLAN AP1	
LogMeasResultWLAN-r16[1] SEQUENCE {	Entry 1		
wlan-Identifiers-r16 SEQUENCE {			
ssid-r16	ssid for WLAN AP 1	OCTET STRING (SIZE (1..32))	
bssid-r16	Not present	OCTET STRING (SIZE (6))	
hessid-r16	Not present	OCTET STRING (SIZE (6))	
}			
rsiWLAN-r16	Any allowed value	INTEGER(0..141)	
rtt-WLAN-r16 SEQUENCE {			
rttValue-r16	Any allowed value	INTEGER(0..16777215)	
rttUnits-r16	Any allowed value		
rttAccuracy-r16	Any allowed value	INTEGER(0..255)	
}			
}			
sensor-LocationInfo-r16	Not present		
}			
}			
}			
}			

8.1.6.3.1.3 Inter-System MDT / Immediate MDT / Measurement reporting / Sensor measurement collection

8.1.6.3.1.3.1 Test Purpose (TP)

(1)

```
with { UE is in RRC_CONNECTED state and supports sensor measurements and receives the ReportConfigNR in RRCReconfiguration message with include Sensor-Meas and measurement configured for event A2 and a sensor type is included in Sensor-NameList }
ensure that {
  when { Entry condition for event A2 is met and sensor measurement results that has not been reported is available }
  then { UE sends MeasurementReport message with MeasResults including sensor measurement results corresponding to Sensor-NameList, and the measurement results of the sensors that are not in the Sensor-NameList are not included }
}
```

(2) Void

8.1.6.3.1.3.2 Conformance requirements

Same as test case 8.1.6.3.1.1.

8.1.6.3.1.3.3 Test description

8.1.6.3.1.3.3.1 Pre-test conditions

System Simulator:

- NR Cell 1

UE:

- The UE at least contains one sensor that supports UE orientation measurement, and optionally contains other sensors to do barometric pressure, UE motion speed etc.

Preamble:

- The UE is in state 3N-A on NR Cell 1 as defined in TS 38.508-1 [4], subclause 4.4A.

8.1.6.3.1.3.3.2 Test procedure sequence

Tables 8.1.6.3.1.3.3.2-1/2 illustrate the downlink power levels. Row marked "T0" denotes the conditions after the preamble.

Table 8.1.6.3.1.3.3.2-1: Time instances of cell power level and parameter changes (FR1)

	Parameter	Unit	NR Cell 1	Remark
T0	SS/PBCH SSS EPRE	dBm/SCS	-78	Power level is such that $M_s > \text{Thresh} + \text{Hys}$
T1	SS/PBCH SSS EPRE	dBm/SCS	-96	Power level is such that entry condition for event A2 is satisfied $M_s + \text{Hys} < \text{Thresh}$

Table 8.1.6.3.1.3.3.2-2: Time instances of cell power level and parameter changes (FR2)

	Parameter	Unit	NR Cell 1	Remark
T0	Cell-specific RS EPRE	dBm/SCS	-82	Power level is such that $M_s > \text{Thresh} + \text{Hys}$

T1	Cell-specific RS EPRE	dBm/SCS	-96	Power level is such that entry condition for event A2 is satisfied $M_s + H_{ys} < Thresh$
----	-----------------------	---------	-----	--

Table 8.1.6.3.1.3.3.2-3: Main behaviour

St	Procedure	Message Sequence		TP	Verdict
		U – S	Message		
1	The SS transmits an <i>RRCReconfiguration</i> message including <i>measConfig</i> to setup intra NR measurement and reporting for event A2 with <i>includeLocationInfo</i> configured.	<--	<i>RRCReconfiguration</i>	-	-
2	The UE transmits an <i>RRCReconfigurationComplete</i> message.	-->	<i>RRCReconfigurationComplete</i>	-	-
3	The SS re-adjusts the cell-specific reference signal level according to row "T1" in tables 8.1.6.3.1.3.3.2-1/2.	-	-	-	-
4	Check: Does the UE transmit a <i>MeasurementReport</i> message to report event A2 with <i>MeasResults</i> including sensor measurement results corresponding to <i>Sensor-NameList</i> ?	-->	<i>MeasurementReport</i>	1	P

8.1.6.3.1.3.3.3 Specific message contents

Same as test case 8.1.6.3.1.1 with the following difference:

Table 8.1.6.3.1.3.3.3-1: ReportConfigNR-EventA2 (Table 8.1.6.3.1.1.3.3-2)

Derivation Path: TS 38.508-1 [4], Table 4.6.3-142, Condition EVENT_A2			
Information Element	Value/remark	Comment	Condition
ReportConfigNR ::= SEQUENCE {			
reportType CHOICE {			
eventTriggered SEQUENCE {			
eventId CHOICE {			
eventA2 SEQUENCE {			EVENT_A2
a2-Threshold CHOICE {			
rsrp	69	-88dBm ≤ SS-RSRP < -87dBm	FR1/FR2
}			
hysteresis	0		
}			
}			
includeSensor-Meas-r16 CHOICE {			
setup	Sensor-NameList-r16		
}			
}			
}			

Table 8.1.6.3.1.3.3.3-2: Sensor-NameList-r16 (Table 8.1.6.3.1.3.3.3-1)

Derivation Path: TS 38.508-1 [4], Table 4.6.5-13			
Information Element	Value/remark	Comment	Condition
Sensor-NameList-r16 ::= SEQUENCE {			

measUncomBarPre-r16	true		pc_barometer_r16
	Not present		
measUeSpeed	true		pc_speed_r16
	Not present		
measUeOrientation	true		pc_orientation_r16
	Not present		
}			

Table 8.1.6.3.1.3.3.3-3: MeasurementReport (step 4, Table 8.1.6.3.1.3.3.2-3)

Derivation Path: TS 38.508-1 [4], Table 4.6.1-5A			
Information Element	Value/remark	Comment	Condition
MeasurementReport ::= SEQUENCE {			
criticalExtensions ::= CHOICE {			
measurementReport ::= SEQUENCE {			
MeasResults ::= SEQUENCE {			
measId	1		
measResultServingMOList SEQUENCE (SIZE (1..maxNrofServingCells)) OF MeasResultServMO {	1 entry		
MeasResultServMO[1] SEQUENCE {		entry 1	
servCellId	ServCellIndex		
measResultServingCell SEQUENCE {			
physCellId	PhysicalCellIdentity of Cell 1		
measResult SEQUENCE {			
cellResults SEQUENCE {			
resultsSSB-Cell SEQUENCE {			
rsrp	(0..127)		
rsrq	(0..127)		
sinr	Not checked		
}			
}			
}			
}			
}			
}			
}			
locationInfo-r16 SEQUENCE {			
commonLocationInfo-r16	Not present		
bt-LocationInfo-r16	Not present		
wlan-LocationInfo-r16	Not present		
sensor-LocationInfo-r16 SEQUENCE {			
sensor-MeasurementInformation-r16	Not present		
sensor-MeasurementInformation-r16	OCTET STRING including Sensor-MeasurementInformation-r13 according to TS 37.355 cl 6.5.5.2		pc_barometer_r16
sensor-MeasurementInformation-r16	Not present		
sensor-MotionInformation-r16	OCTET STRING including Sensor-MotionInformation-r15 according to TS 37.355 cl 6.5.5.2		pc_orientation_r16 OR pc_speed_r16
}			
}			
}			

8.1.6.3.2 Inter-System MDT / Logged MDT

8.1.6.3.2.1 Inter-System MDT / Logged MDT / Logging and reporting / Bluetooth measurement collection

8.1.6.3.2.1.1 Test Purpose (TP)

(1)

```

with { UE received RRCSetup message }
ensure that {
  when { UE has Bluetooth logged measurements available and plmn-Identity stored in VarRLF-Report is equal to the RPLMN }
  then { UE transmits the logMeasAvailableBT in the RRCSetupComplete message }
}

```

(2)

```

with { UE in NR RRC_CONNECTED state and UE has Bluetooth logged measurements available and the RPLMN is included in plmn-IdentityList stored in VarLogMeasReport }
ensure that {
  when { receiving UEInformationRequest message with logMeasReportReq set to true }
  then { UE transmits UEInformationResponse messages with LogMeasInfo-r16 including logMeasResultListBT }
}

```

(3)

```

with { UE has Bluetooth logged measurements available and the RPLMN is included in plmn-IdentityList stored in VarLogMeasReport and a Bluetooth beacon is not included in BT-NameList }
ensure that {
  when { UE in NR RRC_CONNECTED state and receiving UEInformationRequest message with logMeasReportReq set to true }
  then { UE transmits UEInformationResponse messages with LogMeasInfo-r16 not including the measurement result of the Bluetooth beacon not included in BT-NameList }
}

```

8.1.6.3.2.1.2 Conformance requirements

References: The conformance requirements covered in the present TC are specified in: TS 38.331 clauses 5.5a.1.3, 5.5a.3.2, 5.3.3.7. Unless otherwise stated these are Rel-16 requirements

[TS 38.331, clause 5.5a.1.3]

Upon receiving the *LoggedMeasurementConfiguration* message the UE shall:

- 1> discard the logged measurement configuration as well as the logged measurement information as specified in 5.5a.2;
- 1> store the received *loggingDuration*, *reportType* and *areaConfiguration*, if included, in *VarLogMeasConfig*;
- 1> if the *LoggedMeasurementConfiguration* message includes *plmn-IdentityList*:
 - 2> set *plmn-IdentityList* in *VarLogMeasReport* to include the RPLMN as well as the PLMNs included in *plmn-IdentityList*;
- 1> else:
 - 2> set *plmn-IdentityList* in *VarLogMeasReport* to include the RPLMN;
- 1> store the received *absoluteTimeInfo*, *traceReference*, *traceRecordingSessionRef*, and *tce-Id* in *VarLogMeasReport*;
- 1> store the received *bt-NameList*, if included, in *VarLogMeasConfig*;
- 1> store the received *wlan-NameList*, if included, in *VarLogMeasConfig*;

- 1> store the received sensor-NameList, if included, in VarLogMeasConfig;
- 1> start timer T330 with the timer value set to the loggingDuration;

[TS 38.331, clause 5.5a.3.2]

While T330 is running, the UE shall:

- 1> perform the logging in accordance with the following:
 - 2> if the reportType is set to periodical in the VarLogMeasConfig:
 - 3> if the UE is in any cell selection state (as specified in TS 38.304 [20]); or
 - 3> if the UE is in camped normally state on an NR cell and if the RPLMN is included in *plmn-IdentityList* stored in *VarLogMeasReport*:
 - 4> if areaConfiguration is not included in VarLogMeasConfig; or
 - 4> if the serving cell is part of the area indicated by areaConfig in areaConfiguration in VarLogMeasConfig:
 - 5> perform the logging at regular time intervals, as defined by the *loggingInterval* in the *VarLogMeasConfig*;

...

- 2> when performing the logging:

...

- 3> if location information became available during the last logging interval, set the content of the *locationInfo* as in 5.3.3.7:

[TS 38.331, clause 5.3.3.7]

The UE shall:

- 1> if timer T300 expires:

...

- 2> store the following connection establishment failure information in the *VarConnEstFailReport* by setting its fields as follows:

...

- 3> if available, set the *locationInfo* as follows:
 - 4> if available, set the *commonLocationInfo* to include the detailed location information;
 - 4> if available, set the *bt-LocationInfo* to include the Bluetooth measurement results, in order of decreasing RSSI for Bluetooth beacons;
 - 4> if available, set the *wlan-LocationInfo* to include the WLAN measurement results, in order of decreasing RSSI for WLAN APs;
 - 4> if available, set the *sensor-LocationInfo* to include the sensor measurement results as follows:
 - 5> if available, include the *sensor-MeasurementInformation*;
 - 5> if available, include the *sensor-MotionInformation*;

8.1.6.3.2.1.3 Test description

8.1.6.3.2.1.3.1 Pre-test conditions

System Simulator:

- NR Cell 1, Bluetooth beacon 1 (Cell 40) and Bluetooth beacon 2 (Cell 41)
- Cell 40 and Cell 41 are configured as per TS 38.508-1 [4] cl 4.4.1.3.2

UE:

None

Preamble:

- The UE is in state 3N-A on NR Cell 1 as defined in TS 38.508-1 [4], subclause 4.4A.

8.1.6.3.2.1.3.2 Test procedure sequence

Table 8.1.6.3.2.1.3.2-1/2 illustrates the downlink power levels. Row marked "T0" denotes the conditions after the preamble.

Table 8.1.6.3.2.1.3.2-1: Time instances of cell power level and parameter changes (FR1)

	Parameter	Unit	NR Cell 1	Cell 40 (Bluetooth beacon 1)	Cell 41 (Bluetooth beacon 2)	Remark
T0	SS/PBCH SSS EPRE	dBm/ SCS	-85			
	BeaconRSSI	dBm		-80	-50	

Table 8.1.6.3.2.1.3.2-2: Time instances of cell power level and parameter changes (FR2)

	Parameter	Unit	NR Cell 1	Cell 40 (Bluetooth beacon 1)	Cell 41 (Bluetooth beacon 2)	Remark
T0	SS/PBCH SSS EPRE	dBm/ SCS	-82			
	BeaconRSSI	dBm		-80	-50	

Table 8.1.6.3.2.1.3.2-3: Main behaviour

St	Procedure	Message Sequence		TP	Verdict
		U - S	Message		
1	SS transmits a <i>LoggedMeasurementConfiguration</i> message to configure the UE to perform logging of measurement results while in RRC_IDLE.	<--	<i>LoggedMeasurementConfiguration</i>	-	-
2	The SS transmits an <i>RRCRelease</i> message.	<--	<i>RRCRelease</i>	-	-
3	Wait 8s to allow UE to activate logging.	-	-	-	-
4	The SS transmits a <i>Paging</i> message on Cell 1.	<--	<i>Paging</i>	-	-
5	The UE transmits an <i>RRCRequest</i> message on Cell 1.	-->	<i>RRCRequest</i>	-	-
6	SS transmit an <i>RRCSetup</i> message on Cell 1.	<--	<i>RRCSetup</i>	-	-
7	Check: Does the UE transmit an <i>RRCSetupComplete</i> message with <i>logMeasAvailableBT</i> on Cell 1?	-->	<i>RRCSetupComplete</i>	1	P
8-11	Steps 5 to 8 of the generic radio bearer establishment procedure in TS 38.508-1 table 4.5.4.2-3 on NR Cell 1.	-	-	-	-

12	The SS transmits a <i>UEInformationRequest</i> message on Cell 1.	<--	<i>UEInformationRequest</i>	-	-
13	Check: Does the UE transmit a <i>UEInformationResponse</i> message with a <i>LogMeasInfo-r16</i> with one entry (Bluetooth beacon 1) measurement result in the IE <i>logMeasResultListBT</i> ?	-->	<i>UEInformationResponse</i>	2,3	P

8.1.6.3.2.1.3.3 Specific message contents

Table 8.1.6.3.2.1.3.3-1: *LoggedMeasurementConfiguration* (step 1, Table 8.1.6.3.2.1.3.2-3)

Derivation path: TS 38.508-1 [4], table 4.6.1-5AA with condition PERIODICAL			
Information Element	Value/remark	Comment	Condition
<i>LoggedMeasurementConfiguration-r16</i> ::= SEQUENCE {			
criticalExtensions CHOICE {			
loggedMeasurementConfiguration-r16 SEQUENCE {			
bt-NameList-r16 SEQUENCE { SIZE (1..maxBT-Name-r16) OF	1 entry	Bluetooth beacon 1	
BT-Name-r16[1]	Set as per Table 4.4.9-1 of 3GPP TS 36.508	OCTET STRING (SIZE (1..248)) Refers to LOCAL NAME defined in Bluetooth specification	
}			
reportType CHOICE {			
periodical SEQUENCE {			
loggingInterval-r16	ms10240	10.24s	
}			
}			
}			
}			
}			

Table 8.1.6.3.2.1.3.3-2: *RRCSetupComplete* (step 7, Table 8.1.6.3.2.1.3.2-3)

Derivation path: TS 38.508-1 [4], table 4.6.1-22			
Information Element	Value/remark	Comment	Condition
<i>RRCSetupComplete</i> ::= SEQUENCE {			
rrc-TransactionIdentifier	Not checked		
criticalExtensions CHOICE {			
rrcSetupComplete SEQUENCE {			
nonCriticalExtension SEQUENCE {			
iab-NodeIndication-r16	Not checked		
idleMeasAvailable-r16	Not checked		
ue-MeasurementsAvailable-r16	UE-MeasurementsAvailable-r16 with condition LOG and BT		
mobilityHistoryAvail-r16	Not checked		
mobilityState-r16	Not checked		
nonCriticalExtension	Not checked		
}			
}			
}			
}			

Table 8.1.6.3.2.1.3.3-3: *UEInformationRequest* (step 12, Table 8.1.6.3.2.1.3.2-3)

Derivation Path: TS 38.508-1 [4], table 4.6.1-32A with Condition LOG
--

Table 8.1.6.3.2.1.3.3-4: UEInformationResponse (step 13, Table 8.1.6.3.2.1.3.2-3)

Derivation Path: TS 38.508-1 [4], table 4.6.1-32B			
Information Element	Value/remark	Comment	Condition
UEInformationResponse-r16 ::= SEQUENCE {			
criticalExtensions CHOICE {			
ueInformationResponse-r16 SEQUENCE {			
logMeasReport-r16 SEQUENCE {			
absoluteTimeStamp-r16	Same value as sent by SS in LoggedMeasurementConfiguration in step 1		
traceReference-r16	Same value as sent by SS in LoggedMeasurementConfiguration in step 1		
traceRecordingSessionRef-r16	Same value as sent by SS in LoggedMeasurementConfiguration in step 1		
tce-Id-r16	Same value as sent by SS in LoggedMeasurementConfiguration in step 1		
logMeasInfoList-r16 SEQUENCE (SIZE (1..maxLogMeasReport-r16)) OF LogMeasInfo-r16 {			
LogMeasInfo-r16[1] SEQUENCE {		1 entry	
locationInfo-r16 SEQUENCE {			
commonLocationInfo-r16	Not checked		
bt-LocationInfo-r16 SEQUENCE {			
LogMeasResultListBT-r16 ::= SEQUENCE (SIZE (1..maxBT-IdReport-r16)) OF LogMeasResultBT-r16 {	1 entry		
LogMeasResultBT-r16[1] SEQUENCE {		Report Bluetooth beacon 1	
bt-Addr-r16	Bluetooth public address of Bluetooth beacon 1	BIT STRING (SIZE (48))	
rssI-BT-r16	Any allowed value	INTEGER (-128..127)	
}			
}			
}			
wlan-LocationInfo-r16	Not present		
sensor-LocationInfo-r16	Not present		
}			
relativeTimeStamp-r16	Any allowed value	INTEGER (0..7200)	
servCellIdentity-r16	Same as Cell 1		
measResultServingCell-r16	Not checked		
measResultNeighCells-r16 SEQUENCE {			
measResultNeighCellListNR	Not present		
measResultNeighCellListEUTRA	Not present		
}			
anyCellSelectionDetected-r16	Not checked		
}			
}			
logMeasAvailable-r16	Not present		
logMeasAvailableBT-r16	Not present		
logMeasAvailableWLAN-r16	Not present		
}			
}			
}			
}			

8.1.6.3.2.2 Inter-System MDT / Logged MDT / Logging and reporting / WLAN measurement collection

8.1.6.3.2.2.1 Test Purpose (TP)

(1)

```
with { UE received RRCSetup message }
ensure that {
  when { UE has WLAN logged measurements available and plmn-Identity stored in VarRLF-Report is
equal to the RPLMN }
  then { UE transmits the RRCSetupComplete message with logMeasAvailable-r16 and
logMeasAvailableWLAN-r16 included }
}
```

(2)

```
with { UE in NR RRC_CONNECTED state and UE has WLAN logged measurements available and the RPLMN is
included in plmn-IdentityList stored in VarLogMeasReport }
ensure that {
  when { receiving UEInformationRequest message with logMeasReportReq set to true }
  then { UE transmits UEInformationResponse messages with LogMeasInfo-r16 including
logMeasResultListWLAN }
}
```

(3)

```
with { UE has WLAN logged measurements available and the RPLMN is included in plmn-IdentityList
stored in VarLogMeasReport and a WLAN AP is not included in wlan-NameList }
ensure that {
  when { UE in NR RRC_CONNECTED state and receiving UEInformationRequest message with
logMeasReportReq set to true }
  then { UE transmits UEInformationResponse messages with LogMeasInfo-r16 not including the
measurement result of the WLAN AP not included in wlan-NameList }
}
```

8.1.6.3.2.2.2 Conformance requirements

Same as test case 8.1.6.3.2.1.

8.1.6.3.2.2.3 Test description

8.1.6.3.2.2.3.1 Pre-test conditions

System Simulator:

- NR Cell 1, WLAN AP 1 (Cell 27) and WLAN AP 2 (Cell 27b)
- Cell 27 and Cell 27b are configured as per TS 38.508-1 [4] cl 4.4.1.3 with the OFFLOAD condition

UE:

None

Preamble:

- The UE is in state 3N-A on NR Cell 1 as defined in TS 38.508-1 [4], subclause 4.4A.

8.1.6.3.2.2.3.2 Test procedure sequence

Table 8.1.6.3.2.2.3.2-1/2 illustrates the downlink power levels. Row marked "T0" denotes the conditions after the preamble.

Table 8.1.6.3.2.3.2-1: Time instances of cell power level and parameter changes (FR1)

	Parameter	Unit	NR Cell 1	Cell 27 (WLAN AP 1)	Cell 27b (WLAN AP 2)	Remark
T0	SS/PBCH SSS EPRE	dBm/ SCS	-85			
	BeaconRSSI	dBm		-60	-50	

Table 8.1.6.3.2.3.2-2: Time instances of cell power level and parameter changes (FR2)

	Parameter	Unit	NR Cell 1	Cell 27 (WLAN AP 1)	Cell 27b (WLAN AP 2)	Remark
T0	SS/PBCH SSS EPRE	dBm/ SCS	-82			
	BeaconRSSI	dBm		-60	-50	

Table 8.1.6.3.2.3.2-3: Main behaviour

St	Procedure	Message Sequence		TP	Verdict
		U - S	Message		
1	SS transmits a <i>LoggedMeasurementConfiguration</i> message including to configure the UE to perform logging of measurement results while in RRC_IDLE.	<--	<i>LoggedMeasurementConfiguration</i>	-	-
2	The SS transmits an <i>RRCRelease</i> message.	<--	<i>RRCRelease</i>	-	-
3	Wait 8s to allow UE to activate logging.	-	-	-	-
4	The SS transmits a <i>Paging</i> message on NR Cell 1.	<--	<i>Paging</i>	-	-
5	The UE transmits an <i>RRCRequest</i> message on NR Cell 1.	-->	<i>RRCRequest</i>	-	-
6	SS transmit an <i>RRCSetup</i> message on NR Cell 1.	<--	<i>RRCSetup</i>	-	-
7	Check: Does the UE transmit an <i>RRCSetupComplete</i> message with <i>logMeasAvailable-r16</i> and <i>logMeasAvailableWLAN-r16</i> on NR Cell 1?	-->	<i>RRCSetupComplete</i>	1	P
8-11	Steps 5 to 8 of the generic radio bearer establishment procedure in TS 38.508-1 [4] table 4.5.4.2-3 on NR Cell 1.	-	-	-	-
12	The SS transmits a <i>UEInformationRequest</i> message on NR Cell 1.	<--	<i>UEInformationRequest</i>	-	-
13	Check: Does the UE transmit a <i>UEInformationResponse</i> message with a <i>LogMeasInfo-r16</i> with one entry (WLAN AP 1) measurement result in the IE <i>logMeasResultListWLAN?</i>	-->	<i>UEInformationResponse</i>	2, 3	P

8.1.6.3.2.3.3 Specific message contents

Same as test case 8.1.6.3.1.1 with the following difference:

Table 8.1.6.3.2.3.3-1: *LoggedMeasurementConfiguration* (step 1, Table 8.1.6.3.2.3.2-3)

Derivation path: TS 38.508-1 [4], Table 4.6.1-5AA with condition PERIODICAL			
Information Element	Value/remark	Comment	Condition
<i>LoggedMeasurementConfiguration-r16</i> ::= SEQUENCE {			
criticalExtensions CHOICE {			
<i>loggedMeasurementConfiguration-r16</i> SEQUENCE {			
wlan-NameList-r16 CHOICE {			
Setup	WLAN-NameList-r16		
}			
}			
reportType CHOICE {			

periodical SEQUENCE {			
loggingInterval-r16	ms10240	10.24s	
}			
}			
}			
}			

Table 8.1.6.3.2.2.3.3-1A: WLAN-NameList-r16 (Table 8.1.6.3.2.2.3.3-1)

Derivation path: TS 38.508-1 [4], table 4.6.5-18			
Information Element	Value/remark	Comment	Condition
WLAN-NameList-r16 ::= SEQUENCE (SIZE (1..maxWLAN-Name-r16)) OF {	1 entry	WLAN AP1	
WLAN-Name-r16[1]	Set as per Table 4.4.8-1 of TS 36.508	OCTET STRING (SIZE (1..32)) Refers to Service Set Identifier (SSID) defined in IEEE 802.11-2012	
}			

Table 8.1.6.3.2.2.3.3-2: RRCSetupComplete (step 7, Table 8.1.6.3.2.2.3.2-3)

Derivation path: TS 38.508-1 [4], Table 4.6.1-22			
Information Element	Value/remark	Comment	Condition
RRCSetupComplete ::= SEQUENCE {			
criticalExtensions CHOICE {			
rrcSetupComplete SEQUENCE {			
nonCriticalExtension SEQUENCE {			
iab-NodeIndication-r16	Not present		
idleMeasAvailable-r16	Not present		
ue-MeasurementsAvailable-r16	UE-MeasurementsAvailable-r16 with condition LOG and WLAN		
mobilityHistoryAvail-r16	Not present		
mobilityState-r16	Not present		
nonCriticalExtension	Not present		
}			
}			
}			
}			

Table 8.1.6.3.2.2.3.3-3: Void

Table 8.1.6.3.2.2.3.3-4: UEInformationResponse (step 13, Table 8.1.6.3.2.2.3.2-3)

Derivation Path: TS 38.508-1 [4], Table 4.6.1-32B			
Information Element	Value/remark	Comment	Condition
UEInformationResponse-r16 ::= SEQUENCE {			
criticalExtensions CHOICE {			
ueInformationResponse-r16 SEQUENCE {			
logMeasReport-r16 SEQUENCE {			
absoluteTimeStamp-r16	Same value as sent by SS in LoggedMeasurementConfiguration in step 1		

traceReference-r16	Same value as sent by SS in LoggedMeasurementConfiguration in step 1		
traceRecordingSessionRef-r16	Same value as sent by SS in LoggedMeasurementConfiguration in step 1		
tce-Id-r16	Same value as sent by SS in LoggedMeasurementConfiguration in step 1		
logMeasInfoList-r16 SEQUENCE (SIZE (1..maxLogMeasReport-r16)) OF LogMeasInfo-r16 {			
LogMeasInfo-r16[1] SEQUENCE {		entry 1	
locationInfo-r16 SEQUENCE {			
commonLocationInfo-r16	Not checked		
bt-LocationInfo-r1	Not present		
wlan-LocationInfo-r16 SEQUENCE (SIZE (1..maxWLAN-Id-Report-r16)) OF LogMeasResultWLAN-r16 {	1 entry	Report WLAN AP 1	
LogMeasResultWLAN-r16[1] SEQUENCE {			
wlan-Identifiers-r16 SEQUENCE {			
ssid-r12	ssid for WLAN AP 1		
bssid-r12	Not present		
hessid-r12	Not present		
}			
rssiWLAN-r16	Any allowed value		
rtt-WLAN-r16	Any allowed value		
}			
}			
sensor-LocationInfo-r16	Not present		
}			
relativeTimeStamp-r16	Any allowed value	INTEGER (0..7200)	
servCellIdentity-r16	Same as NR Cell 1		
measResultServCell-16	Not checked		
measResultNeighCells-r16 SEQUENCE {			
measResultNeighCellListNR	Not present		
measResultNeighCellListEUTRA	Not present		
}			
anyCellSelectionDetected-r16	Not checked		
}			
}			
logMeasAvailable-r16	Not present		
logMeasAvailableWLAN-r16	Not present		
.....logMeasAvailableWLAN-r16	Not present		
}			
}			
}			
}			

8.1.6.3.2.3 Inter-System MDT / Logged MDT / Logging and reporting / Sensor measurement collection

8.1.6.3.2.3.1 Test Purpose (TP)

(1)

```
with { UE in NR RRC_CONNECTED state and UE has logged Sensor information available and the RPLMN is included in plmn-IdentityList stored in VarLogMeasReport }
ensure that {
    when { receiving UEInformationRequest message with logMeasReportReq set to true }
    then { UE transmits UEInformationResponse messages with LogMeasInfo-r16 including Sensor-LocationInfo-r16 }
```

}

(2)

```
with { UE has logged Sensor information available and the RPLMN is included in plmn-IdentityList
stored in VarLogMeasReport and a sensor is not included in sensor-NameList }
ensure that {
  when { UE in NR RRC_CONNECTED state and receiving UEInformationRequest message with
logMeasReportReq set to true }
  then { UE transmits UEInformationResponse messages with LogMeasInfo-r16 not including the
information of the sensor not included in sensor-NameList }
}
```

8.1.6.3.2.3.2 Conformance requirements

Same as test case 8.1.6.3.2.1.

8.1.6.3.2.3.3 Test description

8.1.6.3.2.3.3.1 Pre-test conditions

System Simulator:

- NR Cell 1

UE:

UE supports at least one of pc_barometer_r16, pc_orientation_r16 and pc_speed_r16.

Preamble:

- The UE is in state 3N-A on NR cell 1 as defined in TS 38.508-1 [4], subclause 4.4A.

8.1.6.3.2.3.3.2 Test procedure sequence

Table 8.1.6.3.2.3.3.2-1/2 illustrates the downlink power levels. Row marked "T0" denotes the conditions after the preamble.

Table 8.1.6.3.2.3.3.2-1: Time instances of cell power level and parameter changes (FR1)

	Parameter	Unit	NR Cell 1	Remark
T0	SS/PBCH SSS EPRE	dBm/ SCS	-85	

Table 8.1.6.3.2.3.3.2-2: Time instances of cell power level and parameter changes (FR2)

	Parameter	Unit	NR Cell 1	Remark
T0	SS/PBCH SSS EPRE	dBm/ SCS	-82	

Table 8.1.6.3.2.3.3.2-3: Main behaviour

St	Procedure	Message Sequence		TP	Verdict
		U - S	Message		
1	SS transmits a <i>LoggedMeasurementConfiguration</i> message to configure the UE to perform logging of measurement results while in RRC_IDLE.	<--	<i>LoggedMeasurementConfiguratio n</i>	-	-
2	The SS transmits an <i>RRCRelease</i> message.	<--	<i>RRCRelease</i>	-	-
3	Wait 8s to allow UE to activate logging.	-	-	-	-

4-11	Steps 1 to 8 of the generic radio bearer establishment procedure in TS 38.508-1 table 4.5.4.2-3 on NR Cell 1.	-	-	-	-
12	The SS transmits a <i>UEInformationRequest</i> message on Cell 1.	<--	<i>UEInformationRequest</i>	-	-
13	Check: Does the UE transmit a <i>UEInformationResponse</i> message with a <i>LogMeasInfo-r16</i> with one entry (sensor 1) measurement result in the IE Sensor-LocationInfo-r16?	-->	<i>UEInformationResponse</i>	1,2	P

8.1.6.3.2.3.3.3 Specific message contents

Same as test case 8.1.6.3.2.1 with the following difference:

Table 8.1.6.3.2.3.3.3-1: *LoggedMeasurementConfiguration* (step 1, Table 8.1.6.3.2.3.3.2-3)

Derivation path: TS 38.508-1 [4], table 4.6.1-5AA with condition PERIODICAL			
Information Element	Value/remark	Comment	Condition
LoggedMeasurementConfiguration-r16 ::= SEQUENCE {			
criticalExtensions CHOICE {			
loggedMeasurementConfiguration-r16 SEQUENCE {			
sensor-NameList-r16 SEQUENCE {			
measUncomBarPre-r16	true		pc_barometer_r16
	Not present		
measUeSpeed	true		pc_speed_r16
	Not present		
measUeOrientation	true		pc_orientation_r16
	Not present		
}			
}			
reportType CHOICE {			
periodical SEQUENCE {			
loggingInterval-r16		10.24s	
}			
}			
}			
}			

Table 8.1.6.3.2.3.3.3-2: Void

Table 8.1.6.3.2.3.3.3-3: *UEInformationResponse* (step 13, Table 8.1.6.3.2.3.3.2-3)

Derivation Path: TS 38.508-1 [4], table 4.6.1-32B			
Information Element	Value/remark	Comment	Condition
UEInformationResponse-r16 ::= SEQUENCE {			
rrc-TransactionIdentifier	Not checked		
criticalExtensions CHOICE {			
ueInformationResponse-r16 SEQUENCE {			
logMeasReport-r16 SEQUENCE {			
absoluteTimeStamp-r16	Same value as sent by SS in LoggedMeasurementConfiguration in step 1		
traceReference-r16	Same value as sent by SS in		

	LoggedMeasurementCon figuration in step 1		
traceRecordingSessionRef-r16	Same value as sent by SS in LoggedMeasurementCon figuration in step 1		
tce-Id-r16	Same value as sent by SS in LoggedMeasurementCon figuration in step 1		
logMeasInfoList-r16 SEQUENCE (SIZE (1..maxLogMeasReport-r16)) OF LogMeasInfo-r16{ locationInfo-r16 SEQUENCE {			
commonLocationInfo-r16	Not checked		
bt-LocationInfo-r16	Not present		
wlan-LocationInfo-r16	Not present		
sensor-LocationInfo-r16 ::= SEQUENCE {		Report sensor measurement information	
sensor-MeasurementInformation-r16	Not present		
sensor-MeasurementInformation-r16	OCTET STRING including Sensor- MeasurementInformation -r13 according to TS 37.355 cl 6.5.5.2.		pc_barome ter_r16
sensor-MotionInformation-r16	Not present		
sensor-MotionInformation-r16	OCTET STRING including Sensor- MotionInformation-r15 according to TS 37.355 cl 6.5.5.2.		pc_orientat ion_r16 OR pc_speed_ r16
}			
relativeTimeStamp-r16	Any allowed value	INTEGER (0..7200)	
servCellIdentity-r16	Same as NR Cell 1		
measResultServCell-16	Not checked		
measResultNeighCells-r16 SEQUENCE {			
measResultNeighCellListNR	Not present		
measResultNeighCellListEUTRA	Not present		
}			
anyCellSelectionDetected-r16	Not checked		
}			
}			
logMeasAvailable-r16	Not present		
logMeasAvailableBT-r16	Not present		
logMeasAvailableWLAN-r16	Not present		
}			
}			
}			
}			

8.1.6.3.3 Inter-System MDT / Radio Link Failure

8.1.6.3.3.1 Inter-System MDT / Radio Link Failure / Logging and reporting / Bluetooth measurement collection

8.1.6.3.3.1.1 Test Purpose (TP)

(1)

```
with { UE in RRC_CONNECTED state detecting radio link failure }
ensure that {
  when { UE has radio link failure information available in VarRLF-Report and plmn-Identity stored
in VarRLF-Report is equal to the RPLMN }
```

```

then { UE sends the RRCReestablishmentComplete message with rlf-InfoAvailable included }
}

```

(2)

```

with { UE in RRC_CONNECTED state with the radio link failure information available and plmn-Identity
stored in VarRLF-Report is equal to the RPLMN }
ensure that {
  when { UE receives the UEInformationRequest message with rlf-ReportReq }
  then { UE sends the UEInformationResponse message with rlf-Report-r16 including LocationInfo-r16
which includes logMeasResultListBT }
}

```

(3)

```

with { UE in RRC_CONNECTED state with the radio link failure information available and plmn-Identity
stored in VarRLF-Report is equal to the RPLMN }
ensure that {
  when { UE receives the UEInformationRequest message with rlf-ReportReq and a Bluetooth beacon is
not included in bt-NameList }
  then { UE sends the UEInformationResponse message not including the measurement result of the
Bluetooth beacon not included in bt-NameList }
}

```

8.1.6.3.3.1.2 Conformance requirements

References: The conformance requirements covered in the present TC are specified in: TS 38.331 clauses 5.3.5.9, 5.3.10.5, 5.3.3.7, 5.7.10.3, 5.3.7.5. Unless otherwise stated these are Rel-16 requirements

[TS 38.331, clause 5.3.5.9]

The UE shall:

- 1> if the received *otherConfig* includes the *btNameList*:
 - 2> if *btNameList* is set to *setup*, include available Bluetooth measurement results for any subsequent measurement report or any subsequent RLF report and SCGFailureInformation;
- 1> if the received *otherConfig* includes the *wlanNameList*:
 - 2> if *wlanNameList* is set to *setup*, include available WLAN measurement results for any subsequent measurement report or any subsequent RLF report, CEF report and SCGFailureInformation;
- 1> if the received *otherConfig* includes the *sensorNameList*:
 - 2> if *sensorNameList* is set to *setup*, include available Sensor measurement results for any subsequent measurement report or any subsequent RLF report, CEF report and SCGFailureInformation;

NOTE 2: The UE is requested to attempt to have valid Bluetooth measurements, WLAN measurements and Sensor measurements whenever sending a measurement report for which it is configured to include these measurements. The UE may not succeed e.g. because the user manually disabled the WLAN or Bluetooth or Sensor hardware. Further details, e.g. regarding when to activate WLAN or Bluetooth or Sensor, are up to UE implementation.

[TS 38.331, clause 5.3.10.5]

The UE shall determine the content in the *VarRLF-Report* as follows:

- 1> clear the information included in *VarRLF-Report*, if any;
- 1> set the *plmn-IdentityList* to include the list of EPLMNs stored by the UE (i.e. includes the RPLMN);
- ...
- 1> else if the failure is detected due to radio link failure as described in 5.3.10.3, set the fields in *VarRLF-report* as follows:
 - 2> set the *connectionFailureType* to *rlf*;

- 2> set the *rlf-Cause* to the trigger for detecting radio link failure in accordance with clause 5.3.10.4;
- 2> set the *nrFailedPCellId* in *failedPCellId* to the global cell identity and the tracking area code, if available, and otherwise to the physical cell identity and carrier frequency of the PCell where radio link failure is detected;
- 2> if an *RRCReconfiguration* message including the *reconfigurationWithSync* was received before the connection failure:
 - 3> if the last *RRCReconfiguration* message including the *reconfigurationWithSync* concerned an intra NR handover:
 - 4> include the *nrPreviousCell* in *previousPCellId* and set it to the global cell identity and the tracking area code of the PCell where the last *RRCReconfiguration* message including *reconfigurationWithSync* was received;
 - 4> set the *timeConnFailure* to the elapsed time since reception of the last *RRCReconfiguration* message including the *reconfigurationWithSync*;

...

- 1> if available, set the *locationInfo* as in 5.3.3.7.

[TS 38.331, clause 5.3.7.5]

The UE shall:

...

- 1> set the content of *RRCReestablishmentComplete* message as follows:

...

- 2> if the UE has radio link failure or handover failure information available in *VarRLF-Report* and if the RPLMN is included in *plmn-IdentityList* stored in *VarRLF-Report*; or
- 2> if the UE has radio link failure or handover failure information available in *VarRLF-Report* of TS 36.331 [10] and if the UE is capable of cross-RAT RLF reporting and if the RPLMN is included in *plmn-IdentityList* stored in *VarRLF-Report* of TS 36.331 [10]:
 - 3> include *rlf-InfoAvailable* in the *RRCReestablishmentComplete* message;

- 1> submit the *RRCReestablishmentComplete* message to lower layers for transmission;

[TS 38.331, clause 5.3.3.7]

The UE shall:

- 1> if timer T300 expires:

...

- 2> store the following connection establishment failure information in the *VarConnEstFailReport* by setting its fields as follows:

...

- 3> if available, set the *locationInfo* as follows:

- 4> if available, set the *commonLocationInfo* to include the detailed location information;
- 4> if available, set the *bt-LocationInfo* to include the Bluetooth measurement results, in order of decreasing RSSI for Bluetooth beacons;
- 4> if available, set the *wlan-LocationInfo* to include the WLAN measurement results, in order of decreasing RSSI for WLAN APs;
- 4> if available, set the *sensor-LocationInfo* to include the sensor measurement results as follows;

5> if available, include the *sensor-MeasurementInformation*;

5> if available, include the *sensor-MotionInformation*;

[TS 38.331, clause 5.7.10.3]

Upon receiving the *UEInformationRequest* message, the UE shall, only after successful security activation:

...

1> if *rlf-ReportReq* is set to *true*:

2> if the UE has radio link failure information or handover failure information available in *VarRLF-Report* and if the RPLMN is included in *plmn-IdentityList* stored in *VarRLF-Report*:

3> set *timeSinceFailure* in *VarRLF-Report* to the time that elapsed since the last radio link failure or handover failure in NR;

3> set the *rlf-Report* in the *UEInformationResponse* message to the value of *rlf-Report* in *VarRLF-Report*;

3> discard the *rlf-Report* from *VarRLF-Report* upon successful delivery of the *UEInformationResponse* message confirmed by lower layers;

8.1.6.3.3.1.3 Test description

8.1.6.3.3.1.3.1 Pre-test conditions

System Simulator:

- NR Cell 1, NR Cell 2, Bluetooth beacon 1 (Cell 40) and Bluetooth beacon 2 (Cell 41)
- System information combination NR-2 as defined in TS 38.508-1 [4] clause 4.4.3.1.2 is used in NR cells.
- Cell 40 and Cell 41 are configured as per 38.508-1 [4] cl 4.4.1.3.

UE:

None

Preamble:

- The UE is in state 3N-A on NR Cell 1 as defined in TS 38.508-1 [4], subclause 4.4A.

8.1.6.3.3.1.3.2 Test procedure sequence

Tables 8.1.6.3.3.1.3.2-1/2 illustrate the downlink power levels. Row marked "T0" denotes the conditions after the preamble.

Table 8.1.6.3.3.1.3.2-1: Time instances of cell power level and parameter changes (FR1)

	Parameter	Unit	NR Cell 1	NR Cell 2	Cell 40 (Bluetooth beacon 1)	Cell 41 (Bluetooth beacon 2)	Remark
T0	SS/PBCH SSS EPRE	dBm/ SCS	-85	-91			The power level values are such that measurement results for Cell 1 (M1) and Cell 2 (M2) satisfy exit condition for event A3 (M2 < M1).
	BeaconRSS I	dBm			-80	-50	
T1	SS/PBCH SSS EPRE	dBm/ SCS	"Off"	-79			Only Cell 2 is available. (NOTE 1)
	BeaconRSS I	dBm			-80	-50	

NOTE 1: Power level "Off" is defined in TS 38.508-1 [4], Table 6.2.2.1-3.

Table 8.1.6.3.3.1.3.2-2: Time instances of cell power level and parameter changes (FR2)

	Parameter	Unit	NR Cell 1	NR Cell 2	Cell 40 (Bluetooth beacon 1)	Cell 41 (Bluetooth beacon 2)	Remark
T0	SS/PBCH SSS EPRE	dBm/ SCS	-82	-94			The power level values are such that measurement results for Cell 1 (M1) and Cell 2 (M2) satisfy exit condition for event A3 (M2 < M1).
	BeaconRSS I	dBm			-80	-50	
T1	SS/PBCH SSS EPRE	dBm/ SCS	"Off"	-82			Only Cell 2 is available. (NOTE 1)
	BeaconRSS I	dBm			-80	-50	
NOTE 1: Power level "Off" is defined in TS 38.508-1 [4], Table 6.2.2.2.2-2.							

Table 8.1.6.3.3.1.3.2-3: Main behaviour

St	Procedure	U - S	Message Sequence	TP	Verdict
			Message		
1	The SS transmits an <i>RRCReconfiguration</i> message on NR Cell 1.	<--	<i>RRCReconfiguration</i>	-	-
2	The UE transmits an <i>RRCReconfigurationComplete</i> message on Cell 1.	-->	<i>RRCReconfigurationComplete</i>	-	-
3	The SS changes NR Cell 1 and NR Cell 2 parameters according to the row "T1" in Tables 8.1.6.3.3.1.3.2-1/2.	-	-	-	-
4	The UE transmits an <i>RRCReestablishmentRequest</i> message on NR Cell 2.	-->	<i>RRCReestablishmentRequest</i>	-	-
5	The SS transmits an <i>RRCReestablishment</i> message on NR Cell 2.	<--	<i>RRCReestablishment</i>	-	-
6	Check: Does the UE transmit an <i>RRCReestablishmentComplete</i> message on NR Cell 2 with <i>rfl-InfoAvailable</i> included?	-->	<i>RRCReestablishmentComplete</i>	1	P
7	The SS transmits an <i>RRCReconfiguration</i> message to establish SRB2 and DRB on NR Cell 2.	<--	<i>RRCReconfiguration</i>	-	-
8	The UE transmits an <i>RRCReconfigurationComplete</i> message on NR Cell 2.	-->	<i>RRCReconfigurationComplete</i>	-	-
9	The SS transmits a <i>UEInformationRequest</i> message on NR Cell 2.	<--	<i>UEInformationRequest</i>	-	-
10	Check: Does the UE transmit a <i>UEInformationResponse</i> message with <i>rfl-Report-r9</i> with <i>logMeasResultListBT</i> including one entry (Bluetooth beacon 1) measurement result?	-->	<i>UEInformationResponse</i>	2, 3	P

8.1.6.3.3.1.3.3 Specific message contents

Table 8.1.6.3.3.1.3.3-1: *RRCReconfiguration* (step 1, Table 8.1.6.3.3.1.3.2-3)

Derivation path: TS 38.508-1 [4], Table 4.6.1-13			
Information Element	Value/remark	Comment	Condition
<i>RRCReconfiguration</i> ::= SEQUENCE {			
criticalExtensions CHOICE {			
rrcReconfiguration SEQUENCE {			
nonCriticalExtension SEQUENCE {			
nonCriticalExtension SEQUENCE {			
nonCriticalExtension SEQUENCE {			
nonCriticalExtension SEQUENCE {			
otherConfig-v1610 SEQUENCE {			
idc-AssistanceConfig-r16	Not present		

criticalExtensions CHOICE {			
ueInformationResponse-r16 SEQUENCE {			
rlf-Report-r16	Present	Specified in Table 8.1.6.3.3.1.3.3-4	
}			
}			

Table 8.1.6.3.3.1.3.3-4: rlf-Report-r16 (Table 8.1.6.3.3.1.3.3-3)

Derivation Path: TS 38.331 [6], clause 6.2.2			
Information Element	Value/remark	Comment	Condition
rlf-Report-r16 CHOICE {			
nr-RLF-Report-r16 SEQUENCE {			
measResultLastServCell-r16	Not checked		
measResultNeighCells-r16 SEQUENCE {}	Not checked		
c-RNTI-r16	Not checked		
previousPCellId-r16 CHOICE {}	Not checked		
failedPCellId-r16 CHOICE {}	Not checked		
reconnectCellId-r16 CHOICE {}	Not checked		
timeUntilReconnection-r16	Not checked		
reestablishmentCellId-r16	Not checked		
timeConnFailure-r16	Not checked		
timeSinceFailure-r16	Not checked		
connectionFailureType-r16	rlf		
rlf-Cause-r16	Not checked		
locationInfo-r16 SEQUENCE {			
commonLocationInfo-r16	Not checked		
bt-LocationInfo-r16 SEQUENCE (SIZE (1..maxBT-IdReport-r16)) OF LogMeasResultBT-r16 SEQUENCE {	1 entry		
LogMeasResultBT-r16[1] SEQUENCE {		Report Bluetooth beacon 1	
bt-Addr-r16	Bluetooth public address of Bluetooth beacon 1	BIT STRING (SIZE (48))	
rssi-BT-r16	Any allowed value	INTEGER (-128..127)	
}			
}			
wlan-LocationInfo-r16	Not checked		
sensor-LocationInfo-r16	Not checked		
}			
noSuitableCellFound-r16	Not checked		
ra-InformationCommon-r16 SEQUENCE {}	Not checked		
csi-rsRLMConfigBitmap-v1650 SEQUENCE {}	Not checked		
}			
}			

8.1.6.3.3.2 Inter-System MDT / Radio Link Failure / Logging and reporting / WLAN measurement collection

8.1.6.3.3.2.1 Test Purpose (TP)

(1)

```

with { UE in RRC_CONNECTED state detecting radio link failure }
ensure that {
  when { UE has radio link failure information available in VarRLF-Report and plmn-Identity stored in VarRLF-Report is equal to the RPLMN }
  then { UE sends the RRCReestablishmentComplete message with rlf-InfoAvailable included }
}
    
```

(2)

```
with { UE in RRC_CONNECTED state with the radio link failure information available and plmn-Identity stored in VarRLF-Report is equal to the RPLMN }
ensure that {
  when { UE receives the UEInformationRequest message with rlf-ReportReq }
  then { UE sends the UEInformationResponse message with rlf-Report-r16 including logMeasResultListWLAN }
}
```

(3)

```
with { UE in RRC_CONNECTED state with the radio link failure information available and plmn-Identity stored in VarRLF-Report is equal to the RPLMN }
ensure that {
  when { UE receives the UEInformationRequest message with rlf-ReportReq and a WLAN AP is not included in wlan-NameList }
  then { UE sends the UEInformationResponse message not including the measurement result of the WLAN AP not included in wlan-NameList }
}
```

8.1.6.3.3.2.2 Conformance requirements

Same as test case 8.1.6.3.3.1

8.1.6.3.3.2.3 Test description

8.1.6.3.3.2.3.1 Pre-test conditions

System Simulator:

- NR Cell 1, NR Cell 2, WLAN AP 1 (Cell 27) and WLAN AP 2 (Cell 27b)

UE:

None

Preamble:

- The UE is in state 3N-A on NR Cell 1 as defined in TS 38.508-1 [4], subclause 4.4A.

8.1.6.3.3.2.3.2 Test procedure sequence

Table 8.1.6.3.3.2.3.2-1/2 illustrates the downlink power levels. Row marked "T0" denotes the conditions after the preamble.

Table 8.1.6.3.3.2.3.2-1: Time instances of cell power level and parameter changes (FR1)

	Parameter	Unit	NR Cell 1	NR Cell 2	Cell 27 (WLAN AP1)	Cell 27b (WLAN AP2)	Remark
T0	SS/PBCH SSS EPRE	dBm/SCS	-85	-91			
	BeaconRSSI	dBm			-60	-50	
T1	SS/PBCH SSS EPRE	dBm/SCS	"Off"	-79			Only Cell 2 is available. (NOTE 1)
	BeaconRSSI	dBm			-60	-50	

NOTE 1: Power level "Off" is defined in TS 38.508-1 Table 6.2.2.1-3.

Table 8.1.6.3.3.2.3.2-2: Time instances of cell power level and parameter changes (FR2)

	Parameter	Unit	NR Cell 1	NR Cell 2	Cell 27	Cell 27b	Remark
--	-----------	------	-----------	-----------	---------	----------	--------

					(WLAN AP1)	(WLAN AP2)	
T0	SS/PBCH SSS EPRE	dBm/SCS	-82	-94			
	BeaconRSSI	dBm			-60	-50	
T1	SS/PBCH SSS EPRE	dBm/SCS	"Off"	-82			Only NR Cell 2 is available. (NOTE 1)
	BeaconRSSI	dBm			-60	-50	
NOTE 1: Power level "Off" is defined in TS 38.508-1 Table 6.2.2.2.2-2.							

Table 8.1.6.3.3.2.3-3: Main behaviour

St	Procedure	Message Sequence		TP	Verdict
		U - S	Message		
1	The SS transmits an <i>RRCReconfiguration</i> message on NR Cell 1.	<--	<i>RRCReconfiguration</i>	-	-
2	The UE transmits an <i>RRCReconfigurationComplete</i> message on NR Cell 1.	-->	<i>RRCReconfigurationComplete</i>	-	-
3	The SS changes NR Cell 1 and NR Cell 2 parameters according to the row "T1" in Tables 8.1.6.3.3.2.3.2-1/2.	-	-	-	-
4	The UE transmits an <i>RRCReestablishmentRequest</i> message on NR Cell 2.	-->	<i>RRCReestablishmentRequest</i>	-	-
5	The SS transmits an <i>RRCReestablishment</i> message on NR Cell 2.	<--	<i>RRCReestablishment</i>	-	-
6	Check: Does the UE transmit an <i>RRCReestablishmentComplete</i> message on NR Cell 2 with <i>r1f-InfoAvailable</i> included?	-->	<i>RRCReestablishmentComplete</i>	1	P
7	The SS transmits an <i>RRCReconfiguration</i> message to establish SRB2 and DRB on NR Cell 2.	<--	<i>RRCReconfiguration</i>	-	-
8	The UE transmits an <i>RRCReconfigurationComplete</i> message on NR Cell 2.	-->	<i>RRCReconfigurationComplete</i>	-	-
9	The SS transmits a <i>UEInformationRequest</i> message on NR Cell 2.	<--	<i>UEInformationRequest</i>	-	-
10	Check: Does the UE transmit a <i>UEInformationResponse</i> message with <i>r1f-Report-r16</i> with <i>logMeasResultListWLAN</i> including one entry (WLAN AP 1) measurement result?	-->	<i>UEInformationResponse</i>	2, 3	P

8.1.6.3.3.2.3.3 Specific message contents

Same as test case 8.1.6.3.1.1 with the following difference:

Table 8.1.6.3.3.2.3-1: *RRCReconfiguration* (step 1, Table 8.1.6.3.3.2.3-3)

Derivation path: TS 38.508-1 [4], Table 4.6.1-13			
Information Element	Value/remark	Comment	Condition
<i>RRCReconfiguration</i> ::= SEQUENCE {			
criticalExtensions CHOICE {			
rrcReconfiguration SEQUENCE {			
nonCriticalExtension SEQUENCE {			
nonCriticalExtension SEQUENCE {			
otherConfig-v1540	Not present		
nonCriticalExtension SEQUENCE {			
nonCriticalExtension SEQUENCE {			
otherConfig-v1610 SEQUENCE {			
idc-AssistanceConfig-r16	Not present		

drx-PreferenceConfig-r16	Not present		
maxBW-PreferenceConfig-r16	Not present		
maxCC-PreferenceConfig-r16	Not present		
maxMIMO-LayerPreferenceConfig-r16	Not present		
minSchedulingOffsetPreferenceConfig-r16	Not present		
releasePreferenceConfig-r16	Not present		
referenceTimePreferenceReporting-r16	Not present		
btNameList-r16	Not present		
wlanNameList-r16 SEQUENCE {			
Setup WLAN-NameList-r16 SEQUENCE (SIZE (1..maxWLAN-Name-r16)) OF WLAN-Name-r16 {	1 entry	WLAN AP1	
WLAN-Name-r16	Set as per Table 4.4.8-1 of TS 36.508	OCTET STRING (SIZE (1..32)) Refers to Service Set Identifier (SSID) defined in IEEE 802.11-2012	
}			
}			
sensorNameList-r16	Not present		
obtainCommonLocation-r16	Not present		
sl-AssistanceConfigNR-r16	Not present		
}			
}			
}			
}			
}			
}			
}			
}			
}			
}			

Table 8.1.6.3.3.2.3.3-2: Void

Table 8.1.6.3.3.2.3.3-3: Void

Table 8.1.6.3.3.2.3.3-4: UEInformationResponse (step 10, Table 8.1.6.3.3.2.3.2-3)

Derivation Path: TS 38.508-1 [4], Table 4.6.1-32B			
Information Element	Value/remark	Comment	Condition
UEInformationResponse-r16 ::= SEQUENCE {			
criticalExtensions CHOICE {			
ueInformationResponse-r16 SEQUENCE {			
rlf-Report-r16 CHOICE {			
nr-RLF-Report-r16 SEQUENCE {			
measResultLastServCell-r16	Not checked		
measResultNeighCells-r16	Not checked		
c-RNTI-r16	Not checked		
previousPCellId-r16	Not checked		
failedPCellId-r16	Not checked		
reconnectCellId-r16	Not checked		
timeUntilReconnection-16	Not checked		
reestablishmentCellId-r16	Not checked		
timeConnFailure-r16	Not checked		
timeSinceFailure-r16	Not checked		
connectionFailureType-r16	rlf		
rlf-Cause-r16	Not checked		
locationInfo-r16 SEQUENCE {	Not checked		
commonLocationInfo-r16	Not checked		
bt-LocationInfo-r16	Not present		

UE:

- UE supports at least one of `pc_barometer_r16`, `pc_orientation_r16` and `pc_speed_r16`.

Preamble:

- The UE is in state 3N-A as defined in TS 38.508-1 [4], subclause 4.4A.

8.1.6.3.3.3.2 Test procedure sequence

Table 8.1.6.3.3.3.2-1 illustrates the downlink power levels. Row marked "T0" denotes the conditions after the preamble.

Table 8.1.6.3.3.3.2-1: Time instances of cell power level and parameter changes (FR1)

	Parameter	Unit	NR Cell 1	NR Cell 2	Remark
T0	SS/PBCH SSS EPRE	dBm/ SCS	-85	-91	The power level values are such that measurement results for Cell 1 (M1) and Cell 2 (M2) satisfy exit condition for event A3 ($M2 < M1$).
T1	SS/PBCH SSS EPRE	dBm/ SCS	"Off"	-79	Only Cell 2 is available. (NOTE 1)
NOTE 1: Power level "Off" is defined in TS 38.508-1 [4], Table 6.2.2.1-3.					

Table 8.1.6.3.3.3.2-2: Time instances of cell power level and parameter changes (FR2)

	Parameter	Unit	NR Cell 1	NR Cell 2	Remark
T0	SS/PBCH SSS EPRE	dBm/ SCS	-82	-94	The power level values are such that measurement results for Cell 1 (M1) and Cell 2 (M2) satisfy exit condition for event A3 ($M2 < M1$).
T1	SS/PBCH SSS EPRE	dBm/ SCS	"Off"	-82	Only Cell 2 is available. (NOTE 1)
NOTE 1: Power level "Off" is defined in TS 38.508-1 [4], Table 6.2.2.2-2.					

Table 8.1.6.3.3.3.2-3: Main behaviour

St	Procedure	Message Sequence		TP	Verdict
		U - S	Message		
1	The SS transmits an <i>RRCReconfiguration</i> message on NR Cell 1.	<--	NR RRC: <i>RRCReconfiguration</i>	-	-
2	The UE transmits an <i>RRCReconfigurationComplete</i> message on NR Cell 1.	-->	NR RRC: <i>RRCReconfigurationComplete</i>	-	-
3	The SS changes NR Cell 1 and NR Cell 2 parameters according to the row "T1" in Tables 8.1.6.3.3.3.2-1/2.	-	-	-	-
4	The UE transmits an <i>RRCReestablishmentRequest</i> message on NR Cell 2.	-->	NR RRC: <i>RRCReestablishmentRequest</i>	-	-
5	The SS transmits an <i>RRCReestablishment</i> message on NR Cell 2.	<--	NR RRC: <i>RRCReestablishment</i>	-	-
6	UE transmit an <i>RRCReestablishmentComplete</i> message on NR Cell 2.	-->	NR RRC: <i>RRCReestablishmentComplete</i>	-	-
7	The SS transmits an <i>RRCReconfiguration</i> message to establish SRB2 and DRB on NR Cell 2.	<--	NR RRC: <i>RRCReconfiguration</i>	-	-

8	The UE transmits an <i>RRCReconfigurationComplete</i> message on NR Cell 2.	-->	NR RRC: <i>RRCReconfigurationComplete</i>	-	-
9	The SS transmits a <i>UEInformationRequest</i> message on NR Cell 2.	<--	NR RRC: <i>UEInformationRequest</i>	-	-
10	Check: Does the UE transmit a <i>UEInformationResponse</i> message with <i>Sensor-LocationInfo</i> - including the measurement result entry specified in the sensor-namelist in step 1?	-->	NR RRC: <i>UEInformationResponse</i>	1,2	P

8.1.6.3.3.3.3 Specific message contents

Same as test case 8.1.6.3.1.1 with the following difference:

Table 8.1.6.3.3.3.3-1: *RRCReconfiguration* (step 1, Table 8.1.6.3.3.3.2-3)

Derivation path: TS 38.508-1 [4], Table 4.6.1-13			
Information Element	Value/remark	Comment	Condition
<i>RRCReconfiguration</i> ::= SEQUENCE {			
<i>criticalExtensions</i> CHOICE {			
<i>rrcReconfiguration</i> SEQUENCE {			
<i>nonCriticalExtension</i> SEQUENCE {			
<i>nonCriticalExtension</i> SEQUENCE {			
<i>otherConfig-v1540</i>	Not present		
<i>nonCriticalExtension</i> SEQUENCE {			
<i>nonCriticalExtension</i> SEQUENCE {			
<i>otherConfig-v1610</i> SEQUENCE {			
<i>idc-AssistanceConfig-r16</i>	Not present		
<i>drx-PreferenceConfig-r16</i>	Not present		
<i>maxBW-PreferenceConfig-r16</i>	Not present		
<i>maxCC-PreferenceConfig-r16</i>	Not present		
<i>maxMIMO-LayerPreferenceConfig-r16</i>	Not present		
<i>minSchedulingOffsetPreferenceConfig-r16</i>	Not present		
<i>releasePreferenceConfig-r16</i>	Not present		
<i>referenceTimePreferenceReporting-r16</i>	Not present		
<i>btNameList-r16</i>	Not present		
<i>wlanNameList-r16</i>	Not present		
<i>sensorNameList-r16</i> CHOICE {			
Setup <i>Sensor-NameList-r16</i> SEQUENCE {			
<i>measUncomBarPre-r16</i>	Not present		
<i>measUeSpeed</i>	true		
<i>measUeOrientation</i>	true		
}			
}			
}			
}			
}			
}			
}			
}			
}			

Table 8.1.6.3.3.3.3-2: *UEInformationResponse* (step 10, Table 8.1.6.3.3.3.2-3)

Derivation Path: 38.508-1 clause 4.6.1 table 4.6.1-32B <i>UEInformationResponse</i>			
Information Element	Value/remark	Comment	Condition
<i>UEInformationResponse-r16</i> ::= SEQUENCE {			
<i>criticalExtensions</i> CHOICE {			
<i>ueInformationResponse-r16</i> SEQUENCE {			

8.1.6.3.4.1.2 Conformance requirements

References: The conformance requirements covered in the present TC are specified in: TS 38.331 clauses 5.5a.1.3, 5.5a.3.2, 5.3.3.4, 5.3.3.7 and 5.7.10.3. Unless otherwise stated these are Rel-16 requirements.

[TS 38.331, clause 5.5a.1.3]

Upon receiving the *LoggedMeasurementConfiguration* message the UE shall:

- 1> discard the logged measurement configuration as well as the logged measurement information as specified in 5.5a.2;
- 1> store the received *loggingDuration*, *reportType* and *areaConfiguration*, if included, in *VarLogMeasConfig*;
- 1> if the *LoggedMeasurementConfiguration* message includes *plmn-IdentityList*:
 - 2> set *plmn-IdentityList* in *VarLogMeasReport* to include the RPLMN as well as the PLMNs included in *plmn-IdentityList*;
- 1> else:
 - 2> set *plmn-IdentityList* in *VarLogMeasReport* to include the RPLMN;
- 1> store the received *absoluteTimeInfo*, *traceReference*, *traceRecordingSessionRef*, and *tce-Id* in *VarLogMeasReport*;
- 1> store the received *bt-NameList*, if included, in *VarLogMeasConfig*;

[TS 38.331, clause 5.5a.3.2]

While T330 is running, the UE shall:

- 1> perform the logging in accordance with the following:
 - 2> if the *reportType* is set to *periodical* in the *VarLogMeasConfig*:
 - 3> if the UE is in any cell selection state (as specified in TS 38.304 [20]):
 - 4> perform the logging at regular time intervals, as defined by the *loggingInterval* in the *VarLogMeasConfig*;
 - 3> if the UE is in camped normally state on an NR cell and if the RPLMN is included in *plmn-IdentityList* stored in *VarLogMeasReport*:
 - 4> if *areaConfiguration* is not included in *VarLogMeasConfig*; or
 - 4> if the serving cell is part of the area indicated by *areaConfig* in *areaConfiguration* in *VarLogMeasConfig*:
 - 5> perform the logging at regular time intervals, as defined by the *loggingInterval* in the *VarLogMeasConfig*;
 - ...
 - 2> when performing the logging:
 - 3> set the *relativeTimeStamp* to indicate the elapsed time since the moment at which the logged measurement configuration was received;
 - 3> if location information became available during the last logging interval, set the content of the *locationInfo* as in 5.3.3.7;

[TS 38.331, clause 5.3.3.4]

The UE shall perform the following actions upon reception of the *RRCSetup*:

...

1> set the content of *RRCSetupComplete* message as follows:

...

2> if the UE has logged measurements available for NR and if the RPLMN is included in *plmn-IdentityList* stored in *VarLogMeasReport*:

3> include the *logMeasAvailable* in the *RRCSetupComplete* message;

3> if Bluetooth measurement results are included in the logged measurements the UE has available for NR:

4> include the *logMeasAvailableBT* in the *RRCSetupComplete* message;

...

2> if the UE has connection establishment failure or connection resume failure information available in *VarConnEstFailReport* and if the RPLMN is equal to *plmn-Identity* stored in *VarConnEstFailReport*:

3> include *connEstFailInfoAvailable* in the *RRCSetupComplete* message;

...

1> submit the *RRCSetupComplete* message to lower layers for transmission, upon which the procedure ends.

[TS 38.331, clause 5.3.3.7]

The UE shall:

1> if timer T300 expires:

...

2> store the following connection establishment failure information in the *VarConnEstFailReport* by setting its fields as follows:

...

3> if available, set the *locationInfo* as follows:

4> if available, set the *commonLocationInfo* to include the detailed location information;

4> if available, set the *bt-LocationInfo* to include the Bluetooth measurement results, in order of decreasing RSSI for Bluetooth beacons;

4> if available, set the *wlan-LocationInfo* to include the WLAN measurement results, in order of decreasing RSSI for WLAN APs;

4> if available, set the *sensor-LocationInfo* to include the sensor measurement results as follows;

5> if available, include the *sensor-MeasurementInformation*;

5> if available, include the *sensor-MotionInformation*;

[TS 38.331, clause 5.7.10.3]

Upon receiving the *UEInformationRequest* message, the UE shall, only after successful security activation:

...

1> if *connEstFailReportReq* is set to *true* and the UE has connection establishment failure or connection resume failure information in *VarConnEstFailReport* and if the RPLMN is equal to *plmn-Identity* stored in *VarConnEstFailReport*:

2> set *timeSinceFailure* in *VarConnEstFailReport* to the time that elapsed since the last connection establishment failure or connection resume failure in NR;

- 2> set the *connEstFailReport* in the *UEInformationResponse* message to the value of *connEstFailReport* in *VarConnEstFailReport*;
- 2> discard the *connEstFailReport* from *VarConnEstFailReport* upon successful delivery of the *UEInformationResponse* message confirmed by lower layers;

8.1.6.3.4.1.3 Test description

8.1.6.3.4.1.3.1 Pre-test conditions

System Simulator:

- NR Cell 1, Bluetooth beacon 1 (Cell 40), Bluetooth beacon 2 (Cell 41)
- Cell 40 and Cell 41 are configured as per 38.508-1 [4] cl 4.4.1.3.2

UE:

None

Preamble:

- The UE is in state 3N-A on NR Cell 1 as defined in TS 38.508-1 [4], subclause 4.4A.

8.1.6.3.4.1.3.2 Test procedure sequence

Table 8.1.6.3.4.1.3.2-1: Main behaviour

St	Procedure	Message Sequence		TP	Verdict
		U - S	Message		
1	SS transmits a <i>LoggedMeasurementConfiguration</i> message to configure the UE to perform logging of measurement results while in RRC_IDLE.	<--	<i>LoggedMeasurementConfiguration</i>	-	-
2	The SS transmits an <i>RRCRelease</i> message.	<--	<i>RRCRelease</i>	-	-
3	Wait 8s to allow UE to activate logging.	-	-	-	-
4-5	Steps 1 to 2 of the generic radio bearer establishment procedure in TS 38.508-1 [4] table 4.5.4.2-3.	-	-	-	-
6	The SS waits for 2sec (T300 expiry).	-	-	-	-
7-9	Steps 1 to 3 of the generic radio bearer establishment procedure in TS 38.508-1 [4] table 4.5.4.2-3.	-	-	-	-
10	Check: Does the UE transmit an <i>RRCSetupComplete</i> message with <i>logMeasAvailable-r16</i> , <i>logMeasAvailableBT-r16</i> and <i>connEstFailInfoAvailable-r16</i> included?	-->	NR RRC: <i>RRCSetupComplete</i> 5GMM: Service Request	1	P
11-14	Steps 5 to 8 of the generic radio bearer establishment procedure in TS 38.508-1 [4] table 4.5.4.2-3.	-	-	-	-
15	The SS sends a <i>UEInformationRequest</i> message to get <i>connEstFailReportReq-r16</i> .	<--	<i>UEInformationRequest</i>	-	-
16	Check: Does the UE transmit a <i>UEInformationResponse</i> message with <i>LogMeasResultListBT</i> including one entry (Bluetooth beacon 1) measurement result?	-->	<i>UEInformationResponse</i>	2	P

8.1.6.3.4.1.3.3 Specific message contents

Table 8.1.6.3.4.1.3.3-1: LoggedMeasurementConfiguration (step 1, Table 8.1.6.3.4.1.3.2-1)

Derivation path: TS 38.508-1 [4], table 4.6.1-5AA with condition PERIODICAL			
Information Element	Value/remark	Comment	Condition
LoggedMeasurementConfiguration-r16 ::= SEQUENCE {			
criticalExtensions CHOICE {			
loggedMeasurementConfiguration-r16 SEQUENCE {			
bt-NameList-r16 CHOICE {			
setup	BT-NameList-r16		
}			
reportType CHOICE {			
periodical SEQUENCE {			
loggingInterval-r16	ms10240	10.24 seconds	
}			
}			
}			
}			

Table 8.1.6.3.4.1.3.3-1A: BT-NameList-r16 (Table 8.1.6.3.4.1.3.3-1)

Derivation path: TS 38.508-1 [4], table 4.6.5-0C			
Information Element	Value/remark	Comment	Condition
BT-NameList-r16 ::= SEQUENCE (SIZE (1..maxBT-Name-r16)) OF BT-Name-r16 {	1 entry	Bluetooth beacon 1	
BT-Name-r16[1]	Set as per Table 4.4.9-1 of 3GPP TS 36.508	OCTET STRING (SIZE (1..248)) Refers to LOCAL NAME defined in Bluetooth specification	
}			

Table 8.1.6.3.4.1.3.3-2: RRCSetupComplete (step 10, Table 8.1.6.3.4.1.3.2-1)

Derivation Path: TS 38.508-1 [4] Table 4.6.1-22			
Information Element	Value/remark	Comment	Condition
RRCSetupComplete ::= SEQUENCE {			
criticalExtensions CHOICE {			
rrcSetupComplete SEQUENCE{			
nonCriticalExtension SEQUENCE{			
iab-NodeIndication-r16	Not checked		
idleMeasAvailable-r16	Not checked		
ue-MeasurementsAvailable-r16	UE-MeasurementsAvailable-r16 with condition LOG and BT and CEF		
mobilityHistoryAvail-r16	Not checked		
mobilityState-r16	Not checked		
nonCriticalExtension	Not checked		
}			
}			
}			
}			

Table 8.1.6.3.4.1.3.3-3: Void

Table 8.1.6.3.4.1.3.3-4: *UEInformationResponse* (step 16, Table 8.1.6.3.4.1.3.2-1)

Derivation Path: TS 38.508-1 [4], Table 4.6.1-32B			
Information Element	Value/remark	Comment	Condition
UEInformationResponse-r16 ::= SEQUENCE {			
criticalExtensions CHOICE {			
ueInformationResponse-r16 SEQUENCE {			
connEstFailReport-r16 SEQUENCE {			
measResultFailedCell-r16 SEQUENCE {			
cgi-Info SEQUENCE {			
plmn-Identity-r16	plmn-Identity within SIB1 broadcasted in NR Cell 1		
cellIdentity-r16	cellIdentity within SIB1 broadcasted in NR Cell 1	BIT STRING (SIZE (36))	
trackingAreaCode-r16	Not checked	BIT STRING (SIZE (24))	
}			
measResult-r16 SEQUENCE {			
cellResults-r16	Not checked		
rsIndexResults-r16	Not checked		
}			
locationInfo-r16 SEQUENCE {			
bt-LocationInfo-r16 SEQUENCE (SIZE (1..maxBT-IdReport-r16)) OF LogMeasResultBT-r16 {	1 entry		
LogMeasResultBT-r16[1] SEQUENCE {		Report Bluetooth beacon 1	
bt-Addr-r16	Bluetooth public address of Bluetooth beacon 1	BIT STRING (SIZE (48))	
rssi-BT-r16	Any allowed value	INTEGER (- 128..127)	
}			
}			
measResultNeighCells-r16 SEQUENCE {			
measResultNeighCellListNR	Not present		
measResultNeighCellListEUTRA	Not present		
}			
numberOfConnFail-r16	Any allowed value	INTEGER (1..8)	
perRAInfoList-r16	Any allowed value		
timeSinceFailure-r16	Any allowed value	INTEGER (0..172800)	
}			
}			
}			
}			

8.1.6.3.4.2 Inter-System MDT / Connection Establishment Failure / Logging and reporting / WLAN measurement collection

8.1.6.3.4.2.1 Test Purpose (TP)

(1)

```

with { UE after being set up with LoggedMeasurementConfiguration detects connection establishment
failure }
ensure that {
  when { UE has WLAN logged measurements available and if the RPLMN is included in plmn-IdentityList
stored in VarLogMeasReport }
  then { UE sends the RRCSetupComplete message with logMeasAvailable-r16, logMeasAvailableWLAN-r16
and connEstFailInfoAvailable-r16 set to true }
}

```

(2)

```
with { UE has sent the RRCSetupComplete message with connEstFailInfoAvailable-r16 set to true }
ensure that {
  when { UE receives a UEInformationRequest message with connEstFailReportReq-r16 set to true }
  then { UE sends the UEInformationResponse message containing only the measurement of the WLAN
  AP(s) that included in wlan-NameList-r16 of LoggedMeasurementConfiguration }
}
```

8.1.6.3.4.2.2 Conformance requirements

Same as test case 8.1.6.3.4.1.

8.1.6.3.4.2.3 Test description

8.1.6.3.4.2.3.1 Pre-test conditions

Same as test case 8.1.6.3.4.1 with the following differences:

System Simulator:

- NR Cell 1, WLAN AP 1 (Cell 27) and WLAN AP 2 (Cell 27b)
- Cell 27 and Cell 27b are configured as per TS 38.508-1 [4] cl 4.4.1.3 with the OFFLOAD condition

8.1.6.3.4.2.3.2 Test procedure sequence

Same as test case 8.1.6.3.4.1 with the following differences: *logMeasAvailableBT-r16* is replaced by *logMeasAvailableWLAN-r16*.

Table 8.1.6.3.4.2.3.2-1: Void

8.1.6.3.4.2.3.3 Specific message contents

Table 8.1.6.3.4.2.3.3-1: LoggedMeasurementConfiguration (step 1, Table 8.1.6.3.4.2.3.2-1)

Derivation path: TS 38.508-1 [4], table 4.6.1-5AA with condition PERIODICAL			
Information Element	Value/remark	Comment	Condition
LoggedMeasurementConfiguration-r16 ::= SEQUENCE {			
criticalExtensions CHOICE {			
loggedMeasurementConfiguration-r16 SEQUENCE {			
wlan-NameList-r16 CHOICE {			
setup	WLAN-NameList-r16		
}			
reportType CHOICE {			
periodical SEQUENCE {			
loggingInterval-r16	ms10240	10.24 seconds	
}			
}			
}			
}			
}			

Table 8.1.6.3.4.2.3.3-1A: WLAN-NameList-r16 (Table 8.1.6.3.4.2.3.3-1)

Derivation path: TS 38.508-1 [4], table 4.6.5-18			
Information Element	Value/remark	Comment	Condition
WLAN-NameList-r16 ::= SEQUENCE (SIZE (1..maxWLAN-Name-r16)) OF WLAN-Name-r16 {	1 entry	WLAN AP1	

WLAN-Name-r16[1]	Set as per Table 4.4.8-1 of TS 36.508	OCTET STRING (SIZE (1..32)) Refers to Service Set Identifier (SSID) defined in IEEE 802.11-2012	
}			

Table 8.1.6.3.4.2.3.3-2: RRCSetupComplete (step 10, Table 8.1.6.3.4.2.3.2-1)

Derivation Path: TS 38.508-1 [4] Table 4.6.1-22			
Information Element	Value/remark	Comment	Condition
RRCSetupComplete ::= SEQUENCE {			
criticalExtensions CHOICE {			
rrcSetupComplete SEQUENCE{			
nonCriticalExtension SEQUENCE{			
iab-NodeIndication-r16	Not checked		
idleMeasAvailable-r16	Not checked		
ue-MeasurementsAvailable-r16	UE-MeasurementsAvailable-r16 with condition LOG and WLAN and CEF		
mobilityHistoryAvail-r16	Not checked		
mobilityState-r16	Not checked		
nonCriticalExtension	Not checked		
}			
}			
}			
}			

Table 8.1.6.3.4.2.3.3-3: Void

Table 8.1.6.3.4.2.3.3-4: UEInformationResponse (step 16, Table 8.1.6.3.4.2.3.2-1)

Derivation Path: TS 38.508-1 [4] table 4.6.1-32B			
Information Element	Value/remark	Comment	Condition
UEInformationResponse-r16 ::= SEQUENCE {			
criticalExtensions CHOICE {			
ueInformationResponse-r16 SEQUENCE {			
connEstFailReport-r16 SEQUENCE {			
measResultFailedCell-r16 SEQUENCE {			
cgi-Info SEQUENCE {			
plmn-Identity-r16	plmn-Identity within SIB1 broadcasted in NR Cell 1		
cellIdentity-r16	cellIdentity within SIB1 broadcasted in NR Cell 1	BIT STRING (SIZE (36))	
trackingAreaCode-r16	Not checked	BIT STRING (SIZE (24))	
}			
measResult-r16 SEQUENCE {			
cellResults-r16	Not checked		
rsIndexResults-r16	Not checked		
}			
locationInfo-r16 SEQUENCE {			
wlan-LocationInfo-r16 SEQUENCE (SIZE (1..maxWLAN-Id-Report-r16)) OF LogMeasResultWLAN-r16 {	1 entry		
LogMeasResultWLAN-r16[1] SEQUENCE {		Report WLAN AP 1	
wlan-Identifiers-r16 SEQUENCE {			

ssid-r12	ssid for WLAN AP 1		
bssid-r12	Not present		
hessid-r12	Not present		
}			
rssiWLAN-r16	Any allowed value		
rtt-WLAN-r16	Any allowed value		
}			
}			
measResultNeighCells-r16 SEQUENCE {			
measResultNeighCellListNR	Not present		
measResultNeighCellListEUTRA	Not present		
}			
numberOfConnFail-r16	Any allowed value	INTEGER (1..8)	
perRAInfoList-r16	Any allowed value		
timeSinceFailure-r16	Any allowed value	INTEGER (0..172800)	
}			
}			
}			
}			

8.1.6.3.4.3 Inter-System MDT / Connection Establishment Failure / Logging and reporting / Sensor measurement collection

8.1.6.3.4.3.1 Test Purpose (TP)

(1)

```
with { UE after being set up with LoggedMeasurementConfiguration detects connection establishment failure }
ensure that {
  when { UE has sensor logged measurements available and if the RPLMN is included in plmn-IdentityList stored in VarLogMeasReport }
  then { UE sends the RRCSetupComplete message with logMeasAvailable-r16 and connEstFailInfoAvailable-r16 set to true }
}
```

(2)

```
with { UE has sent the RRCSetupComplete message with connEstFailInfoAvailable-r16 set to true }
ensure that {
  when { UE receives a UEInformationRequest message with connEstFailReportReq-r16 set to true }
  then { UE sends the UEInformationResponse message containing only the measurement of the sensor(s) that included in sensor-NameList-r16 of LoggedMeasurementConfiguration }
}
```

8.1.6.3.4.3.2 Conformance requirements

Same as test case 8.1.6.3.4.1.

8.1.6.3.4.3.3 Test description

8.1.6.3.4.3.3.1 Pre-test conditions

Same as test case 8.1.6.3.4.1 with the following differences:

System Simulator:

- NR Cell 1

UE:

- UE supports at least one of pc_barometer_r16, pc_orientation_r16 and pc_speed_r16.

8.1.6.3.4.3.3.2 Test procedure sequence

Same as test case 8.1.6.3.4.1 with the following differences: *logMeasAvailableBT-r16* is not mentioned.

Table 8.1.6.3.4.3.3.2-1: Void

8.1.6.3.4.3.3.3 Specific message contents

Table 8.1.6.3.4.3.3.3-1: LoggedMeasurementConfiguration (step 1, Table 8.1.6.3.4.3.3.2-1)

Derivation path: TS 38.508-1 [4], table 4.6.1-5AA with condition PERIODICAL			
Information Element	Value/remark	Comment	Condition
LoggedMeasurementConfiguration-r16 ::= SEQUENCE {			
criticalExtensions CHOICE {			
loggedMeasurementConfiguration-r16 SEQUENCE {			
sensor-NameList-r16 CHOICE {			
setup	Sensor-NameList-r16		
}			
reportType CHOICE {			
periodical SEQUENCE {			
loggingInterval-r16	ms10240	10.24 second	
}			
}			
}			
}			

Table 8.1.6.3.4.3.3.3-1A: Sensor-NameList-r16 (Table 8.1.6.3.4.3.3.3-1)

Derivation path: TS 38.508-1 [4], table 4.6.5-13			
Information Element	Value/remark	Comment	Condition
Sensor-NameList-r16 ::= SEQUENCE {			
measUncomBarPre-r16	true		pc_barometer_r16
	Not present		
measUeSpeed	true		pc_speed_r16
	Not present		
measUeOrientation	true		pc_orientation_r16
	Not present		
}			

Table 8.1.6.3.4.3.3.3-2: RRCSetupComplete (step 10, Table 8.1.6.3.4.3.3.2-1)

Derivation Path: TS 38.508-1 [4] Table 4.6.1-22			
Information Element	Value/remark	Comment	Condition
RRCSetupComplete ::= SEQUENCE {			
criticalExtensions CHOICE {			
rrcSetupComplete SEQUENCE{			
nonCriticalExtension SEQUENCE{			
iab-NodeIndication-r16	Not checked		
idleMeasAvailable-r16	Not checked		
ue-MeasurementsAvailable-r16	UE-MeasurementsAvailable-		

	r16 with condition LOG and CEF		
mobilityHistoryAvail-r16	Not checked		
mobilityState-r16	Not checked		
nonCriticalExtension	Not checked		
}			
}			
}			
}			

Table 8.1.6.3.4.3.3.3-3: Void

Table 8.1.6.3.4.3.3.3-4: UEInformationResponse (step 16, Table 8.1.6.3.4.3.3.2-1)

Derivation Path: TS 38.508-1 [4], table 4.6.1-32B			
Information Element	Value/remark	Comment	Condition
UEInformationResponse-r16 ::= SEQUENCE {			
criticalExtensions CHOICE {			
ueInformationResponse-r16 SEQUENCE {			
connEstFailReport-r16 SEQUENCE {			
measResultFailedCell-r16 SEQUENCE {			
cgi-Info SEQUENCE {			
plmn-Identity-r16	plmn-Identity within SIB1 broadcasted in NR Cell 1		
cellIdentity-r16	cellIdentity within SIB1 broadcasted in NR Cell 1	BIT STRING (SIZE (36))	
trackingAreaCode-r16	Not checked	BIT STRING (SIZE (24))	
}			
measResult-r16 SEQUENCE {			
cellResults-r16	Not checked		
rsIndexResults-r16	Not checked		
}			
}			
locationInfo-r16 SEQUENCE {			
sensor-LocationInfo-r16 SEQUENCE {		Report sensor measurement information	
sensor-MeasurementInformation-r16	Not present OCTET STRING including Sensor-MeasurementInformation-r13 according to TS 37.355 cl 6.5.5.2.		pc_barometer_r16
sensor-MotionInformation-r16	Not present OCTET STRING including Sensor-MotionInformation-r15 according to TS 37.355 cl 6.5.5.2.		pc_orientation_r16 OR pc_speed_r16
}			
}			
measResultNeighCells-r16 SEQUENCE {			
measResultNeighCellListNR	Not present		
measResultNeighCellListEUTRA	Not present		
}			
numberOfConnFail-r16	Any allowed value	INTEGER (1..8)	
perRAInfoList-r16	Any allowed value		
timeSinceFailure-r16	Any allowed value	INTEGER (0..172800)	
}			
}			
}			

}		
---	--	--

8.1.6.4 SON / RACH Optimisation

8.1.6.4.1 SON / RACH logging and reporting

8.1.6.4.1.1 Test Purpose (TP)

(1)

```
with { UE in NR RRC_CONNECTED state and supports delivery of rachReport and no contention resolution
failure occurred for the last successfully completed random access procedure }
ensure that {
  when { UE receives UEInformationRequest message with ra-ReportReq set to true }
  then { UE transmits UEInformationResponse message with RA-Report including contentionDetected
set to false }
}
```

(2)

```
with { UE in NR RRC_CONNECTED state and supports delivery of rachReport and contention resolution
was not successful for at least one of the transmitted preambles for the last successfully completed
random access procedure }
ensure that {
  when { UE receives UEInformationRequest message with ra-ReportReq set to true }
  then { UE transmits UEInformationResponse message with RA-Report including contentionDetected
set to true }
}
```

8.1.6.4.1.2 Conformance requirements

References: The conformance requirements covered in the current TC is specified in: TS 38.331 clause 5.7.10.3, 5.7.10.4, 5.7.10.5.

[TS 38.331, clause 5.7.10.3]

Upon receiving the *UEInformationRequest* message, the UE shall, only after successful security activation:

...

- 1> if *ra-ReportReq* is set to *true* and the UE has random access related information available in *VarRA-Report* and if the RPLMN is included in *plmn-IdentityList* stored in *VarRA-Report*:
- 2> set the *ra-ReportList* in the *UEInformationResponse* message to the value of *ra-ReportList* in *VarRA-Report*;
- 2> discard the *ra-ReportList* from *VarRA-Report* upon successful delivery of the *UEInformationResponse* message confirmed by lower layers;

...

[TS 38.331, clause 5.7.10.4]

Upon successfully performing 4 step random access procedure, the UE shall:

- 1> if the RPLMN or the PLMN selected by upper layers (see TS24.501 [23]) from the PLMN(s) included in the *plmn-IdentityList* in *SIB1* is not included in *plmn-IdentityList* stored in a non-empty *VarRA-Report*:
- 2> clear the information included in *VarRA-Report*;
- 1> if the number of *RA-Report* entries stored in the *ra-ReportList* in *VarRA-Report* is less than *maxRARReport*:
- 2> if the number of PLMN entries in *plmn-IdentityList* stored in *VarRA-Report* is less than *maxPLMN*; or
- 2> if the number of PLMN entries in *plmn-IdentityList* stored in *VarRA-Report* is equal to *maxPLMN* and the list of EPLMNs is subset of or equal to the *plmn-IdentityList* stored in *VarRA-Report*:

- 3> append the following contents associated to the successfully completed random-access procedure as a new entry in the *VarRA-Report*:
 - 4> if the list of EPLMNs has been stored by the UE:
 - 5> set the *plmn-IdentityList* to include the list of EPLMNs stored by the UE (i.e. includes the RPLMN) without exceeding the limit of *maxPLMN*;
 - 4> else:
 - 5> set the *plmn-Identity*, in *plmn-IdentityList*, to the PLMN selected by upper layers (see TS 24.501 [23]) from the PLMN(s) included in the *plmn-IdentityInfoList* in SIB1;
 - 4> set the *cellId* to the global cell identity and the tracking area code, if available, otherwise to the physical cell identity and carrier frequency of the cell in which the corresponding random-access preamble was transmitted;
 - 4> set the *raPurpose* to include the purpose of triggering the random-access procedure;
 - 4> set the *ra-InformationCommon* as specified in subclause 5.7.10.5.

The UE may discard the random access report information, i.e. release the UE variable *VarRA-Report*, 48 hours after the last successful random access procedure related information is added to the *VarRA-Report*.

NOTE 1: The UE does not log the RA information in the RA report if the triggering event of the random access is consistent UL LBT on SpCell as specified in TS 38.321 [6].

[TS 38.331, clause 5.7.10.5]

The UE shall set the content in *ra-InformationCommon* as follows:

- 1> set the *absoluteFrequencyPointA* to indicate the absolute frequency of the reference resource block associated to the random-access resources used in the random-access procedure;
- 1> set the *locationAndBandwidth* and *subcarrierSpacing* associated to the UL BWP of the random-access resources used in the random-access procedure;
- 1> set the *msg1-FrequencyStart*, *msg1-FDM* and *msg1-SubcarrierSpacing* associated to the contention based random-access resources if used in the random-access procedure;
- 1> set the *msg1-FrequencyStartCFRA*, *msg1-FDMCFRA* and *msg1-SubcarrierSpacingCFRA* associated to the contention free random-access resources if used in the random-access procedure;
- 1> set the parameters associated to individual random-access attempt in the chronological order of attempts in the *perRAInfoList* as follows:
 - 2> if the random-access resource used is associated to a SS/PBCH block, set the associated random-access parameters for the successive random-access attempts associated to the same SS/PBCH block for one or more random-access attempts as follows:
 - 3> set the *ssb-Index* to include the SS/PBCH block index associated to the used random-access resource;
 - 3> set the *numberOfPreamblesSentOnSSB* to indicate the number of successive random-access attempts associated to the SS/PBCH block;
 - 3> for each random-access attempt performed on the random-access resource, include the following parameters in the chronological order of the random-access attempt:
 - 4> if the random-access attempt is performed on the contention based random-access resource and if *raPurpose* is not equal to '*requestForOtherSI*', include *contentionDetected* as follows:
 - 5> if contention resolution was not successful as specified in TS 38.321 [6] for the transmitted preamble:
 - 6> set the *contentionDetected* to *true*;
 - 5> else:

- 6> set the *contentionDetected* to *false*;
- 4> if the random-access attempt is performed on the contention based random-access resource; or
- 4> if the random-access attempt is performed on the contention free random-access resource and if the random-access procedure was initiated due to the PDCCH ordering:
- 5> if the SS/PBCH block RSRP of the SS/PBCH block corresponding to the random-access resource used in the random-access attempt is above *rsrp-ThresholdSSB*:
- 6> set the *dlRSRPAboveThreshold* to *true*;
- 5> else:
- 6> set the *dlRSRPAboveThreshold* to *false*;
- 2> else if the random-access resource used is associated to a CSI-RS, set the associated random-access parameters for the successive random-access attempts associated to the same CSI-RS for one or more random-access attempts as follows:
- 3> set the *csi-RS-Index* to include the CSI-RS index associated to the used random-access resource;
- 3> set the *numberOfPreamblesSentOnCSI-RS* to indicate the number of successive random-access attempts associated to the CSI-RS.

NOTE 1: Void.

8.1.6.4.1.3 Test description

8.1.6.4.1.3.1 Pre-test conditions

System Simulator:

- NR Cell 1

Preamble:

- The UE is in state 3N-A as defined in TS 38.508-1 [4], subclause 4.4A on NR Cell 1.

8.1.6.4.1.3.2 Test procedure sequence

Table 8.1.6.4.1.3.2-1: Main behaviour

St	Procedure	Message Sequence		TP	Verdict
		U - S	Message		
1	The SS transmits a <i>UEInformationRequest</i> message on NR Cell 1.	<--	<i>NR RRC: UEInformationRequest</i>	-	-
2	Check: Does the UE transmit a <i>UEInformationResponse</i> message with <i>RA-Report</i> ?	-->	<i>NR RRC: UEInformationResponse</i>	1	P
3	SS transmits an <i>RRCRelease</i> message to release the RRC connection.	<--	<i>NR RRC:RRCRelease</i>		
4	SS waits for 5s.	-	-	-	-
5	SS is configured to transmit MAC control element with non-matched UE Contention Resolution Identity for first RACH procedure and responds with matched UE Contention Resolution from second RACH procedure	-	-	-	-
6	SS sends a <i>Paging</i> message to the UE on the appropriate paging block, and including the UE identity in one entry of the IE <i>pagingRecordLists</i> .	<--	<i>NR RRC: Paging</i>	-	-
6A	The UE transmits a preamble on PRACH	-->	PRACH Preamble	-	-
6B	The SS transmits Random Access Response	<--	Random Access Response	-	-

6C	The UE transmits an <i>RRCSetupRequest</i> message.	-->	<i>RRCSetupRequest</i>	-	-
6D	The SS schedules PDCCH transmission containing an <i>RRCSetup</i> message, but not including a matching 'UE Contention Resolution Identity' MAC control element.	<--	<i>RRCSetup</i>	-	-
7-13	Steps 2 to 8 of the generic procedure in TS 38.508-1 [4] Table 4.5.4.2-3 are performed on NR Cell 1.	-	-	-	-
14	The SS transmits a <i>UEInformationRequest</i> message.	<--	<i>NR RRC: UEInformationRequest</i>	-	-
15	Check: Does the UE transmit a <i>UEInformationResponse</i> message with <i>RA-Report</i> ?	-->	<i>NR RRC: UEInformationResponse</i>	2	P

8.1.6.4.1.3.3 Specific message contents

Table 8.1.6.4.1.3.3-1: *UEInformationRequest* (Step 1 and Step14, Table 8.1.6.4.1.3.2-1)

Derivation Path: TS 38.508-1 [4], Table 4.6.1-32A with condition RA

Table 8.1.6.4.1.3.3-2: *UEInformationResponse* (Step 2, Table 8.1.6.4.1.3.2-1)

Derivation Path: TS 38.508-1 [4], Table 4.6.1-32B			
Information Element	Value/remark	Comment	Condition
<i>UEInformationResponse</i> -r16 ::= SEQUENCE {			
criticalExtensions CHOICE {			
ueInformationResponse-r16 SEQUENCE {			
ra-ReportList-r16 SEQUENCE (SIZE (1..maxRAReport-r16)) OF RA-Report-r16{	1 entry		
RA-Report-r16[1] SEQUENCE {		Entry 1	
cellId-r16 CHOICE {			
cellGlobalId-r16 SEQUENCE {			
plmn-Identity-r16	PLMN identity of Cell 1		
cellIdentity-r16	Cell identity of Cell1		
}			
ra-InformationCommon-r16 SEQUENCE {			
absoluteFrequencyPointA-r16	Not checked		
locationAndBandwidth-r16	Not checked		
subcarrierSpacing-r16	Not checked		
msg1-FrequencyStart-r16	Not checked		
msg1-FrequencyStartCFRA-r16	Not checked		
msg1-SubcarrierSpacing-r16	Not checked		
msg1-SubcarrierSpacingCFRA-r16	Not checked		
msg1-FDM-r16	Not checked		
msg1-FDMCFRA-r16	Not checked		
perRAInfoList-r16 SEQUENCE (SIZE (1..200)) OF PerRAInfo-r16{	x entry		
PerRAInfo-r16[1] CHOICE {		x ranges from 1 to numberOfPreamblesSentOnSSB-r16	
perRASSBInfoList-r16 SEQUENCE {			
ssb-Index-r16	Any allowed value		
numberOfPreamblesSentOnSSB-r16	Any allowed value		
perRAAttemptInfoList-r16 SEQUENCE (SIZE (1..200)) OF PerRAAttemptInfo-r16{	1 entry		
PerRAAttemptInfo-r16[1] SEQUENCE {		Entry 1	
contentionDetected-r16	false		
dIRSRPAboveThreshold-r16	Not checked		
}			
}			
}			

}			
}			
}			
raPurpose-r16	accessRelated		
}			
}			
}			
}			
}			
}			

Table 8.1.6.4.1.3.3-3: UEInformationResponse (Step 15, Table 8.1.6.4.1.3.2-1)

Derivation Path: TS 38.508-1 [4], Table 4.6.1-32B			
Information Element	Value/remark	Comment	Condition
UEInformationResponse-r16 ::= SEQUENCE {			
criticalExtensions CHOICE {			
ueInformationResponse-r16 SEQUENCE {			
ra-ReportList-r16 SEQUENCE (SIZE (1..maxRAReport-r16)) OF RA-Report-r16{	1 entry		
RA-Report-r16[1] SEQUENCE {		Entry 1	
cellId-r16 CHOICE {			
cellGlobalId-r16 SEQUENCE {			
plmn-Identity-r16	PLMN identity of Cell 1		
cellIdentity-r16	Cell identity of Cell1		
}			
ra-InformationCommon-r16 SEQUENCE {			
absoluteFrequencyPointA-r16	Not checked		
locationAndBandwidth-r16	Not checked		
subcarrierSpacing-r16	Not checked		
msg1-FrequencyStart-r16	Not checked		
msg1-FrequencyStartCFRA-r16	Not checked		
msg1-SubcarrierSpacing-r16	Not checked		
msg1-SubcarrierSpacingCFRA-r16	Not checked		
msg1-FDM-r16	Not checked		
msg1-FDMCFRA-r16	Not checked		
perRAInfoList-r16 SEQUENCE (SIZE (1..200)) OF PerRAInfo-r16{	x entry		
PerRAInfo-r16[1] CHOICE {		x ranges from 1 to numberOfPreamblesSentOnSSB-r16	
perRASSBInfoList-r16 SEQUENCE {			
ssb-Index-r16	Any allowed value		
numberOfPreamblesSentOnSSB-r16	Any allowed value		
perRAAttemptInfoList-r16 SEQUENCE (SIZE (1..200)) OF PerRAAttemptInfo-r16{	1 entry		
PerRAAttemptInfo-r16[1] SEQUENCE {		Entry 1	
contentionDetected-r16	true		
dirSRPAboveThreshold-r16	Not checked		
}			
}			
}			
}			
}			
raPurpose-r16	accessRelated		
}			
}			
}			
}			
}			

8.1.7 Non-public networks

8.1.7.1 Measurement for self-optimized networks

8.1.7.1.1 Measurement configuration control and reporting / CGI reporting of NR NPN cell

8.1.7.1.1.1 Test Purpose (TP)

(1)

```
with { UE in NR RRC_CONNECTED state }
ensure that {
  when { UE is configured to report the global cell identity of the neighbour NR NPN cell }
  then { UE determines the global cell identity of the cell included in the associated measurement
object by acquiring the relevant system information from the concerned cell and reports the global
cell identity in the MeasurementReport }
}
```

8.1.7.1.1.2 Conformance requirements

References: The conformance requirements covered in the current TC are specified in: TS 38.331 clauses 5.3.5.3, 5.5.2.1, 5.5.4.1 and 5.5.5.1. Unless otherwise stated these are Rel-16 requirements.

[TS 38.331, clause 5.3.5.3]

The UE shall perform the following actions upon reception of the *RRCReconfiguration*, or upon execution of the conditional reconfiguration (CHO or CPC):

...

1> if the *RRCReconfiguration* message includes the *measConfig*:

2> perform the measurement configuration procedure as specified in 5.5.2;

...

1> else (*RRCReconfiguration* was received via SRB1):

2> submit the *RRCReconfigurationComplete* message via SRB1 to lower layers for transmission using the new configuration;

[TS 38.331, clause 5.5.2.1]

The network applies the procedure as follows:

- to ensure that, whenever the UE has a *measConfig* associated with a CG, it includes a *measObject* for the SpCell and for each NR SCell of the CG to be measured;
- to configure at most one measurement identity across all CGs using a reporting configuration with the *reportType* set to *reportCGI*;

...

The UE shall:

...

1> if the received *measConfig* includes the *reportConfigToAddModList*:

2> perform the reporting configuration addition/modification procedure as specified in 5.5.2.7;

[TS 38.331, clause 5.5.4.1]

If AS security has been activated successfully, the UE shall:

1> for each *measId* included in the *measIdList* within *VarMeasConfig*:

...

- 2> else if the corresponding *reportConfig* includes a *reportType* set to *reportCGI*:
 - 3> consider the cell detected on the associated *measObject* which has a physical cell identity matching the value of the *cellForWhichToReportCGI* included in the corresponding *reportConfig* within the *VarMeasConfig* to be applicable;

...

- 2> if *reportType* is set to *reportCGI*:
 - 3> if the UE acquired the *SIB1* or *SystemInformationBlockType1* for the requested cell; or
 - 3> if the UE detects that the requested NR cell is not transmitting *SIB1* (see TS 38.213 [13], clause 13):
 - 4> stop timer T321;
 - 4> include a measurement reporting entry within the *VarMeasReportList* for this *measId*;
 - 4> set the *numberOfReportsSent* defined within the *VarMeasReportList* for this *measId* to 0;
 - 4> initiate the measurement reporting procedure, as specified in 5.5.5;

[TS 38.331, clause 5.5.5.1]

...

The purpose of this procedure is to transfer measurement results from the UE to the network. The UE shall initiate this procedure only after successful AS security activation.

For the *measId* for which the measurement reporting procedure was triggered, the UE shall set the *measResults* within the *MeasurementReport* message as follows:

...

- 1> if there is at least one applicable neighbouring cell to report:

...

- 2> else:
 - 3> if the cell indicated by *cellForWhichToReportCGI* is an NR cell:
 - 4> if *plmn-IdentityInfoList* of the *cgi-Info* for the concerned cell has been obtained:
 - 5> include the *plmn-IdentityInfoList* including *plmn-IdentityList*, *trackingAreaCode* (if available), *ranac* (if available), *cellIdentity* and *cellReservedForOperatorUse* for each entry of the *plmn-IdentityInfoList*;
 - 5> include *frequencyBandList* if available;
 - 4> if *nr-CGI-Reporting-NPN* is supported by the UE and *nnp-IdentityInfoList* of the *cgi-Info* for the concerned cell has been obtained:
 - 5> include the *nnp-IdentityInfoList* including *nnp-IdentityList*, *trackingAreaCode*, *ranac* (if available), *cellIdentity* and *cellReservedForOperatorUse* for each entry of the *nnp-IdentityInfoList*;
 - 5> include *cellReservedForOtherUse* if available;
 - 4> else if *MIB* indicates the *SIB1* is not broadcast:
 - 5> include the *noSIB1* including the *ssb-SubcarrierOffset* and *pdccch-ConfigSIB1* obtained from *MIB* of the concerned cell;

...

- 1> else:

2> submit the *MeasurementReport* message to lower layers for transmission, upon which the procedure ends.

8.1.7.1.1.3 Test description

8.1.7.1.1.3.1 Pre-test conditions

System Simulator:

- NR Cell 1 is the Serving cell
- NR Cell 2 is a CAG cell and an intra-frequency Suitable neighbour of NR Cell 1.
- System information combination NR-2 as defined in TS 38.508-1 [4] clause 4.4.3.1.2 is used for both NR Cells, and message contents defined in 4.6.1 and 4.6.2 with CAG condition for NR Cell 2.

UE:

- None.

Preamble:

- The UE is in state 3N-A as defined in TS 38.508-1 [4], subclause 4.4A on NR Cell 1.

8.1.7.1.1.3.2 Test procedure sequence

Table 8.1.7.1.1.3.2-1 and 8.1.7.1.1.3.2-2 illustrates the downlink power levels to be applied for NR Cell 1, and NR Cell 2 at various time instants of the test execution. Row marked "T0" denotes the conditions after the preamble. Cell powers are chosen for a serving cell and a suitable neighbour intra-frequency cell as defined in TS 38.508-1 [4] Table 6.2.2.1-3 for FR1 and Table 6.2.2.2-2 for FR2.

Table 8.1.7.1.1.3.2-1: Time instances of cell power level and parameter changes for FR1

	Parameter	Unit	NR Cell 1	NR Cell 2	Remark
T0	SS/PBCH SSS EPRE	dBm/ SCS	-88	-94	

Table 8.1.7.1.1.3.2-2: Time instances of cell power level and parameter changes for FR2

	Parameter	Unit	NR Cell 1	NR Cell 2	Remark
T0	SS/PBCH SSS EPRE	dBm/ SCS	-82	-91	

Table 8.1.7.1.1.3.2-3: Main behaviour

St	Procedure	Message Sequence		TP	Verdict
		U - S	Message		
1	The SS transmits an <i>RRCReconfiguration</i> message including <i>measConfig</i> including <i>reportCGI</i> for Cell 2 and sufficient idle periods for UE to acquire the relevant system information from Cell 2	<--	NR RRC: <i>RRCReconfiguration</i>	-	-
2	The UE transmits an <i>RRCReconfigurationComplete</i> message.	-->	NR RRC: <i>RRCReconfigurationComplete</i>	-	-
3	Check: Does the UE transmit a <i>MeasurementReport</i> message with CGI of NR Cell 2 within 2 sec if Cell 2 is in FR1 (or within 16 sec if Cell 2 is in FR2)?	-->	NR RRC: <i>MeasurementReport</i>	1	P

8.1.7.1.1.3.3 Specific message contents

Table 8.1.7.1.1.3.3-1: RRCReconfiguration (step 1, Table 8.1.7.1.1.3.2-3)

Derivation Path: TS 38.508-1 [4] Table 4.6.1-13 with condition NR_MEAS			
Information Element	Value/remark	Comment	Condition
RRCReconfiguration ::= SEQUENCE {			
criticalExtensions CHOICE {			
rrcReconfiguration SEQUENCE {			
measConfig	MeasConfig-CGI	Table 8.1.7.1.1.3.3-4	
nonCriticalExtension SEQUENCE {			
masterCellGroup	CellGroupConfig-DRX	Table 8.1.7.1.1.3.3-2	
}			
}			
}			

Table 8.1.7.1.1.3.3-2: CellGroupConfig-DRX (Table 8.1.7.1.1.3.3-1)

Derivation Path: TS 508-1 [4], Table 4.6.3-19 with condition MEAS			
Information Element	Value/remark	Comment	Condition
CellGroupConfig ::= SEQUENCE {			
mac-CellGroupConfig	MAC-CellGroupConfig	Table 8.1.7.1.1.3.3-3	
}			

Table 8.1.7.1.1.3.3-3: MAC-CellGroupConfig

Derivation Path: TS 38.508-1 [4], Table 4.6.3-68 with Condition DRX			
Information Element	Value/remark	Comment	Condition
MAC-CellGroupConfig ::= SEQUENCE {			
drx-Config CHOICE {			
setup SEQUENCE {			
drx-InactivityTimer	ms100		
drx-LongCycleStartOffset CHOICE {			
ms640	0		
}			
}			
}			

Table 8.1.7.1.1.3.3-4: MeasConfig-CGI (Table 8.1.7.1.1.3.3-1)

Derivation Path: TS 38.508-1 [4] Table 4.6.3-69			
Information Element	Value/remark	Comment	Condition
MeasConfig ::= SEQUENCE {			
measObjectToAddModList SEQUENCE (SIZE (1..maxNrofMeasId)) OF MeasObjectToAddMod {	1 entry		
MeasObjectToAddMod[1] SEQUENCE {		entry 1	
measObjectId	1		
measObject CHOICE {			
measObjectNR SEQUENCE {			
ssbFrequency	ssbFrequency IE equals the ARFCN for NR Cell 1		
absThreshSS-BlocksConsolidation	Not present		
}			
}			
}			

reportConfigToAddModList SEQUENCE (SIZE (1..maxReportConfigId)) OF ReportConfigToAddMod {	1 entry		
ReportConfigToAddMod[1] SEQUENCE {		entry 1	
reportConfigId	1		
reportConfig CHOICE {			
reportConfigNR	ReportConfigNR-CGI	Table 8.1.7.1.1.3.3-5	
}			
}			
}			
}			
measIdToAddModList SEQUENCE (SIZE (1..maxNrofMeasId)) OF MeasIdToAddMod {	1 entry		
MeasIdToAddMod[1] SEQUENCE {		entry 1	
measId	1		
measObjectId	1		
reportConfigId	1	reportConfigId for CGI measurement	
}			
}			
}			
}			

Table 8.1.7.1.1.3.3-5: ReportConfigNR-CGI (Table 8.1.7.1.1.3.3-4)

Derivation Path: TS 38.508-1 [4] Table 4.6.3-142 with Condition CGI			
Information Element	Value/remark	Comment	Condition
ReportConfigNR ::= SEQUENCE {			
reportType CHOICE {			
reportCGI SEQUENCE {			
cellForWhichToReportCGI	PhysCellId of NR Cell 2		
}			
}			
}			
}			

Table 8.1.7.1.1.3.3-6: MeasurementReport (step 3, Table 8.1.7.1.1.3.2-3)

Derivation Path: TS 38.508-1 [4] Table 4.6.1-5A			
Information Element	Value/remark	Comment	Condition
MeasurementReport ::= SEQUENCE {			
criticalExtensions CHOICE {			
measurementReport SEQUENCE {			
measResults SEQUENCE {			
measId	1		
measResultServingMOList SEQUENCE (SIZE (1..maxNrofServingCells)) OF MeasResultServMO {	1 entry		
MeasResultServMO[1] SEQUENCE {		entry 1	
servCellId	ServCellIndex of NR Cell 1		
measResultServingCell SEQUENCE {			
physCellId	Physical layer cell identity of NR Cell 1		
measResult SEQUENCE {			
cellResults	Not Checked		
}			
}			
}			
}			
}			
}			
measResultNeighCells CHOICE {			
measResultListNR SEQUENCE (SIZE (1..maxCellReport)) OF MeasResultNR {	1 entry		
MeasResultNR[1] SEQUENCE {		entry 1	
physCellId	Physical layer cell identity of NR Cell 2		
measResult SEQUENCE {			
cellResults	Not Checked		

rsIndexResults	Not Checked		
}			
cgI-Info SEQUENCE {			
plmn-IdentityInfoList	Set according to plmn-IdentityInfoList in SIB1 of NR Cell2		
frequencyBandList	Set according to FrequencyBandIndicatorNR in SIB1 of NR Cell2		
noSIB1	Not present		
npr-IdentityInfoList-r16	Set according to npr-IdentityInfoList-r16 in SIB1 of NR Cell2		
cellReservedForOtherUse-r16	true		
}			
}			
}			
}			
}			
}			
}			
}			
}			
}			

8.2 MR-DC RRC

8.2.1 UE Capability

8.2.1.1 UE capability transfer / Success

8.2.1.1.1 UE capability transfer / Success / EN-DC

8.2.1.1.1.1 Test Purpose (TP)

(1)

```
with { UE in RRC_CONNECTED state with EN-DC, and, MCG(s) (E-UTRA PDCP) only }
ensure that {
  when { UE receives an UECapabilityEnquiry message that includes eutra }
  then { UE transmits an UECapabilityInformation message including UE radio access capability
information corresponding to the ue-CapabilityRequest variable }
}
```

(2)

```
with { UE in RRC_CONNECTED state with EN-DC, and, MCG(s) (E-UTRA PDCP) only }
ensure that {
  when { UE receives an UECapabilityEnquiry message that includes eutra-nr and nr }
  then { UE transmits an UECapabilityInformation message including UE radio access capability
information corresponding to the ue-CapabilityRequest variable }
}
```

8.2.1.1.1.2 Conformance requirements

References: The conformance requirements covered in the present TC are specified in: TS 36.331, clause 5.6.3.3, 5.6.22.2 and 5.6.22.3.

[TS 36.331, clause 5.6.3.3]

The UE shall:

1> for NB-IoT, set the contents of *UECapabilityInformation* message as follows:

2> include the UE Radio Access Capability Parameters within the *ue-Capability-Container*;

- 2> include *ue-RadioPagingInfo*;
- 2> submit the *UECapabilityInformation* message to lower layers for transmission, upon which the procedure ends;
- 1> else, set the contents of *UECapabilityInformation* message as follows:
 - 2> if the *ue-CapabilityRequest* includes *eutra*:
 - 3> include the *UE-EUTRA-Capability* within a *ue-CapabilityRAT-Container* and with the *rat-Type* set to *eutra*;
 - 3> if the UE supports FDD and TDD:
 - 4> set all fields of *UECapabilityInformation*, except field *fdd-Add-UE-EUTRA-Capabilities* and *tdd-Add-UE-EUTRA-Capabilities* (including their sub-fields), to include the values applicable for both FDD and TDD (i.e. functionality supported by both modes);
 - 4> if (some of) the UE capability fields have a different value for FDD and TDD:
 - 5> if for FDD, the UE supports additional functionality compared to what is indicated by the previous fields of *UECapabilityInformation*:
 - 6> include field *fdd-Add-UE-EUTRA-Capabilities* and set it to include fields reflecting the additional functionality applicable for FDD;
 - 5> if for TDD, the UE supports additional functionality compared to what is indicated by the previous fields of *UECapabilityInformation*:
 - 6> include field *tdd-Add-UE-EUTRA-Capabilities* and set it to include fields reflecting the additional functionality applicable for TDD;

NOTE 1: The UE includes fields of *XDD-Add-UE-EUTRA-Capabilities* in accordance with the following:

- The field is included only if one or more of its sub-fields (or bits in the feature group indicators string) has a value that is different compared to the value signalled elsewhere within *UE-EUTRA-Capability*;
(this value signalled elsewhere is also referred to as the *Common value* that is supported for both XDD modes)
 - For the fields that are included in *XDD-Add-UE-EUTRA-Capabilities*, the UE sets:
 - the sub-fields (or bits in the feature group indicators string) that are not allowed to be different to the same value as the *Common value*;
 - the sub-fields (or bits in the feature group indicators string) that are allowed to be different to a value indicating at least the same functionality as indicated by the *Common value*;
- 3> else (UE supports single xDD mode):
 - 4> set all fields of *UECapabilityInformation*, except field *fdd-Add-UE-EUTRA-Capabilities* and *tdd-Add-UE-EUTRA-Capabilities* (including their sub-fields), to include the values applicable for the xDD mode supported by the UE;
 - 3> compile a list of band combinations, candidate for inclusion in the *UECapabilityInformation* message, comprising of band combinations supported by the UE according to the following priority order (i.e. listed in order of decreasing priority):
 - 4> include all non-CA bands, regardless of whether UE supports carrier aggregation, only:
 - if the UE includes *ue-Category-v1020* (i.e. indicating category 6 to 8); or
 - if for at least one of the non-CA bands, the UE supports more MIMO layers with TM9 and TM10 than implied by the UE category; or
 - if the UE supports TM10 with one or more CSI processes;

- if the UE supports 1024QAM in DL;
- 4> if the *UECapabilityEnquiry* message includes *requestedFrequencyBands* and UE supports *requestedFrequencyBands*:
 - 5> include all 2DL+1UL CA band combinations, only consisting of bands included in *requestedFrequencyBands*;
 - 5> include all other CA band combinations, only consisting of bands included in *requestedFrequencyBands*, and prioritized in the order of *requestedFrequencyBands*, (i.e. first include remaining band combinations containing the first-listed band, then include remaining band combinations containing the second-listed band, and so on);
- 4> else (no requested frequency bands):
 - 5> include all 2DL+1UL CA band combinations;
 - 5> include all other CA band combinations;
- 4> if UE supports *maximumCCsRetrieval* and if the *UECapabilityEnquiry* message includes the *requestedMaxCCsDL* and the *requestedMaxCCsUL* (i.e. both UL and DL maximums are given):
 - 5> remove from the list of candidates the band combinations for which the number of CCs in DL exceeds the value indicated in the *requestedMaxCCsDL* or for which the number of CCs in UL exceeds the value indicated in the *requestedMaxCCsUL*;
 - 5> indicate in *requestedCCsUL* the same value as received in *requestedMaxCCsUL*;
 - 5> indicate in *requestedCCsDL* the same value as received in *requestedMaxCCsDL*;
- 4> else if UE supports *maximumCCsRetrieval* and if the *UECapabilityEnquiry* message includes the *requestedMaxCCsDL* (i.e. only DL maximum limit is given):
 - 5> remove from the list of candidates the band combinations for which the number of CCs in DL exceeds the value indicated in the *requestedMaxCCsDL*;
 - 5> indicate value in *requestedCCsDL* the same value as received in *requestedMaxCCsDL*;
- 4> else if UE supports *maximumCCsRetrieval* and if the *UECapabilityEnquiry* message includes the *requestedMaxCCsUL* (i.e. only UL maximum limit is given):
 - 5> remove from the list of candidates the band combinations for which the number of CCs in UL exceeds the value indicated in the *requestedMaxCCsUL*;
 - 5> indicate in *requestedCCsUL* the same value as received in *requestedMaxCCsUL*;
- 4> if the UE supports *reducedIntNonContComb* and the *UECapabilityEnquiry* message includes *requestReducedIntNonContComb*:
 - 5> set *reducedIntNonContCombRequested* to true;
 - 5> remove from the list of candidates the intra-band non-contiguous CA band combinations which support is implied by another intra-band non-contiguous CA band combination included in the list of candidates as specified in TS 36.306 [5, 4.3.5.21];
- 4> if the UE supports *requestReducedFormat* and UE supports *skipFallbackCombinations* and *UECapabilityEnquiry* message includes *requestSkipFallbackComb*:
 - 5> set *skipFallbackCombRequested* to true;
 - 5> for each band combination included in the list of candidates (including 2DL+1UL CA band combinations), starting with the ones with the lowest number of DL and UL carriers, that concerns a fallback band combination of another band combination included in the list of candidates as specified in TS 36.306 [5]:
 - 6> remove the band combination from the list of candidates;

- 6> include *differentFallbackSupported* in the band combination included in the list of candidates whose fallback concerns the removed band combination, if its capabilities differ from the removed band combination;
- 4> if the UE supports *requestReducedFormat* and *diffFallbackCombReport*, and *UECapabilityEnquiry* message includes *requestDiffFallbackCombList*:
 - 5> if the UE does not support *skipFallbackCombinations* or *UECapabilityEnquiry* message does not include *requestSkipFallbackComb*:
 - 6> remove all band combination from the list of candidates;
 - 5> for each CA band combination indicated in *requestDiffFallbackCombList*:
 - 6> include the CA band combination, if not already in the list of candidates;
 - 6> include the fallback combinations for which the supported UE capabilities are different from the capability of the CA band combination;
 - 5> include CA band combinations indicated in *requestDiffFallbackCombList* into *requestedDiffFallbackCombList*;
 - 3> if the *UECapabilityEnquiry* message includes *requestReducedFormat* and UE supports *requestReducedFormat*:
 - 4> include in *supportedBandCombinationReduced* as many as possible of the band combinations included in the list of candidates, including the non-CA combinations, determined according to the rules and priority order defined above;
 - 3> else
 - 4> if the *UECapabilityEnquiry* message includes *requestedFrequencyBands* and UE supports *requestedFrequencyBands*:
 - 5> include in *supportedBandCombination* as many as possible of the band combinations included in the list of candidates, including the non-CA combinations and up to 5DL+5UL CA band combinations, determined according to the rules and priority order defined above;
 - 5> include in *supportedBandCombinationAdd* as many as possible of the remaining band combinations included in the list of candidates, (i.e. the candidates not included in *supportedBandCombination*), up to 5DL+5UL CA band combinations, determined according to the rules and priority order defined above;
 - 4> else
 - 5> include in *supportedBandCombination* as many as possible of the band combinations included in the list of candidates, including the non-CA combinations and up to 5DL+5UL CA band combinations, determined according to the rules defined above;
 - 5> if it is not possible to include in *supportedBandCombination* all the band combinations to be included according to the above, selection of the subset of band combinations to be included is left up to UE implementation;
 - 3> indicate in *requestedBands* the same bands and in the same order as included in *requestedFrequencyBands*, if received;
 - 3> if the UE is a category 0, M1 or M2 UE, or supports any UE capability information in *ue-RadioPagingInfo*, according to TS 36.306 [5]:
 - 4> include *ue-RadioPagingInfo* and set the fields according to TS 36.306 [5];
 - 3> if the UE supports EN-DC and if *requestedFreqBandsNR-MRDC* is included in the request:
 - 4> include into *featureSetsEUTRA* the feature sets that are applicable for the received *requestedFreqBandsNR-MRDC* as specified in TS 38.331 [82], clause 5.6.1.4.

NOTE: Even if the network requests (only) capabilities for *eutra*, it may include NR band numbers in the *requestedFreqBandsNR-MRDC* in order to ensure that the UE includes all necessary feature sets (i.e. E-UTRA and NR) needed for subsequently requested *eutra-nr* capabilities.

- 3> if the *UECapabilityEnquiry* message includes *request-sTTI-sPT-Capability* and if the UE supports short TTI and/or SPT:
 - 4> for each band combination the UE included in a field of the *UECapabilityInformation* message in accordance with the previous:
 - 4> if the UE supports short TTI, include the short TTI capabilities for each of the band combinations using the *sTTI-SPT-BandCombinationParameters*;
 - 4> if the UE supports SPT, include the SPT capabilities for each of the band combinations using the *sTTI-SPT-BandCombinationParameters*;

NOTE: The UE may have to add/repeat the band combinations to the list of band combinations included earlier, to include short TTI capabilities and/or SPT capabilities.

- 2> if the UE supports short TTI and/or SPT:
 - 3> include in the UE radio access capabilities the IE *sTTI-SPT-Supported* and set to *supported*;
- 2> if the *ue-CapabilityRequest* includes *geran-cs* and if the UE supports GERAN CS domain:
 - 3> include the UE radio access capabilities for GERAN CS within a *ue-CapabilityRAT-Container* and with the *rat-Type* set to *geran-cs*;
- 2> if the *ue-CapabilityRequest* includes *geran-ps* and if the UE supports GERAN PS domain:
 - 3> include the UE radio access capabilities for GERAN PS within a *ue-CapabilityRAT-Container* and with the *rat-Type* set to *geran-ps*;
- 2> if the *ue-CapabilityRequest* includes *utra* and if the UE supports UTRA:
 - 3> include the UE radio access capabilities for UTRA within a *ue-CapabilityRAT-Container* and with the *rat-Type* set to *utra*;
- 2> if the *ue-CapabilityRequest* includes *cdma2000-1XR* and if the UE supports CDMA2000 1xRTT:
 - 3> include the UE radio access capabilities for CDMA2000 within a *ue-CapabilityRAT-Container* and with the *rat-Type* set to *cdma2000-1XR*;
- 2> if the *ue-CapabilityRequest* includes *nr* and if the UE supports NR:
 - 3> include the UE radio access capabilities for NR within a *ue-CapabilityRAT-Container*, with the *rat-Type* set to *nr*;
 - 3> include band combinations and feature sets as specified in TS 38.331 [82], clause 5.6.1.4, considering the *FreqBandList* included in *requestedFreqBandsNR-MRDC* and the *eutra-nr-only* flag (if present);
- 2> if the *ue-CapabilityRequest* includes *eutra-nr* and if the UE supports EN-DC:
 - 3> include the UE radio access capabilities for EUTRA-NR within a *ue-CapabilityRAT-Container*, with the *rat-Type* set to *eutra-nr*
 - 3> include band combinations and feature sets as specified in TS 38.331 [82], clause 5.6.1.4, considering the *FreqBandList* included in *requestedFreqBandsNR-MRDC*;

1> submit the *UECapabilityInformation* message to lower layers for transmission, upon which the procedure ends;

[TS 36.331, clause 5.6.22.2]

A UE capable of UL RRC message segmentation in RRC_CONNECTED will initiate the procedure when the following conditions are met:

- 1> if the RRC message segmentation is enabled based on the field *rrc-SegAllowed* received, and

- 1> if the encoded RRC message is larger than the maximum supported size of a PDCP SDU specified in TS 36.323 [8];

Upon initiating the procedure, the UE shall:

- 1> initiate transmission of the *ULDedicatedMessageSegment* message as specified in 5.6.22.3;

[TS 36.331, clause 5.6.22.3]

The UE shall segment the encoded RRC PDU based on the maximum supported size of a PDCP SDU specified in TS 36.323 [8]. UE shall minimize the number of segments and set the contents of the *ULDedicatedMessageSegment* messages as follows:

- 1> For each new UL DCCH message, set the *segmentNumber* to 0 for the first message segment and increment the *segmentNumber* for each subsequent RRC message segment;
- 1> set *rrc-MessageSegmentContainer* to include the segment of the UL DCCH message corresponding to the *segmentNumber*;
- 1> if the segment included in the *rrc-MessageSegmentContainer* is the last segment of the UL DCCH message:
- 2> set the *rrc-MessageSegmentType* to *lastSegment*;
- 1> else:
- 2> set the *rrc-MessageSegmentType* to *notLastSegment*;
- 1> submit all the *ULDedicatedMessageSegment* messages generated for the segmented RRC message to lower layers for transmission in ascending order based on the *segmentNumber*, upon which the procedure ends.

8.2.1.1.1.3 Test description

8.2.1.1.1.3.1 Pre-test conditions

System Simulator:

- EUTRA Cell 1 is the PCell and NR Cell 1 is the PS Cell.

UE:

- None

Preamble:

- The UE is in state RRC_CONNECTED in EN-DC mode according to TS 38.508-1 [4] clause 4.5.4.2 with MCG(s) and SCG.

8.2.1.1.1.3.2 Test procedure sequence

Table 8.2.1.1.1.3.2-1: Main behaviour

St	Procedure	Message Sequence		TP	Verdict
		U - S	Message		
1	The SS transmits a <i>UECapabilityEnquiry</i> message including <i>eutra</i> with <i>rrc-segAllowed-r16</i> set to <i>enabled</i> .	<--	<i>UECapabilityEnquiry</i>	-	-
-	EXCEPTION: The "lower case letter" identifies a step sequence that takes place depending on the size of UE capability message. IF <i>pc_LTE_UL_Segmentation</i> and UE's encoded <i>UECapabilityInformation</i> message \geq Max PDCP SDU size then steps 2a1 and 2a2 will be performed else step 2b1 will be performed	-	-	-	-

-	EXCEPTION: Step 2a1 is repeated a maximum of 16 times or till rrc-MessageSegmentType-16 IE within the UIDedicatedMessageSegment message indicate rrc-MessageSegmentType-r16 = lastSegment.	-	-	-	-
2a1	Check: Does the UE send segments of UECapabilityInformation message contained within the rrc-MessageSegmentContainer-r16 IE of the ULDedicatedMessageSegment message?	-->	<i>ULDedicatedMessageSegment</i>	-	-
2a2	Check: Is the received UE radio access capability information as per the ue-CapabilityRequest variable?	-	-	1	P
2b1	Check: Does the UE transmit a <i>UECapabilityInformation</i> message including UE radio access capability information as per the ue-CapabilityRequest variable?	-->	<i>UECapabilityInformation</i>	1	P
3	The SS transmits a <i>UECapabilityEnquiry</i> message including eutra-nr and nr with rrc-segAllowed-r16 set to enabled.	<--	<i>UECapabilityEnquiry</i>	-	-
-	EXCEPTION: The "lower case letter" identifies a step sequence that takes place depending on the size of UE capability message. IF pc_LTE_UL_Segmentation and UE's encoded UECapabilityInformation message >= Max PDCP SDU size then steps 4a1 and 4a2 will be performed else step 4b1 will be performed	-	-	-	-
-	EXCEPTION: Step 4a1 is repeated a maximum of 16 times or till rrc-MessageSegmentType-16 IE within the UIDedicatedMessageSegment message indicate rrc-MessageSegmentType-r16 = lastSegment.	-	-	-	-
4a1	Check: Does the UE send segments of UECapabilityInformation message contained within the rrc-MessageSegmentContainer-r16 IE of the ULDedicatedMessageSegment message?	-->	<i>ULDedicatedMessageSegment</i>	-	-
4a2	Check: Is the received UE radio access capability information as per the ue-CapabilityRequest variable?	-	-	2	P
4b1	Check: Does the UE transmit a <i>UECapabilityInformation</i> message including UE radio access capability information as per the ue-CapabilityRequest variable?	-->	<i>UECapabilityInformation</i>	2	P

8.2.1.1.1.3.3 Specific message contents

Table 8.2.1.1.1.3.3-1: UECapabilityEnquiry (step 1, Table 8.2.1.1.1.3.2-1)

Derivation Path: TS 36.508 [7], Table 4.6.1-22			
Information Element	Value/remark	Comment	Condition
UECapabilityEnquiry ::= SEQUENCE {			
criticalExtensions CHOICE {			
c1 CHOICE {			
ueCapabilityEnquiry-r8 SEQUENCE {			
ue-CapabilityRequest SEQUENCE (SIZE (1..maxRAT-Capabilities)) OF RAT TYPE {			
RAT-Type [1]	eutra		
}			
nonCriticalExtension SEQUENCE {			
lateNonCriticalExtension	Not present		
nonCriticalExtension SEQUENCE {			
requestedFrequencyBands-r11 SEQUENCE {}	Not present		
nonCriticalExtension SEQUENCE {			
requestReducedFormat-r13	Not present		
requestSkipFallbackComb-r13	Not present		
requestedMaxCCsDL-r13	Not present		

	reducedCP-Latency-r15	Not checked		
	}			
	tdd-Add-UE-EUTRA-Capabilities-v1530 SEQUENCE {			
	neighCellSI-AcquisitionParameters-v1530	Not checked		
	reducedCP-Latency-r15	Not checked		
	}			
	nonCriticalExtension SEQUENCE {			
	phyLayerParameters-v1540	Not checked		
	otherParameters-v1540	Not checked		
	fdd-Add-UE-EUTRA-Capabilities-v1540 SEQUENCE {			
	eutra-5GC-Parameters-r15	EUTRA-5GC-Parameters-r15		
	irat-ParametersNR-v1540	IRAT-ParametersNR-v1540		See note 1
	}			
	tdd-Add-UE-EUTRA-Capabilities-v1540 SEQUENCE {			
	eutra-5GC-Parameters-r15	EUTRA-5GC-Parameters-r15		
	irat-ParametersNR-v1540	IRAT-ParametersNR-v1540		See note 1
	}			
	sl-Parameters-v1540	Not checked		
	irat-ParametersNR-v1540	IRAT-ParameterNR-v1540		
SEQUENCE	nonCriticalExtension {			
SEQUENCE	nonCriticalExtension {			
	neighCellSI-AcquisitionParameters-v1550	Not checked		
	phyLayerParameters-v1550	Not checked		
	mac-Parameters-v1550	Not checked		
	fdd-Add-UE-EUTRA-Capabilities-v1550	Not checked		
	tdd-Add-UE-EUTRA-Capabilities-v1550	Not checked		
SEQUENCE	nonCriticalExtension {			
	pdcp-ParametersNR-v1560	Not checked		
	irat-ParametersNR-v1560	Not checked		
r15	appliedCapabilityFilterCommon-	Not checked		
	fdd-Add-UE-EUTRA-Capabilities-v1560	Not checked		
	tdd-Add-UE-EUTRA-Capabilities-v1560	Not checked		
SEQUENCE	nonCriticalExtension {			
	rf-Parameters-v1570	Not checked		
	irat-ParametersNR-v1570	Not checked		
SEQUENCE	nonCriticalExtension {			
	neighCellSI-AcquisitionParameters-v15a0	Not checked		
	eutra-5GC-Parameters-r15	Not checked		
	fdd-Add-UE-EUTRA-Capabilities-v15a0	Not checked		
	tdd-Add-UE-EUTRA-Capabilities-v15a0	Not checked		
SEQUENCE{	nonCriticalExtension			

v1610	highSpeedEnhParameters-	Not checked		
AcquisitionParameters-v1610	neighCellSI-	Not checked		
	mbms-Parameters-v1610	Not checked		
	pdcp-Parameters-v1610	Not checked		
	mac-Parameters-v1610	Not checked		
	phyLayerParameters-v1610	Not checked		
	measParameters-v1610	Not checked		
	pur-Parameters-r16	Not checked		
	eutra-5GC-Parameters-v1610	EUTRA-5GC-Parameters-v1610		
	otherParameters-v1610	Not checked		
DedicatedMessageSegmentation-r16	dl-	Not checked		
	mmtel-Parameters-v1610	Not checked		
SEQUENCE	irat-ParametersNR-v1610			
	{			
	nr-HO-ToEN-DC-r16	Checked		pc_interRAT_NR_ToEND C(see note 2)
FDD-FR1-r16	ce-EUTRA-5GC-HO-ToNR-	Not checked		
TDD-FR1-r16	ce-EUTRA-5GC-HO-ToNR-	Not checked		
FDD-FR2-r16	ce-EUTRA-5GC-HO-ToNR-	Not checked		
TDD-FR2-r16	ce-EUTRA-5GC-HO-ToNR-	Not checked		
	}			
	rf-Parameters-v1610	Not checked		
	mobilityParameters-v1610	Not checked		
BasedNetwPerfMeasParameters-v1610	ue-	Not checked		
	sl-Parameters-v1610	Not checked		
Capabilities-v1610	fdd-Add-UE-EUTRA-			
SEQUENCE	{			
	phyLayerParameters-v1610	Not checked		
	pur-Parameters-r16	Not checked		
	measParameters-v1610	Not checked		
	eutra-5GC-Parameters-v1610	EUTRA-5GC-Parameters-v1610		
SEQUENCE	irat-ParametersNR-v1610			
	{			
	nr-HO-ToEN-DC-r16	Checked		pc_interRAT_NR_ToEND C(see note 2)
FDD-FR1-r16	ce-EUTRA-5GC-HO-ToNR-	Not checked		
TDD-FR1-r16	ce-EUTRA-5GC-HO-ToNR-	Not checked		
FDD-FR2-r16	ce-EUTRA-5GC-HO-ToNR-	Not checked		
TDD-FR2-r16	ce-EUTRA-5GC-HO-ToNR-	Not checked		
	}			
AcquisitionParameters-v1610	neighCellSI-	Not checked		
	mobilityParameters-v1610	Not checked		
	}			
Capabilities-v1610	tdt-Add-UE-EUTRA-			

respectively), and it will not be present in the common IE. It will be signalled in the common IE if the value is the same on both modes (i.e., "supported" on both FDD and TDD). The IE may be signalled independently for either FDD or TDD or both.

Table 8.2.1.1.1.3.3-3A: IRAT-ParametersNR-r15 (Table 8.2.1.1.1.3.3-3)

Derivation Path: TS 36.331 [11], clause 6.3.6			
Information Element	Value/remark	Comment	Condition
IRAT-ParametersNR-r15 SEQUENCE {			
en-DC-r15	Not checked		
eventB2-r15	Not checked		
supportedBandListEN-DC-r15	SupportedBandListNR-r15		
}			

Table 8.2.1.1.1.3.3-3B: PDCP-ParametersNR-r15 (Table 8.2.1.1.1.3.3-3)

Derivation Path: TS 36.331 [11], clause 6.3.6			
Information Element	Value/remark	Comment	Condition
PDCP-ParametersNR-r15	Not checked		

Table 8.2.1.1.1.3.3-3C: EUTRA-5GC-Parameters-r15 (Table 8.2.1.1.1.3.3-3)

Derivation Path: TS 36.331 [11], clause 6.3.6			
Information Element	Value/remark	Comment	Condition
EUTRA-5GC-Parameters-r15 SEQUENCE {			
eutra-5GC-r15	Not checked		
eutra-EPC-HO-EUTRA-5GC-r15	Not checked		
ho-EUTRA-5GC-FDD-TDD-r15	Not checked		
ho-InterfreqEUTRA-5GC-r15	Not checked		
ims-VoiceOverMCG-BearerEUTRA-5GC-r15	Not checked		
inactiveState-r15	Not checked		
reflectiveQoS-r15	Not checked		
}			

Table 8.2.1.1.1.3.3-3D: IRAT-ParametersNR-v1540 (Table 8.2.1.1.1.3.3-3)

Derivation Path: TS 36.331 [11], clause 6.3.6			
Information Element	Value/remark	Comment	Condition
IRAT-ParametersNR-v1540 SEQUENCE {			
eutra-5GC-HO-ToNR-FDD-FR1-r15	Not checked		
eutra-5GC-HO-ToNR-TDD-FR1-r15	Not checked		
eutra-5GC-HO-ToNR-FDD-FR2-r15	Not checked		
eutra-5GC-HO-ToNR-TDD-FR2-r15	Not checked		
eutra-EPC-HO-ToNR-FDD-FR1-r15	Not checked		
eutra-EPC-HO-ToNR-FDD-FR2-r15	Not checked		
eutra-EPC-HO-ToNR-TDD-FR2-r15	Not checked		
ims-VoiceOverNR-FR1-r15	Not checked		
ims-VoiceOverNR-FR2-r15	Not checked		
sa-NR-r15	Not checked		
supportedBandListNR-SA-r15	SupportedBandListNR-r15		
}			

Table 8.2.1.1.1.3.3-3E: SupportedBandListNR-r15 (Table 8.2.1.1.1.3.3-3A and Table 8.2.1.1.1.3.3-3D)

Derivation Path: TS 36.331 [11], clause 6.3.6			
Information Element	Value/remark	Comment	Condition

SupportedBandListNR-r15 SEQUENCE (SIZE (1..maxBandsNR-r15)) OF SupportedBandNR-r15 {			
bandNR-r15	Not checked		
}			
}			

Table 8.2.1.1.1.3.3-3F: EUTRA-5GC-Parameters-v1610 (Table 8.2.1.1.1.3.3-3)

Derivation Path: TS 36.331 [11], clause 6.3.6			
Information Element	Value/remark	Comment	Condition
EUTRA-5GC-Parameters-v1610 SEQUENCE {			
ce-InactiveState-r16	Not checked		
ce-EUTRA-5GC-r16	Not checked		
}			

Table 8.2.1.1.1.3.3-4: UECapabilityEnquiry (step 3, Table 8.2.1.1.1.3.2-1)

Derivation Path: TS 36.508 [7], Table 4.6.1-22			
Information Element	Value/remark	Comment	Condition
UECapabilityEnquiry ::= SEQUENCE {			
criticalExtensions CHOICE {			
c1 CHOICE {			
ueCapabilityEnquiry-r8 SEQUENCE {			
ue-CapabilityRequest SEQUENCE (SIZE (1..maxRAT-Capabilities)) OF RAT-Type {	2 entries		
RAT-Type[1]	nr	entry 1	
RAT-Type[2]	eutra-nr	entry 2	
}			
nonCriticalExtension SEQUENCE {			
nonCriticalExtension SEQUENCE {			
nonCriticalExtension SEQUENCE {			
nonCriticalExtension SEQUENCE {			
nonCriticalExtension SEQUENCE {			
requestedFreqBandsNR-MRDC-r15	OCTET STRING including the FreqBandList IE according to TS 38.508-1 [4] table [4.6.4-21]		
nonCriticalExtension SEQUENCE {			
requestSTTI-SPT-Capability-r15	Not present		
eutra-nr-only-r15	Not present		
nonCriticalExtension SEQUENCE {			
requestedCapabilityNR-r15	Not present		
nonCriticalExtension SEQUENCE {			
requestedCapabilityCommon-r15	Not present		
nonCriticalExtension SEQUENCE {			
rrc-SegAllowed-r16	enabled		
nonCriticalExtension	Not present		
}			
}			
}			
}			
}			
}			
}			
}			
}			
}			
}			
}			
}			
}			
}			
}			

Table 8.2.1.1.1.3.3-5: UECapabilityInformation (steps 4a2 and 4b1, Table 8.2.1.1.1.3.2-1)

Derivation Path: TS 36.508 [7], Table 4.6.1-23			
Information Element	Value/remark	Comment	Condition
UECapabilityInformation ::= SEQUENCE {			
criticalExtensions CHOICE {			
c1 CHOICE {			
ueCapabilityInformation-r8 SEQUENCE {			
ue-CapabilityRAT-ContainerList SEQUENCE (SIZE (1..maxRAT-Capabilities)) OF UE-CapabilityRAT-Container {	2 entries		
UE-CapabilityRAT-Container[1] SEQUENCE {		entry 1	
rat-Type	nr		pc_NR_FDD or pc_NR_TDD
ueCapabilityRAT-Container	UE-NR-Capability	Encoded as per TS 38.331 [12] clause 5.6.1	pc_NR_FDD or pc_NR_TDD
}			
UE-CapabilityRAT-Container[2] SEQUENCE {		entry 2	
rat-Type	eutra-nr		pc_EN_DC
ueCapabilityRAT-Container	UE-MRDC-Capability	Encoded as per TS 38.331 [12] clause 5.6.1	pc_EN_DC
}			
}			
}			
nonCriticalExtension	Not present		
}			
}			

Table 8.2.1.1.1.3.3-6: UE-NR-Capability (Table 8.2.1.1.1.3.3-5)

Derivation Path: TS 38.331 [12], clause 6.3.3			
Information Element	Value/remark	Comment	Condition
UE-NR-Capability ::= SEQUENCE {			
accessStratumRelease	Checked	"rel-15" or higher	
pdcp-Parameters SEQUENCE {			
supportedROHC-Profiles SEQUENCE {			
profile0x0000	Not checked		
profile0x0001	Not checked		
profile0x0002	Not checked		
profile0x0003	Not checked		
profile0x0004	Not checked		
profile0x0006	Not checked		
profile0x0101	Not checked		
profile0x0102	Not checked		
profile0x0103	Not checked		
profile0x0104	Not checked		
}			
maxNumberROHC-ContextSessions	Not checked		
uplinkOnlyROHC-Profiles	Not checked		
continueROHC-Context	Not checked		
outOfOrderDelivery	Checked		pc_outOfOrderDelivery
shortSN	Checked		pc_shortSN
pdcp-DuplicationSRB	Checked		pc_pdcpl_DuplicationSplitSRB
pdcp-DuplicationMCG-OrSCG-DRB	Checked		pc_pdcpl_DuplicationMCG_OrSCG_DRB
drb-IAB-r16	Not checked		

non-DRB-IAB-r16	Not checked		
extendedDiscardTimer-r16	Not checked		
continueEHC-Context-r16	Not checked		
ehc-r16	Checked		pc_NR_ehc_r16
maxNumberEHC-Contexts-r16	Not checked		
jointEHC-ROHC-Config-r16	Not checked		
pdcp-DuplicationMoreThanTwoRLC-r16	Checked		pc_pdcp_DuplicationMoreThanTwoRLC_r16
}			
rlc-Parameters SEQUENCE {			
am-WithShortSN	Checked		pc_am_WithShortSN
um-WithShortSN	Checked		pc_um_WithShortSN
um-WithLongSN	Checked		pc_um_WithLongSN
}			
mac-Parameters SEQUENCE {			
mac-ParametersCommon SEQUENCE {			
lcp-Restriction	Checked		pc_lcp_Restriction
dummy	Not checked		
lch-ToSCellRestriction	Checked		
recommendedBitRate	Checked		pc_recommendedBitRate
recommendedBitRateQuery	Checked		pc_recommendedBitRateQuery
recommendedBitRateMultiplier-r16	Not checked		
preEmptiveBSR-r16	Not checked		
autonomousTransmission-r16	Not checked		
lch-PriorityBasedPrioritization-r16	Checked		pc_lch_PriorityBasedPrioritization_r16
lch-ToConfiguredGrantMapping-r16	Not checked		
lch-ToGrantPriorityRestriction-r16	Checked		pc_lch_ToGrantPriorityRestriction_r16
singlePHR-P-r16	Not checked		
ul-LBT-FailureDetectionRecovery-r16	Not checked		
tdd-MPE-P-MPR-Reporting-r16	Not checked		
lcid-ExtensionIAB-r16	Not checked		
spCell-BFR-CBRA-r16	Not checked		
srs-ResourceId-Ext-r16	Not checked		
}			
mac-ParametersXDD-Diff SEQUENCE {			
skipUplinkTxDynamic	Checked (NOTE 4)		pc_skipUplinkTxDynamic
logicalChannelSR-DelayTimer	Checked (NOTE 5)		pc_logicalChannelSR_DelayTimer
longDRX-Cycle	Checked (NOTE 6)		pc_longDRX_Cycle
shortDRX-Cycle	Checked (NOTE 7)		pc_shortDRX_Cycle
multipleSR-Configurations	Not checked		
multipleConfiguredGrants	Checked (NOTE 12)		pc_multipleConfiguredGrants_r16
}			
}			
phy-Parameters SEQUENCE {			
phy-ParametersCommon SEQUENCE {			

csi-RS-CFRA-ForHO	Checked		pc_csi_RS_CFRA_ForHO
dynamicPRB-BundlingDL	Not checked		
sp-CSI-ReportPUCCH	Not checked		
sp-CSI-ReportPUSCH	Not checked		
nzp-CSI-RS-IntefMgmt	Not checked		
type2-SP-CSI-Feedback-LongPUCCH	Not checked		
precoderGranularityCORESET	Not checked		
dynamicHARQ-ACK-Codebook	supported		
semiStaticHARQ-ACK-Codebook	Not checked		
spatialBundlingHARQ-ACK	Checked		pc_spatialBundlingHARQ_ACK
dynamicBetaOffsetInd-HARQ-ACK-CSI	Not checked		
pucch-Repetition-F1-3-4	Not checked		
ra-Type0-PUSCH	Checked		pc_ra_Type0_PUSCH
dynamicSwitchRA-Type0-1-PDSCH	Checked		pc_dynamicSwitchRA_Type0_1_PDSCH
dynamicSwitchRA-Type0-1-PUSCH	Checked		pc_dynamicSwitchRA_Type0_1_PUSCH
pdsch-MappingTypeA	supported		pc_pdsch_MappingTypeA
pdsch-MappingTypeB	Checked		pc_pdsch_MappingTypeB
interleavingVRB-ToPRB-PDSCH	Checked		pc_interleavingVRB_ToPRB_PDSCH
interSlotFreqHopping-PUSCH	Not checked		
type1-PUSCH-RepetitionMultiSlots	Not checked		
type2-PUSCH-RepetitionMultiSlots	Not checked		
pusch-RepetitionMultiSlots	Checked		pc_pusch_RepetitionMultiSlots
pdsch-RepetitionMultiSlots	Checked		pc_pdsch_RepetitionMultiSlots
downlinkSPS	Checked		pc_downlinkSPS
configuredUL-GrantType1	Checked		pc_configuredUL_GrantType1
configuredUL-GrantType2	Checked		pc_configuredUL_GrantType2
pre-EmptIndication-DL	Not checked		
cbg-TransIndication-DL	Not checked		
cbg-TransIndication-UL	Not checked		
cbg-FlushIndication-DL	Not checked		
dynamicHARQ-ACK-CodeB-CBG-Retx-DL	Not checked		
rateMatchingResrcSetSemi-Static	Not checked		
rateMatchingResrcSetDynamic	Not checked		
bwp-SwitchingDelay	Checked	38.306, 4.2.7.10: It is mandatory to report type 1 or type 2. This capability is not applicable to IAB-MT	pc_bwp_SwitchingDelay_Type1 or pc_bwp_SwitchingDelay_Type2
dummy	Not checked		

maxNumberSearchSpaces	Checked		pc_maxNumberSearchSpaces
rateMatchingCtrlResrsSetDynamic	Not checked		
maxLayersMIMO-Indication	Not checked		
spCellPlacement	Not checked		
twoStepRACH-r16	Not checked		
dci-Format1-2And0-2-r16	Checked		pc_dci_Format1_2And0_2_r16
monitoringDCI-SameSearchSpace-r16	Not checked		
type2-CG-ReleaseDCI-0-1-r16	Not checked		
type2-CG-ReleaseDCI-0-2-r16	Not checked		
sps-ReleaseDCI-1-1-r16	Not checked		
sps-ReleaseDCI-1-2-r16	Not checked		
csi-TriggerStateNon-ActiveBWP-r16	Not checked		
seperateSMTC-InterIAB-Support-r16	Not checked		
seperateRACH-IAB-Support-r16	Not checked		
ul-flexibleDL-SlotFormatSemiStatic-IAB-r16	Not checked		
ul-flexibleDL-SlotFormatDynamics-IAB-r16	Not checked		
dft-S-OFDM-WaveformUL-IAB-r16	Not checked		
dci-25-AI-RNTI-Support-IAB-r16	Not checked		
t-DeltaReceptionSupport-IAB-r16	Not checked		
guardSymbolReportReception-IAB-r16	Not checked		
harqACK-CB-SpatialBundlingPUCCH-Group-r16	Not checked		
crossSlotScheduling-r16	Not checked		
maxNumberSRS-PosPathLossEstimateAllServingCells-r16	Not checked		
extendedCG-Periodicities-r16	Not checked		
extendedSPS-Periodicities-r16	Not checked		
codebookVariantsList-r16	Not checked		
pusch-RepetitionTypeA-r16	Not checked		
dci-DL-PriorityIndicator-r16	Checked		pc_dci_DL_PriorityIndicator_r16
dci-UL-PriorityIndicator-r16	Checked		pc_dci_UL_PriorityIndicator_r16
maxNumberPathlossRS-Update-r16	Not checked		
type2-HARQ-ACK-Codebook-r16	Not checked		
maxTotalResourcesForAcrossFreqRanges-r16	Not checked		
harqACK-separateMultiDCI-MultiTRP-r16	Not checked		
harqACK-jointMultiDCI-MultiTRP-r16	Not checked		
bwp-SwitchingMultiCCs-r16	Not checked		
targetSMTC-SCG-r16	Not checked		
supportRepetitionZeroOffsetRV-r16	Not checked		
cbg-TransInOrderPUSCH-UL-r16	Not checked		
bwp-SwitchingMultiDormancyCCs-r16	Not checked		
supportRetx-Diff-CoresetPool-Multi-DCI-TRP-r16	Not checked		
pdcc-MonitoringAnyOccasionsWithSpanGapCrossCarrierSch-r16	Not checked		
newBeamIdentifications2PortCSI-RS-r16	Not checked		
pathlossEstimation2PortCSI-RS-r16	Not checked		
}			
phy-ParametersXDD-Diff SEQUENCE {			
dynamicSFI	Not checked		
twoPUCCH-F0-2-ConsecSymbols	Not checked		
twoDifferentTPC-Loop-PUSCH	Not checked		
twoDifferentTPC-Loop-PUCCH	Not checked		
dl-SchedulingOffset-PDSCH-TypeA	Not checked		
dl-SchedulingOffset-PDSCH-TypeB	Not checked		
ul-SchedulingOffset	Not checked		
}			
phy-ParametersFRX-Diff SEQUENCE {			
dynamicSFI	Not checked		

dummy1	Not checked		
twoFL-DMRS	Not checked		
dummy2	Not checked		
dummy3	Not checked		
supportedDMRS-TypeDL	Not checked		
supportedDMRS-TypeUL	Not checked		
semiOpenLoopCSI	Not checked		
csi-ReportWithoutPMI	Not checked		
csi-ReportWithoutCQI	Not checked		
onePortsPTRS	Not checked		
twoPUCCH-F0-2-ConsecSymbols	Not checked		
pucch-F2-WithFH	supported		
pucch-F3-WithFH	supported		
pucch-F4-WithFH	Not checked		
freqHoppingPUCCH-F0-2	Not checked		
freqHoppingPUCCH-F1-3-4	Not checked		
mux-SR-HARQ-ACK-CSI-PUCCH-MultiPerSlot	Not checked		
uci-CodeBlockSegmentation	Not checked		
onePUCCH-LongAndShortFormat	Not checked		
twoPUCCH-AnyOthersInSlot	Not checked		
intraSlotFreqHopping-PUSCH	Not checked		
pusch-LBRM	Not checked		
pdccch-BlindDetectionCA	Not checked		
tpc-PUSCH-RNTI	Not checked		
tpc-PUCCH-RNTI	Not checked		
tpc-SRS-RNTI	Not checked		
absoluteTPC-Command	Not checked		
twoDifferentTPC-Loop-PUSCH	Not checked		
twoDifferentTPC-Loop-PUCCH	Not checked		
pusch-HalfPi-BPSK	Not checked		
pucch-F3-4-HalfPi-BPSK	Not checked		
almostContiguousCP-OFDM-UL	Not checked		
sp-CSI-RS	Not checked		
sp-CSI-IM	Not checked		
tdd-MultiDL-UL-SwitchPerSlot	Not checked		
multipleCORESET	Not checked		
csi-RS-IM-ReceptionForFeedback	Not checked	CSI-RS-IM-ReceptionForFeedback	
csi-RS-ProcFrameworkForSRS	Not checked	CSI-RS-ProcFrameworkForSRS	
csi-ReportFramework	Not checked	CSI-ReportFramework	
mux-SR-HARQ-ACK-CSI-PUCCH-OncePerSlot			
SEQUENCE {			
sameSymbol	Not checked		
diffSymbol	Not checked		
}			
mux-SR-HARQ-ACK-PUCCH	Not checked		
mux-MultipleGroupCtrlCH-Overlap	Not checked		
dl-SchedulingOffset-PDSCH-TypeA	Not checked		
dl-SchedulingOffset-PDSCH-TypeB	Not checked		
ul-SchedulingOffset	Not checked		
dl-64QAM-MCS-TableAlt	Not checked		
ul-64QAM-MCS-TableAlt	Not checked		
cqi-TableAlt	Not checked		
oneFL-DMRS-TwoAdditionalDMRS-UL	Not checked		
twoFL-DMRS-TwoAdditionalDMRS-UL	Not checked		
oneFL-DMRS-ThreeAdditionalDMRS-UL	Not checked		
}			
phy-ParametersFR1 SEQUENCE {			
pdccchMonitoringSingleOccasion	Not checked		
scs-60kHz	Not checked		
pdsch-256QAM-FR1	Checked		pc_pdsch_2 56QAM_FR1

pdsch-RE-MappingFR1-PerSymbol	Not checked		
pdsch-RE-MappingFR1-PerSlot	Not checked		
}			
phy-ParametersFR2 SEQUENCE {			
dummy	Not checked		
pdsch-RE-MappingFR2-PerSymbol	Not checked		
pCell-FR2	Not checked		
pdsch-RE-MappingFR2-PerSlot	Not checked		
}			
}			
rf-Parameters SEQUENCE {			
supportedBandListNR SEQUENCE (SIZE (1..maxBands)) OF BandNR {			
BandNR SEQUENCE {			
bandNR	Checked	Checked for 'maxBands' entries of FreqBandIndicator NR[i]	pc_nrBandx ('x' being the band number/type related PICS listed in TS 38.508-2)
modifiedMPR-Behaviour	Not checked		
mimo-ParametersPerBand	Not checked	MIMO-ParametersPerBand[i]	
extendedCP	Not checked		
multipleTCI	supported		
bwp-WithoutRestriction	Checked		pc_bwp_WithoutRestriction
bwp-SameNumerology	Not checked		
bwp-DiffNumerology	Not checked		
crossCarrierScheduling-SameSCS	Not checked		
pdsch-256QAM-FR2	Checked	Note 8	pc_pdsch_256QAM_FR2
pusch-256QAM	Checked	Note 9	pc_pusch_256QAM_FR1 OR pc_pusch_256QAM_FR2
ue-PowerClass	Not checked		
rateMatchingLTE-CRS	Not checked		
channelBWs-DL-v1530 CHOICE {			
fr1 SEQUENCE {			
scs-15kHz	Not checked		
scs-30kHz	Not checked		
scs-60kHz	Not checked		
}			
fr2 SEQUENCE {			
scs-60kHz	Not checked		
scs-120kHz	Not checked		
}			
}			
channelBWs-UL-v1530 CHOICE {			
fr1 SEQUENCE {			
scs-15kHz	Not checked		
scs-30kHz	Not checked		
scs-60kHz	Not checked		
}			
fr2 SEQUENCE {			
scs-60kHz	Not checked		
scs-120kHz	Not checked		
}			
maxUplinkDutyCycle-PC2-FR1	Not checked		
pucch-SpatialRelInfoMAC-CE	Not checked		
powerBoosting-pi2BPSK	Not checked		

maxUplinkDutyCycle-PC1dot5-MPE-FR1-r16	Checked		pc_nrBandx_maxUplinkDutyCycle_PC1dot5_MP_E_FR1_r16 ('x' being the band number related PICS listed in Table A.4.3.1-4h of TS 38.508-2)
maxUplinkDutyCycle-FR2	Not checked		
channelBW-DL-v1590	Not checked		
channelBW-UL-v1590	Not checked		
asymmetricBandwidthCombinationSet	Not checked		
sharedSpectrumChAccessParamsPerBand-r16	Not checked		
cancelOverlappingPUSCH-r16	Not checked		
multipleRateMatchingEUTRA-CRS-r16	Not checked		
overlapRateMatchingEUTRA-CRS-r16	Not checked		
pdsch-MappingTypeB-Alt-r16	Not checked		
oneSlotPeriodicTRS-r16	Not checked		
olpc-SRS-Pos-r16	Not checked		
spatialRelationsSRS-Pos-r16	Not checked		
simulSRS-MIMO-TransWithinBand-r16	Not checked		
channelBW-DL-IAB-r16	Not checked		
channelBW-UL-IAB-r16	Not checked		
rasterShift7dot5-IAB-r16	Not checked		
ue-PowerClass-v1610	Not checked		
condHandover-r16	Checked		pc_condHandover_r16
condHandoverFailure-r16	Checked		pc_condHandoverFailure_r16
condHandoverTwoTriggerEvents-r16	Checked		pc_condHandoverTwoTriggerEvents_r16
condPSCellChange-r16	Checked		pc_condPSCellChange_r16
condPSCellChangeTwoTriggerEvents-r16	Not checked		
mpr-PowerBoost-FR2-r16	Not checked		
activeConfiguredGrant-r16	Not checked		
jointReleaseConfiguredGrantType2-r16	Not checked		
sps-r16	Not checked		
jointReleaseSPS-r16	Not checked		
simulSRS-TransWithinBand-r16	Not checked		
trs-AdditionalBandwidth-r16	Not checked		
handoverIntraF-IAB-r16	Not checked		
simulTX-SRS-AntSwitchingIntraBandUL-CA-r16	Not checked		
sharedSpectrumChAccessParamsPerBand-v1630	Not checked		
handoverUTRA-FDD-r16	Not checked		
enhancedUL-TransientPeriod-r16	Not checked		
sharedSpectrumChAccessParamsPerBand-v1640	Not checked		
type1-PUSCH-RepetitionMultiSlots-v1650	Not checked		
type2-PUSCH-RepetitionMultiSlots-v1650	Not checked		
pusch-RepetitionMultiSlots-v1650	Not checked		
configuredUL-GrantType1-v1650	Not checked		
configuredUL-GrantType2-v1650	Not checked		
sharedSpectrumChAccessParamsPerBand-v1650	Not checked		

enhancedSkipUplinkTxConfigured-v1660	Not checked		
enhancedSkipUplinkTxDynamic-v1660	Not checked		
}			
}			
supportedBandCombinationList SEQUENCE (SIZE (1..maxBandComb)) OF BandCombination {			
BandCombination SEQUENCE {			
bandList SEQUENCE (SIZE (1..maxSimultaneousBands)) OF BandParameters {			
BandParameters CHOICE			
eutra SEQUENCE {		EUTRA bands	
bandEUTRA	Not checked	FreqBandIndicator EUTRA	
ca-BandwidthClassDL-EUTRA	Not checked	CA-BandwidthClassEUTRA	
ca-BandwidthClassUL-EUTRA	Not checked	CA-BandwidthClassEUTRA	
}			
nr SEQUENCE {		NR bands	
bandNR	Not checked	FreqBandIndicator NR	
ca-BandwidthClassDL-NR	Not checked	CA-BandwidthClassNR	
ca-BandwidthClassUL-NR	Not checked	CA-BandwidthClassNR	
}			
}			
}			
}			
featureSetCombination	Not checked	FeatureSetCombinationId	
ca-ParametersEUTRA	Not checked	CA-ParametersEUTRA	
ca-ParametersNR	Not checked	CA-ParametersNR	
mrdc-Parameters	Not checked	MRDC-Parameters	
supportedBandwidthCombinationSet	Not checked		
powerClass-v1530	Not checked		
}			
}			
appliedFreqBandListFilter	Not checked	FreqBandList	
supportedBandCombinationList-v1540 SEQUENCE (SIZE (1..maxBandComb)) OF BandCombination-v1540 {		BandCombinationList-v1540	
BandCombination-v1540 SEQUENCE {			
bandList-v1540 SEQUENCE (SIZE (1..maxSimultaneousBands)) OF BandParameters-v1540 {	Not checked	BandParameters-v1540	
BandParameters-v1540 SEQUENCE {			
srs-CarrierSwitch CHOICE {			
nr SEQUENCE [NR bands	
srs-SwitchingTimesListNR SEQUENCE (SIZE (1..maxSimultaneousBands)) OF SRS-SwitchingTimeNR	Not checked		
}			
eutra SEQUENCE {		EUTRA bands	
srs-SwitchingTimesListEUTRA SEQUENCE (SIZE (1..maxSimultaneousBands)) OF SRS-SwitchingTimeEUTRA	Not checked		

}			
}			
srs-TxSwitch-v1540 SEQUENCE {			
supportedSRS-TxPortSwitch	Not checked		
txSwitchImpactToRx	Not checked		
txSwitchWithAnotherBand	Not checked		
}			
}			
ca-ParametersNR-v1540	Not checked	CA-ParametersNR-v1540	
}			
}			
srs-SwitchingTimeRequested	Not checked		
supportedBandCombinationList-v1550	Not checked	BandCombinationList-v1550	
supportedBandCombinationList-v1560	Not checked	BandCombinationList-v1560	
supportedBandCombinationList-v1610 SEQUENCE (SIZE (1..maxBandComb)) OF BandCombination-v1610 {		BandCombinationList-v1610	
BandCombination-v1610 SEQUENCE {			
bandList-v1610 SEQUENCE (SIZE (1..maxSimultaneousBands)) OF BandParameters-v1610 {			
ca-ParametersNR-v1610	Checked	CA-ParametersNR-v1610 (Table 8.2.1.1.1.3.3-11)	
ca-ParametersNRDC-v1610	Not checked	CA-ParametersNRDC-v1610	
powerClass-v1610	Not checked		
powerClassNRPart-r16	Not checked		
featureSetCombinationDAPS-r16	Not checked	FeatureSetCombinationId	
mrdc-Parameters-v1620	Not checked	MRDC-Parameters-v1620	
}			
}			
}			
supportedBandCombinationListSidelinkEUTRA-NR-r16	Not checked	BandCombinationListSidelinkEUTRA-NR-r16	
supportedBandCombinationList-UplinkTxSwitch-r16	Not checked	BandCombinationList-UplinkTxSwitch-r16	
supportedBandCombinationList-v1630	Not checked	BandCombinationList-v1630	
supportedBandCombinationListSidelinkEUTRA-NR-v1630	Not checked	BandCombinationListSidelinkEUTRA-NR-v1630	
supportedBandCombinationList-UplinkTxSwitch-v1630	Not checked	BandCombinationList-UplinkTxSwitch-v1630	
supportedBandCombinationList-v1640	Not checked	BandCombinationList-v1640	
supportedBandCombinationList-UplinkTxSwitch-v1640	Not checked	BandCombinationList-UplinkTxSwitch-v1640	
supportedBandCombinationList-v1650	Not checked	BandCombinationList-v1650	

supportedBandCombinationList-UplinkTxSwitch-v1650	Not checked	BandCombination List-UplinkTxSwitch-v1650	
extendedBand-n77-r16	Not checked		
}			
measAndMobParameters SEQUENCE {			
measAndMobParametersCommon SEQUENCE {			
supportedGapPattern	Not checked		
ssb-RLM	supported		
ssb-AndCSI-RS-RLM	Not checked		
eventB-MeasAndReport	Checked		pc_eventB_MeasAndReport
handoverFDD-TDD	Not checked		
eutra-CGI-Reporting	Checked		pc_eutra_CGI_Reporting
nr-CGI-Reporting	Checked		pc_nr_CGI_Reporting
independentGapConfig	Checked		pc_independentGapConfig
periodicEUTRA-MeasAndReport	Checked		pc_periodicEUTRA_MeasAndReport
handoverFR1-FR2	Not checked		
maxNumberCSI-RS-RRM-RS-SINR	Not checked		
nr-CGI-Reporting-ENDC	Not checked		
eutra-CGI-Reporting-NEDC	Not checked		
eutra-CGI-Reporting-NRDC	Not checked		
nr-CGI-Reporting-NEDC	Not checked		
nr-CGI-Reporting-NRDC	Not checked		
reportAddNeighMeasForPeriodic-r16	Not checked		
condHandoverParametersCommon-r16	Not checked		
nr-NeedForGap-Reporting-r16	Not checked		
supportedGapPattern-NRonly-r16	Not checked		
supportedGapPattern-NRonly-NEDC-r16	Not checked		
maxNumberCLI-RSSI-r16	Not checked		
maxNumberCLI-SRS-RSRP-r16	Not checked		
maxNumberPerSlotCLI-SRS-RSRP-r16	Not checked		
mfb-IAB-r16	Not checked		
dummy	Not checked		
nr-CGI-Reporting-NPN-r16	Checked		pc_nr_CGI_Reporting_NPN_r16
idleInactiveEUTRA-MeasReport-r16	Not checked		
idleInactive-ValidityArea-r16	Not checked		
eutra-AutonomousGaps-r16	Not checked		
eutra-AutonomousGaps-NEDC-r16	Not checked		
eutra-AutonomousGaps-NRDC-r16	Not checked		
pCellT312-r16	Not checked		
supportedGapPattern-r16	Not checked		
}			
measAndMobParametersXDD-Diff SEQUENCE {			
intraAndInterF-MeasAndReport	Checked (NOTE 1)		pc_intraAndInterF-MeasAndReport
eventA-MeasAndReport	Checked (NOTE 2)		pc_eventA_MeasAndReport
handoverInterF	Checked (NOTE 15)		pc_handoverInterF
handoverLTE	Not checked		

handover-eLTE	Not checked		
sftd-MeasNR-Neigh	Checked (NOTE 13)		pc_SFTD_MeasNR_Neigh_FDD and/or pc_SFTD_MeasNR_Neigh_TDD
sftd-MeasNR-Neigh-DRX	Not checked		
dummy	Not checked		
}			
measAndMobParametersFRX-Diff SEQUENCE {			
ss-SINR-Meas	Checked (NOTE 10)		pc_ss_SINR_Meas
csi-RSRP-AndRSRQ-MeasWithSSB	Checked (NOTE 3)		pc_csi-RSRP-AndRSRQ-MeasWithSSB
csi-RSRP-AndRSRQ-MeasWithoutSSB	Checked (NOTE 11)		pc_csi_RSRP_AndRSRQ_MeasWithoutSSB
csi-SINR-Meas	Not checked		
csi-RS-RLM	Not checked		
handoverInterF	Checked (NOTE 14)		pc_handoverInterF
handoverLTE	Not checked		
handover-eLTE	Not checked		
maxNumberResource-CSI-RS-RLM	Not checked		
simultaneousRxDataSSB-DiffNumerology	Not checked		
nr-AutonomousGaps-r16	Not checked		
nr-AutonomousGaps-ENDC-r16	Not checked		
nr-AutonomousGaps-NEDC-r16	Not checked		
nr-AutonomousGaps-NRDC-r16	Not checked		
dummy	Not checked		
cli-RSSI-Meas-r16	Not checked		
cli-SRS-RSRP-Meas-r16	Not checked		
interFrequencyMeas-NoGap-r16	Not checked		
simultaneousRxDataSSB-DiffNumerology-Inter-r16	Not checked		
idleInactiveNR-MeasReport-r16	Not checked		
idleInactiveNR-MeasBeamReport-r16	Not checked		
increasedNumberOfCSIRSPerMO-r16	Not checked		
}			
}			
fdd-Add-UE-NR-Capabilities SEQUENCE {			
phy-ParametersXDD-Diff SEQUENCE {			
dynamicSFI	Not checked		
twoPUCCH-F0-2-ConsecSymbols	Not checked		
twoDifferentTPC-Loop-PUSCH	Not checked		
twoDifferentTPC-Loop-PUCCH	Not checked		
dl-SchedulingOffset-PDSCH-TypeA	Not checked		
dl-SchedulingOffset-PDSCH-TypeB	Not checked		
ul-SchedulingOffset	Not checked		
}			
mac-ParametersXDD-Diff SEQUENCE {			
skipUplinkTxDynamic	Checked (NOTE 4)		pc_skipUplinkTxDynamic
logicalChannelSR-DelayTimer	Checked (NOTE 5)		pc_logicalChannelSR_DelayTimer
longDRX-Cycle	Checked (NOTE 6)		pc_longDRX_Cycle

shortDRX-Cycle	Checked (NOTE 7)		pc_shortDRX_Cycle
multipleSR-Configurations	Not checked		
multipleConfiguredGrants	Checked (NOTE 12)		pc_multipleConfiguredGrants_r16
}			
measAndMobParametersXDD-Diff SEQUENCE {			
intraAndInterF-MeasAndReport	Checked (NOTE 1)		pc_intraAndInterF-MeasAndReport
eventA-MeasAndReport	Checked (NOTE 2)		pc_eventA-MeasAndReport
handoverInterF	Checked (NOTE 15)		pc_handoverInterF
handoverLTE	Not checked		
handover-eLTE	Not checked		
sftd-MeasNR-Neigh	Checked (NOTE 13)		pc_SFTD_MeasNR_Neigh_FDD and/or pc_SFTD_MeasNR_Neigh_TDD
sftd-MeasNR-Neigh-DRX	Not checked		
dummy	Not checked		
}			
tdd-Add-UE-NR-Capabilities SEQUENCE {			
phy-ParametersXDD-Diff SEQUENCE {			
dynamicSFI	Not checked		
twoPUCCH-F0-2-ConsecSymbols	Not checked		
twoDifferentTPC-Loop-PUSCH	Not checked		
twoDifferentTPC-Loop-PUCCH	Not checked		
dl-SchedulingOffset-PDSCH-TypeA	Not checked		
dl-SchedulingOffset-PDSCH-TypeB	Not checked		
ul-SchedulingOffset	Not checked		
}			
mac-ParametersXDD-Diff SEQUENCE {			
skipUplinkTxDynamic	Checked (NOTE 4)		pc_skipUplinkTxDynamic
logicalChannelSR-DelayTimer	Checked (NOTE 5)		pc_logicalChannelSR-DelayTimer
longDRX-Cycle	Checked (NOTE 6)		pc_longDRX_Cycle
shortDRX-Cycle	Checked (NOTE 7)		pc_shortDRX_Cycle
multipleSR-Configurations	Not checked		
multipleConfiguredGrants	Checked (NOTE 15)		pc_multipleConfiguredGrants_r16
}			
measAndMobParametersXDD-Diff SEQUENCE {			
intraAndInterF-MeasAndReport	Checked (NOTE 1)		pc_intraAndInterF-MeasAndReport
eventA-MeasAndReport	Checked (NOTE 2)		pc_eventA-MeasAndReport
handoverInterF	Checked (NOTE 15)		pc_handoverInterF

handoverLTE-EPC	Not checked		
handover-eLTE-5GC	Not checked		
sftd-MeasNR-Neigh	Checked (NOTE 13)		pc_SFTD_M easNR_Neig h_FDD and/or pc_SFTD_M easNR_Neig h_TDD
sftd-MeasNR-Neigh-DRX	Not checked		
dummy	Not checked		
}			
fr1-Add-UE-NR-Capabilities SEQUENCE {			
phy-ParametersFRX-Diff SEQUENCE {			
dynamicSFI	Not checked		
dummy1	Not checked		
twoFL-DMRS	Not checked		
dummy2	Not checked		
dummy3	Not checked		
supportedDMRS-TypeDL	Not checked		
supportedDMRS-TypeUL	Not checked		
semiOpenLoopCSI	Not checked		
csi-ReportWithoutPMI	Not checked		
csi-ReportWithoutCQI	Not checked		
onePortsPTRS	Not checked		
twoPUCCH-F0-2-ConsecSymbols	Not checked		
pucch-F2-WithFH	Not checked		
pucch-F3-WithFH	Not checked		
pucch-F4-WithFH	Not checked		
freqHoppingPUCCH-F0-2	Not checked		
freqHoppingPUCCH-F1-3-4	Not checked		
mux-SR-HARQ-ACK-CSI-PUCCH-MultiPerSlot	Not checked		
uci-CodeBlockSegmentation	Not checked		
onePUCCH-LongAndShortFormat	Not checked		
twoPUCCH-AnyOthersInSlot	Not checked		
intraSlotFreqHopping-PUSCH	Not checked		
pusch-LBRM	Not checked		
pdccch-BlindDetectionCA	Not checked		
tpc-PUSCH-RNTI	Not checked		
tpc-PUCCH-RNTI	Not checked		
tpc-SRS-RNTI	Not checked		
absoluteTPC-Command	Not checked		
twoDifferentTPC-Loop-PUSCH	Not checked		
twoDifferentTPC-Loop-PUCCH	Not checked		
pusch-HalfPi-BPSK	Not checked		
pucch-F3-4-HalfPi-BPSK	Not checked		
almostContiguousCP-OFDM-UL	Not checked		
sp-CSI-RS	Not checked		
sp-CSI-IM	Not checked		
tdd-MultiDL-UL-SwitchPerSlot	Not checked		
multipleCORESET	Not checked		
csi-RS-IM-ReceptionForFeedback	Not checked		
csi-RS-ProcFrameworkForSRS	Not checked		
csi-ReportFramework	Not checked		
mux-SR-HARQ-ACK-CSI-PUCCH-OncePerSlot SEQUENCE {			
sameSymbol	Not checked		
diffSymbol	Not checked		
}			
mux-SR-HARQ-ACK-PUCCH	Not checked		
mux-MultipleGroupCtrlCH-Overlap	Not checked		
dl-SchedulingOffset-PDSCH-TypeA	Not checked		
dl-SchedulingOffset-PDSCH-TypeB	Not checked		
ul-SchedulingOffset	Not checked		
dl-64QAM-MCS-TableAlt	Not checked		
ul-64QAM-MCS-TableAlt	Not checked		

cqi-TableAlt	Not checked		
oneFL-DMRS-TwoAdditionalDMRS-UL	Not checked		
twoFL-DMRS-TwoAdditionalDMRS-UL	Not checked		
oneFL-DMRS-ThreeAdditionalDMRS-UL	Not checked		
}			
measAndMobParametersFRX-Diff SEQUENCE {			
ss-SINR-Meas	Checked (NOTE 10)		pc_ss_SINR_Meas
csi-RSRP-AndRSRQ-MeasWithSSB	Checked (NOTE 3)		pc_csi-RSRP-AndRSRQ-MeasWithSSB
csi-RSRP-AndRSRQ-MeasWithoutSSB	Checked (NOTE 11)		pc_csi_RSRRP_AndRSRQ_MeasWithoutSSB
csi-SINR-Meas	Not checked		
csi-RS-RLM	Not checked		
handoverInterF	Checked (NOTE 14)		
handoverLTE	Not checked		
handover-eLTE	Not checked		
maxNumberResource-CSI-RS-RLM	Not checked		
simultaneousRxDataSSB-DiffNumerology	Not checked		
nr-AutonomousGaps-r16	Not checked		
nr-AutonomousGaps-ENDC-r16	Not checked		
nr-AutonomousGaps-NEDC-r16	Not checked		
nr-AutonomousGaps-NRDC-r16	Not checked		
dummy	Not checked		
cli-RSSI-Meas-r16	Not checked		
cli-SRS-RSRP-Meas-r16	Not checked		
interFrequencyMeas-NoGap-r16	Not checked		
simultaneousRxDataSSB-DiffNumerology-Inter-r16	Not checked		
idleInactiveNR-MeasReport-r16	Not checked		
idleInactiveNR-MeasBeamReport-r16	Not checked		
increasedNumberOfCSIRSPerMO-r16	Not checked		
}			
}			
fr2-Add-UE-NR-Capabilities SEQUENCE {			
phy-ParametersFRX-Diff SEQUENCE {	Not checked		
dynamicSFI	Not checked		
dummy1	Not checked		
twoFL-DMRS	Not checked		
dummy2	Not checked		
dummy3	Not checked		
supportedDMRS-TypeDL	Not checked		
supportedDMRS-TypeUL	Not checked		
semiOpenLoopCSI	Not checked		
csi-ReportWithoutPMI	Not checked		
csi-ReportWithoutCQI	Not checked		
onePortsPTRS	Not checked		
twoPUCCH-F0-2-ConsecSymbols	Not checked		
pucch-F2-WithFH	Not checked		
pucch-F3-WithFH	Not checked		
pucch-F4-WithFH	Not checked		
freqHoppingPUCCH-F0-2	Not checked		
freqHoppingPUCCH-F1-3-4	Not checked		
mux-SR-HARQ-ACK-CSI-PUCCH-MultiPerSlot	Not checked		
uci-CodeBlockSegmentation	Not checked		
onePUCCH-LongAndShortFormat	Not checked		
twoPUCCH-AnyOthersInSlot	Not checked		
intraSlotFreqHopping-PUSCH	Not checked		
pusch-LBRM	Not checked		
pdcch-BlindDetectionCA	Not checked		
tpc-PUSCH-RNTI	Not checked		

tpc-PUCCH-RNTI	Not checked		
tpc-SRS-RNTI	Not checked		
absoluteTPC-Command	Not checked		
twoDifferentTPC-Loop-PUSCH	Not checked		
twoDifferentTPC-Loop-PUCCH	Not checked		
pusch-HalfPi-BPSK	Not checked		
pucch-F3-4-HalfPi-BPSK	Not checked		
almostContiguousCP-OFDM-UL	Not checked		
sp-CSI-RS	Not checked		
sp-CSI-IM	Not checked		
tdd-MultiDL-UL-SwitchPerSlot	Not checked		
multipleCORESET	Not checked		
csi-RS-IM-ReceptionForFeedback	Not checked		
csi-RS-ProcFrameworkForSRS	Not checked		
csi-ReportFramework	Not checked		
mux-SR-HARQ-ACK-CSI-PUCCH-OncePerSlot			
SEQUENCE {			
sameSymbol	Not checked		
diffSymbol	Not checked		
}			
mux-SR-HARQ-ACK-PUCCH	Not checked		
mux-MultipleGroupCtrlCH-Overlap	Not checked		
dl-SchedulingOffset-PDSCH-TypeA	Not checked		
dl-SchedulingOffset-PDSCH-TypeB	Not checked		
ul-SchedulingOffset	Not checked		
dl-64QAM-MCS-TableAlt	Not checked		
ul-64QAM-MCS-TableAlt	Not checked		
cqi-TableAlt	Not checked		
oneFL-DMRS-TwoAdditionalDMRS-UL	Not checked		
twoFL-DMRS-TwoAdditionalDMRS-UL	Not checked		
oneFL-DMRS-ThreeAdditionalDMRS-UL	Not checked		
}			
measAndMobParametersFRX-Diff SEQUENCE {			
ss-SINR-Meas	Checked (NOTE 10)		pc_ss_SINR_Meas
csi-RSRP-AndRSRQ-MeasWithSSB	Checked (NOTE 3)		pc_csi-RSRP-AndRSRQ-MeasWithSSB
csi-RSRP-AndRSRQ-MeasWithoutSSB	Checked (NOTE 11)		pc_csi_RSRP-AndRSRQ-MeasWithoutSSB
csi-SINR-Meas	Not checked		
csi-RS-RLM	Not checked		
handoverInterF	Checked (NOTE 14)		pc_handoverInterF
handoverLTE-EPC	Not checked		
handover-eLTE-5GC	Not checked		
maxNumberResource-CSI-RS-RLM	Not checked		
simultaneousRxDataSSB-DiffNumerology	Not checked		
nr-AutonomousGaps-r16	Not checked		
nr-AutonomousGaps-ENDC-r16	Not checked		
nr-AutonomousGaps-NEDC-r16	Not checked		
nr-AutonomousGaps-NRDC-r16	Not checked		
dummy	Not checked		
cli-RSSI-Meas-r16	Not checked		
cli-SRS-RSRP-Meas-r16	Not checked		
interFrequencyMeas-NoGap-r16	Not checked		
simultaneousRxDataSSB-DiffNumerology-Inter-r16	Not checked		
idleInactiveNR-MeasReport-r16	Not checked		
idleInactiveNR-MeasBeamReport-r16	Not checked		
increasedNumberOfCSIRSPerMO-r16	Not checked		

}			
}			
featureSets SEQUENCE {			
featureSetsDownlink SEQUENCE (SIZE (1..maxDownlinkFeatureSets)) OF FeatureSetDownlink {			
FeatureSetDownlink SEQUENCE {	Not checked		
featureSetListPerDownlinkCC	Not checked		
intraBandFreqSeparationDL	Not checked		
scalingFactor	Not checked		
crossCarrierScheduling-OtherSCS	Not checked		
scellWithoutSSB	Not checked		
csi-RS-MeasSCellWithoutSSB	Not checked		
dummy1	Not checked		
type1-3-CSS	Not checked		
pdcch-MonitoringAnyOccasions	Not checked		
dummy2	Not checked		
ue-SpecificUL-DL-Assignment	Not checked		
searchSpaceSharingCA-DL	Not checked		
timeDurationForQCL SEQUENCE {			
scs-60kHz	Not checked		
scs-120kHz	Not checked		
}			
pdsch-ProcessingType1-DifferentTB-PerSlot SEQUENCE {			
scs-15kHz	Not checked		
scs-30kHz	Not checked		
scs-60kHz	Not checked		
scs-120kHz	Not checked		
}			
dummy3	Not checked		
dummy4	Not checked		
dummy5	Not checked		
dummy6	Not checked		
dummy7	Not checked		
}			
}			
featureSetsDownlinkPerCC SEQUENCE (SIZE (1..maxPerCC-FeatureSets)) OF FeatureSetDownlinkPerCC {			
FeatureSetDownlinkPerCCSEQUENCE {			
supportedSubcarrierSpacingDL	Not checked	SubcarrierSpacing	
supportedBandwidthDL	Not checked	SupportedBandwidth	
channelBW-90mhz	Not checked		
maxNumberMIMO-LayersPDSCH	Not checked	MIMO-LayersDL	
supportedModulationOrderDL	Not checked	ModulationOrder	
}			
}			
featureSetsUplink SEQUENCE (SIZE (1..maxUplinkFeatureSets)) OF FeatureSetUplink {			
FeatureSetUplink SEQUENCE {			
featureSetListPerUplinkCC	Not checked		
scalingFactor	Not checked		
crossCarrierScheduling-OtherSCS	Not checked		
intraBandFreqSeparationUL	Not checked		
searchSpaceSharingCA-UL	Not checked		
dummy1	Not checked		
supportedSRS-Resources	Not checked	SRS-Resources	
twoPUCCH-Group	Not checked		
dynamicSwitchSUL	Checked		pc_dynamic Switch_SUL
simultaneousTxSUL-NonSUL	Not checked		
pusch-ProcessingType1-DifferentTB-PerSlot SEQUENCE {			
scs-15kHz	Not checked		

scs-30kHz	Not checked		
scs-60kHz	Not checked		
scs-120kHz	Not checked		
}			
dummy2	Not checked		
}			
}			
featureSetsUplinkPerCC SEQUENCE (SIZE (1..maxPerCC-FeatureSets)) OF FeatureSetUplinkPerCC {			
FeatureSetUplinkPerCC SEQUENCE {			
supportedSubcarrierSpacingUL	Not checked	SubcarrierSpacing	
supportedBandwidthUL	Not checked	SupportedBandwidth	
channelBW-90mHz	Not checked		
mimo-CB-PUSCH SEQUENCE {			
maxNumberMIMO-LayersCB-PUSCH	Not checked		
maxNumberSRS-ResourcePerSet	Not checked		
}			
maxNumberMIMO-LayersNonCB-PUSCH	Not checked		
supportedModulationOrderUL	Not checked	ModulationOrder	
}			
}			
featureSetsDownlink-v1540 SEQUENCE (SIZE (1..maxDownlinkFeatureSets)) OF FeatureSetDownlink-v1540 {			
FeatureSetDownlink-v1540SEQUENCE {			
oneFL-DMRS-TwoAdditionalDMRS-DL	Not checked		
additionalDMRS-DL-Alt	Not checked		
twoFL-DMRS-TwoAdditionalDMRS-DL	Not checked		
oneFL-DMRS-ThreeAdditionalDMRS-DL	Not checked		
pdccch-MonitoringAnyOccasionsWithSpanGap SEQUENCE {			
scs-15kHz	Not checked		
scs-30kHz	Not checked		
scs-60kHz	Not checked		
scs-120kHz	Not checked		
}			
pdsch-SeparationWithGap	Not checked		
pdsch-ProcessingType2 SEQUENCE {			
scs-15kHz	Not checked		
scs-30kHz	Not checked		
scs-60kHz	Not checked		
}			
pdsch-ProcessingType2-Limited SEQUENCE {			
differentTB-PerSlot-SCS-30kHz	Not checked		
}			
dl-MCS-TableAlt-DynamicIndication	Not checked		
}			
}			
featureSetsUplink-v1540 SEQUENCE (SIZE (1..maxUplinkFeatureSets)) OF FeatureSetUplink-v1540 {			
FeatureSetUplink-v1540 SEQUENCE {			
zeroSlotOffsetAperiodicSRS	Not checked		
pa-PhaseDiscontinuityImpacts	Not checked		
pusch-SeparationWithGap	Not checked		
pusch-ProcessingType2 SEQUENCE {			
scs-15kHz	Not checked		
scs-30kHz	Not checked		
scs-60kHz	Not checked		
}			
ul-MCS-TableAlt-DynamicIndication	Not checked		
}			
}			

eutra SEQUENCE {			
supportedBandListEUTRA SEQUENCE (SIZE (1..maxBandsEUTRA)) OF FreqBandIndicatorEUTRA	Not checked		
eutra-ParametersCommon SEQUENCE {			
mfbi-EUTRA	Not checked		
modifiedMRP-BehaviorEUTRA	Not checked		
multiNS-Pmax-EUTRA	Not checked		
rs-SINR-MeasEUTRA	C checked		pc_RS_SINR_MeasEUTRA
ne-DC	Not checked		
nr-HO-ToEN-DC-r16	Checked		pc_interRAT_NR_ToENDC
}			
eutra-ParametersXDD-Diff SEQUENCE {			
rsrqMeasWidebandEUTRA	Not checked		
}			
}			
}			
inactiveState	Checked		pc_inactiveState
delayBudgetReporting	Not checked		
nonCriticalExtension SEQUENCE {			
sdap-Parameters SEQUENCE {			
as-ReflectiveQoS	Checked		pc_as_ReflectiveQoS
}			
overheatingInd	Not checked		
ims-Parameters SEQUENCE {			
ims-ParametersCommon SEQUENCE {			
voiceOverEUTRA-5GC	Not checked		
voiceOverSCG-BearerEUTRA-5GC	Not checked		
voiceFallbackIndicationEPS-r16	Checked		pc_voiceFallbackIndication
}			
ims-ParametersFRX-Diff SEQUENCE {			
voiceOverNR	Checked (NOTE 16)		pc_voiceOverNR
}			
}			
fr1-Add-UE-NR-Capabilities-v1540 SEQUENCE {			
ims-ParametersFRX-Diff SEQUENCE {			
voiceOverNR	Checked (NOTE 16)		pc_voiceOverNR
}			
}			
fr2-Add-UE-NR-Capabilities-v1540 SEQUENCE {			
ims-ParametersFRX-Diff SEQUENCE {			
voiceOverNR	Checked (NOTE 16)		pc_voiceOverNR
}			
}			
fr1-fr2-Add-UE-NR-Capabilities SEQUENCE {			
phy-ParametersFRX-Diff SEQUENCE {			
dynamicSFI	Not checked		
dummy1	Not checked		
twoFL-DMRS	Not checked		
dummy2	Not checked		
dummy3	Not checked		
supportedDMRS-TypeDL	Not checked		
supportedDMRS-TypeUL	Not checked		
semiOpenLoopCSI	Not checked		
csi-ReportWithoutPMI	Not checked		
csi-ReportWithoutCQI	Not checked		

onePortsPTRS	Not checked		
twoPUCCH-F0-2-ConsecSymbols	Not checked		
pucch-F2-WithFH	Not checked		
pucch-F3-WithFH	Not checked		
pucch-F4-WithFH	Not checked		
freqHoppingPUCCH-F0-2	Not checked		
freqHoppingPUCCH-F1-3-4	Not checked		
mux-SR-HARQ-ACK-CSI-PUCCH-MultiPerSlot	Not checked		
uci-CodeBlockSegmentation	Not checked		
onePUCCH-LongAndShortFormat	Not checked		
twoPUCCH-AnyOthersInSlot	Not checked		
intraSlotFreqHopping-PUSCH	Not checked		
pusch-LBRM	Not checked		
pdccch-BlindDetectionCA	Not checked		
tpc-PUSCH-RNTI	Not checked		
tpc-PUCCH-RNTI	Not checked		
tpc-SRS-RNTI	Not checked		
absoluteTPC-Command	Not checked		
twoDifferentTPC-Loop-PUSCH	Not checked		
twoDifferentTPC-Loop-PUCCH	Not checked		
pusch-HalfPi-BPSK	Not checked		
pucch-F3-4-HalfPi-BPSK	Not checked		
almostContiguousCP-OFDM-UL	Not checked		
sp-CSI-RS	Not checked		
sp-CSI-IM	Not checked		
tdd-MultiDL-UL-SwitchPerSlot	Not checked		
multipleCORESET	Not checked		
csi-RS-IM-ReceptionForFeedback	Not checked	CSI-RS-IM- eceptionForFeedb ack	
csi-RS-ProcFrameworkForSRS	Not checked	CSI-RS- ProcFrameworkFo rSRS	
csi-ReportFramework	Not checked	CSI- ReportFramework	
mux-SR-HARQ-ACK-CSI-PUCCH-OncePerSlot SEQUENCE {			
sameSymbol	Not checked		
diffSymbol	Not checked		
}			
mux-SR-HARQ-ACK-PUCCH	Not checked		
mux-MultipleGroupCtrlCH-Overlap	Not checked		
dl-SchedulingOffset-PDSCH-TypeA	Not checked		
dl-SchedulingOffset-PDSCH-TypeB	Not checked		
ul-SchedulingOffset	Not checked		
dl-64QAM-MCS-TableAlt	Not checked		
ul-64QAM-MCS-TableAlt	Not checked		
cqi-TableAlt	Not checked		
oneFL-DMRS-TwoAdditionalDMRS-UL	Not checked		
twoFL-DMRS-TwoAdditionalDMRS-UL	Not checked		
oneFL-DMRS-ThreeAdditionalDMRS-UL	Not checked		
}			
measAndMobParametersFRX-Diff SEQUENCE {			
ss-SINR-Meas	Checked (NOTE 10)		pc_ss_SINR _Meas
csi-RSRP-AndRSRQ-MeasWithSSB	Checked (NOTE 3)		pc_csi- RSRP- AndRSRQ- MeasWithSS B
csi-RSRP-AndRSRQ-MeasWithoutSSB	Checked (NOTE 11)		pc_csi_RSR P_AndRSR Q_MeasWith outSSB
csi-SINR-Meas	Not checked		
csi-RS-RLM	Not checked		

handoverInterF	Checked (NOTE 14)		pc_ handoverInterF
handoverLTE-EPC	Not checked		
handover-eLTE-5GC	Not checked		
maxNumberResource-CSI-RS-RLM	Not checked		
simultaneousRxDataSSB-DiffNumerology	Not checked		
nr-AutonomousGaps-r16	Not checked		
nr-AutonomousGaps-ENDC-r16	Not checked		
nr-AutonomousGaps-NEDC-r16	Not checked		
nr-AutonomousGaps-NRDC-r16	Not checked		
dummy	Not checked		
cli-RSSI-Meas-r16	Not checked		
cli-SRS-RSRP-Meas-r16	Not checked		
interFrequencyMeas-NoGap-r16	Not checked		
simultaneousRxDataSSB-DiffNumerology-Inter-r16	Not checked		
idleInactiveNR-MeasReport-r16	Not checked		
idleInactiveNR-MeasBeamReport-r16	Not checked		
increasedNumberOfCSIRSPerMO-r16	Not checked		
}			
}			
nonCriticalExtension SEQUENCE {		UE-NR-Capability-v1550	
reducedCP-Latency	Checked		pc_reduced CP_Latency
nonCriticalExtension SEQUENCE {		UE-NR-Capability-v1560	
nrdc-Parameters	Not checked	NRDC-Parameters	
receivedFilters	Not checked		
nonCriticalExtension SEQUENCE {		UE-NR-Capability-v1570	
nrdc-Parameters-v1570	Not checked	NRDC-Parameters-v1570	
nonCriticalExtension SEQUENCE {		UE-NR-Capability-v1610	
inDeviceCoexInd-r16	Not checked		
dl-DedicatedMessageSegmentation-r16	Not checked		
nrdc-Parameters-v1610	Not checked		
powSav-Parameters-r16	Checked	PowSav-Parameters-r16 (Table 8.2.1.1.1.3.3-12)	
fr1-Add-UE-NR-Capabilities-v1610	Not checked		
fr2-Add-UE-NR-Capabilities-v1610	Not checked		
bh-RLF-Indication-r16	Not checked		
directSN-AdditionFirstRRC-IAB-r16	Not checked		
bap-Parameters-r16	Not checked		
referenceTimeProvision-r16	Not checked		
sidelinkParameters-r16	Not checked		
highSpeedParameters-r16	Not checked		
mac-Parameters-v1610	Not checked		
mcgRLF-RecoveryViaSCG-r16	Not checked		
resumeWithStoredMCG-SCells-r16	Not checked		
resumeWithStoredSCG-r16	Not checked		
resumeWithSCG-Config-r16	Not checked		
ue-BasedPerfMeas-Parameters-r16	Checked	UE-BasedPerfMeas-Parameters-r16 (Table 8.2.1.1.1.3.3-13)	
son-Parameters-r16 {			
rach-Report-r16	Checked		pc_rachReport_r16
}			

onDemandSIB-Connected-r16	Not checked		
nonCriticalExtension SEQUENCE {}	Not checked		
}			
}			
}			
}			
nonCriticalExtension SEQUENCE {}	Not checked		
}			
}			
Note 1:	<p>If the UE is single mode (FDD or TDD), or the UE is dual mode (FDD and TDD) and <i>intraAndInterF-MeasAndReport</i> is supported in both modes, then support of <i>intraAndInterF-MeasAndReport</i> will be signaled in <i>measAndMobParameters/measAndMobParametersXDD-Diff</i>.</p> <p>If the UE is dual mode (FDD + TDD) and <i>intraAndInterF-MeasAndReport</i> is only supported in one mode, then support of <i>intraAndInterF-MeasAndReport</i> will be signaled in one of <i>fdd-Add-UE-NR-Capabilities/measAndMobParametersXDD-Diff</i> or <i>tdd-Add-UE-NR-Capabilities/measAndMobParametersXDD-Diff</i> as appropriate.)</p>		
Note 2:	<p>If the UE is single mode (FDD or TDD), or the UE is dual mode (FDD and TDD) and <i>eventA-MeasAndReport</i> is supported in both modes, then support of <i>eventA-MeasAndReport</i> will be signaled in <i>measAndMobParameters/measAndMobParametersXDD-Diff</i>.</p> <p>If the UE is dual mode (FDD + TDD) and <i>eventA-MeasAndReport</i> is only supported in one mode, then support of <i>eventA-MeasAndReport</i> will be signaled in one of <i>fdd-Add-UE-NR-Capabilities/measAndMobParametersXDD-Diff</i> or <i>tdd-Add-UE-NR-Capabilities/measAndMobParametersXDD-Diff</i> as appropriate.</p>		
Note 3:	<p>If the UE supports single frequency range (FR1 or FR2), or the UE supports both frequency ranges (FR1 and FR2) and <i>csi-RSRP-AndRSRQ-MeasWithSSB</i> is supported in both frequency ranges, then support of <i>csi-RSRP-AndRSRQ-MeasWithSSB</i> will be signaled in <i>measAndMobParameters/MeasAndMobParametersFRX-Diff</i>.</p> <p>If the UE supports both frequency ranges (FR1 + FR2) and <i>csi-RSRP-AndRSRQ-MeasWithSSB</i> is only supported in one frequency range, then support of <i>csi-RSRP-AndRSRQ-MeasWithSSB</i> will be signaled in one of <i>fr1-Add-UE-NR-Capabilities/measAndMobParametersFRX-Diff</i> or <i>fr2-Add-UE-NR-Capabilities/measAndMobParametersFRX-Diff</i> as appropriate.)</p>		
Note 4:	<p>If the UE is single mode (FDD or TDD), or the UE is dual mode (FDD and TDD) and <i>skipUplinkTxDynamic</i> is supported in both modes, then support of <i>skipUplinkTxDynamic</i> will be signaled in <i>mac-Parameters/mac-ParametersXDD-Diff</i>.</p> <p>If the UE is dual mode (FDD + TDD) and <i>skipUplinkTxDynamic</i> is only supported in one mode, then <i>skipUplinkTxDynamic</i> will be signaled in one of <i>fdd-Add-UE-NR-Capabilities/mac-ParametersXDD-Diff</i> or <i>tdd-Add-UE-NR-Capabilities/mac-ParametersXDD-Diff</i> as appropriate.</p>		
Note 5:	<p>If the UE is single mode (FDD or TDD), or the UE is dual mode (FDD and TDD) and <i>logicalChannelSR-DelayTimer</i> is supported in both modes, then support of <i>logicalChannelSR-DelayTimer</i> will be signaled in <i>mac-Parameters/mac-ParametersXDD-Diff</i>.</p> <p>If the UE is dual mode (FDD + TDD) and <i>logicalChannelSR-DelayTimer</i> is only supported in one mode, then support of <i>logicalChannelSR-DelayTimer</i> will be signaled in one of <i>fdd-Add-UE-NR-Capabilities/mac-ParametersXDD-Diff</i> or <i>tdd-Add-UE-NR-Capabilities/mac-ParametersXDD-Diff</i> as appropriate.</p>		
Note 6:	<p>If the UE is single mode (FDD or TDD), or the UE is dual mode (FDD and TDD) and <i>longDRX_Cycle</i> is supported in both modes, then support of <i>longDRX_Cycle</i> will be signaled in <i>mac-Parameters/mac-ParametersXDD-Diff</i>.</p> <p>If the UE is dual mode (FDD + TDD) and <i>longDRX_Cycle</i> is only supported in one mode, then support of <i>longDRX_Cycle</i> will be signaled in one of <i>fdd-Add-UE-NR-Capabilities/mac-ParametersXDD-Diff</i> or <i>tdd-Add-UE-NR-Capabilities/mac-ParametersXDD-Diff</i> as appropriate.</p>		
Note 7:	<p>If the UE is single mode (FDD or TDD), or the UE is dual mode (FDD and TDD) and <i>shortDRX_Cycle</i> is supported in both modes, then support of <i>shortDRX_Cycle</i> will be signaled in <i>mac-Parameters/mac-ParametersXDD-Diff</i>.</p> <p>If the UE is dual mode (FDD + TDD) and <i>shortDRX_Cycle</i> is only supported in one mode, then support of <i>shortDRX_Cycle</i> will be signaled in one of <i>fdd-Add-UE-NR-Capabilities/mac-ParametersXDD-Diff</i> or <i>tdd-Add-UE-NR-Capabilities/mac-ParametersXDD-Diff</i> as appropriate.</p>		
Note 8:	<p>If the UE supports FR2 and <i>pc_pdsch_256QAM_FR2</i> is supported, then support of <i>pdsch_256QAM_FR2</i> will be signaled in at least one entry of <i>supportedBandListNR</i> as appropriate.</p>		
Note 9:	<p>If <i>pc_pusch_256QAM_FR1</i> or <i>pc_pusch_256QAM_FR2</i> is supported, then support of <i>pusch-256QAM</i> will be signaled in at least one entry of <i>supportedBandListNR</i> as appropriate.</p>		
Note 10:	<p>If the UE supports single frequency range (FR1 or FR2), or the UE supports both frequency ranges (FR1 and FR2) and <i>ss-SINR-Meas</i> is supported in both frequency ranges, then support of <i>ss-SINR-Meas</i> will be signaled in <i>measAndMobParameters/MeasAndMobParametersFRX-Diff</i>.</p> <p>If the UE supports both frequency ranges (FR1 + FR2) and <i>ss-SINR-Meas</i> is only supported in one frequency range, then support of <i>ss-SINR-Meas</i> will be signaled in one of <i>fr1-Add-UE-NR-Capabilities/measAndMobParametersFRX-Diff</i> or <i>fr2-Add-UE-NR-Capabilities/measAndMobParametersFRX-Diff</i> as appropriate.)</p>		

Note 11:	<p>If the UE supports single frequency range (FR1 or FR2), or the UE supports both frequency ranges (FR1 and FR2) and <i>csi-RSRP-AndRSRQ-MeasWithoutSSB</i> is supported in both frequency ranges, then support of <i>csi-RSRP-AndRSRQ-MeasWithoutSSB</i> will be signaled in <i>measAndMobParameters/MeasAndMobParametersFRX-Diff</i>.</p> <p>If the UE supports both frequency ranges (FR1 + FR2) and <i>csi-RSRP-AndRSRQ-MeasWithoutSSB</i> is only supported in one frequency range, then support of <i>csi-RSRP-AndRSRQ-MeasWithoutSSB</i> will be signaled in one of <i>fr1-Add-UE-NR-Capabilities/measAndMobParametersFRX-Diff</i> or <i>fr2-Add-UE-NR-Capabilities/measAndMobParametersFRX-Diff</i> as appropriate.)</p>
Note 12:	<p>If the UE is single mode (FDD or TDD), or the UE is dual mode (FDD and TDD) and <i>multipleConfiguredGrants</i> is supported in both modes, then support of <i>multipleConfiguredGrants</i> will be signaled in <i>mac-Parameters/mac-ParametersXDD-Diff</i>.</p> <p>If the UE is dual mode (FDD + TDD) and <i>multipleConfiguredGrants</i> is only supported in one mode, then support of <i>multipleConfiguredGrants</i> will be signaled in one of <i>fdd-Add-UE-NR-Capabilities/mac-ParametersXDD-Diff</i> or <i>tdd-Add-UE-NR-Capabilities/mac-ParametersXDD-Diff</i> as appropriate.</p>
Note 13:	<p>If the UE is single mode (FDD or TDD), or the UE is dual mode (FDD and TDD) and <i>sftd-MeasNR-Neigh</i> is supported in both modes, then support of <i>sftd-MeasNR-Neigh</i> will be signaled in <i>measAndMobParameters/measAndMobParametersXDD-Diff</i>.</p> <p>If the UE is dual mode (FDD + TDD) and <i>sftd-MeasNR-Neigh</i> is only supported in one mode, then support of <i>sftd-MeasNR-Neigh</i> will be signaled in one of <i>fdd-Add-UE-NR-Capabilities/measAndMobParametersXDD-Diff</i> or <i>tdd-Add-UE-NR-Capabilities/measAndMobParametersXDD-Diff</i> as appropriate.)</p>
Note 14:	<p>If the UE supports single frequency range (FR1 or FR2), or the UE supports both frequency ranges (FR1 and FR2) and <i>handoverInterF</i> is supported in both frequency ranges, then support of <i>handoverInterF</i> will be signaled in <i>measAndMobParameters/MeasAndMobParametersFRX-Diff</i>.</p> <p>If the UE supports both frequency ranges (FR1 + FR2) and <i>handoverInterF</i> is only supported in one frequency range, then support of <i>handoverInterF</i> will be signaled in one of <i>fr1-Add-UE-NR-Capabilities/measAndMobParametersFRX-Diff</i> or <i>fr2-Add-UE-NR-Capabilities/measAndMobParametersFRX-Diff</i> as appropriate.)</p>
Note 15:	<p>If the UE is single mode (FDD or TDD), or the UE is dual mode (FDD and TDD) and <i>handoverInterF</i> is supported in both modes, then support of <i>handoverInterF</i> will be signaled in <i>measAndMobParameters/measAndMobParametersXDD-Diff</i>.</p> <p>If the UE is dual mode (FDD + TDD) and <i>handoverInterF</i> is only supported in one mode, then support of <i>handoverInterF</i> will be signaled in one of <i>fdd-Add-UE-NR-Capabilities/measAndMobParametersXDD-Diff</i> or <i>tdd-Add-UE-NR-Capabilities/measAndMobParametersXDD-Diff</i> as appropriate.</p>
Note 16:	<p>If the UE supports single frequency range (FR1 or FR2), or the UE supports both frequency ranges (FR1 and FR2) and <i>voiceOverNR</i> is supported in both frequency ranges, then support of <i>voiceOverNR</i> will be signaled in <i>ims-Parameters/ims-ParametersFRX-Diff</i>.</p> <p>If the UE supports both frequency ranges (FR1 + FR2) and <i>voiceOverNR</i> is only supported in one frequency range, then support of <i>voiceOverNR</i> will be signaled in one of <i>fr1-Add-UE-NR-Capabilities-v1540/ims-ParametersFRX-Diff</i> or <i>fr2-Add-UE-NR-Capabilities-v1540/ims-ParametersFRX-Diff</i> as appropriate.)</p>

Table 8.2.1.1.1.3.3-7: UE-MRDC-Capability (Table 8.2.1.1.1.3.3-5)

Derivation Path: TS 38.508-1 [4], Table 4.6.4-48			
Information Element	Value/remark	Comment	Condition
UE-MRDC-Capability ::= SEQUENCE {			
measAndMobParametersMRDC SEQUENCE {			
measAndMobParametersMRDC-Common			
SEQUENCE {			
independentGapConfig	Checked		pc_independentGapConfig
}			
measAndMobParametersMRDC-XDD-Diff			
SEQUENCE {			
sftd-MeasPSCell	Checked (NOTE 5)		pc_SFTD_MeasPSCell_MRDC_FDD and/or pc_SFTD_MeasPSCell_MRDC_TDD
sftd-MeasNR-Cell	Checked (NOTE 6)		pc_SFTD_MeasNR_Cell_FDD and/or

			pc_SFTD_M easNR_Cell _TDD
}			
measAndMobParametersMRDC-FRX-Diff SEQUENCE {			
simultaneousRxDataSSB-DiffNumerology	Not checked		
}			
}			
phy-ParametersMRDC-v1530 SEQUENCE {			
naics-Capability-List SEQUENCE (SIZE (1..maxNrofNAICS-Entries)) OF NAICS-Capability- Entry {	Not checked		
NAICS-Capability-Entry SEQUENCE {			
numberOfNAICS-CapableCC	Not checked		
numberOfAggregatedPRB	Not checked		
}			
}			
rf-ParametersMRDC SEQUENCE {			
supportedBandCombinationList SEQUENCE { (SIZE (1..maxBandComb)) OF BandCombination {			
BandCombination SEQUENCE {			
bandList SEQUENCE (SIZE (1..maxSimultaneousBands)) OF BandParameters {	Not checked		
BandParameters CHOICE			
eutra SEQUENCE {		EUTRA bands	
bandEUTRA	Not checked	FreqBandIndicator EUTRA	
ca-BandwidthClassDL-EUTRA	Not checked	CA- BandwidthClassE UTRA	
ca-BandwidthClassUL-EUTRA	Not checked	CA- BandwidthClassE UTRA	
}			
nr SEQUENCE {		NR bands	
bandNR	Not checked	FreqBandIndicator NR	
ca-BandwidthClassDL-NR	Not checked	CA- BandwidthClassN R	
ca-BandwidthClassUL-NR	Not checked	CA- BandwidthClassN R	
}			
}			
}			
featureSetCombination	Not checked	FeatureSetCombi nationId	
ca-ParametersEUTRA	Not checked	CA- ParametersEUTR A	
ca-ParametersNR	Not checked	CA- ParametersNR	
mrdc-Parameters SEQUENCE {			
singleUL-Transmission	Not checked		
dynamicPowerSharingENDC	Checked	Note 4	pc_dynamic PowerSharin g
tdm-Pattern	Not checked		
ul-SharingEUTRA-NR	Not checked		
ul-SwitchingTimeEUTRA-NR	Not checked		
simultaneousRxTxInterBandENDC	Not checked		
asyncIntraBandENDC	Not checked		
dualPA-Architecture	Not checked		
intraBandENDC-Support-v1540	Not checked		

ul-TimingAlignmentEUTRA-NR	Not checked		
}			
supportedBandwidthCombinationSet	Not checked		
powerClass-v1530	Not checked		
}			
appliedFreqBandListFilter	Not checked	FreqBandList	
srs-SwitchingTimeRequested	Not checked		
supportedBandCombinationList-v1540 SEQUENCE (SIZE (1..maxBandComb)) OF OF BandCombination-v1540 {		BandCombination List-v1540	
BandCombination-v1540 SEQUENCE {			
bandList-v1540 SEQUENCE (SIZE (1..maxSimultaneousBands)) OF OF BandParameters-v1540 {	Not checked	BandParameters- v1540	
BandParameters-v1540 SEQUENCE {			
srs-CarrierSwitch CHOICE {			
nr SEQUENCE {		NR bands	
srs-SwitchingTimesListNR SEQUENCE (SIZE (1..maxSimultaneousBands)) OF SRS- SwitchingTimeNR	Not checked		
}			
eutra SEQUENCE {		EUTRA bands	
srs-SwitchingTimesListEUTRA SEQUENCE (SIZE (1..maxSimultaneousBands)) OF SRS- SwitchingTimeEUTRA	Not checked		
}			
srs-TxSwitch-v1540 SEQUENCE {			
supportedSRS-TxPortSwitch	Not checked		
txSwitchImpactToRx	Not checked		
txSwitchWithAnotherBand	Not checked		
}			
}			
ca-ParametersNR-v1540 SEQUENCE {			
simultaneousSRS-AssocCSI-RS-AIICC	Not checked		
csi-RS-IM- ReceptionForFeedbackPerBandComb SEQUENCE {			
maxNumberSimultaneousNZIP-CSI-RS- ActBWP-AIICC	Not checked		
totalNumberPortsSimultaneousNZIP-CSI-RS- ActBWP-AIICC	Not checked		
}			
simultaneousCSI-ReportsAIICC	Not checked		
dualPA-Architecture	Not checked		
}			
}			
}			
generalParametersMRDC SEQUENCE {			
splitSRB-WithOneUL-Path	Checked (NOTE 1)		pc_splitSRB _WithOneUL _Path
splitDRB-withUL-Both-MCG-SCG	Checked (NOTE 2)		pc_splitDRB _withUL_Bot h_MCG_SC G
srb3	Checked (NOTE 1)		pc_srb3
v2x-EUTRA	Not checked		
}			
fdd-Add-UE-MRDC-Capabilities SEQUENCE {			
measAndMobParametersMRDC-XDD-Diff SEQUENCE {			
sftd-MeasPSCell	Checked (NOTE 5)		pc_SFTD_M easPSCell_

			MRDC_FDD and/or pc_SFTD_M easPSCell_ MRDC_T DD
sftd-MeasNR-Cell	Checked (NOTE 6)		pc_SFTD_M easNR_Cell _FDD and/or pc_SFTD_M easNR_Cell _TDD
}			
generalParametersMRDC-XDD-Diff SEQUENCE {			
splitSRB-WithOneUL-Path	Checked (NOTE 1)		pc_splitSRB _WithOneUL _Path
splitDRB-withUL-Both-MCG-SCG	Checked (NOTE 2)		pc_splitDRB _withUL_Bot h_MCG_SC G
srb3	Checked (NOTE 3)		pc_srb3
v2x-EUTRA-v1530	Not checked		
}			
}			
tdd-Add-UE-MRDC-Capabilities SEQUENCE {			
measAndMobParametersMRDC-XDD-Diff SEQUENCE {			
sftd-MeasPSCell	Checked (NOTE 5)		pc_SFTD_M easPSCell_ MRDC_FDD and/or pc_SFTD_M easPSCell_ MRDC_T DD
sftd-MeasNR-Cell	Checked (NOTE 6)		pc_SFTD_M easNR_Cell _FDD and/or pc_SFTD_M easNR_Cell _TDD
}			
generalParametersMRDC-XDD-Diff SEQUENCE {			
splitSRB-WithOneUL-Path	Checked (NOTE 1)		pc_splitSRB _WithOneUL _Path
splitDRB-withUL-Both-MCG-SCG	Checked (NOTE 2)		pc_splitDRB _withUL_Bot h_MCG_SC G
srb3	Checked (NOTE 3)		pc_srb3
v2x-EUTRA-v1530	Not checked		
}			
}			
fr1-Add-UE-MRDC-Capabilities SEQUENCE {			
measAndMobParametersMRDC-FRX-Diff SEQUENCE {			
simultaneousRxDataSSB-DiffNumerology	Not checked		
}			
}			
fr2-Add-UE-MRDC-Capabilities SEQUENCE {			
measAndMobParametersMRDC-FRX-Diff SEQUENCE {			
simultaneousRxDataSSB-DiffNumerology	Not checked		

}			
}			
featureSetCombinations SEQUENCE (SIZE (1..maxFeatureSetCombinations)) OF FeatureSetCombination {	Not checked	FeatureSetCombination	
FeatureSetCombination SEQUENCE (SIZE (1..maxSimultaneousBands)) OF FeatureSetsPerBand {			
FeatureSetsPerBand SEQUENCE (SIZE (1..maxFeatureSetsPerBand)) OF FeatureSet {			
FeatureSet CHOICE {			
eutra SEQUENCE {		EUTRA bands	
downlinkSetEUTRA	Not checked		
uplinkSetEUTRA	Not checked		
}			
nr SEQUENCE {		NR bands	
downlinkSetNR	Not checked		
uplinkSetNR	Not checked		
}			
}			
}			
}			
}			
pcdp-ParametersMRDC-v1530 SEQUENCE {			
pcdp-DuplicationSplitSRB	Checked		pc_pdcop_DuplicationSplitSRB
pcdp-DuplicationSplitDRB	Checked		pc_pdcop_DuplicationSplitDRB
}			
lateNonCriticalExtension	Not checked		
nonCriticalExtension SEQUENCE {}	Not checked		
}			
Note 1:	<p>If the UE is single mode (FDD or TDD), or the UE is dual mode (FDD and TDD) and <i>splitSRB-WithOneUL-Path</i> is supported in both modes, then support of <i>splitSRB-WithOneUL-Path</i> will be signaled in generalParametersMRDC/generalParametersMRDC-XDD-Diff.</p> <p>If the UE is dual mode (FDD + TDD) and <i>splitSRB-WithOneUL-Path</i> is only supported in one mode, then support of <i>splitSRB-WithOneUL-Path</i> will be signaled in one of fdd-Add-UE-MRDC-Capabilities/generalParametersMRDC-XDD-Diff or tdd-Add-UE-MRDC-Capabilities/generalParametersMRDC-XDD-Diff as appropriate.</p>		
Note 2:	<p>If the UE is single mode (FDD or TDD), or the UE is dual mode (FDD and TDD) and <i>splitDRB-withUL-Both-MCG-SCG</i> is supported in both modes, then support of <i>splitDRB-withUL-Both-MCG-SCG</i> will be signaled in generalParametersMRDC/generalParametersMRDC-XDD-Diff.</p> <p>If the UE is dual mode (FDD + TDD) and <i>splitDRB-withUL-Both-MCG-SCG</i> is only supported in one mode, then support of <i>splitDRB-withUL-Both-MCG-SCG</i> will be signaled in one of fdd-Add-UE-MRDC-Capabilities/generalParametersMRDC-XDD-Diff or tdd-Add-UE-MRDC-Capabilities/generalParametersMRDC-XDD-Diff as appropriate.</p>		
Note 3:	<p>If the UE is single mode (FDD or TDD), or the UE is dual mode (FDD and TDD) and <i>srb3</i> is supported in both modes, then support of <i>srb3</i> will be signaled in generalParametersMRDC/generalParametersMRDC-XDD-Diff.</p> <p>If the UE is dual mode (FDD + TDD) and <i>srb3</i> is only supported in one mode, then support of <i>srb3</i> will be signaled in one of fdd-Add-UE-MRDC-Capabilities/generalParametersMRDC-XDD-Diff or tdd-Add-UE-MRDC-Capabilities/generalParametersMRDC-XDD-Diff as appropriate.</p>		
Note 4:	<p>If pc_dynamicPowerSharing is supported, then support of dynamicPowerSharingENDC will be signaled in at least one entry of supportedBandCombinationList as appropriate. As per 38.306 cl 4.2.7.9 this is applicable to FR1 only.</p>		
Note 5:	<p>If the UE is single mode (FDD or TDD), or the UE is dual mode (FDD and TDD) and sftd-MeasPSCell is supported in both modes, then support of sftd-MeasPSCell will be signalled in measAndMobParametersMRDC/measAndMobParametersMRDC-XDD-Diff</p> <p>If the UE is dual mode (FDD + TDD) and sftd-MeasPSCell is only supported in one mode, then support of sftd-MeasPSCell will be signalled in one of fdd-Add-UE-MRDC-Capabilities/measAndMobParametersMRDC-XDD-Diff or tdd-Add-UE-MRDC-Capabilities/measAndMobParametersMRDC-XDD-Diff as appropriate.</p>		
Note 6:	<p>If the UE is single mode (FDD or TDD), or the UE is dual mode (FDD and TDD) and sftd-MeasNR-Cell is supported in both modes, then support of sftd-MeasNR-Cell will be signalled in measAndMobParametersMRDC/measAndMobParametersMRDC-XDD-Diff</p>		

If the UE is dual mode (FDD + TDD) and sftd-MeasNR-Cell is only supported in one mode, then support of sftd-MeasNR-Cell will be signalled in one of fdd-Add-UE-MRDC-Capabilities/measAndMobParametersMRDC-XDD-Diff or tdd-Add-UE-MRDC-Capabilities/measAndMobParametersMRDC-XDD-Diff as appropriate.

Table 8.2.1.1.1.3.3-8: ULDedicatedMessageSegment (steps 2a1 and 4a1 Table 8.2.1.1.1.3.2-1)

Derivation Path: 36.508 [7], Table 4.6.1-22A			
Information Element	Value/remark	Comment	Condition
ULDedicatedMessageSegment-r16 ::= SEQUENCE {			
criticalExtensions CHOICE {			
segmentNumber-r16	0 for first segment, and incremented by 1 for each subsequent segment		
rrc-MessageSegmentContainer-r16	Not Checked	OCTET STRING including segmented UECapabilityInformation message	
rrc-MessageSegmentType-r16	<i>notLastSegment</i> for all segments except the last segment. <i>lastSegment</i> for the last segment		
lateNonCriticalExtension	Not present		
nonCriticalExtension	Not present		
}			
}			

Table 8.2.1.1.1.3.3-9: FeatureSetDownlink-v1610 (Table 8.2.1.1.1.3.3-6)

Information Element	Value/remark	Comment	Condition
FeatureSetDownlink-v1610 ::= SEQUENCE {			
cbgPDSCH-ProcessingType1-DifferentTB-PerSlot-r16	Not checked		
cbgPDSCH-ProcessingType2-DifferentTB-PerSlot-r16	Not checked		
intraFreqDAPS-r16	Checked		pc_intraFreqDAPS_r16
intraBandFreqSeparationDL-v1620	Not checked		
intraBandFreqSeparationDL-Only-r16	Not checked		
pdccch-Monitoring-r16	Not checked		
pdccch-MonitoringMixed-r16	Not checked		
crossCarrierSchedulingProcessing-DiffSCS-r16	Not checked		
singleDCI-SDM-scheme-r16	Not checked		
}			

Table 8.2.1.1.1.3.3-10: FeatureSetUplink-v1610 (Table 8.2.1.1.1.3.3-6)

Information Element	Value/remark	Comment	Condition
FeatureSetUplink-v1610 ::= SEQUENCE {			
pusch-RepetitionTypeB-r16	Checked		pc_pusch_RepetitionTypeB_r16
ul-CancellationSelfCarrier-r16	Not checked		
ul-CancellationCrossCarrier-r16	Not checked		
ul-FullPwrMode2-MaxSRS-ResInSet-r16	Not checked		
cbgPUSCH-ProcessingType1-DifferentTB-PerSlot-r16	Not checked		
cbgPUSCH-ProcessingType2-DifferentTB-PerSlot-r16	Not checked		

supportedSRS-PosResources-r16	Not checked		
intraFreqDAPS-UL-r16	Not checked		
intraBandFreqSeparationUL-v1620	Not checked		
multiPUCCH-r16	Not checked		
twoPUCCH-Type1-r16	Not checked		
twoPUCCH-Type2-r16	Not checked		
twoPUCCH-Type3-r16	Not checked		
twoPUCCH-Type4-r16	Not checked		
mux-SR-HARQ-ACK-r16	Not checked		
dummy1	Not checked		
dummy2	Not checked		
twoPUCCH-Type5-r16	Not checked		
twoPUCCH-Type6-r16	Not checked		
twoPUCCH-Type7-r16	Not checked		
twoPUCCH-Type8-r16	Not checked		
twoPUCCH-Type9-r16	Not checked		
twoPUCCH-Type10-r16	Not checked		
twoPUCCH-Type11-r16	Not checked		
ul-IntraUE-Mux-r16	Not checked		
ul-FullPwrMode-r16	Not checked		
crossCarrierSchedulingProcessing-DiffSCS-r16	Not checked		
ul-FullPwrMode1-r16	Not checked		
ul-FullPwrMode2-SRSConfig-diffNumSRSPorts-r16	Not checked		
ul-FullPwrMode2-TPMIGroup-r16	Not checked		
}			

Table 8.2.1.1.1.3.3-11: CA-ParametersNR-v1610 (Table 8.2.1.1.1.3.3-6)

Information Element	Value/remark	Comment	Condition
CA-ParametersNR-v1610 ::= SEQUENCE {			
parallelTxMsgA-SRS-PUCCH-PUSCH-r16	Not checked		
msgA-SUL-r16	Not checked		
jointSearchSpaceSwitchAcrossCells-r16	Not checked		
half-DuplexTDD-CA-SameSCS-r16	Not checked		
scellDormancyWithinActiveTime-r16	Not checked		
scellDormancyOutsideActiveTime-r16	Checked		pc_scellDormancyOutsideActiveTime_r16
crossCarrierA-CSI-trigDiffSCS-r16	Not checked		
defaultQCL-CrossCarrierA-CSI-Trig-r16	Not checked		
interCA-NonAlignedFrame-r16	Not checked		
simul-SRS-Trans-BC-r16	Not checked		
interFreqDAPS-r16	Checked		pc_interFreqDAPS_r16
codebookParametersPerBC-r16	Not checked		
blindDetectFactor-r16	Not checked		
pdccch-MonitoringCA-r16	Not checked		
pdccch-BlindDetectionCA-Mixed-r16	Not checked		
pdccch-BlindDetectionMCG-UE-r16	Not checked		
pdccch-BlindDetectionSCG-UE-r16	Not checked		
pdccch-BlindDetectionMCG-UE-Mixed-r16	Not checked		
pdccch-BlindDetectionSCG-UE-Mixed-r16	Not checked		
crossCarrierSchedulingDL-DiffSCS-r16	Not checked		
crossCarrierSchedulingDefaultQCL-r16	Not checked		
crossCarrierSchedulingUL-DiffSCS-r16	Not checked		
simul-SRS-MIMO-Trans-BC-r16	Not checked		
codebookParametersAdditionPerBC-r16	Not checked		
codebookComboParametersAdditionPerBC-r16	Not checked		
}			

Table 8.2.1.1.1.3.3-12: PowSav-Parameters-r16 (Table 8.2.1.1.1.3.3-6)

Information Element	Value/remark	Comment	Condition
PowSav-Parameters-r16 ::= SEQUENCE {			
powSav-ParametersCommon-r16 SEQUENCE {			
drx-Preference-r16	Not checked		
maxCC-Preference-r16	Not checked		
releasePreference-r16	Checked		pc_releaseP reference_r1 6
minSchedulingOffsetPreference-r16	Not checked		
}			
powSav-ParametersFRX-Diff-r16	Not checked		
}			

Table 8.2.1.1.1.3.3-13: UE-BasedPerfMeas-Parameters-r16 (Table 8.2.1.1.1.3.3-6)

Information Element	Value/remark	Comment	Condition
UE-BasedPerfMeas-Parameters-r16 ::= SEQUENCE {			
barometerMeasReport-r16	Checked		pc_baromete r_r16
immMeasBT-r16	Not checked		
immMeasWLAN-r16	Checked		pc_immMea sWLAN_r16
loggedMeasBT-r16	Not checked		
loggedMeasurements-r16	Checked		pc_loggedM easements _r16
loggedMeasWLAN-r16	Checked		pc_loggedM easWLAN_r 16
orientationMeasReport-r16	Checked		pc_orientatio n_r16
speedMeasReport-r16	Checked		pc_speed_r1 6
gnss-Location-r16	Checked		pc_GNSS_lo cation_r16
ulPDCP-Delay-r16	Checked		pc_PDCP_D elay_r16
}			

8.2.1.1.2 UE capability transfer / Success / NE-DC

8.2.1.1.2.1 Test Purpose (TP)

(1)

```
with { UE in RRC_CONNECTED state with NE-DC, and, MCG(s) and SCG }
ensure that {
  when { UE receives an UECapabilityEnquiry message that includes nr and eutra-nr }
  then { UE transmits an UECapabilityInformation message including UE radio access capability
information corresponding to the ue-CapabilityRequest variable }
}
```

8.2.1.1.2.2 Conformance requirements

References: The conformance requirements covered in the present TC are specified in: TS 38.331, clause 5.6.1.3, 5.6.1.4, 5.7.7.2 and 5.7.7.3.

[TS 38.331, clause 5.6.1.3]

The UE shall set the contents of *UECapabilityInformation* message as follows:

- 1> if the *ue-CapabilityRAT-RequestList* contains a *UE-CapabilityRAT-Request* with *rat-Type* set to *nr*:
 - 2> include in the *ue-CapabilityRAT-ContainerList* a *UE-CapabilityRAT-Container* of the type *UE-NR-Capability* and with the *rat-Type* set to *nr*;
 - 2> include the *supportedBandCombinationList*, *featureSets* and *featureSetCombinations* as specified in clause 5.6.1.4;
- 1> if the *ue-CapabilityRAT-RequestList* contains a *UE-CapabilityRAT-Request* with *rat-Type* set to *eutra-nr*:
 - 2> if the UE supports (NG)EN-DC or NE-DC:
 - 3> include in the *ue-CapabilityRAT-ContainerList* a *UE-CapabilityRAT-Container* of the type *UE-MRDC-Capability* and with the *rat-Type* set to *eutra-nr*;
 - 3> include the *supportedBandCombinationList* and *featureSetCombinations* as specified in clause 5.6.1.4;
- 1> if the *ue-CapabilityRAT-RequestList* contains a *UE-CapabilityRAT-Request* with *rat-Type* set to *eutra*:
 - 2> if the UE supports E-UTRA:
 - 3> include in the *ue-CapabilityRAT-ContainerList* a *ue-CapabilityRAT-Container* of the type *UE-EUTRA-Capability* and with the *rat-Type* set to *eutra* as specified in TS 36.331 [10], clause 5.6.3.3, according to the *capabilityRequestFilter*, if received;
- 1> if the *ue-CapabilityRAT-RequestList* contains a *UE-CapabilityRAT-Request* with *rat-Type* set to *utra-fdd*:
 - 2> if the UE supports UTRA-FDD:
 - 3> include the UE radio access capabilities for UTRA-FDD within a *ue-CapabilityRAT-Container* and with the *rat-Type* set to *utra-fdd*;
- 1> if the RRC message segmentation is enabled based on the field *rrc-SegAllowed* received, and the encoded RRC message is larger than the maximum supported size of a PDCP SDU specified in TS 38.323 [5]:
 - 2> initiate the UL message segment transfer procedure as specified in clause 5.7.7;
- 1> else:
 - 2> submit the *UECapabilityInformation* message to lower layers for transmission, upon which the procedure ends.

[TS 38.331, clause 5.6.1.4]

The UE invokes the procedures in this clause if the NR or E-UTRA network requests UE capabilities for *nr*, *eutra-nr* or *eutra*. This procedure is invoked once per requested *rat-Type* (see clause 5.6.1.3 for capability enquiry by the NR network; see TS 36.331 [10], clause 5.6.3.3 for capability enquiry by the E-UTRA network). The UE shall ensure that the feature set IDs are consistent across feature sets, feature set combinations and band combinations in all three UE capability containers that the network queries with the same fields with the same values, i.e. *UE-CapabilityRequestFilterNR*, *UE-CapabilityRequestFilterCommon* and fields in *UECapabilityEnquiry* message (i.e. *requestedFreqBandsNR-MRDC*, *requestedCapabilityNR*, *eutra-nr-only* flag, and *requestedCapabilityCommon*) as defined in TS 36.331, where applicable.

NOTE 1: Capability enquiry without *frequencyBandListFilter* is not supported.

NOTE 2: In EN-DC, the gNB needs the capabilities for RAT types *nr* and *eutra-nr* and it uses the *featureSets* in the *UE-NR-Capability* together with the *featureSetCombinations* in the *UE-MRDC-Capability* to determine the NR UE capabilities for the supported MRDC band combinations. Similarly, the eNB needs the capabilities for RAT types *eutra* and *eutra-nr* and it uses the *featureSetsEUTRA* in the *UE-EUTRA-Capability* together with the *featureSetCombinations* in the *UE-MRDC-Capability* to determine the E-UTRA UE capabilities for the supported MRDC band combinations. Hence, the IDs used in the *featureSets* must match the IDs referred to in *featureSetCombinations* across all three containers. The requirement on consistency implies that there are no undefined feature sets and feature set combinations.

NOTE 3: If the UE cannot include all feature sets and feature set combinations due to message size or list size constraints, it is up to UE implementation which feature sets and feature set combinations it prioritizes.

The UE shall:

1> compile a list of "candidate band combinations" according to the filter criteria in *capabilityRequestFilterCommon* (if included), only consisting of bands included in *frequencyBandListFilter*, and prioritized in the order of *frequencyBandListFilter* (i.e. first include band combinations containing the first-listed band, then include remaining band combinations containing the second-listed band, and so on), where for each band in the band combination, the parameters of the band do not exceed *maxBandwidthRequestedDL*, *maxBandwidthRequestedUL*, *maxCarriersRequestedDL*, *maxCarriersRequestedUL*, *ca-BandwidthClassDL-EUTRA* or *ca-BandwidthClassUL-EUTRA*, whichever are received;

1> for each band combination included in the list of "candidate band combinations":

2> if the network (E-UTRA) included the *eutra-nr-only* field, or

2> if the requested *rat-Type* is *eutra*:

3> remove the NR-only band combination from the list of "candidate band combinations";

NOTE 4: The (E-UTRA) network may request capabilities for *nr* but indicate with the *eutra-nr-only* flag that the UE shall not include any NR band combinations in the *UE-NR-Capability*. In this case the procedural text above removes all NR-only band combinations from the candidate list and thereby also avoids inclusion of corresponding feature set combinations and feature sets below.

2> if it is regarded as a fallback band combination with the same capabilities of another band combination included in the list of "candidate band combinations", and

2> if this fallback band combination is generated by releasing at least one SCell or uplink configuration of SCell or SUL according to TS 38.306 [26]:

3> remove the band combination from the list of "candidate band combinations";

NOTE 5: Even if the network requests (only) capabilities for *nr*, it may include E-UTRA band numbers in the *frequencyBandListFilter* to ensure that the UE includes all necessary feature sets needed for subsequently requested *eutra-nr* capabilities. At this point of the procedure the list of "candidate band combinations" contains all NR- and/or E-UTRA-NR band combinations that match the filter (*frequencyBandListFilter*) provided by the NW and that match the *eutra-nr-only* flag (if RAT-Type *nr* is requested by E-UTRA). In the following, this candidate list is used to derive the band combinations, feature set combinations and feature sets to be reported in the requested capability container.

1> if the requested *rat-Type* is *nr*:

2> include into *supportedBandCombinationList* as many NR-only band combinations as possible from the list of "candidate band combinations", starting from the first entry;

3> if *srs-SwitchingTimeRequest* is received:

4> if SRS carrier switching is supported;

5> include *srs-SwitchingTimesListNR* for each band combination;

4> set *srs-SwitchingTimeRequested* to *true*;

2> include, into *featureSetCombinations*, the feature set combinations referenced from the supported band combinations as included in *supportedBandCombinationList* according to the previous;

2> compile a list of "candidate feature set combinations" referenced from the list of "candidate band combinations" excluding entries (rows in feature set combinations) with same or lower capabilities;

2> if *uplinkTxSwitchRequest* is received:

3> include into *supportedBandCombinationList-UplinkTxSwitch* as many NR-only band combinations that supported UL TX switching as possible from the list of "candidate band combinations", starting from the first entry;

4> if *srs-SwitchingTimeRequest* is received:

- 5> if SRS carrier switching is supported;
 - 6> include *srs-SwitchingTimesListNR* for each band combination;
 - 5> set *srs-SwitchingTimeRequested* to true;
 - 3> include, into *featureSetCombinations*, the feature set combinations referenced from the supported band combinations as included in *supportedBandCombinationList-UplinkTxSwitch* according to the previous;
- NOTE 6: This list of "candidate feature set combinations" contains the feature set combinations used for NR-only as well as E-UTRA-NR band combinations. It is used to derive a list of NR feature sets referred to from the feature set combinations in the *UE-NR-Capability* and from the feature set combinations in a *UE-MRDC-Capability* container.
- 2> include into *featureSets* the feature sets referenced from the "candidate feature set combinations" and may exclude the feature sets with the parameters that exceed any of *maxBandwidthRequestedDL*, *maxBandwidthRequestedUL*, *maxCarriersRequestedDL* or *maxCarriersRequestedUL*, whichever are received;
- 1> else, if the requested *rat-Type* is *eutra-nr*:
- 2> include into *supportedBandCombinationList* and/or *supportedBandCombinationListNEDC-Only* as many E-UTRA-NR band combinations as possible from the list of "candidate band combinations", starting from the first entry;
 - 3> if *srs-SwitchingTimeRequest* is received:
 - 4> if SRS carrier switching is supported;
 - 5> include *srs-SwitchingTimesListNR* and *srs-SwitchingTimesListEUTRA* for each band combination;
 - 4> set *srs-SwitchingTimeRequested* to true;
 - 2> include, into *featureSetCombinations*, the feature set combinations referenced from the supported band combinations as included in *supportedBandCombinationList* according to the previous;
 - 2> if *uplinkTxSwitchRequest* is received:
 - 3> include into *supportedBandCombinationList-UplinkTxSwitch* as many E-UTRA-NR band combinations that supported UL TX switching as possible from the list of "candidate band combinations", starting from the first entry;
 - 4> if *srs-SwitchingTimeRequest* is received:
 - 5> if SRS carrier switching is supported;
 - 6> include *srs-SwitchingTimesListNR* and *srs-SwitchingTimesListEUTRA* for each band combination;
 - 5> set *srs-SwitchingTimeRequested* to true;
 - 3> include, into *featureSetCombinations*, the feature set combinations referenced from the supported band combinations as included in *supportedBandCombinationList-UplinkTxSwitch* according to the previous;
- 1> else (if the requested *rat-Type* is *eutra*):
- 2> compile a list of "candidate feature set combinations" referenced from the list of "candidate band combinations" excluding entries (rows in feature set combinations) with same or lower capabilities;
- NOTE 7: This list of "candidate feature set combinations" contains the feature set combinations used for E-UTRA-NR band combinations. It is used to derive a list of E-UTRA feature sets referred to from the feature set combinations in a *UE-MRDC-Capability* container.
- 2> include into *featureSetsEUTRA* (in the *UE-EUTRA-Capability*) the feature sets referenced from the "candidate feature set combinations" and may exclude the feature sets with the parameters that exceed *ca-BandwidthClassDL-EUTRA* or *ca-BandwidthClassUL-EUTRA*, whichever are received;

1> include the received *frequencyBandListFilter* in the field *appliedFreqBandListFilter* of the requested UE capability, except if the requested *rat-Type* is *nr* and the network included the *eutra-nr-only* field;

1> if the network included *ue-CapabilityEnquiryExt*:

2> include the received *ue-CapabilityEnquiryExt* in the field *receivedFilters*;

[TS 38.331, clause 5.7.7.2]

A UE capable of UL RRC message segmentation in RRC_CONNECTED will initiate the procedure when the following conditions are met:

1> if the RRC message segmentation is enabled based on the field *rrc-SegAllowed* received, and

1> if the encoded RRC message is larger than the maximum supported size of a PDCP SDU specified in TS 38.323 [5];

Upon initiating the procedure, the UE shall:

1> initiate transmission of the *ULDedicatedMessageSegment* message as specified in 5.7.7.3;

[TS 38.331, clause 5.7.7.3]

The UE shall segment the encoded RRC PDU based on the maximum supported size of a PDCP SDU specified in TS 38.323 [5]. UE shall minimize the number of segments and set the contents of the *ULDedicatedMessageSegment* messages as follows:

1> For each new UL DCCH message, set the *segmentNumber* to 0 for the first message segment and increment the *segmentNumber* for each subsequent RRC message segment;

1> set *rrc-MessageSegmentContainer* to include the segment of the UL DCCH message corresponding to the *segmentNumber*;

1> if the segment included in the *rrc-MessageSegmentContainer* is the last segment of the UL DCCH message:

2> set the *rrc-MessageSegmentType* to *lastSegment*;

1> else:

2> set the *rrc-MessageSegmentType* to *notLastSegment*;

1> submit all the *ULDedicatedMessageSegment* messages generated for the segmented RRC message to lower layers for transmission in ascending order based on the *segmentNumber*, upon which the procedure ends.

8.2.1.1.2.3 Test description

8.2.1.1.2.3.1 Pre-test conditions

System Simulator:

- NR Cell 1 is the PCell and EUTRA Cell 1 is the PS Cell.

UE:

- None

Preamble:

- The UE is in state RRC_CONNECTED in NE-DC mode according to TS 38.508-1 [4] clause 4.5.4.2 with MCG(s) and SCG.

8.2.1.1.2.3.2 Test procedure sequence

Table 8.2.1.1.2.3.2-1: Main behaviour

St	Procedure	Message Sequence		TP	Verdict
		U - S	Message		
1	The SS transmits a <i>UECapabilityEnquiry</i> message including nr and eutra-nr with rrc-segAllowed-r16 set to enabled.	<--	NR RRC: <i>UECapabilityEnquiry</i>	-	-
-	EXCEPTION: The "lower case letter" identifies a step sequence that takes place depending on the size of UE capability message. IF pc_NR_UL_Segmentation and UE's encoded <i>UECapabilityInformation</i> message >= Max PDCP SDU size then steps 2a1 and 2a2 will be performed else step 2b1 will be performed	-	-	-	-
-	EXCEPTION: Step 2a1 is repeated a maximum of 16 times or till rrc-MessageSegmentType-r16 IE within the <i>ULDedicatedMessageSegment-r16</i> message indicate rrc-MessageSegmentType-r16 = lastSegment.	-	-	-	-
2a1	Check: Does the UE send segments of <i>UECapabilityInformation</i> message contained within the rrc-MessageSegmentContainer-r16 IE of the <i>ULDedicatedMessageSegment-r16</i> message?	-->	NR RRC: <i>ULDedicatedMessageSegment</i>	-	-
2a2	Check: Is the received UE radio access capability information as per the ue-CapabilityRequest variable?	-	-	1	P
2b1	Check: Does the UE transmit a <i>UECapabilityInformation</i> message including UE radio access capability information as per the ue-CapabilityRequest variable?	-->	NR RRC: <i>UECapabilityInformation</i>	1	P

8.2.1.1.2.3.3 Specific message contents

Table 8.2.1.1.2.3.3-1: *UECapabilityEnquiry* (step 1, Table 8.2.1.1.2.3.2-1)

Derivation Path: TS 38.508-1 [4], Table 4.6.1-31			
Information Element	Value/remark	Comment	Condition
<i>UECapabilityEnquiry</i> ::= SEQUENCE {			
rrc-TransactionIdentifier	RRC-TransactionIdentifier		
criticalExtensions CHOICE {			
ueCapabilityEnquiry SEQUENCE {			
ue-CapabilityRAT-RequestList SEQUENCE (SIZE (1.. maxRAT-CapabilityContainers)) OF UE-CapabilityRAT-Request {	2 entries		
UE-CapabilityRAT-Request[1] SEQUENCE {		entry 1	
rat-Type	nr		
}			
UE-CapabilityRAT-Request[2] SEQUENCE {			
rat-Type	eutra-nr	entry 2	
}			
lateNonCriticalExtension	Not present		
ue-CapabilityEnquiryExt	OCTET STRING Containing <i>UECapabilityEnquiry-v1560</i> -IEs		
}			
criticalExtensionsFuture			
}			
}			

Table 8.2.1.1.2.3.3-2: UECapabilityEnquiry-v1560-IEs (Table 8.2.1.1.2.3.3-1)

Information Element	Value/remark	Comment	Condition
UECapabilityEnquiry-v1560-IEs ::= SEQUENCE {			
capabilityRequestFilterCommon	Not present		
nonCriticalExtension SEQUENCE {			
rrc-SegAllowed-r16	enabled		
nonCriticalExtension	Not present		
}			
}			

Table 8.2.1.1.2.3.3-3: UECapabilityInformation (steps2a2 and 2b1, Table 8.2.1.1.2.3.2-1)

Derivation Path: TS 38.508-1 [4], Table 4.6.1-32			
Information Element	Value/remark	Comment	Condition
UECapabilityInformation ::= SEQUENCE {			
rrc-TransactionIdentifier	RRC-TransactionIdentifier		
criticalExtensions CHOICE {			
ueCapabilityInformation SEQUENCE {			
ue-CapabilityRAT-ContainerList SEQUENCE (SIZE (0..maxRAT-CapabilityContainers)) OF UE-CapabilityRAT-Container {	2 entries		
UE-CapabilityRAT-Container[1] SEQUENCE {		entry 1	
rat-Type	nr		pc_NR_FDD or pc_NR_TDD
ueCapabilityRAT-Container	UE-NR-Capability	Encoded as per TS 38.331 [12] clause 5.6.1	pc_NR_FDD or pc_NR_TDD
}			
UE-CapabilityRAT-Container[2] SEQUENCE {		entry 2	
rat-Type	eutra-nr		pc_NE_DC
ueCapabilityRAT-Container	UE-MRDC-Capability	Encoded as per TS 38.331 [12] clause 5.6.1	pc_NE_DC
}			
}			
}			
lateNonCriticalExtension	Not checked		
nonCriticalExtension	Not checked		
}			
criticalExtensionsFuture	Not checked		
}			
}			

Table 8.2.1.1.2.3.3-4: UE-NR-Capability (Table 8.2.1.1.2.3.3-3)

Derivation Path: TS 38.331 [12], clause 6.3.3			
Information Element	Value/remark	Comment	Condition
UE-NR-Capability ::= SEQUENCE {			
accessStratumRelease	Checked	"rel-15" or higher	
pdcp-Parameters SEQUENCE {			
supportedROHC-Profiles SEQUENCE {			
profile0x0000	Not checked		
profile0x0001	Not checked		
profile0x0002	Not checked		
profile0x0003	Not checked		
profile0x0004	Not checked		
profile0x0006	Not checked		
profile0x0101	Not checked		
profile0x0102	Not checked		
profile0x0103	Not checked		
profile0x0104	Not checked		
}			
}			

maxNumberROHC-ContextSessions	Not checked		
uplinkOnlyROHC-Profiles	Not checked		
continueROHC-Context	Not checked		
outOfOrderDelivery	Checked		pc_outOfOrderDelivery
shortSN	Checked		pc_shortSN
pdcp-DuplicationSRB	Checked		pc_pdcpc_DuplicationSplitSRB
pdcp-DuplicationMCG-OrSCG-DRB	Checked		pc_pdcpc_DuplicationMCG_OrSCG_DRB
drb-IAB-r16	Not checked		
non-DRB-IAB-r16	Not checked		
extendedDiscardTimer-r16	Not checked		
continueEHC-Context-r16	Not checked		
ehc-r16	Checked		pc_NR_ehc_r16
maxNumberEHC-Contexts-r16	Not checked		
jointEHC-ROHC-Config-r16	Not checked		
pdcp-DuplicationMoreThanTwoRLC-r16	Checked		pc_pdcpc_DuplicationMoreThanTwoRLC_r16
}			
rlc-Parameters SEQUENCE {			
am-WithShortSN	Checked		pc_am_WithShortSN
um-WithShortSN	Checked		pc_um_WithShortSN
um-WithLongSN	Checked		pc_um_WithLongSN
}			
mac-Parameters SEQUENCE {			
mac-ParametersCommon SEQUENCE {			
lcp-Restriction	Checked		pc_lcp_Restriction
dummy	Not checked		
lch-ToSCellRestriction	Not checked		
recommendedBitRate	Checked		pc_recommendedBitRate
recommendedBitRateQuery	Checked		pc_recommendedBitRateQuery
recommendedBitRateMultiplier-r16	Not checked		
preEmptiveBSR-r16	Not checked		
autonomousTransmission-r16	Not checked		
lch-PriorityBasedPrioritization-r16	Checked		pc_lch_PriorityBasedPrioritization_r16
lch-ToConfiguredGrantMapping-r16	Not checked		
lch-ToGrantPriorityRestriction-r16	Checked		pc_lch_ToGrantPriorityRestriction_r16
singlePHR-P-r16	Not checked		
ul-LBT-FailureDetectionRecovery-r16	Not checked		
tdd-MPE-P-MPR-Reporting-r16	Not checked		
lchid-ExtensionIAB-r16	Not checked		
spCell-BFR-CBRA-r16	Not checked		
srs-ResourceId-Ext-r16	Not checked		
}			
mac-ParametersXDD-Diff SEQUENCE {			
skipUplinkTxDynamic	Checked (NOTE 4)		pc_skipUplinkTxDynamic

logicalChannelSR-DelayTimer	Checked (NOTE 5)		pc_logicalChannelSR_DelayTimer
longDRX-Cycle	Checked (NOTE 6)		pc_longDRX_Cycle
shortDRX-Cycle	Checked (NOTE 7)		pc_shortDRX_Cycle
multipleSR-Configurations	Not checked		
multipleConfiguredGrants	Checked (NOTE 12)		pc_multipleConfiguredGrants_r16
}			
}			
phy-Parameters SEQUENCE {			
phy-ParametersCommon SEQUENCE {			
csi-RS-CFRA-ForHO	Checked		pc_csi_RS_CFRA_ForHO
dynamicPRB-BundlingDL	Not checked		
sp-CSI-ReportPUCCH	Not checked		
sp-CSI-ReportPUSCH	Not checked		
nzp-CSI-RS-IntefMgmt	Not checked		
type2-SP-CSI-Feedback-LongPUCCH	Not checked		
precoderGranularityCORESET	Not checked		
dynamicHARQ-ACK-Codebook	supported		
semiStaticHARQ-ACK-Codebook	Not checked		
spatialBundlingHARQ-ACK	Checked		pc_spatialBundlingHARQ_ACK
dynamicBetaOffsetInd-HARQ-ACK-CSI	Not checked		
pucch-Repetition-F1-3-4	Not checked		
ra-Type0-PUSCH	Checked		pc_ra_Type0_PUSCH
dynamicSwitchRA-Type0-1-PDSCH	Checked		pc_dynamicSwitchRA_Type0_1_PDSCH
dynamicSwitchRA-Type0-1-PUSCH	Checked		pc_dynamicSwitchRA_Type0_1_PUSCH
pdsch-MappingTypeA	supported		pc_pdsch_MappingTypeA
pdsch-MappingTypeB	Checked		pc_pdsch_MappingTypeB
interleavingVRB-ToPRB-PDSCH	Checked		pc_interleavingVRB_ToPRB_PDSCH
interSlotFreqHopping-PUSCH	Not checked		
type1-PUSCH-RepetitionMultiSlots	Not checked		
type2-PUSCH-RepetitionMultiSlots	Not checked		
pusch-RepetitionMultiSlots	Checked		pc_pusch_RepetitionMultiSlots
pdsch-RepetitionMultiSlots	Checked		pc_pdsch_RepetitionMultiSlots
downlinkSPS	Checked		pc_downlinkSPS
configuredUL-GrantType1	Checked		pc_configuredUL_GrantType1
configuredUL-GrantType2	Checked		pc_configuredUL_GrantType2

pre-EmptIndication-DL	Not checked		
cbg-TransIndication-DL	Not checked		
cbg-TransIndication-UL	Not checked		
cbg-FlushIndication-DL	Not checked		
dynamicHARQ-ACK-CodeB-CBG-Retx-DL	Not checked		
rateMatchingResrcSetSemi-Static	Not checked		
rateMatchingResrcSetDynamic	Not checked		
bwp-SwitchingDelay	Checked	38.306, 4.2.7.10: It is mandatory to report type 1 or type 2. This capability is not applicable to IAB-MT	pc_bwp_SwitchingDelay_Type1 or pc_bwp_SwitchingDelay_Type2
dummy	Not checked		
maxNumberSearchSpaces	n10		
rateMatchingCtrlResrsSetDynamic	Not checked		
maxLayersMIMO-Indication	Not checked		
spCellPlacement	Not checked		
twoStepRACH-r16	Not checked		
dci-Format1-2And0-2-r16	Checked		pc_dci_Format1_2And0_2_r16
monitoringDCI-SameSearchSpace-r16	Not checked		
type2-CG-ReleaseDCI-0-1-r16	Not checked		
type2-CG-ReleaseDCI-0-2-r16	Not checked		
sps-ReleaseDCI-1-1-r16	Not checked		
sps-ReleaseDCI-1-2-r16	Not checked		
csi-TriggerStateNon-ActiveBWP-r16	Not checked		
seperateSMTC-InterIAB-Support-r16	Not checked		
seperateRACH-IAB-Support-r16	Not checked		
ul-flexibleDL-SlotFormatSemiStatic-IAB-r16	Not checked		
ul-flexibleDL-SlotFormatDynamics-IAB-r16	Not checked		
dft-S-OFDM-WaveformUL-IAB-r16	Not checked		
dci-25-AI-RNTI-Support-IAB-r16	Not checked		
t-DeltaReceptionSupport-IAB-r16	Not checked		
guardSymbolReportReception-IAB-r16	Not checked		
harqACK-CB-SpatialBundlingPUCCH-Group-r16	Not checked		
crossSlotScheduling-r16	Not checked		
maxNumberSRS-PosPathLossEstimateAllServingCells-r16	Not checked		
extendedCG-Periodicities-r16	Not checked		
extendedSPS-Periodicities-r16	Not checked		
codebookVariantsList-r16	Not checked		
pusch-RepetitionTypeA-r16	Not checked		
dci-DL-PriorityIndicator-r16	Checked		pc_dci_DL_PriorityIndicator_r16
dci-UL-PriorityIndicator-r16	Checked		pc_dci_UL_PriorityIndicator_r16
maxNumberPathlossRS-Update-r16	Not checked		
type2-HARQ-ACK-Codebook-r16	Not checked		
maxTotalResourcesForAcrossFreqRanges-r16	Not checked		
harqACK-separateMultiDCI-MultiTRP-r16	Not checked		
harqACK-jointMultiDCI-MultiTRP-r16	Not checked		
bwp-SwitchingMultiCCs-r16	Not checked		
targetSMTC-SCG-r16	Not checked		
supportRepetitionZeroOffsetRV-r16	Not checked		
cbg-TransInOrderPUSCH-UL-r16	Not checked		
bwp-SwitchingMultiDormancyCCs-r16	Not checked		
supportRetx-Diff-CoresetPool-Multi-DCI-TRP-r16	Not checked		
pdccch-MonitoringAnyOccasionsWithSpanGapCrossCarrierSch-r16	Not checked		
newBeamIdentifications2PortCSI-RS-r16	Not checked		

pathlossEstimation2PortCSI-RS-r16	Not checked		
}			
phy-ParametersXDD-Diff SEQUENCE {			
dynamicSFI	Not checked		
twoPUCCH-F0-2-ConsecSymbols	Not checked		
twoDifferentTPC-Loop-PUSCH	Not checked		
twoDifferentTPC-Loop-PUCCH	Not checked		
dl-SchedulingOffset-PDSCH-TypeA	Not checked		
dl-SchedulingOffset-PDSCH-TypeB	Not checked		
ul-SchedulingOffset	Not checked		
}			
phy-ParametersFRX-Diff SEQUENCE {			
dynamicSFI	Not checked		
dummy1	Not checked		
twoFL-DMRS	Not checked		
dummy2	Not checked		
dummy3	Not checked		
supportedDMRS-TypeDL	Not checked		
supportedDMRS-TypeUL	Not checked		
semiOpenLoopCSI	Not checked		
csi-ReportWithoutPMI	Not checked		
csi-ReportWithoutCQI	Not checked		
onePortsPTRS	Not checked		
twoPUCCH-F0-2-ConsecSymbols	Not checked		
pucch-F2-WithFH	supported		
pucch-F3-WithFH	supported		
pucch-F4-WithFH	Not checked		
freqHoppingPUCCH-F0-2	Not checked		
freqHoppingPUCCH-F1-3-4	Not checked		
mux-SR-HARQ-ACK-CSI-PUCCH-MultiPerSlot	Not checked		
uci-CodeBlockSegmentation	Not checked		
onePUCCH-LongAndShortFormat	Not checked		
twoPUCCH-AnyOthersInSlot	Not checked		
intraSlotFreqHopping-PUSCH	Not checked		
pusch-LBRM	Not checked		
pdccch-BlindDetectionCA	Not checked		
tpc-PUSCH-RNTI	Not checked		
tpc-PUCCH-RNTI	Not checked		
tpc-SRS-RNTI	Not checked		
absoluteTPC-Command	Not checked		
twoDifferentTPC-Loop-PUSCH	Not checked		
twoDifferentTPC-Loop-PUCCH	Not checked		
pusch-HalfPi-BPSK	Not checked		
pucch-F3-4-HalfPi-BPSK	Not checked		
almostContiguousCP-OFDM-UL	Not checked		
sp-CSI-RS	Not checked		
sp-CSI-IM	Not checked		
tdd-MultiDL-UL-SwitchPerSlot	Not checked		
multipleCORESET	Not checked		
csi-RS-IM-ReceptionForFeedback	Not checked	CSI-RS-IM-ReceptionForFeedback	
csi-RS-ProcFrameworkForSRS	Not checked	CSI-RS-ProcFrameworkForSRS	
csi-ReportFramework	Not checked	CSI-ReportFramework	
mux-SR-HARQ-ACK-CSI-PUCCH-OncePerSlot SEQUENCE {			
sameSymbol	Not checked		
diffSymbol	Not checked		
}			
mux-SR-HARQ-ACK-PUCCH	Not checked		
mux-MultipleGroupCtrlCH-Overlap	Not checked		
dl-SchedulingOffset-PDSCH-TypeA	Not checked		
dl-SchedulingOffset-PDSCH-TypeB	Not checked		

ul-SchedulingOffset	Not checked		
dl-64QAM-MCS-TableAlt	Not checked		
ul-64QAM-MCS-TableAlt	Not checked		
cqi-TableAlt	Not checked		
oneFL-DMRS-TwoAdditionalDMRS-UL	Not checked		
twoFL-DMRS-TwoAdditionalDMRS-UL	Not checked		
oneFL-DMRS-ThreeAdditionalDMRS-UL	Not checked		
}			
phy-ParametersFR1 SEQUENCE {			
pdcchMonitoringSingleOccasion	Not checked		
scs-60kHz	Not checked		
pdsch-256QAM-FR1	Checked		pc_pdsch_2 56QAM_FR1
pdsch-RE-MappingFR1-PerSymbol	Not checked		
pdsch-RE-MappingFR1-PerSlot	Not checked		
}			
phy-ParametersFR2 SEQUENCE {			
dummy	Not checked		
pdsch-RE-MappingFR2-PerSymbol	Not checked		
pCell-FR2	Not checked		
pdsch-RE-MappingFR2-PerSlot	Not checked		
}			
}			
rf-Parameters SEQUENCE {			
supportedBandListNR SEQUENCE (SIZE (1..maxBands)) OF BandNR {			
BandNR[i] SEQUENCE {			
bandNR	Checked	Checked for 'maxBands' entries of FreqBandIndicator NR[i]	pc_nrBandx ('x' being the band number/type related PICS listed in TS 38.508-2)
modifiedMPR-Behaviour	Not checked		
mimo-ParametersPerBand	Not checked	MIMO- ParametersPerBa nd[i]	
extendedCP	Not checked		
multipleTCI	supported		
bwp-WithoutRestriction	Checked		pc_bwp_Wit houtRestricti on
bwp-SameNumerology	Not checked		
bwp-DiffNumerology	Not checked		
crossCarrierScheduling-SameSCS	Not checked		
pdsch-256QAM-FR2	Checked	Note 8	pc_pdsch_2 56QAM_FR2
pusch-256QAM	Checked	Note 9	pc_pusch_2 56QAM_FR1 OR pc_pusch_2 56QAM_FR2
ue-PowerClass	Not checked		
rateMatchingLTE-CRS	Not checked		
channelBWs-DL-v1530 CHOICE {			
fr1 SEQUENCE {			
scs-15kHz	Not checked		
scs-30kHz	Not checked		
scs-60kHz	Not checked		
}			
fr2 SEQUENCE {			
scs-60kHz	Not checked		
scs-120kHz	Not checked		
}			
}			
}			

}			
channelBWs-UL-v1530[i] CHOICE {			
fr1 SEQUENCE {			
scs-15kHz	Not checked		
scs-30kHz	Not checked		
scs-60kHz	Not checked		
}			
fr2 SEQUENCE {			
scs-60kHz	Not checked		
scs-120kHz	Not checked		
}			
maxUplinkDutyCycle-PC2-FR1	Not checked		
pucch-SpatialRelInfoMAC-CE	Not checked		
powerBoosting-pi2BPSK	Not checked		
maxUplinkDutyCycle-PC1dot5-MPE-FR1-r16	Checked		pc_nrBandx_maxUplinkDutyCycle_PC1dot5_MPE_FR1_r16 ('x' being the band number related PICS listed in Table A.4.3.1-4h of TS 38.508-2)
maxUplinkDutyCycle-FR2	Not checked		
channelBWs-DL-v1590	Not checked		
channelBWs-UL-v1590	Not checked		
asymmetricBandwidthCombinationSet	Not checked		
sharedSpectrumChAccessParamsPerBand-r16	Not checked		
cancelOverlappingPUSCH-r16	Not checked		
multipleRateMatchingEUTRA-CRS-r16	Not checked		
overlapRateMatchingEUTRA-CRS-r16	Not checked		
pdsch-MappingTypeB-Alt-r16	Not checked		
oneSlotPeriodicTRS-r16	Not checked		
olpc-SRS-Pos-r16	Not checked		
spatialRelationsSRS-Pos-r16	Not checked		
simulSRS-MIMO-TransWithinBand-r16	Not checked		
channelBW-DL-IAB-r16	Not checked		
channelBW-UL-IAB-r16	Not checked		
rasterShift7dot5-IAB-r16	Not checked		
ue-PowerClass-v1610	Not checked		
condHandover-r16	Checked		pc_condHandover_r16
condHandoverFailure-r16	Checked		pc_condHandoverFailure_r16
condHandoverTwoTriggerEvents-r16	Checked		pc_condHandoverTwoTriggerEvents_r16
condPSCellChange-r16	Checked		pc_condPSCellChange_r16
condPSCellChangeTwoTriggerEvents-r16	Not checked		
mpr-PowerBoost-FR2-r16	Not checked		
activeConfiguredGrant-r16	Not checked		
jointReleaseConfiguredGrantType2-r16	Not checked		
sps-r16	Not checked		
jointReleaseSPS-r16	Not checked		
simulSRS-TransWithinBand-r16	Not checked		
trs-AdditionalBandwidth-r16	Not checked		
handoverIntraF-IAB-r16	Not checked		
simulTX-SRS-AntSwitchingIntraBandUL-CA-r16	Not checked		

sharedSpectrumChAccessParamsPerBand-v1630	Not checked		
handoverUTRA-FDD-r16	Not checked		
enhancedUL-TransientPeriod-r16	Not checked		
sharedSpectrumChAccessParamsPerBand-v1640	Not checked		
type1-PUSCH-RepetitionMultiSlots-v1650	Not checked		
type2-PUSCH-RepetitionMultiSlots-v1650	Not checked		
pusch-RepetitionMultiSlots-v1650	Not checked		
configuredUL-GrantType1-v1650	Not checked		
configuredUL-GrantType2-v1650	Not checked		
sharedSpectrumChAccessParamsPerBand-v1650	Not checked		
enhancedSkipUplinkTxConfigured-v1660	Not checked		
enhancedSkipUplinkTxDynamic-v1660	Not checked		
}			
}			
supportedBandCombinationList SEQUENCE (SIZE (1..maxBandComb)) OF BandCombination {			
BandCombinationSEQUENCE {			
bandList SEQUENCE (SIZE (1..maxSimultaneousBands)) OF BandParameters {			
BandParameters CHOICE			
eutra SEQUENCE {			
bandEUTRA	Not checked	FreqBandIndicator EUTRA	
ca-BandwidthClassDL-EUTRA	Not checked	CA-BandwidthClassEUTRA	
ca-BandwidthClassUL-EUTRA	Not checked	CA-BandwidthClassEUTRA	
}			
nr SEQUENCE {			
bandNR	Not checked	FreqBandIndicatorNR	
ca-BandwidthClassDL-NR	Not checked	CA-BandwidthClassNR	
ca-BandwidthClassUL-NR	Not checked	CA-BandwidthClassNR	
}			
}			
}			
featureSetCombination	Not checked	FeatureSetCombinationId	
ca-ParametersEUTRA	Not checked	CA-ParametersEUTRA	
ca-ParametersNR	Not checked	CA-ParametersNR	
mrdc-Parameters	Not checked	MRDC-Parameters	
supportedBandwidthCombinationSet	Not checked		
powerClass-v1530	Not checked		
}			
appliedFreqBandListFilter	Not checked	FreqBandList	
supportedBandCombinationList-v1540 SEQUENCE (SIZE (1..maxBandComb)) OF BandCombination-v1540 {		BandCombinationList-v1540	
BandCombination-v1540 SEQUENCE {			
bandList-v1540 SEQUENCE (SIZE (1..maxSimultaneousBands)) OF BandParameters-v1540 {	Not checked	BandParameters-v1540	
BandParameters-v1540 SEQUENCE {			
srs-CarrierSwitch CHOICE {			
nr SEQUENCE [NR bands	

srs-SwitchingTimesListNR SEQUENCE (SIZE (1..maxSimultaneousBands)) OF SRS-SwitchingTimeNR	Not checked		
}			
etra SEQUENCE {		EUTRA bands	
srs-SwitchingTimesListEUTRA SEQUENCE (SIZE (1..maxSimultaneousBands)) OF SRS-SwitchingTimeEUTRA	Not checked		
}			
srs-TxSwitch-v1540 SEQUENCE {			
supportedSRS-TxPortSwitch	Not checked		
txSwitchImpactToRx	Not checked		
txSwitchWithAnotherBand	Not checked		
}			
}			
ca-ParametersNR-v1540[i]	Not checked	CA-ParametersNR-v1540	
}			
srs-SwitchingTimeRequested	Not checked		
supportedBandCombinationList-v1550	Not checked	BandCombinationList-v1550	
supportedBandCombinationList-v1560	Not checked	BandCombinationList-v1560	
supportedBandCombinationList-v1610 SEQUENCE (SIZE (1..maxBandComb)) OF BandCombination-v1610 {		BandCombinationList-v1610	
BandCombination-v1610 SEQUENCE {			
bandList-v1610 SEQUENCE (SIZE (1..maxSimultaneousBands)) OF BandParameters-v1610 {			
ca-ParametersNR-v1610	Checked	CA-ParametersNR-v1610 (Table 8.2.1.1.2.3.3-9)	
ca-ParametersNRDC-v1610	Not checked	CA-ParametersNRDC-v1610	
powerClass-v1610	Not checked		
powerClassNRPart-r16	Not checked		
featureSetCombinationDAPS-r16	Not checked	FeatureSetCombinationId	
mrdc-Parameters-v1620	Not checked	MRDC-Parameters-v1620	
}			
}			
supportedBandCombinationListSidelinkEUTRA-NR-r16	Not checked	BandCombinationListSidelinkEUTRA-NR-r16	
supportedBandCombinationList-UplinkTxSwitch-r16	Not checked	BandCombinationList-UplinkTxSwitch-r16	
supportedBandCombinationList-v1630	Not checked	BandCombinationList-v1630	
supportedBandCombinationListSidelinkEUTRA-NR-v1630	Not checked	BandCombinationListSidelinkEUTRA-NR-v1630	
supportedBandCombinationList-UplinkTxSwitch-v1630	Not checked	BandCombinationList-UplinkTxSwitch-v1630	

supportedBandCombinationList-v1640	Not checked	BandCombination List-v1640	
supportedBandCombinationList-UplinkTxSwitch-v1640	Not checked	BandCombination List-UplinkTxSwitch-v1640	
supportedBandCombinationList-v1650	Not checked	BandCombination List-v1650	
supportedBandCombinationList-UplinkTxSwitch-v1650	Not checked	BandCombination List-UplinkTxSwitch-v1650	
extendedBand-n77-r16	Not checked		
}			
measAndMobParameters SEQUENCE {			
measAndMobParametersCommon SEQUENCE {			
supportedGapPattern	Not checked		
ssb-RLM	supported		
ssb-AndCSI-RS-RLM	Not checked		
eventB-MeasAndReport	Checked		pc_eventB_MeasAndReport
handoverFDD-TDD	Not checked		
eutra-CGI-Reporting	Checked		pc_eutra_CGI_Reporting
nr-CGI-Reporting	Checked		pc_nr_CGI_Reporting
independentGapConfig	Checked		pc_independentGapConfig
periodicEUTRA-MeasAndReport	Checked		pc_periodicEUTRA_MeasAndReport
handoverFR1-FR2	Not checked		
maxNumberCSI-RS-RRM-RS-SINR	Not checked		
nr-CGI-Reporting-ENDC	Not checked		
eutra-CGI-Reporting-NEDC	Not checked		
eutra-CGI-Reporting-NRDC	Not checked		
nr-CGI-Reporting-NEDC	Not checked		
nr-CGI-Reporting-NRDC	Not checked		
reportAddNeighMeasForPeriodic-r16	Not checked		
condHandoverParametersCommon-r16	Not checked		
nr-NeedForGap-Reporting-r16	Not checked		
supportedGapPattern-NRonly-r16	Not checked		
supportedGapPattern-NRonly-NEDC-r16	Not checked		
maxNumberCLI-RSSI-r16	Not checked		
maxNumberCLI-SRS-RSRP-r16	Not checked		
maxNumberPerSlotCLI-SRS-RSRP-r16	Not checked		
mfb-IAB-r16	Not checked		
dummy	Not checked		
nr-CGI-Reporting-NPN-r16	Checked		pc_nr_CGI_Reporting_NPN_r16
idleInactiveEUTRA-MeasReport-r16	Not checked		
idleInactive-ValidityArea-r16	Not checked		
eutra-AutonomousGaps-r16	Not checked		
eutra-AutonomousGaps-NEDC-r16	Not checked		
eutra-AutonomousGaps-NRDC-r16	Not checked		
pCellT312-r16	Not checked		
supportedGapPattern-r16	Not checked		
}			
measAndMobParametersXDD-Diff SEQUENCE {			
intraAndInterF-MeasAndReport	Checked (NOTE 1)		pc_intraAndInterF-

			MeasAndReport
eventA-MeasAndReport	Checked (NOTE 2)		pc_eventA_MeasAndReport
handoverInterF	Checked (NOTE 15)		pc_handoverInterF
handoverLTE-EPC	Not checked		
handoverLTE-5GC	Not checked		
sftd-MeasNR-Neigh	Checked (NOTE 13)		pc_SFTD_MeasNR_Neigh_FDD and/or pc_SFTD_MeasNR_Neigh_TDD
sftd-MeasNR-Neigh-DRX	Not checked		
dummy	Not checked		
}			
measAndMobParametersFRX-Diff SEQUENCE {			
ss-SINR-Meas	Checked (NOTE 10)		pc_ss_SINR_Meas
csi-RSRP-AndRSRQ-MeasWithSSB	Checked (NOTE 3)		pc_csi-RSRP-AndRSRQ-MeasWithSSB
csi-RSRP-AndRSRQ-MeasWithoutSSB	Checked (NOTE 11)		pc_csi_RSRP_AndRSRQ_MeasWithoutSSB
csi-SINR-Meas	Not checked		
csi-RS-RLM	Not checked		
handoverInterF	Checked (NOTE 14)		pc_handoverInterF
handoverLTE-EPC	Not checked		
handoverLTE-5GC	Not checked		
maxNumberResource-CSI-RS-RLM	Not checked		
simultaneousRxDataSSB-DiffNumerology	Not checked		
nr-AutonomousGaps-r16	Not checked		
nr-AutonomousGaps-ENDC-r16	Not checked		
nr-AutonomousGaps-NEDC-r16	Not checked		
nr-AutonomousGaps-NRDC-r16	Not checked		
dummy	Not checked		
cli-RSSI-Meas-r16	Not checked		
cli-SRS-RSRP-Meas-r16	Not checked		
interFrequencyMeas-NoGap-r16	Not checked		
simultaneousRxDataSSB-DiffNumerology-Inter-r16	Not checked		
idleInactiveNR-MeasReport-r16	Not checked		
idleInactiveNR-MeasBeamReport-r16	Not checked		
increasedNumberOfCSIRSPerMO-r16	Not checked		
}			
}			
fdd-Add-UE-NR-Capabilities SEQUENCE {			
phy-ParametersXDD-Diff SEQUENCE {			
dynamicSFI	Not checked		
twoPUCCH-F0-2-ConsecSymbols	Not checked		
twoDifferentTPC-Loop-PUSCH	Not checked		
twoDifferentTPC-Loop-PUCCH	Not checked		
dl-SchedulingOffset-PDSCH-TypeA	Not checked		
dl-SchedulingOffset-PDSCH-TypeB	Not checked		
ul-SchedulingOffset	Not checked		
}			

mac-ParametersXDD-Diff SEQUENCE {			
skipUplinkTxDynamic	Checked (NOTE 4)		pc_skipUplinkTxDynamic
logicalChannelSR-DelayTimer	Checked (NOTE 5)		pc_logicalChannelSR-DelayTimer
longDRX-Cycle	Checked (NOTE 6)		pc_longDRX_Cycle
shortDRX-Cycle	Checked (NOTE 7)		pc_shortDRX_Cycle
multipleSR-Configurations	Not checked		
multipleConfiguredGrants	Checked (NOTE 12)		pc_multipleConfiguredGrants_r16
}			
measAndMobParametersXDD-Diff SEQUENCE {			
intraAndInterF-MeasAndReport	Checked (NOTE 1)		pc_intraAndInterF-MeasAndReport
eventA-MeasAndReport	Checked (NOTE 2)		pc_eventA-MeasAndReport
handoverInterF	Checked (NOTE 15)		pc_handoverInterF
handoverLTE-EPC	Not checked		
handoverLTE-5GC	Not checked		
sftd-MeasNR-Neigh	Checked (NOTE 13)		pc_SFTD_MeasNR_Neigh_FDD and/or pc_SFTD_MeasNR_Neigh_TDD
sftd-MeasNR-Neigh-DRX	Not checked		
dummy	Not checked		
}			
}			
tdt-Add-UE-NR-Capabilities SEQUENCE {			
phy-ParametersXDD-Diff SEQUENCE {			
dynamicSFI	Not checked		
twoPUCCH-F0-2-ConsecSymbols	Not checked		
twoDifferentTPC-Loop-PUSCH	Not checked		
twoDifferentTPC-Loop-PUCCH	Not checked		
dl-SchedulingOffset-PDSCH-TypeA	Not checked		
dl-SchedulingOffset-PDSCH-TypeB	Not checked		
ul-SchedulingOffset	Not checked		
}			
mac-ParametersXDD-Diff SEQUENCE {			
skipUplinkTxDynamic	Checked (NOTE 4)		pc_skipUplinkTxDynamic
logicalChannelSR-DelayTimer	Checked (NOTE 5)		pc_logicalChannelSR-DelayTimer
longDRX-Cycle	Checked (NOTE 6)		pc_longDRX_Cycle
shortDRX-Cycle	Checked (NOTE 7)		pc_shortDRX_Cycle
multipleSR-Configurations	Not checked		
multipleConfiguredGrants	Checked (NOTE 12)		pc_multipleConfiguredGrants_r16
}			
measAndMobParametersXDD-Diff SEQUENCE {			
intraAndInterF-MeasAndReport	Checked (NOTE 1)		pc_intraAndInterF-

			MeasAndReport
eventA-MeasAndReport	Checked (NOTE 2)		pc_eventA_MeasAndReport
handoverInterF	Checked (NOTE 15)		pc_handoverInterF
handoverLTE-EPC	Not checked		
handoverLTE-5GC	Not checked		
sftd-MeasNR-Neigh	Checked (NOTE 13)		pc_SFTD_MeasNR_Neigh_FDD and/or pc_SFTD_MeasNR_Neigh_TDD
sftd-MeasNR-Neigh-DRX	Not checked		
dummy	Not checked		
}			
fr1-Add-UE-NR-Capabilities SEQUENCE {			
phy-ParametersFRX-Diff SEQUENCE {			
dynamicSFI	Not checked		
dummy1	Not checked		
twoFL-DMRS	Not checked		
dummy2	Not checked		
dummy3	Not checked		
supportedDMRS-TypeDL	Not checked		
supportedDMRS-TypeUL	Not checked		
semiOpenLoopCSI	Not checked		
csi-ReportWithoutPMI	Not checked		
csi-ReportWithoutCQI	Not checked		
onePortsPTRS	Not checked		
twoPUCCH-F0-2-ConsecSymbols	Not checked		
pucch-F2-WithFH	Not checked		
pucch-F3-WithFH	Not checked		
pucch-F4-WithFH	Not checked		
freqHoppingPUCCH-F0-2	Not checked		
freqHoppingPUCCH-F1-3-4	Not checked		
mux-SR-HARQ-ACK-CSI-PUCCH-MultiPerSlot	Not checked		
uci-CodeBlockSegmentation	Not checked		
onePUCCH-LongAndShortFormat	Not checked		
twoPUCCH-AnyOthersInSlot	Not checked		
intraSlotFreqHopping-PUSCH	Not checked		
pusch-LBRM	Not checked		
pdcch-BlindDetectionCA	Not checked		
tpc-PUSCH-RNTI	Not checked		
tpc-PUCCH-RNTI	Not checked		
tpc-SRS-RNTI	Not checked		
absoluteTPC-Command	Not checked		
twoDifferentTPC-Loop-PUSCH	Not checked		
twoDifferentTPC-Loop-PUCCH	Not checked		
pusch-HalfPi-BPSK	Not checked		
pucch-F3-4-HalfPi-BPSK	Not checked		
almostContiguousCP-OFDM-UL	Not checked		
sp-CSI-RS	Not checked		
sp-CSI-IM	Not checked		
tdd-MultiDL-UL-SwitchPerSlot	Not checked		
multipleCORESET	Not checked		
csi-RS-IM-ReceptionForFeedback	Not checked		
csi-RS-ProcFrameworkForSRS	Not checked		
csi-ReportFramework	Not checked		
mux-SR-HARQ-ACK-CSI-PUCCH-OncePerSlot			
SEQUENCE {			
sameSymbol	Not checked		
diffSymbol	Not checked		

}			
mux-SR-HARQ-ACK-PUCCH	Not checked		
mux-MultipleGroupCtrlCH-Overlap	Not checked		
dl-SchedulingOffset-PDSCH-TypeA	Not checked		
dl-SchedulingOffset-PDSCH-TypeB	Not checked		
ul-SchedulingOffset	Not checked		
dl-64QAM-MCS-TableAlt	Not checked		
ul-64QAM-MCS-TableAlt	Not checked		
cqi-TableAlt	Not checked		
oneFL-DMRS-TwoAdditionalDMRS-UL	Not checked		
twoFL-DMRS-TwoAdditionalDMRS-UL	Not checked		
oneFL-DMRS-ThreeAdditionalDMRS-UL	Not checked		
}			
measAndMobParametersFRX-Diff SEQUENCE {			
ss-SINR-Meas	Checked (NOTE 10)		pc_ss_SINR_Meas
csi-RSRP-AndRSRQ-MeasWithSSB	Checked (NOTE 3)		pc_csi-RSRP-AndRSRQ-MeasWithSSB
csi-RSRP-AndRSRQ-MeasWithoutSSB	Checked (NOTE 11)		pc_csi_RSRP_AndRSRQ_MeasWithoutSSB
csi-SINR-Meas	Not checked		
csi-RS-RLM	Not checked		
handoverInterF	Checked (NOTE 14)		pc_handoverInterF
handoverLTE-EPC	Not checked		
handoverLTE-5GC	Not checked		
maxNumberResource-CSI-RS-RLM	Not checked		
simultaneousRxDataSSB-DiffNumerology	Not checked		
nr-AutonomousGaps-r16	Not checked		
nr-AutonomousGaps-ENDC-r16	Not checked		
nr-AutonomousGaps-NEDC-r16	Not checked		
nr-AutonomousGaps-NRDC-r16	Not checked		
dummy	Not checked		
cli-RSSI-Meas-r16	Not checked		
cli-SRS-RSRP-Meas-r16	Not checked		
interFrequencyMeas-NoGap-r16	Not checked		
simultaneousRxDataSSB-DiffNumerology-Inter-r16	Not checked		
idleInactiveNR-MeasReport-r16	Not checked		
idleInactiveNR-MeasBeamReport-r16	Not checked		
increasedNumberOfCSIRSPerMO-r16	Not checked		
}			
}			
fr2-Add-UE-NR-Capabilities SEQUENCE {			
phy-ParametersFRX-Diff SEQUENCE {	Not checked		
dynamicSFI	Not checked		
dummy1	Not checked		
twoFL-DMRS	Not checked		
dummy2	Not checked		
dummy3	Not checked		
supportedDMRS-TypeDL	Not checked		
supportedDMRS-TypeUL	Not checked		
semiOpenLoopCSI	Not checked		
csi-ReportWithoutPMI	Not checked		
csi-ReportWithoutCQI	Not checked		
onePortsPTRS	Not checked		
twoPUCCH-F0-2-ConsecSymbols	Not checked		
pucch-F2-WithFH	Not checked		
pucch-F3-WithFH	Not checked		
pucch-F4-WithFH	Not checked		

freqHoppingPUCCH-F0-2	Not checked		
freqHoppingPUCCH-F1-3-4	Not checked		
mux-SR-HARQ-ACK-CSI-PUCCH-MultiPerSlot	Not checked		
uci-CodeBlockSegmentation	Not checked		
onePUCCH-LongAndShortFormat	Not checked		
twoPUCCH-AnyOthersInSlot	Not checked		
intraSlotFreqHopping-PUSCH	Not checked		
pusch-LBRM	Not checked		
pdccch-BlindDetectionCA	Not checked		
tpc-PUSCH-RNTI	Not checked		
tpc-PUCCH-RNTI	Not checked		
tpc-SRS-RNTI	Not checked		
absoluteTPC-Command	Not checked		
twoDifferentTPC-Loop-PUSCH	Not checked		
twoDifferentTPC-Loop-PUCCH	Not checked		
pusch-HalfPi-BPSK	Not checked		
pucch-F3-4-HalfPi-BPSK	Not checked		
almostContiguousCP-OFDM-UL	Not checked		
sp-CSI-RS	Not checked		
sp-CSI-IM	Not checked		
tdd-MultiDL-UL-SwitchPerSlot	Not checked		
multipleCORESET	Not checked		
csi-RS-IM-ReceptionForFeedback	Not checked		
csi-RS-ProcFrameworkForSRS	Not checked		
csi-ReportFramework	Not checked		
mux-SR-HARQ-ACK-CSI-PUCCH-OncePerSlot			
SEQUENCE {			
sameSymbol	Not checked		
diffSymbol	Not checked		
}			
mux-SR-HARQ-ACK-PUCCH	Not checked		
mux-MultipleGroupCtrlCH-Overlap	Not checked		
dl-SchedulingOffset-PDSCH-TypeA	Not checked		
dl-SchedulingOffset-PDSCH-TypeB	Not checked		
ul-SchedulingOffset	Not checked		
dl-64QAM-MCS-TableAlt	Not checked		
ul-64QAM-MCS-TableAlt	Not checked		
cqi-TableAlt	Not checked		
oneFL-DMRS-TwoAdditionalDMRS-UL	Not checked		
twoFL-DMRS-TwoAdditionalDMRS-UL	Not checked		
oneFL-DMRS-ThreeAdditionalDMRS-UL	Not checked		
}			
measAndMobParametersFRX-Diff SEQUENCE {			
ss-SINR-Meas	Checked (NOTE 10)		pc_ss_SINR_Meas
csi-RSRP-AndRSRQ-MeasWithSSB	Checked (NOTE 3)		pc_csi-RSRP-AndRSRQ-MeasWithSSB
csi-RSRP-AndRSRQ-MeasWithoutSSB	Checked (NOTE 11)		pc_csi_RSRP_AndRSRQ_MeasWithoutSSB
csi-SINR-Meas	Not checked		
csi-RS-RLM	Not checked		
handoverInterF	Checked (NOTE 14)		Checked (NOTE 14)
handoverLTE-EPC	Not checked		
handoverLTE-5GC	Not checked		
maxNumberResource-CSI-RS-RLM	Not checked		
simultaneousRxDataSSB-DiffNumerology	Not checked		
nr-AutonomousGaps-r16	Not checked		
nr-AutonomousGaps-ENDC-r16	Not checked		
nr-AutonomousGaps-NEDC-r16	Not checked		
nr-AutonomousGaps-NRDC-r16	Not checked		

dummy	Not checked		
cli-RSSI-Meas-r16	Not checked		
cli-SRS-RSRP-Meas-r16	Not checked		
interFrequencyMeas-NoGap-r16	Not checked		
simultaneousRxDataSSB-DiffNumerology-Inter-r16	Not checked		
idleInactiveNR-MeasReport-r16	Not checked		
idleInactiveNR-MeasBeamReport-r16	Not checked		
increasedNumberOfCSIRSPerMO-r16	Not checked		
}			
}			
featureSets SEQUENCE {			
featureSetsDownlink SEQUENCE (SIZE (1..maxDownlinkFeatureSets)) OF FeatureSetDownlink {			
FeatureSetDownlink SEQUENCE {	Not checked		
featureSetListPerDownlinkCC	Not checked		
intraBandFreqSeparationDL	Not checked		
scalingFactor	Not checked		
crossCarrierScheduling-OtherSCS	Not checked		
scellWithoutSSB	Not checked		
csi-RS-MeasSCellWithoutSSB	Not checked		
dummy1	Not checked		
type1-3-CSS	Not checked		
pdcch-MonitoringAnyOccasions	Not checked		
dummy2	Not checked		
ue-SpecificUL-DL-Assignment	Not checked		
searchSpaceSharingCA-DL	Not checked		
timeDurationForQCL SEQUENCE {			
scs-60kHz	Not checked		
scs-120kHz	Not checked		
}			
pdsch-ProcessingType1-DifferentTB-PerSlot SEQUENCE {			
scs-15kHz	Not checked		
scs-30kHz	Not checked		
scs-60kHz	Not checked		
scs-120kHz	Not checked		
}			
dummy3	Not checked		
dummy4	Not checked		
dummy5	Not checked		
dummy6	Not checked		
dummy7	Not checked		
}			
}			
featureSetsDownlinkPerCC SEQUENCE (SIZE (1..maxPerCC-FeatureSets)) OF FeatureSetDownlinkPerCC {			
FeatureSetDownlinkPerCC SEQUENCE {			
supportedSubcarrierSpacingDL	Not checked	SubcarrierSpacing	
supportedBandwidthDL	Not checked	SupportedBandwidth	
channelBW-90mhz	Not checked		
maxNumberMIMO-LayersPDSCH	Not checked	MIMO-LayersDL	
supportedModulationOrderDL	Not checked	ModulationOrder	
}			
}			
featureSetsUplink SEQUENCE (SIZE (1..maxUplinkFeatureSets)) OF FeatureSetUplink {			
FeatureSetUplink SEQUENCE {			
featureSetListPerUplinkCC	Not checked		
scalingFactor	Not checked		
crossCarrierScheduling-OtherSCS	Not checked		
intraBandFreqSeparationUL	Not checked		
searchSpaceSharingCA-UL	Not checked		

dummy1	Not checked		
supportedSRS-Resources	Not checked	SRS-Resources	
twoPUCCH-Group	Not checked		
dynamicSwitchSUL	Checked		pc_dynamic Switch_SUL
simultaneousTxSUL-NonSUL	Not checked		
pusch-ProcessingType1-DifferentTB-PerSlot SEQUENCE {			
scs-15kHz	Not checked		
scs-30kHz	Not checked		
scs-60kHz	Not checked		
scs-120kHz	Not checked		
}			
dummy2	Not checked		
}			
}			
featureSetsUplinkPerCC SEQUENCE (SIZE (1..maxPerCC-FeatureSets)) OF FeatureSetUplinkPerCC {			
FeatureSetUplinkPerCCSEQUENCE {			
supportedSubcarrierSpacingUL	Not checked	SubcarrierSpacing	
supportedBandwidthUL	Not checked	SupportedBandwidth	
channelBW-90mHz	Not checked		
mimo-CB-PUSCH SEQUENCE {			
maxNumberMIMO-LayersCB-PUSCH	Not checked		
maxNumberSRS-ResourcePerSet	Not checked		
}			
maxNumberMIMO-LayersNonCB-PUSCH	Not checked		
supportedModulationOrderUL	Not checked	ModulationOrder	
}			
}			
featureSetsDownlink-v1540 SEQUENCE (SIZE (1..maxDownlinkFeatureSets)) OF FeatureSetDownlink-v1540 {			
FeatureSetDownlink-v1540 SEQUENCE {			
oneFL-DMRS-TwoAdditionalDMRS-DL	Not checked		
additionalDMRS-DL-Alt	Not checked		
twoFL-DMRS-TwoAdditionalDMRS-DL	Not checked		
oneFL-DMRS-ThreeAdditionalDMRS-DL	Not checked		
pdccch-MonitoringAnyOccasionsWithSpanGap SEQUENCE {			
scs-15kHz	Not checked		
scs-30kHz	Not checked		
scs-60kHz	Not checked		
scs-120kHz	Not checked		
}			
pdsch-SeparationWithGap	Not checked		
pdsch-ProcessingType2 SEQUENCE {			
scs-15kHz	Not checked		
scs-30kHz	Not checked		
scs-60kHz	Not checked		
}			
pdsch-ProcessingType2-Limited SEQUENCE {			
differentTB-PerSlot-SCS-30kHz	Not checked		
}			
dl-MCS-TableAlt-DynamicIndication	Not checked		
}			
}			
featureSetsUplink-v1540 SEQUENCE (SIZE (1..maxUplinkFeatureSets)) OF FeatureSetUplink- v1540 {			
FeatureSetUplink-v1540 SEQUENCE {			
zeroSlotOffsetAperiodicSRS	Not checked		
pa-PhaseDiscontinuityImpacts	Not checked		
pusch-SeparationWithGap	Not checked		

pusch-ProcessingType2 SEQUENCE {			
scs-15kHz	Not checked		
scs-30kHz	Not checked		
scs-60kHz	Not checked		
}			
ul-MCS-TableAlt-DynamicIndication	Not checked		
}			
}			
featureSetsUplinkPerCC-v1540 SEQUENCE (SIZE (1..maxPerCC-FeatureSets)) OF FeatureSetUplinkPerCC-v1540 {			
FeatureSetUplinkPerCC-v1540 SEQUENCE {			
mimo-NonCB-PUSCH SEQUENCE {			
maxNumberSRS-ResourcePerSet	Not checked		
maxNumberSimultaneousSRS-ResourceTx	Not checked		
}			
}			
}			
featureSetsDownlink-v15a0 SEQUENCE (SIZE (1..maxDownlinkFeatureSets)) OF FeatureSetDownlink-v15a0	Not checked	FeatureSetDownlink-v15a0	
featureSetsDownlink-v1610 SEQUENCE (SIZE (1..maxDownlinkFeatureSets)) OF FeatureSetDownlink-v1610	Checked	FeatureSetDownlink-v1610 (Table 8.2.1.1.2.3.3-7)	
featureSetsUplink-v1610 SEQUENCE (SIZE (1..maxUplinkFeatureSets)) OF FeatureSetUplink-v1610	Checked	FeatureSetUplink-v1610 (Table 8.2.1.1.2.3.3-8)	
featureSetDownlinkPerCC-v1620 SEQUENCE (SIZE (1..maxPerCC-FeatureSets)) OF FeatureSetDownlinkPerCC-v1620	Not checked	FeatureSetDownlinkPerCC-v1620	
featureSetsUplink-v1630 SEQUENCE (SIZE (1..maxUplinkFeatureSets)) OF FeatureSetUplink-v1630	Not checked	FeatureSetUplink-v1630	
featureSetsUplink-v1640 SEQUENCE (SIZE (1..maxUplinkFeatureSets)) OF FeatureSetUplink-v1640	Not checked	FeatureSetUplink-v1640	
featureSetCombinations SEQUENCE (SIZE (1..maxFeatureSetCombinations)) OF FeatureSetCombination {			
FeatureSetCombination SEQUENCE (SIZE (1..maxSimultaneousBands)) OF FeatureSetsPerBand {			
FeatureSetsPerBand SEQUENCE (SIZE (1..maxFeatureSetsPerBand)) OF FeatureSet {			
FeatureSetCHOICE {			
eutra SEQUENCE {			
downlinkSetEUTRA	Not checked	FeatureSetEUTRA-DownlinkId	
uplinkSetEUTRA	Not checked	FeatureSetEUTRA-UplinkId	
}			
nr SEQUENCE {			
downlinkSetNR	Not checked	FeatureSetDownlinkId	
uplinkSetNR	Not checked	FeatureSetUplinkId	
}			
}			
}			
}			
lateNonCriticalExtension	Not checked		
nonCriticalExtension SEQUENCE {			
fdd-Add-UE-NR-Capabilities-v1530 SEQUENCE {			
eutra-ParametersXDD-Diff SEQUENCE {			
rsrqMeasWidebandEUTRA	Not checked		
}			

}			
tdd-Add-UE-NR-Capabilities-v1530 SEQUENCE {			
eutra-ParametersXDD-Diff SEQUENCE {			
rsrqMeasWidebandEUTRA	Not checked		
}			
}			
dummy	Not checked		
interRAT-Parameters SEQUENCE {			
eutra SEQUENCE {			
supportedBandListEUTRA SEQUENCE (SIZE (1..maxBandsEUTRA)) OF FreqBandIndicatorEUTRA	Not checked		
eutra-ParametersCommon SEQUENCE {			
mfbi-EUTRA	Not checked		
modifiedMRP-BehaviorEUTRA	Not checked		
multiNS-Pmax-EUTRA	Not checked		
rs-SINR-MeasEUTRA	Checked		pc_RS_SINR_MeasEUTRA
ne-DC	Not checked		
nr-HO-ToEN-DC-r16	Checked		pc_interRAT_NR_ToENDC
}			
eutra-ParametersXDD-Diff SEQUENCE {			
rsrqMeasWidebandEUTRA	Not checked		
}			
}			
inactiveState	Checked		pc_inactiveState
delayBudgetReporting	Not checked		
nonCriticalExtension SEQUENCE {			
sdap-Parameters SEQUENCE {			
as-ReflectiveQoS	Checked		pc_as_ReflectiveQoS
}			
overheatingInd	Not checked		
ims-Parameters SEQUENCE {			
ims-ParametersCommon SEQUENCE {			
voiceOverEUTRA-5GC	Not checked		
voiceOverSCG-BearerEUTRA-5GC	Not checked		
voiceFallbackIndicationEPS-r16	Checked		pc_voiceFallbackIndication
}			
ims-ParametersFRX-Diff SEQUENCE {			
voiceOverNR	Checked (NOTE 16)		pc_voiceOverNR
}			
}			
fr1-Add-UE-NR-Capabilities-v1540 SEQUENCE {			
ims-ParametersFRX-Diff SEQUENCE {			
voiceOverNR	Checked (NOTE 16)		pc_voiceOverNR
}			
}			
fr2-Add-UE-NR-Capabilities-v1540 SEQUENCE {			
ims-ParametersFRX-Diff SEQUENCE {			
voiceOverNR	Checked (NOTE 16)		pc_voiceOverNR
}			
}			
fr1-fr2-Add-UE-NR-Capabilities SEQUENCE {			
phy-ParametersFRX-Diff SEQUENCE {			
dynamicSFI	Not checked		
dummy1	Not checked		

twoFL-DMRS	Not checked		
dummy2	Not checked		
dummy3	Not checked		
supportedDMRS-TypeDL	Not checked		
supportedDMRS-TypeUL	Not checked		
semiOpenLoopCSI	Not checked		
csi-ReportWithoutPMI	Not checked		
csi-ReportWithoutCQI	Not checked		
onePortsPTRS	Not checked		
twoPUCCH-F0-2-ConsecSymbols	Not checked		
pucch-F2-WithFH	Not checked		
pucch-F3-WithFH	Not checked		
pucch-F4-WithFH	Not checked		
freqHoppingPUCCH-F0-2	Not checked		
freqHoppingPUCCH-F1-3-4	Not checked		
mux-SR-HARQ-ACK-CSI-PUCCH-MultiPerSlot	Not checked		
uci-CodeBlockSegmentation	Not checked		
onePUCCH-LongAndShortFormat	Not checked		
twoPUCCH-AnyOthersInSlot	Not checked		
intraSlotFreqHopping-PUSCH	Not checked		
pusch-LBRM	Not checked		
pdccch-BlindDetectionCA	Not checked		
tpc-PUSCH-RNTI	Not checked		
tpc-PUCCH-RNTI	Not checked		
tpc-SRS-RNTI	Not checked		
absoluteTPC-Command	Not checked		
twoDifferentTPC-Loop-PUSCH	Not checked		
twoDifferentTPC-Loop-PUCCH	Not checked		
pusch-HalfPi-BPSK	Not checked		
pucch-F3-4-HalfPi-BPSK	Not checked		
almostContiguousCP-OFDM-UL	Not checked		
sp-CSI-RS	Not checked		
sp-CSI-IM	Not checked		
tdd-MultiDL-UL-SwitchPerSlot	Not checked		
multipleCORESET	Not checked		
csi-RS-IM-ReceptionForFeedback	Not checked	CSI-RS-IM-ReceptionForFeedback	
csi-RS-ProcFrameworkForSRS	Not checked	CSI-RS-ProcFrameworkForSRS	
csi-ReportFramework	Not checked	CSI-ReportFramework	
mux-SR-HARQ-ACK-CSI-PUCCH-OncePerSlot			
SEQUENCE {			
sameSymbol	Not checked		
diffSymbol	Not checked		
}			
mux-SR-HARQ-ACK-PUCCH	Not checked		
mux-MultipleGroupCtrlCH-Overlap	Not checked		
dl-SchedulingOffset-PDSCH-TypeA	Not checked		
dl-SchedulingOffset-PDSCH-TypeB	Not checked		
ul-SchedulingOffset	Not checked		
dl-64QAM-MCS-TableAlt	Not checked		
ul-64QAM-MCS-TableAlt	Not checked		
cqi-TableAlt	Not checked		
oneFL-DMRS-TwoAdditionalDMRS-UL	Not checked		
twoFL-DMRS-TwoAdditionalDMRS-UL	Not checked		
oneFL-DMRS-ThreeAdditionalDMRS-UL	Not checked		
}			
measAndMobParametersFRX-Diff SEQUENCE {			
ss-SINR-Meas	Checked (NOTE 10)		pc_ss_SINR_Meas
csi-RSRP-AndRSRQ-MeasWithSSB	Checked (NOTE 3)		pc_csi-RSRP-AndRSRQ-

			MeasWithSSB
csi-RSRP-AndRSRQ-MeasWithoutSSB	Checked (NOTE 11)		pc_csi_RSRP_AndRSRQ_MeasWithoutSSB
csi-SINR-Meas	Not checked		
csi-RS-RLM	Not checked		
handoverInterF	Checked (NOTE 14)		pc_handoverInterF
handoverLTE-EPC	Not checked		
handoverLTE-5GC	Not checked		
maxNumberResource-CSI-RS-RLM	Not checked		
simultaneousRxDataSSB-DiffNumerology	Not checked		
nr-AutonomousGaps-r16	Not checked		
nr-AutonomousGaps-ENDC-r16	Not checked		
nr-AutonomousGaps-NEDC-r16	Not checked		
nr-AutonomousGaps-NRDC-r16	Not checked		
dummy	Not checked		
cli-RSSI-Meas-r16	Not checked		
cli-SRS-RSRP-Meas-r16	Not checked		
interFrequencyMeas-NoGap-r16	Not checked		
simultaneousRxDataSSB-DiffNumerology-Inter-r16	Not checked		
idleInactiveNR-MeasReport-r16	Not checked		
idleInactiveNR-MeasBeamReport-r16	Not checked		
increasedNumberOfCSIRSPerMO-r16	Not checked		
}			
}			
nonCriticalExtension SEQUENCE {		UE-NR-Capability-v1550	
reducedCP-Latency	Checked		pc_reducedCP_Latency
nonCriticalExtension SEQUENCE {		UE-NR-Capability-v1560	
nrdc-Parameters	Not checked	NRDC-Parameters	
receivedFilters	Not checked		
nonCriticalExtension SEQUENCE {		UE-NR-Capability-v1570	
nrdc-Parameters-v1570	Not checked	NRDC-Parameters-v1570	
nonCriticalExtension SEQUENCE {		UE-NR-Capability-v1610	
inDeviceCoexInd-r16	Not checked		
dl-DedicatedMessageSegmentation-r16	Not checked		
nrdc-Parameters-v1610	Not checked		
powSav-Parameters-r16	Checked	PowSav-Parameters-r16 (Table 8.2.1.1.2.3.3-10)	
fr1-Add-UE-NR-Capabilities-v1610	Not checked		
fr2-Add-UE-NR-Capabilities-v1610	Not checked		
bh-RLF-Indication-r16	Not checked		
directSN-AdditionFirstRRC-IAB-r16	Not checked		
bap-Parameters-r16	Not checked		
referenceTimeProvision-r16	Not checked		
sidelinkParameters-r16	Not checked		
highSpeedParameters-r16	Not checked		
mac-Parameters-v1610	Not checked		
mcgRLF-RecoveryViaSCG-r16	Not checked		
resumeWithStoredMCG-SCells-r16	Not checked		
resumeWithStoredSCG-r16	Not checked		
resumeWithSCG-Config-r16	Not checked		

ue-BasedPerfMeas-Parameters-r16	Checked	UE- BasedPerfMeas- Parameters-r16 (Table 8.2.1.1.2.3.3-11)	
son-Parameters-r16 {			
rach-Report-r16	Checked		pc_rachRep ort_r16
}			
onDemandSIB-Connected-r16	Not checked		
nonCriticalExtension SEQUENCE {}	Not checked		
}			
}			
}			
}			
}			
nonCriticalExtension SEQUENCE {}	Not checked		
}			
}			
Note 1:	<p>If the UE is single mode (FDD or TDD), or the UE is dual mode (FDD and TDD) and <i>intraAndInterF-MeasAndReport</i> is supported in both modes, then support of <i>intraAndInterF-MeasAndReport</i> will be signalled in <i>measAndMobParameters/measAndMobParametersXDD-Diff</i>. If the UE is dual mode (FDD + TDD) and <i>intraAndInterF-MeasAndReport</i> is only supported in one mode, then support of <i>intraAndInterF-MeasAndReport</i> will be signalled in one of <i>fdd-Add-UE-NR-Capabilities/measAndMobParametersXDD-Diff</i> or <i>tdd-Add-UE-NR-Capabilities/measAndMobParametersXDD-Diff</i> as appropriate.)</p>		
Note 2:	<p>If the UE is single mode (FDD or TDD), or the UE is dual mode (FDD and TDD) and <i>eventA-MeasAndReport</i> is supported in both modes, then support of <i>eventA-MeasAndReport</i> will be signalled in <i>measAndMobParameters/measAndMobParametersXDD-Diff</i>. If the UE is dual mode (FDD + TDD) and <i>eventA-MeasAndReport</i> is only supported in one mode, then support of <i>eventA-MeasAndReport</i> will be signalled in one of <i>fdd-Add-UE-NR-Capabilities/measAndMobParametersXDD-Diff</i> or <i>tdd-Add-UE-NR-Capabilities/measAndMobParametersXDD-Diff</i> as appropriate.</p>		
Note 3:	<p>If the UE supports single frequency range (FR1 or FR2), or the UE supports both frequency ranges (FR1 and FR2) and <i>csi-RSRP-AndRSRQ-MeasWithSSB</i> is supported in both frequency ranges, then support of <i>csi-RSRP-AndRSRQ-MeasWithSSB</i> will be signalled in <i>measAndMobParameters/MeasAndMobParametersFRX-Diff</i>. If the UE supports both frequency ranges (FR1 + FR2) and <i>csi-RSRP-AndRSRQ-MeasWithSSB</i> is only supported in one frequency range, then support of <i>csi-RSRP-AndRSRQ-MeasWithSSB</i> will be signalled in one of <i>fr1-Add-UE-NR-Capabilities/measAndMobParametersFRX-Diff</i> or <i>fr2-Add-UE-NR-Capabilities/measAndMobParametersFRX-Diff</i> as appropriate.)</p>		
Note 4:	<p>If the UE is single mode (FDD or TDD), or the UE is dual mode (FDD and TDD) and <i>skipUplinkTxDynamic</i> is supported in both modes, then support of <i>skipUplinkTxDynamic</i> will be signalled in <i>mac-Parameters/mac-ParametersXDD-Diff</i>. If the UE is dual mode (FDD + TDD) and <i>skipUplinkTxDynamic</i> is only supported in one mode, then <i>skipUplinkTxDynamic</i> will be signalled in one of <i>fdd-Add-UE-NR-Capabilities/mac-ParametersXDD-Diff</i> or <i>tdd-Add-UE-NR-Capabilities/mac-ParametersXDD-Diff</i> as appropriate.</p>		
Note 5:	<p>If the UE is single mode (FDD or TDD), or the UE is dual mode (FDD and TDD) and <i>logicalChannelSR-DelayTimer</i> is supported in both modes, then support of <i>logicalChannelSR-DelayTimer</i> will be signalled in <i>mac-Parameters/mac-ParametersXDD-Diff</i>. If the UE is dual mode (FDD + TDD) and <i>logicalChannelSR-DelayTimer</i> is only supported in one mode, then support of <i>logicalChannelSR-DelayTimer</i> will be signalled in one of <i>fdd-Add-UE-NR-Capabilities/mac-ParametersXDD-Diff</i> or <i>tdd-Add-UE-NR-Capabilities/mac-ParametersXDD-Diff</i> as appropriate.</p>		
Note 6:	<p>If the UE is single mode (FDD or TDD), or the UE is dual mode (FDD and TDD) and <i>longDRX_Cycle</i> is supported in both modes, then support of <i>longDRX_Cycle</i> will be signalled in <i>mac-Parameters/mac-ParametersXDD-Diff</i>. If the UE is dual mode (FDD + TDD) and <i>longDRX_Cycle</i> is only supported in one mode, then support of <i>longDRX_Cycle</i> will be signalled in one of <i>fdd-Add-UE-NR-Capabilities/mac-ParametersXDD-Diff</i> or <i>tdd-Add-UE-NR-Capabilities/mac-ParametersXDD-Diff</i> as appropriate.</p>		
Note 7:	<p>If the UE is single mode (FDD or TDD), or the UE is dual mode (FDD and TDD) and <i>shortDRX_Cycle</i> is supported in both modes, then support of <i>shortDRX_Cycle</i> will be signalled in <i>mac-Parameters/mac-ParametersXDD-Diff</i>. If the UE is dual mode (FDD + TDD) and <i>shortDRX_Cycle</i> is only supported in one mode, then support of <i>shortDRX_Cycle</i> will be signalled in one of <i>fdd-Add-UE-NR-Capabilities/mac-ParametersXDD-Diff</i> or <i>tdd-Add-UE-NR-Capabilities/mac-ParametersXDD-Diff</i> as appropriate.</p>		

Note 8: If the UE supports FR2 and pc_pdsch_256QAM_FR2 is supported, then support of pdsch_256QAM_FR2 will be signaled in at least one entry of supportedBandListNR as appropriate.

Note 9: If pc_pusch_256QAM_FR1 or pc_pusch_256QAM_FR2 is supported, then support of pusch-256QAM will be signaled in at least one entry of supportedBandListNR as appropriate.

Note 10: If the UE supports single frequency range (FR1 or FR2), or the UE supports both frequency ranges (FR1 and FR2) and ss-SINR-Meas is supported in both frequency ranges, then support of ss-SINR-Meas will be signaled in measAndMobParameters/MeasAndMobParametersFRX-Diff.
If the UE supports both frequency ranges (FR1 + FR2) and ss-SINR-Meas is only supported in one frequency range, then support of ss-SINR-Meas will be signaled in one of fr1-Add-UE-NR-Capabilities/measAndMobParametersFRX-Diff or fr2-Add-UE-NR-Capabilities/measAndMobParametersFRX-Diff as appropriate.)

Note 11: If the UE supports single frequency range (FR1 or FR2), or the UE supports both frequency ranges (FR1 and FR2) and csi-RSRP-AndRSRQ-MeasWithoutSSB is supported in both frequency ranges, then support of csi-RSRP-AndRSRQ-MeasWithoutSSB will be signaled in measAndMobParameters/MeasAndMobParametersFRX-Diff.
If the UE supports both frequency ranges (FR1 + FR2) and csi-RSRP-AndRSRQ-MeasWithoutSSB is only supported in one frequency range, then support of csi-RSRP-AndRSRQ-MeasWithoutSSB will be signaled in one of fr1-Add-UE-NR-Capabilities/measAndMobParametersFRX-Diff or fr2-Add-UE-NR-Capabilities/measAndMobParametersFRX-Diff as appropriate.)

Note 12: If the UE is single mode (FDD or TDD), or the UE is dual mode (FDD and TDD) and multipleConfiguredGrants is supported in both modes, then support of multipleConfiguredGrants will be signaled in mac-Parameters/mac-ParametersXDD-Diff.
If the UE is dual mode (FDD + TDD) and multipleConfiguredGrants is only supported in one mode, then support of multipleConfiguredGrants will be signaled in one of fdd-Add-UE-NR-Capabilities/mac-ParametersXDD-Diff or tdd-Add-UE-NR-Capabilities/mac-ParametersXDD-Diff as appropriate.

Note 13: If the UE is single mode (FDD or TDD), or the UE is dual mode (FDD and TDD) and sftd-MeasNR-Neigh is supported in both modes, then support of sftd-MeasNR-Neigh will be signaled in measAndMobParameters/measAndMobParametersXDD-Diff.
If the UE is dual mode (FDD + TDD) and sftd-MeasNR-Neigh is only supported in one mode, then support of sftd-MeasNR-Neigh will be signaled in one of fdd-Add-UE-NR-Capabilities/measAndMobParametersXDD-Diff or tdd-Add-UE-NR-Capabilities/measAndMobParametersXDD-Diff as appropriate.)

Note 14: If the UE supports single frequency range (FR1 or FR2), or the UE supports both frequency ranges (FR1 and FR2) and handoverInterF is supported in both frequency ranges, then support of handoverInterF will be signaled in measAndMobParameters/MeasAndMobParametersFRX-Diff.
If the UE supports both frequency ranges (FR1 + FR2) and handoverInterF is only supported in one frequency range, then support of handoverInterF will be signaled in one of fr1-Add-UE-NR-Capabilities/measAndMobParametersFRX-Diff or fr2-Add-UE-NR-Capabilities/measAndMobParametersFRX-Diff as appropriate.)

Note 15: If the UE is single mode (FDD or TDD), or the UE is dual mode (FDD and TDD) and handoverInterF is supported in both modes, then support of handoverInterF will be signaled in measAndMobParameters/measAndMobParametersXDD-Diff.
If the UE is dual mode (FDD + TDD) and handoverInterF is only supported in one mode, then support of handoverInterF will be signaled in one of fdd-Add-UE-NR-Capabilities/measAndMobParametersXDD-Diff or tdd-Add-UE-NR-Capabilities/measAndMobParametersXDD-Diff as appropriate.

Note 16: If the UE supports single frequency range (FR1 or FR2), or the UE supports both frequency ranges (FR1 and FR2) and voiceOverNR is supported in both frequency ranges, then support of voiceOverNR will be signaled in ims-Parameters/ims-ParametersFRX-Diff.
If the UE supports both frequency ranges (FR1 + FR2) and voiceOverNR is only supported in one frequency range, then support of voiceOverNR will be signaled in one of fr1-Add-UE-NR-Capabilities-v1540/ims-ParametersFRX-Diff or fr2-Add-UE-NR-Capabilities-v1540/ims-ParametersFRX-Diff as appropriate.)

Table 8.2.1.1.2.3.3-5: UE-MRDC-Capability (Table 8.2.1.1.2.3.3-3)

Derivation Path: TS 38.508-1 [4], Table 4.6.4-48			
Information Element	Value/remark	Comment	Condition
UE-MRDC-Capability ::= SEQUENCE {			
measAndMobParametersMRDC SEQUENCE {			
measAndMobParametersMRDC-Common			
SEQUENCE {			
independentGapConfig	Checked		pc_independentGapConfig
}			
measAndMobParametersMRDC-XDD-Diff			
SEQUENCE {			
sftd-MeasPSCell	Checked (NOTE 5)		pc_SFTD_MeasPSCell_

			MRDC_FDD and/or pc_SFTD_M easPSCell_ MRDC_T DD
sftd-MeasNR-Cell	Checked (NOTE 6)		pc_SFTD_M easNR_Cell _FDD and/or pc_SFTD_M easNR_Cell _TDD
}			
measAndMobParametersMRDC-FRX-Diff SEQUENCE {			
simultaneousRxDataSSB-DiffNumerology	Not checked		
}			
}			
phy-ParametersMRDC-v1530 SEQUENCE {			
naics-Capability-List SEQUENCE (SIZE (1..maxNrofNAICS-Entries)) OF NAICS-Capability- Entry {	Not checked		
NAICS-Capability-Entry SEQUENCE {			
numberOfNAICS-CapableCC	Not checked		
numberOfAggregatedPRB	Not checked		
}			
}			
rf-ParametersMRDC SEQUENCE {			
supportedBandCombinationList SEQUENCE { (SIZE (1..maxBandComb)) OF BandCombination {			
BandCombination SEQUENCE {			
bandList SEQUENCE (SIZE (1..maxSimultaneousBands)) OF BandParameters {	Not checked		
BandParameters CHOICE			
eutra SEQUENCE {		EUTRA bands	
bandEUTRA	Not checked	FreqBandIndicator EUTRA	
ca-BandwidthClassDL-EUTRA	Not checked	CA- BandwidthClassE UTRA	
ca-BandwidthClassUL-EUTRA	Not checked	CA- BandwidthClassE UTRA	
}			
nr SEQUENCE {		NR bands	
bandNR	Not checked	FreqBandIndicator NR	
ca-BandwidthClassDL-NR	Not checked	CA- BandwidthClassN R	
ca-BandwidthClassUL-NR	Not checked	CA- BandwidthClassN R	
}			
}			
}			
featureSetCombination	Not checked	FeatureSetCombi nationId	
ca-ParametersEUTRA	Not checked	CA- ParametersEUTR A	
ca-ParametersNR	Not checked	CA- ParametersNR	
mrdc-Parameters SEQUENCE {			
singleUL-Transmission	Not checked		

dynamicPowerSharingENDC	Checked	Note 4	pc_dynamicPowerSharing
tdm-Pattern	Not checked		
ul-SharingEUTRA-NR	Not checked		
ul-SwitchingTimeEUTRA-NR	Not checked		
simultaneousRxTxInterBandENDC	Not checked		
asynclntraBandENDC	Not checked		
dualPA-Architecture	Not checked		
intraBandENDC-Support-v1540	Not checked		
ul-TimingAlignmentEUTRA-NR	Not checked		
}			
supportedBandwidthCombinationSet	Not checked		
powerClass-v1530	Not checked		
}			
appliedFreqBandListFilter	Not checked	FreqBandList	
srs-SwitchingTimeRequested	Not checked		
supportedBandCombinationList-v1540 SEQUENCE (SIZE (1..maxBandComb)) OF OF BandCombination-v1540 {		BandCombinationList-v1540	
BandCombination-v1540 SEQUENCE {			
bandList-v1540 SEQUENCE (SIZE (1..maxSimultaneousBands)) OF OF BandParameters-v1540 {	Not checked	BandParameters-v1540	
BandParameters-v1540 SEQUENCE {			
srs-CarrierSwitch CHOICE {			
nr SEQUENCE {		NR bands	
srs-SwitchingTimesListNR SEQUENCE (SIZE (1..maxSimultaneousBands)) OF SRS-SwitchingTimeNR	Not checked		
}			
eutra SEQUENCE {		EUTRA bands	
srs-SwitchingTimesListEUTRA SEQUENCE (SIZE (1..maxSimultaneousBands)) OF SRS-SwitchingTimeEUTRA	Not checked		
}			
}			
srs-TxSwitch-v1540 SEQUENCE {			
supportedSRS-TxPortSwitch	Not checked		
txSwitchImpactToRx	Not checked		
txSwitchWithAnotherBand	Not checked		
}			
}			
ca-ParametersNR-v1540 SEQUENCE {			
simultaneousSRS-AssocCSI-RS-AIICC	Not checked		
csi-RS-IM-ReceptionForFeedbackPerBandComb SEQUENCE {			
maxNumberSimultaneousNZP-CSI-RS-ActBWP-AIICC	Not checked		
totalNumberPortsSimultaneousNZP-CSI-RS-ActBWP-AIICC	Not checked		
}			
simultaneousCSI-ReportsAIICC	Not checked		
dualPA-Architecture	Not checked		
}			
}			
}			
generalParametersMRDC SEQUENCE {			
splitSRB-WithOneUL-Path	Checked (NOTE 1)		pc_splitSRB-WithOneUL-Path
splitDRB-withUL-Both-MCG-SCG	Checked (NOTE 2)		pc_splitDRB-withUL_Bot

			h_MCG_SCG
srb3	Checked (NOTE 1)		pc_srb3
v2x-EUTRA	Not checked		
}			
fdd-Add-UE-MRDC-Capabilities SEQUENCE {			
measAndMobParametersMRDC-XDD-Diff			
SEQUENCE {			
sftd-MeasPSCell	Checked (NOTE 5)		pc_SFTD_MeasPSCell_MRDC_FDD and/or pc_SFTD_MeasPSCell_MRDC_TDD
sftd-MeasNR-Cell	Checked (NOTE 6)		pc_SFTD_MeasNR_Cell_FDD and/or pc_SFTD_MeasNR_Cell_TDD
}			
generalParametersMRDC-XDD-Diff SEQUENCE {			
splitSRB-WithOneUL-Path	Checked (NOTE 1)		pc_splitSRB-WithOneUL_Path
splitDRB-withUL-Both-MCG-SCG	Checked (NOTE 2)		pc_splitDRB_withUL_Both_MCG_SCG
srb3	Checked (NOTE 3)		pc_srb3
v2x-EUTRA-v1530	Not checked		
}			
}			
tdd-Add-UE-MRDC-Capabilities SEQUENCE {			
measAndMobParametersMRDC-XDD-Diff			
SEQUENCE {			
sftd-MeasPSCell	Checked (NOTE 5)		pc_SFTD_MeasPSCell_MRDC_FDD and/or pc_SFTD_MeasPSCell_MRDC_TDD
sftd-MeasNR-Cell	Checked (NOTE 6)		pc_SFTD_MeasNR_Cell_FDD and/or pc_SFTD_MeasNR_Cell_TDD
}			
generalParametersMRDC-XDD-Diff SEQUENCE {			
splitSRB-WithOneUL-Path	Checked (NOTE 1)		pc_splitSRB-WithOneUL_Path
splitDRB-withUL-Both-MCG-SCG	Checked (NOTE 2)		pc_splitDRB_withUL_Both_MCG_SCG
srb3	Checked (NOTE 3)		pc_srb3
v2x-EUTRA-v1530	Not checked		
}			
}			

fr1-Add-UE-MRDC-Capabilities SEQUENCE {			
measAndMobParametersMRDC-FRX-Diff SEQUENCE {			
simultaneousRxDataSSB-DiffNumerology	Not checked		
}			
}			
fr2-Add-UE-MRDC-Capabilities SEQUENCE {			
measAndMobParametersMRDC-FRX-Diff SEQUENCE {			
simultaneousRxDataSSB-DiffNumerology	Not checked		
}			
}			
featureSetCombinations SEQUENCE (SIZE (1..maxFeatureSetCombinations)) OF FeatureSetCombination {	Not checked	FeatureSetCombination	
FeatureSetCombination SEQUENCE (SIZE (1..maxSimultaneousBands)) OF FeatureSetsPerBand {			
FeatureSetsPerBand SEQUENCE (SIZE (1..maxFeatureSetsPerBand)) OF FeatureSet {			
FeatureSet CHOICE {			
eutra SEQUENCE {		EUTRA bands	
downlinkSetEUTRA	Not checked		
uplinkSetEUTRA	Not checked		
}			
nr SEQUENCE {		NR bands	
downlinkSetNR	Not checked		
uplinkSetNR	Not checked		
}			
}			
}			
}			
}			
pcdp-ParametersMRDC-v1530 SEQUENCE {			
pcdp-DuplicationSplitSRB	Checked		pc_pdcpc_DuplicationSplitSRB
pcdp-DuplicationSplitDRB	Checked		pc_pdcpc_DuplicationSplitDRB
}			
lateNonCriticalExtension	Not checked		
nonCriticalExtension SEQUENCE {}	Not checked		
}			
Note 1:	<p>If the UE is single mode (FDD or TDD), or the UE is dual mode (FDD and TDD) and <i>splitSRB-WithOneUL-Path</i> is supported in both modes, then support of <i>splitSRB-WithOneUL-Path</i> will be signalled in generalParametersMRDC/generalParametersMRDC-XDD-Diff.</p> <p>If the UE is dual mode (FDD + TDD) and <i>splitSRB-WithOneUL-Path</i> is only supported in one mode, then support of <i>splitSRB-WithOneUL-Path</i> will be signalled in one of fdd-Add-UE-MRDC-Capabilities/generalParametersMRDC-XDD-Diff or tdd-Add-UE-MRDC-Capabilities/generalParametersMRDC-XDD-Diff as appropriate.</p>		
Note 2:	<p>If the UE is single mode (FDD or TDD), or the UE is dual mode (FDD and TDD) and <i>splitDRB-withUL-Both-MCG-SCG</i> is supported in both modes, then support of <i>splitDRB-withUL-Both-MCG-SCG</i> will be signalled in generalParametersMRDC/generalParametersMRDC-XDD-Diff.</p> <p>If the UE is dual mode (FDD + TDD) and <i>splitDRB-withUL-Both-MCG-SCG</i> is only supported in one mode, then support of <i>splitDRB-withUL-Both-MCG-SCG</i> will be signalled in one of fdd-Add-UE-MRDC-Capabilities/generalParametersMRDC-XDD-Diff or tdd-Add-UE-MRDC-Capabilities/generalParametersMRDC-XDD-Diff as appropriate.</p>		
Note 3:	<p>If the UE is single mode (FDD or TDD), or the UE is dual mode (FDD and TDD) and <i>srb3</i> is supported in both modes, then support of <i>srb3</i> will be signalled in generalParametersMRDC/generalParametersMRDC-XDD-Diff.</p> <p>If the UE is dual mode (FDD + TDD) and <i>srb3</i> is only supported in one mode, then support of <i>srb3</i> will be signalled in one of fdd-Add-UE-MRDC-Capabilities/generalParametersMRDC-XDD-Diff or tdd-Add-UE-MRDC-Capabilities/generalParametersMRDC-XDD-Diff as appropriate.</p>		
Note 4:	<p>If pc_dynamicPowerSharing is supported, then support of dynamicPowerSharingENDC will be signalled in at least one entry of supportedBandCombinationList as appropriate. As per 38.306 cl 4.2.7.9 this is applicable to FR1 only.</p>		

Note 5:	If the UE is single mode (FDD or TDD), or the UE is dual mode (FDD and TDD) and sftd-MeasPSCell is supported in both modes, then support of sftd-MeasPSCell will be signalled in measAndMobParametersMRDC/measAndMobParametersMRDC-XDD-Diff If the UE is dual mode (FDD + TDD) and sftd-MeasPSCell is only supported in one mode, then support of sftd-MeasPSCell will be signalled in one of fdd-Add-UE-MRDC-Capabilities/measAndMobParametersMRDC-XDD-Diff or tdd-Add-UE-MRDC-Capabilities/ measAndMobParametersMRDC-XDD-Diff as appropriate.
Note 6:	If the UE is single mode (FDD or TDD), or the UE is dual mode (FDD and TDD) and sftd-MeasNR-Cell is supported in both modes, then support of sftd-MeasNR-Cell will be signalled in measAndMobParametersMRDC/measAndMobParametersMRDC-XDD-Diff If the UE is dual mode (FDD + TDD) and sftd-MeasNR-Cell is only supported in one mode, then support of sftd-MeasNR-Cell will be signalled in one of fdd-Add-UE-MRDC-Capabilities/measAndMobParametersMRDC-XDD-Diff or tdd-Add-UE-MRDC-Capabilities/ measAndMobParametersMRDC-XDD-Diff as appropriate.

Table 8.2.1.1.2.3.3-6: ULDedicatedMessageSegment (steps 2a1 Table 8.2.1.1.2.3.2-1)

Derivation Path: 38.508-1 [4], Table 4.6.1-32C			
Information Element	Value/remark	Comment	Condition
ULDedicatedMessageSegment-r16 ::= SEQUENCE {			
criticalExtensions CHOICE {			
ulDedicatedMessageSegment-r16 SEQUENCE {			
segmentNumber-r16	0 for first segment, and incremented by 1 for each subsequent segment		
rrc-MessageSegmentContainer-r16	Not Checked	OCTET STRING including segmented UECapabilityInformation message	
rrc-MessageSegmentType-r16	<i>notLastSegment</i> for all segments except the last segment. <i>lastSegment</i> for the last segment		
lateNonCriticalExtension	Not present		
nonCriticalExtension	Not present		
}			
}			
}			

Table 8.2.1.1.2.3.3-7: FeatureSetDownlink-v1610 (Table 8.2.1.1.2.3.3-4)

Information Element	Value/remark	Comment	Condition
FeatureSetDownlink-v1610 ::= SEQUENCE {			
cbgPDSCH-ProcessingType1-DifferentTB-PerSlot-r16	Not checked		
cbgPDSCH-ProcessingType2-DifferentTB-PerSlot-r16	Not checked		
intraFreqDAPS-r16	Checked		pc_intraFreqDAPS_r16
intraBandFreqSeparationDL-v1620	Not checked		
intraBandFreqSeparationDL-Only-r16	Not checked		
pdccch-Monitoring-r16	Not checked		
pdccch-MonitoringMixed-r16	Not checked		
crossCarrierSchedulingProcessing-DiffSCS-r16	Not checked		
singleDCI-SDM-scheme-r16	Not checked		
}			

Table 8.2.1.1.2.3.3-8: FeatureSetUplink-v1610 (Table 8.2.1.1.2.3.3-4)

Information Element	Value/remark	Comment	Condition
FeatureSetUplink-v1610 ::= SEQUENCE {			

pusch-RepetitionTypeB-r16	Checked		pc_pusch_RepetitionTypeB_r16
ul-CancellationSelfCarrier-r16	Not checked		
ul-CancellationCrossCarrier-r16	Not checked		
ul-FullPwrMode2-MaxSRS-ResInSet-r16	Not checked		
cbgPUSCH-ProcessingType1-DifferentTB-PerSlot-r16	Not checked		
cbgPUSCH-ProcessingType2-DifferentTB-PerSlot-r16	Not checked		
supportedSRS-PosResources-r16	Not checked		
intraFreqDAPS-UL-r16	Not checked		
intraBandFreqSeparationUL-v1620	Not checked		
multiPUCCH-r16	Not checked		
twoPUCCH-Type1-r16	Not checked		
twoPUCCH-Type2-r16	Not checked		
twoPUCCH-Type3-r16	Not checked		
twoPUCCH-Type4-r16	Not checked		
mux-SR-HARQ-ACK-r16	Not checked		
dummy1	Not checked		
dummy2	Not checked		
twoPUCCH-Type5-r16	Not checked		
twoPUCCH-Type6-r16	Not checked		
twoPUCCH-Type7-r16	Not checked		
twoPUCCH-Type8-r16	Not checked		
twoPUCCH-Type9-r16	Not checked		
twoPUCCH-Type10-r16	Not checked		
twoPUCCH-Type11-r16	Not checked		
ul-IntraUE-Mux-r16	Not checked		
ul-FullPwrMode-r16	Not checked		
crossCarrierSchedulingProcessing-DiffSCS-r16	Not checked		
ul-FullPwrMode1-r16	Not checked		
ul-FullPwrMode2-SRSConfig-diffNumSRSPorts-r16	Not checked		
ul-FullPwrMode2-TPMIGroup-r16	Not checked		
}			

Table 8.2.1.1.2.3.3-9: CA-ParametersNR-v1610 (Table 8.2.1.1.2.3.3-4)

Information Element	Value/remark	Comment	Condition
CA-ParametersNR-v1610 ::= SEQUENCE {			
parallelTxMsgA-SRS-PUCCH-PUSCH-r16	Not checked		
msgA-SUL-r16	Not checked		
jointSearchSpaceSwitchAcrossCells-r16	Not checked		
half-DuplexTDD-CA-SameSCS-r16	Not checked		
scellDormancyWithinActiveTime-r16	Not checked		
scellDormancyOutsideActiveTime-r16	Checked		pc_scellDormancyOutsideActiveTime_r16
crossCarrierA-CSI-trigDiffSCS-r16	Not checked		
defaultQCL-CrossCarrierA-CSI-Trig-r16	Not checked		
interCA-NonAlignedFrame-r16	Not checked		
simul-SRS-Trans-BC-r16	Not checked		
interFreqDAPS-r16	Checked		pc_interFreqDAPS_r16
codebookParametersPerBC-r16	Not checked		
blindDetectFactor-r16	Not checked		
pdccch-MonitoringCA-r16	Not checked		
pdccch-BlindDetectionCA-Mixed-r16	Not checked		
pdccch-BlindDetectionMCG-UE-r16	Not checked		
pdccch-BlindDetectionSCG-UE-r16	Not checked		
pdccch-BlindDetectionMCG-UE-Mixed-r16	Not checked		
pdccch-BlindDetectionSCG-UE-Mixed-r16	Not checked		
crossCarrierSchedulingDL-DiffSCS-r16	Not checked		

crossCarrierSchedulingDefaultQCL-r16	Not checked		
crossCarrierSchedulingUL-DiffSCS-r16	Not checked		
simul-SRS-MIMO-Trans-BC-r16	Not checked		
codebookParametersAdditionPerBC-r16	Not checked		
codebookComboParametersAdditionPerBC-r16	Not checked		
}			

Table 8.2.1.1.2.3.3-10: PowSav-Parameters-r16 (Table 8.2.1.1.2.3.3-4)

Information Element	Value/remark	Comment	Condition
PowSav-Parameters-r16 ::= SEQUENCE {			
powSav-ParametersCommon-r16 SEQUENCE {			
drx-Preference-r16	Not checked		
maxCC-Preference-r16	Not checked		
releasePreference-r16	Checked		pc_releaseP reference_r1 6
minSchedulingOffsetPreference-r16	Not checked		
}			
powSav-ParametersFRX-Diff-r16	Not checked		
}			

Table 8.2.1.1.2.3.3-11: UE-BasedPerfMeas-Parameters-r16 (Table 8.2.1.1.2.3.3-4)

Information Element	Value/remark	Comment	Condition
UE-BasedPerfMeas-Parameters-r16 ::= SEQUENCE {			
barometerMeasReport-r16	Checked		pc_baromete r_r16
immMeasBT-r16	Not checked		
immMeasWLAN-r16	Checked		pc_immMea sWLAN_r16
loggedMeasBT-r16	Not checked		
loggedMeasurements-r16	Checked		pc_loggedM easements _r16
loggedMeasWLAN-r16	Checked		pc_loggedM easWLAN_r 16
orientationMeasReport-r16	Checked		pc_orientatio n_r16
speedMeasReport-r16	Checked		pc_speed_r1 6
gnss-Location-r16	Checked		pc_GNSS_lo cation_r16
ulPDCP-Delay-r16	Checked		pc_PDCP_D elay_r16
}			

8.2.1.2 Void

8.2.2 Radio Bearer Addition, Modification and Release

8.2.2.1 Radio Bearer Addition, Modification and Release / SRB

8.2.2.1.1 SRB3 Establishment, Reconfiguration and Release / NR addition, modification and release / EN-DC

8.2.2.1.1.1 Test Purpose (TP)

(1)

```
with { UE in RRC_CONNECTED state with EN-DC, and, MCG(s) (E-UTRA PDCP) and SCG }
ensure that {
  when { UE receives an RRCConnectionReconfiguration message to add SRB3 }
  then { UE establishes SRB3 and sends an RRCConnectionReconfigurationComplete message on SRB1 }
}
```

(2)

```
with { UE in RRC_CONNECTED state with EN-DC, and, MCG(s) (E-UTRA PDCP) and SCG and SRB3 configured }
ensure that {
  when { UE receives an RRCReconfiguration message on SRB3 including secondaryCellGroup to
reconfigure NR MAC }
  then { UE sends RRCReconfigurationComplete message on SRB3 }
}
```

(3)

```
with { UE in RRC_CONNECTED state with EN-DC, and, MCG(s) (E-UTRA PDCP) and SCG and SRB3 configured }
ensure that {
  when { UE receives an RRCReconfiguration message on SRB3 including radioBearerConfig to
reconfigure NR PDCP }
  then { UE sends RRCReconfigurationComplete message on SRB3 }
}
```

(4)

```
with { UE in RRC_CONNECTED state with EN-DC, and, MCG(s) (E-UTRA PDCP) and SCG }
ensure that {
  when { UE receives an RRCConnectionReconfiguration message to release SRB3 }
  then { UE releases SRB3 and sends an RRCConnectionReconfigurationComplete message on SRB1 }
}
```

8.2.2.1.1.2 Conformance requirements

References: The conformance requirements covered in the present test case are specified in: TS 36.331, clause 5.3.5.3, TS 38.331, clauses 5.3.5.1, 5.3.5.3, 5.3.5.5.1, 5.3.5.5.3, 5.3.5.5.4, 5.3.5.5.8, 5.3.5.5.9, 5.3.5.6.1, 5.3.5.6.2 and 5.3.5.6.3. Unless otherwise stated these are Rel-15 requirements.

[TS 36.331, 5.3.5.3]

1> if the received RRCConnectionReconfiguration includes the *nr-Config* and it is set to *release*: or

1> if the received RRCConnectionReconfiguration includes *endc-ReleaseAndAdd*:

2> perform ENDC release as specified in TS38.331 [82], clause 5.3.5.10;

...

1> if the received RRCConnectionReconfiguration includes the *nr-SecondaryCellGroupConfig*:

2> perform NR RRC Reconfiguration as specified in TS 38.331 [82], clause 5.3.5.3;

- 1> if the received *RRCConnectionReconfiguration* includes the *nr-RadioBearerConfig1*:
 - 2> perform radio bearer configuration as specified in TS 38.331 [82], clause 5.3.5.6;
- 1> if the received *RRCConnectionReconfiguration* includes the *nr-RadioBearerConfig2*:
 - 2> perform radio bearer configuration as specified in TS 38.331 [82], clause 5.3.5.6;
- ...
- 1> set the content of *RRCConnectionReconfigurationComplete* message as follows:
 - 2> if the received *RRCConnectionReconfiguration* message included *nr-SecondaryCellGroupConfig*:
 - 3> include *scg-ConfigResponseNR* in accordance with TS 38.331 [82], clause 5.3.5.3;
- 1> submit the *RRCConnectionReconfigurationComplete* message to lower layers for transmission using the new configuration, upon which the procedure ends;

[TS 38.331, 5.3.5.1]

In (NG)EN-DC and NR-DC, SRB3 can be used for measurement configuration and reporting, to (re-)configure MAC, RLC, physical layer and RLF timers and constants of the SCG configuration, and to reconfigure PDCP for DRBs associated with the S-K_{gNB} or SRB3, and to reconfigure SDAP for DRBs associated with S-K_{gNB} in (NG)EN-DC and NR-DC, provided that the (re-)configuration does not require any MN involvement. In EN-DC, only *measConfig*, *radioBearerConfig* and/or *secondaryCellGroup* are included in *RRCReconfiguration* received via SRB3.

[TS 38.331, 5.3.5.3]

The UE shall perform the following actions upon reception of the *RRCReconfiguration*:

- 1> if the *RRCReconfiguration* includes the *secondaryCellGroup*:
 - 2> perform the cell group configuration for the SCG according to 5.3.5.5;
- ...
- 1> if the UE is configured with E-UTRA *nr-SecondaryCellGroupConfig* (MCG is E-UTRA):
 - 2> if *RRCReconfiguration* was received via SRB1:
 - 3> construct *RRCReconfigurationComplete* message and submit it via the EUTRA MCG embedded in E-UTRA RRC message *RRCConnectionReconfigurationComplete* as specified in TS 36.331 [10];
 - ...
 - 2> else (*RRCReconfiguration* was received via SRB3):
 - 3> submit the *RRCReconfigurationComplete* message via SRB3 to lower layers for transmission using the new configuration;

NOTE: In the case of SRB1, the random access is triggered by RRC layer itself as there is not necessarily other UL transmission. In the case of SRB3, the random access is triggered by the MAC layer due to arrival of *RRCReconfigurationComplete*.

[TS 38.331, 5.3.5.5.1]

The UE performs the following actions based on a received *CellGroupConfig* IE:

- ...
- 1> if the *CellGroupConfig* contains the *rlc-BearerToReleaseList*:
 - 2> perform RLC bearer release as specified in 5.3.5.5.3;
- 1> if the *CellGroupConfig* contains the *rlc-BearerToAddModList*:

- 2> perform the RLC bearer addition/modification as specified in 5.3.5.5.4;
- 1> if the *CellGroupConfig* contains the *mac-CellGroupConfig*:
 - 2> configure the MAC entity of this cell group as specified in 5.3.5.5.5;
- 1> if the *CellGroupConfig* contains the *sCellToReleaseList*:
 - 2> perform SCell release as specified in 5.3.5.5.8;
- ...
- 1> if the *CellGroupConfig* contains the *sCellToAddModList*:
 - 2> perform SCell addition/modification as specified in 5.3.5.5.9.

[TS 38.331, 5.3.5.5.3]

- 1> for each *logicalChannellIdentity* value included in the *rlc-BearerToReleaseList* that is part of the current UE configuration (LCH release); or
- 1> for each *logicalChannellIdentity* value that is to be released as the result of an SCG release according to 5.3.5.4:
 - 2> release the RLC entity or entities as specified in TS 38.322 [4, clause 5.1.3];
 - 2> release the corresponding logical channel.

[TS 38.331, 5.3.5.5.4]

For each *RLC-Bearer-Config* received in the *rlc-BearerToAddModList* IE the UE shall:

- 1> if the UE's current configuration contains a RLC bearer with the received *logicalChannellIdentity*:
 - ...
 - 2> reconfigure the RLC entity or entities in accordance with the received *rlc-Config*;

[TS 38.331, 5.3.5.5.8]

The UE shall:

- 1> if the release is triggered by reception of the *sCellToReleaseList*:
 - 2> for each *sCellIndex* value included in the *sCellToReleaseList*:
 - 3> if the current UE configuration includes an SCell with value *sCellIndex*:
 - 4> release the SCell.

[TS 38.331, 5.3.5.5.9]

The UE shall:

- 1> for each *sCellIndex* value included in the *sCellToAddModList* that is not part of the current UE configuration (SCell addition):
 - 2> add the SCell, corresponding to the *sCellIndex*, in accordance with the *sCellConfigCommon* and *sCellConfigDedicated*;
 - 2> configure lower layers to consider the SCell to be in deactivated state;
 - ...
- 1> for each *sCellIndex* value included in the *sCellToAddModList* that is part of the current UE configuration (SCell modification):
 - 2> modify the SCell configuration in accordance with the *sCellConfigDedicated*.

[TS 38.331, 5.3.5.6.1]

The UE shall perform the following actions based on a received *RadioBearerConfig* IE:

1> if the *RadioBearerConfig* includes the *srb3-ToRelease* and set to true:

2> perform the SRB release as specified in 5.3.5.6.2;

1> if the *RadioBearerConfig* includes the *srb-ToAddModList*:

2> perform the SRB addition or reconfiguration as specified in 5.3.5.6.3;

[TS 38.331, 5.3.5.6.2]

The UE shall:

1> release the PDCP entity of the SRB3.

[TS 38.331, 5.3.5.6.3]

The UE shall:

1> for each *srb-Identity* value included in the *srb-ToAddModList* that is not part of the current UE configuration (SRB establishment or reconfiguration from E-UTRA PDCP to NR PDCP):

2> establish a PDCP entity and configure it with the security algorithms according to *securityConfig* and apply the keys (K_{RRCEnc} and K_{RRCInt}) associated with the master key (K_{eNB}/ K_{gNB}) or secondary key ($S-K_{gNB}$) as indicated in *keyToUse*, if applicable;

...

2> if the *pdcp-Config* is included:

3> configure the PDCP entity in accordance with the received *pdcp-Config*;

8.2.2.1.1.3 Test description

8.2.2.1.1.3.1 Pre-test conditions

System Simulator:

- E-UTRA Cell 1 is the PCell and NR Cell 1 is the PSCell
- System Information combination as defined in TS 38.508-1 [4] clause 4.4.3.1.1 is used in E-UTRA Cell 1 and NR Cell 1.

UE:

- None.

Preamble:

- The UE is in state RRC_CONNECTED using generic procedure parameter Connectivity (*EN-DC*) and DC bearers (*MCG(s)* and *SCG*) according to TS 38.508-1 [4], Table 4.5.1-1.

8.2.2.1.1.3.2 Test procedure sequence

Table 8.2.2.1.1.3.2-1: Main behaviour

St	Procedure	Message Sequence		TP	Verdict
		U - S	Message		
1	The SS transmits an <i>RRCCONNECTIONRECONFIGURATION</i> message containing NR <i>RRCReconfiguration</i> message to add SRB3 sent on SRB1/E-UTRA Cell 1.	<--	<i>RRCCONNECTIONRECONFIGURATION</i> (<i>RRCReconfiguration</i>)	-	-

Table 8.2.2.1.1.3.3-1A: RRCReconfiguration (Table 8.2.2.1.1.3.3-1)

Derivation Path: TS 38.508-1 [4], Table 4.6.1-13			
Information Element	Value/remark	Comment	Condition
RRCReconfiguration ::= SEQUENCE {			
criticalExtensions CHOICE {			
rrcReconfiguration SEQUENCE {			
secondaryCellGroup	OCTET STRING containing CellGroupConfig according to Table 8.2.2.1.1.3.3-1B.		
}			
}			
}			

Table 8.2.2.1.1.3.3-1B: CellGroupConfig (Table 8.2.2.1.1.3.3-1A)

Derivation Path: TS 38.508-1 [4], Table 4.6.3-19			
Information Element	Value/remark	Comment	Condition
CellGroupConfig ::= SEQUENCE {			
cellGroupId	1		
rlc-BearerToAddModList SEQUENCE (SIZE(1..maxLC-ID)) OF RLC-BearerConfig {	1 entry		
RLC-Bearer-Config[1] SEQUENCE {		entry 1	
logicalChannelIdentity	3		
servedRadioBearer CHOICE {			
srb-Identity	3		
}			
}			
mac-CellGroupConfig	Not Present		
physicalCellGroupConfig	Not Present		
spCellConfig	Not Present		
}			

Table 8.2.2.1.1.3.3-2: RRCReconfiguration (step 3, Table 8.2.2.1.1.3.2-1)

Derivation Path: TS 38.508-1 [4], Table 4.6.1-13			
Information Element	Value/remark	Comment	Condition
RRCReconfiguration ::= SEQUENCE {			
criticalExtensions CHOICE {			
rrcReconfiguration SEQUENCE {			
secondaryCellGroup	OCTET STRING containing CellGroupConfig according to Table 8.2.2.1.1.3.3-3.		
}			
}			
}			

Table 8.2.2.1.1.3.3-3: CellGroupConfig (Table 8.2.2.1.1.3.3-2)

Derivation Path: TS 38.508-1 [4], Table 4.6.3-19			
Information Element	Value/remark	Comment	Condition
CellGroupConfig ::= SEQUENCE {			
cellGroupId	1		
rlc-BearerToAddModList	Not present		
rlc-BearerToReleaseList	Not present		
mac-CellGroupConfig	MAC-CellGroupConfig according to table 8.2.2.1.1.3.3-3a		
physicalCellGroupConfig	Not present		
spCellConfig	Not present		
}			

Table 8.2.2.1.1.3.3-3a: MAC-CellGroupConfig (Table 8.2.2.1.1.3.3-3)

Derivation Path: TS 38.508-1 [4], Table 4.6.3-68			
Information Element	Value/remark	Comment	Condition
MAC-CellGroupConfig ::= SEQUENCE {			
drx-config	Not present.		
schedulingRequestConfig	Not present.		
bsr-Config SEQUENCE {			
periodicBSR-Timer	sf5		
retxBSR-Timer	sf40		
}			
tag-Config	Not present.		
phr-Config	Not present.		
skipUplinkTxDynamic	Not present.		
}			

Table 8.2.2.1.1.3.3-4: RRCReconfiguration (step 5, Table 8.2.2.1.1.3.2-1)

Derivation Path: TS 38.508-1 [4], Table: 4.6.1-13			
Information Element	Value/remark	Comment	Condition
RRCReconfiguration ::= SEQUENCE {			
criticalExtensions CHOICE {			
rrcReconfiguration SEQUENCE {			
radioBearerConfig	RadioBearerConfig	Table 8.2.2.1.1.3.3-4B	
}			
}			
}			

Table 8.2.2.1.1.3.3-4A: PDCP-Config (Table 8.2.2.1.1.3.3-4B)

Derivation Path: TS 38.508-1 [4], Table: 4.6.3-99 with condition SRB			
Information Element	Value/remark	Comment	Condition
PDCP-Config ::= SEQUENCE {			
t-Reordering	ms20		
}			

Table 8.2.2.1.1.3.3-4B: RadioBearerConfig (Table 8.2.2.1.1.3.3-4)

Derivation Path: TS 38.508-1 [4], Table 4.6.3-132 with condition SRB3			
Information Element	Value/remark	Comment	Condition
RadioBearerConfig ::= SEQUENCE {			
srb-ToAddModList SEQUENCE (SIZE (1..2)) OF SRB-ToAddMod {	1 entry		
SRB-ToAddMod[1] SEQUENCE {			
pdcP-Config SEQUENCE {	PDCP-Config		
}			
}			
securityConfig	Not present		
}			

Table 8.2.2.1.1.3.3-5: Void**Table 8.2.2.1.1.3.3-6: RRCConnectionReconfiguration (step 7, Table 8.2.2.1.1.3.2-1)**

Derivation Path: TS 36.508 [7], Table 4.6.1-8 with condition EN-DC_EmbedNR_RRCRecon and EN-DC_Embed_RBConfig			
Information Element	Value/remark	Comment	Condition
RRCConnectionReconfiguration ::= SEQUENCE {			

criticalExtensions CHOICE {			
c1 CHOICE {			
rrcConnectionReconfiguration-r8 SEQUENCE {			
nonCriticalExtension SEQUENCE {			
nonCriticalExtension SEQUENCE {			
nonCriticalExtension SEQUENCE {			
nonCriticalExtension SEQUENCE {			
nonCriticalExtension SEQUENCE {			
nonCriticalExtension SEQUENCE {			
nonCriticalExtension SEQUENCE {			
nonCriticalExtension SEQUENCE {			
nr-Config-r15 CHOICE {}	OCTET STRING including the RRCReconfiguration message according to table 8.2.2.1.1.3.3-8.		
nr-RadioBearerConfig1-r15	RadioBearerConfig according to Table 8.2.2.1.1.3.3-7		
}			
}			
}			
}			
}			
}			
}			
}			
}			
}			
}			
}			
}			
}			

Table 8.2.2.1.1.3.3-7: RadioBearerConfig (Table 8.2.2.1.1.3.3-6)

Derivation Path: TS 38.508-1 [4], Table 4.6.3-132			
Information Element	Value/remark	Comment	Condition
RadioBearerConfig ::= SEQUENCE {			
srb3-ToRelease	true		
securityConfig	Not present		
}			

Table 8.2.2.1.1.3.3-8: RRCReconfiguration (Table 8.2.2.1.1.3.3-6)

Derivation Path: TS 38.508-1 [4], Table 4.6.1-13			
Information Element	Value/remark	Comment	Condition
RRCReconfiguration ::= SEQUENCE {			
criticalExtensions CHOICE {			
rrcReconfiguration SEQUENCE {			
secondaryCellGroup	OCTET STRING containing CellGroupConfig according to Table 8.2.2.1.1.3.3-9.		
}			
}			
}			

Table 8.2.2.1.1.3.3-9: CellGroupConfig (Table 8.2.2.1.1.3.3-8)

Derivation Path: TS 38.508-1 [4], Table 4.6.3-19 with condition EN-DC			
Information Element	Value/remark	Comment	Condition
CellGroupConfig ::= SEQUENCE {			
cellGroupId	1		
rlc-BearerToAddModList	Not Present		

rlc-BearerToReleaseList SEQUENCE (SIZE(1..maxLC-ID)) OF LogicalChannelIdentity {	1 entry		
logicalChannelIdentity[1]	3	entry 1	
}			
mac-CellGroupConfig SEQUENCE {	Not Present		
tag-Config	Not Present		
phr-Config	Not Present		
}			
physicalCellGroupConfig	Not Present		
rfl-TimersAndConstants	Not Present		
}			

8.2.2.1.2 SRB3 Establishment, Reconfiguration and Release / NR addition, modification and release / NR-DC

8.2.2.1.2.1 Test Purpose (TP)

(1)

```
with { UE in NR RRC_CONNECTED state with NR-DC }
ensure that {
  when { UE receives an RRCReconfiguration message to establish SRB3 }
  then { UE establishes SRB3 and sends an RRCReconfigurationComplete message on SRB1 }
}
```

(2)

```
with { UE in NR RRC_CONNECTED state with NR-DC and SRB3 configured }
ensure that {
  when { UE receives an RRCReconfiguration message on SRB3 to reconfigure NR MAC of the SCG }
  then { UE reconfigures NR MAC and sends RRCReconfigurationComplete message on SRB3 }
}
```

(3)

```
with { UE in NR RRC_CONNECTED state with NR-DC and SRB3 configured }
ensure that {
  when { UE receives an RRCReconfiguration message on SRB3 to reestablish NR PDCP of the SCG }
  then { UE reestablishes NR PDCP and sends RRCReconfigurationComplete message on SRB3 }
}
```

(4)

```
with { UE in NR RRC_CONNECTED state with NR-DC and SRB3 configured }
ensure that {
  when { UE receives an RRCReconfiguration message to release SRB3 }
  then { UE releases SRB3 and sends an RRCReconfigurationComplete message on SRB1 }
}
```

8.2.2.1.2.2 Conformance requirements

References: The conformance requirements covered in the present test case are specified in: TS 38.331, clauses 5.3.5.3, 5.3.5.5.1, 5.3.5.5.3, 5.3.5.5.4, 5.3.5.5.8, 5.3.5.5.9, 5.3.5.6.1, 5.3.5.6.2 and 5.3.5.6.3. Unless otherwise stated these are Rel-15 requirements.

[TS 38.331, 5.3.5.3]

The UE shall perform the following actions upon reception of the *RRCReconfiguration*:

...

1> if the *RRCReconfiguration* includes the *secondaryCellGroup*:

2> perform the cell group configuration for the SCG according to 5.3.5.5;

- 1> if the *RRCReconfiguration* includes the *mrdc-SecondaryCellGroupConfig*:
 - 2> if the *mrdc-SecondaryCellGroupConfig* is set to *setup*:
 - 3> if the *mrdc-SecondaryCellGroupConfig* includes *mrdc-ReleaseAndAdd*:
 - 4> perform MR-DC release as specified in clause 5.3.5.10;
 - 3> if the received *mrdc-SecondaryCellGroup* is set to *nr-SCG*:
 - 4> perform the RRC reconfiguration according to 5.3.5.3 for the *RRCReconfiguration* message included in *nr-SCG*;
 - ...
 - 1> if the *RRCReconfiguration* message includes the *radioBearerConfig*:
 - 2> perform the radio bearer configuration according to 5.3.5.6;
 - ...
 - 1> set the content of the *RRCReconfigurationComplete* message as follows:
 - ...
 - 2> if the *RRCReconfiguration* message includes the *mrdc-SecondaryCellGroupConfig* with *mrdc-SecondaryCellGroup* set to *nr-SCG*:
 - 3> include in the *nr-SCG-Response* the *RRCReconfigurationComplete* message;
 - ...
 - 1> else if the *RRCReconfiguration* message was received within the *nr-SCG* within *mrdc-SecondaryCellGroup* (UE in NR-DC, *mrdc-SecondaryCellGroup* was received in *RRCReconfiguration* via SRB1):
 - 2> if *reconfigurationWithSync* was included in *spCellConfig* in *nr-SCG*:
 - 3> initiate the Random Access procedure on the PSCell, as specified in TS 38.321 [3];
 - 2> else
 - 3> the procedure ends;
- NOTE 2a: The order in which the UE sends the *RRCReconfigurationComplete* message and performs the Random Access procedure towards the SCG is left to UE implementation.
- 1> else if the *RRCReconfiguration* message was received via SRB3 (UE in NR-DC):
 - 2> submit the *RRCReconfigurationComplete* message via SRB3 to lower layers for transmission using the new configuration;
 - 1> else (*RRCReconfiguration* was received via SRB1):
 - 2> submit the *RRCReconfigurationComplete* message via SRB1 to lower layers for transmission using the new configuration;
 - ...
 - 1> if *reconfigurationWithSync* was included in *spCellConfig* of an MCG or SCG, and when MAC of an NR cell group successfully completes a Random Access procedure triggered above:
 - 2> stop timer T304 for that cell group;
 - 2> apply the parts of the CSI reporting configuration, the scheduling request configuration and the sounding RS configuration that do not require the UE to know the SFN of the respective target SpCell, if any;

- 2> apply the parts of the measurement and the radio resource configuration that require the UE to know the SFN of the respective target SpCell (e.g. measurement gaps, periodic CQI reporting, scheduling request configuration, sounding RS configuration), if any, upon acquiring the SFN of that target SpCell;

...

[TS 38.331, 5.3.5.1]

In (NG)EN-DC and NR-DC, SRB3 can be used for measurement configuration and reporting, to (re-)configure MAC, RLC, physical layer and RLF timers and constants of the SCG configuration, and to reconfigure PDCP for DRBs associated with the S-K_{gNB} or SRB3, and to reconfigure SDAP for DRBs associated with S-K_{gNB} in (NG)EN-DC and NR-DC, provided that the (re-)configuration does not require any MN involvement. In EN-DC, only *measConfig*, *radioBearerConfig* and/or *secondaryCellGroup* are included in *RRCReconfiguration* received via SRB3.

[TS 38.331, 5.3.5.5.1]

The UE performs the following actions based on a received *CellGroupConfig* IE:

...

- 1> if the *CellGroupConfig* contains the *rlc-BearerToReleaseList*:
 - 2> perform RLC bearer release as specified in 5.3.5.5.3;
- 1> if the *CellGroupConfig* contains the *rlc-BearerToAddModList*:
 - 2> perform the RLC bearer addition/modification as specified in 5.3.5.5.4;
- 1> if the *CellGroupConfig* contains the *mac-CellGroupConfig*:
 - 2> configure the MAC entity of this cell group as specified in 5.3.5.5.5;
- 1> if the *CellGroupConfig* contains the *sCellToReleaseList*:
 - 2> perform SCell release as specified in 5.3.5.5.8;
- ...
- 1> if the *CellGroupConfig* contains the *sCellToAddModList*:
 - 2> perform SCell addition/modification as specified in 5.3.5.5.9.

[TS 38.331, 5.3.5.5.3]

- 1> for each *logicalChannelIdentity* value included in the *rlc-BearerToReleaseList* that is part of the current UE configuration (LCH release); or
- 1> for each *logicalChannelIdentity* value that is to be released as the result of an SCG release according to 5.3.5.4:
 - 2> release the RLC entity or entities as specified in TS 38.322 [4, clause 5.1.3];
 - 2> release the corresponding logical channel.

[TS 38.331, 5.3.5.5.4]

For each *RLC-Bearer-Config* received in the *rlc-BearerToAddModList* IE the UE shall:

- 1> if the UE's current configuration contains a RLC bearer with the received *logicalChannelIdentity*:
 - ...
 - 2> reconfigure the RLC entity or entities in accordance with the received *rlc-Config*;

[TS 38.331, 5.3.5.5.8]

The UE shall:

- 1> if the release is triggered by reception of the *sCellToReleaseList*:
 - 2> for each *sCellIndex* value included in the *sCellToReleaseList*:
 - 3> if the current UE configuration includes an SCell with value *sCellIndex*:
 - 4> release the SCell.

[TS 38.331, 5.3.5.5.9]

The UE shall:

- 1> for each *sCellIndex* value included in the *sCellToAddModList* that is not part of the current UE configuration (SCell addition):
 - 2> add the SCell, corresponding to the *sCellIndex*, in accordance with the *sCellConfigCommon* and *sCellConfigDedicated*;
 - 2> configure lower layers to consider the SCell to be in deactivated state;
 - ...
- 1> for each *sCellIndex* value included in the *sCellToAddModList* that is part of the current UE configuration (SCell modification):
 - 2> modify the SCell configuration in accordance with the *sCellConfigDedicated*.

[TS 38.331, 5.3.5.6.1]

The UE shall perform the following actions based on a received *RadioBearerConfig* IE:

- 1> if the *RadioBearerConfig* includes the *srb3-ToRelease* and set to true:
 - 2> perform the SRB release as specified in 5.3.5.6.2;
- 1> if the *RadioBearerConfig* includes the *srb-ToAddModList*:
 - 2> perform the SRB addition or reconfiguration as specified in 5.3.5.6.3;

[TS 38.331, 5.3.5.6.2]

The UE shall:

- 1> release the PDCP entity of the SRB3.

[TS 38.331, 5.3.5.6.3]

The UE shall:

- 1> for each *srb-Identity* value included in the *srb-ToAddModList* that is not part of the current UE configuration (SRB establishment or reconfiguration from E-UTRA PDCP to NR PDCP):
 - 2> establish a PDCP entity and configure it with the security algorithms according to *securityConfig* and apply the keys (K_{RRCenc} and K_{RRCint}) associated with the master key (K_{eNB} / K_{gNB}) or secondary key ($S\text{-}K_{\text{gNB}}$) as indicated in *keyToUse*, if applicable;
 - ...
- 2> if the *pdcp-Config* is included:
 - 3> configure the PDCP entity in accordance with the received *pdcp-Config*;

8.2.2.1.2.3 Test description

8.2.2.1.2.3.1 Pre-test conditions

System Simulator:

- NR Cell 1 is the PCell and NR Cell 10 is the PSCell
- System information combination NR-4 as defined in TS 38.508-1 [4] clause 4.4.3.1.2 is used in NR cells.

UE:

- None.

Preamble:

- The UE is in state RRC_CONNECTED using generic procedure parameter Connectivity (NR-DC) and NR-DC bearers (MCG(s) and SCG) according to TS 38.508-1 [4], Table 4.5.1-1.

8.2.2.1.2.3.2 Test procedure sequence

Table 8.2.2.1.2.3.2-1: Main behaviour

St	Procedure	Message Sequence		TP	Verdict
		U - S	Message		
1	The SS transmits an <i>RRCReconfiguration</i> message via SRB1 to establish SRB3.	<--	NR RRC: <i>RRCReconfiguration</i>	-	-
2	Check: Does the UE transmit an <i>RRCReconfigurationComplete</i> message via SRB1?	-->	NR RRC: <i>RRCReconfigurationComplete</i>	1	P
3	The SS transmits an <i>RRCReconfiguration</i> message via SRB3 to reconfigure NR MAC.	<--	NR RRC: <i>RRCReconfiguration</i>	-	-
4	Check: Does the UE transmit an <i>RRCReconfigurationComplete</i> message via SRB3?	-->	NR RRC: <i>RRCReconfigurationComplete</i>	2	P
5	The SS transmits an <i>RRCReconfiguration</i> message via SRB3 to reconfigure PDCP.	<--	NR RRC: <i>RRCReconfiguration</i>	-	-
6	Check: Does the UE transmit an <i>RRCReconfigurationComplete</i> message via SRB3?	-->	NR RRC: <i>RRCReconfigurationComplete</i>	3	P
7	The SS transmits an <i>RRCReconfiguration</i> message via SRB1 to release SRB3.	<--	NR RRC: <i>RRCReconfiguration</i>	-	-
8	Check: Does the UE transmit an <i>RRCReconfigurationComplete</i> message via SRB1?	-->	NR RRC: <i>RRCConnectionReconfigurationComplete</i>	4	P

8.2.2.1.2.3.3 Specific message contents

Table 8.2.2.1.2.3.3-1: *RRCReconfiguration* (step 1, Table 8.2.2.1.2.3.2-1)

Derivation Path: TS 38.508-1 [4], Table 4.6.1-13 with condition NR-DC			
Information Element	Value/remark	Comment	Condition
<i>RRCReconfiguration</i> ::= SEQUENCE {			
<i>criticalExtensions</i> CHOICE {			
<i>rrcReconfiguration</i> SEQUENCE {			
<i>radioBearerConfig</i>	Not present		
<i>nonCriticalExtension</i> SEQUENCE {			
<i>masterCellGroup</i>	Not present		
<i>nonCriticalExtension</i> SEQUENCE {			
<i>nonCriticalExtension</i> SEQUENCE {			
<i>mrdc-SecondaryCellGroupConfig</i> CHOICE {			
<i>setup</i> SEQUENCE {			

mrdc-SecondaryCellGroup CHOICE {			
nr-SCG	RRCReconfiguration-SCG	Table 8.2.2.1.2.3.3-2	
}			
}			
radioBearerConfig2	RadioBearerConfig as per TS 38.508-1[4] Table 4.6.3-132 with condition SRB3		
}			
}			
}			
}			
}			
}			

Table 8.2.2.1.2.3.3-2: RRCReconfiguration-SCG (Table 8.2.2.1.2.3.3-1)

Derivation Path: TS 38.508-1 [4], Table 4.6.1-13 with condition NR-DC_SCG			
Information Element	Value/remark	Comment	Condition
RRCReconfiguration ::= SEQUENCE {			
criticalExtensions CHOICE {			
rrcReconfiguration SEQUENCE {			
radioBearerConfig	Not present		
secondaryCellGroup	CellGroupConfig	Table 8.2.2.1.2.3.3-3	
}			
}			
}			

Table 8.2.2.1.2.3.3-3: CellGroupConfig (Table 8.2.2.1.2.3.3-2)

Derivation Path: TS 38.508-1 [4], Table 4.6.3-19			
Information Element	Value/remark	Comment	Condition
CellGroupConfig ::= SEQUENCE {			
cellGroupId	CellGroupId as per TS 38.508-1[4] Table 4.6.3-20 with condition NR-DC_SCG		
rlc-BearerToAddModList SEQUENCE (SIZE(1..maxLC-ID)) OF BearerConfig {	1 entry		
RLC-Bearer-Config[1]	RLC-BearerConfig as per TS 38.508-1[4] Table 4.6.3-148 with condition SRB3	entry 1	
}			
mac-CellGroupConfig	Not Present		
physicalCellGroupConfig	Not Present		
spCellConfig	Not Present		
}			

Table 8.2.2.1.2.3.3-3A: RRCReconfigurationComplete (Steps 2/8, Table 4.5.4.2-5)

Derivation Path: TS 38.508-1, table 4.6.1-14 with condition NR-SCG
--

Table 8.2.2.1.2.3.3-4: RRCReconfiguration (step 3, Table 8.2.2.1.2.3.2-1)

Derivation Path: TS 38.508-1 [4], Table 4.6.1-13 with condition NR-DC_SCG			
Information Element	Value/remark	Comment	Condition

RRCReconfiguration ::= SEQUENCE {			
criticalExtensions CHOICE {			
rrcReconfiguration SEQUENCE {			
secondaryCellGroup	CellGroupConfig	Table 8.2.2.1.2.3.3-5	
}			
}			
}			

Table 8.2.2.1.2.3.3-5: CellGroupConfig (Table 8.2.2.1.2.3.3-2)

Derivation Path: TS 38.508-1 [4], Table 4.6.3-19			
Information Element	Value/remark	Comment	Condition
CellGroupConfig ::= SEQUENCE {			
cellGroupId	CellGroupId as per TS 38.508-1[4] Table 4.6.3-20 with condition NR-DC_SCG		
rlc-BearerToAddModList	Not present		
rlc-BearerToReleaseList	Not present		
mac-CellGroupConfig	MAC-CellGroupConfig as per TS 38.508-1[4] Table 4.6.3-68 with condition DRX		
physicalCellGroupConfig	Not present		
spCellConfig	Not present		
}			

Table 8.2.2.1.2.3.3-6: RRCReconfiguration (step 5, Table 8.2.2.1.2.3.2-1)

Derivation Path: TS 38.508-1 [4], Table 4.6.1-13			
Information Element	Value/remark	Comment	Condition
RRCReconfiguration ::= SEQUENCE {			
criticalExtensions CHOICE {			
rrcReconfiguration ::= SEQUENCE {			
radioBearerConfig	RadioBearerConfig	Table 8.2.2.1.2.3.3-7	
}			
}			
}			

Table 8.2.2.1.2.3.3-7: RadioBearerConfig (Table 8.2.2.1.2.3.3-6)

Derivation Path: TS 38.508-1 [4], Table 4.6.3-132 with condition SRB3			
Information Element	Value/remark	Comment	Condition
RadioBearerConfig ::= SEQUENCE {			
srb-ToAddModList SEQUENCE (SIZE (1..2)) OF SRB-ToAddMod {	1 entry		
SRB-ToAddMod[1] SEQUENCE {			
reestablishPDCP	true		
}			
}			
securityConfig	Not present		
}			

Table 8.2.2.1.2.3.3-8: Void

Table 8.2.2.1.2.3.3-9: RRCReconfiguration (step 7, Table 8.2.2.1.2.3.2-1)

Derivation Path: TS 38.508-1 [4], Table 4.6.1-13 with condition NR-DC			
Information Element	Value/remark	Comment	Condition
RRCReconfiguration ::= SEQUENCE {			
criticalExtensions CHOICE {			
rrcReconfiguration SEQUENCE {			
radioBearerConfig	Not present		
nonCriticalExtension SEQUENCE {			
masterCellGroup	Not present		
nonCriticalExtension SEQUENCE {			
nonCriticalExtension SEQUENCE {			
mrdc-SecondaryCellGroupConfig CHOICE {			
setup SEQUENCE {			
mrdc-ReleaseAndAdd	true		
mrdc-SecondaryCellGroup CHOICE {			
nr-SCG	RRCReconfiguration-SCG	Table 8.2.2.1.2.3.3-10	
}			
}			
}			
radioBearerConfig2	RadioBearerConfig	Table 8.2.2.1.2.3.3-11	
}			
}			
}			

Table 8.2.2.1.2.3.3-10: RRCReconfiguration-SCG (Table 8.2.2.1.2.3.3-9)

Derivation Path: TS 38.508-1 [4], Table 4.6.1-13 with condition NR-DC_SCG			
Information Element	Value/remark	Comment	Condition
RRCReconfiguration ::= SEQUENCE {			
criticalExtensions CHOICE {			
rrcReconfiguration SEQUENCE {			
radioBearerConfig	Not present		
secondaryCellGroup	CellGroupConfig	Table 8.2.2.1.2.3.3-12	
}			
}			

Table 8.2.2.1.2.3.3-11: RadioBearerConfig (Table 8.2.2.1.2.3.3-10)

Derivation Path: TS 38.508-1 [4], Table 4.6.3-132			
Information Element	Value/remark	Comment	Condition
RadioBearerConfig ::= SEQUENCE {			
srb3-ToRelease	true		
securityConfig	Not present		
}			

Table 8.2.2.1.2.3.3-12: CellGroupConfig (Table 8.2.2.1.2.3.3-10)

Derivation Path: TS 38.508-1 [4], Table 4.6.3-19 with condition NR-DC_SCG			
Information Element	Value/remark	Comment	Condition
CellGroupConfig ::= SEQUENCE {			
rlc-BearerToAddModList	Not Present		
rlc-BearerToReleaseList SEQUENCE (SIZE(1..maxLC-ID)) OF LogicalChannelIdentity {	1 entry		

logicalChannelIdentity[1]	LogicalChannelIdentity as per TS 38.508-1[4] Table 4.6.3-67 with condition SRB3	entry 1	
}			
}			

8.2.2.2 Split SRB Establishment and Release

8.2.2.2.1 Split SRB Establishment and Release / EN-DC

8.2.2.2.1.1 Test Purpose (TP)

(1)

```
with { UE in RRC_CONNECTED state with EN-DC, and, MCG(s) (E-UTRA PDCP) and SCG }
ensure that {
  when { UE receives an RRCConnectionReconfiguration message on SRB1 to configure split SRB1 and
split SRB2 with PDCP duplication activated }
  then { UE configures the split SRBs and sends an RRCConnectionReconfigurationComplete message on
split SRB1 with the PDCP PDU duplicated on the MCG and SCG path }
}
```

(2)

```
with { UE in RRC_CONNECTED state with EN-DC, and, MCG(s) (E-UTRA PDCP) and SCG and split SRB
configured }
ensure that {
  when { UE receives an RRCConnectionReconfiguration message on split SRB1 over the SCG path to
release split SRB1 and split SRB2 }
  then { UE releases split SRB1 and split SRB2 and sends an RRCConnectionReconfigurationComplete
message on SRB1 over the MCG path}
}
```

(3)

```
with { UE in RRC_CONNECTED state in EN-DC mode with split SRB1 and split SRB2 configured with PDCP
duplication }
ensure that {
  when { UE receives a CounterCheck on split SRB1 over the SCG path }
  then { UE replies with CounterCheckResponse on split SRB1 duplicated on the MCG and SCG path}
}
```

(4)

```
with { UE in RRC_CONNECTED state in EN-DC mode with split SRB1 and split SRB2 configured with PDCP
duplication }
ensure that {
  when { UE receives a IDENTITY REQUEST on split SRB2 over the SCG path }
  then { UE replies with IDENTITY RESPONSE on split SRB2 duplicated on the MCG and SCG path}
}
```

8.2.2.2.1.2 Conformance requirements

References: The conformance requirements covered in the present TC are specified in: TS 36.331, clause 5.3.5.3 and TS 38.331: clauses 5.3.5.3, 5.3.5.5.3, 5.3.5.6.1 and 5.3.5.6.3. Unless and otherwise stated these are Rel-15 requirements

[TS 36.331, clause 5.3.5.3]

If the *RRCConnectionReconfiguration* message does not include the *mobilityControlInfo* and the UE is able to comply with the configuration included in this message, the UE shall:

...

- 1> if the received *RRCConnectionReconfiguration* includes the *nr-SecondaryCellGroupConfig*:
- 2> perform NR RRC Reconfiguration as specified in TS 38.331 [82], clause 5.3.5.3;

- 1> if the received *RRCConnectionReconfiguration* includes the *nr-RadioBearerConfig1*:
 - 2> perform radio bearer configuration as specified in TS 38.331 [82], clause 5.3.5.6;
- 1> if the received *RRCConnectionReconfiguration* includes the *nr-RadioBearerConfig2*:
 - 2> perform radio bearer configuration as specified in TS 38.331 [82], clause 5.3.5.6;
- ...
- 1> set the content of *RRCConnectionReconfigurationComplete* message as follows:
 - ...
 - 2> if the received *RRCConnectionReconfiguration* message included *nr-SecondaryCellGroupConfig*:
 - 3> include *scg-ConfigResponseNR* in accordance with TS 38.331 [82], clause 5.3.5.3;
- 1> submit the *RRCConnectionReconfigurationComplete* message to lower layers for transmission using the new configuration, upon which the procedure ends;

[TS 38.331, clause 5.3.5.3]

The UE shall perform the following actions upon reception of the *RRCReconfiguration*:

- 1> if the *RRCReconfiguration* includes the *secondaryCellGroup*:
 - 2> perform the cell group configuration for the SCG according to 5.3.5.5;
- 1> if the *RRCReconfiguration* message contains the *radioBearerConfig*:
 - 2> perform the radio bearer configuration according to 5.3.5.6;
- ...
- 1> if the UE is configured with E-UTRA *nr-SecondaryCellGroupConfig* (MCG is E-UTRA):
 - 2> if *RRCReconfiguration* was received via SRB1:
 - 3> submit the *RRCReconfigurationComplete* via the E-UTRA MCG embedded in E-UTRA RRC message *RRCConnectionReconfigurationComplete* as specified in TS 36.331 [10];

[TS 38.331, clause 5.3.5.5.3]

The UE shall:

- 1> for each *logicalChannelIdentity* value included in the *rlc-BearerToReleaseList* that is part of the current UE configuration (LCH release); or
- 1> for each *logicalChannelIdentity* value that is to be released as the result of an SCG release according to 5.3.5.4:
 - 2> release the RLC entity or entities as specified in TS 38.322 [4], clause 5.1.3;
 - 2> release the corresponding logical channel

[TS 38.331, clause 5.3.5.6.1]

The UE shall perform the following actions based on a received *RadioBearerConfig* IE:

- ...
- 1> if the *RadioBearerConfig* includes the *srb-ToAddModList*:
 - 2> perform the SRB addition or reconfiguration as specified in 5.3.5.6.3;

[TS 38.331, clause 5.3.5.6.3]

The UE shall:

- 1> for each *srb-Identity* value included in the *srb-ToAddModList* that is not part of the current UE configuration (SRB establishment or reconfiguration from E-UTRA PDCP to NR PDCP):
 - 2> establish a PDCP entity;
 - 2> if AS security has been activated:
 - 3> if target RAT of handover is E-UTRA/5GC, or;
 - 3> if the UE is only connected to E-UTRA/5GC:
 - 4> configure the PDCP entity with the security algorithms and keys (K_{RRCEnc} and K_{RRCint}) configured/derived as specified in TS 36.331 [10];
 - 3> else:
 - 4> configure the PDCP entity with the security algorithms according to *securityConfig* and apply the keys (K_{RRCEnc} and K_{RRCint}) associated with the master key (K_{eNB}/K_{gNB}) or secondary key ($S-K_{gNB}$) as indicated in *keyToUse*, if applicable;
 - 2> if the current UE configuration as configured by E-UTRA in TS 36.331 [10] includes an SRB identified with the same *srb-Identity* value:
 - 3> associate the E-UTRA RLC entity and DCCH of this SRB with the NR PDCP entity;
 - 3> release the E-UTRA PDCP entity of this SRB;
 - 2> if the *pdcp-Config* is included:
 - 3> configure the PDCP entity in accordance with the received *pdcp-Config*;
 - 2> else:
 - 3> configure the PDCP entity in accordance with the default configuration defined in 9.2.1 for the corresponding SRB;

8.2.2.2.1.3 Test description

8.2.2.2.1.3.1 Pre-test conditions

System Simulator:

- E-UTRA Cell 1 is the PCell and NR Cell 1 is the PSCell.

UE:

- None.

Preamble:

- The UE is in state RRC_CONNECTED using generic procedure parameter Connectivity (*EN-DC*), Bearers (MCG(*s*) and SCG) established according to TS 38.508-1 [4], clause 4.5.4.

8.2.2.2.1.3.2 Test procedure sequence

Table 8.2.2.1.3.2-1: Main behaviour

St	Procedure	Message Sequence		TP	Verdict
		U - S	Message		
0	The SS is configured not to send RLC ACK on split SRB1.	-	-	-	-
1	SS transmits <i>RRCConnectionReconfiguration</i> message containing NR <i>RRCReconfiguration</i>	<--	<i>RRCConnectionReconfiguration</i> (<i>RRCReconfiguration</i>)	-	-

	message to configure split SRB1 and split SRB2.				
-	EXCEPTION: In parallel to the event described in step 2 the steps specified in Table 8.2.2.2.1.3.2-2 is taking place.	-	-	-	-
2	Check: Does the UE send a <i>RRCConnectionReconfigurationComplete</i> message containing NR <i>RRCReconfigurationComplete</i> message on split SRB1 duplicated over the SCG path? Note: The UE RLC might re-transmit this message several times (no more than <i>maxRetxThreshold</i>) until RLC ACK is sent by the SS.	-->	<i>RRCConnectionReconfigurationComplete</i> (<i>RRCReconfigurationComplete</i>)	1	P
2A	After steps in table 8.2.2.2.1.3.2-2 are completed the SS is configured to send RLC ACK on split SRB1 and the last message received in step 2 is acknowledged.	-	-	-	-
2B	The SS is configured not to send RLC ACK on split SRB1.	-	-	-	-
3	SS transmits <i>CounterCheck</i> message for NR capabilities on split SRB1 over the SCG path.	<--	<i>CounterCheck</i>	-	-
-	EXCEPTION: In parallel to the event described in step 4 the steps specified in Table 8.2.2.2.1.3.2-3 is taking place.	-	-	-	-
4	Check: Does the UE send <i>CounterCheckResponse</i> message including UE radio access capability information for NR on split SRB1 duplicated over the SCG path? Note: The UE RLC might re-transmit this message several times (no more than <i>maxRetxThreshold</i>) until RLC ACK is sent by the SS.	-->	<i>CounterCheckResponse</i>	3	P
4A	After steps in table 8.2.2.2.1.3.2-3 are completed the SS is configured to send RLC ACK on split SRB1 and the last message received in step 4 is acknowledged.	-	-	-	-
4B	The SS is configured not to send RLC ACK on split SRB2.	-	-	-	-
4C	The SS sends <i>DLInformationTransfer</i> message (carrying IDENTITY REQUEST message) on split SRB2 over the SCG path.	<--	<i>DLInformationTransfer</i> (IDENTITY REQUEST)	-	-
-	EXCEPTION: In parallel to the event described in step 4B the steps specified in Table 8.2.2.2.1.3.2-4 is taking place.	-	-	-	-
4D	Check: Does the UE send the <i>ULInformationTransfer</i> message (carrying IDENTITY RESPONSE message) on split SRB2 duplicated over the SCG path? Note: The UE RLC might re-transmit this message several times (no more than <i>maxRetxThreshold</i>) until RLC ACK is sent by the SS.	-->	<i>ULInformationTransfer</i> (IDENTITY RESPONSE)	4	P
4E	After steps in table 8.2.2.2.1.3.2-4 are completed the SS is configured to send RLC ACK on split SRB2 and the last message received in step 4D is acknowledged.	-	-	-	-
5	SS transmits <i>RRCConnectionReconfiguration</i> message containing NR <i>RRCReconfiguration</i> message on split SRB1 to release split SRB1 and split SRB2 over the SCG path.	<--	<i>RRCConnectionReconfiguration</i> (<i>RRCReconfiguration</i>)	-	-
6	Check: Does the UE send <i>RRCConnectionReconfigurationComplete</i> containing NR <i>RRCReconfigurationComplete</i> message on SRB1 over the MCG path?	-->	<i>RRCConnectionReconfigurationComplete</i> (<i>RRCReconfigurationComplete</i>)	2	P

	Note: The SS makes sure that the UE does not send any message on the SCG path. The SS sends the RLC ACK for this message.				
--	--	--	--	--	--

Table 8.2.2.2.1.3.2-2: Parallel behaviour

St	Procedure	Message Sequence		TP	Verdict
		U - S	Message		
1	The UE transmits an <i>RRCConnectionReconfigurationComplete</i> message on SRB1 over the MCG path/E-UTRA Cell 1 Note: The UE RLC might re-transmit this message several times (no more than maxRetxThreshold) until RLC ACK is sent by the SS.	-->	<i>RRCConnectionReconfigurationComplete (RRCReconfigurationComplete)</i>	-	-

Table 8.2.2.2.1.3.2-3: Parallel behaviour

St	Procedure	Message Sequence		TP	Verdict
		U - S	Message		
1	The UE transmits an <i>CounterCheckResponse</i> message on SRB1 over the MCG path/E-UTRA Cell 1 Note: The UE RLC might re-transmit this message several times (no more than maxRetxThreshold) until RLC ACK is sent by the SS.	-->	<i>CounterCheckResponse</i>	-	-

Table 8.2.2.2.1.3.2-4: Parallel behaviour

St	Procedure	Message Sequence		TP	Verdict
		U - S	Message		
1	The UE transmits an <i>DLInformationTransfer</i> (IDENTITY RESPONSE) message on SRB2 over the MCG path/E-UTRA Cell 1 Note: The UE RLC might re-transmit this message several times (no more than maxRetxThreshold) until RLC ACK is sent by the SS.	-->	<i>DLInformationTransfer</i> (IDENTITY RESPONSE)	-	-

8.2.2.2.1.3.3 Specific message contents

Table 8.2.2.2.1.3.3-1: RRCConnectionReconfiguration (step 1 Table 8.2.2.2.1.3.2-2)

Derivation Path: TS 36.508 [7], Table 4.6.1-8 with condition MCG_and_SCG and condition HO			
Information Element	Value/remark	Comment	Condition
RRCConnectionReconfiguration ::= SEQUENCE {			
criticalExtensions CHOICE {			
c1 CHOICE {			
rrcConnectionReconfiguration-r8 SEQUENCE {			
mobilityControllInfo	MobilityControllInfo-HO-SameCell	As per Table 8.2.2.2.1.3.3-1a	
nonCriticalExtension SEQUENCE {			
nonCriticalExtension SEQUENCE {			
nonCriticalExtension SEQUENCE {			
nonCriticalExtension SEQUENCE {			
nonCriticalExtension SEQUENCE {			

nonCriticalExtension SEQUENCE {			
nonCriticalExtension SEQUENCE {			
nonCriticalExtension SEQUENCE {			
nr-Config-r15 CHOICE {			
setup SEQUENCE {			
nr-SecondaryCellGroupConfig-r15	OCTET STRING containing RRCReconfiguration-SplitSRB	As per Table 8.2.2.2.1.3.3-1	
}			
}			
nr-RadioBearerConfig1-r15	OCTET STRING containing RadioBearerConfig-SplitSRB	As per Table 8.2.2.2.1.3.3-4	
}			
}			
}			
}			
}			
}			
}			
}			
}			
}			
}			
}			
}			
}			
}			

Table 8.2.2.2.1.3.3-1a: MobilityControllInfo-HO-SameCell (Table 8.2.2.2.1.3.3-1)

Derivation Path: TS 36.508 [7], Table 4.6.5-1			
Information Element	Value/remark	Comment	Condition
MobilityControllInfo-HO ::= SEQUENCE {			
targetPhysCellId	PhysicalCellId of E-UTRA Cell 1		
carrierFreq	Not present		
}			

Table 8.2.2.2.1.3.3-2: RRCReconfiguration-SplitSRB (Table 8.2.2.2.1.3.3-1)

Derivation Path: TS 38.508-1 [4], Table 4.6.1-13 with condition EN-DC_HO			
Information Element	Value/remark	Comment	Condition
RRCReconfiguration ::= SEQUENCE {			
criticalExtensions CHOICE {			
rrcReconfiguration SEQUENCE {			
secondaryCellGroup	CellGroupConfig-SplitSRB		
}			
}			
}			

Table 8.2.2.2.1.3.3-3: CellGroupConfig-SplitSRB (Table 8.2.2.2.1.3.3-2)

Derivation Path: TS 38.508-1 [4], Table 4.6.3-19			
Information Element	Value/remark	Comment	Condition
CellGroupConfig ::= SEQUENCE {			
cellGroupId	1		
rlc-BearerToAddModList SEQUENCE (SIZE(1..maxLC-ID)) OF RLC-BearerConfig {	2 entries		
RLC-BearerConfig[1] SEQUENCE {		entry 1	
logicalChannelIdentity	1		
servedRadioBearer CHOICE {			

srb-Identity	1		
}			
reestablishRLC	Not present		
RLC-Config	Not present.		
mac-LogicalChannelConfig	Not present		
}			
RLC-BearerConfig[2] SEQUENCE {		entry 2	
logicalChannelIdentity	2		
servedRadioBearer CHOICE {			
srb-Identity	2		
}			
reestablishRLC	Not present		
RLC-Config	Not present		
mac-LogicalChannelConfig	Not present		
}			
}			
}			

Table 8.2.2.2.1.3.3-4: RadioBearerConfig-SplitSRB (step 1, Table 8.2.2.2.1.3.3-1)

Derivation Path: TS 38.508-1 [4], Table 4.6.3-132			
Information Element	Value/remark	Comment	Condition
RadioBearerConfig ::= SEQUENCE {			
srb-ToAddModList SEQUENCE (SIZE (1..2)) OF SRB-ToAddMod {	2 entries		
SRB-ToAddMod[1] SEQUENCE {		entry 1	
srb-Identity	1		
pdcp-Config	PDCP-Config-SRB with condition SRB1		
}			
SRB-ToAddMod[2] SEQUENCE {		entry 2	
srb-Identity	2		
pdcp-Config	PDCP-Config-SRB with condition SRB2		
}			
}			
}			

Table 8.2.2.2.1.3.3-5: PDCP-Config-SRB (Table 8.2.2.2.1.3.3-4)

Derivation Path: TS 38.508-1 [4], Table 4.6.3-99 with condition Split_SRB			
Information Element	Value/remark	Comment	Condition
PDCP-Config ::= SEQUENCE {			
moreThanOneRLC SEQUENCE {			
primaryPath SEQUENCE {			
logicalChannel	1		SRB1
logicalChannel	2		SRB2
}			
pdcp-Duplication	TRUE		
}			

Table 8.2.2.2.1.3.3-6: Void

Table 8.2.2.2.1.3.3-7: RRCConnectionReconfigurationComplete (steps 2, 6, Table 8.2.2.2.1.3.2-2)

Derivation Path: TS 36.508 [7], Table 4.6.1-9			
Information Element	Value/remark	Comment	Condition
RRCConnectionReconfigurationComplete ::= SEQUENCE {			

criticalExtensions CHOICE {			
rrcConnectionReconfigurationComplete-r8			
SEQUENCE {			
nonCriticalExtension SEQUENCE {			
nonCriticalExtension SEQUENCE {			
nonCriticalExtension SEQUENCE {			
nonCriticalExtension SEQUENCE {			
nonCriticalExtension SEQUENCE {			
nonCriticalExtension SEQUENCE {			
scg-ConfigResponseNR-r15	Present		
}			
}			
}			
}			
}			
}			
}			

Table 8.2.2.2.1.3.3-8: CounterCheck (step 3, Table 8.2.2.2.1.3.2-2)

Derivation Path: TS 36.508 [7], Table 4.6.1-0a			
Information Element	Value/remark	Comment	Condition
CounterCheck ::= SEQUENCE {			
criticalExtensions CHOICE {			
c1 CHOICE {			
countercheck-r8 SEQUENCE {			
drb-CountMSB-InfoList SEQUENCE (SIZE (1..maxDRB)) OF DRB-CountMSB-Info {	2 entries		
DRB-CountMSB-Info[1] SEQUENCE {		entry 1	
drb-Identity	DRBn	MCG DRB identity	
countMSB-Uplink	0		
countMSB-Downlink	0		
}			
DRB-CountMSB-Info[2] SEQUENCE {		entry 2	
drb-Identity	DRB2	SCG DRB identity	
countMSB-Uplink	0		
countMSB-Downlink	0		
}			
}			
}			
}			
}			
}			

Table 8.2.2.2.1.3.3-9: CounterCheckResponse (step 4, Table 8.2.2.2.1.3.2-2)

Derivation Path: TS 36.508 [7], Table 4.6.1-0b			
Information Element	Value/remark	Comment	Condition
CounterCheckResponse ::= SEQUENCE {			
criticalExtensions CHOICE {			
counterCheckResponse-r8 SEQUENCE {			
drb-CountInfoList SEQUENCE (SIZE (0..maxDRB)) OF DRB-CountInfo {	2 entries		
DRB-CountInfo[1] SEQUENCE {		entry 1	
drb-Identity	DRB-Identity with Condition DRBn	MCG DRB identity as sent in Step 3	
count-Uplink	Not checked		
count-Downlink	Not checked		
}			
DRB-CountInfo[2] SEQUENCE {		entry 2	
}			
}			
}			

drb-Identity	DRB-Identity with Condition DRB2	SCG DRB	
count-Uplink	Not checked		
count-Downlink	Not checked		
}			
}			
}			
}			
}			

Table 8.2.2.2.1.3.3-10: RRCConnectionReconfiguration (step 5, Table 8.2.2.2.1.3.2-2)

Derivation Path: TS 36.508 [7], Table 4.6.1-8 condition MCG_and_split			
Information Element	Value/remark	Comment	Condition
RRCConnectionReconfiguration ::= SEQUENCE {			
criticalExtensions CHOICE {			
c1 CHOICE {			
rrcConnectionReconfiguration-r8 SEQUENCE {			
nonCriticalExtension SEQUENCE {			
nonCriticalExtension SEQUENCE {			
nonCriticalExtension SEQUENCE {			
nonCriticalExtension SEQUENCE {			
nonCriticalExtension SEQUENCE {			
nonCriticalExtension SEQUENCE {			
nonCriticalExtension SEQUENCE {			
nr-Config-r15 CHOICE {			
setup SEQUENCE {			
nr-SecondaryCellGroupConfig-r15	<i>RRCReconfiguration-SplitSRBRelease</i>		
}			
}			
}			
}			
}			
}			
}			
}			
}			
}			

Table 8.2.2.2.1.3.3-11: RRCReconfiguration-SplitSRBRelease (Table 8.2.2.2.1.3.3-10)

Derivation Path: TS 38.508-1 [4], Table 4.6.1-13			
Information Element	Value/remark	Comment	Condition
RRCReconfiguration ::= SEQUENCE {			
criticalExtensions CHOICE {			
c1 CHOICE {			
rrcReconfiguration SEQUENCE {			
radioBearerConfig	Not present		
secondaryCellGroup	CellGroupConfig-SplitSRB-Release		
measConfig	Not Present		
}			
}			
}			

Table 8.2.2.2.1.3.3-12: CellGroupConfig-SplitSRB-Release (Table 8.2.2.2.1.3.3-11)

Derivation Path: TS 38.508-1 [4], Table 4.6.3-8			
Information Element	Value/remark	Comment	Condition
CellGroupConfig ::= SEQUENCE {			
cellGroupld	1		
rlc-BearerToReleaseList SEQUENCE	2 entries		
(SIZE(1..maxLC-ID)) OF LogicalChannelldentity {			
logicalChannelldentity[1]	1	entry 1	
logicalChannelldentity[2]	2	entry 2	
}			
}			

8.2.2.2.2 Split SRB Establishment and Release / NR-DC

8.2.2.2.2.1 Test Purpose (TP)

(1)

```
with { UE in RRC_CONNECTED state with NR-DC }
ensure that {
  when { UE receives an RRCReconfiguration message on SRB1 to configure split SRB1 and split SRB2
with PDCP duplication activated }
  then { UE configures the split SRBs and sends an RRCConnectionReconfigurationComplete message on
split SRB1 with the PDCP PDU duplicated on the MCG and SCG path }
}
```

(2)

```
with { UE in RRC_CONNECTED state with NR-DC and split SRB configured }
ensure that {
  when { UE receives an RRCReconfiguration message on split SRB1 over the SCG path to release split
SRB1 and split SRB2 }
  then { UE releases split SRB1 and split SRB2 and sends an RRCConnectionReconfigurationComplete
message on SRB1 over the MCG path}
}
```

(3)

```
with { UE in RRC_CONNECTED state in NR-DC mode with split SRB1 and split SRB2 configured with PDCP
duplication }
ensure that {
  when { UE receives a CounterCheck on split SRB1 over the SCG path }
  then { UE replies with CounterCheckResponse on split SRB1 duplicated on the MCG and SCG path}
}
```

(4)

```
with { UE in RRC_CONNECTED state in NR-DC mode with split SRB1 and split SRB2 configured with PDCP
duplication }
ensure that {
  when { UE receives a IDENTITY REQUEST on split SRB2 over the SCG path }
  then { UE replies with IDENTITY RESPONSE on split SRB2 duplicated on the MCG and SCG path}
}
```

8.2.2.2.2.2 Conformance requirements

References: The conformance requirements covered in the present TC are specified in: TS 38.331 clauses 5.3.5.3, 5.3.5.5.3, 5.3.5.6.1 and 5.3.5.6.3. Unless and otherwise stated these are Rel-15 requirements

[TS 38.331, clause 5.3.5.3]

The UE shall perform the following actions upon reception of the *RRCReconfiguration*, or upon execution of the conditional reconfiguration (CHO, CPA or CPC):

...

- 1> if the *RRCReconfiguration* includes the *mrdc-SecondaryCellGroupConfig*:
 - 2> if the *mrdc-SecondaryCellGroupConfig* is set to *setup*:
 - 3> if the *mrdc-SecondaryCellGroupConfig* includes *mrdc-ReleaseAndAdd*:
 - 4> perform MR-DC release as specified in clause 5.3.5.10;
 - 3> if the received *mrdc-SecondaryCellGroup* is set to *nr-SCG*:
 - 4> perform the RRC reconfiguration according to 5.3.5.3 for the *RRCReconfiguration* message included in *nr-SCG*;
 - 3> if the received *mrdc-SecondaryCellGroup* is set to *eutra-SCG*:
 - 4> perform the RRC connection reconfiguration as specified in TS 36.331 [10], clause 5.3.5.3 for the *RRCConnectionReconfiguration* message included in *eutra-SCG*;
 - 2> else (*mrdc-SecondaryCellGroupConfig* is set to *release*):
 - 3> perform MR-DC release as specified in clause 5.3.5.10;
 - ...
 - 1> else if the *RRCReconfiguration* message was received via SRB1 within the *nr-SCG* within *mrdc-SecondaryCellGroup* (UE in NR-DC, *mrdc-SecondaryCellGroup* was received in *RRCReconfiguration* or *RRCResume* via SRB1):
 - 2> if the *RRCReconfiguration* is applied due to a conditional reconfiguration execution for CPC which is configured via *conditionalReconfiguration* contained in *nr-SCG* within *mrdc-SecondaryCellGroup*:
 - 3> submit the *RRCReconfigurationComplete* message via the NR MCG embedded in NR RRC message *ULInformationTransferMRDC* as specified in clause 5.7.2a.3.
 - 2> if the *scg-State* is not included in the *RRCReconfiguration* or *RRCResume* message containing the *RRCReconfiguration* message:
 - 3> if *reconfigurationWithSync* was included in *spCellConfig* in *nr-SCG*; or
 - 3> if the SCG was deactivated before the reception of the NR RRC message containing the *RRCReconfiguration* message and lower layers consider that a Random Access procedure is needed for SCG activation:
 - 4> initiate the Random Access procedure on the PSCell, as specified in TS 38.321 [3];
 - 3> else:
 - 4> the procedure ends;
 - 2> else
 - 3> the procedure ends;
- NOTE 2a: The order in which the UE sends the *RRCReconfigurationComplete* message and performs the Random Access procedure towards the SCG is left to UE implementation.
- 1> else if the *RRCReconfiguration* message was received via SRB3 (UE in NR-DC):
 - 2> if the *RRCReconfiguration* message was received within *DLInformationTransferMRDC*:
 - 3> if the *RRCReconfiguration* message was received within the *nr-SCG* within *mrdc-SecondaryCellGroup* (NR SCG RRC Reconfiguration):
 - 4> if *reconfigurationWithSync* was included in *spCellConfig* in *nr-SCG*:
 - 5> initiate the Random Access procedure on the PSCell, as specified in TS 38.321 [3];
 - 4> else:

- 5> the procedure ends;
- 3> else:
 - 4> submit the *RRCReconfigurationComplete* message via SRB1 to lower layers for transmission using the new configuration;
- 2> else:
 - 3> submit the *RRCReconfigurationComplete* message via SRB3 to lower layers for transmission using the new configuration;
- 1> else (*RRCReconfiguration* was received via SRB1):
 - 2> submit the *RRCReconfigurationComplete* message via SRB1 to lower layers for transmission using the new configuration;
 - 2> if this is the first *RRCReconfiguration* message after successful completion of the RRC re-establishment procedure:
 - 3> resume SRB2, SRB4, and DRBs, multicast MRB, and BH RLC channels for IAB-MT, that are suspended;

...

[TS 38.331, clause 5.3.5.5.3]

The UE shall:

- 1> for each *logicalChannelIdentity* value included in the *rlc-BearerToReleaseList* that is part of the current UE configuration (LCH release); or
- 1> for each *logicalChannelIdentity* value that is to be released as the result of an SCG release according to 5.3.5.4:
 - 2> release the RLC entity or entities as specified in TS 38.322 [4], clause 5.1.3;
 - 2> release the corresponding logical channel

[TS 38.331, clause 5.3.5.6.1]

The UE shall perform the following actions based on a received *RadioBearerConfig* IE:

...

- 1> if the *RadioBearerConfig* includes the *srb-ToAddModList*:
 - 2> perform the SRB addition or reconfiguration as specified in 5.3.5.6.3;

[TS 38.331, clause 5.3.5.6.3]

The UE shall:

- 1> for each *srb-Identity* value included in the *srb-ToAddModList* that is not part of the current UE configuration (SRB establishment or reconfiguration from E-UTRA PDCP to NR PDCP):
 - 2> establish a PDCP entity;
 - 2> if AS security has been activated:
 - 3> if target RAT of handover is E-UTRA/5GC, or;
 - 3> if the UE is only connected to E-UTRA/5GC:
 - 4> configure the PDCP entity with the security algorithms and keys (K_{RRCEnc} and K_{RRCInt}) configured/derived as specified in TS 36.331 [10];
 - 3> else:

- 4> configure the PDCP entity with the security algorithms according to *securityConfig* and apply the keys (K_{RRCEnc} and K_{RRCint}) associated with the master key (K_{eNB}/ K_{gNB}) or secondary key ($S-K_{gNB}$) as indicated in *keyToUse*, if applicable;
- 2> if the current UE configuration as configured by E-UTRA in TS 36.331 [10] includes an SRB identified with the same *srb-Identity* value:
 - 3> associate the E-UTRA RLC entity and DCCH of this SRB with the NR PDCP entity;
 - 3> release the E-UTRA PDCP entity of this SRB;
- 2> if the *pdcp-Config* is included:
 - 3> configure the PDCP entity in accordance with the received *pdcp-Config*;
- 2> else:
 - 3> configure the PDCP entity in accordance with the default configuration defined in 9.2.1 for the corresponding SRB;

8.2.2.2.2.3 Test description

8.2.2.2.2.3.1 Pre-test conditions

System Simulator:

- NR Cell 1 is the PCell and NR Cell 2 is the PSCell.

UE:

- None.

Preamble:

- The UE is in state RRC_CONNECTED using generic procedure parameter Connectivity (*NR-DC*), Bearers (*MCG(s)* and *SCG*) established according to TS 38.508-1 [4], clause 4.5.4.

8.2.2.2.2.3.2 Test procedure sequence

Table 8.2.2.2.3.2-1: Main behaviour

St	Procedure	Message Sequence		TP	Verdict
		U - S	Message		
1	The SS is configured not to send RLC ACK on split SRB1.	-	-	-	-
2	SS transmits <i>RRCReconfiguration</i> message with <i>mrdc-SecondaryCellGroup</i> is set to <i>nr-SCG</i> to configure split SRB1 and split SRB2.	<--	<i>RRCReconfiguration</i>	-	-
-	EXCEPTION: In parallel to the event described in step 3 the steps specified in Table 8.2.2.2.3.2-2 is taking place.	-	-	-	-
3	Check: Does the UE send a <i>RRCReconfigurationComplete</i> message on split SRB1 duplicated over the SCG path? Note: The UE RLC might re-transmit this message several times (no more than <i>maxRetxThreshold</i>) until RLC ACK is sent by the SS.	-->	<i>RRCReconfigurationComplete</i>	1	P
4	After steps in table 8.2.2.2.3.2-2 are completed the SS is configured to send RLC ACK on split SRB1 and the last message received in step 3 is acknowledged.	-	-	-	-
5	The SS is configured not to send RLC ACK on	-	-	-	-

	split SRB1.				
6	SS transmits <i>CounterCheck</i> message for capabilities on split SRB1 over the SCG path.	<--	<i>CounterCheck</i>	-	-
-	EXCEPTION: In parallel to the event described in step 7 the steps specified in Table 8.2.2.2.3.2-3 is taking place.	-	-	-	-
7	Check: Does the UE send <i>CounterCheckResponse</i> message including UE radio access capability information on split SRB1 duplicated over the SCG path? Note: The UE RLC might re-transmit this message several times (no more than maxRetxThreshold) until RLC ACK is sent by the SS.	-->	<i>CounterCheckResponse</i>	3	P
8	After steps in table 8.2.2.2.3.2-3 are completed the SS is configured to send RLC ACK on split SRB1 and the last message received in step 7 is acknowledged.	-	-	-	-
-	EXCEPTION: In parallel to the event described in step 9 the steps specified in Table 8.2.2.2.3.2-4 is taking place.	-	-	-	-
9	The SS is configured not to send RLC ACK on split SRB2.	-	-	-	-
10	The SS sends <i>DLInformationTransfer</i> message (carrying IDENTITY REQUEST message) on split SRB2 over the SCG path.	<--	<i>DLInformationTransfer</i> (IDENTITY REQUEST)	-	-
11	Check: Does the UE send the <i>ULInformationTransfer</i> message (carrying IDENTITY RESPONSE message) on split SRB2 duplicated over the SCG path? Note: The UE RLC might re-transmit this message several times (no more than maxRetxThreshold) until RLC ACK is sent by the SS.	-->	<i>ULInformationTransfer</i> (IDENTITY RESPONSE)	4	P
12	After steps in table 8.2.2.2.3.2-4 are completed the SS is configured to send RLC ACK on split SRB2 and the last message received in step 10 is acknowledged.	-	-	-	-
13	SS transmits <i>RRCReconfiguration</i> message on split SRB1 to release split SRB1 and split SRB2 over the SCG path.	<--	<i>RRCReconfiguration</i>	-	-
14	Check: Does the UE send <i>RRCReconfigurationComplete</i> message on SRB1 over the MCG path? Note: The SS makes sure that the UE does not send any message on the SCG path. The SS sends the RLC ACK for this message.	-->	<i>RRCReconfigurationComplete</i>	2	P

Table 8.2.2.2.3.2-2: Parallel behaviour

St	Procedure	Message Sequence		TP	Verdict
		U - S	Message		
1	The UE transmits an <i>RRCReconfigurationComplete</i> message on SRB1 over the MCG path/Cell 1 Note: The UE RLC might re-transmit this message several times (no more than maxRetxThreshold) until RLC ACK is sent by the SS.	-->	<i>RRCReconfigurationComplete</i>	-	-

srb-ToAddModList SEQUENCE (SIZE (1..2)) OF SRB-ToAddMod {	2 entries		
SRB-ToAddMod[1] SEQUENCE {		entry 1	
SRB-Identity	SRB-Identity with condition SRB1		
pdcp-Config	PDCP-Config-SRB1	Table 8.2.2.2.3.3-3	
}			
SRB-ToAddMod[2] SEQUENCE {		entry 2	
SRB-Identity	SRB-Identity with condition SRB2		
reestablishPDCP	Not present		
discardOnPDCP	Not present		
pdcp-Config	PDCP-Config-SRB2	Table 8.2.2.2.3.3-4	
}			
}			
}			

Table 8.2.2.2.3.3-3: PDCP-Config-SRB1 (Table 8.2.2.2.3.3-2)

Derivation Path: TS 38.508-1 [4], Table 4.6.3-99 with condition Split_SRB			
Information Element	Value/remark	Comment	Condition
PDCP-Config ::= SEQUENCE {			
moreThanOneRLC	Not present		Step 13
moreThanOneRLC SEQUENCE {			Step 2
primaryPath SEQUENCE {			
logicalChannel	1		
}			
pdcp-Duplication	true		
}			
}			

Table 8.2.2.2.3.3-4: PDCP-Config-SRB2 (Table 8.2.2.2.3.3-2)

Derivation Path: TS 38.508-1 [4], Table 4.6.3-99 with condition Split_SRB			
Information Element	Value/remark	Comment	Condition
PDCP-Config ::= SEQUENCE {			
moreThanOneRLC	Not present		Step 13
moreThanOneRLC SEQUENCE {			Step 2
primaryPath SEQUENCE {			
logicalChannel	2		
}			
pdcp-Duplication	true		
}			
}			

Table 8.2.2.2.3.3-5: RRCReconfiguration-SCG (Table 8.2.2.2.3.3-1)

Derivation Path: TS 38.508-1 [4], Table 4.6.1-13 with condition NR-DC_SCG			
Information Element	Value/remark	Comment	Condition
RRCReconfiguration ::= SEQUENCE {			
criticalExtensions CHOICE {			
rrcReconfiguration SEQUENCE {			
secondaryCellGroup	CellGroupConfig-SCG	Table 8.2.2.2.3.3-6	
}			
}			
}			

Table 8.2.2.2.3.3-6: CellGroupConfig-SCG (Table 8.2.2.2.3.3-5)

Derivation Path: TS 38.508-1 [4], Table 4.6.3-19 with condition NR-DC_SCG			
Information Element	Value/remark	Comment	Condition
CellGroupConfig ::= SEQUENCE {			
rlc-BearerToAddModList	Not present		Step 13
rlc-BearerToAddModList SEQUENCE (SIZE(1..maxLCH)) OF RLC-BearerConfig {	2 entries		Step 2
RLC-BearerConfig[1]	RLC-BearerConfig with condition SRB1 and AM	entry 1	
RLC-BearerConfig[2]	RLC-BearerConfig with condition SRB2 and AM	entry 2	
}			
rlc-BearerToReleaseList	Not present		Step 2
rlc-BearerToReleaseList SEQUENCE (SIZE(1..maxLC-ID)) OF LogicalChannelIdentity {	2 entries		Step 13
LogicalChannelIdentity[1]	1		
LogicalChannelIdentity[2]	2		
}			
mac-CellGroupConfig	Not present		
physicalCellGroupConfig	Not present		
spCellConfig	Not present		
}			

Table 8.2.2.2.3.3-7: RRCReconfigurationComplete (Table 8.2.2.2.3.2-1, step 3 and 14, Table 8.2.2.2.3.2-2, step 1)

Derivation Path: TS 38.508-1 [4] Table 4.6.1-14 with condition NR-DC
--

Table 8.2.2.2.3.3-8: CounterCheck (Table 8.2.2.2.3.2-1, Step 6)

Derivation Path: TS 38.508-1[4] Table 4.6.1-1			
Information Element	Value/remark	Comment	Condition
CounterCheck ::= SEQUENCE {			
criticalExtensions CHOICE {			
counterCheck SEQUENCE {			
drb-CountMSB-InfoList SEQUENCE (SIZE (1..maxDRB)) OF DRB-CountMSB-Info {	2 entries		
DRB-CountMSB-Info[1] SEQUENCE {		entry 1	
drb-Identity	DRB-Identity of DRBn	DRBn is the MCG DRB established in preamble	
countMSB-Uplink	0		
countMSB-Downlink	0		
}			
DRB-CountMSB-Info[2] SEQUENCE {		entry 2	
drb-Identity	DRB-Identity of DRBj	DRBj is the SCG DRB established in preamble	
countMSB-Uplink	0		
countMSB-Downlink	0		
}			
}			
}			
}			
}			

Table 8.2.2.2.3.3-9: CounterCheckResponse (Table 8.2.2.2.3.2-1, Step 7, Table 8.2.2.2.3.2-3, Step 1)

Derivation Path: TS 38.508-1 [4], Table 4.6.1-2			
Information Element	Value/remark	Comment	Condition

CounterCheckResponse ::= SEQUENCE {			
criticalExtensions CHOICE {			
counterCheckResponse SEQUENCE {			
drb-CountInfoList SEQUENCE (SIZE (0..maxDRB)) OF DRB-CountInfo {	2 entries		
DRB-CountInfo[1] SEQUENCE {		entry 1	
drb-Identity	DRB-Identity of DRBn	DRBn is the MCG DRB established in preamble	
count-Uplink	Not checked		
count-Downlink	Not checked		
}			
DRB-CountInfo[2] SEQUENCE {		entry 1	
drb-Identity	DRB-Identity of DRBj	DRBj is the SCG DRB established in preamble	
count-Uplink	Not checked		
count-Downlink	Not checked		
}			
}			
}			
}			
}			

8.2.2.2.3 Split SRB Establishment and Release / NE-DC

8.2.2.2.3.1 Test Purpose (TP)

(1)

```
with { UE in RRC_CONNECTED state with NE-DC }
ensure that {
  when { UE receives an RRCReconfiguration message on SRB1 to configure split SRB1 and split SRB2
with PDCP duplication activated }
  then { UE configures the split SRBs and sends an RRCConnectionReconfigurationComplete message on
split SRB1 with the PDCP PDU duplicated on the MCG and SCG path }
}
```

(2)

```
with { UE in RRC_CONNECTED state with NE-DC and split SRB configured }
ensure that {
  when { UE receives an RRCReconfiguration message on split SRB1 over the SCG path to release split
SRB1 and split SRB2 }
  then { UE releases split SRB1 and split SRB2 and sends an RRCConnectionReconfigurationComplete
message on SRB1 over the MCG path}
}
```

(3)

```
with { UE in RRC_CONNECTED state in NE-DC mode with split SRB1 and split SRB2 configured with PDCP
duplication }
ensure that {
  when { UE receives a CounterCheck on split SRB1 over the SCG path }
  then { UE replies with CounterCheckResponse on split SRB1 duplicated on the MCG and SCG path}
}
```

(4)

```
with { UE in RRC_CONNECTED state in NE-DC mode with split SRB1 and split SRB2 configured with PDCP
duplication }
ensure that {
  when { UE receives a IDENTITY REQUEST on split SRB2 over the SCG path }
  then { UE replies with IDENTITY RESPONSE on split SRB2 duplicated on the MCG and SCG path}
```

8.2.2.2.3.2 Conformance requirements

References: The conformance requirements covered in the present TC are specified in: TS 38.331, clause 5.3.5.3 and TS 36.331: clauses 5.3.5.3, 5.3.10.1a and 5.3.10.17. Unless and otherwise stated these are Rel-15 requirements

[TS 38.331, clause 5.3.5.3]

The UE shall perform the following actions upon reception of the *RRCReconfiguration*, or upon execution of the conditional reconfiguration (CHO, CPA or CPC):

...

1> if the *RRCReconfiguration* includes the *mrdc-SecondaryCellGroupConfig*:

2> if the *mrdc-SecondaryCellGroupConfig* is set to *setup*:

3> if the *mrdc-SecondaryCellGroupConfig* includes *mrdc-ReleaseAndAdd*:

4> perform MR-DC release as specified in clause 5.3.5.10;

3> if the received *mrdc-SecondaryCellGroup* is set to *nr-SCG*:

4> perform the RRC reconfiguration according to 5.3.5.3 for the *RRCReconfiguration* message included in *nr-SCG*;

3> if the received *mrdc-SecondaryCellGroup* is set to *eutra-SCG*:

4> perform the RRC connection reconfiguration as specified in TS 36.331 [10], clause 5.3.5.3 for the *RRCCConnectionReconfiguration* message included in *eutra-SCG*;

2> else (*mrdc-SecondaryCellGroupConfig* is set to *release*):

3> perform MR-DC release as specified in clause 5.3.5.10;

...

1> set the content of the *RRCReconfigurationComplete* message as follows:...

2> if the *RRCReconfiguration* message includes the *mrdc-SecondaryCellGroupConfig* with *mrdc-SecondaryCellGroup* set to *eutra-SCG*:

3> include in the *eutra-SCG-Response* the *E-UTRA RRCCConnectionReconfigurationComplete* message in accordance with TS 36.331 [10] clause 5.3.5.3;

[TS 36.331, clause 5.3.5.3]

If the *RRCCConnectionReconfiguration* message does not include the *mobilityControlInfo* and the UE is able to comply with the configuration included in this message, the UE shall:

...

1> if the UE is configured with NE-DC:

2> if the received *RRCCConnectionReconfiguration* message was included in an NR *RRCResume* message:

3> transfer the *RRCCConnectionReconfigurationComplete* message via SRB1 embedded in NR RRC message *RRCResumeComplete* as specified in TS 38.331 [82], clause 5.3.13.4;

2> else:

3> transfer the *RRCCConnectionReconfigurationComplete* message via SRB1 embedded in NR RRC message *RRCReconfigurationComplete* as specified in TS 38.331 [82], clause 5.3.5.3;

1> else:

2> submit the *RRCCConnectionReconfigurationComplete* message to lower layers for transmission using the new configuration, upon which the procedure ends;

[TS 38.331, clause 5.3.10.1a]

The UE shall:

- 1> for each *srb-Identity* value included in the *srb-ToAddModListSCG* that is not part of the current UE E-UTRA SCG configuration (i.e. SCG RLC bearer establishment):
 - 2> apply the specified configuration defined in 9.1.2 for the corresponding SRB;
 - 2> establish an (SCG) RLC entity in accordance with the received *rlc-Config*;
 - 2> establish a (SCG) DCCH logical channel in accordance with the received *logicalChannelConfig* and with the logical channel identity set in accordance with 9.1.2;
 - 2> if the UE is configured with DC:
 - 3> associate the established SCG RLC bearer and DCCH logical channel with the E-UTRA PDCP entity with the same value of *srb-Identity* within the current UE configuration;
 - 3> configure the E-UTRA PDCP entity to activate duplication with *t-Reordering* set to *infinity*;
 - 2> else (i.e. the UE is configured with NE-DC):
 - 3> associate the SCG RLC bearer and DCCH logical channel with the NR PDCP entity, i.e. as configured by NR see TS 38.331 [82], identified with the same *srb-Identity* within the current UE configuration;
- 1> for each *srb-Identity* value included in the *srb-ToAddModListSCG* that is part of the current UE SCG configuration (SCG RLC bearer reconfiguration):
 - 2> re-establish the SCG RLC entity, if *reestablishRLC* is included;
 - 2> reconfigure the RLC entity in accordance with the received *rlc-Config*;
 - 2> reconfigure the DCCH logical channel in accordance with the received *logicalChannelConfig*;

[TS 36.331, clause 5.3.10.17]

The UE shall:

- 1> for each *srb-Identity* value included in *srb-ToReleaseList* or in *srb-ToReleaseListSCG* that is part of the current UE configuration:
 - 2> if the SRB configuration does not include an E-UTRA PDCP entity (release the SCG RLC bearer configuration):
 - 3> re-establish the RLC entity as specified in TS 36.322 [7] for this SRB;
 - 3> configure the E-UTRA PDCP entity to deactivate duplication;
 - 2> release the RLC entity or entities;
 - 2> release the DCCH logical channel;
 - 2> if *srb-Identity* value is set to 4, release the PDCP entity;

8.2.2.2.3.3 Test description

8.2.2.2.3.3.1 Pre-test conditions

System Simulator:

- NR Cell 1 is the PCell and E-UTRA Cell 1 is the PSCell.

UE:

- None.

Preamble:

- The UE is in state RRC_CONNECTED using generic procedure parameter Connectivity (*NE-DC*), Bearers (MCG(s) and SCG) established according to TS 38.508-1 [4], clause 4.5.4.

8.2.2.2.3.3.2 Test procedure sequence

Table 8.2.2.2.3.3.2-1: Main behaviour

St	Procedure	Message Sequence		TP	Verdict
		U - S	Message		
0	The SS is configured not to send RLC ACK on split SRB1.	-	-	-	-
1	SS transmits <i>RRCReconfiguration</i> message containing <i>Eutra RRCConnectionReconfiguration</i> message to configure split SRB1 and split SRB2.	<--	<i>RRCReconfiguration (RRCConnectionReconfiguration)</i>	-	-
-	EXCEPTION: In parallel to the event described in step 2 the steps specified in Table 8.2.2.2.3.3.2-2 is taking place.	-	-	-	-
2	Check: Does the UE send a <i>RRCReconfigurationComplete</i> message containing <i>Eutra RRCConnectionReconfigurationComplete</i> message on split SRB1 duplicated over the SCG path? Note: The UE RLC might re-transmit this message several times (no more than maxRetxThreshold) until RLC ACK is sent by the SS.	-->	<i>RRCReconfigurationComplete (RRCConnectionReconfigurationComplete)</i>	1	P
2A	After steps in table 8.2.2.2.3.3.2-2 are completed the SS is configured to send RLC ACK on split SRB1 and the last message received in step 2 is acknowledged.	-	-	-	-
2B	The SS is configured not to send RLC ACK on split SRB1.	-	-	-	-
3	SS transmits <i>CounterCheck</i> message for E-UTRA capabilities on split SRB1 over the SCG path.	<--	<i>CounterCheck</i>	-	-
-	EXCEPTION: In parallel to the event described in step 4 the steps specified in Table 8.2.2.2.3.3.2-3 is taking place.	-	-	-	-
4	Check: Does the UE send <i>CounterCheckResponse</i> message including UE radio access capability information for E-UTRA on split SRB1 duplicated over the SCG path? Note: The UE RLC might re-transmit this message several times (no more than maxRetxThreshold) until RLC ACK is sent by the SS.	-->	<i>CounterCheckResponse</i>	3	P
4A	After steps in table 8.2.2.2.3.3.2-3 are completed the SS is configured to send RLC ACK on split SRB1 and the last message received in step 4 is acknowledged.	-	-	-	-
4B	The SS is configured not to send RLC ACK on split SRB2.	-	-	-	-
4C	The SS sends <i>DLInformationTransfer</i> message (carrying IDENTITY REQUEST message) on split SRB2 over the SCG path.	<--	<i>DLInformationTransfer (IDENTITY REQUEST)</i>	-	-
-	EXCEPTION: In parallel to the event described in step 4B the steps specified in Table 8.2.2.2.3.3.2-4 is taking place.	-	-	-	-
4D	Check: Does the UE send the <i>ULInformationTransfer</i> message (carrying	-->	<i>ULInformationTransfer (IDENTITY RESPONSE)</i>	4	P

	IDENTITY RESPONSE message) on split SRB2 duplicated over the SCG path? Note: The UE RLC might re-transmit this message several times (no more than maxRetxThreshold) until RLC ACK is sent by the SS.				
4E	After steps in table 8.2.2.2.3.3.2-4 are completed the SS is configured to send RLC ACK on split SRB2 and the last message received in step 4D is acknowledged.	-	-	-	-
5	SS transmits <i>RRCReconfiguration</i> message containing <i>Eutra RRCConnectionReconfiguration</i> message on split SRB1 to release split SRB1 and split SRB2 over the SCG path.	<--	<i>RRCReconfiguration (RRCConnectionReconfiguration)</i>	-	-
6	Check: Does the UE send <i>RRCReconfigurationComplete</i> message containing <i>Eutra RRCConnectionReconfigurationComplete</i> message on SRB1 over the MCG path? Note: The SS makes sure that the UE does not send any message on the SCG path. The SS sends the RLC ACK for this message.	-->	<i>RRCReconfigurationComplete (RRCConnectionReconfigurationComplete)</i>	2	P

Table 8.2.2.2.3.3.2-2: Parallel behaviour

St	Procedure	Message Sequence		TP	Verdict
		U - S	Message		
1	The UE transmits an <i>RRCReconfigurationComplete</i> message on SRB1 over the MCG path/NR Cell 1 Note: The UE RLC might re-transmit this message several times (no more than maxRetxThreshold) until RLC ACK is sent by the SS.	-->	<i>RRCReconfigurationComplete (RRCConnectionReconfigurationComplete)</i>	-	-

Table 8.2.2.2.3.3.2-3: Parallel behaviour

St	Procedure	Message Sequence		TP	Verdict
		U - S	Message		
1	The UE transmits an <i>CounterCheckResponse</i> message on SRB1 over the MCG path/NR Cell 1 Note: The UE RLC might re-transmit this message several times (no more than maxRetxThreshold) until RLC ACK is sent by the SS.	-->	<i>CounterCheckResponse</i>	-	-

Table 8.2.2.2.3.3.2-4: Parallel behaviour

St	Procedure	Message Sequence		TP	Verdict
		U - S	Message		
1	The UE transmits an <i>DLInformationTransfer</i> (IDENTITY RESPONSE) message on SRB2 over the MCG path/NR Cell 1 Note: The UE RLC might re-transmit this message several times (no more than maxRetxThreshold) until RLC ACK is sent by the SS.	-->	<i>DLInformationTransfer (IDENTITY RESPONSE)</i>	-	-

8.2.2.2.3.3.3 Specific message contents

FFS

8.2.2.3 Simultaneous SRB3 and Split SRB / Sequential message flow on SRB3 and Split SRB

8.2.2.3.1 Simultaneous SRB3 and Split SRB / Sequential message flow on SRB3 and Split SRB with one UL path / EN-DC

8.2.2.3.1.1 Test Purpose (TP)

(1)

```

with { UE in E-UTRA RRC_CONNECTED state in EN-DC mode with SRB3 and split SRB1 configured with no
PDCP duplication}
ensure that {
  when { UE receives RRCReconfiguration message on SRB3 to modify SCG DRB }
  then { UE sends RRCReconfigurationComplete message on SRB3 over the SCG path }
}

```

(2)

```

with { UE in RRC_CONNECTED state in EN-DC mode with SRB3 and split SRB1 configured with no PDCP
duplication }
ensure that {
  when { UE receives an RRCConnectionReconfiguration message on split SRB1 on the SCG path to
release SRB3 }
  then { UE releases SRB3 and sends an RRCConnectionReconfigurationComplete message on split SRB1
over the MCG path }
}

```

(3)

```

with { UE in RRC_CONNECTED state in EN-DC mode with split SRB1 configured with no PDCP duplication}
ensure that {
  when { UE receives an RRCConnectionReconfiguration message to release split SRB1 on SCG path }
  then { UE releases split SRB1 and sends an RRCConnectionReconfigurationComplete message on SRB1
over the MCG path }
}

```

8.2.2.3.1.2 Conformance requirements

References: The conformance requirements covered in the present TC are specified in: TS 37.340, clause 7.6, TS 36.331, clauses 5.3.5.3 and TS 38.331:5.3.5.3, 5.3.5.5, 5.3.5.5.3, 5.3.5.6, 5.3.5.6.2 and 5.3.5.6.3. Unless and otherwise stated these are Rel-15 requirements.

[TS 37.340, clause 7.6]

Split SRB is supported for both SRB1 and SRB2 (split SRB is not supported for SRB0 and SRB3) in all MR-DC cases. RRC PDUs on split SRB are ciphered and integrity protected using NR PDCP.

Split SRB can be configured by the MN in Secondary Node Addition and/or Modification procedure, with SN configuration part provided by the SN. A UE can be configured with both split SRB and SRB3 simultaneously. SRB3 and the SCG leg of split SRB can be independently configured.

For the split SRB, the selection of transmission path in downlink depends on network implementation. For uplink, the UE is configured via MN RRC signalling whether to use MCG path or duplicate the transmission on both MCG and SCG.

[TS 36.331, clause 5.3.5.3]

If the *RRCCONNECTIONRECONFIGURATION* message does not include the *mobilityControlInfo* and the UE is able to comply with the configuration included in this message, the UE shall:

...

1> if the received *RRCCONNECTIONRECONFIGURATION* includes the *nr-SecondaryCellGroupConfig*:

2> perform NR RRC Reconfiguration as specified in TS 38.331 [82], clause 5.3.5.3;

1> if the received *RRCCONNECTIONRECONFIGURATION* includes the *nr-RadioBearerConfig1*:

2> perform radio bearer configuration as specified in TS 38.331 [82], clause 5.3.5.6;

1> if the received *RRCCONNECTIONRECONFIGURATION* includes the *nr-RadioBearerConfig2*:

2> perform radio bearer configuration as specified in TS 38.331 [82], clause 5.3.5.6;

...

1> set the content of *RRCCONNECTIONRECONFIGURATIONCOMPLETE* message as follows:

...

2> if the received *RRCCONNECTIONRECONFIGURATION* message included *nr-SecondaryCellGroupConfig*:

3> include *scg-ConfigResponseNR* in accordance with TS 38.331 [82], clause 5.3.5.3;

1> submit the *RRCCONNECTIONRECONFIGURATIONCOMPLETE* message to lower layers for transmission using the new configuration, upon which the procedure ends;

[TS 38.331, clause 5.3.5.3]

The UE shall perform the following actions upon reception of the *RRCReconfiguration*:

...

1> if the *RRCReconfiguration* includes the *secondaryCellGroup*:

2> perform the cell group configuration for the SCG according to 5.3.5.5;

1> if the *RRCReconfiguration* message contains the *radioBearerConfig*:

2> perform the radio bearer configuration according to 5.3.5.6;

...

1> if the UE is configured with E-UTRA *nr-SecondaryCellGroupConfig* (MCG is E-UTRA):

2> if *RRCReconfiguration* was received via SRB1:

3> submit the *RRCCONNECTIONRECONFIGURATIONCOMPLETE* via the EUTRA MCG embedded in E-UTRA RRC message *RRCCONNECTIONRECONFIGURATIONCOMPLETE* as specified in TS 36.331 [10].

[TS 38.331, clause 5.3.5.5.3]

The UE shall:

1> for each *logicalChannelIdentity* value included in the *rlc-BearerToReleaseList* that is part of the current UE configuration (LCH release); or

1> for each *logicalChannelIdentity* value that is to be released as the result of an SCG release according to 5.3.5.4:

2> release the RLC entity or entities as specified in TS 38.322 [4] clause 5.1.3;

2> release the corresponding logical channel.

[TS 38.331, clause 5.3.5.6.1]

The UE shall perform the following actions based on a received *RadioBearerConfig* IE:

...

1> if the RadioBearerConfig includes the srb-ToAddModList:

2> perform the SRB addition or reconfiguration as specified in 5.3.5.6.3;

[TS 38.331, clause 5.3.5.6.3]

The UE shall:

1> for each *srb-Identity* value included in the *srb-ToAddModList* that is not part of the current UE configuration (SRB establishment or reconfiguration from E-UTRA PDCP to NR PDCP):

2> establish a PDCP entity and configure it with the security algorithms according to *securityConfig* and apply the keys (K_{RRCEnc} and K_{RRCint}) associated with the master key (K_{eNB}/K_{gNB}) or secondary key ($S-K_{gNB}$) as indicated in *keyToUse*, if applicable;

2> if the current UE configuration as configured by E-UTRA in TS 36.331 includes an SRB identified with the same *srb-Identity* value:

3> associate the E-UTRA RLC entity and DCCH of this SRB with the NR PDCP entity;

3> release the E-UTRA PDCP entity of this SRB;

2> if the *pdcp-Config* is included:

3> configure the PDCP entity in accordance with the received *pdcp-Config*;

2> else:

3> configure the PDCP entity in accordance with the default configuration defined in 9.2.1 for the corresponding SRB;

8.2.2.3.1.3 Test description

8.2.2.3.1.3.1 Pre-test conditions

System Simulator:

- E-UTRA Cell 1 is the PCell and NR Cell 1 is the PSCell.
- System Information combination as defined in TS 38.508-1 [4] clause 4.4.3.1.1 is used in E-UTRA Cell 1 and NR Cell 1.

UE:

- None.

Preamble:

- The UE is in state RRC_CONNECTED using generic procedure parameter Connectivity (*EN-DC*), bearers (MCG(*s*) and SCG) established according to TS 38.508-1 [4], clause 4.5.4.

8.2.2.3.1.3.2 Test procedure sequence

Table 8.2.2.3.1.3.2-1: Main behaviour

St	Procedure	Message Sequence		TP	Verdict
		U - S	Message		
1	The SS transmits on SRB1 over MCG path/E-UTRA Cell 1 an <i>RRConnectionReconfiguration</i> message to configure SRB3, to reconfigure SRB1 to split SRB1 without PDCP duplication and to	<--	<i>RRConnectionReconfiguration</i> (<i>RRReconfiguration</i>)	-	-

	reconfigure SRB2 to change the PDCP type from EUTRA PDCP to NR PDCP.				
2	UE transmits an <i>RRCConnectionReconfigurationComplete</i> message on split SRB1 over the MCG path/EUTRA Cell 1.	-->	<i>RRCConnectionReconfigurationComplete</i> (<i>RRCReconfigurationComplete</i>)	-	-
3	The SS transmits on SRB3/SCG an NR <i>RRCReconfiguration</i> message to reconfigure SCG DRB.	<--	<i>RRCReconfiguration</i>	-	-
4	Check: Does the UE transmit an NR <i>RRCReconfigurationComplete</i> message on SRB3/NR Cell 1?	-->	<i>RRCReconfigurationComplete</i>	1	P
5	The SS transmits over split SRB1 SCG path/NR Cell 1 an <i>RRCConnectionReconfiguration</i> message to release SRB3.	<--	<i>RRCConnectionReconfiguration</i> (<i>RRCReconfiguration</i>)	-	-
-	Void	-	-	-	-
6	Check: Does the UE transmits an <i>RRCConnectionReconfigurationComplete</i> message on split SRB1 over the MCG path/EUTRA Cell 1?	-->	<i>RRCConnectionReconfigurationComplete</i> (<i>RRCReconfigurationComplete</i>)	2	P
7	The SS transmits an <i>RRCConnectionReconfiguration</i> message to release SRB1 over SCG path/NR Cell 1.	<--	<i>RRCConnectionReconfiguration</i> (<i>RRCReconfiguration</i>)	-	-
8	Check: Does the UE transmits an <i>RRCConnectionReconfigurationComplete</i> message on SRB1 over the MCG path/EUTRA Cell 1?	-->	<i>RRCConnectionReconfigurationComplete</i> (<i>RRCReconfigurationComplete</i>)	3	P

Table 8.2.2.3.1.3.2-2: Void

8.2.2.3.1.3.3 Specific message contents

Table 8.2.2.3.1.3.3-1: *RRCConnectionReconfiguration* (step 1, Table 8.2.2.3.1.3.2-1)

Derivation Path: TS 36.508 [7], Table 4.6.1-8			
Information Element	Value/remark	Comment	Condition
<i>RRCConnectionReconfiguration</i> ::= SEQUENCE {			
criticalExtensions CHOICE {			
c1 CHOICE {			
<i>rrcConnectionReconfiguration-r8</i> SEQUENCE {			
<i>mobilityControlInfo</i>	MobilityControlInfo-HO-SameCell	As per Table 8.2.2.3.1.3.3-1E	
nonCriticalExtension SEQUENCE {			
nonCriticalExtension SEQUENCE {			
nonCriticalExtension SEQUENCE {			
nonCriticalExtension SEQUENCE {			
nonCriticalExtension SEQUENCE {			
nonCriticalExtension SEQUENCE {			
nonCriticalExtension SEQUENCE {			
nr-Config-r15 CHOICE {			
setup SEQUENCE {			
nr-SecondaryCellGroupConfig-r15	OCTET STRING including the <i>RRCReconfiguration</i> message and the IE <i>secondaryCellGroup</i> according table 8.2.2.3.1.3.3-1A		
}			
}			
}			
}			
}			
}			
sk-Counter-r15	Increment the value by 1 from the previous value		

nr-RadioBearerConfig1-r15	OCTET STRING including RadioBearerConfig according TS 38.508-1 [4], Table 4.6.3-132 with conditions EN-DC_DRB and Re-establish_PDCP and SRB3		
nr-RadioBearerConfig2-r15	RadioBearerConfig according to Table 8.2.2.3.1.3.3-1C		
}			
}			
}			
}			
}			
}			
}			
}			
}			
}			
}			
}			
}			
}			

Table 8.2.2.3.1.3.3-1A: RRCReconfiguration (Table 8.2.2.3.1.3.3-1)

Derivation Path: TS 38.508-1 [4], Table 4.6.1-13			
Information Element	Value/remark	Comment	Condition
RRCReconfiguration ::= SEQUENCE {			
criticalExtensions CHOICE {			
rrcReconfiguration SEQUENCE {			
secondaryCellGroup	OCTET STRING containing CellGroupConfig according to Table 8.2.2.3.1.3.3-1B.		
}			
}			
}			

Table 8.2.2.3.1.3.3-1B: CellGroupConfig (Table 8.2.2.3.1.3.3-1A)

Derivation Path: TS 38.508-1 [4], Table 4.6.3-19 with condition EN-DC and PSCell_change			
Information Element	Value/remark	Comment	Condition
CellGroupConfig ::= SEQUENCE {			
cellGroupId	1		
rlc-BearerToAddModList SEQUENCE (SIZE(1..maxLC-ID)) OF RLC-BearerConfig {	3 entries		
RLC-BearerConfig[1]	RLC-BearerConfig according to 38.508-1 [4], Table 4.6.3-148 with condition SRB1 and Re-establish_RLC	entry 1	
RLC-BearerConfig[2]	RLC-BearerConfig according to 38.508-1 [4], Table 4.6.3-148 with condition SRB3	entry 2	
RLC-BearerConfig[3]	RLC-BearerConfig according to 38.508-1 [4], Table 4.6.3-148 with conditions AM and DRB2 and Re-establish_RLC	entry 3	
}			
mac-LogicalChannelConfig	LogicalChannelConfig according to 38.508-1 [4], table 4.6.3-66		

--	--	--

Table 8.2.2.3.1.3.3-1C: RadioBearerConfig (Table 8.2.2.3.1.3.3-1)

Derivation Path: TS 38.508-1[4] table 4.6.3-132			
Information Element	Value/remark	Comment	Condition
RadioBearerConfig ::= SEQUENCE {			
srb-ToAddModList SEQUENCE (SIZE (1..2)) OF			
SRB-ToAddMod {			
SRB-ToAddMod[1] SEQUENCE {		entry 1	
srb-Identity	LogicalChannelIdentity with condition SRB1		
reestablishPDCP	true		
discardOnPDCP	Not present		
pdcpc-Config	PDCP-Config according to table 8.2.2.3.1.3.3-1D		
srb-Identity[2]	LogicalChannelIdentity with condition SRB2		
reestablishPDCP[2]	true		
discardOnPDCP[2]	Not present		
pdcpc-Config[2]	Not present		
}			
}			

Table 8.2.2.3.1.3.3-1D: PDCP-Config (Table 8.2.2.3.1.3.3-1C)

Derivation Path: TS 38.508-1[4] table 4.6.3-99 with condition Split_SRB

Table 8.2.2.3.1.3.3-1E: MobilityControlInfo-HO-SameCell (Table 8.2.2.3.1.3.3-1)

Derivation Path: TS 36.508 [7], Table 4.6.5-1			
Information Element	Value/remark	Comment	Condition
MobilityControlInfo-HO ::= SEQUENCE {			
targetPhysCellId	PhysicalCellIdentity of E- UTRA Cell 1		
carrierFreq	Not present		
}			

Table 8.2.2.3.1.3.3-2: Void**Table 8.2.2.3.1.3.3-3: Void****Table 8.2.2.3.1.3.3-4: RRCReconfiguration (step 3, Table 8.2.2.3.1.3.2-1)**

Derivation Path: TS 38.508-1 [4], Table 4.6.1-13			
Information Element	Value/remark	Comment	Condition
RRCReconfiguration ::= SEQUENCE {			
criticalExtensions CHOICE {			
rrcReconfiguration SEQUENCE {			
secondaryCellGroup	OCTET STRING containing <i>CellGroupConfig</i> according to table 8.2.2.3.1.3.3-5.		
}			
}			
}			

Table 8.2.2.3.1.3.3-5: CellGroupConfig (Table 8.2.2.3.1.3.3-4)

Derivation Path: TS 38.508-1 [4], Table 4.6.3-19
--

Information Element	Value/remark	Comment	Condition
CellGroupConfig ::= SEQUENCE {			
cellGroupId	1		
mac-CellGroupConfig	MAC-CellGroupConfig according to table 8.2.2.3.1.3.3-5a		
}			

Table 8.2.2.3.1.3.3-5A: MAC-CellGroupConfig (Table 8.2.2.3.1.3.3-5)

Derivation Path: TS 38.508-1 [4], Table 4.6.3-68			
Information Element	Value/remark	Comment	Condition
MAC-CellGroupConfig ::= SEQUENCE {			
bsr-Config SEQUENCE {			
periodicBSR-Timer	sf5		
retxBSR-Timer	sf40		
}			
}			

Table 8.2.2.3.1.3.3-6: RRCConnectionReconfiguration (step 5, Table 8.2.2.3.1.3.2-1)

Derivation Path: TS 36.508 [7], Table 4.6.1-8			
Information Element	Value/remark	Comment	Condition
RRCConnectionReconfiguration ::= SEQUENCE {			
criticalExtensions CHOICE {			
c1 CHOICE {			
rrcConnectionReconfiguration-r8 SEQUENCE {			
nonCriticalExtension SEQUENCE {			
nonCriticalExtension SEQUENCE {			
nonCriticalExtension SEQUENCE {			
nonCriticalExtension SEQUENCE {			
nonCriticalExtension SEQUENCE {			
nonCriticalExtension SEQUENCE {			
nonCriticalExtension SEQUENCE {			
nr-Config-r15 CHOICE {			
setup SEQUENCE {			
nr-SecondaryCellGroupConfig-r15	OCTET STRING containing RRCReconfiguration according to Table 8.2.2.3.1.3.3-8.		
}			
}			
nr-RadioBearerConfig1-r15	RadioBearerConfig according to Table 8.2.2.3.1.3.3-7.		
}			
}			
}			
}			

Table 8.2.2.3.1.3.3-7: RadioBearerConfig (Table 8.2.2.3.1.3.3-6)

Derivation Path: TS 38.508-1 [4], Table 4.6.3-132			
Information Element	Value/remark	Comment	Condition
RadioBearerConfig ::= SEQUENCE {			
srb-ToAddModList	Not present		
srb3-ToRelease	true		
drb-ToAddModList	Not present		
drb-ToReleaseList	Not present		
securityConfig	Not present		
}			

Table 8.2.2.3.1.3.3-8: RRCReconfiguration (Table 8.2.2.3.1.3.3-6)

Derivation Path: TS 38.508-1 [4], Table 4.6.1-13			
Information Element	Value/remark	Comment	Condition
RRCReconfiguration ::= SEQUENCE {			
criticalExtensions CHOICE {			
rrcReconfiguration SEQUENCE {			
secondaryCellGroup	OCTET STRING containing <i>CellGroupConfig</i> according to table 8.2.2.1.1.3.3-9.		
}			
}			
}			

Table 8.2.2.3.1.3.3-9: CellGroupConfig (Table 8.2.2.3.1.3.3-8)

Derivation Path: TS 38.508-1 [4], Table 4.6.3-19			
Information Element	Value/remark	Comment	Condition
CellGroupConfig ::= SEQUENCE {			
cellGroupId	1		
rlc-BearerToAddModList	Not present		
rlc-BearerToReleaseList SEQUENCE (SIZE (1..maxLC-ID)) OF LogicalChannelIdentity {	1 entry		
LogicalChannelIdentity[1]	3	entry 1	
}			
mac-CellGroupConfig	Not present		
physicalCellGroupConfig	Not present		
sCellToAddModList	Not present		
sCellToReleaseList SEQUENCE (SIZE (1..maxNrofSCells)) OF SCellIndex {	1 entry		
SCellIndex[1]	SCellIndex	entry 1 NR Cell 1	
}			
}			

Table 8.2.2.3.1.3.3-10: RRCConnectionReconfiguration (step 7, Table 8.2.2.3.1.3.2-1)

Derivation Path: TS 36.508 [7], Table 4.6.1-8 with condition HO-TO-EUTRA			
Information Element	Value/remark	Comment	Condition
RRCConnectionReconfiguration ::= SEQUENCE {			
criticalExtensions CHOICE {			
c1 CHOICE {			
rrcConnectionReconfiguration-r8 SEQUENCE {			
mobilityControllInfo	MobilityControllInfo-HO-SameCell	As per Table 8.2.2.3.1.3.3-1E	
radioResourceConfigDedicated SEQUENCE {			
srb-ToAddModList SEQUENCE (SIZE (1..2)) OF SRB-ToAddMod {	1 entry		
SRB-ToAddMod[1]	SRB-ToAddMod-DEFAULT using condition SRB1	entry 1	
}			
}			
}			
}			

8.2.2.3.2 Simultaneous SRB3 and Split SRB / Sequential message flow on SRB3 and Split SRB with one UL path / NR-DC

8.2.2.3.2.1 Test Purpose (TP)

(1)

```
with { UE in NR RRC_CONNECTED state in NR-DC mode with SRB3 and split SRB1 configured with no PDCP duplication }
ensure that {
  when { UE receives RRCReconfiguration message on SRB3 to modify SCG DRB }
  then { UE sends RRCReconfigurationComplete message on SRB3 over the SCG path }
}
```

(2)

```
with { UE in RRC_CONNECTED state in NR-DC mode with SRB3 and split SRB1 configured with no PDCP duplication }
ensure that {
  when { UE receives an RRCReconfiguration message on split SRB1 on the SCG path to release SRB3 }
  then { UE releases SRB3 and sends an RRCReconfigurationComplete message on split SRB1 over the MCG path }
}
```

(3)

```
with { UE in RRC_CONNECTED state in NR-DC mode with split SRB1 configured with no PDCP duplication }
ensure that {
  when { UE receives an RRCReconfiguration message to release split SRB1 on SCG path }
  then { UE releases split SRB1 and sends an RRCReconfigurationComplete message on SRB1 over the MCG path }
}
```

8.2.2.3.2.2 Conformance requirements

References: The conformance requirements covered in the present TC are specified in: TS 37.340, clause 7.6 and TS 38.331, clause 5.3.5.3, 5.3.5.5.3, 5.3.5.5.4, 5.3.5.6.1, 5.3.5.6.3. Unless and otherwise stated these are Rel-15 requirements.

[TS 37.340, clause 7.6]

Split SRB is supported for both SRB1 and SRB2 (split SRB is not supported for SRB0 and SRB3) in all MR-DC cases. RRC PDUs on split SRB are ciphered and integrity protected using NR PDCP.

Split SRB can be configured by the MN in Secondary Node Addition and/or Modification procedure, with SN configuration part provided by the SN. A UE can be configured with both split SRB and SRB3 simultaneously. SRB3 and the SCG leg of split SRB can be independently configured.

For the split SRB, the selection of transmission path in downlink depends on network implementation. For uplink, the UE is configured via MN RRC signalling whether to use MCG path or duplicate the transmission on both MCG and SCG.

[TS 38.331, clause 5.3.5.3]

The UE shall perform the following actions upon reception of the *RRCReconfiguration*:

...

1> if the *RRCReconfiguration* includes the *masterCellGroup*:

2> perform the cell group configuration for the received *masterCellGroup* according to 5.3.5.5;

1> if the *RRCReconfiguration* includes the *masterKeyUpdate*:

2> perform AS security key update procedure as specified in 5.3.5.7;

1> if the *RRCReconfiguration* includes the *sk-Counter*:

- 2> perform security key update procedure as specified in 5.3.5.7;
 - 1> if the *RRCReconfiguration* includes the *secondaryCellGroup*:
 - 2> perform the cell group configuration for the SCG according to 5.3.5.5;
 - 1> if the *RRCReconfiguration* includes the *mrdc-SecondaryCellGroupConfig*:
 - 2> if the *mrdc-SecondaryCellGroupConfig* is set to *setup*:
 - 3> if the *mrdc-SecondaryCellGroupConfig* includes *mrdc-ReleaseAndAdd*:
 - 4> perform MR-DC release as specified in clause 5.3.5.10;
 - 3> if the received *mrdc-SecondaryCellGroup* is set to *nr-SCG*:
 - 4> perform the RRC reconfiguration according to 5.3.5.3 for the *RRCReconfiguration* message included in *nr-SCG*;
 - ...
 - 1> if the *RRCReconfiguration* message includes the *radioBearerConfig*:
 - 2> perform the radio bearer configuration according to 5.3.5.6;
 - 1> if the *RRCReconfiguration* message includes the *radioBearerConfig2*:
 - 2> perform the radio bearer configuration according to 5.3.5.6;
 - ...
 - 1> set the content of the *RRCReconfigurationComplete* message as follows:
 - ...
 - 2> if the *RRCReconfiguration* message includes the *mrdc-SecondaryCellGroupConfig* with *mrdc-SecondaryCellGroup* set to *nr-SCG*:
 - 3> include in the *nr-SCG-Response* the *RRCReconfigurationComplete* message;
 - ...
 - 1> else if the *RRCReconfiguration* message was received within the *nr-SCG* within *mrdc-SecondaryCellGroup* (UE in NR-DC, *mrdc-SecondaryCellGroup* was received in *RRCReconfiguration* via SRB1):
 - 2> if *reconfigurationWithSync* was included in *spCellConfig* in *nr-SCG*:
 - 3> initiate the Random Access procedure on the PSCell, as specified in TS 38.321 [3];
 - 2> else
 - 3> the procedure ends;
- NOTE 2a: The order in which the UE sends the *RRCReconfigurationComplete* message and performs the Random Access procedure towards the SCG is left to UE implementation.
- 1> else if the *RRCReconfiguration* message was received via SRB3 (UE in NR-DC):
 - 2> submit the *RRCReconfigurationComplete* message via SRB3 to lower layers for transmission using the new configuration;
 - 1> else (*RRCReconfiguration* was received via SRB1):
 - 2> submit the *RRCReconfigurationComplete* message via SRB1 to lower layers for transmission using the new configuration;
 - 2> if this is the first *RRCReconfiguration* message after successful completion of the RRC re-establishment procedure:

3> resume SRB2 and DRBs that are suspended;

[TS 38.331, clause 5.3.5.5.3]

The UE shall:

1> for each *logicalChannelIdentity* value included in the *rlc-BearerToReleaseList* that is part of the current UE configuration (LCH release); or

1> for each *logicalChannelIdentity* value that is to be released as the result of an SCG release according to 5.3.5.4:

2> release the RLC entity or entities as specified in TS 38.322 [4] clause 5.1.3;

2> release the corresponding logical channel.

[TS 38.331, clause 5.3.5.5.4]

For each *RLC-BearerConfig* received in the *rlc-BearerToAddModList* IE the UE shall:

1> if the UE's current configuration contains an RLC bearer with the received *logicalChannelIdentity* within the same cell group:

2> if *reestablishRLC* is received:

3> re-establish the RLC entity as specified in TS 38.322 [4];

2> reconfigure the RLC entity or entities in accordance with the received *rlc-Config*;

2> reconfigure the logical channel in accordance with the received *mac-LogicalChannelConfig*;

NOTE: The network does not re-associate an already configured logical channel with another radio bearer. Hence *servedRadioBearer* is not present in this case.

...

[TS 38.331, clause 5.3.5.6.1]

The UE shall perform the following actions based on a received *RadioBearerConfig* IE:

...

1> if the *RadioBearerConfig* includes the *srb-ToAddModList*:

2> perform the SRB addition or reconfiguration as specified in 5.3.5.6.3;

...

[TS 38.331, clause 5.3.5.6.3]

The UE shall:

1> for each *srb-Identity* value included in the *srb-ToAddModList* that is not part of the current UE configuration (SRB establishment or reconfiguration from NR PDCP to NR PDCP):

2> establish a PDCP entity and configure it with the security algorithms according to *securityConfig* and apply the keys (K_{RRCenc} and K_{RRCint}) associated with the master key (K_{eNB}/K_{gNB}) or secondary key ($S-K_{gNB}$) as indicated in *keyToUse*, if applicable;

2> if the current UE configuration as configured by NR in TS 36.331 includes an SRB identified with the same *srb-Identity* value:

3> associate the NR RLC entity and DCCH of this SRB with the NR PDCP entity;

3> release the NR PDCP entity of this SRB;

2> if the *pdcp-Config* is included:

3> configure the PDCP entity in accordance with the received *pdcp-Config*;

2> else:

3> configure the PDCP entity in accordance with the default configuration defined in 9.2.1 for the corresponding SRB;

8.2.2.3.2.3 Test description

8.2.2.3.2.3.1 Pre-test conditions

System Simulator:

- NR Cell 1 is the PCell and NR Cell 10 is the PSCell.
- System information combination NR-4 as defined in TS 38.508-1 [4] clause 4.4.3.1.2 is used in NR cells.

UE:

- None.

Preamble:

- The UE is in state RRC_CONNECTED using generic procedure parameter Connectivity (NR-DC), bearers (MCG(s) and SCG) established according to TS 38.508-1 [4], clause 4.5.4.

8.2.2.3.2.3.2 Test procedure sequence

Table 8.2.2.3.2.3.2-1: Main behaviour

St	Procedure	Message Sequence		TP	Verdict
		U - S	Message		
1	The SS transmits on SRB1 over MCG path/NR Cell 1 an <i>RRCReconfiguration</i> message to configure SRB3 and reconfigure SRB1 to split SRB without PDCP duplication.	<--	<i>RRCReconfiguration</i>	-	-
2	UE transmits an <i>RRCReconfigurationComplete</i> message on split SRB1 over the MCG path/NR Cell 1.	-->	<i>RRCReconfigurationComplete</i>	-	-
3	The SS transmits on SRB3/SCG an NR <i>RRCReconfiguration</i> message to reconfigure SCG DRB.	<--	<i>RRCReconfiguration</i>	-	-
4	Check: Does the UE transmit an NR <i>RRCReconfigurationComplete</i> message on SRB3/NR Cell 10?	-->	<i>RRCReconfigurationComplete</i>	1	P
5	The SS transmits over split SRB1 SCG path/NR Cell 10 an <i>RRCReconfiguration</i> message to release SRB3.	<--	<i>RRCReconfiguration</i>	-	-
6	Check: Does the UE transmits an <i>RRCReconfigurationComplete</i> message on split SRB1 over the MCG path/NR Cell 1?	-->	<i>RRCReconfigurationComplete</i>	2	P
7	The SS transmits an <i>RRCReconfiguration</i> message to release SRB1 over SCG path/NR Cell 10.	<--	<i>RRCReconfiguration</i>	-	-
8	Check: Does the UE transmits an <i>RRCReconfigurationComplete</i> message on SRB1 over the MCG path/NR Cell 1?	-->	<i>RRCReconfigurationComplete</i>	3	P

8.2.2.3.2.3.3 Specific message contents

Table 8.2.2.3.2.3.3-1: *RRCReconfiguration* (step 1, Table 8.2.2.3.2.3.2-1)

Derivation Path: TS 38.508-1 [4], Table 4.6.1-13 with condition NR-DC			
Information Element	Value/remark	Comment	Condition

RRCReconfiguration ::= SEQUENCE {			
criticalExtensions CHOICE {			
rrcReconfiguration SEQUENCE {			
radioBearerConfig	OCTET STRING containing RadioBearerConfig given in Table 8.2.2.3.2.3.3-4		
nonCriticalExtension SEQUENCE {			
masterCellGroup	Not present		
nonCriticalExtension SEQUENCE {			
nonCriticalExtension SEQUENCE {			
mrdc-SecondaryCellGroupConfig CHOICE {			
setup SEQUENCE {			
mrdc-SecondaryCellGroup CHOICE {			
nr-SCG	OCTET STRING containing the RRCReconfiguration given in Table 8.2.2.3.2.3.3-2		
}			
}			
}			
radioBearerConfig2	OCTET STRING containing the RadioBearerConfig specified in TS 38.508-1 [4], Table 4.6.3-132 with condition SRB3		
sk-Counter	Increment the value by 1 from the previous value		
}			
}			
}			
}			
}			
}			

Table 8.2.2.3.2.3.3-2: RRCReconfiguration (Table 8.2.2.3.2.3.3-1)

Derivation Path: TS 38.508-1 [4], Table 4.6.1-13 with Condition NR-DC_SCG			
Information Element	Value/remark	Comment	Condition
RRCReconfiguration ::= SEQUENCE {			
criticalExtensions CHOICE {			
rrcReconfiguration SEQUENCE {			
secondaryCellGroup	OCTET STRING containing CellGroupConfig given in Table 8.2.2.3.2.3.3-3		
}			
}			
}			

Table 8.2.2.3.2.3.3-3: CellGroupConfig (Table 8.2.2.3.2.3.3-2)

Derivation Path: TS 38.508-1 [4], Table 4.6.3-19 with condition NR-DC_SCG			
Information Element	Value/remark	Comment	Condition
CellGroupConfig ::= SEQUENCE {			
rlc-BearerToAddModList SEQUENCE (SIZE(1..maxLC-ID)) OF RLC-BearerConfig {	2+n entries	n is the number of established SCG DRBs. Value of n depends on TTCN implementation	

RLC-BearerConfig[1]	RLC-BearerConfig according to 38.508-1 [4], Table 4.6.3-148 with condition SRB1 and Re-establish_RLC	entry 1	
RLC-BearerConfig[2]	RLC-BearerConfig according to 38.508-1 [4], Table 4.6.3-148 with condition SRB3	entry 2	
RLC-BearerConfig[2+k: k=1..n]	RLC-BearerConfig according to 38.508-1 [4], Table 4.6.3-148 with conditions AM and DRBk and Re-establish_RLC	entry 2+k	
}			
mac-LogicalChannelConfig	LogicalChannelConfig according to 38.508-1 [4], table 4.6.3-66		
}			

Table 8.2.2.3.2.3.3-4: RadioBearerConfig (Table 8.2.2.3.2.3.3-1)

Derivation Path: TS 38.508-1[4] table 4.6.3-132 with condition SRB_NR_PDCP and Re-establish_PDCP			
Information Element	Value/remark	Comment	Condition
RadioBearerConfig ::= SEQUENCE {			
srb-ToAddModList SEQUENCE (SIZE (1..2)) OF SRB-ToAddMod {	2 entries		
SRB-ToAddMod[1] SEQUENCE {		entry 1 SRB1	
pdcp-Config	PDCP-Config according to TS 38.508-1[4] table 4.6.3-99 with condition Split_SRB		
}			
}			
}			

Table 8.2.2.3.2.3.3-5: RRCReconfiguration (step 3, Table 8.2.2.3.2.3.2-1)

Derivation Path: TS 38.508-1 [4], Table 4.6.1-13			
Information Element	Value/remark	Comment	Condition
RRCReconfiguration ::= SEQUENCE {			
criticalExtensions CHOICE {			
rrcReconfiguration SEQUENCE {			
secondaryCellGroup	OCTET STRING containing CellGroupConfig given in Table 8.2.2.3.2.3.3-6		
}			
}			
}			

Table 8.2.2.3.2.3.3-6: CellGroupConfig (Table 8.2.2.3.2.3.3-5)

Derivation Path: TS 38.508-1 [4], Table 4.6.3-19 with condition NR-DC_SCG			
Information Element	Value/remark	Comment	Condition
CellGroupConfig ::= SEQUENCE {			
mac-CellGroupConfig	MAC-CellGroupConfig according to Table 8.2.2.3.2.3.3-7		
}			

Table 8.2.2.3.2.3.3-7: MAC-CellGroupConfig (Table 8.2.2.3.2.3.3-6)

Derivation Path: TS 38.508-1 [4], Table 4.6.3-68			
Information Element	Value/remark	Comment	Condition
MAC-CellGroupConfig ::= SEQUENCE {			
bsr-Config SEQUENCE {			
periodicBSR-Timer	sf5		
retxBSR-Timer	sf40		
}			
}			

Table 8.2.2.3.2.3.3-8: RRCReconfiguration (step 5, Table 8.2.2.3.2.3.2-1)

Derivation Path: TS 38.508-1 [4], Table 4.6.1-13 with condition NR-DC			
Information Element	Value/remark	Comment	Condition
RRCReconfiguration ::= SEQUENCE {			
criticalExtensions CHOICE {			
rrcReconfiguration SEQUENCE {			
radioBearerConfig	Not present		
nonCriticalExtension SEQUENCE {			
masterCellGroup	Not present		
nonCriticalExtension SEQUENCE {			
nonCriticalExtension SEQUENCE {			
mrdc-SecondaryCellGroupConfig CHOICE {			
setup SEQUENCE {			
mrdc-SecondaryCellGroup CHOICE {			
nr-SCG	OCTET STRING containing <i>RRCReconfiguration</i> according to Table 8.2.2.3.2.3.3-10		
}			
}			
}			
radioBearerConfig2	RadioBearerConfig according to Table 8.2.2.3.2.3.3-9		
}			
}			
}			

Table 8.2.2.3.2.3.3-9: RadioBearerConfig (Table 8.2.2.3.2.3.3-8)

Derivation Path: TS 38.508-1 [4], Table 4.6.3-132			
Information Element	Value/remark	Comment	Condition
RadioBearerConfig ::= SEQUENCE {			
srb-ToAddModList	Not present		
srb3-ToRelease	true		
drb-ToAddModList	Not present		
drb-ToReleaseList	Not present		
securityConfig	Not present		
}			

Table 8.2.2.3.2.3.3-10: RRCReconfiguration (Table 8.2.2.3.2.3.3-8)

Derivation Path: TS 38.508-1 [4], Table 4.6.1-13 with condition NR-DC_SCG			
Information Element	Value/remark	Comment	Condition
RRCReconfiguration ::= SEQUENCE {			
criticalExtensions CHOICE {			

rrcReconfiguration SEQUENCE {			
secondaryCellGroup	OCTET STRING containing <i>CellGroupConfig</i> according to Table 8.2.2.3.2.3.3-11		
}			
}			
}			

Table 8.2.2.3.2.3.3-11: *CellGroupConfig* (Table 8.2.2.3.2.3.3-10)

Derivation Path: TS 38.508-1 [4], Table 4.6.3-19 with condition NR-DC_SCG			
Information Element	Value/remark	Comment	Condition
CellGroupConfig ::= SEQUENCE {			
rlc-BearerToAddModList	Not present		
rlc-BearerToReleaseList SEQUENCE (SIZE (1.. maxLC-ID)) OF LogicalChannelIdentity {	1 entry		
LogicalChannelIdentity[1]	3	entry 1	
}			
mac-CellGroupConfig	Not present		
physicalCellGroupConfig	Not present		
}			

Table 8.2.2.3.2.3.3-12: *RRCReconfiguration* (step 7, Table 8.2.2.3.2.3.2-1)

Derivation Path: TS 38.508-1 [4], Table 4.6.1-13 with condition NR-DC			
Information Element	Value/remark	Comment	Condition
RRCReconfiguration ::= SEQUENCE {			
criticalExtensions CHOICE {			
rrcReconfiguration SEQUENCE {			
radioBearerConfig	OCTET STRING containing <i>RadioBearerConfig</i> according Table 8.2.2.3.2.3.3-13		
nonCriticalExtension SEQUENCE {			
masterCellGroup	Not present		
nonCriticalExtension SEQUENCE {			
nonCriticalExtension SEQUENCE {			
mrdc-SecondaryCellGroupConfig CHOICE {			
setup SEQUENCE {			
mrdc-SecondaryCellGroup CHOICE {			
nr-SCG	OCTET STRING containing <i>RRCReconfiguration</i> according to Table 8.2.2.3.2.3.3-14		
}			
}			
}			
radioBearerConfig2	Not present		
}			
}			
}			

Table 8.2.2.3.2.3.3-13: *RadioBearerConfig* (Table 8.2.2.3.2.3.3-12)

Derivation Path: TS 38.508-1 [4] Table 4.6.3-132 with condition SRB1			
Information Element	Value/remark	Comment	Condition
RadioBearerConfig ::= SEQUENCE {			

srb-ToAddModList SEQUENCE (SIZE (1..2)) OF SRB-ToAddMod {	1 entry		
SRB-ToAddMod[1] SEQUENCE {		entry 1	
reestablishPDCP	true		
pdcp-Config	PDCP-Config with condition SRB		
}			
}			
}			

Table 8.2.2.3.2.3.3-14: RRCReconfiguration (Table 8.2.2.3.2.3.3-12)

Derivation Path: TS 38.508-1 [4], Table 4.6.1-13 with condition NR-DC_SCG			
Information Element	Value/remark	Comment	Condition
RRCReconfiguration ::= SEQUENCE {			
criticalExtensions CHOICE {			
rrcReconfiguration SEQUENCE {			
secondaryCellGroup	OCTET STRING containing CellGroupConfig according to Table 8.2.2.3.2.3.3-15		
}			
}			
}			

Table 8.2.2.3.2.3.3-15: CellGroupConfig (Table 8.2.2.3.2.3.3-14)

Derivation Path: TS 38.508-1 [4], Table 4.6.3-19 with condition NR-DC_SCG			
Information Element	Value/remark	Comment	Condition
CellGroupConfig ::= SEQUENCE {			
rlc-BearerToReleaseList SEQUENCE (SIZE (1..maxLC-ID)) OF LogicalChannelIdentity {	1 entry		
LogicalChannelIdentity[1]	1	entry 1	
}			
}			

8.2.2.4 PSCell addition, modification and release / SCG DRB

8.2.2.4.1 PSCell addition, modification and release / SCG DRB / EN-DC

8.2.2.4.1.1 Test Purpose (TP)

(1)

```
with { UE in E-UTRA RRC_CONNECTED state }
ensure that {
  when { UE receives an RRCConnectionReconfiguration message to add PSCell with SCG DRB }
  then { UE configures the PSCell with SCG DRB and sends an RRCConnectionReconfigurationComplete message }
}
```

(2)

```
with { UE in RRC_CONNECTED state with EN-DC, and, MCG(s) (E-UTRA PDCP) and SCG }
ensure that {
  when { UE receives an RRCConnectionReconfiguration message to modify SCG DRB }
  then { UE reconfigures the SCG DRB and sends an RRCConnectionReconfigurationComplete message }
}
```

(3)

```
with { UE in RRC_CONNECTED state with EN-DC, and, MCG(s) (E-UTRA PDCP) and SCG }
ensure that {
```

```

when { UE receives an RRCConnectionReconfiguration message to release PSCell with SCG DRB }
then { UE releases the PSCell and SCG DRB and sends an RRCConnectionReconfigurationComplete
message }
}

```

8.2.2.4.1.2 Conformance requirements

References: The conformance requirements covered in the present test case are specified in: TS 36.331, clause 5.3.5.3, TS 38.331, clauses 5.3.5.3, 5.3.5.5.7, 5.3.5.6.4 and 5.3.5.6.5. Unless otherwise stated these are Rel-15 requirements.

[TS 36.331, clause 5.3.5.3]

If the *RRCConnectionReconfiguration* message does not include the *mobilityControlInfo* and the UE is able to comply with the configuration included in this message, the UE shall:

...

- 1> if the received *RRCConnectionReconfiguration* includes the *nr-Config* and it is set to release: or
- 1> if the received *RRCConnectionReconfiguration* includes *endc-ReleaseAndAdd* and it is set to *TRUE*:
 - 2> perform ENDC release as specified in TS38.331 [82], clause 5.3.5.10;
- 1> if the received *RRCConnectionReconfiguration* includes the *sk-Counter*:
 - 2> perform key update procedure as specified in TS 38.331 [82], clause 5.3.5.7;
- 1> if the received *RRCConnectionReconfiguration* includes the *nr-SecondaryCellGroupConfig*:
 - 2> perform NR RRC Reconfiguration as specified in TS 38.331 [82], clause 5.3.5.3;
- 1> if the received *RRCConnectionReconfiguration* includes the *nr-RadioBearerConfig1*:
 - 2> perform radio bearer configuration as specified in TS 38.331 [82], clause 5.3.5.6;
- 1> if the received *RRCConnectionReconfiguration* includes the *nr-RadioBearerConfig2*:
 - 2> perform radio bearer configuration as specified in TS 38.331 [82], clause 5.3.5.6;

...

- 1> set the content of *RRCConnectionReconfigurationComplete* message as follows:
 - 2> if the *RRCConnectionReconfiguration* message includes *perCC-GapIndicationRequest*:
 - 3> include *perCC-GapIndicationList* and *numFreqEffective*;
 - 2> if the frequencies are configured for reduced measurement performance:
 - 3> include *numFreqEffectiveReduced*;
 - 2> if the received *RRCConnectionReconfiguration* message included *nr-SecondaryCellGroupConfig*:
 - 3> include *scg-ConfigResponseNR* in accordance with TS 38.331 [82], clause 5.3.5.3;
- 1> submit the *RRCConnectionReconfigurationComplete* message to lower layers for transmission using the new configuration, upon which the procedure ends;

[TS 38.331, clause 5.3.5.3]

The UE shall perform the following actions upon reception of the *RRCReconfiguration*:

...

- 1> if the *RRCReconfiguration* includes the *secondaryCellGroup*:
 - 2> perform the cell group configuration for the SCG according to 5.3.5.5;
- 1> if the *RRCReconfiguration* message contains the *radioBearerConfig*:

- 2> perform the radio bearer configuration according to 5.3.5.6;
- 1> if the *RRCReconfiguration* message includes the *measConfig*:
 - 2> perform the measurement configuration procedure as specified in 5.5.2;
- ...
- 1> set the content of *RRCReconfigurationComplete* message as follows:
 - 2> if the *RRCReconfiguration* includes the *masterCellGroup* containing the *reportUplinkTxDirectCurrent*, or;
 - 2> if the *RRCReconfiguration* includes the *secondaryCellGroup* containing the *reportUplinkTxDirectCurrent*:
 - 3> include the *uplinkTxDirectCurrentList*;
- 1> if the UE is configured with E-UTRA *nr-SecondaryCellGroupConfig* (MCG is E-UTRA):
 - 2> if *RRCReconfiguration* was received via SRB1:
 - 3> construct *RRCReconfigurationComplete* message and submit it via the EUTRA MCG embedded in E-UTRA RRC message *RRCConnectionReconfigurationComplete* as specified in TS 36.331 [10].
 - 3> if *reconfigurationWithSync* was included in *spCellConfig* of an SCG:
 - 4> initiate the random access procedure on the SpCell, as specified in TS 38.321 [3];
 - 3> else:
 - 4> the procedure ends;
 - NOTE: The order the UE sends the *RRCConnectionReconfigurationComplete* message and performs the Random Access procedure towards the SCG is left to UE implementation.
 - 2> else (*RRCReconfiguration* was received via SRB3):
 - 3> submit the *RRCReconfigurationComplete* message via SRB3 to lower layers for transmission using the new configuration.

NOTE: For EN-DC, in the case *RRCReconfiguration* is received via SRB1, the random access is triggered by RRC layer itself as there is not necessarily other UL transmission. In the case *RRCReconfiguration* is received via SRB3, the random access is triggered by the MAC layer due to arrival of *RRCReconfigurationComplete*.

- 1 > else:
 - 2> submit the *RRCReconfigurationComplete* message via SRB1 to lower layers for transmission using the new configuration;
 - 2> if this is the first *RRCReconfiguration* message after successful completion of the RRC re-establishment procedure:
- 3> resume SRB2 and DRBs that are suspended;
- 1> if *reconfigurationWithSync* was included in *spCellConfig* of an MCG or SCG, and when MAC of an NR cell group successfully completes a random access procedure triggered above:
 - 2> stop timer T304 for that cell group;
 - 2> apply the parts of the CQI reporting configuration, the scheduling request configuration and the sounding RS configuration that do not require the UE to know the SFN of the respective target SpCell, if any;
 - 2> apply the parts of the measurement and the radio resource configuration that require the UE to know the SFN of the respective target SpCell (e.g. measurement gaps, periodic CQI reporting, scheduling request configuration, sounding RS configuration), if any, upon acquiring the SFN of that target SpCell;

- 2> if the *reconfigurationWithSync* was included in *spCellConfig* of an MCG::
 - 3> if T390 is running:
 - 4> stop timer T390 for all access categories;
 - 4> perform the actions as specified in 5.3.14.4.
 - 3> if *RRCReconfiguration* does not include *dedicatedSIB1-Delivery* and
 - 3> if the active downlink BWP, which is indicated by the *firstActiveDownlinkBWP-Id* for the target SpCell of the MCG, has a common search space configured by *searchSpaceSIB1*:
 - 4> acquire the *SIB1*, which is scheduled as specified in TS 38.213 [13], of the target SpCell of the MCG;
 - 4> upon acquiring *SIB1*, perform the actions specified in clause 5.2.2.4.2;
- 2> the procedure ends;

NOTE: The UE is only required to acquire broadcasted *SIB1* if the UE can acquire it without disrupting unicast data reception, i.e. the broadcast and unicast beams are quasi co-located.

[TS 38.331, clause 5.3.5.5.7]

The UE shall:

...

- 1> if the *SpCellConfig* contains *spCellConfigDedicated*:
 - 2> configure the SpCell in accordance with the *spCellConfigDedicated*;
 - 2> consider the bandwidth part indicated in *firstActiveUplinkBWP-Id* if configured to be the active uplink bandwidth part;
 - 2> consider the bandwidth part indicated in *firstActiveDownlinkBWP-Id* if configured to be the active downlink bandwidth part;
 - 2> if the any of the reference signal(s) that are used for radio link monitoring are reconfigured by the received *spCellConfigDedicated*:
 - 3> stop timer T310 for the corresponding SpCell, if running;
 - 3> reset the counters N310 and N311.

[TS 38.331, clause 5.3.5.6.4]

Editor's Note: FFS / TODO: Add handling for the new QoS concept (mapping of flows; configuration of QFI-to-DRB mapping; reflective QoS...) but keep also EPS-Bearer handling for the EN-DC case

The UE shall:

- 1> for each *drb-Identity* value included in the *drb-ToReleaseList* that is part of the current UE configuration; or
- 1> for each *drb-Identity* value that is to be released as the result of full configuration according to 5.3.5.11:
 - 2> release the PDCP entity and the *drb-Identity*;
 - 2> if SDAP entity associated with this DRB is configured:
 - 3> indicate the release of the DRB to SDAP entity associated with this DRB (TS 37.324 24[] clause 5.3.3);
 - 2> if the UE is operating in EN-DC:

- 3> if a new bearer is not added either with NR or E-UTRA with same *eps-BearerIdentity*:
- 4> indicate the release of the DRB and the *eps-BearerIdentity* of the released DRB to upper layers.

NOTE: The UE does not consider the message as erroneous if the *drb-ToReleaseList* includes any *drb-Identity* value that is not part of the current UE configuration.

NOTE: Whether or not the RLC and MAC entities associated with this PDCP entity are reset or released is determined by the *CellGroupConfig*.

[TS 38.331, clause 5.3.5.6.5]

The UE shall:

- 1> for each *drb-Identity* value included in the *drb-ToAddModList* that is not part of the current UE configuration (DRB establishment including the case when full configuration option is used):
 - 2> establish a PDCP entity and configure it in accordance with the received *pdcp-Config*;
 - 2> if the PDCP entity of this DRB is not configured with *cipheringDisabled*::
 - 3> if target RAT of handover is E-UTRA/5GC, or;
 - 3> if the UE is only connected to E-UTRA/5GC:
 - 4> configure the PDCP entity with the ciphering algorithm and K_{UPenc} key configured/derived as specified in TS 36.331 [10];
 - 3> else:
 - 4> configure the PDCP entity with the ciphering algorithms according to *securityConfig* and apply the K_{UPenc} key associated with the master key (K_{eNB}/K_{gNB}) or the secondary key ($S-K_{gNB}$) as indicated in *keyToUse*;
 - 2> if the PDCP entity of this DRB is configured with *integrityProtection*:
 - 3> configure the PDCP entity with the integrity algorithms according to *securityConfig* and apply the K_{UPint} key associated with the master (K_{eNB}/K_{gNB}) or the secondary key ($S-K_{gNB}$) as indicated in *keyToUse*;
 - ...
 - 2> if the UE is operating in EN-DC:
 - 3> if the DRB was configured with the same *eps-BearerIdentity* either by NR or E-UTRA prior to receiving this reconfiguration:
 - 4> associate the established DRB with the corresponding *eps-BearerIdentity*;
 - 3> else:
 - 4> indicate the establishment of the DRB(s) and the *eps-BearerIdentity* of the established DRB(s) to upper layers;
- 1> for each *drb-Identity* value included in the *drb-ToAddModList* that is part of the current UE configuration:
 - 2> if the *reestablishPDCP* is set:
 - 3> if target RAT is E-UTRA/5GC, or;
 - 3> if the UE is only connected to E-UTRA/5GC:
 - 4> if the PDCP entity of this DRB is not configured with *cipheringDisabled*:
 - 5> configure the PDCP entity with the ciphering algorithm and K_{UPenc} key configured/derived as specified in TS 36.331 [10], clause 5.4.2.3, i.e. the ciphering configuration shall be applied to all subsequent PDCP PDUs received and sent by the UE;
 - 3> else:

- 4> if the PDCP entity of this DRB is not configured with *cipheringDisabled*::
 - 5> configure the PDCP entity with the ciphering algorithm and K_{UPenc} key associated with the master key (K_{eNB}/K_{gNB}) or the secondary key ($S-K_{gNB}$), as indicated in *keyToUse*, i.e. the ciphering configuration shall be applied to all subsequent PDCP PDUs received and sent by the UE;
- 4> if the PDCP entity of this DRB is configured with *integrityProtection*:
 - 5> configure the PDCP entity with the integrity algorithms according to *securityConfig* and apply the K_{UPint} key associated with the master (K_{eNB}/K_{gNB}) or the secondary key ($S-K_{gNB}$) as indicated in *keyToUse*;
- 3> re-establish the PDCP entity of this DRB as specified in 38.323 [5], clause 5.1.2;
- 2> else, if the *recoverPDCP* is set:
 - 3> trigger the PDCP entity of this DRB to perform data recovery as specified in 38.323[5];
- 2> if the *pdcp-Config* is included:
 - 3> reconfigure the PDCP entity in accordance with the received *pdcp-Config*.

...

NOTE 1: Void

NOTE 2: When determining whether a drb-Identity value is part of the current UE configuration, the UE does not distinguish which *RadioBearerConfig* and *DRB-ToAddModList* that DRB was originally configured in. To re-associate a DRB with a different key (K_{eNB} to $S-K_{eNB}$ or vice versa), the network provides the *drb-Identity* value in the (target) *drb-ToAddModList* and sets the *reestablishPDCP* flag. The network does not list the *drb-Identity* in the (source) *drb-ToReleaseList*.

NOTE 3: When setting the *reestablishPDCP* flag for a radio bearer, the network ensures that the RLC receiver entities do not deliver old PDCP PDUs to the re-established PDCP entity. It does that e.g. by triggering a reconfiguration with sync of the cell group hosting the old RLC entity or by releasing the old RLC entity.

NOTE 4: In this specification, UE configuration refers to the parameters configured by NR RRC unless otherwise stated.

NOTE 5: Ciphering and integrity protection can be enabled or disabled for a DRB. The enabling/disabling of ciphering or integrity protection can be changed only by releasing and adding the DRB.

8.2.2.4.1.3 Test description

8.2.2.4.1.3.1 Pre-test conditions

System Simulator:

- E-UTRA Cell 1 is the PCell and NR Cell 1 is the PSCell.

UE:

- None.

Preamble:

- If *pc_IP_Ping* is set to TRUE then, the UE is in state RRC_CONNECTED using generic procedure parameter Connectivity (*E-UTRA/EPC*) established according to TS 38.508-1 [4], clause 4.5.4.
- Else, the UE is in state RRC_CONNECTED using generic procedure parameter Connectivity (*E-UTRA/EPC*) established and Test Mode (*On*) associated with UE test loop mode B configured on E-UTRA Cell 1 according to TS 38.508-1 [4], clause 4.5.4.

8.2.2.4.1.3.2 Test procedure sequence

Table 8.2.2.4.1.3.2-1: Main behaviour

St	Procedure	Message Sequence		TP	Verdict
		U - S	Message		
1	The SS transmits an <i>RRCCONNECTIONRECONFIGURATION</i> message containing NR <i>RRCReconfiguration</i> message to add NR <i>PSCell</i> with SCG DRB. <i>RRCCONNECTIONRECONFIGURATION</i> message contains the ACTIVATE DEDICATED EPS BEARER CONTEXT REQUEST message.	<--	<i>RRCCONNECTIONRECONFIGURATION (RRCReconfiguration)</i>	-	-
2	Check: Does the UE transmit an <i>RRCCONNECTIONRECONFIGURATIONCOMPLETE</i> message containing NR <i>RRCReconfigurationComplete</i> message?	-->	<i>RRCCONNECTIONRECONFIGURATIONCOMPLETE (RRCReconfigurationComplete)</i>	1	P
3	The UE transmits an <i>ULINFORMATIONTRANSFER</i> message containing the ACTIVATE DEDICATED EPS BEARER CONTEXT ACCEPT message.	-->	<i>ULINFORMATIONTRANSFER</i>	-	-
-	EXCEPTION: Steps 4a1 to 4a2 describe behaviour that depends on the UE implementation; the "lower case letter" identifies a step sequence that take place depending on the UE implementation.	-	-	-	-
4a1	IF <i>pc_IP_Ping</i> = FALSE, then, the SS transmits a CLOSE UE TEST LOOP message.	<--	CLOSE UE TEST LOOP	-	-
4a2	The UE transmits a CLOSE UE TEST LOOP COMPLETE message.	-->	CLOSE UE TEST LOOP COMPLETE	-	-
5	Check: Does the test result of generic test procedure in TS 38.508-1 subclause 4.9.1 indicate that the UE is capable of exchanging IP data on SCG DRB#2?	-	-	1	P
6	SS transmits <i>RRCCONNECTIONRECONFIGURATION</i> message containing NR <i>RadioBearerConfig</i> to modify PDCP discardTimer value of SCG DRB.	<--	<i>RRCCONNECTIONRECONFIGURATION</i>	-	-
7	Check: Does the UE transmit an <i>RRCCONNECTIONRECONFIGURATIONCOMPLETE</i> message?	-->	<i>RRCCONNECTIONRECONFIGURATIONCOMPLETE</i>	2	P
8	Check: Does the test result of generic test procedure in TS 38.508-1 subclause 4.9.1 indicate that the UE is capable of exchanging IP data on SCG DRB#2?	-	-	2	P
9	SS transmits <i>RRCCONNECTIONRECONFIGURATION</i> message containing <i>nr-Config-r15</i> and NR <i>RadioBearerConfig</i> to release <i>PSCell</i> and SCG DRB. <i>RRCCONNECTIONRECONFIGURATION</i> message contains the DEACTIVATE EPS BEARER CONTEXT REQUEST message.	<--	<i>RRCCONNECTIONRECONFIGURATION</i>	-	-
10	Check: Does the UE transmit an <i>RRCCONNECTIONRECONFIGURATIONCOMPLETE</i> message?	-->	<i>RRCCONNECTIONRECONFIGURATIONCOMPLETE</i>	3	P
11	The UE transmits an <i>ULINFORMATIONTRANSFER</i> message containing the DEACTIVATE EPS BEARER CONTEXT ACCEPT message.	-->	<i>ULINFORMATIONTRANSFER</i>	-	-

8.2.2.4.1.3.3 Specific message contents

Table 8.2.2.4.1.3.3-1: *RRCCONNECTIONRECONFIGURATION* (step 1, Table 8.2.2.4.1.3.2-1)

Derivation Path: TS 36.508 [7], Table 4.6.1-8			
Information Element	Value/remark	Comment	Condition
<i>RRCCONNECTIONRECONFIGURATION</i> ::= SEQUENCE {			

criticalExtensions CHOICE {			
c1 CHOICE {			
rrcConnectionReconfiguration-r8 SEQUENCE {			
nonCriticalExtension SEQUENCE {			
nonCriticalExtension SEQUENCE {			
nonCriticalExtension SEQUENCE {			
nonCriticalExtension SEQUENCE {			
nonCriticalExtension SEQUENCE {			
nonCriticalExtension SEQUENCE {			
nr-Config-r15 CHOICE {			
setup SEQUENCE {			
nr-SecondaryCellGroupConfig-r15	OCTET STRING including the RRCReconfiguration message and the IE secondaryCellGroup.		
}			
}			
}			
}			
}			
}			
}			
}			
}			
}			
}			

Table 8.2.2.4.1.3.3-2: RRCReconfiguration (Table 8.2.2.4.1.3.3-1)

Derivation Path: TS 38.508-1 [4], Table 4.6.1-13			
Information Element	Value/remark	Comment	Condition
RRCReconfiguration ::= SEQUENCE {			
criticalExtensions CHOICE {			
rrcReconfiguration SEQUENCE {			
secondaryCellGroup	CellGroupConfig		
}			
}			
}			

Table 8.2.2.4.1.3.3-3: CellGroupConfig (Table 8.2.2.4.1.3.3-2)

Derivation Path: TS 38.508-1 [4], Table 4.6.3-19			
Information Element	Value/remark	Comment	Condition
CellGroupConfig ::= SEQUENCE {			
rlc-BearerToAddModList SEQUENCE (SIZE(1..maxLC-ID)) OF RLC-BearerConfig {	1 entry		
RLC-BearerConfig[1] SEQUENCE {		entry 1	
servedRadioBearer CHOICE {			
drb-Identity	2	SCG DRB Id	
}			
}			
}			
}			

eps-BearerIdentity	6	Dedicated EPS bearer Id of SCG DRB	
}			
drb-Identity	2	SCG DRB Id	
pdcp-Config	PDCP-Config		
}			
}			
}			

Table 8.2.2.4.1.3.3-7: PDCP-Config (Table 8.2.2.4.1.3.3-6)

Derivation Path: TS 38.508-1 [4], Table 4.6.3-99			
Information Element	Value/remark	Comment	Condition
PDCP-Config ::= SEQUENCE {			
drb SEQUENCE {			
discardTimer	ms500	Other than default value.	
}			
}			

Table 8.2.2.4.1.3.3-8: RRCConnectionReconfiguration (step 9, Table 8.2.2.4.1.3.2-1)

Derivation Path: TS 36.508 [7], Table 4.6.1-8			
Information Element	Value/remark	Comment	Condition
RRCConnectionReconfiguration ::= SEQUENCE {			
criticalExtensions CHOICE {			
c1 CHOICE {			
rrcConnectionReconfiguration-r8 SEQUENCE {			
nonCriticalExtension SEQUENCE {			
nonCriticalExtension SEQUENCE {			
nonCriticalExtension SEQUENCE {			
nonCriticalExtension SEQUENCE {			
nonCriticalExtension SEQUENCE {			
nonCriticalExtension SEQUENCE {			
nonCriticalExtension SEQUENCE {			
nr-Config-r15 CHOICE {			
release			
}			
nr-RadioBearerConfig1-r15	OCTET STRING including RadioBearerConfig.		
}			
}			
}			
}			
}			
}			
}			
}			
}			
}			
}			
}			

Table 8.2.2.4.1.3.3-9: RadioBearerConfig (Table 8.2.2.4.1.3.3-8)

Derivation Path: TS 38.508-1 [4], Table 4.6.3-132			
Information Element	Value/remark	Comment	Condition
RadioBearerConfig ::= SEQUENCE {			
drb-ToReleaseList	2	SCG DRB Id	

}		
---	--	--

8.2.2.4.2 PSCell addition, modification and release / SCG DRB / NR-DC

8.2.2.4.2.1 Test Purpose (TP)

(1)

```
with { UE in NR RRC_CONNECTED state }
ensure that {
  when { UE receives an RRCReconfiguration message to add an NR PSCell with SCG DRB }
  then { UE configures the PSCell with SCG DRB and sends an RRCReconfigurationComplete message }
}
```

(2)

```
with { UE in NR RRC_CONNECTED state with NR-DC }
ensure that {
  when { UE receives an RRCReconfiguration message to modify SCG DRB }
  then { UE reconfigures the SCG DRB and sends an RRCReconfigurationComplete message }
}
```

(3)

```
with { UE in NR RRC_CONNECTED state with NR-DC }
ensure that {
  when { UE receives an RRCReconfiguration message to release PSCell with SCG DRB }
  then { UE releases the PSCell and SCG DRB and sends an RRCReconfigurationComplete message }
}
```

8.2.2.4.2.2 Conformance requirements

References: The conformance requirements covered in the present test case are specified in: TS 38.331, clauses 5.3.5.3, 5.3.5.5.1, 5.3.5.5.7, 5.3.5.6.4 and 5.3.5.6.5. Unless otherwise stated these are Rel-15 requirements.

[TS 38.331, clause 5.3.5.3]

The UE shall perform the following actions upon reception of the *RRCReconfiguration*:

...

1> if the *RRCReconfiguration* includes the *secondaryCellGroup*:

2> perform the cell group configuration for the SCG according to 5.3.5.5;

1> if the *RRCReconfiguration* message contains the *radioBearerConfig*:

2> perform the radio bearer configuration according to 5.3.5.6;

1> if the *RRCReconfiguration* message includes the *measConfig*:

2> perform the measurement configuration procedure as specified in 5.5.2;

...

1> set the content of the *RRCReconfigurationComplete* message as follows:

2> if the *RRCReconfiguration* message includes the *mrdc-SecondaryCellGroupConfig* with *mrdc-SecondaryCellGroup* set to *nr-SCG*:

3> include in the *nr-SCG-Response* the *RRCReconfigurationComplete* message;

1> else if the *RRCReconfiguration* message was received via SRB1 within the *nr-SCG* within *mrdc-SecondaryCellGroup* (UE in NR-DC, *mrdc-SecondaryCellGroup* was received in *RRCReconfiguration* via SRB1):

- 2> if *reconfigurationWithSync* was included in *spCellConfig* in *nr-SCG*:
 - 3> initiate the Random Access procedure on the PSCell, as specified in TS 38.321 [3];
- 2> else
 - 3> the procedure ends;

NOTE 2a: The order in which the UE sends the *RRCReconfigurationComplete* message and performs the Random Access procedure towards the SCG is left to UE implementation.

[TS 38.331, clause 5.3.5.5.1]

...

- 1> if the *CellGroupConfig* contains the *spCellConfig*:
 - 2> configure the SpCell as specified in 5.3.5.5.7;

[TS 38.331, clause 5.3.5.5.7]

The UE shall:

...

- 1> if the *SpCellConfig* contains *spCellConfigDedicated*:
 - 2> configure the SpCell in accordance with the *spCellConfigDedicated*;
 - 2> consider the bandwidth part indicated in *firstActiveUplinkBWP-Id* if configured to be the active uplink bandwidth part;
 - 2> consider the bandwidth part indicated in *firstActiveDownlinkBWP-Id* if configured to be the active downlink bandwidth part;
 - 2> if any of the reference signal(s) that are used for radio link monitoring are reconfigured by the received *spCellConfigDedicated*:
 - 3> stop timer T310 for the corresponding SpCell, if running;
 - 3> stop timer T312 for the corresponding SpCell, if running;
 - 3> reset the counters N310 and N311.

[TS 38.331, clause 5.3.5.6.4]

- 1> for each *drb-Identity* value included in the *drb-ToReleaseList* that is part of the current UE configuration; or
- 1> for each *drb-Identity* value that is to be released as the result of full configuration according to 5.3.5.11:
 - 2> release the PDCP entity and the *drb-Identity*;
 - 2> if SDAP entity associated with this DRB is configured:
 - 3> indicate the release of the DRB to SDAP entity associated with this DRB (TS 37.324 [24], clause 5.3.3);
 - 2> if the DRB is associated with an *eps-BearerIdentity*:
 - 3> if a new bearer is not added either with NR or E-UTRA with same *eps-BearerIdentity*:
 - 4> indicate the release of the DRB and the *eps-BearerIdentity* of the released DRB to upper layers.

NOTE 1: The UE does not consider the message as erroneous if the *drb-ToReleaseList* includes any *drb-Identity* value that is not part of the current UE configuration.

NOTE 2: Whether or not the RLC and MAC entities associated with this PDCP entity are reset or released is determined by the *CellGroupConfig*.

[TS 38.331, clause 5.3.5.6.5]

The UE shall:

- 1> for each *drb-Identity* value included in the *drb-ToAddModList* that is not part of the current UE configuration (DRB establishment including the case when full configuration option is used):
 - 2> establish a PDCP entity and configure it in accordance with the received *pdcp-Config*;
 - 2> if the PDCP entity of this DRB is not configured with *cipheringDisabled*:
 - 3> if target RAT of handover is E-UTRA/5GC; or
 - 3> if the UE is connected to E-UTRA/5GC:
 - 4> if the UE is capable of E-UTRA/5GC but not capable of NGEN-DC:
 - 5> configure the PDCP entity with the ciphering algorithm and K_{UPenc} key configured/derived as specified in TS 36.331 [10];
 - 4> else (i.e., a UE capable of NGEN-DC):
 - 5> configure the PDCP entity with the ciphering algorithms according to *securityConfig* and apply the key (K_{UPenc}) associated with the master key (K_{eNB}) or secondary key ($S-K_{eNB}$) as indicated in *keyToUse*, if applicable;

...

- 2> if the PDCP entity of this DRB is configured with *integrityProtection*:
 - 3> configure the PDCP entity with the integrity protection algorithms according to *securityConfig* and apply the K_{UPint} key associated with the master (K_{gNB}) or the secondary key ($S-K_{gNB}$) as indicated in *keyToUse*;
- 2> if an *sdap-Config* is included:
 - 3> if an SDAP entity with the received *pdu-Session* does not exist:
 - 4> establish an SDAP entity as specified in TS 37.324 [24] clause 5.1.1;
 - 4> if an SDAP entity with the received *pdu-Session* did not exist prior to receiving this reconfiguration:
 - 5> indicate the establishment of the user plane resources for the *pdu-Session* to upper layers;
 - 3> configure the SDAP entity in accordance with the received *sdap-Config* as specified in TS 37.324 [24] and associate the DRB with the SDAP entity;

...

- 1> for each *drb-Identity* value included in the *drb-ToAddModList* that is part of the current UE configuration and not configured with *dapsConfig*:
 - 2> if the *reestablishPDCP* is set:
 - 3> if target RAT is E-UTRA/5GC; or;
 - 3> if the UE is only connected to E-UTRA/5GC:
 - 4> if the UE is capable of E-UTRA/5GC but not capable of NGEN-DC:
 - 5> if the PDCP entity of this DRB is not configured with *cipheringDisabled*:
 - 6> configure the PDCP entity with the ciphering algorithm and K_{UPenc} key configured/derived as specified in TS 36.331 [10], clause 5.4.2.3, i.e. the ciphering configuration shall be applied to all subsequent PDCP PDUs received and sent by the UE;
 - 4> else (i.e., a UE capable of NGEN-DC):
 - 5> if the PDCP entity of this DRB is not configured with *cipheringDisabled*:

- 6> configure the PDCP entity with the ciphering algorithm and K_{UPenc} key associated with the master key (K_{eNB}) or the secondary key ($S-K_{gNB}$), as indicated in *keyToUse*, i.e. the ciphering configuration shall be applied to all subsequent PDCP PDUs received and sent by the UE;

...

2> else, if the *recoverPDCP* is set:

3> trigger the PDCP entity of this DRB to perform data recovery as specified in TS 38.323 [5];

2> if the *pdcp-Config* is included:

3> reconfigure the PDCP entity in accordance with the received *pdcp-Config*.

2> if the *sdap-Config* is included:

3> reconfigure the SDAP entity in accordance with the received *sdap-Config* as specified in TS37.324 [24];

3> for each QFI value added in *mappedQoS-FlowsToAdd*, if the QFI value is previously configured, the QFI value is released from the old DRB;

NOTE 1: Void.

NOTE 2: When determining whether a *drb-Identity* value is part of the current UE configuration, the UE does not distinguish which *RadioBearerConfig* and *DRB-ToAddModList* that DRB was originally configured in. To re-associate a DRB with a different key (K_{eNB} to $S-K_{gNB}$, K_{gNB} to $S-K_{eNB}$, K_{gNB} to $S-K_{gNB}$, or vice versa), the network provides the *drb-Identity* value in the (target) *drb-ToAddModList* and sets the *reestablishPDCP* flag. The network does not list the *drb-Identity* in the (source) *drb-ToReleaseList*.

NOTE 3: When setting the *reestablishPDCP* flag for a radio bearer, the network ensures that the RLC receiver entities do not deliver old PDCP PDUs to the re-established PDCP entity. It does that e.g. by triggering a reconfiguration with sync of the cell group hosting the old RLC entity or by releasing the old RLC entity.

NOTE 4: In this specification, UE configuration refers to the parameters configured by NR RRC unless otherwise stated.

NOTE 5: Ciphering and integrity protection can be enabled or disabled for a DRB. The enabling/disabling of ciphering or integrity protection can be changed only by releasing and adding the DRB.

8.2.2.4.2.3 Test description

8.2.2.4.2.3.1 Pre-test conditions

System Simulator:

- NR Cell 1 is the PCell and NR Cell 10 is the PSCell.
- System information combination NR-1 as defined in TS 38.508-1 [4] clause 4.4.3.1.3 is used in NR cell 1.

UE:

- None.

Preamble:

- If *pc_IP_Ping* is set to TRUE then, the UE is in state NR RRC_CONNECTED using generic procedure parameter Connectivity (NR), according to TS 38.508-1 [4], clause 4.5.4.
- Else, the UE is in state NR RRC_CONNECTED using generic procedure parameter Connectivity (NR), Test Mode (On) associated with UE test loop mode B configured on NR Cell 1 according to TS 38.508-1 [4], clause 4.5.4.

8.2.2.4.2.3.2 Test procedure sequence

Table 8.2.2.4.2.3.2-1: Main behaviour

St	Procedure	Message Sequence		TP	Verdict
		U - S	Message		
1	The SS transmits an <i>RRCReconfiguration</i> message and a PDU SESSION MODIFICATION COMMAND to add NR <i>PSCell</i> with SCG DRB.	<--	NR RRC: <i>RRCReconfiguration</i> 5GMM: DL NAS TRANSPORT 5GSM: PDU SESSION MODIFICATION COMMAND	-	-
2	Check: Does the UE transmit an <i>RRCReconfigurationComplete</i> message including nr-SCG-Response?	-->	<i>RRCReconfigurationComplete</i>	1	P
2A	The UE transmits a <i>ULInformationTransfer</i> message and an PDU SESSION MODIFICATION COMPLETE message.	-->	NR RRC: <i>ULInformationTransfer</i> 5GMM: UL NAS TRANSPORT 5GSM: PDU SESSION MODIFICATION COMPLETE	-	-
-	EXCEPTION: Steps 2Ba1 to 2Ba2 describe behaviour that depends on the UE implementation; the "lower case letter" identifies a step sequence that take place depending on the UE implementation.	-	-	-	-
2Ba1	IF <i>pc_IP_Ping</i> = FALSE, then, the SS transmits a CLOSE UE TEST LOOP message.	<--	CLOSE UE TEST LOOP	-	-
2Ba2	The UE transmits a CLOSE UE TEST LOOP COMPLETE message.	-->	CLOSE UE TEST LOOP COMPLETE	-	-
3	Check: Does the test result of generic test procedure in TS 38.508-1 subclause 4.9.1 indicate that the UE is capable of exchanging IP data on SCG DRB?	-	-	1	P
4	SS transmits <i>RRCReconfiguration</i> message containing NR <i>RadioBearerConfig</i> to modify PDCP <i>discardTimer</i> value of SCG DRB.	<--	<i>RRCReconfiguration</i>	-	-
5	Check: Does the UE transmit an <i>RRCReconfigurationComplete</i> message?	-->	<i>RRCReconfigurationComplete</i>	2	P
6	Check: Does the test result of generic test procedure in TS 38.508-1 subclause 4.9.1 indicate that the UE is capable of exchanging IP data on SCG DRB?	-	-	2	P
7	SS transmits <i>RRCReconfiguration</i> message to release NR <i>PSCell</i> and SCG DRB.	<--	<i>RRCReconfiguration</i>	-	-
8	Check: Does the UE transmit an <i>RRCReconfigurationComplete</i> message?	-->	<i>RRCReconfigurationComplete</i>	3	P

8.2.2.4.2.3.3 Specific message contents

Table 8.2.2.4.2.3.3-1: *RRCReconfiguration* (step 1, Table 8.2.2.4.2.3.2-1)

Derivation Path: TS 38.508-1 [4], Table 4.6.1-13 with condition NR-DC

Table 8.2.2.4.2.3.3-1A: PDU SESSION MODIFICATION COMMAND (step 1, Table 8.2.2.4.2.3.2-1)

Derivation Path: TS 38.508-1 [4], Table 4.7.2-9.			
Information Element	Value/remark	Comment	Condition
PDU session ID	The same as the PDU session ID in PDU SESSION ESTABLISHMENT REQUEST associated with the Internet PDU session if available or with the first PDU session		
Authorized QoS rules	One entry		

QoS rule [1]	Reference QoS rule #5 as defined in TS 38.508-1 [4], Table 4.8.2.1-5.	QFI=5	
Authorized QoS flow descriptions	One entry		
QoS flow [1]	Reference QoS flow #5 as defined in TS 38.508-1 [4], Table 4.8.2.3-5.	QFI=5	

Table 8.2.2.4.2.3.3-2: Void

Table 8.2.2.4.2.3.3-3: RRCReconfiguration (step 4, Table 8.2.2.4.2.3.2-1)

Derivation Path: TS 38.508-1 [4], Table 4.6.1-13			
Information Element	Value/remark	Comment	Condition
RRCReconfiguration ::= SEQUENCE {			
criticalExtensions CHOICE {			
rrcReconfiguration SEQUENCE {			
nonCriticalExtension SEQUENCE {			
nonCriticalExtension SEQUENCE {			
radioBearerConfig2	OCTET STRING (CONTAINING RadioBearerConfig_SCG-Mod)		
}			
}			
}			
}			
}			

Table 8.2.2.4.2.3.3-4: RadioBearerConfig_SCG-Mod (Table 8.2.2.4.2.3.3-3)

Derivation Path: TS 38.508-1 [4], Table 4.6.1-132			
Information Element	Value/remark	Comment	Condition
RadioBearerConfig ::= SEQUENCE {			
drb-ToAddModList SEQUENCE (SIZE (1..maxDRB)) OF DRB-ToAddMod {	1 entry		
DRB-ToAddMod[1] SEQUENCE {		entry 1	
drb-Identity	DRBn	n set to the same DRB ID as in Table 8.2.2.4.2.3.3-1	
pdcp-Config	PDCCP-Config		
}			
}			
}			

Table 8.2.2.4.2.3.3-5: PDCCP-Config (Table 8.2.2.4.2.3.3-4)

Derivation Path: TS 38.508-1 [4], Table 4.6.3-99			
Information Element	Value/remark	Comment	Condition
PDCCP-Config ::= SEQUENCE {			
drb SEQUENCE {			
discardTimer	ms500	Other than default value.	
}			
}			

Table 8.2.2.4.2.3.3-6: RRCReconfiguration (step 7, Table 8.2.2.4.2.3.2-1)

Derivation Path: TS 38.508 [4], Table 4.6.1-13			
Information Element	Value/remark	Comment	Condition
RRCReconfiguration ::= SEQUENCE {			
criticalExtensions CHOICE {			
rrcReconfiguration SEQUENCE {			
nonCriticalExtension SEQUENCE {			
nonCriticalExtension SEQUENCE {			
mrdc-SecondaryCellGroupConfig CHOICE {			
setup SEQUENCE {			
mrdc-ReleaseAndAdd	true		
}			
}			
radioBearerConfig2	OCTET STRING (CONTAINING RadioBearerConfig_SCG -Rel)		
}			
}			
}			
}			

Table 8.2.2.4.2.3.3-7: RadioBearerConfig_SCG-Rel (Table 8.2.2.4.2.3.3-6)

Derivation Path: TS 38.508-1 [4], Table 4.6.3-132			
Information Element	Value/remark	Comment	Condition
RadioBearerConfig ::= SEQUENCE {			
drb-ToReleaseList	DRBn	n set to the same DRB ID as in Table 8.2.2.4.2.3.3-2	
}			

Table 8.2.2.4.2.3.3-8: RRCReconfigurationComplete (step 2, Table 8.2.2.4.2.3.2-1)

Derivation Path: TS 38.508 [4], Table 4.6.1-14 with condition NR-DC

8.2.2.4.3 PSCell addition, modification and release / SCG DRB / NE-DC

8.2.2.4.3.1 Test Purpose (TP)

(1)

```
with { UE in NR RRC_CONNECTED state }
ensure that {
  when { UE receives an RRCReconfiguration message to add an E-UTRA PSCell with SCG DRB }
  then { UE configures the PSCell with SCG DRB and sends an RRCReconfigurationComplete message }
}
```

(2)

```
with { UE in NR RRC_CONNECTED state with NE-DC, and, MCG(s) (NR PDCP) and SCG }
ensure that {
  when { UE receives an RRCReconfiguration message to modify SCG DRB }
  then { UE reconfigures the SCG DRB and sends an RRCReconfigurationComplete message }
}
```

(3)

```
with { UE in NR RRC_CONNECTED state with NE-DC, and, MCG(s) (NR PDCP) and SCG }
ensure that {
```

```

when { UE receives an RRCReconfiguration message to release E-UTRA PSCell with SCG DRB }
  then { UE releases the PSCell and SCG DRB and sends an RRCReconfigurationComplete message }
  }

```

8.2.2.4.3.2 Conformance requirements

References: The conformance requirements covered in the present test case are specified in: TS 38.331, clauses 5.3.5.3, 5.3.5.5.1, 5.3.5.5.7, TS 36.331, clauses 5.3.5.3, 5.3.10.3d, 5.3.10.3e, 5.3.10.10. Unless otherwise stated these are Rel-15 requirements.

[TS 38.331, clause 5.3.5.3]

The UE shall perform the following actions upon reception of the *RRCReconfiguration*, or upon execution of the conditional reconfiguration (CHO or CPC):

...

1> if the *RRCReconfiguration* includes the *secondaryCellGroup*:

2> perform the cell group configuration for the SCG according to 5.3.5.5;

1> if the *RRCReconfiguration* includes the *mrdc-SecondaryCellGroupConfig*:

2> if the *mrdc-SecondaryCellGroupConfig* is set to *setup*:

3> if the *mrdc-SecondaryCellGroupConfig* includes *mrdc-ReleaseAndAdd*:

4> perform MR-DC release as specified in clause 5.3.5.10;

3> if the received *mrdc-SecondaryCellGroup* is set to *nr-SCG*:

4> perform the RRC reconfiguration according to 5.3.5.3 for the *RRCReconfiguration* message included in *nr-SCG*;

3> if the received *mrdc-SecondaryCellGroup* is set to *eutra-SCG*:

4> perform the RRC connection reconfiguration as specified in TS 36.331 [10], clause 5.3.5.3 for the *RRCConnectionReconfiguration* message included in *eutra-SCG*;

2> else (*mrdc-SecondaryCellGroupConfig* is set to *release*):

3> perform MR-DC release as specified in clause 5.3.5.10;

1> if the *RRCReconfiguration* message includes the *radioBearerConfig*:

2> perform the radio bearer configuration according to 5.3.5.6;

1> if the *RRCReconfiguration* message includes the *radioBearerConfig2*:

2> perform the radio bearer configuration according to 5.3.5.6;

1> if the *RRCReconfiguration* message includes the *measConfig*:

2> perform the measurement configuration procedure as specified in 5.5.2;

...

1> set the content of the *RRCReconfigurationComplete* message as follows:

...

2> if the *RRCReconfiguration* message includes the *mrdc-SecondaryCellGroupConfig* with *mrdc-SecondaryCellGroup* set to *eutra-SCG*:

3> include in the *eutra-SCG-Response* the E-UTRA *RRCConnectionReconfigurationComplete* message in accordance with TS 36.331 [10] clause 5.3.5.3;

...

[TS 38.331, clause 5.3.5.5.1]

The network configures the UE with Master Cell Group (MCG), and zero or one Secondary Cell Group (SCG). In (NG)EN-DC, the MCG is configured as specified in TS 36.331 [10], and for NE-DC, the SCG is configured as specified in TS 36.331 [10]. The network provides the configuration parameters for a cell group in the *CellGroupConfig* IE.

The UE performs the following actions based on a received *CellGroupConfig* IE:

...

1> if the *CellGroupConfig* contains the *spCellConfig*:

2> configure the SpCell as specified in 5.3.5.5.7;

...

[TS 38.331, clause 5.3.5.5.7]

The UE shall:

...

1> if the *SpCellConfig* contains *spCellConfigDedicated*:

2> configure the SpCell in accordance with the *spCellConfigDedicated*;

2> consider the bandwidth part indicated in *firstActiveUplinkBWP-Id* if configured to be the active uplink bandwidth part;

2> consider the bandwidth part indicated in *firstActiveDownlinkBWP-Id* if configured to be the active downlink bandwidth part;

2> if any of the reference signal(s) that are used for radio link monitoring are reconfigured by the received *spCellConfigDedicated*:

3> stop timer T310 for the corresponding SpCell, if running;

3> stop timer T312 for the corresponding SpCell, if running;

3> reset the counters N310 and N311.

[TS 36.331, clause 5.3.5.3]

If the *RRCCConnectionReconfiguration* message does not include the *mobilityControlInfo* and the UE is able to comply with the configuration included in this message, the UE shall:

...

1> if the received *RRCCConnectionReconfiguration* includes the *sCellGroupToReleaseList*:

2> perform SCell group release as specified in 5.3.10.3d;

1> if the received *RRCCConnectionReconfiguration* includes the *sCellGroupToAddModList*:

2> perform SCell group addition or modification as specified in 5.3.10.3e;

1> if the received *RRCCConnectionReconfiguration* includes the *scg-Configuration*; or

1> if the current UE configuration includes one or more split DRBs configured with *pdcp-Config* and the received *RRCCConnectionReconfiguration* includes *radioResourceConfigDedicated* including *drb-ToAddModList*:

2> perform SCG reconfiguration as specified in 5.3.10.10;

...

1> set the content of *RRCCConnectionReconfigurationComplete* message as follows:

- 2> if the *RRCConnectionReconfiguration* message includes *perCC-GapIndicationRequest*:
 - 3> include *perCC-GapIndicationList* and *numFreqEffective*;
- 2> if the frequencies are configured for reduced measurement performance:
 - 3> include *numFreqEffectiveReduced*;
- 2> if the received *RRCConnectionReconfiguration* message included *nr-SecondaryCellGroupConfig*:
 - 3> include *scg-ConfigResponseNR* in accordance with TS 38.331 [82], clause 5.3.5.3;
- 1> if the UE is configured with NE-DC:
 - 2> if the received *RRCConnectionReconfiguration* message was included in an NR *RRCResume* message:
 - 3> transfer the *RRCConnectionReconfigurationComplete* message via SRB1 embedded in NR RRC message *RRCResumeComplete* as specified in TS 38.331 [82], clause 5.3.13.4;
 - 2> else:
 - 3> transfer the *RRCConnectionReconfigurationComplete* message via SRB1 embedded in NR RRC message *RRCReconfigurationComplete* as specified in TS 38.331 [82], clause 5.3.5.3;
- 1> else:
 - 2> submit the *RRCConnectionReconfigurationComplete* message to lower layers for transmission using the new configuration, upon which the procedure ends;

[TS 36.331, clause 5.3.10.3d]

The UE shall:

- 1> if the release is triggered by reception of the *sCellGroupToReleaseList*:
 - 2> for each *sCellGroupIndex* value included in the *sCellGroupToReleaseList*:
 - 3> if the current UE configuration includes an SCell with value *sCellGroupIndex*:
 - 4> consider the SCell not to be part of the SCell group indicated by *sCellGroupIndex*;
 - 4> consider the *sCellConfigCommon* of the SCell group to be not applicable for the SCell;
 - 3> release the SCell group;
- 1> if the release is triggered by RRC connection re-establishment:
 - 2> release all SCell groups that are part of the current UE configuration;

[TS 36.331, clause 5.3.10.3e]

The UE shall:

- 1> for each *sCellGroupIndex* value included in the *sCellGroupToAddModList* that is part of the current UE configuration (SCell group modification):
 - 2> for each *sCellIndex* value included in the *sCellToReleaseList* that is part of the SCell group indicated by *sCellGroupIndex* (SCell deletion from SCell group):
 - 3> consider the *sCellConfigCommon* of the SCell group to be not applicable for the SCell;
 - 3> consider the SCell not to be part of the SCell group indicated by *sCellGroupIndex*
 - 2> for each *sCellIndex* value included in the *sCellToAddModList* that is not part of the SCell group indicated by *sCellGroupIndex* (SCell addition to SCell group):
 - 3> consider the SCell to be part of the SCell group indicated by *sCellGroupIndex*;

- 3> apply the SCell configuration for parameters not already configured as part of the current SCell configuration in accordance with the *sCellConfigCommon* for the SCell group;
- 2> if *sCellConfigCommon* is included (modify the SCell group configuration):
 - 3> for each SCell that is part of the current SCell group indicated by *sCellGroupIndex*:
 - 4> apply the SCell configuration for parameters not already configured as part of the current SCell configuration in accordance with the *sCellConfigCommon* for the SCell group;
- 1> for each *sCellGroupIndex* value included in the *sCellGroupToAddModList* that is not part of the current UE configuration (SCell group addition):
 - 2> for each *sCellIndex* value included in the *sCellToAddModList* (SCell addition to the group):
 - 3> consider the SCell to be part of the SCell group indicated by *sCellGroupIndex*
 - 3> apply the SCell configuration for parameters not already configured as part of the current SCell configuration in accordance with the *sCellConfigCommon* for the SCell group;

[TS 36.331, clause 5.3.10.10]

The UE shall:

...

- 1> if *scg-Configuration* is received and is set to *release* or includes the *mobilityControlInfoSCG* (i.e. SCG release/change):
 - 2> if *mobilityControlInfo* is not received (i.e. SCG release/ change without HO):
 - 3> reset SCG MAC, if configured;
 - 3> if the UE is not configured with NE-DC:
 - 4> for each *drb-Identity* value that is part of the current UE configuration:
 - 5> if the DRB indicated by *drb-Identity* is an SCG DRB:
 - 6> re-establish the PDCP entity and the SCG RLC entity or entities;
 - 5> if the DRB indicated by *drb-Identity* is a split DRB:
 - 6> perform PDCP data recovery and re-establish the SCG RLC entity;
 - 5> if the DRB indicated by *drb-Identity* is an MCG DRB; and
 - 5> *drb-ToAddModListSCG* is received and includes the *drb-Identity* value, while for this entry *drb-Type* is included and set to *scg* (i.e. MCG to SCG):
 - 6> re-establish the PDCP entity and the MCG RLC entity or entities;
 - 3> configure lower layers to consider the SCG SCell(s), except for the PSCell, to be in deactivated state;
 - 1> if *scg-Configuration* is received and is set to *release*:
 - 2> release the entire SCG configuration, except for the DRB configuration (i.e. as configured by *drb-ToAddModListSCG*);
 - 2> if the current UE configuration includes one or more split or SCG DRBs and the received *RRCCONNECTIONRECONFIGURATION* message includes *radioResourceConfigDedicated* including *drb-ToAddModList*:
 - 3> reconfigure the SCG or split DRB by *drb-ToAddModList* as specified in 5.3.10.12;
 - 2> stop timer T313, if running;
 - 2> stop timer T307, if running;

1> else:

- 2> if *scg-ConfigPartMCG* is received and includes the *scg-Counter*:
 - 3> update the $S\text{-}K_{\text{eNB}}$ key based on the K_{eNB} key and using the received *scg-Counter* value, as specified in TS 33.401 [32];
 - 3> derive the K_{UPenc} key associated with the *cipheringAlgorithmSCG* included in *mobilityControlInfoSCG* within the received *scg-ConfigPartSCG*, as specified in TS 33.401 [32];
 - 3> configure lower layers to apply the ciphering algorithm and the K_{UPenc} key;
- 2> if *scg-ConfigPartSCG* is received and includes the *radioResourceConfigDedicatedSCG*:
 - 3> reconfigure the dedicated radio resource configuration for the SCG as specified in 5.3.10.11;
- 2> if the current UE configuration includes one or more split or SCG DRBs and the received *RRCConnectionReconfiguration* message includes *radioResourceConfigDedicated* including *drb-ToAddModList*:
 - 3> reconfigure the SCG or split DRB by *drb-ToAddModList* as specified in 5.3.10.12;
- 2> if *scg-ConfigPartSCG* is received and includes *measConfigSN*:
 - 3> for *measConfigSN* perform the actions as specified in 5.5.2 for *measConfig* unless explicitly stated otherwise;
- 2> if *scg-ConfigPartSCG* is received and includes the *sCellToReleaseListSCG*:
 - 3> perform SCell release for the SCG as specified in 5.3.10.3a;
- 2> if *scg-ConfigPartSCG* is received and includes the *pSCellToAddMod*:
 - 3> perform PSCell addition or modification as specified in 5.3.10.3c;

NOTE 0: This procedure is also used to release the PSCell e.g. PSCell change, SI change for the PSCell.

- 2> if *scg-ConfigPartSCG* is received and includes the *sCellToAddModListSCG*:
 - 3> perform SCell addition or modification as specified in 5.3.10.3b;
- 2> configure lower layers in accordance with *mobilityControlInfoSCG*, if received;
- 2> if *rach-SkipSCG* is configured:
 - 3> configure lower layers to apply the *rach-SkipSCG* for the target SCG, as specified in TS 36.213 [23] and TS 36.321 [6];
- 2> if *scg-ConfigPartSCG* is received and includes the *mobilityControlInfoSCG* (i.e. SCG change):
 - 3> resume all SCG DRBs and resume SCG transmission for split DRBs, if suspended;
 - 3> stop timer T313, if running;
 - 3> start timer T307 with the timer value set to *t307*, as included in the *mobilityControlInfoSCG*, if *makeBeforeBreakSCG* is not configured;
 - 3> start synchronising to the DL of the target PSCell;
 - 3> initiate the random access procedure on the PSCell, as specified in TS 36.321 [6], if *rach-SkipSCG* is not configured;

NOTE 1: The UE is not required to determine the SFN of the target PSCell by acquiring system information from that cell before performing RACH access in the target PSCell.

- 3> the procedure ends, except that the following actions are performed when MAC successfully completes the random access procedure on the PSCell or when MAC indicates the successful reception of a PDCCH transmission addressed to C-RNTI and if *rach-skipSCG* is configured:

- 4> stop timer T307;
- 4> release *rach-SkipSCG*;
- 4> apply the parts of the CQI reporting configuration, the scheduling request configuration and the sounding RS configuration that do not require the UE to know the SFN of the target PSCell, if any;
- 4> apply the parts of the measurement and the radio resource configuration that require the UE to know the SFN of the target PSCell (e.g. periodic CQI reporting, scheduling request configuration, sounding RS configuration), if any, upon acquiring the SFN of the target PSCell;

NOTE 2: Whenever the UE shall setup or reconfigure a configuration in accordance with a field that is received it applies the new configuration, except for the cases addressed by the above statements.

8.2.2.4.3.3 Test description

8.2.2.4.3.3.1 Pre-test conditions

System Simulator:

- NR Cell 1 is the PCell and EUTRA Cell 1 is the PS Cell.

UE:

- None

Preamble:

- If *pc_IP_Ping* is set to TRUE then, the UE is in state NR RRC_CONNECTED using generic procedure parameter Connectivity (NR), according to TS 38.508-1 [4], clause 4.5.4.
- Else, the UE is in state NR RRC_CONNECTED using generic procedure parameter Connectivity (NR), Test Mode (On) associated with UE test loop mode B configured on NR Cell 1 according to TS 38.508-1 [4], clause 4.5.4.

8.2.2.4.3.3.2 Test procedure sequence

Table 8.2.2.4.3.3.2-1: Main behaviour

St	Procedure	Message Sequence		TP	Verdict
		U - S	Message		
1	The SS transmits an <i>RRCReconfiguration</i> message containing <i>RRCConnectionReconfiguration</i> message and a PDU SESSION MODIFICATION COMMAND to add E-UTRA PSCell with SCG DRB.	<--	NR RRC: <i>RRCReconfiguration (RRCConnectionReconfiguration)</i> 5GMM: DL NAS TRANSPORT 5GSM: PDU SESSION MODIFICATION COMMAND	-	-
-	EXCEPTION: Depending upon UE implementation, steps 2 and 2A can occur in any order	-	-	-	-
2	Check: Does the UE transmit an <i>RRCReconfigurationComplete</i> message including <i>eutra-SCG-Response</i> ?	-->	<i>RRCReconfigurationComplete (RRCConnectionReconfigurationComplete)</i>	1	P
2A	The UE transmits a <i>ULInformationTransfer</i> message and an PDU SESSION MODIFICATION COMPLETE message.	-->	NR RRC: <i>ULInformationTransfer</i> 5GMM: UL NAS TRANSPORT 5GSM: PDU SESSION MODIFICATION COMPLETE	-	-
3	Check: Does the test result of generic test procedure in TS 38.508-1 subclause 4.9.1 indicate that the UE is capable of exchanging IP data on SCG DRB?	-	-	1	P
-	EXCEPTION: Steps 3Aa1 to 3Aa2 describe behaviour that depends on the UE implementation; the "lower case letter"	-	-		

	identifies a step sequence that take place depending on the UE implementation.				
3Aa1	IF pc_IP_Ping = FALSE, then, the SS transmits a CLOSE UE TEST LOOP message.	<--	CLOSE UE TEST LOOP		
3Aa2	The UE transmits a CLOSE UE TEST LOOP COMPLETE message.	-->	CLOSE UE TEST LOOP COMPLETE		
3B	Check: Does the test result of generic test procedure in TS 38.508-1 subclause 4.9.1 indicate that the UE is capable of exchanging IP data on SCG DRB?	-	-	1	P
4	SS transmits <i>RRCReconfiguration</i> message containing E-UTRA RadioBearerConfig to modify PDCP discardTimer value of SCG DRB.	<--	NR RRC: <i>RRCReconfiguration</i>	-	-
5	Check: Does the UE transmit an <i>RRCReconfigurationComplete</i> message?	-->	<i>RRCReconfigurationComplete</i>	2	P
6	Check: Does the test result of generic test procedure in TS 38.508-1 subclause 4.9.1 indicate that the UE is capable of exchanging IP data on SCG DRB?	-	-	2	P
7	SS transmits <i>RRCReconfiguration</i> message and a PDU SESSION MODIFICATION COMMAND to release E-UTRA PSCell and SCG DRB.	<--	NR RRC: <i>RRCReconfiguration</i>	-	-
-	EXCEPTION: Depending upon UE implementation, steps 8 and 9 can occur in any order	-	-	-	-
8	Check: Does the UE transmit an <i>RRCReconfigurationComplete</i> message?	-->	<i>RRCReconfigurationComplete</i>	3	P
9	The UE transmits a <i>ULInformationTransfer</i> message and an PDU SESSION MODIFICATION COMPLETE message.	-->	NR RRC: <i>ULInformationTransfer</i> 5GMM: <i>UL NAS TRANSPORT</i> 5GSM: <i>PDU SESSION MODIFICATION COMPLETE</i>	-	-

8.2.2.4.3.3.3 Specific message contents

Table 8.2.2.4.3.3.3-1: *RRCReconfiguration* (step 1 , Table 8.2.2.4.3.3.2-1)

Derivation Path: TS 38.508-1 [4], Table 4.6.1-13			
Information Element	Value/remark	Comment	Condition
<i>RRCReconfiguration</i> ::= SEQUENCE {			
rrc-TransactionIdentifier	RRC-TransactionIdentifier		
criticalExtensions CHOICE {			
rrcReconfiguration SEQUENCE {			
radioBearerConfig	Not present		
secondaryCellGroup	Not present		
measConfig	Not present		
lateNonCriticalExtension	Not present		
nonCriticalExtension SEQUENCE {			
masterCellGroup	Not present		
fullConfig	Not present		
dedicatedNAS-MessageList	Not present		
masterKeyUpdate	Not present		
dedicatedSIB1-Delivery	Not present		
dedicatedSystemInformationDelivery	Not present		
otherConfig	Not present		
nonCriticalExtension SEQUENCE {			
otherConfig-v1540	Not present		
nonCriticalExtension SEQUENCE {			
mrdc-SecondaryCellGroupConfig CHOICE {			
setup SEQUENCE {			
mrdc-ReleaseAndAdd	Not present		
mrdc-SecondaryCellGroup CHOICE {			

Authorized QoS flow descriptions	One entry		
QoS flow	Reference QoS flow #5 as defined in TS 38.508-1 [4], Table 4.8.2.3-5.	QFI=5	

Table 8.2.2.4.3.3-4: RRCReconfiguration (step4 , step7, Table 8.2.2.4.3.3-2-1)

Derivation Path: TS 38.508-1 [4], Table 4.6.1-13			
Information Element	Value/remark	Comment	Condition
RRCReconfiguration ::= SEQUENCE {			
rrc-TransactionIdentifier	RRC-TransactionIdentifier		
criticalExtensions CHOICE {			
rrcReconfiguration SEQUENCE {			
radioBearerConfig	Not Present		
secondaryCellGroup	Not present		
measConfig	Not present		
lateNonCriticalExtension	Not present		
nonCriticalExtension	Not present		Step 4
nonCriticalExtension SEQUENCE {			Step 7
nonCriticalExtension SEQUENCE {			
nonCriticalExtension SEQUENCE {			
mrdc-SecondaryCellGroupConfig CHOICE {			
release			Step 7
}			
radioBearerConfig2	OCTET STRING (CONTAINING RadioBearerConfig_SCG-Mod)	As specified in Table 8.2.2.4.3.3-5	Step 4
	OCTET STRING (CONTAINING RadioBearerConfig_SCG-Rel)	As specified in Table 8.2.2.4.3.3-6	Step 7
sk-Counter	Not present		
nonCriticalExtension	Not present		
}			
}			
}			
}			
}			
}			
}			

Table 8.2.2.4.3.3-5: RadioBearerConfig_SCG-Mod (Table 8.2.2.4.3.3-4)

Derivation Path: TS 38.508-1 [4], Table 4.6.1-132			
Information Element	Value/remark	Comment	Condition
RadioBearerConfig ::= SEQUENCE {			
drb-ToAddModList SEQUENCE (SIZE (1..maxDRB)) OF DRB-ToAddMod {	1 entry		
DRB-ToAddMod[1] SEQUENCE {		entry 1	
drb-Identity	DRBn	n set to the same DRB ID as in Table 8.2.2.4.3.3-1	
pdcp-Config SEQUENCE {			
discardTimer	ms500	Other than default value.	
}			
}			
}			
}			

Table 8.2.2.4.3.3-6: RadioBearerConfig_SCG-Rel (Table 8.2.2.4.3.3-4)

Derivation Path: TS 38.508-1 [4], Table 4.6.1-132			
Information Element	Value/remark	Comment	Condition
RadioBearerConfig ::= SEQUENCE {			
drb-ToReleaseList SEQUENCE (SIZE (1..maxDRB))			
OF DRB-Identity {			
DRB-Identity	DRBn	n set to the same DRB ID as in Table 8.2.2.4.3.3-1	
}			
}			

Table 8.2.2.4.3.3-7: RRCReconfigurationComplete (step 3, Table 8.2.2.4.3.3-1)

Derivation Path: TS 38.508-1 [4], Table 4.6.1-14 Condition with NE-DC

Table 8.2.2.4.3.3-8: PDU SESSION MODIFICATION COMMAND (step 7, Table 8.2.2.4.3.3-1)

Derivation Path: TS 38.508-1 [4], Table 4.7.2-9.			
Information Element	Value/remark	Comment	Condition
PDU session ID	The same as the PDU session ID in PDU SESSION ESTABLISHMENT REQUEST associated with the Internet PDU session if available or with the first PDU session		
Authorized QoS rules	One entry		
QoS rule identifier	'00000101'B	QFI=5	
Rule operation code	'010'B	Delete existing QoS rule	
Authorized QoS flow descriptions			
QoS flow descriptions			
QFI	'00000101'B	QFI=5	
Operation code	'010'B	Delete existing QoS flow	

8.2.2.5 PSCell addition, modification and release / Split DRB

8.2.2.5.1 PSCell addition, modification and release / Split DRB / EN-DC

8.2.2.5.1.1 Test Purpose (TP)

(1)

```
with { UE in E-UTRA RRC_CONNECTED state }
ensure that {
  when { UE receives an RRCConnectionReconfiguration message to add PSCell with Split DRB }
  then { UE configures the PSCell and sends an RRCConnectionReconfigurationComplete message }
}
```

(2)

```
with { UE in RRC_CONNECTED state with EN-DC, and, MCG(s) (E-UTRA PDCP) and Split }
ensure that {
  when { UE receives an RRCConnectionReconfiguration message to modify Split DRB }
  then { UE reconfigures the Split DRB and sends an RRCConnectionReconfigurationComplete message }
}
```

(3)

```

with { UE in RRC_CONNECTED state with EN-DC, and, MCG(s) (E-UTRA PDCP) and Split }
ensure that {
  when { UE receives an RRCConnectionReconfiguration message to release PSCell with Split DRB }
  then { UE releases the PSCell and Split DRB and sends an RRCConnectionReconfigurationComplete
message }
}

```

8.2.2.5.1.2 Conformance requirements

References: The conformance requirements covered in the present TC are specified in: TS 36.331, clause 5.3.5.3, TS 38.331, clauses 5.3.5.3, 5.3.5.5.7, 5.3.5.6.4 and 5.3.5.6.5. Unless otherwise stated these are Rel-15 requirements.

[TS 36.331, clause 5.3.5.3]

If the *RRCConnectionReconfiguration* message does not include the *mobilityControlInfo* and the UE is able to comply with the configuration included in this message, the UE shall:

...

- 1> if the received *RRCConnectionReconfiguration* includes the *nr-Config* and it is set to *release*: or
- 1> if the received *RRCConnectionReconfiguration* includes *endc-ReleaseAndAdd* and it is set to *TRUE*:
 - 2> perform EN-DC release as specified in TS 38.331 [82], clause 5.3.5.10;
- 1> if the received *RRCConnectionReconfiguration* includes the *sk-Counter*:
 - 2> perform key update procedure as specified in TS 38.331 [82], clause 5.3.5.7;
- 1> if the received *RRCConnectionReconfiguration* includes the *nr-SecondaryCellGroupConfig*:
 - 2> perform NR RRC Reconfiguration as specified in TS 38.331 [82], clause 5.3.5.3;
- 1> if the received *RRCConnectionReconfiguration* includes the *nr-RadioBearerConfig1*:
 - 2> perform radio bearer configuration as specified in TS 38.331 [82], clause 5.3.5.6;
- 1> if the received *RRCConnectionReconfiguration* includes the *nr-RadioBearerConfig2*:
 - 2> perform radio bearer configuration as specified in TS 38.331 [82], clause 5.3.5.6;

...

- 1> set the content of *RRCConnectionReconfigurationComplete* message as follows:
 - 2> if the *RRCConnectionReconfiguration* message includes *perCC-GapIndicationRequest*:
 - 3> include *perCC-GapIndicationList* and *numFreqEffective*;
 - 2> if the frequencies are configured for reduced measurement performance:
 - 3> include *numFreqEffectiveReduced*;
 - 2> if the received *RRCConnectionReconfiguration* message included *nr-SecondaryCellGroupConfig*:
 - 3> include *scg-ConfigResponseNR* in accordance with TS 38.331 [82, 5.3.5.3];
- 1> submit the *RRCConnectionReconfigurationComplete* message to lower layers for transmission using the new configuration, upon which the procedure ends;

[TS 38.331, clause 5.3.5.3]

The UE shall perform the following actions upon reception of the *RRCReconfiguration*:

- 1> if the *RRCReconfiguration* includes the *fullConfig*:

- 2> perform the radio configuration procedure as specified in 5.3.5.11;
- 1> if the *RRCReconfiguration* includes the *masterCellGroup*:
 - 2> perform the cell group configuration for the received *masterCellGroup* according to 5.3.5.5;
- 1> if the *RRCReconfiguration* includes the *masterKeyUpdate*:
 - 2> perform security key update procedure as specified in 5.3.5.7;
- 1> if the *RRCReconfiguration* includes the *secondaryCellGroup*:
 - 2> perform the cell group configuration for the SCG according to 5.3.5.5;
- 1> if the *RRCReconfiguration* message contains the *radioBearerConfig*:
 - 2> perform the radio bearer configuration according to 5.3.5.6;
- 1> if the *RRCReconfiguration* message includes the *measConfig*:
 - 2> perform the measurement configuration procedure as specified in 5.5.2;
- 1> if the *RRCReconfiguration* message includes the *dedicatedSIB1-Delivery*:
 - 2> perform the action upon reception of *SIB1* as specified in 5.2.2.4.2;
- 1> if the *RRCReconfiguration* message includes the *dedicatedSystemInformationDelivery*:
 - 2> perform the action upon reception of System Information as specified in 5.2.2.4;
- 1> set the content of *RRCReconfigurationComplete* message as follows:
 - 2> if the *RRCReconfiguration* includes the *masterCellGroup* containing the *reportUplinkTxDirectCurrent*, or;
 - 2> if the *RRCReconfiguration* includes the *secondaryCellGroup* containing the *reportUplinkTxDirectCurrent*:
 - 3> include the *uplinkTxDirectCurrentList*;
- 1> if the UE is configured with E-UTRA *nr-SecondaryCellGroupConfig* (MCG is E-UTRA):
 - 2> if *RRCReconfiguration* was received via SRB1:
 - 3> submit the *RRCReconfigurationComplete* via the EUTRA MCG embedded in E-UTRA RRC message *RRCConnectionReconfigurationComplete* as specified in TS 36.331 [10];
 - 3> if *reconfigurationWithSync* was included in *spCellConfig* of an SCG:
 - 4> initiate the random access procedure on the SpCell, as specified in TS 38.321 [3];
 - 3> else:
 - 4> the procedure ends;

NOTE: The order the UE sends the *RRCConnectionReconfigurationComplete* message and performs the Random Access procedure towards the SCG is left to UE implementation.

- 2> else (*RRCReconfiguration* was received via SRB3):

- 3> submit the *RRCReconfigurationComplete* message via SRB3 to lower layers for transmission using the new configuration;

NOTE: For EN-DC, in the case of SRB1, the random access is triggered by RRC layer itself as there is not necessarily other UL transmission. In the case of SRB3, the random access is triggered by the MAC layer due to arrival of *RRCReconfigurationComplete*.

- 1 > else:

- 2> submit the *RRCReconfigurationComplete* message via SRB1 to lower layers for transmission using the new configuration;
- 1> if *reconfigurationWithSync* was included in *spCellConfig* of an MCG or SCG, and when MAC of an NR cell group successfully completes a random access procedure triggered above;
 - 2> stop timer T304 for that cell group;
 - 2> apply the parts of the CQI reporting configuration, the scheduling request configuration and the sounding RS configuration that do not require the UE to know the SFN of the respective target SpCell, if any;
 - 2> apply the parts of the measurement and the radio resource configuration that require the UE to know the SFN of the respective target SpCell (e.g. measurement gaps, periodic CQI reporting, scheduling request configuration, sounding RS configuration), if any, upon acquiring the SFN of that target SpCell;
 - 2> if the *reconfigurationWithSync* was included in *spCellConfig* of an MCG:
 - 3> if the active downlink BWP, which is indicated by the *firstActiveDownlinkBWP-Id* for the target SpCell of the MCG, has a common search space configured:
 - 4> acquire the *SIB1* of the target SpCell of the MCG, as specified in 5.2.2.3.1;
 - 2> the procedure ends.

NOTE: The UE is only required to acquire broadcasted *SIB1* if the UE can acquire it without disrupting unicast data reception, i.e. the broadcast and unicast beams are quasi co-located.

[TS 38.331, clause 5.3.5.5.7]

The UE shall:

- 1> if the *SpCellConfig* contains the *rlf-TimersAndConstants*:
 - 2> configure the RLF timers and constants for this cell group as specified in 5.3.5.5.6.
- 1> else if *rlf-TimersAndConstants* is not configured for this cell group:
 - 2> use values for timers T301, T310, T311 and constants N310, N311, as included in *ue-TimersAndConstants* received in *SIB1*;
- 1> if the *SpCellConfig* contains *spCellConfigDedicated*:
 - 2> configure the SpCell in accordance with the *spCellConfigDedicated*;
 - 2> consider the bandwidth part indicated in *firstActiveUplinkBWP-Id* if configured to be the active uplink bandwidth part;
 - 2> consider the bandwidth part indicated in *firstActiveDownlinkBWP-Id* if configured to be the active downlink bandwidth part;
 - 2> if the any of the reference signal(s) that are used for radio link monitoring are reconfigured by the received *spCellConfigDedicated*:
 - 3> stop timer T310 for the corresponding SpCell, if running;
 - 3> reset the counters N310 and N311.

[TS 38.331, clause 5.3.5.6.4]

Editor's Note: FFS / TODO: Add handling for the new QoS concept (mapping of flows; configuration of QFI-to-DRB mapping; reflective QoS...) but keep also EPS-Bearer handling for the EN-DC case

The UE shall:

- 1> for each *drb-Identity* value included in the *drb-ToReleaseList* that is part of the current UE configuration (DRB release):

- 2> release the PDCP entity;
- 2> if SDAP entity associated with this DRB is configured:
 - 3> indicate the release of the DRB to SDAP entity associated with this DRB (TS 37.324 [xx] section 5.3.3);
- 2> if the UE is operating in EN-DC:
 - 3> if a new bearer is not added either with NR or E-UTRA with same *eps-BearerIdentity*:
 - 4> indicate the release of the DRB and the *eps-BearerIdentity* of the released DRB to upper layers.

NOTE: The UE does not consider the message as erroneous if the *drb-ToReleaseList* includes any *drb-Identity* value that is not part of the current UE configuration.

NOTE: Whether or not the RLC and MAC entities associated with this PDCP entity are reset or released is determined by the *CellGroupConfig*.

[TS 38.331, clause 5.3.5.6.5]

The UE shall:

- 1> for each *drb-Identity* value included in the *drb-ToAddModList* that is not part of the current UE configuration (DRB establishment including the case when full configuration option is used):
 - 2> if an *sdap-Config* is included:
 - 3> if an SDAP entity with the received *pdu-Session* does not exist:
 - 4> establish an SDAP entity as specified in TS 37.324 [xx] section 5.1.1;
 - 3> configure the SDAP entity in accordance with the received *sdap-Config* as specified in TS 37.324 [xx] and associate the DRB with the SDAP entity;
 - 2> establish a PDCP entity and configure it in accordance with the received *pdcp-Config*;
 - 2> if the PDCP entity of this DRB is not configured with *cipheringDisabled*:
 - 3> configure the PDCP entity with the ciphering algorithms according to *securityConfig* and apply the K_{UPenc} key associated with the master key (K_{eNB}/K_{gNB}) or the secondary key (S- K_{gNB}) as indicated in *keyToUse*;
 - 2> if the PDCP entity of this DRB is configured with *integrityProtection*:
 - 3> configure the PDCP entity with the integrity algorithms according to *securityConfig* and apply the K_{UPint} key associated with the master (K_{eNB}/K_{gNB}) or the secondary key (S- K_{gNB}) as indicated in *keyToUse*;
 - 2> if the UE is operating in EN-DC:
 - 3> if the DRB was configured with the same *eps-BearerIdentity* either by NR or E-UTRA prior to receiving this reconfiguration:
 - 4> associate the established DRB with the corresponding *eps-BearerIdentity*;
 - 3> else:
 - 4> indicate the establishment of the DRB(s) and the *eps-BearerIdentity* of the established DRB(s) to upper layers;
- 1> for each *drb-Identity* value included in the *drb-ToAddModList* that is part of the current UE configuration:
 - 2> if an *sdap-Config* is included, reconfigure the SDAP entity in accordance with the received *sdap-Config* as specified in TS 37.324 [xx];
 - 2> if the *reestablishPDCP* is set:
 - 3> if target RAT is E-UTRA/5GC:

4> if the PDCP entity of this DRB is not configured with *cipheringDisabled*:

5> configure the PDCP entity with the ciphering algorithm and K_{UPenc} key configured/derived as specified in TS 36.331 [10, 5.4.2.3], i.e. the ciphering configuration shall be applied to all subsequent PDCP PDUs received and sent by the UE;

3> else:

4> if the PDCP entity of this DRB is not configured with *cipheringDisabled*:

5> configure the PDCP entity with the ciphering algorithm and K_{UPenc} key associated with the master or secondary key ($K_{eNB}/S-K_{gNB}/K_{gNB}$) as indicated in *keyToUse*, i.e. the ciphering configuration shall be applied to all subsequent PDCP PDUs received and sent by the UE;

3> if the PDCP entity of this DRB is configured with *integrityProtection*:

4> configure the PDCP entity with the integrity algorithms according to *securityConfig* and apply the K_{UPint} key associated with the master (K_{eNB}/K_{gNB}) or the secondary key ($S-K_{gNB}$) as indicated in *keyToUse*;

3> re-establish the PDCP entity of this DRB as specified in 38.323 [5], section 5.1.2;

2> else, if the *recoverPDCP* is set:

3> trigger the PDCP entity of this DRB to perform data recovery as specified in 38.323;

2> if the *pdcp-Config* is included:

3> reconfigure the PDCP entity in accordance with the received *pdcp-Config*.

NOTE 1: Removal and addition of the same *drb-Identity* in a single *radioResourceConfig* is not supported. In case *drb-Identity* is removed and added due to reconfiguration with sync or re-establishment with the full configuration option, the network can use the same value of *drb-Identity*.

NOTE 2: When determining whether a *drb-Identity* value is part of the current UE configuration, the UE does not distinguish which *RadioBearerConfig* and *DRB-ToAddModList* that DRB was originally configured in. To re-associate a DRB with a different key (K_{eNB} to $S-K_{eNB}$ or vice versa), the network provides the *drb-Identity* value in the (target) *drb-ToAddModList* and sets the *reestablishPDCP* flag. The network does not list the *drb-Identity* in the (source) *drb-ToReleaseList*.

NOTE 3: When setting the *reestablishPDCP* flag for a radio bearer, the network ensures that the RLC receiver entities do not deliver old PDCP PDUs to the re-established PDCP entity. It does that e.g. by triggering a reconfiguration with sync of the cell group hosting the old RLC entity or by releasing the old RLC entity.

NOTE 4: In this specification, UE configuration refers to the parameters configured by NR RRC unless otherwise stated.

NOTE 5: Ciphering and integrity protection can be enabled or disabled for a DRB. The enabling/disabling of ciphering or integrity protection can be changed only by releasing and adding the DRB.

8.2.2.5.1.3 Test description

8.2.2.5.1.3.1 Pre-test conditions

System Simulator:

- E-UTRA Cell 1 is the PCell and NR Cell 1 is the PSCell.

UE:

- None.

Preamble:

- If `pc_IP_Ping` is set to TRUE then, the UE is in state RRC_CONNECTED using generic procedure parameter Connectivity (*E-UTRA/EPC*) established according to TS 38.508-1 [4], clause 4.5.4.
- Else, the UE is in state RRC_CONNECTED using generic procedure parameter Connectivity (*E-UTRA/EPC*) established and Test Mode (*On*) associated with UE test loop mode B configured on E-UTRA Cell 1 according to TS 38.508-1 [4], clause 4.5.4.

8.2.2.5.1.3.2 Test procedure sequence

Table 8.2.2.5.1.3.2-1: Main behaviour

St	Procedure	Message Sequence		TP	Verdict
		U - S	Message		
1	The SS transmits an <i>RRConnectionReconfiguration</i> message containing NR <i>RRCReconfiguration</i> message to add NR PSCell with Split DRB. <i>RRConnectionReconfiguration</i> message contains the ACTIVATE DEDICATED EPS BEARER CONTEXT REQUEST message.	<--	<i>RRConnectionReconfiguration (RRCReconfiguration)</i>	-	-
2	Check: Does the UE transmit an <i>RRConnectionReconfigurationComplete</i> message containing NR <i>RRCReconfigurationComplete</i> message?	-->	<i>RRConnectionReconfigurationComplete (RRCReconfigurationComplete)</i>	1	P
3	The UE transmits an <i>ULInformationTransfer</i> message containing the ACTIVATE DEDICATED EPS BEARER CONTEXT ACCEPT message.	-->	<i>ULInformationTransfer</i>	-	-
-	EXCEPTION: Steps 4a1 to 4a2 describe behaviour that depends on the UE implementation; the "lower case letter" identifies a step sequence that take place depending on the UE implementation.	-	-	-	-
4a1	IF <code>pc_IP_Ping</code> = FALSE, then the SS transmits a CLOSE UE TEST LOOP message.	<--	CLOSE UE TEST LOOP	-	-
4a2	The UE transmits a CLOSE UE TEST LOOP COMPLETE message.	-->	CLOSE UE TEST LOOP COMPLETE	-	-
5	Check: Does the test result of generic test procedure in TS 38.508-1 subclause 4.9.1 indicate that the UE is capable of exchanging IP data on Split DRB#2 using NR radio path?	-	-	1	P
6	SS transmits <i>RRConnectionReconfiguration</i> message containing NR RadioBearerConfig to modify PDCP discardTimer value of Split DRB.	<--	<i>RRConnectionReconfiguration</i>	-	-
7	Check: Does the UE transmit an <i>RRConnectionReconfigurationComplete</i> message?	-->	<i>RRConnectionReconfigurationComplete</i>	2	P
8	Check: Does the test result of generic test procedure in TS 38.508-1 subclause 4.9.1 indicate that the UE is capable of exchanging IP data on the Split DRB#2 using NR radio path?	-	-	2	P
9	SS transmits <i>RRConnectionReconfiguration</i> message containing <i>nr-Config-r15</i> and NR RadioBearerConfig to release PSCell and Split DRB. <i>RRConnectionReconfiguration</i> message contains the DEACTIVATE EPS BEARER CONTEXT REQUEST message.	<--	<i>RRConnectionReconfiguration</i>	-	-
10	Check: Does the UE transmit an <i>RRConnectionReconfigurationComplete</i> message?	-->	<i>RRConnectionReconfigurationComplete</i>	3	P
11	The UE transmits an <i>ULInformationTransfer</i> message containing the DEACTIVATE EPS BEARER CONTEXT ACCEPT message.	-->	<i>ULInformationTransfer</i>	-	-

c1 CHOICE {			
rrcConnectionReconfiguration-r8 SEQUENCE {			
nonCriticalExtension SEQUENCE {			
nonCriticalExtension SEQUENCE {			
nonCriticalExtension SEQUENCE {			
nonCriticalExtension SEQUENCE {			
nonCriticalExtension SEQUENCE {			
nonCriticalExtension SEQUENCE {			
nonCriticalExtension SEQUENCE {			
nr-RadioBearerConfig1-r15	OCTET STRING including RadioBearerConfig.		
}			
}			
}			
}			
}			
}			
}			

Table 8.2.2.5.1.3.3-6: RadioBearerConfig (Table 8.2.2.5.1.3.3-5)

Derivation Path: TS 38.508-1 [4], Table 4.6.3-132, condition EN-DC

Table 8.2.2.5.1.3.3-7: PDCP-Config (Table 8.2.2.5.1.3.3-6)

Derivation Path: TS 38.508-1 [4], Table 4.6.3-99			
Information Element	Value/remark	Comment	Condition
PDCP-Config ::= SEQUENCE {			
drb SEQUENCE {			
discardTimer	ms500	Other than default value.	
}			
}			

Table 8.2.2.5.1.3.3-8: RRCConnectionReconfiguration (step 9, Table 8.2.2.5.1.3.2-1)

Derivation Path: TS 36.508 [7], Table 4.6.1-8			
Information Element	Value/remark	Comment	Condition
RRCConnectionReconfiguration ::= SEQUENCE {			
criticalExtensions CHOICE {			
c1 CHOICE {			
rrcConnectionReconfiguration-r8 SEQUENCE {			
nonCriticalExtension SEQUENCE {			
nonCriticalExtension SEQUENCE {			
nonCriticalExtension SEQUENCE {			
nonCriticalExtension SEQUENCE {			
nonCriticalExtension SEQUENCE {			
nonCriticalExtension SEQUENCE {			
nonCriticalExtension SEQUENCE {			
nr-Config-r15 CHOICE {			
release			
}			
}			
}			
}			
}			
}			
}			
}			

nr-RadioBearerConfig1-r15	OCTET STRING including RadioBearerConfig.		
}			
}			
}			
}			
}			
}			
}			
}			
}			
}			
}			
}			
}			
}			
}			

Table 8.2.2.5.1.3.3-9: RadioBearerConfig (Table 8.2.2.5.1.3.3-8)

Derivation Path: TS 38.508-1 [4], Table 4.6.3-132			
Information Element	Value/remark	Comment	Condition
RadioBearerConfig ::= SEQUENCE {			
drb-ToReleaseList	2	Split DRB Id	
}			

8.2.2.5.2 PSCell addition, modification and release / Split DRB / NR-DC

8.2.2.5.2.1 Test Purpose (TP)

(1)

```
with { UE in NR RRC_CONNECTED state }
ensure that {
  when { UE receives an RRCReconfiguration message to add an NR PSCell with Split DRB }
  then { UE configures the PSCell and sends an RRCReconfigurationComplete message }
}
```

(2)

```
with { UE in NR RRC_CONNECTED state with NR-DC }
ensure that {
  when { UE receives an RRCReconfiguration message to modify Split DRB }
  then { UE reconfigures the Split DRB and sends an RRCReconfigurationComplete message }
}
```

(3)

```
with { UE in NR RRC_CONNECTED state with NR-DC }
ensure that {
  when { UE receives an RRCReconfiguration message to release PSCell with Split DRB }
  then { UE releases the PSCell and Split DRB and sends an RRCReconfigurationComplete message }
}
```

8.2.2.5.2.2 Conformance requirements

References: The conformance requirements covered in the present test case are specified in: TS 38.331, clauses 5.3.5.3, 5.3.5.5.1, 5.3.5.5.7, 5.3.5.6.4 and 5.3.5.6.5. Unless otherwise stated these are Rel-15 requirements.

[TS 38.331, clause 5.3.5.3]

The UE shall perform the following actions upon reception of the *RRCReconfiguration*:

...

1> if the *RRCReconfiguration* includes the *secondaryCellGroup*:

- 2> perform the cell group configuration for the SCG according to 5.3.5.5;
- 1> if the *RRCReconfiguration* message contains the *radioBearerConfig*:
 - 2> perform the radio bearer configuration according to 5.3.5.6;
- 1> if the *RRCReconfiguration* message includes the *measConfig*:
 - 2> perform the measurement configuration procedure as specified in 5.5.2;
- ...
- 1> set the content of the *RRCReconfigurationComplete* message as follows:
 - 2> if the *RRCReconfiguration* message includes the *mrdc-SecondaryCellGroupConfig* with *mrdc-SecondaryCellGroup* set to *nr-SCG*:
 - 3> include in the *nr-SCG-Response* the *RRCReconfigurationComplete* message;
 - 1> else if the *RRCReconfiguration* message was received via SRB1 within the *nr-SCG* within *mrdc-SecondaryCellGroup* (UE in NR-DC, *mrdc-SecondaryCellGroup* was received in *RRCReconfiguration* via SRB1):
 - 2> if *reconfigurationWithSync* was included in *spCellConfig* in *nr-SCG*:
 - 3> initiate the Random Access procedure on the PSCell, as specified in TS 38.321 [3];
 - 2> else
 - 3> the procedure ends;

NOTE 2a: The order in which the UE sends the *RRCReconfigurationComplete* message and performs the Random Access procedure towards the SCG is left to UE implementation.

[TS 38.331, clause 5.3.5.5.1]

...

- 1> if the *CellGroupConfig* contains the *spCellConfig*:
 - 2> configure the SpCell as specified in 5.3.5.5.7;

[TS 38.331, clause 5.3.5.5.7]

The UE shall:

...

- 1> if the *SpCellConfig* contains *spCellConfigDedicated*:
 - 2> configure the SpCell in accordance with the *spCellConfigDedicated*;
 - 2> consider the bandwidth part indicated in *firstActiveUplinkBWP-Id* if configured to be the active uplink bandwidth part;
 - 2> consider the bandwidth part indicated in *firstActiveDownlinkBWP-Id* if configured to be the active downlink bandwidth part;
 - 2> if any of the reference signal(s) that are used for radio link monitoring are reconfigured by the received *spCellConfigDedicated*:
 - 3> stop timer T310 for the corresponding SpCell, if running;
 - 3> stop timer T312 for the corresponding SpCell, if running;
 - 3> reset the counters N310 and N311.

[TS 38.331, clause 5.3.5.6.4]

- 1> for each *drb-Identity* value included in the *drb-ToReleaseList* that is part of the current UE configuration; or
- 1> for each *drb-Identity* value that is to be released as the result of full configuration according to 5.3.5.11:
 - 2> release the PDCP entity and the *drb-Identity*;
 - 2> if SDAP entity associated with this DRB is configured:
 - 3> indicate the release of the DRB to SDAP entity associated with this DRB (TS 37.324 [24], clause 5.3.3);
 - 2> if the DRB is associated with an *eps-BearerIdentity*:
 - 3> if a new bearer is not added either with NR or E-UTRA with same *eps-BearerIdentity*:
 - 4> indicate the release of the DRB and the *eps-BearerIdentity* of the released DRB to upper layers.

NOTE 1: The UE does not consider the message as erroneous if the *drb-ToReleaseList* includes any *drb-Identity* value that is not part of the current UE configuration.

NOTE 2: Whether or not the RLC and MAC entities associated with this PDCP entity are reset or released is determined by the *CellGroupConfig*.

[TS 38.331, clause 5.3.5.6.5]

The UE shall:

- 1> for each *drb-Identity* value included in the *drb-ToAddModList* that is not part of the current UE configuration (DRB establishment including the case when full configuration option is used):
 - 2> establish a PDCP entity and configure it in accordance with the received *pdcp-Config*;
 - 2> if the PDCP entity of this DRB is not configured with *cipheringDisabled*:
 - 3> if target RAT of handover is E-UTRA/5GC; or
 - 3> if the UE is connected to E-UTRA/5GC:
 - 4> if the UE is capable of E-UTRA/5GC but not capable of NGEN-DC:
 - 5> configure the PDCP entity with the ciphering algorithm and K_{UPenc} key configured/derived as specified in TS 36.331 [10];
 - 4> else (i.e., a UE capable of NGEN-DC):
 - 5> configure the PDCP entity with the ciphering algorithms according to *securityConfig* and apply the key (K_{UPenc}) associated with the master key (K_{gNB}) or secondary key ($S-K_{gNB}$) as indicated in *keyToUse*, if applicable;

...

- 2> if the PDCP entity of this DRB is configured with *integrityProtection*:
 - 3> configure the PDCP entity with the integrity protection algorithms according to *securityConfig* and apply the K_{UPint} key associated with the master (K_{gNB}) or the secondary key ($S-K_{gNB}$) as indicated in *keyToUse*;
- 2> if an *sdap-Config* is included:
 - 3> if an SDAP entity with the received *pdu-Session* does not exist:
 - 4> establish an SDAP entity as specified in TS 37.324 [24] clause 5.1.1;
 - 4> if an SDAP entity with the received *pdu-Session* did not exist prior to receiving this reconfiguration:
 - 5> indicate the establishment of the user plane resources for the *pdu-Session* to upper layers;
 - 3> configure the SDAP entity in accordance with the received *sdap-Config* as specified in TS 37.324 [24] and associate the DRB with the SDAP entity;

...

- 1> for each *drb-Identity* value included in the *drb-ToAddModList* that is part of the current UE configuration and not configured with *dapsConfig*:
 - 2> if the *reestablishPDCP* is set:
 - 3> if target RAT is E-UTRA/5GC:, or;
 - 3> if the UE is only connected to E-UTRA/5GC:
 - 4> if the UE is capable of E-UTRA/5GC but not capable of NGEN-DC:
 - 5> if the PDCP entity of this DRB is not configured with *cipheringDisabled*:
 - 6> configure the PDCP entity with the ciphering algorithm and K_{UPenc} key configured/derived as specified in TS 36.331 [10], clause 5.4.2.3, i.e. the ciphering configuration shall be applied to all subsequent PDCP PDUs received and sent by the UE;
 - 4> else (i.e., a UE capable of NGEN-DC):
 - 5> if the PDCP entity of this DRB is not configured with *cipheringDisabled*:
 - 6> configure the PDCP entity with the ciphering algorithm and K_{UPenc} key associated with the master key (K_{eNB}) or the secondary key ($S-K_{gNB}$), as indicated in *keyToUse*, i.e. the ciphering configuration shall be applied to all subsequent PDCP PDUs received and sent by the UE;

...

- 2> else, if the *recoverPDCP* is set:
 - 3> trigger the PDCP entity of this DRB to perform data recovery as specified in TS 38.323 [5];
- 2> if the *pdcp-Config* is included:
 - 3> reconfigure the PDCP entity in accordance with the received *pdcp-Config*.
- 2> if the *sdap-Config* is included:
 - 3> reconfigure the SDAP entity in accordance with the received *sdap-Config* as specified in TS37.324 [24];
 - 3> for each QFI value added in *mappedQoS-FlowsToAdd*, if the QFI value is previously configured, the QFI value is released from the old DRB;

NOTE 1: Void.

NOTE 2: When determining whether a *drb-Identity* value is part of the current UE configuration, the UE does not distinguish which *RadioBearerConfig* and *DRB-ToAddModList* that DRB was originally configured in. To re-associate a DRB with a different key (K_{eNB} to $S-K_{gNB}$, K_{gNB} to $S-K_{eNB}$, K_{gNB} to $S-K_{gNB}$, or vice versa), the network provides the *drb-Identity* value in the (target) *drb-ToAddModList* and sets the *reestablishPDCP* flag. The network does not list the *drb-Identity* in the (source) *drb-ToReleaseList*.

NOTE 3: When setting the *reestablishPDCP* flag for a radio bearer, the network ensures that the RLC receiver entities do not deliver old PDCP PDUs to the re-established PDCP entity. It does that e.g. by triggering a reconfiguration with sync of the cell group hosting the old RLC entity or by releasing the old RLC entity.

NOTE 4: In this specification, UE configuration refers to the parameters configured by NR RRC unless otherwise stated.

NOTE 5: Ciphering and integrity protection can be enabled or disabled for a DRB. The enabling/disabling of ciphering or integrity protection can be changed only by releasing and adding the DRB.

8.2.2.5.2.3 Test description

8.2.2.5.2.3.1 Pre-test conditions

System Simulator:

- NR Cell 1 is the PCell and NR Cell 10 is the PSCell.
- System information combination NR-1 as defined in TS 38.508-1 [4] clause 4.4.3.1.3 is used in NR cell 1.

UE:

- None.

Preamble:

- If *pc_IP_Ping* is set to TRUE then, the UE is in state NR RRC_CONNECTED using generic procedure parameter Connectivity (NR), according to TS 38.508-1 [4], clause 4.5.4.
- Else, the UE is in state NR RRC_CONNECTED using generic procedure parameter Connectivity (NR), Test Mode (On) associated with UE test loop mode B configured on NR Cell 1 according to TS 38.508-1 [4], clause 4.5.4.

8.2.2.5.2.3.2 Test procedure sequence

Table 8.2.2.5.2.3.2-1: Main behaviour

St	Procedure	Message Sequence		TP	Verdict
		U - S	Message		
1	The SS transmits an <i>RRCReconfiguration</i> containing <i>RRCReconfiguration-SCG</i> message and a PDU SESSION MODIFICATION COMMAND to add NR PSCell with Split DRB.	<--	NR RRC: <i>RRCReconfiguration</i> 5GMM: DL NAS TRANSPORT 5GSM: PDU SESSION MODIFICATION COMMAND	-	-
2	Check: Does the UE transmit an <i>RRCReconfigurationComplete</i> message including nr-SCG-Response?	-->	<i>RRCReconfigurationComplete</i>	1	P
2A	The UE transmits a <i>ULInformationTransfer</i> message and an PDU SESSION MODIFICATION COMPLETE message.	-->	NR RRC: <i>ULInformationTransfer</i> 5GMM: UL NAS TRANSPORT 5GSM: PDU SESSION MODIFICATION COMPLETE	-	-
-	EXCEPTION: Steps 2Ba1 to 2Ba2 describe behaviour that depends on the UE implementation; the "lower case letter" identifies a step sequence that take place depending on the UE implementation.	-	-	-	-
2Ba1	IF <i>pc_IP_Ping</i> = FALSE, then, the SS transmits a CLOSE UE TEST LOOP message.	<--	CLOSE UE TEST LOOP	-	-
2Ba2	The UE transmits a CLOSE UE TEST LOOP COMPLETE message.	-->	CLOSE UE TEST LOOP COMPLETE	-	-
3	Check: Does the test result of generic test procedure in TS 38.508-1 subclause 4.9.1 indicate that the UE is capable of exchanging IP data on Split DRB over the SCG path?	-	-	1	P
4	SS transmits <i>RRCReconfiguration</i> message containing NR RadioBearerConfig to modify PDCP discardTimer value of Split DRB.	<--	<i>RRCReconfiguration</i>	-	-
5	Check: Does the UE transmit an <i>RRCReconfigurationComplete</i> message?	-->	<i>RRCReconfigurationComplete</i>	2	P
6	Check: Does the test result of generic test procedure in TS 38.508-1 subclause 4.9.1 indicate that the UE is capable of exchanging IP data on Split DRB over the SCG path?	-	-	2	P
7	SS transmits <i>RRCReconfiguration</i> message containing NR RadioBearerConfig to release PSCell and Split DRB.	<--	<i>RRCReconfiguration</i>	-	-

8	Check: Does the UE transmit an <i>RRCReconfigurationComplete</i> message?	-->	<i>RRCReconfigurationComplete</i>	3	P
---	---	-----	-----------------------------------	---	---

8.2.2.5.2.3.3 Specific message contents

Table 8.2.2.5.2.3.3-1: *RRCReconfiguration* (step 1, Table 8.2.2.5.2.3.2-1)

Derivation Path: TS 38.508-1 [4], Table 4.6.1-13			
Information Element	Value/remark	Comment	Condition
<i>RRCReconfiguration</i> ::= SEQUENCE {			
criticalExtensions CHOICE {			
rrcReconfiguration SEQUENCE {			
nonCriticalExtension SEQUENCE {			
masterCellGroup	CellGroupConfig as defined in TS 38.508-1 [4], Table 4.6.1-19 with condition DRBn	SCG DRBn added in master cell group	
nonCriticalExtension SEQUENCE {			
mrdc-SecondaryCellGroupConfig CHOICE {			
setup SEQUENCE {			
mrdc-SecondaryCellGroup CHOICE {			
nr-SCG	OCTET STRING (CONTAINING <i>RRCReconfiguration</i>) as defined in TS 38.508-1 [4], Table 4.6.1-13 with condition NR-DC_SCG		
}			
}			
}			
radioBearerConfig2	OCTET STRING (CONTAINING <i>RadioBearerConfig</i>) as defined in TS 38.508-1 [4], with condition DRBn, Split and SecondaryKeys		
}			
}			
}			
}			

Table 8.2.2.4.5.3.3-1A: PDU SESSION MODIFICATION COMMAND (step 1, Table 8.2.2.5.2.3.2-1)

Derivation Path: TS 38.508-1 [4], Table 4.7.2-9.			
Information Element	Value/remark	Comment	Condition
PDU session ID	The same as the PDU session ID in PDU SESSION ESTABLISHMENT REQUEST associated with the Internet PDU session if available or with the first PDU session		
Authorized QoS rules	One entry		
QoS rule [1]	Reference QoS rule #5 as defined in TS 38.508-1 [4], Table 4.8.2.1-5.	QFI=5	
Authorized QoS flow descriptions	One entry		
QoS flow [1]	Reference QoS flow #5 as defined in TS 38.508-1 [4], Table 4.8.2.3-5.	QFI=5	

Table 8.2.2.5.2.3.3-2: Void

Table 8.2.2.5.2.3.3-3: Void

Table 8.2.2.5.2.3.3-4: RRCReconfiguration (step 4, Table 8.2.2.5.2.3.2-1)

Derivation Path: TS 38.508-1 [4], Table 4.6.1-13			
Information Element	Value/remark	Comment	Condition
RRCReconfiguration ::= SEQUENCE {			
criticalExtensions CHOICE {			
rrcReconfiguration SEQUENCE {			
nonCriticalExtension SEQUENCE {			
nonCriticalExtension SEQUENCE {			
radioBearerConfig2	OCTET STRING (CONTAINING RadioBearerConfig_SCG -Mod)		
}			
}			
}			
}			
}			

Table 8.2.2.5.2.3.3-5: RadioBearerConfig_SCG-Mod (Table 8.2.2.5.2.3.3-4)

Derivation Path: TS 38.508-1 [4], Table 4.6.3-132			
Information Element	Value/remark	Comment	Condition
RadioBearerConfig ::= SEQUENCE {			
drb-ToAddModList SEQUENCE (SIZE (1..maxDRB)) OF DRB-ToAddMod {	1 entry		
DRB-ToAddMod[1] SEQUENCE {		entry 1	
drb-Identity	DRBn	n set to the same DRB ID as in Table 8.2.2.5.2.3.3-2	
pdcp-Config	PDCP-Config		
}			
}			
}			

Table 8.2.2.5.2.3.3-6: PDCP-Config (Table 8.2.2.5.2.3.3-5)

Derivation Path: TS 38.508-1 [4], Table 4.6.3-99			
Information Element	Value/remark	Comment	Condition
PDCP-Config ::= SEQUENCE {			
drb SEQUENCE {			
discardTimer	ms500	Other than default value.	
}			
}			

Table 8.2.2.5.2.3.3-7: RRCReconfiguration (step 7, Table 8.2.2.5.2.3.2-1)

Derivation Path: TS 38.508 [4], Table 4.6.1-13			
Information Element	Value/remark	Comment	Condition
RRCReconfiguration ::= SEQUENCE {			
criticalExtensions CHOICE {			
rrcReconfiguration SEQUENCE {			

nonCriticalExtension SEQUENCE {			
masterCellGroup	CellGroupConfig_Split_R LC-Rel		
nonCriticalExtension SEQUENCE {			
mrdc-SecondaryCellGroupConfig CHOICE {			
setup SEQUENCE {			
mrdc-ReleaseAndAdd	true		
}			
}			
radioBearerConfig2	OCTET STRING (CONTAINING RadioBearerConfig_SCG -Rel)		
}			
}			
}			
}			
}			
}			

Table 8.2.2.5.2.3.3-8: RadioBearerConfig_SCG-Rel (Table 8.2.2.5.2.3.3-7)

Derivation Path: TS 38.508-1 [4], Table 4.6.3-132			
Information Element	Value/remark	Comment	Condition
RadioBearerConfig ::= SEQUENCE {			
drb-ToReleaseList	DRBn	n set to the same DRB ID as in Table 8.2.2.5.2.3.3-2	
}			

Table 8.2.2.5.2.3.3-9: CellGroupConfig_Split_RLC-Rel (Table 8.2.2.5.2.3.3-7)

Derivation Path: TS 38.508-1 [4], Table 4.6.3-19			
Information Element	Value/remark	Comment	Condition
CellGroupConfig ::= SEQUENCE {			
rlc-BearerToReleaseList SEQUENCE {	1 entry		
logicalChannelIdentity	LogicalChannelIdentity with condition DRBn	n is set to the same DRB ID as in Table 8.2.2.5.2.3.3-2	
}			
}			

Table 8.2.2.5.2.3.3-10: RRCReconfigurationComplete (step 2, Table 8.2.2.5.2.3.2-1)

Derivation Path: TS 38.508 [4], Table 4.6.1-14 with condition NR-DC

8.2.2.5.3 PSCell addition, modification and release / Split DRB / NE-DC

8.2.2.5.3.1 Test Purpose (TP)

(1)

```

with { UE in NR RRC_CONNECTED state }
ensure that {
  when { UE receives an RRCReconfiguration message to add an E-UTRA PSCell with Split DRB }
  then { UE configures the PSCell with Split DRB and sends an RRCReconfigurationComplete message }
}

```

(2)

```

with { UE in NR RRC_CONNECTED state with NE-DC, and, MCG(s) (NR PDCP) and SCG }
ensure that {
  when { UE receives an RRCReconfiguration message to modify Split DRB }
  then { UE reconfigures the Split DRB and sends an RRCReconfigurationComplete message }
}

```

(3)

```

with { UE in NR RRC_CONNECTED state with NE-DC, and, MCG(s) (NR PDCP) and SCG }
ensure that {
  when { UE receives an RRCReconfiguration message to release E-UTRA PSCell with Split DRB }
  then { UE releases the PSCell and Split DRB and sends an RRCReconfigurationComplete message }
}

```

8.2.2.5.3.2 Conformance requirements

References: The conformance requirements covered in the present test case are specified in: TS 38.331, clauses 5.3.5.3, 5.3.5.5.1, 5.3.5.5.7, TS 36.331, clauses 5.3.5.3, 5.3.10.10. Unless otherwise stated these are Rel-15 requirements.

[TS 38.331, clause 5.3.5.3]

The UE shall perform the following actions upon reception of the *RRCReconfiguration*, or upon execution of the conditional reconfiguration (CHO or CPC):

...

1> if the *RRCReconfiguration* includes the *secondaryCellGroup*:

2> perform the cell group configuration for the SCG according to 5.3.5.5;

1> if the *RRCReconfiguration* includes the *mrdc-SecondaryCellGroupConfig*:

2> if the *mrdc-SecondaryCellGroupConfig* is set to *setup*:

3> if the *mrdc-SecondaryCellGroupConfig* includes *mrdc-ReleaseAndAdd*:

4> perform MR-DC release as specified in clause 5.3.5.10;

3> if the received *mrdc-SecondaryCellGroup* is set to *nr-SCG*:

4> perform the RRC reconfiguration according to 5.3.5.3 for the *RRCReconfiguration* message included in *nr-SCG*;

3> if the received *mrdc-SecondaryCellGroup* is set to *eutra-SCG*:

4> perform the RRC connection reconfiguration as specified in TS 36.331 [10], clause 5.3.5.3 for the *RRCConnectionReconfiguration* message included in *eutra-SCG*;

2> else (*mrdc-SecondaryCellGroupConfig* is set to *release*):

3> perform MR-DC release as specified in clause 5.3.5.10;

1> if the *RRCReconfiguration* message includes the *radioBearerConfig*:

2> perform the radio bearer configuration according to 5.3.5.6;

1> if the *RRCReconfiguration* message includes the *radioBearerConfig2*:

2> perform the radio bearer configuration according to 5.3.5.6;

1> if the *RRCReconfiguration* message includes the *measConfig*:

2> perform the measurement configuration procedure as specified in 5.5.2;

...

1> set the content of the *RRCReconfigurationComplete* message as follows:

...

2> if the *RRCReconfiguration* message includes the *mrdc-SecondaryCellGroupConfig* with *mrdc-SecondaryCellGroup* set to *eutra-SCG*:

3> include in the *eutra-SCG-Response* the E-UTRA *RRCConnectionReconfigurationComplete* message in accordance with TS 36.331 [10] clause 5.3.5.3;

...

[TS 38.331, clause 5.3.5.5.1]

The network configures the UE with Master Cell Group (MCG), and zero or one Secondary Cell Group (SCG). In (NG)EN-DC, the MCG is configured as specified in TS 36.331 [10], and for NE-DC, the SCG is configured as specified in TS 36.331 [10]. The network provides the configuration parameters for a cell group in the *CellGroupConfig* IE.

The UE performs the following actions based on a received *CellGroupConfig* IE:

...

1> if the *CellGroupConfig* contains the *spCellConfig*:

2> configure the SpCell as specified in 5.3.5.5.7;

...

[TS 38.331, clause 5.3.5.5.7]

The UE shall:

...

1> if the *SpCellConfig* contains *spCellConfigDedicated*:

2> configure the SpCell in accordance with the *spCellConfigDedicated*;

2> consider the bandwidth part indicated in *firstActiveUplinkBWP-Id* if configured to be the active uplink bandwidth part;

2> consider the bandwidth part indicated in *firstActiveDownlinkBWP-Id* if configured to be the active downlink bandwidth part;

2> if any of the reference signal(s) that are used for radio link monitoring are reconfigured by the received *spCellConfigDedicated*:

3> stop timer T310 for the corresponding SpCell, if running;

3> stop timer T312 for the corresponding SpCell, if running;

3> reset the counters N310 and N311.

[TS 36.331, clause 5.3.5.3]

If the *RRCConnectionReconfiguration* message does not include the *mobilityControlInfo* and the UE is able to comply with the configuration included in this message, the UE shall:

...

1> if the received *RRCConnectionReconfiguration* includes the *scg-Configuration*; or

1> if the current UE configuration includes one or more split DRBs configured with *pdcp-Config* and the received *RRCConnectionReconfiguration* includes *radioResourceConfigDedicated* including *drb-ToAddModList*:

2> perform SCG reconfiguration as specified in 5.3.10.10;

...

- 1> set the content of *RRCConnectionReconfigurationComplete* message as follows:
 - 2> if the *RRCConnectionReconfiguration* message includes *perCC-GapIndicationRequest*:
 - 3> include *perCC-GapIndicationList* and *numFreqEffective*;
 - 2> if the frequencies are configured for reduced measurement performance:
 - 3> include *numFreqEffectiveReduced*;
 - 2> if the received *RRCConnectionReconfiguration* message included *nr-SecondaryCellGroupConfig*:
 - 3> include *scg-ConfigResponseNR* in accordance with TS 38.331 [82], clause 5.3.5.3;
- 1> if the UE is configured with NE-DC:
 - 2> if the received *RRCConnectionReconfiguration* message was included in an NR *RRCResume* message:
 - 3> transfer the *RRCConnectionReconfigurationComplete* message via SRB1 embedded in NR RRC message *RRCResumeComplete* as specified in TS 38.331 [82], clause 5.3.13.4;
 - 2> else:
 - 3> transfer the *RRCConnectionReconfigurationComplete* message via SRB1 embedded in NR RRC message *RRCReconfigurationComplete* as specified in TS 38.331 [82], clause 5.3.5.3;
- 1> else:
 - 2> submit the *RRCConnectionReconfigurationComplete* message to lower layers for transmission using the new configuration, upon which the procedure ends;

[TS 36.331, clause 5.3.10.10]

The UE shall:

...

- 1> if *scg-Configuration* is received and is set to *release* or includes the *mobilityControlInfoSCG* (i.e. SCG release/change):
 - 2> if *mobilityControlInfo* is not received (i.e. SCG release/change without HO):
 - 3> reset SCG MAC, if configured;
 - 3> if the UE is not configured with NE-DC:
 - 4> for each *drb-Identity* value that is part of the current UE configuration:
 - 5> if the DRB indicated by *drb-Identity* is an SCG DRB:
 - 6> re-establish the PDCP entity and the SCG RLC entity or entities;
 - 5> if the DRB indicated by *drb-Identity* is a split DRB:
 - 6> perform PDCP data recovery and re-establish the SCG RLC entity;
 - 5> if the DRB indicated by *drb-Identity* is an MCG DRB; and
 - 5> *drb-ToAddModListSCG* is received and includes the *drb-Identity* value, while for this entry *drb-Type* is included and set to *scg* (i.e. MCG to SCG):
 - 6> re-establish the PDCP entity and the MCG RLC entity or entities;
 - 3> configure lower layers to consider the SCG SCell(s), except for the PSCell, to be in deactivated state;
 - 1> if *scg-Configuration* is received and is set to *release*:

- 2> release the entire SCG configuration, except for the DRB configuration (i.e. as configured by *drb-ToAddModListSCG*);
 - 2> if the current UE configuration includes one or more split or SCG DRBs and the received *RRConnectionReconfiguration* message includes *radioResourceConfigDedicated* including *drb-ToAddModList*:
 - 3> reconfigure the SCG or split DRB by *drb-ToAddModList* as specified in 5.3.10.12;
 - 2> stop timer T313, if running;
 - 2> stop timer T307, if running;
 - 1> else:
 - 2> if *scg-ConfigPartMCG* is received and includes the *scg-Counter*:
 - 3> update the S- K_{eNB} key based on the K_{eNB} key and using the received *scg-Counter* value, as specified in TS 33.401 [32];
 - 3> derive the K_{UPenc} key associated with the *cipheringAlgorithmSCG* included in *mobilityControlInfoSCG* within the received *scg-ConfigPartSCG*, as specified in TS 33.401 [32];
 - 3> configure lower layers to apply the ciphering algorithm and the K_{UPenc} key;
 - 2> if *scg-ConfigPartSCG* is received and includes the *radioResourceConfigDedicatedSCG*:
 - 3> reconfigure the dedicated radio resource configuration for the SCG as specified in 5.3.10.11;
 - 2> if the current UE configuration includes one or more split or SCG DRBs and the received *RRConnectionReconfiguration* message includes *radioResourceConfigDedicated* including *drb-ToAddModList*:
 - 3> reconfigure the SCG or split DRB by *drb-ToAddModList* as specified in 5.3.10.12;
 - 2> if *scg-ConfigPartSCG* is received and includes *measConfigSN*:
 - 3> for *measConfigSN* perform the actions as specified in 5.5.2 for *measConfig* unless explicitly stated otherwise;
 - 2> if *scg-ConfigPartSCG* is received and includes the *sCellToReleaseListSCG*:
 - 3> perform SCell release for the SCG as specified in 5.3.10.3a;
 - 2> if *scg-ConfigPartSCG* is received and includes the *pSCellToAddMod*:
 - 3> perform PSCell addition or modification as specified in 5.3.10.3c;
- NOTE 0: This procedure is also used to release the PSCell e.g. PSCell change, SI change for the PSCell.
- 2> if *scg-ConfigPartSCG* is received and includes the *sCellToAddModListSCG*:
 - 3> perform SCell addition or modification as specified in 5.3.10.3b;
 - 2> configure lower layers in accordance with *mobilityControlInfoSCG*, if received;
 - 2> if *rach-SkipSCG* is configured:
 - 3> configure lower layers to apply the *rach-SkipSCG* for the target SCG, as specified in TS 36.213 [23] and TS 36.321 [6];
 - 2> if *scg-ConfigPartSCG* is received and includes the *mobilityControlInfoSCG* (i.e. SCG change):
 - 3> resume all SCG DRBs and resume SCG transmission for split DRBs, if suspended;
 - 3> stop timer T313, if running;

- 3> start timer T307 with the timer value set to t_{307} , as included in the *mobilityControlInfoSCG*, if *makeBeforeBreakSCG* is not configured;
- 3> start synchronising to the DL of the target PSCell;
- 3> initiate the random access procedure on the PSCell, as specified in TS 36.321 [6], if *rach-SkipSCG* is not configured:

NOTE 1: The UE is not required to determine the SFN of the target PSCell by acquiring system information from that cell before performing RACH access in the target PSCell.

- 3> the procedure ends, except that the following actions are performed when MAC successfully completes the random access procedure on the PSCell or when MAC indicates the successful reception of a PDCCH transmission addressed to C-RNTI and if *rach-skipSCG* is configured:
 - 4> stop timer T307;
 - 4> release *rach-SkipSCG*;
 - 4> apply the parts of the CQI reporting configuration, the scheduling request configuration and the sounding RS configuration that do not require the UE to know the SFN of the target PSCell, if any;
 - 4> apply the parts of the measurement and the radio resource configuration that require the UE to know the SFN of the target PSCell (e.g. periodic CQI reporting, scheduling request configuration, sounding RS configuration), if any, upon acquiring the SFN of the target PSCell;

NOTE 2: Whenever the UE shall setup or reconfigure a configuration in accordance with a field that is received it applies the new configuration, except for the cases addressed by the above statements.

8.2.2.5.3.3 Test description

8.2.2.5.3.3.1 Pre-test conditions

System Simulator:

- NR Cell 1 is the PCell and EUTRA Cell 1 is the PS Cell.

UE:

- None

Preamble:

- If *pc_IP_Ping* is set to TRUE then, the UE is in state NR RRC_CONNECTED using generic procedure parameter Connectivity (NR), according to TS 38.508-1 [4], clause 4.5.4.
- Else, the UE is in state NR RRC_CONNECTED using generic procedure parameter Connectivity (NR), Test Mode (On) associated with UE test loop mode B configured on NR Cell 1 according to TS 38.508-1 [4], clause 4.5.4.

8.2.2.5.3.3.2 Test procedure sequence

Table 8.2.2.5.3.3.2-1: Main behaviour

St	Procedure	Message Sequence		TP	Verdict
		U - S	Message		
1	The SS transmits an <i>RRCReconfiguration</i> message containing <i>RRCCConnectionReconfiguration</i> message and a PDU SESSION MODIFICATION COMMAND to add E-UTRA PSCell with Split DRB.	<--	NR RRC: <i>RRCReconfiguration</i> (<i>RRCCConnectionReconfiguration</i>) 5GMM: DL NAS TRANSPORT 5GSM: PDU SESSION MODIFICATION COMMAND	-	-
-	EXCEPTION: Depending upon UE implementation, steps 2 and 2A can occur in any order	-	-	-	-

2	Check: Does the UE transmit an <i>RRCReconfigurationComplete</i> message including <i>eutra-SCG-Response</i> ?	-->	<i>RRCReconfigurationComplete</i> (<i>RRCConnectionReconfigurationComplete</i>)	1	P
2A	The UE transmits a <i>ULInformationTransfer</i> message and an <i>PDU SESSION MODIFICATION COMPLETE</i> message.	-->	NR RRC: <i>ULInformationTransfer</i> 5GMM: <i>UL NAS TRANSPORT MODIFICATION COMPLETE</i> 5GSM: <i>PDU SESSION MODIFICATION COMPLETE</i>	-	-
3	Check: Does the test result of generic test procedure in TS 38.508-1 subclause 4.9.1 indicate that the UE is capable of exchanging IP data on Split DRB?	-	-	1	P
-	EXCEPTION: Steps 3Aa1 to 3Aa2 describe behaviour that depends on the UE implementation; the "lower case letter" identifies a step sequence that take place depending on the UE implementation.	-	-		
3Aa1	IF <i>pc_IP_Ping</i> = FALSE, then, the SS transmits a <i>CLOSE UE TEST LOOP</i> message.	<--	CLOSE UE TEST LOOP		
3Aa2	The UE transmits a <i>CLOSE UE TEST LOOP COMPLETE</i> message.	-->	CLOSE UE TEST LOOP COMPLETE		
3B	Check: Does the test result of generic test procedure in TS 38.508-1 subclause 4.9.1 indicate that the UE is capable of exchanging IP data on Split DRB?	-	-	1	P
4	SS transmits <i>RRCReconfiguration</i> message containing <i>E-UTRA RadioBearerConfig</i> to modify <i>PDCP discardTimer</i> value of Split DRB.	<--	NR RRC: <i>RRCReconfiguration</i> (<i>RRCConnectionReconfiguration</i>)	-	-
5	Check: Does the UE transmit an <i>RRCReconfigurationComplete</i> message?	-->	<i>RRCReconfigurationComplete</i> (<i>RRCConnectionReconfigurationComplete</i>)	2	P
6	Check: Does the test result of generic test procedure in TS 38.508-1 subclause 4.9.1 indicate that the UE is capable of exchanging IP data on Split DRB?	-	-	2	P
7	SS transmits <i>RRCReconfiguration</i> message and a <i>PDU SESSION MODIFICATION COMMAND</i> to release <i>E-UTRA PSCell</i> and Split DRB.	<--	NR RRC: <i>RRCReconfiguration</i> (<i>RRCConnectionReconfiguration</i>) 5GMM: <i>DL NAS TRANSPORT MODIFICATION COMMAND</i> 5GSM: <i>PDU SESSION MODIFICATION COMMAND</i>	-	-
8	Check: Does the UE transmit an <i>RRCReconfigurationComplete</i> message?	-->	<i>RRCReconfigurationComplete</i> (<i>RRCConnectionReconfigurationComplete</i>)	3	P
9	The UE transmits a <i>ULInformationTransfer</i> message and an <i>PDU SESSION MODIFICATION COMPLETE</i> message.	-->	NR RRC: <i>ULInformationTransfer</i> 5GMM: <i>UL NAS TRANSPORT MODIFICATION COMPLETE</i> 5GSM: <i>PDU SESSION MODIFICATION COMPLETE</i>	-	-

8.2.2.5.3.3.3 Specific message contents

Table 8.2.2.5.3.3.3-1: *RRCReconfiguration* (step 1, Table 8.2.2.5.3.3.2-1)

Derivation Path: TS 38.508-1 [4], Table 4.6.1-13			
Information Element	Value/remark	Comment	Condition
<i>RRCReconfiguration</i> ::= SEQUENCE {			
<i>rrc-TransactionIdentifier</i>	RRC- <i>TransactionIdentifier</i>		
<i>criticalExtensions</i> CHOICE {			
<i>rrcReconfiguration</i> SEQUENCE {			
<i>radioBearerConfig</i>	Not present		
<i>secondaryCellGroup</i>	Not present		
<i>measConfig</i>	Not present		
<i>lateNonCriticalExtension</i>	Not present		
<i>nonCriticalExtension</i> SEQUENCE {			

Table 8.2.2.5.3.3.3-3: SCG-Configuration-r12-NE-DC (Table 8.2.2.5.3.3.3-2)

Derivation Path: 36.508, Clause 4.6.3, Table 4.6.3-19G, condition NE-DC

Table 8.2.2.5.3.3.3-3A: PDU SESSION MODIFICATION COMMAND (step 1, Table 8.2.2.5.3.3.2-1)

Derivation Path: TS 38.508-1 [4], Table 4.7.2-9.			
Information Element	Value/remark	Comment	Condition
PDU session ID	The same as the PDU session ID in PDU SESSION ESTABLISHMENT REQUEST associated with the Internet PDU session if available or with the first PDU session		
Authorized QoS rules	One entry		
QoS rule	Reference QoS rule #5 as defined in TS 38.508-1 [4], Table 4.8.2.1-5.	QFI=5	
Authorized QoS flow descriptions	One entry		
QoS flow	Reference QoS flow #5 as defined in TS 38.508-1 [4], Table 4.8.2.3-5.	QFI=5	

Table 8.2.2.5.3.3.3-4: RRCReconfiguration (step4 , step7, Table 8.2.2.5.3.3.2-1)

Derivation Path: TS 38.508-1 [4], Table 4.6.1-13			
Information Element	Value/remark	Comment	Condition
RRCReconfiguration ::= SEQUENCE {			
rrc-TransactionIdentifier	RRC-TransactionIdentifier		
criticalExtensions CHOICE {			
rrcReconfiguration SEQUENCE {			
radioBearerConfig	Not present		
secondaryCellGroup	Not present		
measConfig	Not present		
lateNonCriticalExtension	Not present		
nonCriticalExtension	Not present		Step 4
nonCriticalExtension SEQUENCE {			Step 7
masterCellGroup	CellGroupConfig_Split_R LC-Rel	As specified in Table 8.2.2.5.3.3.3-7A	
nonCriticalExtension SEQUENCE {			Step 7
otherConfig-v1540	Not present		
nonCriticalExtension SEQUENCE {			
mrdc-SecondaryCellGroupConfig CHOICE {			
release			Step 7
}			
radioBearerConfig2	OCTET STRING (CONTAINING RadioBearerConfig_Split-Mod)	As specified in Table 8.2.2.5.3.3.3-7B	Step 4
	OCTET STRING (CONTAINING RadioBearerConfig_Split-Rel)	As specified in Table 8.2.2.5.3.3.3-7C	Step 7
}			
}			
}			
}			
}			
}			
}			
}			

Table 8.2.2.5.3.3-8: RRCReconfigurationComplete (step 3, step 6, step 8, Table 8.2.2.5.3.3.2-1)

Derivation Path: TS 38.508-1 [4], Table 4.6.1-14			
Information Element	Value/remark	Comment	Condition
RRCReconfigurationComplete ::= SEQUENCE {			
rrc-TransactionIdentifier	Not checked		
criticalExtensions CHOICE {			
rrcReconfigurationComplete SEQUENCE {			
lateNonCriticalExtension	Not checked		
nonCriticalExtension SEQUENCE {			
uplinkTxDirectCurrentList	Not checked		
nonCriticalExtension SEQUENCE {			
scg-Response CHOICE {			
eutra-SCG-Response	RRCConnectionReconfigurationComplete	OCTET STRING	
}			
nonCriticalExtension	Not checked		
}			
}			
nonCriticalExtension	Not checked		
}			
}			

Table 8.2.2.5.3.3-9: PDU SESSION MODIFICATION COMMAND (step 7, Table 8.2.2.5.3.3.2-1)

Derivation Path: TS 38.508-1 [4], Table 4.7.2-9.			
Information Element	Value/remark	Comment	Condition
PDU session ID	The same as the PDU session ID in PDU SESSION ESTABLISHMENT REQUEST associated with the Internet PDU session if available or with the first PDU session		
Authorized QoS rules	One entry		
QoS rule identifier	'00000101'B	QFI=5	
Rule operation code	'010'B	Delete existing QoS rule	
Authorized QoS flow descriptions			
QoS flow descriptions			
QFI	'00000101'B	QFI=5	
Operation code	'010'B	Delete existing QoS flow	

8.2.2.6 Bearer Modification / MCG DRB

8.2.2.6.1 Bearer Modification / MCG DRB / SRB / PDCP version change / EN-DC

8.2.2.6.1.1 Test Purpose (TP)

(1)

```

with { UE in E-UTRA RRC_CONNECTED state}
ensure that {
  when { UE receives an RRCConnectionReconfiguration with mobility message to change PDCP version of
the SRB1 and SRB2 from E-UTRA PDCP to NR PDCP }
  then { UE performs PDCP version change and sends an RRCConnectionReconfigurationComplete message
}
}

```

(2)

```

with { UE in E-UTRA RRC_CONNECTED state with SRB1 and SRB2 using NR PDCP }
ensure that {
  when { UE receives an RRCConnectionReconfiguration with mobility message to change PDCP version of
the MCG DRB from E-UTRA PDCP to NR PDCP }
  then { UE performs PDCP version change and sends an RRCConnectionReconfigurationComplete message
}
}

```

(3)

```

with { UE in E-UTRA RRC_CONNECTED state with SRB1 and SRB2 using NR PDCP }
ensure that {
  when { UE receives an RRCConnectionReconfiguration with mobility message to change PDCP version of
the MCG DRB from NR PDCP to E-UTRA PDCP }
  then { UE performs PDCP version change and sends an RRCConnectionReconfigurationComplete message
}
}

```

(4)

```

with { UE in E-UTRA RRC_CONNECTED state with SRB1 and SRB2 using NR PDCP }
ensure that {
  when { UE receives an RRCConnectionReconfiguration with mobility message to change PDCP version of
the SRB1 and SRB2 from NR PDCP to E-UTRA PDCP }
  then { UE performs PDCP version change and sends an RRCConnectionReconfigurationComplete message
}
}

```

8.2.2.6.1.2 Conformance requirements

References: The conformance requirements covered in the present TC are specified in: TS 36.331, clause 5.3.1.1, 5.3.5.4 and 5.3.10.3, TS 38.331, clauses 5.3.5.3, 5.3.5.5, 5.3.5.5.7, 5.3.5.6, 5.3.5.6.3 and 5.3.5.6.5. Unless otherwise stated these are Rel-15 requirements.

[TS 36.331, clause 5.3.1.1]

Change to NR PDCP or vice versa, for both SRBs and DRBs, can be performed using an *RRCConnectionReconfiguration* message including the *mobilityControlInfo* (handover) by release and addition of the concerned RB (for DRBs) or of the concerned PDCP entity (for SRBs). The same *RRCConnectionReconfiguration* message may be used to make changes regarding the CG(s) used for transmission. For SRBs, change from E-UTRA PDCP to NR PDCP type may, before initial security activation, also be performed using an *RRCConnectionReconfiguration* message not including the *mobilityControlInfo*.

[TS 36.331, clause 5.3.5.4]

If the *RRCConnectionReconfiguration* message includes the *mobilityControlInfo* and the UE is able to comply with the configuration included in this message, the UE shall:

- 1> stop timer T310, if running;
- 1> stop timer T312, if running;
- 1> start timer T304 with the timer value set to *t304*, as included in the *mobilityControlInfo*;
- 1> stop timer T370, if running;
- 1> if the *carrierFreq* is included:
 - 2> consider the target PCell to be one on the frequency indicated by the *carrierFreq* with a physical cell identity indicated by the *targetPhysCellId*;
- 1> else:
 - 2> consider the target PCell to be one on the frequency of the source PCell with a physical cell identity indicated by the *targetPhysCellId*;
- 1> start synchronising to the DL of the target PCell;

NOTE 1: The UE should perform the handover as soon as possible following the reception of the RRC message triggering the handover, which could be before confirming successful reception (HARQ and ARQ) of this message.

- 1> reset MCG MAC and SCG MAC, if configured;
- 1> re-establish PDCP for all RBs configured with *pdcp-config* that are established;

NOTE 2: The handling of the radio bearers after the successful completion of the PDCP re-establishment, e.g. the re-transmission of unacknowledged PDCP SDUs (as well as the associated status reporting), the handling of the SN and the HFN, is specified in TS 36.323 [8].

- 1> re-establish MCG RLC and SCG RLC, if configured, for all RBs that are established;
- 1> apply the value of the *newUE-Identity* as the C-RNTI;
- 1> configure lower layers in accordance with the received *radioResourceConfigCommon*;
- 1> configure lower layers in accordance with any additional fields, not covered in the previous, if included in the received *mobilityControlInfo*;
- 1> if the *RRCCONNECTIONRECONFIGURATION* message includes the *radioResourceConfigDedicated*:
 - 2> perform the radio resource configuration procedure as specified in 5.3.10;
- 2> store the *nextHopChainingCount* value;
- 2> else:
 - 3> derive the K_{RRcInt} key associated with the current integrity algorithm, as specified in TS 33.401 [32];
 - 3> if connected as an RN:
 - 4> derive the K_{UPint} key associated with the current integrity algorithm, as specified in TS 33.401 [32];
 - 3> derive the K_{RRcEnc} key and the K_{UPenc} key associated with the current ciphering algorithm, as specified in TS 33.401 [32];
- 1> configure lower layers to apply the integrity protection algorithm and the K_{RRcInt} key, i.e. the integrity protection configuration shall be applied to all subsequent messages received and sent by the UE, including the message used to indicate the successful completion of the procedure;
- 1> configure lower layers to apply the ciphering algorithm, the K_{RRcEnc} key and the K_{UPenc} key, i.e. the ciphering configuration shall be applied to all subsequent messages received and sent by the UE, including the message used to indicate the successful completion of the procedure;
- 1> if the received *RRCCONNECTIONRECONFIGURATION* includes the *nr-RadioBearerConfig1*:
 - 2> perform radio bearer configuration as specified in TS 38.331 [82, 5.3.5.6];
- 1> set the content of *RRCCONNECTIONRECONFIGURATIONCOMPLETE* message as follows:
 - 2> else if the UE has logged measurements available for E-UTRA and if the RPLMN is included in *plmn-IdentityList* stored in *VarLogMeasReport*:
 - 3> include the *logMeasAvailable*;
 - 2> if the UE has connection establishment failure information available in *VarConnEstFailReport* and if the RPLMN is equal to *plmn-Identity* stored in *VarConnEstFailReport*:
 - 3> include *connEstFailInfoAvailable*;
 - 2> if the *RRCCONNECTIONRECONFIGURATION* message includes *perCC-GapIndicationRequest*:
 - 3> include *perCC-GapIndicationList* and *numFreqEffective*;
 - 2> if the frequencies are configured for reduced measurement performance:

- 3> include numFreqEffectiveReduced;
- 2> if the received *RRCConnectionReconfiguration* message included *nr-SecondaryCellGroupConfig*:
 - 3> include *scg-ConfigResponseNR* in accordance with TS 38.331 [82, 5.3.5.3];
- 1> submit the *RRCConnectionReconfigurationComplete* message to lower layers for transmission;
- 1> if MAC successfully completes the random access procedure; or

[TS 36.331, clause 5.3.10.3]

The UE shall:

- 1> for each *drb-Identity* value included in the *drb-ToAddModList* that is part of the current UE configuration (DRB reconfiguration):
 - 2> if *drb-ToAddModListSCG* is not received or does not include the *drb-Identity* value:
 - 3> if the DRB indicated by *drb-Identity* is an MCG DRB or configured with MCG RLC bearer in EN-DC (reconfigure MCG RLC bearer for EN-DC or reconfigure MCG DRB):
 - 4> if the *pdcp-Config* is included:
 - 5> reconfigure the PDCP entity in accordance with the received *pdcp-Config*;
 - 4> if the *rlc-Config* is included:
 - 5> if *reestablishRLC* is received, re-establish the RLC entity of this DRB;
 - 5> reconfigure the RLC entity or entities in accordance with the received *rlc-Config*;
 - 4> if the *logicalChannelConfig* is included:
 - 5> reconfigure the DTCH logical channel in accordance with the received *logicalChannelConfig*;

NOTE: Removal and addition of the same *drb-Identity* in a single *radioResourceConfigDedicated* is not supported. In case *drb-Identity* is removed and added due to handover or re-establishment with the full configuration option, the eNB can use the same value of *drb-Identity*.

[TS 38.331, clause 5.3.5.3]

The UE shall perform the following actions upon reception of the *RRCReconfiguration*:

- 1> if the *RRCReconfiguration* message contains the *radioBearerConfig*:
 - 2> perform the radio bearer configuration according to 5.3.5.6;
- 1> if the *RRCReconfiguration* message includes the *measConfig*:
 - 2> perform the measurement configuration procedure as specified in 5.5.2;
- 1> if the UE is configured with E-UTRA *nr-SecondaryCellGroupConfig* (MCG is E-UTRA):
 - 2> if *RRCReconfiguration* was received via SRB1:
 - 3> construct *RRCReconfigurationComplete* message and submit it via the EUTRA MCG embedded in E-UTRA RRC message *RRCConnectionReconfigurationComplete* as specified in TS 36.331 [10];
 - 3> if *reconfigurationWithSync* was included in *spCellConfig* of an SCG:
 - 4> initiate the random access procedure on the SpCell, as specified in TS 38.321 [3];
 - 2> else (*RRCReconfiguration* was received via SRB3):
 - 3> submit the *RRCReconfigurationComplete* message via SRB3 to lower layers for transmission using the new configuration;

NOTE: In the case of SRB1, the random access is triggered by RRC layer itself as there is not necessarily other UL transmission. In the case of SRB3, the random access is triggered by the MAC layer due to arrival of *RRCReconfigurationComplete*.

- 1> if MAC of an NR cell group successfully completes a random access procedure triggered above;
 - 2> stop timer T304 for that cell group;
 - 2> apply the parts of the CQI reporting configuration, the scheduling request configuration and the sounding RS configuration that do not require the UE to know the SFN of the respective target SpCell, if any;
 - 2> apply the parts of the measurement and the radio resource configuration that require the UE to know the SFN of the respective target SpCell (e.g. measurement gaps, periodic CQI reporting, scheduling request configuration, sounding RS configuration), if any, upon acquiring the SFN of that target SpCell;
 - 2> the procedure ends.

[TS 38.331, clause 5.3.5.6.3]

The UE shall:

- 1> for each *srb-Identity* value included in the *srb-ToAddModList* that is not part of the current UE configuration (SRB establishment or reconfiguration from E-UTRA PDCP to NR PDCP):
 - 2> establish a PDCP entity and configure it with the security algorithms according to *securityConfig* and apply the keys (K_{RRCenc} and K_{RRCint}) associated with the master key ($K_{\text{eNB}}/K_{\text{gNB}}$) or secondary key ($S\text{-}K_{\text{gNB}}$) as indicated in *keyToUse*, if applicable;
 - 2> if the current UE configuration as configured by E-UTRA in TS 36.331 includes an SRB identified with the same *srb-Identity* value:
 - 3> associate the E-UTRA RLC entity and DCCH of this SRB with the NR PDCP entity;
 - 3> release the E-UTRA PDCP entity of this SRB;
 - 2> if the *pdcp-Config* is included:
 - 3> configure the PDCP entity in accordance with the received *pdcp-Config*;
 - 2> else:
 - 3> configure the PDCP entity in accordance with the default configuration defined in 9.2.1 for the corresponding SRB;
- 1> for each *srb-Identity* value included in the *srb-ToAddModList* that is part of the current UE configuration:
 - 2> if the *reestablishPDCP* is set:
 - 3> configure the PDCP entity to apply the integrity protection algorithm and K_{RRCint} key associated with the $K_{\text{eNB}}/S\text{-}K_{\text{gNB}}$ as indicated in *keyToUse*, i.e. the integrity protection configuration shall be applied to all subsequent messages received and sent by the UE, including the message used to indicate the successful completion of the procedure;
 - 3> configure the PDCP entity to apply the ciphering algorithm and K_{RRCenc} key associated with the $K_{\text{eNB}}/S\text{-}K_{\text{gNB}}$ as indicated in *keyToUse*, i.e. the ciphering configuration shall be applied to all subsequent messages received and sent by the UE, including the message used to indicate the successful completion of the procedure;
 - 3> re-establish the PDCP entity of this SRB as specified in 38.323 [5];
 - 2> else, if the *discardOnPDCP* is set:
 - 3> trigger the PDCP entity to perform SDU discard as specified in TS 38.323 [5];
 - 2> if the *pdcp-Config* is included:
 - 3> reconfigure the PDCP entity in accordance with the received *pdcp-Config*.

[TS 38.331, clause 5.3.5.6.5]

The UE shall:

- 1> for each *drb-Identity* value included in the *drb-ToAddModList* that is not part of the current UE configuration (DRB establishment including the case when full configuration option is used):
 - 2> establish a PDCP entity and configure it in accordance with the received *pdcp-Config*;
 - 2> configure the PDCP entity with the ciphering algorithms according to *securityConfig* and apply the K_{UPenc} key associated with the master key (KeNB/KgNB) or the secondary key (S-KgNB) as indicated in *keyToUse*;
 - 2> if the DRB was configured with the same *eps-BearerIdentity* either by NR or E-UTRA prior to receiving this reconfiguration:
 - 3> associate the established DRB with the corresponding *eps-BearerIdentity*;
 - 2> else:
 - 3> indicate the establishment of the DRB(s) and the *eps-BearerIdentity* of the established DRB(s) to upper layers;
- 1> for each *drb-Identity* value included in the *drb-ToAddModList* that is part of the current UE configuration:
 - 2> if the *reestablishPDCP* is set:
 - 3> configure the PDCP entity with the ciphering algorithm and K_{UPenc} key associated with the master or secondary key (KeNB/S-KgNB/KgNB) as indicated in *keyToUse*, i.e. the ciphering configuration shall be applied to all subsequent PDCP PDUs received and sent by the UE;
 - 3> re-establish the PDCP entity of this DRB as specified in 38.323 [5], section 5.1.2;
 - 2> else, if the *recoverPDCP* is set:
 - 3> trigger the PDCP entity of this DRB to perform data recovery as specified in 38.323;
 - 2> if the *pdcp-Config* is included:
 - 3> reconfigure the PDCP entity in accordance with the received *pdcp-Config*.

NOTE 1: Removal and addition of the same *drb-Identity* in a single *radioResourceConfig* is not supported. In case *drb-Identity* is removed and added due to reconfiguration with sync or re-establishment with the full configuration option, the network can use the same value of *drb-Identity*.

NOTE 2: When determining whether a *drb-Identity* value is part of the current UE configuration, the UE does not distinguish which *RadioBearerConfig* and *DRB-ToAddModList* that DRB was originally configured in. To re-associate a DRB with a different key (KeNB to S-KeNB or vice versa), the network provides the *drb-Identity* value in the (target) *drb-ToAddModList* and sets the *reestablishPDCP* flag. The network does not list the *drb-Identity* in the (source) *drb-ToReleaseList*.

NOTE 3: When setting the *reestablishPDCP* flag for a radio bearer, the network ensures that the RLC receiver entities do not deliver old PDCP PDUs to the re-established PDCP entity. It does that e.g. by triggering a reconfiguration with sync of the cell group hosting the old RLC entity or by releasing the old RLC entity.

NOTE 4: In this specification, UE configuration refers to the parameters configured by NR RRC unless otherwise stated.

8.2.2.6.1.3 Test description

8.2.2.6.1.3.1 Pre-test conditions

System Simulator:

- EUTRA Cell 1 is the PCell and NR Cell 1 is the PS Cell.

UE:

- None

Preamble:

- If `pc_IP_Ping` is set to TRUE then, the UE is in state RRC_CONNECTED using generic procedure parameter Connectivity (*E-UTRA/EPC*) established according to TS 38.508-1 [4], clause 4.5.4.
- Else, the UE is in state RRC_CONNECTED using generic procedure parameter Connectivity (*E-UTRA/EPC*) and Test Mode (*On*) associated with UE test loop mode B configured on E-UTRA Cell 1 according to TS 38.508-1 [4], clause 4.5.4.

8.2.2.6.1.3.2 Test procedure sequence

Table 8.2.2.6.1.3.2-1: Main behaviour

St	Procedure	Message Sequence		TP	Verdict
		U - S	Message		
1	The SS transmits an <i>RRCCConnectionReconfiguration</i> message including <i>MobilityControlInfo</i> IE on E-UTRA Cell 1 to reconfigure SRB1 and SRB2 from E-UTRA PDCP to NR PDCP	<--	<i>RRCCConnectionReconfiguration</i>	-	-
2	Check: Does the UE transmit an <i>RRCCConnectionReconfigurationComplete</i> message?	-->	<i>RRCCConnectionReconfigurationComplete</i>	1	P
-	EXCEPTION: Steps 3a1 to 3a2 describe behaviour that depends on the UE implementation; the "lower case letter" identifies a step sequence that take place depending on the UE implementation.	-	-	-	-
3a1	IF <code>pc_IP_Ping</code> = FALSE, then, the SS transmits a CLOSE UE TEST LOOP message.	<--	CLOSE UE TEST LOOP	-	-
3a2	The UE transmits a CLOSE UE TEST LOOP COMPLETE message.	-->	CLOSE UE TEST LOOP COMPLETE		
4	The SS transmits an <i>RRCCConnectionReconfiguration</i> message including <i>MobilityControlInfo</i> IE on E-UTRA Cell 1 to reconfigure MCG DRB from E-UTRA PDCP to NR PDCP?	<--	<i>RRCCConnectionReconfiguration</i>	-	-
5	Check: Does the UE transmit an <i>RRCCConnectionReconfigurationComplete</i> message? NOTE: <i>RRCCConnectionReconfiguration</i> is transmitted using SRB1. This implicitly verifies SRB1 PDCP version change.	-->	<i>RRCCConnectionReconfigurationComplete</i>	1, 2	P
6	Check: Does the test result of generic test procedure in TS 38.508-1 subclause 4.9.1 indicate that the UE is capable of exchanging IP data on MCG DRB using NR radio path?	-	-	2	P
7	The SS transmits an <i>RRCCConnectionReconfiguration</i> message including <i>MobilityControlInfo</i> IE on E-UTRA Cell 1 to reconfigure MCG DRB from NR PDCP to E-UTRA PDCP?	<--	<i>RRCCConnectionReconfiguration</i>	-	-
8	Check: Does the UE transmit an <i>RRCCConnectionReconfigurationComplete</i> message?	-->	<i>RRCCConnectionReconfigurationComplete</i>	3	P
9	Check: Does the test result of generic test procedure in TS 38.508-1 subclause 4.9.1 indicate that the UE is capable of exchanging IP data on MCG DRB using EUTRA radio path?	-	-	3	P
10	The SS transmits an <i>RRCCConnectionReconfiguration</i> message including <i>MobilityControlInfo</i> IE on E-UTRA Cell 1 to	<--	<i>RRCCConnectionReconfiguration</i>	-	-

	reconfigure SRB1 and SRB2 from NR PDCP to E-UTRA PDCP.				
11	Check: Does the UE transmit an <i>RRCCConnectionReconfigurationComplete</i> message?	-->	<i>RRCCConnectionReconfigurationComplete</i>	4	P

8.2.2.6.1.3.3 Specific message contents

Table 8.2.2.6.1.3.3-1: *RRCCConnectionReconfiguration* (step 1, Table 8.2.2.6.1.3.2-1)

Derivation Path: TS 36.508 [7], Table 4.6.1-8 with condition HO			
Information Element	Value/remark	Comment	Condition
<i>RRCCConnectionReconfiguration</i> ::= SEQUENCE {			
criticalExtensions CHOICE {			
c1 CHOICE {			
<i>rrcConnectionReconfiguration-r8</i> SEQUENCE {			
mobilityControlInfo	MobilityControlInfo-HO-SameCell	As per Table 8.2.2.6.1.3.3-2	
nonCriticalExtension SEQUENCE {			
nonCriticalExtension SEQUENCE {			
nonCriticalExtension SEQUENCE {			
nonCriticalExtension SEQUENCE {			
nonCriticalExtension SEQUENCE {			
nonCriticalExtension SEQUENCE {			
nonCriticalExtension SEQUENCE {			
nr-Config-r15	Not present		
nr-RadioBearerConfig1-r15	OCTET STRING containing RadioBearerConfig-MCG-SRB	As per Table 8.2.2.6.1.3.3-3	
}			
}			
}			
}			
}			
}			
}			
}			
}			
}			
}			

Table 8.2.2.6.1.3.3-2: *MobilityControlInfo-HO-SameCell* (Table 8.2.2.6.1.3.3-1)

Derivation Path: TS 36.508 [7], Table 4.6.5-1			
Information Element	Value/remark	Comment	Condition
<i>MobilityControlInfo-HO</i> ::= SEQUENCE {			
targetPhysCellId	PhysicalCellIdentity of E-UTRA Cell 1		
carrierFreq	Not present		
}			

Table 8.2.2.6.1.3.3-3: *RadioBearerConfig-MCG-SRB* (Table 8.2.2.6.1.3.3-1)

Derivation Path: TS 38.508-1 [4], Table 4.6.3-132 with condition SRB_NR_PDCP

Table 8.2.2.6.1.3.3-4: *RRCCConnectionReconfiguration* (step 4, Table 8.2.2.6.1.3.2-1)

Derivation Path: TS 36.508 [7], Table 4.6.1-8 with condition HO

Information Element	Value/remark	Comment	Condition
RRConnectionReconfiguration ::= SEQUENCE {			
criticalExtensions CHOICE {			
c1 CHOICE {			
rrcConnectionReconfiguration-r8 SEQUENCE {			
mobilityControlInfo	MobilityControlInfo-HO-SameCell	As per Table 8.2.2.6.1.3.3-2	
radioResourceConfigDedicated	RadioResourceConfigDedicated-MCG-DRB-NR-PDCP	As per Table 8.2.2.6.1.3.3-5	
nonCriticalExtension SEQUENCE {			
nonCriticalExtension SEQUENCE {			
nonCriticalExtension SEQUENCE {			
nonCriticalExtension SEQUENCE {			
nonCriticalExtension SEQUENCE {			
nonCriticalExtension SEQUENCE {			
nr-Config-r15	Not present		
nr-RadioBearerConfig1-r15	OCTET STRING containing RadioBearerConfig according to TS 38.508-1 [4], Table 4.6.3-132 with conditions MCG_NR_PDCP AND (SRB_NR_PDCP AND Re-establish_PDCP)		
}			
}			
}			
}			
}			
}			
}			
}			
}			

Table 8.2.2.6.1.3.3-5: RadioResourceConfigDedicated-MCG-DRB-NR-PDCP (Table 8.2.2.6.1.3.3-4)

Derivation Path: TS 36.508 [7], Table 4.6.3-19			
Information Element	Value/remark	Comment	Condition
RadioResourceConfigDedicated-MCG-DRB-NR-PDCP ::= SEQUENCE {			
drb-ToAddModList SEQUENCE (SIZE (1..maxDRB)) OF DRB-ToAddMod {	1 entry		
DRB-ToAddMod[1]	DRB-ToAddMod-MCG-DRB-NR-PDCP	entry 1 As per Table 8.2.2.6.1.3.3-6	
}			
drb-ToReleaseList SEQUENCE (SIZE (1..maxDRB)) OF DRB-Identity {	1 entry		
DRB-Identity[1]	Same as the DRB identity associated with the default EPS bearer	entry 1	
}			
physicalConfigDedicated	PhysicalConfigDedicated-DEFAULT with condition RBC-HO		
}			

Table 8.2.2.6.1.3.3-6: DRB-ToAddMod-MCG-DRB-NR-PDCP (Table 8.2.2.6.1.3.3-5)

Derivation Path: TS 36.508 [7], Table 4.8.2.1.7-1			
Information Element	Value/remark	Comment	Condition
DRB-ToAddMod ::= SEQUENCE {			
eps-BearerIdentity	Same as the default EPS bearer Identity		
drb-Identity	Same as the DRB identity associated with the default EPS bearer		
pdcpc-Config	Not present		
}			

Table 8.2.2.6.1.3.3-7: Void

Table 8.2.2.6.1.3.3-8: RRCConnectionReconfiguration (step 7, Table 8.2.2.6.1.3.3-1)

Derivation Path: TS 36.508 [4], Table 4.6.1-8 with condition HO			
Information Element	Value/remark	Comment	Condition
RRCConnectionReconfiguration ::= SEQUENCE {			
criticalExtensions CHOICE {			
c1 CHOICE {			
rrcConnectionReconfiguration-r8 SEQUENCE {			
mobilityControlInfo	MobilityControlInfo-HO-SameCell	As per Table 8.2.2.6.1.3.3-2	
radioResourceConfigDedicated	RadioResourceConfigDedicated-DRB-AddMod	As per Table 8.2.2.6.1.3.3-9	
nonCriticalExtension SEQUENCE {			
nonCriticalExtension SEQUENCE {			
nonCriticalExtension SEQUENCE {			
nonCriticalExtension SEQUENCE {			
nonCriticalExtension SEQUENCE {			
nonCriticalExtension SEQUENCE {			
nonCriticalExtension SEQUENCE {			
nr-Config-r15	Not present		
nr-RadioBearerConfig1-r15	OCTET STRING containing RadioBearerConfig-MCG-DRB-RELEASE	As per Table 8.2.2.6.1.3.3-10	
}			
}			
}			
}			
}			

Table 8.2.2.6.1.3.3-9: RadioResourceConfigDedicated-DRB-AddMod (Table 8.2.2.6.1.3.3-8)

Derivation Path: TS 36.508 [7], Table 4.6.3-17 using DRB configuration from Table 4.8.2.1.7-1 with condition AM			
Information Element	Value/remark	Comment	Condition
RadioResourceConfigDedicated-DRB ::= SEQUENCE {			
drb-ToAddModList SEQUENCE (SIZE (1..maxDRB)) OF DRB-ToAddMod {	1 entry		
DRB-ToAddMod[1] SEQUENCE {		entry 1	

drb-Identity	Same as the DRB associated with the default EPS bearer		
}			
}			
physicalConfigDedicated	PhysicalConfigDedicated-DEFAULT using condition RBC-HO		
}			

Table 8.2.2.6.1.3.3-10 RadioBearerConfig-MCG-DRB-RELEASE (Table 8.2.2.6.1.3.3-8)

Derivation Path: TS 38.508-1 [4], Table 4.6.3-132 with condition SRB_NR_PDCP AND Re-establish_PDCP			
Information Element	Value/remark	Comment	Condition
RadioBearerConfig ::= SEQUENCE {			
drb-ToReleaseList SEQUENCE (SIZE (1.. maxDRB)) OF DRB-Identity {	1 entry		
DRB-Identity[1]	Same as the DRB associated with the default EPS bearer	entry 1	
}			
}			

Table 8.2.2.6.1.3.3-11: RRCConnectionReconfiguration (step 10, Table 8.2.2.6.1.3.2-1)

Derivation Path: TS 36.508 [7], Table 4.6.1-8 with Condition HO			
Information Element	Value/remark	Comment	Condition
RRCConnectionReconfiguration ::= SEQUENCE {			
criticalExtensions CHOICE {			
c1 CHOICE {			
rrcConnectionReconfiguration-r8 SEQUENCE {			
mobilityControlInfo	MobilityControlInfo-HO-SameCell	As per Table 8.2.2.6.1.3.3-2	
radioResourceConfigDedicated	RadioResourceConfigDedicated-SRB-AddMod	As per Table 8.2.2.6.1.3.3-12	
}			
}			
}			
}			

Table 8.2.2.6.1.3.3-12 RadioResourceConfigDedicated-SRB-AddMod (Table 8.2.2.6.1.3.3-11)

Derivation Path: TS 36.508 [7], Table 4.6.3-19			
Information Element	Value/remark	Comment	Condition
RadioResourceConfigDedicated-SRB-AddMod ::= SEQUENCE {	2 entries		
srb-ToAddModList SEQUENCE (SIZE (1..2)) OF SRB-ToAddMod {			
SRB-ToAddMod[1] SEQUENCE {		entry 1	
srb-Identity	Same as the SRB associated with SRB1		
pdcp-verChange-r15	True		
}			
SRB-ToAddMod[2] SEQUENCE {		entry 2	
srb-Identity	Same as the SRB associated with SRB2		
pdcp-verChange-r15	True		
}			
}			
}			

8.2.2.7 Bearer Modification / Handling for bearer type change without security key change

8.2.2.7.1 Bearer Modification / Handling for bearer type change without security key change / EN-DC

8.2.2.7.1.1 Test Purpose (TP)

(1)

```
with { UE in RRC_CONNECTED state with EN-DC, and, MCG(s) (E-UTRA PDCP) and SCG }
ensure that {
  when { UE receives an RRCConnectionReconfiguration message to modify SCG DRB to Split DRB }
  then { UE reconfigures the DRB and sends an RRCConnectionReconfigurationComplete message }
}
```

(2)

```
with { UE in RRC_CONNECTED state with EN-DC, and, MCG(s) (E-UTRA PDCP) and Split }
ensure that {
  when { UE receives an RRCConnectionReconfiguration message to modify Split DRB to MCG DRB (NR PDCP) }
  then { UE reconfigures the DRB and sends an RRCConnectionReconfigurationComplete message }
}
```

(3)

```
with { UE in RRC_CONNECTED state with EN-DC, and, MCG(s) (E-UTRA PDCP) and MCG (NR PDCP) }
ensure that {
  when { UE receives an RRCConnectionReconfiguration message to modify MCG DRB (NR PDCP) to Split DRB }
  then { UE reconfigures the DRB and sends an RRCConnectionReconfigurationComplete message }
}
```

(4)

```
with { UE in RRC_CONNECTED state with EN-DC, and, MCG(s) (E-UTRA PDCP) and Split }
ensure that {
  when { UE receives an RRCConnectionReconfiguration message to modify Split DRB to SCG DRB }
  then { UE reconfigures the DRB and sends an RRCConnectionReconfigurationComplete message }
}
```

(5)

```
with { UE in RRC_CONNECTED state with EN-DC, and, MCG(s) (E-UTRA PDCP) and SCG }
ensure that {
  when { UE receives an RRCConnectionReconfiguration message to modify SCG DRB to MCG DRB (NR PDCP) }
  then { UE reconfigures the DRB and sends an RRCConnectionReconfigurationComplete message }
}
```

(6)

```
with { UE in RRC_CONNECTED state with EN-DC, and, MCG(s) (E-UTRA PDCP) and MCG (NR PDCP) }
ensure that {
  when { UE receives an RRCConnectionReconfiguration message to modify MCG DRB (NR PDCP) to SCG DRB }
  then { UE reconfigures the DRB and sends an RRCConnectionReconfigurationComplete message }
}
```

8.2.2.7.1.2 Conformance requirements

References: The conformance requirements covered in the present TC are specified in TS 36.331, clauses 5.3.5.3 and TS 38.331: 5.3.5.3, 5.3.5.5.1, 5.3.5.6.1 and 5.3.5.6.5. Unless and otherwise stated these are Rel-15 requirements

[TS 36.331, clause 5.3.5.3]

If the *RRCCConnectionReconfiguration* message does not include the *mobilityControlInfo* and the UE is able to comply with the configuration included in this message, the UE shall:

1> if this is the first *RRCCConnectionReconfiguration* message after successful completion of the RRC connection re-establishment procedure:

...

1> else:

2> if the *RRCCConnectionReconfiguration* message includes the *radioResourceConfigDedicated*:

3> perform the radio resource configuration procedure as specified in 5.3.10;

NOTE 3: If the *RRCCConnectionReconfiguration* message includes the establishment of radio bearers other than SRB1, the UE may start using these radio bearers immediately, i.e. there is no need to wait for an outstanding acknowledgment of the *SecurityModeComplete* message.

...

1> if the received *RRCCConnectionReconfiguration* includes the *nr-SecondaryCellGroupConfig*:

2> perform NR RRC Reconfiguration as specified in TS 38.331 [82, 5.3.5.3];

1> if the received *RRCCConnectionReconfiguration* includes the *nr-RadioBearerConfig1*:

2> perform radio bearer configuration as specified in TS 38.331 [82, 5.3.5.6];

1> if the received *RRCCConnectionReconfiguration* includes the *nr-RadioBearerConfig2*:

2> perform radio bearer configuration as specified in TS 38.331 [82, 5.3.5.6];

...

1> set the content of *RRCCConnectionReconfigurationComplete* message as follows:

...

2> if the received *RRCCConnectionReconfiguration* message included *nr-SecondaryCellGroupConfig*:

3> include *scg-ConfigResponseNR* in accordance with TS 38.331 [82, 5.3.5.3];

1> submit the *RRCCConnectionReconfigurationComplete* message to lower layers for transmission using the new configuration, upon which the procedure ends;

[TS 38.331, clause 5.3.5.3]

The UE shall perform the following actions upon reception of the *RRCReconfiguration*:

...

1> if the *RRCReconfiguration* message contains the *radioBearerConfig*:

2> perform the radio bearer configuration according to 5.3.5.6;

...

1> if the UE is configured with E-UTRA *nr-SecondaryCellGroupConfig* (MCG is E-UTRA):

2> if *RRCReconfiguration* was received via SRB1:

3> submit the *RRCReconfigurationComplete* via the EUTRA MCG embedded in E-UTRA RRC message *RRCCConnectionReconfigurationComplete* as specified in TS 36.331 [10];

[TS 38.331, clause 5.3.5.5.1]

The network configures the UE with one Secondary Cell Group (SCG). For EN-DC, the MCG is configured as specified in TS 36.331 [10]. The network provides the configuration parameters for a cell group in the *CellGroupConfig* IE.

The UE performs the following actions based on a received *CellGroupConfig* IE:

- 1> if the *CellGroupConfig* contains the *spCellConfig* with *reconfigurationWithSync*:
 - 2> perform Reconfiguration with sync according to 5.3.5.5.2;
 - 2> resume all suspended radio bearers and resume SCG transmission for all radio bearers, if suspended;
- 1> if the *CellGroupConfig* contains the *rlc-BearerToReleaseList*:
 - 2> perform RLC bearer release as specified in 5.3.5.5.3;
- 1> if the *CellGroupConfig* contains the *rlc-BearerToAddModList*:
 - 2> perform the RLC bearer addition/modification as specified in 5.3.5.5.4;
- 1> if the *CellGroupConfig* contains the *mac-CellGroupConfig*:
 - 2> configure the MAC entity of this cell group as specified in 5.3.5.5.5;
- 1> if the *CellGroupConfig* contains the *sCellToReleaseList*:
 - 2> perform SCell release as specified in 5.3.5.5.8;
- 1> if the *CellGroupConfig* contains the *spCellConfig*:
 - 2> configure the SpCell as specified in 5.3.5.5.7;
- 1> if the *CellGroupConfig* contains the *sCellToAddModList*:
 - 2> perform SCell addition/modification as specified in 5.3.5.5.9

[TS 38.331, clause 5.3.5.6.1]

The UE shall perform the following actions based on a received *RadioBearerConfig* IE:

...

- 1> if the *RadioBearerConfig* includes the *drb-ToReleaseList*:
 - 2> perform DRB release as specified in 5.3.5.6.4;
- 1> if the *RadioBearerConfig* includes the *drb-ToAddModList*:
 - 2> perform DRB addition or reconfiguration as specified in 5.3.5.6.5.

[TS 38.331, clause 5.3.5.6.5]

The UE shall:

- 1> for each *drb-Identity* value included in the *drb-ToAddModList* that is not part of the current UE configuration (DRB establishment including the case when full configuration option is used):
 - 2> establish a PDCP entity and configure it in accordance with the received *pdcp-Config*;
 - 2> configure the PDCP entity with the security algorithms according to *securityConfig* and apply the keys (K_{UPenc}) associated with the $K_{eNB}/S-K_{gNB}$ as indicated in *keyToUse*;
 - 2> if the DRB was configured with the same *eps-BearerIdentity* either by NR or E-UTRA prior to receiving this reconfiguration:
 - 3> associate the established DRB with the corresponding *eps-BearerIdentity*;
 - 2> else:

3> indicate the establishment of the DRB(s) and the *eps-BearerIdentity* of the established DRB(s) to upper layers;

1> for each *drb-Identity* value included in the *drb-ToAddModList* that is part of the current UE configuration:

2> if *reestablishPDCP* is set:

3> configure the PDCP entity of this *RadioBearerConfig* to apply the ciphering algorithm and K_{UPenc} key associated with the $K_{eNB/S-K_{gNB}}$ as indicated in *keyToUse*, i.e. the ciphering configuration shall be applied to all subsequent PDCP PDUs received and sent by the UE;

3> re-establish the PDCP entity of this DRB as specified in 38.323 [5], section 5.1.2;

2> else, if *recoverPDCP* is set:

3> trigger the PDCP entity of this DRB to perform data recovery as specified in 38.323;

2> if the *pdcp-Config* is included:

3> reconfigure the PDCP entity in accordance with the received *pdcp-Config*.

8.2.2.7.1.3 Test description

8.2.2.7.1.3.1 Pre-test conditions

System Simulator:

- E-UTRA Cell 1 is the PCell and NR Cell 1 is the PSCell.

UE:

None.

Preamble:

- If *pc_IP_Ping* is set to TRUE then, the UE is in state *RRC_CONNECTED* using generic procedure parameter *Connectivity (EN-DC)*, Bearers (*MCG(s)* and *SCG*) established according to TS 38.508-1 [4], clause 4.5.4.
- Else, the UE is in state *RRC_CONNECTED* using generic procedure parameter *Connectivity (EN-DC)*, Bearers (*MCG(s)* and *SCG*) established and Test Loop Function (*On*) with UE test loop mode B according to TS 38.508-1 [4], clause 4.5.4.

8.2.2.7.1.3.2 Test procedure sequence

Table 8.2.2.7.1.2-1: Main behaviour

St	Procedure	Message Sequence		TP	Verdict
		U - S	Message		
1	The SS transmits an <i>RRCCConnectionReconfiguration</i> message containing NR <i>RadioBearerConfig</i> to modify SCG DRB to Split DRB.	<--	<i>RRCCConnectionReconfiguration</i>	-	-
2	Check: Does the UE transmit an <i>RRCCConnectionReconfigurationComplete</i> message?	-->	<i>RRCCConnectionReconfigurationComplete</i>	1	P
3	Check: Does the test result of generic test procedure in TS 38.508-1 subclause 4.9.1 indicate that the UE is capable of exchanging IP data on split DRB using NR radio path?	-	-	1	P
4	The SS transmits <i>RRCCConnectionReconfiguration</i> message to modify Split DRB to MCG DRB using NR PDCP.	<--	<i>RRCCConnectionReconfiguration</i>	-	-

5	Check: Does the UE transmit an <i>RRCConnectionReconfigurationComplete</i> message containing NR <i>RRCReconfigurationComplete</i> message?	-->	<i>RRCConnectionReconfigurationComplete</i> (<i>RRCReconfigurationComplete</i>)	2	P
6	Check: Does the test result of generic test procedure in TS 38.508-1 subclause 4.9.1 indicate that the UE is capable of exchanging IP data on MCG DRB?	-	-	2	P
7	The SS transmits an <i>RRCConnectionReconfiguration</i> message containing NR <i>RRCReconfiguration</i> message to modify MCG DRB to Split DRB.	<--	<i>RRCConnectionReconfiguration</i> (<i>RRCReconfiguration</i>)	-	-
8	Check: Does the UE transmit an <i>RRCConnectionReconfigurationComplete</i> message containing NR <i>RRCReconfigurationComplete</i> message?	-->	<i>RRCConnectionReconfigurationComplete</i> (<i>RRCReconfigurationComplete</i>)	3	P
9	Check: Does the test result of generic test procedure in TS 38.508-1 subclause 4.9.1 indicate that the UE is capable of exchanging IP data on split DRB using NR radio path?	-	-	3	P
10	SS transmits <i>RRCConnectionReconfiguration</i> message containing NR <i>RadioBearerConfig</i> to modify Split DRB to SCG DRB.	<--	<i>RRCConnectionReconfiguration</i> (<i>RRCReconfiguration</i>)	-	-
11	Check: Does the UE transmit an <i>RRCConnectionReconfigurationComplete</i> message?	-->	<i>RRCConnectionReconfigurationComplete</i>	4	P
12	Check: Does the test result of generic test procedure in TS 38.508-1 subclause 4.9.1 indicate that the UE is capable of exchanging IP data on SCG DRB?	-	-	4	P
13	SS transmits <i>RRCConnectionReconfiguration</i> message containing NR <i>RRCReconfiguration</i> message to modify SCG DRB to MCG DRB.	<--	<i>RRCConnectionReconfiguration</i> (<i>RRCReconfiguration</i>)	-	-
14	Check: Does the UE transmit an <i>RRCConnectionReconfigurationComplete</i> message containing NR <i>RRCReconfigurationComplete</i> message?	-->	<i>RRCConnectionReconfigurationComplete</i> (<i>RRCReconfigurationComplete</i>)	5	P
15	Check: Does the test result of generic test procedure in TS 38.508-1 subclause 4.9.1 indicate that the UE is capable of exchanging IP data on MCG DRB?	-	-	5	P
16	SS transmits <i>RRCConnectionReconfiguration</i> message containing NR <i>RRCReconfiguration</i> message to modify MCG DRB to SCG DRB.	<--	<i>RRCConnectionReconfiguration</i> (<i>RRCReconfiguration</i>)	-	-
17	Check: Does the UE transmit an <i>RRCConnectionReconfigurationComplete</i> message containing NR <i>RRCReconfigurationComplete</i> message?	-->	<i>RRCConnectionReconfigurationComplete</i> (<i>RRCReconfigurationComplete</i>)	6	P
18	Check: Does the test result of generic test procedure in TS 38.508-1 subclause 4.9.1 indicate that the UE is capable of exchanging IP data on SCG DRB?	-	-	6	P

8.2.2.7.1.3.3 Specific message contents

Table 8.2.2.7.1.3.3-1: *RRCConnectionReconfiguration* (step 1, Table 8.2.2.7.1.3.2-1)

Derivation Path: TS 36.508 [7], Table 4.6.1-8			
Information Element	Value/remark	Comment	Condition
<i>RRCConnectionReconfiguration</i> ::= SEQUENCE {			
<i>criticalExtensions</i> CHOICE {			
c1 CHOICE {			
<i>rrcConnectionReconfiguration-r8</i> SEQUENCE {			
<i>radioResourceConfigDedicated</i>	<i>RadioResourceConfigDedicated-SCG-to-Split</i>		
<i>nonCriticalExtension</i> SEQUENCE {			

RRCConnectionReconfiguration ::= SEQUENCE {			
criticalExtensions CHOICE {			
c1 CHOICE {			
rrcConnectionReconfiguration-r8 SEQUENCE {			
radioResourceConfigDedicated	Not Present		
nonCriticalExtension SEQUENCE {			
nonCriticalExtension SEQUENCE {			
nonCriticalExtension SEQUENCE {			
nonCriticalExtension SEQUENCE {			
nonCriticalExtension SEQUENCE {			
nonCriticalExtension SEQUENCE {			
nr-Config-r15 CHOICE {			
release			
}			
nr-RadioBearerConfig1-r15	OCTET STRING containing RadioBearerConfig-Split- to-MCG		
}			
}			
}			
}			
}			
}			
}			
}			
}			

Table 8.2.2.7.1.3.3-7: Void

Table 8.2.2.7.1.3.3-8: Void

Table 8.2.2.7.1.3.3-9: RadioBearerConfig-Split-to-MCG (step 4, Table 8.2.2.7.1.3.2-1)

Derivation Path: TS 38.508-1 [4], Table 4.6.3-132			
Information Element	Value/remark	Comment	Condition
RadioBearerConfig ::= SEQUENCE {			
drb-ToAddModList SEQUENCE (SIZE (1..maxDRB))	1 entry		
OF DRB-ToAddMod {			
DRB-ToAddMod[1] SEQUENCE {		entry 1	
cnAssociation CHOICE {			
eps-BearerIdentity	6		
}			
drb-Identity	2		
recoverPDCP	true		
pdcpc-Config SEQUENCE {			
Drb	Omit		
moreThanOneRLC	Omit		
t-Reordering	Omit		
cipherringDisabled	Omit		
}			
}			
}			

Table 8.2.2.7.1.3.3-9a: Void

Table 8.2.2.7.1.3.3-10: RRCConnectionReconfiguration (step 7, Table 8.2.2.7.1.3.2-1)

Derivation Path: TS 36.508 [7], Table 4.6.1-8			
Information Element	Value/remark	Comment	Condition
RRCConnectionReconfiguration ::= SEQUENCE {			
criticalExtensions CHOICE {			
c1 CHOICE {			
rrcConnectionReconfiguration-r8 SEQUENCE {			
radioResourceConfigDedicated	Not Present		
nonCriticalExtension SEQUENCE {			
nonCriticalExtension SEQUENCE {			
nonCriticalExtension SEQUENCE {			
nonCriticalExtension SEQUENCE {			
nonCriticalExtension SEQUENCE {			
nonCriticalExtension SEQUENCE {			
nonCriticalExtension SEQUENCE {			
nr-Config-r15 CHOICE {			
setup SEQUENCE {			
nr-SecondaryCellGroupConfig-r15	OCTET STRING containing RRCReconfiguration-MCG-to-Split		
}			
}			
nr-RadioBearerConfig1-r15	OCTET STRING including RadioBearerConfig-MCG-to-Split.		
}			
}			
}			
}			
}			
}			
}			
}			
}			
}			
}			
}			
}			

Table 8.2.2.7.1.3.3-11: RRCReconfiguration-MCG-to-Split (step7, Table 8.2.2.7.1.3.2-1)

Derivation Path: TS 38.508-1 [4], Table 4.6.1-13, condition EN-DC

Table 8.2.2.7.1.3.3-12: Void

Table 8.2.2.7.1.3.3-13: RadioBearerConfig-MCG-to-Split (step 7, Table 8.2.2.7.1.3.2-1)

Derivation Path: TS 38.508-1 [4], Table 4.6.3-132			
Information Element	Value/remark	Comment	Condition
RadioBearerConfig ::= SEQUENCE {			
drb-ToAddModList SEQUENCE (SIZE (1..maxDRB)) OF DRB-ToAddMod {	1 entry		
DRB-ToAddMod[1] SEQUENCE {		entry 1	
cnAssociation CHOICE {			

eps-BearerIdentity	6		
}			
drb-Identity	2		
pdcp-Config	PDCP-Config		
}			
}			
}			

Table 8.2.2.7.1.3.3-14: PDCP-Config (step 7, Table 8.2.2.7.1.3.2-1)

Derivation Path: TS 38.508-1 [4], Table 4.6.3-99			
Information Element	Value/remark	Comment	Condition
PDCP-Config ::= SEQUENCE {			
moreThanOneRLC SEQUENCE {			
primaryPath SEQUENCE {			
cellGroup	1		
}			
ul-DataSplitThreshold	infinity		
}			
}			

Table 8.2.2.7.1.3.3-15: RRCConnectionReconfiguration (step 10, Table 8.2.2.7.1.3.2-1)

Derivation Path: TS 36.508 [7], Table 4.6.1-8			
Information Element	Value/remark	Comment	Condition
RRCConnectionReconfiguration ::= SEQUENCE {			
criticalExtensions CHOICE {			
c1 CHOICE {			
rrcConnectionReconfiguration-r8 SEQUENCE {			
radioResourceConfigDedicated	RadioResourceConfigDe- dedicated-DRB-REL(2)		
nonCriticalExtension SEQUENCE {			
nonCriticalExtension SEQUENCE {			
nonCriticalExtension SEQUENCE {			
nonCriticalExtension SEQUENCE {			
nonCriticalExtension SEQUENCE {			
nonCriticalExtension SEQUENCE {			
nr-RadioBearerConfig1-r15	OCTET STRING including RadioBearerConfig-Split- to-SCG.		
}			
}			
}			
}			
}			
}			
}			
}			
}			

Table 8.2.2.7.1.3.3-16: RadioResourceConfigDedicated-DRB-REL(bid) (step 10, Table 8.2.2.7.1.3.2-1)

Derivation Path: TS 36.508 [7], Table 4.6.3-18C			
Information Element	Value/remark	Comment	Condition
RadioResourceConfigDedicated-DRB-REL(bid) ::= SEQUENCE {		bid is the bearer identity	

drb-ToReleaseList SEQUENCE (SIZE (1..maxDRB)) OF	one entry		
DRB-Identity[1]	2	Split DRB Id	
}			

Table 8.2.2.7.1.3.3-17: RadioBearerConfig-Split-to-SCG (step 10, Table 8.2.2.7.1.3.2-1)

Derivation Path: TS 38.508-1 [4], Table 4.6.3-132			
Information Element	Value/remark	Comment	Condition
RadioBearerConfig ::= SEQUENCE {			
drb-ToAddModList SEQUENCE (SIZE (1..maxDRB)) OF DRB-ToAddMod {	1 entry		
DRB-ToAddMod[1] SEQUENCE {		entry 1	
cnAssociation CHOICE {			
eps-BearerIdentity	6		
}			
drb-Identity	2		
recoverPDCP	true		
pdcop-Config ::= SEQUENCE {			
Drb	Omit		
moreThanOneRLC	Omit		
t-Reordering	Omit		
cipheringDisabled	Omit		
}			
}			
}			
}			

Table 8.2.2.7.1.3.3-18: RRCConnectionReconfiguration (step 13, Table 8.2.2.7.1.3.2-1)

Derivation Path: TS 36.508 [7], Table 4.6.1-8			
Information Element	Value/remark	Comment	Condition
RRCConnectionReconfiguration ::= SEQUENCE {			
criticalExtensions CHOICE {			
c1 CHOICE {			
rrcConnectionReconfiguration-r8 SEQUENCE {			
radioResourceConfigDedicated	<i>RadioResourceConfigDe- dicated-SCG-to-MCG</i>		
nonCriticalExtension SEQUENCE {			
nonCriticalExtension SEQUENCE {			
nonCriticalExtension SEQUENCE {			
nonCriticalExtension SEQUENCE {			
nonCriticalExtension SEQUENCE {			
nonCriticalExtension SEQUENCE {			
nonCriticalExtension SEQUENCE {			
nr-Config-r15 CHOICE {			
release			
}			
nr-RadioBearerConfig1-r15	OCTET STRING including <i>RadioBearerConfig-SCG- to-MCG.</i>		
}			
}			
}			
}			
}			
}			
}			
}			
}			
}			

}			
}			

Table 8.2.2.7.1.3.3-19: RadioResourceConfigDedicated-SCG-to-MCG (step 13, Table 8.2.2.7.1.3.2-1)

Derivation Path: TS 36.508 [7], Table 4.6.3-27			
Information Element	Value/remark	Comment	Condition
RadioResourceConfigDedicated-DRB ::= SEQUENCE {			
drb-ToAddModList	DRB-ToAddModList-SCG-to-MCG		
}			

Table 8.2.2.7.1.3.3-20: DRB-ToAddModList-SCG-to-MCG (step 13, Table 8.2.2.7.1.3.2-1)

Derivation Path: 36.508 [7], Table 4.6.3-2A			
Information Element	Value/remark	Comment	Condition
DRB-ToAddModList ::= SEQUENCE (SIZE (1..maxDRB)) OF DRB-ToAddMod {	1 Entry		
DRB-ToAddMod[1] SEQUENCE {		entry 1	
eps-BearerIdentity	6		
drb-Identity	2		
}			
}			

Table 8.2.2.2.4.3.3-21: Void

Table 8.2.2.7.1.3.3-22: Void

Table 8.2.2.7.1.3.3-23: RadioBearerConfig-SCG-to-MCG (step 13, Table 8.2.2.7.1.3.2-1)

Derivation Path: TS 38.508-1 [4], Table 4.6.3-132 with condition EN-DC_DRB AND Recover_PDCP

Table 8.2.2.7.1.3.3-24: RRCConnectionReconfiguration (step 16, Table 8.2.2.7.1.3.2-1)

Derivation Path: TS 36.508 [7], Table 4.6.1-8			
Information Element	Value/remark	Comment	Condition
RRCConnectionReconfiguration ::= SEQUENCE {			
criticalExtensions CHOICE {			
c1 CHOICE {			
rrcConnectionReconfiguration-r8 SEQUENCE {			
radioResourceConfigDedicated	RadioResourceConfigDedicated-DRB-REL(2)		
nonCriticalExtension SEQUENCE {			
nonCriticalExtension SEQUENCE {			
nonCriticalExtension SEQUENCE {			
nonCriticalExtension SEQUENCE {			
nonCriticalExtension SEQUENCE {			
nonCriticalExtension SEQUENCE {			
nonCriticalExtension SEQUENCE {			
nr-Config-r15 CHOICE {			
setup SEQUENCE {			
nr-SecondaryCellGroupConfig-r15	OCTET STRING containing RRCReconfiguration-MCG-to-SCG		

RRCConnectionReconfigurationComplete ::= SEQUENCE {			
criticalExtensions CHOICE {			
rrcConnectionReconfigurationComplete-r8 SEQUENCE {			
nonCriticalExtension SEQUENCE {			
nonCriticalExtension SEQUENCE {			
nonCriticalExtension SEQUENCE {			
nonCriticalExtension SEQUENCE {			
nonCriticalExtension SEQUENCE {			
nonCriticalExtension SEQUENCE {			
scg-ConfigResponseNR-r15	Present		
}			
}			
}			
}			
}			
}			
}			
}			
}			
}			
}			

8.2.2.7.2 Bearer Modification / Handling for bearer type change without security key change / NR-DC

8.2.2.7.2.1 Test Purpose (TP)

(1)

```
with { UE in NR RRC_CONNECTED state with NR-DC with SCG }
ensure that {
  when { UE receives an RRCReconfiguration message to modify SCG DRB to Split DRB }
  then { UE reconfigures the DRB and sends an RRCReconfigurationComplete message }
}
```

(2)

```
with { UE in NR RRC_CONNECTED state with NR-DC with Split DRB }
ensure that {
  when { UE receives an RRCReconfiguration message to modify Split DRB to MCG DRB }
  then { UE reconfigures the DRB and sends an RRCReconfigurationComplete message }
}
```

(3)

```
with { UE in NR RRC_CONNECTED state with NR-DC and MCG DRB }
ensure that {
  when { UE receives an RRCReconfiguration message to modify MCG DRB to Split DRB }
  then { UE reconfigures the DRB and sends an RRCReconfigurationComplete message }
}
```

(4)

```
with { UE in NR RRC_CONNECTED state with NR-DC with Split DRB }
ensure that {
  when { UE receives an RRCReconfiguration message to modify Split DRB to SCG DRB }
  then { UE reconfigures the DRB and sends an RRCReconfigurationComplete message }
}
```

(5)

```
with { UE in NR RRC_CONNECTED state with NR-DC with SCG }
ensure that {
  when { UE receives an RRCReconfiguration message to modify SCG DRB to MCG DRB }
  then { UE reconfigures the DRB and sends an RRCReconfigurationComplete message }
}
```

(6)

```

with { UE in NR RRC_CONNECTED state with NR-DC and MCG DRB }
ensure that {
  when { UE receives an RRCReconfiguration message to modify MCG DRB to SCG DRB }
  then { UE reconfigures the DRB and sends an RRCReconfigurationComplete message }
}

```

8.2.2.7.2.2 Conformance requirements

References: The conformance requirements covered in the present TC are specified in TS 38.331: 5.3.5.3, 5.3.5.5.7 and 5.3.5.6.5. Unless and otherwise stated these are Rel-15 requirements

[TS 38.331, clause 5.3.5.3]

The UE shall perform the following actions upon reception of the *RRCReconfiguration*:

...

1> if the *RRCReconfiguration* message contains the *radioBearerConfig*:

2> perform the radio bearer configuration according to 5.3.5.6;

...

1> set the content of the *RRCReconfigurationComplete* message as follows:

2> if the *RRCReconfiguration* message includes the *mrdc-SecondaryCellGroupConfig* with *mrdc-SecondaryCellGroup* set to *nr-SCG*:

3> include in the *nr-SCG-Response* the *RRCReconfigurationComplete* message;

...

1> if the UE is configured with E-UTRA *nr-SecondaryCellGroupConfig* (MCG is E-UTRA):

2> if *RRCReconfiguration* was received via SRB1:

3> submit the *RRCReconfigurationComplete* via the EUTRA MCG embedded in E-UTRA RRC message *RRCConnectionReconfigurationComplete* as specified in TS 36.331 [10];

[TS 38.331, clause 5.3.5.5.7]

The UE shall:

1> if the *SpCellConfig* contains the *rlf-TimersAndConstants*:

2> configure the RLF timers and constants for this cell group as specified in 5.3.5.5.6;

1> else if *rlf-TimersAndConstants* is not configured for this cell group:

2> if any DAPS bearer is configured:

3> use values for timers T301, T310, T311 and constants N310, N311 for the target cell group, as included in *ue-TimersAndConstants* received in *SIB1*;

2> else

3> use values for timers T301, T310, T311 and constants N310, N311, as included in *ue-TimersAndConstants* received in *SIB1*;

1> if the *SpCellConfig* contains *spCellConfigDedicated*:

2> configure the SpCell in accordance with the *spCellConfigDedicated*;

2> consider the bandwidth part indicated in *firstActiveUplinkBWP-Id* if configured to be the active uplink bandwidth part;

- 2> consider the bandwidth part indicated in *firstActiveDownlinkBWP-Id* if configured to be the active downlink bandwidth part;
- 2> if any of the reference signal(s) that are used for radio link monitoring are reconfigured by the received *spCellConfigDedicated*:
 - 3> stop timer T310 for the corresponding SpCell, if running;
 - 3> stop timer T312 for the corresponding SpCell, if running;
 - 3> reset the counters N310 and N311.

[TS 38.331, clause 5.3.5.6.5]

The UE shall:

- 1> for each *drb-Identity* value included in the *drb-ToAddModList* that is not part of the current UE configuration (DRB establishment including the case when full configuration option is used):
 - 2> establish a PDCP entity and configure it in accordance with the received *pdcp-Config*;
 - 2> configure the PDCP entity with the security algorithms according to *securityConfig* and apply the keys (K_{UPenc}) associated with the $K_{eNB}/S-K_{gNB}$ as indicated in *keyToUse*;
 - 2> if the DRB was configured with the same *eps-BearerIdentity* either by NR or E-UTRA prior to receiving this reconfiguration:
 - 3> associate the established DRB with the corresponding *eps-BearerIdentity*;
 - 2> else:
 - 3> indicate the establishment of the DRB(s) and the *eps-BearerIdentity* of the established DRB(s) to upper layers;
- 1> for each *drb-Identity* value included in the *drb-ToAddModList* that is part of the current UE configuration:
 - 2> if *reestablishPDCP* is set:
 - 3> configure the PDCP entity of this *RadioBearerConfig* to apply the ciphering algorithm and K_{UPenc} key associated with the $K_{eNB}/S-K_{gNB}$ as indicated in *keyToUse*, i.e. the ciphering configuration shall be applied to all subsequent PDCP PDUs received and sent by the UE;
 - 3> re-establish the PDCP entity of this DRB as specified in 38.323 [5], section 5.1.2;
 - 2> else, if *recoverPDCP* is set:
 - 3> trigger the PDCP entity of this DRB to perform data recovery as specified in 38.323;
 - 2> if the *pdcp-Config* is included:
 - 3> reconfigure the PDCP entity in accordance with the received *pdcp-Config*.

8.2.2.7.2.3 Test description

8.2.2.7.2.3.1 Pre-test conditions

System Simulator:

- NR Cell 1 is the PCell and NR Cell 10 is the PSCell.
- System information combination NR-4 as defined in TS 38.508-1 [4] clause 4.4.3.1.3 is used in NR cells.

UE:

None.

Preamble:

- If *pc_IP_Ping* is set to TRUE then, the UE is in state NR RRC_CONNECTED using generic procedure parameter Connectivity (*NR-DC*), Bearers (*MCG(s) and SCG*) established according to TS 38.508-1 [4], clause 4.5.4.
- Else, the UE is in state NR RRC_CONNECTED using generic procedure parameter Connectivity (*NR-DC*), Bearers (*MCG(s) and SCG*) established and Test Loop Function (*On*) with UE test loop mode B according to TS 38.508-1 [4], clause 4.5.4.

8.2.2.7.2.3.2- Test procedure sequence

Table 8.2.2.7.2.3.2-1: Main behaviour

St	Procedure	Message Sequence		TP	Verdict
		U – S	Message		
1	The SS transmits an <i>RRCReconfiguration</i> message containing NR RadioBearerConfig to modify SCG DRB to Split DRB.	<--	<i>RRCReconfiguration</i>	-	-
2	Check: Does the UE transmit an <i>RRCReconfigurationComplete</i> message including <i>nr-SCG-Response</i> ?	-->	<i>RRCReconfigurationComplete</i>	1	P
3	Check: Does the test result of generic test procedure in TS 38.508-1 subclause 4.9.1 indicate that the UE is capable of exchanging IP data on split DRB on PSCell?	-	-	1	P
4	The SS transmits <i>RRCReconfiguration</i> message to modify Split DRB to MCG DRB.	<--	<i>RRCReconfiguration</i>	-	-
5	Check: Does the UE transmit an <i>RRCReconfigurationComplete</i> message?	-->	<i>RRCReconfigurationComplete</i>	2	P
6	Check: Does the test result of generic test procedure in TS 38.508-1 subclause 4.9.1 indicate that the UE is capable of exchanging IP data on MCG DRB?	-	-	2	P
7	The SS transmits an <i>RRCReconfiguration</i> message to modify MCG DRB to Split DRB.	<--	<i>RRCReconfiguration</i>	-	-
8	Check: Does the UE transmit an <i>RRCReconfigurationComplete</i> message including <i>nr-SCG-Response</i> ?	-->	<i>RRCReconfigurationComplete</i>	3	P
9	Check: Does the test result of generic test procedure in TS 38.508-1 subclause 4.9.1 indicate that the UE is capable of exchanging IP data on split DRB on PCell?	-	-	3	P
10	SS transmits <i>RRCReconfiguration</i> message containing NR RadioBearerConfig to modify Split DRB to SCG DRB.	<--	<i>RRCReconfiguration</i>	-	-
11	Check: Does the UE transmit an <i>RRCReconfigurationComplete</i> message?	-->	<i>RRCReconfigurationComplete</i>	4	P
12	Check: Does the test result of generic test procedure in TS 38.508-1 subclause 4.9.1 indicate that the UE is capable of exchanging IP data on SCG DRB?	-	-	4	P
13	SS transmits <i>RRCReconfiguration</i> message to modify SCG DRB to MCG DRB.	<--	<i>RRCReconfiguration</i>	-	-
14	Check: Does the UE transmit an <i>RRCReconfigurationComplete</i> message?	-->	<i>RRCReconfigurationComplete</i>	5	P
15	Check: Does the test result of generic test procedure in TS 38.508-1 subclause 4.9.1 indicate that the UE is capable of exchanging IP data on MCG DRB?	-	-	5	P
16	SS transmits <i>RRCReconfiguration</i> message to modify MCG DRB to SCG DRB.	<--	<i>RRCReconfiguration</i>	-	-
17	Check: Does the UE transmit an <i>RRCReconfigurationComplete</i> message including <i>nr-SCG-Response</i> ?	-->	<i>RRCReconfigurationComplete</i>	6	P

18	Check: Does the test result of generic test procedure in TS 38.508-1 subclause 4.9.1 indicate that the UE is capable of exchanging IP data on SCG DRB?	-	-	6	P
----	--	---	---	---	---

8.2.2.7.2.3.3 Specific message contents

Table 8.2.2.7.2.3.3-1: RRCReconfiguration (step 1, Table 8.2.2.7.2.3.2-1)

Derivation Path: TS 38.508-1 [4], Table 4.6.1-13			
Information Element	Value/remark	Comment	Condition
RRCReconfiguration ::= SEQUENCE {			
criticalExtensions CHOICE {			
rrcReconfiguration SEQUENCE {			
nonCriticalExtension SEQUENCE {			
nonCriticalExtension SEQUENCE {			
masterCellGroup	CellGroupConfig	See Table 8.2.2.7.2.3.3-2	
nonCriticalExtension SEQUENCE {			
mrdc-SecondaryCellGroupConfig CHOICE {			
setup SEQUENCE {			
mrdc-SecondaryCellGroup CHOICE {			
nr-SCG	OCTET STRING (CONTAINING RRCReconfiguration)	See Table 8.2.2.7.2.3.3-3	
}			
}			
}			
radioBearerConfig2	RadioBearerConfig	See Table 8.2.2.7.2.3.3-5	
}			
}			
}			
}			

Table 8.2.2.7.2.3.3-2: CellGroupConfig (Table 8.2.2.7.2.3.3-1)

Derivation Path: TS 38.508-1, Table 4.6.3-19			
Information Element	Value/remark	Comment	Condition
CellGroupConfig ::= SEQUENCE {			
rlc-BearerToAddModList SEQUENCE (SIZE(1..maxLC-ID)) OF RLC-BearerConfig {	1 entry		
RLC-BearerConfig[1]	RLC-BearerConfig as per TS 38.508-1[4] Table 4.6.3-148: RLC-BearerConfig with conditions AM and DRBm and Re-establish_RLC	entry 1 DRBm is allocated for SCG according to internal TTCN mapping	
}			
}			

Table 8.2.2.7.2.3.3-3: RRCReconfiguration (Table 8.2.2.7.2.3.3-1)

Derivation Path: TS 38.508-1 [4], Table 4.6.1-13			
Information Element	Value/remark	Comment	Condition
RRCReconfiguration ::= SEQUENCE {			
secondaryCellGroup	CellGroupConfig	See Table 8.2.2.7.2.3.3-4	
}			

Table 8.2.2.7.2.3.3-4: CellGroupConfig (Table 8.2.2.7.2.3.3-3)

Derivation Path: TS 38.508-1, Table 4.6.3-19			
Information Element	Value/remark	Comment	Condition
CellGroupConfig ::= SEQUENCE {			
rlc-BearerToAddModList SEQUENCE {	1 entry		
(SIZE(1..maxLC-ID)) OF RLC-BearerConfig {			
RLC-BearerConfig[1]	RLC-BearerConfig as per TS 38.508-1[4] Table 4.6.3-148: <i>RLC-BearerConfig</i> with conditions AM and DRBm and Re-establish_RLC	entry 1 DRBm is allocated for SCG according to internal TTCN mapping	
}			
}			

Table 8.2.2.7.2.3.3-5: RadioBearerConfig (Table 8.2.2.7.2.3.3-1)

Derivation Path: TS 38.508-1 [4], Table 4.6.3-132 with condition DRBm			
Information Element	Value/remark	Comment	Condition
RadioBearerConfig ::= SEQUENCE {			
drb-ToAddModList SEQUENCE (SIZE (1..maxDRB))	1 entry		
OF {			
DRB-ToAddMod[1] SEQUENCE {		entry 1	
drb-Identity	DRB-Identity using condition DRBm	DRBm is allocated for SCG according to internal TTCN mapping	
recoverPDCP	Not present		
pdcp-Config	PDCP-Config	See Table 8.2.2.7.2.3.3-6	
}			
}			
securityConfig	Not present		
}			

Table 8.2.2.7.2.3.3-6: PDCP-Config (Table 8.2.2.7.2.3.3-5)

Derivation Path: TS 38.508-1 [4], Table 4.6.3-99 with condition Split			
Information Element	Value/remark	Comment	Condition
PDCP-Config ::= SEQUENCE {			
moreThanOneRLC SEQUENCE {			
primaryPath SEQUENCE {			
cellGroup	1		
}			
}			
}			

Table 8.2.2.7.2.3.3-7: RRCReconfiguration (step 4, Table 8.2.2.7.2.3.2-1)

Derivation Path: TS 38.508-1 [4], Table 4.6.1-13			
Information Element	Value/remark	Comment	Condition
RRCReconfiguration ::= SEQUENCE {			
criticalExtensions CHOICE {			
rrcReconfiguration SEQUENCE {			
nonCriticalExtension SEQUENCE {			
nonCriticalExtension SEQUENCE {			
nonCriticalExtension SEQUENCE {			
mrdc-SecondaryCellGroupConfig CHOICE {			

Release			
}			
radioBearerConfig2	RadioBearerConfig	See Table 8.2.2.7.2.3.3-8	
}			
}			
}			
}			
}			

Table 8.2.2.7.2.3.3-8: RadioBearerConfig (Table 8.2.2.7.2.3.3-7)

Derivation Path: TS 38.508-1 [4], Table 4.6.3-132 with condition DRBm			
Information Element	Value/remark	Comment	Condition
RadioBearerConfig ::= SEQUENCE {			
drb-ToAddModList SEQUENCE (SIZE (1..maxDRB))	1 entry		
OF {			
DRB-ToAddMod[1] SEQUENCE {		entry 1	
drb-Identity	DRB-Identity using condition DRBm	DRBm is allocated for SCG according to internal TTCN mapping	
recoverPDCP	true		
}			
}			
securityConfig	Not present		
}			

Table 8.2.2.7.2.3.3-9: RRCReconfiguration (step 7, Table 8.2.2.7.2.3.2-1)

Derivation Path: TS 38.508-1 [4], Table 4.6.1-13			
Information Element	Value/remark	Comment	Condition
RRCReconfiguration ::= SEQUENCE {			
criticalExtensions CHOICE {			
rrcReconfiguration SEQUENCE {			
nonCriticalExtension SEQUENCE {			
nonCriticalExtension SEQUENCE {			
nonCriticalExtension SEQUENCE {			
mrdc-SecondaryCellGroupConfig CHOICE {			
nr-SCG	OCTET STRING (CONTAINING RRCReconfiguration)	See Table 8.2.2.7.2.3.3-10	
}			
}			
radioBearerConfig2	RadioBearerConfig	See Table 8.2.2.7.2.3.3-12	
}			
}			
}			

Table 8.2.2.7.2.3.3-10: RRCReconfiguration (Table 8.2.2.7.2.3.3-9)

Derivation Path: TS 38.508-1 [4], Table 4.6.1-13			
Information Element	Value/remark	Comment	Condition
RRCReconfiguration ::= SEQUENCE {			
secondaryCellGroup	CellGroupConfig	See Table 8.2.2.7.2.3.3-11	
}			

Table 8.2.2.7.2.3.3-11: CellGroupConfig (Table 8.2.2.7.2.3.3-10)

Derivation Path: TS 38.508-1, Table 4.6.3-19 with condition NR-DC_SCG			
Information Element	Value/remark	Comment	Condition
CellGroupConfig ::= SEQUENCE {			
rlc-BearerToAddModList SEQUENCE (SIZE(1..maxLC-ID)) OF RLC-BearerConfig {	1 entry		
RLC-BearerConfig[1]	RLC-BearerConfig as per TS 38.508-1[4] Table 4.6.3-148: RLC-BearerConfig with conditions AM and DRBm	entry 1 DRBm is allocated according to internal TTCN mapping	
}			
}			

Table 8.2.2.7.2.3.3-12: RadioBearerConfig (Table 8.2.2.7.2.3.3-9)

Derivation Path: TS 38.508-1 [4], Table 4.6.3-132 with condition DRBm			
Information Element	Value/remark	Comment	Condition
RadioBearerConfig ::= SEQUENCE {			
drb-ToAddModList SEQUENCE (SIZE (1..maxRB)) OF DRB-ToAddMod {	1 entry		
DRB-ToAddMod[1] SEQUENCE {			
cnAssociation CHOICE {			
sdap-Config	SDAP-Config		
}			
drb-Identity	DRB-Identity using condition DRBm		
recoverPDCP	true		
pdcpc-Config	PDCP-Config as per TS 38.508-1[4] Table 4.6.3-99 with condition Split		
}			
}			
securityConfig	Not present		
}			

Table 8.2.2.7.2.3.3-13: RRCReconfiguration (step 10, Table 8.2.2.7.2.3.2-1)

Derivation Path: TS 38.508-1 [4], Table 4.6.1-13			
Information Element	Value/remark	Comment	Condition
RRCReconfiguration ::= SEQUENCE {			
criticalExtensions CHOICE {			
rrcReconfiguration SEQUENCE {			
nonCriticalExtension SEQUENCE {			
nonCriticalExtension SEQUENCE {			
masterCellGroup	CellGroupConfig	See Table 8.2.2.7.2.3.3-14	
nonCriticalExtension SEQUENCE {			
radioBearerConfig2	RadioBearerConfig	See Table 8.2.2.7.2.3.3-15	
}			
}			
}			
}			
}			
}			

Table 8.2.2.7.2.3.3-14: CellGroupConfig (Table 8.2.2.7.2.3.3-13)

Derivation Path: TS 38.508-1, table 4.6.3-19			
Information Element	Value/remark	Comment	Condition

CellGroupConfig ::= SEQUENCE {			
rlc-BearerToReleaseList SEQUENCE			
(SIZE(1..maxLC-ID)) OF LogicalChannelIdentity {			
LogicalChannelIdentity[1]	Logical ChannelID of DRBm		
}			
}			

Table 8.2.2.7.2.3.3-15: RadioBearerConfig (Table 8.2.2.7.2.3.3-13)

Derivation Path: TS 38.508-1 [4], Table 4.6.3-132 with condition DRBm			
Information Element	Value/remark	Comment	Condition
RadioBearerConfig ::= SEQUENCE {			
drb-ToAddModList SEQUENCE (SIZE (1..maxDRB))	1 entry		
OF {			
DRB-ToAddMod[1] SEQUENCE {		entry 1	
drb-Identity	DRB-Identity using condition DRBm	DRBm is allocated for SCG according to internal TTCN mapping	
recoverPDCP	True		
}			
}			
securityConfig	Not present		
}			

Table 8.2.2.7.2.3.3-16: RRCReconfiguration (step 13, Table 8.2.2.7.2.3.2-1)

Derivation Path: TS 38.508-1 [4], Table 4.6.1-13			
Information Element	Value/remark	Comment	Condition
RRCReconfiguration ::= SEQUENCE {			
criticalExtensions CHOICE {			
rrcReconfiguration SEQUENCE {			
nonCriticalExtension SEQUENCE {			
masterCellGroup	CellGroupConfig	See Table 8.2.2.7.2.3.3-17	
nonCriticalExtension SEQUENCE {			
nonCriticalExtension SEQUENCE {			
mrdc-SecondaryCellGroupConfig CHOICE {			
Release			
}			
radioBearerConfig2	RadioBearerConfig	See Table 8.2.2.7.2.3.3-18	
}			
}			
}			
}			
}			
}			
}			
}			

Table 8.2.2.7.2.3.3-17: CellGroupConfig (Table 8.2.2.7.2.3.3-16)

Derivation Path: TS 38.508-1, table 4.6.3-19			
Information Element	Value/remark	Comment	Condition
CellGroupConfig ::= SEQUENCE {			
rlc-BearerToAddModList SEQUENCE	1 entry		
(SIZE(1..maxLC-ID)) OF RLC-BearerConfig {			
RLC-BearerConfig[1]	RLC-BearerConfig as per TS 38.508-1[4] Table 4.6.3-148: <i>RLC-BearerConfig</i> with conditions DRBn	DRBn is allocated according to internal TTCN mapping	

}			
}			

Table 8.2.2.7.2.3.3-18: RadioBearerConfig (Table 8.2.2.7.2.3.3-16)

Derivation Path: TS 38.508-1 [4], Table 4.6.3-132 with condition DRBm			
Information Element	Value/remark	Comment	Condition
RadioBearerConfig ::= SEQUENCE {			
drb-ToAddModList SEQUENCE (SIZE (1..maxDRB))	1 entry		
OF {			
DRB-ToAddMod[1] SEQUENCE {		entry 1	
drb-Identity	DRB-Identity using condition DRBm	DRBm is allocated for SCG according to internal TTCN mapping	
recoverPDCP	True		
}			
}			
securityConfig	Not present		
}			

Table 8.2.2.7.2.3.3-19: RRCReconfiguration (step 16, Table 8.2.2.7.2.3.2-1)

Derivation Path: TS 38.508-1 [4], Table 4.6.1-13			
Information Element	Value/remark	Comment	Condition
RRCReconfiguration ::= SEQUENCE {			
criticalExtensions CHOICE {			
rrcReconfiguration SEQUENCE {			
nonCriticalExtension SEQUENCE {			
masterCellGroup	CellGroupConfig	See Table 8.2.2.7.2.3.3-20	
nonCriticalExtension SEQUENCE {			
nonCriticalExtension SEQUENCE {			
mrdc-SecondaryCellGroupConfig CHOICE {			
nr-SCG	OCTET STRING (CONTAINING RRCReconfiguration)	See Table 8.2.2.7.2.3.3-21	
}			
radioBearerConfig2	RadioBearerConfig	See Table 8.2.2.7.2.3.3-23	
}			
}			
}			

Table 8.2.2.7.2.3.3-20: CellGroupConfig (Table 8.2.2.7.2.3.3-19)

Derivation Path: TS 38.508-1, table 4.6.3-19			
Information Element	Value/remark	Comment	Condition
CellGroupConfig ::= SEQUENCE {			
rlc-BearerToReleaseList SEQUENCE (SIZE(1..maxLC-ID)) OF LogicalChannelIdentity {			
LogicalChannelIdentity[1]	Logical ChannelID of DRBm		
}			
}			

Table 8.2.2.7.2.3.3-21: RRCReconfiguration (Table 8.2.2.7.2.3.3-19)

Derivation Path: TS 38.508-1 [4], Table 4.6.1-13			
Information Element	Value/remark	Comment	Condition
RRCReconfiguration ::= SEQUENCE {			
secondaryCellGroup	CellGroupConfig	See Table 8.2.2.7.2.3.3-22	
}			

Table 8.2.2.7.2.3.3-22: CellGroupConfig (Table 8.2.2.7.2.3.3-21)

Derivation Path: TS 38.508-1, table 4.6.3-19 with condition NR-DC_SCG			
Information Element	Value/remark	Comment	Condition
CellGroupConfig ::= SEQUENCE {			
rlc-BearerToAddModList SEQUENCE (SIZE(1..maxLC-ID)) OF RLC-BearerConfig {			
RLC-BearerConfig[1]	RLC-BearerConfig as per TS 38.508-1[4] Table 4.6.3-148: <i>RLC-BearerConfig</i> with conditions AM and DRBm	entry 1 DRBn is allocated according to internal TTCN mapping	
}			
}			

Table 8.2.2.7.2.3.3-23: RadioBearerConfig (Table 8.2.2.7.2.3.3-19)

Derivation Path: TS 38.508-1 [4], Table 4.6.3-132 with condition DRBm			
Information Element	Value/remark	Comment	Condition
RadioBearerConfig ::= SEQUENCE {			
drb-ToAddModList SEQUENCE (SIZE (1..maxDRB)) OF {	1 entry		
DRB-ToAddMod[1] SEQUENCE {		entry 1	
drb-Identity	DRB-Identity using condition DRBm	DRBm is allocated for SCG according to internal TTCN mapping	
recoverPDCP	True		
}			
}			
securityConfig	Not present		
}			

Table 8.2.2.7.2.3.3-24: RRCReconfigurationComplete (step 2, 8 and 17, Table 8.2.2.7.2.3.2-1)

Derivation Path: TS 38.508-1 [4], Table 4.6.1-14 with condition NR-DC

8.2.2.7.3 Bearer Modification / Handling for bearer type change without security key change / NE-DC

8.2.2.7.3.1 Test Purpose (TP)

(1)

```
with { UE in NR RRC_CONNECTED state with NE-DC with SCG }
ensure that {
  when { UE receives an RRCReconfiguration message to modify SCG DRB to Split DRB }
  then { UE reconfigures the DRB and sends an RRCReconfigurationComplete message }
}
```

(2)

```

with { UE in NR RRC_CONNECTED state with NE-DC with Split DRB }
ensure that {
  when { UE receives an RRCReconfiguration message to modify Split DRB to MCG DRB }
  then { UE reconfigures the DRB and sends an RRCReconfigurationComplete message }
}

```

(3)

```

with { UE in NR RRC_CONNECTED state with NE-DC and MCG DRB }
ensure that {
  when { UE receives an RRCReconfiguration message to modify MCG DRB to Split DRB }
  then { UE reconfigures the DRB and sends an RRCReconfigurationComplete message }
}

```

(4)

```

with { UE in NR RRC_CONNECTED state with NE-DC with Split DRB }
ensure that {
  when { UE receives an RRCReconfiguration message to modify Split DRB to SCG DRB }
  then { UE reconfigures the DRB and sends an RRCReconfigurationComplete message }
}

```

(5)

```

with { UE in NR RRC_CONNECTED state with NE-DC with SCG }
ensure that {
  when { UE receives an RRCReconfiguration message to modify SCG DRB to MCG DRB }
  then { UE reconfigures the DRB and sends an RRCReconfigurationComplete message }
}

```

(6)

```

with { UE in NR RRC_CONNECTED state with NE-DC and MCG DRB }
ensure that {
  when { UE receives an RRCReconfiguration message to modify MCG DRB to SCG DRB }
  then { UE reconfigures the DRB and sends an RRCReconfigurationComplete message }
}

```

8.2.2.7.3.2 Conformance requirements

References: The conformance requirements covered in the present TC are specified in: TS 38.331, clause 5.3.5.3 and TS 36.331 clauses 5.3.5.3 and 5.3.10.3a1. Unless and otherwise stated these are Rel-15 requirements

[TS 38.331, clause 5.3.5.3]

The UE shall perform the following actions upon reception of the RRCReconfiguration, or upon execution of the conditional reconfiguration (CHO, CPA or CPC):

...

1> if the *RRCReconfiguration* includes the *mrdc-SecondaryCellGroupConfig*:

2> if the *mrdc-SecondaryCellGroupConfig* is set to *setup*:

3> if the *mrdc-SecondaryCellGroupConfig* includes *mrdc-ReleaseAndAdd*:

4> perform MR-DC release as specified in clause 5.3.5.10;

3> if the received *mrdc-SecondaryCellGroup* is set to *nr-SCG*:

4> perform the RRC reconfiguration according to 5.3.5.3 for the *RRCReconfiguration* message included in *nr-SCG*;

3> if the received *mrdc-SecondaryCellGroup* is set to *eutra-SCG*:

4> perform the RRC connection reconfiguration as specified in TS 36.331 [10], clause 5.3.5.3 for the *RRCConnectionReconfiguration* message included in *eutra-SCG*;

- 2> else (*mrdc-SecondaryCellGroupConfig* is set to *release*):
 - 3> perform MR-DC release as specified in clause 5.3.5.10;

...

- 1> set the content of the *RRCReconfigurationComplete* message as follows:

...

- 2> if the *RRCReconfiguration* message includes the *mrdc-SecondaryCellGroupConfig* with *mrdc-SecondaryCellGroup* set to *eutra-SCG*:
 - 3> include in the *eutra-SCG-Response* the *E-UTRA RRCConnectionReconfigurationComplete* message in accordance with TS 36.331 [10] clause 5.3.5.3;

[TS 36.331, clause 5.3.5.3]

If the *RRCConnectionReconfiguration* message does not include the *mobilityControlInfo* and the UE is able to comply with the configuration included in this message, the UE shall:

...

- 1> if the UE is configured with NE-DC:
 - 2> if the received *RRCConnectionReconfiguration* message was included in an NR *RRCResume* message:
 - 3> transfer the *RRCConnectionReconfigurationComplete* message via SRB1 embedded in NR RRC message *RRCResumeComplete* as specified in TS 38.331 [82], clause 5.3.13.4;
 - 2> else:
 - 3> transfer the *RRCConnectionReconfigurationComplete* message via SRB1 embedded in NR RRC message *RRCReconfigurationComplete* as specified in TS 38.331 [82], clause 5.3.5.3;
- 1> else:
 - 2> submit the *RRCConnectionReconfigurationComplete* message to lower layers for transmission using the new configuration, upon which the procedure ends;

[TS 36.331, clause 5.3.10.3a1]

For the *drb-Identity* value for which this procedure is initiated, the UE shall:

- 1> if *drb-ToAddModListSCG* is received and includes the *drb-Identity* value; and *drb-Identity* value is not part of the current UE configuration (i.e. DC specific DRB establishment):
 - 2> if *drb-ToAddModList* is received and includes the *drb-Identity* value (i.e. add split DRB):
 - 3> establish a PDCP entity and configure it with the current MCG security configuration and in accordance with the *pdcp-Config* included in *drb-ToAddModList*;
 - 3> establish an MCG RLC entity and an MCG DTCH logical channel in accordance with the *rlc-Config*, *logicalChannelIdentity* and *logicalChannelConfig* included in *drb-ToAddModList*;
 - 3> establish an SCG RLC entity and an SCG DTCH logical channel in accordance with the *rlc-ConfigSCG*, *logicalChannelIdentitySCG* and *logicalChannelConfigSCG* included in *drb-ToAddModListSCG*;
 - 2> else (i.e. add SCG DRB):
 - 3> establish a PDCP entity and configure it with the current SCG security configuration and in accordance with the *pdcp-Config* included in *drb-ToAddModListSCG*;
 - 3> establish a primary SCG RLC entity or entities and a primary SCG DTCH logical channel in accordance with the *rlc-ConfigSCG*, *logicalChannelIdentitySCG* and *logicalChannelConfigSCG* included in *drb-ToAddModListSCG*;

- 3> if *rlc-BearerConfigSecondary* is included with value *setup*;
 - 4> establish a secondary SCG RLC entity or entities and an associated DTCH logical channel in accordance with the received *rlc-BearerConfigSecondary* and associate these with the E-UTRA PDCP entity with the same value of *srb-Identity* within the current UE configuration;
- 2> indicate the establishment of the DRB(s) and the *eps-BearerIdentity* of the established DRB(s) to upper layers;
- 1> else (i.e. DC specific DRB modification; *drb-ToAddModList* and/ or *drb-ToAddModListSCG* received):
 - 2> if the DRB indicated by *drb-Identity* is a split DRB:
 - 3> if *drb-ToAddModList* is received and includes the *drb-Identity* value, while for this entry *drb-TypeChange* is included and set to *toMCG* (i.e. split to MCG):
 - 4> release the SCG RLC entity or entities and the SCG DTCH logical channel(s);
 - 4> reconfigure the PDCP entity in accordance with the *pdcp-Config*, if included in *drb-ToAddModList*;
 - 4> reconfigure the primary MCG RLC entity and/ or the primary MCG DTCH logical channel in accordance with the *rlc-Config* and *logicalChannelConfig*, if included in *drb-ToAddModList*;
 - 4> if *rlc-BearerConfigSecondary* is included with value *setup*;
 - 5> establish a secondary MCG RLC entity or entities and an associated DTCH logical channel in accordance with the received *rlc-BearerConfigSecondary* and associate these with the E-UTRA PDCP entity with the same value of *srb-Identity* within the current UE configuration;
 - 3> else (i.e. reconfigure split):
 - 4> reconfigure the PDCP entity in accordance with the *pdcp-Config*, if included in *drb-ToAddModList*;
 - 4> reconfigure the MCG RLC entity and/ or the MCG DTCH logical channel in accordance with the *rlc-Config* and *logicalChannelConfig*, if included in *drb-ToAddModList*;
 - 4> reconfigure the SCG RLC entity and/ or the SCG DTCH logical channel in accordance with the *rlc-ConfigSCG* and *logicalChannelConfigSCG*, if included in *drb-ToAddModListSCG*;
 - 2> if the DRB indicated by *drb-Identity* is an SCG DRB:
 - 3> if *drb-ToAddModList* is received and includes the *drb-Identity* value, while for this entry *drb-TypeChange* is included and set to *toMCG* (i.e. SCG to MCG):
 - 4> reconfigure the PDCP entity with the current MCG security configuration and in accordance with the *pdcp-Config*, if included in *drb-ToAddModList*;
 - 4> reconfigure the SCG RLC entity or entities (both primary and secondary, if configured) and the SCG DTCH logical channel (both primary and secondary, if configured) to be an MCG RLC entity or entities and an MCG DTCH logical channel;
 - 4> reconfigure the primary MCG RLC entity or entities and/ or the primary MCG DTCH logical channel in accordance with the *rlc-Config*, *logicalChannelIdentity* and *logicalChannelConfig*, if included in *drb-ToAddModList*;
 - 4> if *rlc-BearerConfigSecondary* is included with value *release*:
 - 5> release the secondary MCG RLC entity or entities as well as the associated DTCH logical channel;
 - 4> if *rlc-BearerConfigSecondary* is included with value *setup*;
 - 5> if the current DRB configuration does not include a secondary RLC bearer:
 - 6> establish a secondary MCG RLC entity or entities and an associated DTCH logical channel in accordance with the received *rlc-BearerConfigSecondary* and associate these with the E-UTRA PDCP entity with the same value of *srb-Identity* within the current UE configuration;

- 5> else:
 - 6> reconfigure the secondary MCG RLC entity or entities and the associated DTCH logical channel in accordance with the received *rlc-BearerConfigSecondary*;
- 3> else (i.e. *drb-ToAddModListSCG* is received and includes the *drb-Identity* value i.e. reconfigure SCG):
 - 4> reconfigure the PDCP entity in accordance with the *pdcp-Config*, if included in *drb-ToAddModListSCG*;
 - 4> reconfigure the primary SCG RLC entity or entities and/ or the primary SCG DTCH logical channel in accordance with the *rlc-ConfigSCG* and *logicalChannelConfigSCG*, if included in *drb-ToAddModListSCG*;
 - 4> if *rlc-BearerConfigSecondary* is included with value *release*:
 - 5> release the secondary SCG RLC entity or entities as well as the associated DTCH logical channel;
 - 4> if *rlc-BearerConfigSecondary* is included with value *setup*:
 - 5> if the current DRB configuration does not include a secondary RLC bearer:
 - 6> establish a secondary SCG RLC entity or entities and an associated DTCH logical channel in accordance with the received *rlc-BearerConfigSecondary* and associate these with the E-UTRA PDCP entity with the same value of *srb-Identity* within the current UE configuration;
 - 5> else:
 - 6> reconfigure the secondary SCG RLC entity or entities and the associated DTCH logical channel in accordance with the received *rlc-BearerConfigSecondary*;
- 2> if the DRB indicated by *drb-Identity* is an MCG DRB:
 - 3> if *drb-ToAddModListSCG* is received and includes the *drb-Identity* value, while for this entry *drb-Type* is included and set to *split* (i.e. MCG to split):
 - 4> reconfigure the PDCP entity in accordance with the *pdcp-Config*, if included in *drb-ToAddModList*;
 - 4> reconfigure the primary MCG RLC entity and/ or the primary MCG DTCH logical channel in accordance with the *rlc-Config* and *logicalChannelConfig*, if included in *drb-ToAddModList*;
 - 4> if *rlc-BearerConfigSecondary* is included with value *release*:
 - 5> release the secondary MCG RLC entity or entities as well as the associated DTCH logical channel;
 - 4> establish an SCG RLC entity and an SCG DTCH logical channel in accordance with the *rlc-ConfigSCG*, *logicalChannelIdentitySCG* and *logicalChannelConfigSCG*, included in *drb-ToAddModListSCG*;
 - 3> else (i.e. *drb-Type* is included and set to *scg* i.e. MCG to SCG):
 - 4> reconfigure the PDCP entity with the current SCG security configuration and in accordance with the *pdcp-Config*, if included in *drb-ToAddModListSCG*;
 - 4> reconfigure the MCG RLC entity or entities (both primary and secondary, if configured) and the MCG DTCH logical channel (both primary and secondary, if configured) to be an SCG RLC entity or entities and an SCG DTCH logical channel;
 - 4> reconfigure the primary SCG RLC entity or entities and/ or the primary SCG DTCH logical channel in accordance with the *rlc-ConfigSCG*, *logicalChannelIdentitySCG* and *logicalChannelConfigSCG*, if included in *drb-ToAddModListSCG*;
 - 4> if *rlc-BearerConfigSecondary* is included with value *release*:
 - 5> release the secondary SCG RLC entity or entities as well as the associated DTCH logical channel;
 - 4> if *rlc-BearerConfigSecondary* is included with value *setup*;

5> if the current DRB configuration does not include a secondary RLC bearer:

6> establish a secondary SCG RLC entity or entities and an associated DTCH logical channel in accordance with the received *rlc-BearerConfigSecondary* and associate these with the E-UTRA PDCP entity with the same value of *srb-Identity* within the current UE configuration;

5> else:

6> reconfigure the secondary SCG RLC entity or entities and the associated DTCH logical channel in accordance with the received *rlc-BearerConfigSecondary*;

8.2.2.7.3.3 Test description

8.2.2.7.3.3.1 Pre-test conditions

System Simulator:

- NR Cell 1 is the PCell and E-UTRA Cell 1 is the PSCell.

UE:

None.

Preamble:

- If *pc_IP_Ping* is set to TRUE then, the UE is in state RRC_CONNECTED using generic procedure parameter Connectivity (NE-DC), Bearers (MCG(s) and SCG) established according to TS 38.508-1 [4], clause 4.5.4.
- Else, the UE is in state RRC_CONNECTED using generic procedure parameter Connectivity (NE-DC), Bearers (MCG(s) and SCG) established and Test Loop Function (On) with UE test loop mode B according to TS 38.508-1 [4], clause 4.5.4.

8.2.2.7.3.3.2 Test procedure sequence

Table 8.2.2.7.3.2-1: Main behaviour

St	Procedure	Message Sequence		TP	Verdict
		U - S	Message		
1	The SS transmits an <i>RRCReconfiguration</i> message containing NR RadioBearerConfig to modify SCG DRB to Split DRB.	<--	<i>RRCReconfiguration</i>	-	-
2	Check: Does the UE transmit an <i>RRCReconfigurationComplete</i> message?	-->	<i>RRCReconfigurationComplete</i>	1	P
3	Check: Does the test result of generic test procedure in TS 38.508-1 subclause 4.9.1 indicate that the UE is capable of exchanging IP data on split DRB using E-UTRA radio path?	-	-	1	P
4	The SS transmits <i>RRCReconfiguration</i> message to modify Split DRB to MCG DRB using NR PDCP.	<--	<i>RRCReconfiguration</i>	-	-
5	Check: Does the UE transmit an <i>RRCReconfigurationComplete</i> message containing E-UTRA <i>RRCCConnectionReconfigurationComplete</i> message?	-->	<i>RRCReconfigurationComplete</i> (<i>RRCCConnectionReconfigurationComplete</i>)	2	P
6	Check: Does the test result of generic test procedure in TS 38.508-1 subclause 4.9.1 indicate that the UE is capable of exchanging IP data on MCG DRB?	-	-	2	P
7	The SS transmits an <i>RRCReconfiguration</i> message containing E-UTRA <i>RRCCConnectionReconfiguration</i> message to modify MCG DRB to Split DRB.	<--	<i>RRCReconfiguration</i> (<i>RRCCConnectionReconfiguration</i>)	-	-

8	Check: Does the UE transmit an <i>RRCReconfigurationComplete</i> message containing E-UTRA <i>RRCConnectionReconfigurationComplete</i> message?	-->	<i>RRCReconfigurationComplete</i> (<i>RRCConnectionReconfigurationComplete</i>)	3	P
9	Check: Does the test result of generic test procedure in TS 38.508-1 subclause 4.9.1 indicate that the UE is capable of exchanging IP data on split DRB using E-UTRA radio path?	-	-	3	P
10	SS transmits <i>RRCReconfiguration</i> message containing E-UTRA RadioBearerConfig to modify Split DRB to SCG DRB.	<--	<i>RRCReconfiguration</i> (<i>RRCConnectionReconfiguration</i>)	-	-
11	Check: Does the UE transmit an <i>RRCReconfigurationComplete</i> message?	-->	<i>RRCReconfigurationComplete</i>	4	P
12	Check: Does the test result of generic test procedure in TS 38.508-1 subclause 4.9.1 indicate that the UE is capable of exchanging IP data on SCG DRB?	-	-	4	P
13	SS transmits <i>RRCReconfiguration</i> message containing NR <i>RRCConnectionReconfiguration</i> message to modify SCG DRB to MCG DRB.	<--	<i>RRCReconfiguration</i> (<i>RRCConnectionReconfiguration</i>)	-	-
14	Check: Does the UE transmit an <i>RRCReconfigurationComplete</i> message containing E-UTRA <i>RRCConnectionReconfigurationComplete</i> message?	-->	<i>RRCReconfigurationComplete</i> (<i>RRCConnectionReconfigurationComplete</i>)	5	P
15	Check: Does the test result of generic test procedure in TS 38.508-1 subclause 4.9.1 indicate that the UE is capable of exchanging IP data on MCG DRB?	-	-	5	P
16	SS transmits <i>RRCReconfiguration</i> message containing E-UTRA <i>RRCConnectionReconfiguration</i> message to modify MCG DRB to SCG DRB.	<--	<i>RRCReconfiguration</i> (<i>RRCConnectionReconfiguration</i>)	-	-
17	Check: Does the UE transmit an <i>RRCReconfigurationComplete</i> message containing E-UTRA <i>RRCConnectionReconfigurationComplete</i> message?	-->	<i>RRCReconfigurationComplete</i> (<i>RRCConnectionReconfigurationComplete</i>)	6	P
18	Check: Does the test result of generic test procedure in TS 38.508-1 subclause 4.9.1 indicate that the UE is capable of exchanging IP data on SCG DRB?	-	-	6	P

8.2.2.7.3.3.3 Specific message contents

FFS

8.2.2.8 Bearer Modification / Handling for bearer type change with security key change

8.2.2.8.1 Bearer Modification / Handling for bearer type change with security key change / EN-DC

8.2.2.8.1.1 Test Purpose (TP)

(1)

```
with { UE in RRC_CONNECTED state with EN-DC, and, MCG(s) (E-UTRA PDCP) and SCG }
ensure that {
  when { UE receives an RRCConnectionReconfiguration message to modify the SN terminated SCG DRB to
  MN terminated SCG DRB with security key change to keNB }
  then { UE reconfigures the DRB and sends an RRCConnectionReconfigurationComplete message }
```

```
    }
```

(2)

```
with { UE in RRC_CONNECTED state with EN-DC, and, MCG(s) (E-UTRA PDCP) and MN terminated SCG DRB
established with security key keNB }
ensure that {
  when { UE receives an RRCConnectionReconfiguration message to modify the MN terminated SCG DRB to
SN terminated Split DRB with security key change to s-KgNB }
  then { UE reconfigures the DRB and sends an RRCConnectionReconfigurationComplete message }
}
```

(3)

```
with { UE in RRC_CONNECTED state with EN-DC, and, MCG(s) (E-UTRA PDCP) and SN terminated Split DRB
established with security key s-KgNB }
ensure that {
  when { UE receives an RRCConnectionReconfiguration message to modify the SN terminated Split DRB
to MN terminated Split DRB with security key change to keNB }
  then { UE reconfigures the DRB and sends an RRCConnectionReconfigurationComplete message }
}
```

(4)

```
with { UE in RRC_CONNECTED state with EN-DC, and, MCG(s) (E-UTRA PDCP) and MN terminated Split DRB
established with security key keNB }
ensure that {
  when { UE receives an RRCConnectionReconfiguration message to modify the MN terminated Split DRB
to SN terminated MCG DRB (NR PDCP) with security key change to s-KgNB }
  then { UE reconfigures the DRB and sends an RRCConnectionReconfigurationComplete message }
}
```

(5)

```
with { UE in RRC_CONNECTED state with EN-DC, and, MCG(s) (E-UTRA PDCP) and SN terminated MCG DRB (NR
PDCP) established with security key s-KgNB }
ensure that {
  when { UE receives an RRCConnectionReconfiguration message to modify the SN terminated MCG DRB (NR
PDCP) to MN terminated MCG DRB (NR PDCP) with security key change to keNB }
  then { UE reconfigures the DRB and sends an RRCConnectionReconfigurationComplete message }
}
```

(6)

```
with { UE in RRC_CONNECTED state with EN-DC, and, MCG(s) (E-UTRA PDCP) and MN terminated MCG DRB (NR
PDCP) established with security key keNB }
ensure that {
  when { UE receives an RRCConnectionReconfiguration message to modify the MN terminated MCG DRB (NR
PDCP) to SN terminated Split DRB with security key change to s-KgNB }
  then { UE reconfigures the DRB and sends an RRCConnectionReconfigurationComplete message }
}
```

(7)

```
with { UE in RRC_CONNECTED state with EN-DC, and, MCG(s) (E-UTRA PDCP) and SN terminated Split DRB
established with security key s-KgNB }
ensure that {
  when { UE receives an RRCConnectionReconfiguration message to modify the SN terminated Split DRB
to MN terminated SCG DRB with security key change to keNB }
  then { UE reconfigures the DRB and sends an RRCConnectionReconfigurationComplete message }
}
```

(8)

```
with { UE in RRC_CONNECTED state with EN-DC, and, MCG(s) (E-UTRA PDCP) and MN terminated SCG DRB
established with security key keNB }
ensure that {
  when { UE receives an RRCConnectionReconfiguration message to modify the MN terminated SCG DRB to
SN terminated MCG DRB (NR PDCP) with security key change to s-KgNB }
  then { UE reconfigures the DRB and sends an RRCConnectionReconfigurationComplete message }
}
```

(9)

```

with { UE in RRC_CONNECTED state with EN-DC, and, MCG(s) (E-UTRA PDCP) and SN terminated MCG DRB (NR
PDCP) established with security key s-KgNB }
ensure that {
  when { UE receives an RRCConnectionReconfiguration message to modify the SN terminated MCG DRB (NR
PDCP) to MN terminated SCG DRB with security key change to keNB }
  then { UE reconfigures the DRB and sends an RRCConnectionReconfigurationComplete message }
}

```

8.2.2.8.1.2 Conformance requirements

References: The conformance requirements covered in the present test case are specified in: TS 36.331, clause 5.3.5.3, TS 38.331, clauses 5.3.5.3, 5.3.5.6.1 and 5.3.5.6.5, TS 37.340, clause Annex A: Table A-1: L2 handling for bearer type change with and without security key change. Unless otherwise stated these are Rel-15 requirements.

[TS 36.331, clause 5.3.5.3]

If the *RRCCConnectionReconfiguration* message does not include the *mobilityControlInfo* and the UE is able to comply with the configuration included in this message, the UE shall:

...

- 1> if the received *RRCCConnectionReconfiguration* includes the *nr-Config* and it is set to *release*: or
- 1> if the received *RRCCConnectionReconfiguration* includes *endc-ReleaseAndAdd* and it is set to *TRUE*:
 - 2> perform ENDC release as specified in TS38.331 [82], clause 5.3.5.10;
- 1> if the received *RRCCConnectionReconfiguration* includes the *sk-Counter*:
 - 2> perform key update procedure as specified in TS 38.331 [82], clause 5.3.5.7;
- 1> if the received *RRCCConnectionReconfiguration* includes the *nr-SecondaryCellGroupConfig*:
 - 2> perform NR RRC Reconfiguration as specified in TS 38.331 [82], clause 5.3.5.3;
- 1> if the received *RRCCConnectionReconfiguration* includes the *nr-RadioBearerConfig1*:
 - 2> perform radio bearer configuration as specified in TS 38.331 [82], clause 5.3.5.6;
- 1> if the received *RRCCConnectionReconfiguration* includes the *nr-RadioBearerConfig2*:
 - 2> perform radio bearer configuration as specified in TS 38.331 [82], clause 5.3.5.6;
- 1> if this is the first *RRCCConnectionReconfiguration* message after successful completion of the RRC connection re-establishment procedure:
 - 2> resume SRB2 and all DRBs that are suspended, if any, including RBs configured with NR PDCP;

NOTE 4: The handling of the radio bearers after the successful completion of the PDCP re-establishment, e.g. the re-transmission of unacknowledged PDCP SDUs (as well as the associated status reporting), the handling of the SN and the HFN, is specified in TS 36.323 [8].

NOTE 5: The UE may discard SRB2 messages and data that it receives prior to completing the reconfiguration used to resume these bearers.

...

- 1> set the content of *RRCCConnectionReconfigurationComplete* message as follows:
 - 2> if the *RRCCConnectionReconfiguration* message includes *perCC-GapIndicationRequest*:
 - 3> include *perCC-GapIndicationList* and *numFreqEffective*;
 - 2> if the frequencies are configured for reduced measurement performance:
 - 3> include *numFreqEffectiveReduced*;

- 2> if the received *RRCConnectionReconfiguration* message included *nr-SecondaryCellGroupConfig*:
 - 3> include *scg-ConfigResponseNR* in accordance with TS 38.331 [82], clause 5.3.5.3;
- 1> submit the *RRCConnectionReconfigurationComplete* message to lower layers for transmission using the new configuration, upon which the procedure ends;

[TS 38.331, clause 5.3.5.3]

The UE shall perform the following actions upon reception of the *RRCReconfiguration*:

...

- 1> if the *RRCReconfiguration* includes the *secondaryCellGroup*:
 - 2> perform the cell group configuration for the SCG according to 5.3.5.5;
- 1> if the *RRCReconfiguration* message contains the *radioBearerConfig*:
 - 2> perform the radio bearer configuration according to 5.3.5.6;
- 1> if the *RRCReconfiguration* message includes the *measConfig*:
 - 2> perform the measurement configuration procedure as specified in 5.5.2;
- ...
- 1> set the content of *RRCReconfigurationComplete* message as follows:
 - 2> if the *RRCReconfiguration* includes the *masterCellGroup* containing the *reportUplinkTxDirectCurrent*, or;
 - 2> if the *RRCReconfiguration* includes the *secondaryCellGroup* containing the *reportUplinkTxDirectCurrent*:
 - 3> include the *uplinkTxDirectCurrentList*;
- 1> if the UE is configured with E-UTRA *nr-SecondaryCellGroupConfig* (MCG is E-UTRA):
 - 2> if *RRCReconfiguration* was received via SRB1:
 - 3> construct *RRCReconfigurationComplete* message and submit it via the EUTRA MCG embedded in E-UTRA RRC message *RRCConnectionReconfigurationComplete* as specified in TS 36.331 [10];
 - 3> if *reconfigurationWithSync* was included in *spCellConfig* of an SCG:
 - 4> initiate the random access procedure on the SpCell, as specified in TS 38.321 [3];
 - 3> else:
 - 4> the procedure ends;
 - NOTE: The order the UE sends the *RRCConnectionReconfigurationComplete* message and performs the Random Access procedure towards the SCG is left to UE implementation.
 - 2> else (*RRCReconfiguration* was received via SRB3):
 - 3> submit the *RRCReconfigurationComplete* message via SRB3 to lower layers for transmission using the new configuration .

NOTE: For EN-DC, in the case *RRCReconfiguration* is received via SRB1, the random access is triggered by RRC layer itself as there is not necessarily other UL transmission. In the case *RRCReconfiguration* is received via SRB3, the random access is triggered by the MAC layer due to arrival of *RRCReconfigurationComplete*.

- 1> else:

- 2> submit the *RRCReconfigurationComplete* message via SRB1 to lower layers for transmission using the new configuration;
- 2> if this is the first *RRCReconfiguration* message after successful completion of the RRC re-establishment procedure:
 - 3> resume SRB2 and DRBs that are suspended;
- 1> if *reconfigurationWithSync* was included in *spCellConfig* of an MCG or SCG, and when MAC of an NR cell group successfully completes a random access procedure triggered above;
 - 2> stop timer T304 for that cell group;
 - 2> apply the parts of the CQI reporting configuration, the scheduling request configuration and the sounding RS configuration that do not require the UE to know the SFN of the respective target SpCell, if any;
 - 2> apply the parts of the measurement and the radio resource configuration that require the UE to know the SFN of the respective target SpCell (e.g. measurement gaps, periodic CQI reporting, scheduling request configuration, sounding RS configuration), if any, upon acquiring the SFN of that target SpCell;
 - 2> if the *reconfigurationWithSync* was included in *spCellConfig* of an MCG:
 - 3> if T390 is running:
 - 4> stop timer T390 for all access categories;
 - 4> perform the actions as specified in 5.3.14.4.
 - 3> if *RRCReconfiguration* does not include *dedicatedSIB1-Delivery* and
 - 3> if the active downlink BWP, which is indicated by the *firstActiveDownlinkBWP-Id* for the target SpCell of the MCG, has a common search space configured by *searchSpaceSIB1*:
 - 4> acquire the *SIB1*, which is scheduled as specified in TS 38.213 [13], of the target SpCell of the MCG;
 - 4> upon acquiring *SIB1*, perform the actions specified in clause 5.2.2.4.2;
 - 2> the procedure ends.

NOTE: The UE is only required to acquire broadcasted *SIB1* if the UE can acquire it without disrupting unicast data reception, i.e. the broadcast and unicast beams are quasi co-located.

[TS 38.331, clause 5.3.5.6.1]

The UE shall perform the following actions based on a received *RadioBearerConfig* IE:

...

- 1> if the *RadioBearerConfig* includes the *drb-ToAddModList*:
 - 2> perform DRB addition or reconfiguration as specified in 5.3.5.6.5.

[TS 38.331, clause 5.3.5.6.5]

The UE shall:

- 1> for each *drb-Identity* value included in the *drb-ToAddModList* that is not part of the current UE configuration (DRB establishment including the case when full configuration option is used):
 - 2> establish a PDCP entity and configure it in accordance with the received *pdcp-Config*;
 - 2> if the PDCP entity of this DRB is not configured with *cipheringDisabled*:
 - 3> if target RAT of handover is E-UTRA/5GC, or;
 - 3> if the UE is only connected to E-UTRA/5GC:

- 4> configure the PDCP entity with the ciphering algorithm and K_{UPenc} key configured/derived as specified in TS 36.331 [10];
- 3> else:
 - 4> configure the PDCP entity with the ciphering algorithms according to *securityConfig* and apply the K_{UPenc} key associated with the master key (K_{eNB}/K_{gNB}) or the secondary key ($S-K_{gNB}$) as indicated in *keyToUse*;
- 2> if the PDCP entity of this DRB is configured with *integrityProtection*:
 - 3> configure the PDCP entity with the integrity algorithms according to *securityConfig* and apply the K_{UPint} key associated with the master (K_{eNB}/K_{gNB}) or the secondary key ($S-K_{gNB}$) as indicated in *keyToUse*;
- ...
- 2> if the UE is operating in EN-DC:
 - 3> if the DRB was configured with the same *eps-BearerIdentity* either by NR or E-UTRA prior to receiving this reconfiguration:
 - 4> associate the established DRB with the corresponding *eps-BearerIdentity*;
 - 3> else:
 - 4> indicate the establishment of the DRB(s) and the *eps-BearerIdentity* of the established DRB(s) to upper layers;
- 1> for each *drb-Identity* value included in the *drb-ToAddModList* that is part of the current UE configuration:
 - 2> if the *reestablishPDCP* is set:
 - 3> if target RAT is E-UTRA/5GC, or:
 - 3> if the UE is only connected to E-UTRA/5GC:
 - 4> if the PDCP entity of this DRB is not configured with *cipheringDisabled*:
 - 5> configure the PDCP entity with the ciphering algorithm and K_{UPenc} key configured/derived as specified in TS 36.331 [10, 5.4.2.3], i.e. the ciphering configuration shall be applied to all subsequent PDCP PDUs received and sent by the UE;
 - 3> else:
 - 4> if the PDCP entity of this DRB is not configured with *cipheringDisabled*:
 - 5> configure the PDCP entity with the ciphering algorithm and K_{UPenc} key associated with the master key (K_{eNB}/K_{gNB}) or the secondary key ($S-K_{gNB}$), as indicated in *keyToUse*, i.e. the ciphering configuration shall be applied to all subsequent PDCP PDUs received and sent by the UE;
 - 4> if the PDCP entity of this DRB is configured with *integrityProtection*:
 - 5> configure the PDCP entity with the integrity algorithms according to *securityConfig* and apply the K_{UPint} key associated with the master (K_{eNB}/K_{gNB}) or the secondary key ($S-K_{gNB}$) as indicated in *keyToUse*;
 - 3> re-establish the PDCP entity of this DRB as specified in 38.323 [5], clause 5.1.2;
 - 2> else, if the *recoverPDCP* is set:
 - 3> trigger the PDCP entity of this DRB to perform data recovery as specified in 38.323 [5];
 - 2> if the *pdcp-Config* is included:
 - 3> reconfigure the PDCP entity in accordance with the received *pdcp-Config*.
- ...

NOTE 1: Void.

NOTE 2: When determining whether a drb-Identity value is part of the current UE configuration, the UE does not distinguish which *RadioBearerConfig* and *DRB-ToAddModList* that DRB was originally configured in. To re-associate a DRB with a different key (K_{eNB} to S-K_{eNB} or vice versa), the network provides the *drb-Identity* value in the (target) *drb-ToAddModList* and sets the *reestablishPDCP* flag. The network does not list the *drb-Identity* in the (source) *drb-ToReleaseList*.

NOTE 3: When setting the *reestablishPDCP* flag for a radio bearer, the network ensures that the RLC receiver entities do not deliver old PDCP PDUs to the re-established PDCP entity. It does that e.g. by triggering a reconfiguration with sync of the cell group hosting the old RLC entity or by releasing the old RLC entity.

NOTE 4: In this specification, UE configuration refers to the parameters configured by NR RRC unless otherwise stated.

NOTE 5: Ciphering and integrity protection can be enabled or disabled for a DRB. The enabling/disabling of ciphering or integrity protection can be changed only by releasing and adding the DRB.

[TS 37.340, Annex A]

This subclause provides for information an overview on L2 handling for bearer type change in EN-DC, with and without security key change (from K_{eNB} to S-K_{gNB} and from S-K_{gNB} to K_{eNB}), i.e. with and without a change of the termination point.

Table A-1: L2 handling for bearer type change with and without security key change

Bearer type change from row to col	MCG		Split		SCG	
	no key change	with key change (K _{eNB} <-> S-K _{gNB})	no key change	with key change (K _{eNB} <-> S-K _{gNB})	no key change	with key change (K _{eNB} <-> S-K _{gNB})
MCG	N/A	PDCP: Re-establish MCG RLC: See Note 1 MCG MAC: See Note 1 SCG RLC: No action SCG MAC: No action	PDCP: Reconfigure MCG RLC: No action MCG MAC: No action SCG RLC: Establish SCG MAC: Reconfigure	PDCP: Re-establish MCG RLC: See Note 1 MCG MAC: See Note 1 SCG RLC: Establish SCG MAC: Reconfigure	PDCP: Recovery MCG RLC: See Note 3 MCG MAC: Reconfigure SCG RLC: Establish SCG MAC: Reconfigure	PDCP: Re-establish MCG RLC: See Note 3 MCG MAC: Reconfigure SCG RLC: Establish SCG MAC: Reconfigure
Split	PDCP: Recovery MCG RLC: No action MCG MAC: No action SCG RLC: See Note 4 SCG MAC: Reconfigure	PDCP: Re-establish MCG RLC: See Note 1 MCG MAC: See Note 1 SCG RLC: See Note 4 SCG MAC: Reconfigure	N/A	PDCP: Re-establish MCG RLC: See Note 1 MCG MAC: See Note 1 SCG RLC: See Note 1 SCG MAC: See Note 1	PDCP: Recovery MCG RLC: See Note 3 MCG MAC: Reconfigure SCG RLC: No action SCG MAC: No action	PDCP: Re-establish MCG RLC: See Note 3 MCG MAC: Reconfigure SCG RLC: See Note 1 SCG MAC: See Note 1
SCG	PDCP: Recovery MCG RLC: Establish MCG MAC: Reconfigure SCG RLC: See Note 4 SCG MAC: Reconfigure	PDCP: Re-establish MCG RLC: Establish MCG MAC: Reconfigure SCG RLC: See Note 4 SCG MAC: Reconfigure	PDCP: Reconfigure MCG RLC: Establish MCG MAC: Reconfigure SCG RLC: No action SCG MAC: No action	PDCP: Re-establish MCG RLC: Establish MCG MAC: Reconfigure SCG RLC: See Note 1 SCG MAC: See Note 1	N/A	PDCP: Re-establish MCG RLC: No action MCG MAC: No action SCG RLC: See Note 1 SCG MAC: See note 1

NOTE 1: For EN-DC and NGEN-DC MCG, NE-DC SCG: the MAC/RLC behaviour depends on the solution selected by the network. It can be PCell handover (for EN-DC and NGEN-DC) or PSCell change (for NE-DC), which triggers MAC reset and RLC re-establishment. Alternatively, the logical channel identity can be changed, either via RLC bearer release and add for the same DRB (including RLC re-establishment), or via reconfiguration of the RLC bearer with RLC-re-establishment.

For EN-DC and NGEN-DC SCG, NE-DC MCG, NR-DC MCG and SCG: the MAC/RLC behaviour depends on the solution selected by the network. It can be reconfiguration with sync, with MAC reset and RLC re-establishment. Alternatively, the logical channel identity can be changed via RLC bearer release and add.

NOTE 2: Void

NOTE 3: For EN-DC and NGEN-DC: Re-establishment and release. For NE-DC and NR-DC: Release.

NOTE 4: For NE-DC: Re-establishment and release. For EN-DC, NGEN-DC and NR-DC: Release.

8.2.2.8.1.3 Test description

8.2.2.8.1.3.1 Pre-test conditions

System Simulator:

- E-UTRA Cell 1 is the PCell and NR Cell 1 is the PSCell.

UE:

- None.

Preamble:

- If `pc_IP_Ping` is set to TRUE then, the UE is in state `RRC_CONNECTED` using generic procedure parameter Connectivity (*EN-DC*), Bearers (*MCG(s) and SCG*) established according to TS 38.508-1 [4], clause 4.5.4.
- Else, the UE is in state `RRC_CONNECTED` using generic procedure parameter Connectivity (*EN-DC*), Bearers (*MCG(s) and SCG*) established and Test Loop Function (On) with UE test loop mode B according to TS 38.508-1 [4], clause 4.5.4.

8.2.2.8.1.3.2 Test procedure sequence

Table 8.2.2.8.1.3.2-1: Main behaviour

St	Procedure	Message Sequence		TP	Verdict
		U - S	Message		
1	The SS transmits an <i>RRConnectionReconfiguration</i> message containing NR <i>RRCReconfiguration</i> message to modify SN terminated SCG DRB with security key s-KgNB to MN terminated SCG DRB with security key change to keNB.	<--	<i>RRConnectionReconfiguration (RRCReconfiguration)</i>	-	-
2	Check: Does the UE transmit an <i>RRConnectionReconfigurationComplete</i> message containing NR <i>RRCReconfigurationComplete</i> message?	-->	<i>RRConnectionReconfigurationComplete (RRCReconfigurationComplete)</i>	1	P
3	Check: Does the test result of generic test procedure in TS 38.508-1 subclause 4.9.1 indicate that the UE is capable of exchanging IP data on SCG DRB#2?	-	-	1	P
4	The SS transmits an <i>RRConnectionReconfiguration</i> message containing NR <i>RRCReconfiguration</i> message to modify MN terminated SCG DRB with security key keNB to SN terminated Split DRB with security key change to s-KgNB.	<--	<i>RRConnectionReconfiguration (RRCReconfiguration)</i>	-	-

5	Check: Does the UE transmit an <i>RRCCoReconnectionReconfigurationComplete</i> message containing NR <i>RRCCoReconfigurationComplete</i> message?	-->	<i>RRCCoReconnectionReconfigurationComplete</i> (<i>RRCCoReconfigurationComplete</i>)	2	P
6	Check: Does the test result of generic test procedure in TS 38.508-1 subclause 4.9.1 indicate that the UE is capable of exchanging IP data on Split DRB#2 using NR radio path?	-	-	2	P
7	The SS transmits an <i>RRCCoReconnectionReconfiguration</i> message containing NR <i>RRCCoReconfiguration</i> message to modify SN terminated Split DRB with security key s-KgNB to MN terminated Split DRB with security key change to keNB.	<--	<i>RRCCoReconnectionReconfiguration</i> (<i>RRCCoReconfiguration</i>)	-	-
8	Check: Does the UE transmit an <i>RRCCoReconnectionReconfigurationComplete</i> message containing NR <i>RRCCoReconfigurationComplete</i> message?	-->	<i>RRCCoReconnectionReconfigurationComplete</i> (<i>RRCCoReconfigurationComplete</i>)	3	P
9	Check: Does the test result of generic test procedure in TS 38.508-1 subclause 4.9.1 indicate that the UE is capable of exchanging IP data on Split DRB#2 using NR radio path?	-	-	3	P
10	The SS transmits an <i>RRCCoReconnectionReconfiguration</i> message containing NR <i>RadioBearerConfig</i> and <i>nr-Config</i> set to release to modify MN terminated Split DRB with security key keNB to SN terminated MCG DRB with security key change to s-KgNB.	<--	<i>RRCCoReconnectionReconfiguration</i>	-	-
11	Check: Does the UE transmit an <i>RRCCoReconnectionReconfigurationComplete</i> message?	-->	<i>RRCCoReconnectionReconfigurationComplete</i>	4	P
12	Check: Does the test result of generic test procedure in TS 38.508-1 subclause 4.9.1 indicate that the UE is capable of exchanging IP data on MCG DRB#2?	-	-	4	P
13	The SS transmits an <i>RRCCoReconnectionReconfiguration</i> message containing NR <i>RadioBearerConfig</i> to modify SN terminated MCG DRB with security key s-KgNB to MN terminated MCG DRB with security key change to keNB.	<--	<i>RRCCoReconnectionReconfiguration</i>	-	-
14	Check: Does the UE transmit an <i>RRCCoReconnectionReconfigurationComplete</i> message?	-->	<i>RRCCoReconnectionReconfigurationComplete</i>	5	P
15	Check: Does the test result of generic test procedure in TS 38.508-1 subclause 4.9.1 indicate that the UE is capable of exchanging IP data on MCG DRB#2?	-	-	5	P
16	The SS transmits an <i>RRCCoReconnectionReconfiguration</i> message containing NR <i>RRCCoReconfiguration</i> message to modify MN terminated MCG DRB with security key keNB to SN terminated Split DRB with security key change to s-KgNB.	<--	<i>RRCCoReconnectionReconfiguration</i> (<i>RRCCoReconfiguration</i>)	-	-
17	Check: Does the UE transmit an <i>RRCCoReconnectionReconfigurationComplete</i> message containing NR <i>RRCCoReconfigurationComplete</i> message?	-->	<i>RRCCoReconnectionReconfigurationComplete</i> (<i>RRCCoReconfigurationComplete</i>)	6	P
18	Check: Does the test result of generic test procedure in TS 38.508-1 subclause 4.9.1 indicate that the UE is capable of exchanging IP data on Split DRB#2 using NR radio path?	-	-	6	P

19	The SS transmits an <i>RRCConnectionReconfiguration</i> message containing NR <i>RRCReconfiguration</i> message to modify SN terminated Split DRB with security key s-KgNB to MN terminated SCG DRB with security key change to keNB.	<--	<i>RRCConnectionReconfiguration (RRCReconfiguration)</i>	-	-
20	Check: Does the UE transmit an <i>RRCConnectionReconfigurationComplete</i> message containing NR <i>RRCReconfigurationComplete</i> message?	-->	<i>RRCConnectionReconfigurationComplete (RRCReconfigurationComplete)</i>	7	P
21	Check: Does the test result of generic test procedure in TS 38.508-1 subclause 4.9.1 indicate that the UE is capable of exchanging IP data on SCG DRB#2?	-	-	7	P
22	The SS transmits an <i>RRCConnectionReconfiguration</i> message containing NR <i>RRCReconfiguration</i> message to modify MN terminated SCG DRB with security key keNB to SN terminated MCG DRB with security key change to s-KgNB.	<--	<i>RRCConnectionReconfiguration (RRCReconfiguration)</i>	-	-
23	Check: Does the UE transmit an <i>RRCConnectionReconfigurationComplete</i> message containing NR <i>RRCReconfigurationComplete</i> message?	-->	<i>RRCConnectionReconfigurationComplete (RRCReconfigurationComplete)</i>	8	P
24	Check: Does the test result of generic test procedure in TS 38.508-1 subclause 4.9.1 indicate that the UE is capable of exchanging IP data on MCG DRB#2?	-	-	8	P
25	The SS transmits an <i>RRCConnectionReconfiguration</i> message containing NR <i>RRCReconfiguration</i> message to modify SN terminated MCG DRB with security key s-KgNB to MN terminated SCG DRB with security key change to keNB.	<--	<i>RRCConnectionReconfiguration (RRCReconfiguration)</i>	-	-
26	Check: Does the UE transmit an <i>RRCConnectionReconfigurationComplete</i> message containing NR <i>RRCReconfigurationComplete</i> message?	-->	<i>RRCConnectionReconfigurationComplete (RRCReconfigurationComplete)</i>	9	P
27	Check: Does the test result of generic test procedure in TS 38.508-1 subclause 4.9.1 indicate that the UE is capable of exchanging IP data on SCG DRB#2?	-	-	9	P

8.2.2.8.1.3.3 Specific message contents

Table 8.2.2.8.1.3.3-1: *RRCConnectionReconfiguration* (step 1, Table 8.2.2.8.1.3.2-1)

Derivation Path: TS 36.508 [7], Table 4.6.1-8			
Information Element	Value/remark	Comment	Condition
<i>RRCConnectionReconfiguration</i> ::= SEQUENCE {			
criticalExtensions CHOICE {			
c1 CHOICE {			
rrcConnectionReconfiguration-r8 SEQUENCE {			
nonCriticalExtension SEQUENCE {			
nonCriticalExtension SEQUENCE {			
nonCriticalExtension SEQUENCE {			
nonCriticalExtension SEQUENCE {			
nonCriticalExtension SEQUENCE {			
nonCriticalExtension SEQUENCE {			
nr-Config-r15 CHOICE {			
setup SEQUENCE {			
nr-SecondaryCellGroupConfig-r15	OCTET STRING including the		

Table 8.2.2.8.1.3.3-10: PDCP-Config (Table 8.2.2.8.1.3.3-9)

Derivation Path: TS 38.508-1 [4], Table 4.6.3-99			
Information Element	Value/remark	Comment	Condition
PDCP-Config ::= SEQUENCE {			
moreThanOneRLC SEQUENCE {			
primaryPath SEQUENCE {			
cellGroup	1		
}			
ul-DataSplitThreshold	infinity		
}			
}			

Table 8.2.2.8.1.3.3-11: RRCConnectionReconfiguration (step 7, Table 8.2.2.8.1.3.2-1)

Derivation Path: TS 36.508 [7], Table 4.6.1-8			
Information Element	Value/remark	Comment	Condition
RRCConnectionReconfiguration ::= SEQUENCE {			
criticalExtensions CHOICE {			
c1 CHOICE {			
rrcConnectionReconfiguration-r8 SEQUENCE {			
mobilityControlInfo	MobilityControlInfo-HO-SameCell	As per Table 7.1.3.2.1.3.3-1A	
radioResourceConfigDedicated	RadioResourceConfigDedicated-SN_Split-to-MN_Split		
securityConfigHO	SecurityConfigHO-DEFAULT		HO, HO-TO-EUTRA
nonCriticalExtension SEQUENCE {			
nonCriticalExtension SEQUENCE {			
nonCriticalExtension SEQUENCE {			
nonCriticalExtension SEQUENCE {			
nonCriticalExtension SEQUENCE {			
nonCriticalExtension SEQUENCE {			
nr-Config-r15 CHOICE {			
setup SEQUENCE {			
nr-SecondaryCellGroupConfig-r15	OCTET STRING including the RRCReconfiguration message and the IE secondaryCellGroup according TS 38.508-1 [4], table 4.6.1-13 with condition EN-DC_HO		
}			
}			
}			
}			
}			
}			
}			
nr-RadioBearerConfig1-r15	OCTET STRING including RadioBearerConfig		
}			
}			
}			
}			
}			

Table 8.2.2.8.1.3.3-12: RadioResourceConfigDedicated-SN_Split-to-MN_Split (Table 8.2.2.8.1.3.3-11)

Derivation Path: TS 36.508 [7], Table 4.6.3-18			
Information Element	Value/remark	Comment	Condition
RadioResourceConfigDedicated-HO-TO-EUTRA(1, 0) ::= SEQUENCE {			
drb-ToAddModList	DRB-ToAddModList-SN_Split-to-MN_Split		
}			

Table 8.2.2.8.1.3.3-13: DRB-ToAddModList-SN_Split-to-MN_Split (Table 8.2.2.8.1.3.3-12)

Derivation Path: TS 36.508 [7], Table 4.6.3-2A			
Information Element	Value/remark	Comment	Condition
DRB-ToAddModList ::= SEQUENCE (SIZE (1..maxDRB)) OF DRB-ToAddMod {	1 Entry		
DRB-ToAddMod[1] SEQUENCE {		entry 1	
eps-BearerIdentity	6	Dedicated EPS bearer Id of Split DRB	
drb-Identity	2	Split DRB Id	
rlc-Config-v1510 SEQUENCE {			
reestablishRLC-r15	true		
}			
}			
}			

Table 8.2.2.8.1.3.3-14: Void**Table 8.2.2.8.1.3.3-15: Void****Table 8.2.2.8.1.3.3-16: RadioBearerConfig (Table 8.2.2.8.1.3.3-11)**

Derivation Path: TS 38.508-1 [4], Table 4.6.3-132 with condition EN-DC_DRB AND Re-establish_PDCP			
Information Element	Value/remark	Comment	Condition
RadioBearerConfig ::= SEQUENCE {			
securityConfig SEQUENCE {			
keyToUse	master		
}			
}			

Table 8.2.2.8.1.3.3-17: RRCConnectionReconfiguration (step 10, Table 8.2.2.8.1.3.2-1)

Derivation Path: TS 36.508 [7], Table 4.6.1-8			
Information Element	Value/remark	Comment	Condition
RRCConnectionReconfiguration ::= SEQUENCE {			
criticalExtensions CHOICE {			
c1 CHOICE {			
rrcConnectionReconfiguration-r8 SEQUENCE {			
mobilityControllInfo	MobilityControllInfo-HO-SameCell	As per Table 7.1.3.2.1.3.3-1A	
radioResourceConfigDedicated	RadioResourceConfigDedicated-MN_Split-to-SN_MCG		
securityConfigHO	SecurityConfigHO-DEFAULT		HO, HO-TO-EUTRA
nonCriticalExtension SEQUENCE {			
nonCriticalExtension SEQUENCE {			
nonCriticalExtension SEQUENCE {			
nonCriticalExtension SEQUENCE {			

Table 8.2.2.8.1.3.3-23: RRCConnectionReconfiguration (step 13, Table 8.2.2.8.1.3.2-1)

Derivation Path: TS 36.508 [7], Table 4.6.1-8			
Information Element	Value/remark	Comment	Condition
RRCConnectionReconfiguration ::= SEQUENCE {			
criticalExtensions CHOICE {			
c1 CHOICE {			
rrcConnectionReconfiguration-r8 SEQUENCE {			
mobilityControllInfo	MobilityControllInfo-HO-SameCell	As per Table 7.1.3.2.1.3.3-1A	
radioResourceConfigDedicated	RadioResourceConfigDedicated-SN_MCG-to-MN_MCG		
securityConfigHO	SecurityConfigHO-DEFAULT		HO, HO-TO-EUTRA
nonCriticalExtension SEQUENCE {			
nonCriticalExtension SEQUENCE {			
nonCriticalExtension SEQUENCE {			
nonCriticalExtension SEQUENCE {			
nonCriticalExtension SEQUENCE {			
nonCriticalExtension SEQUENCE {			
nonCriticalExtension SEQUENCE {			
nr-RadioBearerConfig1-r15	OCTET STRING including RadioBearerConfig		
}			
}			
}			
}			
}			
}			
}			
}			
}			
}			
}			
}			
}			
}			
}			
}			
}			

Table 8.2.2.8.1.3.3-24: RadioResourceConfigDedicated-SN_MCG-to-MN_MCG (Table 8.2.2.8.1.3.3-23)

Derivation Path: TS 36.508 [7], Table 4.6.3-18			
Information Element	Value/remark	Comment	Condition
RadioResourceConfigDedicated-HO-TO-EUTRA(1, 0) ::= SEQUENCE {			
drb-ToAddModList	DRB-ToAddModList-SN_MCG-to-MN_MCG		
}			

Table 8.2.2.8.1.3.3-25: DRB-ToAddModList-SN_MCG-to-MN_MCG (Table 8.2.2.8.1.3.3-24)

Derivation Path: TS 36.508 [7], Table 4.6.3-2A			
Information Element	Value/remark	Comment	Condition
DRB-ToAddModList ::= SEQUENCE (SIZE (1..maxDRB)) OF DRB-ToAddMod {	1 Entry		
DRB-ToAddMod[1] SEQUENCE {		entry 1	
eps-BearerIdentity	6	Dedicated EPS bearer Id of MCG DRB	
drb-Identity	2	MCG DRB Id	
rlc-Config-v1510 SEQUENCE {			
reestablishRLC-r15	true		
}			
}			

}		
---	--	--

Table 8.2.2.8.1.3.3-25a: Void

Table 8.2.2.8.1.3.3-25b: Void

Table 8.2.2.8.1.3.3-26: RadioBearerConfig (Table 8.2.2.8.1.3.3-23)

Derivation Path: TS 38.508-1 [4], Table 4.6.3-132 with condition EN-DC_DRB AND Re-establish_PDCP			
Information Element	Value/remark	Comment	Condition
RadioBearerConfig ::= SEQUENCE {			
securityConfig SEQUENCE {			
keyToUse	master		
}			
}			

Table 8.2.2.8.1.3.3-27: RRCConnectionReconfiguration (step 16, Table 8.2.2.8.1.3.2-1)

Derivation Path: TS 36.508 [7], Table 4.6.1-8			
Information Element	Value/remark	Comment	Condition
RRCConnectionReconfiguration ::= SEQUENCE {			
criticalExtensions CHOICE {			
c1 CHOICE {			
rrcConnectionReconfiguration-r8 SEQUENCE {			
mobilityControllInfo	MobilityControllInfo-HO-SameCell	As per Table 7.1.3.2.1.3.3-1A	
radioResourceConfigDedicated	RadioResourceConfigDedicated-MN_MCG-to-SN_Split		
securityConfigHO	SecurityConfigHO-DEFAULT		HO, HO-TO-EUTRA
nonCriticalExtension SEQUENCE {			
nonCriticalExtension SEQUENCE {			
nonCriticalExtension SEQUENCE {			
nonCriticalExtension SEQUENCE {			
nonCriticalExtension SEQUENCE {			
nonCriticalExtension SEQUENCE {			
nr-Config-r15 CHOICE {			
setup SEQUENCE {			
nr-SecondaryCellGroupConfig-r15	OCTET STRING including the RRCReconfiguration message and the IE secondaryCellGroup according TS 38.508-1 [4], table 4.6.1-13 with condition EN-DC		
}			
}			
nr-RadioBearerConfig1-r15	OCTET STRING including RadioBearerConfig		
}			
}			
}			
}			
}			
}			
}			
}			
}			

}			
}			
}			
}			
}			

Table 8.2.2.8.1.3.3-28: RadioResourceConfigDedicated-MN_MCG-to-SN_Split (Table 8.2.2.8.1.3.3-27)

Derivation Path: TS 36.508 [7], Table 4.6.3-18			
Information Element	Value/remark	Comment	Condition
RadioResourceConfigDedicated-HO-TO-EUTRA(1, 0) ::= SEQUENCE {			
drb-ToAddModList	DRB-ToAddModList-MN_MCG-to-SN_Split		
}			

Table 8.2.2.8.1.3.3-29: DRB-ToAddModList-MN_MCG-to-SN_Split (Table 8.2.2.8.1.3.3-30)

Derivation Path: TS 36.508 [7], Table 4.6.3-2A			
Information Element	Value/remark	Comment	Condition
DRB-ToAddModList ::= SEQUENCE (SIZE (1..maxDRB)) OF DRB-ToAddMod {	1 Entry		
DRB-ToAddMod[1] SEQUENCE {		entry 1	
eps-BearerIdentity	6	Dedicated EPS bearer Id of MCG DRB	
drb-Identity	2	MCG DRB Id	
rlc-Config-v1510 SEQUENCE {			
reestablishRLC-r15	true		
}			
}			

Table 8.2.2.8.1.3.3-30: Void

Table 8.2.2.8.1.3.3-31: Void

Table 8.2.2.8.1.3.3-32: RadioBearerConfig (Table 8.2.2.8.1.3.3-27)

Derivation Path: TS 38.508-1 [4], Table 4.6.3-132 with condition EN-DC_DRB AND Re-establish_PDCP			
Information Element	Value/remark	Comment	Condition
RadioBearerConfig ::= SEQUENCE {			
drb-ToAddModList SEQUENCE (SIZE (1..maxDRB)) OF DRB-ToAddMod {	1 entry		
DRB-ToAddMod[1] SEQUENCE {		entry 1	
pdcp-Config	PDCP-Config		
}			
}			
securityConfig SEQUENCE {			
keyToUse	secondary		
}			
}			

Table 8.2.2.8.1.3.3-33: PDCP-Config (Table 8.2.2.8.1.3.3-32)

Derivation Path: TS 38.508-1 [4], Table 4.6.3-99			
Information Element	Value/remark	Comment	Condition
PDCP-Config ::= SEQUENCE {			
moreThanOneRLC SEQUENCE {			

primaryPath SEQUENCE {			
cellGroup	1		
}			
ul-DataSplitThreshold	infinity		
}			
}			

Table 8.2.2.8.1.3.3-34: RRCConnectionReconfiguration (step 19, Table 8.2.2.8.1.3.2-1)

Derivation Path: TS 36.508 [7], Table 4.6.1-8			
Information Element	Value/remark	Comment	Condition
RRCConnectionReconfiguration ::= SEQUENCE {			
criticalExtensions CHOICE {			
c1 CHOICE {			
rrcConnectionReconfiguration-r8 SEQUENCE {			
radioResourceConfigDedicated	RadioResourceConfigDe dicated-DRB-REL(2)		
nonCriticalExtension SEQUENCE {			
nonCriticalExtension SEQUENCE {			
nonCriticalExtension SEQUENCE {			
nonCriticalExtension SEQUENCE {			
nonCriticalExtension SEQUENCE {			
nonCriticalExtension SEQUENCE {			
nonCriticalExtension SEQUENCE {			
nr-Config-r15 CHOICE {			
setup SEQUENCE {			
nr-SecondaryCellGroupConfig-r15	OCTET STRING including the <i>RRCReconfiguration</i> message and the IE secondaryCellGroup according TS 38.508-1 [4], table 4.6.1-13 with condition EN-DC_HO		
}			
}			
nr-RadioBearerConfig1-r15	OCTET STRING including RadioBearerConfig		
}			
}			
}			
}			

Table 8.2.2.8.1.3.3-35: Void

Table 8.2.2.8.1.3.3-36: Void

Table 8.2.2.8.1.3.3-37: RadioBearerConfig (Table 8.2.2.8.1.3.3-34)

Derivation Path: TS 38.508-1 [4], Table 4.6.3-132 with condition EN-DC AND Re-establish_PDCP			
Information Element	Value/remark	Comment	Condition

RadioBearerConfig ::= SEQUENCE {			
securityConfig SEQUENCE {			
keyToUse	master		
}			
}			

Table 8.2.2.8.1.3.3-38: RRCConnectionReconfiguration (step 22, Table 8.2.2.8.1.3.2-1)

Derivation Path: TS 36.508 [7], Table 4.6.1-8			
Information Element	Value/remark	Comment	Condition
RRCConnectionReconfiguration ::= SEQUENCE {			
criticalExtensions CHOICE {			
c1 CHOICE {			
rrcConnectionReconfiguration-r8 SEQUENCE {			
radioResourceConfigDedicated	RadioResourceConfigDedicated-MN_SCG-to-SN_MCG		
nonCriticalExtension SEQUENCE {			
nonCriticalExtension SEQUENCE {			
nonCriticalExtension SEQUENCE {			
nonCriticalExtension SEQUENCE {			
nonCriticalExtension SEQUENCE {			
nonCriticalExtension SEQUENCE {			
nonCriticalExtension SEQUENCE {			
nr-Config-r15 CHOICE {			
release			
}			
nr-RadioBearerConfig1-r15	OCTET STRING including RadioBearerConfig		
}			
}			
}			
}			
}			
}			
}			
}			
}			
}			

Table 8.2.2.8.1.3.3-39: RadioResourceConfigDedicated-MN_SCG-to-SN_MCG (Table 8.2.2.8.1.3.3-38)

Derivation Path: TS 36.508 [7], Table 4.6.3-27			
Information Element	Value/remark	Comment	Condition
RadioResourceConfigDedicated-DRB ::= SEQUENCE {			
drb-ToAddModList	DRB-ToAddModList-MN_SCG-to-SN_MCG		
}			

Table 8.2.2.8.1.3.3-40: DRB-ToAddModList-MN_SCG-to-SN_MCG (Table 8.2.2.8.1.3.3-39)

Derivation Path: TS 36.508 [7], Table 4.6.3-2A			
Information Element	Value/remark	Comment	Condition
DRB-ToAddModList ::= SEQUENCE (SIZE (1..maxDRB)) OF DRB-ToAddMod {	1 Entry		
DRB-ToAddMod[1] SEQUENCE {		entry 1	

eps-BearerIdentity	6	Dedicated EPS bearer Id of SCG DRB	
drb-Identity	2	SCG DRB Id	
}			
}			

Table 8.2.2.8.1.3.3-41: Void

Table 8.2.2.8.1.3.3-42: Void

Table 8.2.2.8.1.3.3-43: *RadioBearerConfig* (Table 8.2.2.8.1.3.3-38)

Derivation Path: TS 38.508-1 [4], Table 4.6.3-132 with condition EN-DC and Re-establish_PDCP			
Information Element	Value/remark	Comment	Condition
RadioBearerConfig ::= SEQUENCE {			
securityConfig SEQUENCE {			
keyToUse	secondary		
}			
}			

Table 8.2.2.8.1.3.3-44: *RRCConnectionReconfiguration* (step 25, Table 8.2.2.8.1.3.2-1)

Derivation Path: TS 36.508 [7], Table 4.6.1-8			
Information Element	Value/remark	Comment	Condition
RRCConnectionReconfiguration ::= SEQUENCE {			
criticalExtensions CHOICE {			
c1 CHOICE {			
rrcConnectionReconfiguration-r8 SEQUENCE {			
radioResourceConfigDedicated	RadioResourceConfigDedicated-DRB-REL(2)		
nonCriticalExtension SEQUENCE {			
nonCriticalExtension SEQUENCE {			
nonCriticalExtension SEQUENCE {			
nonCriticalExtension SEQUENCE {			
nonCriticalExtension SEQUENCE {			
nonCriticalExtension SEQUENCE {			
nonCriticalExtension SEQUENCE {			
nr-Config-r15 CHOICE {			
setup SEQUENCE {			
nr-SecondaryCellGroupConfig-r15	OCTET STRING including the <i>RRCReconfiguration</i> message and the IE <i>secondaryCellGroup</i> according TS 38.508-1 [4], table 4.6.1-13 with condition EN-DC_HO		
}			
}			
}			
}			
}			
}			
}			
}			
}			
}			
nr-RadioBearerConfig1-r15	OCTET STRING including <i>RadioBearerConfig</i>		
}			
}			

}			
}			
}			
}			
}			

Table 8.2.2.8.1.3.3-45: Void

Table 8.2.2.8.1.3.3-46: Void

Table 8.2.2.8.1.3.3-47: *RadioBearerConfig* (Table 8.2.2.8.1.3.3-44)

Derivation Path: TS 38.508-1 [4], Table 4.6.3-132 with condition EN-DC and Re-establish_PDCP			
Information Element	Value/remark	Comment	Condition
RadioBearerConfig ::= SEQUENCE {			
securityConfig SEQUENCE {			
keyToUse	master		
}			
}			

Table 8.2.2.8.1.3.3-48: *RRCConnectionReconfigurationComplete* (steps 2, 5, 8, 17, 20, 23, 26, Table 8.2.2.8.1.3.2-1)

Derivation Path: TS 36.508 [7] Table 4.6.1-9			
Information Element	Value/remark	Comment	Condition
RRCConnectionReconfigurationComplete ::= SEQUENCE {			
criticalExtensions CHOICE {			
rrcConnectionReconfigurationComplete-r8 SEQUENCE {			
nonCriticalExtension SEQUENCE {			
nonCriticalExtension SEQUENCE {			
nonCriticalExtension SEQUENCE {			
nonCriticalExtension SEQUENCE {			
nonCriticalExtension SEQUENCE {			
nonCriticalExtension SEQUENCE {			
scg-ConfigResponseNR-r15	Present		
}			
}			
}			
}			
}			

8.2.2.8.2 Bearer Modification / Handling for bearer type change with security key change / NR-DC

8.2.2.8.2.1 Test Purpose (TP)

(1)

```
with { UE in NR RRC_CONNECTED state with NR-DC }
ensure that {
  when { UE receives an RRCReconfiguration message to modify the SN terminated SCG DRB to MN
    terminated SCG DRB with security key change to kgNB }
  then { UE reconfigures the DRB and sends an RRCReconfigurationComplete message }
```

```
    }
```

(2)

```
with { UE in NR RRC_CONNECTED state with NR-DC and MN terminated SCG DRB established with security
key KgNB }
ensure that {
  when { UE receives an RRCReconfiguration message to modify the MN terminated SCG DRB to SN
terminated Split DRB with security key change to s-KgNB }
  then { UE reconfigures the DRB and sends an RRCReconfigurationComplete message }
}
```

(3)

```
with { UE in RRC_CONNECTED state with NR-DC and SN terminated Split DRB established with security
key s-KgNB }
ensure that {
  when { UE receives an RRCReconfiguration message to modify the SN terminated Split DRB to MN
terminated Split DRB with security key change to KgNB }
  then { UE reconfigures the DRB and sends an RRCReconfigurationComplete message }
}
```

(4)

```
with { UE in RRC_CONNECTED state with NR-DC and MN terminated Split DRB established with security
key KgNB }
ensure that {
  when { UE receives an RRCReconfiguration message to modify the MN terminated Split DRB to SN
terminated MCG DRB with security key change to s-KgNB }
  then { UE reconfigures the DRB and sends an RRCReconfigurationComplete message }
}
```

(5)

```
with { UE in RRC_CONNECTED state with NR-DC and SN terminated MCG DRB established with security key
s-KgNB }
ensure that {
  when { UE receives an RRCReconfiguration message to modify the SN terminated MCG DRB to MN
terminated MCG DRB with security key change to KgNB }
  then { UE reconfigures the DRB and sends an RRCReconfigurationComplete message }
}
```

(6)

```
with { UE in RRC_CONNECTED state with NR-DC and MN terminated MCG DRB established with security key
KgNB }
ensure that {
  when { UE receives an RRCReconfiguration message to modify the MN terminated MCG DRB to SN
terminated Split DRB with security key change to s-KgNB }
  then { UE reconfigures the DRB and sends an RRCReconfigurationComplete message }
}
```

(7)

```
with { UE in RRC_CONNECTED state with NR-DC and SN terminated Split DRB established with security
key s-KgNB }
ensure that {
  when { UE receives an RRCReconfiguration message to modify the SN terminated Split DRB to MN
terminated SCG DRB with security key change to KgNB }
  then { UE reconfigures the DRB and sends an RRCReconfigurationComplete message }
}
```

(8)

```
with { UE in RRC_CONNECTED state with NR-DC and MN terminated SCG DRB established with security key
KgNB }
ensure that {
  when { UE receives an RRCReconfiguration message to modify the MN terminated SCG DRB to SN
terminated MCG DRB with security key change to s-KgNB }
  then { UE reconfigures the DRB and sends an RRCReconfigurationComplete message }
}
```

(9)

```

with { UE in RRC_CONNECTED state with NR-DC and SN terminated MCG DRB established with security key
s-KgNB }
ensure that {
  when { UE receives an RRCReconfiguration message to modify the SN terminated MCG DRB to MN
terminated SCG DRB with security key change to KgNB }
    then { UE reconfigures the DRB and sends an RRCReconfigurationComplete message }
}

```

8.2.2.8.2.2 Conformance requirements

References: The conformance requirements covered in the present test case are specified in: TS 38.331, clauses 5.3.5.3, 5.3.5.6.1 and 5.3.5.6.5, TS 37.340, clause Annex A: Table A-1: L2 handling for bearer type change with and without security key change. Unless otherwise stated these are Rel-15 requirements.

[TS 38.331, clause 5.3.5.3]

The UE shall perform the following actions upon reception of the *RRCReconfiguration*:

...

1> if the *RRCReconfiguration* includes the *secondaryCellGroup*:

2> perform the cell group configuration for the SCG according to 5.3.5.5;

1> if the *RRCReconfiguration* message contains the *radioBearerConfig*:

2> perform the radio bearer configuration according to 5.3.5.6;

1> if the *RRCReconfiguration* message includes the *measConfig*:

2> perform the measurement configuration procedure as specified in 5.5.2;

...

1> set the content of *RRCReconfigurationComplete* message as follows:

2> if the *RRCReconfiguration* includes the *masterCellGroup* containing the *reportUplinkTxDirectCurrent*, or;

2> if the *RRCReconfiguration* includes the *secondaryCellGroup* containing the *reportUplinkTxDirectCurrent*:

3> include the *uplinkTxDirectCurrentList*;

1> if the UE is configured with E-UTRA *nr-SecondaryCellGroupConfig* (MCG is E-UTRA):

2> if *RRCReconfiguration* was received via SRB1:

3> construct *RRCReconfigurationComplete* message and submit it via the EUTRA MCG embedded in E-UTRA RRC message *RRCConnectionReconfigurationComplete* as specified in TS 36.331 [10];

3> if *reconfigurationWithSync* was included in *spCellConfig* of an SCG:

4> initiate the random access procedure on the SpCell, as specified in TS 38.321 [3];

3> else:

4> the procedure ends;

NOTE: The order the UE sends the *RRCConnectionReconfigurationComplete* message and performs the Random Access procedure towards the SCG is left to UE implementation.

2> else (*RRCReconfiguration* was received via SRB3):

3> submit the *RRCReconfigurationComplete* message via SRB3 to lower layers for transmission using the new configuration .

NOTE: For EN-DC, in the case *RRCReconfiguration* is received via SRB1, the random access is triggered by RRC layer itself as there is not necessarily other UL transmission. In the case *RRCReconfiguration* is received via SRB3, the random access is triggered by the MAC layer due to arrival of *RRCReconfigurationComplete*.

1> else:

- 2> submit the *RRCReconfigurationComplete* message via SRB1 to lower layers for transmission using the new configuration;
- 2> if this is the first *RRCReconfiguration* message after successful completion of the RRC re-establishment procedure:
 - 3> resume SRB2 and DRBs that are suspended;
- 1> if *reconfigurationWithSync* was included in *spCellConfig* of an MCG or SCG, and when MAC of an NR cell group successfully completes a random access procedure triggered above;
 - 2> stop timer T304 for that cell group;
 - 2> apply the parts of the CQI reporting configuration, the scheduling request configuration and the sounding RS configuration that do not require the UE to know the SFN of the respective target SpCell, if any;
 - 2> apply the parts of the measurement and the radio resource configuration that require the UE to know the SFN of the respective target SpCell (e.g. measurement gaps, periodic CQI reporting, scheduling request configuration, sounding RS configuration), if any, upon acquiring the SFN of that target SpCell;
 - 2> if the *reconfigurationWithSync* was included in *spCellConfig* of an MCG:
 - 3> if T390 is running:
 - 4> stop timer T390 for all access categories;
 - 4> perform the actions as specified in 5.3.14.4.
 - 3> if *RRCReconfiguration* does not include *dedicatedSIB1-Delivery* and
 - 3> if the active downlink BWP, which is indicated by the *firstActiveDownlinkBWP-Id* for the target SpCell of the MCG, has a common search space configured by *searchSpaceSIB1*:
 - 4> acquire the *SIB1*, which is scheduled as specified in TS 38.213 [13], of the target SpCell of the MCG;
 - 4> upon acquiring *SIB1*, perform the actions specified in clause 5.2.2.4.2;
 - 2> the procedure ends.

NOTE: The UE is only required to acquire broadcasted *SIB1* if the UE can acquire it without disrupting unicast data reception, i.e. the broadcast and unicast beams are quasi co-located.

[TS 38.331, clause 5.3.5.6.1]

The UE shall perform the following actions based on a received *RadioBearerConfig* IE:

...

- 1> if the *RadioBearerConfig* includes the *drb-ToAddModList*:
 - 2> perform DRB addition or reconfiguration as specified in 5.3.5.6.5.

[TS 38.331, clause 5.3.5.6.5]

The UE shall:

- 1> for each *drb-Identity* value included in the *drb-ToAddModList* that is not part of the current UE configuration (DRB establishment including the case when full configuration option is used):
 - 2> establish a PDCP entity and configure it in accordance with the received *pdcp-Config*;

- 2> if the PDCP entity of this DRB is not configured with *cipheringDisabled*:
 - 3> if target RAT of handover is E-UTRA/5GC, or;
 - 3> if the UE is only connected to E-UTRA/5GC:
 - 4> configure the PDCP entity with the ciphering algorithm and K_{UPenc} key configured/derived as specified in TS 36.331 [10];
 - 3> else:
 - 4> configure the PDCP entity with the ciphering algorithms according to *securityConfig* and apply the K_{UPenc} key associated with the master key (K_{eNB}/K_{gNB}) or the secondary key ($S-K_{gNB}$) as indicated in *keyToUse*;
- 2> if the PDCP entity of this DRB is configured with *integrityProtection*:
 - 3> configure the PDCP entity with the integrity algorithms according to *securityConfig* and apply the K_{UPint} key associated with the master (K_{eNB}/K_{gNB}) or the secondary key ($S-K_{gNB}$) as indicated in *keyToUse*;
- ...
- 2> if the UE is operating in EN-DC:
 - 3> if the DRB was configured with the same *eps-BearerIdentity* either by NR or E-UTRA prior to receiving this reconfiguration:
 - 4> associate the established DRB with the corresponding *eps-BearerIdentity*;
 - 3> else:
 - 4> indicate the establishment of the DRB(s) and the *eps-BearerIdentity* of the established DRB(s) to upper layers;
- 1> for each *drb-Identity* value included in the *drb-ToAddModList* that is part of the current UE configuration:
 - 2> if the *reestablishPDCP* is set:
 - 3> if target RAT is E-UTRA/5GC, or;
 - 3> if the UE is only connected to E-UTRA/5GC:
 - 4> if the PDCP entity of this DRB is not configured with *cipheringDisabled*:
 - 5> configure the PDCP entity with the ciphering algorithm and K_{UPenc} key configured/derived as specified in TS 36.331 [10, 5.4.2.3], i.e. the ciphering configuration shall be applied to all subsequent PDCP PDUs received and sent by the UE;
 - 3> else:
 - 4> if the PDCP entity of this DRB is not configured with *cipheringDisabled*:
 - 5> configure the PDCP entity with the ciphering algorithm and K_{UPenc} key associated with the master key (K_{eNB}/K_{gNB}) or the secondary key ($S-K_{gNB}$), as indicated in *keyToUse*, i.e. the ciphering configuration shall be applied to all subsequent PDCP PDUs received and sent by the UE;
 - 4> if the PDCP entity of this DRB is configured with *integrityProtection*:
 - 5> configure the PDCP entity with the integrity algorithms according to *securityConfig* and apply the K_{UPint} key associated with the master (K_{eNB}/K_{gNB}) or the secondary key ($S-K_{gNB}$) as indicated in *keyToUse*;
 - 3> re-establish the PDCP entity of this DRB as specified in 38.323 [5], clause 5.1.2;
- 2> else, if the *recoverPDCP* is set:
 - 3> trigger the PDCP entity of this DRB to perform data recovery as specified in 38.323 [5];

2> if the *pdcp-Config* is included:

3> reconfigure the PDCP entity in accordance with the received *pdcp-Config*.

...

NOTE 1: Void.

NOTE 2: When determining whether a *drb-Identity* value is part of the current UE configuration, the UE does not distinguish which *RadioBearerConfig* and *DRB-ToAddModList* that DRB was originally configured in. To re-associate a DRB with a different key (KeNB to S-KeNB or vice versa), the network provides the *drb-Identity* value in the (target) *drb-ToAddModList* and sets the *reestablishPDCP* flag. The network does not list the *drb-Identity* in the (source) *drb-ToReleaseList*.

NOTE 3: When setting the *reestablishPDCP* flag for a radio bearer, the network ensures that the RLC receiver entities do not deliver old PDCP PDUs to the re-established PDCP entity. It does that e.g. by triggering a reconfiguration with sync of the cell group hosting the old RLC entity or by releasing the old RLC entity.

NOTE 4: In this specification, UE configuration refers to the parameters configured by NR RRC unless otherwise stated.

NOTE 5: Ciphering and integrity protection can be enabled or disabled for a DRB. The enabling/disabling of ciphering or integrity protection can be changed only by releasing and adding the DRB.

[TS 37.340, Annex A]

This clause provides for information an overview on L2 handling for bearer type change in MR-DC, with and without a security key change due to a change of the termination point.

Table A-1: L2 handling for bearer type change with and without a security key change due to a change of the termination point

Bearer type change from row to col	MCG		Split		SCG	
	no change of termination point (no key change)	change of termination point (key change)	no change of termination point (no key change)	change of termination point (key change)	no change of termination point (no key change)	change of termination point (key change)
MCG	N/A	PDCP: Re-establish MCG RLC: See Note 1 MCG MAC: See Note 1 SCG RLC: No action SCG MAC: No action	PDCP: Reconfigure MCG RLC: No action MCG MAC: No action SCG RLC: Establish SCG MAC: Reconfigure	PDCP: Re-establish MCG RLC: See Note 1 MCG MAC: See Note 1 SCG RLC: Establish SCG MAC: Reconfigure	PDCP: Recovery MCG RLC: See Note 3 MCG MAC: Reconfigure SCG RLC: Establish SCG MAC: Reconfigure	PDCP: Re-establish MCG RLC: See Note 3 MCG MAC: Reconfigure SCG RLC: Establish SCG MAC: Reconfigure
Split	PDCP: Recovery MCG RLC: No action MCG MAC: No action SCG RLC: See Note 4 SCG MAC: Reconfigure	PDCP: Re-establish MCG RLC: See Note 1 MCG MAC: See Note 1 SCG RLC: See Note 4 SCG MAC: Reconfigure	N/A	PDCP: Re-establish MCG RLC: See Note 1 MCG MAC: See Note 1 SCG RLC: See Note 1 SCG MAC: See Note 1	PDCP: Recovery MCG RLC: See Note 3 MCG MAC: Reconfigure SCG RLC: No action SCG MAC: No action	PDCP: Re-establish MCG RLC: See Note 3 MCG MAC: Reconfigure SCG RLC: See Note 1 SCG MAC: See Note 1

SCG	PDCP: Recovery MCG RLC: Establish MCG MAC: Reconfigure SCG RLC: See Note 4 SCG MAC: Reconfigure	PDCP: Re-establish MCG RLC: Establish MCG MAC: Reconfigure SCG RLC: See Note 4 SCG MAC: Reconfigure	PDCP: Reconfigure MCG RLC: Establish MCG MAC: Reconfigure SCG RLC: No action SCG MAC: No action	PDCP: Re-establish MCG RLC: Establish MCG MAC: Reconfigure SCG RLC: See Note 1 SCG MAC: See Note 1	N/A	PDCP: Re-establish MCG RLC: No action MCG MAC: No action SCG RLC: See Note 1 SCG MAC: See Note 1
-----	--	--	--	---	-----	---

NOTE 1: For EN-DC and NGEN-DC MCG, NE-DC SCG: the MAC/RLC behaviour depends on the solution selected by the network. It can be PCell handover (for EN-DC and NGEN-DC) or PSCell change (for NE-DC), which triggers MAC reset and RLC re-establishment. Alternatively, the logical channel identity can be changed, either via RLC bearer release and add for the same DRB (including RLC re-establishment), or via reconfiguration of the RLC bearer with RLC-re-establishment.

For EN-DC and NGEN-DC SCG, NE-DC MCG, NR-DC MCG and SCG: the MAC/RLC behaviour depends on the solution selected by the network. It can be reconfiguration with sync, with MAC reset and RLC re-establishment. Alternatively, the logical channel identity can be changed via RLC bearer release and add.

NOTE 2: Void

NOTE 3: For EN-DC and NGEN-DC: Re-establishment and release. For NE-DC and NR-DC: Release.

NOTE 4: For NE-DC: Re-establishment and release. For EN-DC, NGEN-DC and NR-DC: Release.

8.2.2.8.2.3 Test description

8.2.2.8.2.3.1 Pre-test conditions

System Simulator:

- NR Cell 1 is the PCell and NR Cell 10 is the PSCell.
- System information combination NR-4 as defined in TS 38.508-1 [4] clause 4.4.3.1.3 is used in NR cells.

UE:

- None.

Preamble:

- If pc_IP_Ping is set to TRUE then, the UE is in state NR RRC_CONNECTED using generic procedure parameter Connectivity (NR-DC), Bearers (MCG(s) and SCG) established according to TS 38.508-1 [4], clause 4.5.4.
- Else, the UE is in state NR RRC_CONNECTED using generic procedure parameter Connectivity (NR-DC), Bearers (MCG(s) and SCG) established and Test Loop Function (On) with UE test loop mode B according to TS 38.508-1 [4], clause 4.5.4.

8.2.2.8.2.3.2 Test procedure sequence

Table 8.2.2.8.2.3.2-1: Main behaviour

St	Procedure	Message Sequence		TP	Verdict
		U - S	Message		

1	The SS transmits an <i>RRCReconfiguration</i> message containing NR RadioBearerConfig message to modify SN terminated SCG DRB with security key s-KgNB to MN terminated SCG DRB with security key change to KgNB.	<--	<i>RRCReconfiguration</i>	-	-
2	Check: Does the UE transmit an <i>RRCReconfigurationComplete</i> message including nr-SCG-Response?	-->	<i>RRCReconfigurationComplete</i>	1	P
3	Check: Does the test result of generic test procedure in TS 38.508-1 subclause 4.9.1 indicate that the UE is capable of exchanging IP data on SCG DRBn?	-	-	1	P
4	The SS transmits an <i>RRCReconfiguration</i> message containing NR RadioBearerConfig message to modify MN terminated SCG DRB with security key KgNB to SN terminated Split DRB with security key change to s-KgNB.	<--	<i>RRCReconfiguration</i>	-	-
5	Check: Does the UE transmit an <i>RRCReconfigurationComplete</i> message including nr-SCG-Response?	-->	<i>RRCReconfigurationComplete</i>	2	P
6	Check: Does the test result of generic test procedure in TS 38.508-1 subclause 4.9.1 indicate that the UE is capable of exchanging IP data on Split DRBn using SCG path?	-	-	2	P
7	The SS transmits an <i>RRCReconfiguration</i> message containing NR RadioBearerConfig message to modify SN terminated Split DRB with security key s-KgNB to MN terminated Split DRB with security key change to KgNB.	<--	<i>RRCReconfiguration</i>	-	-
8	Check: Does the UE transmit an <i>RRCReconfigurationComplete</i> message including nr-SCG-Response?	-->	<i>RRCReconfigurationComplete</i>	3	P
9	Check: Does the test result of generic test procedure in TS 38.508-1 subclause 4.9.1 indicate that the UE is capable of exchanging IP data on Split DRBn using SCG path?	-	-	3	P
10	The SS transmits an <i>RRCReconfiguration</i> message containing NR RadioBearerConfig and nr-Config set to release to modify MN terminated Split DRB with security key KgNB to SN terminated MCG DRB with security key change to s-KgNB.	<--	<i>RRCReconfiguration</i>	-	-
11	Check: Does the UE transmit an <i>RRCReconfigurationComplete</i> message?	-->	<i>RRCReconfigurationComplete</i>	4	P
12	Check: Does the test result of generic test procedure in TS 38.508-1 subclause 4.9.1 indicate that the UE is capable of exchanging IP data on MCG DRBn?	-	-	4	P
13	The SS transmits an <i>RRCReconfiguration</i> message containing NR RadioBearerConfig to modify SN terminated MCG DRB with security key s-KgNB to MN terminated MCG DRB with security key change to KgNB.	<--	<i>RRCReconfiguration</i>	-	-
14	Check: Does the UE transmit an <i>RRCReconfigurationComplete</i> message including nr-SCG-Response?	-->	<i>RRCReconfigurationComplete</i>	5	P
15	Check: Does the test result of generic test procedure in TS 38.508-1 subclause 4.9.1 indicate that the UE is capable of exchanging IP data on MCG DRBn?	-	-	5	P
16	The SS transmits an <i>RRCReconfiguration</i> message containing NR RadioBearerConfig message to modify MN terminated MCG DRB with security key KgNB to SN terminated Split DRB with security key change to s-KgNB.	<--	<i>RRCReconfiguration</i>	-	-
17	Check: Does the UE transmit an <i>RRCReconfigurationComplete</i> message including nr-SCG-Response?	-->	<i>RRCReconfigurationComplete</i>	6	P

18	Check: Does the test result of generic test procedure in TS 38.508-1 subclause 4.9.1 indicate that the UE is capable of exchanging IP data on Split DRBn using SCG path?	-	-	6	P
19	The SS transmits an <i>RRCReconfiguration</i> message containing NR RadioBearerConfig message to modify SN terminated Split DRB with security key s-KgNB to MN terminated SCG DRB with security key change to KgNB.	<--	<i>RRCReconfiguration</i>	-	-
20	Check: Does the UE transmit an <i>RRCReconfigurationComplete</i> message including nr-SCG-Response?	-->	<i>RRCReconfigurationComplete</i>	7	P
21	Check: Does the test result of generic test procedure in TS 38.508-1 subclause 4.9.1 indicate that the UE is capable of exchanging IP data on SCG DRBn?	-	-	7	P
22	The SS transmits an <i>RRCReconfiguration</i> message containing NR RadioBearerConfig message to modify MN terminated SCG DRB with security key KgNB to SN terminated MCG DRB with security key change to s-KgNB.	<--	<i>RRCReconfiguration</i>	-	-
23	Check: Does the UE transmit an <i>RRCReconfigurationComplete</i> message including nr-SCG-Response?	-->	<i>RRCReconfigurationComplete</i>	8	P
24	Check: Does the test result of generic test procedure in TS 38.508-1 subclause 4.9.1 indicate that the UE is capable of exchanging IP data on MCG DRBn?	-	-	8	P
25	The SS transmits an <i>RRCReconfiguration</i> message containing NR RadioBearerConfig message to modify SN terminated MCG DRB with security key s-KgNB to MN terminated SCG DRB with security key change to KgNB.	<--	<i>RRCReconfiguration</i>	-	-
26	Check: Does the UE transmit an <i>RRCReconfigurationComplete</i> message including nr-SCG-Response?	-->	<i>RRCReconfigurationComplete</i>	9	P
27	Check: Does the test result of generic test procedure in TS 38.508-1 subclause 4.9.1 indicate that the UE is capable of exchanging IP data on SCG DRBn?	-	-	9	P

8.2.2.8.2.3.3 Specific message contents

Table 8.2.2.8.2.3.3-1: *RRCReconfiguration* (step 1, Table 8.2.2.8.2.3.2-1)

Derivation Path: TS 38.508-1 [4], Table 4.6.1-13			
Information Element	Value/remark	Comment	Condition
<i>RRCReconfiguration</i> ::= SEQUENCE {			
criticalExtensions CHOICE {			
rrcReconfiguration SEQUENCE {			
nonCriticalExtension SEQUENCE {			
nonCriticalExtension SEQUENCE {			
nonCriticalExtension SEQUENCE {			
mrdc-SecondaryCellGroupConfig CHOICE {			
setup SEQUENCE {			
mrdc-SecondaryCellGroup CHOICE {			
nr-SCG	OCTET STRING (CONTAINING <i>RRCReconfiguration-SCG</i>)		
}			
}			
}			
}			
}			
}			
radioBearerConfig2	RadioBearerConfig-SCG	See Table 8.2.2.8.2.3.3-1B	

}			
}			
}			
}			
}			
}			

Table 8.2.2.8.2.3.3-1A: RadioBearerConfig-SCG (Table 8.2.2.8.2.3.3-8, Table 8.2.2.8.2.3.3-21, Table 8.2.2.8.2.3.3-28)

Derivation Path: TS 38.508-1 [4], Table 4.6.3-132 with condition DRB1 and Re-establish_PDCP			
Information Element	Value/remark	Comment	Condition
RadioBearerConfig ::= SEQUENCE {			
drb-ToAddModList SEQUENCE (SIZE (1..maxDRB))	1 entry		
OF {			
DRB-ToAddMod[1] SEQUENCE {		entry 1	
drb-Identity	DRB-Identity using condition DRBn	DRBn is allocated for SCG according to internal TTCN mapping	
pdcp-Config	PDCP-Config with Condition Split		
}			
}			
}			

Table 8.2.2.8.2.3.3-1B: RadioBearerConfig-SCG (Table 8.2.2.8.2.3.3-1)

Derivation Path: TS 38.508-1 [4], Table 4.6.3-132 with condition DRB1 and Re-establish_PDCP			
Information Element	Value/remark	Comment	Condition
RadioBearerConfig ::= SEQUENCE {			
drb-ToAddModList SEQUENCE (SIZE (1..maxDRB))	1 entry		
OF {			
DRB-ToAddMod[1] SEQUENCE {		entry 1	
drb-Identity	DRB-Identity using condition DRBn	DRBn is allocated for SCG according to internal TTCN mapping	
pdcp-Config	PDCP-Config		
}			
}			
}			

Table 8.2.2.8.2.3.3-2: RRCReconfiguration-SCG (Table 8.2.2.8.2.3.3-1)

Derivation Path: TS 38.508-1 [4], Table 4.6.1-13			
Information Element	Value/remark	Comment	Condition
RRCReconfiguration ::= SEQUENCE {			
secondaryCellGroup	CellGroupConfig		
}			

Table 8.2.2.8.2.3.3-3: CellGroupConfig (Table 8.2.2.8.2.3.3-2)

Derivation Path: TS 38.508-1, table 4.6.1-3 with condition PSCell_Change			
Information Element	Value/remark	Comment	Condition
CellGroupConfig ::= SEQUENCE {			
cellGroupId	CellGroupId as per TS38.508-1[4] Table 4.6.3-20 condition NR-DC_SCG		

rlc-BearerToAddModList SEQUENCE (SIZE(1..maxLC-ID)) OF RLC-BearerConfig {	1 entry		
RLC-BearerConfig[1]	RLC-BearerConfig as per TS 38.508-1[4] Table 4.6.3-148: <i>RLC-BearerConfig</i> with conditions AM and DRBn and Re-establish_RLC	DRBn is allocated for SCG according to internal TTCN mapping	
}			
}			

Table 8.2.2.8.2.3.3-4: RRCReconfiguration (step 4, Table 8.2.2.8.2.3.2-1)

Derivation Path: TS 38.508-1 [4], Table 4.6.1-13			
Information Element	Value/remark	Comment	Condition
RRCReconfiguration ::= SEQUENCE {			
criticalExtensions CHOICE {			
rrcReconfiguration SEQUENCE {			
nonCriticalExtension SEQUENCE {			
masterCellGroup	CellGroupConfig-MCG	OCTET STRING (CONTAINING CellGroupConfig)	
nonCriticalExtension SEQUENCE {			
nonCriticalExtension SEQUENCE {			
mrdc-SecondaryCellGroupConfig CHOICE {			
setup SEQUENCE {			
mrdc-SecondaryCellGroup CHOICE {			
nr-SCG	OCTET STRING (CONTAINING RRCReconfiguration-SCG)		
}			
}			
}			
radioBearerConfig2	RadioBearerConfig-SCG	See Table 8.2.2.8.2.3.3-4A	
}			
}			
}			
}			
}			

Table 8.2.2.8.2.3.3-4A: RadioBearerConfig-SCG (Table 8.2.2.8.2.3.3-4, Table 8.2.2.8.2.3.3-17)

Derivation Path: TS 38.508-1 [4], Table 4.6.3-132 with condition DRB1 and Re-establish_PDCP			
Information Element	Value/remark	Comment	Condition
RadioBearerConfig ::= SEQUENCE {			
drb-ToAddModList SEQUENCE (SIZE (1..maxDRB)) OF {	1 entry		
DRB-ToAddMod[1] SEQUENCE {		entry 1	
drb-Identity	DRB-Identity using condition DRBn	DRBn is allocated for SCG according to internal TTCN mapping	
pdcp-Config	PDCP-Config-Split	Table 8.2.2.8.2.3.3-4B	
}			
}			
securityConfig SEQUENCE {			
keyToUse	secondary		
}			
}			

Table 8.2.2.8.2.3.3-4B: PDCP-Config-Split (Table 8.2.2.8.2.3.3-4A

Derivation Path: TS 38.508-1 [4], Table 4.6.3-99 with condition Split			
Information Element	Value/remark	Comment	Condition
PDCP-Config ::= SEQUENCE {			
moreThanOneRLC SEQUENCE {			
primaryPath SEQUENCE {			
cellGroup	1		
logicalChannel	LogicalChannelIdentity		
}			
}			
}			

Table 8.2.2.8.2.3.3-5: CellGroupConfig-MCG (Table 8.2.2.8.2.3.3-4)

Derivation Path: TS 38.508-1, table 4.6.3-19			
Information Element	Value/remark	Comment	Condition
CellGroupConfig ::= SEQUENCE {			
rlc-BearerToAddModList SEQUENCE	1 entry		
(SIZE(1..maxLC-ID)) OF RLC-BearerConfig {			
RLC-BearerConfig[1]	RLC-BearerConfig as per TS 38.508-1[4] Table 4.6.3-148: <i>RLC-BearerConfig</i> with conditions DRBn	DRBn is allocated for SCG according to internal TTCN mapping	
}			
}			

Table 8.2.2.8.2.3.3-6: RRCReconfiguration-SCG (Table 8.2.2.8.2.3.3-4)

Derivation Path: TS 38.508-1 [4], Table 4.6.1-13			
Information Element	Value/remark	Comment	Condition
RRCReconfiguration ::= SEQUENCE {			
secondaryCellGroup	CellGroupConfig-SCG		
}			

Table 8.2.2.8.2.3.3-7: CellGroupConfig-SCG (Table 8.2.2.8.2.3.3-6)

Derivation Path: TS 38.508-1, table 4.6.1-3 with condition PSCell_Change			
Information Element	Value/remark	Comment	Condition
CellGroupConfig ::= SEQUENCE {			
cellGroupId	CellGroupId as per TS38.508-1[4] Table 4.6.3-20 condition NR-DC_SCG		
rlc-BearerToAddModList SEQUENCE	1 entry		
(SIZE(1..maxLC-ID)) OF RLC-BearerConfig {			
RLC-BearerConfig[1]	RLC-BearerConfig as per TS 38.508-1[4] Table 4.6.3-148: <i>RLC-BearerConfig</i> with conditions AM and DRBm and Re-establish_RLC	entry 1 DRBn is allocated according to internal TTCN mapping	
}			
}			

Table 8.2.2.8.2.3.3-8: RRCReconfiguration (step 7, Table 8.2.2.8.2.3.2-1)

Derivation Path: TS 38.508-1 [4], Table 4.6.1-13			
Information Element	Value/remark	Comment	Condition

RRCReconfiguration ::= SEQUENCE {			
criticalExtensions CHOICE {			
rrcReconfiguration SEQUENCE {			
radioBearerConfig	RadioBearerConfig according to TS 38.508-1[4] Table 4.6.3-132: <i>RadioBearerConfig</i> with conditions SRB1, SRB2, DRBm, and Re-establish_PDCP	DRBm is DRB(s) on MCG are allocated according to internal TTCN mapping	
nonCriticalExtension SEQUENCE {			
masterCellGroup	CellGroupConfig-MCG	OCTET STRING (CONTAINING CellGroupConfig)	
nonCriticalExtension SEQUENCE {			
nonCriticalExtension SEQUENCE {			
mrdc-SecondaryCellGroupConfig CHOICE {			
setup SEQUENCE {			
mrdc-SecondaryCellGroup CHOICE {			
nr-SCG	OCTET STRING (CONTAINING RRCReconfiguration-SCG)		
}			
}			
}			
radioBearerConfig2	RadioBearerConfig-SCG	See Table 8.2.2.8.2.3.3-8A	
}			
}			
}			
}			
}			
}			

Table 8.2.2.8.2.3.3-8A: RadioBearerConfig-SCG (Table 8.2.2.8.2.3.3-8)

Derivation Path: TS 38.508-1 [4], Table 4.6.3-132 with condition DRB1 and Re-establish_PDCP			
Information Element	Value/remark	Comment	Condition
RadioBearerConfig ::= SEQUENCE {			
drb-ToAddModList SEQUENCE (SIZE (1..maxDRB))	1 entry		
OF {			
DRB-ToAddMod[1] SEQUENCE {		entry 1	
drb-Identity	DRB-Identity using condition DRBn	DRBn is allocated for SCG according to internal TTCN mapping	
pdcp-Config	PDCP-Config-Split	Table 8.2.2.8.2.3.3-8B	
}			
}			
securityConfig SEQUENCE {			
keyToUse	master		
}			
}			

Table 8.2.2.8.2.3.3-8B: PDCP-Config-Split (Table 8.2.2.8.2.3.3-8A)

Derivation Path: TS 38.508-1 [4], Table 4.6.3-99 with condition Split			
Information Element	Value/remark	Comment	Condition
PDCP-Config ::= SEQUENCE {			
moreThanOneRLC SEQUENCE {			
primaryPath SEQUENCE {			
cellGroup	1		

logicalChannel	LogicalChannelIdentity		
}			
}			
}			

Table 8.2.2.8.2.3.3-9: CellGroupConfig-MCG (Table 8.2.2.8.2.3.3-8)

Derivation Path: TS 38.508-1, table 4.6.3-19 with condition PCell_Change			
Information Element	Value/remark	Comment	Condition
CellGroupConfig ::= SEQUENCE {			
rlc-BearerToAddModList SEQUENCE			
(SIZE(1..maxLC-ID)) OF RLC-BearerConfig {			
RLC-BearerConfig[1]	RLC-BearerConfig as per TS 38.508-1[4] Table 4.6.3-148: <i>RLC-BearerConfig</i> with conditions SRB1, SRB2, DRBm, DRBn and Re-establish_RLC	DRBm is DRB(s) on MCG and DRBn is DRB on SCG are allocated according to internal TTCN mapping.	
}			
}			

Table 8.2.2.8.2.3.3-10: RRCReconfiguration-SCG (Table 8.2.2.8.2.3.3-8)

Derivation Path: TS 38.508-1 [4], Table 4.6.1-13			
Information Element	Value/remark	Comment	Condition
RRCReconfiguration ::= SEQUENCE {			
secondaryCellGroup	CellGroupConfig		
}			

Table 8.2.2.8.2.3.3-11: CellGroupConfig (Table 8.2.2.8.2.3.3-10)

Derivation Path: TS 38.508-1, table 4.6.1-3 with condition NR-DC_SCG			
Information Element	Value/remark	Comment	Condition
CellGroupConfig ::= SEQUENCE {			
rlc-BearerToAddModList SEQUENCE	1 entry		
(SIZE(1..maxLC-ID)) OF RLC-BearerConfig {			
RLC-BearerConfig[1]	RLC-BearerConfig as per TS 38.508-1[4] Table 4.6.3-148: <i>RLC-BearerConfig</i> with conditions AM and DRBn and Re-establish_RLC	entry 1 DRBn is allocated according to internal TTCN mapping	
}			
}			

Table 8.2.2.8.2.3.3-12: RRCReconfiguration (step 10, Table 8.2.2.8.2.3.2-1)

Derivation Path: TS 38.508-1 [4], Table 4.6.1-13			
Information Element	Value/remark	Comment	Condition
RRCReconfiguration ::= SEQUENCE {			
criticalExtensions CHOICE {			
rrcReconfiguration SEQUENCE {			
nonCriticalExtension SEQUENCE {			
masterCellGroup	CellGroupConfig	OCTET STRING (CONTAINING CellGroupConfig)	
nonCriticalExtension SEQUENCE {			
nonCriticalExtension SEQUENCE {			
mrdc-SecondaryCellGroupConfig CHOICE {			
release			
}			

radioBearerConfig2	RadioBearerConfig		
}			
}			
}			
}			
}			

Table 8.2.2.8.2.3.3-13: CellGroupConfig (Table 8.2.2.8.2.3.3-12)

Derivation Path: TS 38.508-1, table 4.6.3-19 with condition PCell_Change			
Information Element	Value/remark	Comment	Condition
CellGroupConfig ::= SEQUENCE {			
rlc-BearerToAddModList SEQUENCE (SIZE(1..maxLC-ID)) OF RLC-BearerConfig {	1 entry		
RLC-BearerConfig[1]	RLC-BearerConfig as per TS 38.508-1[4] Table 4.6.3-148: <i>RLC-BearerConfig</i> with conditions SRB1, SRB2, DRBn, DRBm and Re-establish_RLC	DRBn and DRBm are allocated according to internal TTCN mapping	
}			
}			

Table 8.2.2.8.2.3.3-14: RadioBearerConfig (Table 8.2.2.8.2.3.3-12)

Derivation Path: TS 38.508-1 [4], Table 4.6.1-13			
Information Element	Value/remark	Comment	Condition
RadioBearerConfig ::= SEQUENCE {			
drb-ToAddModList SEQUENCE (SIZE (1..maxRB)) OF DRB-ToAddMod {	1 entry		
DRB-ToAddMod[1] SEQUENCE {			
cnAssociation CHOICE {			
sdap-Config	SDAP-Config		
}			
drb-Identity	DRB-Identity using condition DRBm		
reestablishPDCP	True		
recoverPDCP	Not present		
pdcp-Config	PDCP-Config		
}			
securityConfig SEQUENCE {			
keyToUse	Secondary		
}			
}			

Table 8.2.2.8.2.3.3-15: RRCReconfiguration (step 13, Table 8.2.2.8.2.3.2-1)

Derivation Path: TS 38.508-1 [4], Table 4.6.1-13			
Information Element	Value/remark	Comment	Condition
RRCReconfiguration ::= SEQUENCE {			
criticalExtensions CHOICE {			
rrcReconfiguration SEQUENCE {			
radioBearerConfig	RadioBearerConfig according to TS 38.508-1[4] Table 4.6.3-132: <i>RadioBearerConfig</i> with conditions SRB1, SRB2, DRBn, DRBm, Re-establish_PDCP	DRBn and DRBm is allocated according to internal TTCN mapping	
nonCriticalExtension SEQUENCE {			

masterCellGroup	CellGroupConfig	OCTET STRING (CONTAINING CellGroupConfig)	
}			
}			
}			
}			

Table 8.2.2.8.2.3.3-16: CellGroupConfig (Table 8.2.2.8.2.3.3-15)

Derivation Path: TS 38.508-1, table 4.6.3-19 with condition PCell_Change			
Information Element	Value/remark	Comment	Condition
CellGroupConfig ::= SEQUENCE {			
rlc-BearerToAddModList SEQUENCE (SIZE(1..maxLC-ID)) OF RLC-BearerConfig {	1 entry		
RLC-BearerConfig[1]	RLC-BearerConfig as per TS 38.508-1[4] Table 4.6.3-148: <i>RLC-BearerConfig</i> with conditions SRB1, SRB2, DRBn, DRBm and Re-establish_RLC	DRBn on MCG and DRBm on SCG are allocated according to internal TTCN mapping	
}			

Table 8.2.2.8.2.3.3-17: RRCReconfiguration (step 16, Table 8.2.2.8.2.3.2-1)

Derivation Path: TS 38.508-1 [4], Table 4.6.1-13			
Information Element	Value/remark	Comment	Condition
RRCReconfiguration ::= SEQUENCE {			
criticalExtensions CHOICE {			
rrcReconfiguration SEQUENCE {			
radioBearerConfig	RadioBearerConfig according to TS 38.508-1[4] Table 4.6.3-132: <i>RadioBearerConfig</i> with conditions SRB1, SRB2, DRBm, Re-establish_PDCP	DRBm on MCG is allocated according to internal TTCN mapping	
nonCriticalExtension SEQUENCE {			
masterCellGroup	CellGroupConfig-MCG	OCTET STRING (CONTAINING CellGroupConfig)	
nonCriticalExtension SEQUENCE {			
nonCriticalExtension SEQUENCE {			
mrdc-SecondaryCellGroupConfig CHOICE {			
setup SEQUENCE {			
mrdc-SecondaryCellGroup CHOICE {			
nr-SCG	OCTET STRING (CONTAINING RRCReconfiguration-SCG)		
}			
}			
}			
radioBearerConfig2	RadioBearerConfig-SCG	See Table 8.2.2.8.2.3.3-4A	
}			
}			
}			

Table 8.2.2.8.2.3.3-18: CellGroupConfig-MCG (Table 8.2.2.8.2.3.3-17)

Derivation Path: TS 38.508-1, table 4.6.3-19 with condition PCell_Change			
Information Element	Value/remark	Comment	Condition
CellGroupConfig ::= SEQUENCE {			
rlc-BearerToAddModList SEQUENCE			
(SIZE(1..maxLC-ID)) OF RLC-BearerConfig {			
RLC-BearerConfig[1]	RLC-BearerConfig as per TS 38.508-1[4] Table 4.6.3-148: <i>RLC-BearerConfig</i> with conditions SRB1, SRB2, DRBn, DRBm and Re-establish_RLC	DRBn on MCG and DRBm on SCG are allocated according to internal TTCN mapping	
}			
}			

Table 8.2.2.8.2.3.3-19: RRCReconfiguration-SCG (Table 8.2.2.8.2.3.3-17)

Derivation Path: TS 38.508-1 [4], Table 4.6.1-13			
Information Element	Value/remark	Comment	Condition
RRCReconfiguration ::= SEQUENCE {			
secondaryCellGroup	CellGroupConfig-SCG		
}			

Table 8.2.2.8.2.3.3-20: CellGroupConfig-SCG (Table 8.2.2.8.2.3.3-19)

Derivation Path: TS 38.508-1, table 4.6.1-3 with condition NR-DC_SCG			
Information Element	Value/remark	Comment	Condition
CellGroupConfig ::= SEQUENCE {			
rlc-BearerToAddModList SEQUENCE			
(SIZE(1..maxLC-ID)) OF RLC-BearerConfig {			
RLC-BearerConfig[1]	RLC-BearerConfig as per TS 38.508-1[4] Table 4.6.3-148: <i>RLC-BearerConfig</i> with conditions AM and DRBn	entry 1 DRBn is allocated according to internal TTCN mapping	
}			
}			

Table 8.2.2.8.2.3.3-21: RRCReconfiguration (step 19, Table 8.2.2.8.2.3.2-1)

Derivation Path: TS 38.508-1 [4], Table 4.6.1-13			
Information Element	Value/remark	Comment	Condition
RRCReconfiguration ::= SEQUENCE {			
criticalExtensions CHOICE {			
rrcReconfiguration SEQUENCE {			
nonCriticalExtension SEQUENCE {			
masterCellGroup	CellGroupConfig-MCG	OCTET STRING (CONTAINING CellGroupConfig)	
nonCriticalExtension SEQUENCE {			
nonCriticalExtension SEQUENCE {			
mrdc-SecondaryCellGroupConfig CHOICE {			
setup SEQUENCE {			
mrdc-SecondaryCellGroup CHOICE {			
nr-SCG	OCTET STRING (CONTAINING RRCReconfiguration-SCG)		
}			
}			
}			

radioBearerConfig2	RadioBearerConfig-SCG	See Table 8.2.2.8.2.3.3-1A	
}			
}			
}			
}			
}			

Table 8.2.2.8.2.3.3-22: CellGroupConfig-MCG (Table 8.2.2.8.2.3.3-21)

Derivation Path: TS 38.508-1, table 4.6.1-3 with condition PSCell_Change			
Information Element	Value/remark	Comment	Condition
CellGroupConfig ::= SEQUENCE {			
rlc-BearerToReleaseList SEQUENCE			
(SIZE(1..maxLC-ID)) OF LogicalChannelIdentity {			
LogicalChannelIdentity[1]	Logical ChannelID of DRBn		
}			
}			

Table 8.2.2.8.2.3.3-23: RRCReconfiguration-SCG (Table 8.2.2.8.2.3.3-21)

Derivation Path: TS 38.508-1 [4], Table 4.6.1-13			
Information Element	Value/remark	Comment	Condition
RRCReconfiguration ::= SEQUENCE {			
secondaryCellGroup	CellGroupConfig-SCG		

Table 8.2.2.8.2.3.3-24: CellGroupConfig (Table 8.2.2.8.2.3.3-23)

Derivation Path: TS 38.508-1, table 4.6.1-3 with condition PSCell_Change			
Information Element	Value/remark	Comment	Condition
CellGroupConfig ::= SEQUENCE {			
rlc-BearerToAddModList SEQUENCE	1 entry		
(SIZE(1..maxLC-ID)) OF RLC-BearerConfig {			
RLC-BearerConfig[1]	RLC-BearerConfig as per TS 38.508-1[4] Table 4.6.3-148: <i>RLC-BearerConfig</i> with conditions AM and DRBn and Re-establish_RLC	entry 1 DRBn is allocated according to internal TTCN mapping	
}			
}			

Table 8.2.2.8.2.3.3-25: RRCReconfiguration (step 22, Table 8.2.2.8.2.3.2-1)

Derivation Path: TS 38.508-1 [4], Table 4.6.1-13			
Information Element	Value/remark	Comment	Condition
RRCReconfiguration ::= SEQUENCE {			
criticalExtensions CHOICE {			
rrcReconfiguration SEQUENCE {			
nonCriticalExtension SEQUENCE {			
masterCellGroup	CellGroupConfig	OCTET STRING (CONTAINING CellGroupConfig)	
nonCriticalExtension SEQUENCE {			
nonCriticalExtension SEQUENCE {			
mrdc-SecondaryCellGroupConfig CHOICE {			
Release			
}			
}			
radioBearerConfig2	RadioBearerConfig		

}			
}			
}			
}			
}			
}			
}			

Table 8.2.2.8.2.3.3-26: CellGroupConfig (Table 8.2.2.8.2.3.3-25)

Derivation Path: TS 38.508-1, table 4.6.3-19			
Information Element	Value/remark	Comment	Condition
CellGroupConfig ::= SEQUENCE {			
rlc-BearerToAddModList SEQUENCE (SIZE(1..maxLC-ID)) OF RLC-BearerConfig {	1 entry		
RLC-BearerConfig[1]	RLC-BearerConfig as per TS 38.508-1[4] Table 4.6.3-148: <i>RLC-BearerConfig</i> with conditions DRBn	DRBn of SCG are allocated according to internal TTCN mapping	
}			
}			

Table 8.2.2.8.2.3.3-27: RadioBearerConfig (Table 8.2.2.8.2.3.3-26)

Derivation Path: TS 38.508-1 [4], Table 4.6.1-13			
Information Element	Value/remark	Comment	Condition
RadioBearerConfig ::= SEQUENCE {			
drb-ToAddModList SEQUENCE (SIZE (1..maxRB)) OF DRB-ToAddMod {	1 entry		
DRB-ToAddMod[1] SEQUENCE {			
cnAssociation CHOICE {			
sdap-Config	SDAP-Config		
}			
drb-Identity	DRB-Identity using condition DRBn	DRBn of SCG are allocated according to internal TTCN mapping	
reestablishPDCP	True		
recoverPDCP	Not present		
pdcpc-Config	PDCP-Config		
}			
securityConfig SEQUENCE {			
keyToUse	Secondary		
}			
}			

Table 8.2.2.8.2.3.3-28: RRCReconfiguration (step 25, Table 8.2.2.8.2.3.2-1)

Derivation Path: TS 38.508-1 [4], Table 4.6.1-13			
Information Element	Value/remark	Comment	Condition
RRCReconfiguration ::= SEQUENCE {			
criticalExtensions CHOICE {			
rrcReconfiguration SEQUENCE {			
nonCriticalExtension SEQUENCE {			
masterCellGroup	CellGroupConfig-MCG	OCTET STRING (CONTAINING CellGroupConfig)	
nonCriticalExtension SEQUENCE {			
nonCriticalExtension SEQUENCE {			
mrdc-SecondaryCellGroupConfig CHOICE {			
setup SEQUENCE {			

mrdc-SecondaryCellGroup CHOICE {			
nr-SCG	OCTET STRING (CONTAINING RRCReconfiguration-SCG)		
}			
}			
radioBearerConfig2	RadioBearerConfig-SCG	See Table 8.2.2.8.2.3.3-1A	
}			
}			
}			
}			
}			

Table 8.2.2.8.2.3.3-29: CellGroupConfig-MCG (Table 8.2.2.8.2.3.3-28)

Derivation Path: TS 38.508-1, table 4.6.1-3 with condition PSCell_Change			
Information Element	Value/remark	Comment	Condition
CellGroupConfig ::= SEQUENCE {			
rlc-BearerToReleaseList SEQUENCE (SIZE(1..maxLC-ID)) OF LogicalChannelIdentity {			
LogicalChannelIdentity[1]	Logical ChannelID of DRBn		
}			
}			

Table 8.2.2.8.2.3.3-30: RRCReconfiguration-SCG (Table 8.2.2.8.2.3.3-28)

Derivation Path: TS 38.508-1 [4], Table 4.6.1-13			
Information Element	Value/remark	Comment	Condition
RRCReconfiguration ::= SEQUENCE {			
secondaryCellGroup	CellGroupConfig		

Table 8.2.2.8.2.3.3-31: CellGroupConfig (Table 8.2.2.8.2.3.3-30)

Derivation Path: TS 38.508-1, table 4.6.1-3 with condition NR-DC_SCG			
Information Element	Value/remark	Comment	Condition
CellGroupConfig ::= SEQUENCE {			
rlc-BearerToAddModList SEQUENCE (SIZE(1..maxLC-ID)) OF RLC-BearerConfig {	1 entry		
RLC-BearerConfig[1]	RLC-BearerConfig as per TS 38.508-1[4] Table 4.6.3-148: RLC-BearerConfig with conditions AM and DRBn	entry 1 DRBn is allocated according to internal TTCN mapping	
}			
}			

8.2.2.8.3 Bearer Modification / Handling for bearer type change with security key change / NE-DC

8.2.2.8.3.1 Test Purpose (TP)

(1)

with { UE in RRC_CONNECTED state with NE-DC and SCG }
 ensure that {

```

when { UE receives an RRCReconfiguration message to modify the SN terminated SCG DRB to MN
terminated SCG DRB with security key change to  $K_{gNB}$  }
then { UE reconfigures the DRB and sends an RRCReconfigurationComplete message }
}

```

(2)

```

with { UE in RRC_CONNECTED state with NE-DC, and and MN terminated SCG DRB established with security
key  $K_{gNB}$  }
ensure that {
when { UE receives an RRCReconfiguration message to modify the MN terminated SCG DRB to SN
terminated Split DRB with security key change to  $s-K_{eNB}$  }
then { UE reconfigures the DRB and sends an RRCReconfigurationComplete message }
}

```

(3)

```

with { UE in NR RRC_CONNECTED state with NE-DC, and SN terminated Split DRB established with
security key  $s-K_{eNB}$  }
ensure that {
when { UE receives an RRCReconfiguration message to modify the SN terminated Split DRB to MN
terminated Split DRB with security key change to  $K_{gNB}$  }
then { UE reconfigures the DRB and sends an RRCReconfigurationComplete message }
}

```

(4)

```

with { UE in NR RRC_CONNECTED state with NE-DC, and, and MN terminated Split DRB established with
security key  $K_{gNB}$  }
ensure that {
when { UE receives an RRCConnectionReconfiguration message to modify the MN terminated Split DRB
to SN terminated MCG DRB (NR PDCP) with security key change to  $s-K_{eNB}$  }
then { UE reconfigures the DRB and sends an RRCConnectionReconfigurationComplete message }
}

```

(5)

```

with { UE in NR RRC_CONNECTED state with NE-DC, and, and SN terminated MCG DRB established with
security key  $s-K_{eNB}$  }
ensure that {
when { UE receives an RRCConnectionReconfiguration message to modify the SN terminated MCG DRB (NR
PDCP) to MN terminated MCG DRB (NR PDCP) with security key change to  $K_{gNB}$  }
then { UE reconfigures the DRB and sends an RRCConnectionReconfigurationComplete message }
}

```

(6)

```

with { UE in NR RRC_CONNECTED state with NE-DC, and, and MN terminated MCG DRB established with
security key  $K_{gNB}$  }
ensure that {
when { UE receives an RRCConnectionReconfiguration message to modify the MN terminated MCG DRB (NR
PDCP) to SN terminated Split DRB with security key change to  $s-K_{eNB}$  }
then { UE reconfigures the DRB and sends an RRCConnectionReconfigurationComplete message }
}

```

(7)

```

with { UE in NR RRC_CONNECTED state with NE-DC, and, and SN terminated Split DRB established with
security key  $s-K_{eNB}$  }
ensure that {
when { UE receives an RRCConnectionReconfiguration message to modify the SN terminated Split DRB
to MN terminated SCG DRB with security key change to  $K_{gNB}$  }
then { UE reconfigures the DRB and sends an RRCConnectionReconfigurationComplete message }
}

```

(8)

```

with { UE in NR RRC_CONNECTED state with NE-DC, and, and MN terminated SCG DRB established with
security key  $K_{gNB}$  }
ensure that {
when { UE receives an RRCConnectionReconfiguration message to modify the MN terminated SCG DRB to
SN terminated MCG DRB (NR PDCP) with security key change to  $s-K_{eNB}$  }
}

```

```

then { UE reconfigures the DRB and sends an RRCConnectionReconfigurationComplete message }
}

```

(9)

```

with { UE in NR RRC_CONNECTED state with NE-DC, and, and SN terminated MCG DRB established with
security key  $s-K_{eNB}$  }
ensure that {
  when { UE receives an RRCConnectionReconfiguration message to modify the SN terminated MCG DRB (NR
PDCP) to MN terminated SCG DRB with security key change to  $K_{gNB}$  }
    then { UE reconfigures the DRB and sends an RRCConnectionReconfigurationComplete message }
}

```

8.2.2.8.3.2 Conformance requirements

References: The conformance requirements covered in the present TC are specified in: TS 38.331, clause 5.3.5.3 and TS 36.331 clauses 5.3.5.3 and 5.3.10.3a1, TS 37.340, clause Annex A. Unless otherwise stated these are Rel-15 requirements.

[TS 38.331, clause 5.3.5.3]

The UE shall perform the following actions upon reception of the RRCReconfiguration, or upon execution of the conditional reconfiguration (CHO, CPA or CPC):

...

1> if the *RRCReconfiguration* includes the *mrdc-SecondaryCellGroupConfig*:

2> if the *mrdc-SecondaryCellGroupConfig* is set to *setup*:

3> if the *mrdc-SecondaryCellGroupConfig* includes *mrdc-ReleaseAndAdd*:

4> perform MR-DC release as specified in clause 5.3.5.10;

3> if the received *mrdc-SecondaryCellGroup* is set to *nr-SCG*:

4> perform the RRC reconfiguration according to 5.3.5.3 for the *RRCReconfiguration* message included in *nr-SCG*;

3> if the received *mrdc-SecondaryCellGroup* is set to *eutra-SCG*:

4> perform the RRC connection reconfiguration as specified in TS 36.331 [10], clause 5.3.5.3 for the *RRCConnectionReconfiguration* message included in *eutra-SCG*;

2> else (*mrdc-SecondaryCellGroupConfig* is set to *release*):

3> perform MR-DC release as specified in clause 5.3.5.10;

...

1> set the content of the *RRCReconfigurationComplete* message as follows:

...

2> if the *RRCReconfiguration* message includes the *mrdc-SecondaryCellGroupConfig* with *mrdc-SecondaryCellGroup* set to *eutra-SCG*:

3> include in the *eutra-SCG-Response* the *E-UTRA RRCConnectionReconfigurationComplete* message in accordance with TS 36.331 [10] clause 5.3.5.3;

[TS 36.331, clause 5.3.5.3]

If the *RRCConnectionReconfiguration* message does not include the *mobilityControlInfo* and the UE is able to comply with the configuration included in this message, the UE shall:

...

1> if the UE is configured with NE-DC:

- 2> if the received *RRCConnectionReconfiguration* message was included in an NR *RRCResume* message:
 - 3> transfer the *RRCConnectionReconfigurationComplete* message via SRB1 embedded in NR RRC message *RRCResumeComplete* as specified in TS 38.331 [82], clause 5.3.13.4;
- 2> else:
 - 3> transfer the *RRCConnectionReconfigurationComplete* message via SRB1 embedded in NR RRC message *RRCReconfigurationComplete* as specified in TS 38.331 [82], clause 5.3.5.3;
- 1> else:
 - 2> submit the *RRCConnectionReconfigurationComplete* message to lower layers for transmission using the new configuration, upon which the procedure ends;

[TS 36.331, clause 5.3.10.3a1]

For the *drb-Identity* value for which this procedure is initiated, the UE shall:

- 1> if *drb-ToAddModListSCG* is received and includes the *drb-Identity* value; and *drb-Identity* value is not part of the current UE configuration (i.e. DC specific DRB establishment):
 - 2> if *drb-ToAddModList* is received and includes the *drb-Identity* value (i.e. add split DRB):
 - 3> establish a PDCP entity and configure it with the current MCG security configuration and in accordance with the *pdcp-Config* included in *drb-ToAddModList*;
 - 3> establish an MCG RLC entity and an MCG DTCH logical channel in accordance with the *rlc-Config*, *logicalChannelIdentity* and *logicalChannelConfig* included in *drb-ToAddModList*;
 - 3> establish an SCG RLC entity and an SCG DTCH logical channel in accordance with the *rlc-ConfigSCG*, *logicalChannelIdentitySCG* and *logicalChannelConfigSCG* included in *drb-ToAddModListSCG*;
 - 2> else (i.e. add SCG DRB):
 - 3> establish a PDCP entity and configure it with the current SCG security configuration and in accordance with the *pdcp-Config* included in *drb-ToAddModListSCG*;
 - 3> establish a primary SCG RLC entity or entities and a primary SCG DTCH logical channel in accordance with the *rlc-ConfigSCG*, *logicalChannelIdentitySCG* and *logicalChannelConfigSCG* included in *drb-ToAddModListSCG*;
 - 3> if *rlc-BearerConfigSecondary* is included with value *setup*:
 - 4> establish a secondary SCG RLC entity or entities and an associated DTCH logical channel in accordance with the received *rlc-BearerConfigSecondary* and associate these with the E-UTRA PDCP entity with the same value of *srb-Identity* within the current UE configuration;
 - 2> indicate the establishment of the DRB(s) and the *eps-BearerIdentity* of the established DRB(s) to upper layers;
- 1> else (i.e. DC specific DRB modification; *drb-ToAddModList* and/ or *drb-ToAddModListSCG* received):
 - 2> if the DRB indicated by *drb-Identity* is a split DRB:
 - 3> if *drb-ToAddModList* is received and includes the *drb-Identity* value, while for this entry *drb-TypeChange* is included and set to *toMCG* (i.e. split to MCG):
 - 4> release the SCG RLC entity or entities and the SCG DTCH logical channel(s);
 - 4> reconfigure the PDCP entity in accordance with the *pdcp-Config*, if included in *drb-ToAddModList*;
 - 4> reconfigure the primary MCG RLC entity and/ or the primary MCG DTCH logical channel in accordance with the *rlc-Config* and *logicalChannelConfig*, if included in *drb-ToAddModList*;
 - 4> if *rlc-BearerConfigSecondary* is included with value *setup*;

- 5> establish a secondary MCG RLC entity or entities and an associated DTCH logical channel in accordance with the received *rlc-BearerConfigSecondary* and associate these with the E-UTRA PDCP entity with the same value of *srb-Identity* within the current UE configuration;
- 3> else (i.e. reconfigure split):
 - 4> reconfigure the PDCP entity in accordance with the *pdcp-Config*, if included in *drb-ToAddModList*;
 - 4> reconfigure the MCG RLC entity and/ or the MCG DTCH logical channel in accordance with the *rlc-Config* and *logicalChannelConfig*, if included in *drb-ToAddModList*;
 - 4> reconfigure the SCG RLC entity and/ or the SCG DTCH logical channel in accordance with the *rlc-ConfigSCG* and *logicalChannelConfigSCG*, if included in *drb-ToAddModListSCG*;
- 2> if the DRB indicated by *drb-Identity* is an SCG DRB:
 - 3> if *drb-ToAddModList* is received and includes the *drb-Identity* value, while for this entry *drb-TypeChange* is included and set to *toMCG* (i.e. SCG to MCG):
 - 4> reconfigure the PDCP entity with the current MCG security configuration and in accordance with the *pdcp-Config*, if included in *drb-ToAddModList*;
 - 4> reconfigure the SCG RLC entity or entities (both primary and secondary, if configured) and the SCG DTCH logical channel (both primary and secondary, if configured) to be an MCG RLC entity or entities and an MCG DTCH logical channel;
 - 4> reconfigure the primary MCG RLC entity or entities and/ or the primary MCG DTCH logical channel in accordance with the *rlc-Config*, *logicalChannelIdentity* and *logicalChannelConfig*, if included in *drb-ToAddModList*;
 - 4> if *rlc-BearerConfigSecondary* is included with value *release*:
 - 5> release the secondary MCG RLC entity or entities as well as the associated DTCH logical channel;
 - 4> if *rlc-BearerConfigSecondary* is included with value *setup*:
 - 5> if the current DRB configuration does not include a secondary RLC bearer:
 - 6> establish a secondary MCG RLC entity or entities and an associated DTCH logical channel in accordance with the received *rlc-BearerConfigSecondary* and associate these with the E-UTRA PDCP entity with the same value of *srb-Identity* within the current UE configuration;
 - 5> else:
 - 6> reconfigure the secondary MCG RLC entity or entities and the associated DTCH logical channel in accordance with the received *rlc-BearerConfigSecondary*;
 - 3> else (i.e. *drb-ToAddModListSCG* is received and includes the *drb-Identity* value i.e. reconfigure SCG):
 - 4> reconfigure the PDCP entity in accordance with the *pdcp-Config*, if included in *drb-ToAddModListSCG*;
 - 4> reconfigure the primary SCG RLC entity or entities and/ or the primary SCG DTCH logical channel in accordance with the *rlc-ConfigSCG* and *logicalChannelConfigSCG*, if included in *drb-ToAddModListSCG*;
 - 4> if *rlc-BearerConfigSecondary* is included with value *release*:
 - 5> release the secondary SCG RLC entity or entities as well as the associated DTCH logical channel;
 - 4> if *rlc-BearerConfigSecondary* is included with value *setup*:
 - 5> if the current DRB configuration does not include a secondary RLC bearer:
 - 6> establish a secondary SCG RLC entity or entities and an associated DTCH logical channel in accordance with the received *rlc-BearerConfigSecondary* and associate these with the E-UTRA PDCP entity with the same value of *srb-Identity* within the current UE configuration;

- 5> else:
- 6> reconfigure the secondary SCG RLC entity or entities and the associated DTCH logical channel in accordance with the received *rlc-BearerConfigSecondary*;
- 2> if the DRB indicated by *drb-Identity* is an MCG DRB:
- 3> if *drb-ToAddModListSCG* is received and includes the *drb-Identity* value, while for this entry *drb-Type* is included and set to *split* (i.e. MCG to split):
- 4> reconfigure the PDCP entity in accordance with the *pdcp-Config*, if included in *drb-ToAddModList*;
- 4> reconfigure the primary MCG RLC entity and/ or the primary MCG DTCH logical channel in accordance with the *rlc-Config* and *logicalChannelConfig*, if included in *drb-ToAddModList*;
- 4> if *rlc-BearerConfigSecondary* is included with value *release*:
- 5> release the secondary MCG RLC entity or entities as well as the associated DTCH logical channel;
- 4> establish an SCG RLC entity and an SCG DTCH logical channel in accordance with the *rlc-ConfigSCG*, *logicalChannelIdentitySCG* and *logicalChannelConfigSCG*, included in *drb-ToAddModListSCG*;
- 3> else (i.e. *drb-Type* is included and set to *scg* i.e. MCG to SCG):
- 4> reconfigure the PDCP entity with the current SCG security configuration and in accordance with the *pdcp-Config*, if included in *drb-ToAddModListSCG*;
- 4> reconfigure the MCG RLC entity or entities (both primary and secondary, if configured) and the MCG DTCH logical channel (both primary and secondary, if configured) to be an SCG RLC entity or entities and an SCG DTCH logical channel;
- 4> reconfigure the primary SCG RLC entity or entities and/ or the primary SCG DTCH logical channel in accordance with the *rlc-ConfigSCG*, *logicalChannelIdentitySCG* and *logicalChannelConfigSCG*, if included in *drb-ToAddModListSCG*;
- 4> if *rlc-BearerConfigSecondary* is included with value *release*:
- 5> release the secondary SCG RLC entity or entities as well as the associated DTCH logical channel;
- 4> if *rlc-BearerConfigSecondary* is included with value *setup*:
- 5> if the current DRB configuration does not include a secondary RLC bearer:
- 6> establish a secondary SCG RLC entity or entities and an associated DTCH logical channel in accordance with the received *rlc-BearerConfigSecondary* and associate these with the E-UTRA PDCP entity with the same value of *srb-Identity* within the current UE configuration;
- 5> else:
- 6> reconfigure the secondary SCG RLC entity or entities and the associated DTCH logical channel in accordance with the received *rlc-BearerConfigSecondary*;

[TS 37.340, Annex A]

This clause provides for information an overview on L2 handling for bearer type change in MR-DC, with and without a security key change due to a change of the termination point.

Table A-1: L2 handling for bearer type change with and without a security key change due to a change of the termination point.

Bearer type change from row to col	MCG		Split		SCG	
	no change of termination point	change of termination point (key change)	no change of termination point	change of termination point (key change)	no change of termination point (no key)	change of termination point (key change)

	(no key change)		(no key change)		change)	
MCG	N/A	PDCP: Re-establish MCG RLC: See Note 1 MCG MAC: See Note 1 SCG RLC: No action SCG MAC: No action	PDCP: Reconfigure MCG RLC: No action MCG MAC: No action SCG RLC: Establish SCG MAC: Reconfigure	PDCP: Re-establish MCG RLC: See Note 1 MCG MAC: See Note 1 SCG RLC: Establish SCG MAC: Reconfigure	PDCP: Recovery MCG RLC: See Note 3 MCG MAC: Reconfigure SCG RLC: Establish SCG MAC: Reconfigure	PDCP: Re-establish MCG RLC: See Note 3 MCG MAC: Reconfigure SCG RLC: Establish SCG MAC: Reconfigure
Split	PDCP: Recovery MCG RLC: No action MCG MAC: No action SCG RLC: See Note 4 SCG MAC: Reconfigure	PDCP: Re-establish MCG RLC: See Note 1 MCG MAC: See Note 1 SCG RLC: See Note 4 SCG MAC: Reconfigure	N/A	PDCP: Re-establish MCG RLC: See Note 1 MCG MAC: See Note 1 SCG RLC: See Note 1 SCG MAC: See Note 1	PDCP: Recovery MCG RLC: See Note 3 MCG MAC: Reconfigure SCG RLC: No action SCG MAC: No action	PDCP: Re-establish MCG RLC: See Note 3 MCG MAC: Reconfigure SCG RLC: See Note 1 SCG MAC: See Note 1
SCG	PDCP: Recovery MCG RLC: Establish MCG MAC: Reconfigure SCG RLC: See Note 4 SCG MAC: Reconfigure	PDCP: Re-establish MCG RLC: Establish MCG MAC: Reconfigure SCG RLC: See Note 4 SCG MAC: Reconfigure	PDCP: Reconfigure MCG RLC: Establish MCG MAC: Reconfigure SCG RLC: No action SCG MAC: No action	PDCP: Re-establish MCG RLC: Establish MCG MAC: Reconfigure SCG RLC: See Note 1 SCG MAC: See Note 1	N/A	PDCP: Re-establish MCG RLC: No action MCG MAC: No action SCG RLC: See Note 1 SCG MAC: See Note 1

NOTE 1: For EN-DC and NGEN-DC MCG, NE-DC SCG: the MAC/RLC behaviour depends on the solution selected by the network. It can be PCell handover (for EN-DC and NGEN-DC) or PSCell change (for NE-DC), which triggers MAC reset and RLC re-establishment. Alternatively, the logical channel identity can be changed, either via RLC bearer release and add for the same DRB (including RLC re-establishment), or via reconfiguration of the RLC bearer with RLC-re-establishment.

For EN-DC and NGEN-DC SCG, NE-DC MCG, NR-DC MCG and SCG: the MAC/RLC behaviour depends on the solution selected by the network. It can be reconfiguration with sync, with MAC reset and RLC re-establishment. Alternatively, the logical channel identity can be changed via RLC bearer release and add.

NOTE 2: Void

NOTE 3: For EN-DC and NGEN-DC: Re-establishment and release. For NE-DC and NR-DC: Release.

NOTE 4: For NE-DC: Re-establishment and release. For EN-DC, NGEN-DC and NR-DC: Release.

8.2.2.8.3.3 Test description

8.2.2.8.3.3.1 Pre-test conditions

System Simulator:

- NR Cell 1 is the PCell and E-UTRA Cell 1 is the PSCell.

UE:

- None.

Preamble:

- If `pc_IP_Ping` is set to TRUE then, the UE is in state RRC_CONNECTED using generic procedure parameter Connectivity (*NE-DC*), Bearers (*MCG(s) and SCG*) established according to TS 38.508-1 [4], clause 4.5.4.
- Else, the UE is in state RRC_CONNECTED using generic procedure parameter Connectivity (*NE-DC*), Bearers (*MCG(s) and SCG*) established and Test Loop Function (On) with UE test loop mode B according to TS 38.508-1 [4], clause 4.5.4.

8.2.2.8.3.3.2 Test procedure sequence

Table 8.2.2.8.3.3.2-1: Main behaviour

St	Procedure	Message Sequence		TP	Verdict
		U - S	Message		
1	The SS transmits an <i>RRCReconfiguration</i> message containing E-UTRA <i>RRCReconfiguration</i> message to modify SN terminated SCG DRB with security key $s\text{-}K_{eNB}$ to MN terminated SCG DRB with security key change to K_{gNB} .	<--	<i>RRCReconfiguration</i> (<i>RRCCConnectionReconfiguration</i>)	-	-
2	Check: Does the UE transmit an <i>RRCReconfigurationComplete</i> message containing E-UTRA <i>RRCCConnectionReconfigurationComplete</i> message?	-->	<i>RRCReconfigurationComplete</i> (<i>RRCCConnectionReconfigurationC</i> <i>omplete</i>)	1	P
3	Check: Does the test result of generic test procedure in TS 38.508-1 subclause 4.9.1 indicate that the UE is capable of exchanging IP data on SCG DRB#2?	-	-	1	P
4	The SS transmits an <i>RRCReconfiguration</i> message containing E-UTRA <i>RRCReconfiguration</i> message to modify MN terminated SCG DRB with security key K_{gNB} to SN terminated Split DRB with security key change to $s\text{-}K_{eNB}$.	<--	<i>RRCReconfiguration</i> (<i>RRCCConnectionReconfiguration</i>)	-	-
5	Check: Does the UE transmit an <i>RRCReconfigurationComplete</i> message containing E-UTRA <i>RRCCConnectionReconfigurationComplete</i> message?	-->	<i>RRCReconfigurationComplete</i> (<i>RRCCConnectionReconfigurationC</i> <i>omplete</i>)	2	P
6	Check: Does the test result of generic test procedure in TS 38.508-1 subclause 4.9.1 indicate that the UE is capable of exchanging IP data on Split DRB#2 using NR radio path?	-	-	2	P
7	The SS transmits an <i>RRCReconfiguration</i> message containing E-UTRA <i>RRCReconfiguration</i> message to modify SN terminated Split DRB with security key $s\text{-}K_{eNB}$ to MN terminated Split DRB with security key change to K_{gNB} .	<--	<i>RRCReconfiguration</i> (<i>RRCCConnectionReconfiguration</i>)	-	-

8	Check: Does the UE transmit an <i>RRCReconfigurationComplete</i> message containing E-UTRA <i>RRCConnectionReconfigurationComplete</i> message?	-->	<i>RRCReconfigurationComplete</i> (<i>RRCConnectionReconfigurationComplete</i>)	3	P
9	Check: Does the test result of generic test procedure in TS 38.508-1 subclause 4.9.1 indicate that the UE is capable of exchanging IP data on Split DRB#2 using NR radio path?	-	-	3	P
10	The SS transmits an <i>RRCReconfiguration</i> message containing E-UTRA <i>RadioBearerConfig</i> to release to modify MN terminated Split DRB with security key K_{gNB} to SN terminated MCG DRB with security key change to $s-K_{eNB}$.	<--	<i>RRCReconfiguration</i>	-	-
11	Check: Does the UE transmit an <i>RRCReconfigurationComplete</i> message?	-->	<i>RRCReconfigurationComplete</i>	4	P
12	Check: Does the test result of generic test procedure in TS 38.508-1 subclause 4.9.1 indicate that the UE is capable of exchanging IP data on MCG DRB#2?	-	-	4	P
13	The SS transmits an <i>RRCReconfiguration</i> message containing NR <i>RadioBearerConfig</i> to modify SN terminated MCG DRB with security key $s-K_{eNB}$ to MN terminated MCG DRB with security key change to K_{gNB} .	<--	<i>RRCReconfiguration</i>	-	-
14	Check: Does the UE transmit an <i>RRCReconfigurationComplete</i> message?	-->	<i>RRCReconfigurationComplete</i>	5	P
15	Check: Does the test result of generic test procedure in TS 38.508-1 subclause 4.9.1 indicate that the UE is capable of exchanging IP data on MCG DRB#2?	-	-	5	P
16	The SS transmits an <i>RRCReconfiguration</i> message containing E-UTRA <i>RRCReconfiguration</i> message to modify MN terminated MCG DRB with security key K_{gNB} to SN terminated Split DRB with security key change to $s-K_{eNB}$.	<--	<i>RRCReconfiguration</i> (<i>RRCConnectionReconfiguration</i>)	-	-
17	Check: Does the UE transmit an <i>RRCReconfigurationComplete</i> message containing E-UTRA <i>RRCConnectionReconfigurationComplete</i> message?	-->	<i>RRCReconfigurationComplete</i> (<i>RRCConnectionReconfigurationComplete</i>)	6	P
18	Check: Does the test result of generic test procedure in TS 38.508-1 subclause 4.9.1 indicate that the UE is capable of exchanging IP data on Split DRB#2 using NR radio path?	-	-	6	P
19	The SS transmits an <i>RRCReconfiguration</i> message containing E-UTRA <i>RRCReconfiguration</i> message to modify SN terminated Split DRB with security key $s-K_{eNB}$ to MN terminated SCG DRB with security key change to K_{gNB} .	<--	<i>RRCReconfiguration</i> (<i>RRCConnectionReconfiguration</i>)	-	-
20	Check: Does the UE transmit an <i>RRCReconfigurationComplete</i> message containing E-UTRA <i>RRCConnectionReconfigurationComplete</i> message?	-->	<i>RRCReconfigurationComplete</i> (<i>RRCConnectionReconfigurationComplete</i>)	7	P
21	Check: Does the test result of generic test procedure in TS 38.508-1 subclause 4.9.1 indicate that the UE is capable of exchanging IP data on SCG DRB#2?	-	-	7	P
22	The SS transmits an <i>RRCReconfiguration</i> message containing E-UTRA <i>RRCReconfiguration</i> message to modify MN terminated SCG DRB with security key K_{gNB} to SN terminated MCG DRB with security key change to $s-K_{eNB}$.	<--	<i>RRCReconfiguration</i> (<i>RRCConnectionReconfiguration</i>)	-	-

23	Check: Does the UE transmit an <i>RRCReconfigurationComplete</i> message containing E-UTRA <i>RRCConnectionReconfigurationComplete</i> message?	-->	<i>RRCReconfigurationComplete</i> (<i>RRCConnectionReconfigurationComplete</i>)	8	P
24	Check: Does the test result of generic test procedure in TS 38.508-1 subclause 4.9.1 indicate that the UE is capable of exchanging IP data on MCG DRB#2?	-	-	8	P
25	The SS transmits an <i>RRCReconfiguration</i> message containing E-UTRA <i>RRCReconfiguration</i> message to modify SN terminated MCG DRB with security key $s\text{-}K_{eNB}$ to MN terminated SCG DRB with security key change to K_{gNB} .	<--	<i>RRCReconfiguration</i> (<i>RRCConnectionReconfiguration</i>)	-	-
26	Check: Does the UE transmit an <i>RRCReconfigurationComplete</i> message containing E-UTRA <i>RRCConnectionReconfigurationComplete</i> message?	-->	<i>RRCReconfigurationComplete</i> (<i>RRCConnectionReconfigurationComplete</i>)	9	P
27	Check: Does the test result of generic test procedure in TS 38.508-1 subclause 4.9.1 indicate that the UE is capable of exchanging IP data on SCG DRB#2?	-	-	9	P

8.2.2.8.3.3.3 Specific message contents

FFS

8.2.2.9 Bearer Modification / Uplink data path / Split DRB Reconfiguration

8.2.2.9.1 Bearer Modification / Uplink data path / Split DRB Reconfiguration / EN-DC

8.2.2.9.1.1 Test Purpose (TP)

(1)

```
with { UE in RRC_CONNECTED state with EN-DC, and, MCG(s) (E-UTRA PDCP) and Split }
ensure that {
  when { UE receives an RRCConnectionReconfiguration message to change the primaryPath to E-UTRA
radio path from NR }
  then { UE changes the uplink data path to E-UTRA radio path and sends an
RRCConnectionReconfigurationComplete message }
}
```

(2)

```
with { UE in RRC_CONNECTED state with EN-DC, and, MCG(s) (E-UTRA PDCP) and Split }
ensure that {
  when { UE receives an RRCConnectionReconfiguration message to change the primaryPath from E-UTRA
radio path to NR }
  then { UE changes the uplink data path to NR radio path and sends an
RRCConnectionReconfigurationComplete message }
}
```

8.2.2.9.1.2 Conformance requirements

References: The conformance requirements covered in the present test case are specified in: TS 36.331, clause 5.3.5.3, TS 38.331, clauses 5.3.5.3 and 5.3.5.6.5. Unless otherwise stated these are Rel-15 requirements.

[TS 36.331, clause 5.3.5.3]

If the *RRCConnectionReconfiguration* message does not include the *mobilityControlInfo* and the UE is able to comply with the configuration included in this message, the UE shall:

...

- 1> if the received *RRCCONNECTIONRECONFIGURATION* includes the *nr-Config* and it is set to *release*: or
- 1> if the received *RRCCONNECTIONRECONFIGURATION* includes *endc-ReleaseAndAdd* and it is set to *TRUE*:
 - 2> perform ENDC release as specified in TS38.331 [82], clause 5.3.5.10;
- 1> if the received *RRCCONNECTIONRECONFIGURATION* includes the *sk-Counter*:
 - 2> perform key update procedure as specified in TS 38.331 [82], clause 5.3.5.7;
- 1> if the received *RRCCONNECTIONRECONFIGURATION* includes the *nr-SecondaryCellGroupConfig*:
 - 2> perform NR RRC Reconfiguration as specified in TS 38.331 [82], clause 5.3.5.3;
- 1> if the received *RRCCONNECTIONRECONFIGURATION* includes the *nr-RadioBearerConfig1*:
 - 2> perform radio bearer configuration as specified in TS 38.331 [82], clause 5.3.5.6;
- 1> if the received *RRCCONNECTIONRECONFIGURATION* includes the *nr-RadioBearerConfig2*:
 - 2> perform radio bearer configuration as specified in TS 38.331 [82], clause 5.3.5.6;

...

- 1> set the content of *RRCCONNECTIONRECONFIGURATIONCOMPLETE* message as follows:
 - 2> if the *RRCCONNECTIONRECONFIGURATION* message includes *perCC-GapIndicationRequest*:
 - 3> include *perCC-GapIndicationList* and *numFreqEffective*;
 - 2> if the frequencies are configured for reduced measurement performance:
 - 3> include *numFreqEffectiveReduced*;
 - 2> if the received *RRCCONNECTIONRECONFIGURATION* message included *nr-SecondaryCellGroupConfig*:
 - 3> include *scg-ConfigResponseNR* in accordance with TS 38.331 [82], clause 5.3.5.3;
- 1> submit the *RRCCONNECTIONRECONFIGURATIONCOMPLETE* message to lower layers for transmission using the new configuration, upon which the procedure ends;

[TS 38.331, clause 5.3.5.3]

The UE shall perform the following actions upon reception of the *RRCReconfiguration*:

...

- 1> if the *RRCReconfiguration* includes the *secondaryCellGroup*:
 - 2> perform the cell group configuration for the SCG according to 5.3.5.5;
 - 1> if the *RRCReconfiguration* message contains the *radioBearerConfig*:
 - 2> perform the radio bearer configuration according to 5.3.5.6;
 - 1> if the *RRCReconfiguration* message includes the *measConfig*:
 - 2> perform the measurement configuration procedure as specified in 5.5.2
- ...
- 1> set the content of *RRCReconfigurationComplete* message as follows:
 - 2> if the *RRCReconfiguration* includes the *masterCellGroup* containing the *reportUplinkTxDirectCurrent*, or;
 - 2> if the *RRCReconfiguration* includes the *secondaryCellGroup* containing the *reportUplinkTxDirectCurrent*:

- 3> include the `uplinkTxDirectCurrentList`;
- 1> if the UE is configured with E-UTRA `nr-SecondaryCellGroupConfig` (MCG is E-UTRA):
 - 2> if `RRCReconfiguration` was received via SRB1:
 - 3> construct `RRCReconfigurationComplete` message and submit it via the EUTRA MCG embedded in E-UTRA RRC message `RRCConnectionReconfigurationComplete` as specified in TS 36.331 [10];
 - 3> if `reconfigurationWithSync` was included in `spCellConfig` of an SCG:
 - 4> initiate the random access procedure on the SpCell, as specified in TS 38.321 [3];
 - 3> else:
 - 4> the procedure ends;
 - NOTE: The order the UE sends the `RRCConnectionReconfigurationComplete` message and performs the Random Access procedure towards the SCG is left to UE implementation.
 - 2> else (`RRCReconfiguration` was received via SRB3):
 - 3> submit the `RRCReconfigurationComplete` message via SRB3 to lower layers for transmission using the new configuration.

NOTE: For EN-DC, in the case `RRCReconfiguration` is received via SRB1, the random access is triggered by RRC layer itself as there is not necessarily other UL transmission. In the case `RRCReconfiguration` is received via SRB3, the random access is triggered by the MAC layer due to arrival of `RRCReconfigurationComplete`.

- 1 > else:
 - 2> submit the `RRCReconfigurationComplete` message via SRB1 to lower layers for transmission using the new configuration;
 - 2> if this is the first `RRCReconfiguration` message after successful completion of the RRC re-establishment procedure:
 - 3> resume SRB2 and DRBs that are suspended;
- 1> if `reconfigurationWithSync` was included in `spCellConfig` of an MCG or SCG, and when MAC of an NR cell group successfully completes a random access procedure triggered above:
 - 2> stop timer T304 for that cell group;
 - 2> apply the parts of the CQI reporting configuration, the scheduling request configuration and the sounding RS configuration that do not require the UE to know the SFN of the respective target SpCell, if any;
 - 2> apply the parts of the measurement and the radio resource configuration that require the UE to know the SFN of the respective target SpCell (e.g. measurement gaps, periodic CQI reporting, scheduling request configuration, sounding RS configuration), if any, upon acquiring the SFN of that target SpCell;
 - 2> if the `reconfigurationWithSync` was included in `spCellConfig` of an MCG:
 - 3> if T390 is running:
 - 4> stop timer T390 for all access categories;
 - 4> perform the actions as specified in 5.3.14.4.
 - 3> if `RRCReconfiguration` does not include `dedicatedSIB1-Delivery` and
 - 3> if the active downlink BWP, which is indicated by the `firstActiveDownlinkBWP-Id` for the target SpCell of the MCG, has a common search space configured by `searchSpaceSIB1`:
 - 4> acquire the `SIB1`, which is scheduled as specified in TS 38.213 [13], of the target SpCell of the MCG;

4> upon acquiring *SIB1*, perform the actions specified in clause 5.2.2.4.2;

2> the procedure ends.

NOTE: The UE is only required to acquire broadcasted *SIB1* if the UE can acquire it without disrupting unicast data reception, i.e. the broadcast and unicast beams are quasi co-located.

[TS 38.331, clause 5.3.5.6.5]

The UE shall:

- 1> for each *drb-Identity* value included in the *drb-ToAddModList* that is not part of the current UE configuration (DRB establishment including the case when full configuration option is used):
 - 2> establish a PDCP entity and configure it in accordance with the received *pdcp-Config*;
 - 2> if the PDCP entity of this DRB is not configured with *cipheringDisabled*:
 - 3> if target RAT of handover is E-UTRA/5GC, or;
 - 3> if the UE is only connected to E-UTRA/5GC:
 - 4> configure the PDCP entity with the ciphering algorithm and K_{UPenc} key configured/derived as specified in TS 36.331 [10];
 - 3> else:
 - 4> configure the PDCP entity with the ciphering algorithms according to *securityConfig* and apply the K_{UPenc} key associated with the master key (K_{eNB}/K_{gNB}) or the secondary key ($S-K_{gNB}$) as indicated in *keyToUse*;
 - 2> if the PDCP entity of this DRB is configured with *integrityProtection*:
 - 3> configure the PDCP entity with the integrity algorithms according to *securityConfig* and apply the K_{UPint} key associated with the master (K_{eNB}/K_{gNB}) or the secondary key ($S-K_{gNB}$) as indicated in *keyToUse*;
- ...
- 2> if the UE is operating in EN-DC:
 - 3> if the DRB was configured with the same *eps-BearerIdentity* either by NR or E-UTRA prior to receiving this reconfiguration:
 - 4> associate the established DRB with the corresponding *eps-BearerIdentity*;
 - 3> else:
 - 4> indicate the establishment of the DRB(s) and the *eps-BearerIdentity* of the established DRB(s) to upper layers;
- 1> for each *drb-Identity* value included in the *drb-ToAddModList* that is part of the current UE configuration:
 - 2> if the *reestablishPDCP* is set:
 - 3> if target RAT is E-UTRA/5GC, or;
 - 3> if the UE is only connected to E-UTRA/5GC:
 - 4> if the PDCP entity of this DRB is not configured with *cipheringDisabled*:
 - 5> configure the PDCP entity with the ciphering algorithm and K_{UPenc} key configured/derived as specified in TS 36.331 [10], clause 5.4.2.3, i.e. the ciphering configuration shall be applied to all subsequent PDCP PDUs received and sent by the UE;
 - 3> else:
 - 4> if the PDCP entity of this DRB is not configured with *cipheringDisabled*:

- 5> configure the PDCP entity with the ciphering algorithm and K_{UPenc} key associated with the master key (K_{eNB}/K_{gNB}) or the secondary key ($S-K_{gNB}$), as indicated in *keyToUse*, i.e. the ciphering configuration shall be applied to all subsequent PDCP PDUs received and sent by the UE;
- 4> if the PDCP entity of this DRB is configured with *integrityProtection*:
 - 5> configure the PDCP entity with the integrity algorithms according to *securityConfig* and apply the K_{UPint} key associated with the master (K_{eNB}/K_{gNB}) or the secondary key ($S-K_{gNB}$) as indicated in *keyToUse*;
- 3> re-establish the PDCP entity of this DRB as specified in 38.323 [5], clause 5.1.2;
- 2> else, if the *recoverPDCP* is set:
 - 3> trigger the PDCP entity of this DRB to perform data recovery as specified in 38.323 [5];
- 2> if the *pdcp-Config* is included:
 - 3> reconfigure the PDCP entity in accordance with the received *pdcp-Config*.

...

NOTE 1: Void.

NOTE 2: When determining whether a *drb-Identity* value is part of the current UE configuration, the UE does not distinguish which *RadioBearerConfig* and *DRB-ToAddModList* that DRB was originally configured in. To re-associate a DRB with a different key (K_{eNB} to $S-K_{eNB}$ or vice versa), the network provides the *drb-Identity* value in the (target) *drb-ToAddModList* and sets the *reestablishPDCP* flag. The network does not list the *drb-Identity* in the (source) *drb-ToReleaseList*.

NOTE 3: When setting the *reestablishPDCP* flag for a radio bearer, the network ensures that the RLC receiver entities do not deliver old PDCP PDUs to the re-established PDCP entity. It does that e.g. by triggering a reconfiguration with sync of the cell group hosting the old RLC entity or by releasing the old RLC entity.

NOTE 4: In this specification, UE configuration refers to the parameters configured by NR RRC unless otherwise stated.

NOTE 5: Ciphering and integrity protection can be enabled or disabled for a DRB. The enabling/disabling of ciphering or integrity protection can be changed only by releasing and adding the DRB.

8.2.2.9.1.3 Test description

8.2.2.9.1.3.1 Pre-test conditions

System Simulator:

- E-UTRA Cell 1 is the PCell and NR Cell 1 is the PSCell.

UE:

- None.

Preamble:

- If *pc_IP_Ping* is set to TRUE then, the UE is in state RRC_CONNECTED using generic procedure parameter Connectivity (*EN-DC*), Bearers (*MCG(s) and Split*) established according to TS 38.508-1 [4], clause 4.5.4.
- Else, the UE is in state RRC_CONNECTED using generic procedure parameter Connectivity (*EN-DC*), Bearers (*MCG(s) and Split*) established and Test Loop Function (*On*) with UE test loop mode B according to TS 38.508-1 [4], clause 4.5.4.

8.2.2.9.1.3.2 Test procedure sequence

Table 8.2.2.9.1.3.2-1: Main behaviour

St	Procedure	Message Sequence		TP	Verdict
		U - S	Message		
1	The SS transmits an <i>RRCCONNECTIONRECONFIGURATION</i> message containing NR RadioBearerConfig to change the primaryPath of the Split DRB to E-UTRA radio path from NR.	<--	<i>RRCCONNECTIONRECONFIGURATION</i>	-	-
2	Check: Does the UE transmit an <i>RRCCONNECTIONRECONFIGURATIONCOMPLETE</i> message?	-->	<i>RRCCONNECTIONRECONFIGURATIONCOMPLETE</i>	1	P
3	Check: Does the test result of generic test procedure in TS 38.508-1 subclause 4.9.1 indicate that the UE is capable of exchanging IP data on Split DRB#2 using E-UTRA radio path in the uplink?	-	-	1	P
4	The SS transmits an <i>RRCCONNECTIONRECONFIGURATION</i> message containing NR RadioBearerConfig to change the primaryPath of the Split DRB from E-UTRA radio path to NR.	<--	<i>RRCCONNECTIONRECONFIGURATION</i>	-	-
5	Check: Does the UE transmit an <i>RRCCONNECTIONRECONFIGURATIONCOMPLETE</i> message?	-->	<i>RRCCONNECTIONRECONFIGURATIONCOMPLETE</i>	2	P
6	Check: Does the test result of generic test procedure in TS 38.508-1 subclause 4.9.1 indicate that the UE is capable of exchanging IP data on the Split DRB#2 using NR radio path in the uplink?	-	-	2	P

8.2.2.9.1.3.3 Specific message contents

Table 8.2.2.9.1.3.3-1: *RRCCONNECTIONRECONFIGURATION* (step 1, Table 8.2.2.9.1.3.2-1)

Derivation Path: TS 36.508 [7], Table 4.6.1-8			
Information Element	Value/remark	Comment	Condition
<i>RRCCONNECTIONRECONFIGURATION</i> ::= SEQUENCE {			
criticalExtensions CHOICE {			
c1 CHOICE {			
<i>rrcConnectionReconfiguration-r8</i> SEQUENCE {			
nonCriticalExtension SEQUENCE {			
nonCriticalExtension SEQUENCE {			
nonCriticalExtension SEQUENCE {			
nonCriticalExtension SEQUENCE {			
nonCriticalExtension SEQUENCE {			
nonCriticalExtension SEQUENCE {			
nonCriticalExtension SEQUENCE {			
nr-RadioBearerConfig1-r15	OCTET STRING including RadioBearerConfig.		
}			
}			
}			
}			
}			
}			
}			
}			
}			
}			
}			

}		
---	--	--

Table 8.2.2.9.1.3.3-2: RadioBearerConfig (Table 8.2.2.9.1.3.3-1)

Derivation Path: TS 38.508-1 [4], Table 4.6.3-132			
Information Element	Value/remark	Comment	Condition
RadioBearerConfig ::= SEQUENCE {			
drb-ToAddModList SEQUENCE (SIZE (1..maxDRB))	1 entry		
OF DRB-ToAddMod {			
DRB-ToAddMod[1] SEQUENCE {		entry 1	
pdcp-Config	PDCP-Config		
}			
}			
}			

Table 8.2.2.9.1.3.3-3: PDCP-Config (Table 8.2.2.9.1.3.3-2)

Derivation Path: TS 38.508-1 [4], Table 4.6.3-99			
Information Element	Value/remark	Comment	Condition
PDCP-Config ::= SEQUENCE {			
drb SEQUENCE {			
statusReportRequired	true		
}			
moreThanOneRLC SEQUENCE {			
primaryPath SEQUENCE {			
cellGroup	0		
}			
ul-DataSplitThreshold	infinity		
}			
}			

Table 8.2.2.9.1.3.3-4: RRCConnectionReconfiguration (step 4, Table 8.2.2.9.1.3.2-1)

Derivation Path: TS 36.508 [7], Table 4.6.1-8			
Information Element	Value/remark	Comment	Condition
RRCConnectionReconfiguration ::= SEQUENCE {			
criticalExtensions CHOICE {			
c1 CHOICE {			
rrcConnectionReconfiguration-r8 SEQUENCE {			
nonCriticalExtension SEQUENCE {			
nonCriticalExtension SEQUENCE {			
nonCriticalExtension SEQUENCE {			
nonCriticalExtension SEQUENCE {			
nonCriticalExtension SEQUENCE {			
nonCriticalExtension SEQUENCE {			
nr-RadioBearerConfig1-r15	OCTET STRING including RadioBearerConfig.		
}			
}			
}			
}			
}			
}			
}			
}			
}			
}			

Table 8.2.2.9.1.3.3-5: RadioBearerConfig (Table 8.2.2.9.1.3.3-4)

Derivation Path: TS 38.508-1 [4], Table 4.6.3-132			
Information Element	Value/remark	Comment	Condition
RadioBearerConfig ::= SEQUENCE {			
drb-ToAddModList SEQUENCE (SIZE (1..maxDRB))	1 entry		
OF DRB-ToAddMod {			
DRB-ToAddMod[1] SEQUENCE {		entry 1	
pdcp-Config	PDCP-Config		
}			
}			
}			

Table 8.2.2.9.1.3.3-6: PDCP-Config (Table 8.2.2.9.1.3.3-5)

Derivation Path: TS 38.508-1 [4], Table 4.6.3-99			
Information Element	Value/remark	Comment	Condition
PDCP-Config ::= SEQUENCE {			
drb SEQUENCE {			
statusReportRequired	true		
}			
moreThanOneRLC SEQUENCE {			
primaryPath SEQUENCE {			
cellGroup	1		
}			
ul-DataSplitThreshold	infinity		
}			
}			

8.2.2.9.2 Bearer Modification / Uplink data path / Split DRB Reconfiguration / NR-DC

8.2.2.9.2.1 Test Purpose (TP)

(1)

```
with { UE in RRC_CONNECTED state with NR-DC,and, MCG and Split }
ensure that {
  when { UE receives an RRCReconfiguration message to change the primaryPath to MCG radio path from
SCG radio path }
  then { UE changes the uplink data path to MCG radio path and sends an RRCReconfigurationComplete
message }
}
```

(2)

```
with { UE in RRC_CONNECTED state with NR-DC, and, MCG and Split }
ensure that {
  when { UE receives an RRCReconfiguration message to change the primaryPath to SCG radio path from
MCG radio path }
  then { UE changes the uplink data path to SCG radio path and sends an RRCReconfigurationComplete
message }
}
```

8.2.2.9.2.2 Conformance requirements

References: The conformance requirements covered in the present test case are specified in: TS 38.331, clauses 5.3.5.3 and 5.3.5.6.5. Unless otherwise stated these are Rel-15 requirements.

[TS 38.331, clause 5.3.5.3]

The UE shall perform the following actions upon reception of the *RRCReconfiguration*, or upon execution of the conditional reconfiguration (CHO or CPC):

- 1> if the *RRCReconfiguration* is applied due to a conditional reconfiguration execution upon cell selection while timer T311 is running, as defined in 5.3.7.3:
 - 2> remove all the entries within *VarConditionalReconfig*, if any;
 - ...
- 1> else:
 - 2> if the *RRCReconfiguration* includes the *fullConfig*:
 - 3> perform the full configuration procedure as specified in 5.3.5.11;
- 1> if the *RRCReconfiguration* includes the *masterCellGroup*:
 - 2> perform the cell group configuration for the received *masterCellGroup* according to 5.3.5.5;
- 1> if the *RRCReconfiguration* includes the *masterKeyUpdate*:
 - 2> perform AS security key update procedure as specified in 5.3.5.7;
- 1> if the *RRCReconfiguration* includes the *sk-Counter*:
 - 2> perform security key update procedure as specified in 5.3.5.7;
- 1> if the *RRCReconfiguration* includes the *secondaryCellGroup*:
 - 2> perform the cell group configuration for the SCG according to 5.3.5.5;
 -
- 1> if the *RRCReconfiguration* message includes the *radioBearerConfig*:
 - 2> perform the radio bearer configuration according to 5.3.5.6;
 - ...
- 1> set the content of the *RRCReconfigurationComplete* message as follows:
 -
 - 2> if the *RRCReconfiguration* message was received via SRB1, but not within *mrdc-SecondaryCellGroup* or E-UTRA *RRCConnectionReconfiguration*:
 - 3> if the UE is configured to provide the measurement gap requirement information of NR target bands:
 - 4> if the *RRCReconfiguration* message includes the *needForGapsConfigNR*; or
 - 4> if the *NeedForGapsInfoNR* information is changed compared to last time the UE reported this information:
 - 5> include the *NeedForGapsInfoNR* and set the contents as follows:
 - 6> include *intraFreq-needForGap* and set the gap requirement information of intra-frequency measurement for each NR serving cell;
 - 6> if *requestedTargetBandFilterNR* is configured, for each supported NR band that is also included in *requestedTargetBandFilterNR*, include an entry in *interFreq-needForGap* and set the gap requirement information for that band; otherwise, include an entry in *interFreq-needForGap* and set the corresponding gap requirement information for each supported NR band;
 - ...
- 1> else (*RRCReconfiguration* was received via SRB1):
 - 2> submit the *RRCReconfigurationComplete* message via SRB1 to lower layers for transmission using the new configuration;

- 2> if this is the first *RRCReconfiguration* message after successful completion of the RRC re-establishment procedure:
- 3> resume SRB2 and DRBs that are suspended;

...

[TS 38.331, clause 5.3.5.6.5]

The UE shall:

- 1> for each *drb-Identity* value included in the *drb-ToAddModList* that is not part of the current UE configuration (DRB establishment including the case when full configuration option is used):
 - 2> establish a PDCP entity and configure it in accordance with the received *pdcp-Config*;
 - ...
 - 3> else (i.e., UE connected to NR or UE connected to E-UTRA/EPC):
 - 4> configure the PDCP entity with the ciphering algorithms according to *securityConfig* and apply the K_{UPenc} key associated with the master key (K_{eNB}/K_{gNB}) or the secondary key ($S-K_{gNB}/S-K_{eNB}$) as indicated in *keyToUse*;
 - 2> if the PDCP entity of this DRB is configured with *integrityProtection*:
 - 3> configure the PDCP entity with the integrity protection algorithms according to *securityConfig* and apply the K_{UPint} key associated with the master (K_{gNB}) or the secondary key ($S-K_{gNB}$) as indicated in *keyToUse*;
 -
- 1> for each *drb-Identity* value included in the *drb-ToAddModList* that is part of the current UE configuration and not configured as DAPS bearer:
 - ...
 - 2> if the *pdcp-Config* is included:
 - 3> reconfigure the PDCP entity in accordance with the received *pdcp-Config*.
 - ...

NOTE 1: Void.

NOTE 2: When determining whether a *drb-Identity* value is part of the current UE configuration, the UE does not distinguish which *RadioBearerConfig* and *DRB-ToAddModList* that DRB was originally configured in. To re-associate a DRB with a different key (K_{eNB} to $S-K_{gNB}$, K_{gNB} to $S-K_{eNB}$, K_{gNB} to $S-K_{gNB}$, or vice versa), the network provides the *drb-Identity* value in the (target) *drb-ToAddModList* and sets the *reestablishPDCP* flag. The network does not list the *drb-Identity* in the (source) *drb-ToReleaseList*.

NOTE 3: When setting the *reestablishPDCP* flag for a radio bearer, the network ensures that the RLC receiver entities do not deliver old PDCP PDUs to the re-established PDCP entity. It does that e.g. by triggering a reconfiguration with sync of the cell group hosting the old RLC entity or by releasing the old RLC entity.

NOTE 4: In this specification, UE configuration refers to the parameters configured by NR RRC unless otherwise stated.

NOTE 5: Ciphering and integrity protection can be enabled or disabled for a DRB. The enabling/disabling of ciphering or integrity protection can be changed only by releasing and adding the DRB.

8.2.2.9.2.3 Test description

8.2.2.9.2.3.1 Pre-test conditions

System Simulator:

- NR Cell 1 is the PCell and NR Cell 10 is the PSCell.
- System information combination NR-1 as defined in TS 38.508-1 [4] clause 4.4.3.1.3 is used in NR cell 1.

UE:

- None.

Preamble:

- If *pc_IP_Ping* is set to TRUE then, the UE is in state RRC_CONNECTED using generic procedure parameter Connectivity (*NR-DC*), Bearers (*MCG(s) and Split*) established according to TS 38.508-1 [4], clause 4.5.4.
- Else, the UE is in state RRC_CONNECTED using generic procedure parameter Connectivity (*NR-DC*), Bearers (*MCG and Split*) established and Test Loop Function (*On*) with UE test loop mode B according to TS 38.508-1 [4], clause 4.5.4.

8.2.2.9.2.3.2 Test procedure sequence

Table 8.2.2.9.2.3.2-1: Main behaviour

St	Procedure	Message Sequence		TP	Verdict
		U - S	Message		
1	The SS transmits an <i>RRCReconfiguration</i> message containing NR RadioBearerConfig to change the primaryPath to MCG radio path from SCG radio path.	<--	NR RRC: <i>RRCReconfiguration</i>	-	-
2	Check: Does the UE transmit an <i>RRCReconfigurationComplete</i> message?	-->	NR RRC: <i>RRCReconfigurationComplete</i>	1	P
3	Check: Does the test result of generic test procedure in TS 38.508-1 subclause 4.9.1 indicate that the UE is capable of exchanging IP data on Split DRB#n using MCG radio path in the uplink?	-	-	1	P
4	The SS transmits an <i>RRCReconfiguration</i> message containing NR RadioBearerConfig to change the primaryPath to SCG radio path from MCG radio path.	<--	NR RRC: <i>RRCReconfiguration</i>	-	-
5	Check: Does the UE transmit an <i>RRCReconfigurationComplete</i> message?	-->	NR RRC: <i>RRCReconfigurationComplete</i>	2	P
6	Check: Does the test result of generic test procedure in TS 38.508-1 subclause 4.9.1 indicate that the UE is capable of exchanging IP data on on Split DRB#n using SCG radio path in the uplink?	-	-	2	P

8.2.2.9.2.3.3 Specific message contents

Table 8.2.2.9.2.3.3-1: *RRCReconfiguration* (step 4, Table 8.2.2.9.2.3.2-1)

Derivation Path: TS 38.508-1 [4], Table 4.6.1-13			
Information Element	Value/remark	Comment	Condition
<i>RRCReconfiguration</i> ::= SEQUENCE {			
criticalExtensions CHOICE {			
rrcReconfiguration SEQUENCE {			
nonCriticalExtension SEQUENCE {			
nonCriticalExtension SEQUENCE {			

nonCriticalExtension SEQUENCE {			
radioBearerConfig2	RadioBearerConfig-NR-DC_SCG	See Table 8.2.2.9.2.3.3-2	
}			
}			
}			
}			
}			

Table 8.2.2.9.2.3.3-2: RadioBearerConfig-NR-DC_SCG (Table 8.2.2.9.2.3.3-1)

Derivation Path: TS 38.508-1 [4], Table 4.6.3-132 with condition DRBn			
Information Element	Value/remark	Comment	Condition
RadioBearerConfig ::= SEQUENCE {			
drb-ToAddModList SEQUENCE (SIZE (1..maxDRB))	1 entry		
OF DRB-ToAddMod {			
DRB-ToAddMod[1] SEQUENCE {		entry 1	
drb-Identity	DRB-Identity with condition DRBn	DRBn is allocated for SCG according to internal TTCN mapping	
pdcp-Config	PDCP-Config		
}			
}			
}			

Table 8.2.2.9.2.3.3-3: PDCP-Config (Table 8.2.2.9.2.3.3-2)

Derivation Path: TS 38.508-1 [4], Table 4.6.3-99			
Information Element	Value/remark	Comment	Condition
PDCP-Config ::= SEQUENCE {			
drb SEQUENCE {			
statusReportRequired	True		
}			
moreThanOneRLC SEQUENCE {			
primaryPath SEQUENCE {			
cellGroup	1		
}			
ul-DataSplitThreshold	Infinity		
}			
}			

Table 8.2.2.9.2.3.3-4: RRCReconfiguration (step 1, Table 8.2.2.9.2.3.2-1)

Derivation Path: TS 38.508-1 [4], Table 4.6.1-13			
Information Element	Value/remark	Comment	Condition
RRCReconfiguration ::= SEQUENCE {			
criticalExtensions CHOICE {			
rrcReconfiguration SEQUENCE {			
nonCriticalExtension SEQUENCE {			
nonCriticalExtension SEQUENCE {			
nonCriticalExtension SEQUENCE {			
radioBearerConfig2	RadioBearerConfig-NR-DC_SCG	See Table 8.2.2.9.2.3.3-5	
}			
}			
}			
}			
}			
}			

Table 8.2.2.9.2.3.3-5: RadioBearerConfig-NR-DC_SCG (Table 8.2.2.9.2.3.3-4)

Derivation Path: TS 38.508-1 [4], Table 4.6.3-132 with condition DRBn			
Information Element	Value/remark	Comment	Condition
RadioBearerConfig ::= SEQUENCE {			
drb-ToAddModList SEQUENCE (SIZE (1..maxDRB))	1 entry		
OF DRB-ToAddMod {			
DRB-ToAddMod[1] SEQUENCE {		entry 1	
drb-Identity	DRB-Identity with condition DRBn	DRBn is allocated for SCG according to internal TTCN mapping	
}			
}	PDCP-Config		
}			
}			
}			

Table 8.2.2.9.2.3.3-6: PDCP-Config (Table 8.2.2.9.2.3.3-5)

Derivation Path: TS 38.508-1 [4], Table 4.6.3-99			
Information Element	Value/remark	Comment	Condition
PDCP-Config ::= SEQUENCE {			
drb SEQUENCE {			
statusReportRequired	true		
}			
moreThanOneRLC SEQUENCE {			
primaryPath SEQUENCE {			
cellGroup	0		
}			
}	infinity		
}			
}			

8.2.2.9.3 Bearer Modification / Uplink data path / Split DRB Reconfiguration / NE-DC

8.2.2.9.3.1 Test Purpose (TP)

(1)

```
with { UE in RRC_CONNECTED state with NE-DC, and, MCG(s) and Split }
ensure that {
  when { UE receives an RRCReconfiguration message to change the primaryPath to NR radio path from EUTRA }
  then { UE changes the uplink data path to NR radio path and sends an RRCReconfigurationComplete message }
}
```

(2)

```
with { UE in RRC_CONNECTED state with NE-DC, and, MCG(s) and Split }
ensure that {
  when { UE receives an RRCReconfiguration message to change the primaryPath from NR radio path to EUTRA }
  then { UE changes the uplink data path to EUTRA radio path and sends an RRCReconfigurationComplete message }
}
```

8.2.2.9.3.2 Conformance requirements

References: The conformance requirements covered in the present TC are specified in: TS 38.331, clause 5.3.5.3 and TS 36.331 clauses 5.3.5.3 and 5.3.10.3a1. Unless and otherwise stated these are Rel-15 requirements

[TS 38.331, clause 5.3.5.3]

The UE shall perform the following actions upon reception of the *RRCReconfiguration*, or upon execution of the conditional reconfiguration (CHO, CPA or CPC):

...

1> if the *RRCReconfiguration* includes the *mrdc-SecondaryCellGroupConfig*:

2> if the *mrdc-SecondaryCellGroupConfig* is set to *setup*:

3> if the *mrdc-SecondaryCellGroupConfig* includes *mrdc-ReleaseAndAdd*:

4> perform MR-DC release as specified in clause 5.3.5.10;

3> if the received *mrdc-SecondaryCellGroup* is set to *nr-SCG*:

4> perform the RRC reconfiguration according to 5.3.5.3 for the *RRCReconfiguration* message included in *nr-SCG*;

3> if the received *mrdc-SecondaryCellGroup* is set to *eutra-SCG*:

4> perform the RRC connection reconfiguration as specified in TS 36.331 [10], clause 5.3.5.3 for the *RRCConnectionReconfiguration* message included in *eutra-SCG*;

2> else (*mrdc-SecondaryCellGroupConfig* is set to *release*):

3> perform MR-DC release as specified in clause 5.3.5.10;

...

1> set the content of the *RRCReconfigurationComplete* message as follows:

...

2> if the *RRCReconfiguration* message includes the *mrdc-SecondaryCellGroupConfig* with *mrdc-SecondaryCellGroup* set to *eutra-SCG*:

3> include in the *eutra-SCG-Response* the *E-UTRA RRCConnectionReconfigurationComplete* message in accordance with TS 36.331 [10] clause 5.3.5.3;

[TS 36.331, clause 5.3.5.3]

If the *RRCConnectionReconfiguration* message does not include the *mobilityControlInfo* and the UE is able to comply with the configuration included in this message, the UE shall:

...

1> if the UE is configured with NE-DC:

2> if the received *RRCConnectionReconfiguration* message was included in an NR *RRCResume* message:

3> transfer the *RRCConnectionReconfigurationComplete* message via SRB1 embedded in NR RRC message *RRCResumeComplete* as specified in TS 38.331 [82], clause 5.3.13.4;

2> else:

3> transfer the *RRCConnectionReconfigurationComplete* message via SRB1 embedded in NR RRC message *RRCReconfigurationComplete* as specified in TS 38.331 [82], clause 5.3.5.3;

1> else:

2> submit the *RRCConnectionReconfigurationComplete* message to lower layers for transmission using the new configuration, upon which the procedure ends;

[TS 36.331, clause 5.3.10.3a1]

For the *drb-Identity* value for which this procedure is initiated, the UE shall:

- 1> if *drb-ToAddModListSCG* is received and includes the *drb-Identity* value; and *drb-Identity* value is not part of the current UE configuration (i.e. DC specific DRB establishment):
 - 2> if *drb-ToAddModList* is received and includes the *drb-Identity* value (i.e. add split DRB):
 - 3> establish a PDCP entity and configure it with the current MCG security configuration and in accordance with the *pdcp-Config* included in *drb-ToAddModList*;
 - 3> establish an MCG RLC entity and an MCG DTCH logical channel in accordance with the *rlc-Config*, *logicalChannelIdentity* and *logicalChannelConfig* included in *drb-ToAddModList*;
 - 3> establish an SCG RLC entity and an SCG DTCH logical channel in accordance with the *rlc-ConfigSCG*, *logicalChannelIdentitySCG* and *logicalChannelConfigSCG* included in *drb-ToAddModListSCG*;
 - 2> else (i.e. add SCG DRB):
 - 3> establish a PDCP entity and configure it with the current SCG security configuration and in accordance with the *pdcp-Config* included in *drb-ToAddModListSCG*;
 - 3> establish a primary SCG RLC entity or entities and a primary SCG DTCH logical channel in accordance with the *rlc-ConfigSCG*, *logicalChannelIdentitySCG* and *logicalChannelConfigSCG* included in *drb-ToAddModListSCG*;
 - 3> if *rlc-BearerConfigSecondary* is included with value *setup*;
 - 4> establish a secondary SCG RLC entity or entities and an associated DTCH logical channel in accordance with the received *rlc-BearerConfigSecondary* and associate these with the E-UTRA PDCP entity with the same value of *srb-Identity* within the current UE configuration;
 - 2> indicate the establishment of the DRB(s) and the *eps-BearerIdentity* of the established DRB(s) to upper layers;
- 1> else (i.e. DC specific DRB modification; *drb-ToAddModList* and/ or *drb-ToAddModListSCG* received):
 - 2> if the DRB indicated by *drb-Identity* is a split DRB:
 - 3> if *drb-ToAddModList* is received and includes the *drb-Identity* value, while for this entry *drb-TypeChange* is included and set to *toMCG* (i.e. split to MCG):
 - 4> release the SCG RLC entity or entities and the SCG DTCH logical channel(s);
 - 4> reconfigure the PDCP entity in accordance with the *pdcp-Config*, if included in *drb-ToAddModList*;
 - 4> reconfigure the primary MCG RLC entity and/ or the primary MCG DTCH logical channel in accordance with the *rlc-Config* and *logicalChannelConfig*, if included in *drb-ToAddModList*;
 - 4> if *rlc-BearerConfigSecondary* is included with value *setup*;
 - 5> establish a secondary MCG RLC entity or entities and an associated DTCH logical channel in accordance with the received *rlc-BearerConfigSecondary* and associate these with the E-UTRA PDCP entity with the same value of *srb-Identity* within the current UE configuration;
 - 3> else (i.e. reconfigure split):
 - 4> reconfigure the PDCP entity in accordance with the *pdcp-Config*, if included in *drb-ToAddModList*;
 - 4> reconfigure the MCG RLC entity and/ or the MCG DTCH logical channel in accordance with the *rlc-Config* and *logicalChannelConfig*, if included in *drb-ToAddModList*;
 - 4> reconfigure the SCG RLC entity and/ or the SCG DTCH logical channel in accordance with the *rlc-ConfigSCG* and *logicalChannelConfigSCG*, if included in *drb-ToAddModListSCG*;
 - 2> if the DRB indicated by *drb-Identity* is an SCG DRB:
 - 3> if *drb-ToAddModList* is received and includes the *drb-Identity* value, while for this entry *drb-TypeChange* is included and set to *toMCG* (i.e. SCG to MCG):

- 4> reconfigure the PDCP entity with the current MCG security configuration and in accordance with the *pdcp-Config*, if included in *drb-ToAddModList*;
- 4> reconfigure the SCG RLC entity or entities (both primary and secondary, if configured) and the SCG DTCH logical channel (both primary and secondary, if configured) to be an MCG RLC entity or entities and an MCG DTCH logical channel;
- 4> reconfigure the primary MCG RLC entity or entities and/ or the primary MCG DTCH logical channel in accordance with the *rlc-Config*, *logicalChannelIdentity* and *logicalChannelConfig*, if included in *drb-ToAddModList*;
- 4> if *rlc-BearerConfigSecondary* is included with value *release*:
 - 5> release the secondary MCG RLC entity or entities as well as the associated DTCH logical channel;
- 4> if *rlc-BearerConfigSecondary* is included with value *setup*:
 - 5> if the current DRB configuration does not include a secondary RLC bearer:
 - 6> establish a secondary MCG RLC entity or entities and an associated DTCH logical channel in accordance with the received *rlc-BearerConfigSecondary* and associate these with the E-UTRA PDCP entity with the same value of *srb-Identity* within the current UE configuration;
 - 5> else:
 - 6> reconfigure the secondary MCG RLC entity or entities and the associated DTCH logical channel in accordance with the received *rlc-BearerConfigSecondary*;
- 3> else (i.e. *drb-ToAddModListSCG* is received and includes the *drb-Identity* value i.e. reconfigure SCG):
 - 4> reconfigure the PDCP entity in accordance with the *pdcp-Config*, if included in *drb-ToAddModListSCG*;
 - 4> reconfigure the primary SCG RLC entity or entities and/ or the primary SCG DTCH logical channel in accordance with the *rlc-ConfigSCG* and *logicalChannelConfigSCG*, if included in *drb-ToAddModListSCG*;
 - 4> if *rlc-BearerConfigSecondary* is included with value *release*:
 - 5> release the secondary SCG RLC entity or entities as well as the associated DTCH logical channel;
 - 4> if *rlc-BearerConfigSecondary* is included with value *setup*:
 - 5> if the current DRB configuration does not include a secondary RLC bearer:
 - 6> establish a secondary SCG RLC entity or entities and an associated DTCH logical channel in accordance with the received *rlc-BearerConfigSecondary* and associate these with the E-UTRA PDCP entity with the same value of *srb-Identity* within the current UE configuration;
 - 5> else:
 - 6> reconfigure the secondary SCG RLC entity or entities and the associated DTCH logical channel in accordance with the received *rlc-BearerConfigSecondary*;
- 2> if the DRB indicated by *drb-Identity* is an MCG DRB:
 - 3> if *drb-ToAddModListSCG* is received and includes the *drb-Identity* value, while for this entry *drb-Type* is included and set to *split* (i.e. MCG to split):
 - 4> reconfigure the PDCP entity in accordance with the *pdcp-Config*, if included in *drb-ToAddModList*;
 - 4> reconfigure the primary MCG RLC entity and/ or the primary MCG DTCH logical channel in accordance with the *rlc-Config* and *logicalChannelConfig*, if included in *drb-ToAddModList*;
 - 4> if *rlc-BearerConfigSecondary* is included with value *release*:
 - 5> release the secondary MCG RLC entity or entities as well as the associated DTCH logical channel;

- 4> establish an SCG RLC entity and an SCG DTCH logical channel in accordance with the *rlc-ConfigSCG*, *logicalChannelIdentitySCG* and *logicalChannelConfigSCG*, included in *drb-ToAddModListSCG*;
- 3> else (i.e. *drb-Type* is included and set to *scg* i.e. MCG to SCG):
 - 4> reconfigure the PDCP entity with the current SCG security configuration and in accordance with the *pdcp-Config*, if included in *drb-ToAddModListSCG*;
 - 4> reconfigure the MCG RLC entity or entities (both primary and secondary, if configured) and the MCG DTCH logical channel (both primary and secondary, if configured) to be an SCG RLC entity or entities and an SCG DTCH logical channel;
 - 4> reconfigure the primary SCG RLC entity or entities and/ or the primary SCG DTCH logical channel in accordance with the *rlc-ConfigSCG*, *logicalChannelIdentitySCG* and *logicalChannelConfigSCG*, if included in *drb-ToAddModListSCG*;
 - 4> if *rlc-BearerConfigSecondary* is included with value *release*:
 - 5> release the secondary SCG RLC entity or entities as well as the associated DTCH logical channel;
 - 4> if *rlc-BearerConfigSecondary* is included with value *setup*:
 - 5> if the current DRB configuration does not include a secondary RLC bearer:
 - 6> establish a secondary SCG RLC entity or entities and an associated DTCH logical channel in accordance with the received *rlc-BearerConfigSecondary* and associate these with the E-UTRA PDCP entity with the same value of *srb-Identity* within the current UE configuration;
 - 5> else:
 - 6> reconfigure the secondary SCG RLC entity or entities and the associated DTCH logical channel in accordance with the received *rlc-BearerConfigSecondary*;

8.2.2.9.3.3 Test description

8.2.2.9.3.3.1 Pre-test conditions

System Simulator:

- NR Cell 1 is the PCell and E-UTRA Cell 1 is the PSCell.

UE:

- None.

Preamble:

- If *pc_IP_Ping* is set to TRUE then, the UE is in state RRC_CONNECTED using generic procedure parameter Connectivity (*NE-DC*), Bearers (*MCG(s) and Split*) established according to TS 38.508-1 [4], clause 4.5.4.
- Else, the UE is in state RRC_CONNECTED using generic procedure parameter Connectivity (*NE-DC*), Bearers (*MCG(s) and Split*) established and Test Loop Function (*On*) with UE test loop mode B according to TS 38.508-1 [4], clause 4.5.4.

8.2.2.9.3.3.2 Test procedure sequence

Table 8.2.2.9.3.3.2-1: Main behaviour

St	Procedure	Message Sequence		TP	Verdict
		U - S	Message		
1	The SS transmits an <i>RRCReconfiguration</i> message containing NR RadioBearerConfig to	<--	<i>RRCReconfiguration</i>	-	-

	change the primaryPath of the Split DRB to NR radio path from E-UTRA.				
2	Check: Does the UE transmit an <i>RRCReconfigurationComplete</i> message?	-->	<i>RRCReconfigurationComplete</i>	1	P
3	Check: Does the test result of generic test procedure in TS 38.508-1 subclause 4.9.1 indicate that the UE is capable of exchanging IP data on Split DRB#2 using NR radio path in the uplink?	-	-	1	P
4	The SS transmits an <i>RRCReconfiguration</i> message containing NR RadioBearerConfig to change the primaryPath of the Split DRB from NR radio path to E-UTRA.	<--	<i>RRCReconfiguration</i>	-	-
5	Check: Does the UE transmit an <i>RRCReconfigurationComplete</i> message?	-->	<i>RRCReconfigurationComplete</i>	2	P
6	Check: Does the test result of generic test procedure in TS 38.508-1 subclause 4.9.1 indicate that the UE is capable of exchanging IP data on the Split DRB#2 using E-UTRA radio path in the uplink?	-	-	2	P

8.2.2.9.3.3.3 Specific message contents

FFS

8.2.3 Measurement Configuration Control and Reporting / Handovers

8.2.3.1 Measurement configuration control and reporting / Inter-RAT measurements / Event B1 / Measurement of NR cells

8.2.3.1.1 Measurement configuration control and reporting / Inter-RAT measurements / Event B1 / Measurement of NR cells / EN-DC

8.2.3.1.1.1 Test Purpose (TP)

(1)

```
with { UE in E-UTRA RRC_CONNECTED state having completed the radio bearer establishment and
performed the inter RAT measurement for NR cell and not detected entering condition for the event B1
is met }
ensure that {
  when { UE detects entering condition for the event B1 is not met }
  then { UE does not transmit any MeasurementReport }
}
```

(2)

```
with { UE in E-UTRA RRC_CONNECTED state having completed the radio bearer establishment and
performed the inter RAT measurement for NR cell and not detected entering condition for the event B1
is met }
ensure that {
  when { UE detects entering condition for the event B1 is met }
  then { UE transmits a MeasurementReport }
}
```

(3)

```
with { UE in E-UTRA RRC_CONNECTED state having completed the radio bearer establishment and
performed the inter RAT measurement for NR cell and detected entering condition for the event B1 is
met }
ensure that {
  when { UE detects leaving condition for the event B1 is met }
  then { UE does not transmit any MeasurementReport }
}
```

8.2.3.1.1.2 Conformance requirements

References: The conformance requirements covered in the present TC are specified in: TS 36.331, clauses 5.5.1, 5.5.4.1, 5.5.4.7, 5.5.5 and 5.5.5.3. Unless otherwise stated these are Rel-15 requirements.

[TS 36.331, clause 5.5.1]

The UE reports measurement information in accordance with the measurement configuration as provided by E-UTRAN. E-UTRAN provides the measurement configuration applicable for a UE in RRC_CONNECTED by means of dedicated signalling, i.e. using the *RRCCONNECTIONRECONFIGURATION* or *RRCCONNECTIONRESUME* message.

The UE can be requested to perform the following types of measurements:

- Intra-frequency measurements: measurements at the downlink carrier frequency(ies) of the serving cell(s).
- Inter-frequency measurements: measurements at frequencies that differ from any of the downlink carrier frequency(ies) of the serving cell(s).
- Inter-RAT measurements of NR frequencies.
- ...

The measurement configuration includes the following parameters:

1. **Measurement objects:** The objects on which the UE shall perform the measurements.
 - For intra-frequency and inter-frequency measurements a measurement object is a single E-UTRA carrier frequency. Associated with this carrier frequency, E-UTRAN can configure a list of cell specific offsets, a list of 'blacklisted' cells and a list of 'whitelisted' cells. Blacklisted cells are not considered in event evaluation or measurement reporting.
 - For inter-RAT NR measurements a measurement object is a single NR carrier frequency. Associated with this carrier frequency, E-UTRAN can configure a list of 'blacklisted' cells. Blacklisted cells are not considered in event evaluation or measurement reporting.
 - ...

NOTE 1: Some measurements using the above mentioned measurement objects, only concern a single cell, e.g. measurements used to report neighbouring cell system information, PCell UE Rx-Tx time difference, or a pair of cells, e.g. SSTD measurements between the PCell and the PSCell.

2. **Reporting configurations:** A list of reporting configurations where each reporting configuration consists of the following:
 - Reporting criterion: The criterion that triggers the UE to send a measurement report. This can either be periodical or a single event description.
 - Reporting format: The quantities that the UE includes in the measurement report and associated information (e.g. number of cells to report).
3. **Measurement identities:** A list of measurement identities where each measurement identity links one measurement object with one reporting configuration. By configuring multiple measurement identities it is possible to link more than one measurement object to the same reporting configuration, as well as to link more than one reporting configuration to the same measurement object. The measurement identity is used as a reference number in the measurement report.
4. **Quantity configurations:** One quantity configuration is configured per RAT type. The quantity configuration defines the measurement quantities and associated filtering used for all event evaluation and related reporting of that measurement type. One filter can be configured per measurement quantity, except for NR where the network may configure up to 2 sets of quantity configurations each comprising per measurement quantity separate filters for cell and RS index measurement results. The quantity configuration set that applies for a given measurement is indicated within the NR measurement object.
5. **Measurement gaps:** Periods that the UE may use to perform measurements, i.e. no (UL, DL) transmissions are scheduled.

...

For E-UTRA, the UE measures and reports on the serving cell(s), listed cells, detected cells, transmission resource pools for V2X sidelink communication, and, for RSSI and channel occupancy measurements, the UE measures and reports on any reception on the indicated frequency. For inter-RAT NR, the UE measures and reports on detected cells and, if configured with EN-DC, on NR serving cell(s). For inter-RAT UTRA, the UE measures and reports on listed cells and optionally on cells that are within a range for which reporting is allowed by E-UTRAN. For inter-RAT GERAN, the UE measures and reports on detected cells. For inter-RAT CDMA2000, the UE measures and reports on listed cells. For inter-RAT WLAN, the UE measures and reports on listed cells.

[TS 36.331, clause 5.5.4.1]

If security has been activated successfully, The UE shall:

1> for each *measId* included in the *measIdList* within *VarMeasConfig*:

...

2> else:

...

3> else if the corresponding *measObject* concerns NR:

4> if the *reportSFTD-Meas* is set to *pSCell* in the corresponding *reportConfigInterRAT*:

5> consider the PSCell to be applicable;

4> else if the *reportSFTD-Meas* is set to *neighborCells* in the corresponding *reportConfigInterRAT*;

5> if *cellsForWhichToReportSFTD* is configured in the corresponding *measObjectNR*:6> consider any neighbouring NR cell on the associated frequency that is included in *cellsForWhichToReportSFTD* to be applicable;

5> else:

6> consider up to 3 strongest neighbouring NR cells detected on the associated frequency to be applicable when the concerned cell is not included in the *blackCellsToAddModList* defined within the *VarMeasConfig* for this *measId*;

4> else:

5> if the *eventB1* or *eventB2* is configured in the corresponding *reportConfig*:

6> consider a serving cell, if any, on the associated NR frequency as neighbouring cell;

5> consider any neighbouring cell detected on the associated frequency to be applicable when the concerned cell is not included in the *blackCellsToAddModList* defined within the *VarMeasConfig* for this *measId*;[TS 36.331, clause 5.5.4.7]

The UE shall:

1> for UTRA and CDMA2000, only trigger the event for cells included in the corresponding measurement object;

1> consider the entering condition for this event to be satisfied when condition B1-1, as specified below, is fulfilled;

1> consider the leaving condition for this event to be satisfied when condition B1-2, as specified below, is fulfilled;

Inequality B1-1 (Entering condition)

$$Mn + Ofn - Hys > Thresh$$

Inequality B1-2 (Leaving condition)

$$Mn + Ofn + Hys < Thresh$$

The variables in the formula are defined as follows:

Mn is the measurement result of the inter-RAT neighbour cell, not taking into account any offsets. For CDMA 2000 measurement result, *pilotStrength* is divided by -2.

Ofn is the frequency specific offset of the frequency of the inter-RAT neighbour cell (i.e. *offsetFreq* as defined within the *measObject* corresponding to the frequency of the neighbour inter-RAT cell).

Hys is the hysteresis parameter for this event (i.e. *hysteresis* as defined within *reportConfigInterRAT* for this event).

Thresh is the threshold parameter for this event (i.e. *b1-Threshold* as defined within *reportConfigInterRAT* for this event). For CDMA2000, *b1-Threshold* is divided by -2.

Mn is expressed in dBm or in dB, depending on the measurement quantity of the inter-RAT neighbour cell.

Ofn, Hys are expressed in dB.

Thresh is expressed in the same unit as **Mn**.

[TS 36.331, clause 5.5.5]

The purpose of this procedure is to transfer measurement results from the UE to E-UTRAN. The UE shall initiate this procedure only after successful security activation.

For the *measId* for which the measurement reporting procedure was triggered, the UE shall set the *measResults* within the *MeasurementReport* message as follows:

- 1> set the *measId* to the measurement identity that triggered the measurement reporting;
- 1> set the *measResultPCell* to include the quantities of the PCell;
- 1> set the *measResultServFreqList* to include for each E-UTRA SCell that is configured, if any, within *measResultSCell* the quantities of the concerned SCell, if available according to performance requirements in 36.133 [16], except if *purpose* for the *reportConfig* associated with the *measId* that triggered the measurement reporting is set to *reportLocation*;
- 1> if the *reportConfig* associated with the *measId* that triggered the measurement reporting includes *reportAddNeighMeas*:
 - 2> for each E-UTRA serving frequency for which *measObjectId* is referenced in the *measIdList*, other than the frequency corresponding with the *measId* that triggered the measurement reporting:
 - 3> set the *measResultServFreqList* to include within *measResultBestNeighCell* the *physCellId* and the quantities of the best non-serving cell, based on RSRP, on the concerned serving frequency;
- 1> if the *triggerType* is set to *event*; and if the corresponding *measObject* concerns NR; and if *eventId* is set to *eventB1-NR* or *eventB2-NR*; or
- 1> if the *triggerType* is set to *event*; and if *eventId* is set to *eventA3* or *eventA4* or *eventA5*:
 - 2> if *purpose* for the *reportConfig* associated with the *measId* that triggered the measurement reporting is set to a value other than *reportLocation*:
 - 3> set the *measResultServFreqListNR* to include for each NR serving frequency that the UE is configured to measure according to TS 38.331 [82], if any, the following:
 - 4> set *measResultSCell* to include the available results of the NR serving cell, as specified in 5.5.5.2;
 - 4> if the *reportConfig* associated with the *measId* that triggered the measurement reporting includes *reportAddNeighMeas*:
 - 5> set *measResultBestNeighCell* to include the available results, as specified in 5.5.5.2, of the best non-serving cell, ordered based on the quantity determined as specified in 5.5.5.2;
 - 3> for each (serving or neighbouring) cell for which the UE reports results according to the previous, additionally include available beam results according to the following:

4> if *maxReportRS-Index* is configured, set *measResultRS-IndexList* to include available results, as specified in 5.5.5.2, of up to *maxReportRS-Index* beams, ordered based on the quantity determined as specified in 5.5.5.3;

1> if there is at least one applicable neighbouring cell to report:

2> set the *measResultNeighCells* to include the best neighbouring cells up to *maxReportCells* in accordance with the following:

3> if the *triggerType* is set to *event*:

4> include the cells included in the *cellsTriggeredList* as defined within the *VarMeasReportList* for this *measId*;

3> else:

4> include the applicable cells for which the new measurement results became available since the last periodical reporting or since the measurement was initiated or reset;

NOTE 1: The reliability of the report (i.e. the certainty it contains the strongest cells on the concerned frequency) depends on the measurement configuration i.e. the *reportInterval*. The related performance requirements are specified in TS 36.133 [16].

3> for each cell that is included in the *measResultNeighCells*, include the *physCellId*;

3> if the *triggerType* is set to *event*; or the *purpose* is set to *reportStrongestCells* or to *reportStrongestCellsForSON*:

4> for each included cell, include the layer 3 filtered measured results in accordance with the *reportConfig* for this *measId*, ordered as follows:

5> if the *measObject* associated with this *measId* concerns E-UTRA:

6> set the *measResult* to include the quantity(ies) indicated in the *reportQuantity* within the concerned *reportConfig*;

6> sort the included cells in order of decreasing *triggerQuantity*, i.e. the best cell is included first;

5> if the *measObject* associated with this *measId* concerns NR:

6> set the *measResultCell* to include the quantity(ies) indicated in the *reportQuantityCellNR* within the concerned *reportConfig*;

6> if *maxReportRS-Index* and *reportQuantityRS-IndexNR* are configured, set *measResultRS-IndexList* to include results of the best beam and the beams whose quantity is above *threshRS-Index* defined in the *VarMeasConfig* for the corresponding *measObject*, up to *maxReportRS-Index* beams in total:

7> order beams based on the sorting quantity determined as specified in 5.5.5.3;

7> include *ssbIndex*;

7> for each included beam:

8> include *ssbIndex*;

8> if *reportRS-IndexResultsNR* is configured, for each quantity indicated, include the corresponding measurement result in *measResultNeighCells*;

6> sort the included cells in order of decreasing sorting quantity determined as specified in 5.5.5.3;

...

[TS 36.331, clause 5.5.5.3]

- 1> for cells on the frequency associated with the *measId* that triggered the measurement reporting, if the *reportTrigger* is set to *event*, consider the quantity used in *bN-ThresholdYNR* to be the sorting quantity;
- 1> for other cases, determine the sorting quantity as follows:
 - 2> consider the following quantities as candidate sorting quantities:
 - 3> for cells on the frequency associated with the *measId* that triggered the measurement reporting (for a *triggerType* set to *periodical*):
 - 4> the quantities defined by *reportQuantityCellNR*, when used for sorting cells;
 - 4> the quantities defined by *reportQuantityRS-IndexNR*, when used for sorting beams;
 - 3> for cells, serving or non-serving (i.e. within *reportAddNeighMeas*), on NR serving frequencies other than the one associated with the *measId* triggering reporting:
 - 4> the available quantities of available NR measurement results as specified in 5.5.5.2;
 - 2> if there is a single candidate sorting quantity;
 - 3> consider the concerned quantity to be the sorting quantity;
 - 2> else:
 - 3> if RSRP is one of the candidate sorting quantities;
 - 4> consider RSRP to be the sorting quantity;
 - 3> else:
 - 4> consider RSRQ to be the sorting quantity;

8.2.3.1.1.3 Test description

8.2.3.1.1.3.1 Pre-test conditions

System Simulator:

- E-UTRA Cell 1 and NR Cell 1.

UE:

- None.

Preamble:

- The UE is in state RRC_CONNECTED using generic procedure parameter Connectivity (*E-UTRA/EPC*) established according to TS 38.508-1 [4].

8.2.3.1.1.3.2 Test procedure sequence

Table 8.2.3.1.3.2-1 and Table 8.2.3.1.3.2-1A illustrates the downlink power levels and other changing parameters to be applied for the cells at various time instants of the test execution. Row marked "T0" denotes the initial conditions after preamble, while columns marked "T1" and "T2" are to be applied subsequently. The exact instants on which these values shall be applied are described in the texts in this clause.

Table 8.2.3.1.1.3.2-1: Time instances of cell power level and parameter changes for conducted test environment

	Parameter	Unit	E-UTRA Cell 1	NR Cell 1	Remark
T0	Cell-specific RS EPRE	dBm/15 kHz	-85	-	

	SS/PBCH SSS EPRE	dBm/SC S	-	-91	The power level values are such that entering conditions for event B1 are not satisfied.
T1	Cell-specific RS EPRE	dBm/15 kHz	-85	-	The power level values are such that entering conditions for event B1 are satisfied.
	SS/PBCH SSS EPRE	dBm/SC S	-	-79	
T2	Cell-specific RS EPRE	dBm/15 kHz	-85	-	The power level values are such that leaving conditions for event B1 are satisfied.
	SS/PBCH SSS EPRE	dBm/SC S	-	-91	

Table 8.2.3.1.1.3.2-1A: Time instances of cell power level and parameter changes for OTA test environment

	Parameter	Unit	E-UTRA Cell 1	NR Cell 1	Remark
T0	Cell-specific RS EPRE	dBm/15 kHz	-96	-	The power level values are such that entering conditions for event B1 are not satisfied.
	SS/PBCH SSS EPRE	dBm/SC S	-	-100	
T1	Cell-specific RS EPRE	dBm/15 kHz	-96	-	The power level values are such that entering conditions for event B1 are satisfied.
	SS/PBCH SSS EPRE	dBm/SC S	-	-82	
T2	Cell-specific RS EPRE	dBm/15 kHz	-96	-	The power level values are such that leaving conditions for event B1 are satisfied.
	SS/PBCH SSS EPRE	dBm/SC S	-	-100	

Table 8.2.3.1.1.3.2-2: Main behaviour

St	Procedure	Message Sequence		TP	Verdict
		U - S	Message		
1	The SS transmits an <i>RRCCONNECTIONRECONFIGURATION</i> including measConfig to setup inter RAT measurements and reporting for NR Cell 1.	<--	<i>RRCCONNECTIONRECONFIGURATION</i>	-	-
2	The UE transmits an <i>RRCCONNECTIONRECONFIGURATIONCOMPLETE</i> message to confirm the setup of inter RAT measurements for NR Cell 1.	-->	<i>RRCCONNECTIONRECONFIGURATIONCOMPLETE</i>	-	-
3	Check: Does the UE transmit a <i>MEASUREMENTREPORT</i> message on E-UTRA Cell 1 to report the event B1 during the next 10s?	-->	<i>MEASUREMENTREPORT</i>	1	F
4	The SS changes NR Cell 1 parameters according to the row "T1".	-	-	-	-
5	Check: Does the UE transmit a <i>MEASUREMENTREPORT</i> message to report the event B1 for NR Cell 1?	-->	<i>MEASUREMENTREPORT</i>	2	P
6	The SS changes NR Cell 1 parameters according to the row "T2".	-	-	-	-
7	Wait and ignore <i>MEASUREMENTREPORT</i> messages for 57s if NR Cell 1 is on FR2 frequency else wait for 15 s to allow change of power levels and UE measurements for NR Cell 1.	-	-	-	-
8	Check: Does the UE transmit a <i>MEASUREMENTREPORT</i> message on E-UTRA Cell 1 to report the event B1 during the next 10s?	-->	<i>MEASUREMENTREPORT</i>	3	F

8.2.3.1.1.3.3 Specific message contents

Table 8.2.3.1.1.3.3-0: Conditions for specific message contents in Tables 8.2.3.1.1.3.3-2.

Condition	Explanation
Band > 64	If band > 64 is selected

Table 8.2.3.1.1.3.3-1: RRCConnectionReconfiguration (step 1, Table 8.2.3.1.1.3.2-2)

Derivation Path: TS 36.508 [7], Table 4.6.1-8, condition MEAS

Table 8.2.3.1.1.3.3-2: MeasConfig (Table 8.2.3.1.1.3.3-1)

Derivation Path: TS 36.508 [7], Table 4.6.6-1			
Information Element	Value/remark	Comment	Condition
MeasConfig ::= SEQUENCE {			
measObjectToAddModList SEQUENCE (SIZE (1..maxObjectId)) OF MeasObjectToAddMod {	2 entries		
MeasObjectToAddMod[1] SEQUENCE {		entry 1	
measObjectId	1		
measObject	MeasObjectEUTRA- GENERIC(f1)		
	MeasObjectEUTRA- GENERIC(maxEARFCN)		Band > 64
}			
MeasObjectToAddMod[2] SEQUENCE {		entry 2	
measObjectId	2		
measObject	MeasObjectNR- GENERIC (NRf1)		
}			
}			
reportConfigToAddModList SEQUENCE (SIZE (1..maxReportConfigId)) OF ReportConfigToAddMod {	1 entry		
ReportConfigToAddMod[1] SEQUENCE {		entry 1	
reportConfigId	1		
reportConfig	ReportConfig1-B1-NR- r15(-85)		FR1
	ReportConfig2-B1-NR- r15(-91 + Δ(NRf1))		FR2
}			
measIdToAddModList SEQUENCE (SIZE (1..maxMeasId)) OF MeasIdToAddMod {	1 entry		
MeasIdToAddMod[1] SEQUENCE {		entry 1	
measId	1		
measObjectId	2		
reportConfigId	1		
}			
}			
quantityConfig	QuantityConfig- DEFAULT		
measGapConfig	MeasGapConfig		
measObjectToAddModList-v9e0 SEQUENCE (SIZE (1..maxObjectId)) OF MeasObjectToAddMod-v9e0 {	1 entry		Band > 64
MeasObjectToAddMod-v9e0[1] SEQUENCE {		entry 1	
measObjectEUTRA-v9e0 SEQUENCE {			
carrierFreq-v9e0	Same downlink EARFCN as used for f1		
}			
}			
}			
}			

Table 8.2.3.1.1.3.3-3: QuantityConfig-DEFAULT (Table 8.2.3.1.1.3.3-2)

Derivation Path: TS 36.508 [7], Table 4.6.6-3A			
Information Element	Value/remark	Comment	Condition
QuantityConfig-DEFAULT ::= SEQUENCE {			
quantityConfigNRLList-r15 SEQUENCE ((SIZE (1..maxQuantSetsNR-r15)) OF QuantityConfigNR-r15 {	1 entry		
QuantityConfigNR-r15[1] SEQUENCE {		entry 1	
measQuantityCellNR-r15 SEQUENCE {			
filterCoeff-RSRP-r15	fc0		
filterCoeff-RSRQ-r15	fc0		
filterCoefficient-SINR-r13	fc0		
}			
}			
}			
}			

Table 8.2.3.1.1.3.3-4: MeasObjectNR-GENERIC (NRf1) (Table 8.2.3.1.1.3.3-2)

Derivation Path: TS 36.508 [7], Table 4.6.6-2B			
Information Element	Value/remark	Comment	Condition
MeasObjectNR-GENERIC(Freq) ::= SEQUENCE {			
carrierFreq-r15	Downlink carrier frequency of NR cell 1		
}			

Table 8.2.3.1.1.3.3-5: ReportConfig1-B1-NR-r15(-85) (Table 8.2.3.1.1.3.3-2)

Derivation Path: TS 36.508 [7], Table 4.6.6-7AA			
Information Element	Value/remark	Comment	Condition
ReportConfig-B1-NR ::= SEQUENCE {			
triggerType CHOICE {			
reportAmount	infinity		
reportQuantityCellNR-r15 SEQUENCE {			
ss-rsrp	true		
ss-rsrq	true		
ss-sinr	true		pc_ss_SINR_Meas
}	false		
}			

Table 8.2.3.1.1.3.3-6: MeasurementReport (step 5, Table 8.2.3.1.1.3.2-2)

Derivation Path: TS 36.508 [7], Table 4.6.1-5			
Information Element	Value/remark	Comment	Condition
MeasurementReport ::= SEQUENCE {			
criticalExtensions CHOICE {			
c1 CHOICE {			
measurementReport-r8 SEQUENCE {			
measResults SEQUENCE {			
measId	1		
measResultPCell SEQUENCE {			
rsrpResult	(0..97)		
rsrqResult	(0..34)		
}			
measResultNeighCells CHOICE {			
measResultNeighCellListNR-r15 SEQUENCE (SIZE (1..maxCellReport)) OF MeasResultCellNR-r15 {	1 entry		
MeasResultCellNR-r15[1] SEQUENCE {		entry 1	

pci-r15 [1]	PhysicalCellIdentity of NR Cell 1		
measResultCell-r15 [1] SEQUENCE {			
rsrpResult-r15	(0..127)		
rsrqResult-r15	(0..127)		
rs-sinr-Result-r15	(0..127)		pc_ss_SINR_Meas
	Not present		
}			
measResultRS-IndexList-r15	Not present		
cgi-Info-r15	Not present		
}			
}			
}			
}			
}			
}			
}			
}			
}			

Table 8.2.3.1.1.3.3-7: MeasGapConfig(Table 8.2.3.1.1.3.3-2)

Derivation Path: TS 36.331, clause 6.3.5			
Information Element	Value/remark	Comment	Condition
MeasGapConfig-GP2 ::= CHOICE {			
setup SEQUENCE {			
gapOffset CHOICE {			
gp1	19	TGRP = 80 ms	
}			
}			
}			

Table 8.2.3.1.1.3.3-8: ReportConfig2-B1-NR-r15(-91 + Δ(NRf1)) (Table 8.2.3.1.1.3.3-2)

Derivation Path: TS 36.508 [7], Table 4.6.6-7AA			
Information Element	Value/remark	Comment	Condition
ReportConfig-B1-NR ::= SEQUENCE {			
triggerType CHOICE {			
reportAmount	Infinity		
reportQuantityCellNR-r15 SEQUENCE {			
ss-rsrp	true		
ss-rsrq	true		
ss-sinr	true		pc_ss_SINR_Meas
	Not present		
}			
}			
NOTE 1: Δ(NRf1) is derived based on calibration procedure defined in the TS 38.508-1 [4], clause 6.1.3.3			

8.2.3.1.2 Measurement configuration control and reporting / Inter-RAT measurements / Event B1 / Measurement of NR cells / NE-DC

8.2.3.1.2.1 Test Purpose (TP)

(1)

```

with { UE in RRC_CONNECTED state in NE-DC, and, MCG(s) (NR PDCP) and SCG, and performed the inter
RAT measurement for E-UTRA cell and not detected entering condition for the event B1 is met }
ensure that {
  when { UE detects entering condition for the event B1 is not met }
  then { UE does not transmit any MeasurementReport }
}
    
```

(2)

```

with { UE in RRC_CONNECTED state in NE-DC, and, MCG(s) (NR PDCP) and SCG, and having completed the
radio bearer establishment and performed the inter RAT measurement for E-UTRA cell and not detected
entering condition for the event B1 is met }
ensure that {
  when { UE detects entering condition for the event B1 is met }
  then { UE transmits a MeasurementReport }
}

```

(3)

```

with { UE in RRC_CONNECTED state in NE-DC, and, MCG(s) (NR PDCP) and SCG, and performed the inter
RAT measurement for E-UTRA cell and detected entering condition for the event B1 is met }
ensure that {
  when { UE detects leaving condition for the event B1 is met }
  then { UE does not transmit any MeasurementReport }
}

```

8.2.3.1.2.2 Conformance requirements

References: The conformance requirements covered in the present TC are specified in: TS 38.331, clauses 5.5.1, 5.5.4.1, 5.5.4.7, 5.5.5 and 5.5.5.3. Unless otherwise stated these are Rel-15 requirements.

[TS 38.331, clause 5.5.1]

The network may configure an RRC_CONNECTED UE to perform measurements. The network may configure the UE to report them in accordance with the measurement configuration or perform conditional reconfiguration evaluation in accordance with the conditional reconfiguration. The measurement configuration is provided by means of dedicated signalling i.e. using the *RRCReconfiguration* or *RRCResume*.

The network may configure the UE to perform the following types of measurements:

- NR measurements;
- Inter-RAT measurements of E-UTRA frequencies;
- Inter-RAT measurements of UTRA-FDD frequencies;
- NR sidelink measurements of L2 U2N Relay UEs.

The network may configure the UE to report the following measurement information based on SS/PBCH block(s):

- Measurement results per SS/PBCH block;
- Measurement results per cell based on SS/PBCH block(s);
- SS/PBCH block(s) indexes.

The network may configure the UE to report the following measurement information based on CSI-RS resources:

- Measurement results per CSI-RS resource;
- Measurement results per cell based on CSI-RS resource(s);
- CSI-RS resource measurement identifiers.

The network may configure the UE to perform the following types of measurements for NR sidelink and V2X sidelink:

- CBR measurements.

The network may configure the UE to report the following CLI measurement information based on SRS resources:

- Measurement results per SRS resource;
- SRS resource(s) indexes.

The network may configure the UE to report the following CLI measurement information based on CLI-RSSI resources:

- Measurement results per CLI-RSSI resource;
- CLI-RSSI resource(s) indexes.

The network may configure the UE to report the following Rx-Tx time difference measurement information based on CSI-RS for tracking or PRS:

- UE Rx-Tx time difference measurement result.

The measurement configuration includes the following parameters:

1. Measurement objects: A list of objects on which the UE shall perform the measurements.

- For intra-frequency and inter-frequency measurements a measurement object indicates the frequency/time location and subcarrier spacing of reference signals to be measured. Associated with this measurement object, the network may configure a list of cell specific offsets, a list of 'exclude-listed' cells and a list of 'allow-listed' cells. Exclude-listed cells are not applicable in event evaluation or measurement reporting. Allow-listed cells are the only ones applicable in event evaluation or measurement reporting.
- The *measObjectId* of the MO which corresponds to each serving cell is indicated by *servingCellMO* within the serving cell configuration.
- For inter-RAT E-UTRA measurements a measurement object is a single E-UTRA carrier frequency. Associated with this E-UTRA carrier frequency, the network can configure a list of cell specific offsets and a list of 'exclude-listed' cells. Exclude-listed cells are not applicable in event evaluation or measurement reporting.
- For inter-RAT UTRA-FDD measurements a measurement object is a set of cells on a single UTRA-FDD carrier frequency.
- For NR sidelink measurements of L2 U2N Relay UEs, a measurement object is a single NR sidelink frequency to be measured.
- For CBR measurement of NR sidelink communication, a measurement object is a set of transmission resource pool(s) on a single carrier frequency for NR sidelink communication.
- For CLI measurements a measurement object indicates the frequency/time location of SRS resources and/or CLI-RSSI resources, and subcarrier spacing of SRS resources to be measured.

2. Reporting configurations: A list of reporting configurations where there can be one or multiple reporting configurations per measurement object. Each measurement reporting configuration consists of the following:

- Reporting criterion: The criterion that triggers the UE to send a measurement report. This can either be periodical or a single event description.
- RS type: The RS that the UE uses for beam and cell measurement results (SS/PBCH block or CSI-RS).
- Reporting format: The quantities per cell and per beam that the UE includes in the measurement report (e.g. RSRP) and other associated information such as the maximum number of cells and the maximum number beams per cell to report.

In case of conditional reconfiguration, each configuration consists of the following:

- Execution criteria: The criteria the UE uses for conditional reconfiguration execution.
- RS type: The RS that the UE uses for obtaining beam and cell measurement results (SS/PBCH block-based or CSI-RS-based), used for evaluating conditional reconfiguration execution condition.

3. Measurement identities: For measurement reporting, a list of measurement identities where each measurement identity links one measurement object with one reporting configuration. By configuring multiple measurement identities, it is possible to link more than one measurement object to the same reporting configuration, as well as to link more than one reporting configuration to the same measurement object. The measurement identity is also included in the measurement report that triggered the reporting, serving as a reference to the network. For

conditional reconfiguration triggering, one measurement identity links to exactly one conditional reconfiguration trigger configuration. And up to 2 measurement identities can be linked to one conditional reconfiguration execution condition.

4. **Quantity configurations:** The quantity configuration defines the measurement filtering configuration used for all event evaluation and related reporting, and for periodical reporting of that measurement. For NR measurements, the network may configure up to 2 quantity configurations with a reference in the NR measurement object to the configuration that is to be used. In each configuration, different filter coefficients can be configured for different measurement quantities, for different RS types, and for measurements per cell and per beam.
5. **Measurement gaps:** Periods that the UE may use to perform measurements.

Editor Note: It is FFS whether and how the definition of measurement gap should be updated due to pre-configured MG.

A UE in RRC_CONNECTED maintains a measurement object list, a reporting configuration list, and a measurement identities list according to signalling and procedures in this specification. The measurement object list possibly includes NR measurement object(s), CLI measurement object(s), inter-RAT objects, and L2 U2N Relay objects. Similarly, the reporting configuration list includes NR, inter-RAT, and L2 U2N Relay reporting configurations. Any measurement object can be linked to any reporting configuration of the same RAT type. Some reporting configurations may not be linked to a measurement object. Likewise, some measurement objects may not be linked to a reporting configuration.

The measurement procedures distinguish the following types of cells:

1. The NR serving cell(s) – these are the SpCell and one or more SCells.
2. Listed cells – these are cells listed within the measurement object(s).
3. Detected cells – these are cells that are not listed within the measurement object(s) but are detected by the UE on the SSB frequency(ies) and subcarrier spacing(s) indicated by the measurement object(s).

For NR measurement object(s), the UE measures and reports on the serving cell(s)/serving Relay UE (for L2 U2N Remote UE), listed cells and/or detected cells. For inter-RAT measurements object(s) of E-UTRA, the UE measures and reports on listed cells and detected cells and, for RSSI and channel occupancy measurements, the UE measures and reports on the configured resources on the indicated frequency. For inter-RAT measurements object(s) of UTRA-FDD, the UE measures and reports on listed cells. For CLI measurement object(s), the UE measures and reports on configured measurement resources (i.e. SRS resources and/or CLI-RSSI resources). For L2 U2N Relay object(s), the UE measures and reports on the serving NR cell(s), as well as the discovered L2 U2N Relay UEs.

Whenever the procedural specification, other than contained in clause 5.5.2, refers to a field it concerns a field included in the *VarMeasConfig* unless explicitly stated otherwise i.e. only the measurement configuration procedure covers the direct UE action related to the received *measConfig*.

In NR-DC, the UE may receive two independent *measConfig*:

- a *measConfig*, associated with MCG, that is included in the *RRCReconfiguration* message received via SRB1; and
- a *measConfig*, associated with SCG, that is included in the *RRCReconfiguration* message received via SRB3, or, alternatively, included within a *RRCReconfiguration* message embedded in a *RRCReconfiguration* message received via SRB1.

In this case, the UE maintains two independent *VarMeasConfig* and *VarMeasReportList*, one associated with each *measConfig*, and independently performs all the procedures in clause 5.5 for each *measConfig* and the associated *VarMeasConfig* and *VarMeasReportList*, unless explicitly stated otherwise.

The configurations related to CBR measurements are only included in the *measConfig* associated with MCG.

The configurations related to Rx-Tx time difference measurement are only included in the *measConfig* associated with MCG.

[TS 38.331, clause 5.5.4.1]

If AS security has been activated successfully, the UE shall:

- 1> for each *measId* included in the *measIdList* within *VarMeasConfig*:
 - 2> if the corresponding *reportConfig* includes a *reportType* set to *eventTriggered* or *periodical*:
 - 3> if the corresponding *measObject* concerns NR:
 - 4> if the corresponding *reportConfig* includes *measRSSI-ReportConfig*:
 - 5> consider the resource indicated by the *rmtc-Config* on the associated frequency to be applicable;
 - 4> if the *eventA1* or *eventA2* is configured in the corresponding *reportConfig*:
 - 5> consider only the serving cell to be applicable;
 - 4> if the *eventA3* or *eventA5* is configured in the corresponding *reportConfig*:
 - 5> if a serving cell is associated with a *measObjectNR* and neighbours are associated with another *measObjectNR*, consider any serving cell associated with the other *measObjectNR* to be a neighbouring cell as well;
 - 4> if corresponding *reportConfig* includes *reportType* set to *periodical*; or
 - 4> for measurement events other than *eventA1* or *eventA2*:
 - 5> if *useAllowedCellList* is set to *true*:
 - 6> consider any neighbouring cell detected based on parameters in the associated *measObjectNR* to be applicable when the concerned cell is included in the *allowedCellsToAddModList* defined within the *VarMeasConfig* for this *measId*;
 - 5> else:
 - 6> consider any neighbouring cell detected based on parameters in the associated *measObjectNR* to be applicable when the concerned cell is not included in the *excludedCellsToAddModList* defined within the *VarMeasConfig* for this *measId*;
 - 3> else if the corresponding *measObject* concerns E-UTRA:
 - 4> if *eventB1* or *eventB2* is configured in the corresponding *reportConfig*:
 - 5> consider a serving cell, if any, on the associated E-UTRA frequency as neighbour cell;
 - 4> consider any neighbouring cell detected on the associated frequency to be applicable when the concerned cell is not included in the *excludedCellsToAddModListEUTRAN* defined within the *VarMeasConfig* for this *measId*;
 - 3> else if the corresponding *measObject* concerns UTRA-FDD:
 - 4> if *eventB1-UTRA-FDD* or *eventB2-UTRA-FDD* is configured in the corresponding *reportConfig*; or
 - 4> if corresponding *reportConfig* includes *reportType* set to *periodical*:
 - 5> consider a neighbouring cell on the associated frequency to be applicable when the concerned cell is included in the *cellsToAddModList* defined within the *VarMeasConfig* for this *measId*;
 - 3> else if the corresponding *measObject* concerns L2 U2N Relay UE:
 - 4> if *eventY1-Relay* is configured in the corresponding *reportConfig*; or
 - 4> if corresponding *reportConfig* includes *reportType* set to *periodical*:
 - 5> consider any L2 U2N Relay UE detected on the associated frequency to be applicable for this *measId*;
 - 2> else if the corresponding *reportConfig* includes a *reportType* set to *reportCGI*:

- 3> consider the cell detected on the associated *measObject* which has a physical cell identity matching the value of the *cellForWhichToReportCGI* included in the corresponding *reportConfig* within the *VarMeasConfig* to be applicable;
- 2> else if the corresponding *reportConfig* includes a *reportType* set to *reportSFTD*:
 - 3> if the corresponding *measObject* concerns NR:
 - 4> if the *reportSFTD-Meas* is set to *true*:
 - 5> consider the NR PSCell to be applicable;
 - 4> else if the *reportSFTD-NeighMeas* is included:
 - 5> if *cellsForWhichToReportSFTD* is configured in the corresponding *reportConfig*:
 - 6> consider any NR neighbouring cell detected on the associated *measObjectNR* which has a physical cell identity that is included in the *cellsForWhichToReportSFTD* to be applicable;
 - 5> else:
 - 6> consider up to 3 strongest NR neighbouring cells detected based on parameters in the associated *measObjectNR* to be applicable when the concerned cells are not included in the *excludedCellsToAddModList* defined within the *VarMeasConfig* for this *measId*;
 - 3> else if the corresponding *measObject* concerns E-UTRA:
 - 4> if the *reportSFTD-Meas* is set to *true*:
 - 5> consider the E-UTRA PSCell to be applicable;
 - 2> else if the corresponding *reportConfig* includes a *reportType* set to *cli-Periodical* or *cli-EventTriggered*:
 - 3> consider all CLI measurement resources included in the corresponding *measObject* to be applicable;
 - 2> else if the corresponding *reportConfig* includes a *reportType* set to *rxTxPeriodical*:
 - 3> consider all Rx-Tx time difference measurement resources included in the corresponding *measObject* to be applicable;
 - 2> if the corresponding *reportConfig* concerns the reporting for NR sidelink communication (i.e. *reportConfigNR-SL*):
 - 3> consider the transmission resource pools indicated by the *tx-PoolMeasToAddModList* defined within the *VarMeasConfig* for this *measId* to be applicable;
 - 2> if the *reportType* is set to *eventTriggered* and if the entry condition applicable for this event, i.e. the event corresponding with the *eventId* of the corresponding *reportConfig* within *VarMeasConfig*, is fulfilled for one or more applicable cells for all measurements after layer 3 filtering taken during *timeToTrigger* defined for this event within the *VarMeasConfig*, while the *VarMeasReportList* does not include a measurement reporting entry for this *measId* (a first cell triggers the event):
 - 3> include a measurement reporting entry within the *VarMeasReportList* for this *measId*;
 - 3> set the *numberOfReportsSent* defined within the *VarMeasReportList* for this *measId* to 0;
 - 3> include the concerned cell(s) in the *cellsTriggeredList* defined within the *VarMeasReportList* for this *measId*;
 - 3> if *useT312* is set to *true* in *reportConfig* for this event:
 - 4> if T310 for the corresponding SpCell is running; and
 - 4> if T312 is not running for corresponding SpCell:
 - 5> start timer T312 for the corresponding SpCell with the value of T312 configured in the corresponding *measObjectNR*;

- 3> initiate the measurement reporting procedure, as specified in 5.5.5;
- 2> else if the *reportType* is set to *eventTriggered* and if the entry condition applicable for this event, i.e. the event corresponding with the *eventId* of the corresponding *reportConfig* within *VarMeasConfig*, is fulfilled for one or more applicable cells not included in the *cellsTriggeredList* for all measurements after layer 3 filtering taken during *timeToTrigger* defined for this event within the *VarMeasConfig* (a subsequent cell triggers the event):
 - 3> set the *numberOfReportsSent* defined within the *VarMeasReportList* for this *measId* to 0;
 - 3> include the concerned cell(s) in the *cellsTriggeredList* defined within the *VarMeasReportList* for this *measId*;
 - 3> if *useT312* is set to *true* in *reportConfig* for this event:
 - 4> if T310 for the corresponding SpCell is running; and
 - 4> if T312 is not running for corresponding SpCell:
 - 5> start timer T312 for the corresponding SpCell with the value of T312 configured in the corresponding *measObjectNR*;
 - 3> initiate the measurement reporting procedure, as specified in 5.5.5;
- 2> else if the *reportType* is set to *eventTriggered* and if the leaving condition applicable for this event is fulfilled for one or more of the cells included in the *cellsTriggeredList* defined within the *VarMeasReportList* for this *measId* for all measurements after layer 3 filtering taken during *timeToTrigger* defined within the *VarMeasConfig* for this event:
 - 3> remove the concerned cell(s) in the *cellsTriggeredList* defined within the *VarMeasReportList* for this *measId*;
 - 3> if *reportOnLeave* is set to *true* for the corresponding reporting configuration:
 - 4> initiate the measurement reporting procedure, as specified in 5.5.5;
 - 3> if the *cellsTriggeredList* defined within the *VarMeasReportList* for this *measId* is empty:
 - 4> remove the measurement reporting entry within the *VarMeasReportList* for this *measId*;
 - 4> stop the periodical reporting timer for this *measId*, if running;
- 2> if the *reportType* is set to *eventTriggered* and if the entry condition applicable for this event, i.e. the event corresponding with the *eventId* of the corresponding *reportConfig* within *VarMeasConfig*, is fulfilled for one or more applicable L2 U2N Relay UEs for all measurements after layer 3 filtering taken during *timeToTrigger* defined for this event within the *VarMeasConfig*, while the *VarMeasReportList* does not include a measurement reporting entry for this *measId* (a first L2 U2N Relay UE triggers the event):
 - 3> include a measurement reporting entry within the *VarMeasReportList* for this *measId*;
 - 3> set the *numberOfReportsSent* defined within the *VarMeasReportList* for this *measId* to 0;
 - 3> include the concerned L2 U2N Relay UE(s) in the *relaysTriggeredList* defined within the *VarMeasReportList* for this *measId*;
 - 3> initiate the measurement reporting procedure, as specified in 5.5.5;
- 2> else if the *reportType* is set to *eventTriggered* and if the entry condition applicable for this event, i.e. the event corresponding with the *eventId* of the corresponding *reportConfig* within *VarMeasConfig*, is fulfilled for one or more applicable L2 U2N Relay UEs not included in the *relaysTriggeredList* for all measurements after layer 3 filtering taken during *timeToTrigger* defined for this event within the *VarMeasConfig* (a subsequent L2 U2N Relay UE triggers the event):
 - 3> set the *numberOfReportsSent* defined within the *VarMeasReportList* for this *measId* to 0;
 - 3> include the concerned L2 U2N Relay UE(s) in the *relaysTriggeredList* defined within the *VarMeasReportList* for this *measId*;

- 3> initiate the measurement reporting procedure, as specified in 5.5.5;
- 2> else if the *reportType* is set to *eventTriggered* and if the leaving condition applicable for this event is fulfilled for one or more of the L2 U2N Relay UEs included in the *relaysTriggeredList* defined within the *VarMeasReportList* for this *measId* for all measurements after layer 3 filtering taken during *timeToTrigger* defined within the *VarMeasConfig* for this event:
 - 3> remove the concerned L2 U2N Relay UE(s) in the *relaysTriggeredList* defined within the *VarMeasReportList* for this *measId*;
 - 3> if *reportOnLeave* is set to *true* for the corresponding reporting configuration:
 - 4> initiate the measurement reporting procedure, as specified in 5.5.5;
 - 3> if the *relaysTriggeredList* defined within the *VarMeasReportList* for this *measId* is empty:
 - 4> remove the measurement reporting entry within the *VarMeasReportList* for this *measId*;
 - 4> stop the periodical reporting timer for this *measId*, if running;
- 2> else if the *reportType* is set to *eventTriggered* and if the entry condition applicable for this event, i.e. the event corresponding with the *eventId* of the corresponding *reportConfig* within *VarMeasConfig*, is fulfilled for one or more applicable transmission resource pools for all measurements taken during *timeToTrigger* defined for this event within the *VarMeasConfig*, while the *VarMeasReportList* does not include a measurement reporting entry for this *measId* (a first transmission resource pool triggers the event):
 - 3> include a measurement reporting entry within the *VarMeasReportList* for this *measId*;
 - 3> set the *numberOfReportsSent* defined within the *VarMeasReportList* for this *measId* to 0;
 - 3> include the concerned transmission resource pool(s) in the *poolsTriggeredList* defined within the *VarMeasReportList* for this *measId*;
 - 3> initiate the measurement reporting procedure, as specified in 5.5.5;
- 2> else if the *reportType* is set to *eventTriggered* and if the entry condition applicable for this event, i.e. the event corresponding with the *eventId* of the corresponding *reportConfig* within *VarMeasConfig*, is fulfilled for one or more applicable transmission resource pools not included in the *poolsTriggeredList* for all measurements taken during *timeToTrigger* defined for this event within the *VarMeasConfig* (a subsequent transmission resource pool triggers the event):
 - 3> set the *numberOfReportsSent* defined within the *VarMeasReportList* for this *measId* to 0;
 - 3> include the concerned transmission resource pool(s) in the *poolsTriggeredList* defined within the *VarMeasReportList* for this *measId*;
 - 3> initiate the measurement reporting procedure, as specified in 5.5.5;
- 2> else if the *reportType* is set to *eventTriggered* and if the leaving condition applicable for this event is fulfilled for one or more applicable transmission resource pools included in the *poolsTriggeredList* defined within the *VarMeasReportList* for this *measId* for all measurements taken during *timeToTrigger* defined within the *VarMeasConfig* for this event:
 - 3> remove the concerned transmission resource pool(s) in the *poolsTriggeredList* defined within the *VarMeasReportList* for this *measId*;
 - 3> if the *poolsTriggeredList* defined within the *VarMeasReportList* for this *measId* is empty:
 - 4> remove the measurement reporting entry within the *VarMeasReportList* for this *measId*;
 - 4> stop the periodical reporting timer for this *measId*, if running
- 2> else if the *reportType* is set to *eventTriggered* and if the *eventId* is set to *eventD1* and if the entering condition applicable for this event, i.e. the event corresponding with the *eventId* of the corresponding *reportConfig* within *VarMeasConfig*, is fulfilled during *timeToTrigger* defined within the *VarMeasConfig* for this event:
 - 3> include a measurement reporting entry within the *VarMeasReportList* for this *measId*;

- 3> set the *numberOfReportsSent* defined within the *VarMeasReportList* for this *measId* to 0;
- 3> initiate the measurement reporting procedure, as specified in 5.5.5;

NOTE 1: Void.

- 2> if *reportType* is set to *periodical* and if a (first) measurement result is available:
 - 3> include a measurement reporting entry within the *VarMeasReportList* for this *measId*;
 - 3> set the *numberOfReportsSent* defined within the *VarMeasReportList* for this *measId* to 0;
 - 3> if the corresponding *reportConfig* includes *measRSSI-ReportConfig*:
 - 4> initiate the measurement reporting procedure as specified in 5.5.5 immediately when RSSI sample values are reported by the physical layer after the first L1 measurement duration;
 - 3> else if the corresponding *reportConfig* includes the *ul-DelayValueConfig*:
 - 4> initiate the measurement reporting procedure, as specified in 5.5.5, immediately after a first measurement result is provided from lower layers of the associated DRB identity;
 - 3> else if the corresponding *reportConfig* includes the *ul-ExcessDelayConfig*:
 - 4> initiate the measurement reporting procedure, as specified in 5.5.5, immediately after a first measurement result is provided from lower layers of the associated DRB identity(ies) according to the configured threshold per DRB identity(ies);
 - 3> else if the *reportAmount* exceeds 1:
 - 4> initiate the measurement reporting procedure, as specified in 5.5.5, immediately after the quantity to be reported becomes available for the NR SpCell or for the serving L2 U2N Relay UE (if the UE is a L2 U2N Remote UE);
 - 3> else (i.e. the *reportAmount* is equal to 1):
 - 4> initiate the measurement reporting procedure, as specified in 5.5.5, immediately after the quantity to be reported becomes available for the NR SpCell and for the strongest cell among the applicable cells, or for the NR SpCell and for the strongest L2 U2N Relay UEs among the applicable L2 U2N Relay UEs; or initiate the measurement reporting procedure, as specified in 5.5.5, immediately after the quantity to be reported becomes available for the serving L2 U2N Relay UE and for the strongest cell among the applicable cells (if the UE is a L2 U2N Remote UE);
- 2> if, in case the corresponding *reportConfig* concerns the reporting for NR sidelink communication, *reportType* is set to *periodical* and if a (first) measurement result is available:
 - 3> include a measurement reporting entry within the *VarMeasReportList* for this *measId*;
 - 3> set the *numberOfReportsSent* defined within the *VarMeasReportList* for this *measId* to 0;
 - 3> initiate the measurement reporting procedure, as specified in 5.5.5, immediately after the quantity to be reported becomes available for the NR SpCell and CBR measurement results become available;
- 2> if the *reportType* is set to *cli-EventTriggered* and if the entry condition applicable for this event, i.e. the event corresponding with the *eventId* of the corresponding *reportConfig* within *VarMeasConfig*, is fulfilled for one or more applicable CLI measurement resources for all measurements after layer 3 filtering taken during *timeToTrigger* defined for this event within the *VarMeasConfig*, while the *VarMeasReportList* does not include a measurement reporting entry for this *measId* (a first CLI measurement resource triggers the event):
 - 3> include a measurement reporting entry within the *VarMeasReportList* for this *measId*;
 - 3> set the *numberOfReportsSent* defined within the *VarMeasReportList* for this *measId* to 0;
 - 3> include the concerned CLI measurement resource(s) in the *cli-TriggeredList* defined within the *VarMeasReportList* for this *measId*;
 - 3> initiate the measurement reporting procedure, as specified in 5.5.5;

- 2> else if the *reportType* is set to *cli-EventTriggered* and if the entry condition applicable for this event, i.e. the event corresponding with the *eventId* of the corresponding *reportConfig* within *VarMeasConfig*, is fulfilled for one or more CLI measurement resources not included in the *cli-TriggeredList* for all measurements after layer 3 filtering taken during *timeToTrigger* defined for this event within the *VarMeasConfig* (a subsequent CLI measurement resource triggers the event):
 - 3> set the *numberOfReportsSent* defined within the *VarMeasReportList* for this *measId* to 0;
 - 3> include the concerned CLI measurement resource(s) in the *cli-TriggeredList* defined within the *VarMeasReportList* for this *measId*;
 - 3> initiate the measurement reporting procedure, as specified in 5.5.5;
- 2> else if the *reportType* is set to *cli-EventTriggered* and if the leaving condition applicable for this event is fulfilled for one or more of the CLI measurement resources included in the *cli-TriggeredList* defined within the *VarMeasReportList* for this *measId* for all measurements after layer 3 filtering taken during *timeToTrigger* defined within the *VarMeasConfig* for this event:
 - 3> remove the concerned CLI measurement resource(s) in the *cli-TriggeredList* defined within the *VarMeasReportList* for this *measId*;
 - 3> if *reportOnLeave* is set to *true* for the corresponding reporting configuration:
 - 4> initiate the measurement reporting procedure, as specified in 5.5.5;
 - 3> if the *cli-TriggeredList* defined within the *VarMeasReportList* for this *measId* is empty:
 - 4> remove the measurement reporting entry within the *VarMeasReportList* for this *measId*;
 - 4> stop the periodical reporting timer for this *measId*, if running;
- 2> if *reportType* is set to *cli-Periodical* and if a (first) measurement result is available:
 - 3> include a measurement reporting entry within the *VarMeasReportList* for this *measId*;
 - 3> set the *numberOfReportsSent* defined within the *VarMeasReportList* for this *measId* to 0;
 - 3> initiate the measurement reporting procedure, as specified in 5.5.5, immediately after the quantity to be reported becomes available for at least one CLI measurement resource;
- 2> if *reportType* is set to *rxTxPeriodical* and if a (first) measurement result is available:
 - 3> include a measurement reporting entry within the *VarMeasReportList* for this *measId*;
 - 3> set the *numberOfReportsSent* defined within the *VarMeasReportList* for this *measId* to 0;
 - 3> initiate the measurement reporting procedure, as specified in 5.5.5;
- 2> upon expiry of the periodical reporting timer for this *measId*:
 - 3> initiate the measurement reporting procedure, as specified in 5.5.5.
- 2> if the corresponding *reportConfig* includes a *reportType* is set to *reportSFTD*:
 - 3> if the corresponding *measObject* concerns NR:
 - 4> if the *drx-SFTD-NeighMeas* is included:
 - 5> if the quantity to be reported becomes available for each requested pair of PCell and NR cell:
 - 6> stop timer T322;
 - 6> initiate the measurement reporting procedure, as specified in 5.5.5;
 - 4> else

- 5> initiate the measurement reporting procedure, as specified in 5.5.5, immediately after the quantity to be reported becomes available for each requested pair of PCell and NR cell or the maximal measurement reporting delay as specified in TS 38.133 [14];
- 3> else if the corresponding *measObject* concerns E-UTRA:
 - 4> initiate the measurement reporting procedure, as specified in 5.5.5, immediately after the quantity to be reported becomes available for the pair of PCell and E-UTRA PSCell or the maximal measurement reporting delay as specified in TS 38.133 [14];
- 2> if *reportType* is set to *reportCGI*:
 - 3> if the UE acquired the *SIB1* or *SystemInformationBlockType1* for the requested cell; or
 - 3> if the UE detects that the requested NR cell is not transmitting *SIB1* (see TS 38.213 [13], clause 13):
 - 4> stop timer T321;
 - 4> include a measurement reporting entry within the *VarMeasReportList* for this *measId*;
 - 4> set the *numberOfReportsSent* defined within the *VarMeasReportList* for this *measId* to 0;
 - 4> initiate the measurement reporting procedure, as specified in 5.5.5;
 - 2> upon the expiry of T321 for this *measId*:
 - 3> include a measurement reporting entry within the *VarMeasReportList* for this *measId*;
 - 3> set the *numberOfReportsSent* defined within the *VarMeasReportList* for this *measId* to 0;
 - 3> initiate the measurement reporting procedure, as specified in 5.5.5.
 - 2> upon the expiry of T322 for this *measId*:
 - 3> initiate the measurement reporting procedure, as specified in 5.5.5.

[TS 38.331, clause 5.5.4. 8]

The UE shall:

- 1> consider the entering condition for this event to be satisfied when condition B1-1, as specified below, is fulfilled;
- 1> consider the leaving condition for this event to be satisfied when condition B1-2, as specified below, is fulfilled.

Inequality B1-1 (Entering condition)

$$Mn + Ofn + Ocn - Hys > Thresh$$

Inequality B1-2 (Leaving condition)

$$Mn + Ofn + Ocn + Hys < Thresh$$

The variables in the formula are defined as follows:

Mn is the measurement result of the inter-RAT neighbour cell, not taking into account any offsets.

Ofn is the measurement object specific offset of the frequency of the inter-RAT neighbour cell (i.e. *eutra-Q-OffsetRange* as defined within the *measObjectEUTRA* corresponding to the frequency of the neighbour inter-RAT cell, *utra-FDD-Q-OffsetRange* as defined within the *measObjectUTRA-FDD* corresponding to the frequency of the neighbour inter-RAT cell).

Ocn is the cell specific offset of the inter-RAT neighbour cell (i.e. *cellIndividualOffset* as defined within the *measObjectEUTRA* corresponding to the neighbour inter-RAT cell), and set to zero if not configured for the neighbour cell.

Hys is the hysteresis parameter for this event (i.e. *hysteresis* as defined within *reportConfigInterRAT* for this event).

Thresh is the threshold parameter for this event (i.e. *b1-ThresholdEUTRA* as defined within *reportConfigInterRAT* for this event, *b1-ThresholdUTRA-FDD* as defined for UTRA-FDD within *reportConfigInterRAT* for this event).

Mn is expressed in dBm or in dB, depending on the measurement quantity of the inter-RAT neighbour cell.

Ofn, Ocn, Hys are expressed in dB.

Thresh is expressed in the same unit as **Mn**.

[TS 38.331, clause 5.5.5]



Figure 5.5.5-1: Measurement reporting

The purpose of this procedure is to transfer measurement results from the UE to the network. The UE shall initiate this procedure only after successful security activation.

For the *measId* for which the measurement reporting procedure was triggered, the UE shall set the *measResults* within the *MeasurementReport* message as follows:

- 1> set the *measId* to the measurement identity that triggered the measurement reporting;
- 1> set the *measResultServingCell* within *measResultServingMOList* to include, for each NR serving cell that is configured with *servingCellMO*, RSRP, RSRQ and the available SINR, derived based on the *rsType* if indicated in the associated *reportConfig*, otherwise based on SSB if available, otherwise based on CSI-RS;
- 1> set the *measResultServingCell* within *measResultServingMOList* to include for each NR serving cell that is configured with *servingCellMO*, if any, the *servCellId*;
- 1> if the *reportConfig* associated with the *measId* that triggered the measurement reporting includes *reportQuantityRsIndexes* and *maxNrofRSIndexesToReport*:
 - 2> for each serving cell configured with *servingCellMO*, include beam measurement information according to the associated *reportConfig* as described in 5.5.5.2;
- ...
- 1> if there is at least one applicable neighbouring cell to report:
 - 2> if the *reportType* is set to *eventTriggered* or *periodical*:
 - 3> set the *measResultNeighCells* to include the best neighbouring cells up to *maxReportCells* in accordance with the following:
 - 4> if the *reportType* is set to *eventTriggered*:
 - 5> include the cells included in the *cellsTriggeredList* as defined within the *VarMeasReportList* for this *measId*;
 - ...
 - 4> for each cell that is included in the *measResultNeighCells*, include the *physCellId*;
 - 4> if the *reportType* is set to *eventTriggered* or *periodical*:
 - 5> for each included cell, include the layer 3 filtered measured results in accordance with the *reportConfig* for this *measId*, ordered as follows:

6> if the *measObject* associated with this *measId* concerns NR:

7> if *rsType* in the associated *reportConfig* is set to *ssb*:

8> set *resultsSSB-Cell* within the *measResult* to include the SS/PBCH block based quantity(ies) indicated in the *reportQuantityCell* within the concerned *reportConfig*, in decreasing order of the sorting quantity, determined as specified in 5.5.5.3, i.e. the best cell is included first:

9> if *reportQuantityRSIndexes* and *maxNrofRSIndexesToReport* are configured, include beam measurement information as described in 5.5.5.2;

...

6> if the *measObject* associated with this *measId* concerns E-UTRA:

7> set the *measResult* to include the quantity(ies) indicated in the *reportQuantity* within the concerned *reportConfigInterRAT* in decreasing order of the sorting quantity, determined as specified in 5.5.5.3, i.e. the best cell is included first;

...

1> increment the *numberOfReportsSent* as defined within the *VarMeasReportList* for this *measId* by 1;

1> stop the periodical reporting timer, if running;

...

1> if the UE is configured with EN-DC:

2> if SRB3 is configured:

3> submit the *MeasurementReport* message via SRB3 to lower layers for transmission, upon which the procedure ends;

2> else:

3> submit the *MeasurementReport* message via the EUTRA MCG embedded in E-UTRA RRC message *ULInformationTransferMRDC* as specified in TS 36.331 [10].

1> else:

2> submit the *MeasurementReport* message to lower layers for transmission, upon which the procedure ends.

8.2.3.1.2.3 Test description

8.2.3.1.2.3.1 Pre-test conditions

System Simulator:

- NR Cell 1 is the PCell and E-UTRA Cell 1 is the PSCell.

UE:

- None.

Preamble:

- The UE is in state NE-DC RRC_CONNECTED using generic procedure parameter Connectivity (NE-DC) according to TS 38.508-1 [4], Table 4.5.4.2-6.

8.2.3.1.2.3.2 Test procedure sequence

Table 8.2.3.1.2.3.2-1 and Table 8.2.3.1.2.3.2-2 illustrates the downlink power levels and other changing parameters to be applied for the cells at various time instants of the test execution. Row marked "T0" denotes the initial conditions after preamble, while columns marked "T1" and "T2" are to be applied subsequently. The exact instants on which these values shall be applied are described in the texts in this clause.

Table 8.2.3.1.2.3.2-1: Time instances of cell power level and parameter changes for FR1

	Parameter	Unit	E-UTRA Cell 1	NR Cell 1	Remark
T0	Cell-specific RS EPRE	dBm/15 kHz	-93	-	The power level values are such that entering conditions for event B1 are not satisfied.
	SS/PBCH SSS EPRE	dBm/SC S	-	-85	
T1	Cell-specific RS EPRE	dBm/15 kHz	-73	-	The power level values are such that entering conditions for event B1 are satisfied.
	SS/PBCH SSS EPRE	dBm/SC S	-	-85	
T2	Cell-specific RS EPRE	dBm/15 kHz	-93	-	The power level values are such that leaving conditions for event B1 are satisfied.
	SS/PBCH SSS EPRE	dBm/SC S	-	-85	

Table 8.2.3.1.2.3.2-2: Time instances of cell power level and parameter changes for FR2

	Parameter	Unit	E-UTRA Cell 1	NR Cell 1	Remark
T0	Cell-specific RS EPRE	dBm/15 kHz	-93	-	The power level values are such that entering conditions for event B1 are not satisfied.
	SS/PBCH SSS EPRE	dBm/SC S	-	-82	
T1	Cell-specific RS EPRE	dBm/15 kHz	-73	-	The power level values are such that entering conditions for event B1 are satisfied.
	SS/PBCH SSS EPRE	dBm/SC S	-	-82	
T2	Cell-specific RS EPRE	dBm/15 kHz	-93	-	The power level values are such that leaving conditions for event B1 are satisfied.
	SS/PBCH SSS EPRE	dBm/SC S	-	-82	

Table 8.2.3.1.2.3.2-3: Main behaviour

St	Procedure	Message Sequence		TP	Verdict
		U - S	Message		
1	The SS transmits an <i>RRCReconfiguration</i> including measConfig to setup inter RAT measurements and reporting for E-UTRA Cell 1.	<--	<i>RRCReconfiguration</i>	-	-
2	The UE transmits an <i>RRCReconfigurationComplete</i> message to confirm the setup of inter RAT measurements for E-UTRA Cell 1.	-->	<i>RRCReconfigurationComplete</i>	-	-
3	Check: Does the UE transmit a <i>MeasurementReport</i> message on NR Cell 1 to report the event B1 during the next 10s?	-->	<i>MeasurementReport</i>	1	F
4	The SS changes E-UTRA Cell 1 parameters according to the row "T1".	-	-	-	-
5	Check: Does the UE transmit a <i>MeasurementReport</i> message to report the event B1 for E-UTRA Cell 1?	-->	<i>MeasurementReport</i>	2	P
6	The SS changes E-UTRA Cell 1 parameters according to the row "T2".	-	-	-	-

7	Wait and ignore <i>MeasurementReport</i> messages for 15 s to allow change of power levels and UE measurements for E-UTRA Cell 1.	-	-	-	-
8	Check: Does the UE transmit a <i>MeasurementReport</i> message on NR Cell 1 to report the event B1 during the next 10s?	-->	<i>MeasurementReport</i>	3	F

8.2.3.1.2.3.3 Specific message contents

Table 8.2.3.1.2.3.3-1: RRCReconfiguration (step 1 Table 8.2.3.1.2.3.2-3)

Derivation Path: TS 38.508-1 [4], Table 4.6.1-13 with conditions NR_MEAS and NE-DC
--

Table 8.2.3.1.2.3.3-2: MeasConfig (Table 8.2.3.1.2.3.3-1)

Derivation Path: TS 38.508-1 [4] Table 4.6.3-69			
Information Element	Value/remark	Comment	Condition
MeasConfig ::= SEQUENCE {			
measObjectToAddModList SEQUENCE (SIZE (1..maxNrofMeasId)) OF MeasObjectToAddMod {	2 entries		
MeasObjectToAddMod[1] SEQUENCE {		entry 1	
measObjectId	1	MeasObjectIdNR-f1	
measObject CHOICE {			
measObjectNR SEQUENCE {			
ssbFrequency	ssbFrequency IE equals the ARFCN for NR Cell 1		
absThreshSS-BlocksConsolidation	Not present		
}			
}			
MeasObjectToAddMod[2] SEQUENCE {		entry 2	
measObjectId	2	MeasObjectIdE-UTRA-f1	
measObject CHOICE {			
measObjectEUTRA SEQUENCE {			
carrierFreq	ARFCN-ValueEUTRA for E-UTRA Cell 1		
}			
}			
}			
reportConfigToAddModList SEQUENCE (SIZE (1..maxReportConfigId)) OF ReportConfigToAddMod {	1 entry		
ReportConfigToAddMod[1] SEQUENCE {		entry 1	
reportConfigId	1		
reportConfig CHOICE {			
reportConfigInterRAT	ReportConfigInterRAT-EventB1	Table 8.2.3.1.2.3.3-3	
}			
}			
measIdToAddModList SEQUENCE (SIZE (1..maxNrofMeasId)) OF MeasIdToAddMod {	1 entry		
MeasIdToAddMod[1] SEQUENCE {		entry 1	
measId	1		
measObjectId	2		
reportConfigId	1		
}			
}			
quantityConfig	QuantityConfig with condition INTER-RAT		
measGapConfig	MeasGapConfig		

}		
---	--	--

Table 8.2.3.1.2.3.3-3: ReportConfigInterRAT-EventB1 (Table 8.2.3.1.2.3.3-2)

Derivation Path: TS 38.508-1 [4] Table 4.6.3-141 with condition EVENT_B1			
Information Element	Value/remark	Comment	Condition
ReportConfigNR ::= SEQUENCE {			
reportType CHOICE {			
eventTriggered SEQUENCE {			
eventId CHOICE {			
eventB1 SEQUENCE {			
b1-ThresholdEUTRA SEQUENCE {			
rsrp	61	-80dBm	
}			
}			
}			
reportAmount	r1		
}			
}			

Table 8.2.3.1.2.3.3-4: QuantityConfig with condition INTER-RAT (Table 8.2.3.1.2.3.3-2)

Derivation Path: TS 38.508-1 [4], Table 4.6.3-127 with condition INTER-RAT
--

Table 8.2.3.1.2.3.3-5: MeasurementReport (step 5, Table 8.2.3.1.2.3.2-3)

Derivation Path: TS 38.508-1 [4] Table 4.6.1-5A			
Information Element	Value/remark	Comment	Condition
MeasurementReport ::= SEQUENCE {			
criticalExtensions CHOICE {			
measurementReport SEQUENCE {			
measResults SEQUENCE {			
measId	1		Step 5
measResultServingMOList SEQUENCE (SIZE (1..maxNrofServingCells)) OF MeasResultServMO {	1 entry	Report NR Cell 1	
MeasResultServMO[1] SEQUENCE {		entry 1	
servCellId	ServCellIndex of NR Cell 1		
measResultServingCell SEQUENCE {			
physCellId	Physical layer cell identity of NR Cell 1		
measResult SEQUENCE {			
cellResults SEQUENCE {			
resultsSSB-Cell SEQUENCE {			
rsrp	(0..127)		
rsrq	(0..127)		
sinr	Not present		
}	Not checked		pc_ss_SIN R_Meas
}			
}			
}			
}			
}			
}			
}			
measResultNeighCells CHOICE {			
measResultListEUTRA SEQUENCE (SIZE (1..maxCellReport)) OF MeasResultEUTRA {	1 entry	Report E-UTRA neighbour cell	
MeasResultEUTRA[1] SEQUENCE {		entry 1	
eutra-PhysCellId	Physical layer cell identity of E-UTRA Cell 1		Step 5
}			
measResult SEQUENCE {			

rsrp	(0..97)		
rsrq	(0..34)		
sinr	Not present		
}			
cgi-Info	Not present		
}			
}			
}			
}			
}			
}			

8.2.3.2 Measurement configuration control and reporting / Inter-RAT measurements / Event B1 / Measurement of NR cells / RSRQ based measurements

8.2.3.2.1 Measurement configuration control and reporting / Inter-RAT measurements / Event B1 / Measurement of NR cells / RSRQ based measurements / EN-DC

8.2.3.2.1.1 Test Purpose (TP)

(1)

```
with { UE in E-UTRA RRC_CONNECTED state having completed the radio bearer establishment and
performed the inter RAT measurement for NR cell, configured b1-Threshold set to threshold-RSRQ and
not detected entering condition for the event B1 is met }
ensure that {
  when { UE detects entering condition for the event B1 is not met }
    then { UE does not transmit any MeasurementReport }
}
```

(2)

```
with { UE in E-UTRA RRC_CONNECTED state having completed the radio bearer establishment and
performed the inter RAT measurement for NR cell, configured b1-Threshold set to threshold-RSRQ and
not detected entering condition for the event B1 is met }
ensure that {
  when { UE detects entering condition for the event B1 is met }
    then { UE transmits a MeasurementReport }
}
```

(3)

```
with { UE in E-UTRA RRC_CONNECTED state having completed the radio bearer establishment and
performed the inter RAT measurement for NR cell, configured b1-Threshold set to threshold-RSRQ and
detected entering condition for the event B1 is met }
ensure that {
  when { UE detects leaving condition for the event B1 is met }
    then { UE does not transmit any MeasurementReport }
}
```

8.2.3.2.1.2 Conformance requirements

References: The conformance requirements covered in the present TC are specified in: TS 36.331, clauses 5.5.1, 5.5.4.1, 5.5.4.7, 5.5.5.1 and 5.5.5.3. Unless otherwise stated these are Rel-15 requirements.

[TS 36.331, clause 5.5.1]

The UE reports measurement information in accordance with the measurement configuration as provided by E-UTRAN. E-UTRAN provides the measurement configuration applicable for a UE in RRC_CONNECTED by means of dedicated signalling, i.e. using the *RRCConnectionReconfiguration* or *RRCConnectionResume* message.

The UE can be requested to perform the following types of measurements:

- Intra-frequency measurements: measurements at the downlink carrier frequency(ies) of the serving cell(s).

- Inter-frequency measurements: measurements at frequencies that differ from any of the downlink carrier frequency(ies) of the serving cell(s).
- Inter-RAT measurements of NR frequencies.
- ...

The measurement configuration includes the following parameters:

1. **Measurement objects:** The objects on which the UE shall perform the measurements.
 - For intra-frequency and inter-frequency measurements a measurement object is a single E-UTRA carrier frequency. Associated with this carrier frequency, E-UTRAN can configure a list of cell specific offsets, a list of 'blacklisted' cells and a list of 'whitelisted' cells. Blacklisted cells are not considered in event evaluation or measurement reporting.
 - For inter-RAT NR measurements a measurement object is a single NR carrier frequency. Associated with this carrier frequency, E-UTRAN can configure a list of 'blacklisted' cells. Blacklisted cells are not considered in event evaluation or measurement reporting.
 - ...

NOTE 1: Some measurements using the above mentioned measurement objects, only concern a single cell, e.g. measurements used to report neighbouring cell system information, PCell UE Rx-Tx time difference, or a pair of cells, e.g. SSTD measurements between the PCell and the PSCell.

2. **Reporting configurations:** A list of reporting configurations where each reporting configuration consists of the following:
 - Reporting criterion: The criterion that triggers the UE to send a measurement report. This can either be periodical or a single event description.
 - Reporting format: The quantities that the UE includes in the measurement report and associated information (e.g. number of cells to report).
3. **Measurement identities:** A list of measurement identities where each measurement identity links one measurement object with one reporting configuration. By configuring multiple measurement identities it is possible to link more than one measurement object to the same reporting configuration, as well as to link more than one reporting configuration to the same measurement object. The measurement identity is used as a reference number in the measurement report.
4. **Quantity configurations:** One quantity configuration is configured per RAT type. The quantity configuration defines the measurement quantities and associated filtering used for all event evaluation and related reporting of that measurement type. One filter can be configured per measurement quantity, except for NR where the network may configure up to 2 sets of quantity configurations each comprising per measurement quantity separate filters for cell and RS index measurement results. The quantity configuration set that applies for a given measurement is indicated within the NR measurement object.
5. **Measurement gaps:** Periods that the UE may use to perform measurements, i.e. no (UL, DL) transmissions are scheduled.

E-UTRAN only configures a single measurement object for a given frequency (except for WLAN and except for CBR measurements), i.e. it is not possible to configure two or more measurement objects for the same frequency with different associated parameters, e.g. different offsets and/ or blacklists. E-UTRAN may configure multiple instances of the same event e.g. by configuring two reporting configurations with different thresholds.

The UE maintains a single measurement object list, a single reporting configuration list, and a single measurement identities list. The measurement object list includes measurement objects, that are specified per RAT type, possibly including intra-frequency object(s) (i.e. the object(s) corresponding to the serving frequency(ies)), inter-frequency object(s) and inter-RAT objects. Similarly, the reporting configuration list includes E-UTRA and inter-RAT reporting configurations. Any measurement object can be linked to any reporting configuration of the same RAT type. Some reporting configurations may not be linked to a measurement object. Likewise, some measurement objects may not be linked to a reporting configuration.

[TS 36.331, clause 5.5.4.1]

If security has been activated successfully, the UE shall:

- 1> for each *measId* included in the *measIdList* within *VarMeasConfig*:
 - ...
 - 2> else:
 - ...
 - 3> else if the corresponding *measObject* concerns NR:
 - 4> if the *reportSFTD-Meas* is set to *pSCell* in the corresponding *reportConfigInterRAT*:
 - 5> consider the PSCell to be applicable;
 - 4> else if the *reportSFTD-Meas* is set to *neighborCells* in the corresponding *reportConfigInterRAT*:
 - 5> if *cellsForWhichToReportSFTD* is configured in the corresponding *measObjectNR*:
 - 6> consider any neighbouring NR cell on the associated frequency that is included in *cellsForWhichToReportSFTD* to be applicable;
 - 5> else:
 - 6> consider up to 3 strongest neighbouring NR cells detected on the associated frequency to be applicable when the concerned cells are not included in the *blackCellsToAddModList* defined within the *VarMeasConfig* for this *measId*;
 - ...
 - 2> else if the *purpose* is included and set to *reportStrongestCells*, *reportStrongestCellsForSON*, *reportLocation* *sidelink* or *sensing sidelink* and if a (first) measurement result is available:
 - 3> include a measurement reporting entry within the *VarMeasReportList* for this *measId*;
 - 3> set the *numberOfReportsSent* defined within the *VarMeasReportList* for this *measId* to 0;
 - 3> if the *purpose* is set to *reportStrongestCells* and *reportStrongestCSI-RSs* is not included:
 - 4> if the *triggerType* is set to *periodical* and the corresponding *reportConfig* includes the *ul-DelayConfig*:
 - 5> initiate the measurement reporting procedure, as specified in 5.5.5, immediately after a first measurement result is provided by lower layers;
 - ...
 - 4> else if the *reportAmount* exceeds 1:
 - 5> initiate the measurement reporting procedure, as specified in 5.5.5, immediately after the quantity to be reported becomes available for the PCell;
 - 4> else (i.e. the *reportAmount* is equal to 1):
 - 5> initiate the measurement reporting procedure, as specified in 5.5.5, immediately after the quantity to be reported becomes available for the PCell and for the strongest cell among the applicable cells, or becomes available for the pair of PCell and the PSCell in case of SSTD measurements, or becomes available for each requested pair of PCell and NR cell or the maximal measurement reporting delay as specified in TS 38.133 [84, 8.17.2.3] in case of SFTD measurements;
 - ...
 - 3> else:
 - 4> initiate the measurement reporting procedure, as specified in 5.5.5, when it has determined the strongest cells on the associated frequency;

- 2> upon expiry of the periodical reporting timer for this *measId*:
- 3> initiate the measurement reporting procedure, as specified in 5.5.5;

...

NOTE 2: The UE does not stop the periodical reporting with *triggerType* set to *event* or to *periodical* while the corresponding measurement is not performed due to the PCell RSRP being equal to or better than *s-Measure* or due to the measurement gap not being setup.

NOTE 3: If the UE is configured with DRX, the UE may delay the measurement reporting for event triggered and periodical triggered measurements until the Active Time, which is defined in TS 36.321 [6].

[TS 36.331, clause 5.5.4.7]

The UE shall:

- 1> for UTRA and CDMA2000, only trigger the event for cells included in the corresponding measurement object;
- 1> consider the entering condition for this event to be satisfied when condition B1-1, as specified below, is fulfilled;
- 1> consider the leaving condition for this event to be satisfied when condition B1-2, as specified below, is fulfilled;

Inequality B1-1 (Entering condition)

$$Mn + Ofn - Hys > Thresh$$

Inequality B1-2 (Leaving condition)

$$Mn + Ofn + Hys < Thresh$$

The variables in the formula are defined as follows:

Mn is the measurement result of the inter-RAT neighbour cell, not taking into account any offsets. For CDMA 2000 measurement result, *pilotStrength* is divided by -2.

Ofn is the frequency specific offset of the frequency of the inter-RAT neighbour cell (i.e. *offsetFreq* as defined within the *measObject* corresponding to the frequency of the neighbour inter-RAT cell).

Hys is the hysteresis parameter for this event (i.e. *hysteresis* as defined within *reportConfigInterRAT* for this event).

Thresh is the threshold parameter for this event (i.e. *b1-Threshold* as defined within *reportConfigInterRAT* for this event). For CDMA2000, *b1-Threshold* is divided by -2.

Mn is expressed in dBm or in dB, depending on the measurement quantity of the inter-RAT neighbour cell.

Ofn, ***Hys*** are expressed in dB.

Thresh is expressed in the same unit as ***Mn***.

[TS 36.331, clause 5.5.5.1]

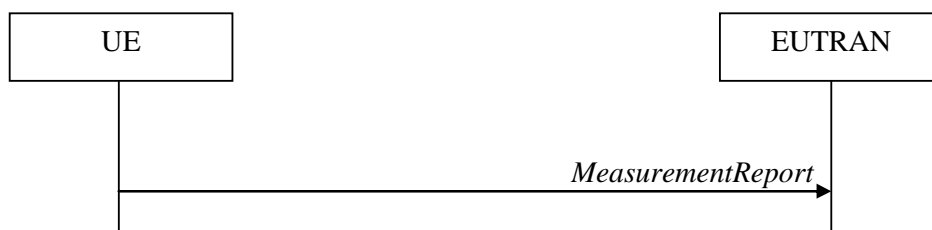

Figure 5.5.5.1-1: Measurement reporting

The purpose of this procedure is to transfer measurement results from the UE to E-UTRAN. The UE shall initiate this procedure only after successful security activation.

For the *measId* for which the measurement reporting procedure was triggered, the UE shall set the *measResults* within the *MeasurementReport* message as follows:

- 1> set the *measId* to the measurement identity that triggered the measurement reporting;
 - 1> set the *measResultPCell* to include the quantities of the PCell;
 - 1> set the *measResultServFreqList* to include for each E-UTRA SCell that is configured, if any, within *measResultSCell* the quantities of the concerned SCell, if available according to performance requirements in [16], except if *purpose* for the *reportConfig* associated with the *measId* that triggered the measurement reporting is set to *reportLocation*;
 - 1> if the *reportConfig* associated with the *measId* that triggered the measurement reporting includes *reportAddNeighMeas*:
 - 2> for each E-UTRA serving frequency for which *measObjectId* is referenced in the *measIdList*, other than the frequency corresponding with the *measId* that triggered the measurement reporting:
 - 3> set the *measResultServFreqList* to include within *measResultBestNeighCell* the *physCellId* and the quantities of the best non-serving cell, based on RSRP, on the concerned serving frequency;
 - 1> if the *triggerType* is set to *event*; and if the corresponding *measObject* concerns NR; and if *eventId* is set to *eventB1* or *eventB2*; or
 - 1> if the *triggerType* is set to *event*; and if *eventId* is set to *eventA3* or *eventA4* or *eventA5*:
 - 2> if *purpose* for the *reportConfig* associated with the *measId* that triggered the measurement reporting is set to a value other than *reportLocation*:
 - 3> set the *measResultServFreqListNR* to include for each NR serving frequency, if any, the following:
 - 4> set *measResultSCell* to include the available results of the NR serving cell, as specified in 5.5.5.2;
 - 4> if the *reportConfig* associated with the *measId* that triggered the measurement reporting includes *reportAddNeighMeas*:
 - 5> set *measResultBestNeighCell* to include the available results, as specified in 5.5.5.2, of the best non-serving cell, ordered based on the quantity determined as specified in 5.5.5.3;
 - 5> for each (serving or neighbouring) cell for which the UE reports results according to the previous, additionally include available beam results according to the following:
 - 6> if *maxReportRS-Index* is configured, set *measResultCellRS-Index* to include available results, as specified in 5.5.5.2, of up to *maxReportRS-Index* beams, ordered based on the quantity determined as specified in 5.5.5.3;
 - 1> if there is at least one applicable neighbouring cell to report:
 - 2> set the *measResultNeighCells* to include the best neighbouring cells up to *maxReportCells* in accordance with the following:
 - 3> if the *triggerType* is set to *event*:
 - 4> include the cells included in the *cellsTriggeredList* as defined within the *VarMeasReportList* for this *measId*;
 - 3> else:
 - 4> include the applicable cells for which the new measurement results became available since the last periodical reporting or since the measurement was initiated or reset;
- NOTE 1: The reliability of the report (i.e. the certainty it contains the strongest cells on the concerned frequency) depends on the measurement configuration i.e. the *reportInterval*. The related performance requirements are specified in TS 36.133 [16].
- 3> for each cell that is included in the *measResultNeighCells*, include the *physCellId*;

- 3> if the *triggerType* is set to *event*; or the *purpose* is set to *reportStrongestCells* or to *reportStrongestCellsForSON*:
- 4> for each included cell, include the layer 3 filtered measured results in accordance with the *reportConfig* for this *measId*, ordered as follows:
 - 5> if the *measObject* associated with this *measId* concerns E-UTRA:
 - 6> set the *measResult* to include the quantity(ies) indicated in the *reportQuantity* within the concerned *reportConfig* in order of decreasing *triggerQuantity*, i.e. the best cell is included first;
 - 5> if the *measObject* associated with this *measId* concerns NR:
 - 6> set the *measResultCell* to include the quantity(ies) indicated in the *reportQuantityCellNR* within the concerned *reportConfig* in order of decreasing quantity according to *bN-ThresholdYNR*, i.e. the best cell is included first;
 - 6> if *maxReportRS-Index* and *reportQuantityRS-IndexNR* are configured, set *measResultCellRS-Index* to include results of the best beam and the beams whose quantity is above *threshRS-Index* defined in the *VarMeasConfig* for the corresponding *measObject*, up to *maxReportRS-Index* beams in total, and in order of decreasing quantity, same as used for cell reporting, and as follows:
 - 7> order beams based on the sorting quantity determined as specified in 5.5.5.2;
 - 7> include *ssbIndex*;
 - 7> if *reportRS-IndexResultsNR* is configured, for each quantity indicated, include the corresponding measurement result;

[TS 36.331, clause 5.5.5.3]

When configured to report the best cells or beams, the UE shall determine the quantity that is used to order and select as follows:

- 1> consider the quantities the UE reports as candidate sorting quantities i.e. as follows:
 - 2> for NR cells for which measurement reporting is triggered (i.e. NR cells included in *cellsTriggered*):
 - 3> the quantities defined by *reportQuantityCellNR*, when used for sorting cells;
 - 3> the quantities defined by *reportQuantityRS-IndexNR*, when used for sorting beams;
 - 2> for cells on NR serving frequencies:
 - 3> the available quantities of available NR measurement results as specified in 5.5.5.2;
- 1> if *reportType* is set to *eventTriggered*; and if *eventId* is set to *eventB1* or *eventB2*:
 - 2> consider the trigger quantity to be the sorting quantity;
- 1> if *reportType* is set to *periodical*:
 - 2> if there is a single candidate sorting quantity;
 - 3> consider the concerned quantity to be the sorting quantity;
 - 2> else:
 - 3> if RSRP is one of the candidate sorting quantities;
 - 4> consider RSRP to be the sorting quantity;
 - 3> else:
 - 4> consider RSRQ to be the sorting quantity;

8.2.3.2.1.3 Test description

8.2.3.2.1.3.1 Pre-test conditions

System Simulator:

- E-UTRA Cell 1 and NR Cell 1.
- NR Cell 1 is configured to operate in FR1 bands as defined in TS 38.508-1 [4] clause 6.2.3.

UE:

- None.

Preamble:

- The UE is in state RRC_CONNECTED using generic procedure parameter Connectivity (*E-UTRA/EPC*) established according to TS 38.508-1 [4], clause 4.5.4.

8.2.3.2.1.3.2 Test procedure sequence

Table 8.2.3.2.1.3.2-1 illustrates the downlink power levels and other changing parameters to be applied for the cells at various time instants of the test execution. Row marked "T0" denotes the initial conditions after preamble, while columns marked "T1" and "T2" are to be applied subsequently. The exact instants on which these values shall be applied are described in the texts in this clause.

Table 8.2.3.2.1.3.2-1: Time instances of cell power level and parameter changes for conducted test environment

	Parameter	Unit	E-UTRA Cell 1	NR Cell 1	Remark
T0	Cell-specific RS EPRE	dBm/15 kHz	-85	-	The power level values are such that entering conditions for event B1 are not satisfied.
	SS/PBCH SSS EPRE	dBm/SC S	-	-91	
	SS-RSRQ	dB	-	-16.24	
	Noc	dBm/SC S	-	-87	
T1	Cell-specific RS EPRE	dBm/15 kHz	-85	-	The power level values are such that entering conditions for event B1 are satisfied.
	SS/PBCH SSS EPRE	dBm/SC S	-	-85	
	SS-RSRQ	dB	-	-12.91	
	Noc	dBm/SC S	-	-87	
T2	Cell-specific RS EPRE	dBm/15 kHz	-85	-	The power level values are such that leaving conditions for event B1 are satisfied.
	SS/PBCH SSS EPRE	dBm/SC S	-	-91	
	SS-RSRQ	dB	-	-16.24	
	Noc	dBm/SC S	-	-87	

Table 8.2.3.2.1.3.2-1A: Void

Table 8.2.3.2.1.3.2-2: Main behaviour

St	Procedure	Message Sequence		TP	Verdict
		U - S	Message		

1	The SS transmits an <i>RRCCONNECTIONRECONFIGURATION</i> including <i>measConfig</i> to setup inter RAT measurements and reporting for NR Cell 1.	<--	<i>RRCCONNECTIONRECONFIGURATION</i>	-	-
2	The UE transmits an <i>RRCCONNECTIONRECONFIGURATIONCOMPLETE</i> message to confirm the setup of inter RAT measurements for NR Cell 1.	-->	<i>RRCCONNECTIONRECONFIGURATIONCOMPLETE</i>	-	-
3	Check: Does the UE transmit a <i>MEASUREMENTREPORT</i> message on E-UTRA Cell 1 to report the event B1 during the next 10s?	-->	<i>MEASUREMENTREPORT</i>	1	F
4	The SS changes E-UTRA Cell 1 and NR Cell 1 parameters according to the row "T1".	-	-	-	-
5	Check: Does the UE transmit a <i>MEASUREMENTREPORT</i> message to report the event B1 for NR Cell 1?	-->	<i>MEASUREMENTREPORT</i>	2	P
6	The SS changes E-UTRA Cell 1 and NR Cell 1 parameters according to the row "T2".	-	-	-	-
7	Wait and ignore <i>MEASUREMENTREPORT</i> messages for 15 s to allow change of power levels and UE measurements for NR Cell 1.	-	-	-	-
8	Check: Does the UE transmit a <i>MEASUREMENTREPORT</i> message on E-UTRA Cell 1 to report the event B1 during the next 10s?	-->	<i>MEASUREMENTREPORT</i>	3	F

8.2.3.2.1.3.3 Specific message contents

Table 8.2.3.2.1.3.3-1: *RRCCONNECTIONRECONFIGURATION* (step 1, Table 8.2.3.2.1.3.2-2)

Derivation Path: TS 36.508 [7], Table 4.6.1-8, condition MEAS

Table 8.2.3.2.1.3.3-2: *MeasConfig* (Table 8.2.3.2.1.3.3-1)

Derivation Path: TS 36.508 [7], Table 4.6.6-1			
Information Element	Value/remark	Comment	Condition
<i>MeasConfig</i> ::= SEQUENCE {			
<i>measObjectToAddModList</i> SEQUENCE (SIZE (1.. <i>maxObjectId</i>)) OF <i>MeasObjectToAddMod</i> {	2 entries		
<i>MeasObjectToAddMod</i> [1] SEQUENCE {		entry 1	
<i>measObjectId</i>	<i>IdMeasObject-f1</i>		
<i>measObject</i>	<i>MeasObjectEUTRA-GENERIC(f1)</i>		
	<i>MeasObjectEUTRA-GENERIC(maxEARFCN)</i>		Band > 64
}			
<i>MeasObjectToAddMod</i> [2] SEQUENCE {		entry 2	
<i>measObjectId</i>	<i>IdMeasObject-NRf1</i>		
<i>measObject</i>	<i>MeasObjectNR-GENERIC (NRf1)</i>		
}			
<i>reportConfigToAddModList</i> SEQUENCE (SIZE (1.. <i>maxReportConfigId</i>)) OF <i>ReportConfigToAddMod</i> {	1 entry		
<i>ReportConfigToAddMod</i> [1] SEQUENCE {		entry 1	
<i>reportConfigId</i>	<i>IdReportConfig-B1-NR</i>		
<i>reportConfig</i>	<i>ReportConfig-B1-NR-r15</i>		
}			
}			
<i>measIdToAddModList</i> SEQUENCE (SIZE (1.. <i>maxMeasId</i>)) OF <i>MeasIdToAddMod</i> {	1 entry		
<i>MeasIdToAddMod</i> [1] SEQUENCE {		entry 1	
<i>measId</i>	1		
<i>measObjectId</i>	<i>IdMeasObject-NRf1</i>		
<i>reportConfigId</i>	<i>IdReportConfig-B1-NR</i>		

}			
}			
quantityConfig	QuantityConfig-DEFAULT		
measGapConfig	MeasGapConfig		
}			

Table 8.2.3.2.1.3.3-3: QuantityConfig-DEFAULT (Table 8.2.3.2.1.3.3-2)

Derivation Path: TS 36.508 [7], Table 4.6.6-3A			
Information Element	Value/remark	Comment	Condition
QuantityConfig-DEFAULT ::= SEQUENCE {			
quantityConfigNRList-r15 SEQUENCE ((SIZE (1..maxQuantSetsNR-r15)) OF QuantityConfigNR-r15 {	1 entry		
QuantityConfigNR-r15[1] SEQUENCE {		entry 1	
measQuantityCellNR-r15 SEQUENCE {			
filterCoeff-RSRP-r15	fc4		
filterCoeff-RSRQ-r15	fc4		
}			
}			
}			
}			

Table 8.2.3.2.1.3.3-4: MeasObjectNR-GENERIC (NRf1) (Table 8.2.3.2.1.3.3-2)

Derivation Path: TS 36.508 [7], Table 4.6.6-2B			
Information Element	Value/remark	Comment	Condition
MeasObjectNR-GENERIC(Freq) ::= SEQUENCE {			
carrierFreq-r15	Downlink carrier frequency of NR cell 1		
}			

Table 8.2.3.2.1.3.3-5: ReportConfig-B1-NR-r15 (Table 8.2.3.2.1.3.3-2)

Derivation Path: TS 36.508 [7], Table 4.6.6-7AA			
Information Element	Value/remark	Comment	Condition
ReportConfig-B1-NR ::= SEQUENCE {			
triggerType CHOICE {			
event SEQUENCE {			
eventId CHOICE {			
eventB1-NR-r15 SEQUENCE{			
b1-ThresholdNR-r15 CHOICE {			
nr-RSRQ-r15	58		
}			
}			
}			
}			
reportAmount	infinity		
reportQuantityCellNR-r15 SEQUENCE {			
ss-rsrq	true		
}			

Table 8.2.3.2.1.3.3-6: MeasurementReport (step 5, Table 8.2.3.2.1.3.2-2)

Derivation Path: TS 36.508 [7], Table 4.6.1-5			
Information Element	Value/remark	Comment	Condition
MeasurementReport ::= SEQUENCE {			
criticalExtensions CHOICE {			
c1 CHOICE {			
measurementReport-r8 SEQUENCE {			

measResults SEQUENCE {			
measId	1		
measResultPCell SEQUENCE {			
rsrpResult	(0..97)		
rsrqResult	(0..34)		
}			
measResultNeighCells CHOICE {			
measResultNeighCellListNR-r15 SEQUENCE (SIZE (1..maxCellReport)) OF MeasResultCellNR-r15 {	1 entry		
MeasResultCellNR-r15[1] SEQUENCE {		entry 1	
pci-r15	PhysicalCellIdentity of NR Cell 1		
measResultCell-r15 SEQUENCE {			
rsrqResult-r15	(0..127)		
}			
}			
}			
}			

Table 8.2.3.2.1.3.3-7: MeasGapConfig(Table 8.2.3.2.1.3.3-2)

Derivation Path: TS 36.331, clause 6.3.5			
Information Element	Value/remark	Comment	Condition
MeasGapConfig-GP2 ::= CHOICE {			
setup SEQUENCE {			
gapOffset CHOICE {			
gp1	19	TGRP = 80 ms	
}			
}			
}			

8.2.3.2.2 Measurement configuration control and reporting / Inter-RAT measurements / Event B1 / Measurement of NR cells / NE-DC

8.2.3.2.2.1 Test Purpose (TP)

(1)

```
with { UE in RRC_CONNECTED state in NE-DC, and, MCG(s) (NR PDCP) and SCG, and performed the inter
RAT measurement for E-UTRA cell and not detected entering condition for the event B1 is met }
ensure that {
  when { UE detects entering condition for the event B1 is not met }
  then { UE does not transmit any MeasurementReport }
}
```

(2)

```
with { UE in RRC_CONNECTED state in NE-DC, and, MCG(s) (NR PDCP) and SCG, and having completed the
radio bearer establishment and performed the inter RAT measurement for E-UTRA cell and configured
b1-Threshold set to threshold-RSRQ and not detected entering condition for the event B1 is met }
ensure that {
  when { UE detects entering condition for the event B1 is met }
  then { UE transmits a MeasurementReport }
}
```

(3)

```

with { UE in RRC_CONNECTED state in NE-DC, and, MCG(s) (NR PDCP) and SCG, and performed the inter
RAT measurement for E-UTRA cell and configured b1-Threshold set to threshold-RSRQ and detected
entering condition for the event B1 is met}
ensure that {
  when { UE detects leaving condition for the event B1 is met }
  then { UE does not transmit any MeasurementReport }
}

```

8.2.3.2.2.2 Conformance requirements

References: The conformance requirements covered in the present TC are specified in: TS 38.331, clauses 5.5.1, 5.5.4.1, 5.5.4.7, 5.5.5 and 5.5.5.3. Unless otherwise stated these are Rel-15 requirements.

[TS 38.331, clause 5.5.1]

The network may configure an RRC_CONNECTED UE to perform measurements. The network may configure the UE to report them in accordance with the measurement configuration or perform conditional reconfiguration evaluation in accordance with the conditional reconfiguration. The measurement configuration is provided by means of dedicated signalling i.e. using the *RRCReconfiguration* or *RRCResume*.

The network may configure the UE to perform the following types of measurements:

- NR measurements;
- Inter-RAT measurements of E-UTRA frequencies;
- Inter-RAT measurements of UTRA-FDD frequencies;
- NR sidelink measurements of L2 U2N Relay UEs.

The network may configure the UE to report the following measurement information based on SS/PBCH block(s):

- Measurement results per SS/PBCH block;
- Measurement results per cell based on SS/PBCH block(s);
- SS/PBCH block(s) indexes.

The network may configure the UE to report the following measurement information based on CSI-RS resources:

- Measurement results per CSI-RS resource;
- Measurement results per cell based on CSI-RS resource(s);
- CSI-RS resource measurement identifiers.

The network may configure the UE to perform the following types of measurements for NR sidelink and V2X sidelink:

- CBR measurements.

The network may configure the UE to report the following CLI measurement information based on SRS resources:

- Measurement results per SRS resource;
- SRS resource(s) indexes.

The network may configure the UE to report the following CLI measurement information based on CLI-RSSI resources:

- Measurement results per CLI-RSSI resource;
- CLI-RSSI resource(s) indexes.

The network may configure the UE to report the following Rx-Tx time difference measurement information based on CSI-RS for tracking or PRS:

- UE Rx-Tx time difference measurement result.

The measurement configuration includes the following parameters:

1. Measurement objects: A list of objects on which the UE shall perform the measurements.

- For intra-frequency and inter-frequency measurements a measurement object indicates the frequency/time location and subcarrier spacing of reference signals to be measured. Associated with this measurement object, the network may configure a list of cell specific offsets, a list of 'exclude-listed' cells and a list of 'allow-listed' cells. Exclude-listed cells are not applicable in event evaluation or measurement reporting. Allow-listed cells are the only ones applicable in event evaluation or measurement reporting.
- The *measObjectId* of the MO which corresponds to each serving cell is indicated by *servingCellMO* within the serving cell configuration.
- For inter-RAT E-UTRA measurements a measurement object is a single E-UTRA carrier frequency. Associated with this E-UTRA carrier frequency, the network can configure a list of cell specific offsets and a list of 'exclude-listed' cells. Exclude-listed cells are not applicable in event evaluation or measurement reporting.
- For inter-RAT UTRA-FDD measurements a measurement object is a set of cells on a single UTRA-FDD carrier frequency.
- For NR sidelink measurements of L2 U2N Relay UEs, a measurement object is a single NR sidelink frequency to be measured.
- For CBR measurement of NR sidelink communication, a measurement object is a set of transmission resource pool(s) on a single carrier frequency for NR sidelink communication.
- For CLI measurements a measurement object indicates the frequency/time location of SRS resources and/or CLI-RSSI resources, and subcarrier spacing of SRS resources to be measured.

2. Reporting configurations: A list of reporting configurations where there can be one or multiple reporting configurations per measurement object. Each measurement reporting configuration consists of the following:

- Reporting criterion: The criterion that triggers the UE to send a measurement report. This can either be periodical or a single event description.
- RS type: The RS that the UE uses for beam and cell measurement results (SS/PBCH block or CSI-RS).
- Reporting format: The quantities per cell and per beam that the UE includes in the measurement report (e.g. RSRP) and other associated information such as the maximum number of cells and the maximum number beams per cell to report.

In case of conditional reconfiguration, each configuration consists of the following:

- Execution criteria: The criteria the UE uses for conditional reconfiguration execution.
- RS type: The RS that the UE uses for obtaining beam and cell measurement results (SS/PBCH block-based or CSI-RS-based), used for evaluating conditional reconfiguration execution condition.

3. Measurement identities: For measurement reporting, a list of measurement identities where each measurement identity links one measurement object with one reporting configuration. By configuring multiple measurement identities, it is possible to link more than one measurement object to the same reporting configuration, as well as to link more than one reporting configuration to the same measurement object. The measurement identity is also included in the measurement report that triggered the reporting, serving as a reference to the network. For conditional reconfiguration triggering, one measurement identity links to exactly one conditional reconfiguration trigger configuration. And up to 2 measurement identities can be linked to one conditional reconfiguration execution condition.

4. Quantity configurations: The quantity configuration defines the measurement filtering configuration used for all event evaluation and related reporting, and for periodical reporting of that measurement. For NR measurements, the network may configure up to 2 quantity configurations with a reference in the NR measurement object to the configuration that is to be used. In each configuration, different filter coefficients can be configured for different measurement quantities, for different RS types, and for measurements per cell and per beam.

5. Measurement gaps: Periods that the UE may use to perform measurements.

Editor Note: It is FFS whether and how the definition of measurement gap should be updated due to pre-configured MG.

A UE in RRC_CONNECTED maintains a measurement object list, a reporting configuration list, and a measurement identities list according to signalling and procedures in this specification. The measurement object list possibly includes NR measurement object(s), CLI measurement object(s), inter-RAT objects, and L2 U2N Relay objects. Similarly, the reporting configuration list includes NR, inter-RAT, and L2 U2N Relay reporting configurations. Any measurement object can be linked to any reporting configuration of the same RAT type. Some reporting configurations may not be linked to a measurement object. Likewise, some measurement objects may not be linked to a reporting configuration.

The measurement procedures distinguish the following types of cells:

1. The NR serving cell(s) – these are the SpCell and one or more SCells.
2. Listed cells – these are cells listed within the measurement object(s).
3. Detected cells – these are cells that are not listed within the measurement object(s) but are detected by the UE on the SSB frequency(ies) and subcarrier spacing(s) indicated by the measurement object(s).

For NR measurement object(s), the UE measures and reports on the serving cell(s)/serving Relay UE (for L2 U2N Remote UE), listed cells and/or detected cells. For inter-RAT measurements object(s) of E-UTRA, the UE measures and reports on listed cells and detected cells and, for RSSI and channel occupancy measurements, the UE measures and reports on the configured resources on the indicated frequency. For inter-RAT measurements object(s) of UTRA-FDD, the UE measures and reports on listed cells. For CLI measurement object(s), the UE measures and reports on configured measurement resources (i.e. SRS resources and/or CLI-RSSI resources). For L2 U2N Relay object(s), the UE measures and reports on the serving NR cell(s), as well as the discovered L2 U2N Relay UEs.

Whenever the procedural specification, other than contained in clause 5.5.2, refers to a field it concerns a field included in the *VarMeasConfig* unless explicitly stated otherwise i.e. only the measurement configuration procedure covers the direct UE action related to the received *measConfig*.

In NR-DC, the UE may receive two independent *measConfig*:

- a *measConfig*, associated with MCG, that is included in the *RRCReconfiguration* message received via SRB1; and
- a *measConfig*, associated with SCG, that is included in the *RRCReconfiguration* message received via SRB3, or, alternatively, included within a *RRCReconfiguration* message embedded in a *RRCReconfiguration* message received via SRB1.

In this case, the UE maintains two independent *VarMeasConfig* and *VarMeasReportList*, one associated with each *measConfig*, and independently performs all the procedures in clause 5.5 for each *measConfig* and the associated *VarMeasConfig* and *VarMeasReportList*, unless explicitly stated otherwise.

The configurations related to CBR measurements are only included in the *measConfig* associated with MCG.

The configurations related to Rx-Tx time difference measurement are only included in the *measConfig* associated with MCG.

[TS 38.331, clause 5.5.4.1]

If AS security has been activated successfully, the UE shall:

- 1> for each *measId* included in the *measIdList* within *VarMeasConfig*:
- 2> if the corresponding *reportConfig* includes a *reportType* set to *eventTriggered* or *periodical*:
- 3> if the corresponding *measObject* concerns NR:
 - 4> if the corresponding *reportConfig* includes *measRSSI-ReportConfig*:
 - 5> consider the resource indicated by the *rmtc-Config* on the associated frequency to be applicable;
 - 4> if the *eventA1* or *eventA2* is configured in the corresponding *reportConfig*:
 - 5> consider only the serving cell to be applicable;

- 4> if the *eventA3* or *eventA5* is configured in the corresponding *reportConfig*:
 - 5> if a serving cell is associated with a *measObjectNR* and neighbours are associated with another *measObjectNR*, consider any serving cell associated with the other *measObjectNR* to be a neighbouring cell as well;
- 4> if corresponding *reportConfig* includes *reportType* set to *periodical*;
- 4> for measurement events other than *eventA1* or *eventA2*:
 - 5> if *useAllowedCellList* is set to *true*:
 - 6> consider any neighbouring cell detected based on parameters in the associated *measObjectNR* to be applicable when the concerned cell is included in the *allowedCellsToAddModList* defined within the *VarMeasConfig* for this *measId*;
 - 5> else:
 - 6> consider any neighbouring cell detected based on parameters in the associated *measObjectNR* to be applicable when the concerned cell is not included in the *excludedCellsToAddModList* defined within the *VarMeasConfig* for this *measId*;
- 3> else if the corresponding *measObject* concerns E-UTRA:
 - 4> if *eventB1* or *eventB2* is configured in the corresponding *reportConfig*:
 - 5> consider a serving cell, if any, on the associated E-UTRA frequency as neighbour cell;
 - 4> consider any neighbouring cell detected on the associated frequency to be applicable when the concerned cell is not included in the *excludedCellsToAddModListEUTRAN* defined within the *VarMeasConfig* for this *measId*;
- 3> else if the corresponding *measObject* concerns UTRA-FDD:
 - 4> if *eventB1-UTRA-FDD* or *eventB2-UTRA-FDD* is configured in the corresponding *reportConfig*; or
 - 4> if corresponding *reportConfig* includes *reportType* set to *periodical*:
 - 5> consider a neighbouring cell on the associated frequency to be applicable when the concerned cell is included in the *cellsToAddModList* defined within the *VarMeasConfig* for this *measId*;
- 3> else if the corresponding *measObject* concerns L2 U2N Relay UE:
 - 4> if *eventY1-Relay* is configured in the corresponding *reportConfig*; or
 - 4> if corresponding *reportConfig* includes *reportType* set to *periodical*:
 - 5> consider any L2 U2N Relay UE detected on the associated frequency to be applicable for this *measId*;
- 2> else if the corresponding *reportConfig* includes a *reportType* set to *reportCGI*:
 - 3> consider the cell detected on the associated *measObject* which has a physical cell identity matching the value of the *cellForWhichToReportCGI* included in the corresponding *reportConfig* within the *VarMeasConfig* to be applicable;
- 2> else if the corresponding *reportConfig* includes a *reportType* set to *reportSFTD*:
 - 3> if the corresponding *measObject* concerns NR:
 - 4> if the *reportSFTD-Meas* is set to *true*:
 - 5> consider the NR PSCell to be applicable;
 - 4> else if the *reportSFTD-NeighMeas* is included:
 - 5> if *cellsForWhichToReportSFTD* is configured in the corresponding *reportConfig*:

- 6> consider any NR neighbouring cell detected on the associated *measObjectNR* which has a physical cell identity that is included in the *cellsForWhichToReportSFTD* to be applicable;
- 5> else:
 - 6> consider up to 3 strongest NR neighbouring cells detected based on parameters in the associated *measObjectNR* to be applicable when the concerned cells are not included in the *excludedCellsToAddModList* defined within the *VarMeasConfig* for this *measId*;
- 3> else if the corresponding *measObject* concerns E-UTRA:
 - 4> if the *reportSFTD-Meas* is set to *true*:
 - 5> consider the E-UTRA PSCell to be applicable;
- 2> else if the corresponding *reportConfig* includes a *reportType* set to *cli-Periodical* or *cli-EventTriggered*:
 - 3> consider all CLI measurement resources included in the corresponding *measObject* to be applicable;
- 2> else if the corresponding *reportConfig* includes a *reportType* set to *rxTxPeriodical*:
 - 3> consider all Rx-Tx time difference measurement resources included in the corresponding *measObject* to be applicable;
- 2> if the corresponding *reportConfig* concerns the reporting for NR sidelink communication (i.e. *reportConfigNR-SL*):
 - 3> consider the transmission resource pools indicated by the *tx-PoolMeasToAddModList* defined within the *VarMeasConfig* for this *measId* to be applicable;
- 2> if the *reportType* is set to *eventTriggered* and if the entry condition applicable for this event, i.e. the event corresponding with the *eventId* of the corresponding *reportConfig* within *VarMeasConfig*, is fulfilled for one or more applicable cells for all measurements after layer 3 filtering taken during *timeToTrigger* defined for this event within the *VarMeasConfig*, while the *VarMeasReportList* does not include a measurement reporting entry for this *measId* (a first cell triggers the event):
 - 3> include a measurement reporting entry within the *VarMeasReportList* for this *measId*;
 - 3> set the *numberOfReportsSent* defined within the *VarMeasReportList* for this *measId* to 0;
 - 3> include the concerned cell(s) in the *cellsTriggeredList* defined within the *VarMeasReportList* for this *measId*;
 - 3> if *useT312* is set to *true* in *reportConfig* for this event:
 - 4> if T310 for the corresponding SpCell is running; and
 - 4> if T312 is not running for corresponding SpCell:
 - 5> start timer T312 for the corresponding SpCell with the value of T312 configured in the corresponding *measObjectNR*;
 - 3> initiate the measurement reporting procedure, as specified in 5.5.5;
- 2> else if the *reportType* is set to *eventTriggered* and if the entry condition applicable for this event, i.e. the event corresponding with the *eventId* of the corresponding *reportConfig* within *VarMeasConfig*, is fulfilled for one or more applicable cells not included in the *cellsTriggeredList* for all measurements after layer 3 filtering taken during *timeToTrigger* defined for this event within the *VarMeasConfig* (a subsequent cell triggers the event):
 - 3> set the *numberOfReportsSent* defined within the *VarMeasReportList* for this *measId* to 0;
 - 3> include the concerned cell(s) in the *cellsTriggeredList* defined within the *VarMeasReportList* for this *measId*;
 - 3> if *useT312* is set to *true* in *reportConfig* for this event:

- 4> if T310 for the corresponding SpCell is running; and
- 4> if T312 is not running for corresponding SpCell:
 - 5> start timer T312 for the corresponding SpCell with the value of T312 configured in the corresponding *measObjectNR*;
- 3> initiate the measurement reporting procedure, as specified in 5.5.5;
- 2> else if the *reportType* is set to *eventTriggered* and if the leaving condition applicable for this event is fulfilled for one or more of the cells included in the *cellsTriggeredList* defined within the *VarMeasReportList* for this *measId* for all measurements after layer 3 filtering taken during *timeToTrigger* defined within the *VarMeasConfig* for this event:
 - 3> remove the concerned cell(s) in the *cellsTriggeredList* defined within the *VarMeasReportList* for this *measId*;
 - 3> if *reportOnLeave* is set to *true* for the corresponding reporting configuration:
 - 4> initiate the measurement reporting procedure, as specified in 5.5.5;
 - 3> if the *cellsTriggeredList* defined within the *VarMeasReportList* for this *measId* is empty:
 - 4> remove the measurement reporting entry within the *VarMeasReportList* for this *measId*;
 - 4> stop the periodical reporting timer for this *measId*, if running;
- 2> if the *reportType* is set to *eventTriggered* and if the entry condition applicable for this event, i.e. the event corresponding with the *eventId* of the corresponding *reportConfig* within *VarMeasConfig*, is fulfilled for one or more applicable L2 U2N Relay UEs for all measurements after layer 3 filtering taken during *timeToTrigger* defined for this event within the *VarMeasConfig*, while the *VarMeasReportList* does not include a measurement reporting entry for this *measId* (a first L2 U2N Relay UE triggers the event):
 - 3> include a measurement reporting entry within the *VarMeasReportList* for this *measId*;
 - 3> set the *numberOfReportsSent* defined within the *VarMeasReportList* for this *measId* to 0;
 - 3> include the concerned L2 U2N Relay UE(s) in the *relaysTriggeredList* defined within the *VarMeasReportList* for this *measId*;
 - 3> initiate the measurement reporting procedure, as specified in 5.5.5;
- 2> else if the *reportType* is set to *eventTriggered* and if the entry condition applicable for this event, i.e. the event corresponding with the *eventId* of the corresponding *reportConfig* within *VarMeasConfig*, is fulfilled for one or more applicable L2 U2N Relay UEs not included in the *relaysTriggeredList* for all measurements after layer 3 filtering taken during *timeToTrigger* defined for this event within the *VarMeasConfig* (a subsequent L2 U2N Relay UE triggers the event):
 - 3> set the *numberOfReportsSent* defined within the *VarMeasReportList* for this *measId* to 0;
 - 3> include the concerned L2 U2N Relay UE(s) in the *relaysTriggeredList* defined within the *VarMeasReportList* for this *measId*;
 - 3> initiate the measurement reporting procedure, as specified in 5.5.5;
- 2> else if the *reportType* is set to *eventTriggered* and if the leaving condition applicable for this event is fulfilled for one or more of the L2 U2N Relay UEs included in the *relaysTriggeredList* defined within the *VarMeasReportList* for this *measId* for all measurements after layer 3 filtering taken during *timeToTrigger* defined within the *VarMeasConfig* for this event:
 - 3> remove the concerned L2 U2N Relay UE(s) in the *relaysTriggeredList* defined within the *VarMeasReportList* for this *measId*;
 - 3> if *reportOnLeave* is set to *true* for the corresponding reporting configuration:
 - 4> initiate the measurement reporting procedure, as specified in 5.5.5;

- 3> if the *relaysTriggeredList* defined within the *VarMeasReportList* for this *measId* is empty:
 - 4> remove the measurement reporting entry within the *VarMeasReportList* for this *measId*;
 - 4> stop the periodical reporting timer for this *measId*, if running;
- 2> else if the *reportType* is set to *eventTriggered* and if the entry condition applicable for this event, i.e. the event corresponding with the *eventId* of the corresponding *reportConfig* within *VarMeasConfig*, is fulfilled for one or more applicable transmission resource pools for all measurements taken during *timeToTrigger* defined for this event within the *VarMeasConfig*, while the *VarMeasReportList* does not include an measurement reporting entry for this *measId* (a first transmission resource pool triggers the event):
 - 3> include a measurement reporting entry within the *VarMeasReportList* for this *measId*;
 - 3> set the *numberOfReportsSent* defined within the *VarMeasReportList* for this *measId* to 0;
 - 3> include the concerned transmission resource pool(s) in the *poolsTriggeredList* defined within the *VarMeasReportList* for this *measId*;
 - 3> initiate the measurement reporting procedure, as specified in 5.5.5;
- 2> else if the *reportType* is set to *eventTriggered* and if the entry condition applicable for this event, i.e. the event corresponding with the *eventId* of the corresponding *reportConfig* within *VarMeasConfig*, is fulfilled for one or more applicable transmission resource pools not included in the *poolsTriggeredList* for all measurements taken during *timeToTrigger* defined for this event within the *VarMeasConfig* (a subsequent transmission resource pool triggers the event):
 - 3> set the *numberOfReportsSent* defined within the *VarMeasReportList* for this *measId* to 0;
 - 3> include the concerned transmission resource pool(s) in the *poolsTriggeredList* defined within the *VarMeasReportList* for this *measId*;
 - 3> initiate the measurement reporting procedure, as specified in 5.5.5;
- 2> else if the *reportType* is set to *eventTriggered* and if the leaving condition applicable for this event is fulfilled for one or more applicable transmission resource pools included in the *poolsTriggeredList* defined within the *VarMeasReportList* for this *measId* for all measurements taken during *timeToTrigger* defined within the *VarMeasConfig* for this event:
 - 3> remove the concerned transmission resource pool(s) in the *poolsTriggeredList* defined within the *VarMeasReportList* for this *measId*;
 - 3> if the *poolsTriggeredList* defined within the *VarMeasReportList* for this *measId* is empty:
 - 4> remove the measurement reporting entry within the *VarMeasReportList* for this *measId*;
 - 4> stop the periodical reporting timer for this *measId*, if running
- 2> else if the *reportType* is set to *eventTriggered* and if the *eventId* is set to *eventD1* and if the entering condition applicable for this event, i.e. the event corresponding with the *eventId* of the corresponding *reportConfig* within *VarMeasConfig*, is fulfilled during *timeToTrigger* defined within the *VarMeasConfig* for this event:
 - 3> include a measurement reporting entry within the *VarMeasReportList* for this *measId*;
 - 3> set the *numberOfReportsSent* defined within the *VarMeasReportList* for this *measId* to 0;
 - 3> initiate the measurement reporting procedure, as specified in 5.5.5;

NOTE 1: Void.

- 2> if *reportType* is set to *periodical* and if a (first) measurement result is available:
 - 3> include a measurement reporting entry within the *VarMeasReportList* for this *measId*;
 - 3> set the *numberOfReportsSent* defined within the *VarMeasReportList* for this *measId* to 0;
 - 3> if the corresponding *reportConfig* includes *measRSSI-ReportConfig*:

- 4> initiate the measurement reporting procedure as specified in 5.5.5 immediately when RSSI sample values are reported by the physical layer after the first L1 measurement duration;
- 3> else if the corresponding *reportConfig* includes the *ul-DelayValueConfig*:
 - 4> initiate the measurement reporting procedure, as specified in 5.5.5, immediately after a first measurement result is provided from lower layers of the associated DRB identity;
- 3> else if the corresponding *reportConfig* includes the *ul-ExcessDelayConfig*:
 - 4> initiate the measurement reporting procedure, as specified in 5.5.5, immediately after a first measurement result is provided from lower layers of the associated DRB identity(ies) according to the configured threshold per DRB identity(ies);
- 3> else if the *reportAmount* exceeds 1:
 - 4> initiate the measurement reporting procedure, as specified in 5.5.5, immediately after the quantity to be reported becomes available for the NR SpCell or for the serving L2 U2N Relay UE (if the UE is a L2 U2N Remote UE);
- 3> else (i.e. the *reportAmount* is equal to 1):
 - 4> initiate the measurement reporting procedure, as specified in 5.5.5, immediately after the quantity to be reported becomes available for the NR SpCell and for the strongest cell among the applicable cells, or for the NR SpCell and for the strongest L2 U2N Relay UEs among the applicable L2 U2N Relay UEs; or initiate the measurement reporting procedure, as specified in 5.5.5, immediately after the quantity to be reported becomes available for the serving L2 U2N Relay UE and for the strongest cell among the applicable cells (if the UE is a L2 U2N Remote UE);
- 2> if, in case the corresponding *reportConfig* concerns the reporting for NR sidelink communication, *reportType* is set to *periodical* and if a (first) measurement result is available:
 - 3> include a measurement reporting entry within the *VarMeasReportList* for this *measId*;
 - 3> set the *numberOfReportsSent* defined within the *VarMeasReportList* for this *measId* to 0;
 - 3> initiate the measurement reporting procedure, as specified in 5.5.5, immediately after the quantity to be reported becomes available for the NR SpCell and CBR measurement results become available;
- 2> if the *reportType* is set to *cli-EventTriggered* and if the entry condition applicable for this event, i.e. the event corresponding with the *eventId* of the corresponding *reportConfig* within *VarMeasConfig*, is fulfilled for one or more applicable CLI measurement resources for all measurements after layer 3 filtering taken during *timeToTrigger* defined for this event within the *VarMeasConfig*, while the *VarMeasReportList* does not include a measurement reporting entry for this *measId* (a first CLI measurement resource triggers the event):
 - 3> include a measurement reporting entry within the *VarMeasReportList* for this *measId*;
 - 3> set the *numberOfReportsSent* defined within the *VarMeasReportList* for this *measId* to 0;
 - 3> include the concerned CLI measurement resource(s) in the *cli-TriggeredList* defined within the *VarMeasReportList* for this *measId*;
 - 3> initiate the measurement reporting procedure, as specified in 5.5.5;
- 2> else if the *reportType* is set to *cli-EventTriggered* and if the entry condition applicable for this event, i.e. the event corresponding with the *eventId* of the corresponding *reportConfig* within *VarMeasConfig*, is fulfilled for one or more CLI measurement resources not included in the *cli-TriggeredList* for all measurements after layer 3 filtering taken during *timeToTrigger* defined for this event within the *VarMeasConfig* (a subsequent CLI measurement resource triggers the event):
 - 3> set the *numberOfReportsSent* defined within the *VarMeasReportList* for this *measId* to 0;
 - 3> include the concerned CLI measurement resource(s) in the *cli-TriggeredList* defined within the *VarMeasReportList* for this *measId*;
 - 3> initiate the measurement reporting procedure, as specified in 5.5.5;

- 2> else if the *reportType* is set to *cli-EventTriggered* and if the leaving condition applicable for this event is fulfilled for one or more of the CLI measurement resources included in the *cli-TriggeredList* defined within the *VarMeasReportList* for this *measId* for all measurements after layer 3 filtering taken during *timeToTrigger* defined within the *VarMeasConfig* for this event:
 - 3> remove the concerned CLI measurement resource(s) in the *cli-TriggeredList* defined within the *VarMeasReportList* for this *measId*;
 - 3> if *reportOnLeave* is set to *true* for the corresponding reporting configuration:
 - 4> initiate the measurement reporting procedure, as specified in 5.5.5;
 - 3> if the *cli-TriggeredList* defined within the *VarMeasReportList* for this *measId* is empty:
 - 4> remove the measurement reporting entry within the *VarMeasReportList* for this *measId*;
 - 4> stop the periodical reporting timer for this *measId*, if running;
- 2> if *reportType* is set to *cli-Periodical* and if a (first) measurement result is available:
 - 3> include a measurement reporting entry within the *VarMeasReportList* for this *measId*;
 - 3> set the *numberOfReportsSent* defined within the *VarMeasReportList* for this *measId* to 0;
 - 3> initiate the measurement reporting procedure, as specified in 5.5.5, immediately after the quantity to be reported becomes available for at least one CLI measurement resource;
- 2> if *reportType* is set to *rxTxPeriodical* and if a (first) measurement result is available:
 - 3> include a measurement reporting entry within the *VarMeasReportList* for this *measId*;
 - 3> set the *numberOfReportsSent* defined within the *VarMeasReportList* for this *measId* to 0;
 - 3> initiate the measurement reporting procedure, as specified in 5.5.5;
- 2> upon expiry of the periodical reporting timer for this *measId*:
 - 3> initiate the measurement reporting procedure, as specified in 5.5.5.
- 2> if the corresponding *reportConfig* includes a *reportType* is set to *reportSFTD*:
 - 3> if the corresponding *measObject* concerns NR:
 - 4> if the *drx-SFTD-NeighMeas* is included:
 - 5> if the quantity to be reported becomes available for each requested pair of PCell and NR cell:
 - 6> stop timer T322;
 - 6> initiate the measurement reporting procedure, as specified in 5.5.5;
 - 4> else
 - 5> initiate the measurement reporting procedure, as specified in 5.5.5, immediately after the quantity to be reported becomes available for each requested pair of PCell and NR cell or the maximal measurement reporting delay as specified in TS 38.133 [14];
 - 3> else if the corresponding *measObject* concerns E-UTRA:
 - 4> initiate the measurement reporting procedure, as specified in 5.5.5, immediately after the quantity to be reported becomes available for the pair of PCell and E-UTRA PSCell or the maximal measurement reporting delay as specified in TS 38.133 [14];
- 2> if *reportType* is set to *reportCGI*:
 - 3> if the UE acquired the *SIB1* or *SystemInformationBlockType1* for the requested cell; or
 - 3> if the UE detects that the requested NR cell is not transmitting *SIB1* (see TS 38.213 [13], clause 13):

- 4> stop timer T321;
 - 4> include a measurement reporting entry within the *VarMeasReportList* for this *measId*;
 - 4> set the *numberOfReportsSent* defined within the *VarMeasReportList* for this *measId* to 0;
 - 4> initiate the measurement reporting procedure, as specified in 5.5.5;
- 2> upon the expiry of T321 for this *measId*:
- 3> include a measurement reporting entry within the *VarMeasReportList* for this *measId*;
 - 3> set the *numberOfReportsSent* defined within the *VarMeasReportList* for this *measId* to 0;
 - 3> initiate the measurement reporting procedure, as specified in 5.5.5.
- 2> upon the expiry of T322 for this *measId*:
- 3> initiate the measurement reporting procedure, as specified in 5.5.5.

[TS 38.331, clause 5.5.4. 8]

The UE shall:

- 1> consider the entering condition for this event to be satisfied when condition B1-1, as specified below, is fulfilled;
- 1> consider the leaving condition for this event to be satisfied when condition B1-2, as specified below, is fulfilled.

Inequality B1-1 (Entering condition)

$$Mn + Ofn + Ocn - Hys > Thresh$$

Inequality B1-2 (Leaving condition)

$$Mn + Ofn + Ocn + Hys < Thresh$$

The variables in the formula are defined as follows:

Mn is the measurement result of the inter-RAT neighbour cell, not taking into account any offsets.

Ofn is the measurement object specific offset of the frequency of the inter-RAT neighbour cell (i.e. *eutra-Q-OffsetRange* as defined within the *measObjectEUTRA* corresponding to the frequency of the neighbour inter-RAT cell, *utra-FDD-Q-OffsetRange* as defined within the *measObjectUTRA-FDD* corresponding to the frequency of the neighbour inter-RAT cell).

Ocn is the cell specific offset of the inter-RAT neighbour cell (i.e. *cellIndividualOffset* as defined within the *measObjectEUTRA* corresponding to the neighbour inter-RAT cell), and set to zero if not configured for the neighbour cell.

Hys is the hysteresis parameter for this event (i.e. *hysteresis* as defined within *reportConfigInterRAT* for this event).

Thresh is the threshold parameter for this event (i.e. *b1-ThresholdEUTRA* as defined within *reportConfigInterRAT* for this event, *b1-ThresholdUTRA-FDD* as defined for UTRA-FDD within *reportConfigInterRAT* for this event).

Mn is expressed in dBm or in dB, depending on the measurement quantity of the inter-RAT neighbour cell.

Ofn*, *Ocn*, *Hys are expressed in dB.

Thresh is expressed in the same unit as ***Mn***.

[TS 38.331, clause 5.5.5]



Figure 5.5.5-1: Measurement reporting

The purpose of this procedure is to transfer measurement results from the UE to the network. The UE shall initiate this procedure only after successful security activation.

For the *measId* for which the measurement reporting procedure was triggered, the UE shall set the *measResults* within the *MeasurementReport* message as follows:

- 1> set the *measId* to the measurement identity that triggered the measurement reporting;
- 1> set the *measResultServingCell* within *measResultServingMOList* to include, for each NR serving cell that is configured with *servingCellMO*, RSRP, RSRQ and the available SINR, derived based on the *rsType* if indicated in the associated *reportConfig*, otherwise based on SSB if available, otherwise based on CSI-RS;
- 1> set the *measResultServingCell* within *measResultServingMOList* to include for each NR serving cell that is configured with *servingCellMO*, if any, the *servCellId*;
- 1> if the *reportConfig* associated with the *measId* that triggered the measurement reporting includes *reportQuantityRsIndexes* and *maxNrofRSIndexesToReport*:
 - 2> for each serving cell configured with *servingCellMO*, include beam measurement information according to the associated *reportConfig* as described in 5.5.5.2;
- ...
- 1> if there is at least one applicable neighbouring cell to report:
 - 2> if the *reportType* is set to *eventTriggered* or *periodical*:
 - 3> set the *measResultNeighCells* to include the best neighbouring cells up to *maxReportCells* in accordance with the following:
 - 4> if the *reportType* is set to *eventTriggered*:
 - 5> include the cells included in the *cellsTriggeredList* as defined within the *VarMeasReportList* for this *measId*;
 - ...
 - 4> for each cell that is included in the *measResultNeighCells*, include the *physCellId*;
 - 4> if the *reportType* is set to *eventTriggered* or *periodical*:
 - 5> for each included cell, include the layer 3 filtered measured results in accordance with the *reportConfig* for this *measId*, ordered as follows:
 - 6> if the *measObject* associated with this *measId* concerns NR:
 - 7> if *rsType* in the associated *reportConfig* is set to *ssb*:
 - 8> set *resultsSSB-Cell* within the *measResult* to include the SS/PBCH block based quantity(ies) indicated in the *reportQuantityCell* within the concerned *reportConfig*, in decreasing order of the sorting quantity, determined as specified in 5.5.5.3, i.e. the best cell is included first:

9> if *reportQuantityRSIndexes* and *maxNrofRSIndexesToReport* are configured, include beam measurement information as described in 5.5.5.2;

...

6> if the *measObject* associated with this *measId* concerns E-UTRA:

7> set the *measResult* to include the quantity(ies) indicated in the *reportQuantity* within the concerned *reportConfigInterRAT* in decreasing order of the sorting quantity, determined as specified in 5.5.5.3, i.e. the best cell is included first;

...

1> increment the *numberOfReportsSent* as defined within the *VarMeasReportList* for this *measId* by 1;

1> stop the periodical reporting timer, if running;

...

1> if the UE is configured with EN-DC:

2> if SRB3 is configured:

3> submit the *MeasurementReport* message via SRB3 to lower layers for transmission, upon which the procedure ends;

2> else:

3> submit the *MeasurementReport* message via the EUTRA MCG embedded in E-UTRA RRC message *ULInformationTransferMRDC* as specified in TS 36.331 [10].

1> else:

2> submit the *MeasurementReport* message to lower layers for transmission, upon which the procedure ends.

8.2.3.2.2.3 Test description

8.2.3.2.2.3.1 Pre-test conditions

System Simulator:

- NR Cell 1 is the PCell and E-UTRA Cell 1 is the PSCell.

UE:

- None.

Preamble:

- The UE is in state NE-DC RRC_CONNECTED using generic procedure parameter Connectivity (NE-DC) according to TS 38.508-1 [4], Table 4.5.4.2-6.

8.2.3.2.2.3.2 Test procedure sequence

Table 8.2.3.2.2.3.2-1 and Table 8.2.3.2.2.3.2-2 illustrates the downlink power levels and other changing parameters to be applied for the cells at various time instants of the test execution. Row marked "T0" denotes the initial conditions after preamble, while columns marked "T1" and "T2" are to be applied subsequently. The exact instants on which these values shall be applied are described in the texts in this clause.

Table 8.2.3.2.2.3.2-1: Time instances of cell power level and parameter changes for FR1

	Parameter	Unit	E-UTRA Cell 1	NR Cell 1	Remark
--	-----------	------	---------------	-----------	--------

T0	Cell-specific RS EPRE	dBm/SC S	-	-85	The power level values are such that entering conditions for event B1 are not satisfied.
	Cell-specific RS EPRE	dBm/15 kHz	-94	-	
	RSRQ	dB	-11.46	-	
	Noc	dBm/15 kHz	-94	-	
T1	Cell-specific RS EPRE	dBm/SC S	-	-85	The power level values are such that entering conditions for event B1 are satisfied.
	SS/PBCH SSS EPRE	dBm/15 kHz	-80	-	
	SS-RSRQ	dB	-3.94	-	
	Noc	dBm/15 kHz	-94	-	
T2	Cell-specific RS EPRE	dBm/SC S	-	-85	The power level values are such that leaving conditions for event B1 are satisfied.
	SS/PBCH SSS EPRE	dBm/15 kHz	-94	-	
	SS-RSRQ	dB	-3.94	-	
	Noc	dBm/15 kHz	-94	-	

Table 8.2.3.2.3.2-2: Time instances of cell power level and parameter changes for FR2

	Parameter	Unit	E-UTRA Cell 1	NR Cell 1	Remark
T0	Cell-specific RS EPRE	dBm/SC S	-	-82	The power level values are such that entering conditions for event B1 are not satisfied.
	Cell-specific RS EPRE	dBm/15 kHz	-94	-	
	RSRQ	dB	-11.46	-	
	Noc	dBm/15 kHz	-94	-	
T1	Cell-specific RS EPRE	dBm/SC S	-	-82	The power level values are such that entering conditions for event B1 are satisfied.
	SS/PBCH SSS EPRE	dBm/15 kHz	-80	-	
	SS-RSRQ	dB	-3.94	-	
	Noc	dBm/15 kHz	-94	-	
T2	Cell-specific RS EPRE	dBm/SC S	-	-82	The power level values are such that leaving conditions for event B1 are satisfied.
	SS/PBCH SSS EPRE	dBm/15 kHz	-94	-	
	SS-RSRQ	dB	-11.46	-	
	Noc	dBm/15 kHz	-94	-	

Table 8.2.3.2.3.2-3: Main behaviour

St	Procedure	Message Sequence		TP	Verdict
		U - S	Message		
1	The SS transmits an <i>RRCReconfiguration</i> including measConfig to setup inter RAT measurements and reporting for E-UTRA Cell 1.	<--	<i>RRCReconfiguration</i>	-	-
2	The UE transmits an <i>RRCReconfigurationComplete</i> message to confirm the setup of inter RAT measurements for E-UTRA Cell 1.	-->	<i>RRCReconfigurationComplete</i>	-	-
3	Check: Does the UE transmit a <i>MeasurementReport</i> message on NR Cell 1 to report the event B1 during the next 10s?	-->	<i>MeasurementReport</i>	1	F

4	The SS changes E-UTRA Cell 1 parameters according to the row "T1".	-	-	-	-
5	Check: Does the UE transmit a <i>MeasurementReport</i> message to report the event B1 for E-UTRA Cell 1?	-->	<i>MeasurementReport</i>	2	P
6	The SS changes E-UTRA Cell 1 parameters according to the row "T2".	-	-	-	-
7	Wait and ignore <i>MeasurementReport</i> messages for 15 s to allow change of power levels and UE measurements for E-UTRA Cell 1.	-	-	-	-
8	Check: Does the UE transmit a <i>MeasurementReport</i> message on NR Cell 1 to report the event B1 during the next 10s?	-->	<i>MeasurementReport</i>	3	F

8.2.3.2.2.3.3 Specific message contents

Table 8.2.3.2.2.3.3-1: RRCReconfiguration (step 1 Table 8.2.3.2.2.3.2-3)

Derivation Path: TS 38.508-1 [4], Table 4.6.1-13 with conditions NR_MEAS and NE-DC

Table 8.2.3.2.2.3.3-2: MeasConfig (Table 8.2.3.2.2.3.3-1)

Derivation Path: TS 38.508-1 [4] Table 4.6.3-69			
Information Element	Value/remark	Comment	Condition
MeasConfig ::= SEQUENCE {			
measObjectToAddModList SEQUENCE (SIZE (1..maxNrofMeasId)) OF MeasObjectToAddMod {	2 entries		
MeasObjectToAddMod[1] SEQUENCE {		entry 1	
measObjectId	1	MeasObjectIdNR-f1	
measObject CHOICE {			
measObjectNR SEQUENCE {			
ssbFrequency	ssbFrequency IE equals the ARFCN for NR Cell 1		
absThreshSS-BlocksConsolidation	Not present		
}			
}			
}			
MeasObjectToAddMod[2] SEQUENCE {		entry 2	
measObjectId	2	MeasObjectIdE-UTRA-f1	
measObject CHOICE {			
measObjectEUTRA SEQUENCE {			
carrierFreq	ARFCN-ValueEUTRA for E-UTRA Cell 1		
}			
}			
}			
reportConfigToAddModList SEQUENCE(SIZE (1..maxReportConfigId)) OF ReportConfigToAddMod {	1 entry		
ReportConfigToAddMod[1] SEQUENCE {		entry 1	
reportConfigId	1		
reportConfig CHOICE {			
reportConfigInterRAT	ReportConfigInterRAT-EventB1	Table 8.2.3.2.2.3.3-3	
}			
}			
measIdToAddModList SEQUENCE (SIZE (1..maxNrofMeasId)) OF MeasIdToAddMod {	1 entry		
MeasIdToAddMod[1] SEQUENCE {		entry 1	
measId	1		

measObjectId	2		
reportConfigId	1		
}			
}			
quantityConfig	QuantityConfig with condition INTER-RAT		
measGapConfig	MeasGapConfig		
}			

Table 8.2.3.2.2.3.3-3: ReportConfigInterRAT-EventB1 (Table 8.2.3.2.2.3.3-2)

Derivation Path: TS 38.508-1 [4] Table 4.6.3-141 with condition EVENT_B1			
Information Element	Value/remark	Comment	Condition
ReportConfigNR ::= SEQUENCE {			
reportType CHOICE {			
eventTriggered SEQUENCE {			
eventId CHOICE {			
eventB1 SEQUENCE {			
b1-ThresholdEUTRA SEQUENCE {			
rsrq	23	Actual value = -8dB	
}			
}			
}			
}			
reportAmount	r1		
}			
}			

Table 8.2.3.2.2.3.3-4: QuantityConfig with condition INTER-RAT (Table 8.2.3.2.2.3.3-2)

Derivation Path: TS 38.508-1 [4], Table 4.6.3-127 with condition INTER-RAT
--

Table 8.2.3.2.2.3.3-5: MeasurementReport (step 5, Table 8.2.3.2.2.3.2-3)

Derivation Path: TS 38.508-1 [4] Table 4.6.1-5A			
Information Element	Value/remark	Comment	Condition
MeasurementReport ::= SEQUENCE {			
criticalExtensions CHOICE {			
measurementReport SEQUENCE {			
measResults SEQUENCE {			
measId	1		
measResultServingMOList SEQUENCE (SIZE (1..maxNrofServingCells)) OF MeasResultServMO {	1 entry	Report NR Cell 1	
MeasResultServMO[1] SEQUENCE {		entry 1	
servCellId	ServCellIndex of NR Cell 1		
measResultServingCell SEQUENCE {			
physCellId	Physical layer cell identity of NR Cell 1		
measResult SEQUENCE {			
cellResults SEQUENCE {			
resultsSSB-Cell SEQUENCE {			
rsrp	(0..127)		
rsrq	(0..127)		
sinr	Not present		
}	Not checked		pc_ss_SINR_Meas
}			
}			
}			
}			
}			

}			
measResultNeighCells CHOICE {			
measResultListEUTRA SEQUENCE (SIZE (1..maxCellReport)) OF MeasResultEUTRA {	1 entry	Report E-UTRA neighbour cell	
MeasResultEUTRA[1] SEQUENCE {		entry 1	
eutra-PhysCellId	Physical layer cell identity of E-UTRA Cell 1		
measResult SEQUENCE {			
rsrp	(0..97)		
rsrq	(0..34)		
sinr	Not present		
}			
cgi-Info	Not present		
}			
}			
}			
}			
}			
}			

8.2.3.3 Measurement configuration control and reporting / Inter-RAT measurements / Periodic reporting / Measurement of NR cells

8.2.3.3.1 Measurement configuration control and reporting / Inter-RAT measurements / Periodic reporting / Measurement of NR cells / EN-DC

8.2.3.3.1.1 Test Purpose (TP)

(1)

```
with { UE in E-UTRA E-UTRA RRC_CONNECTED state having completed the radio bearer establishment and performed the inter RAT measurement for NR cell }
ensure that {
  when { The UE receives reference signal power for cells on the NR frequencies where measurements are configured }
  then { UE sends MeasurementReport message at regular intervals for these NR cells }
}
```

(2)

```
with { UE in E-UTRA RRC_CONNECTED state and a MeasurementReport message for a configured periodic measurement reporting of NR cells on a configured frequency were sent }
ensure that {
  when { A previously reported cell become unavailable and the UE receives reference signal power on a reported NR frequency for a cell which was previously not reported }
  then { UE sends MeasurementReport message at regular intervals for the available NR cells }
}
```

(3)

```
with { UE in E-UTRA RRC_CONNECTED state and periodic measurement reporting of NR cells ongoing }
ensure that {
  when { The UE receives a RRCConnectionReconfiguration message removing the measId of periodic reporting of NR cells }
  then { UE stops sending MeasurementReport message for NR cells }
}
```

8.2.3.3.1.2 Conformance requirements

References: The conformance requirements covered in the present TC are specified in: TS 36.331, clauses 5.5.1, 5.5.4.1, 5.5.4.7 and 5.5.5.1. Unless otherwise stated these are Rel-15 requirements.

[TS 36.331, clause 5.5.1]

The UE reports measurement information in accordance with the measurement configuration as provided by E-UTRAN. E-UTRAN provides the measurement configuration applicable for a UE in RRC_CONNECTED by means of dedicated signalling, i.e. using the *RRCConnectionReconfiguration* or *RRCConnectionResume* message.

The UE can be requested to perform the following types of measurements:

- Intra-frequency measurements: measurements at the downlink carrier frequency(ies) of the serving cell(s).
- Inter-frequency measurements: measurements at frequencies that differ from any of the downlink carrier frequency(ies) of the serving cell(s).
- Inter-RAT measurements of NR frequencies.
- ...

The measurement configuration includes the following parameters:

1. **Measurement objects:** The objects on which the UE shall perform the measurements.
 - For intra-frequency and inter-frequency measurements a measurement object is a single E-UTRA carrier frequency. Associated with this carrier frequency, E-UTRAN can configure a list of cell specific offsets, a list of 'blacklisted' cells and a list of 'whitelisted' cells. Blacklisted cells are not considered in event evaluation or measurement reporting.
 - For inter-RAT NR measurements a measurement object is a single NR carrier frequency. Associated with this carrier frequency, E-UTRAN can configure a list of 'blacklisted' cells. Blacklisted cells are not considered in event evaluation or measurement reporting.
 - ...

NOTE 1: Some measurements using the above mentioned measurement objects, only concern a single cell, e.g. measurements used to report neighbouring cell system information, PCell UE Rx-Tx time difference, or a pair of cells, e.g. SSTD measurements between the PCell and the PSCell.

2. **Reporting configurations:** A list of reporting configurations where each reporting configuration consists of the following:
 - Reporting criterion: The criterion that triggers the UE to send a measurement report. This can either be periodical or a single event description.
 - Reporting format: The quantities that the UE includes in the measurement report and associated information (e.g. number of cells to report).
3. **Measurement identities:** A list of measurement identities where each measurement identity links one measurement object with one reporting configuration. By configuring multiple measurement identities it is possible to link more than one measurement object to the same reporting configuration, as well as to link more than one reporting configuration to the same measurement object. The measurement identity is used as a reference number in the measurement report.
4. **Quantity configurations:** One quantity configuration is configured per RAT type. The quantity configuration defines the measurement quantities and associated filtering used for all event evaluation and related reporting of that measurement type. One filter can be configured per measurement quantity, except for NR where the network may configure up to 2 sets of quantity configurations each comprising per measurement quantity separate filters for cell and RS index measurement results. The quantity configuration set that applies for a given measurement is indicated within the NR measurement object.
5. **Measurement gaps:** Periods that the UE may use to perform measurements, i.e. no (UL, DL) transmissions are scheduled.

E-UTRAN only configures a single measurement object for a given frequency (except for WLAN and except for CBR measurements), i.e. it is not possible to configure two or more measurement objects for the same frequency with different associated parameters, e.g. different offsets and/ or blacklists. E-UTRAN may configure multiple instances of the same event e.g. by configuring two reporting configurations with different thresholds.

The UE maintains a single measurement object list, a single reporting configuration list, and a single measurement identities list. The measurement object list includes measurement objects, that are specified per RAT type, possibly

including intra-frequency object(s) (i.e. the object(s) corresponding to the serving frequency(ies)), inter-frequency object(s) and inter-RAT objects. Similarly, the reporting configuration list includes E-UTRA and inter-RAT reporting configurations. Any measurement object can be linked to any reporting configuration of the same RAT type. Some reporting configurations may not be linked to a measurement object. Likewise, some measurement objects may not be linked to a reporting configuration.

[TS 36.331, clause 5.5.4.1]

If security has been activated successfully, the UE shall:

1> for each *measId* included in the *measIdList* within *VarMeasConfig*:

...

2> else:

...

3> else if the corresponding *measObject* concerns NR:

4> if the *reportSFTD-Meas* is set to *pSCell* in the corresponding *reportConfigInterRAT*:

5> consider the PSCell to be applicable;

4> else if the *reportSFTD-Meas* is set to *neighborCells* in the corresponding *reportConfigInterRAT*:

5> if *cellsForWhichToReportSFTD* is configured in the corresponding *measObjectNR*:

6> consider any neighbouring NR cell on the associated frequency that is included in *cellsForWhichToReportSFTD* to be applicable;

5> else:

6> consider up to 3 strongest neighbouring NR cells detected on the associated frequency to be applicable when the concerned cells are not included in the *blackCellsToAddModList* defined within the *VarMeasConfig* for this *measId*;

4> else:

5> consider any neighbouring cell detected on the associated frequency to be applicable when the concerned cell is not included in the *blackCellsToAddModList* defined within the *VarMeasConfig* for this *measId*;

...

2> else if the *purpose* is included and set to *reportStrongestCells*, *reportStrongestCellsForSON*, *reportLocation* or *sidelink* and if a (first) measurement result is available:

3> include a measurement reporting entry within the *VarMeasReportList* for this *measId*;

3> set the *numberOfReportsSent* defined within the *VarMeasReportList* for this *measId* to 0;

3> if the *purpose* is set to *reportStrongestCells* and *reportStrongestCSI-RSs* is not included:

4> if the *triggerType* is set to *periodical* and the corresponding *reportConfig* includes the *ul-DelayConfig*:

5> initiate the measurement reporting procedure, as specified in 5.5.5, immediately after a first measurement result is provided by lower layers;

...

4> else if the *reportAmount* exceeds 1:

5> initiate the measurement reporting procedure, as specified in 5.5.5, immediately after the quantity to be reported becomes available for the PCell;

4> else (i.e. the *reportAmount* is equal to 1):

5> initiate the measurement reporting procedure, as specified in 5.5.5, immediately after the quantity to be reported becomes available for the PCell and for the strongest cell among the applicable cells, or becomes available for the pair of PCell and the PSCell in case of SSTD measurements, or becomes available for each requested pair of PCell and NR cell or the maximal measurement reporting delay as specified in TS 38.133 [X, 8.17.2.3] in case of SFTD measurements;

...

3> else:

4> initiate the measurement reporting procedure, as specified in 5.5.5, when it has determined the strongest cells on the associated frequency;

2> upon expiry of the periodical reporting timer for this *measId*:

3> initiate the measurement reporting procedure, as specified in 5.5.5;

...

2> upon expiry of the T321 for this *measId*:

3> include a measurement reporting entry within the *VarMeasReportList* for this *measId*;

3> set the *numberOfReportsSent* defined within the *VarMeasReportList* for this *measId* to 0;

3> initiate the measurement reporting procedure, as specified in 5.5.5;

NOTE 2: The UE does not stop the periodical reporting with *triggerType* set to *event* or to *periodical* while the corresponding measurement is not performed due to the PCell RSRP being equal to or better than *s-Measure* or due to the measurement gap not being setup.

NOTE 3: If the UE is configured with DRX, the UE may delay the measurement reporting for event triggered and periodical triggered measurements until the Active Time, which is defined in TS 36.321 [6].

[TS 36.331, clause 5.5.5.1]

The purpose of this procedure is to transfer measurement results from the UE to E-UTRAN. The UE shall initiate this procedure only after successful security activation.

For the *measId* for which the measurement reporting procedure was triggered, the UE shall set the *measResults* within the *MeasurementReport* message as follows:

1> set the *measId* to the measurement identity that triggered the measurement reporting;

1> set the *measResultPCell* to include the quantities of the PCell;

1> set the *measResultServFreqList* to include for each E-UTRA SCell that is configured, if any, within *measResultSCell* the quantities of the concerned SCell, if available according to performance requirements in [16], except if *purpose* for the *reportConfig* associated with the *measId* that triggered the measurement reporting is set to *reportLocation*;

1> if the *reportConfig* associated with the *measId* that triggered the measurement reporting includes *reportAddNeighMeas*:

2> for each E-UTRA serving frequency for which *measObjectId* is referenced in the *measIdList*, other than the frequency corresponding with the *measId* that triggered the measurement reporting:

3> set the *measResultServFreqList* to include within *measResultBestNeighCell* the *physCellId* and the quantities of the best non-serving cell, based on RSRP, on the concerned serving frequency;

...

1> if there is at least one applicable neighbouring cell to report:

- 2> set the *measResultNeighCells* to include the best neighbouring cells up to *maxReportCells* in accordance with the following:
 - 3> if the *triggerType* is set to *event*:
 - 4> include the cells included in the *cellsTriggeredList* as defined within the *VarMeasReportList* for this *measId*;...3> else:
 - 4> include the applicable cells for which the new measurement results became available since the last periodical reporting or since the measurement was initiated or reset;

NOTE 1: The reliability of the report (i.e. the certainty it contains the strongest cells on the concerned frequency) depends on the measurement configuration i.e. the *reportInterval*. The related performance requirements are specified in TS 36.133 [16].

- 3> for each cell that is included in the *measResultNeighCells*, include the *physCellId*;
- 3> if the *triggerType* is set to *event*; or the *purpose* is set to *reportStrongestCells* or to *reportStrongestCellsForSON*:
 - 4> for each included cell, include the layer 3 filtered measured results in accordance with the *reportConfig* for this *measId*, ordered as follows:
 - 5> if the *measObject* associated with this *measId* concerns E-UTRA:
 - 6> set the *measResult* to include the quantity(ies) indicated in the *reportQuantity* within the concerned *reportConfig* in order of decreasing *triggerQuantity*, i.e. the best cell is included first;
 - 5> if the *measObject* associated with this *measId* concerns NR:
 - 6> set the *measResultCell* to include the quantity(ies) indicated in the *reportQuantityCellNR* within the concerned *reportConfig* in order of decreasing quantity according to *bN-ThresholdYNR*, i.e. the best cell is included first;
 - 6> if *maxReportRS-Index* and *reportQuantityRS-IndexNR* are configured, set *measResultCellRS-Index* to include results of the best beam and the beams whose quantity is above *threshRS-Index* defined in the *VarMeasConfig* for the corresponding *measObject*, up to *maxReportRS-Index* beams in total, and in order of decreasing quantity, same as used for cell reporting, and as follows:
 - 7> order beams based on the reporting quantity determined as specified in 5.5.5.2;
 - 7> include *ssbIndex*;
 - 7> if *reportQuantityRS-IndexNR* and *reportRS-IndexResultsNR* are configured, for each quantity indicated, include the corresponding measurement result;
 - 5> if the *measObject* associated with this *measId* concerns UTRA FDD and if *ReportConfigInterRAT* includes the *reportQuantityUTRA-FDD*:
 - 6> set the *measResult* to include the quantities indicated by the *reportQuantityUTRA-FDD* in order of decreasing *measQuantityUTRA-FDD* within the *quantityConfig*, i.e. the best cell is included first;
 - 5> if the *measObject* associated with this *measId* concerns UTRA FDD and if *ReportConfigInterRAT* does not include the *reportQuantityUTRA-FDD*; or
 - 5> if the *measObject* associated with this *measId* concerns UTRA TDD, GERAN or CDMA2000:
 - 6> set the *measResult* to the quantity as configured for the concerned RAT within the *quantityConfig* in order of either decreasing quantity for UTRA and GERAN or increasing quantity for CDMA2000 *pilotStrength*, i.e. the best cell is included first;

1> for the cells included according to the previous (i.e. covering the PCell, the SCells, the best non-serving cells on serving frequencies as well as neighbouring EUTRA cells) include results according to the extended RSRQ if corresponding results are available according to the associated performance requirements defined in 36.133 [16];

1> if there is at least one applicable CSI-RS resource to report:

2> set the *measResultCSI-RS-List* to include the best CSI-RS resources up to *maxReportCells* in accordance with the following:

3> if the *triggerType* is set to *event*:

4> include the CSI-RS resources included in the *csi-RS-TriggeredList* as defined within the *VarMeasReportList* for this *measId*;

3> else:

4> include the applicable CSI-RS resources for which the new measurement results became available since the last periodical reporting or since the measurement was initiated or reset;

NOTE 2: The reliability of the report (i.e. the certainty it contains the strongest CSI-RS resources on the concerned frequency) depends on the measurement configuration i.e. the *reportInterval*. The related performance requirements are specified in TS 36.133 [16].

...

1> increment the *numberOfReportsSent* as defined within the *VarMeasReportList* for this *measId* by 1;

1> stop the periodical reporting timer, if running;

1> if the *numberOfReportsSent* as defined within the *VarMeasReportList* for this *measId* is less than the *reportAmount* as defined within the corresponding *reportConfig* for this *measId*:

2> start the periodical reporting timer with the value of *reportInterval* as defined within the corresponding *reportConfig* for this *measId*;

1> else:

2> if the *triggerType* is set to *periodical*:

3> remove the entry within the *VarMeasReportList* for this *measId*;

3> remove this *measId* from the *measIdList* within *VarMeasConfig*;

...

1> submit the *MeasurementReport* message to lower layers for transmission, upon which the procedure ends;

8.2.3.3.1.3 Test description

8.2.3.3.1.3.1 Pre-test conditions

System Simulator:

- E-UTRA Cell 1, NR Cell 1 and NR Cell 2.

UE:

- None.

Preamble:

- The UE is in state RRC_CONNECTED using generic procedure parameter Connectivity (*E-UTRA/EPC*) established according to TS 38.508-1 [4], clause 4.5.4.

8.2.3.3.1.3.2 Test procedure sequence

Table 8.2.3.3.1.3.2-1 and Table 8.2.3.3.1.3.2-1A illustrates the downlink power levels and other changing parameters to be applied for the cells at various time instants of the test execution. Row marked "T0" denotes the initial conditions after preamble, while columns marked "T1", "T2" and "T3" are to be applied subsequently. The exact instants on which these values shall be applied are described in the texts in this clause.

Table 8.2.3.3.1.3.2-1: Time instances of cell power level and parameter changes for conducted test environment

	Parameter	Unit	E-UTRA Cell 1	NR Cell 1	NR Cell 2	Remark
T0	Cell-specific RS EPRE	dBm/15 kHz	-85	-	-	The power level values are such that camping on E-UTRA Cell 1 is guaranteed.
	SS/PBCH SSS EPRE	dBm/SCS	-	Off	Off	
T1	Cell-specific RS EPRE	dBm/15 kHz	-85	-	-	The power level values are such that NR Cell 1 is satisfied for periodic reporting.
	SS/PBCH SSS EPRE	dBm/SCS	-	-91	Off	
T2	Cell-specific RS EPRE	dBm/15 kHz	-85	-	-	The power level values are such that NR Cell 2 is satisfied for periodic reporting and NR Cell 1 become unavailable.
	SS/PBCH SSS EPRE	dBm/SCS	-	Off	-91	
T3	Cell-specific RS EPRE	dBm/15 kHz	-85	-	-	The power level values are such that NR Cell 1 and NR Cell 2 are satisfied for periodic reporting.
	SS/PBCH SSS EPRE	dBm/SCS	-	-91	-91	

Table 8.2.3.3.1.3.2-1A: Time instances of cell power level and parameter changes for OTA test environment

	Parameter	Unit	E-UTRA Cell 1	NR Cell 1	NR Cell 2	Remark
T0	Cell-specific RS EPRE	dBm/15 kHz	-96	-	-	The power level values are such that camping on E-UTRA Cell 1 is guaranteed.
	SS/PBCH SSS EPRE	dBm/SCS	-	Off	Off	
T1	Cell-specific RS EPRE	dBm/15 kHz	-96	-	-	The power level values are such that NR Cell 1 is satisfied for periodic reporting.
	SS/PBCH SSS EPRE	dBm/SCS	-	-82	Off	
T2	Cell-specific RS EPRE	dBm/15 kHz	-96	-	-	The power level values are such that NR Cell 2 is satisfied for periodic reporting and NR Cell 1 become unavailable.
	SS/PBCH SSS EPRE	dBm/SCS	-	Off	-82	
T3	Cell-specific RS EPRE	dBm/15 kHz	-96	-	-	The power level values are such that NR Cell 1 and NR Cell 2 are satisfied for periodic reporting.
	SS/PBCH SSS EPRE	dBm/SCS	-	-82	-82	

Table 8.2.3.3.1.3.2-2: Main behaviour

St	Procedure	Message Sequence		TP	Verdict
		U - S	Message		
1	The SS transmits an <i>RRCCONNECTIONRECONFIGURATION</i> including <i>measConfig</i> to setup inter RAT measurements and reporting for NR Cell.	<--	<i>RRCCONNECTIONRECONFIGURATION</i>	-	-
2	The UE transmits an <i>RRCCONNECTIONRECONFIGURATIONCOMPLETE</i> message to confirm the setup of inter RAT measurements for NR Cell.	-->	<i>RRCCONNECTIONRECONFIGURATIONCOMPLETE</i>	-	-

3	The SS changes NR Cell y parameters according to the row "T1".	-	-	-	-
4	Wait and ignore <i>MeasurementReport</i> messages for 57s if NR Cell 1 is on FR2 frequency else wait for 15 s to allow change of power levels and UE measurements for NR Cell 1.	-	-	-	-
5	Check: Does the UE transmit a <i>MeasurementReport</i> message on E-UTRA Cell 1 to perform periodical reporting for NR Cell 1?	-->	<i>MeasurementReport</i>	1	P
6	The SS changes NR Cell y parameters according to the row "T2".	-	-	-	-
7	Wait and ignore <i>MeasurementReport</i> messages for 57s if NR Cell 1 is on FR2 frequency else wait for 15 s to allow change of power levels and UE measurements for NR Cell 2.	-	-	-	-
8	Check: Does the UE transmit a <i>MeasurementReport</i> message on E-UTRA Cell 1 to perform periodical reporting for NR Cell 2?	-->	<i>MeasurementReport</i>	2	P
9	The SS changes NR Cell y parameters according to the row "T3".	-	-	-	-
10	Wait and ignore <i>MeasurementReport</i> messages for 57s if NR Cell 1 is on FR2 frequency else wait for 15 s to allow change of power levels and UE measurements for NR Cell 1 and NR Cell 2.	-	-	-	-
11	The SS transmits an <i>RRCConnectionReconfiguration</i> including measConfig to remove inter RAT measurements and reporting for NR Cell.	<--	<i>RRCConnectionReconfiguration</i>	-	-
12	The UE transmits an <i>RRCConnectionReconfigurationComplete</i> message to confirm the remove of inter RAT measurements for NR Cell.	-->	<i>RRCConnectionReconfigurationComplete</i>	-	-
13	Check: Does the UE transmit a <i>MeasurementReport</i> message on E-UTRA Cell 1 to perform periodical reporting for NR Cell 1 and NR Cell 2 during the next 10s?	-->	<i>MeasurementReport</i>	3	F

8.2.3.3.1.3.3 Specific message contents

Table 8.2.3.3.1.3.3-1: *RRCConnectionReconfiguration* (step 1, Table 8.2.3.3.1.3.2-2)

Derivation Path: TS 36.508 [7], Table 4.6.1-8, condition MEAS

Table 8.2.3.3.1.3.3-2: *MeasConfig* (Table 8.2.3.3.1.3.3-1)

Derivation Path: TS 36.508 [7], Table 4.6.6-1			
Information Element	Value/remark	Comment	Condition
<i>MeasConfig</i> ::= SEQUENCE {			
measObjectToAddModList SEQUENCE (SIZE (1..maxObjectId)) OF MeasObjectToAddMod {	1 entry		
MeasObjectToAddMod[1] SEQUENCE {		entry 1	
measObjectId	IdMeasObject-NRf1		
measObject	MeasObjectNR-GENERIC (NRf1)		
}			
}			
reportConfigToAddModList SEQUENCE (SIZE (1..maxReportConfigId)) OF ReportConfigToAddMod {	1 entry		
ReportConfigToAddMod[1] SEQUENCE {		entry 1	
reportConfigId	IdReportConfig-NR		
reportConfig	ReportConfigInterRAT-PERIODICAL-NR		
}			
}			

}			
measIdToAddModList SEQUENCE (SIZE (1..maxMeasId)) OF MeasIdToAddMod {	1 entry		
MeasIdToAddMod[1] SEQUENCE {		entry 1	
measId	1		
measObjectId	IdMeasObject-NRf1		
reportConfigId	IdReportConfig-NR		
}			
}			
quantityConfig	QuantityConfig-DEFAULT		
measGapConfig	MeasGapConfig		
}			

Table 8.2.3.3.1.3.3-3: QuantityConfig-DEFAULT (Table 8.2.3.3.1.3.3-2)

Derivation Path: TS 36.508 [7], Table 4.6.6-3A			
Information Element	Value/remark	Comment	Condition
QuantityConfig-DEFAULT ::= SEQUENCE {			
quantityConfigNRLList-r15 SEQUENCE ((SIZE (1..maxQuantSetsNR-r15)) OF QuantityConfigNR-r15 {	1 entry		
QuantityConfigNR-r15[1] SEQUENCE {		entry 1	
measQuantityCellNR-r15 SEQUENCE {			
filterCoeff-RSRP-r15	fc0		
filterCoeff-RSRQ-r15	fc0		
filterCoefficient-SINR-r13	fc0		
}			
}			
}			
}			

Table 8.2.3.3.1.3.3-4: MeasObjectNR-GENERIC (NRf1) (Table 8.2.3.3.1.3.3-2)

Derivation Path: TS 36.508 [7], Table 4.6.6-2B			
Information Element	Value/remark	Comment	Condition
MeasObjectNR-GENERIC(Freq) ::= SEQUENCE {			
carrierFreq-r15	Downlink carrier frequency of NR cell 1		
}			

Table 8.2.3.3.1.3.3-5: ReportConfigInterRAT-PERIODICAL-NR (Table 8.2.3.3.1.3.3-2)

Derivation Path: TS 36.508 [7], Table 4.6.6-7			
Information Element	Value/remark	Comment	Condition
ReportConfigInterRAT ReportConfigInterRAT-PERIODICAL-NR ::= SEQUENCE {			
maxReportCells	2		
reportAmount	Infinity		
reportQuantityCellNR-r15 SEQUENCE {			
ss-rsrp	true		
ss-rsrq	true		
ss-sinr	true		pc_ss_SINR_Meas
	false		
}			
}			

Table 8.2.3.3.1.3.3-6: MeasurementReport (step 5, Table 8.2.3.3.1.3.2-2)

Derivation Path: TS 36.508 [7], Table 4.6.1-5			
---	--	--	--

Information Element	Value/remark	Comment	Condition
MeasurementReport ::= SEQUENCE {			
criticalExtensions CHOICE {			
c1 CHOICE {			
measurementReport-r8 SEQUENCE {			
measResults SEQUENCE {			
measId	1		
measResultPCell SEQUENCE {			
rsrpResult	(0..97)		
rsrqResult	(0..34)		
}			
measResultNeighCells CHOICE {			
measResultNeighCellListNR-r15 SEQUENCE (SIZE (1..maxCellReport)) OF MeasResultCellNR-r15 {	1 entry		
MeasResultCellNR-r15[1] SEQUENCE {		entry 1	
pci-r15	PhysicalCellIdentity of NR Cell 1		
measResultCell-r15 SEQUENCE {			
rsrpResult-r15	(0..127)		
rsrqResult-r15	(0..127)		
rs-sinr-Result-r15	(0..127)		pc_ss_SIN R_Meas
	Not present		
}			
}			
}			
}			
}			
}			
}			
}			
}			
}			
}			

Table 8.2.3.3.1.3.3-7: MeasurementReport (step 8, Table 8.2.3.3.1.3.2-2)

Derivation Path: TS 36.508 [7], Table 4.6.1-5			
Information Element	Value/remark	Comment	Condition
MeasurementReport ::= SEQUENCE {			
criticalExtensions CHOICE {			
c1 CHOICE {			
measurementReport-r8 SEQUENCE {			
measResults SEQUENCE {			
measId	1		
measResultPCell SEQUENCE {			
rsrpResult	(0..97)		
rsrqResult	(0..34)		
}			
measResultNeighCells CHOICE {			
measResultNeighCellListNR-r15 SEQUENCE (SIZE (1..maxCellReport)) OF MeasResultCellNR-r15 {	1 entry		
MeasResultCellNR-r15[1] SEQUENCE {		entry 1	
pci-r15	PhysicalCellIdentity of NR Cell 2		
measResultCell-r15 SEQUENCE {			
rsrpResult-r15	(0..127)		
rsrqResult-r15	(0..127)		
rs-sinr-Result-r15	(0..127)		pc_ss_SIN R_Meas
	Not present		
}			
}			
}			
}			
}			
}			
}			
}			

}			
}			
}			
}			
}			

Table 8.2.3.3.1.3.3-8: MeasConfig (step 11, Table 8.2.3.3.1.3.2-2)

Derivation Path: TS 36.508 [7], Table 4.6.6-1			
Information Element	Value/remark	Comment	Condition
MeasConfig ::= SEQUENCE {			
measIdToRemoveList SEQUENCE (SIZE (1..maxMeasId)) OF MeasId {	1 entry		
measId[1]	1	entry 1	
}			
}			

Table 8.2.3.3.1.3.3-9: MeasGapConfig (Table 8.2.3.3.1.3.3-2)

Derivation Path: TS 36.508, clause 6.5.1-2			
Information Element	Value/remark	Comment	Condition
MeasGapConfig-GP2 ::= CHOICE {			
setup SEQUENCE {			
gapOffset CHOICE {			
gp1	19	TGRP = 80 ms	
}			
}			
}			

8.2.3.4 Measurement configuration control and reporting / Event A1 / Measurement of NR PSCell

8.2.3.4.1 Measurement configuration control and reporting / Event A1 / Measurement of NR PSCell / EN-DC

8.2.3.4.1.1 Test Purpose (TP)

(1)

```
with { UE in RRC_CONNECTED state in EN-DC, and, MCG(s) (E-UTRA PDCP) and SCG and measurement
configured for event A1 with event based periodical reporting }
ensure that {
  when { Serving NR cell becomes better than absolute threshold plus hysteresis }
  then {UE sends MeasurementReport message at regular intervals while entering condition for event
A1 is satisfied }
}
```

(2)

```
with { UE in RRC_CONNECTED state in EN-DC, and, MCG(s) (E-UTRA PDCP) and SCG and periodical
measurement reporting triggered by event A1 ongoing }
ensure that {
  when { Serving NR cell becomes worse than absolute threshold minus hysteresis }
  then {UE stops sending MeasurementReport message }
}
```

(3)

```
with { UE in RRC_CONNECTED state with EN-DC, and, MCG(s) (E-UTRA PDCP) and SCG and measurements are
re-configured for event A1 with event based reporting to report on leaving condition }
ensure that {
  when { Serving NR cell becomes worse than absolute threshold minus hysteresis }
}
```

```

then { UE sends MeasurementReport message when leaving condition for event A1 is satisfied }
}

```

8.2.3.4.1.2 Conformance requirements

References: The conformance requirements covered in the present TC are specified in: TS 36.331:5.3.5.3; TS 38.331:5.3.5.3, 5.5.2, 5.5.4.1, 5.5.4.2 and 5.5.5.1. Unless otherwise stated these are Rel-15 requirements.

[TS 36.331, clause 5.3.5.3]

If the *RRCConnectionReconfiguration* message does not include the *mobilityControllInfo* and the UE is able to comply with the configuration included in this message, the UE shall:

...

- 1> if the received *RRCConnectionReconfiguration* includes the *nr-SecondaryCellGroupConfig*:
 - 2> perform NR RRC Reconfiguration as specified in TS 38.331 [82, 5.3.5.3];

[TS 38.331, clause 5.3.5.3]

The UE shall perform the following actions upon reception of the *RRCReconfiguration*:

...

- 1> if the *RRCReconfiguration* message includes the *measConfig*:
 - 2> perform the measurement configuration procedure as specified in 5.5.2.
- 1> set the content of *RRCReconfigurationComplete* message as follows:
 - 2> if the *RRCReconfiguration* includes the *masterCellGroup* containing the *reportUplinkTxDirectCurrent*, or;
 - 2> if the *RRCReconfiguration* includes the *secondaryCellGroup* containing the *reportUplinkTxDirectCurrent*:
 - 3> include the *uplinkTxDirectCurrentList*;
- 1> if the UE is configured with E-UTRA *nr-SecondaryCellGroupConfig* (MCG is E-UTRA):
 - 2> if *RRCReconfiguration* was received via SRB1:
 - 3> submit the *RRCReconfigurationComplete* via the EUTRA MCG embedded in E-UTRA RRC message *RRCConnectionReconfigurationComplete* as specified in TS 36.331 [10];
 - 3> if *reconfigurationWithSync* was included in *spCellConfig* of an SCG:
 - 4> initiate the random access procedure on the SpCell, as specified in TS 38.321 [3];
 - 3> else:
 - 4> the procedure ends;
 - 2> else (*RRCReconfiguration* was received via SRB3):
 - 3> submit the *RRCReconfigurationComplete* message via SRB3 to lower layers for transmission using the new configuration;

NOTE: For EN-DC, in the case of SRB1, the random access is triggered by RRC layer itself as there is not necessarily other UL transmission. In the case of SRB3, the random access is triggered by the MAC layer due to arrival of *RRCReconfigurationComplete*.

1 > else:

- 2> submit the *RRCReconfigurationComplete* message via SRB1 to lower layers for transmission using the new configuration;

[TS 38.331, clause 5.5.2.3]

The network applies the procedure as follows:

- configure a *measId* only if the corresponding measurement object, the corresponding reporting configuration and the corresponding quantity configuration, are configured;

The UE shall:

- 1> for each *measId* included in the received *measIdToAddModList*:
 - 2> if an entry with the matching *measId* exists in the *measIdList* within the *VarMeasConfig*:
 - 3> replace the entry with the value received for this *measId*;
 - 2> else:
 - 3> add a new entry for this *measId* within the *VarMeasConfig*;
 - 2> remove the measurement reporting entry for this *measId* from the *VarMeasReportList*, if included;
 - 2> stop the periodical reporting timer and reset the associated information (e.g. *timeToTrigger*) for this *measId*;

[TS 38.331, clause 5.5.4.1]

If security has been activated successfully, the UE shall:

- 1> for each *measId* included in the *measIdList* within *VarMeasConfig*:
 - 2> if the corresponding *reportConfig* includes a *reportType* set to *eventTriggered* or *periodical*;
 - 3> if the corresponding *measObject* concerns NR;
 - 4> if the *eventA1* or *eventA2* is configured in the corresponding *reportConfig*:
 - 5> consider only the serving cell to be applicable;
 - ...
 - 2> if the *reportType* is set to *eventTriggered* and if the leaving condition applicable for this event is fulfilled for one or more of the cells included in the *cellsTriggeredList* defined within the *VarMeasReportList* for this *measId* for all measurements after layer 3 filtering taken during *timeToTrigger* defined within the *VarMeasConfig* for this event:
 - 3> remove the concerned cell(s) in the *cellsTriggeredList* defined within the *VarMeasReportList* for this *measId*;
 - 3> if *reportOnLeave* is set to *TRUE* for the corresponding reporting configuration:
 - 4> initiate the measurement reporting procedure, as specified in 5.5.5;
 - 2> upon expiry of the periodical reporting timer for this *measId*:
 - ...
 - 3> initiate the measurement reporting procedure, as specified in 5.5.5;

[TS 38.331, clause 5.5.4.2]

The UE shall:

- 1> consider the entering condition for this event to be satisfied when condition A1-1, as specified below, is fulfilled;
- 1> consider the leaving condition for this event to be satisfied when condition A1-2, as specified below, is fulfilled;

- 1> for this measurement, consider the NR serving cell corresponding to the associated *measObjectNR* associated with this event.

Inequality A1-1 (Entering condition)

$$Ms - Hys > Thresh$$

Inequality A1-2 (Leaving condition)

$$Ms + Hys < Thresh$$

The variables in the formula are defined as follows:

Ms is the measurement result of the serving cell, not taking into account any offsets.

Hys is the hysteresis parameter for this event (i.e. *hysteresis* as defined within *reportConfigNR* for this event).

Thresh is the threshold parameter for this event (i.e. *a1-Threshold* as defined within *reportConfigNR* for this event).

Ms is expressed in dBm in case of RSRP, or in dB in case of RSRQ and RS-SINR.

Hys is expressed in dB.

Thresh is expressed in the same unit as *Ms*.

[TS 38.331, clause 5.5.5.1]



Figure 5.5.5.1-1: Measurement reporting

The purpose of this procedure is to transfer measurement results from the UE to the network. The UE shall initiate this procedure only after successful security activation.

For the *measId* for which the measurement reporting procedure was triggered, the UE shall set the *measResults* within the *MeasurementReport* message as follows:

- 1> set the *measId* to the measurement identity that triggered the measurement reporting;
- 1> set the *measResultServingCell* within *measResultServingMOList* to include RSRP, RSRQ and the available SINR for each configured serving cell derived based on the *rsType* indicated in the associated *reportConfig*;
- 1> set the *measResultServingCell* within *measResultServingMOList* to include for each NR serving cell that is configured, if any, the *servFreqId*;
- ...
- 1> increment the *numberOfReportsSent* as defined within the *VarMeasReportList* for this *measId* by 1;
- 1> stop the periodical reporting timer, if running;
- 1> if the *numberOfReportsSent* as defined within the *VarMeasReportList* for this *measId* is less than the *reportAmount* as defined within the corresponding *reportConfig* for this *measId*:
 - 2> start the periodical reporting timer with the value of *reportInterval* as defined within the corresponding *reportConfig* for this *measId*.

1> else:

2> if the *reportType* is set to *periodical*:

3> remove the entry within the *VarMeasReportList* for this *measId*;

3> remove this *measId* from the *measIdList* within *VarMeasConfig*.

1> if the UE is configured with EN-DC:

2> if SRB3 is configured:

3> submit the *MeasurementReport* message via SRB3 to lower layers for transmission, upon which the procedure ends;

2>else:

3> submit the *MeasurementReport* message via the EUTRA MCG embedded in E-UTRA RRC message *ULInformationTransferMRDC* as specified in TS 36.331 [10].

1> else:

2>submit the *MeasurementReport* message to lower layers for transmission, upon which the procedure ends.

8.2.3.4.1.3 Test description

System Simulator:

- EUTRA Cell 1 is the PCell and NR Cell 1 is the PSCell.

UE:

- None

Preamble:

- The UE is in state RRC_CONNECTED using generic procedure parameter Connectivity (*EN-DC*) and Bearers (*MCG(s) and SCG*) on E-UTRA Cell 1 according to TS 38.508-1 [4], clause 4.5.4.

8.2.3.4.1.3.2 Test procedure sequence

Table 8.2.3.4.1.3.2-1 and Table 8.2.3.4.1.3.2-1A illustrates the downlink power levels to be applied for NR Cell 1 at various time instants of the test execution. Row marked "T0" denotes the conditions after the preamble, while row marked "T1" are to be applied subsequently. The exact instants on which these values shall be applied are described in the texts in this clause.

Table 8.2.3.4.1.3.2-1: Time instances of cell power level and parameter changes for conducted test environment

	Parameter	Unit	E-UTRA Cell 1	NR Cell 1	Remark
T0	Cell-specific RS EPRE	dBm/15 kHz	-85	-	Power level is such that exit condition for event A1 is satisfied $M_s < Thresh - Hys$
	SS/PBCH SSS EPRE	dBm/SC S	-	-91	
T1	Cell-specific RS EPRE	dBm/15 kHz	-85	-	Power level is such that entry condition for event A1 is satisfied $M_s - Hys > Thresh$
	SS/PBCH SSS EPRE	dBm/SC S	-	-79	

Table 8.2.3.4.1.3.2-1A: Time instances of cell power level and parameter changes for OTA test environment

	Parameter	Unit	E-UTRA Cell 1	NR Cell 1	Remark
T0	Cell-specific RS EPRE	dBm/15 kHz	-96	-	Power level is such that $M_s < Thresh - Hys$
	SS/PBCH SSS EPRE	dBm/SC S	-	-100	
T1	Cell-specific RS EPRE	dBm/15 kHz	-96	-	Power level is such that entry condition for event A1 is satisfied $M_s - Hys > Thresh$
	SS/PBCH SSS EPRE	dBm/SC S	-	-82	

Table 8.2.3.4.1.3.2-2: Main behaviour

St	Procedure	Message Sequence		TP	Verdict
		U - S	Message		
1	The SS transmits an <i>RRCCONNECTIONRECONFIGURATION</i> message including nr Config to setup intra NR measurement for NR Cell 1 and reporting for event A1	<--	<i>RRCCONNECTIONRECONFIGURATION</i>	-	-
2	The UE transmit an <i>RRCCONNECTIONRECONFIGURATIONCOMPLETE</i> message	-->	<i>RRCCONNECTIONRECONFIGURATIONCOMPLETE</i>	-	-
3	SS re-adjusts the cell-specific reference signal level according to row "T1".	-	-	-	-
4	Check: Does the UE transmit a <i>MEASUREMENTREPORT</i> encapsulated in <i>ULINFORMATIONTRANSFERMRDC</i> message to report event A1 with the measured [Results] for NR Cell 1?	-->	<i>ULINFORMATIONTRANSFERMRDC (MeasurementReport)</i>	1	P
-	EXCEPTION: Step 5 below is repeated until 3 <i>MEASUREMENTREPORT</i> messages are received from the UE	-	-	-	-
5	Check: Does the UE transmit a <i>MEASUREMENTREPORT</i> encapsulated in <i>ULINFORMATIONTRANSFERMRDC</i> message, with the measured [Results] value for NR Cell 1?	-->	<i>ULINFORMATIONTRANSFERMRDC (MeasurementReport)</i>	1	P
6	SS re-adjusts the cell-specific reference signal level according to row "T0".	-	-	-	-
7	Wait and ignore <i>MEASUREMENTREPORT</i> messages for 15 s to allow change of power levels for NR Cell 1 and UE measurement.	-	-	-	-
8	Check: Does the UE transmit a <i>MEASUREMENTREPORT</i> encapsulated in <i>ULINFORMATIONTRANSFERMRDC</i> message, with the measured [Results] value for NR Cell 1 within the next 10s?	-->	<i>ULINFORMATIONTRANSFERMRDC (MeasurementReport)</i>	2	F
9	The SS transmits an <i>RRCCONNECTIONRECONFIGURATION</i> message including nr Config to setup intra NR measurement for NR Cell 1 and reporting for event A1 on leaving condition.	<--	<i>RRCCONNECTIONRECONFIGURATION</i>	-	-
10	The UE transmit an <i>RRCCONNECTIONRECONFIGURATIONCOMPLETE</i> message?	-->	<i>RRCCONNECTIONRECONFIGURATIONCOMPLETE</i>	-	-
11	SS re-adjusts the cell-specific reference signal level according to row "T1" in table 8.2.3.4.1.3.2-1.	-	-	-	-
12	The UE transmit a <i>MEASUREMENTREPORT</i> encapsulated in <i>ULINFORMATIONTRANSFERMRDC</i> message to report event A1 for NR Cell 1.	-->	<i>ULINFORMATIONTRANSFERMRDC (MeasurementReport)</i>	-	-
13	SS re-adjusts the cell-specific reference signal level according to row "T0" in table 8.2.3.4.1.3.2-1.	-	-	-	-
14	Check: Does the UE transmit a <i>MEASUREMENTREPORT</i> encapsulated in <i>ULINFORMATIONTRANSFERMRDC</i> message, with the measured [Results] value for NR Cell 1?	-->	<i>ULINFORMATIONTRANSFERMRDC (MeasurementReport)</i>	3	P

8.2.3.4.1.3.3 Specific message contents

Table 8.2.3.4.1.3.3-1: RRCConnectionReconfiguration (step 1, 9, Table 8.2.3.4.1.3.2-2)

Derivation Path: TS 36.508 [7], Table 4.6.1-8 with condition EN-DC_EmbedNR_RRCRecon

Table 8.2.3.4.1.3.3-2: RRCReconfiguration (Table 8.2.3.4.1.3.3-1)

Derivation Path: TS 38.508-1 [4], Table [4.6.1-13] with condition EN-DC_MEAS

Table 8.2.3.4.1.3.3-3: MeasConfig (Table 8.2.3.4.1.3.3-2)

Derivation Path: TS 38.508-1[4] Table 4.6.3-69			
Information Element	Value/Remark	Comment	Condition
measConfig ::= SEQUENCE {			
measObjectToAddModList SEQUENCE (SIZE (1..maxNrofObjectId)) OF MeasObjectToAddMod {	1 entry		
MeasObjectToAddMod[1] SEQUENCE {		entry 1	
measObjectId	MeasObjectId		
measObject CHOICE {			
measObjectNR	MeasObjectNR-GENERIC(72)		
}			
}			
}			
reportConfigToAddModList SEQUENCE (SIZE (1..maxReportConfigId)) OF ReportConfigToAddMod {	1 entry		
ReportConfigToAddMod[1] SEQUENCE {		entry 1	
reportConfigId	ReportConfigId		
reportConfig	ReportConfig1-A1 ReportConfig2-A1		FR1 FR2
}			
}			
measIdToAddModList SEQUENCE (SIZE (1..maxNrofMeasId)) OF MeasIdToAddMod {	1 entry		
MeasIdToAddMod[1] SEQUENCE {		entry 1	
measId[1]	MeasId		
measObjectId[1]	MeasObjectId		
reportConfigId[1]	ReportConfigId		
}			
}			
}			

Table 8.2.3.4.1.3.3-4: MeasObjectNR-GENERIC(72) (Table 8.2.3.4.1.3.3-3)

Derivation Path: TS 38.508-1 [4], Table 4.6.3-76			
Information Element	Value/remark	Comment	Condition
MeasObjectNR-GENERIC(Freq) ::= SEQUENCE {			
ssbFrequency	Downlink carrier frequency of NR cell 1		
}			

Table 8.2.3.4.1.3.3-5: ReportConfig1-A1 (Step 1, Table 8.2.3.4.1.3.3-3)

Derivation Path: TS 38.508-1 [4], Table 4.6.3-142 with condition EVENT_A1			
Information Element	Value/remark	Comment	Condition
ReportConfigNR ::= SEQUENCE {			
reportType CHOICE {			

Table 8.2.3.4.1.3.3-9: ReportConfig1-A1 (Step 9, Table 8.2.3.4.1.3.3-3)

Derivation Path: TS 38.508-1 [4], Table 4.6.3-142 with condition EVENT_A1			
Information Element	Value/remark	Comment	Condition
ReportConfigNR::= SEQUENCE {			
reportType CHOICE {			
eventTriggered SEQUENCE {			
eventId CHOICE {			
eventA1 SEQUENCE {			
a1-Threshold CHOICE {			
rsrp	72		
}			
reportOnLeave	True		
hysteresis	6	3dB	
}			
reportAmount	1		
}			
}			

Table 8.2.3.4.1.3.3-10: ReportConfig2-A1 (Step 1, Table 8.2.3.4.1.3.3-3)

Derivation Path: TS 38.508-1 [4], Table 4.6.3-142 with condition EVENT_A1			
Information Element	Value/remark	Comment	Condition
ReportConfigNR::= SEQUENCE {			
reportType CHOICE {			
eventTriggered SEQUENCE {			
eventId CHOICE {			
eventA1 SEQUENCE {			
a1-Threshold CHOICE {			
rsrp	69+delta(NRfs))		
}			
hysteresis	6	3dB	
}			
reportAmount	Infinity		
}			
}			

NOTE 1: delta(NRfs) is derived based on calibration procedure defined in the TS 38.508-1 [4], clause 6.1.3.3

Table 8.2.3.4.1.3.3-11: ReportConfig2-A1 (Step 9, Table 8.2.3.4.1.3.3-3)

Derivation Path: TS 38.508-1 [4], Table 4.6.3-142 with condition EVENT_A1			
Information Element	Value/remark	Comment	Condition
ReportConfigNR::= SEQUENCE {			
reportType CHOICE {			
eventTriggered SEQUENCE {			
eventId CHOICE {			
eventA1 SEQUENCE {			
a1-Threshold CHOICE {			
rsrp	69+delta(NRfs))		
}			
reportOnLeave	True		
hysteresis	6	3dB	
}			
reportAmount	1		
}			
}			

NOTE 1: delta(NRfs) is derived based on calibration procedure defined in the TS 38.508-1 [4], clause 6.1.3.3

8.2.3.4.2 Measurement configuration control and reporting / Event A1 / Measurement of E-UTRA PSCell / NE-DC

8.2.3.4.2.1 Test Purpose (TP)

(1)

```
with { UE in RRC_CONNECTED state with NE-DC, and, MCG(s) (NR PDCP) and SCG and measurement
configured for event A1 with event based periodical reporting }
ensure that {
  when { Serving E-UTRA cell becomes better than absolute threshold plus hysteresis }
    then { UE sends MeasurementReport message at regular intervals while entering condition for event
A1 is satisfied }
}
```

(2)

```
with { UE in RRC_CONNECTED state in NE-DC, and, MCG(s) (NR PDCP) and SCG and periodical measurement
reporting triggered by event A1 ongoing }
ensure that {
  when { Serving E-UTRA cell becomes worse than absolute threshold minus hysteresis }
    then { UE stops sending MeasurementReport message }
}
```

8.2.3.4.2.2 Conformance requirements

References: The conformance requirements covered in the present TC are specified in: 38.331:5.3.5.3, 5.5.5.1, 5.7.2a.3; TS 36.331:5.3.5.3, 5.5.2.3, 5.5.4.1, 5.5.4.2 and 5.5.5.1. Unless otherwise stated these are Rel-15 requirements.

[TS 38.331, clause 5.3.5.3]

The UE shall perform the following actions upon reception of the *RRCReconfiguration*:

...

1> if the *RRCReconfiguration* includes the *mrdc-SecondaryCellGroupConfig*:

2> if the *mrdc-SecondaryCellGroupConfig* is set to *setup*:

3> if the *mrdc-SecondaryCellGroupConfig* includes *mrdc-ReleaseAndAdd*:

4> perform MR-DC release as specified in clause 5.3.5.10;

3> if the received *mrdc-SecondaryCellGroup* is set to *nr-SCG*:

4> perform the RRC reconfiguration according to 5.3.5.3 for the *RRCReconfiguration* message included in *nr-SCG*;

3> if the received *mrdc-SecondaryCellGroup* is set to *eutra-SCG*:

4> perform the RRC connection reconfiguration as specified in TS 36.331 [10], clause 5.3.5.3 for the *RRCCConnectionReconfiguration* message included in *eutra-SCG*;

2> else (*mrdc-SecondaryCellGroupConfig* is set to *release*):

3> perform MR-DC release as specified in clause 5.3.5.10;

...

1> set the content of the *RRCReconfigurationComplete* message as follows:

...

2> if the *RRCReconfiguration* message includes the *mrdc-SecondaryCellGroupConfig* with *mrdc-SecondaryCellGroup* set to *eutra-SCG*:

- 3> include in the *eutra-SCG-Response* the E-UTRA *RRCConnectionReconfigurationComplete* message in accordance with TS 36.331 [10] clause 5.3.5.3;

[TS 38.331, clause 5.7.2a.3]

The UE shall set the contents of the *ULInformationTransferMRDC* message as follows:

- 1> if there is a need to transfer MR-DC dedicated information related to NR:
 - 2> set the *ul-DCCH-MessageNR* to include the NR MR-DC dedicated information to be transferred (e.g., NR *RRC MeasurementReport* and *FailureInformation* message);
- 1> else if there is a need to transfer MR-DC dedicated information related to E-UTRA:
 - 2> set the *ul-DCCH-MessageEUTRA* to include the E-UTRA MR-DC dedicated information to be transferred (e.g., E-UTRA *RRC MeasurementReport*);
- 1> submit the *ULInformationTransferMRDC* message to lower layers for transmission, upon which the procedure ends;

[TS 36.331, clause 5.3.5.3]

If the *RRCConnectionReconfiguration* message does not include the *mobilityControlInfo* and the UE is able to comply with the configuration included in this message, the UE shall:

...

- 1> if the received *RRCConnectionReconfiguration* includes the *sCellGroupToAddModList*:
 - 2> perform SCell group addition or modification as specified in 5.3.10.3e;
- 1> if the received *RRCConnectionReconfiguration* includes the *scg-Configuration*; or
- 1> if the current UE configuration includes one or more split DRBs configured with *pdcp-Config* and the received *RRCConnectionReconfiguration* includes *radioResourceConfigDedicated* including *drb-ToAddModList*:
 - 2> perform SCG reconfiguration as specified in 5.3.10.10;

...

- 1> if the *RRCConnectionReconfiguration* message includes the *measConfig*:
 - 2> perform the measurement configuration procedure as specified in 5.5.2;

...

- 1> if the UE is configured with NE-DC:
 - 2> if the received *RRCConnectionReconfiguration* message was included in an NR *RRCResume* message:
 - 3> transfer the *RRCConnectionReconfigurationComplete* message via SRB1 embedded in NR RRC message *RRCResumeComplete* as specified in TS 38.331 [82], clause 5.3.13.4;
 - 2> else:
 - 3> transfer the *RRCConnectionReconfigurationComplete* message via SRB1 embedded in NR RRC message *RRCReconfigurationComplete* as specified in TS 38.331 [82], clause 5.3.5.3;
- 1> else:
 - 2> submit the *RRCConnectionReconfigurationComplete* message to lower layers for transmission using the new configuration, upon which the procedure ends;

[TS 36.331, clause 5.5.2.3]

E-UTRAN applies the procedure as follows:

- configure a *measId* only if the corresponding measurement object, the corresponding reporting configuration and the corresponding quantity configuration, are configured;

The UE shall:

- 1> for each *measId* included in the received *measIdToAddModList*:
 - 2> if an entry with the matching *measId* exists in the *measIdList* within the *VarMeasConfig*:
 - 3> replace the entry with the value received for this *measId*;
 - 2> else:
 - 3> add a new entry for this *measId* within the *VarMeasConfig*;
- 2> remove the measurement reporting entry for this *measId* from the *VarMeasReportList*, if included;
- 2> stop the periodical reporting timer or timer T321, whichever one is running, and reset the associated information (e.g. *timeToTrigger*) for this *measId*;

...

[TS 36.331, clause 5.5.4.1]

If security has been activated successfully, the UE shall:

- 1> for each *measId* included in the *measIdList* within *VarMeasConfig*:
 - ...
 - 2> else:
 - 3> if the corresponding *measObject* concerns E-UTRA:
 - 4> if the *ue-RxTxTimeDiffPeriodical* is configured in the corresponding *reportConfig*:
 - 5> consider only the PCell to be applicable;
 - 4> else if the *reportSSTD-Meas* is set to *true* in the corresponding *reportConfig*:
 - 5> consider the PSCell to be applicable;
 - 4> else if the *eventA1* or *eventA2* is configured in the corresponding *reportConfig*:
 - 5> consider only the serving cell to be applicable;
 - ...
 - 2> if the *triggerType* is set to *event* and if the leaving condition applicable for this event is fulfilled for one or more of the cells included in the *cellsTriggeredList* defined within the *VarMeasReportList* for this *measId* for all measurements after layer 3 filtering taken during *timeToTrigger* defined within the *VarMeasConfig* for this event:
 - 3> remove the concerned cell(s) in the *cellsTriggeredList* defined within the *VarMeasReportList* for this *measId*;
 - 3> if *reportOnLeave* is set to *TRUE* for the corresponding reporting configuration or if *a6-ReportOnLeave* is set to *TRUE* or if *a4-a5-ReportOnLeave* is set to *TRUE* for the corresponding reporting configuration:
 - 4> initiate the measurement reporting procedure, as specified in 5.5.5;
 - 3> if the *cellsTriggeredList* defined within the *VarMeasReportList* for this *measId* is empty:
 - 4> remove the measurement reporting entry within the *VarMeasReportList* for this *measId*;
 - 4> stop the periodical reporting timer for this *measId*, if running;

- 2> if the *triggerType* is set to *event* and if the entry condition applicable for this event, i.e. the event corresponding with the *eventId* of the corresponding *reportConfig* within *VarMeasConfig*, is fulfilled for one or more applicable CSI-RS resources for all measurements after layer 3 filtering taken during *timeToTrigger* defined for this event within the *VarMeasConfig*, while the *VarMeasReportList* does not include an measurement reporting entry for this *measId* (i.e. a first CSI-RS resource triggers the event):
 - 3> include a measurement reporting entry within the *VarMeasReportList* for this *measId*;
 - 3> set the *numberOfReportsSent* defined within the *VarMeasReportList* for this *measId* to 0;
 - 3> include the concerned CSI-RS resource(s) in the *csi-RS-TriggeredList* defined within the *VarMeasReportList* for this *measId*;
 - 3> initiate the measurement reporting procedure, as specified in 5.5.5;
- ...
- 2> upon expiry of the periodical reporting timer for this *measId*:
 - 3> initiate the measurement reporting procedure, as specified in 5.5.5;

[TS 36.331, clause 5.5.4.2]

The UE shall:

- 1> consider the entering condition for this event to be satisfied when condition A1-1, as specified below, is fulfilled;
- 1> consider the leaving condition for this event to be satisfied when condition A1-2, as specified below, is fulfilled;
- 1> for this measurement, consider the primary or secondary cell that is configured on the frequency indicated in the associated *measObjectEUTRA* to be the serving cell;

Inequality A1-1 (Entering condition)

$$Ms - Hys > Thresh$$

Inequality A1-2 (Leaving condition)

$$Ms + Hys < Thresh$$

The variables in the formula are defined as follows:

Ms is the measurement result of the serving cell, not taking into account any offsets.

Hys is the hysteresis parameter for this event (i.e. *hysteresis* as defined within *reportConfigEUTRA* for this event).

Thresh is the threshold parameter for this event (i.e. *a1-Threshold* as defined within *reportConfigEUTRA* for this event).

Ms is expressed in dBm in case of RSRP, or in dB in case of RSRQ and RS-SINR.

Hys is expressed in dB.

Thresh is expressed in the same unit as ***Ms***.

[TS 36.331, clause 5.5.5.1]

The purpose of this procedure is to transfer measurement results from the UE to E-UTRAN. The UE shall initiate this procedure only after successful security activation.

For the *measId* for which the measurement reporting procedure was triggered, the UE shall set the *measResults* within the *MeasurementReport* message as follows:

- 1> set the *measId* to the measurement identity that triggered the measurement reporting;
- 1> set the *measResultPCell* to include the quantities of the PCell;

1> set the *measResultServFreqList* to include for each E-UTRA SCell that is configured, if any, within *measResultSCell* the quantities of the concerned SCell, if available according to performance requirements in TS 36.133 [16], except if *purpose* for the *reportConfig* associated with the *measId* that triggered the measurement reporting is set to *reportLocation*;

...

1> increment the *numberOfReportsSent* as defined within the *VarMeasReportList* for this *measId* by 1;

1> stop the periodical reporting timer, if running;

1> if the *numberOfReportsSent* as defined within the *VarMeasReportList* for this *measId* is less than the *reportAmount* as defined within the corresponding *reportConfig* for this *measId*:

2> start the periodical reporting timer with the value of *reportInterval* as defined within the corresponding *reportConfig* for this *measId*;

1> else:

2> if the *triggerType* is set to *periodical*:

3> remove the entry within the *VarMeasReportList* for this *measId*;

3> remove this *measId* from the *measIdList* within *VarMeasConfig*;

...

1> if the UE is configured with NE-DC:

2> submit the *MeasurementReport* message via SRB1 embedded in NR RRC message *ULInformationTransferMRDC* as specified in TS 38.331 [82].

1> else:

2> submit the *MeasurementReport* message to lower layers for transmission, upon which the procedure ends;

8.2.3.4.2.3 Test description

8.2.3.4.2.3.1 Pre-test conditions

System Simulator:

- NR Cell 1 is the PCell and EUTRA Cell 1 is the PSCell.

UE:

- None

Preamble:

- The UE is in state 3N-A as defined in TS 38.508-1 [4], subclause 4.4A on NR Cell 1.

8.2.3.4.2.3.2 Test procedure sequence

Table 8.2.3.4.2.3.2-1 illustrates the downlink power levels to be applied for E-UTRA Cell 1 at various time instants of the test execution. Row marked "T0" denotes the conditions after the preamble, while row marked "T1" are to be applied subsequently. The exact instants on which these values shall be applied are described in the texts in this clause.

Table 8.2.3.4.2.3.2-1: Time instances of cell power level and parameter changes for conducted test environment

	Parameter	Unit	E-UTRA Cell 1	NR Cell 1	Remark

T0	Cell-specific RS EPRE	dBm/15 kHz	-93	-	Power level is such that exit condition for event A1 is satisfied $M_s < Thresh - Hys$
	SS/PBCH SSS EPRE	dBm/SC S	-	-88	
T1	Cell-specific RS EPRE	dBm/15 kHz	-75	-	Power level is such that entry condition for event A1 is satisfied $M_s > Thresh + Hys$
	SS/PBCH SSS EPRE	dBm/SC S	-	-88	

Table 8.2.3.4.2.3.2-2: Main behaviour

St	Procedure	Message Sequence		TP	Verdict
		U - S	Message		
1	The SS transmits an <i>RRCReconfiguration</i> message containing <i>RRCCONNECTIONRECONFIGURATION</i> message to setup measurement for E-UTRA Cell 1 and reporting for event A1	<--	NR RRC: <i>RRCReconfiguration</i> (<i>RRCCONNECTIONRECONFIGURATION</i>)	-	-
2	The UE transmit an <i>RRCReconfigurationComplete</i> message.	-->	NR RRC: <i>RRCReconfigurationComplete</i> (<i>RRCCONNECTIONRECONFIGURATIONCOMPLETE</i>)	-	-
3	SS re-adjusts the cell-specific reference signal level according to row "T1" in Table 8.2.3.4.2.3.2-1.	-	-	-	-
4	Check: Does the UE transmit a <i>MeasurementReport</i> encapsulated in <i>ULINFORMATIONTRANSFERMRDC</i> message to report event A1 with the measured value for E-UTRA Cell 1?	-->	NR RRC: <i>ULINFORMATIONTRANSFERMRDC</i> (<i>MEASUREMENTREPORT</i>)	1	P
-	EXCEPTION: Step 5 below is repeated until 3 <i>MeasurementReport</i> messages are received from the UE	-	-	-	-
5	Check: Does the UE transmit a <i>MeasurementReport</i> encapsulated in <i>ULINFORMATIONTRANSFERMRDC</i> message, with the measured value for E-UTRA Cell 1	-->	NR RRC: <i>ULINFORMATIONTRANSFERMRDC</i> (<i>MEASUREMENTREPORT</i>)	1	P
6	SS re-adjusts the cell-specific reference signal level according to row "T0" in Table 8.2.3.4.2.3.2-1.	-	-	-	-
7	Wait and ignore <i>MeasurementReport</i> messages for 15s to allow change of power levels for E-UTRA Cell 1 and UE measurement.	-	-	-	-
8	Check: Does the UE transmit a <i>MeasurementReport</i> encapsulated in <i>ULINFORMATIONTRANSFERMRDC</i> message, with the measured value for NR Cell 1 within the next 10s?	-->	NR RRC: <i>ULINFORMATIONTRANSFERMRDC</i> (<i>MEASUREMENTREPORT</i>)	2	F

8.2.3.4.2.3.3 Specific message contents

Table 8.2.3.4.2.3.3-1: *RRCReconfiguration* (step 1, Table 8.2.3.4.2.3.2-2)

Derivation Path: TS 38.508-1 [4], Table 4.6.1-13 with condition NE-DC

Table 8.2.3.4.2.3.3-2: *SCG-Configuration-r12-NE-DC* (step 1, Table 8.2.3.4.2.3.2-2)

Derivation Path: TS 36.508 [7], Table 4.6.3-19G			
Information Element	Value/remark	Comment	Condition
scg-Configuration-r12 CHOICE {			
setup SEQUENCE {			
scg-ConfigPartSCG-r12 SEQUENCE {			
measConfigSN-r15	MeasConfig-A1-E-UTRA		
}			
}			
}			

Table 8.2.3.4.2.3.3-6: ULInformationTransferMRDC (step 4 and 5, Table 8.2.3.4.2.3.2-2)

Derivation Path: TS 38.508-1 [4], Table 4.6.1-34			
Information Element	Value/remark	Comment	Condition
ULInformationTransferMRDC ::= SEQUENCE {			
ul-DCCH-MessageEUTRA	OCTET STRING including the MeasurementReport message according to Table 8.2.3.4.2.3.3-7		
}			

Table 8.2.3.4.2.3.3-7: MeasurementReport (step 4 and 5, Table 8.2.3.4.2.3.2-2)

Derivation path: TS 36.508 [7], Table 4.6.1-5			
Information Element	Value/Remark	Comment	Condition
MeasurementReport ::= SEQUENCE {			
criticalExtensions CHOICE {			
c1 CHOICE {			
measurementReport-r8 SEQUENCE {			
measResults SEQUENCE {			
measId	1		
measResultPCell SEQUENCE {		Report E-UTRA Cell 1	
rsrpResult	(0..97)		
rsrqResult	(0..34)		
}			
measResultNeighCells	Not present		
}			
nonCriticalExtension	Not checked		
}			
}			

8.2.3.5 Measurement configuration control and reporting / Event A2 / Measurement of NR PSCell

8.2.3.5.1 Measurement configuration control and reporting / Event A2 / Measurement of NR PSCell / EN-DC

8.2.3.5.1.1 Test Purpose (TP)

(1)

```
with { UE in RRC_CONNECTED state in EN-DC mode and measurement configured for event A2 with event based periodical reporting }
ensure that {
  when { Serving NR cell becomes worse than absolute threshold minus hysteresis }
  then { UE sends MeasurementReport message at regular intervals while entering condition for event A2 is satisfied }
}
```

(2)

```
with { UE in RRC_CONNECTED state in EN-DC mode and periodical measurement reporting triggered by event A2 ongoing }
ensure that {
  when { Serving NR cell becomes better than absolute threshold plus hysteresis }
  then { UE stops sending MeasurementReport message }
}
```

8.2.3.5.1.2 Conformance requirements

References: The conformance requirements covered in the present TC are specified in: TS 36.331, clause 5.3.5.3, TS 38.331, clauses 5.3.5.3, 5.5.4.3. Unless otherwise stated these are Rel-15 requirements.

[TS 36.331, clause 5.3.5.3]

1> else:

2> if the *RRCCONNECTIONRECONFIGURATION* message includes the *radioResourceConfigDedicated*:

3> perform the radio resource configuration procedure as specified in 5.3.10;

NOTE 3: If the *RRCCONNECTIONRECONFIGURATION* message includes the establishment of radio bearers other than SRB1, the UE may start using these radio bearers immediately, i.e. there is no need to wait for an outstanding acknowledgment of the *SecurityModeComplete* message.

...

1> if the received *RRCCONNECTIONRECONFIGURATION* includes the *sCellToAddModList*:

2> perform SCell addition or modification as specified in 5.3.10.3b;

[TS 38.331, clause 5.3.5.3]

1> if the *RRCRECONFIGURATION* message includes the *measConfig*:

2> perform the measurement configuration procedure as specified in 5.5.2;

...

1> if the UE is configured with E-UTRA *nr-SecondaryCellGroupConfig* (MCG is E-UTRA):

2> if *RRCRECONFIGURATION* was received via SRB1:

3> submit the *RRCRECONFIGURATIONCOMPLETE* via the EUTRA MCG embedded in E-UTRA RRC message *RRCCONNECTIONRECONFIGURATIONCOMPLETE* as specified in TS 36.331 [10];

3> if *reconfigurationWithSync* was included in *spCellConfig* of an SCG:

4> initiate the random access procedure on the SpCell, as specified in TS 38.321 [3];

3> else:

4> the procedure ends;

NOTE: The order the UE sends the *RRCCONNECTIONRECONFIGURATIONCOMPLETE* message and performs the Random Access procedure towards the SCG is left to UE implementation.

2> else (*RRCRECONFIGURATION* was received via SRB3):

3> submit the *RRCRECONFIGURATIONCOMPLETE* message via SRB3 to lower layers for transmission using the new configuration;

NOTE: For EN-DC, in the case of SRB1, the random access is triggered by RRC layer itself as there is not necessarily other UL transmission. In the case of SRB3, the random access is triggered by the MAC layer due to arrival of *RRCRECONFIGURATIONCOMPLETE*.

1 > else:

2> submit the *RRCRECONFIGURATIONCOMPLETE* message via SRB1 to lower layers for transmission using the new configuration;

....

[TS 38.331, clause 5.5.4.3]

The UE shall:

- 1> consider the entering condition for this event to be satisfied when condition A2-1, as specified below, is fulfilled;
- 1> consider the leaving condition for this event to be satisfied when condition A2-2, as specified below, is fulfilled;
- 1> for this measurement, consider the primary or secondary cell that is configured on the frequency indicated in the associated *measObjectNR* to be the serving cell;

Inequality A2-1 (Entering condition)

$$Ms + Hys < Thresh$$

Inequality A2-2 (Leaving condition)

$$Ms - Hys > Thresh$$

The variables in the formula are defined as follows:

Ms is the measurement result of the serving cell, not taking into account any offsets.

Hys is the hysteresis parameter for this event (i.e. *hysteresis* as defined within *reportConfigNR* for this event).

Thresh is the threshold parameter for this event (i.e. *a2-Threshold* as defined within *reportConfigNR* for this event).

Ms is expressed in dBm in case of RSRP, or in dB in case of RSRQ and RS-SINR.

Hys is expressed in dB.

Thresh is expressed in the same unit as *Ms*.

8.2.3.5.1.3 Test description

8.2.3.5.1.3.1 Pre-test conditions

System Simulator:

- EUTRA Cell 1 is the PCell and NR Cell 1 is the PSCell.

UE:

- None

Preamble:

- The UE is in state RRC_CONNECTED using generic procedure parameter Connectivity (EN-DC) and DC Bearers (MCG(*s*) and SCG) on E-UTRA Cell 1 according to TS 38.508-1, clause 4.5.4 [4].

8.2.3.5.1.3.2 Test procedure sequence

Table 8.2.3.5.1.3.2-1 and Table 8.2.3.5.1.3.2-1A illustrates the downlink power levels to be applied for NR Cell 1 at various time instants of the test execution. Row marked "T0" denotes the conditions after the preamble, while rows marked "T1" and "T2" are to be applied subsequently. The exact instants on which these values shall be applied are described in the texts in this clause.

Table 8.2.3.5.1.3.2-1: Time instances of cell power level and parameter changes for conducted test environment

	Parameter	Unit	EUTRA Cell 1	NR Cell 1	Remark
T0	Cell-specific RS EPRE	dBm/15 kHz	-85	-	
	SS/PBCH SSS EPRE	dBm/S CS	-	-79	Power level is such that $Ms > Thresh + Hys$
T1	Cell-specific RS EPRE	dBm/15 kHz	-85	-	

	SS/PBCH SSS EPRE	dBm/S CS	-	-95	Power level is such that entry condition for event A2 is satisfied $M_s + H_{ys} < Thresh$
T2	Cell-specific RS EPRE	dBm/15 kHz	-85	-	
	SS/PBCH SSS EPRE	dBm/S CS	-	-79	Power level is such that exit condition for event A2 is satisfied $M_s > Thresh + H_{ys}$

Table 8.2.3.5.1.3.2-1A: Time instances of cell power level and parameter changes for OTA test environment

	Parameter	Unit	EUTRA Cell 1	NR Cell 1	Remark
T0	Cell-specific RS EPRE	dBm/15 kHz	-96	-	
	SS/PBCH SSS EPRE	dBm/S CS	-	-82	Power level is such that $M_s > Thresh + H_{ys}$
T1	Cell-specific RS EPRE	dBm/15 kHz	-96	-	
	SS/PBCH SSS EPRE	dBm/S CS	-	-100	Power level is such that entry condition for event A2 is satisfied $M_s + H_{ys} < Thresh$
T2	Cell-specific RS EPRE	dBm/15 kHz	-96	-	
	SS/PBCH SSS EPRE	dBm/S CS	-	-82	Power level is such that exit condition for event A2 is satisfied $M_s > Thresh + H_{ys}$

Table 8.2.3.5.1.3.2-2: Main behaviour

St	Procedure	Message Sequence		TP	Verdict
		U - S	Message		
1	The SS transmits an <i>RRCCONNECTIONRECONFIGURATION</i> message including <i>measConfig</i> to setup intra NR measurement for PSCell and reporting for event A2	<--	<i>RRCCONNECTIONRECONFIGURATION</i>	-	-
2	The UE transmits an <i>RRCCONNECTIONRECONFIGURATIONCOMPLETE</i> message	-->	<i>RRCCONNECTIONRECONFIGURATIONCOMPLETE</i>	-	-
3	SS re-adjusts the cell-specific reference signal level according to row "T1".	-	-	-	-
4	Check: Does the UE transmit <i>ULINFORMATIONTRANSFERMRDC</i> message containing NR <i>MeasurementReport</i> message to report event A2 with the measured results for NR Cell 1?	-->	<i>ULINFORMATIONTRANSFERMRDC (MeasurementReport)</i>	1	P
-	EXCEPTION: Step 5 below is repeated until 3 <i>MeasurementReport</i> messages are received from the UE	-	-	-	-
5	Check: Does the UE transmit a <i>ULINFORMATIONTRANSFERMRDC</i> message containing NR <i>MeasurementReport</i> message to report event A2 with the measured results for NR Cell 1?	-->	<i>ULINFORMATIONTRANSFERMRDC (MeasurementReport)</i>	1	P
6	SS re-adjusts the cell-specific reference signal level according to row "T2".	-	-	-	-
7	Wait and ignore <i>MeasurementReport</i> messages for 15 s to allow change of power levels for NR Cell 1 and UE measurement.	-	-	-	-
8	Check: Does the UE attempt to transmit an uplink message within the next 10s?	-	-	2	F

8.2.3.5.1.3.3 Specific message contents

Table 8.2.3.5.1.3.3-1: RRCCONNECTIONRECONFIGURATION (step 1, Table 8.2.3.5.1.3.2-2)

Derivation Path: TS 36.508 [7], Table 4.6.1-8 with condition EN-DC_EmbedNR_RRCRecon

Table 8.2.3.5.1.3.3-2: RRCReconfiguration (Table 8.2.3.5.1.3.3-1)

Derivation Path: TS 38.508-1 [4], Table 4.6.1-13 with condition EN-DC_MEAS

Table 8.2.3.5.1.3.3-3: MeasConfig (Table 8.2.3.5.1.3.3-2)

Derivation Path: TS 38.508-1[4]. Table 4.6.3-69			
Information Element	Value/Remark	Comment	Condition
measConfig ::= SEQUENCE {			
measObjectToAddModList SEQUENCE (SIZE (1..maxNrofObjectId)) OF MeasObjectToAddMod {	1 entry		
MeasObjectToAddMod[1] SEQUENCE {		entry 1	
measObjectId	1		
measObject CHOICE {			
measObjectNR	Downlink ARFCN of NR Cell2(68)	ssbFrequency IE equals to ARFCN of NR Cell1	
}			
}			
}			
reportConfigToAddModList SEQUENCE (SIZE (1..maxReportConfigId)) OF ReportConfigToAddMod {	1 entry		
ReportConfigToAddMod[1] SEQUENCE {		entry 1	
reportConfigId	1		
reportConfig	ReportConfigNR1-A2		FR1
	ReportConfigNR2-A2		FR2
}			
}			
measIdToAddModList SEQUENCE (SIZE (1..maxMeasId)) OF MeasIdToAddMod {	1 entry		
MeasIdToAddMod[1] SEQUENCE {		entry 1	
measId[1]	1		
measObjectId[1]	1		
reportConfigId[1]	1		
}			
}			
}			

Table 8.2.3.5.1.3.3-4: RRCConnectionReconfigurationComplete (step 2, Table 8.2.3.5.1.3.2-2)

Derivation Path: TS 36.508 [7], Table 4.6.1-9 with condition MCG_and_SCG

Table 8.2.3.5.1.3.3-5: MeasurementReport (steps 4, 5, Table 8.2.3.5.1.3.2-2)

Derivation Path: TS 38.331 [6], clause 6.2.2			
Information Element	Value/remark	Comment	Condition
MeasurementReport ::= SEQUENCE {			
criticalExtensions CHOICE {			
c1 CHOICE {			
measurementReport SEQUENCE {			
measResults SEQUENCE {			
measId	1		
measResultServingMOList SEQUENCE {	1 entry		
servCellId	Cell index corresponding to NR Cell 1		
measResultServingCell SEQUENCE {			
physCellId	Physical CellID of the NR Cell 1		
measResult SEQUENCE {			
cellResults SEQUENCE {			
resultsSSB-Cell SEQUENCE {			

rsrp	(0..127)		
rsrq	(0..127)		
sinr	(0..127)		pc_ss_SINR _Meas
	Not present		
}			
}			
}			
}			
}			
}			
}			
}			
}			
}			
}			

Table 8.2.3.5.1.3.3-6: ReportConfigNR-A2(68) (Table 8.2.3.5.1.3.3-3)

Derivation Path: TS 38.508-1 [4], Table 4.6.3-142 with condition EVENT_A2			
Information Element	Value/remark	Comment	Condition
ReportConfigNR ::= SEQUENCE {			
reportType CHOICE {			
eventTriggered SEQUENCE {			
eventId CHOICE {			
reportAmount	infinity		
}			
}			
}			
}			

Table 8.2.3.5.1.3.3-7: ReportConfigNR-A2(66 + Δ(NRf1)) (Table 8.2.3.5.1.3.3-3)

Derivation Path: TS 38.508-1 [4], Table 4.6.3-142 with condition EVENT_A2			
Information Element	Value/remark	Comment	Condition
ReportConfigNR ::= SEQUENCE {			
reportType CHOICE {			
eventTriggered SEQUENCE {			
eventId CHOICE {			
reportAmount	infinity		
}			
}			
}			
}			
NOTE 1: Δ(NRf1) is derived based on calibration procedure defined in the TS 38.508-1 [4], clause 6.1.3.3			

8.2.3.5.2 Measurement configuration control and reporting / Event A2 / Measurement of E-UTRA PSCell / NE-DC

8.2.3.5.2.1 Test Purpose (TP)

(1)

```
with { UE in RRC_CONNECTED state with NE-DC, and, MCG(s) (NR PDCP) and SCG and measurement
configured for event A2 with event based periodical reporting }
ensure that {
  when { Serving E-UTRA cell becomes worse than absolute threshold minus hysteresis}
  then { UE sends MeasurementReport message at regular intervals while entering condition for
event A2 is satisfied }
}
```

(2)

```

with { UE in RRC_CONNECTED state with NE-DC, and, MCG(s) (NR PDCP) and SCG and periodical
measurement reporting triggered by event A2 ongoing }
ensure that {
  when { Serving E-UTRA cell becomes better than absolute threshold plus hysteresis }
  then { UE stops sending MeasurementReport message }
}

```

8.2.3.5.2.2 Conformance requirements

References: The conformance requirements covered in the present TC are specified in: 38.331:5.3.5.3, 5.5.5.1, 5.7.2a.3; TS 36.331:5.3.5.3, 5.5.2.3, 5.5.4.1, 5.5.4.3 and 5.5.5.1. Unless otherwise stated these are Rel-15 requirements.

[TS 38.331, clause 5.3.5.3]

The UE shall perform the following actions upon reception of the *RRCReconfiguration*:

...

1> if the *RRCReconfiguration* includes the *mrdc-SecondaryCellGroupConfig*:

2> if the *mrdc-SecondaryCellGroupConfig* is set to *setup*:

3> if the *mrdc-SecondaryCellGroupConfig* includes *mrdc-ReleaseAndAdd*:

4> perform MR-DC release as specified in clause 5.3.5.10;

3> if the received *mrdc-SecondaryCellGroup* is set to *nr-SCG*:

4> perform the RRC reconfiguration according to 5.3.5.3 for the *RRCReconfiguration* message included in *nr-SCG*;

3> if the received *mrdc-SecondaryCellGroup* is set to *eutra-SCG*:

4> perform the RRC connection reconfiguration as specified in TS 36.331 [10], clause 5.3.5.3 for the *RRCConnectionReconfiguration* message included in *eutra-SCG*;

2> else (*mrdc-SecondaryCellGroupConfig* is set to *release*):

3> perform MR-DC release as specified in clause 5.3.5.10;

...

1> set the content of the *RRCReconfigurationComplete* message as follows:

...

2> if the *RRCReconfiguration* message includes the *mrdc-SecondaryCellGroupConfig* with *mrdc-SecondaryCellGroup* set to *eutra-SCG*:

3> include in the *eutra-SCG-Response* the E-UTRA *RRCConnectionReconfigurationComplete* message in accordance with TS 36.331 [10] clause 5.3.5.3;

[TS 38.331, clause 5.7.2a.3]

The UE shall set the contents of the *ULInformationTransferMRDC* message as follows:

1> if there is a need to transfer MR-DC dedicated information related to NR:

2> set the *ul-DCCH-MessageNR* to include the NR MR-DC dedicated information to be transferred (e.g., NR RRC *MeasurementReport* and *FailureInformation* message);

1> else if there is a need to transfer MR-DC dedicated information related to E-UTRA:

2> set the *ul-DCCH-MessageEUTRA* to include the E-UTRA MR-DC dedicated information to be transferred (e.g., E-UTRA RRC *MeasurementReport*);

- 1> submit the *ULInformationTransferMRDC* message to lower layers for transmission, upon which the procedure ends;

[TS 36.331, clause 5.3.5.3]

If the *RRCCONNECTIONRECONFIGURATION* message does not include the *mobilityControlInfo* and the UE is able to comply with the configuration included in this message, the UE shall:

...

- 1> if the received *RRCCONNECTIONRECONFIGURATION* includes the *sCellGroupToAddModList*:

- 2> perform SCell group addition or modification as specified in 5.3.10.3e;

- 1> if the received *RRCCONNECTIONRECONFIGURATION* includes the *scg-Configuration*; or

- 1> if the current UE configuration includes one or more split DRBs configured with *pdcp-Config* and the received *RRCCONNECTIONRECONFIGURATION* includes *radioResourceConfigDedicated* including *drb-ToAddModList*:

- 2> perform SCG reconfiguration as specified in 5.3.10.10;

...

- 1> if the *RRCCONNECTIONRECONFIGURATION* message includes the *measConfig*:

- 2> perform the measurement configuration procedure as specified in 5.5.2;

...

- 1> if the UE is configured with NE-DC:

- 2> if the received *RRCCONNECTIONRECONFIGURATION* message was included in an NR *RRCResume* message:

- 3> transfer the *RRCCONNECTIONRECONFIGURATIONCOMPLETE* message via SRB1 embedded in NR RRC message *RRCResumeComplete* as specified in TS 38.331 [82], clause 5.3.13.4;

- 2> else:

- 3> transfer the *RRCCONNECTIONRECONFIGURATIONCOMPLETE* message via SRB1 embedded in NR RRC message *RRCReconfigurationComplete* as specified in TS 38.331 [82], clause 5.3.5.3;

- 1> else:

- 2> submit the *RRCCONNECTIONRECONFIGURATIONCOMPLETE* message to lower layers for transmission using the new configuration, upon which the procedure ends;

[TS 36.331, clause 5.5.2.3]

E-UTRAN applies the procedure as follows:

- configure a *measId* only if the corresponding measurement object, the corresponding reporting configuration and the corresponding quantity configuration, are configured;

The UE shall:

- 1> for each *measId* included in the received *measIdToAddModList*:

- 2> if an entry with the matching *measId* exists in the *measIdList* within the *VarMeasConfig*:

- 3> replace the entry with the value received for this *measId*;

- 2> else:

- 3> add a new entry for this *measId* within the *VarMeasConfig*;

- 2> remove the measurement reporting entry for this *measId* from the *VarMeasReportList*, if included;

- 2> stop the periodical reporting timer or timer T321, whichever one is running, and reset the associated information (e.g. *timeToTrigger*) for this *measId*;

...

[TS 36.331, clause 5.5.4.1]

If security has been activated successfully, the UE shall:

- 1> for each *measId* included in the *measIdList* within *VarMeasConfig*:

...

- 2> else:

- 3> if the corresponding *measObject* concerns E-UTRA:

- 4> if the *ue-RxTxTimeDiffPeriodical* is configured in the corresponding *reportConfig*:

- 5> consider only the PCell to be applicable;

- 4> else if the *reportSSTD-Meas* is set to *true* in the corresponding *reportConfig*:

- 5> consider the PSCell to be applicable;

- 4> else if the *eventA1* or *eventA2* is configured in the corresponding *reportConfig*:

- 5> consider only the serving cell to be applicable;

...

- 2> if the *triggerType* is set to *event* and if the leaving condition applicable for this event is fulfilled for one or more of the cells included in the *cellsTriggeredList* defined within the *VarMeasReportList* for this *measId* for all measurements after layer 3 filtering taken during *timeToTrigger* defined within the *VarMeasConfig* for this event:

- 3> remove the concerned cell(s) in the *cellsTriggeredList* defined within the *VarMeasReportList* for this *measId*;

- 3> if *reportOnLeave* is set to *TRUE* for the corresponding reporting configuration or if *a6-ReportOnLeave* is set to *TRUE* or if *a4-a5-ReportOnLeave* is set to *TRUE* for the corresponding reporting configuration:

- 4> initiate the measurement reporting procedure, as specified in 5.5.5;

- 3> if the *cellsTriggeredList* defined within the *VarMeasReportList* for this *measId* is empty:

- 4> remove the measurement reporting entry within the *VarMeasReportList* for this *measId*;

- 4> stop the periodical reporting timer for this *measId*, if running;

- 2> if the *triggerType* is set to *event* and if the entry condition applicable for this event, i.e. the event corresponding with the *eventId* of the corresponding *reportConfig* within *VarMeasConfig*, is fulfilled for one or more applicable CSI-RS resources for all measurements after layer 3 filtering taken during *timeToTrigger* defined for this event within the *VarMeasConfig*, while the *VarMeasReportList* does not include an measurement reporting entry for this *measId* (i.e. a first CSI-RS resource triggers the event):

- 3> include a measurement reporting entry within the *VarMeasReportList* for this *measId*;

- 3> set the *numberOfReportsSent* defined within the *VarMeasReportList* for this *measId* to 0;

- 3> include the concerned CSI-RS resource(s) in the *csi-RS-TriggeredList* defined within the *VarMeasReportList* for this *measId*;

- 3> initiate the measurement reporting procedure, as specified in 5.5.5;

...

- 2> upon expiry of the periodical reporting timer for this *measId*:

3> initiate the measurement reporting procedure, as specified in 5.5.5;

[TS 36.331, clause 5.5.4.3]

The UE shall:

- 1> consider the entering condition for this event to be satisfied when condition A2-1, as specified below, is fulfilled;
- 1> consider the leaving condition for this event to be satisfied when condition A2-2, as specified below, is fulfilled;
- 1> for this measurement, consider the primary or secondary cell that is configured on the frequency indicated in the associated *measObjectEUTRA* to be the serving cell;

Inequality A2-1 (Entering condition)

$$Ms + Hys < Thresh$$

Inequality A2-2 (Leaving condition)

$$Ms - Hys > Thresh$$

The variables in the formula are defined as follows:

Ms is the measurement result of the serving cell, not taking into account any offsets.

Hys is the hysteresis parameter for this event (i.e. *hysteresis* as defined within *reportConfigEUTRA* for this event).

Thresh is the threshold parameter for this event (i.e. *a2-Threshold* as defined within *reportConfigEUTRA* for this event).

Ms is expressed in dBm in case of RSRP, or in dB in case of RSRQ and RS-SINR.

Hys is expressed in dB.

Thresh is expressed in the same unit as ***Ms***.

[TS 36.331, clause 5.5.5.1]

The purpose of this procedure is to transfer measurement results from the UE to E-UTRAN. The UE shall initiate this procedure only after successful security activation.

For the *measId* for which the measurement reporting procedure was triggered, the UE shall set the *measResults* within the *MeasurementReport* message as follows:

- 1> set the *measId* to the measurement identity that triggered the measurement reporting;
 - 1> set the *measResultPCell* to include the quantities of the PCell;
 - 1> set the *measResultServFreqList* to include for each E-UTRA SCell that is configured, if any, within *measResultSCell* the quantities of the concerned SCell, if available according to performance requirements in TS 36.133 [16], except if *purpose* for the *reportConfig* associated with the *measId* that triggered the measurement reporting is set to *reportLocation*;
 - ...
 - 1> increment the *numberOfReportsSent* as defined within the *VarMeasReportList* for this *measId* by 1;
 - 1> stop the periodical reporting timer, if running;
 - 1> if the *numberOfReportsSent* as defined within the *VarMeasReportList* for this *measId* is less than the *reportAmount* as defined within the corresponding *reportConfig* for this *measId*:
 - 2> start the periodical reporting timer with the value of *reportInterval* as defined within the corresponding *reportConfig* for this *measId*;
 - 1> else:
 - 2> if the *triggerType* is set to *periodical*:

- 3> remove the entry within the *VarMeasReportList* for this *measId*;
- 3> remove this *measId* from the *measIdList* within *VarMeasConfig*;

...

1> if the UE is configured with NE-DC:

- 2> submit the *MeasurementReport* message via SRB1 embedded in NR RRC message *ULInformationTransferMRDC* as specified in TS 38.331 [82].

1> else:

- 2> submit the *MeasurementReport* message to lower layers for transmission, upon which the procedure ends;

8.2.3.5.2.3 Test description

8.2.3.5.2.3.1 Pre-test conditions

System Simulator:

- NR Cell 1 is the PCell and EUTRA Cell 1 is the PSCell.

UE:

- None

Preamble:

- The UE is in state 3N-A as defined in TS 38.508-1 [4], subclause 4.4A on NR Cell 1.

8.2.3.5.2.3.2 Test procedure sequence

Table 8.2.3.5.2.3.2-1 illustrates the downlink power levels to be applied for E-UTRA Cell 1 at various time instants of the test execution. Row marked "T0" denotes the conditions after the preamble, while row marked "T1" are to be applied subsequently. The exact instants on which these values shall be applied are described in the texts in this clause.

Table 8.2.3.5.2.3.2-1: Time instances of cell power level and parameter changes for conducted test environment

	Parameter	Unit	E-UTRA Cell 1	NR Cell 1	Remark
T0	Cell-specific RS EPRE	dBm/15 kHz	-70	-	Power level is such that $M_s > Thresh + Hys$
	SS/PBCH SSS EPRE	dBm/SC S	-	-88	
T1	Cell-specific RS EPRE	dBm/15 kHz	-96	-	Power level is such that entry condition for event A2 is satisfied $M_s < Thresh - Hys$
	SS/PBCH SSS EPRE	dBm/SC S	-	-88	
T2	Cell-specific RS EPRE	dBm/15 kHz	-70	-	Power level is such that exit condition for event A2 is satisfied $M_s > Thresh + Hys$
	SS/PBCH SSS EPRE	dBm/SC S	-	-88	

Table 8.2.3.5.2.3.2-2: Main behaviour

St	Procedure	Message Sequence		TP	Verdict
		U - S	Message		
1	The SS transmits an <i>RRCReconfiguration</i> message containing <i>RRCConnectionReconfiguration</i> message to setup measurement for E-UTRA Cell 1 and reporting for event A2	<--	NR RRC: <i>RRCReconfiguration</i> (<i>RRCConnectionReconfiguration</i>)	-	-

2	The UE transmit an <i>RRCReconfigurationComplete</i> message.	-->	NR RRC: <i>RRCReconfigurationComplete</i> (<i>RRCConnectionReconfigurationComplete</i>)	-	-
3	SS re-adjusts the cell-specific reference signal level according to row "T1" in Table 8.2.3.5.2.3.2-1.	-	-	-	-
4	Check: Does the UE transmit a <i>MeasurementReport</i> encapsulated in <i>ULInformationTransferMRDC</i> message to report event A2 with the measured value for E-UTRA Cell 1?	-->	NR RRC: <i>ULInformationTransferMRDC</i> (<i>MeasurementReport</i>)	1	P
-	EXCEPTION: Step 5 below is repeated until 3 <i>MeasurementReport</i> messages are received from the UE	-	-	-	-
5	Check: Does the UE transmit a <i>MeasurementReport</i> encapsulated in <i>ULInformationTransferMRDC</i> message, with the measured value for E-UTRA Cell 1	-->	NR RRC: <i>ULInformationTransferMRDC</i> (<i>MeasurementReport</i>)	1	P
6	SS re-adjusts the cell-specific reference signal level according to row "T2" in Table 8.2.3.5.2.3.2-1.	-	-	-	-
7	Wait and ignore <i>MeasurementReport</i> messages for 15s to allow change of power levels for E-UTRA Cell 1 and UE measurement.	-	-	-	-
8	Check: Does the UE transmit a <i>MeasurementReport</i> encapsulated in <i>ULInformationTransferMRDC</i> message, with the measured value for NR Cell 1 within the next 10s?	-->	NR RRC: <i>ULInformationTransferMRDC</i> (<i>MeasurementReport</i>)	2	F

8.2.3.5.2.3.3 Specific message contents

Table 8.2.3.5.2.3.3-1: *RRCReconfiguration* (step 1, Table 8.2.3.5.2.3.2-2)

Derivation Path: TS 38.508-1 [4], Table 4.6.1-13 with condition NE-DC

Table 8.2.3.5.2.3.3-2: *SCG-Configuration-r12-NE-DC* (step 1, Table 8.2.3.5.2.3.2-2)

Derivation Path: TS 36.508 [7], Table 4.6.3-19G

Information Element	Value/remark	Comment	Condition
scg-Configuration-r12 CHOICE {			
setup SEQUENCE {			
scg-ConfigPartSCG-r12 SEQUENCE {			
measConfigSN-r15	MeasConfig-A2-E-UTRA		
}			
}			
}			

Table 8.2.3.5.2.3.3-3: *MeasConfig-A2-E-UTRA* (Table 8.2.3.5.2.3.3-2)

Derivation path: TS 36.508 [7], Table 4.6.6-1

Information Element	Value/Remark	Comment	Condition
measConfig ::= SEQUENCE {			
measObjectToAddModList SEQUENCE (SIZE (1..maxObjectld)) OF MeasObjectToAddMod {	1 entry		
MeasObjectToAddMod[1] SEQUENCE {		entry 1	
measObjectld	ldMeasObject-f1		
measObject CHOICE {			
measObjectEUTRA	MeasObjectEUTRA-GENERIC(f1)		
	MeasObjectEUTRA-GENERIC(maxEARFCN)		Band > 64
}			
}			
}			

}			
reportConfigToAddModList SEQUENCE (SIZE (1..maxReportConfigId)) OF ReportConfigToAddMod{	1 entry		
ReportConfigToAddMod[1] SEQUENCE {		entry 1	
reportConfigId	IdReportConfig-A2		
reportConfig CHOICE {			
reportConfigEUTRA	ReportConfig-A2		
}			
}			
}			
measIdToAddModList SEQUENCE (SIZE (1..maxMeasId)) OF MeasIdToAddMod {	1 entry		
MeasIdToAddMod[1] SEQUENCE {		entry 1	
measId	1		
measObjectId	IdMeasObject-f1		
reportConfigId	IdReportConfig-A2		
}			
}			
measObjectToAddModList-v9e0 ::= SEQUENCE (SIZE (1..maxObjectId)) OF MeasObjectToAddMod-v9e0 {	1 entry		Band > 64
MeasObjectToAddMod-v9e0[1] SEQUENCE {		entry 1	
measObjectEUTRA-v9e0 SEQUENCE {			
carrierFreq-v9e0	Same downlink EARFCN as used for f1		
}			
}			
}			
}			

Table 8.2.3.5.2.3.3-4: ReportConfig-A2 (Table 8.2.3.5.2.3.3-3)

Derivation path: TS 36.508 [7], Table 4.6.6-5 ReportConfigEUTRA-A2(-83)			
Information Element	Value/Remark	Comment	Condition
ReportConfigEUTRA ::= SEQUENCE {			
triggerType CHOICE {			
event SEQUENCE {			
hysteresis	6	3 dB	
}			
}			
reportAmount	infinity		
}			

Table 8.2.3.5.2.3.3-5: RRCReconfigurationComplete (step 2, Table 8.2.3.5.2.3.2-2)

Derivation Path: TS 38.508-1 [4], Table 4.6.1-14 Condition with NE-DC

Table 8.2.3.5.2.3.3-6: ULInformationTransferMRDC (step 4 and 5, Table 8.2.3.5.2.3.2-2)

Derivation Path: TS 38.508-1 [4], Table 4.6.1-34			
Information Element	Value/remark	Comment	Condition
ULInformationTransferMRDC ::= SEQUENCE {			
ul-DCCH-MessageEUTRA	OCTET STRING including the MeasurementReport message according to Table 8.2.3.5.2.3.3-7		
}			

Table 8.2.3.5.2.3.3-7: MeasurementReport (step 4 and 5, Table 8.2.3.5.2.3.2-2)

Derivation path: TS 36.508 [7], Table 4.6.1-5

Information Element	Value/Remark	Comment	Condition
MeasurementReport ::= SEQUENCE {			
criticalExtensions CHOICE {			
c1 CHOICE {			
measurementReport-r8 SEQUENCE {			
measResults SEQUENCE {			
measId	1		
measResultPCell SEQUENCE {		Report E-UTRA Cell 1	
rsrpResult	(0..97)		
rsrqResult	(0..34)		
}			
measResultNeighCells	Not present		
}			
nonCriticalExtension	Not checked		
}			
}			
}			
}			

8.2.3.6 Measurement configuration control and reporting / Event A3 / Measurement of Neighbour NR cells

8.2.3.6.1 Measurement configuration control and reporting / Event A3 / Measurement of Neighbour NR cells / Intra-frequency measurements / EN-DC

8.2.3.6.1.1 Test Purpose (TP)

(1)

```
with { UE in RRC_CONNECTED state with EN-DC, and, MCG(s) (E-UTRA PDCP) and SCG and measurements
configured for event A3 }
ensure that {
  when { Entry condition for event A3 is not met for neighbour NR cell }
  then { UE does not send MeasurementReport }
}
```

(2)

```
with { UE in RRC_CONNECTED state with EN-DC, and, MCG(s) (E-UTRA PDCP) and SCG and measurements
configured for event A3 }
ensure that {
  when { Neighbour NR cell becomes offset better than serving NR PSCell }
  then { UE sends MeasurementReport with correct measId for event A3 }
}
```

8.2.3.6.1.2 Conformance requirements

References: The conformance requirements covered in the present TC are specified in: TS 36.331, clause 5.3.5.3, TS 38.331, clauses 5.3.5.3, 5.5.2, 5.5.4.1, 5.5.4.4 and 5.5.5. Unless otherwise stated these are Rel-15 requirements.

[TS 36.331, clause 5.3.5.3]

If the *RRCCONNECTIONRECONFIGURATION* message does not include the *mobilityControlInfo* and the UE is able to comply with the configuration included in this message, the UE shall:

- 1> if the *RRCCONNECTIONRECONFIGURATION* message includes the *measConfig*:
 - 2> perform the measurement configuration procedure as specified in 5.5.2;
- 1> set the content of *RRCCONNECTIONRECONFIGURATIONCOMPLETE* message as follows:
 - 2> if the received *RRCCONNECTIONRECONFIGURATION* message included *nr-SecondaryCellGroupConfig*:

- 3> include *scg-ConfigResponseNR* in accordance with TS 38.331 [82], clause 5.3.5.3;
- 1> set the content of *RRCConnectionReconfigurationComplete* message as follows:
 - 2> if the received *RRCConnectionReconfiguration* message included *nr-SecondaryCellGroupConfig*:
 - 3> include *scg-ConfigResponseNR* in accordance with TS 38.331 [82, 5.3.5.3]; 1> submit the *RRCConnectionReconfigurationComplete* message to lower layers for transmission using the new configuration, upon which the procedure ends;

[TS 38.331, clause 5.3.5.3]

The UE shall perform the following actions upon reception of the *RRCReconfiguration*:

- 1> if the *RRCReconfiguration* includes the *secondaryCellGroup*:
 - 2> perform the cell group configuration for the SCG according to 5.3.5.5;
- 1> if the *RRCReconfiguration* message includes the *measConfig*:
 - 2> perform the measurement configuration procedure as specified in 5.5.2;
 - 1> if the UE is configured with E-UTRA *nr-SecondaryCellGroupConfig* (MCG is E-UTRA):
 - 2> if *RRCReconfiguration* was received via SRB1:
 - 3> construct *RRCReconfigurationComplete* message and submit it via the EUTRA MCG embedded in E-UTRA RRC message *RRCConnectionReconfigurationComplete* as specified in TS 36.331 [10];

[TS 38.331, clause 5.5.2]

The UE shall:

- 1> if the received *measConfig* includes the *measObjectToAddModList*:
 - 2> perform the measurement object addition/modification procedure as specified in 5.5.2.5;
- 1> if the received *measConfig* includes the *reportConfigToAddModList*:
 - 2> perform the reporting configuration addition/modification procedure as specified in 5.5.2.7;
- 1> if the received *measConfig* includes the *measIdToAddModList*:
 - 2> perform the measurement identity addition/modification procedure as specified in 5.5.2.3;

[TS 38.331, clause 5.5.4.1]

If security has been activated successfully, the UE shall:

- 1> for each *measId* included in the *measIdList* within *VarMeasConfig*:
 - 2> if the corresponding *reportConfig* includes a *reportType* set to *eventTriggered* or *periodical*;
 - 3> if the corresponding *measObject* concerns NR;
 - 4> if the *eventA1* or *eventA2* is configured in the corresponding *reportConfig*:
 - 5> consider only the serving cell to be applicable;
 - 4> else:
 - 5> for events involving a serving cell associated with a *measObjectNR* and neighbours associated with another *measObjectNR*, consider any serving cell associated with the other *measObjectNR* to be a neighbouring cell as well;
 - 2> if the *reportType* is set to *eventTriggered* and if the entry condition applicable for this event, i.e. the event corresponding with the *eventId* of the corresponding *reportConfig* within *VarMeasConfig*, is fulfilled for one or more applicable cells for all measurements after layer 3 filtering taken during *timeToTrigger* defined for

this event within the *VarMeasConfig*, while the *VarMeasReportList* does not include a measurement reporting entry for this *measId* (a first cell triggers the event):

- 3> include a measurement reporting entry within the *VarMeasReportList* for this *measId*;
 - 3> set the *numberOfReportsSent* defined within the *VarMeasReportList* for this *measId* to 0;
 - 3> include the concerned cell(s) in the *cellsTriggeredList* defined within the *VarMeasReportList* for this *measId*;
 - 3> initiate the measurement reporting procedure, as specified in 5.5.5;
- 2> if the *reportType* is set to *eventTriggered* and if the entry condition applicable for this event, i.e. the event corresponding with the *eventId* of the corresponding *reportConfig* within *VarMeasConfig*, is fulfilled for one or more applicable cells not included in the *cellsTriggeredList* for all measurements after layer 3 filtering taken during *timeToTrigger* defined for this event within the *VarMeasConfig* (a subsequent cell triggers the event):
- 3> set the *numberOfReportsSent* defined within the *VarMeasReportList* for this *measId* to 0;
 - 3> include the concerned cell(s) in the *cellsTriggeredList* defined within the *VarMeasReportList* for this *measId*;
 - 3> initiate the measurement reporting procedure, as specified in 5.5.5;

[TS 38.331, clause 5.5.4.4]

The UE shall:

- 1> consider the entering condition for this event to be satisfied when condition A3-1, as specified below, is fulfilled;
- 1> consider the leaving condition for this event to be satisfied when condition A3-2, as specified below, is fulfilled;
- 1> use the SpCell for *Mp*, *Ofp* and *Ocp*.

NOTE The cell(s) that triggers the event is on the frequency indicated in the associated *measObjectNR* which may be different from the frequency used by the NR SpCell.

Inequality A3-1 (Entering condition)

$$Mn + Ofn + Ocn - Hys > Mp + Ofp + Ocp + Off$$

Inequality A3-2 (Leaving condition)

$$Mn + Ofn + Ocn + Hys < Mp + Ofp + Ocp + Off$$

The variables in the formula are defined as follows:

Mn is the measurement result of the neighbouring cell, not taking into account any offsets.

Ofn is the measurement object specific offset of the neighbour cell (i.e. *offsetMO* as defined within *measObjectNR* corresponding to the frequency of the neighbour cell).

Ocn is the cell specific offset of the neighbour cell (i.e. *cellIndividualOffset* as defined within *measObjectNR* corresponding to the frequency of the neighbour cell), and set to zero if not configured for the neighbour cell.

Mp is the measurement result of the SpCell, not taking into account any offsets.

Ofp is the measurement object specific offset of the frequency of the SpCell (i.e. *offsetMO* as defined within *measObjectNR* corresponding to the frequency of the SpCell).

Ocp is the cell specific offset of the SpCell (i.e. *cellIndividualOffset* as defined within *measObjectNR* corresponding to the frequency of the SpCell), and is set to zero if not configured for the SpCell.

Hys is the hysteresis parameter for this event (i.e. *hysteresis* as defined within *reportConfigNR* for this event).

Off is the offset parameter for this event (i.e. *a3-Offset* as defined within *reportConfigNR* for this event).

Mn, *Mp* are expressed in dBm in case of RSRP, or in dB in case of RSRQ and RS-SINR.

Ofn, *Ocn*, *Ofp*, *Ocp*, *Hys*, *Off* are expressed in dB.

[TS 38.331, clause 5.5.5]

For the *measId* for which the measurement reporting procedure was triggered, the UE shall set the *measResults* within the *MeasurementReport* message as follows:

- 1> set the *measId* to the measurement identity that triggered the measurement reporting;
- 1> for each serving cell configured with *servingCellMO*:
 - 2> if the *reportConfig* associated with the *measId* that triggered the measurement reporting includes *rsType*:
 - 3> if the serving cell measurements based on the *rsType* included in the *reportConfig* that triggered the measurement report are available:
 - 4> set the *measResultServingCell* within *measResultServingMOList* to include RSRP, RSRQ and the available SINR of the serving cell, derived based on the *rsType* included in the *reportConfig* that triggered the measurement report;
 - 1> set the *servCellId* within *measResultServingMOList* to include each NR serving cell that is configured with *servingCellMO*, if any;
- ...
- 1> if there is at least one applicable neighbouring cell to report:
 - 2> if the *reportType* is set to *eventTriggered* or *periodical*:
 - 3> set the *measResultNeighCells* to include the best neighbouring cells up to *maxReportCells* in accordance with the following:
 - 4> if the *reportType* is set to *eventTriggered*:
 - 5> include the cells included in the *cellsTriggeredList* as defined within the *VarMeasReportList* for this *measId*;
 - 4> else:
 - ...
 - 4> for each cell that is included in the *measResultNeighCells*, include the *physCellId*;
 - 4> if the *reportType* is set to *eventTriggered* or *periodical*:
 - 5> for each included cell, include the layer 3 filtered measured results in accordance with the *reportConfig* for this *measId*, ordered as follows:
 - 6> if the *measObject* associated with this *measId* concerns NR:
 - 7> if *rsType* in the associated *reportConfig* is set to *ssb*:
 - 8> set *resultsSSB-Cell* within the *measResult* to include the SS/PBCH block based quantity(ies) indicated in the *reportQuantityCell* within the concerned *reportConfig*, in decreasing order of the sorting quantity, determined as specified in 5.5.5.3, i.e. the best cell is included first;
 - 7> else if *rsType* in the associated *reportConfig* is set to *csi-rs*:
 - ...
 - 1> if the UE is configured with EN-DC:
 - 2> if SRB3 is configured:

3> submit the *MeasurementReport* message via SRB3 to lower layers for transmission, upon which the procedure ends;

2>else:

3> submit the *MeasurementReport* message via the EUTRA MCG embedded in E-UTRA RRC message *ULInformationTransferMRDC* as specified in TS 36.331 [10].

1> else:

2>submit the *MeasurementReport* message to lower layers for transmission, upon which the procedure ends.

8.2.3.6.1.3 Test description

8.2.3.6.1.3.1 Pre-test conditions

System Simulator:

- EUTRA Cell 1 is the PCell and NR Cell 1 is the PS Cell.
- NR Cell 2 is the intra-frequency neighbour cell.

UE:

- None

Preamble:

- The UE is in state RRC_CONNECTED in EN-DC mode and DC Bearers (MCG and SCG) on E-UTRA Cell 1 according to TS 38.508-1 [4].

8.2.3.6.1.3.2 Test procedure sequence

Table 8.2.3.6.1.3.2-1 and Table 8.2.3.6.1.3.2-1A illustrates the downlink power levels to be applied for NR Cell 1 and NR Cell 2 at various time instants of the test execution. Row marked "T0" denotes the conditions after the preamble, while rows marked "T1" is to be applied subsequently. The exact instants on which these values shall be applied are described in the texts in this clause.

Table 8.2.3.6.1.3.2-1: Time instances of cell power level and parameter changes for conducted test environment

	Parameter	Unit	EUTRA Cell 1	NR Cell 1	NR Cell 2			Remark
T0	Cell-specific RS EPRE	dBm/15 kHz	-85	-	-			Power levels are such that entry condition for event A3 is not satisfied for any of the neighbour NR cells: $Mn + Ofn + Ocn - Hys > Mp + Ofp + Ocp + Off$
	SS/PBCH SSS EPRE	dBm/S CS	-	-85	-91			
T1	Cell-specific RS EPRE	dBm/15 kHz	-85	-	-			Power levels are such that entry condition for event A3 is satisfied for intra-frequency neighbour NR cell (<i>measId 1</i>): $Mn + Ofn + Ocn - Hys > Ms + OfS + Ocs + Off$
	SS/PBCH SSS EPRE	dBm/S CS	-	-85	-79			

Table 8.2.3.6.1.3.2-1A: Time instances of cell power level and parameter changes for OTA test environment

	Parameter	Unit	EUTRA Cell 1	NR Cell 1	NR Cell 2			Remark
T0	Cell-specific RS EPRE	dBm/15 kHz	-96	-	-			Power levels are such that entry condition for event A3 is not satisfied for

	SS/PBCH SSS EPRE	dBm/S CS	-	-91	-100			any of the neighbour NR cells: $Mn + Ofn + Ocn - Hys > Mp + Offp + Ocp + Off$
T1	Cell-specific RS EPRE	dBm/15 kHz	-96	-	-			Power levels are such that entry condition for event A3 is satisfied for intra-frequency neighbour NR cell (<i>measId 1</i>):
	SS/PBCH SSS EPRE	dBm/S CS	-	-91	-82			$Mn + Ofn + Ocn - Hys > Ms + Ofs + Ocs + Off$

Table 8.2.3.6.1.3.2-2: Main behaviour

St	Procedure	Message Sequence		TP	Verdict
		U - S	Message		
1	The SS transmits an <i>RRCConnectionReconfiguration</i> message containing NR <i>RRCReconfiguration</i> to setup measurements for neighbour NR Cells and reporting for event A3	<--	<i>RRCConnectionReconfiguration (RRCReconfiguration)</i>	-	-
2	Check: Does the UE transmit an <i>RRCConnectionReconfigurationComplete</i> message containing NR <i>RRCReconfigurationComplete</i> message?	-->	<i>RRCConnectionReconfigurationComplete (RRCReconfigurationComplete)</i>	-	-
3	Check: Does the UE transmit an <i>ULInformationTransferMRDC</i> message containing NR <i>MeasurementReport</i> message within the next 10s to report event A3?	-->	<i>ULInformationTransferMRDC (MeasurementReport)</i>	1	F
4	The SS re-adjusts the cell-specific reference signal level according to row "T1".	-	-	-	-
5	Check: Does the UE transmit an <i>ULInformationTransferMRDC</i> message containing NR <i>MeasurementReport</i> message to report event A3 (<i>measId 1</i>) with the measured value for NR Cell 2?	-->	<i>ULInformationTransferMRDC (MeasurementReport)</i>	2	P

8.2.3.6.1.3.3 Specific message contents

Table 8.2.3.6.1.3.3-1: *RRCConnectionReconfiguration* (step 1, Table 8.2.3.6.1.3.2-2)

Derivation Path: TS 36.508 [7], Table 4.6.1-8 with condition EN-DC_EmbedNR_RRCRecon

Table 8.2.3.6.1.3.3-2: *RRCReconfiguration* (Table 8.2.3.6.1.3.3-1)

Derivation Path: TS 38.508-1 [4], Table 4.6.1-13 with condition EN-DC_MEAS

Table 8.2.3.6.1.3.3-3: *MeasConfig-A3* (Table 8.2.3.6.1.3.3-2)

Derivation Path: TS 38.508-1 [4], Table 4.6.3-69			
Information Element	Value/remark	Comment	Condition
MeasConfig ::= SEQUENCE {			
measObjectToAddModList	MeasObjectNRAddMod		
ReportConfigToAddModList SEQUENCE(SIZE (1..maxReportConfigId)) OF ReportConfigToAddMod {			
ReportConfigToAddMod[1] SEQUENCE {		entry 1	
reportConfigId	ReportConfigId		
reportConfig CHOICE {			
reportConfigNR	ReportConfigNR(2) Same as TS 38.508-1 [4], Table 4.6.3-142 except for reportAmount set to 'r1'	a3-Offset value set to 1 dB (2*0.5 dB)	EVENT_A3

}			
}			
MeasIdToAddModList ::= SEQUENCE (SIZE (1..maxNrofMeasId)) OF MeasIdToAddMod {	1 entry		
MeasIdToAddMod[1] SEQUENCE {		entry 1	
measId	1		
measObjectId	1		
reportConfigId	1		
}			
}			
}			

Table 8.2.3.6.1.3.3-4: MeasObjectNRAddMod (Table 8.2.3.6.1.3.3-3)

Derivation Path: TS 38.508-1 [4], Table 4.6.3-76			
Information Element	Value/remark	Comment	Condition
measObjectToAddModList ::= SEQUENCE (SIZE (1..maxNrofObjectId)) OF MeasObjectToAddMod {	1 entry		
MeasObjectToAddMod[1] SEQUENCE {		entry 1	
measObjectId	1		
measObject CHOICE {			
measObjectNR	MeasObjectNR(59)	ssbFrequency IE equals the ARFCN for NR Cell 2 Thresh value set to -97dBm	
}			
}			
}			

Table 8.2.3.6.1.3.3-5: RRCConnectionReconfigurationComplete (step 2, Table 8.2.3.6.1.3.2-2)

Derivation Path: TS 36.508 [7], Table 4.6.1-9 with condition MCG_and_SCG
--

Table 8.2.3.6.1.3.3-6: ULInformationTransferMRDC (step 5, Table 8.2.3.6.1.3.2-2)

Derivation Path: TS 36.508 [7], Table 4.6.1-27			
Information Element	Value/remark	Comment	Condition
ULInformationTransferMRDC ::= SEQUENCE {			
ul-DCCH-MessageNR-r15	OCTET STRING including the MeasurementReport message according to Table 8.2.3.6.1.3.3-7		
}			

Table 8.2.3.6.1.3.3-7: MeasurementReport (Table 8.2.3.6.1.3.3-6)

Derivation Path: TS 38.508-1 [4], Table 4.6.1-5A			
Information Element	Value/remark	Comment	Condition
measurementReport ::= SEQUENCE {			
measResults SEQUENCE {			
measId	1		
measResultServingMOList SEQUENCE (SIZE (1..maxNrofServingCells)) {		Report NR Cell 1	
servCellId	Cell index corresponding to NR Cell 1		
measResultServingCell SEQUENCE {			
physCellId	Phy cell id corresponding to NR Cell 1		

1> if *measGapConfig* is set to *setup*:

...

2> if EN-DC is configured:

3> if the UE is configured with *fr1-Gap* set to *TRUE*:

4> apply the gap configuration for LTE serving cells and for NR serving cells on FR1;

3> else:

4> apply the gap configuration for all LTE and NR serving cells;

Test description

8.2.3.6.1a.3.1 Pre-test conditions

Same as test case 8.2.3.6.1 with the following differences:

- Cells configuration: NR Cell 3 replaces NR Cell 2.

8.2.3.6.1a.3.2 Test procedure sequence

Same as test case 8.2.3.6.1 with the following differences:

- Cells configuration: NR Cell 3 replaces NR Cell 2.

8.2.3.6.1a.3.3 Specific message contents

Same as test case 8.2.3.6.1 with the following differences:

- Cells configuration: NR Cell 3 replaces NR Cell 2.

Table 8.2.3.6.1a.3.3-0: RRCConnectionReconfiguration (step 1, Table 8.2.3.6.1.3.2-2)

Derivation Path: TS 36.508 [7], Table 4.6.1-8 with condition EN-DC_EmbedNR_RRCRecon			
Information Element	Value/remark	Comment	Condition
RRCConnectionReconfiguration ::= SEQUENCE {			
criticalExtensions CHOICE {			
c1 CHOICE {			
rrcConnectionReconfiguration-r8 SEQUENCE {			
measConfig	Table 8.2.3.6.1a.3.3-0a		
}			
}			
}			

Table 8.2.3.6.1a.3.3-0a: measConfig (Table 8.2.3.6.1a.3.3-0)

Derivation Path: TS 36.508 [7], Table 4.6.6-1			
Information Element	Value/remark	Comment	Condition
measConfig ::= SEQUENCE {			
measGapConfig CHOICE {			
setup SEQUENCE {			
gapOffset CHOICE {			
gp0	9	MGRP = 40 ms, MGL = 6 ms	
}			
}			
fr1-gap-r15	False		
mgta-r15	False		
}			

Table 8.2.3.6.1a.3.3-1: *MeasConfig-A3* (Table 8.2.3.6.1.3.3-2)

Derivation Path: TS 38.508-1 [4] Table 4.6.3-69			
Information Element	Value/remark	Comment	Condition
MeasConfig ::= SEQUENCE {			
measObjectToAddModList SEQUENCE (SIZE (1..maxNrofMeasId)) OF MeasObjectToAddMod {	2 entries		
MeasObjectToAddMod[1] SEQUENCE {		entry 1	
measObjectId	1		
measObject CHOICE {			
measObjectNR	MeasObjectNR-f1	Table 8.2.3.6.1a.3.3-2	
}			
}			
MeasObjectToAddMod[2] SEQUENCE {		entry 2	
measObjectId	2		
measObject CHOICE {			
measObjectNR	MeasObjectNR-f2	Table 8.2.3.6.1a.3.3-3	
}			
}			
reportConfigToAddModList SEQUENCE(SIZE (1..maxReportConfigId)) OF ReportConfigToAddMod {	1 entry		
ReportConfigToAddMod[1] SEQUENCE {		entry 1	
reportConfigId	1		
reportConfig CHOICE {			
reportConfigNR	ReportConfigNR(2) Same as TS 38.508-1 Table 4.6.3-142 except for reportAmount set to 'r1'	a3-Offset Thresh value set to 1 dB (2*0.5 dB)	EVENT_A3 AND FR1
	ReportConfigNR(2+ Delta(NRf ₂) - Delta(NRf ₁)) Same as TS 38.508-1 [4], Table 4.6.3-142 except for reportAmount set to 'r1'	a3-Offset value set to (2+ Delta(NRf ₂) - Delta(NRf ₁)). (Note 1)	EVENT_A3 AND FR2
}			
}			
}			
measIdToAddModList SEQUENCE (SIZE (1..maxNrofMeasId)) OF MeasIdToAddMod {	1 entry		
MeasIdToAddMod[1] SEQUENCE {		entry 1	
measId	1		
measObjectId	2		
reportConfigId	1		
}			
}			
}			
Note 1: Delta(NRf ₂) and Delta(NRf ₁) are derived based on calibration procedure defined in the TS 38.508-1 [4], clause 6.1.3.3.			

Table 8.2.3.6.1a.3.3-2: *MeasObjectNR-f1* (Table 8.2.3.6.1a.3.3-1)

Derivation Path: TS 38.508-1 [4], Table 4.6.3-76			
Information Element	Value/remark	Comment	Condition
MeasObjectNR ::= SEQUENCE {			
ssbFrequency	ARFCN-ValueNR for SSB of NR Cell 1		
absThreshSS-BlocksConsolidation	Not present		
nrofSS-BlocksToAverage	Not present		

}		
---	--	--

Table 8.2.3.6.1a.3.3-3: MeasObjectNR-f2 (Table 8.2.3.6.1a.3.3-1)

Derivation Path: TS 38.508-1 [4], Table 4.6.3-76			
Information Element	Value/remark	Comment	Condition
MeasObjectNR ::= SEQUENCE {			
ssbFrequency	ARFCN-ValueNR for SSB of NR Cell 3		
absThreshSS-BlocksConsolidation	Not present		
nrofSS-BlocksToAverage	Not present		
}			

8.2.3.6.1b Measurement configuration control and reporting / Event A3 / Measurement of Neighbour NR cell / Inter-band measurements / EN-DC

8.2.3.6.1b.1 Test Purpose (TP)

(1)
with { UE in RRC_CONNECTED state with EN-DC, and, MCG(s) (E-UTRA PDCP) and SCG and inter-band measurements configured for event A3 }
ensure that {
 when { Entry condition for event A3 is not met for neighbour NR cell }
 then { UE does not send MeasurementReport }
}

(2)
with { UE in RRC_CONNECTED state with EN-DC, and, MCG(s) (E-UTRA PDCP) and SCG and inter-band measurements configured for event A3 }
ensure that {
 when { Neighbour NR cell becomes offset better than serving NR PSCell }
 then { UE sends MeasurementReport with correct measId for event A3 }
}

8.2.3.6.1b.2 Conformance requirements

Same as test case 8.2.3.6.1 with the following difference:

[TS 36.331, clause 5.5.2.9]

The UE shall:

1> if *measGapConfig* is set to *setup*:

...

2> if EN-DC is configured:

3> if the UE is configured with *fr1-Gap* set to *TRUE*:

4> apply the gap configuration for LTE serving cells and for NR serving cells on FR1;

3> else:

4> apply the gap configuration for all LTE and NR serving cells;

...

8.2.3.6.1b.3 Test description

8.2.3.6.1b.3.1 Pre-test conditions

Same as test case 8.2.3.6.1 with the following differences:

- Cells configuration: NR Cell 10 replaces NR Cell 2.

8.2.3.6.1b.3.2 Test procedure sequence

Same as test case 8.2.3.6.1 with the following differences:

- Cells configuration: NR Cell 10 replaces NR Cell 2.

8.2.3.6.1b.3.3 Specific message contents

Same as test case 8.2.3.6.1 with the following differences:

- Cells configuration: NR Cell 10 replaces NR Cell 2.

Table 8.2.3.6.1b.3.3-0: RRCConnectionReconfiguration (step 1, Table 8.2.3.6.1.3.2-2)

Derivation Path: TS 36.508 [7], Table 4.6.1-8 with condition EN-DC_EmbedNR_RRCRecon			
Information Element	Value/remark	Comment	Condition
RRCConnectionReconfiguration ::= SEQUENCE {			
criticalExtensions CHOICE {			
c1 CHOICE {			
rrcConnectionReconfiguration-r8 SEQUENCE {			
measConfig	Table 8.2.3.6.1b.3.3-0a		
}			
}			
}			
}			

Table 8.2.3.6.1b.3.3-0a: measConfig (Table 8.2.3.6.1b.3.3-0)

Derivation Path: TS 36.508 [7], Table 4.6.6-1			
Information Element	Value/remark	Comment	Condition
measConfig ::= SEQUENCE {			
measGapConfig CHOICE {			
setup SEQUENCE {			
gapOffset CHOICE {			
gp0	9	MGRP = 40 ms, MGL = 6 ms	
}			
}			
fr1-gap-r15	False		
mgta-r15	False		
}			

Table 8.2.3.6.1b.3.3-1: MeasConfig-A3 (Table 8.2.3.6.1.3.3-2)

Derivation Path: TS 38.508-1 [4] Table 4.6.3-69			
Information Element	Value/remark	Comment	Condition
MeasConfig ::= SEQUENCE {			
measObjectToAddModList SEQUENCE (SIZE (1..maxNrofMeasId)) OF MeasObjectToAddMod {	2 entries		
MeasObjectToAddMod[1] SEQUENCE {		entry 1	
measObjectId	1		
measObject CHOICE {			
measObjectNR	MeasObjectNR-f1	Table 8.2.3.6.1b.3.3-2	
}			
}			
MeasObjectToAddMod[2] SEQUENCE {		entry 2	
measObjectId	2		
measObject CHOICE {			

measObjectNR	MeasObjectNR-f2	Table 8.2.3.6.1b.3.3-3	
}			
}			
reportConfigToAddModList SEQUENCE(SIZE (1..maxReportConfigId)) OF ReportConfigToAddMod {	1 entry		
ReportConfigToAddMod[1] SEQUENCE {		entry 1	
reportConfigId	1		
reportConfig CHOICE {			
reportConfigNR	ReportConfigNR(2) Same as TS 38.508-1 [4], Table 4.6.3-142 except for reportAmount set to 'r1'	a3-Offset Thresh value set to 1 dB (2*0.5 dB)	EVENT_A3
}			
}			
}			
measIdToAddModList SEQUENCE (SIZE (1..maxNrofMeasId)) OF MeasIdToAddMod {	1 entry		
MeasIdToAddMod[1] SEQUENCE {		entry 1	
measId	1		
measObjectId	2		
reportConfigId	1		
}			
}			
}			

Table 8.2.3.6.1b.3.3-2: MeasObjectNR-f1 (Table 8.2.3.6.1b.3.3-1)

Derivation Path: TS 38.508-1 [4], Table 4.6.3-76			
Information Element	Value/remark	Comment	Condition
MeasObjectNR ::= SEQUENCE {			
ssbFrequency	ARFCN-ValueNR for SSB of NR Cell 1		
absThreshSS-BlocksConsolidation	Not present		
nrofSS-BlocksToAverage	Not present		
}			

Table 8.2.3.6.1b.3.3-3: MeasObjectNR-f2 (Table 8.2.3.6.1b.3.3-1)

Derivation Path: TS 38.508-1 [4], Table 4.6.3-76			
Information Element	Value/remark	Comment	Condition
MeasObjectNR ::= SEQUENCE {			
ssbFrequency	ARFCN-ValueNR for SSB of NR Cell 10		
absThreshSS-BlocksConsolidation	Not present		
nrofSS-BlocksToAverage	Not present		
}			

8.2.3.6.2 Measurement configuration control and reporting / Event A3 / Measurement of Neighbour E-UTRA and NR cells / Intra-frequency measurements / NE-DC

8.2.3.6.2.1 Test Purpose (TP)

(1)

with { UE in RRC_CONNECTED state in NE-DC, and, MCG(s) (NR PDCP) and SCG and intra-frequency measurements configured for event A3 }
 ensure that {
 when { Entry condition for event A3 is not met for neighbour E-UTRA cell }
 then { UE does not send MeasurementReport }
 }

```

    }

```

(2)

```

with { UE in RRC_CONNECTED state in NE-DC, and, MCG(s) (NR PDCP) and SCG and intra-frequency
measurements configured for event A3 }
ensure that {
  when { Neighbour E-UTRA cell becomes offset better than serving E-UTRA PSCell }
  then { UE sends MeasurementReport with correct measId for event A3 }
}

```

(3)

```

with { UE in RRC_CONNECTED state in NE-DC, and, MCG(s) (NR PDCP) and SCG and intra-frequency
measurements configured for event A3 }
ensure that {
  when { Neighbour NR cell becomes offset better than serving NR PCell }
  then { UE sends MeasurementReport with correct measId for event A3 and includes measurement
result for the PSCell }
}

```

8.2.3.6.2.2 Conformance requirements

References: The conformance requirements covered in the present TC are specified in: 38.331:5.3.5.3, 5.5.5.1, 5.7.2a.3; TS 36.331:5.3.5.3, 5.5.2.3, 5.5.4.1, 5.5.4.4, 5.5.5.1. Unless otherwise stated these are Rel-15 requirements.

[TS 38.331, clause 5.3.5.3]

The UE shall perform the following actions upon reception of the *RRCReconfiguration*, or upon execution of the conditional reconfiguration (CHO or CPC):

...

1> if the *RRCReconfiguration* includes the *mrdc-SecondaryCellGroupConfig*:

2> if the *mrdc-SecondaryCellGroupConfig* is set to *setup*:

3> if the *mrdc-SecondaryCellGroupConfig* includes *mrdc-ReleaseAndAdd*:

4> perform MR-DC release as specified in clause 5.3.5.10;

3> if the received *mrdc-SecondaryCellGroup* is set to *nr-SCG*:

4> perform the RRC reconfiguration according to 5.3.5.3 for the *RRCReconfiguration* message included in *nr-SCG*;

3> if the received *mrdc-SecondaryCellGroup* is set to *eutra-SCG*:

4> perform the RRC connection reconfiguration as specified in TS 36.331 [10], clause 5.3.5.3 for the *RRCConnectionReconfiguration* message included in *eutra-SCG*;

2> else (*mrdc-SecondaryCellGroupConfig* is set to *release*):

3> perform MR-DC release as specified in clause 5.3.5.10;

...

1> set the content of the *RRCReconfigurationComplete* message as follows:

...

2> if the *RRCReconfiguration* message includes the *mrdc-SecondaryCellGroupConfig* with *mrdc-SecondaryCellGroup* set to *eutra-SCG*:

3> include in the *eutra-SCG-Response* the E-UTRA *RRCConnectionReconfigurationComplete* message in accordance with TS 36.331 [10] clause 5.3.5.3;

...

[TS 38.331, clause 5.5.5.1]



Figure 5.5.5.1-1: Measurement reporting

For the *measId* for which the measurement reporting procedure was triggered, the UE shall set the *measResults* within the *MeasurementReport* message as follows:

- 1> set the *measId* to the measurement identity that triggered the measurement reporting;
- ...
- 1> if the *reportConfig* associated with the *measId* that triggered the measurement reporting is set to *eventTriggered* and *eventID* is set to *eventA3*, or *eventA4*, or *eventA5*, or *eventB1*, or *eventB2*:
- 2> if the UE is in NE-DC and the measurement configuration that triggered this measurement report is associated with the MCG:
- 3> set the *measResultServFreqListEUTRA-SCG* to include an entry for each E-UTRA SCG serving frequency with the following:
 - 4> include *carrierFreq* of the E-UTRA serving frequency;
 - 4> set the *measResultServingCell* to include the available measurement quantities that the UE is configured to measure by the measurement configuration associated with the SCG;
 - 4> if *reportConfig* associated with the *measId* that triggered the measurement reporting includes *reportAddNeighMeas*:
 - 5> set the *measResultServFreqListEUTRA-SCG* to include within *measResultBestNeighCell* the quantities of the best non-serving cell, based on RSRP, on the concerned serving frequency;
- ...
- 1> if there is at least one applicable neighbouring cell to report:
 - 2> if the *reportType* is set to *eventTriggered* or *periodical*:
 - 3> set the *measResultNeighCells* to include the best neighbouring cells up to *maxReportCells* in accordance with the following:
 - 4> if the *reportType* is set to *eventTriggered*:
 - 5> include the cells included in the *cellsTriggeredList* as defined within the *VarMeasReportList* for this *measId*;
 - 4> else:
 - 5> include the applicable cells for which the new measurement results became available since the last periodical reporting or since the measurement was initiated or reset;
 - 4> for each cell that is included in the *measResultNeighCells*, include the *physCellId*;
 - 4> if the *reportType* is set to *eventTriggered* or *periodical*:
 - 5> for each included cell, include the layer 3 filtered measured results in accordance with the *reportConfig* for this *measId*, ordered as follows:
 - 6> if the *measObject* associated with this *measId* concerns NR:

7> if *rsType* in the associated *reportConfig* is set to *ssb*:

8> set *resultsSSB-Cell* within the *measResult* to include the SS/PBCH block based quantity(ies) indicated in the *reportQuantityCell* within the concerned *reportConfig*, in decreasing order of the sorting quantity, determined as specified in 5.5.5.3, i.e. the best cell is included first;

8> if *reportQuantityRS-Indexes* and *maxNrofRS-IndexesToReport* are configured, include beam measurement information as described in 5.5.5.2;

7> else if *rsType* in the associated *reportConfig* is set to *csi-rs*:

8> set *resultsCSI-RS-Cell* within the *measResult* to include the CSI-RS based quantity(ies) indicated in the *reportQuantityCell* within the concerned *reportConfig*, in decreasing order of the sorting quantity, determined as specified in 5.5.5.3, i.e. the best cell is included first;

8> if *reportQuantityRS-Indexes* and *maxNrofRS-IndexesToReport* are configured, include beam measurement information as described in 5.5.5.2;

6> if the *measObject* associated with this *measId* concerns E-UTRA:

7> set the *measResult* to include the quantity(ies) indicated in the *reportQuantity* within the concerned *reportConfigInterRAT* in decreasing order of the sorting quantity, determined as specified in 5.5.5.3, i.e. the best cell is included first;

6> if the *measObject* associated with this *measId* concerns UTRA-FDD and if *ReportConfigInterRAT* includes the *reportQuantityUTRA-FDD*:

7> set the *measResult* to include the quantity(ies) indicated in the *reportQuantityUTRA-FDD* within the concerned *reportConfigInterRAT* in decreasing order of the sorting quantity, determined as specified in 5.5.5.3, i.e. the best cell is included first;

2> else:

...

[TS 38.331, clause 5.7.2a.3]

The UE shall set the contents of the *ULInformationTransferMRDC* message as follows:

1> if there is a need to transfer MR-DC dedicated information related to NR:

2> set the *ul-DCCH-MessageNR* to include the NR MR-DC dedicated information to be transferred (e.g., NR RRC *MeasurementReport*, *UEAssistanceInformation*, *FailureInformation*, *RRCReconfigurationComplete* or *MCGFailureInformation* message);

1> else if there is a need to transfer MR-DC dedicated information related to E-UTRA:

2> set the - to include the E-UTRA MR-DC dedicated information to be transferred (e.g., E-UTRA RRC *MeasurementReport*, or *MCGFailureInformation* message);

1> submit the *ULInformationTransferMRDC* message to lower layers for transmission, upon which the procedure ends.

[TS 36.331, clause 5.3.5.3]

If the *RRCCConnectionReconfiguration* message does not include the *mobilityControlInfo* and the UE is able to comply with the configuration included in this message, the UE shall:

...

1> if the received *RRCCConnectionReconfiguration* includes the *sCellGroupToAddModList*:

2> perform SCell group addition or modification as specified in 5.3.10.3e;

1> if the received *RRCCConnectionReconfiguration* includes the *scg-Configuration*; or

- 1> if the current UE configuration includes one or more split DRBs configured with *pdcp-Config* and the received *RRCConnectionReconfiguration* includes *radioResourceConfigDedicated* including *drb-ToAddModList*:
 - 2> perform SCG reconfiguration as specified in 5.3.10.10;
- ...
- 1> if the *RRCConnectionReconfiguration* message includes the *measConfig*:
 - 2> perform the measurement configuration procedure as specified in 5.5.2;
- ...
- 1> if the UE is configured with NE-DC:
 - 2> if the received *RRCConnectionReconfiguration* message was included in an NR *RRCResume* message:
 - 3> transfer the *RRCConnectionReconfigurationComplete* message via SRB1 embedded in NR RRC message *RRCResumeComplete* as specified in TS 38.331 [82], clause 5.3.13.4;
 - 2> else:
 - 3> transfer the *RRCConnectionReconfigurationComplete* message via SRB1 embedded in NR RRC message *RRCReconfigurationComplete* as specified in TS 38.331 [82], clause 5.3.5.3;
- 1> else:
 - 2> submit the *RRCConnectionReconfigurationComplete* message to lower layers for transmission using the new configuration, upon which the procedure ends;

[TS 36.331, clause 5.5.2.3]

E-UTRAN applies the procedure as follows:

- configure a *measId* only if the corresponding measurement object, the corresponding reporting configuration and the corresponding quantity configuration, are configured;

The UE shall:

- 1> for each *measId* included in the received *measIdToAddModList*:
 - 2> if an entry with the matching *measId* exists in the *measIdList* within the *VarMeasConfig*:
 - 3> replace the entry with the value received for this *measId*;
 - 2> else:
 - 3> add a new entry for this *measId* within the *VarMeasConfig*;
 - 2> remove the measurement reporting entry for this *measId* from the *VarMeasReportList*, if included;
 - 2> stop the periodical reporting timer or timer T321, whichever one is running, and reset the associated information (e.g. *timeToTrigger*) for this *measId*;

...

[TS 36.331, clause 5.5.4.1]

If security has been activated successfully, the UE shall:

- 1> for each *measId* included in the *measIdList* within *VarMeasConfig*:
 - ...
 - 2> else:
 - 3> if the corresponding *measObject* concerns E-UTRA:

- 4> if the *ue-RxTxTimeDiffPeriodical* is configured in the corresponding *reportConfig*:
 - 5> consider only the PCell to be applicable;
- 4> else if the *reportSSTD-Meas* is set to *true* in the corresponding *reportConfig*:
 - 5> consider the PSCell to be applicable;
- 4> else if the *eventA1* or *eventA2* is configured in the corresponding *reportConfig*:
 - 5> consider only the serving cell to be applicable;
- 4> else if *eventC1* or *eventC2* is configured in the corresponding *reportConfig*; or if *reportStrongestCSI-RSs* is set to *true* in the corresponding *reportConfig*:
 - 5> consider a CSI-RS resource on the associated frequency to be applicable when the concerned CSI-RS resource is included in the *measCSI-RS-ToAddModList* defined within the *VarMeasConfig* for this *measId*;
- 4> else if *measRSSI-ReportConfig* is configured in the corresponding *reportConfig*:
 - 5> consider the resource indicated by the *rmtc-Config* on the associated frequency to be applicable;
- 4> else:
 - 5> if *useWhiteCellList* is set to *TRUE*:
 - 6> consider any neighbouring cell detected on the associated frequency to be applicable when the concerned cell is included in the *whiteCellsToAddModList* defined within the *VarMeasConfig* for this *measId*;
 - 5> else:
 - 6> consider any neighbouring cell detected on the associated frequency to be applicable when the concerned cell is not included in the *blackCellsToAddModList* defined within the *VarMeasConfig* for this *measId*;
 - 5> for events involving a serving cell on one frequency and neighbours on another frequency, consider the serving cell on the other frequency as a neighbouring cell;
- 4> if the corresponding *reportConfig* includes *alternativeTimeToTrigger* and if the UE supports *alternativeTimeToTrigger*:
 - 5> use the value of *alternativeTimeToTrigger* as the time to trigger instead of the value of *timeToTrigger* in the corresponding *reportConfig* for cells included in the *altTTT-CellsToAddModList* of the corresponding *measObject*;

...

[TS 36.331, clause 5.5.4.4]

The UE shall:

- 1> consider the entering condition for this event to be satisfied when condition A3-1, as specified below, is fulfilled;
- 1> consider the leaving condition for this event to be satisfied when condition A3-2, as specified below, is fulfilled;
- 1> if *usePSCell* of the corresponding *reportConfig* is set to *true*:
 - 2> use the PSCell for *Mp*, *Ofp* and *Ocp*;
- 1> else:
 - 2> use the PCell for *Mp*, *Ofp* and *Ocp*;

NOTE The cell(s) that triggers the event is on the frequency indicated in the associated *measObject* which may be different from the frequency used by the PCell/ PSCell.

Inequality A3-1 (Entering condition)

$$Mn + Ofn + Ocn - Hys > Mp + Ofp + Ocp + Off$$

Inequality A3-2 (Leaving condition)

$$Mn + Ofn + Ocn + Hys < Mp + Ofp + Ocp + Off$$

The variables in the formula are defined as follows:

Mn is the measurement result of the neighbouring cell, not taking into account any offsets.

Ofn is the frequency specific offset of the frequency of the neighbour cell (i.e. *offsetFreq* as defined within *measObjectEUTRA* corresponding to the frequency of the neighbour cell).

Ocn is the cell specific offset of the neighbour cell (i.e. *cellIndividualOffset* as defined within *measObjectEUTRA* corresponding to the frequency of the neighbour cell), and set to zero if not configured for the neighbour cell.

Mp is the measurement result of the PCell/ PSCell, not taking into account any offsets.

Ofp is the frequency specific offset of the frequency of the PCell/ PSCell (i.e. *offsetFreq* as defined within *measObjectEUTRA* corresponding to the frequency of the PCell/ PSCell).

Ocp is the cell specific offset of the PCell/ PSCell (i.e. *cellIndividualOffset* as defined within *measObjectEUTRA* corresponding to the frequency of the PCell/ PSCell), and is set to zero if not configured for the PCell/ PSCell.

Hys is the hysteresis parameter for this event (i.e. *hysteresis* as defined within *reportConfigEUTRA* for this event).

Off is the offset parameter for this event (i.e. *a3-Offset* as defined within *reportConfigEUTRA* for this event).

Mn, Mp are expressed in dBm in case of RSRP, or in dB in case of RSRQ and RS-SINR.

Ofn, Ocn, Ofp, Ocp, Hys, Off are expressed in dB.

[TS 36.331, clause 5.5.5.1]

For the *measId* for which the measurement reporting procedure was triggered, the UE shall set the *measResults* within the *MeasurementReport* message as follows:

...

1> if the measurement configuration that triggered the measurement reporting procedure was configured by an *sl-ConfigDedicatedEUTRA* that was received within an NR *RRCReconfiguration* message:

2> submit the *MeasurementReport* message via SRB1 embedded in NR RRC message *ULInformationTransferIRAT* as specified in TS 38.331 [82].

1> else if the UE is configured with NE-DC:

2> submit the *MeasurementReport* message via SRB1 embedded in NR RRC message *ULInformationTransferMRDC* as specified in TS 38.331 [82].

1> else:

2> submit the *MeasurementReport* message to lower layers for transmission, upon which the procedure ends;

8.2.3.6.2.3 Test description

8.2.3.6.2.3.1 Pre-test conditions

System Simulator:

- NR Cell 1 is the PCell and EUTRA Cell 1 is the PS Cell.
- NR Cell 2 is the intra-frequency neighbour NR cell.

- EUTRA Cell 2 is the intra-frequency neighbour EUTRA cell.
- System information combination NR-6 as defined in TS 38.508-1 [4] clause 4.4.3.1.2 is used in NR cells.

UE:

- None

Preamble:

- The UE is in state 3N-A as defined in TS 38.508-1 [4], subclause 4.4A on NR Cell 1.

8.2.3.6.2.3.2 Test procedure sequence

Table 8.2.3.6.2.3.2-1 and Table 8.2.3.6.2.3.2-2 illustrates the downlink power levels to be applied for NR Cells and EUTRA Cells at various time instants of the test execution. Row marked "T0" denotes the conditions after the preamble, while row marked "T1" are to be applied subsequently. The exact instants on which these values shall be applied are described in the texts in this clause.

Table 8.2.3.6.2.3.2-1: Time instances of cell power level and parameter changes for FR1

	Parameter	Unit	E-UTRA Cell 1	E-UTRA Cell 2	NR Cell 1	NR Cell 2	Remark
T0	Cell-specific RS EPRE	dBm/15 kHz	-85	-91	-	-	Power levels are such that entry condition for event A3 is not satisfied for any of the neighbour E-UTRA cells: $Mn + Ofn + Ocn + Hys < Mp + Ofp + Ocp + Off$
	SS/PBCH SSS EPRE	dBm/SC S	-	-	-85	-91	
T1	Cell-specific RS EPRE	dBm/15 kHz	-85	-79	-	-	Power levels are such that entry condition for event A3 is satisfied for intra-frequency neighbour E-UTRA cell (<i>measId 1</i>): $Mn + Ofn + Ocn - Hys > Mp + Ofp + Ocp + Off$
	SS/PBCH SSS EPRE	dBm/SC S	-	-	-85	-91	
T2	Cell-specific RS EPRE	dBm/15 kHz	-85	-91	-	-	Power levels are such that entry condition for event A3 is satisfied for intra-frequency neighbour NR cell (<i>measId 2</i>): $Mn + Ofn + Ocn - Hys > Mp + Ofp + Ocp + Off$
	SS/PBCH SSS EPRE	dBm/SC S	-	-	-85	-79	

Table 8.2.3.6.2.3.2-2: Time instances of cell power level and parameter changes for FR2

	Parameter	Unit	E-UTRA Cell 1	E-UTRA Cell 2	NR Cell 1	NR Cell 2	Remark
T0	Cell-specific RS EPRE	dBm/15 kHz	FFS	FFS	-	-	Power levels are such that entry condition for event A3 is not satisfied for any of the neighbour E-UTRA cells: $Mn + Ofn + Ocn + Hys < Mp + Ofp + Ocp + Off$
	SS/PBCH SSS EPRE	dBm/SC S	-	-	FFS	FFS	
T1	Cell-specific RS EPRE	dBm/15 kHz	FFS	FFS	-	-	Power levels are such that entry condition for event A3 is satisfied for intra-frequency neighbour E-UTRA cell (<i>measId 1</i>): $Mn + Ofn + Ocn - Hys > Mp + Ofp + Ocp + Off$
	SS/PBCH SSS EPRE	dBm/SC S	-	-	FFS	FFS	
T2	Cell-specific RS EPRE	dBm/15 kHz	FFS	FFS	-	-	Power levels are such that entry condition for event A3 is satisfied for intra-frequency neighbour NR cell (<i>measId 2</i>): $Mn + Ofn + Ocn - Hys > Mp + Ofp + Ocp + Off$
	SS/PBCH SSS EPRE	dBm/SC S	-	-	FFS	FFS	

Table 8.2.3.6.2.3.2-3: Main behaviour

St	Procedure	Message Sequence		TP	Verdict
		U - S	Message		
1	The SS transmits an <i>RRCReconfiguration</i> message containing <i>RRCConnectionReconfiguration</i> message to setup measurements for neighbour E-UTRA Cells and reporting for event A3	<--	NR RRC: <i>RRCReconfiguration</i> (<i>RRCConnectionReconfiguration</i>)	-	-
2	The UE transmit an <i>RRCReconfigurationComplete</i> message.	-->	NR RRC: <i>RRCReconfigurationComplete</i> (<i>RRCConnectionReconfigurationComplete</i>)	-	-
3	Check: Does the UE transmit an <i>ULInformationTransferMRDC</i> message containing <i>MeasurementReport</i> message within the next 10s to report event A3?	-->	NR RRC: <i>ULInformationTransferMRDC</i> (<i>MeasurementReport</i>)	1	F
4	The SS re-adjusts the cell-specific reference signal level according to row "T1".	-	-	-	-
5	Check: Does the UE transmit an <i>ULInformationTransferMRDC</i> message containing <i>MeasurementReport</i> message to report event A3 (<i>measId 1</i>) with the measured value for E-UTRA Cell 2?	-->	NR RRC: <i>ULInformationTransferMRDC</i> (<i>MeasurementReport</i>)	2	P
6	SS re-adjusts the cell-specific reference signal level according to row "T0".	-	-	-	-
7	The SS transmits an <i>RRCReconfiguration</i> message including <i>MeasConfig</i> to setup NR measurement and reporting for intra-frequency event A3 (<i>measId 2</i>) and <i>reportAddNeighMeas</i> .	<--	NR RRC: <i>RRCReconfiguration</i>	-	-
8	The UE transmit an <i>RRCReconfigurationComplete</i> message.	-->	NR RRC: <i>RRCReconfigurationComplete</i>	-	-
9	SS re-adjusts the cell-specific reference signal level according to row "T2".	-	-	-	-
10	Check: Does the UE transmit a <i>MeasurementReport</i> message to report event A3 (<i>measId 2</i>) with the measured RSRP value for NR Cell 2, E-UTRA PSCell and E-UTRA neighbour Cell 2.	-->	NR RRC: <i>MeasurementReport</i>	3	P

8.2.3.6.2.3.3 Specific message contents

Table 8.2.3.6.2.3.3-1: *RRCReconfiguration* (step 1, Table 8.2.3.6.2.3.2-3)

Derivation Path: TS 38.508-1 [4], Table 4.6.1-13 with condition NE-DC

Table 8.2.3.6.2.3.3-2: *SCG-Configuration-r12-NE-DC* (step 1, Table 8.2.3.6.2.3.2-3)

Derivation Path: 36.508, Clause 4.6.3, Table 4.6.3-19G			
Information Element	Value/remark	Comment	Condition
scg-Configuration-r12 CHOICE {			
setup SEQUENCE {			
scg-ConfigPartSCG-r12 SEQUENCE {			
measConfigSN-r15	MeasConfig-A3-E-UTRA		
}			
}			
}			

Table 8.2.3.6.2.3.3-3: MeasConfig-A3-E-UTRA (Table 8.2.3.6.2.3.3-2)

Derivation path: 36.508 clause 4.6.6 table 4.6.6-1			
Information Element	Value/Remark	Comment	Condition
measConfig ::= SEQUENCE {			
measObjectToAddModList SEQUENCE (SIZE (1..maxObjectId)) OF SEQUENCE {	1 entry		
measObjectId[1]	1		
measObject[1]	MeasObjectEUTRA-GENERIC(f1)		
measObject[1]	MeasObjectEUTRA-GENERIC(maxEARFCN)		Band > 64
}			
reportConfigToAddModList SEQUENCE (SIZE (1..maxReportConfigId)) OF SEQUENCE {	1 entry		
reportConfigId[1]	1		
reportConfig[1]	ReportConfig-A3-H		
}			
measIdToAddModList SEQUENCE (SIZE (1..maxMeasId)) OF SEQUENCE {	1 entry		
measId[1]	1		
measObjectId[1]	1		
reportConfigId[1]	1		
}			
measObjectToAddModList-v9e0 ::= SEQUENCE (SIZE (1..maxObjectId)) OF SEQUENCE {	1 entry		Band > 64
measObjectEUTRA-v9e0[1] SEQUENCE {			
carrierFreq-v9e0	Same downlink EARFCN as used for f1		
}			
}			
}			
}			

Table 8.2.3.6.2.3.3-4: ReportConfig-A3-H (step 1, Table 8.2.3.6.2.3.2-3)

Derivation path: 36.508 clause 4.6.6 table 4.6.6-6 ReportConfigEUTRA-A3			
Information Element	Value/remark	Comment	Condition
ReportConfigEUTRA-A3 ::= SEQUENCE {			
triggerType CHOICE {			
event SEQUENCE {			
timeToTrigger	ms0		
}			
}			
reportQuantity	sameAsTriggerQuantity		
}			

Table 8.2.3.6.2.3.3-5: RRCReconfigurationComplete (step 2, step 8, Table 8.2.3.6.2.3.2-3)

Derivation Path: TS 38.508-1 [4], Table 4.6.1-14 Condition with NE-DC

Table 8.2.3.6.2.3.3-6: ULInformationTransferMRDC (step 5, Table 8.2.3.6.2.3.2-3)

Derivation Path: TS 38.508-1 [4], Table 4.6.1-34			
Information Element	Value/remark	Comment	Condition
ULInformationTransferMRDC ::= SEQUENCE {			
ul-DCCH-MessageEUTRA	OCTET STRING including the MeasurementReport message according to Table 8.2.3.6.2.3.3-7		
}			

Table 8.2.3.6.2.3.3-7: MeasurementReport (Table 8.2.3.6.2.3.3-6)

Derivation path: 36.508 4.6.1 table 4.6.1-5			
Information Element	Value/Remark	Comment	Condition
MeasurementReport ::= SEQUENCE {			
criticalExtensions CHOICE {			
c1 CHOICE {			
measurementReport-r8 SEQUENCE {			
measResults ::= SEQUENCE {			
measId	1		
measResultPCell ::= SEQUENCE {		Report E-UTRA Cell 1	
rsrpResult	(0..97)		
rsrqResult	(0..34)		
}			
measResultNeighCells CHOICE {			
measResultListEUTRA SEQUENCE (SIZE (1..maxCellReport)) OF SEQUENCE {	1 entry	Report E-UTRA Cell 2	
physCellId	physCellId of the E-UTRA Cell 2.		
measResult SEQUENCE{			
rsrpResult	(0..97)		
rsrqResult	Not present		
}			
}			
measResultListUTRA	Not present		
measResultListGERAN	Not present		
measResultsCDMA2000	Not present		
measResultNeighCellListNR-r15	Not present		
}			
}			
}			
}			
}			
}			

Table 8.2.3.6.2.3.3-8: RRCReconfiguration (step 7, Table 8.2.3.6.2.3.2-3)

Derivation Path: TS 38.508-1 [4] Table 4.6.1-13 with condition NR_MEAS
--

Table 8.2.3.6.2.3.3-9: MeasConfig-A3 (Table 8.2.3.6.2.3.3-8)

Derivation Path: TS 38.508-1 [4] Table 4.6.3-69			
Information Element	Value/remark	Comment	Condition
MeasConfig ::= SEQUENCE {			
measObjectToAddModList SEQUENCE (SIZE (1..maxNrofMeasId)) OF MeasObjectToAddMod {	1 entry		
MeasObjectToAddMod[1] SEQUENCE {		entry 1	
measObjectId	1		
measObject CHOICE {			
measObjectNR	MeasObjectNR		
}			
}			
reportConfigToAddModList SEQUENCE(SIZE (1..maxReportConfigId)) OF ReportConfigToAddMod {	1 entry		
ReportConfigToAddMod[1] SEQUENCE {		entry 1	
reportConfigId	1		
reportConfig CHOICE {			
reportConfigNR	ReportConfigNR-EventA3		
}			
}			
}			

}			
measIdToAddModList SEQUENCE (SIZE (1..maxNrofMeasId)) OF MeasIdToAddMod {	1 entry		
MeasIdToAddMod[1] SEQUENCE {		entry 1	
measId	2		
measObjectId	1		
reportConfigId	1		
}			
}			
}			

Table 8.2.3.6.2.3.3-10: MeasObjectNR (Table 8.2.3.6.2.3.3-9)

Derivation Path: TS 38.508-1 [4], Table 4.6.3-76			
Information Element	Value/remark	Comment	Condition
MeasObjectNR ::= SEQUENCE {			
ssbFrequency	ARFCN-ValueNR for SSB of NR Cell 2		
absThreshSS-BlocksConsolidation	Not present		
nrofSS-BlocksToAverage	Not present		
}			

Table 8.2.3.6.2.3.3-11: ReportConfigNR-EventA3 (Table 8.2.3.6.2.3.3-9)

Derivation Path: TS 38.508-1 [4] Table 4.6.3-142 with condition EVENT_A3			
Information Element	Value/remark	Comment	Condition
ReportConfigNR ::= SEQUENCE {			
reportType CHOICE {			
eventTriggered SEQUENCE {			
eventId CHOICE {			
eventA3 SEQUENCE {			
a3-Offset CHOICE {			
rsrp	2	1 dB (2*0.5 dB)	FR1
	FFS		FR2
}			
}			
}			
reportAmount	1		
reportQuantityCell SEQUENCE {			
rsrp	true		
rsrq	false		
sinr	false		
}			
reportAddNeighMeas	setup		
}			
}			
}			

Table 8.2.3.6.2.3.3-12: MeasurementReport (step 10, Table 8.2.3.6.2.3.2-3)

Derivation Path: TS 38.508-1 [4] Table 4.6.1-5A			
Information Element	Value/remark	Comment	Condition
MeasurementReport ::= SEQUENCE {			
criticalExtensions CHOICE {			
measurementReport SEQUENCE {			
measResults SEQUENCE {			
measId	2		
measResultServingMOList SEQUENCE (SIZE (1..maxNrofServingCells)) OF MeasResultServMO {	1 entry	Measurement report for NR Cell 1	
MeasResultServMO[1] SEQUENCE {		entry 1	
servCellId	ServCellIndex of NR Cell 1		

}			
}			
}			
}			

8.2.3.6.2a Measurement configuration control and reporting / Event A3 / Measurement of Neighbor E-UTRA and NR cell / Inter-frequency measurements / NE-DC

8.2.3.6.2a.1 Test Purpose (TP)

(1)

```
with { UE in RRC_CONNECTED state in NE-DC, and, MCG(s) (NR PDCP) and SCG and inter-frequency
measurements configured for event A3 }
ensure that {
  when { Entry condition for event A3 is not met for neighbor E-UTRA cell }
  then { UE does not send MeasurementReport }
}
```

(2)

```
with { UE in RRC_CONNECTED state in NE-DC, and, MCG(s) (NR PDCP) and SCG and inter-frequency
measurements configured for event A3 }
ensure that {
  when { Neighbour E-UTRA cell becomes offset better than serving E-UTRA PSCell }
  then { UE sends MeasurementReport with correct measId for event A3 }
}
```

(3)

```
with { UE in RRC_CONNECTED state in NE-DC, and, MCG(s) (NR PDCP) and SCG and inter-frequency
measurements configured for event A3 }
ensure that {
  when { Neighbour NR cell becomes offset better than serving NR PCell }
  then { UE sends MeasurementReport with correct measId for event A3 and includes measurement
result for PSCell }
}
```

8.2.3.6.2a.2 Conformance requirements

Same as test case 8.2.3.6.2.2 with the following difference:

[TS 38.331, clause 5.5.2.9]

The UE shall:

- 1> if *gapFR1* is set to *setup*:
 - 2> if an FR1 measurement gap configuration is already setup, release the FR1 measurement gap configuration;
 - 2> setup the FR1 measurement gap configuration indicated by the *measGapConfig* in accordance with the received *gapOffset*, i.e., the first subframe of each gap occurs at an SFN and subframe meeting the following condition:

```
SFN mod T = FLOOR(gapOffset/10);
subframe = gapOffset mod 10;
```

with $T = \text{MGRP}/10$ as defined in TS 38.133 [14];
 - 2> apply the specified timing advance *mgta* to the gap occurrences calculated above (i.e. the UE starts the measurement *mgta* ms before the gap subframe occurrences);
- 1> else if *gapFR1* is set to *release*:
 - 2> release the FR1 measurement gap configuration;

1> if *gapFR2* is set to *setup*:

- 2> if an FR2 measurement gap configuration is already setup, release the FR2 measurement gap configuration;
- 2> setup the FR2 measurement gap configuration indicated by the *measGapConfig* in accordance with the received *gapOffset*, i.e., the first subframe of each gap occurs at an SFN and subframe meeting the following condition:

$$\text{SFN mod } T = \text{FLOOR}(\text{gapOffset}/10);$$

$$\text{subframe} = \text{gapOffset mod } 10;$$

with $T = \text{MGRP}/10$ as defined in TS 38.133 [14];

- 2> apply the specified timing advance *mgta* to the gap occurrences calculated above (i.e. the UE starts the measurement *mgta* ms before the gap subframe occurrences);

1> else if *gapFR2* is set to *release*:

- 2> release the FR2 measurement gap configuration;

1> if *gapUE* is set to *setup*:

- 2> if a per UE measurement gap configuration is already setup, release the per UE measurement gap configuration;
- 2> setup the per UE measurement gap configuration indicated by the *measGapConfig* in accordance with the received *gapOffset*, i.e., the first subframe of each gap occurs at an SFN and subframe meeting the following condition:

$$\text{SFN mod } T = \text{FLOOR}(\text{gapOffset}/10);$$

$$\text{subframe} = \text{gapOffset mod } 10;$$

with $T = \text{MGRP}/10$ as defined in TS 38.133 [14];

- 2> apply the specified timing advance *mgta* to the gap occurrences calculated above (i.e. the UE starts the measurement *mgta* ms before the gap subframe occurrences);

1> else if *gapUE* is set to *release*:

- 2> release the per UE measurement gap configuration.

NOTE 1: For *gapFR2* configuration with synchronous CA, for the UE in NE-DC or NR-DC, the SFN and subframe of the serving cell indicated by the *refServCellIndicator* in *gapFR2* is used in the gap calculation. Otherwise, the SFN and subframe of a serving cell on FR2 frequency is used in the gap calculation

NOTE 2: For *gapFR1* or *gapUE* configuration, for the UE in NE-DC or NR-DC, the SFN and subframe of the serving cell indicated by the *refServCellIndicator* in corresponding *gapFR1* or *gapUE* is used in the gap calculation. Otherwise, the SFN and subframe of the PCell is used in the gap calculation.

NOTE 3: For *gapFR2* configuration with asynchronous CA, for the UE in NE-DC or NR-DC, the SFN and subframe of the serving cell indicated by the *refServCellIndicator* and *refFR2ServCellAsyncCA* in *gapFR2* is used in the gap calculation. Otherwise, the SFN and subframe of a serving cell on FR2 frequency indicated by the *refFR2ServCellAsyncCA* in *gapFR2* is used in the gap calculation

8.2.3.6.2a.3 Test description

8.2.3.6.2a.3.1 Pre-test conditions

Same as test case 8.2.3.6.2 with the following differences:

- Cells configuration: NR Cell 3 replaces NR Cell 2; EUTRA Cell 3 replaces EUTRA Cell 2.

8.2.3.6.2a.3.2 Test procedure sequence

Same as test case 8.2.3.6.2 with the following differences:

- Cells configuration: NR Cell 3 replaces NR Cell 2; EUTRA Cell 3 replaces EUTRA Cell 2.

8.2.3.6.2a.3.3 Specific message contents

Same as test case 8.2.3.6.2 with the following differences:

- Cells configuration: Cells configuration: NR Cell 3 replaces NR Cell 2; EUTRA Cell 3 replaces EUTRA Cell 2.

Table 8.2.3.6.2a.3.3-1: MeasConfig-A3-E-UTRA (Table 8.2.3.6.2.3.3-3)

Derivation path: 36.508 clause 4.6.6 table 4.6.6-1			
Information Element	Value/Remark	Comment	Condition
measConfig ::= SEQUENCE {			
measObjectToAddModList SEQUENCE (SIZE (1..maxObjectld)) OF SEQUENCE {	2 entries		
measObjectld[1]	1		
measObject[1]	MeasObjectEUTRA-GENERIC(f1)		
measObject[1]	MeasObjectEUTRA-GENERIC(maxEARFCN)		Band > 64
measObjectld[2]	2		
measObject[2]	MeasObjectEUTRA-GENERIC(f2)		
measObject[2]	MeasObjectEUTRA-GENERIC(maxEARFCN)		Band > 64
}			
reportConfigToAddModList SEQUENCE (SIZE (1..maxReportConfigld)) OF SEQUENCE {	1 entry		
reportConfigld[1]	1		
reportConfig[1]	ReportConfig-A3-H		
}			
measldToAddModList SEQUENCE (SIZE (1..maxMeasld)) OF SEQUENCE {	1 entry		
measld[1]	1		
measObjectld[1]	2		
reportConfigld[1]	1		
}			
measGapConfig	MeasGapConfig-GP1		INTER-FREQ
	MeasGapConfig-CE		intraFreq-CE-NeedForGaps
measObjectToAddModList-v9e0 ::= SEQUENCE (SIZE (1..maxObjectld)) OF SEQUENCE {	2 entries		Band > 64
measObjectEUTRA-v9e0[1] SEQUENCE {			
carrierFreq-v9e0	Same downlink EARFCN as used for f1		
}			
measObjectEUTRA-v9e0[2] SEQUENCE {			
carrierFreq-v9e0	Same downlink EARFCN as used for f2		
}			
}			
}			
}			

Table 8.2.3.6.2a.3.3-2: MeasConfig-A3 (Table 8.2.3.6.2.3.3-9)

Derivation Path: TS 38.508-1 [4] Table 4.6.3-69			
Information Element	Value/remark	Comment	Condition
MeasConfig ::= SEQUENCE {			

measObjectToAddModList SEQUENCE (SIZE (1..maxNrofMeasId)) OF MeasObjectToAddMod {	2 entries		
MeasObjectToAddMod[1] SEQUENCE {		entry 1	
measObjectId	1		
measObject CHOICE {			
measObjectNR	MeasObjectNR-f1		
}			
}			
MeasObjectToAddMod[2] SEQUENCE {		entry 2	
measObjectId	2		
measObject CHOICE {			
measObjectNR	MeasObjectNR-f2		
}			
}			
reportConfigToAddModList SEQUENCE(SIZE (1..maxReportConfigId)) OF ReportConfigToAddMod {	1 entry		
ReportConfigToAddMod[1] SEQUENCE {		entry 1	
reportConfigId	1		
reportConfig CHOICE {			
reportConfigNR	ReportConfigNR(2) Same as TS 38.508-1 Table 4.6.3-142 except for reportAmount set to 'r1' and reportAddNeighMeas is set to 'setup'	a3-Offset Thresh value set to 1 dB (2*0.5 dB)	EVENT_A3 AND FR1
	ReportConfigNR(2+ Delta(NRf ₂) - Delta(NRf ₁)) Same as TS 38.508-1 [4], Table 4.6.3-142 except for reportAmount set to 'r1' and reportAddNeighMeas is set to 'setup'	a3-Offset value set to (2+ Delta(NRf ₂) - Delta(NRf ₁)). (Note 1)	EVENT_A3 AND FR2
}			
}			
}			
measIdToAddModList SEQUENCE (SIZE (1..maxNrofMeasId)) OF MeasIdToAddMod {	1 entry		
MeasIdToAddMod[1] SEQUENCE {		entry 1	
measId	2		
measObjectId	2		
reportConfigId	1		
}			
}			
measGapConfig	MeasGapConfig		
}			
Note 1: Delta(NRf ₂) and Delta(NRf ₁) are derived based on calibration procedure defined in the TS 38.508-1 [4], clause 6.1.3.3.			

Table 8.2.3.6.2a.3.3-3: MeasObjectNR-f1 (Table 8.2.3.6.2a.3.3-2)

Derivation Path: TS 38.508-1 [4], Table 4.6.3-76			
Information Element	Value/remark	Comment	Condition
MeasObjectNR ::= SEQUENCE {			
ssbFrequency	ARFCN-ValueNR for SSB of NR Cell 1		
absThreshSS-BlocksConsolidation	Not present		
nrofSS-BlocksToAverage	Not present		
}			

Table 8.2.3.6.2a.3.3-4: *MeasObjectNR-f2* (Table 8.2.3.6.2a.3.3-2)

Derivation Path: TS 38.508-1 [4], Table 4.6.3-76			
Information Element	Value/remark	Comment	Condition
MeasObjectNR ::= SEQUENCE {			
ssbFrequency	ARFCN-ValueNR for SSB of NR Cell 3		
absThreshSS-BlocksConsolidation	Not present		
nrofSS-BlocksToAverage	Not present		
}			

8.2.3.6.2b Measurement configuration control and reporting / Event A3 / Measurement of Neighbor E-UTRA and NR cell / Inter-band measurements / NE-DC

8.2.3.6.2b.1 Test Purpose (TP)

(1)

```
with { UE in RRC_CONNECTED state in NE-DC, and, MCG(s) (NR PDCP) and SCG and inter-band measurements
configured for event A3 }
ensure that {
  when { Entry condition for event A3 is not met for neighbor E-UTRA cell }
    then { UE does not send MeasurementReport }
}
```

(2)

```
with { UE in RRC_CONNECTED state in NE-DC, and, MCG(s) (NR PDCP) and SCG and inter-band measurements
configured for event A3 }
ensure that {
  when { Neighbour E-UTRA cell becomes offset better than serving E-UTRA PSCell }
    then { UE sends MeasurementReport with correct measId for event A3 }
}
```

(3)

```
with { UE in RRC_CONNECTED state in NE-DC, and, MCG(s) (NR PDCP) and SCG and inter-band measurements
configured for event A3 }
ensure that {
  when { Neighbour NR cell becomes offset better than serving NR PCell }
    then { UE sends MeasurementReport with correct measId for event A3 and includes measurement
result for PSCell }
}
```

8.2.3.6.2b.2 Conformance requirements

Same as test case 8.2.3.6.2.2 with the following difference:

[TS 38.331, clause 5.5.2.9]

The UE shall:

- 1> if *gapFR1* is set to *setup*:
- 2> if an FR1 measurement gap configuration is already setup, release the FR1 measurement gap configuration;
- 2> setup the FR1 measurement gap configuration indicated by the *measGapConfig* in accordance with the received *gapOffset*, i.e., the first subframe of each gap occurs at an SFN and subframe meeting the following condition:
$$\text{SFN mod } T = \text{FLOOR}(\text{gapOffset}/10);$$

$$\text{subframe} = \text{gapOffset mod } 10;$$
 with $T = \text{MGRP}/10$ as defined in TS 38.133 [14];

- 2> apply the specified timing advance *mgta* to the gap occurrences calculated above (i.e. the UE starts the measurement *mgta* ms before the gap subframe occurrences);
- 1> else if *gapFR1* is set to *release*:
- 2> release the FR1 measurement gap configuration;
- 1> if *gapFR2* is set to *setup*:
- 2> if an FR2 measurement gap configuration is already setup, release the FR2 measurement gap configuration;
- 2> setup the FR2 measurement gap configuration indicated by the *measGapConfig* in accordance with the received *gapOffset*, i.e., the first subframe of each gap occurs at an SFN and subframe meeting the following condition:
- $$\text{SFN mod } T = \text{FLOOR}(\text{gapOffset}/10);$$
- $$\text{subframe} = \text{gapOffset mod } 10;$$
- with $T = \text{MGRP}/10$ as defined in TS 38.133 [14];
- 2> apply the specified timing advance *mgta* to the gap occurrences calculated above (i.e. the UE starts the measurement *mgta* ms before the gap subframe occurrences);
- 1> else if *gapFR2* is set to *release*:
- 2> release the FR2 measurement gap configuration;
- 1> if *gapUE* is set to *setup*:
- 2> if a per UE measurement gap configuration is already setup, release the per UE measurement gap configuration;
- 2> setup the per UE measurement gap configuration indicated by the *measGapConfig* in accordance with the received *gapOffset*, i.e., the first subframe of each gap occurs at an SFN and subframe meeting the following condition:
- $$\text{SFN mod } T = \text{FLOOR}(\text{gapOffset}/10);$$
- $$\text{subframe} = \text{gapOffset mod } 10;$$
- with $T = \text{MGRP}/10$ as defined in TS 38.133 [14];
- 2> apply the specified timing advance *mgta* to the gap occurrences calculated above (i.e. the UE starts the measurement *mgta* ms before the gap subframe occurrences);
- 1> else if *gapUE* is set to *release*:
- 2> release the per UE measurement gap configuration.

NOTE 1: For *gapFR2* configuration with synchronous CA, for the UE in NE-DC or NR-DC, the SFN and subframe of the serving cell indicated by the *refServCellIndicator* in *gapFR2* is used in the gap calculation. Otherwise, the SFN and subframe of a serving cell on FR2 frequency is used in the gap calculation

NOTE 2: For *gapFR1* or *gapUE* configuration, for the UE in NE-DC or NR-DC, the SFN and subframe of the serving cell indicated by the *refServCellIndicator* in corresponding *gapFR1* or *gapUE* is used in the gap calculation. Otherwise, the SFN and subframe of the PCell is used in the gap calculation.

NOTE 3: For *gapFR2* configuration with asynchronous CA, for the UE in NE-DC or NR-DC, the SFN and subframe of the serving cell indicated by the *refServCellIndicator* and *refFR2ServCellAsyncCA* in *gapFR2* is used in the gap calculation. Otherwise, the SFN and subframe of a serving cell on FR2 frequency indicated by the *refFR2ServCellAsyncCA* in *gapFR2* is used in the gap calculation

8.2.3.6.2b.3 Test description

8.2.3.6.2b.3.1 Pre-test conditions

Same as test case 8.2.3.6.2 with the following differences:

- Cells configuration: NR Cell 10 replaces NR Cell 2; EUTRA Cell 10 replaces EUTRA Cell 2.

8.2.3.6.2b.3.2 Test procedure sequence

Same as test case 8.2.3.6.2 with the following differences:

- Cells configuration: NR Cell 10 replaces NR Cell 2; EUTRA Cell 10 replaces EUTRA Cell 2.

8.2.3.6.2b.3.3 Specific message contents

Same as test case 8.2.3.6.2 with the following differences:

- Cells configuration: Cells configuration: NR Cell 10 replaces NR Cell 2; EUTRA Cell 10 replaces EUTRA Cell 2.

Table 8.2.3.6.2b.3.3-1: MeasConfig-A3-E-UTRA (Table 8.2.3.6.2.3.3-3)

Derivation path: 36.508 clause 4.6.6 table 4.6.6-1			
Information Element	Value/Remark	Comment	Condition
measConfig ::= SEQUENCE {			
measObjectToAddModList SEQUENCE (SIZE (1..maxObjectld)) OF SEQUENCE {	2 entries		
measObjectld[1]	1		
measObject[1]	MeasObjectEUTRA-GENERIC(f1)		
measObject[1]	MeasObjectEUTRA-GENERIC(maxEARFCN)		Band > 64
measObjectld[2]	2		
measObject[2]	MeasObjectEUTRA-GENERIC(f5)		
measObject[2]	MeasObjectEUTRA-GENERIC(maxEARFCN)		Band > 64
}			
reportConfigToAddModList SEQUENCE (SIZE (1..maxReportConfigld)) OF SEQUENCE {	1 entry		
reportConfigld[1]	1		
reportConfig[1]	ReportConfig-A3-H		
}			
measldToAddModList SEQUENCE (SIZE (1..maxMeasld)) OF SEQUENCE {	1 entry		
measld[1]	1		
measObjectld[1]	2		
reportConfigld[1]	1		
}			
measGapConfig	MeasGapConfig-GP1		INTER-FREQ
	MeasGapConfig-CE		intraFreq-CE-NeedForGaps
measObjectToAddModList-v9e0 ::= SEQUENCE (SIZE (1..maxObjectld)) OF SEQUENCE {	2 entries		Band > 64
measObjectEUTRA-v9e0[1] SEQUENCE {			
carrierFreq-v9e0	Same downlink EARFCN as used for f1		
}			
measObjectEUTRA-v9e0[2] SEQUENCE {			
carrierFreq-v9e0	Same downlink EARFCN as used for f5		

}			
}			
}			

Table 8.2.3.6.2b.3.3-2: MeasConfig-A3 (Table 8.2.3.6.2.3.3-9)

Derivation Path: TS 38.508-1 [4] Table 4.6.3-69			
Information Element	Value/remark	Comment	Condition
MeasConfig ::= SEQUENCE {			
measObjectToAddModList SEQUENCE (SIZE (1..maxNrofMeasId)) OF MeasObjectToAddMod {	2 entries		
MeasObjectToAddMod[1] SEQUENCE {		entry 1	
measObjectId	1		
measObject CHOICE {			
measObjectNR	MeasObjectNR-f1		
}			
}			
MeasObjectToAddMod[2] SEQUENCE {		entry 2	
measObjectId	2		
measObject CHOICE {			
measObjectNR	MeasObjectNR-f2		
}			
}			
reportConfigToAddModList SEQUENCE(SIZE (1..maxReportConfigId)) OF ReportConfigToAddMod {	1 entry		
ReportConfigToAddMod[1] SEQUENCE {		entry 1	
reportConfigId	1		
reportConfig CHOICE {			
reportConfigNR	ReportConfigNR(2) Same as TS 38.508-1 Table 4.6.3-142 except for reportAmount set to 'r1' and reportAddNeighMeas is set to 'setup'	a3-Offset Thresh value set to 1 dB (2*0.5 dB)	EVENT_A3 AND FR1
	ReportConfigNR(2+ Delta(NRf ₂) - Delta(NRf ₁)) Same as TS 38.508-1 [4], Table 4.6.3-142 except for reportAmount set to 'r1' and reportAddNeighMeas is set to 'setup'	a3-Offset value set to (2+ Delta(NRf ₂) - Delta(NRf ₁)). (Note 1)	EVENT_A3 AND FR2
}			
}			
}			
measIdToAddModList SEQUENCE (SIZE (1..maxNrofMeasId)) OF MeasIdToAddMod {	1 entry		
MeasIdToAddMod[1] SEQUENCE {		entry 1	
measId	2		
measObjectId	2		
reportConfigId	1		
}			
}			
measGapConfig	MeasGapConfig		
}			
Note 1: Delta(NRf ₂) and Delta(NRf ₁) are derived based on calibration procedure defined in the TS 38.508-1 [4], clause 6.1.3.3.			

Table 8.2.3.6.2b.3.3-3: MeasObjectNR-f1 (Table 8.2.3.6.2a.3.3-2)

Derivation Path: TS 38.508-1 [4], Table 4.6.3-76
--

Information Element	Value/remark	Comment	Condition
MeasObjectNR ::= SEQUENCE {			
ssbFrequency	ARFCN-ValueNR for SSB of NR Cell 1		
absThreshSS-BlocksConsolidation	Not present		
nrofSS-BlocksToAverage	Not present		
}			

Table 8.2.3.6.2b.3.3-4: MeasObjectNR-f2 (Table 8.2.3.6.2a.3.3-2)

Derivation Path: TS 38.508-1 [4], Table 4.6.3-76			
Information Element	Value/remark	Comment	Condition
MeasObjectNR ::= SEQUENCE {			
ssbFrequency	ARFCN-ValueNR for SSB of NR Cell 10		
absThreshSS-BlocksConsolidation	Not present		
nrofSS-BlocksToAverage	Not present		
}			

8.2.3.7 Measurement configuration control and reporting / Event A4 (intra-frequency, inter-frequency and inter-band measurements) / Measurement of Neighbour NR cell

8.2.3.7.1 Measurement configuration control and reporting / Event A4 / Measurement of Neighbour NR cell / Intra-frequency measurements / EN-DC

8.2.3.7.1.1 Test Purpose (TP)

(1)

```
with { UE in RRC_CONNECTED state with EN-DC, and, MCG(s) (E-UTRA PDCP) and SCG and measurement
configured for event A4 with event based periodical reporting }
ensure that {
  when { Neighbour NR cell becomes better than absolute threshold }
    then { UE sends MeasurementReport message at regular intervals while entering condition for
event A4 is satisfied }
}
```

(2)

```
with { UE in RRC_CONNECTED state with EN-DC, and, MCG(s) (E-UTRA PDCP) and SCG and periodical
measurement reporting triggered by event A4 ongoing }
ensure that {
  when { Neighbour NR cell becomes worse than absolute threshold }
    then { UE stops sending MeasurementReport message }
}
```

8.2.3.7.1.2 Conformance requirements

References: The conformance requirements covered in the current TC are specified in: TS 36.331, clause 5.3.5.3, and TS 38.331, clause 5.3.5.3, 5.5.2.1, 5.5.4.1, 5.5.4.5 and 5.5.5.1. Unless otherwise stated these are Rel-15 requirements.

[TS 36.331, clause 5.3.5.3]

If the *RRCCONNECTIONRECONFIGURATION* message does not include the *mobilityControlInfo* and the UE is able to comply with the configuration included in this message, the UE shall:

...

1> if the received *RRCCONNECTIONRECONFIGURATION* includes the *nr-SecondaryCellGroupConfig*:

2> perform NR RRC Reconfiguration as specified in TS 38.331 [82, 5.3.5.3];

...

1> set the content of *RRCCConnectionReconfigurationComplete* message as follows:

...

2> if the received *RRCCConnectionReconfiguration* message included *nr-SecondaryCellGroupConfig*:

3> include *scg-ConfigResponseNR* in accordance with TS 38.331 [82, 5.3.5.3];

1> submit the *RRCCConnectionReconfigurationComplete* message to lower layers for transmission using the new configuration, upon which the procedure ends;

[TS 38.331, clause 5.3.5.3]

The UE shall perform the following actions upon reception of the *RRCCReconfiguration*:

1> if the *RRCCReconfiguration* includes the *secondaryCellGroup*:

2> perform the cell group configuration for the SCG according to 5.3.5.5;

...

1> if the *RRCCReconfiguration* message includes the *measConfig*:

2> perform the measurement configuration procedure as specified in 5.5.2;

...

1> if the UE is configured with E-UTRA *nr-SecondaryCellGroupConfig* (MCG is E-UTRA):

2> if *RRCCReconfiguration* was received via SRB1:

3> submit the *RRCCReconfigurationComplete* via the EUTRA MCG embedded in E-UTRA RRC message *RRCCConnectionReconfigurationComplete* as specified in TS 36.331 [10];

[TS 38.331, clause 5.5.2.1]

The network applies the procedure as follows:

- to ensure that, whenever the UE has a *measConfig*, it includes a *measObject* for the SpCell and for each NR SCell to be measured;
- to configure at most one measurement identity using a reporting configuration with the *reportType* set to *reportCGI*;
- to ensure that, for all SSB based reporting configurations have at most one measurement object with the same *ssbFrequency* and *ssbSubcarrierSpacing*;

The UE shall:

...

1> if the received *measConfig* includes the *measObjectToAddModList*:

2> perform the measurement object addition/modification procedure as specified in 5.5.2.5;

...

1> if the received *measConfig* includes the *reportConfigToAddModList*:

2> perform the reporting configuration addition/modification procedure as specified in 5.5.2.7;

...

1> if the received *measConfig* includes the *measIdToAddModList*:

2> perform the measurement identity addition/modification procedure as specified in 5.5.2.3;

- 1> if the received *measConfig* includes the *measGapConfig*:
 - 2> perform the measurement gap configuration procedure as specified in 5.5.2.9;

[TS 38.331, clause 5.5.4.1]

If security has been activated successfully, the UE shall:

- 1> for each *measId* included in the *measIdList* within *VarMeasConfig*:
 - 2> if the corresponding *reportConfig* includes a *reportType* set to *eventTriggered* or *periodical*;
 - 3> if the corresponding *measObject* concerns NR;
 - 4> if the *eventA1* or *eventA2* is configured in the corresponding *reportConfig*:
 - 5> consider only the serving cell to be applicable;
 - 4> else:
 - 5> for events involving a serving cell associated with a *measObjectNR* and neighbours associated with another *measObjectNR*, consider any serving cell associated with the other *measObjectNR* to be a neighbouring cell as well;
 - 5> if *useWhiteCellList* is set to TRUE:
 - ...
 - 5> else:
 - 6> consider any neighbouring cell detected based on parameters in the associated *measObjectNR* to be applicable when the concerned cell is not included in the *blackCellsToAddModList* defined within the *VarMeasConfig* for this *measId*;
 - 2> if the *reportType* is set to *eventTriggered* and if the entry condition applicable for this event, i.e. the event corresponding with the *eventId* of the corresponding *reportConfig* within *VarMeasConfig*, is fulfilled for one or more applicable cells for all measurements after layer 3 filtering taken during *timeToTrigger* defined for this event within the *VarMeasConfig*, while the *VarMeasReportList* does not include a measurement reporting entry for this *measId* (a first cell triggers the event):
 - 3> include a measurement reporting entry within the *VarMeasReportList* for this *measId*;
 - 3> set the *numberOfReportsSent* defined within the *VarMeasReportList* for this *measId* to 0;
 - 3> include the concerned cell(s) in the *cellsTriggeredList* defined within the *VarMeasReportList* for this *measId*;
 - 3> initiate the measurement reporting procedure, as specified in 5.5.5;
 - 2> if the *reportType* is set to *eventTriggered* and if the entry condition applicable for this event, i.e. the event corresponding with the *eventId* of the corresponding *reportConfig* within *VarMeasConfig*, is fulfilled for one or more applicable cells not included in the *cellsTriggeredList* for all measurements after layer 3 filtering taken during *timeToTrigger* defined for this event within the *VarMeasConfig* (a subsequent cell triggers the event):
 - 3> set the *numberOfReportsSent* defined within the *VarMeasReportList* for this *measId* to 0;
 - 3> include the concerned cell(s) in the *cellsTriggeredList* defined within the *VarMeasReportList* for this *measId*;
 - 3> initiate the measurement reporting procedure, as specified in 5.5.5;
 - 2> if the *reportType* is set to *eventTriggered* and if the leaving condition applicable for this event is fulfilled for one or more of the cells included in the *cellsTriggeredList* defined within the *VarMeasReportList* for this *measId* for all measurements after layer 3 filtering taken during *timeToTrigger* defined within the *VarMeasConfig* for this event:

- 3> remove the concerned cell(s) in the *cellsTriggeredList* defined within the *VarMeasReportList* for this *measId*;
- 3> if *reportOnLeave* is set to *TRUE* for the corresponding reporting configuration:
 - 4> initiate the measurement reporting procedure, as specified in 5.5.5;
- 3> if the *cellsTriggeredList* defined within the *VarMeasReportList* for this *measId* is empty:
 - 4> remove the measurement reporting entry within the *VarMeasReportList* for this *measId*;
 - 4> stop the periodical reporting timer for this *measId*, if running;
- 2> if *reportType* is set to *periodical* and if a (first) measurement result is available:
 - 3> include a measurement reporting entry within the *VarMeasReportList* for this *measId*;
 - 3> set the *numberOfReportsSent* defined within the *VarMeasReportList* for this *measId* to 0;
 - 4> if the *reportAmount* exceeds 1:
 - 5> initiate the measurement reporting procedure, as specified in 5.5.5, immediately after the quantity to be reported becomes available for the NR SpCell;
 - 4> else (i.e. the *reportAmount* is equal to 1):
 - 5> initiate the measurement reporting procedure, as specified in 5.5.5, immediately after the quantity to be reported becomes available for the NR SpCell and for the strongest cell among the applicable cells;
- 2> upon expiry of the periodical reporting timer for this *measId*:
 - 3> initiate the measurement reporting procedure, as specified in 5.5.5.

[TS 38.331, clause 5.5.4.5]

The UE shall:

- 1> consider the entering condition for this event to be satisfied when condition A4-1, as specified below, is fulfilled;
- 1> consider the leaving condition for this event to be satisfied when condition A4-2, as specified below, is fulfilled.

Inequality A4-1 (Entering condition)

$$Mn + Ofn + Ocn - Hys > Thresh$$

Inequality A4-2 (Leaving condition)

$$Mn + Ofn + Ocn + Hys < Thresh$$

The variables in the formula are defined as follows:

Mn is the measurement result of the neighbouring cell, not taking into account any offsets.

Ofn is the measurement object specific offset of the neighbour cell (i.e. *offsetMO* as defined within *measObjectNR* corresponding to the neighbour cell).

Ocn is the measurement object specific offset of the neighbour cell (i.e. *cellIndividualOffset* as defined within *measObjectNR* corresponding to the neighbour cell), and set to zero if not configured for the neighbour cell.

Hys is the hysteresis parameter for this event (i.e. *hysteresis* as defined within *reportConfigNR* for this event).

Thresh is the threshold parameter for this event (i.e. *a4-Threshold* as defined within *reportConfigNR* for this event).

Mn is expressed in dBm in case of RSRP, or in dB in case of RSRQ and RS-SINR.

Ofn*, *Ocn*, *Hys are expressed in dB.

Thresh is expressed in the same unit as *Mn*.

[TS 38.331, clause 5.5.5.1]

The purpose of this procedure is to transfer measurement results from the UE to the network. The UE shall initiate this procedure only after successful security activation.

For the *measId* for which the measurement reporting procedure was triggered, the UE shall set the *measResults* within the *MeasurementReport* message as follows:

- 1> set the *measId* to the measurement identity that triggered the measurement reporting;
- 1> set the *measResultServingCell* within *measResultServingMOList* to include RSRP, RSRQ and the available SINR for each configured serving cell derived based on the *rsType* indicated in the associated *reportConfig*;
- 1> set the *measResultServingCell* within *measResultServingMOList* to include for each NR serving cell that is configured with *servingCellMO*, if any, the *servCellId*;
- 1> if there is at least one applicable neighbouring cell to report:
 - 2> set the *measResultNeighCells* to include the best neighbouring cells up to *maxReportCells* in accordance with the following:
 - 3> if the *reportType* is set to *eventTriggered*:
 - 4> include the cells included in the *cellsTriggeredList* as defined within the *VarMeasReportList* for this *measId*;
 - 3> else:
 - 3> for each cell that is included in the *measResultNeighCells*, include the *physCellId*;
 - 3> if the *reportType* is set to *eventTriggered*:
 - 4> for each included cell, include the layer 3 filtered measured results in accordance with the *reportConfig* for this *measId*, ordered as follows:
 - 5> if the *measObject* associated with this *measId* concerns NR:
 - 6> if *rsType* in the associated *reportConfig* is set to *ssb*:
 - 7> set *resultsSSB-Cell* within the *measResult* to include the SS/PBCH block based quantity(ies) indicated in the *reportQuantityCell* within the concerned *reportConfig*, in order of decreasing trigger quantity, i.e. the best cell is included first:
 - 8> if *reportQuantityRsIndexes* and *maxNrofRSIndexesToReport* are configured, include beam measurement information as described in 5.5.5.2;
 - 6> else if *rsType* in the associated *reportConfig* is set to *csi-rs*:
 - ...
 - 1> increment the *numberOfReportsSent* as defined within the *VarMeasReportList* for this *measId* by 1;
 - 1> stop the periodical reporting timer, if running;
 - 1> if the *numberOfReportsSent* as defined within the *VarMeasReportList* for this *measId* is less than the *reportAmount* as defined within the corresponding *reportConfig* for this *measId*:
 - 2> start the periodical reporting timer with the value of *reportInterval* as defined within the corresponding *reportConfig* for this *measId*;
 - 1> else:
 - 2> if the *reportType* is set to *periodical*:
 - 3> remove the entry within the *VarMeasReportList* for this *measId*;

3> remove this *measId* from the *measIdList* within *VarMeasConfig*;

1> if the UE is configured with EN-DC:

2> if SRB3 is configured:

3> submit the *MeasurementReport* message via SRB3 to lower layers for transmission, upon which the procedure ends;

2>else:

3> submit the *MeasurementReport* message via the EUTRA MCG embedded in E-UTRA RRC message *ULInformationTransferMRDC* as specified in TS 36.331 [10].

1> else:

2> submit the *MeasurementReport* message to lower layers for transmission, upon which the procedure ends.

8.2.3.7.1.3 Test description

8.2.3.7.1.3.1 Pre-test conditions

System Simulator:

- E-UTRA Cell 1 is the PCell and NR Cell 1 is the PSCell
- NR Cell 2 is the intra-frequency neighbour cell of NR Cell 1.

UE:

- None

Preamble:

- The UE is in state RRC_CONNECTED using generic procedure parameter Connectivity (EN-DC) and DC Bearers (MCG(s) and SCG) on E-UTRA Cell 1 according to TS 38.508-1 [4], clause 4.5.4.

8.2.3.7.1.3.2 Test procedure sequence

Table 8.2.3.7.1.3.2-1 and Table 8.2.3.7.1.3.2-1A illustrates the downlink power levels to be applied for E-UTRA Cell 1, NR Cell 1 and NR Cell 2 at various time instants of the test execution. Row marked "T0" denotes the conditions after the preamble, while rows marked "T1" and "T2" are to be applied subsequently. The exact instants on which these values shall be applied are described in the texts in this clause.

Table 8.2.3.7.1.3.2-1: Time instances of cell power level and parameter changes for conducted test environment

	Parameter	Unit	E-UTRA Cell 1	NR Cell 1	NR Cell 2	Remark
T0	Cell-specific RS EPRE	dBm/15k Hz	-85	-	-	The power level values are such that entry condition for event A4 is not satisfied
	SS/PBCH SSS EPRE	dBm/SC S	-	-88	Off	
T1	Cell-specific RS EPRE	dBm/15k Hz	-85	-	-	The power level values are such that entry condition for event A4 is satisfied for intra-frequency neighbour NR Cell 2
	SS/PBCH SSS EPRE	dBm/SC S	-	-88	-79	
T2	Cell-specific RS EPRE	dBm/15k Hz	-85	-	-	The power level values are such that entry conditions for event A4

	SS/PBCH SSS EPRE	dBm/SC S	-	-88	-91	is not satisfied for intra-frequency neighbour NR Cell 2
--	---------------------	-------------	---	-----	-----	--

Table 8.2.3.7.1.3.2-1A: Time instances of cell power level and parameter changes for OTA test environment

	Parameter	Unit	E-UTRA Cell 1	NR Cell 1	NR Cell 2	Remark
T0	Cell-specific RS EPRE	dBm/15k Hz	-96	-	-	The power level values are such that entry condition for event A4 is not satisfied
	SS/PBCH SSS EPRE	dBm/SC S	-	-91	Off	
T1	Cell-specific RS EPRE	dBm/15k Hz	-96	-	-	The power level values are such that entry condition for event A4 is satisfied for intra-frequency neighbour NR Cell 2
	SS/PBCH SSS EPRE	dBm/SC S	-	-91	-82	
T2	Cell-specific RS EPRE	dBm/15k Hz	-96	-	-	The power level values are such that entry conditions for event A4 is not satisfied for intra-frequency neighbour NR Cell 2
	SS/PBCH SSS EPRE	dBm/SC S	-	-91	-100	

Table 8.2.3.7.1.3.2-2: Main behaviour

St	Procedure	Message Sequence		TP	Verdict
		U - S	Message		
1	The SS transmits an <i>RRCCONNECTIONRECONFIGURATION</i> message containing NR <i>RRCRECONFIGURATION</i> message to setup NR measurement and reporting of event A4.	<--	<i>RRCCONNECTIONRECONFIGURATION (RRCRECONFIGURATION)</i>	-	-
2	Check: Does the UE transmit an <i>RRCCONNECTIONRECONFIGURATIONCOMPLETE</i> message containing NR <i>RRCRECONFIGURATIONCOMPLETE</i> message?	-->	<i>RRCCONNECTIONRECONFIGURATIONCOMPLETE (RRCRECONFIGURATIONCOMPLETE)</i>	-	-
3	The SS re-adjusts the cell-specific reference signal level according to row "T1".	-	-	-	-
4	Check: Does the UE transmit <i>ULINFORMATIONTRANSFERMRDC</i> message containing NR <i>MEASUREMENTREPORT</i> message to report event A4 with the measured Results for NR Cell 2?	-->	<i>ULINFORMATIONTRANSFERMRDC (MEASUREMENTREPORT)</i>	1	P
-	EXCEPTION: Step 5 below is repeated until 3 <i>MEASUREMENTREPORT</i> messages are received from the UE	-	-	-	-
5	Check: Does the UE transmit <i>ULINFORMATIONTRANSFERMRDC</i> message containing NR <i>MEASUREMENTREPORT</i> message to report event A4 with the measured Results for NR Cell 2?	-->	<i>ULINFORMATIONTRANSFERMRDC (MEASUREMENTREPORT)</i>	1	P
6	The SS re-adjusts the cell-specific reference signal level according to row "T2".	-	-	-	-
7	Wait and ignore <i>MEASUREMENTREPORT</i> messages for 15 s to allow change of power levels for NR Cell 2 and UE measurement.	-	-	-	-
8	Check: Does the UE attempt to transmit an uplink message within the next 10s?	-	-	2	F

8.2.3.7.1.3.3 Specific message contents

Table 8.2.3.7.1.3.3-1: RRCConnectionReconfiguration (step 1, Table 8.2.3.7.1.3.2-2)

Derivation Path: TS 36.508 [7], Table 4.6.1-8 with condition EN-DC_EmbedNR_RRCRecon

Table 8.2.3.7.1.3.3-2: RRCReconfiguration (Table 8.2.3.7.1.3.3-1)

Derivation Path: TS 38.508-1 [4], Table 4.6.1-13 with condition EN-DC_MEAS

Table 8.2.3.7.1.3.3-3: MeasConfig-A4 (Table 8.2.3.7.1.3.3-2)

Derivation Path: TS 38.508-1 [4], Table 4.6.3-69			
Information Element	Value/remark	Comment	Condition
MeasConfig ::= SEQUENCE {			
measObjectToAddModList	MeasObjectNR-A4		
reportConfigToAddModList	ReportConfigNR1-A4		FR1
reportConfigToAddModList	ReportConfigNR2-A4		FR2
MeasIdToAddModList SEQUENCE (SIZE (1..maxNrofMeasId)) OF MeasIdToAddMod {	1 entry		
MeasIdToAddMod[1] SEQUENCE {		entry 1	
measId	1		
measObjectId	1		
reportConfigId	1		
}			
}			
}			

Table 8.2.3.7.1.3.3-4: MeasObjectNR-A4 (Table 8.2.3.7.1.3.3-3)

Derivation Path: TS 38.508-1 [4], Table 4.6.3-76			
Information Element	Value/remark	Comment	Condition
measObjectToAddModList ::= SEQUENCE (SIZE (1..maxNrofObjectId)) OF MeasObjectToAddMod {	1 entry		
MeasObjectToAddMod[1] SEQUENCE {		entry 1	
measObjectId[1]	1		
measObject CHOICE {			
measObjectNR SEQUENCE {			
ssbFrequency	ssbFrequency IE equals the ARFCN for NR Cell 2		
absThreshSS-BlocksConsolidation	Not Present		
absThreshCSI-RS-Consolidation	Not Present		
}			
}			
}			
}			

Table 8.2.3.7.1.3.3-5: ReportConfigNR1-A4 (Table 8.2.3.7.1.3.3-3)

Derivation Path: TS 38.508-1 [4], Table 4.6.3-142 with condition EVENT_A4			
Information Element	Value/remark	Comment	Condition
ReportConfigToAddModList ::= SEQUENCE (SIZE (1..maxNrofMeasId)) OF ReportConfigToAddMod {	1 entry		
ReportConfigToAddMod[1] SEQUENCE {		entry 1	
reportConfigId	1		
reportConfig CHOICE {			
reportConfigNR SEQUENCE {			
reportType CHOICE {			
eventTriggered SEQUENCE {			
eventId CHOICE {			
eventA4 SEQUENCE {			

a4-Threshold CHOICE {			
rsrp	71	SS RSRP corresponding to -85 dBm	
}			
}			
}			
}			
}			
}			
}			
}			
reportInterval	ms1024		
reportAmount	Infinity		
}			
}			
}			

Table 8.2.3.7.1.3.3-6: RRCConnectionReconfigurationComplete (step 2, Table 8.2.3.7.1.3.2-2)

Derivation Path: TS 36.508 [7], Table 4.6.1-9 with condition MCG_and_SCG

Table 8.2.3.7.1.3.3-7: ULInformationTransferMRDC (steps 4, 5, Table 8.2.3.7.1.3.2-2)

Derivation Path: TS 36.508 [7], Table 4.6.1-27			
Information Element	Value/remark	Comment	Condition
ULInformationTransferMRDC ::= SEQUENCE {			
ul-DCCH-MessageNR-r15	OCTET STRING including the MeasurementReport message according to Table 8.2.3.7.1.3.3-8		
}			

Table 8.2.3.7.1.3.3-8: MeasurementReport (steps 4, 5, Table 8.2.3.7.1.3.2-2)

Derivation Path: TS 38.508-1 [4], Table 4.6.1-5A			
Information Element	Value/remark	Comment	Condition
measurementReport ::= SEQUENCE {			
measResults SEQUENCE {			
measId	1		
measResultServingMOList SEQUENCE (SIZE (1..maxNrofServingCells)) {		Report NR Cell 1	
servCellId	Cell index corresponding to NR Cell 1		
measResultServingCell SEQUENCE {			
physCellId	Phy cell id corresponding to NR Cell 1		
measResult SEQUENCE {			
cellResults SEQUENCE {			
resultsSSB-Cell SEQUENCE {			
rsrp	(0..127)		
rsrq	(0..127)		
sinr	(0..127)		pc_ss_SINR_Meas
}	Not present		
}			
}			
}			
measResultNeighCells SEQUENCE (SIZE (1..maxCellReport)) {	1 entry	Report NR Cell 2	
measResultListNR SEQUENCE {			

```

    then { UE sends MeasurementReport message at regular intervals while entering condition for
event A4 is satisfied }
    }

```

(2)

```

with { UE in RRC_CONNECTED state with EN-DC, and, MCG(s) (E-UTRA PDCP) and SCG and periodical
measurement reporting triggered by event A4 ongoing }
ensure that {
    when { Neighbour NR cell becomes worse than absolute threshold }
        then { UE stops sending MeasurementReport message }
    }

```

8.2.3.7.1a.2 Conformance requirements

Same as test case 8.2.3.7.1 with the following difference:

[TS 36.331, clause 5.5.2.9]

The UE shall:

- 1> if *measGapConfig* is set to *setup*:
 - ...
- 2> if EN-DC is configured:
 - 3> if the UE is configured with *fr1-Gap* set to *TRUE*:
 - 4> apply the gap configuration for LTE serving cells and for NR serving cells on FR1;
 - 3> else:
 - 4> apply the gap configuration for all LTE and NR serving cells;

8.2.3.7.1a.3 Test description

8.2.3.7.1a.3.1 Pre-test conditions

Same as test case 8.2.3.7.1 with the following differences:

- Cells configuration: NR Cell 3 replaces NR Cell 2.

8.2.3.7.1a.3.2 Test procedure sequence

Same as test case 8.2.3.7.1 with the following differences:

- Cells configuration: NR Cell 3 replaces NR Cell 2.

8.2.3.7.1a.3.3 Specific message contents

Same as test case 8.2.3.7.1 with the following differences:

- Cells configuration: NR Cell 3 replaces NR Cell 2.

Table 8.2.3.7.1a.3.3-0: RRCConnectionReconfiguration (step 1, Table 8.2.3.7.1.3.2-2)

Derivation Path: TS 36.508 [7], Table 4.6.1-8 with condition EN-DC_EmbedNR_RRCRecon			
Information Element	Value/remark	Comment	Condition
RRCConnectionReconfiguration ::= SEQUENCE {			
criticalExtensions CHOICE {			
c1 CHOICE {			
rrcConnectionReconfiguration-r8 SEQUENCE {			
measConfig	Table 8.2.3.7.1a.3.3-0a		
}			
}			
}			

}			
}			

Table 8.2.3.7.1a.3.3-0a: measConfig (Table 8.2.3.7.1a.3.3-0)

Derivation Path: TS 36.508 [7], Table 4.6.6-1			
Information Element	Value/remark	Comment	Condition
measConfig SEQUENCE {			
measGapConfig CHOICE {			
setup SEQUENCE {			
gapOffset CHOICE {			
gp0	9	MGRP = 40 ms, MGL = 6 ms	
}			
}			
}			
fr1-gap-r15	False		
mgta-r15	False		
}			

Table 8.2.3.7.1a.3.3-1: MeasConfig-A4 (Table 8.2.3.7.1.3.3-2)

Derivation Path: TS 38.508-1 [4] Table 4.6.3-69			
Information Element	Value/remark	Comment	Condition
MeasConfig ::= SEQUENCE {			
measObjectToAddModList SEQUENCE (SIZE (1..maxNrofMeasId)) OF MeasObjectToAddMod {	2 entries		
MeasObjectToAddMod[1] SEQUENCE {		entry 1	
measObjectId	1		
measObject CHOICE {			
measObjectNR	MeasObjectNR-f1	Table 8.2.3.7.1a.3.3-2	
}			
MeasObjectToAddMod[2] SEQUENCE {		entry 2	
measObjectId	2		
measObject CHOICE {			
measObjectNR	MeasObjectNR-f2	Table 8.2.3.7.1a.3.3-3	
}			
}			
reportConfigToAddModList SEQUENCE(SIZE (1..maxReportConfigId)) OF ReportConfigToAddMod {	1 entry		
ReportConfigToAddMod[1] SEQUENCE {		entry 1	
reportConfigId	1		
reportConfig CHOICE {			
reportConfigNR	ReportConfigNR(71) Same as TS 38.508-1 [4], Table 4.6.3-142 except for reportAmount set to 'infinity'. ReportInterval value is set to 'ms1024'	Thresh value set to -85dBm	EVENT_A4 and FR1
reportConfigNR	ReportConfigNR(66 + delta(NRfs)) Same as TS 38.508-1 [4], Table 4.6.3-142 except for reportAmount set to 'infinity'. ReportInterval	Thresh value set to -91dBm	EVENT_A4 and FR2
}			
}			
}			
measIdToAddModList SEQUENCE (SIZE (1..maxNrofMeasId)) OF MeasIdToAddMod {	1 entry		

MeasIdToAddMod[1] SEQUENCE {		entry 1	
measId	1		
measObjectId	2		
reportConfigId	1		
}			
}			
}			

Table 8.2.3.7.1a.3.3-2: *MeasObjectNR-f1* (Table 8.2.3.7.1a.3.3-1)

Derivation Path: TS 38.508-1 [4], Table 4.6.3-76			
Information Element	Value/remark	Comment	Condition
MeasObjectNR ::= SEQUENCE {			
ssbFrequency	ARFCN-ValueNR for SSB of NR Cell 1		
absThreshSS-BlocksConsolidation	Not present		
nrofSS-BlocksToAverage	Not present		
}			

Table 8.2.3.7.1a.3.3-3: *MeasObjectNR-f2* (Table 8.2.3.7.1a.3.3-1)

Derivation Path: TS 38.508-1 [4], Table 4.6.3-76			
Information Element	Value/remark	Comment	Condition
MeasObjectNR ::= SEQUENCE {			
ssbFrequency	ARFCN-ValueNR for SSB of NR Cell 3		
absThreshSS-BlocksConsolidation	Not present		
nrofSS-BlocksToAverage	Not present		
}			

8.2.3.7.1b Measurement configuration control and reporting / Event A4 / Measurement of Neighbour NR cell / Inter-band measurements / EN-DC

8.2.3.7.1b.1 Test Purpose (TP)

(1)

```
with { UE in RRC_CONNECTED state with EN-DC, and, MCG(s) (E-UTRA PDCP) and SCG and inter-band
measurements configured for event A4 with event based periodical reporting }
ensure that {
  when { Neighbour NR cell becomes better than absolute threshold }
    then { UE sends MeasurementReport message at regular intervals while entering condition for
event A4 is satisfied }
}
```

(2)

```
with { UE in RRC_CONNECTED state with EN-DC, and, MCG(s) (E-UTRA PDCP) and SCG and periodical
measurement reporting triggered by event A4 ongoing }
ensure that {
  when { Neighbour NR cell becomes worse than absolute threshold }
    then { UE stops sending MeasurementReport message }
}
```

8.2.3.7.1b.2 Conformance requirements

Same as test case 8.2.3.7.1 with the following difference:

[TS 36.331, clause 5.5.2.9]

The UE shall:

1> if *measGapConfig* is set to *setup*:

...

2> if EN-DC is configured:

3> if the UE is configured with *fr1-Gap* set to *TRUE*:

4> apply the gap configuration for LTE serving cells and for NR serving cells on FR1;

3> else:

4> apply the gap configuration for all LTE and NR serving cells;

...

8.2.3.7.1b.3 Test description

8.2.3.7.1b.3.1 Pre-test conditions

Same as test case 8.2.3.7.1 with the following differences:

- Cells configuration: NR Cell 10 replaces NR Cell 2.

8.2.3.7.1b.3.2 Test procedure sequence

Same as test case 8.2.3.7.1 with the following differences:

- Cells configuration: NR Cell 10 replaces NR Cell 2.

8.2.3.7.1b.3.3 Specific message contents

Same as test case 8.2.3.7.1 with the following differences:

- Cells configuration: NR Cell 10 replaces NR Cell 2.

Table 8.2.3.7.1b.3.3-0: RRCConnectionReconfiguration (step 1, Table 8.2.3.7.1.3.2-2)

Derivation Path: TS 36.508 [7], Table 4.6.1-8 with condition EN-DC_EmbedNR_RRCRecon			
Information Element	Value/remark	Comment	Condition
RRCConnectionReconfiguration ::= SEQUENCE {			
criticalExtensions CHOICE {			
c1 CHOICE {			
rrcConnectionReconfiguration-r8 SEQUENCE {			
measConfig	Table 8.2.3.7.1b.3.3-0a		
}			
}			
}			
}			

Table 8.2.3.7.1b.3.3-0a: measConfig (Table 8.2.3.7.1b.3.3-0)

Derivation Path: TS 36.508 [7], Table 4.6.6-1			
Information Element	Value/remark	Comment	Condition
measConfig ::= SEQUENCE {			
measGapConfig CHOICE {			
setup SEQUENCE {			
gapOffset CHOICE {			
gp0	9	MGRP = 40 ms, MGL = 6 ms	
}			
}			
}			
fr1-gap-r15	False		

mgta-r15	False		
}			

Table 8.2.3.7.1b.3.3-1: MeasConfig-A4 (Table 8.2.3.7.1.3.3-2)

Derivation Path: TS 38.508-1 [4] Table 4.6.3-69			
Information Element	Value/remark	Comment	Condition
MeasConfig ::= SEQUENCE {			
measObjectToAddModList SEQUENCE (SIZE (1..maxNrofMeasId)) OF MeasObjectToAddMod {	2 entries		
MeasObjectToAddMod[1] SEQUENCE {		entry 1	
measObjectId	1		
measObject CHOICE {			
measObjectNR	MeasObjectNR-f1	Table 8.2.3.7.1b.3.3-2	
}			
}			
MeasObjectToAddMod[2] SEQUENCE {		entry 2	
measObjectId	2		
measObject CHOICE {			
measObjectNR	MeasObjectNR-f2	Table 8.2.3.7.1b.3.3-3	
}			
}			
reportConfigToAddModList SEQUENCE (SIZE (1..maxReportConfigId)) OF ReportConfigToAddMod {	1 entry		
ReportConfigToAddMod[1] SEQUENCE {		entry 1	
reportConfigId	1		
reportConfig CHOICE {			
reportConfigNR	ReportConfigNR(71) Same as TS 38.508-1 [4], Table 4.6.3-142 except for reportAmount set to 'infinity'. ReportInterval value is set to 'ms1024'	Thresh value set to -85dBm	EVENT_A4
}			
}			
}			
measIdToAddModList SEQUENCE (SIZE (1..maxNrofMeasId)) OF MeasIdToAddMod {	1 entry		
MeasIdToAddMod[1] SEQUENCE {		entry 1	
measId	1		
measObjectId	2		
reportConfigId	1		
}			
}			
}			

Table 8.2.3.7.1b.3.3-2: MeasObjectNR-f1 (Table 8.2.3.7.1b.3.3-1)

Derivation Path: TS 38.508-1 [4], Table 4.6.3-76			
Information Element	Value/remark	Comment	Condition
MeasObjectNR ::= SEQUENCE {			
ssbFrequency	ARFCN-ValueNR for SSB of NR Cell 1		
absThreshSS-BlocksConsolidation	Not present		
nrofSS-BlocksToAverage	Not present		
}			

Table 8.2.3.7.1b.3.3-3: MeasObjectNR-f2 (Table 8.2.3.7.1b.3.3-1)

Derivation Path: TS 38.508-1 [4], Table 4.6.3-76			
--	--	--	--

Information Element	Value/remark	Comment	Condition
MeasObjectNR ::= SEQUENCE {			
ssbFrequency	ARFCN-ValueNR for SSB of NR Cell 10		
absThreshSS-BlocksConsolidation	Not present		
nrofSS-BlocksToAverage	Not present		
}			

8.2.3.7.2 Measurement configuration control and reporting / Event A4 / Measurement of Neighbour E-UTRA and NR cells / Intra-frequency measurements / NE-DC

8.2.3.7.2.1 Test Purpose (TP)

(1)

```
with { UE in RRC_CONNECTED state with NE-DC, and, MCG(s) (NR PDCP) and SCG and intra-frequency
measurements configured for event A4 with event based periodical reporting }
ensure that {
  when { Neighbour E-UTRA cell becomes better than absolute threshold }
  then { UE sends MeasurementReport message at regular intervals while entering condition for
event A4 is satisfied }
}
```

(2)

```
with { UE in RRC_CONNECTED state with NE-DC, and, MCG(s) (NR PDCP) and SCG and periodical
measurement reporting triggered by event A4 ongoing }
ensure that {
  when { Neighbour E-UTRA cell becomes worse than absolute threshold }
  then { UE stops sending MeasurementReport message }
}
```

(3)

```
with { UE in RRC_CONNECTED state with NE-DC, and, MCG(s) (NR PDCP) and SCG and measurements
configured for event A4 including reportAddNeighMeas with event based periodical reporting }
ensure that {
  when { Neighbour NR cell becomes better than absolute threshold }
  then { UE sends MeasurementReport at regular intervals while entering condition for event A4 is
satisfied, and includes measurement result for the PSCCELL. }
}
```

8.2.3.7.2.2 Conformance requirements

References: The conformance requirements covered in the present TC are specified in: TS 38.331, 5.5.4.1, 5.5.4.5, 5.5.5.1 and 5.5.5.3, TS36.331, clauses 5.3.5.3, 5.5.4.1 and 5.5.4.5. Unless otherwise stated these are Rel-15 requirements.

[TS 38.331, clause 5.5.4.1]

If AS security has been activated successfully, the UE shall:

- 1> for each *measId* included in the *measIdList* within *VarMeasConfig*:
- 2> if the corresponding *reportConfig* includes a *reportType* set to *eventTriggered* or *periodical*:
- 3> if the corresponding *measObject* concerns NR:
 - ...
- 4> for measurement events other than *eventA1* or *eventA2*:
 - 5> if *useAllowedCellList* is set to *true*:

- 6> consider any neighbouring cell detected based on parameters in the associated *measObjectNR* to be applicable when the concerned cell is included in the *allowedCellsToAddModList* defined within the *VarMeasConfig* for this *measId*;
- 5> else:
 - 6> consider any neighbouring cell detected based on parameters in the associated *measObjectNR* to be applicable when the concerned cell is not included in the *excludedCellsToAddModList* defined within the *VarMeasConfig* for this *measId*;
- 3> else if the corresponding *measObject* concerns E-UTRA:
 - 4> if *eventB1* or *eventB2* is configured in the corresponding *reportConfig*:
 - 5> consider a serving cell, if any, on the associated E-UTRA frequency as neighbour cell;
 - 4> consider any neighbouring cell detected on the associated frequency to be applicable when the concerned cell is not included in the *excludedCellsToAddModListEUTRAN* defined within the *VarMeasConfig* for this *measId*;
 - ...
- 2> if the *reportType* is set to *eventTriggered* and if the entry condition applicable for this event, i.e. the event corresponding with the *eventId* of the corresponding *reportConfig* within *VarMeasConfig*, is fulfilled for one or more applicable cells for all measurements after layer 3 filtering taken during *timeToTrigger* defined for this event within the *VarMeasConfig*, while the *VarMeasReportList* does not include a measurement reporting entry for this *measId* (a first cell triggers the event):
 - 3> include a measurement reporting entry within the *VarMeasReportList* for this *measId*;
 - 3> set the *numberOfReportsSent* defined within the *VarMeasReportList* for this *measId* to 0;
 - 3> include the concerned cell(s) in the *cellsTriggeredList* defined within the *VarMeasReportList* for this *measId*;
 - 3> if *useT312* is set to *true* in *reportConfig* for this event:
 - 4> if T310 for the corresponding SpCell is running; and
 - 4> if T312 is not running for corresponding SpCell:
 - 5> start timer T312 for the corresponding SpCell with the value of T312 configured in the corresponding *measObjectNR*;
 - 3> initiate the measurement reporting procedure, as specified in 5.5.5;
- 2> else if the *reportType* is set to *eventTriggered* and if the entry condition applicable for this event, i.e. the event corresponding with the *eventId* of the corresponding *reportConfig* within *VarMeasConfig*, is fulfilled for one or more applicable cells not included in the *cellsTriggeredList* for all measurements after layer 3 filtering taken during *timeToTrigger* defined for this event within the *VarMeasConfig* (a subsequent cell triggers the event):
 - 3> set the *numberOfReportsSent* defined within the *VarMeasReportList* for this *measId* to 0;
 - 3> include the concerned cell(s) in the *cellsTriggeredList* defined within the *VarMeasReportList* for this *measId*;
 - 3> if *useT312* is set to *true* in *reportConfig* for this event:
 - 4> if T310 for the corresponding SpCell is running; and
 - 4> if T312 is not running for corresponding SpCell:
 - 5> start timer T312 for the corresponding SpCell with the value of T312 configured in the corresponding *measObjectNR*;
 - 3> initiate the measurement reporting procedure, as specified in 5.5.5;

...

[TS 38.331, clause 5.5.4.5]

The UE shall:

- 1> consider the entering condition for this event to be satisfied when condition A4-1, as specified below, is fulfilled;
- 1> consider the leaving condition for this event to be satisfied when condition A4-2, as specified below, is fulfilled.

Inequality A4-1 (Entering condition)

$$Mn + Ofn + Ocn - Hys > Thresh$$

Inequality A4-2 (Leaving condition)

$$Mn + Ofn + Ocn + Hys < Thresh$$

The variables in the formula are defined as follows:

Mn is the measurement result of the neighbouring cell, not taking into account any offsets.

Ofn is the measurement object specific offset of the neighbour cell (i.e. *offsetMO* as defined within *measObjectNR* corresponding to the neighbour cell).

Ocn is the measurement object specific offset of the neighbour cell (i.e. *cellIndividualOffset* as defined within *measObjectNR* corresponding to the neighbour cell), and set to zero if not configured for the neighbour cell.

Hys is the hysteresis parameter for this event (i.e. *hysteresis* as defined within *reportConfigNR* for this event).

Thresh is the threshold parameter for this event (i.e. *a4-Threshold* as defined within *reportConfigNR* for this event).

Mn is expressed in dBm in case of RSRP, or in dB in case of RSRQ and RS-SINR.

Ofn*, *Ocn*, *Hys are expressed in dB.

Thresh is expressed in the same unit as ***Mn***.

NOTE: The definition of Event A4 also applies to CondEvent A4.

[TS 38.331, clause 5.5.5.1]



Figure 5.5.5.1-1: Measurement reporting

The purpose of this procedure is to transfer measurement results from the UE to the network. The UE shall initiate this procedure only after successful security activation.

For the *measId* for which the measurement reporting procedure was triggered, the UE shall set the *measResults* within the *MeasurementReport* message as follows:

- 1> set the *measId* to the measurement identity that triggered the measurement reporting;
- 1> set the *measResultServingCell* within *measResultServingMOList* to include, for each NR serving cell that is configured with *servingCellMO*, RSRP, RSRQ and the available SINR, derived based on the *rsType* if indicated in the associated *reportConfig*, otherwise based on SSB if available, otherwise based on CSI-RS;

- 1> set the *measResultServingCell* within *measResultServingMOList* to include for each NR serving cell that is configured with *servingCellMO*, if any, the *servCellId*;
- 1> if the *reportConfig* associated with the *measId* that triggered the measurement reporting includes *reportQuantityRSIndexes* and *maxNrofRSIndexesToReport*:
 - 2> for each serving cell configured with *servingCellMO*, include beam measurement information according to the associated *reportConfig* as described in 5.5.5.2;
- ...
- 1> if *reportConfig* associated with the *measId* that triggered the measurement reporting is set to *eventTriggered* and *eventID* is set to *eventA3*, or *eventA4*, or *eventA5*:
 - 2> if the UE is in NR-DC and the measurement configuration that triggered this measurement report is associated with the MCG:
 - 3> set the *measResultServFreqListNR-SCG* to include for each NR SCG serving cell that is configured with *servingCellMO*, if any, the following:
 - ...
 - 4> if *reportConfig* associated with the *measId* that triggered the measurement reporting includes *reportAddNeighMeas*:
 - 5> if the *measObjectNR* indicated by the *servingCellMO* includes the RS resource configuration corresponding to the *rsType* indicated in the *reportConfig*:
 - 6> set the *measResultBestNeighCellListNR* within *measResultServFreqListNR-SCG* to include one entry with the *physCellId* and the available measurement quantities based on the *reportQuantityCell* and *rsType* indicated in *reportConfig* of the non-serving cell corresponding to the concerned *measObjectNR* with the highest measured RSRP if RSRP measurement results are available for cells corresponding to this *measObjectNR*, otherwise with the highest measured RSRQ if RSRQ measurement results are available for cells corresponding to this *measObjectNR*, otherwise with the highest measured SINR, where availability is considered according to the measurement configuration associated with the SCG;
 - 7> if the *reportConfig* associated with the *measId* that triggered the measurement reporting includes *reportQuantityRS-Indexes* and *maxNrofRS-IndexesToReport*:
 - 8> for each best non-serving cell included in the measurement report:
 - 9> include beam measurement information according to the associated *reportConfig* as described in 5.5.5.2, where availability is considered according to the measurement configuration associated with the SCG;
 - ...
 - 1> if there is at least one applicable neighbouring cell to report:
 - 2> if the *reportType* is set to *eventTriggered* or *periodical*:
 - 3> set the *measResultNeighCells* to include the best neighbouring cells up to *maxReportCells* in accordance with the following:
 - 4> if the *reportType* is set to *eventTriggered*:
 - 5> include the cells included in the *cellsTriggeredList* as defined within the *VarMeasReportList* for this *measId*;
 - ...
 - 4> for each cell that is included in the *measResultNeighCells*, include the *physCellId*;
 - 4> if the *reportType* is set to *eventTriggered* or *periodical*:

5> for each included cell, include the layer 3 filtered measured results in accordance with the *reportConfig* for this *measId*, ordered as follows:

6> if the *measObject* associated with this *measId* concerns NR:

7> if *rsType* in the associated *reportConfig* is set to *ssb*:

8> set *resultsSSB-Cell* within the *measResult* to include the SS/PBCH block based quantity(ies) indicated in the *reportQuantityCell* within the concerned *reportConfig*, in decreasing order of the sorting quantity, determined as specified in 5.5.5.3, i.e. the best cell is included first:

9> if *reportQuantityRsIndexes* and *maxNrofRSIndexesToReport* are configured, include beam measurement information as described in 5.5.5.2;

...

6> if the *measObject* associated with this *measId* concerns E-UTRA:

7> set the *measResult* to include the quantity(ies) indicated in the *reportQuantity* within the concerned *reportConfigInterRAT* in decreasing order of the sorting quantity, determined as specified in 5.5.5.3, i.e. the best cell is included first;

...

1> increment the *numberOfReportsSent* as defined within the *VarMeasReportList* for this *measId* by 1;

1> stop the periodical reporting timer, if running;

...

1> if the UE is configured with EN-DC:

2> if SRB3 is configured:

3> submit the *MeasurementReport* message via SRB3 to lower layers for transmission, upon which the procedure ends;

2> else:

3> submit the *MeasurementReport* message via the EUTRA MCG embedded in E-UTRA RRC message *ULInformationTransferMRDC* as specified in TS 36.331 [10].

1> else:

2> submit the *MeasurementReport* message to lower layers for transmission, upon which the procedure ends.

[TS 36.331, clause 5.3.5.3]

If the *RRCConnectionReconfiguration* message does not include the *mobilityControlInfo* and the UE is able to comply with the configuration included in this message, the UE shall:

...

1> if the *RRCConnectionReconfiguration* message includes the *measConfig*:

2> perform the measurement configuration procedure as specified in 5.5.2;

...

[TS 36.331, clause 5.5.4.1]

The UE shall:

1> for each *measId* included in the *measIdList* within *VarMeasConfig*:

2> else:

- 3> if the corresponding *measObject* concerns E-UTRA:
 - 4> if the *ue-RxTxTimeDiffPeriodical*, *eventA1* or *eventA2* is configured in the corresponding *reportConfig*:
 - 5> consider only the serving cell to be applicable;
 - 4> else:
 - 5> consider any neighbouring cell detected on the associated frequency to be applicable when the concerned cell is not included in the *blackCellsToAddModList* defined within the *VarMeasConfig* for this *measId*;
- ...
- 2> if the *triggerType* is set to 'event' and if the entry condition applicable for this event, i.e. the event corresponding with the *eventId* of the corresponding *reportConfig* within *VarMeasConfig*, is fulfilled for one or more applicable cells for all measurements after layer 3 filtering taken during *timeToTrigger* defined for this event within the *VarMeasConfig*, while the *VarMeasReportList* does not include an measurement reporting entry for this *measId* (a first cell triggers the event):
 - 3> include a measurement reporting entry within the *VarMeasReportList* for this *measId*;
 - 3> set the *numberOfReportsSent* defined within the *VarMeasReportList* for this *measId* to 0;
 - 3> include the concerned cell(s) in the *cellsTriggeredList* defined within the *VarMeasReportList* for this *measId*;
 - 3> initiate the measurement reporting procedure, as specified in 5.5.5;
- 2> if the *triggerType* is set to 'event' and if the entry condition applicable for this event, i.e. the event corresponding with the *eventId* of the corresponding *reportConfig* within *VarMeasConfig*, is fulfilled for one or more applicable cells not included in the *cellsTriggeredList* for all measurements after layer 3 filtering taken during *timeToTrigger* defined for this event within the *VarMeasConfig* (a subsequent cell triggers the event):
 - 3> set the *numberOfReportsSent* defined within the *VarMeasReportList* for this *measId* to 0;
 - 3> include the concerned cell(s) in the *cellsTriggeredList* defined within the *VarMeasReportList* for this *measId*;
 - 3> initiate the measurement reporting procedure, as specified in 5.5.5;
- 2> if the *triggerType* is set to 'event' and if the leaving condition applicable for this event is fulfilled for one or more of the cells included in the *cellsTriggeredList* defined within the *VarMeasReportList* for this *measId* for all measurements after layer 3 filtering taken during *timeToTrigger* defined within the *VarMeasConfig* for this event:
 - 3> remove the concerned cell(s) in the *cellsTriggeredList* defined within the *VarMeasReportList* for this *measId*;
 - 3> if *reportOnLeave* is set to *TRUE* for the corresponding reporting configuration:
 - 4> initiate the measurement reporting procedure, as specified in 5.5.5;
 - 3> if the *cellsTriggeredList* defined within the *VarMeasReportList* for this *measId* is empty:
 - 4> remove the measurement reporting entry within the *VarMeasReportList* for this *measId*;
 - 4> stop the periodical reporting timer for this *measId*, if running;
- 2> if the *purpose* is included and set to 'reportStrongestCells' or 'reportStrongestCellsForSON' and if a (first) measurement result is available for one or more applicable cells:
 - 3> include a measurement reporting entry within the *VarMeasReportList* for this *measId*;
 - 3> set the *numberOfReportsSent* defined within the *VarMeasReportList* for this *measId* to 0;

3> initiate the measurement reporting procedure, as specified in 5.5.5;

NOTE 1: If the *purpose* is set to '*reportStrongestCells*', the UE initiates a first measurement report immediately after the quantity to be reported becomes available for at least either serving cell or one of the applicable cells. If the *purpose* is set to '*reportStrongestCellsForSON*', the UE initiates a first measurement report when it has determined the strongest cells on the associated frequency.

2> upon expiry of the periodical reporting timer for this *measId*:

3> initiate the measurement reporting procedure, as specified in 5.5.5;

2> if the *purpose* is included and set to '*reportCGI*' and if the UE acquired the information needed to set all fields of *cgi-Info* for the requested cell:

3> include a measurement reporting entry within the *VarMeasReportList* for this *measId*;

3> set the *numberOfReportsSent* defined within the *VarMeasReportList* for this *measId* to 0;

3> stop timer T321;

3> initiate the measurement reporting procedure, as specified in 5.5.5;

2> upon expiry of the T321 for this *measId*:

3> include a measurement reporting entry within the *VarMeasReportList* for this *measId*;

3> set the *numberOfReportsSent* defined within the *VarMeasReportList* for this *measId* to 0;

3> initiate the measurement reporting procedure, as specified in 5.5.5;

NOTE 2: The UE does not stop the periodical reporting with *triggerType* set to '*event*' or to '*periodical*' while the corresponding measurement is not performed due to the serving cell RSRP being equal to or better than *s-Measure* or due to the measurement gap not being setup.

NOTE 3: If the UE is configured with DRX, the UE may delay the measurement reporting for event triggered and periodical triggered measurements until the Active Time, which is defined in TS 36.321 [6].

[TS 36.331, clause 5.5.4.5]

The UE shall:

1> consider the entering condition for this event to be satisfied when condition A4-1, as specified below, is fulfilled;

1> consider the leaving condition for this event to be satisfied when condition A4-2, as specified below, is fulfilled;

Inequality A4-1 (Entering condition)

$$Mn + Ofn + Ocn - Hys > Thresh$$

Inequality A4-2 (Leaving condition)

$$Mn + Ofn + Ocn + Hys < Thresh$$

The variables in the formula are defined as follows:

Mn is the measurement result of the neighbouring cell, not taking into account any offsets.

Ofn is the frequency specific offset of the frequency of the neighbour cell (i.e. *offsetFreq* as defined within *measObjectEUTRA* corresponding to the frequency of the neighbour cell).

Ocn is the cell specific offset of the neighbour cell (i.e. *cellIndividualOffset* as defined within *measObjectEUTRA* corresponding to the frequency of the neighbour cell), and set to zero if not configured for the neighbour cell.

Hys is the hysteresis parameter for this event (i.e. *hysteresis* as defined within *reportConfigEUTRA* for this event).

Thresh is the threshold parameter for this event (i.e. *a4-Threshold* as defined within *reportConfigEUTRA* for this event).

Mn is expressed in dBm in case of RSRP, or in dB in case of RSRQ and RS-SINR.

Ofn, Ocn, Hys are expressed in dB.

Thresh is expressed in the same unit as *Mn*.

8.2.3.7.2.3 Test description

8.2.3.7.2.3.1 Pre-test conditions

System Simulator:

- NR Cell 1 is the PCell and E-UTRA Cell 1 is the PSCell.
- E-UTRA Cell 2 is the intra-frequency neighbour cell and NR Cell 2 is the intra-frequency neighbour cell.

UE:

- None.

Preamble:

- The UE is in state NE-DC RRC_CONNECTED using generic procedure parameter Connectivity (NE-DC) according to TS 38.508-1 [4], Table 4.5.4.2-6.

8.2.3.7.2.3.2 Test procedure sequence

Table 8.2.3.7.2.3.2-1 and Table 8.2.3.7.2.3.2-1A illustrates the downlink power levels to be applied for E-UTRA Cell 1 and E-UTRA Cell 2, NR Cell 1 and NR Cell 2 at various time instants of the test execution. Row marked "T0" denotes the conditions after the preamble, while rows marked "T1", "T2" and "T3" are to be applied subsequently. The exact instants on which these values shall be applied are described in the texts in this clause.

Table 8.2.3.7.2.3.2-1: Time instances of cell power level and parameter changes for FR1

	Parameter	Unit	E-UTRA Cell 1	E-UTRA Cell 2	NR Cell 1	NR Cell 2	Remark
T0	Cell-specific RS EPRE	dBm/15k Hz	-85	-91	-	-	The power level values are such that entry condition for event A4 is not satisfied
	SS/PBCH SSS EPRE	dBm/SC S	-		-88	-91	
T1	Cell-specific RS EPRE	dBm/15k Hz	-85	-76	-	-	The power level values are such that entry condition for event A4 is satisfied for intra-frequency neighbour E-UTRA Cell 2
	SS/PBCH SSS EPRE	dBm/SC S	-		-88	-91	
T2	Cell-specific RS EPRE	dBm/15k Hz	-85	-91	-	-	The power level values are such that entry conditions for event A4 is not satisfied for intra-frequency neighbour E-UTRA Cell 2
	SS/PBCH SSS EPRE	dBm/SC S	-		-88	-91	
T2	Cell-specific RS EPRE	dBm/15k Hz	-85	-91			The power level values are such that entry condition for event A4 is satisfied for intra-frequency neighbour NR Cell 2
	SS/PBCH SSS EPRE	dBm/SC S	-	-	-88	-79	

Table 8.2.3.7.2.3.2-1A: Time instances of cell power level and parameter changes for FR2

	Parameter	Unit	E-UTRA Cell 1	E-UTRA Cell 2	NR Cell 1	NR Cell 2	Remark
--	-----------	------	---------------	---------------	-----------	-----------	--------

T0	Cell-specific RS EPRE	dBm/15k Hz	FFS	FFS	-	-	The power level values are such that entry condition for event A4 is not satisfied
	SS/PBCH SSS EPRE	dBm/SC S	-	-	FFS	FFS	
T1	Cell-specific RS EPRE	dBm/15k Hz	FFS	FFS	-	-	The power level values are such that entry condition for event A4 is satisfied for intra-frequency neighbour E-UTRA Cell 2
	SS/PBCH SSS EPRE	dBm/SC S	-	-	FFS	FFS	
T2	Cell-specific RS EPRE	dBm/15k Hz	FFS	FFS	-	-	The power level values are such that entry conditions for event A4 is not satisfied for intra-frequency neighbour E-UTRA Cell 2
	SS/PBCH SSS EPRE	dBm/SC S	-	-	FFS	FFS	
T3	Cell-specific RS EPRE	dBm/15k Hz	FFS	FFS	-	-	The power level values are such that entry condition for event A4 is satisfied for intra-frequency neighbour NR Cell 2
	SS/PBCH SSS EPRE	dBm/SC S	-	-	FFS	FFS	

Table 8.2.3.7.2.3.2-2: Main behaviour

St	Procedure	Message Sequence		TP	Verdict
		U - S	Message		
1	The SS transmits an <i>RRCReconfiguration</i> message containing <i>RRCConnectionReconfiguration</i> message to setup measurements for neighbour E-UTRA Cells and reporting for event A4	<--	NR RRC: <i>RRCReconfiguration</i> (<i>RRCConnectionReconfiguration</i>)	-	-
2	The UE transmit an <i>RRCReconfigurationComplete</i> message.	-->	NR RRC: <i>RRCReconfigurationComplete</i> (<i>RRCConnectionReconfigurationComplete</i>)	-	-
3	The SS re-adjusts the cell-specific reference signal level according to row "T1".	-	-	-	-
4	Check: Does the UE transmit an <i>ULInformationTransferMRDC</i> message containing <i>MeasurementReport</i> message to report event A4 (<i>measId 1</i>) with the measured value for E-UTRA Cell 2?	→	NR RRC: <i>ULInformationTransferMRDC</i> (<i>MeasurementReport</i>)	1	P
-	EXCEPTION: Step 5 below is repeated until 3 <i>MeasurementReport</i> messages are received from the UE	-	-	-	-
5	Check: Does the UE transmit an <i>ULInformationTransferMRDC</i> message containing <i>MeasurementReport</i> message to report event A4 (<i>measId 1</i>) with the measured value for E-UTRA Cell 2?	→	NR RRC: <i>ULInformationTransferMRDC</i> (<i>MeasurementReport</i>)	1	P
6	The SS re-adjusts the cell-specific reference signal level according to row "T2".	-	-	-	-
7	Wait and ignore <i>MeasurementReport</i> messages for 15 s to allow change of power levels for E-UTRA Cell 2 and UE measurement.	-	-	-	-
8	Check: Does the UE transmit an <i>ULInformationTransferMRDC</i> message containing <i>MeasurementReport</i> message within the next 10s to report event A4?	-->	NR RRC: <i>ULInformationTransferMRDC</i> (<i>MeasurementReport</i>)	2	F
9	The SS transmits an <i>RRCReconfiguration</i> message including <i>MeasConfig</i> to setup NR measurement and reporting for intra-frequency event A4 (<i>measId 2</i>) and reportAddNeighMeas.	<--	NR RRC: <i>RRCReconfiguration</i>	-	-

10	The UE transmit an <i>RRCReconfigurationComplete</i> message.	-->	NR RRC: <i>RRCReconfigurationComplete</i>	-	-
11	SS re-adjusts the cell-specific reference signal level according to row "T3".	-	-	-	-
12	Check: Does the UE transmit a <i>MeasurementReport</i> message to report event A4 (<i>measId 2</i>) with the measured RSRP value for NR Cell 2, E-UTRA PSCell and E-UTRA neighbour Cell 2.	-->	NR RRC: <i>MeasurementReport</i>	3	P

8.2.3.2.2.3.3 Specific message contents

Table 8.2.3.7.2.3.3-1: *RRCReconfiguration* (step 1, Table 8.2.3.7.2.3.2-3)

Derivation Path: TS 38.508-1 [4], Table 4.6.1-13 with condition NE-DC

Table 8.2.3.7.2.3.3-2: *SCG-Configuration-r12-NE-DC* (step 1, Table 8.2.3.7.2.3.2-3)

Derivation Path: TS 36.508, Table 4.6.3-19G			
Information Element	Value/remark	Comment	Condition
scg-Configuration-r12 CHOICE {			
setup SEQUENCE {			
scg-ConfigPartSCG-r12 SEQUENCE {			
measConfigSN-r15	MeasConfig-A4-E-UTRA		
}			
}			
}			

Table 8.2.3.7.2.3.3-3: *MeasConfig-A4-E-UTRA* (Table 8.2.3.7.2.3.3-2)

Derivation path: TS 36.508, table 4.6.6-1			
Information Element	Value/Remark	Comment	Condition
MeasConfig-DEFAULT ::= SEQUENCE {			
measObjectToAddModList SEQUENCE (SIZE (1..maxObjectId)) OF MeasObjectToAddMod {	1 entry		
MeasObjectToAddMod[1] SEQUENCE {		entry 1	
measObjectId	1		
measObject CHOICE {			
measObjectEUTRA	MeasObjectEUTRA-GENERIC(f1)		
	MeasObjectEUTRA-GENERIC(maxEARFCN)		Band > 64
}			
}			
reportConfigToAddModList SEQUENCE (SIZE (1..maxReportConfigId)) OF reportConfigToAddMod {	1 entry		
reportConfigToAddMod[1] SEQUENCE {		entry 1	
reportConfigId	1		
reportConfig	ReportConfig-A4		
}			
}			
measIdToAddModList SEQUENCE (SIZE (1..maxMeasId)) OF measIdToAddMod {	1 entry		
measIdToAddMod[1] SEQUENCE {		entry 1	
measId	1		
measObjectId	1		
reportConfigId	1		
}			
}			

measObjectToAddModList-v9e0 ::= SEQUENCE (SIZE (1..maxObjectld)) OF measObjectEUTRA-v9e0 {	1 entry		Band > 64
measObjectEUTRA-v9e0[1] SEQUENCE {		entry 1	
carrierFreq-v9e0	Same downlink EARFCN as used for f1		
}			
}			
}			

Table 8.2.3.7.2.3.3-4: ReportConfig-A4 (step 1, Table 8.2.3.7.2.3.2-3)

Derivation path: TS 36.508 table 4.6.6-6AA ReportConfigEUTRA-A4			
Information Element	Value/remark	Comment	Condition
ReportConfigEUTRA-A4 ::= SEQUENCE {			
triggerType CHOICE {			
event SEQUENCE {			
eventId CHOICE {			
eventA4 SEQUENCE {			
a4-Threshold CHOICE{			
threshold-RSRP	55	-85dbm	
}			
}			
}			
reportQuantity	sameAsTriggerQuantity		
reportAmount	r16		
}			

Table 8.2.3.7.2.3.3-5: RRCReconfigurationComplete (step 2 and step 10, Table 8.2.3.7.2.3.2-3)

Derivation Path: TS 38.508-1 [4], Table 4.6.1-14 Condition with NE-DC

Table 8.2.3.7.2.3.3-6: ULInformationTransferMRDC (step 4 and step 5, Table 8.2.3.7.2.3.2-3)

Derivation Path: TS 36.508 [7], Table 4.6.1-27			
Information Element	Value/remark	Comment	Condition
ULInformationTransferMRDC ::= SEQUENCE {			
ul-DCCH-MessageEUTRA	OCTET STRING including the MeasurementReport message according to Table 8.2.3.7.2.3.3-7		
}			

Table 8.2.3.7.2.3.3-7: MeasurementReport (Table 8.2.3.7.2.3.3-6)

Derivation path: TS 36.508 4.6.1 table 4.6.1-5			
Information Element	Value/Remark	Comment	Condition
MeasurementReport ::= SEQUENCE {			
criticalExtensions CHOICE {			
c1 CHOICE {			
measurementReport-r8 SEQUENCE {			
measResults SEQUENCE {			
measId	1		
measResultPCell SEQUENCE {		Report E-UTRA Cell 1	
rsrpResult	(0..97)		
rsrqResult	(0..34)		
}			

measResultNeighCells CHOICE {			
measResultListEUTRA SEQUENCE (SIZE (1..maxCellReport)) OF measResultEUTRA {	1 entry	Report E-UTRA Cell 2	
measResultEUTRA[1] SEQUENCE {		entry1	
physCellId	physCellId of the E-UTRA Cell 2.		
measResult SEQUENCE{			
rsrpResult	(0..97)		
rsrqResult	Not present		
}			
}			
}			
measResultListUTRA	Not present		
measResultListGERAN	Not present		
measResultsCDMA2000	Not present		
measResultNeighCellListNR-r15	Not present		
}			
}			
}			
}			
}			
}			

Table 8.2.3.7.2.3.3-8: RRCReconfiguration (step 9, Table 8.2.3.7.2.3.2-3)

Derivation Path: TS 38.508-1 [4] Table 4.6.1-13 with condition NR_MEAS

Table 8.2.3.7.2.3.3-9: MeasConfig-A4 (Table 8.2.3.7.2.3.3-8)

Derivation Path: TS 38.508-1 [4] Table 4.6.3-69			
Information Element	Value/remark	Comment	Condition
MeasConfig ::= SEQUENCE {			
measObjectToAddModList SEQUENCE (SIZE (1..maxNrofMeasId)) OF MeasObjectToAddMod {	1 entry		
MeasObjectToAddMod[1] SEQUENCE {		entry 1	
measObjectId	1		
measObject CHOICE {			
measObjectNR	MeasObjectNR		
}			
}			
}			
reportConfigToAddModList SEQUENCE(SIZE (1..maxReportConfigId)) OF ReportConfigToAddMod {	1 entry		
ReportConfigToAddMod[1] SEQUENCE {		entry 1	
reportConfigId	1		
reportConfig CHOICE {			
reportConfigNR	ReportConfigNR-EventA4		
}			
}			
}			
measIdToAddModList SEQUENCE (SIZE (1..maxNrofMeasId)) OF MeasIdToAddMod {	1 entry		
MeasIdToAddMod[1] SEQUENCE {		entry 1	
measId	2		
measObjectId	1		
reportConfigId	1		
}			
}			
}			

Table 8.2.3.7.2.3.3-10: *MeasObjectNR* (Table 8.2.3.7.2.3.3-9)

Derivation Path: TS 38.508-1 [4], Table 4.6.3-76			
Information Element	Value/remark	Comment	Condition
MeasObjectNR ::= SEQUENCE {			
ssbFrequency	ARFCN-ValueNR for SSB of NR Cell 2		
absThreshSS-BlocksConsolidation	Not present		
nrofSS-BlocksToAverage	Not present		
}			

Table 8.2.3.7.2.3.3-11: *ReportConfigNR-EventA4* (Table 8.2.3.7.2.3.3-9)

Derivation Path: TS 38.508-1 [4] Table 4.6.3-142 with condition EVENT_A4			
Information Element	Value/remark	Comment	Condition
ReportConfigNR ::= SEQUENCE {			
reportType CHOICE {			
eventTriggered SEQUENCE {			
eventId CHOICE {			
EventA4 SEQUENCE {			
a4-Threshold CHOICE {			
rsrp	72	-84dbm	FR1
	FFS		FR2
}			
}			
}			
reportAmount	r16		
reportQuantityCell SEQUENCE {			
rsrp	true		
rsrq	false		
sinr	false		
}			
reportAddNeighMeas	setup		
}			
}			

Table 8.2.3.7.2.3.3-12: *MeasurementReport* (step 12, Table 8.2.3.7.2.3.2-3)

Derivation Path: TS 38.508-1 [4] Table 4.6.1-5A			
Information Element	Value/remark	Comment	Condition
MeasurementReport ::= SEQUENCE {			
criticalExtensions CHOICE {			
measurementReport SEQUENCE {			
measResults SEQUENCE {			
measId	2		
measResultServingMOList SEQUENCE (SIZE (1..maxNrofServingCells)) OF MeasResultServMO {	1 entry	Measurement report for NR Cell 1	
MeasResultServMO[1] SEQUENCE {		entry 1	
servCellId	ServCellIndex of NR Cell 1		
measResultServingCell SEQUENCE {			
physCellId	PCI of NR Cell 1		
measResult SEQUENCE {			
cellResults SEQUENCE {			
resultsSSB-Cell SEQUENCE {			
rsrp	(0..127)		
rsrq	(0..127)		
sinr	Not present		
}	Not checked		pc_ss_SIN R_Meas
}			
}			
}			
}			
}			

}			
}			
}			
measResultNeighCells CHOICE {			
measResultListNR SEQUENCE (SIZE (1..maxCellReport)) OF MeasResultNR {	1 entry	Measurement report for NR Cell 2	
MeasResultNR[1] SEQUENCE {		entry 1	
physCellId	Physical layer cell identity of NR Cell 2		
measResult SEQUENCE {			
cellResults SEQUENCE {			
resultsSSB-Cell SEQUENCE {			
rsrp	(0..127)		
rsrq	Not present		
sinr	Not present		
}			
resultsCSI-RS-Cell	Not present		
}			
rsIndexResults	Not present		
}			
cgi-Info	Not present		
}			
}			
measResultServFreqListEUTRA-SCG SEQUENCE (SIZE (1..maxNrofServingCellsEUTRA)) OF MeasResult2EUTRA {	1 entry		
MeasResult2EUTRA[1] SEQUENCE {		entry 1	
carrierFreq	ARFCN-Value for E-UTRA Cell 1		
measResultServingCell SEQUENCE {			
eutra-PhysCellId	PhysCellId of E-UTRA Cell 1		
measResult SEQUENCE {			
rsrp	(0..97)		
rsrq	Not present		
sinr	Not present		
}			
cgi-Info	Not present		
}			
measResultBestNeighCell SEQUENCE {			
eutra-PhysCellId	PhysCellId of E-UTRA Cell 2		
measResult SEQUENCE {			
rsrp	(0..97)		
rsrq	Not present		
sinr	Not present		
}			
cgi-Info	Not present		
}			
}			
}			
}			
}			
}			
}			

8.2.3.7.2a Measurement configuration control and reporting / Event A4 / Measurement of Neighbour E-UTRA and NR cells / Inter-frequency measurements / NE-DC

8.2.3.7.2a.1 Test Purpose (TP)

(1)

```
with { UE in RRC_CONNECTED state with NE-DC, and, MCG(s) (NR PDCP) and SCG and Inter-frequency
measurements configured for event A4 with event based periodical reporting }
ensure that {
  when { Neighbour E-UTRA cell becomes better than absolute threshold }
  then { UE sends MeasurementReport message at regular intervals while entering condition for
event A4 is satisfied }
}
```

(2)

```
with { UE in RRC_CONNECTED state with NE-DC, and, MCG(s) (NR PDCP) and SCG and periodical
measurement reporting triggered by event A4 ongoing }
ensure that {
  when { Neighbour E-UTRA cell becomes worse than absolute threshold }
  then { UE stops sending MeasurementReport message }
}
```

(3)

```
with { UE in RRC_CONNECTED state with NE-DC, and, MCG(s) (NR PDCP) and SCG and measurements
configured for event A4 including reportAddNeighMeas with event based periodical reporting }
ensure that {
  when { Neighbour NR cell becomes better than absolute threshold }
  then { UE sends MeasurementReport at regular intervals while entering condition for event A4 is
satisfied, and includes measurement result for the PSCELL. }
}
```

8.2.3.7.2a.2 Conformance requirements

Same as test case 8.2.3.7.2

8.2.3.7.2a.3 Test description

8.2.3.7.2a.3.1 Pre-test conditions

Same as test case 8.2.3.7.2 with the following differences:

- Cells configuration: NR Cell 3 replaces NR Cell 2 and E-UTRA Cell 3 replaces E-UTRA Cell 2.

8.2.3.7.2a.3.2 Test procedure sequence

Same as test case 8.2.3.7.2 with the following differences:

- Cells configuration: NR Cell 3 replaces NR Cell 2 and E-UTRA Cell 3 replaces E-UTRA Cell 2.

8.2.3.2.2.3.3 Specific message contents

Same as test case 8.2.3.7.2 with the following differences:

- Cells configuration: NR Cell 3 replaces NR Cell 2 and E-UTRA Cell 3 replaces E-UTRA Cell 2.

Table 8.2.3.7.2a.3.3-3: MeasConfig-A4-E-UTRA (Table 8.2.3.7.2.3.3-2)

Derivation path: 36.508 table 4.6.6-1			
Information Element	Value/Remark	Comment	Condition
MeasConfig-DEFAULT ::= SEQUENCE {			
measObjectToAddModList SEQUENCE (SIZE (1..maxObjectId)) OF measObjectToAddMod {	2 entries		
measObjectId[1] SEQUENCE {		entry 1	

measObjectId	1		
measObject CHOICE {			
measObjectEUTRA	MeasObjectEUTRA- GENERIC(f1)		
	MeasObjectEUTRA- GENERIC(maxEARFCN)		Band > 64
}			
}			
measObjectId[2] SEQUENCE {		entry 2	
measObjectId	2		
measObject CHOICE {			
measObjectEUTRA	MeasObjectEUTRA- GENERIC(f2)		
	MeasObjectEUTRA- GENERIC(maxEARFCN)		Band > 64
}			
}			
}			
reportConfigToAddModList SEQUENCE (SIZE (1..maxReportConfigId)) OF reportConfigToAddMod {	1 entry		
reportConfigToAddMod[1] SEQUENCE {		entry 1	
reportConfigId	1		
reportConfig	ReportConfig-A4		
}			
}			
measIdToAddModList SEQUENCE (SIZE (1..maxMeasId)) OF measIdToAddMod {	1 entry		
measIdToAddMod[1] SEQUENCE {		entry 1	
measId	1		
measObjectId	1		
reportConfigId	1		
}			
}			
measGapConfig	MeasGapConfig-GP1		
measObjectToAddModList-v9e0 ::= SEQUENCE (SIZE (1..maxObjectId)) OF measObjectEUTRA-v9e0 {	1 entry		Band > 64
measObjectEUTRA-v9e0[1] SEQUENCE {		entry 1	
carrierFreq-v9e0	Same downlink EARFCN as used for f1		
}			
}			
}			

Table 8.2.3.7.2a.3.3-9: MeasConfig-A4 (Table 8.2.3.7.2.3.3-8)

Derivation Path: TS 38.508-1 [4] Table 4.6.3-69			
Information Element	Value/remark	Comment	Condition
MeasConfig ::= SEQUENCE {			
measObjectToAddModList SEQUENCE (SIZE (1..maxNrofMeasId)) OF MeasObjectToAddMod {	2 entries		
MeasObjectToAddMod[1] SEQUENCE {		entry 1	
measObjectId	1		
measObject CHOICE {			
measObjectNR	MeasObjectNR-f1		
}			
}			
MeasObjectToAddMod[2] SEQUENCE {		entry 2	
measObjectId	2		
measObject CHOICE {			
measObjectNR	MeasObjectNR-f2		
}			
}			
}			

8.2.3.7.2b.2 Conformance requirements

Same as test case 8.2.3.7.2a

8.2.3.7.2b.3 Test description

8.2.3.7.2b.3.1 Pre-test conditions

Same as test case 8.2.3.7.2a with the following differences:

- Cells configuration: NR Cell 10 replaces NR Cell 3; EUTRA Cell 10 replaces EUTRA Cell 3.

8.2.3.7.2b.3.2 Test procedure sequence

Same as test case 8.2.3.7.2a with the following differences:

- Cells configuration: NR Cell 10 replaces NR Cell 3; EUTRA Cell 10 replaces EUTRA Cell 3.

8.2.3.7.2b.3.3 Specific message contents

Same as test case 8.2.3.7.2a with the following differences:

- Cells configuration: NR Cell 10 replaces NR Cell 3; EUTRA Cell 10 replaces EUTRA Cell 3.

8.2.3.8 Measurement configuration control and reporting / Event A5 / Measurement of Neighbour NR cell

8.2.3.8.1 Measurement configuration control and reporting / Event A5 / Measurement of Neighbour NR cell / Intra-frequency measurements / EN-DC

8.2.3.8.1.1 Test Purpose (TP)

(1)

```
with { UE in RRC_CONNECTED state with EN-DC, and, MCG(s) (E-UTRA PDCP) and SCG and measurement
configured for event A5 with event based periodical reporting }
ensure that {
  when { Serving NR PSCell becomes worse than absolute threshold1 and neighbour NR cell becomes
better than absolute threshold2 }
  then { UE sends MeasurementReport message at regular intervals while entering conditions for
event A5 are satisfied }
}
```

(2)

```
with { UE in RRC_CONNECTED state with EN-DC, and, MCG(s) (E-UTRA PDCP) and SCG and periodical
measurement reporting triggered by event A5 ongoing }
ensure that {
  when { Serving NR PSCell becomes better than absolute threshold1 or neighbour NR cell becomes
worse than absolute threshold2 }
  then { UE stops sending MeasurementReport message }
}
```

8.2.3.8.1.2 Conformance requirements

References: The conformance requirements covered in the present TC are specified in: TS 36.331, clause 5.3.5.3, TS 38.331, clauses 5.3.5.3, 5.5.2, 5.5.4.1 and 5.5.4.6. Unless otherwise stated these are Rel-15 requirements.

[TS 36.331, clause 5.3.5.3]

If the *RRConnectionReconfiguration* message does not include the *mobilityControlInfo* and the UE is able to comply with the configuration included in this message, the UE shall:

- 1> if the *RRCConnectionReconfiguration* message includes the *measConfig*:
 - 2> perform the measurement configuration procedure as specified in 5.5.2;
- 1> set the content of *RRCConnectionReconfigurationComplete* message as follows:
 - 2> if the received *RRCConnectionReconfiguration* message included *nr-SecondaryCellGroupConfig*:
 - 3> include *scg-ConfigResponseNR* in accordance with TS 38.331 [82], clause 5.3.5.3;
- 1> set the content of *RRCConnectionReconfigurationComplete* message as follows:
 - 2> if the received *RRCConnectionReconfiguration* message included *nr-SecondaryCellGroupConfig*:
 - 3> include *scg-ConfigResponseNR* in accordance with TS 38.331 [82], 5.3.5.3;
- 1> submit the *RRCConnectionReconfigurationComplete* message to lower layers for transmission using the new configuration, upon which the procedure ends;

[TS 38.331, clause 5.3.5.3]

The UE shall perform the following actions upon reception of the *RRCReconfiguration*:

- 1> if the *RRCReconfiguration* includes the *secondaryCellGroup*:
 - 2> perform the cell group configuration for the SCG according to 5.3.5.5;
- 1> if the *RRCReconfiguration* message includes the *measConfig*:
 - 2> perform the measurement configuration procedure as specified in 5.5.2;
 - 1> if the UE is configured with E-UTRA *nr-SecondaryCellGroupConfig* (MCG is E-UTRA):
 - 2> if *RRCReconfiguration* was received via SRB1:
 - 3> construct *RRCReconfigurationComplete* message and submit it via the EUTRA MCG embedded in E-UTRA RRC message *RRCConnectionReconfigurationComplete* as specified in TS 36.331 [10];

[TS 38.331, clause 5.5.2]

The UE shall:

- 1> if the received *measConfig* includes the *measObjectToAddModList*:
 - 2> perform the measurement object addition/modification procedure as specified in 5.5.2.5;
- 1> if the received *measConfig* includes the *reportConfigToAddModList*:
 - 2> perform the reporting configuration addition/modification procedure as specified in 5.5.2.7;
- 1> if the received *measConfig* includes the *measIdToAddModList*:
 - 2> perform the measurement identity addition/modification procedure as specified in 5.5.2.3;

[TS 38.331, clause 5.5.4.1]

If security has been activated successfully, the UE shall:

- 1> for each *measId* included in the *measIdList* within *VarMeasConfig*:
 - 2> if the corresponding *reportConfig* includes a *reportType* set to *eventTriggered* or *periodical*;
 - 3> if the corresponding *measObject* concerns NR;
 - 4> if the *eventA1* or *eventA2* is configured in the corresponding *reportConfig*:
 - 5> consider only the serving cell to be applicable;
 - 4> else:

- 5> for events involving a serving cell associated with a *measObjectNR* and neighbours associated with another *measObjectNR*, consider any serving cell associated with the other *measObjectNR* to be a neighbouring cell as well;
- 2> if the *reportType* is set to *eventTriggered* and if the entry condition applicable for this event, i.e. the event corresponding with the *eventId* of the corresponding *reportConfig* within *VarMeasConfig*, is fulfilled for one or more applicable cells for all measurements after layer 3 filtering taken during *timeToTrigger* defined for this event within the *VarMeasConfig*, while the *VarMeasReportList* does not include a measurement reporting entry for this *measId* (a first cell triggers the event):
- 3> include a measurement reporting entry within the *VarMeasReportList* for this *measId*;
- 3> set the *numberOfReportsSent* defined within the *VarMeasReportList* for this *measId* to 0;
- 3> include the concerned cell(s) in the *cellsTriggeredList* defined within the *VarMeasReportList* for this *measId*;
- 3> initiate the measurement reporting procedure, as specified in 5.5.5;
- 2> if the *reportType* is set to *eventTriggered* and if the entry condition applicable for this event, i.e. the event corresponding with the *eventId* of the corresponding *reportConfig* within *VarMeasConfig*, is fulfilled for one or more applicable cells not included in the *cellsTriggeredList* for all measurements after layer 3 filtering taken during *timeToTrigger* defined for this event within the *VarMeasConfig* (a subsequent cell triggers the event):
- 3> set the *numberOfReportsSent* defined within the *VarMeasReportList* for this *measId* to 0;
- 3> include the concerned cell(s) in the *cellsTriggeredList* defined within the *VarMeasReportList* for this *measId*;
- 3> initiate the measurement reporting procedure, as specified in 5.5.5;

[TS 38.331, clause 5.5.4.6]

The UE shall:

- 1> consider the entering condition for this event to be satisfied when both condition A5-1 and condition A5-2, as specified below, are fulfilled;
- 1> consider the leaving condition for this event to be satisfied when condition A5-3 or condition A5-4, i.e. at least one of the two, as specified below, is fulfilled;
- 1> use the SpCell for *Mp*.

NOTE: The cell(s) that triggers the event is on the frequency indicated in the associated *measObjectNR* which may be different from the frequency used by the NR SpCell.

Inequality A5-1 (Entering condition 1)

$$M_p + H_{ys} < Thresh_L$$

Inequality A5-2 (Entering condition 2)

$$M_n + O_{fn} + O_{cn} - H_{ys} > Thresh_L$$

Inequality A5-3 (Leaving condition 1)

$$M_p - H_{ys} > Thresh_L$$

Inequality A5-4 (Leaving condition 2)

$$M_n + O_{fn} + O_{cn} + H_{ys} < Thresh_L$$

The variables in the formula are defined as follows:

Mp is the measurement result of the NR SpCell, not taking into account any offsets.

Mn is the measurement result of the neighbouring cell/SCell, not taking into account any offsets.

Ofn is the measurement object specific offset of the neighbour/SCell cell (i.e. *offsetMO* as defined within *measObjectNR* corresponding to the frequency of the neighbour cell/SCell).

Ocn is the cell specific offset of the neighbour cell (i.e. *cellIndividualOffset* as defined within *measObjectNR* corresponding to the neighbour cell/SCell), and set to zero if not configured for the neighbour cell.

Hys is the hysteresis parameter for this event (i.e. *hysteresis* as defined within *reportConfigNR* for this event).

Thresh1 is the threshold parameter for this event (i.e. *a5-Threshold1* as defined within *reportConfigNR* for this event).

Thresh2 is the threshold parameter for this event (i.e. *a5-Threshold2* as defined within *reportConfigNR* for this event).

Mn, Mp are expressed in dBm in case of RSRP, or in dB in case of RSRQ and RS-SINR.

Ofn, Ocn, Hys are expressed in dB.

Thresh1 is expressed in the same unit as **Mp**.

Thresh2 is expressed in the same unit as **Mn**.

[TS 38.331, clause 5.5.5]

For the *measId* for which the measurement reporting procedure was triggered, the UE shall set the *measResults* within the *MeasurementReport* message as follows:

- 1> set the *measId* to the measurement identity that triggered the measurement reporting;
- 1> set the *measResultServingCell* within *measResultServingMOList* to include RSRP, RSRQ and the available SINR for each configured serving cell derived based on the *rsType* indicated in the associated *reportConfig*;
- 1> set the *measResultServingCell* within *measResultServingMOList* to include for each NR serving cell that is configured with *servingCellMO*, if any, the *servCellId*;
- ...
- 1> if there is at least one applicable neighbouring cell to report:
 - 2> if the *reportType* is set to *eventTriggered* or *periodical*:
 - 3> set the *measResultNeighCells* to include the best neighbouring cells up to *maxReportCells* in accordance with the following:
 - 4> if the *reportType* is set to *eventTriggered*:
 - 5> include the cells included in the *cellsTriggeredList* as defined within the *VarMeasReportList* for this *measId*;
 - 4> else:
 - 5> include the applicable cells for which the new measurement results became available since the last periodical reporting or since the measurement was initiated or reset;
 - 4> for each cell that is included in the *measResultNeighCells*, include the *physCellId*;
 - 4> if the *reportType* is set to *eventTriggered* or *periodical*:
 - 5> for each included cell, include the layer 3 filtered measured results in accordance with the *reportConfig* for this *measId*, ordered as follows:
 - 6> if the *measObject* associated with this *measId* concerns NR:
 - 7> if *rsType* in the associated *reportConfig* is set to *ssb*:

8> set *resultsSSB-Cell* within the *measResult* to include the SS/PBCH block based quantity(ies) indicated in the *reportQuantityCell* within the concerned *reportConfig*, in decreasing order of the sorting quantity, determined as specified in 5.5.5.3, i.e. the best cell is included first;

1> if the UE is configured with EN-DC:

2> if SRB3 is configured:

3> submit the *MeasurementReport* message via SRB3 to lower layers for transmission, upon which the procedure ends;

2>else:

3> submit the *MeasurementReport* message via the EUTRA MCG embedded in E-UTRA RRC message *ULInformationTransferMRDC* as specified in TS 36.331 [10].

1> else:

2>submit the *MeasurementReport* message to lower layers for transmission, upon which the procedure ends.

8.2.3.8.1.3 Test description

8.2.3.8.1.3.1 Pre-test conditions

System Simulator:

- EUTRA Cell 1 is the PCell and NR Cell 1 is the Serving PS Cell.
- NR Cell 2 is the intra-frequency neighbour cell.

UE:

- None

Preamble:

- The UE is in state RRC_CONNECTED in EN-DC mode and DC Bearers (MCG and SCG) on E-UTRA Cell 1 according to TS 38.508-1 [4].

8.2.3.8.1.3.2 Test procedure sequence

Table 8.2.3.8.1.3.2-1 and Table 8.2.3.8.1.3.2-1A illustrates the downlink power levels to be applied for NR Cell 1 and NR Cell 2 at various time instants of the test execution. Row marked "T0" denotes the conditions after the preamble, while rows marked "T1", "T2", "T3", "T4" and "T5" are to be applied subsequently. The exact instants on which these values shall be applied are described in the texts in this clause.

Table 8.2.3.8.1.3.2-1: Time instances of cell power level and parameter changes for conducted test environment

	Parameter	Unit	EUTRA Cell 1	NR Cell 1	NR Cell 2	Remark
T0	Cell-specific RS EPRE	dBm/15kHz	-85	-	-	Power levels are such that entry condition for event A5 is not satisfied, i.e. condition A5-1 ($Mp+Hys<Thresh$) is fulfilled but condition A5-2 ($Mn+Ofn+Ocn-Hys>Thresh2$) is not fulfilled for intra-frequency neighbour NR Cell 2.
	SS/PBCH SSS EPRE	dBm/SCS	-	-90	-96	
T1	Cell-specific RS EPRE	dBm/15kHz	-85	-	-	Power levels are such that entry condition for event A5 is not satisfied, i.e. condition A5-1 ($Mp+Hys<Thresh$) is not fulfilled but condition A5-2 ($Mn+Ofn+Ocn-Hys>Thresh2$) is fulfilled for intra-frequency neighbour NR Cell 2.
	SS/PBCH SSS EPRE	dBm/SCS	-	-78	-84	

T2	Cell-specific RS EPRE	dBm/15kHz	-85	-	-	Power levels are such that entry condition for event A5 is satisfied, i.e. condition A5-1 ($Mp+Hys < Thresh1$) and condition A5-2 ($Mn+Ofn+Ocn-Hys > Thresh2$) are fulfilled for intra-frequency neighbour NR Cell 2 (i.e. periodical reporting for event A5 starts).
	SS/PBCH SSS EPRE	dBm/SCS	-	-90	-84	
T3	Cell-specific RS EPRE	dBm/15kHz	-85	-	-	Power levels are such that leaving condition for event A5 is satisfied, i.e. condition A5-3 ($Mp-Hys > Thresh1$) is satisfied but condition A5-4 ($Mn+Ofn+Ocn+Hys < Thresh2$) is not satisfied for intra-frequency neighbour NR Cell 2 (i.e. periodical reporting for event A5 stops).
	SS/PBCH SSS EPRE	dBm/SCS	-	-78	-84	
T4	Cell-specific RS EPRE	dBm/15kHz	-85	-	-	Power levels are such that entry condition for event A5 is satisfied, i.e. condition A5-1 ($Mp+Hys < Thresh1$) and condition A5-2 ($Mn+Ofn+Ocn-Hys > Thresh2$) are fulfilled for intra-frequency neighbour NR Cell 2 (i.e. periodical reporting for event A5 starts).
	SS/PBCH SSS EPRE	dBm/SCS	-	-90	-84	
T5	Cell-specific RS EPRE	dBm/15kHz	-85	-	-	Power levels are such that leaving condition for event A5 is satisfied, i.e. condition A5-3 ($Mp-Hys > Thresh1$) is not satisfied but condition A5-4 ($Mn+Ofn+Ocn+Hys < Thresh2$) is satisfied for intra-frequency neighbour NR Cell 2 (i.e. periodical reporting for event A5 stops).
	SS/PBCH SSS EPRE	dBm/SCS	-	-90	-96	

Table 8.2.3.8.1.3.2-1A: Time instances of cell power level and parameter changes for OTA test environment

	Parameter	Unit	EUTRA Cell 1	NR Cell 1	NR Cell 2	Remark
T0	Cell-specific RS EPRE	dBm/15kHz	-96	-	-	Power levels are such that entry condition for event A5 is not satisfied, i.e. condition A5-1 ($Mp+Hys < Thresh1$) is fulfilled but condition A5-2 ($Mn+Ofn+Ocn-Hys > Thresh2$) is not fulfilled for intra-frequency neighbour NR Cell 2.
	SS/PBCH SSS EPRE	dBm/SCS	-	-100	-109	
T1	Cell-specific RS EPRE	dBm/15kHz	-96	-	-	Power levels are such that entry condition for event A5 is not satisfied, i.e. condition A5-1 ($Mp+Hys < Thresh1$) is not fulfilled but condition A5-2 ($Mn+Ofn+Ocn-Hys > Thresh2$) is fulfilled for intra-frequency neighbour NR Cell 2.
	SS/PBCH SSS EPRE	dBm/SCS	-	-82	-91	
T2	Cell-specific RS EPRE	dBm/15kHz	-96	-	-	Power levels are such that entry condition for event A5 is satisfied, i.e. condition A5-1 ($Mp+Hys < Thresh1$) and condition A5-2 ($Mn+Ofn+Ocn-Hys > Thresh2$) are fulfilled for intra-frequency neighbour NR Cell 2 (i.e. periodical reporting for event A5 starts).
	SS/PBCH SSS EPRE	dBm/SCS	-	-100	-82	
T3	Cell-specific RS EPRE	dBm/15kHz	-96	-	-	Power levels are such that leaving condition for event A5 is satisfied, i.e. condition A5-3 ($Mp-Hys > Thresh1$) is satisfied but condition A5-4 ($Mn+Ofn+Ocn+Hys < Thresh2$) is not satisfied for intra-frequency neighbour NR Cell 2 (i.e. periodical reporting for event A5 stops).
	SS/PBCH SSS EPRE	dBm/SCS	-	-82	-82	
T4	Cell-specific RS EPRE	dBm/15kHz	-96	-	-	Power levels are such that entry condition for event A5 is satisfied, i.e. condition A5-1 ($Mp+Hys < Thresh1$) and condition A5-2 ($Mn+Ofn+Ocn-Hys > Thresh2$) are fulfilled for intra-frequency neighbour NR Cell 2 (i.e. periodical reporting for event A5 starts).
	SS/PBCH SSS EPRE	dBm/SCS	-	-100	-82	
T5	Cell-specific RS EPRE	dBm/15kHz	-96	-	-	Power levels are such that leaving condition for event A5 is satisfied, i.e. condition A5-3 ($Mp-Hys > Thresh1$) is not satisfied but condition A5-4 ($Mn+Ofn+Ocn+Hys < Thresh2$) is satisfied
	SS/PBCH SSS EPRE	dBm/SCS	-	-100	-100	

						for intra-frequency neighbour NR Cell 2 (i.e. periodical reporting for event A5 stops).
--	--	--	--	--	--	---

Table 8.2.3.8.1.3.2-2: Main behaviour

St	Procedure	Message Sequence		TP	Verdict
		U - S	Message		
1	The SS transmits an <i>RRCCoNNECTIONReCoNFIGURATIoN</i> message containing NR <i>RRCCoNFIGURATIoN</i> message to setup measurements for neighbour NR Cells and reporting for event A5.	<--	<i>RRCCoNNECTIONReCoNFIGURATIoN (RRCCoNFIGURATIoN)</i>	-	-
2	Check: Does the UE transmit an <i>RRCCoNNECTIONReCoNFIGURATIoNCoMPLETE</i> message containing NR <i>RRCCoNFIGURATIoNCoMPLETE</i> message?	-->	<i>RRCCoNNECTIONReCoNFIGURATIoNCoMPLETE (RRCCoNFIGURATIoNCoMPLETE)</i>	-	-
3	Check: Does the UE transmit an <i>ULINFORMATIONTRANSFERMRDC</i> message containing NR <i>MEASUREMENTREPORT</i> message within the next 10s?	-->	<i>ULINFORMATIONTRANSFERMRDC (MEASUREMENTREPORT)</i>	1	F
4	The SS re-adjusts the cell-specific reference signal level according to row "T1".	-	-	-	-
5	Check: Does the UE transmit an <i>ULINFORMATIONTRANSFERMRDC</i> message containing NR <i>MEASUREMENTREPORT</i> message to report event A5 with the measured value for NR Cell 2?	-->	<i>ULINFORMATIONTRANSFERMRDC (MEASUREMENTREPORT)</i>	1	F
-	EXCEPTION: Steps 5a1-5a2 are executed in case of FR2	-	-	-	-
5a1	The SS transmits an <i>RRCCoNNECTIONReCoNFIGURATIoN</i> message containing NR <i>RRCCoNFIGURATIoN</i> message to setup measurements for neighbour NR Cells and reporting for event A5.	<--	<i>RRCCoNNECTIONReCoNFIGURATIoN (RRCCoNFIGURATIoN)</i>	-	-
5a2	Check: Does the UE transmit an <i>RRCCoNNECTIONReCoNFIGURATIoNCoMPLETE</i> message containing NR <i>RRCCoNFIGURATIoNCoMPLETE</i> message?	-->	<i>RRCCoNNECTIONReCoNFIGURATIoNCoMPLETE (RRCCoNFIGURATIoNCoMPLETE)</i>	-	-
6	The SS re-adjusts the cell-specific reference signal level according to row "T2".	-	-	-	-
7	Check: Does the UE transmit an <i>ULINFORMATIONTRANSFERMRDC</i> message containing NR <i>MEASUREMENTREPORT</i> message to report event A5 with the measured value for NR Cell 2?	-->	<i>ULINFORMATIONTRANSFERMRDC (MEASUREMENTREPORT)</i>	1	P
-	EXCEPTION: Step 8 below is repeated until 3 <i>MEASUREMENTREPORT</i> messages are received from the UE.	-	-	-	-
8	Check: Does the UE transmit an <i>ULINFORMATIONTRANSFERMRDC</i> message containing NR <i>MEASUREMENTREPORT</i> message, with the measured value for NR Cell 2?	-->	<i>ULINFORMATIONTRANSFERMRDC (MEASUREMENTREPORT)</i>	1	P
9	The SS re-adjusts the cell-specific reference signal level according to row "T3".	-	-	-	-
10	Wait and ignore NR <i>MEASUREMENTREPORT</i> messages for 15 s to allow change of power levels for NR Cell 2 and UE measurements.	-	-	-	-
11	Check: Does the UE attempt to transmit an uplink message within the next 10s?	-->	<i>ULINFORMATIONTRANSFERMRDC (MEASUREMENTREPORT)</i>	2	F
12	The SS re-adjusts the cell-specific reference signal level according to row "T4".	-	-	-	-
13	Check: Does the UE transmit an <i>ULINFORMATIONTRANSFERMRDC</i> message containing NR <i>MEASUREMENTREPORT</i> message to report event A5 with the measured value for NR Cell 2?	-->	<i>ULINFORMATIONTRANSFERMRDC (MEASUREMENTREPORT)</i>	1	P
14	The SS re-adjusts the cell-specific reference signal level according to row "T5".	-	-	-	-

15	Wait and ignore NR <i>MeasurementReport</i> messages for 15 s to allow change of power levels for NR Cell 2 and UE measurements.	-	-	-	-
16	Check: Does the UE attempt to transmit an uplink message within the next 10s?	-->	<i>ULInformationTransferMRD C (MeasurementReport)</i>	2	F

8.2.3.8.1.3.3 Specific message contents

Table 8.2.3.8.1.3.3-1: RRCConnectionReconfiguration (step 1, Step 5a1 Table 8.2.3.8.1.3.2-2)

Derivation Path: TS 36.508 [7], Table 4.6.1-8 with condition EN-DC_EmbedNR_RRCRecon

Table 8.2.3.8.1.3.3-2: RRCReconfiguration (Table 8.2.3.8.1.3.3-1)

Derivation Path: TS 38.508-1 [4], Table 4.6.1-13 with condition EN-DC_MEAS

Table 8.2.3.8.1.3.3-3: MeasConfig-A5 (Table 8.2.3.8.1.3.3-2, Step 1)

Derivation Path: TS 38.508-1 [4], Table 4.6.3-69

Information Element	Value/remark	Comment	Condition
MeasConfig ::= SEQUENCE {			
measObjectToAddModList	MeasObjectNR		
ReportConfigToAddModList SEQUENCE(SIZE (1..maxReportConfigId)) OF ReportConfigToAddMod {	1 entry		
ReportConfigToAddMod[1] SEQUENCE {		entry 1	
reportConfigId[1]	ReportConfigId		
reportConfig[1] CHOICE {			
reportConfigNR	ReportConfigNR(72,66). Same as TS 38.508-1 Table 4.6.3-142 except for hysteresis value in eventA5 set to '0', reportAmount set to 'infinity', and reportInterval value set to 'ms1024'.	Thresh values set to -84 dBm, -90 dBm	EVENT_A5 AND FR1
	ReportConfigNR(65+Delta(NRf1),56+Delta(NRf1)). Same as TS 38.508-1 Table 4.6.3-142 except for hysteresis value in eventA5 set to '0', reportAmount set to 'infinity', and reportInterval value set to 'ms1024'.	Thresh values set to -91 dBm, -100 dBm	EVENT_A5 AND FR2
}			
}			
MeasIdToAddModList SEQUENCE (SIZE (1..maxNrofMeasId)) OF MeasIdToAddMod {	1 entry		
MeasIdToAddMod[1] SEQUENCE {		entry 1	
measId	1		
measObjectId	1		
reportConfigId	1		
}			
}			
}			

NOTE 1: Delta(NRf1) is derived based on calibration procedure defined in the TS 38.508-1 [4], clause 6.1.3.3

Table 8.2.3.8.1.3.3-3A: MeasConfig-A5 (Table 8.2.3.8.1.3.3-2, Step 5a1)

Derivation Path: TS 38.508-1 [4], Table 4.6.3-69			
Information Element	Value/remark	Comment	Condition
MeasConfig ::= SEQUENCE {			
measObjectToAddModList	MeasObjectNR		
ReportConfigToAddModList SEQUENCE(SIZE (1..maxReportConfigId)) OF ReportConfigToAddMod {			
ReportConfigToAddMod[1] SEQUENCE {		entry 1	
reportConfigId	ReportConfigId		
reportConfig CHOICE {			
reportConfigNR	ReportConfigNR(65+Delta(NRf1),65+Delta(NRf1)). Same as TS 38.508-1 Table 4.6.3-142 except for hysteresis value in eventA5 set to '0', reportAmount set to 'infinity', and reportInterval value set to 'ms1024'.	Thresh values set to -91 dBm, -91 dBm	EVENT_A5 AND FR2
}			
}			
}			
MeasIdToAddModList SEQUENCE (SIZE (1..maxNrofMeasId)) OF MeasIdToAddMod {	1 entry		
MeasIdToAddMod[1] SEQUENCE {		entry 1	
measId	1		
measObjectId	1		
reportConfigId	1		
}			
}			
}			

Table 8.2.3.8.1.3.3-4: MeasObjectNR (Table 8.2.3.8.1.3.3-3)

Derivation Path: TS 38.508-1 [4], Table 4.6.3-76			
Information Element	Value/remark	Comment	Condition
measObjectToAddModList ::= SEQUENCE (SIZE (1..maxNrofObjectId)) OF MeasObjectToAddMod {	1 entry		
MeasObjectToAddMod[1] SEQUENCE {		entry 1	
measObjectId	1		
measObject CHOICE {			
measObjectNR	MeasObjectNR(60)	ssbFrequency IE equals the ARFCN for NR Cell 2 Thresh value set to -97dBm	
}			
}			
}			

Table 8.2.3.8.1.3.3-5: RRCConnectionReconfigurationComplete (step 2, Table 8.2.3.8.1.3.2-2)

Derivation Path: TS 36.508 [7], Table 4.6.1-9 with condition MCG_and_SCG
--

Table 8.2.3.8.1.3.3-6: ULInformationTransferMRDC (steps 7, 8, 13 Table 8.2.3.8.1.3.2-2)

Derivation Path: TS 36.508 [7], Table 4.6.1-27			
Information Element	Value/remark	Comment	Condition
ULInformationTransferMRDC ::= SEQUENCE {			

ul-DCCH-MessageNR-r15	OCTET STRING including the MeasurementReport message according to Table 8.2.3.8.1.3.3-7		
}			

Table 8.2.3.8.1.3.3-7: MeasurementReport (Table 8.2.3.8.1.3.3-6)

Derivation Path: TS 38.508-1 [4], Table 4.6.1-5A			
Information Element	Value/remark	Comment	Condition
measurementReport ::= SEQUENCE {			
measResults SEQUENCE {			
measId	1		
measResultServingMOList SEQUENCE (SIZE (1..maxNrofServingCells)) {		Report NR Cell 1	
servCellId	Cell index corresponding to NR Cell 1		
measResultServingCell SEQUENCE {			
physCellId	Phy cell id corresponding to NR Cell 1		
measResult SEQUENCE {			
cellResults SEQUENCE{			
resultsSSB-Cell SEQUENCE {			
rsrp	(0..127)		
rsrq	(0..127)		
sinr	(0..127)		pc_ss_SINR_Meas
	Not present		
}			
}			
}			
}			
measResultNeighCells SEQUENCE (SIZE (1..maxCellReport)) {	1 entry	Report NR Cell 2	
measResultListNR SEQUENCE {			
physCellId	Phy cell id corresponding to NR Cell 2		
measResult SEQUENCE {			
cellResults SEQUENCE{			
resultsSSB-Cell SEQUENCE {			
rsrp	(0..127)		
rsrq	(0..127)		
sinr	(0..127)		pc_ss_SINR_Meas
	Not present		
}			
}			
}			
resultsCSI-RS-Cell	Not present		
rsIndexResults	Not present		
cgi-Info	Not present		
}			
}			
}			

8.2.3.8.1a Measurement configuration control and reporting / Event A5 / Measurement of Neighbour NR cell / Inter-frequency measurements / EN-DC

8.2.3.8.1a.1 Test Purpose (TP)

(1)

```
with { UE in RRC_CONNECTED state with EN-DC, and, MCG(s) (E-UTRA PDCP) and SCG and inter-frequency
measurements configured for event A5 with event based periodical reporting }
ensure that {
  when { Serving NR PSCell becomes worse than absolute threshold1 and neighbour NR cell becomes
better than absolute threshold2 }
  then { UE sends MeasurementReport message at regular intervals while entering conditions for
event A5 are satisfied }
}
```

(2)

```
with { UE in RRC_CONNECTED state with EN-DC, and, MCG(s) (E-UTRA PDCP) and SCG and periodical
measurement reporting triggered by event A5 ongoing }
ensure that {
  when { Serving NR PSCell becomes better than absolute threshold1 or neighbour NR cell becomes
worse than absolute threshold2 }
  then { UE stops sending MeasurementReport message }
}
```

8.2.3.8.1a.2 Conformance requirements

Same as test case 8.2.3.8.1 with the following difference:

[TS 36.331, clause 5.5.2.9]

The UE shall:

1> if *measGapConfig* is set to *setup*:

...

2> if EN-DC is configured:

3> if the UE is configured with *fr1-Gap* set to *TRUE*:

4> apply the gap configuration for LTE serving cells and for NR serving cells on FR1;

3> else:

4> apply the gap configuration for all LTE and NR serving cells;

...

8.2.3.8.1a.3 Test description

8.2.3.8.1a.3.1 Pre-test conditions

Same as test case 8.2.3.8.1 with the following differences:

- Cells configuration: NR Cell 3 replaces NR Cell 2.

8.2.3.8.1a.3.2 Test procedure sequence

Same as test case 8.2.3.8.1 with the following differences:

- Cells configuration: NR Cell 3 replaces NR Cell 2.

8.2.3.8.1a.3.3 Specific message contents

Same as test case 8.2.3.8.1 with the following differences:

- Cells configuration: NR Cell 3 replaces NR Cell 2.

Table 8.2.3.8.1a.3.3-0: RRCConnectionReconfiguration (step 1, Table 8.2.3.8.1.3.2-2)

Derivation Path: TS 36.508 [7], Table 4.6.1-8 with condition EN-DC_EmbedNR_RRCRecon			
Information Element	Value/remark	Comment	Condition
RRCConnectionReconfiguration ::= SEQUENCE {			
criticalExtensions CHOICE {			
c1 CHOICE {			
rrcConnectionReconfiguration-r8 SEQUENCE {			
measConfig	Table 8.2.3.8.1a.3.3-0a		
}			
}			
}			

Table 8.2.3.8.1a.3.3-0a: measConfig (Table 8.2.3.8.1a.3.3-0)

Derivation Path: TS 36.508 [7], Table 4.6.6-1			
Information Element	Value/remark	Comment	Condition
measConfig ::= SEQUENCE {			
measGapConfig CHOICE {			
setup SEQUENCE {			
gapOffset CHOICE {			
gp0	9	MGRP = 40 ms, MGL = 6 ms	
}			
}			
}			
fr1-gap-r15	False		
mgta-r15	False		
}			

Table 8.2.3.8.1a.3.3-1: MeasConfig-A5 (Table 8.2.3.8.1.3.3-2)

Derivation Path: TS 38.508-1 [4] Table 4.6.3-69			
Information Element	Value/remark	Comment	Condition
MeasConfig ::= SEQUENCE {			
measObjectToAddModList SEQUENCE (SIZE (1..maxNrofMeasId)) OF MeasObjectToAddMod {	2 entries		
MeasObjectToAddMod[1] SEQUENCE {		entry 1	
measObjectId	1		
measObject CHOICE {			
measObjectNR	MeasObjectNR-f1	Table 8.2.3.8.1a.3.3-2	
}			
}			
MeasObjectToAddMod[2] SEQUENCE {		entry 2	
measObjectId	2		
measObject CHOICE {			
measObjectNR	MeasObjectNR-f2	Table 8.2.3.8.1a.3.3-3	
}			
}			
reportConfigToAddModList SEQUENCE (SIZE (1..maxReportConfigId)) OF ReportConfigToAddMod {	1 entry		
ReportConfigToAddMod[1] SEQUENCE {		entry 1	
reportConfigId	1		

reportConfig CHOICE { reportConfigNR	ReportConfigNR(77,71) Same as TS 38.508-1 [4], Table 4.6.3-142 except for hysteresis value in eventA5 set to '0', reportAmount set to 'infinity', and reportInterval value is set to 'ms1024'	Thresh values set to -79dBm, - 85dBm	EVENT_A5 and FR1
	ReportConfigNR(66+ Delta(NRf1),57+Delta(NR f2)). Same as TS 38.508- 1 [4], Table 4.6.3-142 except for hysteresis value in eventA5 set to '0', reportAmount set to 'infinity', and reportInterval value set to 'ms1024'.	Thresh values set to -90dBm, -99 dBm	EVENT_A5 AND FR2
}			
}			
measIdToAddModList SEQUENCE (SIZE (1..maxNrofMeasId)) OF MeasIdToAddMod {	1 entry		
MeasIdToAddMod[1] SEQUENCE {		entry 1	
measId	1		
measObjectId	2		
reportConfigId	1		
}			
}			
}			
NOTE 1: Delta(NRf1) and Delta(NRf2) is derived based on calibration procedure defined in the TS 38.508-1 [4], clause 6.1.3.3.			

Table 8.2.3.8.1a.3.3-2: MeasObjectNR-f1 (Table 8.2.3.8.1a.3.3-1)

Derivation Path: TS 38.508-1 [4], Table 4.6.3-76			
Information Element	Value/remark	Comment	Condition
MeasObjectNR ::= SEQUENCE {			
ssbFrequency	ARFCN-ValueNR for SSB of NR Cell 1		
absThreshSS-BlocksConsolidation	Not present		
nrofSS-BlocksToAverage	Not present		
}			

Table 8.2.3.8.1a.3.3-3: MeasObjectNR-f2 (Table 8.2.3.8.1a.3.3-1)

Derivation Path: TS 38.508-1 [4], Table 4.6.3-76			
Information Element	Value/remark	Comment	Condition
MeasObjectNR ::= SEQUENCE {			
ssbFrequency	ARFCN-ValueNR for SSB of NR Cell 3		
absThreshSS-BlocksConsolidation	Not present		
nrofSS-BlocksToAverage	Not present		
}			

Table 8.2.3.8.1a.3.3-4: MeasConfig-A5 (Table 8.2.3.8.1.3.3-2, Step 5a1)

Derivation Path: TS 38.508-1 [4], Table 4.6.3-69			
Information Element	Value/remark	Comment	Condition
MeasConfig ::= SEQUENCE {			
measObjectToAddModList	MeasObjectNR		

ReportConfigToAddModList SEQUENCE(SIZE (1..maxReportConfigId)) OF ReportConfigToAddMod {	1 entry		
ReportConfigToAddMod[1] SEQUENCE {		entry 1	
reportConfigId	ReportConfigId		
reportConfig CHOICE {			
reportConfigNR	ReportConfigNR(66+Delta(NRf1),66+Delta(NRf2)). Same as TS 38.508-1 [4], Table 4.6.3-142 except for hysteresis value in eventA5 set to '0', reportAmount set to 'infinity', and reportInterval value set to 'ms1024'	Thresh values set to -90dBm, -90 dBm	EVENT_A5 AND FR2
}			
}			
}			
MeasIdToAddModList SEQUENCE (SIZE (1..maxNrofMeasId)) OF MeasIdToAddMod {	1 entry		
MeasIdToAddMod[1] SEQUENCE {		entry 1	
measId	1		
measObjectId	1		
reportConfigId	1		
}			
}			
}			
NOTE 1: Delta(NRf1) and Delta(NRf2) is derived based on calibration procedure defined in the TS 38.508-1 [4], clause 6.1.3.3.			

8.2.3.8.1b Measurement configuration control and reporting / Event A5 / Measurement of Neighbour NR cell / Inter-band measurements / EN-DC

8.2.3.8.1b.1 Test Purpose (TP)

(1)

```
with { UE in RRC_CONNECTED state with EN-DC, and, MCG(s) (E-UTRA PDCP) and SCG and inter-band
measurements configured for event A5 with event based periodical reporting }
ensure that {
  when { Serving NR PSCell becomes worse than absolute threshold1 and neighbour NR cell becomes
better than absolute threshold2 }
  then { UE sends MeasurementReport message at regular intervals while entering conditions for
event A5 are satisfied }
}
```

(2)

```
with { UE in RRC_CONNECTED state with EN-DC, and, MCG(s) (E-UTRA PDCP) and SCG and periodical
measurement reporting triggered by event A5 ongoing }
ensure that {
  when { Serving NR PSCell becomes better than absolute threshold1 or neighbour NR cell becomes
worse than absolute threshold2 }
  then { UE stops sending MeasurementReport message }
}
```

8.2.3.8.1b.2 Conformance requirements

Same as test case 8.2.3.8.1 with the following difference:

[TS 36.331, clause 5.5.2.9]

The UE shall:

1> if *measGapConfig* is set to *setup*:

...

2> if EN-DC is configured:

3> if the UE is configured with *fr1-Gap* set to *TRUE*:

4> apply the gap configuration for LTE serving cells and for NR serving cells on FR1;

3> else:

4> apply the gap configuration for all LTE and NR serving cells;

...

8.2.3.8.1b.3 Test description

8.2.3.8.1b.3.1 Pre-test conditions

Same as test case 8.2.3.8.1 with the following differences:

- Cells configuration: NR Cell 10 replaces NR Cell 2.

8.2.3.8.1b.3.2 Test procedure sequence

Same as test case 8.2.3.8.1 with the following differences:

- Cells configuration: NR Cell 10 replaces NR Cell 2.

8.2.3.8.1b.3.3 Specific message contents

Same as test case 8.2.3.8.1 with the following differences:

- Cells configuration: NR Cell 10 replaces NR Cell 2.

Table 8.2.3.8.1b.3.3-0: RRCConnectionReconfiguration (step 1, Table 8.2.3.8.1.3.2-2)

Derivation Path: TS 36.508 [7], Table 4.6.1-8 with condition EN-DC_EmbedNR_RRCRecon			
Information Element	Value/remark	Comment	Condition
RRCConnectionReconfiguration ::= SEQUENCE {			
criticalExtensions CHOICE {			
c1 CHOICE {			
rrcConnectionReconfiguration-r8 SEQUENCE {			
measConfig	Table 8.2.3.8.1b.3.3-0a		
}			
}			
}			

Table 8.2.3.8.1b.3.3-0a: measConfig (Table 8.2.3.8.1b.3.3-0)

Derivation Path: TS 36.508 [7], Table 4.6.6-1			
Information Element	Value/remark	Comment	Condition
measConfig SEQUENCE {			
measGapConfig CHOICE {			
setup SEQUENCE {			
gapOffset CHOICE {			
gp0	9	MGRP = 40 ms, MGL = 6 ms	
}			
}			
}			
fr1-gap-r15	False		

mgta-r15	False		
}			

Table 8.2.3.8.1b.3.3-1: MeasConfig-A5 (Table 8.2.3.8.1.3.3-2)

Derivation Path: TS 38.508-1 [4] Table 4.6.3-69			
Information Element	Value/remark	Comment	Condition
MeasConfig ::= SEQUENCE {			
measObjectToAddModList SEQUENCE (SIZE (1..maxNrofMeasId)) OF MeasObjectToAddMod {	2 entries		
MeasObjectToAddMod[1] SEQUENCE {		entry 1	
measObjectId	1		
measObject CHOICE {			
measObjectNR	MeasObjectNR-f1	Table 8.2.3.8.1b.3.3-2	
}			
}			
MeasObjectToAddMod[2] SEQUENCE {		entry 2	
measObjectId	2		
measObject CHOICE {			
measObjectNR	MeasObjectNR-f2	Table 8.2.3.8.1b.3.3-3	
}			
}			
reportConfigToAddModList SEQUENCE (SIZE (1..maxReportConfigId)) OF ReportConfigToAddMod {	1 entry		
ReportConfigToAddMod[1] SEQUENCE {		entry 1	
reportConfigId	1		
reportConfig CHOICE {			
reportConfigNR	ReportConfigNR(77,71) Same as TS 38.508-1 [4], Table 4.6.3-142 except for hysteresis value in eventA5 set to '0', reportAmount set to 'infinity', and reportInterval value is set to 'ms1024'	Thresh values set to -79dBm, - 85dBm	EVENT_A5
}			
}			
measIdToAddModList SEQUENCE (SIZE (1..maxNrofMeasId)) OF MeasIdToAddMod {	1 entry		
MeasIdToAddMod[1] SEQUENCE {		entry 1	
measId	1		
measObjectId	2		
reportConfigId	1		
}			
}			
}			

Table 8.2.3.8.1b.3.3-2: MeasObjectNR-f1 (Table 8.2.3.8.1b.3.3-1)

Derivation Path: TS 38.508-1 [4], Table 4.6.3-76			
Information Element	Value/remark	Comment	Condition
MeasObjectNR ::= SEQUENCE {			
ssbFrequency	ARFCN-ValueNR for SSB of NR Cell 1		
absThreshSS-BlocksConsolidation	Not present		
nrofSS-BlocksToAverage	Not present		
}			

Table 8.2.3.8.1b.3.3-3: *MeasObjectNR-f2* (Table 8.2.3.8.1b.3.3-1)

Derivation Path: TS 38.508-1 [4], Table 4.6.3-76			
Information Element	Value/remark	Comment	Condition
MeasObjectNR ::= SEQUENCE {			
ssbFrequency	ARFCN-ValueNR for SSB of NR Cell 10		
absThreshSS-BlocksConsolidation	Not present		
nrofSS-BlocksToAverage	Not present		
}			

8.2.3.8.2 Measurement configuration control and reporting / Event A5 / Measurement of Neighbour E-UTRA and NR cells / Intra-frequency measurements / NE-DC

8.2.3.8.2.1 Test Purpose (TP)

(1)

```
with { UE in RRC_CONNECTED state with NE-DC, and, MCG(s) (NR PDCP) and SCG and intra-frequency
measurements configured for event A5 with event based periodical reporting }
ensure that {
  when { Serving E-UTRA PSCell becomes worse than absolute threshold1 and neighbour E-UTRA cell
becomes better than absolute threshold2 }
  then { UE sends MeasurementReport message at regular intervals while entering condition for
event A5 is satisfied }
}
```

(2)

```
with { UE in RRC_CONNECTED state with NE-DC, and, MCG(s) (NR PDCP) and SCG and periodical
measurement reporting triggered by event A5 ongoing }
ensure that {
  when { Serving E-UTRA PSCell becomes better than absolute threshold1 or neighbour E-UTRA cell
becomes worse than absolute threshold2 }
  then { UE stops sending MeasurementReport message }
}
```

(3)

```
with { UE in RRC_CONNECTED state with NE-DC, and, MCG(s) (NR PDCP) and SCG and measurements
configured for event A5 including reportAddNeighMeas with event based periodical reporting }
ensure that {
  when { Serving NR PCell becomes worse than absolute threshold1 and neighbour NR cell becomes
better than absolute threshold2 }
  then { UE sends MeasurementReport at regular intervals while entering condition for event A5 is
satisfied, and includes measurement result for the PSCELL. }
}
```

8.2.3.8.2.2 Conformance requirements

References: The conformance requirements covered in the present TC are specified in: TS 38.331, 5.5.4.1, 5.5.4.6, 5.5.5.1 and 5.5.5.3, TS36.331, clauses 5.3.5.3, 5.5.4.1 and 5.5.4.6. Unless otherwise stated these are Rel-15 requirements.

[TS 38.331, clause 5.5.4.1]

If AS security has been activated successfully, the UE shall:

- 1> for each *measId* included in the *measIdList* within *VarMeasConfig*:
- 2> if the corresponding *reportConfig* includes a *reportType* set to *eventTriggered* or *periodical*:
- 3> if the corresponding *measObject* concerns NR:
 - ...
 - 4> for measurement events other than *eventA1* or *eventA2*:

- 5> if *useAllowedCellList* is set to *true*:
 - 6> consider any neighbouring cell detected based on parameters in the associated *measObjectNR* to be applicable when the concerned cell is included in the *allowedCellsToAddModList* defined within the *VarMeasConfig* for this *measId*;
- 5> else:
 - 6> consider any neighbouring cell detected based on parameters in the associated *measObjectNR* to be applicable when the concerned cell is not included in the *excludedCellsToAddModList* defined within the *VarMeasConfig* for this *measId*;
- 3> else if the corresponding *measObject* concerns E-UTRA:
 - 4> if *eventB1* or *eventB2* is configured in the corresponding *reportConfig*:
 - 5> consider a serving cell, if any, on the associated E-UTRA frequency as neighbour cell;
 - 4> consider any neighbouring cell detected on the associated frequency to be applicable when the concerned cell is not included in the *excludedCellsToAddModListEUTRAN* defined within the *VarMeasConfig* for this *measId*;
 - ...
- 2> if the *reportType* is set to *eventTriggered* and if the entry condition applicable for this event, i.e. the event corresponding with the *eventId* of the corresponding *reportConfig* within *VarMeasConfig*, is fulfilled for one or more applicable cells for all measurements after layer 3 filtering taken during *timeToTrigger* defined for this event within the *VarMeasConfig*, while the *VarMeasReportList* does not include a measurement reporting entry for this *measId* (a first cell triggers the event):
 - 3> include a measurement reporting entry within the *VarMeasReportList* for this *measId*;
 - 3> set the *numberOfReportsSent* defined within the *VarMeasReportList* for this *measId* to 0;
 - 3> include the concerned cell(s) in the *cellsTriggeredList* defined within the *VarMeasReportList* for this *measId*;
 - 3> if *useT312* is set to *true* in *reportConfig* for this event:
 - 4> if T310 for the corresponding SpCell is running; and
 - 4> if T312 is not running for corresponding SpCell:
 - 5> start timer T312 for the corresponding SpCell with the value of T312 configured in the corresponding *measObjectNR*;
 - 3> initiate the measurement reporting procedure, as specified in 5.5.5;
- 2> else if the *reportType* is set to *eventTriggered* and if the entry condition applicable for this event, i.e. the event corresponding with the *eventId* of the corresponding *reportConfig* within *VarMeasConfig*, is fulfilled for one or more applicable cells not included in the *cellsTriggeredList* for all measurements after layer 3 filtering taken during *timeToTrigger* defined for this event within the *VarMeasConfig* (a subsequent cell triggers the event):
 - 3> set the *numberOfReportsSent* defined within the *VarMeasReportList* for this *measId* to 0;
 - 3> include the concerned cell(s) in the *cellsTriggeredList* defined within the *VarMeasReportList* for this *measId*;
 - 3> if *useT312* is set to *true* in *reportConfig* for this event:
 - 4> if T310 for the corresponding SpCell is running; and
 - 4> if T312 is not running for corresponding SpCell:
 - 5> start timer T312 for the corresponding SpCell with the value of T312 configured in the corresponding *measObjectNR*;

3> initiate the measurement reporting procedure, as specified in 5.5.5;

...

[TS 38.331, clause 5.5.4.6]

The UE shall:

1> consider the entering condition for this event to be satisfied when both condition A5-1 and condition A5-2, as specified below, are fulfilled;

1> consider the leaving condition for this event to be satisfied when condition A5-3 or condition A5-4, i.e. at least one of the two, as specified below, is fulfilled;

1> use the SpCell for M_p .

NOTE 1: The parameters of the reference signal(s) of the cell(s) that triggers the event are indicated in the *measObjectNR* associated to the event which may be different from the *measObjectNR* of the NR SpCell.

Inequality A5-1 (Entering condition 1)

$$M_p + H_{ys} < Thresh1$$

Inequality A5-2 (Entering condition 2)

$$M_n + Ofn + Ocn - H_{ys} > Thresh2$$

Inequality A5-3 (Leaving condition 1)

$$M_p - H_{ys} > Thresh1$$

Inequality A5-4 (Leaving condition 2)

$$M_n + Ofn + Ocn + H_{ys} < Thresh2$$

The variables in the formula are defined as follows:

M_p is the measurement result of the NR SpCell, not taking into account any offsets.

M_n is the measurement result of the neighbouring cell, not taking into account any offsets.

Ofn is the measurement object specific offset of the neighbour cell (i.e. *offsetMO* as defined within *measObjectNR* corresponding to the neighbour cell).

Ocn is the cell specific offset of the neighbour cell (i.e. *cellIndividualOffset* as defined within *measObjectNR* corresponding to the neighbour cell), and set to zero if not configured for the neighbour cell.

H_{ys} is the hysteresis parameter for this event (i.e. *hysteresis* as defined within *reportConfigNR* for this event).

$Thresh1$ is the threshold parameter for this event (i.e. *a5-Threshold1* as defined within *reportConfigNR* for this event).

$Thresh2$ is the threshold parameter for this event (i.e. *a5-Threshold2* as defined within *reportConfigNR* for this event).

M_n , M_p are expressed in dBm in case of RSRP, or in dB in case of RSRQ and RS-SINR.

Ofn , Ocn , H_{ys} are expressed in dB.

$Thresh1$ is expressed in the same unit as M_p .

$Thresh2$ is expressed in the same unit as M_n .

NOTE 2: The definition of Event A5 also applies to CondEvent A5.

[TS 38.331, clause 5.5.5.1]



Figure 5.5.5.1-1: Measurement reporting

The purpose of this procedure is to transfer measurement results from the UE to the network. The UE shall initiate this procedure only after successful security activation.

For the *measId* for which the measurement reporting procedure was triggered, the UE shall set the *measResults* within the *MeasurementReport* message as follows:

- 1> set the *measId* to the measurement identity that triggered the measurement reporting;
- 1> set the *measResultServingCell* within *measResultServingMOList* to include, for each NR serving cell that is configured with *servingCellMO*, RSRP, RSRQ and the available SINR, derived based on the *rsType* if indicated in the associated *reportConfig*, otherwise based on SSB if available, otherwise based on CSI-RS;
- 1> set the *measResultServingCell* within *measResultServingMOList* to include for each NR serving cell that is configured with *servingCellMO*, if any, the *servCellId*;
- 1> if the *reportConfig* associated with the *measId* that triggered the measurement reporting includes *reportQuantityRsIndexes* and *maxNrofRSIndexesToReport*:
 - 2> for each serving cell configured with *servingCellMO*, include beam measurement information according to the associated *reportConfig* as described in 5.5.5.2;
- ...
- 1> if *reportConfig* associated with the *measId* that triggered the measurement reporting is set to *eventTriggered* and *eventID* is set to *eventA3*, or *eventA4*, or *eventA5*:
 - 2> if the UE is in NR-DC and the measurement configuration that triggered this measurement report is associated with the MCG:
 - 3> set the *measResultServFreqListNR-SCG* to include for each NR SCG serving cell that is configured with *servingCellMO*, if any, the following:
 - ...
 - 4> if *reportConfig* associated with the *measId* that triggered the measurement reporting includes *reportAddNeighMeas*:
 - 5> if the *measObjectNR* indicated by the *servingCellMO* includes the RS resource configuration corresponding to the *rsType* indicated in the *reportConfig*:
 - 6> set the *measResultBestNeighCellListNR* within *measResultServFreqListNR-SCG* to include one entry with the *physCellId* and the available measurement quantities based on the *reportQuantityCell* and *rsType* indicated in *reportConfig* of the non-serving cell corresponding to the concerned *measObjectNR* with the highest measured RSRP if RSRP measurement results are available for cells corresponding to this *measObjectNR*, otherwise with the highest measured RSRQ if RSRQ measurement results are available for cells corresponding to this *measObjectNR*, otherwise with the highest measured SINR, where availability is considered according to the measurement configuration associated with the SCG;
 - 7> if the *reportConfig* associated with the *measId* that triggered the measurement reporting includes *reportQuantityRS-Indexes* and *maxNrofRS-IndexesToReport*:
 - 8> for each best non-serving cell included in the measurement report:

9> include beam measurement information according to the associated *reportConfig* as described in 5.5.5.2, where availability is considered according to the measurement configuration associated with the SCG;

...

1> if there is at least one applicable neighbouring cell to report:

2> if the *reportType* is set to *eventTriggered* or *periodical*:

3> set the *measResultNeighCells* to include the best neighbouring cells up to *maxReportCells* in accordance with the following:

4> if the *reportType* is set to *eventTriggered*:

5> include the cells included in the *cellsTriggeredList* as defined within the *VarMeasReportList* for this *measId*;

...

4> for each cell that is included in the *measResultNeighCells*, include the *physCellId*;

4> if the *reportType* is set to *eventTriggered* or *periodical*:

5> for each included cell, include the layer 3 filtered measured results in accordance with the *reportConfig* for this *measId*, ordered as follows:

6> if the *measObject* associated with this *measId* concerns NR:

7> if *rsType* in the associated *reportConfig* is set to *ssb*:

8> set *resultsSSB-Cell* within the *measResult* to include the SS/PBCH block based quantity(ies) indicated in the *reportQuantityCell* within the concerned *reportConfig*, in decreasing order of the sorting quantity, determined as specified in 5.5.5.3, i.e. the best cell is included first:

9> if *reportQuantityRSIndexes* and *maxNrofRSIndexesToReport* are configured, include beam measurement information as described in 5.5.5.2;

...

6> if the *measObject* associated with this *measId* concerns E-UTRA:

7> set the *measResult* to include the quantity(ies) indicated in the *reportQuantity* within the concerned *reportConfigInterRAT* in decreasing order of the sorting quantity, determined as specified in 5.5.5.3, i.e. the best cell is included first;

...

1> increment the *numberOfReportsSent* as defined within the *VarMeasReportList* for this *measId* by 1;

1> stop the periodical reporting timer, if running;

...

1> if the UE is configured with EN-DC:

2> if SRB3 is configured:

3> submit the *MeasurementReport* message via SRB3 to lower layers for transmission, upon which the procedure ends;

2> else:

3> submit the *MeasurementReport* message via the EUTRA MCG embedded in E-UTRA RRC message *ULInformationTransferMRDC* as specified in TS 36.331 [10].

1> else:

2> submit the *MeasurementReport* message to lower layers for transmission, upon which the procedure ends.

[TS 36.331, clause 5.3.5.3]

If the *RRConnectionReconfiguration* message does not include the *mobilityControlInfo* and the UE is able to comply with the configuration included in this message, the UE shall:

...

1> if the *RRConnectionReconfiguration* message includes the *measConfig*:

2> perform the measurement configuration procedure as specified in 5.5.2;

...

[TS 36.331, clause 5.5.4.1]

The UE shall:

1> for each *measId* included in the *measIdList* within *VarMeasConfig*:

2> else:

3> if the corresponding *measObject* concerns E-UTRA:

4> if the *ue-RxTxTimeDiffPeriodical*, *eventA1* or *eventA2* is configured in the corresponding *reportConfig*:

5> consider only the serving cell to be applicable;

4> else:

5> consider any neighbouring cell detected on the associated frequency to be applicable when the concerned cell is not included in the *blackCellsToAddModList* defined within the *VarMeasConfig* for this *measId*;

...

2> if the *triggerType* is set to 'event' and if the entry condition applicable for this event, i.e. the event corresponding with the *eventId* of the corresponding *reportConfig* within *VarMeasConfig*, is fulfilled for one or more applicable cells for all measurements after layer 3 filtering taken during *timeToTrigger* defined for this event within the *VarMeasConfig*, while the *VarMeasReportList* does not include an measurement reporting entry for this *measId* (a first cell triggers the event):

3> include a measurement reporting entry within the *VarMeasReportList* for this *measId*;

3> set the *numberOfReportsSent* defined within the *VarMeasReportList* for this *measId* to 0;

3> include the concerned cell(s) in the *cellsTriggeredList* defined within the *VarMeasReportList* for this *measId*;

3> initiate the measurement reporting procedure, as specified in 5.5.5;

2> if the *triggerType* is set to 'event' and if the entry condition applicable for this event, i.e. the event corresponding with the *eventId* of the corresponding *reportConfig* within *VarMeasConfig*, is fulfilled for one or more applicable cells not included in the *cellsTriggeredList* for all measurements after layer 3 filtering taken during *timeToTrigger* defined for this event within the *VarMeasConfig* (a subsequent cell triggers the event):

3> set the *numberOfReportsSent* defined within the *VarMeasReportList* for this *measId* to 0;

3> include the concerned cell(s) in the *cellsTriggeredList* defined within the *VarMeasReportList* for this *measId*;

3> initiate the measurement reporting procedure, as specified in 5.5.5;

- 2> if the *triggerType* is set to 'event' and if the leaving condition applicable for this event is fulfilled for one or more of the cells included in the *cellsTriggeredList* defined within the *VarMeasReportList* for this *measId* for all measurements after layer 3 filtering taken during *timeToTrigger* defined within the *VarMeasConfig* for this event:
 - 3> remove the concerned cell(s) in the *cellsTriggeredList* defined within the *VarMeasReportList* for this *measId*;
 - 3> if *reportOnLeave* is set to *TRUE* for the corresponding reporting configuration:
 - 4> initiate the measurement reporting procedure, as specified in 5.5.5;
 - 3> if the *cellsTriggeredList* defined within the *VarMeasReportList* for this *measId* is empty:
 - 4> remove the measurement reporting entry within the *VarMeasReportList* for this *measId*;
 - 4> stop the periodical reporting timer for this *measId*, if running;
- 2> if the *purpose* is included and set to 'reportStrongestCells' or 'reportStrongestCellsForSON' and if a (first) measurement result is available for one or more applicable cells:
 - 3> include a measurement reporting entry within the *VarMeasReportList* for this *measId*;
 - 3> set the *numberOfReportsSent* defined within the *VarMeasReportList* for this *measId* to 0;
 - 3> initiate the measurement reporting procedure, as specified in 5.5.5;

NOTE 1: If the *purpose* is set to 'reportStrongestCells', the UE initiates a first measurement report immediately after the quantity to be reported becomes available for at least either serving cell or one of the applicable cells. If the *purpose* is set to 'reportStrongestCellsForSON', the UE initiates a first measurement report when it has determined the strongest cells on the associated frequency.

- 2> upon expiry of the periodical reporting timer for this *measId*:
 - 3> initiate the measurement reporting procedure, as specified in 5.5.5;
- 2> if the *purpose* is included and set to 'reportCGI' and if the UE acquired the information needed to set all fields of *cgi-Info* for the requested cell:
 - 3> include a measurement reporting entry within the *VarMeasReportList* for this *measId*;
 - 3> set the *numberOfReportsSent* defined within the *VarMeasReportList* for this *measId* to 0;
 - 3> stop timer T321;
 - 3> initiate the measurement reporting procedure, as specified in 5.5.5;
- 2> upon expiry of the T321 for this *measId*:
 - 3> include a measurement reporting entry within the *VarMeasReportList* for this *measId*;
 - 3> set the *numberOfReportsSent* defined within the *VarMeasReportList* for this *measId* to 0;
 - 3> initiate the measurement reporting procedure, as specified in 5.5.5;

NOTE 2: The UE does not stop the periodical reporting with *triggerType* set to 'event' or to 'periodical' while the corresponding measurement is not performed due to the serving cell RSRP being equal to or better than *s-Measure* or due to the measurement gap not being setup.

NOTE 3: If the UE is configured with DRX, the UE may delay the measurement reporting for event triggered and periodical triggered measurements until the Active Time, which is defined in TS 36.321 [6].

[TS 36.331, clause 5.5.4.6]

The UE shall:

- 1> consider the entering condition for this event to be satisfied when both condition A5-1 and condition A5-2, as specified below, are fulfilled;
- 1> consider the leaving condition for this event to be satisfied when condition A5-3 or condition A5-4, i.e. at least one of the two, as specified below, is fulfilled;
- 1> if *usePSCell* of the corresponding *reportConfig* is set to *true*:
 - 2> use the PSCell for *Mp*;
- 1> else:
 - 2> use the PCell for *Mp*;

NOTE: The cell(s) that triggers the event is on the frequency indicated in the associated *measObject* which may be different from the frequency used by the PCell/ PSCell.

Inequality A5-1 (Entering condition 1)

$$M_p + H_{ys} < Thresh1$$

Inequality A5-2 (Entering condition 2)

$$M_n + O_{fn} + O_{cn} - H_{ys} > Thresh2$$

Inequality A5-3 (Leaving condition 1)

$$M_p - H_{ys} > Thresh1$$

Inequality A5-4 (Leaving condition 2)

$$M_n + O_{fn} + O_{cn} + H_{ys} < Thresh2$$

The variables in the formula are defined as follows:

Mp is the measurement result of the PCell/ PSCell, not taking into account any offsets.

Mn is the measurement result of the neighbouring cell, not taking into account any offsets.

Ofn is the frequency specific offset of the frequency of the neighbour cell (i.e. *offsetFreq* as defined within *measObjectEUTRA* corresponding to the frequency of the neighbour cell).

Ocn is the cell specific offset of the neighbour cell (i.e. *cellIndividualOffset* as defined within *measObjectEUTRA* corresponding to the frequency of the neighbour cell), and set to zero if not configured for the neighbour cell.

Hys is the hysteresis parameter for this event (i.e. *hysteresis* as defined within *reportConfigEUTRA* for this event).

Thresh1 is the threshold parameter for this event (i.e. *a5-Threshold1* as defined within *reportConfigEUTRA* for this event).

Thresh2 is the threshold parameter for this event (i.e. *a5-Threshold2* as defined within *reportConfigEUTRA* for this event).

Mn, Mp are expressed in dBm in case of RSRP, or in dB in case of RSRQ and RS-SINR.

Ofn, Ocn, Hys are expressed in dB.

Thresh1 is expressed in the same unit as ***Mp***.

Thresh2 is expressed in the same unit as ***Mn***.

8.2.3.8.2.3 Test description

8.2.3.8.2.3.1 Pre-test conditions

System Simulator:

- NR Cell 1 is the PCell and E-UTRA Cell 1 is the PSCell.
- E-UTRA Cell 2 is the intra-frequency neighbour cell and NR Cell 2 is the intra-frequency neighbour cell.

UE:

- None.

Preamble:

- The UE is in state NE-DC RRC_CONNECTED using generic procedure parameter Connectivity (NE-DC) according to TS 38.508-1 [4], Table 4.5.4.2-6.

8.2.3.8.2.3.2 Test procedure sequence

Table 8.2.3.8.2.3.2-1 and Table 8.2.3.8.2.3.2-1A illustrates the downlink power levels to be applied for E-UTRA Cell 1 and E-UTRA Cell 2, NR Cell 1 and NR Cell 2 at various time instants of the test execution. Row marked "T0" denotes the conditions after the preamble, while rows marked "T1", "T2" and "T3" are to be applied subsequently. The exact instants on which these values shall be applied are described in the texts in this clause.

Table 8.2.3.8.2.3.2-1: Time instances of cell power level and parameter changes for FR1

	Parameter	Unit	E-UTRA Cell 1	E-UTRA Cell 2	NR Cell 1	NR Cell 2	Remark
T0	Cell-specific RS EPRE	dBm/15k Hz	-85	-91	-	-	The power level values are such that entry condition for event A5 is not satisfied
	SS/PBCH SSS EPRE	dBm/SC S	-	-	-88	-91	
T1	Cell-specific RS EPRE	dBm/15k Hz	-91	-76	-	-	The power level values are such that entry condition for event A5 is satisfied for E-UTRA Cell 1 and intra-frequency neighbour E-UTRA Cell 2
	SS/PBCH SSS EPRE	dBm/SC S	-	-	-88	-91	
T2	Cell-specific RS EPRE	dBm/15k Hz	-85	-91	-	-	The power level values are such that entry conditions for event A5 is not satisfied for E-UTRA Cell 1 and intra-frequency neighbour E-UTRA Cell 2
	SS/PBCH SSS EPRE	dBm/SC S	-	-	-88	-91	
T3	Cell-specific RS EPRE	dBm/15k Hz	-85	-91	-	-	The power level values are such that entry condition for event A5 is satisfied for NR Cell 1 and intra-frequency neighbour NR Cell 2
	SS/PBCH SSS EPRE	dBm/SC S	-	-	-91	-79	

Table 8.2.3.8.2.3.2-1A: Time instances of cell power level and parameter changes for FR2

	Parameter	Unit	E-UTRA Cell 1	E-UTRA Cell 2	NR Cell 1	NR Cell 2	Remark
T0	Cell-specific RS EPRE	dBm/15k Hz	FFS	FFS	-	-	The power level values are such that entry condition for event A5 is not satisfied
	SS/PBCH SSS EPRE	dBm/SC S	-	-	FFS	FFS	

T1	Cell-specific RS EPRE	dBm/15k Hz	FFS	FFS	-	-	The power level values are such that entry condition for event A5 is satisfied for E-UTRA Cell 1 and intra-frequency neighbour E-UTRA Cell 2
	SS/PBCH SSS EPRE	dBm/SC S	-	-	FFS	FFS	
T2	Cell-specific RS EPRE	dBm/15k Hz	FFS	FFS	-	-	The power level values are such that entry conditions for event A5 is not satisfied for E-UTRA Cell 1 and intra-frequency neighbour E-UTRA Cell 2
	SS/PBCH SSS EPRE	dBm/SC S	-	-	FFS	FFS	
T3	Cell-specific RS EPRE	dBm/15k Hz	FFS	FFS	-	-	The power level values are such that entry condition for event A5 is satisfied for NR Cell 1 and intra-frequency neighbour NR Cell 2
	SS/PBCH SSS EPRE	dBm/SC S	-	-	FFS	FFS	

Table 8.2.3.8.2.3.2-2: Main behaviour

St	Procedure	Message Sequence		TP	Verdict
		U - S	Message		
1	The SS transmits an <i>RRCReconfiguration</i> message containing <i>RRCCONNECTIONRECONFIGURATION</i> message to setup measurements for neighbour E-UTRA Cells and reporting for event A5	<--	NR RRC: <i>RRCReconfiguration</i> (<i>RRCCONNECTIONRECONFIGURATION</i>)	-	-
2	The UE transmit an <i>RRCReconfigurationComplete</i> message.	-->	NR RRC: <i>RRCReconfigurationComplete</i> (<i>RRCCONNECTIONRECONFIGURATIONCOMPLETE</i>)	-	-
3	The SS re-adjusts the cell-specific reference signal level according to row "T1".	-	-	-	-
4	Check: Does the UE transmit an <i>ULInformationTransferMRDC</i> message containing <i>MEASUREMENTREPORT</i> message to report event A5 (<i>measId 1</i>) with the measured value for E-UTRA Cell 2?	→	NR RRC: <i>ULInformationTransferMRDC</i> (<i>MEASUREMENTREPORT</i>)	1	P
-	EXCEPTION: Step 5 below is repeated until 3 <i>MEASUREMENTREPORT</i> messages are received from the UE	-	-	-	-
5	Check: Does the UE transmit an <i>ULInformationTransferMRDC</i> message containing <i>MEASUREMENTREPORT</i> message to report event A4 (<i>measId 1</i>) with the measured value for E-UTRA Cell 2?	→	NR RRC: <i>ULInformationTransferMRDC</i> (<i>MEASUREMENTREPORT</i>)	1	P
6	The SS re-adjusts the cell-specific reference signal level according to row "T2".	-	-	-	-
7	Wait and ignore <i>MEASUREMENTREPORT</i> messages for 15 s to allow change of power levels for E-UTRA Cell 2 and UE measurement.	-	-	-	-
8	Check: Does the UE transmit an <i>ULInformationTransferMRDC</i> message containing <i>MEASUREMENTREPORT</i> message within the next 10s to report event A5?	-->	NR RRC: <i>ULInformationTransferMRDC</i> (<i>MEASUREMENTREPORT</i>)	2	F
9	The SS transmits an <i>RRCReconfiguration</i> message including <i>MeasConfig</i> to setup NR measurement and reporting for intra-frequency event A5 (<i>measId 2</i>) and <i>reportAddNeighMeas</i> .	<--	NR RRC: <i>RRCReconfiguration</i>	-	-
10	The UE transmit an <i>RRCReconfigurationComplete</i> message.	-->	NR RRC: <i>RRCReconfigurationComplete</i>	-	-

11	SS re-adjusts the cell-specific reference signal level according to row "T3".	-	-	-	-
12	Check: Does the UE transmit a <i>MeasurementReport</i> message to report event A5 (<i>measId</i> 2) with the measured RSRP value for NR Cell 2, E-UTRA PSCell and E-UTRA neighbour Cell 2.	-->	NR RRC: <i>MeasurementReport</i>	3	P

8.2.3.2.2.3.3 Specific message contents

Table 8.2.3.8.2.3.3-1: RRCReconfiguration (step 1, Table 8.2.3.8.2.3.2-3)

Derivation Path: TS 38.508-1 [4], Table 4.6.1-13 with condition NE-DC

Table 8.2.3.8.2.3.3-2: SCG-Configuration-r12-NE-DC (step 1, Table 8.2.3.8.2.3.2-3)

Derivation Path: TS 36.508, Table 4.6.3-19G			
Information Element	Value/remark	Comment	Condition
scg-Configuration-r12 CHOICE {			
setup SEQUENCE {			
scg-ConfigPartSCG-r12 SEQUENCE {			
measConfigSN-r15	MeasConfig-A5-E-UTRA		
}			
}			
}			

Table 8.2.3.8.2.3.3-3: MeasConfig-A5-E-UTRA (Table 8.2.3.8.2.3.3-2)

Derivation path: TS 36.508, table 4.6.6-1			
Information Element	Value/Remark	Comment	Condition
MeasConfig-DEFAULT ::= SEQUENCE {			
measObjectToAddModList SEQUENCE (SIZE (1..maxObjectld)) OF MeasObjectToAddMod {	1 entry		
MeasObjectToAddMod[1] SEQUENCE {		entry 1	
measObjectld	1		
measObject CHOICE {			
measObjectEUTRA	MeasObjectEUTRA-GENERIC(f1)		
	MeasObjectEUTRA-GENERIC(maxEARFCN)		Band > 64
}			
}			
reportConfigToAddModList SEQUENCE (SIZE (1..maxReportConfigld)) OF reportConfigToAddMod {	1 entry		
reportConfigToAddMod[1] SEQUENCE {		entry 1	
reportConfigld	1		
reportConfig	ReportConfig-A5		
}			
}			
measldToAddModList SEQUENCE (SIZE (1..maxMeasld)) OF measldToAddMod {	1 entry		
measldToAddMod[1] SEQUENCE {		entry 1	
measld	1		
measObjectld	1		
reportConfigld	1		
}			
}			
measObjectToAddModList-v9e0 ::= SEQUENCE (SIZE (1..maxObjectld)) OF measObjectEUTRA-v9e0 {	1 entry		Band > 64
measObjectEUTRA-v9e0[1] SEQUENCE {		entry 1	

carrierFreq-v9e0	Same downlink EARFCN as used for f1		
}			
}			
}			

Table 8.2.3.8.2.3.3-4: ReportConfig-A5 (step 1, Table 8.2.3.8.2.3.2-3)

Derivation path: TS 36.508 table 4.6.6-6AB ReportConfigEUTRA-A5			
Information Element	Value/remark	Comment	Condition
ReportConfigEUTRA-A5 ::= SEQUENCE {			
triggerType CHOICE {			
eventId CHOICE {			
eventA5 SEQUENCE {			
a5-Threshold1 CHOICE{			
threshold-RSRP	52	-88dbm	
}			
a5-Threshold2 CHOICE{			
threshold-RSRP	52	-88dbm	
}			
}			
}			
}			
}			
}			
reportQuantity	sameAsTriggerQuantity		
reportAmount	r16		
}			

Table 8.2.3.8.2.3.3-5: RRCReconfigurationComplete (step 2 and step 10, Table 8.2.3.8.2.3.2-3)

Derivation Path: TS 38.508-1 [4], Table 4.6.1-14 Condition with NE-DC

Table 8.2.3.8.2.3.3-6: ULInformationTransferMRDC (step 4 and step 5, Table 8.2.3.8.2.3.2-3)

Derivation Path: TS 36.508 [7], Table 4.6.1-27			
Information Element	Value/remark	Comment	Condition
ULInformationTransferMRDC ::= SEQUENCE {			
ul-DCCCH-MessageEUTRA	OCTET STRING including the MeasurementReport message according to Table 8.2.3.8.2.3.3-7		
}			

Table 8.2.3.8.2.3.3-7: MeasurementReport (Table 8.2.3.8.2.3.3-6)

Derivation path: TS 36.508 4.6.1 table 4.6.1-5			
Information Element	Value/Remark	Comment	Condition
MeasurementReport ::= SEQUENCE {			
criticalExtensions CHOICE {			
c1 CHOICE {			
measurementReport-r8 SEQUENCE {			
measResults SEQUENCE {			
measId	1		
measResultPCell SEQUENCE {		Report E-UTRA Cell 1	
rsrpResult	(0..97)		
rsrqResult	(0..34)		
}			
}			
}			
measResultNeighCells CHOICE {			

measResultListEUTRA SEQUENCE (SIZE (1..maxCellReport)) OF measResultEUTRA {	1 entry	Report E-UTRA Cell 2	
measResultEUTRA[1] SEQUENCE {		entry1	
physCellId	physCellId of the E-UTRA Cell 2.		
measResult SEQUENCE{			
rsrpResult	(0..97)		
rsrqResult	Not present		
}			
}			
}			
measResultListUTRA	Not present		
measResultListGERAN	Not present		
measResultsCDMA2000	Not present		
measResultNeighCellListNR-r15	Not present		
}			
}			
}			
}			
}			
}			

Table 8.2.3.8.2.3.3-8: RRCReconfiguration (step 9, Table 8.2.3.8.2.3.2-3)

Derivation Path: TS 38.508-1 [4] Table 4.6.1-13 with condition NR_MEAS

Table 8.2.3.8.2.3.3-9: MeasConfig-A5 (Table 8.2.3.8.2.3.3-8)

Derivation Path: TS 38.508-1 [4] Table 4.6.3-69			
Information Element	Value/remark	Comment	Condition
MeasConfig ::= SEQUENCE {			
measObjectToAddModList SEQUENCE (SIZE (1..maxNrofMeasId)) OF MeasObjectToAddMod {	1 entry		
MeasObjectToAddMod[1] SEQUENCE {		entry 1	
measObjectId	1		
measObject CHOICE {			
measObjectNR	MeasObjectNR		
}			
}			
}			
reportConfigToAddModList SEQUENCE(SIZE (1..maxReportConfigId)) OF ReportConfigToAddMod {	1 entry		
ReportConfigToAddMod[1] SEQUENCE {		entry 1	
reportConfigId	1		
reportConfig CHOICE {			
reportConfigNR	ReportConfigNR-EventA5		
}			
}			
}			
measIdToAddModList SEQUENCE (SIZE (1..maxNrofMeasId)) OF MeasIdToAddMod {	1 entry		
MeasIdToAddMod[1] SEQUENCE {		entry 1	
measId	2		
measObjectId	1		
reportConfigId	1		
}			
}			
}			

Table 8.2.3.8.2.3.3-10: *MeasObjectNR* (Table 8.2.3.8.2.3.3-9)

Derivation Path: TS 38.508-1 [4], Table 4.6.3-76			
Information Element	Value/remark	Comment	Condition
MeasObjectNR ::= SEQUENCE {			
ssbFrequency	ARFCN-ValueNR for SSB of NR Cell 2		
absThreshSS-BlocksConsolidation	Not present		
nrofSS-BlocksToAverage	Not present		
}			

Table 8.2.3.8.2.3.3-11: *ReportConfigNR-EventA5* (Table 8.2.3.8.2.3.3-9)

Derivation Path: TS 38.508-1 [4] Table 4.6.3-142 with condition EVENT_A5			
Information Element	Value/remark	Comment	Condition
ReportConfigNR ::= SEQUENCE {			
reportType CHOICE {			
eventTriggered SEQUENCE {			
eventId CHOICE {			
eventA5 SEQUENCE {			
a5-Threshold1 CHOICE {			
rsrp	68	-88dbm	FR1
	FFS		FR2
a5-Threshold2 CHOICE {			
rsrp	68	-88dbm	FR1
	FFS		FR2
}			
}			
}			
reportAmount	r16		
reportQuantityCell SEQUENCE {			
rsrp	true		
rsrq	false		
sinr	false		
}			
reportAddNeighMeas	setup		
}			

Table 8.2.3.8.2.3.3-12: *MeasurementReport* (step 12, Table 8.2.3.8.2.3.2-3)

Derivation Path: TS 38.508-1 [4] Table 4.6.1-5A			
Information Element	Value/remark	Comment	Condition
MeasurementReport ::= SEQUENCE {			
criticalExtensions CHOICE {			
measurementReport SEQUENCE {			
measResults SEQUENCE {			
measId	2		
measResultServingMOList SEQUENCE (SIZE (1..maxNrofServingCells)) OF MeasResultServMO {	1 entry	Measurement report for NR Cell 1	
MeasResultServMO[1] SEQUENCE {		entry 1	
servCellId	ServCellIndex of NR Cell 1		
measResultServingCell SEQUENCE {			
physCellId	PCI of NR Cell 1		
measResult SEQUENCE {			
cellResults SEQUENCE {			
resultsSSB-Cell SEQUENCE {			
rsrp	(0..127)		
rsrq	(0..127)		
sinr	Not present		
}	Not checked		pc_ss_SIN
}			
}			
}			
}			
}			
}			
}			

			R_Meas
}			
}			
}			
}			
}			
measResultNeighCells CHOICE {			
measResultListNR SEQUENCE (SIZE (1..maxCellReport)) OF MeasResultNR {	1 entry	Measurement report for NR Cell 2	
MeasResultNR[1] SEQUENCE {		entry 1	
physCellId	Physical layer cell identity of NR Cell 2		
measResult SEQUENCE {			
cellResults SEQUENCE {			
resultsSSB-Cell SEQUENCE {			
rsrp	(0..127)		
rsrq	Not present		
sinr	Not present		
}			
resultsCSI-RS-Cell	Not present		
}			
rsIndexResults	Not present		
}			
cgi-Info	Not present		
}			
}			
measResultServFreqListEUTRA-SCG SEQUENCE (SIZE (1..maxNrofServingCellsEUTRA)) OF MeasResult2EUTRA {	1 entry		
MeasResult2EUTRA[1] SEQUENCE {		entry 1	
carrierFreq	ARFCN-Value for E-UTRA Cell 1		
measResultServingCell SEQUENCE {			
eutra-PhysCellId	PhysCellId of E-UTRA Cell 1		
measResult SEQUENCE {			
rsrp	(0..97)		
rsrq	Not present		
sinr	Not present		
}			
cgi-Info	Not present		
}			
measResultBestNeighCell SEQUENCE {			
eutra-PhysCellId	PhysCellId of E-UTRA Cell 2		
measResult SEQUENCE {			
rsrp	(0..97)		
rsrq	Not present		
sinr	Not present		
}			
cgi-Info	Not present		
}			
}			
}			
}			
}			
}			
}			

8.2.3.8.2a Measurement configuration control and reporting / Event A5 / Measurement of Neighbour E-UTRA and NR cells / Inter-frequency measurements / NE-DC

8.2.3.8.2a.1 Test Purpose (TP)

(1)

```
with { UE in RRC_CONNECTED state with NE-DC, and, MCG(s) (NR PDCP) and SCG and Inter-frequency
measurements configured for event A5 with event based periodical reporting }
ensure that {
  when { Serving E-UTRA PSCell becomes worse than absolute threshold1 and neighbour E-UTRA cell
becomes better than absolute threshold2 }
    then { UE sends MeasurementReport message at regular intervals while entering condition for
event A5 is satisfied }
}
```

(2)

```
with { UE in RRC_CONNECTED state with NE-DC, and, MCG(s) (NR PDCP) and SCG and periodical
measurement reporting triggered by event A5 ongoing }
ensure that {
  when { Serving E-UTRA PSCell becomes better than absolute threshold1 or neighbour E-UTRA cell
becomes worse than absolute threshold2 }
    then { UE stops sending MeasurementReport message }
}
```

(3)

```
with { UE in RRC_CONNECTED state with NE-DC, and, MCG(s) (NR PDCP) and SCG and measurements
configured for event A5 including reportAddNeighMeas with event based periodical reporting }
ensure that {
  when { Serving NR PCell becomes worse than absolute threshold1 and neighbour NR cell becomes
better than absolute threshold2 }
    then { UE sends MeasurementReport at regular intervals while entering condition for event A5 is
satisfied, and includes measurement result for the PSCELL. }
}
```

8.2.3.8.2a.2 Conformance requirements

Same as test case 8.2.3.8.2

8.2.3.8.2a.3 Test description

8.2.3.8.2a.3.1 Pre-test conditions

Same as test case 8.2.3.8.2a with the following differences:

- Cells configuration: NR Cell 3 replaces NR Cell 2; EUTRA Cell 3 replaces EUTRA Cell 2.

8.2.3.8.2a.3.2 Test procedure sequence

Same as test case 8.2.3.8.2a with the following differences:

- Cells configuration: NR Cell 3 replaces NR Cell 2; EUTRA Cell 3 replaces EUTRA Cell 2.

8.2.3.2.2.3.3 Specific message contents

Same as test case 8.2.3.8.2a with the following differences:

- Cells configuration: NR Cell 3 replaces NR Cell 2; EUTRA Cell 3 replaces EUTRA Cell 2.

Table 8.2.3.8.2a.3.3-3: MeasConfig-A5-E-UTRA (Table 8.2.3.8.2.3.3-2)

Derivation path: 36.508 table 4.6.6-1			
Information Element	Value/Remark	Comment	Condition
MeasConfig-DEFAULT ::= SEQUENCE {			

measObjectToAddModList SEQUENCE (SIZE (1..maxObjectld)) OF measObjectToAddMod {	2 entries		
measObjectld[1] SEQUENCE {		entry 1	
measObjectld	1		
measObject CHOICE {			
measObjectEUTRA	MeasObjectEUTRA- GENERIC(f1)		
	MeasObjectEUTRA- GENERIC(maxEARFCN)		Band > 64
}			
}			
measObjectld[2] SEQUENCE {		entry 2	
measObjectld	2		
measObject CHOICE {			
measObjectEUTRA	MeasObjectEUTRA- GENERIC(f2)		
	MeasObjectEUTRA- GENERIC(maxEARFCN)		Band > 64
}			
}			
}			
reportConfigToAddModList SEQUENCE (SIZE (1..maxReportConfigld)) OF reportConfigToAddMod {	1 entry		
reportConfigToAddMod[1] SEQUENCE {		entry 1	
reportConfigld	1		
reportConfig	ReportConfig-A5		
}			
}			
measldToAddModList SEQUENCE (SIZE (1..maxMeasld)) OF measldToAddMod {	1 entry		
measldToAddMod[1] SEQUENCE {		entry 1	
measld	1		
measObjectld	1		
reportConfigld	1		
}			
}			
measGapConfig	MeasGapConfig-GP1		
measObjectToAddModList-v9e0 ::= SEQUENCE (SIZE (1..maxObjectld)) OF measObjectEUTRA-v9e0 {	1 entry		Band > 64
measObjectEUTRA-v9e0[1] SEQUENCE {		entry 1	
carrierFreq-v9e0	Same downlink EARFCN as used for f1		
}			
}			
}			

Table 8.2.3.8.2a.3.3-9: MeasConfig-A5 (Table 8.2.3.8.2.3.3-8)

Derivation Path: TS 38.508-1 [4] Table 4.6.3-69			
Information Element	Value/remark	Comment	Condition
MeasConfig ::= SEQUENCE {			
measObjectToAddModList SEQUENCE (SIZE (1..maxNrofMeasld)) OF MeasObjectToAddMod {	2 entries		
MeasObjectToAddMod[1] SEQUENCE {		entry 1	
measObjectld	1		
measObject CHOICE {			
measObjectNR	MeasObjectNR-f1		
}			
}			
MeasObjectToAddMod[2] SEQUENCE {		entry 2	
measObjectld	2		
measObject CHOICE {			
measObjectNR	MeasObjectNR-f2		
}			
}			

}			
}			
reportConfigToAddModList SEQUENCE (SIZE (1..maxReportConfigId)) OF ReportConfigToAddMod {	1 entry		
ReportConfigToAddMod[1] SEQUENCE {		entry 1	
reportConfigId	2		
reportConfig CHOICE {			
reportConfigNR	ReportConfigNR-EventA5		
}			
}			
}			
}			
measIdToAddModList SEQUENCE (SIZE (1..maxNrofMeasId)) OF MeasIdToAddMod {	1 entry		
MeasIdToAddMod[1] SEQUENCE {		entry 1	
measId	2		
measObjectId	2		
reportConfigId	1		
}			
}			
}			
}			

Table 8.2.3.8.2a.3.3-12: MeasurementReport (step 12, Table 8.2.3.8.2.3.2-3)

Derivation Path: TS 38.508-1 [4] Table 4.6.1-5A			
Information Element	Value/remark	Comment	Condition
MeasurementReport ::= SEQUENCE {			
criticalExtensions CHOICE {			
measurementReport SEQUENCE {			
measResults SEQUENCE {			
measId	2		
measResultServingMOList SEQUENCE (SIZE (1..maxNrofServingCells)) OF MeasResultServMO {	1 entry	Measurement report for NR Cell 1	
MeasResultServMO[1] SEQUENCE {		entry 1	
servCellId	ServCellIndex of NR Cell 1		
measResultServingCell SEQUENCE {			
physCellId	PCI of NR Cell 1		
measResult SEQUENCE {			
cellResults SEQUENCE {			
resultsSSB-Cell SEQUENCE {			
rsrp	(0..127)		
rsrq	(0..127)		
sinr	Not present		
}	Not checked		pc_ss_SINR_Meas
}			
}			
}			
}			
}			
}			
}			
}			
measResultNeighCells CHOICE {			
measResultListNR SEQUENCE (SIZE (1..maxCellReport)) OF MeasResultNR {	1 entry	Measurement report for NR Cell 3	
MeasResultNR[1] SEQUENCE {		entry 1	
physCellId	Physical layer cell identity of NR Cell 3		
measResult SEQUENCE {			
cellResults SEQUENCE {			
resultsSSB-Cell SEQUENCE {			
rsrp	(0..127)		
rsrq	Not present		
sinr	Not present		
}			
}			
}			
}			
}			
}			

```

    then { UE sends MeasurementReport at regular intervals while entering condition for event A5 is
satisfied, and includes measurement result for the PSCCELL. }
}

```

8.2.3.8.2b.2 Conformance requirements

Same as test case 8.2.3.8.2a

8.2.3.8.2b.3 Test description

8.2.3.8.2b.3.1 Pre-test conditions

Same as test case 8.2.3.8.2a with the following differences:

- Cells configuration: NR Cell 10 replaces NR Cell 3; EUTRA Cell 10 replaces EUTRA Cell 3.

8.2.3.8.2b.3.2 Test procedure sequence

Same as test case 8.2.3.8.2a with the following differences:

- Cells configuration: NR Cell 10 replaces NR Cell 3; EUTRA Cell 10 replaces EUTRA Cell 3.

8.2.3.8.2b.3.3 Specific message contents

Same as test case 8.2.3.8.2a with the following differences:

- Cells configuration: NR Cell 10 replaces NR Cell 3; EUTRA Cell 10 replaces EUTRA Cell 3.

8.2.3.9 Measurement configuration control and reporting / SS/PBCH block based / CSI-RS based intra-frequency measurements / Measurement of Neighbour NR cell

8.2.3.9.1 Measurement configuration control and reporting / SS/PBCH block based / CSI-RS based Intra-frequency measurements / Measurement of Neighbour NR Cell / EN-DC

8.2.3.9.1.1 Test Purpose (TP)

(1)

```

with { UE in RRC_CONNECTED state in EN-DC mode and measurement configured for SS/PBCH measurement
reporting of intra-frequency on specified frequency }
ensure that {
  when { SS/PBCH block sorting quantity is above absThreshSS-BlocksConsolidation for each beam of NR
Neighbour Cell }
  then { UE sends MeasurementReport message containing rsIndexResults with resultsSSB-Indexes }
}

```

(2)

```

with { UE in RRC_CONNECTED state in EN-DC mode and measurement configured for SS/PBCH measurement
reporting of intra-frequency on specified frequency }
ensure that {
  when { SS/PBCH block sorting quantity is below absThreshSS-BlocksConsolidation for one beam of NR
Neighbour Cell and another beam(s) is above absThreshSS-BlocksConsolidation }
  then { UE sends MeasurementReport message containing rsIndexResults with resultsSSB-Indexes
includes RsIndex above absThreshSS-BlocksConsolidation and excludes RsIndex below absThreshSS-
BlocksConsolidation }
}

```

(3)

```

with { UE in RRC_CONNECTED state in EN-DC mode and measurement configured for CSI-RS measurement
reporting of intra frequency on specified frequency }
ensure that {
  when { CSI-RS sorting quantity is above absThreshCSI-RS-Consolidation for each beam of NR
  Neighbour Cell }
  then { UE sends MeasurementReport message containing rsIndexResults with resultsCSI-RS-Indexes }
}

```

(4)

```

with { UE in RRC_CONNECTED state in EN-DC mode and measurement configured for CSI-RS measurement
reporting of intra frequency on specified frequency }
ensure that {
  when { CSI-RS sorting quantity is below absThreshCSI-RS-Consolidation for one beam of NR Neighbour
  Cell and another beam(s) is above absThreshCSI-RS-Consolidation }
  then { UE sends MeasurementReport message containing rsIndexResults with resultsCSI-RS-Indexes
  includes RsIndex above absThreshCSI-RS-Consolidation and excludes RsIndex below absThreshCSI-RS-
  Consolidation }
}

```

8.2.3.9.1.2 Conformance requirements

References: The conformance requirements covered in the present TC are specified in: TS 38.331 clauses 5.5.5.1 and 5.5.5.2. Unless otherwise stated these are Rel-15 requirements.

[TS 38.331, clause 5.5.5.1]

The purpose of this procedure is to transfer measurement results from the UE to the network. The UE shall initiate this procedure only after successful security activation.

For the *measId* for which the measurement reporting procedure was triggered, the UE shall set the *measResults* within the *MeasurementReport* message as follows:

- 1> set the *measId* to the measurement identity that triggered the measurement reporting;
- 1> for each serving cell configured with *servicingCellMO*:
 - 2> if the *reportConfig* associated with the *measId* that triggered the measurement reporting includes *rsType*:
 - 3> if the serving cell measurements based on the *rsType* included in the *reportConfig* that triggered the measurement report are available:
 - 4> set the *measResultServingCell* within *measResultServingMOList* to include RSRP, RSRQ and the available SINR of the serving cell, derived based on the *rsType* included in the *reportConfig* that triggered the measurement report;
 - 2> else:
 - 3> if SSB based serving cell measurements are available:
 - 4> set the *measResultServingCell* within *measResultServingMOList* to include RSRP, RSRQ and the available SINR of the serving cell, derived based on SSB;
 - 3> else if CSI-RS based serving cell measurements are available:
 - 4> set the *measResultServingCell* within *measResultServingMOList* to include RSRP, RSRQ and the available SINR of the serving cell, derived based on CSI-RS;
 - 1> set the *servicingCellId* within *measResultServingMOList* to include for each NR serving cell that is configured, if any;
 - 1> if the *reportConfig* associated with the *measId* that triggered the measurement reporting includes *reportQuantityRS-Indexes* and *maxNrofRS-IndexesToReport*:
 - 2> for each serving cell configured with *servicingCellMO*, include beam measurement information according to the associated *reportConfig* as described in 5.5.5.2;

...

- 1> if there is at least one applicable neighbouring cell to report:
 - 2> if the *reportType* is set to *eventTriggered* or *periodical*:
 - 3> set the *measResultNeighCells* to include the best neighbouring cells up to *maxReportCells* in accordance with the following:
 - 4> if the *reportType* is set to *eventTriggered*:
 - 5> include the cells included in the *cellsTriggeredList* as defined within the *VarMeasReportList* for this *measId*;
 - 4> else:
 - 5> include the applicable cells for which the new measurement results became available since the last periodical reporting or since the measurement was initiated or reset;
 - 4> for each cell that is included in the *measResultNeighCells*, include the *physCellId*;
 - 4> if the *reportType* is set to *eventTriggered*:
 - 5> for each included cell, include the layer 3 filtered measured results in accordance with the *reportConfig* for this *measId*, ordered as follows:
 - 6> if the *measObject* associated with this *measId* concerns NR:
 - 7> if *rsType* in the associated *reportConfig* is set to *ssb*:
 - 8> set *resultsSSB-Cell* within the *measResult* to include the SS/PBCH block based quantity(ies) indicated in the *reportQuantityCell* within the concerned *reportConfig*, in decreasing order of the sorting quantity, determined as specified in 5.5.5.3, i.e. the best cell is included first;
 - 8> if *reportQuantityRS-Indexes* and *maxNrofRS-IndexesToReport* are configured, include beam measurement information as described in 5.5.5.2;
 - 7> else if *rsType* in the associated *reportConfig* is set to *csi-rs*:
 - 8> set *resultsCSI-RS-Cell* within the *measResult* to include the CSI-RS based quantity(ies) indicated in the *reportQuantityCell* within the concerned *reportConfig*, in decreasing order of the sorting quantity, determined as specified in 5.5.5.3, i.e. the best cell is included first;
 - 8> if *reportQuantityRS-Indexes* and *maxNrofRS-IndexesToReport* are configured, include beam measurement information as described in 5.5.5.2;

[TS 38.331, clause 5.5.5.1]

- 1> increment the *numberOfReportsSent* as defined within the *VarMeasReportList* for this *measId* by 1;
- 1> stop the periodical reporting timer, if running;
- 1> if the *numberOfReportsSent* as defined within the *VarMeasReportList* for this *measId* is less than the *reportAmount* as defined within the corresponding *reportConfig* for this *measId*:
 - 2> start the periodical reporting timer with the value of *reportInterval* as defined within the corresponding *reportConfig* for this *measId*;
- 1> else:
 - 2> if the *reportType* is set to *periodical*:
 - 3> remove the entry within the *VarMeasReportList* for this *measId*;
 - 3> remove this *measId* from the *measIdList* within *VarMeasConfig*;

- 1> if the UE is in (NG)EN-DC:
 - 2> if SRB3 is configured:
 - 3> submit the *MeasurementReport* message via SRB3 to lower layers for transmission, upon which the procedure ends;
 - 2>else:
 - 3> submit the *MeasurementReport* message via the EUTRA MCG embedded in E-UTRA RRC message *ULInformationTransferMRDC* as specified in TS 36.331 [10].

[TS 38.331, clause 5.5.5.2]

For beam measurement information to be included in a measurement report the UE shall:

- 1> if *reportType* is set to *eventTriggered*:
 - 2> consider the trigger quantity as the sorting quantity if available, otherwise RSRP as sorting quantity if available, otherwise RSRQ as sorting quantity if available, otherwise SINR as sorting quantity;
- 1> set *rsIndexResults* to include up to *maxNrofRS-IndexesToReportSS/PBCH* block indexes or CSI-RS indexes in order of decreasing sorting quantity as follows:
 - 2> if the measurement information to be included is based on SS/PBCH block:
 - 3> include within *resultsSSB-Indexes* the index associated to the best beam for that SS/PBCH block sorting quantity and if *absThreshSS-BlocksConsolidation* is included in the *VarMeasConfig* for the *measObject* associated to the cell for which beams are to be reported, the remaining beams whose sorting quantity is above *absThreshSS-BlocksConsolidation*;
 - 3> if *includeBeamMeasurements* is configured, include the SS/PBCH based measurement results for the quantities in *reportQuantityRS-Indexes* set to *true* for each SS/PBCH block index;
 - 2> else if the beam measurement information to be included is based on CSI-RS:
 - 3> include within *resultsCSI-RS-Indexes* the index associated to the best beam for that CSI-RS sorting quantity and, if *absThreshCSI-RS-Consolidation* is included in the *VarMeasConfig* for the *measObject* associated to the cell for which beams are to be reported, the remaining beams whose sorting quantity is above *absThreshCSI-RS-Consolidation*;
 - 3> if *includeBeamMeasurements* is configured, include the CSI-RS based measurement results for the quantities in *reportQuantityRS-Indexes* set to *true* for each CSI-RS index.

8.2.3.9.1.3 Test description

8.2.3.9.1.3.1 Pre-test conditions

System Simulator:

- EUTRA Cell 1 is the PCell and NR Cell 1 is the PS Cell and NR Cell 2 is the intra-frequency neighbour cell of NR Cell 1. NR Cell2 has two beams: SSB/CSI-RS index#0 and SSB/CSI-RS index#1.

UE:

- None

Preamble:

- The UE is in state RRC_CONNECTED in EN-DC using generic procedure parameter Connectivity (EN-DC) and DC Bearers (MCG(s) and SCG) on E-UTRA Cell 1 according to TS 38.508-1 [4].

8.2.3.9.1.3.2 Test procedure sequence

Table 8.2.3.9.1.3.2-1 and Table 8.2.3.9.1.3.2-1A illustrates the downlink power levels to be applied for NR Cell 1 and NR Cell 2 at various time instants of the test execution. Row marked "T0" denotes the conditions after the preamble, while rows marked "T1" and "T2" are to be applied subsequently. The exact instants on which these values shall be applied are described in the texts in this clause.

Table 8.2.3.9.1.3.2-1: Time instances of cell power level and parameter changes for conducted test environment

	Parameter	Unit	E-UTRA Cell 1	NR Cell 1	NR Cell 2	NR Cell 2 Beam 0 (NOTE)	NR Cell 2 Beam 1 (NOTE)	Remark
T0	Cell-specific RS EPRE	dBm/15k Hz	-85	-	-	-	-	
	SS/PBCH SSS EPRE	dBm/SC S	-	-94	-	-	-	
	Reference Power	dBm/SC S	-	-	-90	-	-	
	SS/PBCH SSS EPRE, CSI-RS EPRE offset	dB	-	-	-	-4	-4	
T1	Cell-specific RS EPRE	dBm/15k Hz	-85	-	-	-	-	$Mn + Ofn + Ocn - Hys > Mp + Ofp + Ocp + Off$ Power level is such that SS/PBCH quality and CSI-RS quality for both beams of NR Cell 2 are above <i>absThreshSS-BlocksConsolidation</i> .
	SS/PBCH SSS EPRE	dBm/SC S	-	-106	-	-	-	
	Reference Power	dBm/SC S	-	-	-90	-	-	
	SS/PBCH SSS EPRE, CSI-RS EPRE offset	dB	-	-	-	-4	-4	
T2	Cell-specific RS EPRE	dBm/15k Hz	-85	-	-	-	-	$Mn + Ofn + Ocn + Hys < Mp + Ofp + Ocp + Off$ Power level is such that SS/PBCH quality and CSI-RS quality for both beams of NR Cell 2 are below <i>absThreshSS-BlocksConsolidation</i>
	SS/PBCH SSS EPRE	dBm/SC S	-	-94	-	-	-	
	Reference Power	dBm/SC S	-	-	-90	-	-	
	SS/PBCH SSS EPRE, CSI-RS EPRE offset	dB	-	-	-	-12	-12	
T3	Cell-specific RS EPRE	dBm/15k Hz	-85	-	-	-	-	Power level is such that SS/PBCH quality and CSI-RS quality for beam 0 of NR Cell 2 is above <i>absThreshSS-BlocksConsolidation</i> and for beam 1 of NR Cell 2 is below <i>absThreshSS-BlocksConsolidation</i> .
	SS/PBCH SSS EPRE	dBm/SC S	-	-106	-	-	-	
	Reference Power	dBm/SC S	-	-	-90	-	-	

	SS/PBCH SSS EPRE, CSI-RS EPRE offset	dB	-	-	-	-4	-12	
<p>NOTE: "Beam 0" refers to transmission of the SS/PBCH block with SSB index #0 (according to the <i>ssb-PositionsInBurst</i>) and CSI-RS with index #0 (according to the <i>csi-rs-ResourceList-Mobility</i> being signalled to the UE at step 9); "Beam 1" refers to transmission of the SS/PBCH block with SSB index #1 (according to the <i>ssb-PositionsInBurst</i>) and CSI-RS with index #1 (according to the <i>csi-rs-ResourceList-Mobility</i> being signalled to the UE at step 9). For each beam SSS and CSI-RS have the same power levels at any given time instance.</p>								

Table 8.2.3.9.1.3.2-1A: Time instances of cell power level and parameter changes for OTA test environment

	Parameter	Unit	E-UTRA Cell 1	NR Cell 1	NR Cell 2	NR Cell 2 Beam 0 (NOTE)	NR Cell 2 Beam 1 (NOTE)	Remark
T0	Cell-specific RS EPRE	dBm/15k Hz	-96	-	-	-	-	
	SS/PBCH SSS EPRE	dBm/SC S	-	-82	-	-	-	
	Reference Power	dBm/SC S	-	-	-90	-	-	
	SS/PBCH SSS EPRE, CSI-RS EPRE offset	dB	-	-	-	-1	-1	
T1	Cell-specific RS EPRE	dBm/15k Hz	-96	-	-	-	-	$Mn + Ofn + Ocn - Hys > Mp + Ofp + Ocp + Off$ Power level is such that SS/PBCH quality and CSI-RS quality for both beams of NR Cell 2 are above <i>absThreshSS-BlocksConsolidation</i> .
	SS/PBCH SSS EPRE	dBm/SC S	-	-100	-	-	-	
	Reference Power	dBm/SC S	-	-	-90	-	-	
	SS/PBCH SSS EPRE, CSI-RS EPRE offset	dB	-	-	-	-1	-1	
T2	Cell-specific RS EPRE	dBm/15k Hz	-96	-	-	-	-	$Mn + Ofn + Ocn + Hys < Mp + Ofp + Ocp + Off$ Power level is such that SS/PBCH quality and CSI-RS quality for both beams of NR Cell 2 are below <i>absThreshSS-BlocksConsolidation</i> .
	SS/PBCH SSS EPRE	dBm/SC S	-	-82	-	-	-	
	Reference Power	dBm/SC S	-	-	-90	-	-	
	SS/PBCH SSS EPRE, CSI-RS EPRE offset	dB	-	-	-	-10	-10	
T3	Cell-specific RS EPRE	dBm/15k Hz	-96	-	-	-	-	Power level is such that SS/PBCH quality and CSI-RS quality for beam 0 of NR Cell 2 is above <i>absThreshSS-</i>

SS/PBCH SSS EPRE	dBm/SC S	-	-100	-	-	-	-	<i>BlocksConsolidation</i> and for beam 1 of NR Cell 2 is below <i>absThreshSS-BlocksConsolidation</i> .
Reference Power	dBm/SC S	-	-	-90	-	-	-	
SS/PBCH SSS EPRE, CSI-RS EPRE offset	dB	-	-	-	-1	-10	-	
NOTE: "Beam 0" refers to transmission of the SS/PBCH block with SSB index #0 (according to the <i>ssb-PositionsInBurst</i>) and CSI-RS with index #0 (according to the <i>csi-rs-ResourceList-Mobility</i> being signalled to the UE at step 9); "Beam 1" refers to transmission of the SS/PBCH block with SSB index #1 (according to the <i>ssb-PositionsInBurst</i>) and CSI-RS with index #1 (according to the <i>csi-rs-ResourceList-Mobility</i> being signalled to the UE at step 9). For each beam SSS and CSI-RS have the same power levels at any given time instance.								

Table 8.2.3.9.1.3.2-2: Main behaviour

St	Procedure	Message Sequence		TP	Verdict
		U - S	Message		
1	The SS transmits an <i>RRCCONNECTIONRECONFIGURATION</i> message containing NR <i>RRCCONNECTIONRECONFIGURATION</i> including <i>measConfig</i> to setup SS/PBCH block based intra-frequency NR measurement for PSCell (NR Cell 1) and reporting for event A3.	<--	EUTRA RRC: <i>RRCCONNECTIONRECONFIGURATION(RRCCONNECTIONRECONFIGURATION)</i>	-	-
2	The UE transmits an <i>RRCCONNECTIONRECONFIGURATIONCOMPLETE</i> message containing NR <i>RRCCONNECTIONRECONFIGURATIONCOMPLETE</i> .	-->	EUTRA RRC: <i>RRCCONNECTIONRECONFIGURATIONCOMPLETE(RRCCONNECTIONRECONFIGURATIONCOMPLETE)</i>	-	-
3	The SS re-adjusts the cell-specific reference signal level according to row "T1".	-	-	-	-
4	Check: Does the UE transmit a <i>MEASUREMENTREPORT</i> message to report event A3 with the measured results for NR Cell 2 with beam information containing <i>RsIndex[0]</i> and <i>RsIndex[1]</i> ?	-->	EUTRA RRC: <i>ULINFORMATIONTRANSFERMRDC(MEASUREMENTREPORT)</i>	1	P
4A	The SS re-adjusts the cell-specific reference signal level according to the row "T2".	-	-	-	-
4B	Check: Does the UE transmit a <i>MEASUREMENTREPORT</i> message on E-UTRA Cell 1 to report the event A3 during the next 10s?	-	-	1	F
5	The SS re-adjusts the cell-specific reference signal level according to row "T3".	-	-	-	-
6	Check: Does the UE transmit a <i>MEASUREMENTREPORT</i> message to report event A3 with the measured results for NR Cell 2 with beam information containing <i>RsIndex[0]</i> and excludes <i>RsIndex[1]</i> ?	-->	EUTRA RRC: <i>ULINFORMATIONTRANSFERMRDC(MEASUREMENTREPORT)</i>	2	P
7-8	Void	-	-	-	-
9	The SS transmits an <i>RRCCONNECTIONRECONFIGURATION</i> message containing NR <i>RRCCONNECTIONRECONFIGURATION</i> including <i>measConfig</i> to setup CSI-RS based intra-frequency NR measurement for PSCell (NR Cell 1) and reporting for event A3.	<--	EUTRA RRC: <i>RRCCONNECTIONRECONFIGURATION(RRCCONNECTIONRECONFIGURATION)</i>	-	-
10	The UE transmits an <i>RRCCONNECTIONRECONFIGURATIONCOMPLETE</i> message containing NR <i>RRCCONNECTIONRECONFIGURATIONCOMPLETE</i> .	-->	EUTRA RRC: <i>RRCCONNECTIONRECONFIGURATIONCOMPLETE(RRCCONNECTIONRECONFIGURATIONCOMPLETE)</i>	-	-
11	SS re-adjusts the cell-specific reference signal level according to row "T1".	-	-	-	-
12	Check: Does the UE transmit a <i>MEASUREMENTREPORT</i> message to report event A3	-->	EUTRA RRC: <i>ULINFORMATIONTRANSFERMRDC(MEASUREMENTREPORT)</i>	3	P

	with the measured results for NR Cell 2 with beam information containing RsIndex[0] and RsIndex[1]?				
12A	The SS re-adjusts the cell-specific reference signal level according to the row "T2".	-	-	-	-
12B	Check: Does the UE transmit a <i>MeasurementReport</i> message on E-UTRA Cell 1 to report the event A3 during the next 10s?	-	-	3	F
13	The SS re-adjusts the cell-specific reference signal level according to row "T3".	-	-	-	-
14	Check: Does the UE transmit a <i>MeasurementReport</i> message to report event A3 with the measured results for NR Cell 2 with beam information containing RsIndex[0] and excludes RsIndex[1]?	-->	EUTRA RRC: <i>ULInformationTransferMRD</i> <i>C(MeasurementReport)</i>	4	P

8.2.3.9.1.3.3 Specific message contents

Table 8.2.3.9.1.3.3-1: RRCConnectionReconfiguration (steps 1, 9 Table 8.2.3.9.1.3.2-2)

Derivation Path: TS 36.508 [7], Table 4.6.1-8 with condition EN-DC_EmbedNR_RRCRecon

Table 8.2.3.9.1.3.3-2: RRCReconfiguration (Table 8.2.3.9.1.3.3-1)

Derivation Path: TS 38.508-1 [4], Table 4.6.1-13 with condition EN-DC_MEAS

Table 8.2.3.9.1.3.3-3: MeasConfig (Table 8.2.3.9.1.3.3-2)

Derivation Path: TS 38.508-1 [4], Table 4.6.3-69

Information Element	Value/remark	Comment	Condition
MeasConfig ::= SEQUENCE {			
measObjectToAddModList	IdMeasObjectToAdd Not present		Step 1 Step 9
reportConfigToAddModList	IdReportConfigToAdd Not present		Step 1 Step 9
measIdToAddModList	IdMeasIdToAdd		
}			

Table 8.2.3.9.1.3.3-4: IdMeasObjectToAdd (Table 8.2.3.9.1.3.3-3)

Derivation Path: TS 38.331 [6], clause 6.3.2

Information Element	Value/remark	Comment	Condition
MeasObjectToAddModList ::= SEQUENCE (SIZE (1..maxNrofMeasId)) OF MeasObjectToAddMod {	1 entry		
MeasObjectToAddMod[1] SEQUENCE {		entry 1	
measObjectld	1		
measObject CHOICE {			
measObjectNR	Id-MeasObjectNR		
}			
}			
}			

Table 8.2.3.9.1.3.3-5: Id-MeasObjectNR (Table 8.2.3.9.1.3.3-4)

Derivation Path: TS 38.508-1 [4], Table 4.6.3-76

Information Element	Value/remark	Comment	Condition
MeasObjectNR ::= SEQUENCE {			
ssbFrequency	Downlink ARFCN of NR Cell 1		

refFreqCSI-RS	Same as "Point A" defined for the downlink of NR Cell 1		
referenceSignalConfig SEQUENCE {			
ssb-ConfigMobility SEQUENCE {			
ssb-ToMeasure CHOICE {			
setup CHOICE {			
shortBitmap	1100		(FREQ<=3G Hz AND (FR1_FDD OR NOT CASE_C)) OR (FREQ<=2.4 GHz AND FR1_TDD)
mediumBitmap	11000000		(FREQ>3G Hz AND FR1) OR (FREQ>2.4 GHz AND FR1_TDD AND CASE_C)
longBitmap	11000000 00000000 00000000 00000000 00000000 00000000 00000000 00000000		FR2
}			
}			
}			
csi-rs-ResourceConfigMobility CHOICE {			
setup SEQUENCE {			
subcarrierSpacing	SubcarrierSpacing		
csi-RS-CellList-Mobility SEQUENCE (SIZE (1..maxNrofCSI-RS-CellsRRM)) OF CSI-RS-CellMobility {	2 entries		
CSI-RS-CellMobility[1] SEQUENCE {		entry 1	
cellId	Physical CellID of the NR Cell 1		
csi-rs-MeasurementBW SEQUENCE {			
nrofPRBs	size24		
startPRB	same value as 'offsetToCarrier' as defined for the DL frequency of NR Cell 1		
}			
density	d3		
csi-rs-ResourceList-Mobility SEQUENCE (SIZE (1..maxNrofCSI-RS-ResourcesRRM)) OF CSI-RS-Resource-Mobility {	1 entry		
CSI-RS-Resource-Mobility[1] SEQUENCE {		entry 1	
csi-RS-Index	0		
slotConfig CHOICE {			
ms20	0	To avoid collision with CSI-RS of NR Cell 2	
}			
associatedSSB	Not present		
associatedSSB SEQUENCE {			pc_csi_RSR P_AndRSR Q_MeasWit hSSB
ssb-Index	0		
isQuasiColocated	false		
}			
frequencyDomainAllocation CHOICE {			

row1	1000		
}			
firstOFDMSymbolInTimeDomain	4		
sequenceGenerationConfig	24		
}			
}			
CSI-RS-CellMobility[2] SEQUENCE {		entry 2	
cellId	Physical CellID of the NR Cell 2		
csi-rs-MeasurementBW SEQUENCE {			
nrofPRBs	size24		
startPRB	same value as 'offsetToCarrier' as defined for the DL frequency of the cell		
}			
density	d3		
csi-rs-ResourceList-Mobility SEQUENCE (SIZE (1..maxNrofCSI-RS-ResourcesRRM)) OF CSI-RS-Resource-Mobility {	2 entries		
CSI-RS-Resource-Mobility[1] SEQUENCE {		entry 1	
csi-RS-Index	0	CSI-RS with Index 0	
slotConfig CHOICE {			
ms20	10 * 2 ^μ	μ is numerology index (SCS=15kHz: 0, SCS=30kHz: 1, etc.)	
}			
associatedSSB	Not present		
associatedSSB SEQUENCE {			pc_csi_RSR P_AndRSR Q_MeasWit hSSB
ssb-Index	0		
isQuasiColocated	false		
}			
frequencyDomainAllocation CHOICE {			
row1	1000		
}			
firstOFDMSymbolInTimeDomain	4		
sequenceGenerationConfig	24		
}			
CSI-RS-Resource-Mobility[2] SEQUENCE {		entry 2	
csi-RS-Index	1	CSI-RS with Index 1	
slotConfig CHOICE {			
ms20	10 * 2 ^μ	μ: numerology index (SCS=15kHz: 0, SCS=30kHz: 1, etc.)	
}			
associatedSSB	Not present		
associatedSSB SEQUENCE {			pc_csi_RSR P_AndRSR Q_MeasWit hSSB
ssb-Index	1		
isQuasiColocated	false		
}			
frequencyDomainAllocation CHOICE {			
row1	0001		
}			

firstOFDMSymbolInTimeDomain	0		
sequenceGenerationConfig	24		
}			
}			
}			
}			
}			
}			
absThreshSS-BlocksConsolidation SEQUENCE {			
thresholdRSRP	57	corresponding to -99dBm	FR1
	66	corresponding to -90dBm	FR2
}			
absThreshCSI-RS-Consolidation SEQUENCE {	2		
thresholdRSRP	57	corresponding to -99dBm	FR1
	66	corresponding to -90dBm	FR2
thresholdRSRQ	Not Present		
thresholdSINR	Not Present		
}			
nrofCSI-RS-ResourcesToAverage			
}			

Table 8.2.3.9.1.3.3-6: IdReportConfigToAdd (Table 8.2.3.9.1.3.3-3)

Derivation Path: TS 38.331 [6], clause 6.3.2			
Information Element	Value/remark	Comment	Condition
ReportConfigToAddModList ::= SEQUENCE(SIZE (1..maxReportConfigId)) OF ReportConfigToAddMod {	2 entries		
ReportConfigToAddMod[1] SEQUENCE {		entry 1	
reportConfigId	1		
reportConfig CHOICE {			
reportConfigNR	IdReportConfig-A3-SSB		
}			
}			
ReportConfigToAddMod[2] SEQUENCE {		entry 2	
reportConfigId	2		
reportConfig CHOICE {			
reportConfigNR	IdReportConfig-A3-CSI-RS		
}			
}			
}			

Table 8.2.3.9.1.3.3-7: IdReportConfig-A3-SSB (Table 8.2.3.9.1.3.3-6)

Derivation Path: TS 38.508-1 [4], Table 4.6.3-142 with condition EVENT_A3			
Information Element	Value/remark	Comment	Condition
ReportConfigNR ::= SEQUENCE {			
reportType CHOICE {			
eventTriggered SEQUENCE {			
eventId CHOICE {			
eventA3 SEQUENCE {			
a3-Offset CHOICE {			
rsrp	2		
}			
}			
}			
}			
reportAmount	r1		

reportQuantityRS-Indexes SEQUENCE {			
rsrp	true		
rsrq	false		
sinr	false		
}			
maxNrofRS-IndexesToReport	2		
includeBeamMeasurements	true		
}			
}			
}			

Table 8.2.3.9.1.3.3-7A: IdReportConfig-A3-CSI-RS (Table 8.2.3.9.1.3.3-6)

Derivation Path: TS 38.508-1 [4], Table 4.6.3-142 with condition EVENT_A3			
Information Element	Value/remark	Comment	Condition
ReportConfigNR ::= SEQUENCE {			
reportType CHOICE {			
eventTriggered SEQUENCE {			
eventId CHOICE {			
eventA3 SEQUENCE {			
a3-Offset CHOICE {			
rsrp	2		
}			
}			
}			
}			
rsType	csi-rs		
reportAmount	r1		
reportQuantityCell SEQUENCE {			
sinr	false		
}			
reportQuantityRS-Indexes SEQUENCE {			
rsrp	true		
rsrq	false		
sinr	false		
}			
maxNrofRS-IndexesToReport	2		
includeBeamMeasurements	true		
}			
}			
}			
}			

Table 8.2.3.9.1.3.3-8: IdMeasIdToAdd (Table 8.2.3.9.1.3.3-3)

Derivation Path: TS 38.508-1 [4], Table 4.6.3-73			
Information Element	Value/remark	Comment	Condition
MeasIdToAddModList ::= SEQUENCE (SIZE (1..maxNrofMeasId)) OF MeasIdToAddMod {	1 entry		
MeasIdToAddMod[1] SEQUENCE {		entry 1	
measId	1		
measObjectId	1		
reportConfigId	1		Step 1
}	2		Step 9
}			
}			

Table 8.2.3.9.1.3.3-9: RRCConnectionReconfigurationComplete (steps 2, 10, Table 8.2.3.9.1.3.2-2)

Derivation Path: TS 36.508 [7], Table 4.6.1-9 with condition MCG_and_SCG
--

Table 8.2.3.9.1.3.3-10: ULInformationTransferMRDC (steps 4, 6, 12, 14 Table 8.2.3.9.1.3.2-2)

Derivation Path: TS 36.508 [7], Table 4.6.1-27			
Information Element	Value/remark	Comment	Condition
ULInformationTransferMRDC-r15 ::= SEQUENCE {			
criticalExtensions CHOICE {			
c1 CHOICE {			
ulInformationTransferMRDC-r15 SEQUENCE {			
ul-DCCH-MessageNR-r15	OCTET STRING containing NR RRC MeasurementReport		
}			
}			
}			
}			

Table 8.2.3.9.1.3.3-11: MeasurementReport (step 4, Table 8.2.3.9.1.3.2-2)

Derivation Path: TS 38.508-1 [4], Table 4.6.1-7			
Information Element	Value/remark	Comment	Condition
MeasurementReport ::= SEQUENCE {			
criticalExtensions CHOICE {			
measurementReport SEQUENCE {			
measResults	MeasResults		
}			
}			
}			

Table 8.2.3.9.1.3.3-11A: MeasResults (Table 8.2.3.9.1.3.3-11)

Derivation Path: TS 38.508-1 [4], Table 4.6.3-79			
Information Element	Value/remark	Comment	Condition
MeasResults ::= SEQUENCE {			
measId	1		
measResultServingMOList SEQUENCE (SIZE (1..maxNrofServingCells)) OF MeasResultServMO {	1 entry		
MeasResultServMO[1] SEQUENCE {		entry 1	
servCellId	ServCellIndex of NR Cell 1		
measResultServingCell SEQUENCE {			
physCellId	Physical CellID of the NR Cell 1		
measResult SEQUENCE {			
cellResults SEQUENCE {			
resultsSSB-Cell SEQUENCE {			
rsrp	(0..127)		
rsrq	(0..127)		
sinr	Not present (0..127)		pc_ss_SINR_Meas
}			
}			
rsIndexResults SEQUENCE {			
resultsSSB-Indexes SEQUENCE (SIZE (1..maxNrofIndexesToReport2)) OF ResultsPerSSB-Index {	1 entry		
ResultsPerSSB-Index[1] EQUENCE {		entry 1	
ssb-Index	Not checked		
ssb-Results SEQUENCE {			
rsrp	(0..127)		
rsrq	(0..127)		
sinr	Not present Not checked		pc_ss_SINR_Meas
}			
}			
}			
}			
}			
}			

}			
}			
}			
resultsCSI-RS-Indexes	Not present		
}			
}			
}			
}			
measResultNeighCells CHOICE {			
measResultListNR SEQUENCE (SIZE (1..maxCellReport)) OF MeasResultNR {	1 entry		
MeasResultNR[1] SEQUENCE {		entry 1	
physCellId	Physical CellID of the NR Cell 2		
measResult SEQUENCE {			
cellResults SEQUENCE {			
resultsSSB-Cell SEQUENCE {			
rsrp	(0..127)		
rsrq	(0..127)		
sinr	(0..127)		pc_ss_SINR_Meas
}	Not present		
}			
}			
}			
resultsCSI-RS-Cell	Not present		
}			
rsIndexResults SEQUENCE {			
resultsSSB-Indexes SEQUENCE (SIZE (1..maxNrofIndexesToReport2)) OF ResultsPerSSB-Index {	2 entries that may appear in an arbitrary order		
ResultsPerSSB-Index[1] SEQUENCE {		entry 1	
ssb-Index	SSB index 0		
ssb-Results SEQUENCE {			
rsrp	(0..127)		
rsrq	Not present		
sinr	Not present		
}			
}			
ResultsPerSSB-Index[2] SEQUENCE {		entry 2	
ssb-Index	SSB index 1		
ssb-Results SEQUENCE {			
rsrp	(0..127)		
rsrq	Not present		
sinr	Not present		
}			
}			
}			
resultsCSI-RS-Indexes	Not present		
}			
}			
}			
cgi-Info	Not present		
}			
}			
}			

Table 8.2.3.9.1.3.3-12: MeasurementReport (step 6, Table 8.2.3.9.1.3.2-2)

Derivation Path: TS 38.508-1 [4], Table 4.6.1-7			
Information Element	Value/remark	Comment	Condition
MeasurementReport ::= SEQUENCE {			
criticalExtensions CHOICE {			
measurementReport SEQUENCE {			
measResults	MeasResults		

}			
}			
}			

Table 8.2.3.9.1.3.3-12A: MeasResults (Table 8.2.3.9.1.3.3-12)

Derivation Path: TS 38.508-1 [4], Table 4.6.3-79			
Information Element	Value/remark	Comment	Condition
MeasResults ::= SEQUENCE {			
measId	1		
measResultServingMOList SEQUENCE (SIZE (1..maxNrofServingCells)) OF MeasResultServMO {	1 entry		
MeasResultServMO[1] SEQUENCE {		entry 1	
servCellId	ServCellIndex of NR Cell 1		
measResultServingCell SEQUENCE {			
physCellId	Physical CellID of the NR Cell 1		
measResult SEQUENCE {			
cellResults SEQUENCE{			
resultsSSB-Cell SEQUENCE {			
rsrp	(0..127)		
rsrq	(0..127)		
sinr	Not present (0..127)		pc_ss_SINR_Meas
}			
}			
rsIndexResults SEQUENCE {			
resultsSSB-Indexes SEQUENCE (SIZE (1..maxNrofIndexesToReport2)) OF ResultsPerSSB-Index {	1 entry		
ResultsPerSSB-Index[1] SEQUENCE {		entry 1	
ssb-Index	Not checked		
ssb-Results SEQUENCE {			
rsrp	(0..127)		
rsrq	(0..127)		
sinr	Not present Not checked		pc_ss_SINR_Meas
}			
}			
resultsCSI-RS-Indexes	Not present		
}			
}			
}			
}			
measResultNeighCells CHOICE {			
measResultListNR SEQUENCE (SIZE (1..maxCellReport)) OF MeasResultNR {	1 entry		
MeasResultNR[1] SEQUENCE {		entry 1	
physCellId	Physical CellID of the NR Cell2		
measResult SEQUENCE {			
cellResults SEQUENCE {			
resultsSSB-Cell SEQUENCE {			
rsrp	(0..127)		
rsrq	(0..127)		
sinr	(0..127)		pc_ss_SINR_Meas
}	Not present		
}			
}			
}			
resultsCSI-RS-Cell	Not present		

}			
rsIndexResults SEQUENCE {			
resultsSSB-Indexes SEQUENCE (SIZE (1..maxNrofIndexesToReport2)) OF ResultsPerSSB-Index {	1 entry		
ResultsPerSSB-Index[1] SEQUENCE {		entry 1	
ssb-Index	SSB index 0		
ssb-Results SEQUENCE {			
rsrp	(0..127)		
rsrq	Not present		
sinr	Not present		
}			
}			
resultsCSI-RS-Indexes	Not present		
}			
}			
cgi-Info	Not present		
}			
}			
}			

Table 8.2.3.9.1.3.3-13: Void

Table 8.2.3.9.1.3.3-14: Void

Table 8.2.3.9.1.3.3-14A: Void

Table 8.2.3.9.1.3.3-14B: Void

Table 8.2.3.9.1.3.3-14C: Void

Table 8.2.3.9.1.3.3-14D: Void

Table 8.2.3.9.1.3.3-15: MeasurementReport (step 12, Table 8.2.3.9.1.3.2-2)

Derivation Path: TS 38.508-1 [4], Table 4.6.1-7			
Information Element	Value/remark	Comment	Condition
MeasurementReport ::= SEQUENCE {			
criticalExtensions CHOICE {			
measurementReport SEQUENCE {			
measResults	MeasResults		
}			
}			
}			

Table 8.2.3.9.1.3.3-15A: MeasResults (Table 8.2.3.9.1.3.3-15)

Derivation Path: TS 38.508-1 [4], Table 4.6.3-79			
Information Element	Value/remark	Comment	Condition
MeasResults ::= SEQUENCE {			
measId	1		
measResultServingMOList SEQUENCE {(SIZE (1..maxNrofServingCells)) OF MeasResultServMO {	1 entry		
MeasResultServMO[1] SEQUENCE {		entry 1	
servCellId	ServCellIndex of NR Cell 1		
}			
measResultServingCell SEQUENCE {			

rsrq	Not present		
sinr	Not present		
}			
}			
}			
cgj-Info	Not present		
}			
}			
}			
}			
}			

Table 8.2.3.9.1.3.3-16: MeasurementReport (step 14, Table 8.2.3.9.1.3.2-2)

Derivation Path: TS 38.508-1 [4], Table 4.6.1-7			
Information Element	Value/remark	Comment	Condition
MeasurementReport ::= SEQUENCE {			
criticalExtensions CHOICE {			
measurementReport SEQUENCE {			
measResults	MeasResults		
}			
}			
}			

Table 8.2.3.9.1.3.3-16A: MeasResults (Table 8.2.3.9.1.3.3-16)

Derivation Path: TS 38.508-1 [4], Table 4.6.3-79			
Information Element	Value/remark	Comment	Condition
MeasResults ::= SEQUENCE {			
measId	1		
measResultServingMOList SEQUENCE (SIZE (1..maxNrofServingCells)) OF MeasResultServMO {	1 entry		
MeasResultServMO[1] SEQUENCE {		entry 1	
servCellId	ServCellIndex of NR Cell 1		
measResultServingCell SEQUENCE {			
physCellId	Physical CellID of the NR Cell 1		
measResult SEQUENCE {			
cellResults SEQUENCE{			
resultsSSB-Cell	Not present		
resultsCSI-RS-Cell ::= SEQUENCE {			
rsrp	(0..127)		
rsrq	(0..127)		
sinr	Not present		
	Not checked		pc_ss_SINR_Meas
}			
}			
rsIndexResults SEQUENCE {			
resultsSSB-Indexes	Not present		
resultsCSI-RS-Indexes SEQUENCE (SIZE (1..maxNrofIndexesToReport2)) OF ResultsPerCSI-RS-Index {	1 entry		
ResultsPerCSI-RS-Index[1] SEQUENCE {		entry 1	
csi-RS-Index	0		
csi-RS-Results SEQUENCE {			
rsrp	(0..127)		
rsrq	(0..127)		
sinr	Not present		
	Not checked		pc_ss_SINR_Meas

}			
}			
}			
}			
}			
}			
}			
measResultNeighCells CHOICE {			
measResultListNR SEQUENCE (SIZE (1..maxCellReport)) OF MeasResultNR {	1 entry		
MeasResultNR[1] SEQUENCE {		entry 1	
physCellId	Physical CellID of the NR Cell 2		
measResult SEQUENCE {			
cellResults SEQUENCE {			
resultsSSB-Cell	Not present		
resultsCSI-RS-Cell SEQUENCE {			
rsrp	(0..127)		
rsrq	(0..127)		
sinr	Not present		
}			
}			
rsIndexResults SEQUENCE {			
resultsSSB-Indexes	Not Present		
resultsCSI-RS-Indexes SEQUENCE (SIZE (1..maxNrofIndexesToReport2)) OF ResultsPerCSI-RS-Index {	1 entry		
ResultsPerCSI-RS-Index[1] SEQUENCE {		entry 1	
csi-RS-Index	CSI-RS-Index 0		
csi-RS-Results SEQUENCE {			
rsrp	(0..127)		
rsrq	Not present		
sinr	Not present		
}			
}			
}			
}			
}			
cgi-Info	Not present		
}			
}			
}			

8.2.3.10 Measurement configuration control and reporting / SS/PBCH block based / CSI-RS based inter-frequency measurements / Measurement of Neighbour NR cell

8.2.3.10.1 Measurement configuration control and reporting / SS/PBCH block based /CSI-RS based Inter-frequency measurements/ Measurement of Neighbour NR Cell / EN-DC

8.2.3.10.1.1 Test Purpose (TP)

(1)

```
with { UE in RRC_CONNECTED state in EN-DC mode and measurement configured for SS/PBCH measurement reporting of inter frequency on specified frequency }
ensure that {
  when { SS/PBCH block sorting quantity is above absThreshSS-BlocksConsolidation for each beam of NR Neighbour Cell }
  then { UE sends MeasurementReport message containing rsIndexResults with resultsSSB-Indexes }
```

}

(2)

```

with { UE in RRC_CONNECTED state in EN-DC mode and measurement configured for SS/PBCH measurement
reporting of inter frequency on specified frequency }
ensure that {
  when { SS/PBCH block sorting quantity is below absThreshSS-BlocksConsolidation for one beam of NR
Neighbour Cell and another beam(s) is above absThreshSS-BlocksConsolidation }
  then { UE sends MeasurementReport message containing rsIndexResults with resultsSSB-Indexes
includes RsIndex above absThreshSS-BlocksConsolidation and excludes RsIndex below absThreshSS-
BlocksConsolidation }
}

```

(3)

```

with { UE in RRC_CONNECTED state in EN-DC mode and measurement configured for CSI-RS measurement
reporting of inter frequency on specified frequency }
ensure that {
  when { CSI-RS sorting quantity is above absThreshCSI-RS-Consolidation for each beam of NR
Neighbour Cell }
  then { UE sends MeasurementReport message containing rsIndexResults with resultsCSI-RS-Indexes }
}

```

(4)

```

with { UE in RRC_CONNECTED state in EN-DC mode and measurement configured for CSI-RS measurement
reporting of inter frequency on specified frequency }
ensure that {
  when { CSI-RS sorting quantity is below absThreshCSI-RS-Consolidation for one beam of NR Neighbour
Cell and another beam(s) is above absThreshCSI-RS-Consolidation }
  then { UE sends MeasurementReport message containing rsIndexResults with resultsCSI-RS-Indexes
includes RsIndex above absThreshCSI-RS-Consolidation and excludes RsIndex below absThreshCSI-RS-
Consolidation }
}

```

8.2.3.10.1.2 Conformance requirements

References: The conformance requirements covered in the present TC are specified in: TS 38.331 clauses 5.5.5.1 and 5.5.5.2. Unless otherwise stated these are Rel-15 requirements.

[TS 38.331, clause 5.5.5.1]

The purpose of this procedure is to transfer measurement results from the UE to the network. The UE shall initiate this procedure only after successful security activation.

For the *measId* for which the measurement reporting procedure was triggered, the UE shall set the *measResults* within the *MeasurementReport* message as follows:

- 1> set the *measId* to the measurement identity that triggered the measurement reporting;
- 1> for each serving cell configured with *servicingCellMO*:
 - 2> if the *reportConfig* associated with the *measId* that triggered the measurement reporting includes *rsType*:
 - 3> if the serving cell measurements based on the *rsType* included in the *reportConfig* that triggered the measurement report are available:
 - 4> set the *measResultServingCell* within *measResultServingMOList* to include RSRP, RSRQ and the available SINR of the serving cell, derived based on the *rsType* included in the *reportConfig* that triggered the measurement report;
 - 2> else:
 - 3> if SSB based serving cell measurements are available:
 - 4> set the *measResultServingCell* within *measResultServingMOList* to include RSRP, RSRQ and the available SINR of the serving cell, derived based on SSB;

- 3> else if CSI-RS based serving cell measurements are available:
- 4> set the *measResultServingCell* within *measResultServingMOList* to include RSRP, RSRQ and the available SINR of the serving cell, derived based on CSI-RS;
- 1> set the *servingCellId* within *measResultServingMOList* to include for each NR serving cell that is configured, if any;
- 1> if the *reportConfig* associated with the *measId* that triggered the measurement reporting includes *reportQuantityRS-Indexes* and *maxNrofRS-IndexesToReport*:
 - 2> for each serving cell configured with *servingCellMO*, include beam measurement information according to the associated *reportConfig* as described in 5.5.5.2;
- ...
- 1> if there is at least one applicable neighbouring cell to report:
 - 2> if the *reportType* is set to *eventTriggered* or *periodical*:
 - 3> set the *measResultNeighCells* to include the best neighbouring cells up to *maxReportCells* in accordance with the following:
 - 4> if the *reportType* is set to *eventTriggered*:
 - 5> include the cells included in the *cellsTriggeredList* as defined within the *VarMeasReportList* for this *measId*;
 - 4> else:
 - 5> include the applicable cells for which the new measurement results became available since the last periodical reporting or since the measurement was initiated or reset;
 - 4> for each cell that is included in the *measResultNeighCells*, include the *physCellId*;
 - 4> if the *reportType* is set to *eventTriggered* or *periodical*:
 - 5> for each included cell, include the layer 3 filtered measured results in accordance with the *reportConfig* for this *measId*, ordered as follows:
 - 6> if the *measObject* associated with this *measId* concerns NR:
 - 7> if *rsType* in the associated *reportConfig* is set to *ssb*:
 - 8> set *resultsSSB-Cell* within the *measResult* to include the SS/PBCH block based quantity(ies) indicated in the *reportQuantityCell* within the concerned *reportConfig*, in decreasing order of the sorting quantity, determined as specified in 5.5.5.3, i.e. the best cell is included first;
 - 8> if *reportQuantityRS-Indexes* and *maxNrofRS-IndexesToReport* are configured, include beam measurement information as described in 5.5.5.2;
 - 7> else if *rsType* in the associated *reportConfig* is set to *csi-rs*:
 - 8> set *resultsCSI-RS-Cell* within the *measResult* to include the CSI-RS based quantity(ies) indicated in the *reportQuantityCell* within the concerned *reportConfig*, in decreasing order of the sorting quantity, determined as specified in 5.5.5.3, i.e. the best cell is included first;
 - 8> if *reportQuantityRS-Indexes* and *maxNrofRS-IndexesToReport* are configured, include beam measurement information as described in 5.5.5.2;

[TS 38.331, clause 5.5.5.1]

- 1> increment the *numberOfReportsSent* as defined within the *VarMeasReportList* for this *measId* by 1;
- 1> stop the periodical reporting timer, if running;

- 1> if the *numberOfReportsSent* as defined within the *VarMeasReportList* for this *measId* is less than the *reportAmount* as defined within the corresponding *reportConfig* for this *measId*:
 - 2> start the periodical reporting timer with the value of *reportInterval* as defined within the corresponding *reportConfig* for this *measId*;
- 1> else:
 - 2> if the *reportType* is set to *periodical*:
 - 3> remove the entry within the *VarMeasReportList* for this *measId*;
 - 3> remove this *measId* from the *measIdList* within *VarMeasConfig*;
- 1> if the UE is in (NG)EN-DC:
 - 2> if SRB3 is configured:
 - 3> submit the *MeasurementReport* message via SRB3 to lower layers for transmission, upon which the procedure ends;
 - 2>else:
 - 3> submit the *MeasurementReport* message via the EUTRA MCG embedded in E-UTRA RRC message *ULInformationTransferMRDC* as specified in TS 36.331 [10].

[TS 38.331, clause 5.5.5.2]

For beam measurement information to be included in a measurement report the UE shall:

- 1> if *reportType* is set to *eventTriggered*:
 - 2> consider the trigger quantity as the sorting quantity if available, otherwise RSRP as sorting quantity if available, otherwise RSRQ as sorting quantity if available, otherwise SINR as sorting quantity;
- 1> set *rsIndexResults* to include up to *maxNrofRS-IndexesToReport* SS/PBCH block indexes or CSI-RS indexes in order of decreasing sorting quantity as follows:
 - 2> if the measurement information to be included is based on SS/PBCH block:
 - 3> include within *resultsSSB-Indexes* the index associated to the best beam for that SS/PBCH block sorting quantity and if *absThreshSS-BlocksConsolidation* is included in the *VarMeasConfig* for the *measObject* associated to the cell for which beams are to be reported, the remaining beams whose sorting quantity is above *absThreshSS-BlocksConsolidation*;
 - 3> if *includeBeamMeasurements* is configured, include the SS/PBCH based measurement results for the quantities in *reportQuantityRS-Indexes* set to *true* for each SS/PBCH block index;
 - 2> else if the beam measurement information to be included is based on CSI-RS:
 - 3> include within *resultsCSI-RS-Indexes* the index associated to the best beam for that CSI-RS sorting quantity and, if *absThreshCSI-RS-Consolidation* is included in the *VarMeasConfig* for the *measObject* associated to the cell for which beams are to be reported, the remaining beams whose sorting quantity is above *absThreshCSI-RS-Consolidation*;
 - 3> if *includeBeamMeasurements* is configured, include the CSI-RS based measurement results for the quantities in *reportQuantityRS-Indexes* set to *true* for each CSI-RS index.

8.2.3.10.1.3 Test description

8.2.3.10.1.3.1 Pre-test conditions

System Simulator:

- EUTRA Cell 1 is the PCell and NR Cell 1 is the PS Cell and NR Cell 3 is the inter-frequency neighbour cell of NR Cell 1. NR Cell 3 has two beams: SSB/CSI-RS index#0 and SSB/CSI-RS index#1.

UE:

- None

Preamble:

- The UE is in state RRC_CONNECTED in EN-DC using generic procedure parameter Connectivity (EN-DC) and DC Bearers (MCG(s) and SCG) on E-UTRA Cell 1 according to TS 38.508-1 [4].

8.2.3.10.1.3.2 Test procedure sequence

Table 8.2.3.10.1.3.2-1 and Table 8.2.3.10.1.3.2-1A illustrates the downlink power levels to be applied for NR Cell 1 and NR Cell 3 at various time instants of the test execution. Row marked "T0" denotes the conditions after the preamble, while rows marked "T1" and "T2" are to be applied subsequently. The exact instants on which these values shall be applied are described in the texts in this clause.

Table 8.2.3.10.1.3.2-1: Time instances of cell power level and parameter changes for conducted test environment

	Parameter	Unit	E-UTRA Cell 1	NR Cell 1	NR Cell 3	NR Cell 3 Beam 0 (NOTE)	NR Cell 3 Beam 1 (NOTE)	Remark
T0	Cell-specific RS EPRE	dBm/15k Hz	-85	-	-	-	-	
	SS/PBCH SSS EPRE	dBm/SC S	-	-94	-	-	-	
	Reference Power	dBm/SC S	-	-	-90	-	-	
	SS/PBCH SSS EPRE, CSI-RS EPRE offset	dB	-	-	-	-4	-4	
T1	Cell-specific RS EPRE	dBm/15k Hz	-85	-	-	-	-	$Mn + Ofn + Ocn - Hys > Mp + Ofp + Ocp + Off$ Power level is such that SS/PBCH quality and CSI-RS quality for both beams of NR Cell 3 are above <i>absThreshSS-BlocksConsolidation</i> .
	SS/PBCH SSS EPRE	dBm/SC S	-	-106	-	-	-	
	Reference Power	dBm/SC S	-	-	-90	-	-	
	SS/PBCH SSS EPRE, CSI-RS EPRE offset	dB	-	-	-	-4	-4	
T2	Cell-specific RS EPRE	dBm/15k Hz	-85	-	-	-	-	$Mn + Ofn + Ocn + Hys < Mp + Ofp + Ocp + Off$

	SS/PBCH SSS EPRE	dBm/SC S	-	-106	-	-	-	Power level is such that SS/PBCH quality and CSI-RS quality for both beams of NR Cell 3 are below <i>absThreshSS-BlocksConsolidation</i>
	Reference Power	dBm/SC S	-	-	-90	-	-	
	SS/PBCH SSS EPRE, CSI-RS EPRE offset	dB	-	-	-	-12	-12	
	Cell-specific RS EPRE	dBm/15k Hz	-85	-	-	-	-	
T3	SS/PBCH SSS EPRE	dBm/SC S	-	-106	-	-	-	Power level is such that SS/PBCH quality and CSI-RS quality for beam 0 of NR Cell 3 is above <i>absThreshSS-BlocksConsolidation</i> and for beam 1 of NR Cell 3 is below <i>absThreshSS-BlocksConsolidation</i> .
	Reference Power	dBm/SC S	-	-	-90	-	-	
	SS/PBCH SSS EPRE, CSI-RS EPRE offset	dB	-	-	-	-4	-12	
	Cell-specific RS EPRE	dBm/15k Hz	-85	-	-	-	-	
<p>NOTE: "Beam 0" refers to transmission of the SS/PBCH block with SSB index #0 (according to the <i>ssb-PositionsInBurst</i>) and CSI-RS with index #0 (according to the <i>csi-rs-ResourceList-Mobility</i> being signalled to the UE at step 9); "Beam 1" refers to transmission of the SS/PBCH block with SSB index #1 (according to the <i>ssb-PositionsInBurst</i>) and CSI-RS with index #1 (according to the <i>csi-rs-ResourceList-Mobility</i> being signalled to the UE at step 9). For each beam SSS and CSI-RS have the same power levels at any given time instance.</p>								

Table 8.2.3.10.1.3.2-1A: Time instances of cell power level and parameter changes for OTA test environment

	Parameter	Unit	E-UTRA Cell 1	NR Cell 1	NR Cell 3	NR Cell 3 Beam 0 (NOTE)	NR Cell 3 Beam 1 (NOTE)	Remark
T0	Cell-specific RS EPRE	dBm/15k Hz	-96	-	-	-	-	
	SS/PBCH SSS EPRE	dBm/SC S	-	-82	-	-	-	
	Reference Power	dBm/SC S	-	-	-81	-	-	
	SS/PBCH SSS EPRE, CSI-RS EPRE offset	dB	-	-	-	-1	-1	
T1	Cell-specific RS EPRE	dBm/15k Hz	-96	-	-	-	-	$Mn + Ofn + Ocn - Hys > Mp + Ofp + Ocp + Off$ Power level is such that SS/PBCH quality and CSI-RS quality for both beams of NR Cell 3 are above <i>absThreshSS-BlocksConsolidation</i> .
	SS/PBCH SSS EPRE	dBm/SC S	-	-100	-	-	-	
	Reference Power	dBm/SC S	-	-	-81	-	-	
	SS/PBCH SSS EPRE,	dB	-	-	-	-1	-1	

	CSI-RS EPRE offset							
T2	Cell-specific RS EPRE	dBm/15k Hz	-96	-	-	-	-	$Mn + Ofn + Ocn + Hys < Mp + Ofp + Ocp + Off$
	SS/PBCH SSS EPRE	dBm/SC S	-	-100	-	-	-	Power level is such that SS/PBCH quality and CSI-RS quality for both beams of NR Cell 3 are below <i>absThreshSS-BlocksConsolidation</i>
	Reference Power	dBm/SC S	-	-	-81	-	-	
	SS/PBCH SSS EPRE, CSI-RS EPRE offset	dB	-	-	-	-19	-19	
T3	Cell-specific RS EPRE	dBm/15k Hz	-96	-	-	-	-	
	SS/PBCH SSS EPRE	dBm/SC S	-	-100	-	-	-	
	Reference Power	dBm/SC S	-	-	-81	-	-	
	SS/PBCH SSS EPRE, CSI-RS EPRE offset	dB	-	-	-	-1	-19	
NOTE: "Beam 0" refers to transmission of the SS/PBCH block with SSB index #0 (according to the <i>ssb-PositionsInBurst</i>) and CSI-RS with index #0 (according to the <i>csi-rs-ResourceList-Mobility</i> being signalled to the UE at step 9); "Beam 1" refers to transmission of the SS/PBCH block with SSB index #1 (according to the <i>ssb-PositionsInBurst</i>) and CSI-RS with index #1 (according to the <i>csi-rs-ResourceList-Mobility</i> being signalled to the UE at step 9). For each beam SSS and CSI-RS have the same power levels at any given time instance.								

Table 8.2.3.10.1.3.2-2: Main behaviour

St	Procedure	Message Sequence		TP	Verdict
		U - S	Message		
1	The SS transmits an <i>RRCCONNECTIONRECONFIGURATION</i> message containing NR <i>RRCCONNECTIONRECONFIGURATION</i> including <i>measConfig</i> to setup SS/PBCH block based inter-frequency NR measurement for PSCell (NR Cell 1) and reporting for A3.	<--	EUTRA RRC: <i>RRCCONNECTIONRECONFIGURATION(RRCCONNECTIONRECONFIGURATION)</i>	-	-
2	The UE transmits an <i>RRCCONNECTIONRECONFIGURATIONCOMPLETE</i> message containing NR <i>RRCCONNECTIONRECONFIGURATIONCOMPLETE</i> .	-->	EUTRA RRC: <i>RRCCONNECTIONRECONFIGURATIONCOMPLETE(RRCCONNECTIONRECONFIGURATIONCOMPLETE)</i>	-	-
3	The SS re-adjusts the cell-specific reference signal level according to row "T1".	-	-	-	-
4	Check: Does the UE transmit a <i>MEASUREMENTREPORT</i> message to report event A3 with the measured results for NR Cell 3 with beam information containing <i>RsIndex[0]</i> and <i>RsIndex[1]</i> ?	-->	EUTRA RRC: <i>ULINFORMATIONTRANSFERMRDC(MEASUREMENTREPORT)</i>	1	P
4A	The SS re-adjusts the cell-specific reference signal level according to the row "T2".	-	-	-	-
4B	Check: Does the UE transmit a <i>MEASUREMENTREPORT</i> message on E-UTRA Cell 1 to report the event A3 during the next 10s?	-	-	1	F
5	The SS re-adjusts the cell-specific reference signal level according to row "T3".	-	-	-	-

6	Check: Does the UE transmit a <i>MeasurementReport</i> message to report event A3 with the measured results for NR Cell 3 with beam information containing <i>RsIndex[0]</i> and excludes <i>RsIndex[1]</i> ?	-->	EUTRA RRC: <i>ULInformationTransferMRDC(MeasurementReport)</i>	2	P
7-8	Void	-	-	-	-
9	The SS transmits an <i>RRCCONNECTIONRECONFIGURATION</i> message containing NR RRCReconfiguration including <i>measConfig</i> to setup CSI-RS based inter-frequency NR measurement for PSCell (NR Cell 1) and event A3.	<--	EUTRA RRC: <i>RRCCONNECTIONRECONFIGURATION(RRCReconfiguration)</i>	-	-
10	The UE transmits an <i>RRCCONNECTIONRECONFIGURATIONCOMPLETE</i> message containing NR <i>RRCCONFIGURATIONCOMPLETE</i> .	-->	EUTRA RRC: <i>RRCCONNECTIONRECONFIGURATIONCOMPLETE(RRCReconfigurationComplete)</i>	-	-
11	The SS re-adjusts the cell-specific reference signal level according to row "T1".	-	-	-	-
12	Check: Does the UE transmit a <i>MeasurementReport</i> message to report event A3 with the measured results for NR Cell 3 with beam information containing <i>RsIndex[0]</i> and <i>RsIndex[1]</i> ?	-->	EUTRA RRC: <i>ULInformationTransferMRDC(MeasurementReport)</i>	3	P
12A	The SS re-adjusts the cell-specific reference signal level according to the row "T2".	-	-	-	-
12B	Check: Does the UE transmit a <i>MeasurementReport</i> message on E-UTRA Cell 1 to report the event A3 during the next 10s?	-	-	3	F
13	The SS re-adjusts the cell-specific reference signal level according to row "T3".	-	-	-	-
14	Check: Does the UE transmit a <i>MeasurementReport</i> message to report event A3 with the measured results for NR Cell 3 with beam information containing <i>RsIndex[0]</i> and excludes <i>RsIndex[1]</i> ?	-->	EUTRA RRC: <i>ULInformationTransferMRDC(MeasurementReport)</i>	4	P

8.2.3.10.1.3.3 Specific message contents

Table 8.2.3.10.1.3.3-1: *RRCCONNECTIONRECONFIGURATION* (steps 1, 9, Table 8.2.3.10.1.3.2-2)

Derivation Path: TS 36.508 [7], Table 4.6.1-8 with condition EN-DC_EmbedNR_RRCRecon

Table 8.2.3.10.1.3.3-2: *RRCReconfiguration* (Table 8.2.3.10.1.3.3-1)

Derivation Path: TS 38.508-1 [4], Table 4.6.1-13 with condition EN-DC_MEAS

Table 8.2.3.10.1.3.3-3: *MeasConfig* (Table 8.2.3.10.1.3.3-2)

Derivation Path: TS 38.508-1 [4], Table 4.6.3-69			
Information Element	Value/remark	Comment	Condition
<i>MeasConfig</i> ::= SEQUENCE {			
<i>measObjectToAddModList</i>	<i>IdMeasObjectToAdd</i>		Step 1
	Not present		Step 9
<i>reportConfigToAddModList</i>	<i>IdReportConfigToAdd</i>		Step 1
	Not present		Step 9
<i>measIdToAddModList</i>	<i>IdMeasIdToAdd</i>		
}			

Table 8.2.3.10.1.3.3-4: *IdMeasObjectToAdd* (Table 8.2.3.10.1.3.3-3)

Derivation Path: TS 38.331 [6], clause 6.3.2			
Information Element	Value/remark	Comment	Condition

MeasObjectToAddModList ::= SEQUENCE (SIZE (1..maxNrofMeasId)) OF MeasObjectToAddMod {	2 entries		
MeasObjectToAddMod[1] SEQUENCE {		entry 1	
measObjectId	1		
measObject CHOICE {			
measObjectNR	Id-MeasObjectNR-f1		
}			
}			
MeasObjectToAddMod[2] SEQUENCE {		entry 2	
measObjectId	2		
measObject CHOICE {			
measObjectNR	Id-MeasObjectNR-f2		
}			
}			
}			

Table 8.2.3.10.1.3.3-5: Id-MeasObjectNR-f1 (Table 8.2.3.10.1.3.3-4)

Derivation Path: TS 38.508-1 [4], Table 4.6.3-76			
Information Element	Value/remark	Comment	Condition
MeasObjectNR ::= SEQUENCE {			
ssbFrequency	Downlink ARFCN of NR Cell 1		
refFreqCSI-RS	Same as "Point A" defined for the downlink of NR Cell1		
referenceSignalConfig SEQUENCE {			
csi-rs-ResourceConfigMobility CHOICE {			
setup SEQUENCE {			
subcarrierSpacing	SubcarrierSpacing		
csi-RS-CellList-Mobility SEQUENCE (SIZE (1..maxNrofCSI-RS-CellsRRM)) OF CSI-RS-CellMobility {	1 entry		
CSI-RS-CellMobility[1] SEQUENCE {		entry 1	
cellId	Physical CellID of the NR Cell 1		
csi-rs-MeasurementBW SEQUENCE {			
nrofPRBs	size24		
startPRB	same value as 'offsetToCarrier' as defined for the DL frequency of NR Cell 1		
}			
density	d3		
csi-rs-ResourceList-Mobility SEQUENCE (SIZE (1..maxNrofCSI-RS-ResourcesRRM)) OF CSI-RS-Resource-Mobility {	1 entry		
CSI-RS-Resource-Mobility[1] SEQUENCE {		entry 1	
csi-RS-Index	0		
slotConfig CHOICE {			
ms20	0		
}			
associatedSSB	Not present		
associatedSSB SEQUENCE {			pc_csi_RSR P_AndRSR Q_MeasWit hSSB
ssb-Index	0		
isQuasiColocated	false		
}			
frequencyDomainAllocation CHOICE {			
row1	1000		
}			
firstOFDMsymbolInTimeDomain	4		
sequenceGenerationConfig	24		
}			

}			
}			
}			
}			
}			
}			
absThreshSS-BlocksConsolidation SEQUENCE {			
thresholdRSRP	57	corresponding to -99dBm	FR1
	66	corresponding to -90dBm	FR2
}			
absThreshCSI-RS-Consolidation SEQUENCE {			
thresholdRSRP	57	corresponding to -99dBm	FR1
	66	corresponding to -90dBm	FR2
thresholdRSRQ	Not Present		
thresholdSINR	Not Present		
}			
nrofCSI-RS-ResourcesToAverage	2		
}			

Table 8.2.3.10.1.3.3-5A: Id-MeasObjectNR-f2 (Table 8.2.3.10.1.3.3-4)

Derivation Path: TS 38.508-1 [4], Table 4.6.3-76			
Information Element	Value/remark	Comment	Condition
MeasObjectNR ::= SEQUENCE {			
ssbFrequency	Downlink ARFCN of NCell 3		
refFreqCSI-RS	Same as "Point A" defined for the downlink of NR Cell3		
referenceSignalConfig SEQUENCE {			
ssb-ConfigMobility SEQUENCE {			
ssb-ToMeasure CHOICE {			
setup CHOICE {			
shortBitmap	1100		(FREQ<=3G Hz AND (FR1_FDD OR NOT CASE_C)) OR (FREQ<=2.4 GHz AND FR1_TDD)
mediumBitmap	11000000		(FREQ>3G Hz AND FR1) OR (FREQ>2.4 GHz AND FR1_TDD AND CASE_C)
longBitmap	11000000 00000000 00000000 00000000 00000000 00000000 00000000 00000000		FR2
}			
}			
}			
csi-rs-ResourceConfigMobility CHOICE {			
setup SEQUENCE {			
subcarrierSpacing	SubcarrierSpacing		

csi-RS-CellList-Mobility SEQUENCE (SIZE (1..maxNrofCSI-RS-CellsRRM)) OF CSI-RS-CellMobility {	1 entry		
CSI-RS-CellMobility[1] SEQUENCE {		entry 1	
cellId	Physical CellID of the NR Cell 3		
csi-rs-MeasurementBW SEQUENCE {			
nrofPRBs	size24		
startPRB	same value as 'offsetToCarrier' as defined for the DL frequency of the cell		
}			
density	d3		
csi-rs-ResourceList-Mobility SEQUENCE (SIZE (1.. maxNrofCSI-RS-ResourcesRRM)) OF CSI-RS-Resource-Mobility {	2 entries		
CSI-RS-Resource-Mobility[1] SEQUENCE {		entry 1	
csi-RS-Index	0	CSI-RS with Index 0	
slotConfig CHOICE {			
ms20	$10 * 2^{\mu}$	μ is numerology index (SCS=15kHz: 0, SCS=30kHz: 1, etc.)	
}			
associatedSSB	Not present		
associatedSSB SEQUENCE {			pc_csi_RSR P_AndRSR Q_MeasWit hSSB
ssb-Index	0		
isQuasiColocated	false		
}			
frequencyDomainAllocation CHOICE {			
row1	1000		
}			
firstOFDMSymbolInTimeDomain	4		
sequenceGenerationConfig	24		
}			
CSI-RS-Resource-Mobility[2] SEQUENCE {		entry 2	
csi-RS-Index	1	CSI-RS with Index 1	
slotConfig CHOICE {			
ms20	$10 * 2^{\mu}$	μ : numerology index (SCS=15kHz: 0, SCS=30kHz: 1, etc.)	
}			
associatedSSB	Not present		
associatedSSB SEQUENCE {			pc_csi_RSR P_AndRSR Q_MeasWit hSSB
ssb-Index	1		
isQuasiColocated	false		
}			
frequencyDomainAllocation CHOICE {			
row1	0001		
}			
firstOFDMSymbolInTimeDomain	0		
sequenceGenerationConfig	24		
}			
}			

}			
}			
}			
}			
absThreshSS-BlocksConsolidation SEQUENCE {			
thresholdRSRP	57	corresponding to -99dBm	FR1
	66	corresponding to -90dBm	FR2
}			
absThreshCSI-RS-Consolidation SEQUENCE {			
thresholdRSRP	57	corresponding to -99dBm	FR1
	66	corresponding to -90dBm	FR2
thresholdRSRQ	Not Present		
thresholdSINR	Not Present		
}			
nrofCSI-RS-ResourcesToAverage	2		
}			

Table 8.2.3.10.1.3.3-6: IdReportConfigToAdd (Table 8.2.3.10.1.3.3-3)

Derivation Path: TS 38.331 [6], clause 6.3.2			
Information Element	Value/remark	Comment	Condition
ReportConfigToAddModList ::= SEQUENCE(SIZE (1..maxReportConfigId)) OF ReportConfigToAddMod {	2 entries		
ReportConfigToAddMod[1] SEQUENCE {		entry 1	
reportConfigId	1		
reportConfig CHOICE {			
reportConfigNR	IdReportConfig-A3-SSB		
}			
}			
ReportConfigToAddMod[2] SEQUENCE {		entry 2	
reportConfigId	2		
reportConfig CHOICE {			
reportConfigNR	IdReportConfig-A3-CSI-RS		
}			
}			
}			

Table 8.2.3.10.1.3.3-7: IdReportConfig-A3-SSB (Table 8.2.3.10.1.3.3-3)

Derivation Path: TS 38.508-1 [4], Table 4.6.3-142 with condition EVENT_A3			
Information Element	Value/remark	Comment	Condition
ReportConfigNR ::= SEQUENCE {			
reportType CHOICE {			
eventTriggered SEQUENCE {			
eventId CHOICE {			
eventA3 SEQUENCE {			
a3-Offset CHOICE {			
rsrp	2		FR1
	2+ Delta(NR _{f2}) - Delta(NR _{f1})	a3-Offset value set to (2+ Delta(NR _{f2}) - Delta(NR _{f1})). (Note 1)	FR2
}			
}			
}			
}			
}			
reportAmount	r1		

reportQuantityRS-Indexes SEQUENCE {			
rsrp	true		
rsrq	false		
sinr	false		
}			
maxNrofRS-IndexesToReport	2		
includeBeamMeasurements	true		
}			
}			
}			
NOTE 1: Delta(NRf ₂) and Delta(NRf ₁) are derived based on calibration procedure defined in the TS 38.508-1 [4], clause 6.1.3.3 where Delta(NRf ₁) derived NR Cell1 and Delta(NRf ₂) derived NR Cell3			

Table 8.2.3.10.1.3.3-7A: IdReportConfig-A3-CSI-RS (Table 8.2.3.10.1.3.3-3)

Derivation Path: TS 38.508-1 [4], Table 4.6.3-142 with condition EVENT_A3			
Information Element	Value/remark	Comment	Condition
ReportConfigNR ::= SEQUENCE {			
reportType CHOICE {			
eventTriggered SEQUENCE {			
eventId CHOICE {			
eventA3 SEQUENCE {			
a3-Offset CHOICE {			
rsrp	2		FR1
	2+ Delta(NRf ₂) - Delta(NRf ₁)	a3-Offset value set to (2+ Delta(NRf ₂) - Delta(NRf ₁)). (Note 1)	FR2
}			
}			
}			
}			
rsType	csi-rs		
reportAmount	r1		
reportQuantityCell SEQUENCE {			
sinr	false		
}			
reportQuantityRS-Indexes SEQUENCE {			
rsrp	true		
rsrq	false		
sinr	false		
}			
maxNrofRS-IndexesToReport	2		
includeBeamMeasurements	true		
}			
}			
}			
NOTE 1: Delta(NRf ₂) and Delta(NRf ₁) are derived based on calibration procedure defined in the TS 38.508-1 [4], clause 6.1.3.3 where Delta(NRf ₁) derived NR Cell1 and Delta(NRf ₂) derived NR Cell3			

Table 8.2.3.10.1.3.3-8: IdMeasIdToAdd (Table 8.2.3.10.1.3.3-3)

Derivation Path: TS 38.331 [6], clause 6.3.2			
Information Element	Value/remark	Comment	Condition
MeasIdToAddModList ::= SEQUENCE (SIZE (1..maxNrofMeasId)) OF MeasIdToAddMod {	1 entry		
MeasIdToAddMod[1] SEQUENCE {		entry 1	
measId	1		
measObjectId	2		
reportConfigId	1		Step 1
	2		Step 9
}			
}			

Table 8.2.3.10.1.3.3-9: RRCConnectionReconfigurationComplete (steps 2, 10, Table 8.2.3.10.1.3.2-2)

Derivation Path: TS 36.508 [7], Table 4.6.1-9 with condition MCG_and_SCG

Table 8.2.3.10.1.3.3-10: ULInformationTransferMRDC (steps 4, 6, 12, 14, Table 8.2.3.10.1.3.2-2)

Derivation Path: TS 36.508 [7], Table 4.6.1-27			
Information Element	Value/remark	Comment	Condition
ULInformationTransferMRDC-r15 ::= SEQUENCE {			
criticalExtensions CHOICE {			
c1 CHOICE {			
ulInformationTransferMRDC-r15 SEQUENCE {			
ul-DCCH-MessageNR-r15	OCTET STRING containing NR RRC MeasurementReport		
}			
}			
}			
}			

Table 8.2.3.10.1.3.3-11: MeasurementReport (step 4, Table 8.2.3.10.1.3.2-2)

Derivation Path: TS 38.508-1 [4], Table 4.6.1-7			
Information Element	Value/remark	Comment	Condition
MeasurementReport ::= SEQUENCE {			
criticalExtensions CHOICE {			
measurementReport SEQUENCE {			
measResults	MeasResults		
}			
}			
}			

Table 8.2.3.10.1.3.3-11A: MeasResults (Table 8.2.3.10.1.3.3-11)

Derivation Path: TS 38.508-1 [4], Table 4.6.3-79			
Information Element	Value/remark	Comment	Condition
MeasResults ::= SEQUENCE {			
measId	1		
measResultServingMOList SEQUENCE (SIZE (1..maxNrofServingCells)) OF MeasResultServMO {	1 entry		
MeasResultServMO[1] SEQUENCE {		entry 1	
servCellId	ServCellIndex of NR Cell 1		
measResultServingCell SEQUENCE {			
physCellId	Physical CellID of the NR Cell 1		
measResult SEQUENCE {			
cellResults SEQUENCE {			
resultsSSB-Cell SEQUENCE {			
rsrp	(0..127)		
rsrq	(0..127)		
sinr	Not present (0..127)		pc_ss_SINR _Meas
}			
}			
rsIndexResults SEQUENCE {			
resultsSSB-Indexes SEQUENCE (SIZE (1..maxNrofIndexesToReport2)) OF ResultsPerSSB- Index {	1 entry		

Table 8.2.3.10.1.3.3-12: MeasurementReport (step 6, Table 8.2.3.10.1.3.2-2)

Derivation Path: TS 38.508-1 [4], Table 4.6.1-7			
Information Element	Value/remark	Comment	Condition
MeasurementReport ::= SEQUENCE {			
criticalExtensions CHOICE {			
measurementReport SEQUENCE {			
measResults	MeasResults		
}			
}			
}			

Table 8.2.3.10.1.3.3-12A: MeasResults (Table 8.2.3.10.1.3.3-12)

Derivation Path: TS 38.508-1 [4], Table 4.6.3-79			
Information Element	Value/remark	Comment	Condition
MeasResults ::= SEQUENCE {			
measId	1		
measResultServingMOList SEQUENCE (SIZE (1..maxNrofServingCells)) OF MeasResultServMO {	1 entry		
MeasResultServMO[1] SEQUENCE {		entry 1	
servCellId	ServCellIndex of NR Cell 1		
measResultServingCell SEQUENCE {			
physCellId	Physical CellID of the NR Cell 1		
measResult SEQUENCE {			
cellResults SEQUENCE {			
resultsSSB-Cell SEQUENCE {			
rsrp	(0..127)		
rsrq	(0..127)		
sinr	Not present		
	(0..127)		pc_ss_SINR_Meas
}			
}			
rsIndexResults SEQUENCE {			
resultsSSB-Indexes SEQUENCE (SIZE (1..maxNrofIndexesToReport2)) OF ResultsPerSSB-Index {	1 entry		
ResultsPerSSB-Index[1] SEQUENCE {		entry 1	
ssb-Index	Not checked		
ssb-Results SEQUENCE {			
rsrp	(0..127)		
rsrq	(0..127)		
sinr	Not present		
	Not checked		pc_ss_SINR_Meas
}			
}			
}			
resultsCSI-RS-Indexes	Not present		
}			
}			
}			
}			
measResultNeighCells CHOICE {			
measResultListNR SEQUENCE (SIZE (1..maxCellReport)) OF MeasResultNR {	1 entry		
MeasResultNR[1] SEQUENCE {		entry 1	
physCellId	Physical CellID of the NR Cell 3		
measResult SEQUENCE {			
cellResults SEQUENCE {			

resultsSSB-Cell SEQUENCE {			
rsrp	(0..127)		
rsrq	(0..127)		
sinr	(0..127)		pc_ss_SINR _Meas
	Not present		
}			
resultsCSI-RS-Cell	Not present		
}			
rsIndexResults SEQUENCE {			
resultsSSB-Indexes SEQUENCE (SIZE (1..maxNrofIndexesToReport2)) OF ResultsPerSSB-Index {	1 entry		
ResultsPerSSB-Index[1] SEQUENCE {		entry 1	
ssb-Index	SSB index 0		
ssb-Results SEQUENCE {			
rsrp	(0..127)		
rsrq	Not present		
sinr	Not present		
}			
}			
}			
resultsCSI-RS-Indexes	Not present		
}			
}			
}			
cgi-Info	Not present		
}			
}			
}			

Table 8.2.3.10.1.3.3-13: Void

Table 8.2.3.10.1.3.3-14: Void

Table 8.2.3.10.1.3.3-14A: Void

Table 8.2.3.10.1.3.3-14B: Void

Table 8.2.3.10.1.3.3-14C: Void

Table 8.2.3.10.1.3.3-14D: Void

Table 8.2.3.10.1.3.3-14E: Void

Table 8.2.3.10.1.3.3-14F: MeasurementReport (step 12, Table 8.2.310.1.3.2-2)

Derivation Path: TS 38.508-1 [4], Table 4.6.1-7			
Information Element	Value/remark	Comment	Condition
MeasurementReport ::= SEQUENCE {			
criticalExtensions CHOICE {			
measurementReport SEQUENCE {			
measResults	MeasResults		
}			
}			
}			

Table 8.2.3.10.1.3.3-15: MeasResults (Table 8.2.3.10.1.3.3-14F)

Derivation Path: TS 38.508-1 [4], Table 4.6.3-79
--

rsrp	(0..127)		
rsrq	Not present		
sinr	Not present		
}			
}			
ResultsPerCSI-RS-Index[2] SEQUENCE {		entry 2	
csi-RS-Index	CSI-RS-Index#1		
csi-RS--Results SEQUENCE {	0		
rsrp	(0..127)		
rsrq	Not present		
sinr	Not present		
}			
}			
}			
cg-Info	Not present		
}			
}			
}			
}			
}			

Table 8.2.3.10.1.3.3-15A: MeasurementReport (step 14, Table 8.2.3.10.1.3.2-2)

Derivation Path: TS 38.508-1 [4], Table 4.6.1-7			
Information Element	Value/remark	Comment	Condition
MeasurementReport ::= SEQUENCE {			
criticalExtensions CHOICE {			
measurementReport SEQUENCE {			
measResults	MeasResults		
}			
}			
}			

Table 8.2.3.10.1.3.3-16: MeasResults (Table 8.2.3.10.1.3.3-15A)

Derivation Path: TS 38.331 [6], clause 6.2.2			
Information Element	Value/remark	Comment	Condition
MeasResults ::= SEQUENCE {			
measId	1		
measResultServingMOList SEQUENCE (SIZE (1..maxNrofServingCells)) OF MeasResultServMO {	1 entry		
MeasResultServMO[1] SEQUENCE {		entry 1	
servCellId	ServCellIndex of NR Cell 1		
measResultServingCell SEQUENCE {			
physCellId	Physical CellID of the NR Cell 1		
measResult SEQUENCE {			
cellResults SEQUENCE{			
resultsSSB-Cell	Not present		
resultsCSI-RS-Cell ::= SEQUENCE {			
rsrp	(0..127)		
rsrq	(0..127)		
sinr	Not present		
	Not checked		pc_ss_SINR_Meas
}			
}			
rsIndexResults SEQUENCE {			
resultsSSB-Indexes	Not present		

resultsCSI-RS-Indexes SEQUENCE (SIZE (1..maxNrofIndexesToReport2)) OF ResultsPerCSI-RS-Index {	1 entry		
ResultsPerCSI-RS-Index[1] SEQUENCE {		entry 1	
csi-RS-Index	0		
csi-RS-Results SEQUENCE {			
rsrp	(0..127)		
rsrq	(0..127)		
sinr	Not present		
	Not checked		pc_ss_SINR_Meas
}			
}			
}			
}			
}			
}			
}			
measResultNeighCells CHOICE {			
measResultListNR SEQUENCE (SIZE (1..maxCellReport)) OF MeasResultNR {	1 entry		
MeasResultNR[1] SEQUENCE {		entry 1	
physCellId	Physical CellID of the NR Cell 3		
measResult SEQUENCE {			
cellResults SEQUENCE {			
resultsSSB-Cell	Not present		
resultsCSI-RS-Cell SEQUENCE {			
rsrp	(0..127)		
rsrq	(0..127)		
sinr	Not present		
}			
}			
rsIndexResults SEQUENCE {			
resultsSSB-Indexes	Not Present		
resultsCSI-RS-Indexes SEQUENCE (SIZE (1..maxNrofIndexesToReport2)) OF ResultsPerCSI-RS-Index {	1 entry		
ResultsPerCSI-RS-Index[1] SEQUENCE {		entry 1	
csi-RS-Index	CSI-RS-Index 0		
csi-RS-Results SEQUENCE {			
rsrp	(0..127)		
rsrq	Not present		
sinr	Not present		
}			
}			
}			
}			
}			
cgi-Info	Not present		
}			
}			
}			

8.2.3.11 Measurement configuration control and reporting / Measurement Gaps

8.2.3.11.1 Measurement configuration control and reporting / Measurement Gaps / NR FR1 / EN-DC

8.2.3.11.1.1 Test Purpose (TP)

(1)

```
with { UE in RRC_CONNECTED state with EN-DC, and, MCG (E-UTRA PDCP) and SCG }
ensure that {
  when { UE receives RRCConnectionReconfiguration message to setup fr1-Gap to report periodical
measurements for LTE serving and NR neighbor cell on FR1 frequency }
  then { UE applies fr1-Gap and sends periodical measurement reports for LTE serving and NR
neighbor cell on FR1 frequency }
}
```

(2)

```
with { UE in RRC_CONNECTED state with EN-DC, and, MCG (E-UTRA PDCP) and SCG }
ensure that {
  when { UE receives RRCConnectionReconfiguration message to setup fr1-Gap and nr-Config IE
containing MeasConfig to report periodical measurements for NR serving and neighbor cells on FR1
frequency }
  then { UE applies fr1-Gap and sends periodical measurement reports for NR serving and neighbor
cells on FR1 frequency }
}
```

8.2.3.11.1.2 Conformance requirements

References: The conformance requirements covered in the current TC are specified in: TS 36.331, clause 5.3.5.3 and 5.5.2.9, and TS 38.331, clause 5.5.2.1 and 5.5.5.1. Unless otherwise stated these are Rel-15 requirements.

[TS 36.331, clause 5.3.5.3]

If the *RRCConnectionReconfiguration* message does not include the *mobilityControlInfo* and the UE is able to comply with the configuration included in this message, the UE shall:

...

1> if the received *RRCConnectionReconfiguration* includes the *nr-SecondaryCellGroupConfig*:

2> perform NR RRC Reconfiguration as specified in TS 38.331 [82], clause 5.3.5.3;

...

1> if the *RRCConnectionReconfiguration* message includes the *measConfig*:

2> perform the measurement configuration procedure as specified in 5.5.2;

...

1> set the content of *RRCConnectionReconfigurationComplete* message as follows:

...

2> if the received *RRCConnectionReconfiguration* message included *nr-SecondaryCellGroupConfig*:

3> include *scg-ConfigResponseNR* in accordance with TS 38.331 [82, 5.3.5.3];

1> submit the *RRCConnectionReconfigurationComplete* message to lower layers for transmission using the new configuration, upon which the procedure ends;

[TS 36.331, clause 5.5.2.9]

The UE shall:

- 1> if *measGapConfig* is set to *setup*:
 - 2> if a measurement gap configuration *measGapConfig* or *measGapConfigPerCC-List* is already setup, release the measurement gap configuration;
 - 2> if the *gapOffset* in *measGapConfig* indicates a non-uniform gap pattern:
 - ...
 - 2> else:
 - 3> setup the measurement gap configuration indicated by the *measGapConfig* in accordance with the received *gapOffset*, i.e., the first subframe of each gap occurs at an SFN and subframe meeting the following condition (SFN and subframe of MCG cells):

$$\text{SFN mod } T = \text{FLOOR}(\text{gapOffset}/10);$$

$$\text{subframe} = \text{gapOffset mod } 10;$$
 with $T = \text{MGRP}/10$ as defined in TS 36.133 [16];
 - 2> if EN-DC is configured:
 - 3> if the UE is configured with *fr1-Gap* set to *TRUE*:
 - 4> apply the gap configuration for LTE serving cells and for NR serving cells on FR1;
 - 3> else:
 - 4> apply the gap configuration for all LTE and NR serving cells;
 - 2> if *mgta* is set to *TRUE*, apply a timing advance value of 0.5ms to the gap occurrences calculated above according to TS 38.133 [16];

NOTE 1: The UE applies a single gap, which timing is relative to the MCG cells, even when configured with DC. In case of EN-DC, the UE may either be configured with a single (common) gap or with two separate gaps i.e. a first one for FR1 (configured by E-UTRA RRC) and a second one for FR2 (configured by NR RRC).

- 1> else if *measGapConfig* is set to *release*:
 - 2> release the measurement gap configuration *measGapConfig*;
 - ...

[TS 38.331, clause 5.5.2.1]

The network applies the procedure as follows:

- to ensure that, whenever the UE has a *measConfig*, it includes a *measObject* for the SpCell and for each NR SCell to be measured;
- to configure at most one measurement identity using a reporting configuration with the *reportType* set to *reportCGI*;
- to ensure that, for all SSB based reporting configurations have at most one measurement object with the same *ssbFrequency* and *ssbSubcarrierSpacing*;

The UE shall:

- 1> if the received *measConfig* includes the *measObjectToRemoveList*:
 - 2> perform the measurement object removal procedure as specified in 5.5.2.4;
- 1> if the received *measConfig* includes the *measObjectToAddModList*:
 - 2> perform the measurement object addition/modification procedure as specified in 5.5.2.5;

- 1> if the received *measConfig* includes the *reportConfigToRemoveList*:
 - 2> perform the reporting configuration removal procedure as specified in 5.5.2.6;
- 1> if the received *measConfig* includes the *reportConfigToAddModList*:
 - 2> perform the reporting configuration addition/modification procedure as specified in 5.5.2.7;
- 1> if the received *measConfig* includes the *quantityConfig*:
 - 2> perform the quantity configuration procedure as specified in 5.5.2.8;
- 1> if the received *measConfig* includes the *measIdToRemoveList*:
 - 2> perform the measurement identity removal procedure as specified in 5.5.2.2;
- 1> if the received *measConfig* includes the *measIdToAddModList*:
 - 2> perform the measurement identity addition/modification procedure as specified in 5.5.2.3;
- 1> if the received *measConfig* includes the *measGapConfig*:
 - 2> perform the measurement gap configuration procedure as specified in 5.5.2.9;

...

[TS 38.331, clause 5.5.5.1]



Figure 5.5.5.1-1: Measurement reporting

The purpose of this procedure is to transfer measurement results from the UE to the network. The UE shall initiate this procedure only after successful security activation.

For the *measId* for which the measurement reporting procedure was triggered, the UE shall set the *measResults* within the *MeasurementReport* message as follows:

- 1> for each serving cell configured with *servingCellMO*:
 - 2> if the *reportConfig* associated with the *measId* that triggered the measurement reporting includes *rsType*:
 - 3> if the serving cell measurements based on the *rsType* included in the *reportConfig* that triggered the measurement report are available:
 - 4> set the *measResultServingCell* within *measResultServingMOList* to include RSRP, RSRQ and the available SINR of the serving cell, derived based on the *rsType* included in the *reportConfig* that triggered the measurement report;
 - 1> set the *servCellId* within *measResultServingMOList* to include each NR serving cell that is configured with *servingCellMO*, if any;
- ...
- 1> if there is at least one applicable neighbouring cell to report:
 - 2> if the *reportType* is set to *eventTriggered* or *periodical*:

- 3> set the *measResultNeighCells* to include the best neighbouring cells up to *maxReportCells* in accordance with the following:
 - 4> if the *reportType* is set to *eventTriggered*:
 - 5> include the cells included in the *cellsTriggeredList* as defined within the *VarMeasReportList* for this *measId*;
 - 4> else:
 - ...
 - 4> for each cell that is included in the *measResultNeighCells*, include the *physCellId*;
 - 4> if the *reportType* is set to *eventTriggered* or *periodical*:
 - 5> for each included cell, include the layer 3 filtered measured results in accordance with the *reportConfig* for this *measId*, ordered as follows:
 - 6> if the *measObject* associated with this *measId* concerns NR:
 - 7> if *rsType* in the associated *reportConfig* is set to *ssb*:
 - 8> set *resultsSSB-Cell* within the *measResult* to include the SS/PBCH block based quantity(ies) indicated in the *reportQuantityCell* within the concerned *reportConfig*, in decreasing order of the sorting quantity, determined as specified in 5.5.5.3, i.e. the best cell is included first;
- ...
- 1> increment the *numberOfReportsSent* as defined within the *VarMeasReportList* for this *measId* by 1;
- 1> stop the periodical reporting timer, if running;
- 1> if the *numberOfReportsSent* as defined within the *VarMeasReportList* for this *measId* is less than the *reportAmount* as defined within the corresponding *reportConfig* for this *measId*:
 - 2> start the periodical reporting timer with the value of *reportInterval* as defined within the corresponding *reportConfig* for this *measId*;
- 1> else:
 - 2> if the *reportType* is set to *periodical*:
 - 3> remove the entry within the *VarMeasReportList* for this *measId*;
 - 3> remove this *measId* from the *measIdList* within *VarMeasConfig*;
- 1> if the UE is configured with EN-DC:
 - 2> if SRB3 is configured:
 - 3> submit the *MeasurementReport* message via SRB3 to lower layers for transmission, upon which the procedure ends;
 - 2> else:
 - 3> submit the *MeasurementReport* message via the EUTRA MCG embedded in E-UTRA RRC message *ULInformationTransferMRDC* as specified in TS 36.331 [10].
- ...

8.2.3.11.1.3 Test description

8.2.3.11.1.3.1 Pre-test conditions

System Simulator:

- E-UTRA Cell 1 is PCell , NR Cell 1 is PSCell on FR1 and NR Cell 3 is inter-frequency neighbour Cell on FR1.

UE:

- None.

Preamble:

- The UE is in state RRC_CONNECTED using generic procedure parameter Connectivity (EN-DC) and Bearers (MCG and SCG) established according to TS 38.508-1 [4].

8.2.3.11.1.3.2 Test procedure sequence

Table 8.2.3.11.3.2-1 illustrates the downlink power levels and other changing parameters to be applied for the cells at various time instants of the test execution. Row marked "T0" denotes the initial conditions after preamble. The exact instants on which these values shall be applied are described in the texts in this clause.

Table 8.2.3.11.1.3.2-1: Time instances of cell power level and parameter changes

	Parameter	Unit	E-UTRA Cell 1	NR Cell 1	NR Cell 3	Remark
T0	Cell-specific RS EPRE	dBm/15 kHz	-85	-	-	Switch on NR neighbour Cell and UE start to perform E-UTRA interRAT measurement.
	SS/PBCH SSS EPRE	dBm/SC S	-	-88	-88	

Table 8.2.3.11.1.3.2-2: Main behaviour

St	Procedure	Message Sequence		TP	Verdict
		U - S	Message		
1	The SS transmits an <i>RRCCONNECTIONRECONFIGURATION</i> message to setup fr1-Gap to report periodical measurements for E-UTRA serving Cell 1 and NR neighbor cell 3 on FR1 frequency.	<--	<i>RRCCONNECTIONRECONFIGURATION</i>	-	-
2	The UE transmits an <i>RRCCONNECTIONRECONFIGURATIONCOMPLETE</i> message to confirm the setup of fr1-Gap and report periodical measurements for E-UTRA serving cell1 and NR neighbor cell 3 on FR1 frequency.	-->	<i>RRCCONNECTIONRECONFIGURATIONCOMPLETE</i>	-	-
3	Wait and ignore <i>MEASUREMENTREPORT</i> messages for 8 s to allow UE to measure the neighbouring cells.	-	-	-	-
-	EXCEPTION: In parallel to events described in step 4 the steps specified in table 8.2.3.11.1.3.2-3 shall take place.	-	-	-	-
4	Wait for 30 s to ensure that the UE performs a periodical inter frequency reporting.	-	-	-	-
-	EXCEPTION: Steps 5 to 7 shall be repeated for k=1 to 11 (increment=1). Note: skip the gap pattern among #2 - #11 not supported by the UE according to the PICS setting given in TS 38.508-2[5] table A.4.3.6-1	-	-	-	-

5	The SS transmits an <i>RRCCONNECTIONRECONFIGURATION</i> including measConfig to change fr1-Gap.	<--	<i>RRCCONNECTIONRECONFIGURATION</i>	-	-
6	The UE transmits an <i>RRCCONNECTIONRECONFIGURATIONCOMPLETE</i> message to confirm the change of fr1-Gap.	-->	<i>RRCCONNECTIONRECONFIGURATIONCOMPLETE</i>	-	-
-	EXCEPTION: In parallel to events described in step 7 the steps specified in table 8.2.3.11.1.3.2-3 shall take place.	-	-	-	-
7	Wait for 30 s to ensure that the UE performs a periodical inter frequency reporting.	-	-	-	-
8	SS transmits an <i>RRCCONNECTIONRECONFIGURATION</i> message including measConfig to release fr1-Gap and measid of periodical measurements.	<--	<i>RRCCONNECTIONRECONFIGURATION</i>	-	-
9	The UE transmits an <i>RRCCONNECTIONRECONFIGURATIONCOMPLETE</i> message.	-->	<i>RRCCONNECTIONRECONFIGURATIONCOMPLETE</i>	-	-
10	Wait 10s	-	-	-	-
11	The SS transmits an <i>RRCCONNECTIONRECONFIGURATION</i> including measConfig to setup fr1-Gap and nr-Config IE containing measConfig to report periodical measurements for NR serving Cell 1 and NR neighbor cell 3 on FR1 frequency.	<--	<i>RRCCONNECTIONRECONFIGURATION (RRCRECONFIGURATION)</i>	-	-
12	The UE transmits an <i>RRCCONNECTIONRECONFIGURATIONCOMPLETE</i> message to confirm the setup of fr1-Gap and report periodical measurements for NR serving Cell 1 and NR neighbor cell 3 on FR1 frequency.	-->	<i>RRCCONNECTIONRECONFIGURATIONCOMPLETE (RRCRECONFIGURATIONCOMPLETE)</i>	-	-
13	Wait and ignore <i>MEASUREMENTREPORT</i> messages for 8 s to allow for UE to measure the neighbouring cells.	-	-	-	-
-	EXCEPTION: In parallel to events described in step 14 the steps specified in table 8.2.3.11.1.3.2-4 shall take place.	-	-	-	-
14	Wait for 30 s to ensure that the UE performs a periodical inter frequency reporting.	-	-	-	-
-	EXCEPTION: Steps 15 to 17 shall be repeated for k=1 to 11 (increment=1). Note: skip the gap pattern among #2 - #11 not supported by the UE according to the PICS setting given in TS 38.508-2[5] table A.4.3.6-1.	-	-	-	-
15	The SS transmits an <i>RRCCONNECTIONRECONFIGURATION</i> including measConfig to change fr1-Gap.	<--	<i>RRCCONNECTIONRECONFIGURATION</i>	-	-
16	The UE transmits an <i>RRCCONNECTIONRECONFIGURATIONCOMPLETE</i> message to confirm the change of fr1-Gap.	-->	<i>RRCCONNECTIONRECONFIGURATIONCOMPLETE</i>	-	-
-	EXCEPTION: In parallel to events described in step 17 the steps specified in table 8.2.3.11.1.3.2-4 shall take place.	-	-	-	-
17	Wait for 30 s to ensure that the UE performs a periodical inter frequency reporting.	-	-	-	-
18	SS transmits an <i>RRCCONNECTIONRECONFIGURATION</i> message including measConfig to release fr1-Gap and measid of periodical measurements.	<--	<i>RRCCONNECTIONRECONFIGURATION</i>	-	-
19	The UE transmits an <i>RRCCONNECTIONRECONFIGURATIONCOMPLETE</i> message.	-->	<i>RRCCONNECTIONRECONFIGURATIONCOMPLETE</i>	-	-

Table 8.2.3.11.1.3.2-3: Parallel behaviour

St	Procedure	Message Sequence		TP	Verdict
		U - S	Message		
-	EXCEPTION: After the 1st message is received, step 1 below shall be repeated every time the duration indicated in the IE <i>reportInterval</i> has elapsed.	-	-	-	-
1	Check: Does the UE transmit a <i>MeasurementReport</i> message to perform periodical interRAT reporting for E-UTRA serving Cell 1 and NR Cell 3?	-->	<i>MeasurementReport</i>	1	P

Table 8.2.3.11.1.3.2-4: Parallel behaviour

St	Procedure	Message Sequence		TP	Verdict
		U - S	Message		
-	EXCEPTION: After the 1st message is received, step 1 below shall be repeated every time the duration indicated in the IE <i>reportInterval</i> has elapsed.	-	-	-	-
1	Check: Does the UE transmit a <i>MeasurementReport</i> encapsulated in <i>ULInformationTransferMRDC</i> message to perform periodical inter frequency reporting for NR serving Cell 1 and NR Cell 3?	-->	<i>ULInformationTransferMRDC (MeasurementReport)</i>	2	P

8.2.3.11.1.3.3 Specific message contents

Table 8.2.3.11.1.3.3-0: Conditions for specific message contents in Table 8.2.3.11.1.3.3-1

Condition	Explanation
Band > 64	If band > 64 is selected

Table 8.2.3.11.1.3.3-1: RRCConnectionReconfiguration (step 1, Table 8.2.3.11.1.3.2-2)

Derivation Path: TS 36.508 [7], Table 4.6.1-8			
Information Element	Value/remark	Comment	Condition
RRCConnectionReconfiguration ::= SEQUENCE {			
criticalExtensions CHOICE {			
c1 CHOICE {			
rrcConnectionReconfiguration-r8 SEQUENCE {			
measConfig SEQUENCE {			
measObjectToAddModList SEQUENCE (SIZE (1.. maxNrofObjectId)) OF MeasObjectToAddMod {	2 entries		
MeasObjectToAddMod[1] SEQUENCE {		entry 1	
measObjectId	1	MeasObjectIdEutra-f1	
measObject CHOICE {			
measObjectEUTRA	MeasObjectEUTRA-GENERIC(f1)		
measObjectEUTRA	MeasObjectEUTRA-GENERIC(maxEARFCN)		Band > 64
}			
}			
MeasObjectToAddMod[2] SEQUENCE {		entry 2	
measObjectId	2	MeasObjectIdNR-f2	
measObject CHOICE {			
measObjectNR-r15	MeasObjectNR-GENERIC(NRf2)		

}			
}			
}			
reportConfigToAddModList SEQUENCE (SIZE (1..maxReportConfigId)) OF ReportConfigToAddMod {	1 entry		
ReportConfigToAddMod[1] SEQUENCE {		entry 1	
reportConfigId	1		
reportConfig	ReportConfigInterRAT-PERIODICAL		
}			
}			
measIdToAddModList SEQUENCE (SIZE (1..maxNrofMeasId)) OF MeasIdToAddMod {	1 entry		
MeasIdToAddMod[1] SEQUENCE {		entry 1	
measId	1		
measObjectId	2	MeasObjectIdNR-f2	
reportConfigId	1		
}			
}			
quantityConfig	QuantityConfig-DEFAULT		
measGapConfig CHOICE {			
setup SEQUENCE {			
gapOffset CHOICE {			
gp0	9	MGRP = 40 ms, MGL = 6 ms	
}			
}			
}			
measObjectToAddModList-v9e0 SEQUENCE (SIZE (1..maxObjectId)) OF MeasObjectToAddMod-v9e0 {	1 entry		Band > 64
MeasObjectToAddMod-v9e0[1] SEQUENCE {		entry 1	
measObjectEUTRA-v9e0 SEQUENCE {			
carrierFreq-v9e0	Same downlink EARFCN as used for f1		
}			
}			
fr1-gap-r15	True		
mgta-r15	True	Mgta=0.5ms	
}			
}			
}			
}			
}			

Table 8.2.3.11.1.3.3-2: MeasObjectNR-GENERIC(NRf2) (Table 8.2.3.11.1.3.3-1)

Derivation Path: TS 36.508 [7], Table 4.6.6-2B			
Information Element	Value/remark	Comment	Condition
MeasObjectNR-r15 ::= SEQUENCE {			
carrierFreq-r15	Downlink carrier frequency of NR cell 3		
}			

Table 8.2.3.11.1.3.3-3: ReportConfigInterRAT-PERIODICAL (Table 8.2.3.11.1.3.3-1)

Derivation Path: TS 36.508 [7], Table 4.6.6-9			
Information Element	Value/remark	Comment	Condition
ReportConfigInterRAT-PERIODICAL ::= SEQUENCE {			
reportQuantityCellNR-r15 SEQUENCE {			

ss-rsrp	true		
ss-rsrq	true		
ss-sinr	false		
}			
}			

Table 8.2.3.11.1.3.3-4: QuantityConfig-DEFAULT (Table 8.2.3.11.1.3.3-1)

Derivation Path: TS 36.508 [7], Table 4.6.6-3A			
Information Element	Value/remark	Comment	Condition
QuantityConfig-DEFAULT ::= SEQUENCE {			
quantityConfigNRLList-r15 SEQUENCE ((SIZE (1..maxQuantSetsNR-r15)) OF QuantityConfigNR-r15 {	1 entry		
QuantityConfigNR-r15[1] SEQUENCE {		entry 1	
measQuantityCellNR-r15 SEQUENCE {			
filterCoeff-RSRP-r15	fc4		
filterCoeff-RSRQ-r15	fc4		
filterCoefficient-SINR-r13	fc4		
}			
}			
}			
}			

Table 8.2.3.11.1.3.3-5: MeasurementReport (step 1, Table 8.2.3.11.1.3.2-3)

Derivation Path: TS 36.508 [7], Table 4.6.1-5			
Information Element	Value/remark	Comment	Condition
MeasurementReport ::= SEQUENCE {			
criticalExtensions CHOICE {			
c1 CHOICE {			
measurementReport-r8 SEQUENCE {			
measResults SEQUENCE {			
measId	1		
measResultPCell SEQUENCE {			
rsrpResult	(0..97)		
rsrqResult	(0..34)		
}			
measResultNeighCells CHOICE {			
measResultNeighCellListNR-r15 SEQUENCE (SIZE (1..maxCellReport)) OF MeasResultCellNR-r15 {	1 entry		
MeasResultCellNR-r15[1] SEQUENCE {		entry 1	
pci-r15	PhysicalCellIdentity of NR Cell 3		
measResultCell-r15 SEQUENCE {			
rsrpResult-r15	(0..127)		
rsrqResult-r15	(0..127)		
}			
}			
}			
}			
}			
}			
}			
}			
}			

Table 8.2.3.11.1.3.3-6: RRCConnectionReconfiguration (steps 5, 15 Table 8.2.3.11.1.3.2-2)

Derivation Path: TS 36.508 [7], Table 4.6.1-8			
Information Element	Value/remark	Comment	Condition

RRCCONNECTIONRECONFIGURATION ::= SEQUENCE {			
criticalExtensions CHOICE {			
c1 CHOICE {			
rrcConnectionReconfiguration-r8 SEQUENCE {			
measConfig SEQUENCE {			
quantityConfig	Not present		
measGapConfig CHOICE {			
setup SEQUENCE {			
gapOffset CHOICE {			
gp1	9	Gap Pattern #1, MGRP = 80 ms, MGL = 6 ms	k=1
gp2-r14	9	Gap Pattern #2, MGRP = 40 ms, MGL = 3 ms	k=2 pc_gp2_gp3_en_dc=True
gp3-r14	9	Gap Pattern #3, MGRP = 80 ms, MGL = 3 ms	k=3 pc_gp2_gp3_en_dc=True
gp4-r15	9	Gap Pattern #4, MGRP = 20 ms, MGL = 6 ms	k=4 pc_gp4_en_dc=True
gp5-r15	9	Gap Pattern #5, MGRP = 160 ms, MGL = 6 ms	k=5 pc_gp5_en_dc=True
gp6-r15	9	Gap Pattern #6, MGRP = 20 ms, MGL = 4 ms	k=6 pc_gp6_en_dc=True
gp7-r15	9	Gap Pattern #7, MGRP = 40 ms, MGL = 4 ms	k=7 pc_gp7_en_dc=True
gp8-r15	9	Gap Pattern #8, MGRP = 80 ms, MGL = 4 ms	k=8 pc_gp8_en_dc=True
gp9-r15	9	Gap Pattern #9, MGRP = 160 ms, MGL = 4 ms	k=9 pc_gp9_en_dc=True
gp10-r15	9	Gap Pattern #10, MGRP = 20 ms, MGL = 3 ms	k=10 pc_gp10_en_dc=True
gp11-r15	9	Gap Pattern #11, MGRP = 160 ms, MGL = 3 ms	k=11 pc_gp11_en_dc=True
}			
}			
fr1-gap-r15	True		
mgta-r15	False	Mgta=0ms	k=6-11
	True	Mgta=0.5ms	k=1-5
}			
}			
}			
}			
}			

Table 8.2.3.11.1.3.3-7: RRCCONNECTIONRECONFIGURATION (step 8 Table 8.2.3.11.1.3.2-2)

Derivation Path: TS 36.508 [7], Table 4.6.1-8			
Information Element	Value/remark	Comment	Condition
RRCCONNECTIONRECONFIGURATION ::= SEQUENCE {			
criticalExtensions CHOICE {			
c1 CHOICE {			
rrcConnectionReconfiguration-r8 SEQUENCE {			
measConfig SEQUENCE {			

}		
---	--	--

Table 8.2.3.11.1.3.3-9: RRCReconfiguration (Table 8.2.3.11.1.3.3-8)

Derivation Path: TS 38.508-1 [4], Table 4.6.1-13 with condition EN-DC_MEAS
--

Table 8.2.3.11.1.3.3-10: MeasConfig (Table 8.2.3.11.1.3.3-9)

Derivation Path: TS 38.508-1[4] Table 4.6.3-69			
Information Element	Value/Remark	Comment	Condition
measConfig ::= SEQUENCE {			
measObjectToAddModList SEQUENCE (SIZE (1..maxNrofObjectId)) OF MeasObjectToAddMod {	2 entries		
MeasObjectToAddMod[1] SEQUENCE {		entry 1	
measObjectId	1	MeasObjectIdNR-f1	
measObject CHOICE {			
measObjectNR	MeasObjectNR-GENERIC(0)	NR Cell 1	
}			
}			
MeasObjectToAddMod[2] SEQUENCE {		entry 2	
measObjectId	2	MeasObjectIdNR-f2	
measObject CHOICE {			
measObjectNR	MeasObjectNR-GENERIC(0)	NR Cell 3	
}			
}			
reportConfigToAddModList SEQUENCE (SIZE (1..maxReportConfigId)) OF ReportConfigToAddMod {	1 entry		
ReportConfigToAddMod[1] SEQUENCE {		entry 1	
reportConfigId	1	ReportConfigId	
reportConfig	ReportConfig-Periodical		
}			
}			
measIdToAddModList SEQUENCE (SIZE (1..maxNrofMeasId)) OF MeasIdToAddMod {	1 entry		
MeasIdToAddMod[1] SEQUENCE {		entry 1	
measId	2		
measObjectId	2	MeasObjectIdNR-f2	
reportConfigId	1	ReportConfigId	
}			
}			
quantityConfig	QuantityConfig		
}			

Table 8.2.3.11.1.3.3-11: MeasObjectNR-GENERIC(0) (Table 8.2.3.11.1.3.3-10)

Derivation Path: TS 38.508-1 [4], Table 4.6.3-76			
Information Element	Value/remark	Comment	Condition
MeasObjectNR ::= SEQUENCE {			
ssbFrequency	Downlink ARFCN of NR cell 3 SSB		
}			

Table 8.2.3.11.1.3.3-12: MeasObjectNR-GENERIC(0) (Table 8.2.3.11.1.3.3-10)

Derivation Path: TS 38.508-1 [4], Table 4.6.3-76			
Information Element	Value/remark	Comment	Condition
MeasObjectNR ::= SEQUENCE {			
ssbFrequency	Downlink ARFCN of NR cell 1 SSB		
}			

Table 8.2.3.11.1.3.3-13: ReportConfig-Periodical (Table 8.2.3.11.1.3.3-10)

Derivation Path: TS 38.508-1 [4], Table 4.6.3-142 with condition Periodical			
Information Element	Value/remark	Comment	Condition
ReportConfigNR ::= SEQUENCE {			
reportType CHOICE {			
Periodical SEQUENCE {			
reportQuantityCell SEQUENCE {			
rsrp	true		
rsrq	true		
sinr	false		
}			
maxReportCells	1		
}			
}			
}			

Table 8.2.3.11.1.3.3-14: QuantityConfig (Table 8.2.3.11.1.3.3-10)

Derivation Path: TS 38.508-1 [4], Table 4.6.3-127			
Information Element	Value/remark	Comment	Condition
QuantityConfig ::= SEQUENCE {			
quantityConfigNR-List SEQUENCE (SIZE (1..maxNrofQuantityConfig)) OF QuantityConfigNR {	1 entry		
QuantityConfigNR[1] SEQUENCE {		entry 1	
quantityConfigCell SEQUENCE {			
ssb-FilterConfig SEQUENCE {			
filterCoefficientRSRP	fc4		
filterCoefficientRSRQ	fc4		
filterCoefficientRS-SINR	fc4		
}			
}			
}			
}			
}			

Table 8.2.3.11.1.3.3-15: ULInformationTransferMRDC (step1, Table 8.2.3.11.1.3.2-4)

Derivation Path: TS 36.508 [7], Table 4.6.1-27			
Information Element	Value/remark	Comment	Condition
ULInformationTransferMRDC ::= SEQUENCE {			
ul-DCCH-MessageNR-r15	OCTET STRING including the MeasurementReport message according to Table 8.2.3.11.1.3.3-16		
}			

Table 8.2.3.11.1.3.3-16: MeasurementReport (Table 8.2.3.11.1.3.3-15)

Derivation Path: TS 38.508-1 [4], clause 4.6.1-5A			
Information Element	Value/remark	Comment	Condition

Information Element	Value/remark	Comment	Condition
RRCReconfiguration ::= SEQUENCE {			
rrc-TransactionIdentifier	RRC-TransactionIdentifier	38.508-1 [4] Table 4.6.5-12.	
criticalExtensions CHOICE {			
c1 CHOICE {			
rrcReconfiguration SEQUENCE {			
radioBearerConfig	Not present		
secondaryCellGroup	Not present		
measConfig SEQUENCE {			
measObjectToAddModList	Not present		
reportConfigToAddModList	Not present		
measIdToRemoveList SEQUENCE (SIZE (1..maxMeasId)) OF MeasId {	1 entry		
MeasId[1]	2	entry 1	
}			
measIdToAddModList	Not present		
quantityConfig	Not present		
}			
lateNonCriticalExtension	Not present		
nonCriticalExtension	Not present		
}			
}			
}			

8.2.3.11.2 Measurement configuration control and reporting / Measurement Gaps / NR FR2 / EN-DC

8.2.3.11.2.1 Test Purpose (TP)

(1)

```
with { UE in RRC_CONNECTED state with EN-DC, and, MCG (E-UTRA PDCP) and SCG }
ensure that {
  when { UE receives RRCConnectionReconfiguration message with nr-Config IE containing MeasConfig to
  setup gapFR2 and report periodical measurements for NR neighbor cell on FR2 frequency }
  then { UE applies gapFR2 and sends periodical measurements for NR neighbor cell on FR2 frequency }
}
```

8.2.3.11.2.2 Conformance requirements

References: The conformance requirements covered in the current TC are specified in: TS 36.331, clause 5.3.5.3, and TS 38.331, clause 5.5.2.9. Unless otherwise stated these are Rel-15 requirements.

[TS 36.331, clause 5.3.5.3]

If the *RRCConnectionReconfiguration* message does not include the *mobilityControlInfo* and the UE is able to comply with the configuration included in this message, the UE shall:

...

1> set the content of *RRCConnectionReconfigurationComplete* message as follows:

...

2> if the received *RRCConnectionReconfiguration* message included *nr-SecondaryCellGroupConfig*:

3> include *scg-ConfigResponseNR* in accordance with TS 38.331 [82, 5.3.5.3];

1> submit the *RRCConnectionReconfigurationComplete* message to lower layers for transmission using the new configuration, upon which the procedure ends;

[TS 38.331, clause 5.5.2.9]

The UE shall:

...

1> if *gapFR2* is set to setup:

- 2> if an FR2 measurement gap configuration is already setup, release the FR2 measurement gap configuration;
- 2> setup the FR2 measurement gap configuration indicated by the *measGapConfig* in accordance with the received *gapOffset*, i.e., the first subframe of each gap occurs at an SFN and subframe meeting the following condition:

$$\text{SFN mod } T = \text{FLOOR}(\text{gapOffset}/10);$$

$$\text{subframe} = \text{gapOffset mod } 10;$$

with $T = \text{MGRP}/10$ as defined in TS 38.133 [14];

- 2> if *mgta* is configured, apply the specified timing advance to the gap occurrences calculated above (i.e. the UE starts the measurement *mgta* ms before the gap subframe occurrences);

1> else if *gapFR2* is set to release:

- 2> release the FR2 measurement gap configuration;

1> if *gapUE* is set to setup:

- 2> if a per UE measurement gap configuration is already setup, release the per UE measurement gap configuration;
- 2> setup the per UE measurement gap configuration indicated by the *measGapConfig* in accordance with the received *gapOffset*, i.e., the first subframe of each gap occurs at an SFN and subframe meeting the following condition:

$$\text{SFN mod } T = \text{FLOOR}(\text{gapOffset}/10);$$

$$\text{subframe} = \text{gapOffset mod } 10;$$

with $T = \text{MGRP}/10$ as defined in TS 38.133 [14];

- 2> if *mgta* is configured, apply the specified timing advance to the gap occurrences calculated above (i.e. the UE starts the measurement *mgta* ms before the gap subframe occurrences);

1> else if *gapUE* is set to release:

- 2> release the per UE measurement gap configuration.

...

NOTE 1: For *gapFR2* configuration, the SFN and subframe of a serving cell on FR2 frequency is used in the gap calculation

8.2.3.11.2.3 Test description

8.2.3.11.2.3.1 Pre-test conditions

System Simulator:

- E-UTRA Cell 1 is PCell, NR Cell 1 is PSCell on FR2 and NR Cell 3 is inter-frequency neighbour Cell on FR2.

UE:

- None.

Preamble:

- The UE is in state RRC_CONNECTED using generic procedure parameter Connectivity (*EN-DC*) and Bearers (*MCG and SCG*) established according to TS 38.508-1 [4].

8.2.3.11.2.3.2 Test procedure sequence

Table 8.2.3.11.3.2-1 illustrates the downlink power levels and other changing parameters to be applied for the cells at various time instants of the test execution. Row marked "T0" denotes the initial conditions after preamble. The exact instants on which these values shall be applied are described in the texts in this clause.

Table 8.2.3.11.2.3.2-1: Time instances of cell power level and parameter changes for OTA test environment

	Parameter	Unit	E-UTRA Cell 1	NR Cell 1	NR Cell 3	Remark
T0	Cell-specific RS EPRE	dBm/15 kHz	-96	-	-	Switch on NR neighbour Cell and UE start to perform E-UTRA interRAT measurement.
	SS/PBCH SSS EPRE	dBm/SC S	-	-91	-91	

Table 8.2.3.11.2.3.2-2: Main behaviour

St	Procedure	Message Sequence		TP	Verdict
		U - S	Message		
1	The SS transmits an <i>RRCCONNECTIONRECONFIGURATION</i> including nr-Config IE containing measConfig to setup gapFR2 and report periodical measurements for NR neighbor cell 3 on FR2 frequency.	<--	<i>RRCCONNECTIONRECONFIGURATION (RRCReconfiguration)</i>	-	-
2	The UE transmits an <i>RRCCONNECTIONRECONFIGURATIONCOMPLETE</i> message to confirm the setup gapFR2 and report periodical measurements for NR neighbor cell 3 on FR2 frequency.	-->	<i>RRCCONNECTIONRECONFIGURATIONCOMPLETE (RRCReconfigurationComplete)</i>	-	-
3	Wait and ignore <i>MEASUREMENTREPORT</i> messages for 8 s to allow for UE to measure the neighbouring cells.	-	-	-	-
-	EXCEPTION: In parallel to events described in step 4 the steps specified in table 8.2.3.11.2.3.2-3 shall take place	-	-	-	-
4	Wait for 30 s to ensure that the UE performs a periodical inter frequency reporting.	-	-	-	-
-	EXCEPTION: Steps 5 to 7 shall be repeated for k=13 to 23 (increment=1). Note: skip the gap pattern among #12 and #15 - #23 not supported by the UE according to the PICS setting.	-	-	-	-
5	The SS transmits an <i>RRCCONNECTIONRECONFIGURATION</i> including nr-Config IE containing measConfig to change gapFR2	<--	<i>RRCCONNECTIONRECONFIGURATION (RRCReconfiguration)</i>	-	-
6	The UE transmits an <i>RRCCONNECTIONRECONFIGURATIONCOMPLETE</i> message to confirm the change of gapFR2	-->	<i>RRCCONNECTIONRECONFIGURATIONCOMPLETE (RRCReconfigurationComplete)</i>	-	-
-	EXCEPTION: In parallel to events described in step 7 the steps specified in table 8.2.3.11.1.3.2-3 shall take place	-	-	-	-
7	Wait for 30 s to ensure that the UE performs a periodical inter frequency reporting.	-	-	-	-
8	SS transmits an <i>RRCCONNECTIONRECONFIGURATION</i> message including measConfig to release gapFR2 and measid of periodical measurements.	<--	<i>RRCCONNECTIONRECONFIGURATION (RRCReconfiguration)</i>	-	-

9	The UE transmits an <i>RCConnectionReconfigurationComplete</i> message	-->	<i>RRConnectionReconfigurationComplete</i> (<i>RRCReconfigurationComplete</i>)	-	-
---	--	-----	---	---	---

Table 8.2.3.11.2.3.2-3: Parallel behaviour

St	Procedure	Message Sequence		TP	Verdict
		U - S	Message		
-	EXCEPTION: After the 1st message is received, step 1 below shall be repeated every time the duration indicated in the IE <i>reportInterval</i> has elapsed	-	-	-	-
1	Check: Does the UE transmit a <i>MeasurementReport</i> encapsulated in <i>ULInformationTransferMRDC</i> message to perform periodical inter frequency reporting for NR serving Cell 1 and NR Cell 3?	-->	<i>ULInformationTransferMRDC</i> (<i>MeasurementReport</i>)	1	P

8.2.3.11.2.3.3 Specific message contents

Table 8.2.3.11.2.3.3-1: RRConnectionReconfiguration (step 1, Table 8.2.3.11.2.3.2-2)

Derivation Path: TS 36.508 [7], Table 4.6.1-8 with condition EN-DC_EmbedNR_RRCRecon

Table 8.2.3.11.2.3.3-2: RRCReconfiguration (Table 8.2.3.11.2.3.3-1)

Derivation Path: TS 38.508-1 [4], Table 4.6.1-13 with condition EN-DC_MEAS

Table 8.2.3.11.2.3.3-3: MeasConfig (Table 8.2.3.11.2.3.3-2)

Derivation Path: TS 38.508-1[4] Table 4.6.3-69			
Information Element	Value/Remark	Comment	Condition
measConfig ::= SEQUENCE {			
measObjectToAddModList SEQUENCE (SIZE (1..maxNrofObjectId)) OF MeasObjectToAddMod {	2 entries		
MeasObjectToAddMod[1] SEQUENCE {		entry 1	
measObjectId	1	MeasObjectIdNR-f1	
measObject CHOICE {			
measObjectNR	MeasObjectNR-GENERIC(0)	NR Cell 1	
}			
}			
MeasObjectToAddMod[2] SEQUENCE {		entry 2	
measObjectId	2	MeasObjectIdNR-f2	
measObject CHOICE {			
measObjectNR	MeasObjectNR-GENERIC(0)	NR Cell 3	
}			
}			
reportConfigToAddModList SEQUENCE (SIZE (1..maxReportConfigId)) OF ReportConfigToAddMod {	1 entry		
ReportConfigToAddMod[1] SEQUENCE {		entry 1	
reportConfigId	1	ReportConfigId	
reportConfig	ReportConfig-Periodical		
}			
}			

measIdToAddModList SEQUENCE (SIZE (1..maxNrofMeasId)) OF MeasIdToAddMod {	1 entry		
MeasIdToAddMod[1] SEQUENCE {		entry 1	
measId	1		
measObjectId	2	MeasObjectIdNR-f2	
reportConfigId	1	ReportConfigId	
}			
}			
quantityConfig	QuantityConfig		
measGapConfig SEQUENCE {	MeasGapConfig		
gapFR2 SteupRelease {			
gapOffset	-9		
mgl	ms5dot5	5.5ms	Gap pattern #13
mgrp	ms40	40ms	
mgta	ms0dot25	0.25ms	
}			
}			
}			
}			

Table 8.2.3.11.2.3.3-4: MeasObjectNR-GENERIC(0) (Table 8.2.3.11.2.3.3-3)

Derivation Path: TS 38.508-1 [4], Table 4.6.3-76			
Information Element	Value/remark	Comment	Condition
MeasObjectNR ::= SEQUENCE {			
ssbFrequency	Downlink ARFCN of NR cell 1 SSB		
}			

Table 8.2.3.11.2.3.3-5: MeasObjectNR-GENERIC(0) (Table 8.2.3.11.2.3.3-3)

Derivation Path: TS 38.508-1 [4], Table 4.6.3-76			
Information Element	Value/remark	Comment	Condition
MeasObjectNR ::= SEQUENCE {			
ssbFrequency	Downlink ARFCN of NR cell 3 SSB		
}			

Table 8.2.3.11.2.3.3-6: ReportConfig-Periodical (Table 8.2.3.11.2.3.3-3)

Derivation Path: TS 38.508-1 [4], Table 4.6.3-142 with condition Periodical			
Information Element	Value/remark	Comment	Condition
ReportConfigNR ::= SEQUENCE {			
reportType CHOICE {			
Periodical SEQUENCE {			
reportQuantityCell SEQUENCE {			
rsrp	true		
rsrq	true		
sinr	false		
}			
maxReportCells	1		
}			
}			
}			

Table 8.2.3.11.2.3.3-7: QuantityConfig (Table 8.2.3.11.1.3.3-3)

Derivation Path: TS 38.508-1 [4], Table 4.6.3-127			
Information Element	Value/remark	Comment	Condition
QuantityConfig ::= SEQUENCE {			

quantityConfigNR-List SEQUENCE (SIZE (1..maxNrofQuantityConfig)) OF QuantityConfigNR {	1 entry		
QuantityConfigNR[1] SEQUENCE {		entry 1	
quantityConfigCell SEQUENCE {			
ssb-FilterConfig SEQUENCE {			
filterCoefficientRSRP	fc4		
filterCoefficientRSRQ	fc4		
filterCoefficientRS-SINR	fc4		
}			
}			
}			
}			

Table 8.2.3.11.2.3.3-8: ULInformationTransferMRDC (step1, Table 8.2.3.11.2.3.2-3)

Derivation Path: TS 36.508 [7], Table 4.6.1-27			
Information Element	Value/remark	Comment	Condition
ULInformationTransferMRDC ::= SEQUENCE {			
ul-DCCH-MessageNR-r15	OCTET STRING including the MeasurementReport message according to Table 8.2.3.11.2.3.3-9		
}			

Table 8.2.3.11.2.3.3-9: MeasurementReport (Table 8.2.3.11.2.3.3-8)

Derivation Path: TS 38.508-1 [4], clause 4.6.1-5A			
Information Element	Value/remark	Comment	Condition
MeasurementReport ::= SEQUENCE {			
criticalExtensions CHOICE {			
c1 CHOICE {			
measurementReport SEQUENCE {			
measResults SEQUENCE {			
measId	1		
measResultServingMOList SEQUENCE {	1 entry		
servCellId	ServCellIndex of NR Cell 1		
measResultServingCell SEQUENCE {			
physCellId	Physical CellID of the NR Cell 1		
measResult SEQUENCE {			
cellResults SEQUENCE {			
resultsSSB-Cell SEQUENCE {			
rsrp	(0..127)		
rsrq	(0..127)		
}			
}			
}			
}			
measResultNeighCells CHOICE {			
measResultListNR SEQUENCE {	1 entry		
physCellId	Physical CellID of the NR Cell 3		
measResult SEQUENCE {			
cellResults SEQUENCE {			
resultsSSB-Cell SEQUENCE {			
rsrp	(0..127)		
rsrq	(0..127)		
}			
resultsCSI-RS-Cell	Not present		
}			
rsIndexResults	Not present		
}			
}			
}			
}			

cgi-Info	Not present		
}			
}			
}			
}			
}			
}			

Table 8.2.3.11.2.3.3-10: RRCConnectionReconfiguration (step 5, Table 8.2.3.11.2.3.2-2)

Derivation Path: TS 36.508 [7], Table 4.6.1-8 with condition EN-DC_EmbedNR_RRCRecon

Table 8.2.3.11.2.3.3-11: RRCReconfiguration (Table 8.2.3.11.2.3.3-10)

Derivation Path: TS 38.508-1 [4], Table 4.6.1-13 with condition EN-DC_MEAS
--

Table 8.2.3.11.2.3.3-12: MeasConfig (Table 8.2.3.11.2.3.3-11)

Derivation Path: TS 38.508-1[4] Table 4.6.3-69			
Information Element	Value/Remark	Comment	Condition
measConfig ::= SEQUENCE {			
measObjectToAddModList	Not present		
reportConfigToAddModList	Not present		
measIdToAddModList	Not present		
quantityConfig	Not present		
measGapConfig SEQUENCE {	MeasGapConfig		
gapFR2 CHOICE {			
Setup SEQUENCE{			
gapOffset	9		k=13-23
mgl	ms5dot5	Gap Pattern #12, 5.5ms	k=13 pc_gp12_n r=True
mgl	ms5dot5	Gap Pattern #14, 5.5ms	k=14
mgl	ms5dot5	Gap Pattern #15, 5.5ms	k=15 pc_gp15_n r=True
mgl	ms3dot5	Gap Pattern #16, 3.5ms	k=16 pc_gp16_n r=True
mgl	ms3dot5	Gap Pattern #17, 3.5ms	k=17 pc_gp17_n r=True
mgl	ms3dot5	Gap Pattern #18, 3.5ms	k=18 pc_gp18_n r=True
mgl	ms3dot5	Gap Pattern #19, 3.5ms	k=19 pc_gp19_n r=True
mgl	ms1dot5	Gap Pattern #20, 1.5ms	k=20 pc_gp20_n r=True
mgl	ms1dot5	Gap Pattern #21, 1.5ms	k=21 pc_gp21_n r=True
mgl	ms1dot5	Gap Pattern #22, 1.5ms	k=22 pc_gp22_n r=True
mgl	ms1dot5	Gap Pattern #23, 1.5ms	k=23 pc_gp23_n r=True

mgrp	ms20	Gap Pattern #12, 20ms	k=13 pc_gp12_n r=True
mgrp	ms80	Gap Pattern #14, 80ms	k=14
mgrp	ms160	Gap Pattern #15, 160ms,	k=15 pc_gp15_n r=True
mgrp	ms20	Gap Pattern #16, 20ms	k=16 pc_gp16_n r=True
mgrp	ms40	Gap Pattern #17, 40ms	k=17 pc_gp17_n r=True
mgrp	ms80	Gap Pattern #18, 80ms	k=18 pc_gp18_n r=True
mgrp	ms160	Gap Pattern #19, 160ms	k=19 pc_gp19_n r=True
mgrp	ms20	Gap Pattern #20, 20ms	k=20 pc_gp20_n r=True
mgrp	ms40	Gap Pattern #21, 40ms	k=21 pc_gp21_n r=True
mgrp	ms80	Gap Pattern #22, 80ms	k=22 pc_gp22_n r=True
mgrp	ms160	Gap Pattern #23, 160ms	k=23 pc_gp23_n r=True
mgta	ms0dot25	0.25ms	k=18-23
mgta	ms0	0 ms	k=13-17
}			
}			
}			
}			

Table 8.2.3.11.2.3.3-13: RRCConnectionReconfiguration (step 8, Table 8.2.3.11.2.3.2-2)

Derivation Path: TS 36.508 [7], Table 4.6.1-8 with condition EN-DC_EmbedNR_RRCRecon

Table 8.2.3.11.2.3.3-14: RRCReconfiguration (Table 8.2.3.11.2.3.3-13)

Derivation Path: TS 38.508-1 [4], Table 4.6.1-13 with condition EN-DC_MEAS

Table 8.2.3.11.2.3.3-15: MeasConfig (Table 8.2.3.11.2.3.3-14)

Derivation Path: TS 38.508-1[4] Table 4.6.3-69			
Information Element	Value/Remark	Comment	Condition
measConfig ::= SEQUENCE {			
measObjectToAddModList	Not present		
reportConfigToAddModList	Not present		
MeasIdToRemoveList SEQUENCE (SIZE (1..maxNrofMeasId)) OF MeasId {	1 entry		
MeasId[1]	1	entry 1	
}			
measIdToAddModList	Not present		
quantityConfig	Not present		
measGapConfig SEQUENCE {	MeasGapConfig		
gapFR2 CHOICE {			
release	NULL		

}			
}			
}			

8.2.3.11.3 Measurement configuration control and reporting / Measurement Gaps / NR-DC

8.2.3.11.3.1 Test Purpose (TP)

(1)

```

with { UE in RRC_CONNECTED state with NR-DC, and SCG }
ensure that {
  when { UE receives RRCReconfiguration message containing MeasConfig for the PCell to setup gapFR2
and refServCellIndicator set to pCell to report periodical measurements of NR serving PCell and
neighbour cell on FR2 frequency }
  then { UE applies gapFR2, calculates the gaps using pCell as the reference cell and sends
periodical measurements for NR serving PCell and neighbour cell on FR2 frequency }
}

```

8.2.3.11.3.2 Conformance requirements

References: The conformance requirements covered in the current TC are specified in: TS 38.331, clause 5.5.2.9. Unless otherwise stated these are Rel-15 requirements.

[TS 38.331, clause 5.5.2.9]

The UE shall:

...

1> if *gapFR2* is set to setup:

- 2> if an FR2 measurement gap configuration is already setup, release the FR2 measurement gap configuration;
- 2> setup the FR2 measurement gap configuration indicated by the *measGapConfig* in accordance with the received *gapOffset*, i.e., the first subframe of each gap occurs at an SFN and subframe meeting the following condition:

$$\text{SFN mod } T = \text{FLOOR}(\text{gapOffset}/10);$$

$$\text{subframe} = \text{gapOffset mod } 10;$$

with $T = \text{MGRP}/10$ as defined in TS 38.133 [14];

- 2> if *mgta* is configured, apply the specified timing advance to the gap occurrences calculated above (i.e. the UE starts the measurement *mgta* ms before the gap subframe occurrences);

1> else if *gapFR2* is set to release:

- 2> release the FR2 measurement gap configuration;

1> if *gapUE* is set to setup:

- 2> if a per UE measurement gap configuration is already setup, release the per UE measurement gap configuration;
- 2> setup the per UE measurement gap configuration indicated by the *measGapConfig* in accordance with the received *gapOffset*, i.e., the first subframe of each gap occurs at an SFN and subframe meeting the following condition:

$$\text{SFN mod } T = \text{FLOOR}(\text{gapOffset}/10);$$

$$\text{subframe} = \text{gapOffset mod } 10;$$

with $T = \text{MGRP}/10$ as defined in TS 38.133 [14];

- 2> if *mgta* is configured, apply the specified timing advance to the gap occurrences calculated above (i.e. the UE starts the measurement *mgta* ms before the gap subframe occurrences);
- 1> else if *gapUE* is set to release:
 - 2> release the per UE measurement gap configuration.
- ...

NOTE 1: For gapFR2 configuration, the SFN and subframe of a serving cell on FR2 frequency is used in the gap calculation

8.2.3.11.3.3 Test description

8.2.3.11.3.3.1 Pre-test conditions

System Simulator:

- NR Cell 1 is the PCell, NR Cell 10 is the PSCell and NR Cell 3 is Neighbour Cell on FR2.

UE:

- None.

Preamble:

- The UE is in state RRC_CONNECTED using generic procedure parameter Connectivity (NR-DC) and Bearers (MCG and SCG) established according to TS 38.508-1 [4] Table 4.5.1-1.

8.2.3.11.3.3.2 Test procedure sequence

Table 8.2.3.11.3.3.2-1 illustrates the downlink power levels and other changing parameters to be applied for the cells at various time instants of the test execution. Row marked "T0" denotes the initial conditions after preamble. The exact instants on which these values shall be applied are described in the texts in this clause.

Table 8.2.3.11.3.3.2-1: Time instances of cell power level and parameter changes for OTA test environment

	Parameter	Unit	NR Cell 1	NR Cell 10	NR Cell 3	Remark
T0	SS/PBCH SSS EPRE	dBm/SC S	-88	-82	-91	The power level values are such that NR Cell 3 is satisfied for periodic reporting.

Table 8.2.3.11.3.3.2-2: Main behaviour

St	Procedure	Message Sequence		TP	Verdict
		U - S	Message		
1	The SS transmits an <i>RRCReconfiguration</i> message to setup gapFR2 (pattern #13) to report periodical measurements for NR serving Cell 1 and NR neighbour cell 3 on FR2 frequency.	<--	<i>RRCReconfiguration</i>	-	-
2	The UE transmits an <i>RRCReconfigurationComplete</i> message to confirm the setup of gapFR2 and report periodical measurements for NR serving Cell 1 and NR neighbour cell 3 on FR1 frequency.	-->	<i>RRCReconfigurationComplete</i>	-	-
3	Wait and ignore <i>MeasurementReport</i> messages for 8 s to allow for UE to measure the neighbouring cells.	-	-	-	-

-	EXCEPTION: In parallel to events described in step 4 the steps specified in table 8.2.3.11.3.3.2-3 shall take place.	-	-	-	-
4	Wait for 30 s to ensure that the UE performs a periodical inter frequency reporting.	-	-	-	-
-	EXCEPTION: Steps 5 to 7 shall be repeated for k=1 to 11 (increment=1). Note: skip the gap pattern among #2 - #11 not supported by the UE according to the PICS setting given in TS 38.508-2[5] table A.4.3.6-1.	-	-	-	-
5	The SS transmits an <i>RRCReconfiguration</i> including measConfig to change gapFR2 to pattern #14..	<--	<i>RRCConnectionReconfiguration</i>	-	-
6	The UE transmits an <i>RRCReconfigurationComplete</i> message to confirm the change of gapFR2.	-->	<i>RRCReconfigurationComplete</i>	-	-
-	EXCEPTION: In parallel to events described in step 7 the steps specified in table 8.2.3.11.3.3.2-3 shall take place.	-	-	-	-
7	Wait for 30 s to ensure that the UE performs a periodical inter frequency reporting.	-	-	-	-
8	SS transmits an <i>RRCReconfiguration</i> message including measConfig to release gapFR2 and measid of periodical measurements.	<--	<i>RRCReconfiguration</i>	-	-
9	The UE transmits an <i>RRCReconfigurationComplete</i> message.	-->	<i>RRCReconfigurationComplete</i>	-	-

Table 8.2.3.11.3.3.2-3: Parallel behaviour

St	Procedure	Message Sequence		TP	Verdict
		U - S	Message		
-	EXCEPTION: After the 1st message is received, step 1 below shall be repeated every time the duration indicated in the IE <i>reportInterval</i> has elapsed.	-	-	-	-
1	Check: Does the UE transmit a <i>MeasurementReport</i> message to perform periodical inter frequency reporting for NR Cell 1 and NR Cell 3??	-->	<i>MeasurementReport</i>	1	P

8.2.3.11.3.3.3 Specific message contents

Table 8.2.3.11.3.3.3-1: *RRCReconfiguration* (step 1, Table 8.2.3.11.3.3.2-2)

Derivation Path: TS 38.508-1 [4] Table 4.6.1-13 with condition NR_MEAS

Table 8.2.3.11.3.3.3-2: *MeasConfig* (Table 8.2.3.11.3.3.3-1)

Derivation Path: TS 38.508-1 [4] Table 4.6.3-69			
Information Element	Value/remark	Comment	Condition
<i>MeasConfig</i> ::= SEQUENCE {			
<i>measObjectToAddModList</i>	Not present		Step 5
<i>measObjectToAddModList</i> SEQUENCE (SIZE (1..maxNrofMeasId)) OF <i>MeasObjectToAddMod</i> {	2 entries		Step 1
<i>MeasObjectToAddMod</i> [1] SEQUENCE {		entry 1	
<i>measObjectId</i>	1		
<i>measObject</i> CHOICE {			
<i>measObjectNR</i>	<i>MeasObjectNR</i> -f1	Table 8.2.3.11.3.3.3-2	
}			
}			
<i>MeasObjectToAddMod</i> [2] SEQUENCE {		entry 2	
<i>measObjectId</i>	2		

measObject CHOICE {			
measObjectNR	MeasObjectNR-f2	Table 8.2.3.11.3.3.3-3	
}			
}			
reportConfigToAddModList	Not present		Step 5
reportConfigToAddModList SEQUENCE(SIZE (1..maxReportConfigId)) OF ReportConfigToAddMod {	1 entry		Step 1
ReportConfigToAddMod[1] SEQUENCE {		entry 1	
reportConfigId	1		
reportConfig CHOICE {			
reportConfigNR	ReportConfigNR with condition PERIODICAL		
}			
}			
}			
measIdToAddModList SEQUENCE (SIZE (1..maxNrofMeasId)) OF MeasIdToAddMod {	Not present		Step 5
MeasIdToAddMod[1] SEQUENCE {	1 entry		Step 1
measId		entry 1	
measId	1		
measObjectId	2		
reportConfigId	1		
}			
}			
measGapConfig	MeasGapConfig-gapFR2	Table 8.2.3.11.3.3.3-5	
}			

Table 8.2.3.11.3.3.3-3: MeasObjectNR-f1 (Table 8.2.3.11.3.3.3-2)

Derivation Path: TS 38.508-1 [4], Table 4.6.3-76			
Information Element	Value/remark	Comment	Condition
MeasObjectNR ::= SEQUENCE {			
ssbFrequency	ARFCN-ValueNR for SSB of NR Cell 1		
smtc1 SEQUENCE {			
periodicityAndOffset CHOICE {			
sf20	10	To make sure SMTC for intra-frequency measurement is non-overlapping with MG	
}			
}			
absThreshSS-BlocksConsolidation	Not present		
nrofSS-BlocksToAverage	Not present		
}			

Table 8.2.3.11.3.3.3-4: MeasObjectNR-f2 (Table 8.2.3.11.3.3.3-2)

Derivation Path: TS 38.508-1 [4], Table 4.6.3-76			
Information Element	Value/remark	Comment	Condition
MeasObjectNR ::= SEQUENCE {			
ssbFrequency	ARFCN-ValueNR for SSB of NR Cell 3		
smtc1 SEQUENCE {			
periodicityAndOffset CHOICE {			
sf20	0		
}			
}			
absThreshSS-BlocksConsolidation	Not present		

nrofSS-BlocksToAverage	Not present		
}			

Table 8.2.3.11.3.3.3-5: MeasGapConfig-gapFR2 (Table 8.2.3.11.3.3.3-2)

Derivation Path: TS 38.508-1 [4], Table 4.6.3-70 with Condition GAP_FR2			
Information Element	Value/remark	Comment	Condition
MeasGapConfig ::= SEQUENCE {			
gapFR2 CHOICE {			
setup SEQUENCE {			
gapOffset	0		
mgl	ms1dot5		Pattern #20, #21, #22 or #23
	ms3dot5		Pattern #16, #17, #18 or #19
	ms5dot5		Pattern #12, #13, #14 or #15
mgrp	ms20		Pattern #12, #16 or #20
	ms40		Pattern #13, #17 or #21
	ms80		Pattern #14, #18 or #22
	ms160		Pattern #15, #19 or #23
mgta	ms0		
}			
}			
}			

Table 8.2.3.11.3.3.3-6: MeasurementReport (step 1, Table 8.2.3.11.3.3.2-3)

Derivation Path: TS 38.508-1 [4] Table 4.6.1-5A			
Information Element	Value/remark	Comment	Condition
MeasurementReport ::= SEQUENCE {			
criticalExtensions CHOICE {			
measurementReport SEQUENCE {			
measResults SEQUENCE {			
measId	1		
measResultServingMOList SEQUENCE (SIZE (1..maxNrofServingCells)) OF MeasResultServMO {	1 entry	Measurement report for NR Cell 1	
MeasResultServMO[1] SEQUENCE {		entry 1	
servCellId	ServCellIndex of NR Cell 10		
measResultServingCell SEQUENCE {			
physCellId	PCI of NR Cell 1		
measResult SEQUENCE {			
cellResults SEQUENCE {			
resultsSSB-Cell SEQUENCE {			
rsrp	(0..127)		
rsrq	(0..127)		
sinr	(0..127)		pc_ss_SINR_Meas
}	Not present		
}			
}			
}			
}			
}			
}			
}			
}			
measResultNeighCells CHOICE {			
measResultListNR SEQUENCE (SIZE (1..maxCellReport)) OF MeasResultNR {	1 entry	Measurement report for NR Cell 3	
MeasResultNR[1] SEQUENCE {		entry 1	
physCellId	Physical layer cell identity of NR Cell 3		
measResult SEQUENCE {			
cellResults SEQUENCE {			

resultsSSB-Cell SEQUENCE {			
rsrp	(0..127)		
rsrq	(0..127)		
sinr	(0..127)		pc_ss_SINR_Meas
	Not present		
}			
resultsCSI-RS-Cell	Not present		
}			
rsIndexResults	Not present		
}			
cgi-Info	Not present		
}			
}			
}			
}			
}			
}			
}			
}			
}			

8.2.3.12 Measurement configuration control and reporting / Inter-RAT measurements / Event B2 / Measurement of NR cells

8.2.3.12.1 Measurement configuration control and reporting / Inter-RAT measurements / Event B2 / Measurement of NR cells / EN-DC

8.2.3.12.1.1 Test Purpose (TP)

(1)

```
with { UE in E-UTRA RRC_CONNECTED state having completed the radio bearer establishment and
performed the inter RAT measurement for NR cell and not detected entering condition for the event B2
is met }
ensure that {
  when { UE detects entering condition for the event B2 is not met }
  then { UE does not transmit any MeasurementReport }
}
```

(2)

```
with { UE in E-UTRA RRC_CONNECTED state having completed the radio bearer establishment and
performed the inter RAT measurement for NR cell and not detected entering condition for the event B2
is met }
ensure that {
  when { UE detects entering condition for the event B2 is met }
  then { UE transmits a MeasurementReport }
}
```

(3)

```
with { UE in E-UTRA RRC_CONNECTED state having completed the radio bearer establishment and
performed the inter RAT measurement for NR cell and detected entering condition for the event B2 is
met }
ensure that {
  when { UE detects leaving condition for the event B2 is met }
  then { UE does not transmit any MeasurementReport }
}
```

8.2.3.12.1.2 Conformance requirements

References: The conformance requirements covered in the present TC are specified in: TS 36.331, clauses 5.5.1, 5.5.4.1, 5.5.4.8, 5.5.5 and 5.5.5.3. Unless otherwise stated these are Rel-15 requirements.

[TS 36.331, clause 5.5.1]

The UE reports measurement information in accordance with the measurement configuration and performs conditional reconfiguration evaluation in accordance with conditional reconfiguration as provided by E-UTRAN. E-UTRAN provides the measurement configuration or the conditional reconfiguration applicable for a UE in RRC_CONNECTED by means of dedicated signalling, i.e. using the *RRConnectionReconfiguration* or *RRConnectionResume* message.

The UE can be requested to perform the following types of measurements:

- Intra-frequency measurements: measurements at the downlink carrier frequency(ies) of the serving cell(s).
- Inter-frequency measurements: measurements at frequencies that differ from any of the downlink carrier frequency(ies) of the serving cell(s).
- Inter-RAT measurements of NR frequencies.
- ...

The measurement configuration includes the following parameters:

1. **Measurement objects:** The objects on which the UE shall perform the measurements.
 - For intra-frequency and inter-frequency measurements a measurement object is a single E-UTRA carrier frequency. Associated with this carrier frequency, E-UTRAN can configure a list of cell specific offsets, a list of 'blacklisted' cells and a list of 'whitelisted' cells. Blacklisted cells are not considered in event evaluation or measurement reporting.
 - For inter-RAT NR measurements a measurement object is a single NR carrier frequency. Associated with this carrier frequency, E-UTRAN can configure a list of 'blacklisted' cells. Blacklisted cells are not considered in event evaluation or measurement reporting.
 - ...

NOTE 1: Some measurements using the above mentioned measurement objects, only concern a single cell, e.g. measurements used to report neighbouring cell system information, PCell UE Rx-Tx time difference, or a pair of cells, e.g. SSTD measurements between the PCell and the PSCell.

2. **Reporting configurations:** A list of measurement reporting configurations where each measurement reporting configuration consists of the following:
 - Reporting criterion: The criterion that triggers the UE to send a measurement report. This can either be periodical or a single event description.
 - Reporting format: The quantities that the UE includes in the measurement report and associated information (e.g. number of cells to report).

In case of conditional handover triggering configuration, each configuration consists of the following:

- Execution criteria: The criteria that triggers the UE to perform conditional handover.
3. **Measurement identities:** For measurement reporting, a list of measurement identities where each measurement identity links one measurement object with one measurement reporting configuration. By configuring multiple measurement identities it is possible to link more than one measurement object to the same reporting configuration, as well as to link more than one reporting configuration to the same measurement object. The measurement identity is used as a reference number in the measurement report. For conditional reconfiguration triggering, one measurement identity links to exactly one conditional reconfiguration trigger configuration. And up to two measurement identities can be linked to one conditional reconfiguration execution condition.
 4. **Quantity configurations:** One quantity configuration is configured per RAT type. The quantity configuration defines the measurement quantities and associated filtering used for all event evaluation and related reporting of that measurement type. One filter can be configured per measurement quantity, except for NR where the network may configure up to 2 sets of quantity configurations each comprising per measurement quantity separate filters for cell and RS index measurement results. The quantity configuration set that applies for a given measurement is indicated within the NR measurement object.

[TS 36.331, clause 5.5.4.1]

If security has been activated successfully, the UE shall:

1> for each *measId* included in the *measIdList* within *VarMeasConfig*:

...

2> else:

...

3> else if the corresponding *measObject* concerns NR:

4> if the *reportSFTD-Meas* is set to *pSCell* in the corresponding *reportConfigInterRAT*:

5> consider the PSCell to be applicable;

4> else if the *reportSFTD-Meas* is set to *neighborCells* in the corresponding *reportConfigInterRAT*:

5> if *cellsForWhichToReportSFTD* is configured in the corresponding *measObjectNR*:

6> consider any neighbouring NR cell on the associated frequency that is included in *cellsForWhichToReportSFTD* to be applicable;

5> else:

6> consider up to 3 strongest neighbouring NR cells detected on the associated frequency to be applicable when the concerned cells are not included in the *blackCellsToAddModList* defined within the *VarMeasConfig* for this *measId*;

4> else:

5> if the *eventB1* or *eventB2* is configured in the corresponding *reportConfig*:

6> consider a serving cell, if any, on the associated NR frequency as neighbouring cell;

5> consider any neighbouring cell detected on the associated frequency to be applicable when the concerned cell is not included in the *blackCellsToAddModList* defined within the *VarMeasConfig* for this *measId*;

[TS 36.331, clause 5.5.4.8]

The UE shall:

1> for UTRA and CDMA2000, only trigger the event for cells included in the corresponding measurement object;

1> consider the entering condition for this event to be satisfied when both condition B2-1 and condition B2-2, as specified below, are fulfilled;

1> consider the leaving condition for this event to be satisfied when condition B2-3 or condition B2-4, i.e. at least one of the two, as specified below, is fulfilled;

Inequality B2-1 (Entering condition 1)

$$M_p + H_{ys} < Thresh_1$$

Inequality B2-2 (Entering condition 2)

$$M_n + Ofn - H_{ys} > Thresh_2$$

Inequality B2-3 (Leaving condition 1)

$$M_p - H_{ys} > Thresh_1$$

Inequality B2-4 (Leaving condition 2)

$$M_n + Ofn + H_{ys} < Thresh_2$$

The variables in the formula are defined as follows:

M_p is the measurement result of the PCell, not taking into account any offsets.

Mn is the measurement result of the inter-RAT neighbour cell, not taking into account any offsets. For CDMA2000 measurement result, *pilotStrength* is divided by -2.

Ofn is the frequency specific offset of the frequency of the inter-RAT neighbour cell (i.e. *offsetFreq* as defined within the *measObject* corresponding to the frequency of the inter-RAT neighbour cell).

Hys is the hysteresis parameter for this event (i.e. *hysteresis* as defined within *reportConfigInterRAT* for this event).

Thresh1 is the threshold parameter for this event (i.e. *b2-Threshold1* as defined within *reportConfigInterRAT* for this event).

Thresh2 is the threshold parameter for this event (i.e. *b2-Threshold2* as defined within *reportConfigInterRAT* for this event). For CDMA2000, *b2-Threshold2* is divided by -2.

Mp is expressed in dBm in case of RSRP, or in dB in case of RSRQ.

Mn is expressed in dBm or dB, depending on the measurement quantity of the inter-RAT neighbour cell.

Ofn, **Hys** are expressed in dB.

Thresh1 is expressed in the same unit as **Mp**.

Thresh2 is expressed in the same unit as **Mn**.

[TS 36.331, clause 5.5.5]

The purpose of this procedure is to transfer measurement results from the UE to E-UTRAN. The UE shall initiate this procedure only after successful security activation.

For the *measId* for which the measurement reporting procedure was triggered, the UE shall set the *measResults* within the *MeasurementReport* message as follows:

- 1> set the *measId* to the measurement identity that triggered the measurement reporting;
- 1> set the *measResultPCell* to include the quantities of the PCell;
- 1> set the *measResultServFreqList* to include for each E-UTRA SCell that is configured, if any, within *measResultSCell* the quantities of the concerned SCell, if available according to performance requirements in TS 36.133 [16], except if *purpose* for the *reportConfig* associated with the *measId* that triggered the measurement reporting is set to *reportLocation*;
- 1> if the *reportConfig* associated with the *measId* that triggered the measurement reporting includes *reportAddNeighMeas*:
 - 2> for each E-UTRA serving frequency for which *measObjectId* is referenced in the *measIdList*, other than the frequency corresponding with the *measId* that triggered the measurement reporting:
 - 3> set the *measResultServFreqList* to include within *measResultBestNeighCell* the *physCellId* and the quantities of the best non-serving cell, based on RSRP, on the concerned serving frequency;
- 1> if the *triggerType* is set to *event*; and if the corresponding *measObject* concerns NR; and if *eventId* is set to *eventB1-NR* or *eventB2-NR*; or
- ...
- 2> if *purpose* for the *reportConfig* or *reportConfigInterRAT* associated with the *measId* that triggered the measurement reporting is set to a value other than *reportLocation*:
 - 3> set the *measResultServFreqListNR* to include for each NR serving frequency that the UE is configured to measure according to TS 38.331 [82], if any, the following:
 - 4> set *measResultSCell* to include the available results of the NR serving cell, as specified in 5.5.5.2;
 - 4> if the *reportConfig* associated with the *measId* that triggered the measurement reporting includes *reportAddNeighMeas* and if *eventId* is set to *eventA3* or *eventA4* or *eventA5*:

- 5> set *measResultBestNeighCell* to include the available results, as specified in 5.5.5.2, of the non-serving cell with the highest sorting quantity determined as specified in 5.5.5.3;
- 3> for each (serving or neighbouring) cell for which the UE reports results according to the previous, additionally include available beam results according to the following:
 - 4> if *maxReportRS-Index* is configured, set *measResultCellRS-Index* to include available results, as specified in 5.5.5.2, of up to *maxReportRS-Index* beams, ordered based on the quantity determined as specified in 5.5.5.3;
- 1> if there is at least one applicable neighbouring cell to report:
 - 2> set the *measResultNeighCells* to include the best neighbouring cells up to *maxReportCells* in accordance with the following:
 - 3> if the *triggerType* is set to *event*:
 - 4> include the cells included in the *cellsTriggeredList* as defined within the *VarMeasReportList* for this *measId*;
 - 3> else:
 - 4> include the applicable cells for which the new measurement results became available since the last periodical reporting or since the measurement was initiated or reset;

NOTE 1: The reliability of the report (i.e. the certainty it contains the strongest cells on the concerned frequency) depends on the measurement configuration i.e. the *reportInterval*. The related performance requirements are specified in TS 36.133 [16].

- 3> for each cell that is included in the *measResultNeighCells*, include the *physCellId*;
- 3> if the *triggerType* is set to *event*; or the *purpose* is set to *reportStrongestCells* or to *reportStrongestCellsForSON*:
 - 4> for each included cell, include the layer 3 filtered measured results in accordance with the *reportConfig* for this *measId*, ordered as follows:
 - 5> if the *measObject* associated with this *measId* concerns E-UTRA:
 - 6> set the *measResult* to include the quantity(ies) indicated in the *reportQuantity* within the concerned *reportConfig*;
 - 6> sort the included cells in order of decreasing *triggerQuantity*, i.e. the best cell is included first;
 - 5> if the *measObject* associated with this *measId* concerns NR:
 - 6> set the *measResultCell* to include the quantity(ies) indicated in the *reportQuantityCellNR* within the concerned *reportConfig*;
 - 6> if *maxReportRS-Index* and *reportQuantityRS-IndexNR* are configured, set *measResultRS-IndexList* to include the result of the best beam if *threshRS-Index* is included in the *VarMeasConfig* for the corresponding *measObject*, and the remaining beams whose quantity is above *threshRS-Index*, up to *maxReportRS-Index* beams in total:
 - 7> order beams based on the sorting quantity determined as specified in 5.5.5.3;
 - 7> for each included beam:
 - 8> include *ssbIndex*;
 - 8> if *reportRS-IndexResultsNR* is set to TRUE, for each quantity indicated, include the corresponding measurement result in *measResultSSB-Index* for each *ssb-Index*;

[TS 36.331, clause 5.5.5.3]

When configured to report the best cells or beams, the UE shall determine the quantity that is used to order and select as follows:

- 1> for cells on the frequency associated with the *measId* that triggered the measurement reporting, if the *reportTrigger* is set to *event*, consider the quantity used in *bN-ThresholdYNR* to be the sorting quantity;
- 1> for other cases, determine the sorting quantity as follows:
- 2> consider the following quantities as candidate sorting quantities:
- 3> for cells on the frequency associated with the *measId* that triggered the measurement reporting (for a *triggerType* set to *periodical*):
- 4> the quantities defined by *reportQuantityCellNR*, when used for sorting cells;
- 4> the quantities defined by *reportQuantityRS-IndexNR*, when used for sorting beams;
- 3> for cells, serving or non-serving (i.e. within *reportAddNeighMeas*), on NR serving frequencies other than the one associated with the *measId* triggering reporting:
- 4> the available quantities of available NR measurement results as specified in 5.5.5.2;
- 2> if there is a single candidate sorting quantity;
- 3> consider the concerned quantity to be the sorting quantity;
- 2> else:
- 3> if RSRP is one of the candidate sorting quantities;
- 4> consider RSRP to be the sorting quantity;
- 3> else:
- 4> consider RSRQ to be the sorting quantity;

8.2.3.12.1.3 Test description

8.2.3.12.1.3.1 Pre-test conditions

System Simulator:

- E-UTRA Cell 1 and NR Cell 1.
- NR Cell 1 is configured to operate in FR1 bands as defined in TS 38.508-1 [4] clause 6.2.3.

UE:

- None.

Preamble:

- The UE is in state RRC_CONNECTED using generic procedure parameter Connectivity established according to [4].

8.2.3.12.1.3.2 Test procedure sequence

Table 8.2.3.12.1.3.2-1 illustrates the downlink power levels and other changing parameters to be applied for the cells at various time instants of the test execution. Row marked "T0" denotes the initial conditions after preamble, while columns marked "T1", "T2", "T3", "T4" and "T5" are to be applied subsequently. The exact instants on which these values shall be applied are described in the texts in this clause.

Table 8.2.3.12.1.3.2-1: Time instances of cell power level and parameter changes for conducted test environment

	Parameter	Unit	E-UTRA Cell 1	NR Cell 1	Remark

T0	Cell-specific RS EPRE	dBm/15 kHz	-84	-	The power level values are such that entering conditions for event B2 are not satisfied, i.e. condition B2-1($Mp + Hys < Thresh1$) is fulfilled but condition B2-2($Mn + Ofn - Hys > Thresh2$) is not fulfilled.
	SS/PBCH SSS EPRE	dBm/SC S	-	-91	
T1	Cell-specific RS EPRE	dBm/15 kHz	-60	-	The power level values are such that entering conditions for event B2 are not satisfied, i.e condition B2-1($Mp + Hys < Thresh1$) is not fulfilled but condition B2-2($Mn + Ofn - Hys > Thresh2$) is fulfilled.
	SS/PBCH SSS EPRE	dBm/SC S	-	-79	
T2	Cell-specific RS EPRE	dBm/15 kHz	-84	-	The power level values are such that entering conditions for event B2 are satisfied, i.e. condition B2-1($Mp + Hys < Thresh1$) and B2-2($Mn + Ofn - Hys > Thresh2$) are fulfilled.
	SS/PBCH SSS EPRE	dBm/SC S	-	-79	
T3	Cell-specific RS EPRE	dBm/15 kHz	-60	-	The power level values are such that leaving conditions for event B2 are satisfied, i.e. condition B2-3($Mp - Hys > Thresh1$) is fulfilled but condition B2-4($Mn + Ofn + Hys < Thresh2$) is not fulfilled.
	SS/PBCH SSS EPRE	dBm/SC S	-	-79	
T4	Cell-specific RS EPRE	dBm/15 kHz	-84	-	The power level values are such that entering conditions for event B2 are satisfied, i.e. condition B2-1($Mp + Hys < Thresh1$) and B2-2($Mn + Ofn - Hys > Thresh2$) are fulfilled.
	SS/PBCH SSS EPRE	dBm/SC S	-	-79	
T5	Cell-specific RS EPRE	dBm/15 kHz	-84	-	The power level values are such that leaving conditions for event B2 are satisfied, i.e. condition B2-3($Mp - Hys > Thresh1$) is not fulfilled but condition B2-4($Mn + Ofn + Hys < Thresh2$) is fulfilled.
	SS/PBCH SSS EPRE	dBm/SS C	-	-91	

Table 8.2.3.12.1.3.2-1A: Void

Table 8.2.3.12.1.3.2-2: Main behaviour

St	Procedure	Message Sequence		TP	Verdict
		U – S	Message		
1	The SS transmits an <i>RRCCONNECTIONRECONFIGURATION</i> including measConfig to setup inter RAT measurements and reporting for NR Cell 1.	<--	<i>RRCCONNECTIONRECONFIGURATION</i>	-	-
2	The UE transmits an <i>RRCCONNECTIONRECONFIGURATIONCOMPLETE</i> message to confirm the setup of inter RAT measurements for NR Cell 1.	-->	<i>RRCCONNECTIONRECONFIGURATIONCOMPLETE</i>	-	-

3	Check: Does the UE transmit a <i>MeasurementReport</i> message on E-UTRA Cell 1 to report the event B2 during the next 10s?	-->	<i>MeasurementReport</i>	1	F
4	The SS changes NR Cell 1 and E-UTRA Cell 1 parameters according to the row "T1".	-	-	-	-
5	Check: Does the UE transmit a <i>MeasurementReport</i> message on E-UTRA Cell 1 to report the event B2 during the next 10s?	-->	<i>MeasurementReport</i>	1	F
6	The SS changes NR Cell 1 and E-UTRA Cell 1 parameters according to the row "T2".	-	-	-	-
7	Check: Does the UE transmit a <i>MeasurementReport</i> message to report the event B2 for NR Cell 1?	-->	<i>MeasurementReport</i>	2	P
8	The SS changes NR Cell 1 and E-UTRA Cell 1 parameters according to the row "T3".	-	-	-	-
9	Wait and ignore <i>MeasurementReport</i> messages for 15 s to allow change of power levels and UE measurements for NR Cell 1 and E-UTRA Cell 1.	-	-	-	-
10	Check: Does the UE transmit a <i>MeasurementReport</i> message on E-UTRA Cell 1 to report the event B2 during the next 10s?	-->	<i>MeasurementReport</i>	3	F
11	The SS changes NR Cell 1 and E-UTRA Cell 1 parameters according to the row "T4" in table 8.2.3.12.1.3.2-1.	-	-	-	-
12	Void				
13	Check: Does the UE transmit a <i>MeasurementReport</i> message to report the event B2 for NR Cell 1?	-->	<i>MeasurementReport</i>	2	P
14	The SS changes NR Cell 1 and E-UTRA Cell 1 parameters according to the row "T5" in table 8.2.3.12.1.3.2-1.	-	-	-	-
15	Wait and ignore <i>MeasurementReport</i> messages for 15 s to allow change of power levels and UE measurements for NR Cell 1 and E-UTRA Cell 1.	-	-	-	-
16	Check: Does the UE transmit a <i>MeasurementReport</i> message on E-UTRA Cell 1 to report the event B2 during the next 10s?	-->	<i>MeasurementReport</i>	3	F

8.2.3.12.1.3.3 Specific message contents

Table 8.2.3.12.1.3.3-1: RRCConnectionReconfiguration (step 1, Table 8.2.3.12.1.3.2-2)

Derivation Path: TS 36.508 [7], Table 4.6.1-8, condition MEAS

Table 8.2.3.12.1.3.3-2: MeasConfig (Table 8.2.3.12.1.3.3-1)

Derivation Path: TS 36.508 [7], Table 4.6.6-1			
Information Element	Value/remark	Comment	Condition
MeasConfig ::= SEQUENCE {			
measObjectToAddModList SEQUENCE (SIZE (1..maxObjectld)) OF MeasObjectToAddMod {	2 entries		
MeasObjectToAddMod[1] SEQUENCE {		entry 1	
measObjectld	1		
measObject	MeasObjectEUTRA-GENERIC(f1)		
measObject	MeasObjectEUTRA-GENERIC(maxEARFCN)		Band > 64
}			
MeasObjectToAddMod[2] SEQUENCE {		entry 2	
measObjectld	IdMeasObject-NRf1		
measObject	MeasObjectNR-GENERIC (NRf1)		

}			
}			
reportConfigToAddModList SEQUENCE (SIZE (1..maxReportConfigId) OF ReportConfigToAddMod {	1 entry		
ReportConfigToAddMod[1] SEQUENCE {		entry 1	
reportConfigId	IdReportConfig-B2-NR		
reportConfig	ReportConfigInterRAT-B2-NR-r15(-72, -85)		FR1
}			
}			
}			
measIdToAddModList SEQUENCE (SIZE (1..maxMeasId) OF MeasIdToAddMod {	1 entry		
MeasIdToAddMod[1] SEQUENCE {		entry 1	
measId	1		
measObjectId	IdMeasObject-NRf1		
reportConfigId	IdReportConfig-B2-NR		
}			
}			
quantityConfig	QuantityConfig-DEFAULT		
measGapConfig	MeasGapConfig		
measObjectToAddModList-v9e0 SEQUENCE (SIZE (1..maxObjectId) OF MeasObjectToAddMod-v9e0 {	1 entry		Band > 64
MeasObjectToAddMod-v9e0[1] SEQUENCE {		entry 1	
measObjectEUTRA-v9e0 SEQUENCE {			
carrierFreq-v9e0	Same downlink EARFCN as used for f1		
}			
}			
}			
}			
}			
}			

Table 8.2.3.12.1.3.3-3: QuantityConfig-DEFAULT (Table 8.2.3.12.1.3.3-2)

Derivation Path: TS 36.508 [7], Table 4.6.6-3A			
Information Element	Value/remark	Comment	Condition
QuantityConfig-DEFAULT ::= SEQUENCE {			
quantityConfigNRLList-r15 SEQUENCE ((SIZE (1..maxQuantSetsNR-r15)) OF QuantityConfigNR-r15 {	1 entry		
QuantityConfigNR-r15[1] SEQUENCE {		entry 1	
measQuantityCellNR-r15 SEQUENCE {			
filterCoeff-RSRP-r15	fc0		
filterCoeff-RSRQ-r15	fc0		
filterCoefficient-SINR-r13	fc0		
}			
}			
}			
}			

Table 8.2.3.12.1.3.3-4: MeasObjectNR-GENERIC (NRf1) (Table 8.2.3.12.1.3.3-2)

Derivation Path: TS 36.508 [7], Table 4.6.6-2B			
Information Element	Value/remark	Comment	Condition
MeasObjectNR-GENERIC(Freq) ::= SEQUENCE {			
carrierFreq-r15	Downlink carrier frequency of NR cell 1		
}			

Table 8.2.3.12.1.3.3-5: ReportConfigInterRAT-B2-NR-r15 (Table 8.2.3.12.1.3.3-2)

Derivation Path: TS 36.508 [7], Table 4.6.6-8A			
--	--	--	--

Information Element	Value/remark	Comment	Condition
ReportConfig-B2-NR ::= SEQUENCE {			
reportQuantityCellNR-r15 SEQUENCE {			
ss-rsrp	true		
ss-rsrq	true		
ss-sinr	true		pc_ss_SINR_Meas
	false		
}			
}			

Table 8.2.3.12.1.3.3-6: MeasurementReport (step 3, 5, 7, 10, 13, 16, Table 8.2.3.12.1.3.2-2)

Derivation Path: TS 36.508 [7], Table 4.6.1-5			
Information Element	Value/remark	Comment	Condition
MeasurementReport ::= SEQUENCE {			
criticalExtensions CHOICE {			
c1 CHOICE {			
measurementReport-r8 SEQUENCE {			
measResults SEQUENCE {			
measId	1		
measResultPCell SEQUENCE {			
rsrpResult	(0..97)		
rsrqResult	(0..34)		
}			
measResultNeighCells CHOICE {			
measResultNeighCellListNR-r15 SEQUENCE (SIZE (1..maxCellReport)) OF MeasResultCellNR-r15 {	1 entry		
MeasResultCellNR-r15[1] SEQUENCE {		entry 1	
pci-r15	PhysicalCellIdentity of NR Cell 1		
measResultCell-r15 SEQUENCE {			
rsrpResult-r15	(0..127)		
rsrqResult-r15	(0..127)		
rs-sinr-Result-r15	(0..127)		pc_ss_SINR_Meas
}	Not present		
}			
cgi-Info-r15	Not present		
}			
}			
}			
}			

Table 8.2.3.12.1.3.3-7: MeasGapConfig (Table 8.2.3.12.1.3.3-2)

Derivation Path: TS 36.331, clause 6.3.5			
Information Element	Value/remark	Comment	Condition
MeasGapConfig ::= CHOICE {			
setup SEQUENCE {			
gapOffset CHOICE {			
gp1	19	TGRP = 80 ms	
}			
}			
}			

8.2.3.12.2 Measurement configuration control and reporting / Inter-RAT measurements / Event B2 / Measurement of E-UTRA cells / NE-DC

8.2.3.12.2.1 Test Purpose (TP)

(1)

```
with { UE in RRC_CONNECTED state with NE-DC, and, MCG(s) (NR PDCP) and SCG and measurement
configured for event A1 with event based periodical reporting }
ensure that {
  when { Serving E-UTRA cell becomes better than absolute threshold plus hysteresis }
  then { UE sends MeasurementReport message at regular intervals while entering condition for event
A1 is satisfied }
}
```

(2)

```
with { UE in RRC_CONNECTED state in NE-DC, and, MCG(s) (NR PDCP) and SCG and periodical measurement
reporting triggered by event A1 ongoing }
ensure that {
  when { Serving E-UTRA cell becomes worse than absolute threshold minus hysteresis }
  then { UE stops sending MeasurementReport message }
}
```

8.2.3.12.2.2 Conformance requirements

References: The conformance requirements covered in the present TC are specified in: TS 38.331, clauses 5.3.5.3, 5.5.2, 5.5.4.1, 5.5.4.9 and 5.5.5. Unless otherwise stated these are Rel-15 requirements.

[TS 38.331, clause 5.3.5.3]

The UE shall perform the following actions upon reception of the *RRCReconfiguration*:

...

1> if the *RRCReconfiguration* message includes the *measConfig*:

2> perform the measurement configuration procedure as specified in 5.5.2;

...

1> if the *RRCReconfiguration* includes the *mrdc-SecondaryCellGroupConfig*:

2> if the *mrdc-SecondaryCellGroupConfig* is set to *setup*:

3> if the *mrdc-SecondaryCellGroupConfig* includes *mrdc-ReleaseAndAdd*:

4> perform MR-DC release as specified in clause 5.3.5.10;

3> if the received *mrdc-SecondaryCellGroup* is set to *nr-SCG*:

4> perform the RRC reconfiguration according to 5.3.5.3 for the *RRCReconfiguration* message included in *nr-SCG*;

3> if the received *mrdc-SecondaryCellGroup* is set to *eutra-SCG*:

4> perform the RRC connection reconfiguration as specified in TS 36.331 [10], clause 5.3.5.3 for the *RRCConnectionReconfiguration* message included in *eutra-SCG*;

2> else (*mrdc-SecondaryCellGroupConfig* is set to *release*):

3> perform MR-DC release as specified in clause 5.3.5.10;

...

1> set the content of the *RRCReconfigurationComplete* message as follows:

...

2> if the *RRCReconfiguration* message includes the *mrdc-SecondaryCellGroupConfig* with *mrdc-SecondaryCellGroup* set to *eutra-SCG*:

3> include in the *eutra-SCG-Response* the E-UTRA *RRCConnectionReconfigurationComplete* message in accordance with TS 36.331 [10] clause 5.3.5.3;

[TS 38.331, clause 5.5.2.1]

...

The UE shall:

...

1> if the received *measConfig* includes the *measObjectToAddModList*:

2> perform the measurement object addition/modification procedure as specified in 5.5.2.5;

...

1> if the received *measConfig* includes the *reportConfigToAddModList*:

2> perform the reporting configuration addition/modification procedure as specified in 5.5.2.7;

...

1> if the received *measConfig* includes the *measIdToAddModList*:

2> perform the measurement identity addition/modification procedure as specified in 5.5.2.3;

1> if the received *measConfig* includes the *measGapConfig*:

2> perform the measurement gap configuration procedure as specified in 5.5.2.9;

...

[TS 38.331, clause 5.5.2.9]

The UE shall:

1> if *gapUE* is set to setup:

2> if a per UE measurement gap configuration is already setup, release the per UE measurement gap configuration;

2> setup the per UE measurement gap configuration indicated by the *measGapConfig* in accordance with the received *gapOffset*, i.e., the first subframe of each gap occurs at an SFN and subframe meeting the following condition:

$$\text{SFN mod } T = \text{FLOOR}(\text{gapOffset}/10);$$

$$\text{subframe} = \text{gapOffset mod } 10;$$

with $T = \text{MGRP}/10$ as defined in TS 38.133 [14];

2> if *mgta* is configured, apply the specified timing advance to the gap occurrences calculated above (i.e. the UE starts the measurement *mgta* ms before the gap subframe occurrences);

1> else if *gapUE* is set to release:

2> release the per UE measurement gap configuration.

[TS 38.331, clause 5.5.4.1]

If security has been activated successfully, the UE shall:

1> for each *measId* included in the *measIdList* within *VarMeasConfig*:

- 2> if the corresponding *reportConfig* includes a *reportType* set to *eventTriggered* or *periodical*;
- 3> if the corresponding *measObject* concerns NR;
- ...
- 4> for measurement events other than *eventA1* or *eventA2*:
 - 5> if *useWhiteCellList* is set to TRUE:
 - 6> consider any neighbouring cell detected based on parameters in the associated *measObjectNRto* be applicable when the concerned cell is included in the *whiteCellsToAddModList* defined within the *VarMeasConfig* for this *measId*;
 - 5> else:
 - 6> consider any neighbouring cell detected based on parameters in the associated *measObjectNRto* be applicable when the concerned cell is not included in the *blackCellsToAddModList* defined within the *VarMeasConfig* for this *measId*;
- 3> else if the corresponding *measObject* concerns E-UTRA;
 - 4> consider any neighbouring cell detected on the associated frequency to be applicable when the concerned cell is not included in the *blackCellsToAddModListEUTRAN* defined within the *VarMeasConfig* for this *measId*;
- ...
- 2> if the *reportType* is set to *eventTriggered* and if the entry condition applicable for this event, i.e. the event corresponding with the *eventId* of the corresponding *reportConfig* within *VarMeasConfig*, is fulfilled for one or more applicable cells for all measurements after layer 3 filtering taken during *timeToTrigger* defined for this event within the *VarMeasConfig*, while the *VarMeasReportList* does not include a measurement reporting entry for this *measId* (a first cell triggers the event):
 - 3> include a measurement reporting entry within the *VarMeasReportList* for this *measId*;
 - 3> set the *numberOfReportsSent* defined within the *VarMeasReportList* for this *measId* to 0;
 - 3> include the concerned cell(s) in the *cellsTriggeredList* defined within the *VarMeasReportList* for this *measId*;
 - 3> initiate the measurement reporting procedure, as specified in 5.5.5;
- 2> else if the *reportType* is set to *eventTriggered* and if the entry condition applicable for this event, i.e. the event corresponding with the *eventId* of the corresponding *reportConfig* within *VarMeasConfig*, is fulfilled for one or more applicable cells not included in the *cellsTriggeredList* for all measurements after layer 3 filtering taken during *timeToTrigger* defined for this event within the *VarMeasConfig* (a subsequent cell triggers the event):
 - 3> set the *numberOfReportsSent* defined within the *VarMeasReportList* for this *measId* to 0;
 - 3> include the concerned cell(s) in the *cellsTriggeredList* defined within the *VarMeasReportList* for this *measId*;
 - 3> initiate the measurement reporting procedure, as specified in 5.5.5;
- 2> else if the *reportType* is set to *eventTriggered* and if the leaving condition applicable for this event is fulfilled for one or more of the cells included in the *cellsTriggeredList* defined within the *VarMeasReportList* for this *measId* for all measurements after layer 3 filtering taken during *timeToTrigger* defined within the *VarMeasConfig* for this event:
 - 3> remove the concerned cell(s) in the *cellsTriggeredList* defined within the *VarMeasReportList* for this *measId*;
 - 3> if *reportOnLeave* is set to *TRUE* for the corresponding reporting configuration:
 - 4> initiate the measurement reporting procedure, as specified in 5.5.5;

- 3> if the *cellsTriggeredList* defined within the *VarMeasReportList* for this *measId* is empty:
 - 4> remove the measurement reporting entry within the *VarMeasReportList* for this *measId*;
 - 4> stop the periodical reporting timer for this *measId*, if running;

...

- 2> upon the expiry of T321 for this *measId*:
 - 3> include a measurement reporting entry within the *VarMeasReportList* for this *measId*;
 - 3> set the *numberOfReportsSent* defined within the *VarMeasReportList* for this *measId* to 0;
 - 3> initiate the measurement reporting procedure, as specified in 5.5.5.

[TS 38.331, clause 5.5.4.9]

The UE shall:

- 1> consider the entering condition for this event to be satisfied when both condition B2-1 and condition B2-2, as specified below, are fulfilled;
- 1> consider the leaving condition for this event to be satisfied when condition B2-3 or condition B2-4, i.e. at least one of the two, as specified below, is fulfilled;

Inequality B2-1 (Entering condition 1)

$$Mp + Hys < Thresh1$$

Inequality B2-2 (Entering condition 2)

$$Mn + Ofn + Ocn - Hys > Thresh2$$

Inequality B2-3 (Leaving condition 1)

$$Mp - Hys > Thresh1$$

Inequality B2-4 (Leaving condition 2)

$$Mn + Ofn + Ocn + Hys < Thresh2$$

The variables in the formula are defined as follows:

Mp is the measurement result of the PCell, not taking into account any offsets.

Mn is the measurement result of the inter-RAT neighbour cell, not taking into account any offsets.

Ofn is the measurement object specific offset of the frequency of the inter-RAT neighbour cell (i.e. *eutra-Q-OffsetRange* as defined within the *measObjectEUTRA* corresponding to the frequency of the inter-RAT neighbour cell).

Ocn is the cell specific offset of the inter-RAT neighbour cell (i.e. *cellIndividualOffset* as defined within the *measObjectEUTRA* corresponding to the neighbour inter-RAT cell), and set to zero if not configured for the neighbour cell.

Hys is the hysteresis parameter for this event (i.e. *hysteresis* as defined within *reportConfigInterRAT* for this event).

Thresh1 is the threshold parameter for this event (i.e. *b2-Threshold1* as defined within *reportConfigInterRAT* for this event).

Thresh2 is the threshold parameter for this event (i.e. *b2-Threshold2EUTRA* as defined within *reportConfigInterRAT* for this event).

Mp is expressed in dBm in case of RSRP, or in dB in case of RSRQ and SINR.

Mn is expressed in dBm or dB, depending on the measurement quantity of the inter-RAT neighbour cell.

Ofn, *Ocn*, *Hys* are expressed in dB.

Thresh1 is expressed in the same unit as *Mp*.

Thresh2 is expressed in the same unit as *Mn*.

[TS 38.331, clause 5.5.5]



Figure 5.5.5-1: Measurement reporting

The purpose of this procedure is to transfer measurement results from the UE to the network. The UE shall initiate this procedure only after successful security activation.

For the *measId* for which the measurement reporting procedure was triggered, the UE shall set the *measResults* within the *MeasurementReport* message as follows:

- 1> set the *measId* to the measurement identity that triggered the measurement reporting;
- 1> set the *measResultServingCell* within *measResultServingMOList* to include, for each NR serving cell that is configured with *servingCellMO*, RSRP, RSRQ and the available SINR, derived based on the *rsType* if indicated in the associated *reportConfig*, otherwise based on SSB if available, otherwise based on CSI-RS;
- 1> set the *measResultServingCell* within *measResultServingMOList* to include for each NR serving cell that is configured with *servingCellMO*, if any, the *servCellId*;
- 1> if the *reportConfig* associated with the *measId* that triggered the measurement reporting includes *reportQuantityRsIndexes* and *maxNrofRSIndexesToReport*:
 - 2> for each serving cell configured with *servingCellMO*, include beam measurement information according to the associated *reportConfig* as described in 5.5.5.2;
- ...
- 1> if there is at least one applicable neighbouring cell to report:
 - 2> if the *reportType* is set to *eventTriggered* or *periodical*:
 - 3> set the *measResultNeighCells* to include the best neighbouring cells up to *maxReportCells* in accordance with the following:
 - 4> if the *reportType* is set to *eventTriggered*:
 - 5> include the cells included in the *cellsTriggeredList* as defined within the *VarMeasReportList* for this *measId*;
 - ...
 - 4> for each cell that is included in the *measResultNeighCells*, include the *physCellId*;
 - 4> if the *reportType* is set to *eventTriggered* or *periodical*:
 - 5> for each included cell, include the layer 3 filtered measured results in accordance with the *reportConfig* for this *measId*, ordered as follows:
 - 6> if the *measObject* associated with this *measId* concerns NR:
 - 7> if *rsType* in the associated *reportConfig* is set to *ssb*:

8> set *resultsSSB-Cell* within the *measResult* to include the SS/PBCH block based quantity(ies) indicated in the *reportQuantityCell* within the concerned *reportConfig*, in decreasing order of the sorting quantity, determined as specified in 5.5.5.3, i.e. the best cell is included first:

9> if *reportQuantityRsIndexes* and *maxNrofRSIndexesToReport* are configured, include beam measurement information as described in 5.5.5.2;

...

6> if the *measObject* associated with this *measId* concerns E-UTRA:

7> set the *measResult* to include the quantity(ies) indicated in the *reportQuantity* within the concerned *reportConfigInterRAT* in decreasing order of the sorting quantity, determined as specified in 5.5.5.3, i.e. the best cell is included first;

...

1> increment the *numberOfReportsSent* as defined within the *VarMeasReportList* for this *measId* by 1;

1> stop the periodical reporting timer, if running;

...

1> if the UE is configured with EN-DC:

2> if SRB3 is configured:

3> submit the *MeasurementReport* message via SRB3 to lower layers for transmission, upon which the procedure ends;

2> else:

3> submit the *MeasurementReport* message via the EUTRA MCG embedded in E-UTRA RRC message *ULInformationTransferMRDC* as specified in TS 36.331 [10].

1> else:

2> submit the *MeasurementReport* message to lower layers for transmission, upon which the procedure ends.

8.2.3.12.2.3 Test description

8.2.3.12.2.3.1 Pre-test conditions

System Simulator:

- NR Cell 1 is the PCell and EUTRA Cell 1 is the PSCell.

UE:

- None

Preamble:

- The UE is in state 3N-A as defined in TS 38.508-1 [4], subclause 4.4A on NR Cell 1.

8.2.3.12.2.3.2 Test procedure sequence

Table 8.2.3.12.2.3.2-1 and Table 8.2.3.12.2.3.2-2 illustrates the downlink power levels to be applied for E-UTRA Cell 1 at various time instants of the test execution. Row marked "T0" denotes the conditions after the preamble, while row marked "T1" are to be applied subsequently. The exact instants on which these values shall be applied are described in the texts in this clause.

Table 8.2.3.12.2.3.2-1: Time instances of cell power level and parameter changes for conducted test environment

	Parameter	Unit	E-UTRA Cell 1	NR Cell 1	Remark
T0	Cell-specific RS EPRE	dBm/15 kHz	-91	-	The power level values are such that entering conditions for event B2 are not satisfied, i.e. condition B2-1($Mp + Hys < Thresh1$) is fulfilled but condition B2-2($Mn + Ofn + Ocn - Hys > Thresh2$) is not fulfilled.
	SS/PBCH SSS EPRE	dBm/SC S	-	-90	
T1	Cell-specific RS EPRE	dBm/15 kHz	-73	-	The power level values are such that entering conditions for event B2 are not satisfied, i.e condition B2-1($Mp + Hys < Thresh1$) is not fulfilled but condition B2-2($Mn + Ofn + Ocn - Hys > Thresh2$) is fulfilled.
	SS/PBCH SSS EPRE	dBm/SC S	-	-78	
T2	Cell-specific RS EPRE	dBm/15 kHz	-73	-	The power level values are such that entering conditions for event B2 are satisfied, i.e. condition B2-1($Mp + Hys < Thresh1$) and B2-2($Mn + Ofn + Ocn - Hys > Thresh2$) are fulfilled.
	SS/PBCH SSS EPRE	dBm/SC S	-	-90	
T3	Cell-specific RS EPRE	dBm/15 kHz	-73	-	The power level values are such that leaving conditions for event B2 are satisfied, i.e. condition B2-3($Mp - Hys > Thresh1$) is fulfilled but condition B2-4($Mn + Ofn + Ocn - Hys < Thresh2$) is not fulfilled.
	SS/PBCH SSS EPRE	dBm/SC S	-	-78	
T4	Cell-specific RS EPRE	dBm/15 kHz	-73	-	The power level values are such that entering conditions for event B2 are satisfied, i.e. condition B2-1($Mp + Hys < Thresh1$) and B2-2($Mn + Ofn + Ocn - Hys > Thresh2$) are fulfilled.
	SS/PBCH SSS EPRE	dBm/SC S	-	-90	
T5	Cell-specific RS EPRE	dBm/15 kHz	-91	-	The power level values are such that leaving conditions for event B2 are satisfied, i.e. condition B2-3($Mp - Hys > Thresh1$) is not fulfilled but condition B2-4($Mn + Ofn + Ocn - Hys < Thresh2$) is fulfilled.
	SS/PBCH SSS EPRE	dBm/SS C	-	-90	

Table 8.2.3.12.2.3.2-2: Time instances of cell power level and parameter changes for OTA test environment

	Parameter	Unit	E-UTRA Cell 1	NR Cell 1	Remark
T0	Cell-specific RS EPRE	dBm/15 kHz	FFS	-	The power level values are such that entering conditions for event B2 are not satisfied, i.e. condition B2-1($Mp + Hys < Thresh1$) is fulfilled but condition B2-2($Mn + Ofn + Ocn - Hys > Thresh2$) is not fulfilled.
	SS/PBCH SSS EPRE	dBm/SC S	-	FFS	
T1	Cell-specific RS EPRE	dBm/15 kHz	FFS	-	The power level values are such that entering conditions for event B2 are not satisfied, i.e condition B2-1($Mp + Hys < Thresh1$) is not fulfilled but condition B2-2($Mn + Ofn + Ocn - Hys > Thresh2$) is fulfilled.
	SS/PBCH SSS EPRE	dBm/SC S	-	FFS	

T2	Cell-specific RS EPRE	dBm/15 kHz	FFS	-	The power level values are such that entering conditions for event B2 are satisfied, i.e. condition B2-1($M_p + Hys < Thresh1$) and B2-2($M_n + Ofn + Ocn - Hys > Thresh2$) are fulfilled.
	SS/PBCH SSS EPRE	dBm/SC S	-	FFS	
T3	Cell-specific RS EPRE	dBm/15 kHz	FFS	-	The power level values are such that leaving conditions for event B2 are satisfied, i.e. condition B2-3($M_p - Hys > Thresh1$) is fulfilled but condition B2-4 ($M_n + Ofn + Ocn - Hys < Thresh2$) is not fulfilled.
	SS/PBCH SSS EPRE	dBm/SC S	-	FFS	
T4	Cell-specific RS EPRE	dBm/15 kHz	FFS	-	The power level values are such that entering conditions for event B2 are satisfied, i.e. condition B2-1($M_p + Hys < Thresh1$) and B2-2($M_n + Ofn + Ocn - Hys > Thresh2$) are fulfilled.
	SS/PBCH SSS EPRE	dBm/SC S	-	FFS	
T5	Cell-specific RS EPRE	dBm/15 kHz	FFS	-	The power level values are such that leaving conditions for event B2 are satisfied, i.e. condition B2-3($M_p - Hys > Thresh1$) is not fulfilled but condition B2-4 ($M_n + Ofn + Ocn - Hys < Thresh2$) is fulfilled.
	SS/PBCH SSS EPRE	dBm/SS C	-	FFS	

Table 8.2.3.12.2.3.2-3: Main behaviour

St	Procedure	Message Sequence		TP	Verdict
		U - S	Message		
1	The SS transmits an <i>RRCReconfiguration</i> message including <i>MeasConfig</i> to setup inter-RAT measurement for E-UTRA Cell 1 and reporting for event B2.	<<	NR RRC: <i>RRCReconfiguration</i>	-	-
2	The UE transmit an <i>RRCReconfigurationComplete</i> message.	-->	NR RRC: <i>RRCReconfigurationComplete</i>	-	-
3	Check: Does the UE transmit a <i>MeasurementReport</i> message to report event B2 within the next 10s?	-->	NR RRC: <i>MeasurementReport</i>	1	F
4	SS re-adjusts the cell-specific reference signal level according to row "T1".	-	-	-	-
5	Check: Does the UE transmit a <i>MeasurementReport</i> message to report event B2 within the next 10s?	-->	NR RRC: <i>MeasurementReport</i>	1	F
6	SS re-adjusts the cell-specific reference signal level according to row "T2".	-	-		
7	Check: Does the UE transmit a <i>MeasurementReport</i> message to report event B2 with the measured value for NR Cell 1 and E-UTRA Cell 1 within the next 10s?	-->	NR RRC: <i>MeasurementReport</i>	2	P
8	SS re-adjusts the cell-specific reference signal level according to row "T3".	-	-		
9	Wait and ignore <i>MeasurementReport</i> messages for 15s to allow change of power levels and UE measurement.	-	-		
10	Check: Does the UE transmit a <i>MeasurementReport</i> message to report event B2 within the next 10s?	-->	NR RRC: <i>MeasurementReport</i>	3	F
11	SS re-adjusts the cell-specific reference signal level according to row "T4".				
12	Check: Does the UE transmit a <i>MeasurementReport</i> message to report event B2 with the measured value for NR Cell 1 and E-UTRA Cell 1 within the next 10s?	-->	NR RRC: <i>MeasurementReport</i>	2	P
13	SS re-adjusts the cell-specific reference signal level according to row "T5".	-	-		

14	Wait and ignore <i>MeasurementReport</i> messages for 15s to allow change of power levels and UE measurement.	-	-		
15	Check: Does the UE transmit a <i>MeasurementReport</i> message to report event B2 within the next 10s?	-->	NR RRC: <i>MeasurementReport</i>	3	F

8.2.3.12.2.3.3 Specific message contents

Table 8.2.3.12.2.3.3-1: RRCReconfiguration (step 1, Table 8.2.3.12.2.3.2-3)

Derivation Path: TS 38.508-1 [4], Table 4.6.1-13 with condition NR_MEAS

Table 8.2.3.12.2.3.3-2: MeasConfig (Table 8.2.3.12.2.3.3-1)

Derivation Path: TS 38.508-1 [4] Table 4.6.3-69			
Information Element	Value/remark	Comment	Condition
MeasConfig ::= SEQUENCE {			
measObjectToAddModList SEQUENCE (SIZE (1..maxNrofMeasId)) OF MeasObjectToAddMod {	2 entries		
MeasObjectToAddMod[1] SEQUENCE {		entry 1	
measObjectId	1	MeasObjectIdNR-f1	
measObject CHOICE {			
measObjectNR SEQUENCE {			
ssbFrequency	ssbFrequency IE equals the ARFCN for NR Cell 1		
absThreshSS-BlocksConsolidation	Not present		
}			
}			
}			
MeasObjectToAddMod[2] SEQUENCE {		entry 2	
measObjectId	2	MeasObjectIdE-UTRA-f1	
measObject CHOICE {			
measObjectEUTRA SEQUENCE {			
carrierFreq	ARFCN-ValueEUTRA for E-UTRA Cell 1		
}			
}			
}			
reportConfigToAddModList SEQUENCE (SIZE (1..maxReportConfigId)) OF ReportConfigToAddMod {	1 entry		
ReportConfigToAddMod[1] SEQUENCE {		entry 1	
reportConfigId	1		
reportConfig CHOICE {			
reportConfigInterRAT	ReportConfigInterRAT-EventB2	Table 8.2.3.12.2.3.3-3	
}			
}			
measIdToAddModList SEQUENCE (SIZE (1..maxNrofMeasId)) OF MeasIdToAddMod {	1 entry		
MeasIdToAddMod[1] SEQUENCE {		entry 1	
measId	1		
measObjectId	2		
reportConfigId	1		
}			
}			
quantityConfig	QuantityConfig with Condition INTER-RAT		
measGapConfig	MeasGapConfig		
}			

Table 8.2.3.12.2.3.3-3: ReportConfigInterRAT-EventB2 (Table 8.2.3.12.2.3.3-2)

Derivation Path: TS 38.508-1 [4] Table 4.6.3-141 with condition EVENT_B2			
Information Element	Value/remark	Comment	Condition
ReportConfigNR ::= SEQUENCE {			
reportType CHOICE {			
eventTriggered SEQUENCE {			
eventId CHOICE {			
eventB2 SEQUENCE {			
b2-Threshold1 SEQUENCE {			
rsrp	73	-83dBm	FR1
	FFS	FFS	FR2
}			
b2-Threshold2EUTRA SEQUENCE {			
rsrp	58	-83dBm	FR1
	FFS	FFS	FR2
}			
}			
}			
reportAmount	r1		
}			
}			

Table 8.2.3.12.2.3.3-4: MeasurementReport (step 7 and 12, Table 8.2.3.12.2.3.2-3)

Derivation Path: TS 38.508-1 [4] Table 4.6.1-5A			
Information Element	Value/remark	Comment	Condition
MeasurementReport ::= SEQUENCE {			
criticalExtensions CHOICE {			
measurementReport SEQUENCE {			
measResults SEQUENCE {			
measId	1		
measResultServingMOList SEQUENCE (SIZE (1..maxNrofServingCells)) OF MeasResultServMO {	1 entry	Report NR Cell 1	
MeasResultServMO[1] SEQUENCE {		entry 1	
servCellId	ServCellIndex of NR Cell 1		
measResultServingCell SEQUENCE {			
physCellId	Physical layer cell identity of NR Cell 1		
measResult SEQUENCE {			
cellResults SEQUENCE {			
resultsSSB-Cell SEQUENCE {			
rsrp	(0..127)		
rsrq	(0..127)		
sinr	Not present		
}	Not checked		pc_ss_SINR_Meas
}			
}			
}			
}			
}			
}			
}			
measResultNeighCells CHOICE {			
measResultListEUTRA SEQUENCE (SIZE (1..maxCellReport)) OF MeasResultEUTRA {	1 entry	Report E-UTRA neighbour cell	
MeasResultEUTRA[1] SEQUENCE {		entry 1	
eutra-PhysCellId	Physical layer cell identity of E-UTRA Cell 1		
measResult SEQUENCE {			
rsrp	(0..97)		

rsrq	(0..34)		
sinr	Not present		
}			
cgi-Info	Not present		
}			
}			
}			
}			
}			
}			

8.2.3.13 PCell Handover with SCG change / Reconfiguration with sync / SCG DRB

8.2.3.13.1 PCell Handover with SCG change / Reconfiguration with sync / SCG DRB / EN-DC

8.2.3.13.1.1 Test Purpose (TP)

(1)

```
with { UE in RRC_CONNECTED state in EN-DC mode, and, MCG(s) (E-UTRA PDCP) and SCG DRB established }
ensure that {
  when { UE receives an RRCConnectionReconfiguration message containing mobilityControlInfo to
handover to target E-UTRAN PCell involving SCG change with reconfigurationWithSync on the same
PSCell }
  then { UE sends an RRCConnectionReconfigurationComplete message }
}
```

8.2.3.13.1.2 Conformance requirements

References: The conformance requirements covered in the present TC are specified in: TS 36.331, clause 5.3.5.4, TS 38.331, clauses 5.3.5.3, 5.3.5.5.1 and 5.3.5.5.2. Unless otherwise stated these are Rel-15 requirements.

[TS 36.331, clause 5.3.5.4]

If the *RRCConnectionReconfiguration* message includes the *mobilityControlInfo* and the UE is able to comply with the configuration included in this message, the UE shall:

- 1> stop timer T310, if running;
- 1> stop timer T312, if running;
- 1> start timer T304 with the timer value set to *t304*, as included in the *mobilityControlInfo*;
- 1> stop timer T370, if running;
- 1> if the *carrierFreq* is included:
 - 2> consider the target PCell to be one on the frequency indicated by the *carrierFreq* with a physical cell identity indicated by the *targetPhysCellId*;
- 1> else:
 - 2> consider the target PCell to be one on the frequency of the source PCell with a physical cell identity indicated by the *targetPhysCellId*;
- 1> stop timer T309, if running, for all access categories;
- 1> start synchronising to the DL of the target PCell;

NOTE 1: The UE should perform the handover as soon as possible following the reception of the RRC message triggering the handover, which could be before confirming successful reception (HARQ and ARQ) of this message.

...

1> if the received *RRCConnectionReconfiguration* includes the *nr-SecondaryCellGroupConfig*:

2> perform NR RRC Reconfiguration as specified in TS 38.331 [82], clause 5.3.5.3.

...

1> set the content of *RRCConnectionReconfigurationComplete* message as follows:

...

2> if the received *RRCConnectionReconfiguration* message included *nr-SecondaryCellGroupConfig*:

3> perform NR RRC Reconfiguration as specified in TS 38.331 [82], clause 5.3.5.3.

[TS 38.331, clause 5.3.5.3]

The UE shall perform the following actions upon reception of the *RRCReconfiguration*:

...

1> if the *RRCReconfiguration* includes the *secondaryCellGroup*:

2> perform the cell group configuration for the SCG according to 5.3.5.5;

...

1> set the content of *RRCReconfigurationComplete* message as follows:

2> if the *RRCReconfiguration* includes the *masterCellGroup* containing the *reportUplinkTxDirectCurrent*, or;

2> if the *RRCReconfiguration* includes the *secondaryCellGroup* containing the *reportUplinkTxDirectCurrent*:

3> include the *uplinkTxDirectCurrentList*;

1> if the UE is configured with E-UTRA *nr-SecondaryCellGroupConfig* (MCG is E-UTRA):

2> if *RRCReconfiguration* was received via SRB1:

3> submit the *RRCReconfigurationComplete* via the EUTRA MCG embedded in E-UTRA RRC message *RRCConnectionReconfigurationComplete* as specified in TS 36.331 [10];

3> if *reconfigurationWithSync* was included in *spCellConfig* of an SCG:

4> initiate the random access procedure on the SpCell, as specified in TS 38.321 [3];

3> else:

4> the procedure ends;

NOTE: The order the UE sends the *RRCConnectionReconfigurationComplete* message and performs the Random Access procedure towards the SCG is left to UE implementation.

2> else (*RRCReconfiguration* was received via SRB3):

3> submit the *RRCReconfigurationComplete* message via SRB3 to lower layers for transmission using the new configuration;

NOTE: For EN-DC, in the case of SRB1, the random access is triggered by RRC layer itself as there is not necessarily other UL transmission. In the case of SRB3, the random access is triggered by the MAC layer due to arrival of *RRCReconfigurationComplete*.

1> else:

2> submit the *RRCReconfigurationComplete* message via SRB1 to lower layers for transmission using the new configuration;

...

- 1> if *reconfigurationWithSync* was included in *spCellConfig* of an MCG or SCG, and when MAC of an NR cell group successfully completes a random access procedure triggered above;
 - 2> stop timer T304 for that cell group;
 - 2> apply the parts of the CQI reporting configuration, the scheduling request configuration and the sounding RS configuration that do not require the UE to know the SFN of the respective target SpCell, if any;
 - 2> apply the parts of the measurement and the radio resource configuration that require the UE to know the SFN of the respective target SpCell (e.g. measurement gaps, periodic CQI reporting, scheduling request configuration, sounding RS configuration), if any, upon acquiring the SFN of that target SpCell;
- 2> if the *reconfigurationWithSync* was included in *spCellConfig* of an MCG:
 - 3> if T390 is running:
 - 4> stop timer T390 for all access categories;
 - 4> perform the actions as specified in 5.3.14.4.

...

[TS 38.331, clause 5.3.5.5.1]

The network configures the UE with Master Cell Group (MCG), and zero or one Secondary Cell Group (SCG). For EN-DC, the MCG is configured as specified in TS 36.331 [10]. The network provides the configuration parameters for a cell group in the *CellGroupConfig* IE.

The UE performs the following actions based on a received *CellGroupConfig* IE:

- 1> if the *CellGroupConfig* contains the *spCellConfig* with *reconfigurationWithSync*:
 - 2> perform Reconfiguration with sync according to 5.3.5.5.2;
 - 2> resume all suspended radio bearers and resume SCG transmission for all radio bearers, if suspended;
- 1> if the *CellGroupConfig* contains the *rlc-BearerToReleaseList*:
 - 2> perform RLC bearer release as specified in 5.3.5.5.3;
- 1> if the *CellGroupConfig* contains the *rlc-BearerToAddModList*:
 - 2> perform the RLC bearer addition/modification as specified in 5.3.5.5.4;
- 1> if the *CellGroupConfig* contains the *mac-CellGroupConfig*:
 - 2> configure the MAC entity of this cell group as specified in 5.3.5.5.5;
- 1> if the *CellGroupConfig* contains the *sCellToReleaseList*:
 - 2> perform SCell release as specified in 5.3.5.5.8;
- 1> if the *CellGroupConfig* contains the *spCellConfig*:
 - 2> configure the SpCell as specified in 5.3.5.5.7;
- 1> if the *CellGroupConfig* contains the *sCellToAddModList*:
 - 2> perform SCell addition/modification as specified in 5.3.5.5.9.

[TS 38.331, clause 5.3.5.5.2]

The UE shall perform the following actions to execute a reconfiguration with sync.

- 1> if the security is not activated, perform the actions upon going to RRC_IDLE as specified in 5.3.11 with the release cause 'other' upon which the procedure ends;

- 1> stop timer T310 for the corresponding SpCell, if running;
- 1> start timer T304 for the corresponding SpCell with the timer value set to $t304$, as included in the *reconfigurationWithSync*;
- 1> if the *frequencyInfoDL* is included:
 - 2> consider the target SpCell to be one on the frequency indicated by the *frequencyInfoDL* with a physical cell identity indicated by the *physCellId*;
- 1> else:
 - 2> consider the target SpCell to be one on the SSB frequency of the source SpCell with a physical cell identity indicated by the *physCellId*;
- 1> start synchronising to the DL of the target SpCell;
- 1> apply the specified BCCH configuration defined in 9.1.1.1;
- 1> acquire the *MIB*, which is scheduled as specified in TS 38.213 [13];
- 1> perform the actions specified in clause 5.2.2.4.1;

NOTE 1: The UE should perform the reconfiguration with sync as soon as possible following the reception of the RRC message triggering the reconfiguration with sync, which could be before confirming successful reception (HARQ and ARQ) of this message.

NOTE 2: The UE may omit reading the MIB if the UE already has the required timing information, or the timing information is not needed for random access.

- 1> reset the MAC entity of this cell group;
- 1> consider the SCell(s) of this cell group, if configured, to be in deactivated state;
- 1> apply the value of the *newUE-Identity* as the C-RNTI for this cell group;

Editor's Note: Verify that this does not configure some common parameters which are later discarded due to e.g. SCell release or due to LCH release.

- 1> configure lower layers in accordance with the received *spCellConfigCommon*;
- 1> configure lower layers in accordance with any additional fields, not covered in the previous, if included in the received *reconfigurationWithSync*.

8.2.3.13.1.3 Test description

8.2.3.13.1.3.1 Pre-test conditions

System Simulator:

- E-UTRA Cell 1 is the PCell, E-UTRA Cell 2 is the target PCell and NR Cell 1 is the PSCell.

UE:

- None.

Preamble:

- If *pc_IP_Ping* is set to TRUE then, the UE is in state RRC_CONNECTED using generic procedure parameter Connectivity (EN-DC), Bearers (*MCG(s)* and *SCG*) established according to TS 38.508-1 [4], clause 4.5.4.2-1.
- Else, the UE is in state RRC_CONNECTED using generic procedure parameter Connectivity (EN-DC), Bearers (*MCG(s)* and *SCG*) and Test Loop Function (On) with UE test loop mode B activated according to TS 38.508-1 [4], table 4.5.4.2-1.

8.2.3.13.1.3.2 Test procedure sequence

Tables 8.2.3.13.1.3.2-1 and 8.2.3.13.1.3.2-2 and Table 8.2.3.13.1.3.2-1A illustrate the downlink power levels and other changing parameters to be applied for the cells, with NR cells configured with FR1 and FR2 bands respectively, at various time instants of the test execution. Row marked "T0" denotes the initial conditions after preamble, while columns marked "T1" is to be applied subsequently. The exact instants on which these values shall be applied are described in the texts in this clause.

Table 8.2.3.13.1.3.2-1: Time instances of cell power level and parameter changes for conducted test environment

	Parameter	Unit	E-UTRA Cell 1	E-UTRA Cell 2	NR Cell 1	Remark
T0	Cell-specific RS EPRE	dBm/15kHz	-85	-91	-	
	SS/PBCH SSS EPRE	dBm/SCS	-	-	-88	
T1	Cell-specific RS EPRE	dBm/15kHz	-85	-79	-	
	SS/PBCH SSS EPRE	dBm/SCS	-	-	-88	

Table 8.2.3.13.1.3.2-2: Time instances of cell power level and parameter changes for OTA test environment

	Parameter	Unit	E-UTRA Cell 1	E-UTRA Cell 2	NR Cell 1	Remark
T0	Cell-specific RS EPRE	dBm/15kHz	FFS	FFS	-	
	SS/PBCH SSS EPRE	[dBm/SCS]	-	-	FFS	
T1	Cell-specific RS EPRE	dBm/15kHz	FFS	FFS	-	
	SS/PBCH SSS EPRE	[dBm/SCS]	-	-	FFS	

Table 8.2.3.13.1.3.2-3: Main behaviour

St	Procedure	Message Sequence		TP	Verdict
		U - S	Message		
1	SS re-adjusts the cell-specific reference signal level according to row "T1" 8.2.3.13.1.3.2-1 or 8.2.3.13.1.3.2-1A depending upon whether NR cell is configured on FR1 or FR2 band respectively.	-	-	-	-
2	The SS transmits an <i>RRCConnectionReconfiguration</i> message containing <i>mobilityControlInfo</i> to handover to E-UTRA Cell 2 and NR <i>RRCReconfiguration</i> message to perform SCG change with <i>reconfigurationWithSync</i> with the same PSCell.	<--	<i>RRCConnectionReconfiguration (RRCReconfiguration)</i>	-	-
3	Check: Does the UE transmit an <i>RRCConnectionReconfigurationComplete</i> message containing NR <i>RRCReconfigurationComplete</i> message on E-UTRA Cell 2?	-->	<i>RRCConnectionReconfigurationComplete (RRCReconfigurationComplete)</i>	1	P
4	Void	-	-	-	-
5	Check: Does the test result of generic test procedure in TS 38.508-1 subclause 4.9.1 indicate that the UE is capable of exchanging IP data on SCG DRB using NR radio path?	-	-	1	P

8.2.3.14 SCG change / Reconfiguration with sync / Split DRB

8.2.3.14.1 SCG change / Reconfiguration with sync / Split DRB / EN-DC

8.2.3.14.1.1 Test Purpose (TP)

(1)

```
with { UE in RRC_CONNECTED state with EN-DC, and, MCG(s) (E-UTRA PDCP) and Split }
ensure that {
  when { UE receives an RRCConnectionReconfiguration message to handover from NR PSCell involving
  SCG change with reconfigurationWithSync to the target NR cell with Split DRB }
  then { UE sends an RRCConnectionReconfigurationComplete message }
}
```

8.2.3.14.1.2 Conformance requirements

References: The conformance requirements covered in the present TC are specified in: TS 36.331, clause 5.3.5.3, TS 38.331, clauses 5.3.5.3, 5.3.5.5.1 and 5.3.5.5.2. Unless otherwise stated these are Rel-15 requirements.

[TS 36.331, clause 5.3.5.3]

If the *RRCConnectionReconfiguration* message does not include the *mobilityControlInfo* and the UE is able to comply with the configuration included in this message, the UE shall:

...

1> if the received *RRCConnectionReconfiguration* includes the *sk-Counter*:

2> perform key update procedure as specified in TS 38.331 [82], clause 5.3.5.7;

1> if the received *RRCConnectionReconfiguration* includes the *nr-SecondaryCellGroupConfig*:

2> perform NR RRC Reconfiguration as specified in TS 38.331 [82], clause 5.3.5.3;

...

1> set the content of *RRCConnectionReconfigurationComplete* message as follows:

...

2> if the received *RRCConnectionReconfiguration* message included *nr-SecondaryCellGroupConfig*:

3> include *scg-ConfigResponseNR* in accordance with TS 38.331 [82], clause 5.3.5.3;

1> submit the *RRCConnectionReconfigurationComplete* message to lower layers for transmission using the new configuration, upon which the procedure ends;

[TS 38.331, clause 5.3.5.3]

The UE shall perform the following actions upon reception of the *RRCReconfiguration*:

...

1> if the *RRCReconfiguration* includes the *secondaryCellGroup*:

2> perform the cell group configuration for the SCG according to 5.3.5.5;

...

1> set the content of *RRCReconfigurationComplete* message as follows:

2> if the *RRCReconfiguration* includes the *masterCellGroup* containing the *reportUplinkTxDirectCurrent*, or;

2> if the *RRCReconfiguration* includes the *secondaryCellGroup* containing the *reportUplinkTxDirectCurrent*:

3> include the *uplinkTxDirectCurrentList*;

- 1> if the UE is configured with E-UTRA *nr-SecondaryCellGroupConfig* (MCG is E-UTRA):
 - 2> if *RRCReconfiguration* was received via SRB1:
 - 3> submit the *RRCReconfigurationComplete* via the EUTRA MCG embedded in E-UTRA RRC message *RRCConnectionReconfigurationComplete* as specified in TS 36.331 [10];
 - 3> if *reconfigurationWithSync* was included in *spCellConfig* of an SCG:
 - 4> initiate the random access procedure on the SpCell, as specified in TS 38.321 [3];
 - 3> else:
 - 4> the procedure ends;

NOTE: The order the UE sends the *RRCConnectionReconfigurationComplete* message and performs the Random Access procedure towards the SCG is left to UE implementation.

- 2> else (*RRCReconfiguration* was received via SRB3):
 - 3> submit the *RRCReconfigurationComplete* message via SRB3 to lower layers for transmission using the new configuration;

NOTE: For EN-DC, in the case of SRB1, the random access is triggered by RRC layer itself as there is not necessarily other UL transmission. In the case of SRB3, the random access is triggered by the MAC layer due to arrival of *RRCReconfigurationComplete*.

1> else:

...

- 1> if *reconfigurationWithSync* was included in *spCellConfig* of an MCG or SCG, and when MAC of an NR cell group successfully completes a random access procedure triggered above:
 - 2> stop timer T304 for that cell group;
 - 2> apply the parts of the CQI reporting configuration, the scheduling request configuration and the sounding RS configuration that do not require the UE to know the SFN of the respective target SpCell, if any;
 - 2> apply the parts of the measurement and the radio resource configuration that require the UE to know the SFN of the respective target SpCell (e.g. measurement gaps, periodic CQI reporting, scheduling request configuration, sounding RS configuration), if any, upon acquiring the SFN of that target SpCell;
- 2> if the *reconfigurationWithSync* was included in *spCellConfig* of an MCG:
 - 3> if T390 is running:
 - 4> stop timer T390 for all access categories;
 - 4> perform the actions as specified in 5.3.14.4.

[TS 38.331, clause 5.3.5.5.1]

The network configures the UE with Master Cell Group (MCG), and zero or one Secondary Cell Group (SCG). For EN-DC, the MCG is configured as specified in TS 36.331 [10]. The network provides the configuration parameters for a cell group in the *CellGroupConfig* IE.

The UE performs the following actions based on a received *CellGroupConfig* IE:

- 1> if the *CellGroupConfig* contains the *spCellConfig* with *reconfigurationWithSync*:
 - 2> perform Reconfiguration with sync according to 5.3.5.5.2;
 - 2> resume all suspended radio bearers and resume SCG transmission for all radio bearers, if suspended;
- 1> if the *CellGroupConfig* contains the *rlc-BearerToReleaseList*:
 - 2> perform RLC bearer release as specified in 5.3.5.5.3;

- 1> if the *CellGroupConfig* contains the *rlc-BearerToAddModList*:
 - 2> perform the RLC bearer addition/modification as specified in 5.3.5.5.4;
- 1> if the *CellGroupConfig* contains the *mac-CellGroupConfig*:
 - 2> configure the MAC entity of this cell group as specified in 5.3.5.5.5;
- 1> if the *CellGroupConfig* contains the *sCellToReleaseList*:
 - 2> perform SCell release as specified in 5.3.5.5.8;
- 1> if the *CellGroupConfig* contains the *spCellConfig*:
 - 2> configure the SpCell as specified in 5.3.5.5.7;
- 1> if the *CellGroupConfig* contains the *sCellToAddModList*:
 - 2> perform SCell addition/modification as specified in 5.3.5.5.9.

[TS 38.331, clause 5.3.5.5.2]

The UE shall perform the following actions to execute a reconfiguration with sync.

- 1> if the security is not activated, perform the actions upon going to RRC_IDLE as specified in 5.3.11 with the release cause 'other' upon which the procedure ends;
- 1> stop timer T310 for the corresponding SpCell, if running;
- 1> start timer T304 for the corresponding SpCell with the timer value set to *t304*, as included in the *reconfigurationWithSync*;
- 1> if the *frequencyInfoDL* is included:
 - 2> consider the target SpCell to be one on the frequency indicated by the *frequencyInfoDL* with a physical cell identity indicated by the *physCellId*;
- 1> else:
 - 2> consider the target SpCell to be one on the SSB frequency of the source SpCell with a physical cell identity indicated by the *physCellId*;
- 1> start synchronising to the DL of the target SpCell;
- 1> apply the specified BCCH configuration defined in 9.1.1.1;
- 1> acquire the *MIB*, which is scheduled as specified in TS 38.213 [13];
- 1> perform the actions specified in clause 5.2.2.4.1;

NOTE 1: The UE should perform the reconfiguration with sync as soon as possible following the reception of the RRC message triggering the reconfiguration with sync, which could be before confirming successful reception (HARQ and ARQ) of this message.

NOTE 2: The UE may omit reading the MIB if the UE already has the required timing information, or the timing information is not needed for random access.

- 1> reset the MAC entity of this cell group;
- 1> consider the SCell(s) of this cell group, if configured, to be in deactivated state;
- 1> apply the value of the *newUE-Identity* as the C-RNTI for this cell group;

Editor's Note: Verify that this does not configure some common parameters which are later discarded due to e.g. SCell release or due to LCH release.

1> configure lower layers in accordance with the received *spCellConfigCommon*;

1> configure lower layers in accordance with any additional fields, not covered in the previous, if included in the received *reconfigurationWithSync*.

8.2.3.14.1.3 Test description

8.2.3.14.1.3.1 Pre-test conditions

System Simulator:

- E-UTRA Cell 1 is the PCell, NR Cell 1 is the source PSCell and NR Cell 2 is the target PSCell.

UE:

- None.

Preamble:

- If *pc_IP_Ping* is set to TRUE then, the UE is in state RRC_CONNECTED using generic procedure parameter Connectivity (*EN-DC*), Bearers (*MCG(s) and Split*) established according to TS 38.508-1 [4], clause 4.5.4.2-1.
- Else, the UE is in state RRC_CONNECTED using generic procedure parameter Connectivity (*EN-DC*), Bearers (*MCG(s) and Split*) and Test Loop Function (On) with UE test loop mode B activated according to TS 38.508-1 [4], table 4.5.4.2-1.

8.2.3.14.1.3.2 Test procedure sequence

Table 8.2.3.14.1.3.2-1 and 8.2.3.14.1.3.2-2 illustrate the downlink power levels and other changing parameters to be applied for the cells, with NR cell configured with FR1 and FR2 band respectively, at various time instants of the test execution. Row marked "T0" denotes the initial conditions after preamble, while columns marked "T1" is to be applied subsequently. The exact instants on which these values shall be applied are described in the texts in this clause.

Table 8.2.3.14.1.3.2-1: Time instances of cell power level and parameter changes for conducted test environment

	Parameter	Unit	E-UTRA Cell 1	NR Cell 1	NR Cell 2	Remark
T0	Cell-specific RS EPRE	dBm/15kHz	-85	-	-	
	SS/PBCH SSS EPRE	dBm/SCS	-	-88	"Off"	
T1	Cell-specific RS EPRE	dBm/15kHz	-85	-	-	
	SS/PBCH SSS EPRE	dBm/SCS	-	-88	-82	

Table 8.2.3.14.1.3.2-2: Time instances of cell power level and parameter changes for OTA test environment

	Parameter	Unit	E-UTRA Cell 1	NR Cell 1	NR Cell 2	Remark
T0	Cell-specific RS EPRE	dBm/15kHz	-96	-	-	
	SS/PBCH SSS EPRE	dBm/SCS	-	-91	"Off"	
T1	Cell-specific RS EPRE	dBm/15kHz	-96	-	-	
	SS/PBCH SSS EPRE	dBm/SCS	-	-91	-82	

Table 8.2.3.14.1.3.2-3: Main behaviour

St	Procedure	Message Sequence		TP	Verdict
		U - S	Message		
1	SS re-adjusts the cell-specific reference signal level according to row "T1" in table 8.2.3.14.1.3.2-1 or 8.2.3.14.1.3.2-2 depending upon whether NR cells are configured on FR1 or FR2 bands respectively.	-	-	-	-
2	The SS transmits an <i>RRCConnectionReconfiguration</i> message containing NR <i>RRCReconfiguration</i> message including <i>reconfigurewithsync</i> to handover source PSCell NR Cell 1 to target NR Cell 2 with Split DRB	<--	<i>RRCConnectionReconfiguration (RRCReconfiguration)</i>	-	-
3	Check: Does the UE transmit an <i>RRCConnectionReconfigurationComplete</i> message containing NR <i>RRCReconfigurationComplete</i> message?	-->	<i>RRCConnectionReconfigurationComplete (RRCReconfigurationComplete)</i>	1	P
4	Void.	-	-	-	-
5	Check: Does the test result of generic test procedure in TS 38.508-1 subclause 4.9.1 indicate that the UE is capable of exchanging IP data on Split DRB using NR radio path on NR Cell 2?	-	-	1	P

8.2.3.14.1.3.3 Specific message contents

Table 8.2.3.14.1.3.3-1: *RRCConnectionReconfiguration* (step 2, Table 8.2.3.14.1.3.2-3)

Derivation Path: TS 36.508 [7], Table 4.6.1-8 with condition EN-DC_PSCell_HO AND RBConfig_KeyChange			
Information Element	Value/remark	Comment	Condition
<i>RRCConnectionReconfiguration</i> ::= SEQUENCE {			
criticalExtensions CHOICE {			
c1 CHOICE {			
<i>rrcConnectionReconfiguration-r8</i> SEQUENCE {			
<i>nonCriticalExtension</i> SEQUENCE {			
<i>nonCriticalExtension</i> SEQUENCE {			
<i>nonCriticalExtension</i> SEQUENCE {			
<i>nonCriticalExtension</i> SEQUENCE {			
<i>nonCriticalExtension</i> SEQUENCE {			
<i>nonCriticalExtension</i> SEQUENCE {			
<i>nonCriticalExtension</i> SEQUENCE {			
<i>nr-Config-r15</i> CHOICE {			
<i>setup</i> SEQUENCE {			
<i>nr-SecondaryCellGroupConfig-r15</i>	OCTET STRING including the <i>RRCReconfiguration</i> message containing the IE <i>secondaryCellGroup</i>	<i>reconfigurewithsync</i> is present in <i>spCellConfig</i> IE in the <i>secondaryCellGroup</i> IE	
}			
}			
<i>sk-Counter-r15</i>	Different counter value used before Handover than what was used for initial Split bearer configuration.		
}			
}			
}			
}			
}			
}			

}			
}			
}			
}			
}			
}			
}			

Table 8.2.3.14.1.3.3-2: RRCReconfiguration (Table 8.2.3.14.1.3.3-1)

Derivation Path: TS 38.508-1 [4], Table 4.6.1-13			
Information Element	Value/remark	Comment	Condition
RRCReconfiguration ::= SEQUENCE {			
criticalExtensions CHOICE {			
rrcReconfiguration SEQUENCE {			
secondaryCellGroup	CellGroupConfig		
}			
}			
}			

Table 8.2.3.14.1.3.3-3 CellGroupConfig (Table 8.2.3.14.1.3.3-2)

Derivation Path: TS 38.508-1 [4], Table 4.6.3-19 with condition PSCell_change			
Information Element	Value/remark	Comment	Condition
CellGroupConfig ::= SEQUENCE {			
spCellConfig SEQUENCE {			
reconfigurationWithSync SEQUENCE {			
spCellConfigCommon SEQUENCE {			
physCellId	Physical Cell Identity of NR Cell 2		
}			
newUE-Identity	'4148'H		
}			
}			
}			

8.2.3.14.2 SCG change / Reconfiguration with sync / Split DRB / NR-DC

8.2.3.14.2.1 Test Purpose (TP)

(1)

```
with { UE in NR RRC_CONNECTED state }
ensure that {
  when { UE receives an RRCReconfiguration message to handover from NR PSCell involving SCG change
with reconfigurationWithSync to the target NR cell with Split DRB }
  then { UE sends an RRCReconfigurationComplete message }
}
```

8.2.3.14.2.2 Conformance requirements

References: The conformance requirements covered in the present TC are specified in: TS 38.331, clauses 5.3.5.3, 5.3.5.5.1 and 5.3.5.5.2. Unless otherwise stated these are Rel-15 requirements.

[TS 38.331, clause 5.3.5.3]

The UE shall perform the following actions upon reception of the RRCReconfiguration:

...

- 1> if the RRCReconfiguration includes the secondaryCellGroup:

2> perform the cell group configuration for the SCG according to 5.3.5.5;

...

1> set the content of *RRCReconfigurationComplete* message as follows:

2> if the *RRCReconfiguration* includes the *masterCellGroup* containing the *reportUplinkTxDirectCurrent*, or;

2> if the *RRCReconfiguration* includes the *secondaryCellGroup* containing the *reportUplinkTxDirectCurrent*:

3> include the *uplinkTxDirectCurrentList*;

1> if the UE is configured with E-UTRA *nr-SecondaryCellGroupConfig* (MCG is E-UTRA):

2> if *RRCReconfiguration* was received via SRB1:

3> submit the *RRCReconfigurationComplete* via the EUTRA MCG embedded in E-UTRA RRC message *RRCConnectionReconfigurationComplete* as specified in TS 36.331 [10];

3> if *reconfigurationWithSync* was included in *spCellConfig* of an SCG:

4> initiate the random access procedure on the SpCell, as specified in TS 38.321 [3];

3> else:

4> the procedure ends;

NOTE: The order the UE sends the *RRCConnectionReconfigurationComplete* message and performs the Random Access procedure towards the SCG is left to UE implementation.

2> else (*RRCReconfiguration* was received via SRB3):

3> submit the *RRCReconfigurationComplete* message via SRB3 to lower layers for transmission using the new configuration;

NOTE: For EN-DC, in the case of SRB1, the random access is triggered by RRC layer itself as there is not necessarily other UL transmission. In the case of SRB3, the random access is triggered by the MAC layer due to arrival of *RRCReconfigurationComplete*.

1> else:

...

1> if *reconfigurationWithSync* was included in *spCellConfig* of an MCG or SCG, and when MAC of an NR cell group successfully completes a random access procedure triggered above;

2> stop timer T304 for that cell group;

2> apply the parts of the CQI reporting configuration, the scheduling request configuration and the sounding RS configuration that do not require the UE to know the SFN of the respective target SpCell, if any;

2> apply the parts of the measurement and the radio resource configuration that require the UE to know the SFN of the respective target SpCell (e.g. measurement gaps, periodic CQI reporting, scheduling request configuration, sounding RS configuration), if any, upon acquiring the SFN of that target SpCell;

2> if the *reconfigurationWithSync* was included in *spCellConfig* of an MCG:

3> if T390 is running:

4> stop timer T390 for all access categories;

4> perform the actions as specified in 5.3.14.4.

[TS 38.331, clause 5.3.5.5.1]

The network configures the UE with Master Cell Group (MCG), and zero or one Secondary Cell Group (SCG). For EN-DC, the MCG is configured as specified in TS 36.331 [10]. The network provides the configuration parameters for a cell group in the *CellGroupConfig* IE.

The UE performs the following actions based on a received *CellGroupConfig* IE:

- 1> if the *CellGroupConfig* contains the *spCellConfig* with *reconfigurationWithSync*:
 - 2> perform Reconfiguration with sync according to 5.3.5.5.2;
 - 2> resume all suspended radio bearers and resume SCG transmission for all radio bearers, if suspended;
- 1> if the *CellGroupConfig* contains the *rlc-BearerToReleaseList*:
 - 2> perform RLC bearer release as specified in 5.3.5.5.3;
- 1> if the *CellGroupConfig* contains the *rlc-BearerToAddModList*:
 - 2> perform the RLC bearer addition/modification as specified in 5.3.5.5.4;
- 1> if the *CellGroupConfig* contains the *mac-CellGroupConfig*:
 - 2> configure the MAC entity of this cell group as specified in 5.3.5.5.5;
- 1> if the *CellGroupConfig* contains the *sCellToReleaseList*:
 - 2> perform SCell release as specified in 5.3.5.5.8;
- 1> if the *CellGroupConfig* contains the *spCellConfig*:
 - 2> configure the SpCell as specified in 5.3.5.5.7;
- 1> if the *CellGroupConfig* contains the *sCellToAddModList*:
 - 2> perform SCell addition/modification as specified in 5.3.5.5.9.

[TS 38.331, clause 5.3.5.5.2]

The UE shall perform the following actions to execute a reconfiguration with sync.

- 1> if the security is not activated, perform the actions upon going to RRC_IDLE as specified in 5.3.11 with the release cause 'other' upon which the procedure ends;
- 1> stop timer T310 for the corresponding SpCell, if running;
- 1> start timer T304 for the corresponding SpCell with the timer value set to *t304*, as included in the *reconfigurationWithSync*;
- 1> if the *frequencyInfoDL* is included:
 - 2> consider the target SpCell to be one on the frequency indicated by the *frequencyInfoDL* with a physical cell identity indicated by the *physCellId*;
- 1> else:
 - 2> consider the target SpCell to be one on the SSB frequency of the source SpCell with a physical cell identity indicated by the *physCellId*;
- 1> start synchronising to the DL of the target SpCell;
- 1> apply the specified BCCH configuration defined in 9.1.1.1;
- 1> acquire the *MIB*, which is scheduled as specified in TS 38.213 [13];
- 1> perform the actions specified in clause 5.2.2.4.1;

NOTE 1: The UE should perform the reconfiguration with sync as soon as possible following the reception of the RRC message triggering the reconfiguration with sync, which could be before confirming successful reception (HARQ and ARQ) of this message.

NOTE 2: The UE may omit reading the MIB if the UE already has the required timing information, or the timing information is not needed for random access.

- 1> reset the MAC entity of this cell group;
- 1> consider the SCell(s) of this cell group, if configured, to be in deactivated state;
- 1> apply the value of the *newUE-Identity* as the C-RNTI for this cell group;

Editor’s Note: Verify that this does not configure some common parameters which are later discarded due to e.g. SCell release or due to LCH release.

- 1> configure lower layers in accordance with the received *spCellConfigCommon*;
- 1> configure lower layers in accordance with any additional fields, not covered in the previous, if included in the received *reconfigurationWithSync*.

8.2.3.14.2.3 Test description

8.2.3.14.2.3.1 Pre-test conditions

System Simulator:

- NR Cell 1 is the PCell, NR Cell 10 is the source PSCell and NR Cell 30 is the target PSCell.
- System information combination NR-4 as defined in TS 38.508-1 [4] clause 4.4.3.1.3 is used in NR cells.

UE:

- None.

Preamble:

- If *pc_IP_Ping* is set to TRUE then, the UE is in state NR RRC_CONNECTED using generic procedure parameter Connectivity (*NR-DC*), Bearers (*MCG(s) and Split*) established according to TS 38.508-1 [4], clause 4.5.4.2-5 with the exception of Primary path being set as SCG path.
- Else, the UE is in state NR RRC_CONNECTED using generic procedure parameter Connectivity (*NR-DC*), Bearers (*MCG(s) and Split*) and Test Loop Function (On) with UE test loop mode B activated according to TS 38.508-1 [4], table 4.5.4.2-5 with the exception of Primary path being set as SCG path.

8.2.3.14.2.3.2 Test procedure sequence

Table 8.2.3.14.2.3.2-2 illustrate the downlink power levels and other changing parameters to be applied for the cells at various time instants of the test execution. Row marked "T0" denotes the initial conditions after preamble, while columns marked "T1" is to be applied subsequently. The exact instants on which these values shall be applied are described in the texts in this clause.

Table 8.2.3.14.2.3.2-1: Void

Table 8.2.3.14.2.3.2-2: Time instances of cell power level and parameter changes for OTA test environment

	Parameter	Unit	NR Cell 1	NR Cell 10	NR Cell 30	Remark
T0	SS/PBCH SSS EPRE	dBm/ SCS	-82	-91	“Off”	
T1	SS/PBCH SSS EPRE	dBm/ SCS	-82	-91	-82	

Table 8.2.3.14.2.3.2-3: Main behaviour

St	Procedure	Message Sequence	TP	Verdict
----	-----------	------------------	----	---------

RLC-BearerConfig[1]	RLC-BearerConfig with conditions SRB1 and Re-establish_RLC	entry 1	
RLC-BearerConfig[2]	RLC-BearerConfig with conditions SRB2 and Re-establish_RLC	entry 2	
RLC-BearerConfig[3]	RLC-BearerConfig with conditions AM, DRBn and Re-establish_RLC	entry 3	
}			
}			

Table 8.2.3.14.2.3.3-2: RRCReconfiguration-Mod (Table 8.2.3.14.2.3.3-1)

Derivation Path: TS 38.508-1 [4], Table 4.6.1-13 with condition NR-DC_SCG			
Information Element	Value/remark	Comment	Condition
RRCReconfiguration ::= SEQUENCE {			
criticalExtensions CHOICE {			
rrcReconfiguration SEQUENCE {			
secondaryCellGroup	CellGroupConfig		
}			
}			
}			

Table 8.2.3.14.2.3.3-2A: RadioBearerConfig_SCG-Mod (Table 8.2.3.14.2.3.3-2)

Derivation Path: TS 38.508-1 [4], Table 4.6.3-132 with condition DRBn and SecondaryKeys			
Information Element	Value/remark	Comment	Condition
RadioBearerConfig ::= SEQUENCE {			
drb-ToAddModList SEQUENCE (SIZE (1..maxDRB)) OF SEQUENCE {	1 entry		
drb-Identity	DRBn	n set to the Split SCG DRB identity	
reestablishPDCP	true		
pdcp-Config	PDCP-Config with Condition Split		
}			
}			

Table 8.2.3.14.2.3.3-3: CellGroupConfig (Table 8.2.3.14.2.3.3-2)

Derivation Path: TS 38.508-1 [4], Table 4.6.3-19			
Information Element	Value/remark	Comment	Condition
CellGroupConfig ::= SEQUENCE {			
cellGroupId	CellGroupId condition NR-DC_SCG		
rlc-BearerToAddModList SEQUENCE (SIZE(1..maxLC-ID)) OF RLC-BearerConfig {	1 entry		n set to the Split SCG DRB identity
RLC-BearerConfig[1]	RLC-BearerConfig as per TS 38.508-1[4] Table 4.6.3-148: RLC-BearerConfig with conditions AM and DRBn and Re-establish_RLC	entry 1 n set to the Split SCG DRB identity	
}			
spCellConfig SEQUENCE {			
servCellIndex	ServCellIndex with condition NR-DC_SCG		
reconfigurationWithSync SEQUENCE {			
spCellConfigCommon SEQUENCE {			

physCellId	Physical Cell Identity of NR Cell 30		
}			
newUE-Identity	'4148'H		
}			
spCellConfigDedicated	ServingCellConfig		
}			
}			

8.2.3.15 Measurement configuration control and reporting / Two simultaneous events A2 and A3 (intra-frequency measurements) / Measurement of Neighbour NR cells

8.2.3.15.1 Measurement configuration control and reporting / Two simultaneous events A2 and A3 (intra-frequency measurements) / Measurement of Neighbour NR cells / EN-DC

8.2.3.15.1.1 Test Purpose (TP)

(1)

```
with { UE in RRC_CONNECTED state with EN-DC, and, MCG(s) (E-UTRA PDCP) and SCG and measurements
configured for event A2 and event A3 }
ensure that {
  when { Serving NR cell becomes worse than absolute threshold minus hysteresis }
  then { UE sends MeasurementReport for event A2 }
}
```

(2)

```
with { UE in RRC_CONNECTED state with EN-DC, and, MCG(s) (E-UTRA PDCP) and SCG and measurements
configured for event A2 and event A3 }
ensure that {
  when { Neighbour NR cell becomes offset better than serving NR PSCell }
  then { UE sends MeasurementReport for event A3 }
}
```

8.2.3.15.1.2 Conformance requirements

References: The conformance requirements covered in the present TC are specified in: TS 36.331, clause 5.3.5.3, TS 38.331, clauses 5.3.5.3, 5.5.2, 5.5.4.1, 5.5.4.3, 5.5.4.4 and 5.5.5. Unless otherwise stated these are Rel-15 requirements.

[TS 36.331, clause 5.3.5.3]

If the *RRCCONNECTIONRECONFIGURATION* message does not include the *mobilityControlInfo* and the UE is able to comply with the configuration included in this message, the UE shall:

...

1> else:

2> if the *RRCCONNECTIONRECONFIGURATION* message includes the *radioResourceConfigDedicated*:

3> perform the radio resource configuration procedure as specified in 5.3.10;

NOTE 3: If the *RRCCONNECTIONRECONFIGURATION* message includes the establishment of radio bearers other than SRB1, the UE may start using these radio bearers immediately, i.e. there is no need to wait for an outstanding acknowledgment of the *SecurityModeComplete* message.

...

...

1> set the content of *RRCCONNECTIONRECONFIGURATIONCOMPLETE* message as follows:

...

- 2> if the received *RRCConnectionReconfiguration* message included *nr-SecondaryCellGroupConfig*:
 - 3> include *scg-ConfigResponseNR* in accordance with TS 38.331 [82], clause 5.3.5.3;
- 1> submit the *RRCConnectionReconfigurationComplete* message to lower layers for transmission using the new configuration, upon which the procedure ends;

[TS 38.331, clause 5.3.5.3]

The UE shall perform the following actions upon reception of the *RRCReconfiguration*:

...

- 1> if the *RRCReconfiguration* message includes the *measConfig*:
 - 2> perform the measurement configuration procedure as specified in 5.5.2;

...

- 1> if the UE is configured with E-UTRA *nr-SecondaryCellGroupConfig* (MCG is E-UTRA):
 - 2> if *RRCReconfiguration* was received via SRB1:
 - 3> submit the *RRCReconfigurationComplete* via the EUTRA MCG embedded in E-UTRA RRC message *RRCConnectionReconfigurationComplete* as specified in TS 36.331 [10];
 - 3> if *reconfigurationWithSync* was included in *spCellConfig* of an SCG:
 - 4> initiate the random access procedure on the SpCell, as specified in TS 38.321 [3];
 - 3> else:
 - 4> the procedure ends;

NOTE: The order the UE sends the *RRCConnectionReconfigurationComplete* message and performs the Random Access procedure towards the SCG is left to UE implementation.

- 2> else (*RRCReconfiguration* was received via SRB3):

...

NOTE: For EN-DC, in the case of SRB1, the random access is triggered by RRC layer itself as there is not necessarily other UL transmission. In the case of SRB3, the random access is triggered by the MAC layer due to arrival of *RRCReconfigurationComplete*.

- 1> else:

...

[TS 38.331, clause 5.5.2]

The UE shall:

...

- 1> if the received *measConfig* includes the *measObjectToAddModList*:
 - 2> perform the measurement object addition/modification procedure as specified in 5.5.2.5;

...

- 1> if the received *measConfig* includes the *reportConfigToAddModList*:
 - 2> perform the reporting configuration addition/modification procedure as specified in 5.5.2.7;

...

- 1> if the received *measConfig* includes the *measIdToAddModList*:
- 2> perform the measurement identity addition/modification procedure as specified in 5.5.2.3;

[TS 38.331, clause 5.5.4.1]

If security has been activated successfully, the UE shall:

- 1> for each *measId* included in the *measIdList* within *VarMeasConfig*:
 - 2> if the corresponding *reportConfig* includes a *reportType* set to *eventTriggered* or *periodical*;
 - 3> if the corresponding *measObject* concerns NR;
 - 4> if the *eventA1* or *eventA2* is configured in the corresponding *reportConfig*:
 - 5> consider only the serving cell to be applicable;
 - 4> else:
 - 5> for events involving a serving cell associated with a *measObjectNR* and neighbours associated with another *measObjectNR*, consider any serving cell associated with the other *measObjectNR* to be a neighbouring cell as well;

...

- 2> if the *reportType* is set to *eventTriggered* and if the entry condition applicable for this event, i.e. the event corresponding with the *eventId* of the corresponding *reportConfig* within *VarMeasConfig*, is fulfilled for one or more applicable cells for all measurements after layer 3 filtering taken during *timeToTrigger* defined for this event within the *VarMeasConfig*, while the *VarMeasReportList* does not include a measurement reporting entry for this *measId* (a first cell triggers the event):
 - 3> include a measurement reporting entry within the *VarMeasReportList* for this *measId*;
 - 3> set the *numberOfReportsSent* defined within the *VarMeasReportList* for this *measId* to 0;
 - 3> include the concerned cell(s) in the *cellsTriggeredList* defined within the *VarMeasReportList* for this *measId*;
 - 3> initiate the measurement reporting procedure, as specified in 5.5.5;

...

- 2> if the *reportType* is set to *eventTriggered* and if the entry condition applicable for this event, i.e. the event corresponding with the *eventId* of the corresponding *reportConfig* within *VarMeasConfig*, is fulfilled for one or more applicable cells not included in the *cellsTriggeredList* for all measurements after layer 3 filtering taken during *timeToTrigger* defined for this event within the *VarMeasConfig* (a subsequent cell triggers the event):
 - 3> set the *numberOfReportsSent* defined within the *VarMeasReportList* for this *measId* to 0;
 - 3> include the concerned cell(s) in the *cellsTriggeredList* defined within the *VarMeasReportList* for this *measId*;
 - 3> initiate the measurement reporting procedure, as specified in 5.5.5;

[TS 38.331, clause 5.5.4.3]

The UE shall:

- 1> consider the entering condition for this event to be satisfied when condition A2-1, as specified below, is fulfilled;
- 1> consider the leaving condition for this event to be satisfied when condition A2-2, as specified below, is fulfilled;
- 1> for this measurement, consider the serving cell indicated by the *measObjectNR* associated to this event.

Inequality A2-1 (Entering condition)

$$M_s + H_{ys} < Thresh$$

Inequality A2-2 (Leaving condition)

$$M_s - H_{ys} > Thresh$$

The variables in the formula are defined as follows:

M_s is the measurement result of the serving cell, not taking into account any offsets.

H_{ys} is the hysteresis parameter for this event (i.e. *hysteresis* as defined within *reportConfigNR* for this event).

Thresh is the threshold parameter for this event (i.e. *a2-Threshold* as defined within *reportConfigNR* for this event).

M_s is expressed in dBm in case of RSRP, or in dB in case of RSRQ and RS-SINR.

H_{ys} is expressed in dB.

Thresh is expressed in the same unit as ***M_s***.

[TS 38.331, clause 5.5.4.4]

The UE shall:

1> consider the entering condition for this event to be satisfied when condition A3-1, as specified below, is fulfilled;

1> consider the leaving condition for this event to be satisfied when condition A3-2, as specified below, is fulfilled;

1> use the SpCell for *M_p*, *O_{fp}* and *O_{cp}*.

NOTE The cell(s) that triggers the event has reference signals indicated in the *measObjectNR* associated to this event which may be different from the NR SpCell*measObjectNR*.

Inequality A3-1 (Entering condition)

$$M_n + O_{fn} + O_{cn} - H_{ys} > M_p + O_{fp} + O_{cp} + Off$$

Inequality A3-2 (Leaving condition)

$$M_n + O_{fn} + O_{cn} + H_{ys} < M_p + O_{fp} + O_{cp} + Off$$

The variables in the formula are defined as follows:

M_n is the measurement result of the neighbouring cell, not taking into account any offsets.

O_{fn} is the measurement object specific offset of the reference signal of the neighbour cell (i.e. *offsetMO* as defined within *measObjectNR* corresponding to the neighbour cell).

O_{cn} is the cell specific offset of the neighbour cell (i.e. *cellIndividualOffset* as defined within *measObjectNR* corresponding to the frequency of the neighbour cell), and set to zero if not configured for the neighbour cell.

M_p is the measurement result of the SpCell, not taking into account any offsets.

O_{fp} is the measurement object specific offset of the SpCell (i.e. *offsetMO* as defined within *measObjectNR* corresponding to the SpCell).

O_{cp} is the cell specific offset of the SpCell (i.e. *cellIndividualOffset* as defined within *measObjectNR* corresponding to the SpCell), and is set to zero if not configured for the SpCell.

H_{ys} is the hysteresis parameter for this event (i.e. *hysteresis* as defined within *reportConfigNR* for this event).

Off is the offset parameter for this event (i.e. *a3-Offset* as defined within *reportConfigNR* for this event).

M_n, ***M_p*** are expressed in dBm in case of RSRP, or in dB in case of RSRQ and RS-SINR.

O_{fn}, ***O_{cn}***, ***O_{fp}***, ***O_{cp}***, ***H_{ys}***, ***Off*** are expressed in dB.

[TS 38.331, clause 5.5.5]

For the *measId* for which the measurement reporting procedure was triggered, the UE shall set the *measResults* within the *MeasurementReport* message as follows:

- 1> set the *measId* to the measurement identity that triggered the measurement reporting;
- 1> for each serving cell configured with *servingCellMO*:
 - 2> if the *reportConfig* associated with the *measId* that triggered the measurement reporting includes *rsType*:
 - 3> if the serving cell measurements based on the *rsType* included in the *reportConfig* that triggered the measurement report are available:
 - 4> set the *measResultServingCell* within *measResultServingMOList* to include RSRP, RSRQ and the available SINR of the serving cell, derived based on the *rsType* included in the *reportConfig* that triggered the measurement report;
- 1> set the *servCellId* within *measResultServingMOList* to include each NR serving cell that is configured with *servingCellMO*, if any;
- ...
- 1> if there is at least one applicable neighbouring cell to report:
 - 2> if the *reportType* is set to *eventTriggered* or *periodical*:
 - 3> set the *measResultNeighCells* to include the best neighbouring cells up to *maxReportCells* in accordance with the following:
 - 4> if the *reportType* is set to *eventTriggered*:
 - 5> include the cells included in the *cellsTriggeredList* as defined within the *VarMeasReportList* for this *measId*;
 - 4> for each cell that is included in the *measResultNeighCells*, include the *physCellId*;
 - 4> if the *reportType* is set to *eventTriggered* or *periodical*:
 - 5> for each included cell, include the layer 3 filtered measured results in accordance with the *reportConfig* for this *measId*, ordered as follows:
 - 6> if the *measObject* associated with this *measId* concerns NR:
 - 7> if *rsType* in the associated *reportConfig* is set to *ssb*:
 - 8> set *resultsSSB-Cell* within the *measResult* to include the SS/PBCH block based quantity(ies) indicated in the *reportQuantityCell* within the concerned *reportConfig*, in decreasing order of the sorting quantity, determined as specified in 5.5.5.3, i.e. the best cell is included first;
 - ...
 - 1> if the UE is configured with EN-DC:
 - 2> if SRB3 is configured:
 - 3> submit the *MeasurementReport* message via SRB3 to lower layers for transmission, upon which the procedure ends;
 - 2> else:
 - 3> submit the *MeasurementReport* message via the EUTRA MCG embedded in E-UTRA RRC message *ULInformationTransferMRDC* as specified in TS 36.331 [10].
 - 1> else:
 - 2> submit the *MeasurementReport* message to lower layers for transmission, upon which the procedure ends.

8.2.3.15.1.3 Test description

8.2.3.15.1.3.1 Pre-test conditions

System Simulator:

- EUTRA Cell 1 is the PCell and NR Cell 1 is the PS Cell.
- NR Cell 2 is the intra-frequency neighbour cell.
- NR Cell 1 and NR Cell 2 are configured to operate in FR1 bands as defined in TS 38.508-1 [4] clause 6.2.3.

UE:

- None

Preamble:

- The UE is in state RRC_CONNECTED using generic procedure parameter Connectivity (EN-DC) and DC Bearers (MCG(s) and SCG) on E-UTRA Cell 1 according to TS 38.508-1, clause 4.5.4 [4].

8.2.3.15.1.3.2 Test procedure sequence

Table 8.2.3.15.1.3.2-1 and Table 8.2.3.15.1.3.2-1A illustrates the downlink power levels to be applied for NR Cell 1 and NR Cell 2 at various time instants of the test execution. Row marked "T0" denotes the conditions after the preamble, while rows marked "T1" and "T2" are to be applied subsequently. The exact instants on which these values shall be applied are described in the texts in this clause.

Table 8.2.3.15.1.3.2-1: Time instances of cell power level and parameter changes for conducted test environment

	Parameter	Unit	EUTRA Cell 1	NR Cell 1	NR Cell 2	Remark
T0	Cell-specific RS EPRE	dBm/15 kHz	-85	-	-	Power levels are such that entry condition for event A2 and event A3 is not satisfied:
	SS/PBCH SSS EPRE	dBm/S CS	-	-85	-103	$M_s - H_{ys} > Thresh$ AND $M_n + O_{fn} + O_{cn} + H_{ys} < M_s + O_{fs} + O_{cs} + O_{ff}$
T1	Cell-specific RS EPRE	dBm/15 kHz	-85	-	-	Power level of Cell 1 is such that entry condition for event A2 is satisfied for the serving cell:
	SS/PBCH SSS EPRE	dBm/S CS	-	-103	-113	$M_s + H_{ys} < Thresh$ AND Power levels of Cell 1 and Cell 2 are such that entry condition for event A3 is not satisfied for any of the neighbour NR cells: $M_n + O_{fn} + O_{cn} + H_{ys} < M_s + O_{fs} + O_{cs} + O_{ff}$
T2	Cell-specific RS EPRE	dBm/15 kHz	-85	-	-	Power levels are such that entry condition for event A2 is not satisfied:
	SS/PBCH SSS EPRE	dBm/S CS	-	-85	-78	$M_s - H_{ys} > Thresh$ Power levels of Cell 1 and Cell 2 are such that entry condition for event A3 is satisfied for intra-frequency neighbour NR cell: $M_n + O_{fn} + O_{cn} - H_{ys} > M_s + O_{fs} + O_{cs} + O_{ff}$

Table 8.2.3.15.1.3.2-1A: Void

Table 8.2.3.15.1.3.2-2: Main behaviour

St	Procedure	Message Sequence		TP	Verdict
		U - S	Message		
1	The SS transmits an <i>RRCConnectionReconfiguration</i> message containing NR <i>RRCReconfiguration</i> to setup measurement for PSCell and reporting for event A2, and measurement for neighbour NR Cell and reporting for event A3 (intra-frequency measurement)	<--	<i>RRCConnectionReconfiguration (RRCReconfiguration)</i>	-	-
2	Check: Does the UE transmit an <i>RRCConnectionReconfigurationComplete</i> message containing NR <i>RRCReconfigurationComplete</i> message?	-->	<i>RRCConnectionReconfigurationComplete (RRCReconfigurationComplete)</i>	-	-
3	Check: Does the UE transmit an <i>ULInformationTransferMRDC</i> message containing NR <i>MeasurementReport</i> message within the next 10s to report event A2 or A3?	-->	<i>ULInformationTransferMRDC (MeasurementReport)</i>	1	F
4	The SS re-adjusts the cell-specific reference signal level according to row "T1".	-	-	-	-
5	Check: Does the UE transmit an <i>ULInformationTransferMRDC</i> message containing NR <i>MeasurementReport</i> message to report event A2 (<i>measId 1</i>) with the measured value for NR Cell 1?	-->	<i>ULInformationTransferMRDC (MeasurementReport)</i>	1	P
6	The SS re-adjusts the cell-specific reference signal level according to row "T2".	-	-	-	-
7	Check: Does the UE transmit an <i>ULInformationTransferMRDC</i> message containing NR <i>MeasurementReport</i> message to report event A3 (<i>measId 2</i>) with the measured value for NR Cell 2?	-->	<i>ULInformationTransferMRDC (MeasurementReport)</i>	2	P

8.2.3.15.1.3.3 Specific message contents

Table 8.2.3.15.1.3.3-1: *RRCConnectionReconfiguration* (step 1, Table 8.2.3.15.1.3.2-2)

Derivation Path: TS 36.508 [7], Table 4.6.1-8 with condition EN-DC_EmbedNR_RRCRecon

Table 8.2.3.15.1.3.3-2: *RRCReconfiguration* (Table 8.2.3.15.1.3.3-1)

Derivation Path: TS 38.508-1 [4], Table 4.6.1-13 with condition EN-DC_MEAS

Table 8.2.3.15.1.3.3-3: *MeasConfig* (Table 8.2.3.15.1.3.3-2)

Derivation Path: TS 38.508-1 [4], Table 4.6.3-69			
Information Element	Value/remark	Comment	Condition
<i>MeasConfig</i> ::= SEQUENCE {			
<i>measObjectToAddModList</i> SEQUENCE (SIZE (1..maxNrofObjectId)) OF <i>MeasObjectToAddMod</i> {	1 entry		
<i>MeasObjectToAddMod</i> [1] SEQUENCE {		entry 1	
<i>measObjectId</i>	1		
<i>measObject</i> CHOICE {			
<i>measObjectNR</i>	<i>MeasObjectNR</i> (54)	<i>ssbFrequency</i> IE equals the ARFCN for NR Cell 1 Thresh value set to -102dBm	
}			
}			
}			
}			

ReportConfigToAddModList SEQUENCE(SIZE (1..maxReportConfigId)) OF ReportConfigToAddMod {	2 entries		
ReportConfigToAddMod[1] SEQUENCE {		entry 1	
reportConfigId	1		
reportConfig CHOICE {			
reportConfigNR	ReportConfigNR(63)	Thresh value set to -93dBm	EVENT_A2
}			
}			
ReportConfigToAddMod[2] SEQUENCE {		entry 2	
reportConfigId	2		
reportConfig CHOICE {			
reportConfigNR	ReportConfigNR(0)	Offset value set to 0dBm	EVENT_A3
}			
}			
MeasIdToAddModList SEQUENCE (SIZE (1..maxNrofMeasId)) OF MeasIdToAddMod {	2 entries		
MeasIdToAddMod[1] SEQUENCE {		entry 1	
measId	1		
measObjectId	1		
reportConfigId	1		
}			
MeasIdToAddMod[2] SEQUENCE {		entry 2	
measId	2		
measObjectId	1		
reportConfigId	2		
}			
}			

Table 8.2.3.15.1.3.3-3a: ReportConfigNR(Thres) (Table 8.2.3.15.1.3.3-3)

Derivation Path: TS 38.508-1 [4], Table 4.6.3-142			
Information Element	Value/remark	Comment	Condition
ReportConfigNR ::= SEQUENCE {			
reportType CHOICE {			
eventTriggered SEQUENCE {			
reportAmount	r1		
}			
}			
}			

Table 8.2.3.15.1.3.3-4: RRCConnectionReconfigurationComplete (step 2, Table 8.2.3.15.1.3.2-2)

Derivation Path: TS 36.508 [7], Table 4.6.1-9 with condition MCG_and_SCG
--

Table 8.2.3.15.1.3.3-5: ULInformationTransferMRDC (step 5, Table 8.2.3.15.1.3.2-2)

Derivation Path: TS 36.508 [7], Table 4.6.1-27			
Information Element	Value/remark	Comment	Condition
ULInformationTransferMRDC ::= SEQUENCE {			
ul-DCCH-MessageNR-r15	OCTET STRING including the MeasurementReport message according to Table 8.2.3.15.1.3.3-6		
}			

Table 8.2.3.15.1.3.3-6: MeasurementReport (Table 8.2.3.15.1.3.3-5)

Derivation Path: TS 38.508-1 [4], Table 4.6.1-5A			
Information Element	Value/remark	Comment	Condition
measurementReport ::= SEQUENCE {			
measResults SEQUENCE {			
measId	1		
measResultServingMOList SEQUENCE (SIZE (1..maxNrofServingCells)) {	1 entry		
servCellId	Cell index corresponding to NR Cell 1		
measResultServingCell SEQUENCE {			
physCellId	Physical CellID of the NR Cell 1		
measResult SEQUENCE {			
cellResults SEQUENCE{			
resultsSSB-Cell SEQUENCE {			
rsrp	(0..127)		
rsrq	(0..127)		
sinr	Not present		
	(0..127)		pc_ss_SINR_Meas
}			
}			
}			
}			
}			

Table 8.2.3.15.1.3.3-7: ULInformationTransferMRDC (step 7, Table 8.2.3.15.1.3.2-2)

Derivation Path: TS 36.508 [7], Table 4.6.1-27			
Information Element	Value/remark	Comment	Condition
ULInformationTransferMRDC ::= SEQUENCE {			
ul-DCCH-MessageNR-r15	OCTET STRING including the MeasurementReport message according to Table 8.2.3.15.1.3.3-8		
}			

Table 8.2.3.15.1.3.3-8: MeasurementReport (Table 8.2.3.15.1.3.3-7)

Derivation Path: TS 38.508-1 [4], Table 4.6.1-5A			
Information Element	Value/remark	Comment	Condition
measurementReport ::= SEQUENCE {			
measResults SEQUENCE {			
measId	2		
measResultServingMOList SEQUENCE (SIZE (1..maxNrofServingCells)) {	1 entry	Report NR Cell 1	
servCellId	Cell index corresponding to NR Cell 1		
measResultServingCell SEQUENCE {			
physCellId	Physical CellID of the NR Cell 1		
measResult SEQUENCE {			
cellResults SEQUENCE{			
resultsSSB-Cell SEQUENCE {			
rsrp	(0..127)		
rsrq	(0..127)		
sinr	Not present		
	(0..127)		pc_ss_SINR_Meas
}			
}			
}			
}			
}			

}			
}			
}			
}			
measResultNeighCells SEQUENCE (SIZE (1..maxCellReport)) {	1 entry	Report NR Cell 2	
measResultListNR SEQUENCE {			
physCellId	Phy cell id corresponding to NR Cell 2		
measResult SEQUENCE {			
cellResults SEQUENCE{			
resultsSSB-Cell SEQUENCE {			
rsrp	(0..127)		
rsrq	(0..127)		
sinr	Not present		
	(0..127)		pc_ss_SINR_Meas
}			
resultsCSI-RS-Cell	Not present		
}			
rsIndexResults	Not present		
}			
cgi-Info	Not present		
}			
}			
}			
}			

8.2.3.16 Measurement configuration control and reporting / SRB3

8.2.3.16.1 Measurement configuration control and reporting / SRB3 / Intra NR measurements / EN-DC

8.2.3.16.1.1 Test Purpose (TP)

(1)

```
with { UE in RRC_CONNECTED state with EN-DC, and, MCG(s) (E-UTRA PDCP) and SCG with SRB3 configured }
ensure that {
  when { UE receives RRCReconfiguration on SRB3 including MeasConfig to setup periodical measurement reporting }
  then { UE sends RRCReconfigurationComplete and starts sending periodic measurement reports over SRB3 }
}
```

8.2.3.16.1.2 Conformance requirements

References: The conformance requirements covered in the present TC are specified in: TS 36.331, clauses 5.3.5.3, TS 38.331, clause 5.5.4.1, 5.5.4.7 and 5.5.5.1. Unless otherwise stated these are Rel-15 requirements.

[TS 36.331, clause 5.3.5.3]

If the *RRCConnectionReconfiguration* message does not include the *mobilityControlInfo* and the UE is able to comply with the configuration included in this message, the UE shall:

...

1> if the received *RRCConnectionReconfiguration* includes the *nr-RadioBearerConfig1*:

2> perform radio bearer configuration as specified in TS 38.331 [82], clause 5.3.5.6;

...

1> else:

- 2> submit the *RRCConnectionReconfigurationComplete* message to lower layers for transmission using the new configuration, upon which the procedure ends;

[TS 38.331, clause 5.3.5.3]

The UE shall perform the following actions upon reception of the *RRCReconfiguration*:

...

1> if the *RRCReconfiguration* message includes the *measConfig*:

- 2> perform the measurement configuration procedure as specified in 5.5.2;

...

1> if the UE is configured with E-UTRA *nr-SecondaryCellGroupConfig* (UE in (NG)EN-DC):

...

2> else (*RRCReconfiguration* was received via SRB3):

- 3> submit the *RRCReconfigurationComplete* message via SRB3 to lower layers for transmission using the new configuration;

...

[TS 38.331, clause 5.5.2.1]

The UE shall:

...

1> if the received *measConfig* includes the *measObjectToAddModList*:

- 2> perform the measurement object addition/modification procedure as specified in 5.5.2.5;

...

1> if the received *measConfig* includes the *reportConfigToAddModList*:

- 2> perform the reporting configuration addition/modification procedure as specified in 5.5.2.7;

...

1> if the received *measConfig* includes the *measIdToAddModList*:

- 2> perform the measurement identity addition/modification procedure as specified in 5.5.2.3;

...

[TS 38.331, clause 5.5.3.1]

The UE shall:

1> whenever the UE has a *measConfig*, perform RSRP and RSRQ measurements for each serving cell for which *servingCellMO* is configured as follows:

- 2> if the *reportConfig* associated with at least one *measId* included in the *measIdList* within *VarMeasConfig* contains an *rsType* set to *ssb* and *ssb-ConfigMobility* is configured in the *measObject* indicated by the *servingCellMO*:

...

- 3> derive serving cell measurement results based on SS/PBCH block, as described in 5.5.3.3;

...

- 1> for each serving cell for which *servingCellMO* is configured, if the *reportConfig* associated with at least one *measId* included in the *measIdList* within *VarMeasConfig* contains SINR as trigger quantity and/or reporting quantity:
 - 2> if the *reportConfig* contains *rsType* set to *ssb* and *ssb-ConfigMobility* is configured in the *servingCellMO*:
 - ...
 - 3> derive serving cell SINR based on SS/PBCH block, as described in 5.5.3.3;
 - ...

[TS 38.331, clause 5.5.4.1]

If AS security has been activated successfully, the UE shall:

- 1> for each *measId* included in the *measIdList* within *VarMeasConfig*:
 - ...
 - 2> if *reportType* is set to *periodical* and if a (first) measurement result is available:
 - 3> include a measurement reporting entry within the *VarMeasReportList* for this *measId*;
 - 3> set the *numberOfReportsSent* defined within the *VarMeasReportList* for this *measId* to 0;
 - 3> if the *reportAmount* exceeds 1:
 - 4> initiate the measurement reporting procedure, as specified in 5.5.5, immediately after the quantity to be reported becomes available for the NR SpCell;
 - ...
 - 2> upon expiry of the periodical reporting timer for this *measId*:
 - 3> initiate the measurement reporting procedure, as specified in 5.5.5.
 - ...

[TS 38.331, clause 5.5.5.1]



Figure 5.5.5.1-1: Measurement reporting

The purpose of this procedure is to transfer measurement results from the UE to the network. The UE shall initiate this procedure only after successful AS security activation.

For the *measId* for which the measurement reporting procedure was triggered, the UE shall set the *measResults* within the *MeasurementReport* message as follows:

- 1> set the *measId* to the measurement identity that triggered the measurement reporting;
- 1> for each serving cell configured with *servingCellMO*:
 - 2> if the *reportConfig* associated with the *measId* that triggered the measurement reporting includes *rsType*:
 - 3> if the serving cell measurements based on the *rsType* included in the *reportConfig* that triggered the measurement report are available:

4> set the *measResultServingCell* within *measResultServingMOList* to include RSRP, RSRQ and the available SINR of the serving cell, derived based on the *rsType* included in the *reportConfig* that triggered the measurement report;

...

1> set the *servCellId* within *measResultServingMOList* to include each NR serving cell that is configured with *servingCellMO*, if any;

...

1> increment the *numberOfReportsSent* as defined within the *VarMeasReportList* for this *measId* by 1;

1> stop the periodical reporting timer, if running;

1> if the *numberOfReportsSent* as defined within the *VarMeasReportList* for this *measId* is less than the *reportAmount* as defined within the corresponding *reportConfig* for this *measId*:

2> start the periodical reporting timer with the value of *reportInterval* as defined within the corresponding *reportConfig* for this *measId*;

1> else:

2> if the *reportType* is set to *periodical*:

3> remove the entry within the *VarMeasReportList* for this *measId*;

3> remove this *measId* from the *measIdList* within *VarMeasConfig*;

1> if the UE is in (NG)EN-DC:

2> if SRB3 is configured:

3> submit the *MeasurementReport* message via SRB3 to lower layers for transmission, upon which the procedure ends;

...

8.2.3.16.1.3 Test description

8.2.3.16.1.3.1 Pre-test conditions

System Simulator:

- E-UTRA Cell 1, NR Cell 1

UE:

- None.

Preamble:

- The UE is in state RRC_CONNECTED using generic procedure parameter Connectivity (*EN-DC*), Bearers (*MCG(s) and SCG*) established according to TS 38.508-1 [4], clause 4.5.4.

8.2.3.16.1.3.2 Test procedure sequence

Table 8.2.3.16.1.3.2-1: Main behaviour

St	Procedure	Message Sequence		TP	Verdict
		U - S	Message		
1	The SS transmits an <i>RRCCONNECTIONRECONFIGURATION</i> to establish SRB3	<--	EUTRA RRC: <i>RRCCONNECTIONRECONFIGURATION</i>	-	-

2	The UE transmits an <i>RRCConnectionReconfigurationComplete</i> message	-->	EUTRA RRC: <i>RRCConnectionReconfigurationComplete</i>	-	-
3	The SS transmits an <i>RRCReconfiguration</i> to setup periodical intra-NR measurements and reporting on NR Cell 1 via SRB3	<--	NR RRC: <i>RRCReconfiguration</i>	-	-
4	Check: Does the UE transmits an <i>RRCReconfigurationComplete</i> message via SRB3?	-->	NR RRC: <i>RRCReconfigurationComplete</i>	1	P
5	Check: Does the UE transmits at least 10 <i>MeasurementReport</i> message to periodically report the measured RSRP value for NR Cell 1 via SRB3 within the next 30 seconds?	-->	NR RRC: <i>MeasurementReport</i>	1	P

8.2.3.16.1.3.3 Specific message contents

Table 8.2.3.16.1.3.3-1: *RRCConnectionReconfiguration* (step 1, Table 8.2.3.16.1.3.2-1)

Derivation Path: TS 36.508 [7] Table 4.6.1-8 with Condition EN-DC_Embed_RBConfig			
Information Element	Value/remark	Comment	Condition
<i>RRCConnectionReconfiguration</i> ::= SEQUENCE {			
<i>criticalExtensions</i> CHOICE {			
c1 CHOICE {			
<i>rrcConnectionReconfiguration-r8</i> SEQUENCE {			
<i>nonCriticalExtension</i> SEQUENCE {			
<i>nonCriticalExtension</i> SEQUENCE {			
<i>nonCriticalExtension</i> SEQUENCE {			
<i>nonCriticalExtension</i> SEQUENCE {			
<i>nonCriticalExtension</i> SEQUENCE {			
<i>nonCriticalExtension</i> SEQUENCE {			
<i>nr-RadioBearerConfig1-r15</i>	OCTET STRING including <i>RadioBearerConfig</i> according to 38.508-1 [4] table 4.6.3.132 with Condition SRB3		
}			
}			
}			
}			
}			
}			
}			
}			
}			

Table 8.2.3.16.1.3.3-2: *RRCReconfiguration* (Step 3, Table 8.2.3.16.1.3.2-1)

Derivation Path: TS 38.508-1 [4], Table 4.6.1-13 with Condition EN-DC_MEAS
--

Table 8.2.3.16.1.3.3-3: *MeasConfig* (Table 8.2.3.16.1.3.3-2)

Derivation Path: TS 38.508-1 [4], Table 4.6.3-69			
Information Element	Value/remark	Comment	Condition
<i>MeasConfig</i> ::= SEQUENCE {			
<i>measObjectToAddModList</i> SEQUENCE (SIZE (1.. <i>maxNrofObjectId</i>)) OF <i>MeasObjectToAddMod</i> {	1 entry		

MeasObjectToAddMod[1] SEQUENCE {		entry 1	
measObject CHOICE {			
measObjectNR SEQUENCE {			
ssbFrequency	ARFCN-ValueNR of NR Cell 1		
absThreshSS-BlocksConsolidation	Not present		
nrofSS-BlocksToAverage	Not present		
}			
}			
}			
}			
reportConfigToAddModList SEQUENCE(SIZE (1..maxReportConfigId)) OF ReportConfigToAddMod {	1 entry		
ReportConfigToAddMod[1] SEQUENCE {		entry 1	
reportConfig CHOICE {			
reportConfigNR	ReportConfigNR with Condition PERIODICAL		
}			
}			
}			
}			
}			
}			

Table 8.2.3.16.1.3.3-4: MeasurementReport (step 5, Table 8.2.3.16.1.3.2-1)

Derivation Path: TS 38.508-1 [4], Table 4.6.1-5A			
Information Element	Value/remark	Comment	Condition
MeasurementReport ::= SEQUENCE {			
criticalExtensions CHOICE {			
measurementReport SEQUENCE {			
measResults	MeasResults	Table 8.2.3.16.1.3.3-5	
}			
}			
}			
}			

Table 8.2.3.16.1.3.3-5: MeasResults (Table 8.2.3.16.1.3.3-4)

Derivation Path: TS 38.331 [6], clause 6.3.2			
Information Element	Value/remark	Comment	Condition
MeasResults ::= SEQUENCE {			
measResultServingMOList ::= SEQUENCE (SIZE (1.. maxNrofServingCells)) OF MeasResultServMO {	1 entry		
MeasResultServMO[1] SEQUENCE {		entry 1	
measResultServingCell SEQUENCE {			
physCellId	PhysCellId of NR Cell 1		
measResult SEQUENCE {			
cellResults SEQUENCE {			
resultsSSB-Cell SEQUENCE {			
rsrp	(0..127)		
rsrq	(0..127)		
sinr	(0..127)		pc_ss_SINR_Meas
}			
}			
}			
}			
}			
}			
}			
}			

8.2.3.16.2 Measurement configuration control and reporting / SRB3 / Intra NR measurements / NR-DC

8.2.3.16.2.1 Test Purpose (TP)

(1)

```
with { UE in NR RRC_CONNECTED state with NR-DC and SCG with SRB3 configured }
ensure that {
  when { UE receives RRCReconfiguration on SRB3 including MeasConfig to setup periodical measurement reporting }
  then { UE sends RRCReconfigurationComplete and starts sending periodic measurement reports over SRB3 }
}
```

8.2.3.16.2.2 Conformance requirements

References: The conformance requirements covered in the present TC are specified in: TS 36.331, clauses 5.3.5.3, TS 38.331, clause 5.5.4.1, 5.5.4.7 and 5.5.5.1. Unless otherwise stated these are Rel-15 requirements.

[TS 38.331, 5.3.5.3]

The UE shall perform the following actions upon reception of the *RRCReconfiguration*:

...

1> if the *RRCReconfiguration* includes the *secondaryCellGroup*:

2> perform the cell group configuration for the SCG according to 5.3.5.5;

1> if the *RRCReconfiguration* includes the *mrdc-SecondaryCellGroupConfig*:

2> if the *mrdc-SecondaryCellGroupConfig* is set to *setup*:

3> if the *mrdc-SecondaryCellGroupConfig* includes *mrdc-ReleaseAndAdd*:

4> perform MR-DC release as specified in clause 5.3.5.10;

3> if the received *mrdc-SecondaryCellGroup* is set to *nr-SCG*:

4> perform the RRC reconfiguration according to 5.3.5.3 for the *RRCReconfiguration* message included in *nr-SCG*;

...

1> if the *RRCReconfiguration* message includes the *radioBearerConfig*:

2> perform the radio bearer configuration according to 5.3.5.6;

...

1> set the content of the *RRCReconfigurationComplete* message as follows:

...

2> if the *RRCReconfiguration* message includes the *mrdc-SecondaryCellGroupConfig* with *mrdc-SecondaryCellGroup* set to *nr-SCG*:

3> include in the *nr-SCG-Response* the *RRCReconfigurationComplete* message;

...

1> else if the *RRCReconfiguration* message was received within the *nr-SCG* within *mrdc-SecondaryCellGroup* (UE in NR-DC, *mrdc-SecondaryCellGroup* was received in *RRCReconfiguration* via SRB1):

2> if *reconfigurationWithSync* was included in *spCellConfig* in *nr-SCG*:

3> initiate the Random Access procedure on the PSCell, as specified in TS 38.321 [3];

2> else

3> the procedure ends;

NOTE 2a: The order in which the UE sends the *RRCReconfigurationComplete* message and performs the Random Access procedure towards the SCG is left to UE implementation.

1> else if the *RRCReconfiguration* message was received via SRB3 (UE in NR-DC):

2> submit the *RRCReconfigurationComplete* message via SRB3 to lower layers for transmission using the new configuration;

1> else (*RRCReconfiguration* was received via SRB1):

2> submit the *RRCReconfigurationComplete* message via SRB1 to lower layers for transmission using the new configuration;

...

1> if *reconfigurationWithSync* was included in *spCellConfig* of an MCG or SCG, and when MAC of an NR cell group successfully completes a Random Access procedure triggered above;

2> stop timer T304 for that cell group;

2> apply the parts of the CSI reporting configuration, the scheduling request configuration and the sounding RS configuration that do not require the UE to know the SFN of the respective target SpCell, if any;

2> apply the parts of the measurement and the radio resource configuration that require the UE to know the SFN of the respective target SpCell (e.g. measurement gaps, periodic CQI reporting, scheduling request configuration, sounding RS configuration), if any, upon acquiring the SFN of that target SpCell;

...

[TS 38.331, clause 5.5.2.1]

The UE shall:

...

1> if the received *measConfig* includes the *measObjectToAddModList*:

2> perform the measurement object addition/modification procedure as specified in 5.5.2.5;

...

1> if the received *measConfig* includes the *reportConfigToAddModList*:

2> perform the reporting configuration addition/modification procedure as specified in 5.5.2.7;

...

1> if the received *measConfig* includes the *measIdToAddModList*:

2> perform the measurement identity addition/modification procedure as specified in 5.5.2.3;

...

[TS 38.331, clause 5.5.3.1]

The UE shall:

1> whenever the UE has a *measConfig*, perform RSRP and RSRQ measurements for each serving cell for which *servingCellMO* is configured as follows:

2> if the *reportConfig* associated with at least one *measId* included in the *measIdList* within *VarMeasConfig* contains an *rsType* set to *ssb* and *ssb-ConfigMobility* is configured in the *measObject* indicated by the *servingCellMO*:

...

3> derive serving cell measurement results based on SS/PBCH block, as described in 5.5.3.3;

...

1> for each serving cell for which *servingCellMO* is configured, if the *reportConfig* associated with at least one *measId* included in the *measIdList* within *VarMeasConfig* contains SINR as trigger quantity and/or reporting quantity:

2> if the *reportConfig* contains *rsType* set to *ssb* and *ssb-ConfigMobility* is configured in the *servingCellMO*:

...

3> derive serving cell SINR based on SS/PBCH block, as described in 5.5.3.3;

...

[TS 38.331, clause 5.5.4.1]

If AS security has been activated successfully, the UE shall:

1> for each *measId* included in the *measIdList* within *VarMeasConfig*:

...

2> if *reportType* is set to *periodical* and if a (first) measurement result is available:

3> include a measurement reporting entry within the *VarMeasReportList* for this *measId*;

3> set the *numberOfReportsSent* defined within the *VarMeasReportList* for this *measId* to 0;

3> if the *reportAmount* exceeds 1:

4> initiate the measurement reporting procedure, as specified in 5.5.5, immediately after the quantity to be reported becomes available for the NR SpCell;

...

2> upon expiry of the periodical reporting timer for this *measId*:

3> initiate the measurement reporting procedure, as specified in 5.5.5.

...

[TS 38.331, clause 5.5.5.1]



Figure 5.5.5.1-1: Measurement reporting

The purpose of this procedure is to transfer measurement results from the UE to the network. The UE shall initiate this procedure only after successful AS security activation.

For the *measId* for which the measurement reporting procedure was triggered, the UE shall set the *measResults* within the *MeasurementReport* message as follows:

- 1> set the *measId* to the measurement identity that triggered the measurement reporting;
- 1> for each serving cell configured with *servingCellMO*:
 - 2> if the *reportConfig* associated with the *measId* that triggered the measurement reporting includes *rsType*:
 - 3> if the serving cell measurements based on the *rsType* included in the *reportConfig* that triggered the measurement report are available:
 - 4> set the *measResultServingCell* within *measResultServingMOList* to include RSRP, RSRQ and the available SINR of the serving cell, derived based on the *rsType* included in the *reportConfig* that triggered the measurement report;
- ...
- 1> set the *servCellId* within *measResultServingMOList* to include each NR serving cell that is configured with *servingCellMO*, if any;
- ...
- 1> increment the *numberOfReportsSent* as defined within the *VarMeasReportList* for this *measId* by 1;
- 1> stop the periodical reporting timer, if running;
- 1> if the *numberOfReportsSent* as defined within the *VarMeasReportList* for this *measId* is less than the *reportAmount* as defined within the corresponding *reportConfig* for this *measId*:
 - 2> start the periodical reporting timer with the value of *reportInterval* as defined within the corresponding *reportConfig* for this *measId*;
- 1> else:
 - 2> if the *reportType* is set to *periodical*:
 - 3> remove the entry within the *VarMeasReportList* for this *measId*;
 - 3> remove this *measId* from the *measIdList* within *VarMeasConfig*;
- 1> if the UE is in (NG)EN-DC:
 - 2> if SRB3 is configured:
 - 3> submit the *MeasurementReport* message via SRB3 to lower layers for transmission, upon which the procedure ends;
- ...

8.2.3.16.2.3 Test description

8.2.3.16.2.3.1 Pre-test conditions

System Simulator:

- NR Cell 1 is the PCell and NR Cell 10 is the PSCell
- System information combination NR-4 as defined in TS 38.508-1 [4] clause 4.4.3.1.2 is used in NR cells.

UE:

- None.

Preamble:

- The UE is in state RRC_CONNECTED using generic procedure parameter Connectivity (NR-DC) and Bearers (MCG(s) and SCG) according to TS 38.508-1 [4], Table 4.5.1-1.

8.2.3.16.2.3.2 Test procedure sequence

Table 8.2.3.16.2.3.2-1: Main behaviour

St	Procedure	Message Sequence		TP	Verdict
		U - S	Message		
1	The SS transmits an <i>RRCReconfiguration</i> message via SRB1 to establish SRB3	<--	NR RRC: <i>RRCReconfiguration</i>	-	-
2	The UE transmits an <i>RRCReconfigurationComplete</i> message via SRB 1.	-->	NR RRC: <i>RRCReconfigurationComplete</i>	-	-
3	The SS transmits an <i>RRCReconfiguration</i> message from Cell 10 to setup periodical intra-NR measurements and reporting via SRB3	<--	NR RRC: <i>RRCReconfiguration</i>	-	-
4	Check: Does the UE transmits an <i>RRCReconfigurationComplete</i> message via SRB3?	-->	NR RRC: <i>RRCReconfigurationComplete</i>	1	P
5	Check: Does the UE transmits at least 10 <i>MeasurementReport</i> message to periodically report the measured RSRP value for Cell 10 via SRB3 within the next 30 seconds?	-->	NR RRC: <i>MeasurementReport</i>	1	P

8.2.3.16.2.3.3 Specific message contents

Table 8.2.3.16.2.3.3-1: RRCReconfiguration (step 1, Table 8.2.3.16.2.3.2-1)

Derivation Path: TS 38.508-1 [4], Table 4.6.1-13 with condition NR-DC			
Information Element	Value/remark	Comment	Condition
RRCReconfiguration ::= SEQUENCE {			
criticalExtensions CHOICE {			
rrcReconfiguration SEQUENCE {			
radioBearerConfig	Not present		
nonCriticalExtension SEQUENCE {			
masterCellGroup	Not present		
nonCriticalExtension SEQUENCE {			
nonCriticalExtension SEQUENCE {			
mrdc-SecondaryCellGroupConfig CHOICE {			
setup SEQUENCE {			
mrdc-SecondaryCellGroup CHOICE {			
nr-SCG	RRCReconfiguration-SCG	Table 8.2.3.16.2.3.3-2	
}			
}			
}			
radioBearerConfig2	OCTET STRING (CONTAINING RadioBearerConfig specified in TS 38.508-1 [4] Table 4.6.3-132 with condition SRB3)		
}			
}			
}			
}			
}			

Table 8.2.3.16.2.3.3-2: RRCReconfiguration-SCG (Table 8.2.3.16.2.3.3-1)

Derivation Path: TS 38.508-1 [4], Table 4.6.1-13 with condition NR-DC_SCG			
Information Element	Value/remark	Comment	Condition
RRCReconfiguration ::= SEQUENCE {			
criticalExtensions CHOICE {			
rrcReconfiguration SEQUENCE {			
secondaryCellGroup	CellGroupConfig	Table 8.2.3.16.2.3.3-3	
}			
}			
}			

Table 8.2.3.16.2.3.3-3: CellGroupConfig (Table 8.2.3.16.2.3.3-2)

Derivation Path: TS 38.508-1 [4], Table 4.6.3-19			
Information Element	Value/remark	Comment	Condition
CellGroupConfig ::= SEQUENCE {			
cellGroupId	CellGroupId condition NR-DC_SCG		
rlc-BearerToAddModList SEQUENCE (SIZE(1..maxLC-ID)) OF RLC-BearerConfig {	1 entry		
RLC-BearerConfig[1]	RLC-BearerConfig with condition SRB3	entry 1	
}			
mac-CellGroupConfig	Not Present		
physicalCellGroupConfig	Not Present		
spCellConfig	Not Present		
}			

Table 8.2.3.16.2.3.3-4: RRCReconfiguration (Step 3, Table 8.2.3.16.2.3.2-1)

Derivation Path: TS 38.508-1 [4], Table 4.6.1-13 with Condition NR_MEAS			
---	--	--	--

Table 8.2.3.16.2.3.3-5: MeasConfig (Table 8.2.3.16.2.3.3-4)

Derivation Path: TS 38.508-1 [4], Table 4.6.3-69			
Information Element	Value/remark	Comment	Condition
MeasConfig ::= SEQUENCE {			
measObjectToAddModList SEQUENCE (SIZE (1..maxNrofObjectId)) OF MeasObjectToAddMod {	1 entry		
MeasObjectToAddMod[1] SEQUENCE {		entry 1	
measObject CHOICE {			
measObjectNR SEQUENCE {			
ssbFrequency	ARFCN-ValueNR of NR Cell 10		
absThreshSS-BlocksConsolidation	Not present		
nrofSS-BlocksToAverage	Not present		
}			
}			
}			
reportConfigToAddModList SEQUENCE(SIZE (1..maxReportConfigId)) OF ReportConfigToAddMod {	1 entry		
ReportConfigToAddMod[1] SEQUENCE {		entry 1	
reportConfig CHOICE {			
reportConfigNR	ReportConfigNR with Condition PERIODICAL		
}			
}			
}			

}			
}			

Table 8.2.3.16.2.3.3-6: MeasurementReport (step 5, Table 8.2.3.16.2.3.2-1)

Derivation Path: TS 38.508-1 [4], Table 4.6.1-5A			
Information Element	Value/remark	Comment	Condition
MeasurementReport ::= SEQUENCE {			
criticalExtensions CHOICE {			
measurementReport SEQUENCE {			
measResults	MeasResults	Table 8.2.3.16.2.3.3-7	
}			
}			
}			

Table 8.2.3.16.2.3.3-7: MeasResults (Table 8.2.3.16.2.3.3-6)

Derivation Path: TS 38.508-1 [4], Table 4.6.3-79			
Information Element	Value/remark	Comment	Condition
MeasResults ::= SEQUENCE {			
measResultServingMOList SEQUENCE (SIZE (1..maxNrofServingCells)) OF MeasResultServMO {	1 entry		
MeasResultServMO[1] SEQUENCE {		entry 1	
measResultServingCell SEQUENCE {			
physCellId	PhysCellId of NR Cell 10		
measResult SEQUENCE {			
cellResults SEQUENCE {			
resultsSSB-Cell SEQUENCE {			
rsrp	(0..127)		
rsrq	(0..127)		
sinr	(0..127)		pc_ss_SINR_Meas
}			
}			
}			
}			
}			
}			

8.2.3.17 Measurement configuration control and reporting / SFTD:

8.2.3.17.1 Measurement configuration control and reporting / SFTD / EN-DC

8.2.3.17.1.1 Test Purpose (TP)

(1)

```
with { UE in E-UTRA RRC_CONNECTED state with reportSFTD-Meas configured }
ensure that {
  when { The sfn-OffsetResult and frameBoundaryOffsetResult results become available }
  then { UE transmits a MeasurementReport message including the MeasResultCellSFTD IE }
}
```

(2)

```
with { UE in RRC_CONNECTED state in EN-DC mode with reportSFTD-Meas configured for Serving NR PSCell }
ensure that {
  when { The sfn-OffsetResult and frameBoundaryOffsetResult results for the Serving NR PSCell becomes available }
  then { UE transmits a MeasurementReport message including the MeasResultCellSFTD IE }
}
```

}

8.2.3.17.1.2 Conformance requirements

References: The conformance requirements covered in the current TC are specified in: TS 36.331, clauses 5.3.5.3, 5.5.2.1, 5.5.3.1, 5.5.4.1, and 5.5.5.1. Unless otherwise stated these are Rel-15 requirements.

[TS 36.331, clause 5.3.5.3]

If the *RRCCONNECTIONRECONFIGURATION* message does not include the *mobilityControlInfo* and the UE is able to comply with the configuration included in this message, the UE shall:

...

1> if the *RRCCONNECTIONRECONFIGURATION* message includes the *measConfig*:

2> perform the measurement configuration procedure as specified in 5.5.2;

...

1> else:

2> submit the *RRCCONNECTIONRECONFIGURATIONCOMPLETE* message to lower layers for transmission using the new configuration, upon which the procedure ends; [TS 38.331, clause 5.5.2.1]

[TS 36.331, clause 5.5.2.1]

E-UTRAN applies the procedure as follows:

- to ensure that, whenever the UE has a *measConfig*, it includes a *measObject* for each LTE serving frequency;

...

- to configure at most one measurement identity using a reporting configuration with *reportSFTD-Meas*;

...

The UE shall:

...

1> if the received *measConfig* includes the *measObjectToAddModList*:

2> perform the measurement object addition/ modification procedure as specified in 5.5.2.5;

...

1> if the received *measConfig* includes the *reportConfigToAddModList*:

2> perform the reporting configuration addition/ modification procedure as specified in 5.5.2.7;

...

1> if the received *measConfig* includes the *measIdToAddModList*:

2> perform the measurement identity addition/ modification procedure as specified in 5.5.2.3;

...

[TS 36.331, clause 5.5.3.1]

The UE shall:

1> whenever the UE has a *measConfig*, perform RSRP and RSRQ measurements for each serving cell as follows:

...

1> for each *measId* included in the *measIdList* within *VarMeasConfig*:

...

2> else:

3> if a measurement gap configuration is setup; or

3> if the UE does not require measurement gaps to perform the concerned measurements:

...

4> if the *reportSFTD-Meas* is set to *pSCell* in the associated *reportConfig*:

5> perform SFTD measurements between the PCell and the NR PSCell;

4> if the *reportSFTD-Meas* is set to *neighborCells* in the associated *reportConfig*:

5> perform SFTD measurements between the PCell and NR cell(s) on the frequency indicated in the associated *measObject*;

...

2> perform the evaluation of reporting criteria as specified in 5.5.4;

...

[TS 36.331, clause 5.5.4.1]

If security has been activated successfully, the UE shall:

1> for each *measId* included in the *measIdList* within *VarMeasConfig*:

...

2> else:

...

3> else if the corresponding *measObject* concerns NR:

4> if the *reportSFTD-Meas* is set to *pSCell* in the corresponding *reportConfigInterRAT*:

5> consider the PSCell to be applicable;

4> else if the *reportSFTD-Meas* is set to *neighborCells* in the corresponding *reportConfigInterRAT*:

5> if *cellsForWhichToReportSFTD* is configured in the corresponding *measObjectNR*:

6> consider any neighbouring NR cell on the associated frequency that is included in *cellsForWhichToReportSFTD* to be applicable;

5> else:

6> consider up to 3 strongest neighbouring NR cells detected on the associated frequency to be applicable when the concerned cells are not included in the *blackCellsToAddModList* defined within the *VarMeasConfig* for this *measId*;

...

2> else if the *purpose* is included and set to *reportStrongestCells*, *reportStrongestCellsForSON*, *reportLocationSidelink* or *sensing* and if a (first) measurement result is available:

3> include a measurement reporting entry within the *VarMeasReportList* for this *measId*;

3> set the *numberOfReportsSent* defined within the *VarMeasReportList* for this *measId* to 0;

3> if the *purpose* is set to *reportStrongestCells* and *reportStrongestCSI-RSs* is set to *FALSE*:

...

4> else (i.e. the *reportAmount* is equal to 1):

5> initiate the measurement reporting procedure, as specified in 5.5.5, immediately after the quantity to be reported becomes available for the PCell and for the strongest cell among the applicable cells, or becomes available for the pair of PCell and the PSCell in case of SSTD measurements, or becomes available for each requested pair of PCell and NR cell or the maximal measurement reporting delay as specified in TS 36.133 [16], clause 8.17.2.3 in case of SFTD measurements;

...

[TS 36.331, clause 5.5.5.1]

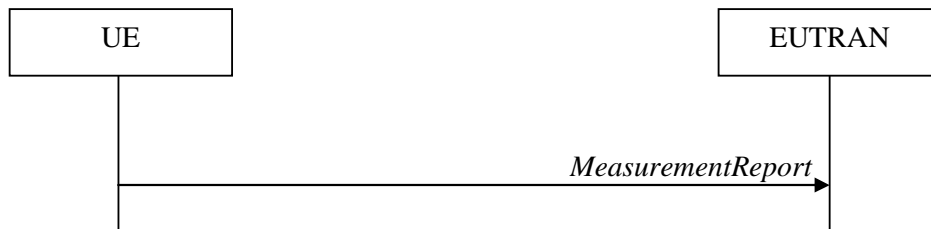

Figure 5.5.5.1-1: Measurement reporting

For the *measId* for which the measurement reporting procedure was triggered, the UE shall set the *measResults* within the *MeasurementReport* message as follows:

1> set the *measId* to the measurement identity that triggered the measurement reporting;

1> set the *measResultPCell* to include the quantities of the PCell;

...

1> if there is at least one applicable neighbouring cell to report:

2> set the *measResultNeighCells* to include the best neighbouring cells up to *maxReportCells* in accordance with the following:

...

3> else:

4> include the applicable cells for which the new measurement results became available since the last periodical reporting or since the measurement was initiated or reset;

NOTE 1: The reliability of the report (i.e. the certainty it contains the strongest cells on the concerned frequency) depends on the measurement configuration i.e. the *reportInterval*. The related performance requirements are specified in TS 36.133 [16].

3> for each cell that is included in the *measResultNeighCells*, include the *physCellId*;

3> if the *triggerType* is set to *event*; or the *purpose* is set to *reportStrongestCells* or to *reportStrongestCellsForSON*:

4> for each included cell, include the layer 3 filtered measured results in accordance with the *reportConfig* for this *measId*, ordered as follows:

...

5> if the *measObject* associated with this *measId* concerns NR:

6> set the *measResultCell* to include the quantity(ies) indicated in the *reportQuantityCellNR* within the concerned *reportConfig*;

...

6> sort the included cells in order of decreasing sorting quantity determined as specified in 5.5.5.3;

...

- 1> if the *reportSFTD-Meas* is set to *neighborCells* or *pSCell* within the corresponding *reportConfigInterRAT* for this *measId*, for each applicable cell for which results are available:
 - 2> set *sfm-OffsetResult* and *frameBoundaryOffsetResult* to the measurement results provided by lower layers;
 - 2> if the *ss-rsrp* in the *reportQuantityCellNR* is set to *TRUE* within the corresponding *reportConfigInterRAT* for this *measId*:
 - 3> include *rsrpResult* set to the RSRP of the concerned cell;
 - 1> increment the *numberOfReportsSent* as defined within the *VarMeasReportList* for this *measId* by 1;
 - 1> stop the periodical reporting timer, if running;
 - 1> if the *numberOfReportsSent* as defined within the *VarMeasReportList* for this *measId* is less than the *reportAmount* as defined within the corresponding *reportConfig* for this *measId*:
 - 2> start the periodical reporting timer with the value of *reportInterval* as defined within the corresponding *reportConfig* for this *measId*;
 - 1> else:
 - 2> if the *triggerType* is set to *periodical*:
 - 3> remove the entry within the *VarMeasReportList* for this *measId*;
 - 3> remove this *measId* from the *measIdList* within *VarMeasConfig*;
- ...
- 1> else:
 - 2> submit the *MeasurementReport* message to lower layers for transmission, upon which the procedure ends;

8.2.3.17.1.3 Test description

8.2.3.17.1.3.1 Pre-test conditions

System Simulator:

- E-UTRA Cell 1 is the PCell, NR Cell 1 is the inter-RAT neighbour cell.
- System information blocks combination 31 as defined in TS 36.508 [7] clause 4.4.3.1.1 is used in E-UTRA PCell.

UE:

- None.

Preamble:

- The UE is in state RRC_CONNECTED using generic procedure parameter Connectivity (*E-UTRA/EPC*) established according to TS 38.508-1 [4], clause 4.5.4..

8.2.3.17.1.3.2 Test procedure sequence

Table 8.2.3.17.1.3.2-1: Main behaviour

St	Procedure	Message Sequence		TP	Verdict
		U - S	Message		
1	The SS transmits an <i>RRCCONNECTIONRECONFIGURATION</i> message	<--	E-UTRA RRC: <i>RRCCONNECTIONRECONFIGURATION</i>	-	-

	including <i>MeasConfig</i> to setup inter-RAT SFTD measurement on NR neighbour cell (NR Cell 1)				
2	The UE transmits an <i>RRCConnectionReconfigurationComplete</i> message.	-->	E-UTRA RRC: <i>RRCConnectionReconfigurationComplete</i>	-	-
3	Check: Does the UE transmit a <i>MeasurementReport</i> message including <i>measResultCellListSFTD</i> within the next 5s? NOTE 1	-->	E-UTRA RRC: <i>MeasurementReport</i>	1	P
4	The SS transmits an <i>RRCConnectionReconfiguration</i> including <i>nrSecondaryCellGroupConfig</i> messages to add NR Cell 1 as PSCell.	<--	E-UTRA RRC: <i>RRCConnectionReconfiguration</i> (<i>RRCReconfiguration</i>)	-	-
5	The UE transmits an <i>RRCConnectionReconfigurationComplete</i> message including <i>scg-ConfigResponseNR-r15</i>	-->	E-UTRA RRC: <i>RRCConnectionReconfigurationComplete</i> (<i>RRCReconfigurationComplete</i>)	-	-
6	The SS transmits an <i>RRCConnectionReconfiguration</i> message including <i>MeasConfig</i> to setup intra-frequency SFTD measurement on NR PSCell (NR Cell 1)	<--	E-UTRA RRC: <i>RRCConnectionReconfiguration</i>	-	-
7	The UE transmits an <i>RRCConnectionReconfigurationComplete</i> message.	-->	E-UTRA RRC: <i>RRCConnectionReconfigurationComplete</i>	-	-
8	Check: Does the UE transmit a <i>MeasurementReport</i> message including <i>measResultCellListSFTD</i> within the next 3s? NOTE 2	-->	E-UTRA RRC: <i>MeasurementReport</i>	2	P
NOTE 1: Time limit is chosen based on the inter-RAT SFTD measurement reporting delay requirements specified in TS 36.133 [10] clause 8.1.2.4.25 and 8.1.2.4.26.					
NOTE 2: Time limit is chosen based on the intra-frequency SFTD measurement reporting delay requirements specified in TS 36.133 [10] clause 8.17.2					

8.2.3.17.1.3.3 Specific message contents Table 8.2.3.17.1.3.3-1: *RRCConnectionReconfiguration* (step 1 and 6, Table 8.2.3.17.1.3.2-1)

Derivation Path: TS 36.508 [7] Table 4.6.1-8 with condition MEAS

Table 8.2.3.17.1.3.3-2: *MeasConfig* (Table 8.2.3.17.1.3.3-1)

Derivation Path: TS 36.508 [7] Table 4.6.6-1			
Information Element	Value/remark	Comment	Condition
<i>MeasConfig</i> ::= SEQUENCE {			
<i>measObjectToAddModList</i> SEQUENCE (SIZE (1.. <i>maxObjectld</i>)) OF <i>MeasObjectToAddMod</i> {	2 entries		
<i>MeasObjectToAddMod</i> [1] SEQUENCE {		entry 1	
<i>measObjectld</i>	1		
<i>measObject</i> CHOICE {			
<i>measObjectEUTRA</i>	<i>MeasObjectEUTRA-GENERIC</i> (<i>Freq</i>) specified in 36.508 [7] Table 4.6.6-2	<i>Freq</i> is the carrier frequency for E-UTRA Cell 1	
	<i>MeasObjectEUTRA-GENERIC</i> (<i>Freq</i>) with condition <i>Band > 64</i> specified in 36.508 [7] Table 4.6.6-2	<i>Freq</i> is the carrier frequency for E-UTRA Cell 1	<i>Band > 64</i>
}			
}			
<i>MeasObjectToAddMod</i> [2] SEQUENCE {		entry 2	
<i>measObjectld</i>	2		
<i>measObject</i> CHOICE {			
<i>measObjectNR-r15</i>	<i>MeasObjectNR-GENERIC</i> (<i>Freq</i>)	<i>Freq</i> is the carrier frequency for NR Cell 1	

	specified in 36.508 [7] Table 4.6.6-2B		
}			
}			
reportConfigToAddModList SEQUENCE (SIZE (1..maxReportConfigId)) OF ReportConfigToAddMod {	1 entry		
ReportConfigToAddMod[1] SEQUENCE {		entry 1	
reportConfigId	1		
reportConfig CHOICE {			
reportConfigInterRAT	ReportConfigInterRAT	Table 8.2.3.17.1.3.3-3	
}			
}			
}			
measIdToAddModList SEQUENCE (SIZE (1..maxMeasId)) OF MeasIdToAddMod {	1 entry		
MeasIdToAddMod[1] SEQUENCE {		entry 1	
measId	1		
measObjectId	2		
reportConfigId	1		
}			
}			
measGapConfig	MeasGapConfig-GP1 specified in 36.508 [7] Table 4.6.6-1A		
measObjectToAddModList-v9e0	Not present		
measObjectToAddModList-v9e0 SEQUENCE (SIZE (1..maxObjectId)) OF MeasObjectToAddMod-v9e0 {	1 entry		Band > 64
MeasObjectToAddMod-v9e0[1] SEQUENCE {		entry 1	
measObjectEUTRA-v9e0 SEQUENCE {			
carrierFreq-v9e0	Downlink EARFCN for the carrier frequency of E-UTRA Cell 1		
}			
}			
}			
}			

Table 8.2.3.17.1.3.3-3: ReportConfigInterRAT (Table 8.2.3.17.1.3.3-2)

Derivation Path: TS 36.508 [7] Table 4.6.6-8B			
Information Element	Value/remark	Comment	Condition
ReportConfigInterRAT-PERIODICAL ::= SEQUENCE {			
reportQuantityCellINR-r15 SEQUENCE {			step 6
ss-rsrp	false		
ss-rsrq	false		
ss-sinr	false		
}			
reportQuantityCellINR-r15 SEQUENCE {			step 1
ss-rsrp	true		
ss-rsrq	false		
ss-sinr	false		
}			
reportSFTD-Meas-r15	neighborCells		step 1
	pSCell		step 6
}			

Table 8.2.3.17.1.3.3-4: MeasurementReport (step 3 and 8, Table 8.2.3.17.1.3.2-1)

Derivation Path: TS 36.508 [7] Table 4.6.1-5			
Information Element	Value/remark	Comment	Condition
MeasurementReport ::= SEQUENCE {			
criticalExtensions CHOICE {			

```

ensure that {
  when { The sfn-OffsetResult and frameBoundaryOffsetResult results become available }
  then { UE transmits a MeasurementReport message including the MeasResultCellListSFTD-NR IE }
}

```

(2)

```

with { UE in NR RRC_CONNECTED state in NR-DC mode with reportSFTD-Meas configured for Serving NR PSCell }
ensure that {
  when { The sfn-OffsetResult and frameBoundaryOffsetResult results for the Serving NR PSCell becomes available }
  then { UE transmits a MeasurementReport message including the MeasResultCellListSFTD-NR IE }
}

```

8.2.3.17.2.2 Conformance requirements

References: The conformance requirements covered in the current TC are specified in: TS 38.331, clauses 5.3.5.3, 5.5.2.1, 5.5.3.1, 5.5.4.1, and 5.5.5.1. Unless otherwise stated these are Rel-15 requirements.

[TS 38.331, clause 5.3.5.3]

The UE shall perform the following actions upon reception of the *RRCReconfiguration*:

...

1> if the *RRCReconfiguration* message includes the *measConfig*:

2> perform the measurement configuration procedure as specified in 5.5.2;

...

1> else (*RRCReconfiguration* was received via SRB1):

2> submit the *RRCReconfigurationComplete* message via SRB1 to lower layers for transmission using the new configuration;

...

[TS 38.331, clause 5.5.2.1]

The network applies the procedure as follows:

- to ensure that, whenever the UE has a *measConfig* associated with a CG, it includes a *measObject* for the SpCell and for each NR SCell of the CG to be measured;

...

- when the UE is in NE-DC, NR-DC, or NR standalone, to configure at most one measurement identity across all CGs using a reporting configuration with the *reportType* set to *reportSFTD*;

...

The UE shall:

...

1> if the received *measConfig* includes the *measObjectToAddModList*:

2> perform the measurement object addition/modification procedure as specified in 5.5.2.5;

...

1> if the received *measConfig* includes the *reportConfigToAddModList*:

2> perform the reporting configuration addition/modification procedure as specified in 5.5.2.7;

...

- 1> if the received *measConfig* includes the *measIdToAddModList*:
 - 2> perform the measurement identity addition/modification procedure as specified in 5.5.2.3;
- 1> if the received *measConfig* includes the *measGapConfig*:
 - 2> perform the measurement gap configuration procedure as specified in 5.5.2.9;

...

[TS 38.331, clause 5.5.3.1]

The UE shall:

- 1> whenever the UE has a *measConfig*, perform RSRP and RSRQ measurements for each serving cell for which *servingCellMO* is configured as follows:
 - 2> if the *reportConfig* associated with at least one *measId* included in the *measIdList* within *VarMeasConfig* contains an *rsType* set to *ssb* and *ssb-ConfigMobility* is configured in the *measObject* indicated by the *servingCellMO*:
 - ...
 - 3> derive serving cell measurement results based on SS/PBCH block, as described in 5.5.3.3;
 - ...
 - 1> for each *measId* included in the *measIdList* within *VarMeasConfig*:
 - ...
 - 2> if the *reportType* for the associated *reportConfig* is set to *reportSFTD* and the *numberOfReportsSent* as defined within the *VarMeasReportList* for this *measId* is less than one:
 - 3> if the *reportSFTD-Meas* is set to *true*:
 - ...
 - 4> else if the *measObject* is associated to NR:
 - 5> perform SFTD measurements between the PCell and the NR PSCell;
 - 5> if the *reportRSRP* is set to *true*;
 - 6> perform RSRP measurements for the NR PSCell based on SSB;
 - 3> else if the *reportSFTD-NeighMeas* is included:
 - 4> if the *measObject* is associated to NR:
 - 5> if the *drx-SFTD-NeighMeas* is included:
 - 6> perform SFTD measurements between the PCell and the NR neighbouring cell(s) detected based on parameters in the associated *measObject* using available idle periods;
 - 5> else:
 - 6> perform SFTD measurements between the PCell and the NR neighbouring cell(s) detected based on parameters in the associated *measObject*;
 - 5> if the *reportRSRP* is set to *true*:
 - 6> perform RSRP measurements based on SSB for the NR neighbouring cell(s) detected based on parameters in the associated *measObject*;
 - 2> perform the evaluation of reporting criteria as specified in 5.5.4.

[TS 38.331, clause 5.5.4.1]

If AS security has been activated successfully, the UE shall:

1> for each *measId* included in the *measIdList* within *VarMeasConfig*:

...

2> else if the corresponding *reportConfig* includes a *reportType* set to *reportSFTD*:

3> if the corresponding *measObject* concerns NR:

4> if the *reportSFTD-Meas* is set to *true*:

5> consider the NR PCell to be applicable;

4> else if the *reportSFTD-NeighMeas* is included:

5> if *cellsForWhichToReportSFTD* is configured in the corresponding *reportConfig*:

6> consider any NR neighbouring cell detected on the associated *measObjectNR* which has a physical cell identity that is included in the *cellsForWhichToReportSFTD* to be applicable;

5> else:

6> consider up to 3 strongest NR neighbouring cells detected based on parameters in the associated *measObjectNR* to be applicable when the concerned cells are not included in the *blackCellsToAddModList* defined within the *VarMeasConfig* for this *measId*;

...

2> if the corresponding *reportConfig* includes a *reportType* is set to *reportSFTD*:

3> if the corresponding *measObject* concerns NR:

...

4> else

5> initiate the measurement reporting procedure, as specified in 5.5.5, immediately after the quantity to be reported becomes available for each requested pair of PCell and NR cell or the maximal measurement reporting delay as specified in TS 38.133 [14];

...

[TS 38.331, clause 5.5.5.1]



Figure 5.5.5.1-1: Measurement reporting

For the *measId* for which the measurement reporting procedure was triggered, the UE shall set the *measResults* within the *MeasurementReport* message as follows:

1> set the *measId* to the measurement identity that triggered the measurement reporting;

...

1> if the corresponding *measObject* concerns NR:

2> if the *reportSFTD-Meas* is set to *true* within the corresponding *reportConfigNR* for this *measId*:

3> set the *measResultSFTD-NR* in accordance with the following:

- 4> set *sfn-OffsetResult* and *frameBoundaryOffsetResult* to the measurement results provided by lower layers;
- 4> if the *reportRSRP* is set to *true*;
 - 5> set *rsrp-Result* to the RSRP of the NR PSCell derived based on SSB;
- 2> else if the *reportSFTD-NeighMeas* is included within the corresponding *reportConfigNR* for this *measId*:
 - 3> for each applicable cell which measurement results are available, include an entry in the *measResultCellListSFTD-NR* and set the contents as follows:
 - 4> set *physCellId* to the physical cell identity of the concerned NR neighbour cell.
 - 4> set *sfn-OffsetResult* and *frameBoundaryOffsetResult* to the measurement results provided by lower layers;
 - 4> if the *reportRSRP* is set to *true*:
 - 5> set *rsrp-Result* to the RSRP of the concerned cell derived based on SSB;
 - ...
 - 1> increment the *numberOfReportsSent* as defined within the *VarMeasReportList* for this *measId* by 1;
 - 1> stop the periodical reporting timer, if running;
 - ...
 - 1> else if the UE is in NR-DC:
 - ...
 - 2> else:
 - 3> submit the *MeasurementReport* message via SRB1 to lower layers for transmission, upon which the procedure ends;
 - 1> else:
 - 2> submit the *MeasurementReport* message to lower layers for transmission, upon which the procedure ends.

8.2.3.17.2.3 Test description

8.2.3.17.2.3.1 Pre-test conditions

System Simulator:

- NR Cell 1 is the PCell, NR Cell 10 is the inter-frequency neighbour cell.
- System information combination NR-4 as defined in TS 38.508-1 [4] clause 4.4.3.1.2 is used in NR PCell.

UE:

- None.

Preamble:

- The UE is in state RRC_CONNECTED using generic procedure parameter Connectivity (NR) established according to TS 38.508-1 [4], clause 4.5.4..

8.2.3.17.2.3.2 Test procedure sequence

Table 8.2.3.17.2.3.2-1: Main behaviour

St	Procedure	Message Sequence		TP	Verdict
		U - S	Message		
1	The SS transmits an <i>RRCReconfiguration</i> message including <i>MeasConfig</i> to setup inter-frequency SFTD measurement on NR neighbour cell (NR Cell 10)	<--	NR RRC: <i>RRCReconfiguration</i>	-	-
2	The UE transmits an <i>RRCReconfigurationComplete</i> message.	-->	NR RRC: <i>RRCReconfigurationComplete</i>	-	-
3	Check: Does the UE transmit a <i>MeasurementReport</i> message including <i>measResultCellListSFTD-NR</i> within the next 5s? NOTE 1	-->	NR RRC: <i>MeasurementReport</i>	1	P
4	The SS transmits an <i>RRCReconfiguration</i> message including <i>nr-SCG</i> to add NR Cell 10 as PSCell.	<--	NR RRC: <i>RRCReconfiguration (RRCReconfiguration)</i>	-	-
5	The UE transmits an <i>RRCReconfigurationComplete</i> message including <i>nr-SCG-Response</i>	-->	NR RRC: <i>RRCReconfigurationComplete (RRCReconfigurationComplete)</i>	-	-
6	The SS transmits an <i>RRCReconfiguration</i> message including <i>MeasConfig</i> to setup intra-frequency SFTD measurement on NR PSCell (NR Cell 10)	<--	NR RRC: <i>RRCReconfiguration</i>	-	-
7	The UE transmits an <i>RRCReconfigurationComplete</i> message.	-->	NR RRC: <i>RRCReconfigurationComplete</i>	-	-
8	Check: Does the UE transmit a <i>MeasurementReport</i> message including <i>measResultSFTD-NR</i> within the next 3s? NOTE 2	-->	NR RRC: <i>MeasurementReport</i>	2	P
NOTE 1: Time limit is chosen based on the inter-frequency SFTD measurement reporting delay requirements specified in TS 38.133 [30] clause 9.3.8.					
NOTE 2: Time limit is chosen based on the intra-frequency SFTD measurement reporting delay requirements specified in TS 38.133 [30] clause 9.2.5.4.					

8.2.3.17.2.3.3 Specific message contents Table 8.2.3.17.2.3.3-1: *RRCReconfiguration* (step 1 and 6, Table 8.2.3.17.2.3.2-1)

Derivation Path: TS 38.508-1 [4] Table 4.6.1-13 with condition NR_MEAS

Table 8.2.3.17.2.3.3-2: *MeasConfig* (Table 8.2.3.17.2.3.3-1)

Derivation Path: TS 38.508-1 [4] Table 4.6.3-69			
Information Element	Value/remark	Comment	Condition
<i>MeasConfig</i> ::= SEQUENCE {			
<i>measObjectToAddModList</i> SEQUENCE (SIZE (1..maxNrofMeasId)) OF <i>MeasObjectToAddMod</i> {	2 entries		
<i>MeasObjectToAddMod</i> [1] SEQUENCE {		entry 1	
<i>measObjectId</i>	1		
<i>measObject</i> CHOICE {			
<i>measObjectNR</i>	<i>MeasObjectNR</i> -1	for NR Cell 1	
}			
}			
<i>MeasObjectToAddMod</i> [2] SEQUENCE {		entry 2	
<i>measObjectId</i>	2		
<i>measObject</i> CHOICE {			
<i>measObjectNR</i>	<i>MeasObjectNR</i> -2	for NR Cell 10	
}			
}			
<i>reportConfigToAddModList</i> SEQUENCE (SIZE (1..maxReportConfigId)) OF <i>ReportConfigToAddMod</i> {	1 entry		
<i>ReportConfigToAddMod</i> [1] SEQUENCE {		entry 1	

reportConfigId	1		
reportConfig CHOICE {			
reportConfigNR	ReportConfigNR-neighbour	Table 8.2.3.17.2.3.3-5	step 1
	ReportConfigNR specified in TS 38.508-1 [4], Table 4.6.3-142 with condition SFTD_PSCCELL		step 6
}			
}			
}			
measIdToAddModList SEQUENCE (SIZE (1..maxMeasId)) OF MeasIdToAddMod {	1 entry		
MeasIdToAddMod[1] SEQUENCE {		entry 1	
measId	1		
measObjectId	2		
reportConfigId	1		
}			
}			
measGapConfig	MeasGapConfig specified in 38.508-1 [4] Table 4.6.3-70		
}			

Table 8.2.3.17.2.3.3-3: MeasObjectNR-1 (Table 8.2.3.17.2.3.3-2)

Derivation Path: TS 38.508-1 [4], Table 4.6.3-76			
Information Element	Value/remark	Comment	Condition
MeasObjectNR ::= SEQUENCE {			
ssbFrequency	ARFCN-ValueNR of NR Cell 1		
absThreshSS-BlocksConsolidation	Not present		
}			

Table 8.2.3.17.2.3.3-4: MeasObjectNR-2 (Table 8.2.3.17.2.3.3-2)

Derivation Path: TS 38.508-1 [4], Table 4.6.3-76			
Information Element	Value/remark	Comment	Condition
MeasObjectNR ::= SEQUENCE {			
ssbFrequency	ARFCN-ValueNR of NR Cell 10		
absThreshSS-BlocksConsolidation	Not present		
}			

Table 8.2.3.17.2.3.3-5: ReportConfigNR-neighbour (Table 8.2.3.17.2.3.3-2)

Derivation Path: TS 38.508-1 [4], Table 4.6.3-142 with condition SFTD_NEIGHBOUR			
Information Element	Value/remark	Comment	Condition
ReportConfigNR ::= SEQUENCE {			
reportType CHOICE {			
reportSFTD SEQUENCE {			
reportRSRP	true		
}			
}			
}			

Table 8.2.3.17.2.3.3-6: MeasResults (step 3, Table 8.2.3.17.2.3.2-1)

Derivation Path: TS 38.508-1 [4], Table 4.6.3-79 with condition SFTD_NEIGHBOUR			
Information Element	Value/remark	Comment	Condition
MeasResults ::= SEQUENCE {			

measId	1		
measResultCellListSFTD-NR SEQUENCE (SIZE (1..maxCellsSFTD)) OF MeasResultCellsSFTD-NR {	1 entry		
MeasResultCellsSFTD-NR[1] SEQUENCE {		entry 1	
physCellId	PhysCellId of NR Cell 10		
sfn-OffsetResult	(0..1023)		
frameBoundaryOffsetResult	(-30720..30719)		
rsrp-Result	(0..127)		
}			
}			
}			

Table 8.2.3.17.2.3.3-7: *MeasResults* (step 8, Table 8.2.3.17.2.3.2-1)

Derivation Path: TS 38.508-1 [4], Table 4.6.3-79 with condition SFTD_PSCCELL			
Information Element	Value/remark	Comment	Condition
MeasResults ::= SEQUENCE {			
measId	1		
measResultSFTD-NR SEQUENCE {			
physCellId	PhysCellId of NR Cell 10		
sfn-OffsetResult	(0..1023)		
frameBoundaryOffsetResult	(-30720..30719)		
rsrp-Result	Not present		
}			
}			

Table 8.2.3.17.2.3.3-8: *RRCReconfiguration* (step 4, Table 8.2.3.17.2.3.2-1)

Derivation Path: TS 38.508-1 [4] Table 4.6.1-13 with condition NR-DC
--

Table 8.2.3.17.2.3.3-9: *RRCReconfigurationComplete* (step 5, Table 8.2.3.17.2.3.2-1)

Derivation Path: TS 38.508-1 [4] Table 4.6.1-14 with condition NR-DC
--

8.2.3.18 Conditional PSCell change

8.2.3.18.1 Conditional PSCell change / Success / EN-DC

8.2.3.18.1.1 Test Purpose (TP)

(1)

```
with { UE in RRC_CONNECTED state with EN-DC and receiving an RRCReconfiguration message for
conditional PSCell change }
ensure that {
  when { Any CPC execution condition is not satisfied }
  then { UE maintains connection with source PSCell and continue to evaluate the CPC execution
conditions }
}
```

(2)

```
with { UE in NR RRC_CONNECTED state with EN-DC and receiving an RRCReconfiguration message for
conditional PSCell change }
ensure that {
  when { Any CPC execution condition is satisfied }
  then { UE performs conditional PSCell change to the candidate target cell }
}
```

(3)

```

with { UE in NR RRC_CONNECTED state with EN-DC and receiving an RRCReconfiguration message for
conditional PSCell change }
ensure that {
  when { UE performs conditional PSCell change successfully }
  then { UE releases stored CPC configurations }
}

```

8.2.3.18.1.2 Conformance requirements

References: The conformance requirements covered in the present TC are specified in: TS 37.340 clause 10.3.1 and 10.6 and TS 38.331 clause 5.3.5.1. Unless otherwise stated these are Rel-16 requirements.

[TS 38.331, clause 10.3.1]

The Secondary Node Modification procedure may be initiated either by the MN or by the SN and be used to modify, establish or release bearer contexts, to transfer bearer contexts to and from the SN or to modify other properties of the UE context within the same SN. It may also be used to transfer an NR RRC message from the SN to the UE via the MN and the response from the UE via MN to the SN (e.g. when SRB3 is not used). In case of CPC, this procedure is used to configure or modify CPC configuration within the same SN.

...

SN initiated Conditional SN Modification (CPC) without MN involvement (SRB3 is used)

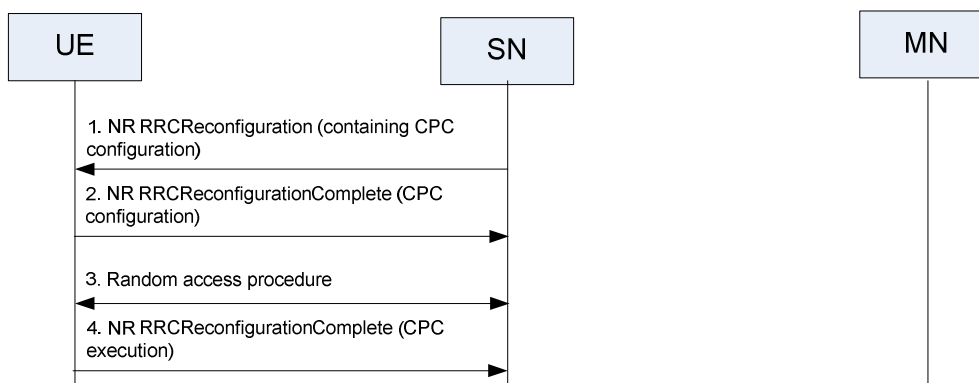

Figure 10.3.1-3a: SN Modification - SN-initiated without MN involvement and SRB3 is used to configure CPC.

The SN initiates the procedure when it needs to transfer an NR RRC message to the UE and SRB3 is used to configure CPC.

1. The SN sends the *RRCReconfiguration* message including CPC configuration to the UE through SRB3.
2. The UE applies the new configuration. The UE starts evaluating the CPC execution conditions for the candidate PSCell(s). The UE maintains connection with the source PSCell and replies with the *RRCReconfigurationComplete* message to the SN via SRB3.
3. If at least one CPC candidate PSCell satisfies the corresponding CPC execution condition, the UE detaches from the source PSCell, applies the stored configuration corresponding to the selected candidate PSCell and synchronises to the candidate PSCell.
4. The UE completes the CPC execution procedure by sending an *RRCReconfigurationComplete* message to the new PSCell.

Transfer of an NR RRC message to/from the UE (when SRB3 is not used)

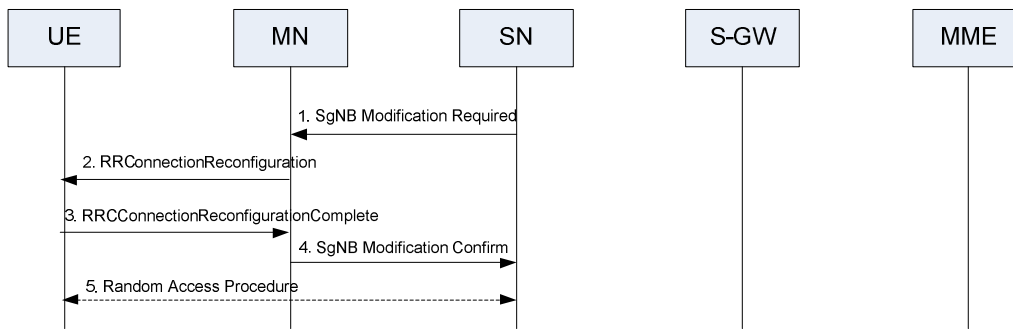

Figure 10.3.1-4: Transfer of an NR RRC message to/from the UE

The SN initiates the procedure when it needs to transfer an NR RRC message to the UE and SRB3 is not used.

1. The SN initiates the procedure by sending the *SgNB Modification Required* to the MN.
2. The MN forwards the NR RRC message to the UE in the *RRCConnectionReconfiguration* message.
3. The UE applies the new configuration and replies with the *RRCConnectionReconfigurationComplete* message.
4. The MN forwards the NR RRC response message, if received from the UE, to the SN in the *SgNB Modification Confirm* message.
5. If instructed, the UE performs synchronisation towards the PSCell of the SN as described in SgNB Addition procedure. Otherwise the UE may perform UL transmission after having applied the new configuration.

SN initiated Conditional SN Modification (CPC) without MN involvement (SRB3 is not used)

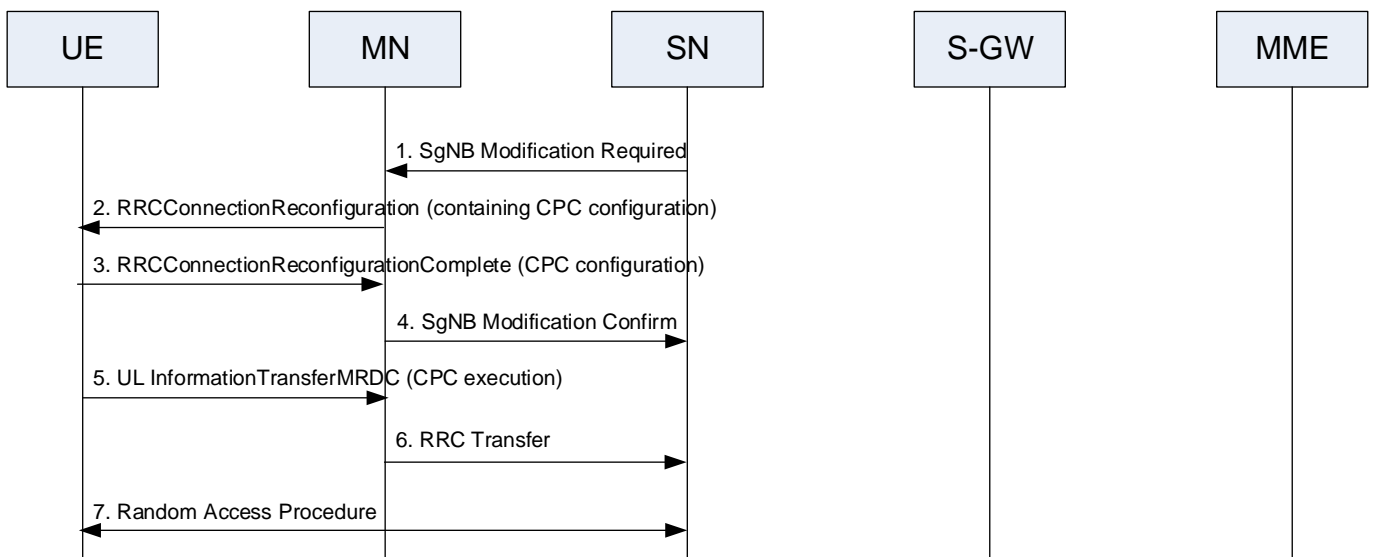

Figure 10.3.1-5: SN Modification - SN-initiated without MN involvement and SRB3 is not used to configure CPC

The SN initiates the procedure when it needs to transfer an NR RRC message to the UE and SRB3 is not used to configure CPC.

1. The SN initiates the procedure by sending the *SgNB Modification Required* to the MN including the SN RRC reconfiguration message with CPC configuration.
2. The MN forwards the SN RRC reconfiguration message to the UE including it in the *RRCConnectionReconfiguration* message.
3. The UE replies with the *RRCConnectionReconfigurationComplete* message by including the SN RRC reconfiguration complete message. The UE maintains connection with source PSCell after receiving CPC configuration, and starts evaluating the CPC execution conditions for the candidate PSCell(s).

4. The MN forwards the SN RRC response message, if received from the UE, to the SN by including it in the *SgNB Modification Confirm* message.
5. If at least one CPC candidate PSCell satisfies the corresponding CPC execution condition, the UE completes the CPC execution procedure by an *ULInformationTransferMRDC* message to the MN which includes an embedded *RRCReconfigurationComplete* message to the selected target PSCell.
6. The *RRCReconfigurationComplete* is forwarded to the SN embedded in RRC Transfer.
7. The UE detaches from the source PSCell, applies the stored corresponding configuration and synchronises to the selected candidate PSCell.

[TS 38.331, clause 10.6]

In MR-DC, a PSCell change does not always require a security key change.

...

A Conditional PSCell Change (CPC) is defined as a PSCell change that is executed by the UE when execution condition(s) is met. The UE starts evaluating the execution condition(s) upon receiving the CPC configuration, and stops evaluating the execution condition(s) once PSCell change is triggered. Only intra-SN CPC without MN involvement is supported.

The following principles apply to CPC:

- The CPC configuration contains the configuration of CPC candidate PSCell(s) and execution condition(s) generated by the SN.
- An execution condition may consist of one or two trigger condition(s) (CPC events A3/A5, as defined in TS 38.331 [4]). Only single RS type is supported and at most two different trigger quantities (e.g. RSRP and RSRQ, RSRP and SINR, etc.) can be configured simultaneously for the evaluation of CPC execution condition of a single candidate PSCell.
- Before any CPC execution condition is satisfied, upon reception of PSCell change command or PCell change command, the UE executes the PSCell change procedure as described in clause 10.3 and 10.5 or the PCell change procedure as described in clause 9.2.3.2 in TS 38.300[3] or clause 10.1.2.1 in TS 36.300 [2], regardless of any previously received CPC configuration. Upon the successful completion of PSCell change procedure or PCell change procedure, the UE releases all stored CPC configurations.
- While executing CPC, the UE is not required to continue evaluating the execution condition of other candidate PSCell(s).
- Once the CPC procedure is executed successfully, the UE releases all stored CPC configurations.
- Upon the release of SCG, the UE releases the stored CPC configurations.

CPC configuration in HO command, PSCell change command or conditional reconfiguration is not supported.

[TS 38.331, clause 5.3.5.1]

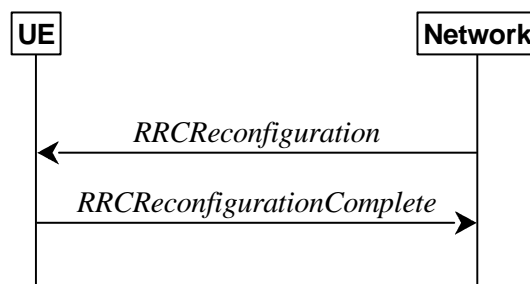

Figure 5.3.5.1-1: RRC reconfiguration, successful

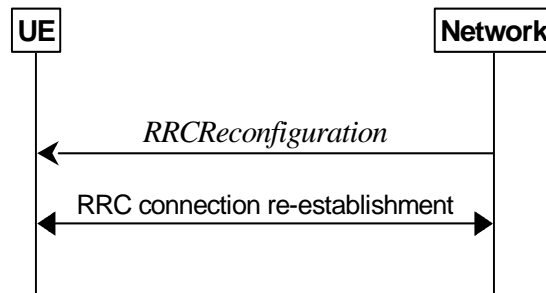

Figure 5.3.5.1-2: RRC reconfiguration, failure

The purpose of this procedure is to modify an RRC connection, e.g. to establish/modify/release RBs, to perform reconfiguration with sync, to setup/modify/release measurements, to add/modify/release SCells and cell groups, to add/modify/release conditional handover configuration, to add/modify/release conditional PSCell change configuration. As part of the procedure, NAS dedicated information may be transferred from the Network to the UE.

[TS 38.331, clause 5.3.5.13.1]

The network configures the UE with one or more candidate target SpCells in the conditional reconfiguration. The UE evaluates the condition of each configured candidate target SpCell. The UE applies the conditional reconfiguration associated with one of the target SpCells which fulfils associated execution condition. The network provides the configuration parameters for the target SpCell in the *ConditionalReconfiguration* IE.

The UE performs the following actions based on a received *ConditionalReconfiguration* IE:

- 1> if the *ConditionalReconfiguration* contains the *condReconfigToRemoveList*:
 - 2> perform conditional reconfiguration removal procedure as specified in 5.3.5.13.2;
- 1> if the *ConditionalReconfiguration* contains the *condReconfigToAddModList*:
 - 2> perform conditional reconfiguration addition/modification as specified in 5.3.5.13.3;

8.2.3.18.1.3 Test description

8.2.3.18.1.3.1 Pre-test conditions

System Simulator:

- E-UTRA Cell 1 is the PCell, NR Cell 1 is the source PSCell and NR Cell 2 and NR Cell 4 are the candidate target PSCell.

UE:

- None.

Preamble:

- If *pc_IP_Ping* is set to TRUE then, the UE is in state RRC_CONNECTED using generic procedure parameter Connectivity (*EN-DC*), Bearers (*MCG(s) and SCG*) established according to TS 38.508-1 [4], clause 4.5.4.2-1.
- Else, the UE is in state RRC_CONNECTED using generic procedure parameter Connectivity (*EN-DC*), Bearers (*MCG(s) and SCG*) and Test Loop Function (On) with UE test loop mode B activated according to TS 38.508-1 [4], table 4.5.4.2-1.

8.2.3.18.1.3.2 Test procedure sequence

Tables 8.2.3.18.1.3.2-1 and 8.2.3.18.1.3.2-2 illustrate the downlink power levels to be applied for NR Cells at various time instants of the test execution. Row marked "T0" denotes the conditions after the preamble, while the configuration

marked "T1", T2 and "T3", are applied at the point indicated in the Main behaviour description in Table 8.2.3.18.1.3.2-3.

Table 8.2.3.18.1.3.2-1: Power levels in FR1

	Parameter	Unit	E-UTRA Cell 1	NR Cell 1	NR Cell 2	NR Cell 4	Remark
T0	Cell-specific RS EPRE	dBm/15kHz	-85	-	-	-	Power levels are such that event A3 is not satisfied for NR Cell 2 and NR Cell 4.
	SS/PBCH SSS EPRE	dBm/SCS	-	-88	-94	-94	
T1	Cell-specific RS EPRE	dBm/15kHz	-85	-	-	-	Power levels are such that entry condition for event A3 is satisfied for NR Cell 2
	SS/PBCH SSS EPRE	dBm/SCS	-	-94	-79	-94	
T2	Cell-specific RS EPRE	dBm/15kHz	-85	-	-	-	Power levels are such that entry condition for event A3 is satisfied for NR Cell 4
	SS/PBCH SSS EPRE	dBm/SCS	-	-94	-94	-79	

Table 8.2.3.18.1.3.2-2: Power levels in FR2

	Parameter	Unit	E-UTRA Cell 1	NR Cell 1	NR Cell 2	NR Cell 4	Remark
T0	Cell-specific RS EPRE	dBm/15kHz	FFS	-	-	-	Power levels are such that event A3 is not satisfied for NR Cell 2 and NR Cell 4.
	SS/PBCH SSS EPRE	dBm/SCS	-	FFS	FFS	FFS	
T1	Cell-specific RS EPRE	dBm/15kHz	FFS	-	-	-	Power levels are such that entry condition for event A3 is satisfied for NR Cell 2
	SS/PBCH SSS EPRE	dBm/SCS	-	FFS	FFS	FFS	
T2	Cell-specific RS EPRE	dBm/15kHz	FFS	-	-	-	Power levels are such that entry condition for event A3 is satisfied for NR Cell 4
	SS/PBCH SSS EPRE	dBm/SCS	-	FFS	FFS	FFS	

Table 8.2.3.18.1.3.2-3: Main behaviour

St	Procedure	Message Sequence		TP	Verdict
		U - S	Message		
1	The SS transmits an RRCConnectionReconfiguration message containing NR RRCReconfiguration message to perform conditional PSCell change with <i>ConditionalReconfiguration</i> to set NR Cell 2 and NR Cell 4 as target candidate cells.	<--	RRCConnectionReconfiguration (RRCReconfiguration)	-	-
2	Check: Does the UE initiate a random access procedure by transmitting Preamble in NR Cell 2 within 10s?	-->	(PRACH Preamble)	1	F
3	SS adjusts the cell-specific reference signal level according to row "T1".	-	-	-	-
4	Check: Does the UE initiate a random access procedure by transmitting Preamble in NR Cell 2 within 10s?	-->	(PRACH Preamble)	2	P
5	The SS transmits Random Access Response.	<--	Random Access Response	-	-
6	The UE transmits an RRCConnectionReconfigurationComplete message containing NR RRCReconfigurationComplete message on E-UTRA Cell 1	-->	RRCConnectionReconfigurationComplete (RRCReconfigurationComplete)	-	-
7	Check: Does the test result of generic test procedure in TS 38.508-1 Table 4.9.1-1	-	-	2	P

	indicate that the UE is capable of exchanging IP data on SCG DRB using NR radio path?				
8	SS adjusts the cell-specific reference signal level according to row "T2".	-	-	-	-
9	Check: Does the UE initiate a random access procedure by transmitting Preamble in NR Cell 4 within 10s?	-->	(PRACH Preamble)	3	F

8.2.3.18.1.3.3 Specific message contents

Table 8.2.3.18.1.3.3-1: RRCConnectionReconfiguration (step 1, Table 8.2.3.18.1.3.2-3)

Derivation Path: TS 36.508 [7], Table 4.6.1-8 with condition EN-DC_EmbedNR_RRCRecon

Table 8.2.3.18.1.3.3-2: RRCReconfiguration (Table 8.2.3.18.1.3.3-1)

Derivation Path: TS 38.508-1 [4], Table 4.6.1-13 with condition EN-DC_MEAS and CHO			
Information Element	Value/remark	Comment	Condition
RRCReconfiguration ::= SEQUENCE {			
criticalExtensions CHOICE {			
rrcReconfiguration SEQUENCE {			
measConfig	MeasConfig	Table 8.2.3.18.1.3.3-3	
nonCriticalExtension SEQUENCE {			
nonCriticalExtension SEQUENCE {			
nonCriticalExtension SEQUENCE {			
nonCriticalExtension SEQUENCE {			
conditionalReconfiguration-r16	ConditionalReconfiguration	Table 8.2.3.18.1.3.3-6	
}			
}			
}			
}			
}			
}			
}			

Table 8.2.3.18.1.3.3-3: MeasConfig (Table 8.2.3.18.1.3.3-2)

Derivation Path: TS 38.508-1 [4] Table 4.6.3-69			
Information Element	Value/remark	Comment	Condition
MeasConfig ::= SEQUENCE {			
measObjectToAddModList SEQUENCE (SIZE (1..maxNrofMeasId)) OF MeasObjectToAddMod {	1 entry		
MeasObjectToAddMod[1] SEQUENCE {		entry 1	
measObjectId	1		
measObject CHOICE {			
measObjectNR	MeasObjectNR	Table 8.2.3.18.1.3.3-4	
}			
}			
}			
reportConfigToAddModList SEQUENCE (SIZE (1..maxReportConfigId)) OF ReportConfigToAddMod {	1 entry		
ReportConfigToAddMod[1] SEQUENCE {		entry 1	
reportConfigId	1		
reportConfig CHOICE {			
reportConfigNR	ReportConfigNR-condEventA3	Table 8.2.3.18.1.3.3-5	
}			
}			
}			

measIdToAddModList SEQUENCE (SIZE (1..maxNrofMeasId)) OF MeasIdToAddMod {	1 entry		
MeasIdToAddMod[1] SEQUENCE {		entry 1	
measId	1		
measObjectId	1		
reportConfigId	1		
}			
}			
}			

Table 8.2.3.18.1.3.3-4: MeasObjectNR (Table 8.2.3.18.1.3.3-3)

Derivation Path: TS 38.508-1 [4] Table 4.6.3-76			
Information Element	Value/remark	Comment	Condition
MeasObjectNR ::= SEQUENCE {			
ssbFrequency	ARFCN-ValueNR for SSB of NR Cell 1	The SSB of NR cell 1, NR Cell 2 and NR cell 4 have the same ARFCN value as specified in TS 38.508-1 [4] clause 6.2.3	
absThreshSS-BlocksConsolidation	Not present		
nrofSS-BlocksToAverage	Not present		
}			

Table 8.2.3.18.1.3.3-5: ReportConfigNR-condEventA3 (Table 8.2.3.18.1.3.3-3)

Derivation Path: TS 38.508-1 [4] Table 4.6.3-142 with condition CHO AND EVENT_A3			
Information Element	Value/remark	Comment	Condition
ReportConfigNR ::= SEQUENCE {			
reportType CHOICE {			
condTriggerConfig SEQUENCE {			
condEventId CHOICE {			
condEventA3 SEQUENCE {			
a3-Offset CHOICE {			
rsp	2	1 dB (2*0.5 dB)	FR1
	FFS		FR2
}			
}			
}			
}			
}			
}			

Table 8.2.3.18.1.3.3-6: ConditionalReconfiguration (Table 8.2.3.18.1.3.3-3)

Derivation Path: TS 38.508-1 [4] Table 4.6.3-25D			
Information Element	Value/remark	Comment	Condition
ConditionalReconfiguration-r16 ::= SEQUENCE {			
condReconfigToAddModList-r16 ::= SEQUENCE (SIZE (1.. maxNrofCondCells-r16)) OF CondReconfigToAddMod-r16 {	2 entries		
CondReconfigToAddMod-r16[1] ::= SEQUENCE {		entry 1	
condReconfigId-r16	1		
condExecutionCond-r16 ::= SEQUENCE {	1 entry		
MeasId[1]	1	entry 1	
}			
condRRCReconfig-r16	RRCReconfiguration-HO with condition HO_NR cell 2	Table 8.2.3.18.1.3.3-7	
}			

CondReconfigToAddMod-r16[2] ::= SEQUENCE {		entry 2	
condReconfigId-r16	2		
condExecutionCond-r16 ::= SEQUENCE {	1 entry		
MeasId[1]	1	entry 1	
}			
condRRCReconfig-r16	RRCReconfiguration-HO with condition HO_NR cell 4	Table 8.2.3.18.1.3.3-7	
}			
}			
}			
}			

Table 8.2.3.18.1.3.3-7: RRCReconfiguration-HO (Table 8.2.3.18.1.3.3-6)

Derivation Path: TS 38.508-1 [4] Table 4.8.1-1A with condition RBConfig_KeyChange			
Information Element	Value/remark	Comment	Condition
RRCReconfiguration ::= SEQUENCE {			
criticalExtensions CHOICE {			
rrcReconfiguration SEQUENCE {			
secondaryCellGroup SEQUENCE {	CellGroupConfig with condition PCI_NR cell 2	Table 8.2.3.18.1.3.3-9	HO_NR cell 2
	CellGroupConfig with condition PCI_NR cell 4	Table 8.2.3.18.1.3.3-9	HO_NR cell 4
}			
}			
}			
}			

8.2.3.18.1.3.3-8: CellGroupConfig (Table 8.2.3.18.1.3.3-7)

Derivation Path: TS 38.508-1 [4], Table 4.6.3-19 with Condition PSCell_change			
Information Element	Value/remark	Comment	Condition
CellGroupConfig ::= SEQUENCE {			
spCellConfig SEQUENCE {			
reconfigurationWithSync SEQUENCE {			
spCellConfigCommon SEQUENCE {			
physCellId	Physical Cell Identity of NR Cell 2		PCI_NR cell 2
	Physical Cell Identity of NR Cell 4		PCI_NR Cell 4
}			
}			
}			
}			
}			

8.2.3.18.2 Conditional PSCell change / Failure / EN-DC

8.2.3.18.2.1 Test Purpose (TP)

(1)

```
with { UE in RRC_CONNECTED state with EN-DC and receiving an RRCReconfiguration message for conditional PSCell change }
ensure that {
  when { CPC execution failure happens }
  then { UE suspends SCG transmissions for all radio bearers and reports the SCG Failure Information to the MN }
}
```

(2)

```
with { UE in RRC_CONNECTED state with EN-DC and receiving an RRCReconfiguration message for conditional PSCell change }
```

```

ensure that {
  when { radio link failure is detected for MCG during the execution of CPC }
  then { the UE initiates the RRC connection re-establishment procedure }
}

```

8.2.3.18.2.2 Conformance requirements

References: The conformance requirements covered in the present TC are specified in: TS 37.340 clause 7.7. Unless otherwise stated these are Rel-16 requirements.

[TS 37.340, clause 7.7]

RLF is declared separately for the MCG and for the SCG.

If radio link failure is detected for MCG, and fast MCG link recovery is configured, the UE triggers fast MCG link recovery. Otherwise, the UE initiates the RRC connection re-establishment procedure. During the execution of CPC, if radio link failure is detected for MCG, the UE initiates the RRC connection re-establishment procedure.

During fast MCG link recovery, the UE suspends MCG transmissions for all radio bearers and reports the failure with *MCGFailureInformation* message to the MN via the SCG, using the SCG leg of split SRB1 or SRB3.

The UE includes in the *MCGFailureInformation* message the measurement results available according to current measurement configuration of both the MN and the SN. Once the fast MCG link recovery is triggered, the UE maintains the current measurement configurations from both the MN and the SN, and continues measurements based on configuration from the MN and the SN, if possible. The UE initiates the RRC connection re-establishment procedure if it does not receive an *RRCReconfiguration* message, *MobilityFromNRCommand* message, *MobilityFromEUTRACCommand* message or *RRCRelease* message within a certain time after fast MCG link recovery was initiated.

Upon reception of the *MCGFailureInformation* message, the MN can send *RRCReconfiguration* message, *MobilityFromNRCommand* message, *MobilityFromEUTRACCommand* message or *RRCRelease* message to the UE, using the SCG leg of split SRB1 or SRB3. Upon receiving an *RRCReconfiguration* message, *MobilityFromNRCommand* message or *MobilityFromEUTRACCommand* message, the UE resumes MCG transmissions for all radio bearers. Upon receiving an *RRCRelease* message, the UE releases all the radio bearers and configurations.

NOTE 1: It is up to network implementation to guarantee that the RRC-related messages are delivered to the UE by the SN before the release of its control plane resources.

The following SCG failure cases are supported:

- SCG RLF;
- SN addition/change failure;
- For EN-DC, NGEN-DC and NR-DC, SCG configuration failure or CPC configuration failure (only for messages on SRB3);
- For EN-DC, NGEN-DC and NR-DC, SCG RRC integrity check failure (on SRB3);
- For EN-DC, NGEN-DC and NR-DC, consistent UL LBT failure on PSCell;
- For IAB-MT, reception of a BH RLF indication from SCG;
- CPC execution failure.

Upon SCG failure, if MCG transmissions of radio bearers are not suspended, the UE suspends SCG transmissions for all radio bearers and reports the *SCGFailureInformation* to the MN, instead of triggering re-establishment. If SCG failure is detected while MCG transmissions for all radio bearers are suspended, the UE initiates the RRC connection re-establishment procedure.

SCG/MCG failure handling by UE also applies to IAB MT.

In all SCG failure cases, the UE maintains the current measurement configurations from both the MN and the SN and the UE continues measurements based on configuration from the MN and the SN if possible. The SN measurements configured to be routed via the MN will continue to be reported after the SCG failure.

NOTE 2: UE may not continue measurements based on configuration from the SN after SCG failure in certain cases (e.g. UE cannot maintain the timing of PSCell).

The UE includes in the *SCGFailureInformation* message the measurement results available according to current measurement configuration of both the MN and the SN. The MN handles the *SCGFailureInformation* message and may decide to keep, change, or release the SN/SCG. In all the cases, the measurement results according to the SN configuration and the SCG failure type may be forwarded to the old SN and/or to the new SN.

In case of CPC, upon transmission of the *SCGFailureInformation* message to the MN, the UE stops evaluating the CPC execution condition. The UE is not required to continue measurements for candidate PSCell(s) for execution condition upon transmission of the *SCGFailureInformation* message to the MN.

8.2.3.18.2.3 Test description

8.2.3.18.2.3.1 Pre-test conditions

System Simulator:

- E-UTRA Cell 1 is the PCell, E-UTRA Cell 2 is the neighbour cell, NR Cell 1 is the source PSCell and NR Cell 2 is the candidate target PSCell.

UE:

- None.

Preamble:

- If *pc_IP_Ping* is set to TRUE then, the UE is in state RRC_CONNECTED using generic procedure parameter Connectivity (*EN-DC*), Bearers (*MCG(s) and SCG*) established according to TS 38.508-1 [4], clause 4.5.4.2-1.
- Else, the UE is in state RRC_CONNECTED using generic procedure parameter Connectivity (*EN-DC*), Bearers (*MCG(s) and SCG*) and Test Loop Function (On) with UE test loop mode B activated according to TS 38.508-1 [4], table 4.5.4.2-1.

8.2.3.18.2.3.2 Test procedure sequence

Tables 8.2.3.18.2.3.2-1 and 8.2.3.18.2.3.2-2 illustrate the downlink power levels to be applied for E-UTRA and NR Cells at various time instants of the test execution. Row marked "T0" denotes the conditions after the preamble, while the configuration marked "T1", T2 and "T3" are applied at the point indicated in the Main behaviour description in Table 8.2.3.18.2.3.2-3.

Table 8.2.3.18.2.3.2-1: Power levels in FR1

	Parameter	Unit	E-UTRA Cell 1	E-UTRA Cell 2	NR Cell 1	NR Cell 2	Remark
T0	Cell-specific RS EPRE	dBm/15kHz	-85	off	-	-	Power levels are such that UE registered on E-UTRA Cell 1 and added NR Cell 1 as the PSCell and event A3 is not satisfied for NR Cell 2.
	SS/PBCH SSS EPRE	dBm/SCS	-	-	-88	-94	
T1	Cell-specific RS EPRE	dBm/15kHz	-85	off	-	-	Power levels are such that entry condition for event A3 is satisfied for NR Cell 2
	SS/PBCH SSS EPRE	dBm/SCS	-	-	-94	-79	
T2	Cell-specific RS EPRE	dBm/15kHz	-85	off	-	-	Power levels are such that entry condition for event A3 is not satisfied for NR Cell 2.
	SS/PBCH SSS EPRE	dBm/SCS	-	-	-88	-113	
T3	Cell-specific RS EPRE	dBm/15kHz	off	-85	-	-	Power levels are such that The radio link quality of E-UTRA Cell 1 is degraded, E-UTRA Cell 2 is suitable for camping and entry
	SS/PBCH SSS EPRE	dBm/SCS	-	-	-94	-79	

							condition for event A3 is satisfied for NR Cell 2
--	--	--	--	--	--	--	---

Table 8.2.3.18.2.3.2-2: Power levels in FR2

	Parameter	Unit	E-UTRA Cell 1	E-UTRA Cell 2	NR Cell 1	NR Cell 2	Remark
T0	Cell-specific RS EPRE	dBm/15kHz	FFS	off	-	-	Power levels are such that UE registered on E-UTRA Cell 1 and added NR Cell 1 as the PSCell and event A3 is not satisfied for NR Cell 2.
	SS/PBCH SSS EPRE	dBm/SCS	-	-	FFS	FFS	
T1	Cell-specific RS EPRE	dBm/15kHz	FFS	off	-	-	Power levels are such that entry condition for event A3 is satisfied for NR Cell 2
	SS/PBCH SSS EPRE	dBm/SCS	-	-	FFS	FFS	
T2	Cell-specific RS EPRE	dBm/15kHz	FFS	off	-	-	Power levels are such that entry condition for event A3 is not satisfied for NR Cell 2.
	SS/PBCH SSS EPRE	dBm/SCS	-	-	FFS	FFS	
T3	Cell-specific RS EPRE	dBm/15kHz	FFS	FFS	-	-	Power levels are such that The radio link quality of E-UTRA Cell 1 is degraded, E-UTRA Cell 2 is suitable for camping and entry condition for event A3 is satisfied for NR Cell 2
	SS/PBCH SSS EPRE	dBm/SCS	-	-	FFS	FFS	

Table 8.2.3.18.2.3.2-3: Main behaviour

St	Procedure	Message Sequence		TP	Verdict
		U - S	Message		
1	The SS transmits an <i>RRCConnectionReconfiguration</i> message containing NR <i>RRCReconfiguration</i> message to perform conditional PSCell change with <i>ConditionalReconfiguration</i> to set NR Cell 2 as target candidate cell.	<--	<i>RRCConnectionReconfiguration (RRCReconfiguration)</i>	-	-
2	The UE transmits an <i>RRCConnectionReconfigurationComplete</i> message containing NR <i>RRCReconfigurationComplete</i> message on E-UTRA Cell 1	-->	<i>RRCConnectionReconfigurationComplete (RRCReconfigurationComplete)</i>	-	-
3	SS adjusts the cell-specific reference signal level according to row "T1".	-	-	-	-
4	Wait for 5s to ensure that T304 expires. NOTE: SS does not respond to the UE transmitted RACH preambles on NR Cell 2.	-	-	-	-
5	Check: Does UE transmit the <i>SCGFailureInformationNR</i> message with <i>failureType</i> set to 'synchReconfigFailureSCG' in E-UTRA Cell 1?	-->	<i>SCGFailureInformationNR</i>	1	P
6	SS adjusts the cell-specific reference signal level according to row "T2".	-	-	-	-
7	The SS transmits an <i>RRCConnectionReconfiguration</i> message containing NR <i>RRCReconfiguration</i> message to add NR PSCell with SCG DRB. <i>RRCConnectionReconfiguration</i> message contains the ACTIVATE DEDICATED EPS BEARER CONTEXT REQUEST message.	<--	<i>RRCConnectionReconfiguration (RRCReconfiguration)</i>	-	-
8	The UE transmits an <i>RRCConnectionReconfigurationComplete</i> message containing NR <i>RRCReconfigurationComplete</i> message.	-->	<i>RRCConnectionReconfigurationComplete (RRCReconfigurationComplete)</i>	-	-

9	The UE transmits an <i>ULInformationTransfer</i> message containing the ACTIVATE DEDICATED EPS BEARER CONTEXT ACCEPT message.	-->	<i>ULInformationTransfer</i>	-	-
10	The SS transmits an <i>RRCCONNECTIONRECONFIGURATION</i> message containing NR <i>RRCCONNECTIONRECONFIGURATION</i> message to perform conditional PSCell change with <i>CONDITIONALRECONFIGURATION</i> to set NR Cell 2 as target candidate cell.	<--	<i>RRCCONNECTIONRECONFIGURATION (RRCCONNECTIONRECONFIGURATION)</i>	-	-
11	The UE transmits an <i>RRCCONNECTIONRECONFIGURATIONCOMPLETE</i> message containing NR <i>RRCCONNECTIONRECONFIGURATIONCOMPLETE</i> message on E-UTRA Cell 1.	-->	<i>RRCCONNECTIONRECONFIGURATIONCOMPLETE (RRCCONNECTIONRECONFIGURATIONCOMPLETE)</i>	-	-
12	SS adjusts the cell-specific reference signal level according to row "T3" in order that the radio link quality of E-UTRA Cell 1 is degraded and E-UTRA Cell 2 is suitable for camping.	-	-	-	-
13	Check: Does the UE send <i>RRCCONNECTIONREESTABLISHMENTREQUEST</i> message on E-UTRA Cell 1 within 10s?	-->	<i>RRCCONNECTIONREESTABLISHMENTREQUEST</i>	2	P
14	The SS transmits <i>RRCCONNECTIONREESTABLISHMENT</i> message.	<--	<i>RRCCONNECTIONREESTABLISHMENT</i>	-	-
15	The UE transmits <i>RRCCONNECTIONREESTABLISHMENTCOMPLETE</i> message.	-->	<i>RRCCONNECTIONREESTABLISHMENTCOMPLETE</i>	-	-
16	The SS transmits an <i>RRCCONNECTIONRECONFIGURATION</i> message to resume existing radio bearer.	<--	<i>RRCCONNECTIONRECONFIGURATION</i>	-	-
17	The UE transmits an <i>RRCCONNECTIONRECONFIGURATIONCOMPLETE</i> message.	-->	<i>RRCCONNECTIONRECONFIGURATIONCOMPLETE</i>	-	-

8.2.3.18.2.3.3 Specific message contents

Table 8.2.3.18.2.3.3-1: *RRCCONNECTIONRECONFIGURATION* (step 1 and step 10, Table 8.2.3.18.2.3.2-3)

Derivation Path: TS 36.508 [7], Table 4.6.1-8 with condition EN-DC_EmbedNR_RRCRecon

Table 8.2.3.18.2.3.3-2: *RRCCONNECTIONRECONFIGURATION* (Table 8.2.3.18.2.3.3-1)

Derivation Path: TS 38.508-1 [4], Table 4.6.1-13 with condition EN-DC_MEAS and CHO			
Information Element	Value/remark	Comment	Condition
<i>RRCCONNECTIONRECONFIGURATION</i> ::= SEQUENCE {			
criticalExtensions CHOICE {			
rrcReconfiguration SEQUENCE {			
measConfig	MeasConfig	Table 8.2.3.18.2.3.3-3	
nonCriticalExtension SEQUENCE {			
nonCriticalExtension SEQUENCE {			
nonCriticalExtension SEQUENCE {			
nonCriticalExtension SEQUENCE {			
conditionalReconfiguration-r16	ConditionalReconfiguration	Table 8.2.3.18.2.3.3-6	
}			
}			
}			
}			
}			
}			
}			

Table 8.2.3.18.2.3.3-3: *MeasConfig* (Table 8.2.3.18.2.3.3-2)

Derivation Path: TS 38.508-1 [4] Table 4.6.3-69			
Information Element	Value/remark	Comment	Condition
MeasConfig ::= SEQUENCE {			
measObjectToAddModList SEQUENCE (SIZE (1..maxNrofMeasId)) OF MeasObjectToAddMod {	1 entry		
MeasObjectToAddMod[1] SEQUENCE {		entry 1	
measObjectId	1		
measObject CHOICE {			
measObjectNR	MeasObjectNR	Table 8.2.3.18.2.3.3-4	
}			
}			
}			
reportConfigToAddModList SEQUENCE (SIZE (1..maxReportConfigId)) OF ReportConfigToAddMod {	1 entry		
ReportConfigToAddMod[1] SEQUENCE {		entry 1	
reportConfigId	1		
reportConfig CHOICE {			
reportConfigNR	<i>ReportConfigNR-condEventA3</i>	Table 8.2.3.18.2.3.3-5	
}			
}			
}			
measIdToAddModList SEQUENCE (SIZE (1..maxNrofMeasId)) OF MeasIdToAddMod {	1 entry		
MeasIdToAddMod[1] SEQUENCE {		entry 1	
measId	1		
measObjectId	1		
reportConfigId	1		
}			
}			
}			

Table 8.2.3.18.2.3.3-4: *MeasObjectNR* (Table 8.2.3.18.2.3.3-3)

Derivation Path: TS 38.508-1 [4] Table 4.6.3-76			
Information Element	Value/remark	Comment	Condition
MeasObjectNR ::= SEQUENCE {			
ssbFrequency	ARFCN-ValueNR for SSB of NR Cell 1	The SSB of NR Cell 1, NR Cell 2 and NR Cell 4 have the same ARFCN value as specified in TS 38.508-1 [4] clause 6.2.3	
absThreshSS-BlocksConsolidation	Not present		
nrofSS-BlocksToAverage	Not present		
}			

Table 8.2.3.18.2.3.3-5: *ReportConfigNR-condEventA3* (Table 8.2.3.18.2.3.3-3)

Derivation Path: TS 38.508-1 [4] Table 4.6.3-142 with condition CHO AND EVENT_A3			
Information Element	Value/remark	Comment	Condition
ReportConfigNR ::= SEQUENCE {			
reportType CHOICE {			
condTriggerConfig SEQUENCE {			
condEventId CHOICE {			
condEventA3 SEQUENCE {			
a3-Offset CHOICE {			
rsrp	2	1 dB (2*0.5 dB)	FR1
	FFS		FR2

}			
}			
}			
}			
}			
}			

Table 8.2.3.18.2.3.3-6: ConditionalReconfiguration (Table 8.2.3.18.2.3.3-2)

Derivation Path: TS 38.508-1 [4] Table 4.6.3-25D			
Information Element	Value/remark	Comment	Condition
ConditionalReconfiguration-r16 ::= SEQUENCE {			
condReconfigToAddModList-r16 ::= SEQUENCE (SIZE (1.. maxNrofCondCells-r16)) OF CondReconfigToAddMod-r16 {	1 entry		
CondReconfigToAddMod-r16[1] ::= SEQUENCE {		entry 1	
condReconfigId-r16	1		
condExecutionCond-r16 ::= SEQUENCE {	1 entry		
MeasId[1]	1	entry 1	
}			
condRRCReconfig-r16	RRCReconfiguration-HO with condition HO_NR cell 2	Table 8.2.3.18.2.3.3-7	
}			
}			
}			
}			

Table 8.2.3.18.2.3.3-7: RRCReconfiguration-HO (Table 8.2.3.18.2.3.3-6)

Derivation Path: TS 38.508-1 [4] Table 4.8.1-1A with condition RBConfig_KeyChange			
Information Element	Value/remark	Comment	Condition
RRCReconfiguration ::= SEQUENCE {			
criticalExtensions CHOICE {			
rrcReconfiguration SEQUENCE {			
secondaryCellGroup SEQUENCE {	CellGroupConfig	Table 8.2.3.18.2.3.3-8	
}			
}			
}			

8.2.3.18.2.3.3-8: CellGroupConfig (Table 8.2.3.18.2.3.3-7)

Derivation Path: TS 38.508-1 [4], Table 4.6.3-19 with Condition PSCell_change			
Information Element	Value/remark	Comment	Condition
CellGroupConfig ::= SEQUENCE {			
spCellConfig SEQUENCE {			
reconfigurationWithSync SEQUENCE {			
spCellConfigCommon SEQUENCE {			
physCellId	Physical Cell Identity of NR Cell 2		
}			
}			
}			
}			

Table 8.2.3.18.2.3.3-9: SCGFailureInformationNR (step 5, Table 8.2.3.18.2.3.2-3)

Derivation Path: TS 36.508 [7], Table 4.6.1-18AA			
Information Element	Value/remark	Comment	Condition
SCGFailureInformationNR-r15 ::= SEQUENCE {			
criticalExtensions CHOICE {			

c1 CHOICE {			
scgFailureInformationNR-r15 SEQUENCE {			
failureReportSCG-NR-r15 SEQUENCE {			
failureType-r15	synchReconfigFailure-SCG		
measResultFreqListNR-r15	Not checked		
measResultSCG-r15	Not checked		
}			
nonCriticalExtension SEQUENCE {}			
}			
}			
}			
}			
}			

Table 8.2.3.18.2.3.3-10: RRCConnectionReconfiguration (step 7, Table 8.2.3.18.2.3.2-3)

Derivation Path: TS 36.508 [7], Table 4.6.1-8			
Information Element	Value/remark	Comment	Condition
RRCConnectionReconfiguration ::= SEQUENCE {			
criticalExtensions CHOICE {			
c1 CHOICE {			
rrcConnectionReconfiguration-r8 SEQUENCE {			
nonCriticalExtension SEQUENCE {			
nonCriticalExtension SEQUENCE {			
nonCriticalExtension SEQUENCE {			
nonCriticalExtension SEQUENCE {			
nonCriticalExtension SEQUENCE {			
nonCriticalExtension SEQUENCE {			
nonCriticalExtension SEQUENCE {			
nr-Config-r15 CHOICE {			
setup SEQUENCE {			
nr-SecondaryCellGroupConfig-r15	OCTET STRING including the RRCReconfiguration message and the IE secondaryCellGroup.	Table 8.2.3.18.2.3.3-11	
}			
}			
}			
}			
}			
}			
}			
}			
nr-RadioBearerConfig1-r15	OCTET STRING including RadioBearerConfig.	Table 8.2.3.18.2.3.3-13	
}			
}			
}			
}			
}			

Table 8.2.3.18.2.3.3-11: RRCReconfiguration (Table 8.2.3.18.2.3.3-10)

Derivation Path: TS 38.508-1 [4], Table 4.6.1-13			
Information Element	Value/remark	Comment	Condition
RRCReconfiguration ::= SEQUENCE {			
criticalExtensions CHOICE {			
rrcReconfiguration SEQUENCE {			

secondaryCellGroup	CellGroupConfig	Table 8.2.3.18.2.3.3-12	
}			
}			
}			

Table 8.2.3.18.2.3.3-12: CellGroupConfig (Table 8.2.3.18.2.3.3-11)

Derivation Path: TS 38.508-1 [4], Table 4.6.3-19			
Information Element	Value/remark	Comment	Condition
CellGroupConfig ::= SEQUENCE {			
rlc-BearerToAddModList SEQUENCE (SIZE(1..maxLC-ID)) OF RLC-BearerConfig {	1 entry		
RLC-BearerConfig[1] SEQUENCE {		entry 1	
servedRadioBearer CHOICE {			
drb-Identity	2	SCG DRB Id	
}			
}			
}			
}			

Table 8.2.3.18.2.3.3-13: RadioBearerConfig (Table 8.2.3.18.2.3.3-10)

Derivation Path: TS 38.508-1 [4], Table 4.6.3-132			
Information Element	Value/remark	Comment	Condition
RadioBearerConfig ::= SEQUENCE {			
drb-ToAddModList SEQUENCE (SIZE (1..maxDRB)) OF DRB-ToAddMod {	1 entry		
DRB-ToAddMod[1] SEQUENCE {		entry 1	
cnAssociation CHOICE {			
eps-BearerIdentity	6	Dedicated EPS bearer Id of SCG DRB	
}			
drb-Identity	2	SCG DRB Id	
}			
}			
securityConfig SEQUENCE {			
keyToUse	secondary		
}			
}			

8.2.3.18.3 Conditional PSCell change / PCell change / PSCell change / EN-DC

8.2.3.18.3.1 Test Purpose (TP)

(1)

```
with { UE in RRC_CONNECTED state with EN-DC and receiving an RRCReconfiguration message for conditional PScell change }
ensure that {
  when { UE receives PCell change command }
  then { UE executes the PCell change procedure, regardless of any previously received CPC configuration }
}
```

(2)

```
with { UE in NR RRC_CONNECTED state with EN-DC and receiving an RRCReconfiguration message for conditional PScell change }
ensure that {
  when { UE receives PSCell change command }
```

```

    then { UE executes the PSCell change procedure, regardless of any previously received CPC
configuration }
}

```

8.2.3.18.3.2 Conformance requirements

References: The conformance requirements covered in the present TC are specified in: TS 37.340 clause 10.3.1 and 10.6 and TS 38.331 clause 5.3.5.1. Unless otherwise stated these are Rel-16 requirements.

[TS 37.340, clause 10.3.1]

The Secondary Node Modification procedure may be initiated either by the MN or by the SN and be used to modify, establish or release bearer contexts, to transfer bearer contexts to and from the SN or to modify other properties of the UE context within the same SN. It may also be used to transfer an NR RRC message from the SN to the UE via the MN and the response from the UE via MN to the SN (e.g. when SRB3 is not used). In case of CPC, this procedure is used to configure or modify CPC configuration within the same SN.

...

SN initiated Conditional SN Modification (CPC) without MN involvement (SRB3 is used)

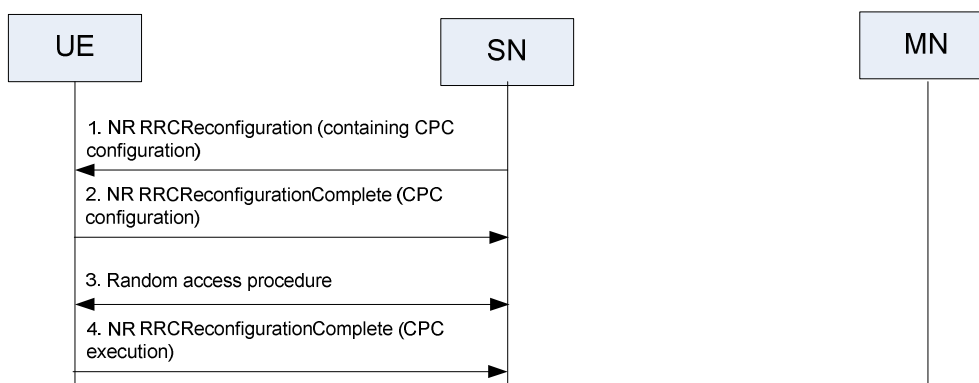

Figure 10.3.1-3a: SN Modification - SN-initiated without MN involvement and SRB3 is used to configure CPC.

The SN initiates the procedure when it needs to transfer an NR RRC message to the UE and SRB3 is used to configure CPC.

1. The SN sends the *RRCReconfiguration* message including CPC configuration to the UE through SRB3.
2. The UE applies the new configuration. The UE starts evaluating the CPC execution conditions for the candidate PSCell(s). The UE maintains connection with the source PSCell and replies with the *RRCReconfigurationComplete* message to the SN via SRB3.
3. If at least one CPC candidate PSCell satisfies the corresponding CPC execution condition, the UE detaches from the source PSCell, applies the stored configuration corresponding to the selected candidate PSCell and synchronises to the candidate PSCell.
4. The UE completes the CPC execution procedure by sending an *RRCReconfigurationComplete* message to the new PSCell.

Transfer of an NR RRC message to/from the UE (when SRB3 is not used)

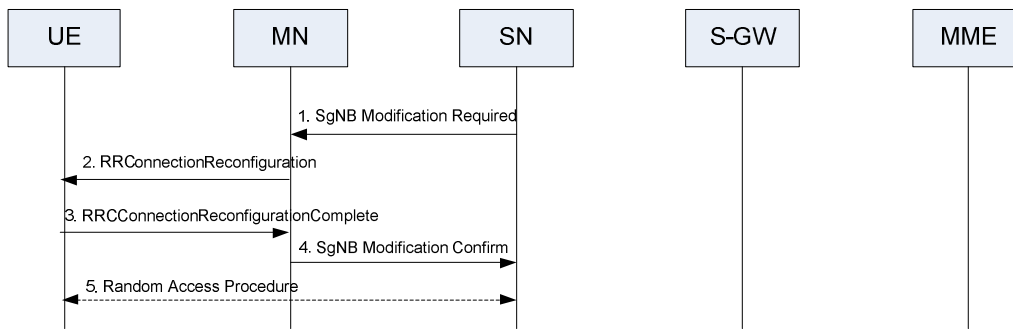

Figure 10.3.1-4: Transfer of an NR RRC message to/from the UE

The SN initiates the procedure when it needs to transfer an NR RRC message to the UE and SRB3 is not used.

1. The SN initiates the procedure by sending the *SgNB Modification Required* to the MN.
2. The MN forwards the NR RRC message to the UE in the *RRCConnectionReconfiguration* message.
3. The UE applies the new configuration and replies with the *RRCConnectionReconfigurationComplete* message.
4. The MN forwards the NR RRC response message, if received from the UE, to the SN in the *SgNB Modification Confirm* message.
5. If instructed, the UE performs synchronisation towards the PSCell of the SN as described in *SgNB Addition* procedure. Otherwise the UE may perform UL transmission after having applied the new configuration.

SN initiated Conditional SN Modification (CPC) without MN involvement (SRB3 is not used)

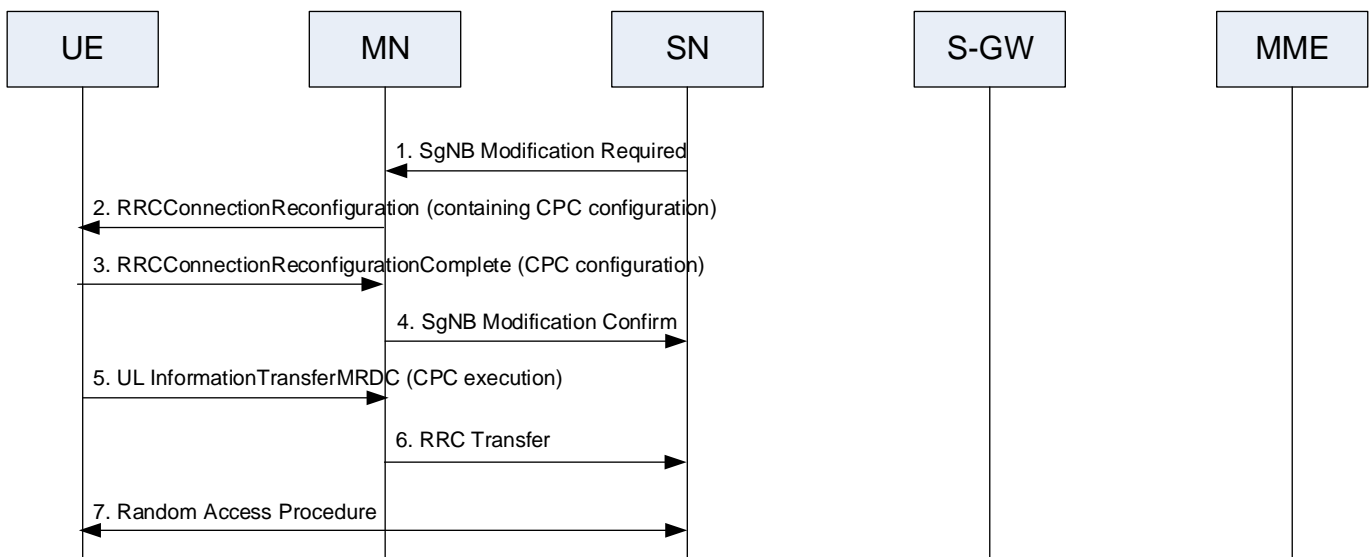

Figure 10.3.1-5: SN Modification - SN-initiated without MN involvement and SRB3 is not used to configure CPC

The SN initiates the procedure when it needs to transfer an NR RRC message to the UE and SRB3 is not used to configure CPC.

1. The SN initiates the procedure by sending the *SgNB Modification Required* to the MN including the SN RRC reconfiguration message with CPC configuration.
2. The MN forwards the SN RRC reconfiguration message to the UE including it in the *RRCConnectionReconfiguration* message.
3. The UE replies with the *RRCConnectionReconfigurationComplete* message by including the SN RRC reconfiguration complete message. The UE maintains connection with source PSCell after receiving CPC configuration, and starts evaluating the CPC execution conditions for the candidate PSCell(s).

4. The MN forwards the SN RRC response message, if received from the UE, to the SN by including it in the *SgNB Modification Confirm* message.
5. If at least one CPC candidate PSCell satisfies the corresponding CPC execution condition, the UE completes the CPC execution procedure by an *ULInformationTransferMRDC* message to the MN which includes an embedded *RRCReconfigurationComplete* message to the selected target PSCell.
6. The *RRCReconfigurationComplete* is forwarded to the SN embedded in RRC Transfer.
7. The UE detaches from the source PSCell, applies the stored corresponding configuration and synchronises to the selected candidate PSCell.

[TS 37.340, clause 10.6]

In MR-DC, a PSCell change does not always require a security key change.

...

A Conditional PSCell Change (CPC) is defined as a PSCell change that is executed by the UE when execution condition(s) is met. The UE starts evaluating the execution condition(s) upon receiving the CPC configuration, and stops evaluating the execution condition(s) once PSCell change is triggered. Only intra-SN CPC without MN involvement is supported.

The following principles apply to CPC:

- The CPC configuration contains the configuration of CPC candidate PSCell(s) and execution condition(s) generated by the SN.
- An execution condition may consist of one or two trigger condition(s) (CPC events A3/A5, as defined in TS 38.331 [4]). Only single RS type is supported and at most two different trigger quantities (e.g. RSRP and RSRQ, RSRP and SINR, etc.) can be configured simultaneously for the evaluation of CPC execution condition of a single candidate PSCell.
- Before any CPC execution condition is satisfied, upon reception of PSCell change command or PCell change command, the UE executes the PSCell change procedure as described in clause 10.3 and 10.5 or the PCell change procedure as described in clause 9.2.3.2 in TS 38.300[3] or clause 10.1.2.1 in TS 36.300 [2], regardless of any previously received CPC configuration. Upon the successful completion of PSCell change procedure or PCell change procedure, the UE releases all stored CPC configurations.
- While executing CPC, the UE is not required to continue evaluating the execution condition of other candidate PSCell(s).
- Once the CPC procedure is executed successfully, the UE releases all stored CPC configurations.
- Upon the release of SCG, the UE releases the stored CPC configurations.

CPC configuration in HO command, PSCell change command or conditional reconfiguration is not supported.

[TS 38.331, clause 5.3.5.1]

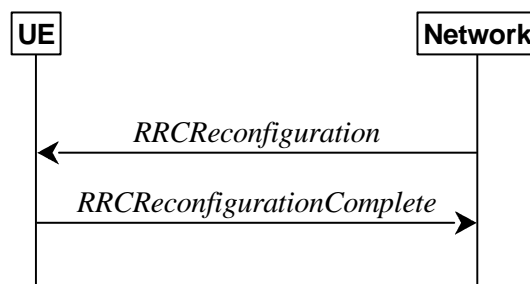

Figure 5.3.5.1-1: RRC reconfiguration, successful

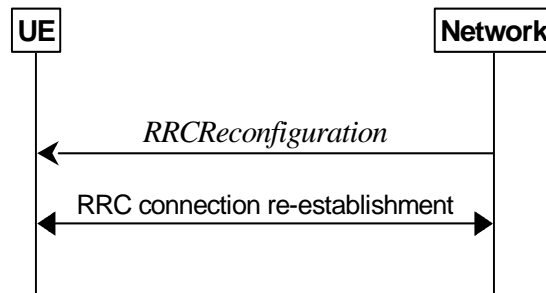

Figure 5.3.5.1-2: RRC reconfiguration, failure

The purpose of this procedure is to modify an RRC connection, e.g. to establish/modify/release RBs, to perform reconfiguration with sync, to setup/modify/release measurements, to add/modify/release SCells and cell groups, to add/modify/release conditional handover configuration, to add/modify/release conditional PSCell change configuration. As part of the procedure, NAS dedicated information may be transferred from the Network to the UE.

[TS 38.331, clause 5.3.5.13.1]

The network configures the UE with one or more candidate target SpCells in the conditional reconfiguration. The UE evaluates the condition of each configured candidate target SpCell. The UE applies the conditional reconfiguration associated with one of the target SpCells which fulfils associated execution condition. The network provides the configuration parameters for the target SpCell in the *ConditionalReconfiguration* IE.

The UE performs the following actions based on a received *ConditionalReconfiguration* IE:

- 1> if the *ConditionalReconfiguration* contains the *condReconfigToRemoveList*:
 - 2> perform conditional reconfiguration removal procedure as specified in 5.3.5.13.2;
- 1> if the *ConditionalReconfiguration* contains the *condReconfigToAddModList*:
 - 2> perform conditional reconfiguration addition/modification as specified in 5.3.5.13.3;

8.2.3.18.3.3 Test description

8.2.3.18.3.3.1 Pre-test conditions

System Simulator:

- E-UTRA Cell 1 is the PCell, E-UTRA Cell 2 is the target Pcell, NR Cell 1 is the source PSCell and NR Cell 2 and NR Cell 4 are the candidate target PSCell.

UE:

- None.

Preamble:

- If *pc_IP_Ping* is set to TRUE then, the UE is in state RRC_CONNECTED using generic procedure parameter Connectivity (*EN-DC*), Bearers (*MCG(s) and SCG*) established according to TS 38.508-1 [4], clause 4.5.4.2-1.
- Else, the UE is in state RRC_CONNECTED using generic procedure parameter Connectivity (*EN-DC*), Bearers (*MCG(s) and SCG*) and Test Loop Function (On) with UE test loop mode B activated according to TS 38.508-1 [4], table 4.5.4.2-1.

8.2.3.18.3.3.2 Test procedure sequence

Tables 8.2.3.18.3.3.2-1 and 8.2.3.18.3.3.2-2 illustrate the downlink power levels to be applied for NR Cells at various time instants of the test execution. Row marked "T0" denotes the conditions after the preamble, while the configuration

marked "T1", T2 and "T3", are applied at the point indicated in the Main behaviour description in Table 8.2.3.18.3.3.2-3.

Table 8.2.3.18.3.3.2-1: Power levels in FR1

	Parameter	Unit	E-UTRA Cell 1	E-UTRA Cell 2	NR Cell 1	NR Cell 2	NR Cell 4	Remark	
T0	Cell-specific RS EPRE	dBm/15kHz	-85	-91	-	-	-		
	SS/PBCH SSS EPRE	dBm/SCS	-	-	-88	-94	-94		
T1	Cell-specific RS EPRE	dBm/15kHz	-85	-79	-	-	-		
	SS/PBCH SSS EPRE	dBm/SCS	-	-	-88	-94	-94		
T2	Cell-specific RS EPRE	dBm/15kHz	-91	-85	-	-	-		Power levels are such that entry condition for event A3 is satisfied for NR Cell 4
	SS/PBCH SSS EPRE	dBm/SCS	-	-	-94	-94	-79		
T3	Cell-specific RS EPRE	dBm/15kHz	-91	-85	-	-	-		
	SS/PBCH SSS EPRE	dBm/SCS	-	-	-91	-82	-94		
T4	Cell-specific RS EPRE	dBm/15kHz	-91	-85	-	-	-	Power levels are such that entry condition for event A3 is satisfied for NR Cell 4	
	SS/PBCH SSS EPRE	dBm/SCS	-	-	-94	-94	-79		

Table 8.2.3.18.3.3.2-2: Power levels in FR2

	Parameter	Unit	E-UTRA Cell 1	E-UTRA Cell 2	NR Cell 1	NR Cell 2	NR Cell 4	Remark	
T0	Cell-specific RS EPRE	dBm/15kHz	FFS	FFS	-	-	-		
	SS/PBCH SSS EPRE	dBm/SCS	-	-	FFS	FFS	FFS		
T1	Cell-specific RS EPRE	dBm/15kHz	FFS	FFS	-	-	-		
	SS/PBCH SSS EPRE	dBm/SCS	-	-	FFS	FFS	FFS		
T2	Cell-specific RS EPRE	dBm/15kHz	FFS	FFS	-	-	-		Power levels are such that entry condition for event A3 is satisfied for NR Cell 4
	SS/PBCH SSS EPRE	dBm/SCS	-	-	FFS	FFS	FFS		
T3	Cell-specific RS EPRE	dBm/15kHz	FFS	FFS	-	-	-		
	SS/PBCH SSS EPRE	dBm/SCS	-	-	FFS	FFS	FFS		
T4	Cell-specific RS EPRE	dBm/15kHz	FFS	FFS	-	-	-	Power levels are such that entry condition for event A3 is satisfied for NR Cell 4	
	SS/PBCH SSS EPRE	dBm/SCS	-	-	FFS	FFS	FFS		

Table 8.2.3.18.3.3.2-3: Main behaviour

St	Procedure	Message Sequence		TP	Verdict
		U - S	Message		
1	The SS transmits an RRCConnectionReconfiguration message containing NR RRCReconfiguration message to perform conditional PSCell change with <i>ConditionalReconfiguration</i> to set NR Cell 4 as target candidate cell.	<-	RRCConnectionReconfiguration (RRCReconfiguration)	-	-

2	The UE transmits an <i>RRCConnectionReconfigurationComplete</i> message containing NR <i>RRCReconfigurationComplete</i> message on E-UTRA Cell 1	-->	RRCConnectionReconfigurationComplete (RRCReconfigurationComplete)	-	-
3	SS adjusts the cell-specific reference signal level according to row "T1".	-	-	-	-
4	The SS transmits an <i>RRCConnectionReconfiguration</i> message containing <i>mobilityControlInfo</i> to handover to E-UTRA Cell 2 and NR <i>RRCReconfiguration</i> message to perform SCG change with <i>reconfigurationWithSync</i> with the same PSCell.	<--	RRCConnectionReconfiguration (RRCReconfiguration)	-	-
5	SS adjusts the cell-specific reference signal level according to row "T2".	-	-	-	-
6	Check: Does the UE transmit an <i>RRCConnectionReconfigurationComplete</i> message containing NR <i>RRCReconfigurationComplete</i> message on E-UTRA Cell 2?	-->	RRCConnectionReconfigurationComplete (RRCReconfigurationComplete)	1	P
7	Check: Does the UE initiate a random access procedure by transmitting Preamble in NR Cell 4 within 10s?	-->	(PRACH Preamble)	1	F
8	SS adjusts the cell-specific reference signal level according to row "T3".	-	-	-	-
9	The SS transmits an <i>RRCConnectionReconfiguration</i> message containing NR <i>RRCReconfiguration</i> message to perform conditional PSCell change with <i>ConditionalReconfiguration</i> to set NR Cell 4 as target candidate cell.	<--	RRCConnectionReconfiguration (RRCReconfiguration)	-	-
10	The UE transmits an <i>RRCConnectionReconfigurationComplete</i> message containing NR <i>RRCReconfigurationComplete</i> message on E-UTRA Cell 1	-->	RRCConnectionReconfigurationComplete (RRCReconfigurationComplete)	-	-
11	The SS transmits an <i>RRCConnectionReconfiguration</i> message containing NR <i>RRCReconfiguration</i> message including <i>reconfigurewithsync</i> to handover source PSCell NR Cell 1 to target NR Cell 2 with Split DRB	<--	RRCConnectionReconfiguration (RRCReconfiguration)	-	-
12	Check: Does the UE transmit an <i>RRCConnectionReconfigurationComplete</i> message containing NR <i>RRCReconfigurationComplete</i> message?	-->	RRCConnectionReconfigurationComplete (RRCReconfigurationComplete)	2	P
13	SS adjusts the cell-specific reference signal level according to row "T4".	-	-	-	-
14	Check: Does the UE initiate a random access procedure by transmitting Preamble in NR Cell 4 within 10s?	-->	(PRACH Preamble)	2	F

8.2.3.18.3.3.3 Specific message contents

Table 8.2.3.18.3.3-1: *RRCConnectionReconfiguration* (step 1, 9 Table 8.2.3.18.3.3-2-3)

Derivation Path: TS 36.508 [7], Table 4.6.1-8 with condition EN-DC_EmbedNR_RRCRecon

Table 8.2.3.18.3.3-2: *RRCReconfiguration* (Table 8.2.3.18.3.3-1)

Derivation Path: TS 38.508-1 [4], Table 4.6.1-13 with condition EN-DC_MEAS and CHO			
Information Element	Value/remark	Comment	Condition
RRCReconfiguration ::= SEQUENCE {			

criticalExtensions CHOICE {			
rrcReconfiguration SEQUENCE {			
measConfig	MeasConfig	Table 8.2.3.18.1.3.3-3	
nonCriticalExtension SEQUENCE {			
nonCriticalExtension SEQUENCE {			
nonCriticalExtension SEQUENCE {			
nonCriticalExtension SEQUENCE {			
conditionalReconfiguration-r16	ConditionalReconfiguration	Table 8.2.3.18.1.3.3-6	
}			
}			
}			
}			
}			

Table 8.2.3.18.3.3-3: MeasConfig (Table 8.2.3.18.3.3-2)

Derivation Path: TS 38.508-1 [4] Table 4.6.3-69			
Information Element	Value/remark	Comment	Condition
MeasConfig ::= SEQUENCE {			
measObjectToAddModList SEQUENCE (SIZE (1..maxNrofMeasId)) OF MeasObjectToAddMod {	1 entry		
MeasObjectToAddMod[1] SEQUENCE {			
measObjectId	1		
measObject CHOICE {			
measObjectNR	MeasObjectNR	Table 8.2.3.18.1.3.3-4	
}			
}			
reportConfigToAddModList SEQUENCE (SIZE (1..maxReportConfigId)) OF ReportConfigToAddMod {	1 entry		
ReportConfigToAddMod[1] SEQUENCE {			
reportConfigId	1		
reportConfig CHOICE {			
reportConfigNR	ReportConfigNR-condEventA3	Table 8.2.3.18.1.3.3-5	
}			
}			
measIdToAddModList SEQUENCE (SIZE (1..maxNrofMeasId)) OF MeasIdToAddMod {	1 entry		
MeasIdToAddMod[1] SEQUENCE {			
measId	1		
measObjectId	1		
reportConfigId	1		
}			
}			
}			

Table 8.2.3.18.3.3-4: MeasObjectNR (Table 8.2.3.18.3.3-3)

Derivation Path: TS 38.508-1 [4] Table 4.6.3-76			
Information Element	Value/remark	Comment	Condition
MeasObjectNR ::= SEQUENCE {			
ssbFrequency	ARFCN-ValueNR for SSB of NR Cell 1	The SSB of NR cell 1, NR Cell 2 and NR cell 4 have the same ARFCN value as specified in TS	

		38.508-1 [4] clause 6.2.3	
absThreshSS-BlocksConsolidation	Not present		
nrofSS-BlocksToAverage	Not present		
}			

Table 8.2.3.18.3.3.3-5: ReportConfigNR-condEventA3 (Table 8.2.3.18.3.3.3-3)

Derivation Path: TS 38.508-1 [4] Table 4.6.3-142 with condition CHO AND EVENT_A3			
Information Element	Value/remark	Comment	Condition
ReportConfigNR ::= SEQUENCE {			
reportType CHOICE {			
condTriggerConfig SEQUENCE {			
condEventId CHOICE {			
condEventA3 SEQUENCE {			
a3-Offset CHOICE {			
rsp	2	1 dB (2*0.5 dB)	FR1
	FFS		FR2
}			
}			
}			
}			
}			

Table 8.2.3.18.3.3.3-6: ConditionalReconfiguration (Table 8.2.3.18.3.3.3-2)

Derivation Path: TS 38.508-1 [4] Table 4.6.3-25D			
Information Element	Value/remark	Comment	Condition
ConditionalReconfiguration-r16 ::= SEQUENCE {			
condReconfigToAddModList-r16 ::= SEQUENCE (SIZE (1.. maxNrofCondCells-r16)) OF CondReconfigToAddMod-r16 {	1 entry		
CondReconfigToAddMod-r16[2] ::= SEQUENCE {			
condReconfigId-r16	1		
condExecutionCond-r16 ::= SEQUENCE {	1 entry		
MeasId[1]	1		
}			
condRRCReconfig-r16	RRCReconfiguration-HO with condition HO_NR cell 4	Table 8.2.3.18.3.3.3-7	
}			
}			

Table 8.2.3.18.3.3.3-7: RRCReconfiguration-HO (Table 8.2.3.18.3.3.3-6)

Derivation Path: TS 38.508-1 [4] Table 4.8.1-1A with condition RBConfig_KeyChange			
Information Element	Value/remark	Comment	Condition
RRCReconfiguration ::= SEQUENCE {			
criticalExtensions CHOICE {			
rrcReconfiguration SEQUENCE {			
secondaryCellGroup SEQUENCE {	CellGroupConfig with condition PCI_NR cell 4	Table 8.2.3.18.3.3.3-8	HO_NR cell 4
}			
}			
}			

Table 8.2.3.18.3.3.3-8: CellGroupConfig (Table 8.2.3.18.3.3.3-7)

Derivation Path: TS 38.508-1 [4], Table 4.6.3-19 with Condition PSCell_change

Information Element	Value/remark	Comment	Condition
CellGroupConfig ::= SEQUENCE {			
spCellConfig SEQUENCE {			
reconfigurationWithSync SEQUENCE {			
spCellConfigCommon SEQUENCE {			
physCellId	Physical Cell Identity of NR Cell 4		PCI_NR cell 4
}			
}			
}			
}			

Table 8.2.3.18.3.3-9: RRCConnectionReconfiguration (step 4, Table 8.2.3.18.3.3.2-3)

Derivation Path: TS 36.508 [7], Table 4.6.1-8 with condition EN-DC_EmbedNR_RRCRecon and EN-DC_PSCell_HO AND RBConfig_KeyChange

Information Element	Value/remark	Comment	Condition
RRCConnectionReconfiguration ::= SEQUENCE {			
criticalExtensions CHOICE {			
c1 CHOICE {			
rrcConnectionReconfiguration-r8 SEQUENCE {			
mobilityControlInfo SEQUENCE {	MobilityControlInfo-HO		
targetPhysCellId	PhysicalCellIdentity of E-UTRA Cell 2		
carrierFreq SEQUENCE {			
dl-CarrierFreq	Same downlink EARFCN as used for E-UTRA Cell 2		
}			
carrierFreq SEQUENCE {}	Not present		Band > 64
carrierFreq-v9e0 SEQUENCE {			Band > 64
dl-CarrierFreq-v9e0	Same downlink EARFCN as used for E-UTRA Cell 2		
}			
}			
nonCriticalExtension SEQUENCE {			
nonCriticalExtension SEQUENCE {			
nonCriticalExtension SEQUENCE {			
nonCriticalExtension SEQUENCE {			
nonCriticalExtension SEQUENCE {			
nonCriticalExtension SEQUENCE {			
nonCriticalExtension SEQUENCE {			
nonCriticalExtension SEQUENCE {			
sk-Counter-r15	Different counter value used before Handover than what was used for initial Split bearer configuration.		
}			
}			
}			

Condition	Explanation
-----------	-------------

Information Element	Value/remark	Comment	Condition
CellGroupConfig ::= SEQUENCE {			
spCellConfig SEQUENCE {			
reconfigurationWithSync SEQUENCE {			
spCellConfigCommon SEQUENCE {			
physCellId	Physical Cell Identity of NR Cell 2		
}			
newUE-Identity	'4148'H		
}			
}			

8.2.4 Carrier Aggregation

8.2.4.1 NR CA / NR SCell addition / modification / release / Success

8.2.4.1.1 NR CA / NR SCell addition / modification / release / Success / EN-DC

8.2.4.1.1.1 NR CA / NR SCell addition / modification / release / Success / EN-DC / Intra-band Contiguous CA

8.2.4.1.1.1.1 Test Purpose (TP)

(1)

```
with { UE in RRC_CONNECTED state with EN-DC, and, MCG(s) (E-UTRA PDCP) and SCG with initial AS security activated }
ensure that {
  when { UE receives an RRCConnectionReconfiguration message with nr-Config IE including NR RRCReconfiguration message containing sCellToAddModList with an sCellIndex set to the configured SCell }
  then { UE adds the new SCell, configures lower layers to consider the SCell to be in deactivated state and sends an RRCConnectionReconfigurationComplete message }
}
```

(2)

```
with { UE in RRC_CONNECTED state with EN-DC, and, MCG(s) (E-UTRA PDCP) and SCG with SCell(s) configured }
ensure that {
  when { UE receives an RRCConnectionReconfiguration message with nr-Config IE including NR RRCReconfiguration message containing sCellToAddModList with an sCellIndex matching one of the current UE SCell configuration }
  then { UE modifies the affected SCell dedicated configurations and sends an RRCConnectionReconfigurationComplete message }
}
```

(3)

```
with { UE in RRC_CONNECTED state with EN-DC, and, MCG(s) (E-UTRA PDCP) and SCG with SCell(s) configured }
ensure that {
  when { UE receives an RRCConnectionReconfiguration message with nr-Config IE including NR RRCReconfiguration message containing sCellToReleaseList with an sCellIndex matching one of the current UE SCell configuration }
  then { UE releases the SCell and sends an RRCConnectionReconfigurationComplete message }
}
```

8.2.4.1.1.1.2 Conformance requirements

References: The conformance requirements covered in the present TC are specified in: TS 36.331: 5.3.5.3; TS 38.331: 5.3.5.3, 5.3.5.5.8, 5.3.5.5.9. Unless otherwise stated these are Rel-15 requirements.

[TS 36.331, clause 5.3.5.3]

If the *RRCCConnectionReconfiguration* message does not include the *mobilityControlInfo* and the UE is able to comply with the configuration included in this message, the UE shall:

- 1> if this is the first *RRCCConnectionReconfiguration* message after successful completion of the RRC connection re-establishment procedure:
 - 2> re-establish PDCP for SRB2 configured with E-UTRA PDCP entity and for all DRBs that are established and configured with E-UTRA PDCP, if any;
 - 2> re-establish RLC for SRB2 and for all DRBs that are established and configured with E-UTRA RLC, if any;
- 2> if the *RRCCConnectionReconfiguration* message includes the *fullConfig*:
 - 3> perform the radio configuration procedure as specified in 5.3.5.8;
- 2> if the *RRCCConnectionReconfiguration* message includes the *radioResourceConfigDedicated*:
 - 3> perform the radio resource configuration procedure as specified in 5.3.10;

NOTE 1: Void

NOTE 2: Void

1> else:

- 2> if the *RRCCConnectionReconfiguration* message includes the *radioResourceConfigDedicated*:
 - 3> perform the radio resource configuration procedure as specified in 5.3.10;

NOTE 3: If the *RRCCConnectionReconfiguration* message includes the establishment of radio bearers other than SRB1, the UE may start using these radio bearers immediately, i.e. there is no need to wait for an outstanding acknowledgment of the *SecurityModeComplete* message.

- 1> if the received *RRCCConnectionReconfiguration* includes the *sCellToReleaseList*:
 - 2> perform SCell release as specified in 5.3.10.3a;
- 1> if the received *RRCCConnectionReconfiguration* includes the *sCellToAddModList*:
 - 2> perform SCell addition or modification as specified in 5.3.10.3b;
- 1> if the received *RRCCConnectionReconfiguration* includes the *scg-Configuration*; or
- 1> if the current UE configuration includes one or more split DRBs configured with *pdcp-Config* and the received *RRCCConnectionReconfiguration* includes *radioResourceConfigDedicated* including *drb-ToAddModList*:
 - 2> perform SCG reconfiguration as specified in 5.3.10.10;
- 1> if the received *RRCCConnectionReconfiguration* includes the *nr-Config* and it is set to *release*: or
- 1> if the received *RRCCConnectionReconfiguration* includes *endc-ReleaseAndAdd* and it is set to *TRUE*:
 - 2> perform EN-DC release as specified in TS 38.331 [82], clause 5.3.5.10;
- 1> if the received *RRCCConnectionReconfiguration* includes the *sk-Counter*:
 - 2> perform key update procedure as specified in TS 38.331 [82], clause 5.3.5.7;
- 1> if the received *RRCCConnectionReconfiguration* includes the *nr-SecondaryCellGroupConfig*:
 - 2> perform NR RRC Reconfiguration as specified in TS 38.331 [82], clause 5.3.5.3;
- 1> if the received *RRCCConnectionReconfiguration* includes the *nr-RadioBearerConfig1*:
 - 2> perform radio bearer configuration as specified in TS 38.331 [82], clause 5.3.5.6;

- 1> if the received *RRCCONNECTIONRECONFIGURATION* includes the *nr-RadioBearerConfig2*:
 - 2> perform radio bearer configuration as specified in TS 38.331 [82], clause 5.3.5.6;
- 1> if this is the first *RRCCONNECTIONRECONFIGURATION* message after successful completion of the RRC connection re-establishment procedure:
 - 2> resume SRB2 and all DRBs that are suspended, if any, including RBs configured with NR PDCP;

NOTE 4: The handling of the radio bearers after the successful completion of the PDCP re-establishment, e.g. the re-transmission of unacknowledged PDCP SDUs (as well as the associated status reporting), the handling of the SN and the HFN, is specified in TS 36.323 [8].

NOTE 5: The UE may discard SRB2 messages and data that it receives prior to completing the reconfiguration used to resume these bearers.

- 1> if the received *RRCCONNECTIONRECONFIGURATION* includes the *systemInformationBlockType1Dedicated*:
 - 2> perform the actions upon reception of the *SystemInformationBlockType1* message as specified in 5.2.2.7;
- 1> if the *RRCCONNECTIONRECONFIGURATION* message includes the *dedicatedInfoNASList*:
 - 2> forward each element of the *dedicatedInfoNASList* to upper layers in the same order as listed;
- 1> if the *RRCCONNECTIONRECONFIGURATION* message includes the *measConfig*:
 - 2> perform the measurement configuration procedure as specified in 5.5.2;
- 1> perform the measurement identity autonomous removal as specified in 5.5.2.2a;
- 1> if the *RRCCONNECTIONRECONFIGURATION* message includes the *otherConfig*:
 - 2> perform the other configuration procedure as specified in 5.3.10.9;
- 1> upon RRC connection establishment, if UE does not need UL gaps during continuous uplink transmission:
 - 2> configure lower layers to stop using UL gaps during continuous uplink transmission in FDD for *RRCCONNECTIONRECONFIGURATIONCOMPLETE* message and subsequent uplink transmission in RRC_CONNECTED except for UL transmissions as specified in TS36.211 [21];
- 1> set the content of *RRCCONNECTIONRECONFIGURATIONCOMPLETE* message as follows:
 - 2> if the *RRCCONNECTIONRECONFIGURATION* message includes *perCC-GapIndicationRequest*:
 - 3> include *perCC-GapIndicationList* and *numFreqEffective*;
 - 2> if the frequencies are configured for reduced measurement performance:
 - 3> include *numFreqEffectiveReduced*;
 - 2> if the received *RRCCONNECTIONRECONFIGURATION* message included *nr-SecondaryCellGroupConfig*:
 - 3> include *scg-ConfigResponseNR* in accordance with TS 38.331 [82, 5.3.5.3];
- 1> submit the *RRCCONNECTIONRECONFIGURATIONCOMPLETE* message to lower layers for transmission using the new configuration, upon which the procedure ends;

[TS 38.331, clause 5.3.5.3]

The UE shall perform the following actions upon reception of the *RRCReconfiguration*:

- 1> if the *RRCReconfiguration* includes the *fullConfig*:
 - 2> perform the radio configuration procedure as specified in 5.3.5.11;
- 1> if the *RRCReconfiguration* includes the *masterCellGroup*:
 - 2> perform the cell group configuration for the received *masterCellGroup* according to 5.3.5.5;

- 1> if the *RRCReconfiguration* includes the *masterKeyUpdate*:
 - 2> perform security key update procedure as specified in 5.3.5.7;
 - 1> if the *RRCReconfiguration* includes the *secondaryCellGroup*:
 - 2> perform the cell group configuration for the SCG according to 5.3.5.5;
 - 1> if the *RRCReconfiguration* message contains the *radioBearerConfig*:
 - 2> perform the radio bearer configuration according to 5.3.5.6;
 - 1> if the *RRCReconfiguration* message includes the *measConfig*:
 - 2> perform the measurement configuration procedure as specified in 5.5.2;
 - 1> if the *RRCReconfiguration* message includes the *dedicatedNAS-MessageList*:
 - 2> forward each element of the *dedicatedNAS-MessageList* to upper layers in the same order as listed;
 - 1> if the *RRCReconfiguration* message includes the *dedicatedSIB1-Delivery*:
 - 2> perform the action upon reception of *SIB1* as specified in 5.2.2.4.2;
 - 1> if the *RRCReconfiguration* message includes the *dedicatedSystemInformationDelivery*:
 - 2> perform the action upon reception of System Information as specified in 5.2.2.4;
 - 1> set the content of *RRCReconfigurationComplete* message as follows:
 - 2> if the *RRCReconfiguration* includes the *masterCellGroup* containing the *reportUplinkTxDirectCurrent*, or;
 - 2> if the *RRCReconfiguration* includes the *secondaryCellGroup* containing the *reportUplinkTxDirectCurrent*:
 - 3> include the *uplinkTxDirectCurrentList*;
 - 1> if the UE is configured with E-UTRA *nr-SecondaryCellGroupConfig* (MCG is E-UTRA):
 - 2> if *RRCReconfiguration* was received via SRB1:
 - 3> submit the *RRCReconfigurationComplete* via the EUTRA MCG embedded in E-UTRA RRC message *RRCCConnectionReconfigurationComplete* as specified in TS 36.331 [10];
 - 3> if *reconfigurationWithSync* was included in *spCellConfig* of an SCG:
 - 4> initiate the random access procedure on the SpCell, as specified in TS 38.321 [3];
 - 3> else:
 - 4> the procedure ends;
- NOTE: The order the UE sends the *RRCCConnectionReconfigurationComplete* message and performs the Random Access procedure towards the SCG is left to UE implementation.
- 2> else (*RRCReconfiguration* was received via SRB3):
 - 3> submit the *RRCReconfigurationComplete* message via SRB3 to lower layers for transmission using the new configuration;
- NOTE: For EN-DC, in the case *RRCReconfiguration* is received via SRB1, the random access is triggered by RRC layer itself as there is not necessarily other UL transmission. In the case *RRCReconfiguration* is received via SRB3, the random access is triggered by the MAC layer due to arrival of *RRCCReconfigurationComplete*.
- 1 > else:
 - 2> submit the *RRCReconfigurationComplete* message via SRB1 to lower layers for transmission using the new configuration;

- 2> if this is the first *RRCReconfiguration* message after successful completion of the RRC re-establishment procedure:
- 3> resume SRB2 and DRBs that are suspended;
- 1> if *reconfigurationWithSync* was included in *spCellConfig* of an MCG or SCG, and when MAC of an NR cell group successfully completes a random access procedure triggered above;
 - 2> stop timer T304 for that cell group;
 - 2> apply the parts of the CQI reporting configuration, the scheduling request configuration and the sounding RS configuration that do not require the UE to know the SFN of the respective target SpCell, if any;
 - 2> apply the parts of the measurement and the radio resource configuration that require the UE to know the SFN of the respective target SpCell (e.g. measurement gaps, periodic CQI reporting, scheduling request configuration, sounding RS configuration), if any, upon acquiring the SFN of that target SpCell;
- 2> if the *reconfigurationWithSync* was included in *spCellConfig* of an MCG:
 - 3> if T390 is running:
 - 4> stop timer T390 for all access categories;
 - 4> perform the actions as specified in 5.3.14.4.
 - 3> if *RRCReconfiguration* does not include *dedicatedSIB1-Delivery* and
 - 3> if the active downlink BWP, which is indicated by the *firstActiveDownlinkBWP-Id* for the target SpCell of the MCG, has a common search space configured by *searchSpaceSIB1*:
 - 4> acquire the *SIB1*, which is scheduled as specified in TS 38.213 [13], of the target SpCell of the MCG;
 - 4> upon acquiring *SIB1*, perform the actions specified in clause 5.2.2.4.2;
 - 2> the procedure ends.

NOTE: The UE is only required to acquire broadcasted *SIB1* if the UE can acquire it without disrupting unicast data reception, i.e. the broadcast and unicast beams are quasi co-located.

[TS 38.331, clause 5.3.5.5.8]

The UE shall:

- 1> if the release is triggered by reception of the *sCellToReleaseList*:
 - 2> for each *sCellIndex* value included in the *sCellToReleaseList*:
 - 3> if the current UE configuration includes an SCell with value *sCellIndex*:
 - 4> release the SCell.

[TS 38.331, clause 5.3.5.5.9]

The UE shall:

- 1> for each *sCellIndex* value included in the *sCellToAddModList* that is not part of the current UE configuration (SCell addition):
 - 2> add the SCell, corresponding to the *sCellIndex*, in accordance with the *sCellConfigCommon* and *sCellConfigDedicated*;
 - 2> configure lower layers to consider the SCell to be in deactivated state;

Editor's Note: FFS Check automatic measurement handling for SCells.

- 2> for each *measId* included in the *measIdList* within *VarMeasConfig*:
 - 3> if SCells are not applicable for the associated measurement; and

3> if the concerned SCell is included in *cellsTriggeredList* defined within the *VarMeasReportList* for this *measId*:

4> remove the concerned SCell from *cellsTriggeredList* defined within the *VarMeasReportList* for this *measId*;

1> for each *sCellIndex* value included in the *sCellToAddModList* that is part of the current UE configuration (SCell modification):

1> modify the SCell configuration in accordance with the *sCellConfigDedicated*.

8.2.4.1.1.1.3 Test description

8.2.4.1.1.1.3.1 Pre-test conditions

System Simulator:

- E-UTRA Cell 1 is the PCell. NR Cell 1 is the PSCell and NR Cell 3 is the SCell.

UE:

- None.

Preamble:

- If *pc_IP_Ping* is set to TRUE then, the UE is in state RRC_CONNECTED using generic procedure parameter Connectivity (*EN-DC*), Bearers (*MCG(s) and SCG*) established according to TS 38.508-1 [4], clause 4.5.4.
- Else, the UE is in state RRC_CONNECTED using generic procedure parameter Connectivity (*EN-DC*), Bearers (*MCG(s) and SCG*) established and Test Loop Function (On) with UE test loop mode B according to TS 38.508-1 [4], clause 4.5.4.

8.2.4.1.1.1.3.2 Test procedure sequence

Table 8.2.4.1.1.1.3.2-1: Main behaviour

St	Procedure	Message Sequence		TP	Verdict
		U - S	Message		
1	The SS transmits a <i>RRCConnectionReconfiguration</i> message including NR <i>RRCReconfiguration</i> message to configure the NR SCell.	<--	<i>RRCConnectionReconfiguration (RRCReconfiguration)</i>	-	-
2	Check: Does the UE transmit a <i>RRCConnectionReconfigurationComplete</i> message containing <i>RRCReconfigurationComplete</i> message?	-->	<i>RRCConnectionReconfigurationComplete (RRCReconfigurationComplete)</i>	1	P
2A	Check: Does the test result of generic test procedure in TS 38.508-1 Table 4.9.1-1A indicate that the UE is capable of exchanging IP data on DRB #n associated with the first PDU session on NR Cell 3?	-	-	-	-
3	The SS transmits a <i>RRCConnectionReconfiguration</i> message including NR <i>RRCReconfiguration</i> message to modify the <i>startingBitOfFormat2-3</i> of the NR SCell.	<--	<i>RRCConnectionReconfiguration (RRCReconfiguration)</i>	-	-
4	Check: Does the UE transmit a <i>RRCConnectionReconfigurationComplete</i> message containing NR <i>RRCReconfigurationComplete</i> message?	-->	<i>RRCConnectionReconfigurationComplete (RRCReconfigurationComplete)</i>	2	P
4A	Check: Does the test result of generic test procedure in TS 38.508-1 Table 4.9.1-1A indicate that the UE is capable of exchanging	-	-	-	-

	IP data on DRB #n associated with the first PDU session on NR Cell 3?				
5	The SS transmits a <i>RRCConnectionReconfiguration</i> message including NR <i>RRCReconfiguration</i> message to release the NR SCell.	<--	<i>RRCConnectionReconfiguration</i> (<i>RRCReconfiguration</i>)	-	-
6	Check: Does the UE release SCell and sends a <i>RRCConnectionReconfigurationComplete</i> message containing NR <i>RRCReconfigurationComplete</i> message?	-->	<i>RRCConnectionReconfigurationComplete</i> (<i>RRCReconfigurationComplete</i>)	3	P

8.2.4.1.1.1.3.3 Specific message contents

Table 8.2.4.1.1.1.3.3-1: RRCConnectionReconfiguration (step 1, Table 8.2.4.1.1.1.3.2-1)

Derivation Path: TS 36.508 [7], Table 4.6.1-8 with condition EN-DC_NR_CA			
Information Element	Value/remark	Comment	Condition
RRCConnectionReconfiguration ::= SEQUENCE {			
criticalExtensions CHOICE {			
c1 CHOICE {			
rrcConnectionReconfiguration-r8 SEQUENCE {			
nonCriticalExtension SEQUENCE {			
nonCriticalExtension SEQUENCE {			
nonCriticalExtension SEQUENCE {			
nonCriticalExtension SEQUENCE {			
nonCriticalExtension SEQUENCE {			
nonCriticalExtension SEQUENCE {			
nr-Config-r15 CHOICE {			
setup SEQUENCE {			
nr-SecondaryCellGroupConfig-r15	OCTET STRING including the <i>RRCReconfiguration</i> message and the IE <i>secondaryCellGroup</i> .		
}			
}			
}			
}			
}			
}			
}			
}			

Table 8.2.4.1.1.1.3.3-2: RRCReconfiguration (Table 8.2.4.1.1.1.3.3-1)

Derivation Path: TS 38.508-1 [4], Table 4.6.1-13			
Information Element	Value/remark	Comment	Condition
RRCReconfiguration ::= SEQUENCE {			
criticalExtensions CHOICE {			
rrcReconfiguration SEQUENCE {			
secondaryCellGroup	CellGroupConfig		
}			
}			
}			

Table 8.2.4.1.1.3.3-3: CellGroupConfig (Table 8.2.4.1.1.3.3-2)

Derivation Path: TS 38.508-1 [4], Table 4.6.3-19 With condition SCell_Add			
Information Element	Value/remark	Comment	Condition
CellGroupConfig ::= SEQUENCE {			
sCellToAddModList SEQUENCE (SIZE (1..maxMeasId)) OF SCellConfig {	1 entry		
SCellConfig[1] SEQUENCE {		entry 1	
sCellIndex	1		
sCellConfigCommon	ServingCellConfigCommon		
}			
}			
}			

Table 8.2.4.1.1.3.3-4: ServingCellConfigCommon (Table 8.2.4.1.1.3.3-3)

Derivation Path: TS 38.508-1 [4], Table 4.6.3-168.			
Information Element	Value/remark	Comment	Condition
ServingCellConfigCommon ::= SEQUENCE {			
PhysCellId	Physical Cell Identity of NR Cell 3		
}			

Table 8.2.4.1.1.3.3-5: RRCConnectionReconfiguration (step 3, Table 8.2.4.1.1.3.2-1)

Derivation Path: TS 36.508 [7], Table 4.6.1-8 with condition EN-DC_NR_CA			
Information Element	Value/remark	Comment	Condition
RRCConnectionReconfiguration ::= SEQUENCE {			
criticalExtensions CHOICE {			
c1 CHOICE {			
rrcConnectionReconfiguration-r8 SEQUENCE {			
nonCriticalExtension SEQUENCE {			
nonCriticalExtension SEQUENCE {			
nonCriticalExtension SEQUENCE {			
nonCriticalExtension SEQUENCE {			
nonCriticalExtension SEQUENCE {			
nonCriticalExtension SEQUENCE {			
nonCriticalExtension SEQUENCE {			
nr-Config-r15 CHOICE {			
setup SEQUENCE {			
nr-SecondaryCellGroupConfig-r15	OCTET STRING including the <i>RRCReconfiguration</i> message and the IE <i>secondaryCellGroup</i> .		
}			
}			
}			
}			
}			
}			
}			
}			
}			
}			

Table 8.2.4.1.1.3.3-6: RRCReconfiguration (Table 8.2.4.1.1.3.3-5)

Derivation Path: TS 38.508-1 [4], Table 4.6.1-13			
Information Element	Value/remark	Comment	Condition
RRCReconfiguration ::= SEQUENCE {			
criticalExtensions CHOICE {			
rrcReconfiguration SEQUENCE {			
secondaryCellGroup	CellGroupConfig		
}			
}			
}			

Table 8.2.4.1.1.3.3-7: CellGroupConfig (Table 8.2.4.1.1.3.3-6)

Derivation Path: TS 38.508-1 [4], Table 4.6.3-19 with condition SCell_Add			
Information Element	Value/remark	Comment	Condition
CellGroupConfig ::= SEQUENCE {			
sCellToAddModList SEQUENCE	1 entry		
(SIZE(1..maxNrofSCells)) OF SCellConfig {			
SCellConfig[1] SEQUENCE {		entry 1	
sCellConfigDedicated	ServingCellConfig		
}			
}			
}			

Table 8.2.4.1.1.3.3-8: ServingCellConfig (Table 8.2.4.1.1.3.3-7)

Derivation Path: TS 38.508-1 [4], Table 4.6.3-167			
Information Element	Value/remark	Comment	Condition
ServingCellConfig ::= SEQUENCE {			
initialDownlinkBWP	BWP-DownlinkDedicated		
firstActiveDownlinkBWP-Id	Not present		
uplinkConfig SEQUENCE {			
firstActiveUplinkBWP-Id	Not present		
}			
}			

Table 8.2.4.1.1.3.3-9: BWP-DownlinkDedicated (Table 8.2.4.1.1.3.3-8)

Derivation Path: TS 38.508-1 [4], Table 4.6.3-11 with condition Scell_Add			
Information Element	Value/remark	Comment	Condition
BWP-DownlinkDedicated ::= SEQUENCE {			
pdcch-Config CHOICE {			
setup	PDCCH-Config		
}			
}			

Table 8.2.4.1.1.3.3-10: PDCCH-Config (Table 8.2.4.1.1.3.3-9)

Derivation Path: TS 38.508-1 [4], Table 4.6.3-100			
Information Element	Value/remark	Comment	Condition
PDCCH-Config ::= SEQUENCE {			
tpc-SRS SetupRelease {			
setup	SRS-TPC- CommandConfig		
}			
}			

Table 8.2.4.1.1.1.3.3-11: SRS-TPC-CommandConfig (Table 8.2.4.1.1.1.3.3-10)

Derivation Path: TS 38.508-1 [4], Table 4.6.3-183			
Information Element	Value/remark	Comment	Condition
SRS-TPC-CommandConfig ::= SEQUENCE {			
startingBitOfFormat2-3	1		
fieldTypeFormat2-3	1		
}			

Table 8.2.4.1.1.1.3.3-12: RRCConnectionReconfiguration (step 5, Table 8.2.4.1.1.1.3.2-1)

Derivation Path: TS 36.508 [7], Table 4.6.1-8 with condition EN-DC_NR_CA			
Information Element	Value/remark	Comment	Condition
RRCConnectionReconfiguration ::= SEQUENCE {			
criticalExtensions CHOICE {			
c1 CHOICE {			
rrcConnectionReconfiguration-r8 SEQUENCE {			
nonCriticalExtension SEQUENCE {			
nonCriticalExtension SEQUENCE {			
nonCriticalExtension SEQUENCE {			
nonCriticalExtension SEQUENCE {			
nonCriticalExtension SEQUENCE {			
nonCriticalExtension SEQUENCE {			
nonCriticalExtension SEQUENCE {			
nonCriticalExtension SEQUENCE {			
nr-Config-r15 CHOICE {			
setup SEQUENCE {			
nr-SecondaryCellGroupConfig-r15	OCTET STRING including the <i>RRCReconfiguration</i> message and the IE <i>secondaryCellGroup</i> .		
}			
}			
}			
}			
}			
}			
}			

Table 8.2.4.1.1.1.3.3-13: RRCReconfiguration (Table 8.2.4.1.1.1.3.3-12)

Derivation Path: TS 38.508-1 [4], Table 4.6.1-13			
Information Element	Value/remark	Comment	Condition
RRCReconfiguration ::= SEQUENCE {			
criticalExtensions CHOICE {			
rrcReconfiguration SEQUENCE {			
secondaryCellGroup	CellGroupConfig		
}			
}			
}			

Table 8.2.4.1.1.1.3.3-14: CellGroupConfig (Table 8.2.4.1.1.1.3.3-13)

Derivation Path: TS 38.508-1 [4], Table 4.6.3-19			
--	--	--	--

Information Element	Value/remark	Comment	Condition
CellGroupConfig ::= SEQUENCE {			
sCellToReleaseList SEQUENCE (SIZE(1..maxNrofSCells)) OF SCellIndex {	1 entry		
SCellIndex[1]	2	entry 1	
}			
}			

8.2.4.1.1.2 NR CA / NR SCell addition / modification / release / Success / EN-DC / Intra-band non-Contiguous CA

8.2.4.1.1.2.1 Test Purpose (TP)

Same as TC 8.2.4.1.1.1 but applied to Intra-band non-Contiguous CA.

8.2.4.1.1.2.2 Conformance requirements

Same as TC 8.2.4.1.1.1 but applied to Intra-band non-Contiguous CA.

8.2.4.1.1.2.3 Test description

8.2.4.1.1.2.3.1 Pre-test conditions

Same as TC 8.2.4.1.1.1 with the following differences:

- CA configuration: Intra-band non-Contiguous CA replaces Intra-band Contiguous CA

8.2.4.1.1.2.3.2 Test procedure sequence

Same as TC 8.2.4.1.1.1 with the following differences:

- CA configuration: Intra-band non-Contiguous CA replaces Intra-band Contiguous CA

8.2.4.1.1.3 NR CA / NR SCell addition / modification / release / Success / EN-DC / Inter-band CA

8.2.4.1.1.3.1 Test Purpose (TP)

Same as TC 8.2.4.1.1.1 but applied to Inter-band CA

8.2.4.1.1.3.2 Conformance requirements

Same as TC 8.2.4.1.1.1 but applied to Inter-band CA

8.2.4.1.1.3.3 Test description

8.2.4.1.1.3.3.1 Pre-test conditions

Same as TC 8.2.4.1.1.1 with the following differences:

- CA configuration: Inter-band CA replaces Intra-band Contiguous CA
- Cells configuration: NR Cell 10 replaces NR Cell 3

8.2.4.1.1.3.3.2 Test procedure sequence

Same as TC 8.2.4.1.1.1 with the following differences:

- CA configuration: Inter-band CA replaces Intra-band Contiguous CA
- Cells configuration: NR Cell 10 replaces NR Cell 3

8.2.4.1.1.4 NR CA / NR SCell addition / modification / release / Success / EN-DC / Active SCG SCell addition / Intra-band Contiguous CA

8.2.4.1.1.4.1 Test Purpose (TP)

(1)

```
with { UE in RRC_CONNECTED state with EN-DC, and, MCG(s) (E-UTRA PDCP) and SCG with initial AS security activated }
ensure that {
  when { UE receives an RRCConnectionReconfiguration message with nr-Config IE including NR RRCReconfiguration message containing sCellToAddModList for SCG SCell addition including IE sCellState }
  then { UE adds the new NR SCell, configures lower layers to consider the SCell to be in activated state and sends an RRCConnectionReconfigurationComplete message }
}
```

(2)

```
with { UE in RRC_CONNECTED state with EN-DC, and, MCG(s) (E-UTRA PDCP) and SCG with SCell(s) configured }
ensure that {
  when { UE receives an RRCConnectionReconfiguration message with nr-Config IE including NR RRCReconfiguration message containing sCellToAddModList for SCG SCell modification including IE sCellState }
  then { UE modifies the affected SCell dedicated configurations and sends an RRCConnectionReconfigurationComplete message and consider the SCell to be in activated state }
}
```

(3)

```
with { UE in RRC_CONNECTED state with EN-DC, and, MCG(s) (E-UTRA PDCP) and SCG with SCell(s) configured }
ensure that {
  when { UE receives an RRCConnectionReconfiguration message with nr-Config IE including NR RRCReconfiguration message containing sCellToReleaseList }
  then { UE releases the SCell and sends an RRCConnectionReconfigurationComplete message }
}
```

8.2.4.1.1.4.2 Conformance requirements

References: The conformance requirements covered in the present TC are specified in: TS 36.331: 5.3.5.3; TS 38.331: 5.3.5.3, 5.3.5.5.8, 5.3.5.5.9. Unless otherwise stated these are Rel-15 requirements.

[TS 36.331, clause 5.3.5.3]

If the *RRCConnectionReconfiguration* message does not include the *mobilityControlInfo* and the UE is able to comply with the configuration included in this message, the UE shall:

- 1> if this is the first *RRCConnectionReconfiguration* message after successful completion of the RRC connection re-establishment procedure:
 - 2> re-establish PDCP for SRB2 configured with E-UTRA PDCP entity and for all DRBs that are established and configured with E-UTRA PDCP, if any;
 - 2> re-establish RLC for SRB2 and for all DRBs that are established and configured with E-UTRA RLC, if any;
 - 2> if the *RRCConnectionReconfiguration* message includes the *fullConfig*:
 - 3> perform the radio configuration procedure as specified in 5.3.5.8;
 - 2> if the *RRCConnectionReconfiguration* message includes the *radioResourceConfigDedicated*:
 - 3> perform the radio resource configuration procedure as specified in 5.3.10;

NOTE 1: Void

NOTE 2: Void

1> else:

2> if the *RRCCConnectionReconfiguration* message includes the *radioResourceConfigDedicated*:

3> perform the radio resource configuration procedure as specified in 5.3.10;

NOTE 3: If the *RRCCConnectionReconfiguration* message includes the establishment of radio bearers other than SRB1, the UE may start using these radio bearers immediately, i.e. there is no need to wait for an outstanding acknowledgment of the *SecurityModeComplete* message.

1> if the received *RRCCConnectionReconfiguration* includes the *sCellToReleaseList*:

2> perform SCell release as specified in 5.3.10.3a;

1> if the received *RRCCConnectionReconfiguration* includes the *sCellToAddModList*:

2> perform SCell addition or modification as specified in 5.3.10.3b;

1> if the received *RRCCConnectionReconfiguration* includes the *scg-Configuration*; or

1> if the current UE configuration includes one or more split DRBs configured with *pdcp-Config* and the received *RRCCConnectionReconfiguration* includes *radioResourceConfigDedicated* including *drb-ToAddModList*:

2> perform SCG reconfiguration as specified in 5.3.10.10;

1> if the received *RRCCConnectionReconfiguration* includes the *nr-Config* and it is set to *release*: or

1> if the received *RRCCConnectionReconfiguration* includes *endc-ReleaseAndAdd* and it is set to *TRUE*:

2> perform EN-DC release as specified in TS 38.331 [82], clause 5.3.5.10;

1> if the received *RRCCConnectionReconfiguration* includes the *sk-Counter*:

2> perform key update procedure as specified in TS 38.331 [82], clause 5.3.5.7;

1> if the received *RRCCConnectionReconfiguration* includes the *nr-SecondaryCellGroupConfig*:

2> perform NR RRC Reconfiguration as specified in TS 38.331 [82], clause 5.3.5.3;

1> if the received *RRCCConnectionReconfiguration* includes the *nr-RadioBearerConfig1*:

2> perform radio bearer configuration as specified in TS 38.331 [82], clause 5.3.5.6;

1> if the received *RRCCConnectionReconfiguration* includes the *nr-RadioBearerConfig2*:

2> perform radio bearer configuration as specified in TS 38.331 [82], clause 5.3.5.6;

1> if this is the first *RRCCConnectionReconfiguration* message after successful completion of the RRC connection re-establishment procedure:

2> resume SRB2 and all DRBs that are suspended, if any, including RBs configured with NR PDCP;

NOTE 4: The handling of the radio bearers after the successful completion of the PDCP re-establishment, e.g. the re-transmission of unacknowledged PDCP SDUs (as well as the associated status reporting), the handling of the SN and the HFN, is specified in TS 36.323 [8].

NOTE 5: The UE may discard SRB2 messages and data that it receives prior to completing the reconfiguration used to resume these bearers.

1> if the received *RRCCConnectionReconfiguration* includes the *systemInformationBlockType1Dedicated*:

2> perform the actions upon reception of the *SystemInformationBlockType1* message as specified in 5.2.2.7;

1> if the *RRCCConnectionReconfiguration* message includes the *dedicatedInfoNASList*:

2> forward each element of the *dedicatedInfoNASList* to upper layers in the same order as listed;

1> if the *RRCCConnectionReconfiguration* message includes the *measConfig*:

- 2> perform the measurement configuration procedure as specified in 5.5.2;
- 1> perform the measurement identity autonomous removal as specified in 5.5.2.2a;
- 1> if the *RRCCConnectionReconfiguration* message includes the *otherConfig*:
 - 2> perform the other configuration procedure as specified in 5.3.10.9;
- 1> upon RRC connection establishment, if UE does not need UL gaps during continuous uplink transmission:
 - 2> configure lower layers to stop using UL gaps during continuous uplink transmission in FDD for *RRCCConnectionReconfigurationComplete* message and subsequent uplink transmission in RRC_CONNECTED except for UL transmissions as specified in TS36.211 [21];
- 1> set the content of *RRCCConnectionReconfigurationComplete* message as follows:
 - 2> if the *RRCCConnectionReconfiguration* message includes *perCC-GapIndicationRequest*:
 - 3> include *perCC-GapIndicationList* and *numFreqEffective*;
 - 2> if the frequencies are configured for reduced measurement performance:
 - 3> include *numFreqEffectiveReduced*;
 - 2> if the received *RRCCConnectionReconfiguration* message included *nr-SecondaryCellGroupConfig*:
 - 3> include *scg-ConfigResponseNR* in accordance with TS 38.331 [82, 5.3.5.3];
- 1> submit the *RRCCConnectionReconfigurationComplete* message to lower layers for transmission using the new configuration, upon which the procedure ends;

[TS 38.331, clause 5.3.5.3]

The UE shall perform the following actions upon reception of the *RRCReconfiguration*:

- 1> if the *RRCReconfiguration* includes the *fullConfig*:
 - 2> perform the radio configuration procedure as specified in 5.3.5.11;
- 1> if the *RRCReconfiguration* includes the *masterCellGroup*:
 - 2> perform the cell group configuration for the received *masterCellGroup* according to 5.3.5.5;
- 1> if the *RRCReconfiguration* includes the *masterKeyUpdate*:
 - 2> perform security key update procedure as specified in 5.3.5.7;
- 1> if the *RRCReconfiguration* includes the *secondaryCellGroup*:
 - 2> perform the cell group configuration for the SCG according to 5.3.5.5;
- 1> if the *RRCReconfiguration* message contains the *radioBearerConfig*:
 - 2> perform the radio bearer configuration according to 5.3.5.6;
- 1> if the *RRCReconfiguration* message includes the *measConfig*:
 - 2> perform the measurement configuration procedure as specified in 5.5.2;
- 1> if the *RRCReconfiguration* message includes the *dedicatedNAS-MessageList*:
 - 2> forward each element of the *dedicatedNAS-MessageList* to upper layers in the same order as listed;
- 1> if the *RRCReconfiguration* message includes the *dedicatedSIB1-Delivery*:
 - 2> perform the action upon reception of *SIB1* as specified in 5.2.2.4.2;
- 1> if the *RRCReconfiguration* message includes the *dedicatedSystemInformationDelivery*:

- 2> perform the action upon reception of System Information as specified in 5.2.2.4;
- 1> set the content of *RRCReconfigurationComplete* message as follows:
 - 2> if the *RRCReconfiguration* includes the *masterCellGroup* containing the *reportUplinkTxDirectCurrent*, or;
 - 2> if the *RRCReconfiguration* includes the *secondaryCellGroup* containing the *reportUplinkTxDirectCurrent*:
 - 3> include the *uplinkTxDirectCurrentList*;
- 1> if the UE is configured with E-UTRA *nr-SecondaryCellGroupConfig* (MCG is E-UTRA):
 - 2> if *RRCReconfiguration* was received via SRB1:
 - 3> submit the *RRCReconfigurationComplete* via the EUTRA MCG embedded in E-UTRA RRC message *RRCConnectionReconfigurationComplete* as specified in TS 36.331 [10];
 - 3> if *reconfigurationWithSync* was included in *spCellConfig* of an SCG:
 - 4> initiate the random access procedure on the SpCell, as specified in TS 38.321 [3];
 - 3> else:
 - 4> the procedure ends;

NOTE: The order the UE sends the *RRCConnectionReconfigurationComplete* message and performs the Random Access procedure towards the SCG is left to UE implementation.

- 2> else (*RRCReconfiguration* was received via SRB3):

- 3> submit the *RRCReconfigurationComplete* message via SRB3 to lower layers for transmission using the new configuration;

NOTE: For EN-DC, in the case *RRCReconfiguration* is received via SRB1, the random access is triggered by RRC layer itself as there is not necessarily other UL transmission. In the case *RRCReconfiguration* is received via SRB3, the random access is triggered by the MAC layer due to arrival of *RRCReconfigurationComplete*.

- 1 > else:

- 2> submit the *RRCReconfigurationComplete* message via SRB1 to lower layers for transmission using the new configuration;
 - 2> if this is the first *RRCReconfiguration* message after successful completion of the RRC re-establishment procedure:
 - 3> resume SRB2 and DRBs that are suspended;
- 1> if *reconfigurationWithSync* was included in *spCellConfig* of an MCG or SCG, and when MAC of an NR cell group successfully completes a random access procedure triggered above:
 - 2> stop timer T304 for that cell group;
 - 2> apply the parts of the CQI reporting configuration, the scheduling request configuration and the sounding RS configuration that do not require the UE to know the SFN of the respective target SpCell, if any;
 - 2> apply the parts of the measurement and the radio resource configuration that require the UE to know the SFN of the respective target SpCell (e.g. measurement gaps, periodic CQI reporting, scheduling request configuration, sounding RS configuration), if any, upon acquiring the SFN of that target SpCell;
 - 2> if the *reconfigurationWithSync* was included in *spCellConfig* of an MCG:
 - 3> if T390 is running:
 - 4> stop timer T390 for all access categories;
 - 4> perform the actions as specified in 5.3.14.4.

- 3> if *RRCReconfiguration* does not include *dedicatedSIB1-Delivery* and
 - 3> if the active downlink BWP, which is indicated by the *firstActiveDownlinkBWP-Id* for the target SpCell of the MCG, has a common search space configured by *searchSpaceSIB1*:
 - 4> acquire the *SIB1*, which is scheduled as specified in TS 38.213 [13], of the target SpCell of the MCG;
 - 4> upon acquiring *SIB1*, perform the actions specified in clause 5.2.2.4.2;
- 2> the procedure ends.

NOTE: The UE is only required to acquire broadcasted *SIB1* if the UE can acquire it without disrupting unicast data reception, i.e. the broadcast and unicast beams are quasi co-located.

[TS 38.331, clause 5.3.5.5.8]

The UE shall:

- 1> if the release is triggered by reception of the *sCellToReleaseList*:
 - 2> for each *sCellIndex* value included in the *sCellToReleaseList*:
 - 3> if the current UE configuration includes an SCell with value *sCellIndex*:
 - 4> release the SCell.

[TS 38.331, clause 5.3.5.5.9]

The UE shall:

...

- 1> for each *sCellIndex* value included in the *sCellToAddModList* that is part of the current UE configuration (SCell modification):
 - 2> modify the SCell configuration in accordance with the *sCellConfigDedicated*.
 - 2> if the *sCellToAddModList* was received in an *RRCReconfiguration* message including *reconfigurationWithSync*, or received in an *RRCResume* message, or received in an *RRCReconfiguration* message including *reconfigurationWithSync* embedded in an *RRCResume* message or embedded in an *RRCReconfiguration* message or embedded in an E-UTRA *RRCCConnectionReconfiguration* message or embedded in an E-UTRA *RRCCConnectionResume* message:
 - 3> if the *sCellState* is included:
 - 4> configure lower layers to consider the SCell to be in activated state;
 - 3> else:
 - 4> configure lower layers to consider the SCell to be in deactivated state.

8.2.4.1.1.4.3 Test description

8.2.4.1.1.4.3.1 Pre-test conditions

System Simulator:

- E-UTRA Cell 1 is the PCell. NR Cell 1 is the PSCell and NR Cell 3 is the SCell.

UE:

- None.

Preamble:

- If pc_IP_Ping is set to TRUE then, the UE is in state RRC_CONNECTED using generic procedure parameter Connectivity (EN-DC), Bearers (MCG(s) and SCG) established according to TS 38.508-1 [4], clause 4.5.4.
- Else, the UE is in state RRC_CONNECTED using generic procedure parameter Connectivity (EN-DC), Bearers (MCG(s) and SCG) established and Test Loop Function (On) with UE test loop mode B according to TS 38.508-1 [4], clause 4.5.4.

8.2.4.1.1.4.3.2 Test procedure sequence

Table 8.2.4.1.1.4.3.2-1: Main behaviour

St	Procedure	Message Sequence		TP	Verdict
		U - S	Message		
1	The SS transmits a <i>RRCConnectionReconfiguration</i> message including NR <i>RRCReconfiguration</i> message to configure the NR SCell.	<--	<i>RRCConnectionReconfiguration</i> (<i>RRCReconfiguration</i>)	-	-
2	Check: Does the UE transmit a <i>RRCConnectionReconfigurationComplete</i> message containing <i>RRCReconfigurationComplete</i> message?	-->	<i>RRCConnectionReconfigurationComplete</i> (<i>RRCReconfigurationComplete</i>)	1	P
2A	Check: Does the test result of generic test procedure in TS 38.508-1 Table 4.9.1-1A indicate that the UE is capable of exchanging IP data on DRB #n associated with the first PDU session on NR Cell 3?	-	-	-	-
3	The SS transmits a <i>RRCConnectionReconfiguration</i> message including NR <i>RRCReconfiguration</i> message to modify the <i>startingBitOfFormat2-3</i> of the NR SCell.	<--	<i>RRCConnectionReconfiguration</i> (<i>RRCReconfiguration</i>)	-	-
4	Check: Does the UE transmit a <i>RRCConnectionReconfigurationComplete</i> message containing NR <i>RRCReconfigurationComplete</i> message?	-->	<i>RRCConnectionReconfigurationComplete</i> (<i>RRCReconfigurationComplete</i>)	2	P
4A	Check: Does the test result of generic test procedure in TS 38.508-1 Table 4.9.1-1A indicate that the UE is capable of exchanging IP data on DRB #n associated with the first PDU session on NR Cell 3?	-	-	-	-
5	The SS transmits a <i>RRCConnectionReconfiguration</i> message including NR <i>RRCReconfiguration</i> message to release the NR SCell.	<--	<i>RRCConnectionReconfiguration</i> (<i>RRCReconfiguration</i>)	-	-
6	Check: Does the UE release SCell and sends a <i>RRCConnectionReconfigurationComplete</i> message containing NR <i>RRCReconfigurationComplete</i> message?	-->	<i>RRCConnectionReconfigurationComplete</i> (<i>RRCReconfigurationComplete</i>)	3	P

8.2.4.1.1.4.3.3 Specific message contents

Table 8.2.4.1.1.4.3.3-1: RRCConnectionReconfiguration (step 1, Table 8.2.4.1.1.4.3.2-1)

Derivation Path: TS 36.508 [7], Table 4.6.1-8 with condition EN-DC_NR_CA			
Information Element	Value/remark	Comment	Condition
<i>RRCConnectionReconfiguration</i> ::= SEQUENCE {			
criticalExtensions CHOICE {			
c1 CHOICE {			
rrcConnectionReconfiguration-r8 SEQUENCE {			
nonCriticalExtension SEQUENCE {			
nonCriticalExtension SEQUENCE {			
nonCriticalExtension SEQUENCE {			
nonCriticalExtension SEQUENCE {			

Table 8.2.4.1.1.4.3.3-5: RRCConnectionReconfiguration (step 3, Table 8.2.4.1.1.4.3.2-1)

Derivation Path: TS 36.508 [7], Table 4.6.1-8 with condition EN-DC_NR_CA			
Information Element	Value/remark	Comment	Condition
RRCConnectionReconfiguration ::= SEQUENCE {			
criticalExtensions CHOICE {			
c1 CHOICE {			
rrcConnectionReconfiguration-r8 SEQUENCE {			
nonCriticalExtension SEQUENCE {			
nonCriticalExtension SEQUENCE {			
nonCriticalExtension SEQUENCE {			
nonCriticalExtension SEQUENCE {			
nonCriticalExtension SEQUENCE {			
nonCriticalExtension SEQUENCE {			
nr-Config-r15 CHOICE {			
setup SEQUENCE {			
nr-SecondaryCellGroupConfig-r15	OCTET STRING including the <i>RRCReconfiguration</i> message and the IE <i>secondaryCellGroup</i> .		
}			
}			
}			
}			
}			
}			
}			
}			

Table 8.2.4.1.1.4.3.3-6: RRCReconfiguration (Table 8.2.4.1.1.4.3.3-5)

Derivation Path: TS 38.508-1 [4], Table 4.6.1-13			
Information Element	Value/remark	Comment	Condition
RRCReconfiguration ::= SEQUENCE {			
criticalExtensions CHOICE {			
rrcReconfiguration SEQUENCE {			
secondaryCellGroup	CellGroupConfig		
}			
}			
}			

Table 8.2.4.1.1.4.3.3-7: CellGroupConfig (Table 8.2.4.1.1.4.3.3-6)

Derivation Path: TS 38.508-1 [4], Table 4.6.3-19 with condition SCell_Add			
Information Element	Value/remark	Comment	Condition
CellGroupConfig ::= SEQUENCE {			
sCellToAddModList SEQUENCE (SIZE(1..maxNrofSCells)) OF SCellConfig {	1 entry		
SCellConfig[1] SEQUENCE {		entry 1	
sCellConfigDedicated	ServingCellConfig		
sCellState-r16	activated		
}			

nonCriticalExtension SEQUENCE {			
nr-Config-r15 CHOICE {			
setup SEQUENCE {			
nr-SecondaryCellGroupConfig-r15	OCTET STRING including the <i>RRCReconfiguration</i> message and the IE <i>secondaryCellGroup</i> .		
}			
}			
}			
}			
}			
}			
}			
}			
}			
}			
}			
}			
}			
}			
}			
}			

Table 8.2.4.1.1.4.3.3-13: RRCReconfiguration (Table 8.2.4.1.1.4.3.3-12)

Derivation Path: TS 38.508-1 [4], Table 4.6.1-13			
Information Element	Value/remark	Comment	Condition
RRCReconfiguration ::= SEQUENCE {			
criticalExtensions CHOICE {			
rrcReconfiguration SEQUENCE {			
secondaryCellGroup	CellGroupConfig		
}			
}			
}			

Table 8.2.4.1.1.4.3.3-14: CellGroupConfig (Table 8.2.4.1.1.4.3.3-13)

Derivation Path: TS 38.508-1 [4], Table 4.6.3-19			
Information Element	Value/remark	Comment	Condition
CellGroupConfig ::= SEQUENCE {			
sCellToReleaseList SEQUENCE (SIZE(1..maxNrofSCells)) OF SCellIndex {	1 entry		
SCellIndex[1]	2	entry 1	
}			
}			

8.2.4.1.1.5 NR CA / NR SCell addition / modification / release / Success / EN-DC / Active SCG SCell addition / Intra-band non-Contiguous CA

8.2.4.1.1.5.1 Test Purpose (TP)

Same as TC 8.2.4.1.1.4 but applied to Intra-band non-Contiguous CA.

8.2.4.1.1.5.2 Conformance requirements

Same as TC 8.2.4.1.1.4 but applied to Intra-band non-Contiguous CA.

8.2.4.1.1.5.3 Test description

8.2.4.1.1.5.3.1 Pre-test conditions

Same as TC 8.2.4.1.1.4 with the following differences:

- CA configuration: Intra-band non-Contiguous CA replaces Intra-band Contiguous CA

8.2.4.1.1.5.3.2 Test procedure sequence

Same as TC 8.2.4.1.1.4 with the following differences:

- CA configuration: Intra-band non-Contiguous CA replaces Intra-band Contiguous CA

8.2.4.1.1.6 NR CA / NR SCell addition / modification / release / Success / EN-DC / Active SCG SCell addition / Inter-band CA

8.2.4.1.1.6.1 Test Purpose (TP)

Same as TC 8.2.4.1.1.4 but applied to Inter-band CA

8.2.4.1.1.6.2 Conformance requirements

Same as TC 8.2.4.1.1.4 but applied to Inter-band CA

8.2.4.1.1.6.3 Test description

8.2.4.1.1.6.3.1 Pre-test conditions

Same as TC 8.2.4.1.1.4 with the following differences:

- CA configuration: Inter-band CA replaces Intra-band Contiguous CA
- Cells configuration: NR Cell 10 replaces NR Cell 3

8.2.4.1.1.6.3.2 Test procedure sequence

Same as TC 8.2.4.1.1.4 with the following differences:

- CA configuration: Inter-band CA replaces Intra-band Contiguous CA
- Cells configuration: NR Cell 10 replaces NR Cell 3

8.2.4.1.2 NR CA / NR SCell addition / modification / release / Success / NR-DC / Active SCG SCell addition

8.2.4.1.2.1 NR CA / NR SCell addition / modification / release / Success / NR-DC / Active SCG SCell addition / Intra-band Contiguous CA

8.2.4.1.2.1.1 Test Purpose (TP)

(1)

```
with { UE in NR RRC_CONNECTED state }
ensure that {
  when { UE receives an RRCReconfiguration message containing sCellToAddModList for SCG SCell
addition including IE sCellState }
  then { UE adds the new SCG SCell and sends an RRCReconfigurationComplete message and consider
the SCell to be in activated state }
}
```

(2)

```

with { UE in NR RRC_CONNECTED state with SCell configured}
ensure that {
  when { UE receives an RRCReconfiguration message containing sCellToAddModList for SCG SCell
modification including IE sCellState }
  then { UE modifies the SCG SCell configuration and sends an RRCReconfigurationComplete message
and consider the SCell to be in activated state }
}

```

(3)

```

with { UE in NR RRC_CONNECTED state with SCG SCell configured}
ensure that {
  when { UE receives an RRCReconfiguration message containing SCG sCellToReleaseList }
  then { UE sends an RRCReconfigurationComplete message }
}

```

8.2.4.1.2.1.2 Conformance requirements

References: The conformance requirements covered in the current TC are specified in: TS 38.331 clauses 5.3.5.3, 5.3.5.5.1 and 5.3.5.5.9.

[TS 38.331 clause 5.3.5.3]

The UE shall perform the following actions upon reception of the *RRCReconfiguration*:

...

1> if the *RRCReconfiguration* includes the *masterCellGroup*:

2> perform the cell group configuration for the received *masterCellGroup* according to 5.3.5.5;

...

1> else:

2> submit the *RRCReconfigurationComplete* message via SRB1 to lower layers for transmission using the new configuration;

[TS 38.331 clause 5.3.5.5.1]

The UE performs the following actions based on a received *CellGroupConfig* IE:

...

1> if the *CellGroupConfig* contains the *sCellToReleaseList*:

2> perform SCell release as specified in 5.3.5.5.8;

...

1> if the *CellGroupConfig* contains the *sCellToAddModList*:

2> perform SCell addition/modification as specified in 5.3.5.5.9.

[TS 38.331 clause 5.3.5.5.9]

The UE shall:

1> for each *sCellIndex* value included in the *sCellToAddModList* that is not part of the current UE configuration (SCell addition):

2> add the SCell, corresponding to the *sCellIndex*, in accordance with the *sCellConfigCommon* and *sCellConfigDedicated*;

2> configure lower layers to consider the SCell to be in deactivated state;

...

- 1> for each *sCellIndex* value included in the *sCellToAddModList* that is part of the current UE configuration (SCell modification):
- 2> modify the SCell configuration in accordance with the *sCellConfigDedicated*.
- 2> if the *sCellToAddModList* was received in an *RRCReconfiguration* message including *reconfigurationWithSync*, or received in an *RRCResume* message, or received in an *RRCReconfiguration* message including *reconfigurationWithSync* embedded in an *RRCResume* message or embedded in an *RRCReconfiguration* message or embedded in an E-UTRA *RRCConnectionReconfiguration* message or embedded in an E-UTRA *RRCConnectionResume* message:
- 3> if the *sCellState* is included:
- 4> configure lower layers to consider the SCell to be in activated state;
- 3> else:
- 4> configure lower layers to consider the SCell to be in deactivated state.

8.2.4.1.2.1.3 Test description

8.2.4.1.2.1.3.1 Pre-test conditions

System Simulator:

- NR Cell 1 is the PCell, NR Cell 10 is the PSCell, NR Cell 28 is the SCG SCell.
- System information combination NR-4 as defined in TS 38.508-1 [4] clause 4.4.3.1.2 is used in NR cells.

None.

Preamble:

- The UE is in state RRC_CONNECTED using generic procedure parameter Connectivity (*NR-DC*) and NR-DC bearers (*MCG(s)* and *SCG*) and with UE test loop mode B active if *pc_IP_Ping* is set to FALSE according to TS 38.508-1 [4], Table 4.5.1-1.

8.2.4.1.2.1.3.2 Test procedure sequence

Table 8.2.4.1.2.1.3.2-1: Main behaviour

St	Procedure	Message Sequence		TP	Verdict
		U - S	Message		
1	The SS transmits an <i>RRCReconfiguration</i> message containing an <i>sCellToAddModList</i> with SCell NR Cell 3 addition.	<--	NR RRC: <i>RRCReconfiguration</i>	-	-
2	Check: Does the UE transmits an <i>RRCReconfigurationComplete</i> message?	-->	NR RRC: <i>RRCReconfigurationComplete</i>	1	P
3	Check: Does the test result of generic test procedure in TS 38.508-1 subclause 4.9.1 indicate that the UE is capable of exchanging IP data on DRB1 and Cell 3?	-	-	1	P
4	The SS transmits an <i>RRCReconfiguration</i> message containing an <i>sCellToAddModList</i> with SCell NR Cell 3 modification.	<--	NR RRC: <i>RRCReconfiguration</i>	-	-
5	Check: Does the UE transmit an <i>RRCReconfigurationComplete</i> message?	-->	NR RRC: <i>RRCReconfigurationComplete</i>	2	P
6	Check: Does the test result of generic test procedure in TS 38.508-1 subclause 4.9.1 indicate that the UE is capable of exchanging IP data on DRB1 and Cell 3?	-	-	2	P

7	The SS transmits an <i>RRCReconfiguration</i> message containing an <i>sCellToReleaseList</i> with <i>SCell NR Cell 3</i> .	<--	NR RRC: <i>RRCReconfiguration</i>	-	-
8	Check: Does the UE transmit an <i>RRCReconfigurationComplete</i> message?	-->	NR RRC: <i>RRCReconfigurationComplete</i>	3	P

8.1.2.5.1.1.3.3 Specific message contents

Table 8.1.2.5.1.1.3.3-1: *RRCReconfiguration* (step 1, Table 8.2.4.1.2.1.3.2-1)

Derivation Path: TS 38.508-1 [4] Table 4.6.1-13 with condition <i>SCell_add</i>			
Information Element	Value/remark	Comment	Condition
<i>RRCReconfiguration</i> ::= SEQUENCE {			
<i>criticalExtensions</i> CHOICE {			
<i>rrcReconfiguration</i> SEQUENCE {			
<i>secondaryCellGroup</i>	<i>CellGroupConfig</i>		
}			
}			
}			

Table 8.1.2.5.1.1.3.3-2: *CellGroupConfig* (Table 8.1.2.5.1.1.3.3-1)

Derivation Path: TS 38.508-1 [4] Table 4.6.3-19 with condition <i>SCell_add</i>			
Information Element	Value/remark	Comment	Condition
<i>CellGroupConfig</i> ::= SEQUENCE {			
<i>sCellToAddModList</i> SEQUENCE (SIZE (1.. <i>maxNrofSCells</i>)) OF <i>SCellConfig</i> {	1 entry		
<i>SCellConfig</i> [1] SEQUENCE {		entry 1	
<i>sCellState-r16</i>	activated		
}			
}			
}			

Table 8.1.2.5.1.1.3.3-3: *RRCReconfiguration* (step 4, Table 8.2.4.1.2.1.3.2-1)

Derivation Path: TS 38.508-1 [4] Table 4.6.1-13 with condition <i>SCell_add</i>			
Information Element	Value/remark	Comment	Condition
<i>RRCReconfiguration</i> ::= SEQUENCE {			
<i>criticalExtensions</i> CHOICE {			
<i>rrcReconfiguration</i> SEQUENCE {			
<i>secondaryCellGroup</i>	<i>CellGroupConfig</i>		
}			
}			
}			

Table 8.1.2.5.1.1.3.3-4: *CellGroupConfig* (Table 8.1.2.5.1.1.3.3-3)

Derivation Path: TS 38.508-1 [4] Table 4.6.3-19 with condition <i>SCell_add</i>			
Information Element	Value/remark	Comment	Condition
<i>CellGroupConfig</i> ::= SEQUENCE {			
<i>sCellToAddModList</i> SEQUENCE (SIZE (1.. <i>maxNrofSCells</i>)) OF <i>SCellConfig</i> {	1 entry		
<i>SCellConfig</i> [1] SEQUENCE {		entry 1	
<i>sCellConfigCommon</i>	Not present		
<i>sCellConfigDedicated</i>	<i>ServingCellConfig</i>		
<i>sCellState-r16</i>	activated		
}			
}			
}			

Table 8.1.2.5.1.1.3.3-5: ServingCellConfig (Table 8.1.2.5.1.1.3.3-4)

Derivation Path: TS 38.508-1 [4] Table 4.6.3-167			
Information Element	Value/remark	Comment	Condition
ServingCellConfig ::= SEQUENCE {			
firstActiveDownlinkBWP-Id	Not present		
uplinkConfig SEQUENCE {			
firstActiveUplinkBWP-Id	Not present		
}			
pdsch-ServingCellConfig CHOICE {			
setup	PDSCH-ServingCellConfig		
}			
}			

Table 8.1.2.5.1.1.3.3-6: PDSCH-ServingCellConfig (Table 8.1.2.5.1.1.3.3-5)

Derivation Path: TS 38.508-1 [4] Table 4.6.3-102			
Information Element	Value/remark	Comment	Condition
PDSCH-ServingCellConfig ::= SEQUENCE {			
nrofHARQ-ProcessesForPDSCH	n16		
}			

Table 8.1.2.5.1.1.3.3-7: RRCReconfiguration (step 7, Table 8.2.4.1.2.1.3.2-6)

Derivation Path: TS 38.508-1 [4] Table 4.6.1-13 with condition SCell_add			
Information Element	Value/remark	Comment	Condition
RRCReconfiguration ::= SEQUENCE {			
criticalExtensions CHOICE {			
rrcReconfiguration SEQUENCE {			
secondaryCellGroup	CellGroupConfig		
}			
}			
}			

Table 8.1.2.5.1.1.3.3-8: CellGroupConfig (Table 8.1.2.5.1.1.3.3-7)

Derivation Path: TS 38.508-1 [4] Table 4.6.3-19 with condition SCell_add			
Information Element	Value/remark	Comment	Condition
CellGroupConfig ::= SEQUENCE {			
sCellToAddModList	Not present		
sCellToReleaseList SEQUENCE (SIZE (1..maxNrofSCells)) OF SCellIndex {	1 entry		
SCellIndex[1]	1	entry 1	
}			
}			

8.2.4.1.2.2 NR CA / NR SCell addition / modification / release / Success / NR-DC / Active SCG SCell addition / Inter-band CA

8.2.4.1.2.2.1 Test Purpose (TP)

Same as TC 8.2.4.1.2.1 but applied to Inter-band CA.

8.2.4.1.2.2.2 Conformance requirements

Same as TC 8.2.4.1.2.1 but applied to Inter-band CA.

8.2.4.1.2.2.3 Test description

8.2.4.1.2.2.3.1 Pre-test conditions

Same as TC 8.2.4.1.2.1 with the following differences:

- CA configuration: Inter-band CA replaces Intra-band Contiguous CA
- Cells configuration: NR Cell 10 and NR Cell 28 are in the different band.

8.2.4.1.2.2.3.2 Test procedure sequence

Same as TC 8.2.4.1.2.1 with the following differences:

- CA configuration: Inter-band CA replaces Intra-band Contiguous CA
- Cells configuration: NR Cell 10 replaces NR Cell 3

8.2.4.1.2.3 NR CA / NR SCell addition / modification / release / Success / NR-DC / Active SCG SCell addition / Intra-band non-contiguous CA

8.2.4.1.2.3.1 Test Purpose (TP)

Same as TC 8.2.4.1.2.1 but applied to Intra-band non-contiguous CA.

8.2.4.1.2.3.2 Conformance requirements

Same as TC 8.2.4.1.2.1 but applied to Intra-band non-contiguous CA.

8.2.4.1.2.3.3 Test description

8.2.4.1.2.3.3.1 Pre-test conditions

Same as TC 8.2.4.1.2.1 with the following differences:

- CA configuration: Intra-band non-contiguous replaces Intra-band Contiguous CA

8.2.4.1.2.3.3.2 Test procedure sequence

Same as TC 8.2.4.1.2.1 with the following differences:

- CA configuration: Intra-band non-contiguous replaces Intra-band Contiguous CA
- Cells configuration: NR Cell 10 and NR Cell 28 are in the different band

8.2.4.2 NR CA / Simultaneous PSCell and SCell addition / PSCell and SCell change / CA Release

8.2.4.2.1 NR CA / Simultaneous PSCell and SCell addition / PSCell and SCell change / CA Release/ EN-DC

8.2.4.2.1.1 NR CA / Simultaneous PSCell and SCell addition / PSCell and SCell change / CA Release / EN-DC / Intra-band Contiguous CA

8.2.4.2.1.1.1 Test Purpose (TP)

(1)

```
with { UE in RRC_CONNECTED state with E-UTRA }
ensure that {
```

```

when { UE receives an RRCConnectionReconfiguration message with nr-Config IE including NR
RRCReconfiguration message to configure NR PSCell and sCellToAddModList with an sCellIndex set to
the configured SCell }
then { UE sends an RRCConnectionReconfigurationComplete message indicating the addition of
PSCell and configures lower layers to consider the SCell to be in deactivated state }
}

```

(2)

```

with { UE in RRC_CONNECTED state with EN-DC, and, MCG(s) (E-UTRA PDCP) and SCG with SCell(s)
configured }
ensure that {
when { UE receives an RRCConnectionReconfiguration message with nr-Config IE including NR
RRCReconfiguration message to perform both PSCell and SCell change to the configured target PSCell
and SCell }
then { UE sends an RRCConnectionReconfigurationComplete message and configures new PSCell and
configures lower layers to consider the SCell to be in deactivated state }
}

```

(3)

```

with { UE in RRC_CONNECTED state with EN-DC, and, MCG(s) (E-UTRA PDCP) and SCG with SCell(s)
configured }
ensure that {
when { UE receives an RRCConnectionReconfiguration message with nr-Config IE including NR
RRCReconfiguration message to perform PSCell change to one of the SCell equalling to one of the
current UE SCell configuration }
then { UE sends an RRCConnectionReconfigurationComplete message and reconfigures the current NR
Scell to PSCell }
}

```

8.2.4.2.1.1.2 Conformance requirements

References: The conformance requirements covered in the present TC are specified in: TS 36.331: 5.3.5.3; TS 38.331: 5.3.5.3, 5.3.5.5.7, 5.3.5.5.8, 5.3.5.5.9, 5.3.5.6.4 and 5.3.5.6.5. Unless otherwise stated these are Rel-15 requirements.

[TS 36.331, clause 5.3.5.3]

If the *RRCConnectionReconfiguration* message does not include the *mobilityControlInfo* and the UE is able to comply with the configuration included in this message, the UE shall:

- 1> if this is the first *RRCConnectionReconfiguration* message after successful completion of the RRC connection re-establishment procedure:
 - 2> re-establish PDCP for SRB2 configured with E-UTRA PDCP entity and for all DRBs that are established and configured with E-UTRA PDCP, if any;
 - 2> re-establish RLC for SRB2 and for all DRBs that are established and configured with E-UTRA RLC, if any;
 - 2> if the *RRCConnectionReconfiguration* message includes the *fullConfig*:
 - 3> perform the radio configuration procedure as specified in 5.3.5.8;
 - 2> if the *RRCConnectionReconfiguration* message includes the *radioResourceConfigDedicated*:
 - 3> perform the radio resource configuration procedure as specified in 5.3.10;

NOTE 1: Void

NOTE 2: Void

1> else:

- 2> if the *RRCConnectionReconfiguration* message includes the *radioResourceConfigDedicated*:
 - 3> perform the radio resource configuration procedure as specified in 5.3.10;

NOTE 3: If the *RRCConnectionReconfiguration* message includes the establishment of radio bearers other than SRB1, the UE may start using these radio bearers immediately, i.e. there is no need to wait for an outstanding acknowledgment of the *SecurityModeComplete* message.

- 1> if the received *RRCCConnectionReconfiguration* includes the *sCellToReleaseList*:
 - 2> perform SCell release as specified in 5.3.10.3a;
 - 1> if the received *RRCCConnectionReconfiguration* includes the *sCellToAddModList*:
 - 2> perform SCell addition or modification as specified in 5.3.10.3b;
 - 1> if the received *RRCCConnectionReconfiguration* includes the *scg-Configuration*; or
 - 1> if the current UE configuration includes one or more split DRBs configured with *pdcp-Config* and the received *RRCCConnectionReconfiguration* includes *radioResourceConfigDedicated* including *drb-ToAddModList*:
 - 2> perform SCG reconfiguration as specified in 5.3.10.10;
 - 1> if the received *RRCCConnectionReconfiguration* includes the *nr-Config* and it is set to *release*: or
 - 1> if the received *RRCCConnectionReconfiguration* includes *endc-ReleaseAndAdd* and it is set to *TRUE*:
 - 2> perform EN-DC release as specified in TS 38.331 [82], clause 5.3.5.10;
 - 1> if the received *RRCCConnectionReconfiguration* includes the *sk-Counter*:
 - 2> perform key update procedure as specified in TS 38.331 [82], clause 5.3.5.7;
 - 1> if the received *RRCCConnectionReconfiguration* includes the *nr-SecondaryCellGroupConfig*:
 - 2> perform NR RRC Reconfiguration as specified in TS 38.331 [82], clause 5.3.5.3;
 - 1> if the received *RRCCConnectionReconfiguration* includes the *nr-RadioBearerConfig1*:
 - 2> perform radio bearer configuration as specified in TS 38.331 [82], clause 5.3.5.6;
 - 1> if the received *RRCCConnectionReconfiguration* includes the *nr-RadioBearerConfig2*:
 - 2> perform radio bearer configuration as specified in TS 38.331 [82], clause 5.3.5.6;
 - 1> if this is the first *RRCCConnectionReconfiguration* message after successful completion of the RRC connection re-establishment procedure:
 - 2> resume SRB2 and all DRBs that are suspended, if any, including RBs configured with NR PDCP;
- NOTE 4: The handling of the radio bearers after the successful completion of the PDCP re-establishment, e.g. the re-transmission of unacknowledged PDCP SDUs (as well as the associated status reporting), the handling of the SN and the HFN, is specified in TS 36.323 [8].
- NOTE 5: The UE may discard SRB2 messages and data that it receives prior to completing the reconfiguration used to resume these bearers.
- 1> if the received *RRCCConnectionReconfiguration* includes the *systemInformationBlockType1Dedicated*:
 - 2> perform the actions upon reception of the *SystemInformationBlockType1* message as specified in 5.2.2.7;
 - 1> if the *RRCCConnectionReconfiguration* message includes the *dedicatedInfoNASList*:
 - 2> forward each element of the *dedicatedInfoNASList* to upper layers in the same order as listed;
 - 1> if the *RRCCConnectionReconfiguration* message includes the *measConfig*:
 - 2> perform the measurement configuration procedure as specified in 5.5.2;
 - 1> perform the measurement identity autonomous removal as specified in 5.5.2.2a;
 - 1> if the *RRCCConnectionReconfiguration* message includes the *otherConfig*:
 - 2> perform the other configuration procedure as specified in 5.3.10.9;
 - 1> if the *RRCCConnectionReconfiguration* message includes the *sl-DiscConfig* or *sl-CommConfig*:

- 2> perform the sidelink dedicated configuration procedure as specified in 5.3.10.15;
- 1> if the *RRCCONNECTIONRECONFIGURATION* message includes the *sl-V2X-ConfigDedicated*:
 - 2> perform the V2X sidelink communication dedicated configuration procedure as specified in 5.3.10.15a;
- 1> if the *RRCCONNECTIONRECONFIGURATION* message includes *wlan-OffloadInfo*:
 - 2> perform the dedicated WLAN offload configuration procedure as specified in 5.6.12.2;
- 1> if the *RRCCONNECTIONRECONFIGURATION* message includes *rclwi-Configuration*:
 - 2> perform the WLAN traffic steering command procedure as specified in 5.6.16.2;
- 1> if the *RRCCONNECTIONRECONFIGURATION* message includes *lwa-Configuration*:
 - 2> perform the LWA configuration procedure as specified in 5.6.14.2;
- 1> if the *RRCCONNECTIONRECONFIGURATION* message includes *lwip-Configuration*:
 - 2> perform the LWIP reconfiguration procedure as specified in 5.6.17.2;
- 1> upon RRC connection establishment, if UE does not need UL gaps during continuous uplink transmission:
 - 2> configure lower layers to stop using UL gaps during continuous uplink transmission in FDD for *RRCCONNECTIONRECONFIGURATIONCOMPLETE* message and subsequent uplink transmission in RRC_CONNECTED except for UL transmissions as specified in TS36.211 [21];
- 1> set the content of *RRCCONNECTIONRECONFIGURATIONCOMPLETE* message as follows:
 - 2> if the *RRCCONNECTIONRECONFIGURATION* message includes *perCC-GapIndicationRequest*:
 - 3> include *perCC-GapIndicationList* and *numFreqEffective*;
 - 2> if the frequencies are configured for reduced measurement performance:
 - 3> include *numFreqEffectiveReduced*;
 - 2> if the received *RRCCONNECTIONRECONFIGURATION* message included *nr-SecondaryCellGroupConfig*:
 - 3> include *scg-ConfigResponseNR* in accordance with TS 38.331 [82, 5.3.5.3];
- 1> submit the *RRCCONNECTIONRECONFIGURATIONCOMPLETE* message to lower layers for transmission using the new configuration, upon which the procedure ends;

[TS 38.331, clause 5.3.5.3]

The UE shall perform the following actions upon reception of the *RRCReconfiguration*:

- 1> if the *RRCReconfiguration* includes the *fullConfig*:
 - 2> perform the radio configuration procedure as specified in 5.3.5.11;
- 1> if the *RRCReconfiguration* includes the *masterCellGroup*:
 - 2> perform the cell group configuration for the received *masterCellGroup* according to 5.3.5.5;
- 1> if the *RRCReconfiguration* includes the *masterKeyUpdate*:
 - 2> perform security key update procedure as specified in 5.3.5.7;
- 1> if the *RRCReconfiguration* includes the *secondaryCellGroup*:
 - 2> perform the cell group configuration for the SCG according to 5.3.5.5;
- 1> if the *RRCReconfiguration* message contains the *radioBearerConfig*:
 - 2> perform the radio bearer configuration according to 5.3.5.6;

- 1> if the *RRCReconfiguration* message includes the *measConfig*:
 - 2> perform the measurement configuration procedure as specified in 5.5.2;
 - 1> if the *RRCReconfiguration* message includes the *dedicatedSIB1-Delivery*:
 - 2> perform the action upon reception of *SIB1* as specified in 5.2.2.4.2;
 - 1> if the *RRCReconfiguration* message includes the *dedicatedSystemInformationDelivery*:
 - 2> perform the action upon reception of System Information as specified in 5.2.2.4;
 - 1> set the content of *RRCReconfigurationComplete* message as follows:
 - 2> if the *RRCReconfiguration* includes the *masterCellGroup* containing the *reportUplinkTxDirectCurrent*, or;
 - 2> if the *RRCReconfiguration* includes the *secondaryCellGroup* containing the *reportUplinkTxDirectCurrent*:
 - 3> include the *uplinkTxDirectCurrentList*;
 - 1> if the UE is configured with E-UTRA *nr-SecondaryCellGroupConfig* (MCG is E-UTRA):
 - 2> if *RRCReconfiguration* was received via SRB1:
 - 3> submit the *RRCReconfigurationComplete* via the EUTRA MCG embedded in E-UTRA RRC message *RRCCConnectionReconfigurationComplete* as specified in TS 36.331 [10];
 - 3> if *reconfigurationWithSync* was included in *spCellConfig* of an SCG:
 - 4> initiate the random access procedure on the SpCell, as specified in TS 38.321 [3];
 - 3> else:
 - 4> the procedure ends;
- NOTE: The order the UE sends the *RRCCConnectionReconfigurationComplete* message and performs the Random Access procedure towards the SCG is left to UE implementation.
- 2> else (*RRCReconfiguration* was received via SRB3):
 - 3> submit the *RRCReconfigurationComplete* message via SRB3 to lower layers for transmission using the new configuration;
- NOTE: For EN-DC, in the case of SRB1, the random access is triggered by RRC layer itself as there is not necessarily other UL transmission. In the case of SRB3, the random access is triggered by the MAC layer due to arrival of *RRCReconfigurationComplete*.
- 1> else:
 - 2> submit the *RRCReconfigurationComplete* message via SRB1 to lower layers for transmission using the new configuration;
 - 1> if *reconfigurationWithSync* was included in *spCellConfig* of an MCG or SCG, and when MAC of an NR cell group successfully completes a random access procedure triggered above:
 - 2> stop timer T304 for that cell group;
 - 2> apply the parts of the CQI reporting configuration, the scheduling request configuration and the sounding RS configuration that do not require the UE to know the SFN of the respective target SpCell, if any;
 - 2> apply the parts of the measurement and the radio resource configuration that require the UE to know the SFN of the respective target SpCell (e.g. measurement gaps, periodic CQI reporting, scheduling request configuration, sounding RS configuration), if any, upon acquiring the SFN of that target SpCell;
 - 2> if the *reconfigurationWithSync* was included in *spCellConfig* of an MCG:
 - 3> if the active downlink BWP, which is indicated by the *firstActiveDownlinkBWP-Id* for the target SpCell of the MCG, has a common search space configured:

4> acquire the *SIB1* of the target SpCell of the MCG, as specified in 5.2.2.3.1;

2> the procedure ends.

NOTE: The UE is only required to acquire broadcasted *SIB1* if the UE can acquire it without disrupting unicast data reception, i.e. the broadcast and unicast beams are quasi co-located.

[TS 38.331, clause 5.3.5.5.7]

The UE shall:

1> if the SpCellConfig contains the *rlf-TimersAndConstants*:

2> configure the RLF timers and constants for this cell group as specified in 5.3.5.5.6.

1> else if *rlf-TimersAndConstants* is not configured for this cell group:

2> use values for timers T301, T310, T311 and constants N310, N311, as included in *ue-TimersAndConstants* received in *SIB1*;

1> if the SpCellConfig contains *spCellConfigDedicated*:

2> configure the SpCell in accordance with the *spCellConfigDedicated*;

2> consider the bandwidth part indicated in *firstActiveUplinkBWP-Id* if configured to be the active uplink bandwidth part;

2> consider the bandwidth part indicated in *firstActiveDownlinkBWP-Id* if configured to be the active downlink bandwidth part;

2> if any of the reference signal(s) that are used for radio link monitoring are reconfigured by the received *spCellConfigDedicated*:

3> stop timer T310 for the corresponding SpCell, if running;

3> reset the counters N310 and N311.

[TS 38.331, clause 5.3.5.5.8]

The UE shall:

1> if the release is triggered by reception of the *sCellToReleaseList*:

2> for each *sCellIndex* value included in the *sCellToReleaseList*:

3> if the current UE configuration includes an SCell with value *sCellIndex*:

4> release the SCell.

[TS 38.331, clause 5.3.5.5.9]

The UE shall:

1> for each *sCellIndex* value included in the *sCellToAddModList* that is not part of the current UE configuration (SCell addition):

2> add the SCell, corresponding to the *sCellIndex*, in accordance with the *sCellConfigCommon* and *sCellConfigDedicated*;

2> configure lower layers to consider the SCell to be in deactivated state;

Editor's Note: FFS Check automatic measurement handling for SCells.

2> for each *measId* included in the *measIdList* within *VarMeasConfig*:

3> if SCells are not applicable for the associated measurement; and

- 3> if the concerned SCell is included in *cellsTriggeredList* defined within the *VarMeasReportList* for this *measId*:
- 4> remove the concerned SCell from *cellsTriggeredList* defined within the *VarMeasReportList* for this *measId*;
- 1> for each *sCellIndex* value included in the *sCellToAddModList* that is part of the current UE configuration (SCell modification):
 - 2> modify the SCell configuration in accordance with the *sCellConfigDedicated*.

[TS 38.331, clause 5.3.5.6.4]

Editor's Note: FFS / TODO: Add handling for the new QoS concept (mapping of flows; configuration of QFI-to-DRB mapping; reflective QoS...) but keep also EPS-Bearer handling for the EN-DC case

The UE shall:

- 1> for each *drb-Identity* value included in the *drb-ToReleaseList* that is part of the current UE configuration (DRB release):
 - 2> release the PDCP entity;
 - 2> if SDAP entity associated with this DRB is configured:
 - 3> indicate the release of the DRB to SDAP entity associated with this DRB (TS 37.324 [xx] section 5.3.3);
 - 2> if the UE is operating in EN-DC:
- 3> if a new bearer is not added either with NR or E-UTRA with same *eps-BearerIdentity*:
 - 4> indicate the release of the DRB and the *eps-BearerIdentity* of the released DRB to upper layers.

NOTE 1: The UE does not consider the message as erroneous if the *drb-ToReleaseList* includes any *drb-Identity* value that is not part of the current UE configuration.

NOTE 2: Whether or not the RLC and MAC entities associated with this PDCP entity are reset or released is determined by the *CellGroupConfig*.

[TS 38.331, clause 5.3.5.6.5]

The UE shall:

- 1> for each *drb-Identity* value included in the *drb-ToAddModList* that is not part of the current UE configuration (DRB establishment including the case when full configuration option is used):
 - 2> if an *sdap-Config* is included:
 - 3> if an SDAP entity with the received *pdu-Session* does not exist:
 - 4> establish an SDAP entity as specified in TS 37.324 [xx] section 5.1.1;
 - 3> configure the SDAP entity in accordance with the received *sdap-Config* as specified in TS 37.324 [xx] and associate the DRB with the SDAP entity;
 - 2> establish a PDCP entity and configure it in accordance with the received *pdcp-Config*;
 - 2> if the PDCP entity of this DRB is not configured with *cipheringDisabled*:
 - 3> configure the PDCP entity with the ciphering algorithms according to *securityConfig* and apply the K_{UPenc} key associated with the master key (K_{eNB}/K_{gNB}) or the secondary key ($S-K_{gNB}$) as indicated in *keyToUse*;
 - 2> if the PDCP entity of this DRB is configured with *integrityProtection*:
 - 3> configure the PDCP entity with the integrity algorithms according to *securityConfig* and apply the K_{UPint} key associated with the master (K_{eNB}/K_{gNB}) or the secondary key ($S-K_{gNB}$) as indicated in *keyToUse*;
 - 2> if the UE is operating in EN-DC:

- 3> if the DRB was configured with the same *eps-BearerIdentity* either by NR or E-UTRA prior to receiving this reconfiguration:
 - 4> associate the established DRB with the corresponding *eps-BearerIdentity*;
- 3> else:
 - 4> indicate the establishment of the DRB(s) and the *eps-BearerIdentity* of the established DRB(s) to upper layers;
- 1> for each *drb-Identity* value included in the *drb-ToAddModList* that is part of the current UE configuration:
 - 2> if an *sdap-Config* is included, reconfigure the SDAP entity in accordance with the received *sdap-Config* as specified in TS 37.324 [xx];
 - 2> if the *reestablishPDCP* is set:
 - 3> if target RAT is E-UTRA/5GC:
 - 4> if the PDCP entity of this DRB is not configured with *cipheringDisabled*:
 - 5> configure the PDCP entity with the ciphering algorithm and K_{UPenc} key configured/derived as specified in TS 36.331 [10, 5.4.2.3], i.e. the ciphering configuration shall be applied to all subsequent PDCP PDUs received and sent by the UE;
 - 3> else:
 - 4> if the PDCP entity of this DRB is not configured with *cipheringDisabled*:
 - 5> configure the PDCP entity with the ciphering algorithm and K_{UPenc} key associated with the master or secondary key ($K_{eNB/S-K_{gNB}/K_{gNB}}$) as indicated in *keyToUse*, i.e. the ciphering configuration shall be applied to all subsequent PDCP PDUs received and sent by the UE;
 - 4> if the PDCP entity of this DRB is configured with *integrityProtection*:
 - 5> configure the PDCP entity with the integrity algorithms according to *securityConfig* and apply the K_{UPint} key associated with the master (K_{eNB}/K_{gNB}) or the secondary key ($S-K_{gNB}$) as indicated in *keyToUse*;
 - 3> re-establish the PDCP entity of this DRB as specified in 38.323 [5], section 5.1.2;
 - 2> else, if the *recoverPDCP* is set:
 - 3> trigger the PDCP entity of this DRB to perform data recovery as specified in 38.323;
 - 2> if the *pdcp-Config* is included:
 - 3> reconfigure the PDCP entity in accordance with the received *pdcp-Config*.

NOTE 1: Removal and addition of the same *drb-Identity* in a single *radioResourceConfig* is not supported. In case *drb-Identity* is removed and added due to reconfiguration with sync or re-establishment with the full configuration option, the network can use the same value of *drb-Identity*.

NOTE 2: When determining whether a *drb-Identity* value is part of the current UE configuration, the UE does not distinguish which *RadioBearerConfig* and *DRB-ToAddModList* that DRB was originally configured in. To re-associate a DRB with a different key (K_{eNB} to $S-K_{eNB}$ or vice versa), the network provides the *drb-Identity* value in the (target) *drb-ToAddModList* and sets the *reestablishPDCP* flag. The network does not list the *drb-Identity* in the (source) *drb-ToReleaseList*.

NOTE 3: When setting the *reestablishPDCP* flag for a radio bearer, the network ensures that the RLC receiver entities do not deliver old PDCP PDUs to the re-established PDCP entity. It does that e.g. by triggering a reconfiguration with sync of the cell group hosting the old RLC entity or by releasing the old RLC entity.

NOTE 4: In this specification, UE configuration refers to the parameters configured by NR RRC unless otherwise stated.

NOTE 5: Ciphering and integrity protection can be enabled or disabled for a DRB. The enabling/disabling of ciphering or integrity protection can be changed only by releasing and adding the DRB.

8.2.4.2.1.1.3 Test description

8.2.4.2.1.1.3.1 Pre-test conditions

System Simulator:

- E-UTRA Cell 1 is the PCell, NR Cell 1 is the PSCell to be added, and NR Cell 3 is Scell to be added. NR Cell 2 and NR Cell 12 are the target PSCell and SCell.
- NR Cell 1 and NR Cell 3 are Intra-band Contiguous. NR Cell 2 and NR Cell 12 are Intra-band Contiguous.

UE:

None

Preamble:

- If `pc_IP_Ping` is set to `TRUE` then, the UE is in state `RRC_CONNECTED` using generic procedure parameter `Connectivity (E-UTRA/EPC)` established according to TS 38.508-1 [4], clause 4.5.4.
- Else, the UE is in state `RRC_CONNECTED` using generic procedure parameter `Connectivity (E-UTRA/EPC)` established and Test Mode (*On*) associated with UE test loop mode B configured on E-UTRA Cell 1 according to TS 38.508-1 [4], clause 4.5.4.

8.2.4.2.1.1.3.2 Test procedure sequence

Table 8.2.4.2.1.1.3.2-1 illustrates the downlink power levels to be applied for EUTRA Cell 1, NR Cell 1, NR Cell 3, NR Cell 2 and NR Cell 12 at various time instants of the test execution. Row marked “T0” denotes the conditions after the preamble, while rows marked “T1” are to be applied subsequently. The exact instants on which these values shall be applied are described in the texts in this clause.

Table 8.2.4.2.1.1.3.2-1: Power levels for conducted test environment

	Parameter	Unit	E-UTRA Cell 1	NR Cell 1	NR Cell 3	NR Cell 2	NR Cell 12	Remark
T0	Cell-specific RS EPRE	dBm/15kHz	-85	-	-	-	-	EUTRA Cell 1, NR Cell 1 and NR Cell 3 are available. NR Cell 2 and NR Cell 12 are not available.
	SS/PBCH SSS EPRE	dBm/SCS	-	-88	-88	off	off	
T1	Cell-specific RS EPRE	dBm/15kHz	-85	-	-	-	-	EUTRA Cell 1, NR Cell 1, NR Cell 3, NR Cell 2 and NR Cell 12 are available.
	SS/PBCH SSS EPRE	dBm/SCS	-	-88	-88	-88	-88	

Table 8.2.4.2.1.1.3.2-1A: Power levels for OTA test environment

	Parameter	Unit	E-UTRA Cell 1	NR Cell 1	NR Cell 3	NR Cell 2	NR Cell 12	Remark
T0	Cell-specific RS EPRE	dBm/15kHz	-96	-	-	-	-	EUTRA Cell 1, NR Cell 1 and NR Cell 3 are available. NR Cell 2 and NR Cell 12 are not available.
	SS/PBCH SSS EPRE	dBm/SCS	-	-91	-91	off	off	
T1	Cell-specific RS EPRE	dBm/15kHz	-96	-	-	-	-	EUTRA Cell 1, NR Cell 1, NR Cell 3, NR Cell 2 and NR Cell 12 are available.
	SS/PBCH SSS EPRE	dBm/SCS	-	-91	-91	-91	-91	

Table 8.2.4.2.1.1.3.2-2: Main behaviour

St	Procedure	Message Sequence		TP	Verdict
		U – S	Message		
1	The SS changes Cell parameters according to the row "T0" in table 8.2.4.2.1.1.3.2-1.	-	-	-	-
2	The SS transmits an <i>RRCCONNECTIONRECONFIGURATION</i> message with nr-Config IE including NR RRCReconfiguration message to configure NR Cell 1 as the NR PSCell and sCellToAddModList with a sCellIndex set to NR Cell 3 as the configured Scell.	<--	<i>RRCCONNECTIONRECONFIGURATION</i>	-	-
3	Check: Does the UE transmit an <i>RRCCONNECTIONRECONFIGURATIONCOMPLETE</i> message?	-->	<i>RRCCONNECTIONRECONFIGURATIONCOMPLETE</i>	1	P
-	EXCEPTION: Steps 3AAa1 to 3AAa2 describe behaviour that depends on the UE implementation; the "lower case letter" identifies a step sequence that take place depending on the UE implementation.	-	-	-	-
3AAa1	IF pc_IP_Ping = FALSE, then, the SS transmits a CLOSE UE TEST LOOP message.	<--	CLOSE UE TEST LOOP	-	-
3AAa2	The UE transmits a CLOSE UE TEST LOOP COMPLETE message.	-->	CLOSE UE TEST LOOP COMPLETE	-	-
3A	Check: Does the test result of generic test procedure in TS 38.508-1 Table 4.9.1-1A indicate that the UE is capable of exchanging IP data on DRB #n associated with the first PDU session on NR Cell 3?	-	-	-	-
4	The SS changes NR Cell 2 and NR Cell 12 parameters according to the row "T1" in table 8.2.4.2.1.1.3.2-1.	-	-	-	-
5	The SS transmits an <i>RRCCONNECTIONRECONFIGURATION</i> message with nr-Config IE including NR RRCReconfiguration message to perform both NR Cell 1 and NR Cell 3 changed to the configured target NR Cell 2 and NR Cell 12.	<--	<i>RRCCONNECTIONRECONFIGURATION</i>	-	-
6	Check: Does the UE transmit an <i>RRCCONNECTIONRECONFIGURATIONCOMPLETE</i> message configuring the new PSCell and SCell and configure lower layers to consider the SCell to be in deactivated state?	-->	<i>RRCCONNECTIONRECONFIGURATIONCOMPLETE</i>	2	P
-	EXCEPTION: Steps 7Aa1 to 7Aa2 describe behaviour that depends on the UE implementation; the "lower case letter" identifies a step sequence that take place depending on the UE implementation.	-	-	-	-
7Aa1	IF pc_IP_Ping = FALSE, then, the SS transmits a OPEN UE TEST LOOP message.	<--	OPEN UE TEST LOOP	-	-
7Aa2	The UE transmits a OPEN UE TEST LOOP COMPLETE message.	-->	OPEN UE TEST LOOP COMPLETE	-	-
6A	Check: Does the test result of generic test procedure in TS 38.508-1 Table 4.9.1-1A indicate that the UE is capable of exchanging IP data on DRB #n associated with the first PDU session on NR Cell 12?	-	-	-	-
7	The SS transmits an <i>RRCCONNECTIONRECONFIGURATION</i> message with nr-Config IE including NR RRCReconfiguration message to change the current PSCell (NR Cell 2) to NR Cell 12 equaling to one of the current UE SCell configuration.	<--	<i>RRCCONNECTIONRECONFIGURATION</i>	-	-
8	Check: Does the UE send an <i>RRCCONNECTIONRECONFIGURATIONCOMPLETE</i> message and reconfigure the current NR Scell to PSCell?	-->	<i>RRCCONNECTIONRECONFIGURATIONCOMPLETE</i>	3	P

rrcReconfiguration SEQUENCE {			
secondaryCellGroup	CellGroupConfig	OCTET STRING (CONTAINING CellGroupConfig)	
}			
}			
}			

Table 8.2.4.2.1.1.3.3-7: CellGroupConfig (Table 8.2.4.2.1.1.3.3-6: RRCReconfiguration)

Derivation Path: TS 38.508-1 [4], Table 4.6.3-19 with Condition PSCell_change and SCell_add			
Information Element	Value/remark	Comment	Condition
CellGroupConfig ::= SEQUENCE {			
spCellConfig SEQUENCE {			
servCellIndex	1		
reconfigurationWithSync SEQUENCE {			
spCellConfigCommon SEQUENCE {			
physCellId	Physical Cell Identity of NR Cell 2		
}			
}			
}			
sCellToAddModList SEQUENCE (SIZE (1..maxNrofSCells)) OF SCellConfig {	1 entry		
SCellConfig[1] SEQUENCE {		entry 1	
sCellIndex	2		
sCellConfigCommon SEQUENCE {			
physCellId	Physical Cell Identity of NR Cell 12		
}			
}			
}			
sCellToReleaseList SEQUENCE (SIZE (1..maxNrofSCells)) OF SCellIndex {	1 entry		
SCellIndex[1]	2	entry 1	
}			

Table 8.2.4.2.1.1.3.3-8: RRCConnectionReconfiguration (step 7, Table 8.2.4.2.1.1.3.2-2)

Derivation Path: TS 36.508 [7], Table 4.6.1-8 with Condition EN-DC_PSCell_HO AND RBConfig_NoKeyChange			
Information Element	Value/remark	Comment	Condition
RRCConnectionReconfiguration ::= SEQUENCE {			
criticalExtensions CHOICE {			
c1 CHOICE {			
rrcConnectionReconfiguration-r8 SEQUENCE {			
nonCriticalExtension SEQUENCE {			
nonCriticalExtension SEQUENCE {			
nonCriticalExtension SEQUENCE {			
nonCriticalExtension SEQUENCE {			
nonCriticalExtension SEQUENCE {			
nonCriticalExtension SEQUENCE {			
nonCriticalExtension SEQUENCE {			
nonCriticalExtension SEQUENCE {			
nr-Config-r15 CHOICE {			
setup SEQUENCE {			
nr-SecondaryCellGroupConfig-r15	RRCReconfiguration	OCTET STRING including the RRCReconfiguration	
}			
}			
}			
}			
}			
}			

}			
}			
}			
}			
}			
}			
}			
}			
}			
}			

Table 8.2.4.2.1.1.3.3-9: RRCReconfiguration (Table 8.2.4.2.1.1.3.3-8: RRCConnectionReconfiguration)

Derivation Path: TS 38.508-1 [4], Table 4.6.1-13 with Condition EN-DC			
Information Element	Value/remark	Comment	Condition
RRCReconfiguration ::= SEQUENCE {			
criticalExtensions CHOICE {			
rrcReconfiguration SEQUENCE {			
secondaryCellGroup	CellGroupConfig	OCTET STRING (CONTAINING CellGroupConfig)	
}			
}			
}			

Table 8.2.4.2.1.1.3.3-10: CellGroupConfig (Table 8.2.4.2.1.1.3.3-10: RRCReconfiguration)

Derivation Path: TS 38.508-1 [4], Table 4.6.3-19 with condition PSCell_change and SCell_Add			
Information Element	Value/remark	Comment	Condition
CellGroupConfig ::= SEQUENCE {			
spCellConfig SEQUENCE {			
servCellIndex	1		
reconfigurationWithSync SEQUENCE {			
spCellConfigCommon SEQUENCE {			
physCellId	Physical Cell Identity of NR Cell 12		
}			
}			
}			
sCellToAddModList	Not present		
sCellToReleaseList SEQUENCE (SIZE (1..maxNrofSCells)) OF SCellIndex {	1 entry		
SCellIndex[1]	2	entry 1	
}			

8.2.4.2.1.2 NR CA / Simultaneous PSCell and SCell addition / PSCell and SCell change / CA Release / EN-DC / Intra-band non-Contiguous CA

8.2.4.2.1.2.1 Test Purpose (TP)

Same as TC 8.2.4.2.1.1 but applied to Intra-band non-Contiguous CA.

8.2.4.2.1.2.2 Conformance requirements

Same as TC 8.2.4.2.1.1 but applied to Intra-band non-Contiguous CA.

8.2.4.2.1.2.3 Test description

8.2.4.2.1.2.3.1 Pre-test conditions

Same as TC 8.2.4.2.1.1 with the following differences:

- CA configuration: Intra-band non-Contiguous CA replaces Intra-band Contiguous CA

8.2.4.2.1.2.3.2 Test procedure sequence

Same as TC 8.2.4.2.1.1 with the following differences:

- CA configuration: Intra-band non-Contiguous CA replaces Intra-band Contiguous CA

8.2.4.2.1.3 NR CA / Simultaneous PSCell and SCell addition / PSCell and SCell change / CA Release / EN-DC / Inter-band CA

8.2.4.2.1.3.1 Test Purpose (TP)

Same as TC 8.2.4.2.1.1 but applied to Inter-band CA.

8.2.4.2.1.3.2 Conformance requirements

Same as TC 8.2.4.2.1.1 but applied to Inter-band CA.

8.2.4.2.1.3.3 Test description

8.2.4.2.1.3.3.1 Pre-test conditions

Same as TC 8.2.4.2.1.1 with the following differences:

- CA configuration: Inter-band CA replaces Intra-band Contiguous CA

8.2.4.2.1.3.3.2 Test procedure sequence

Same as TC 8.2.4.2.1.1 with the following differences:

- CA configuration: Inter-band CA replaces Intra-band Contiguous CA
- Cells configuration: NR Cell 10 replaces NR Cell 3, NR Cell 30 replaces NR Cell 12

8.2.4.3 NR CA / SCell change / Intra-NR measurement event A6 / SRB3

8.2.4.3.1 NR CA / SCell change / Intra-NR measurement event A6 / SRB3 / EN-DC

8.2.4.3.1.1 NR CA / SCell change / Intra-NR measurement event A6 / SRB3 / EN-DC / Intra-band Contiguous CA

8.2.4.3.1.1.1 Test Purpose (TP)

(1)

```
with { UE in RRC_CONNECTED state with EN-DC, and MCG(s) (E-UTRA PDCP) and SCG with SCell(s)
configured and SRB3 configured and Intra-NR measurement configured for event A6 }
ensure that {
  when { Neighbour becomes offset better than NR SCell }
  then { UE sends a Measurement Report message on SRB3 while entering condition for event A6 is
satisfied }
}
```

(2)

```
with { UE in RRC_CONNECTED state with EN-DC, and MCG(s) (E-UTRA PDCP) and SCG with SCell(s)
configured and Intra-NR measurement is configured for event A6 }
ensure that {
  when { UE receives an RRCReconfiguration message containing sCellToReleaseList with an sCellIndex
equalling to one of the current UE SCell configuration and sCellToAddModList with an sCellIndex set
to the configured target SCell and servingCellMO equalling to one of the released SCell }
}
```



```

    then { UE sends an RRCReconfigurationComplete message and changes the SCell and continues
performing measurements on that SCell}
    }

```

8.2.4.3.1.1.2 Conformance requirements

References: The conformance requirements covered in the present test case are specified in: TS 36.331, clause 5.3.5.3, TS 38.331, clauses 5.3.5.3, 5.3.5.5.8, 5.3.5.5.9, 5.5.4.7 and 5.5.5. Unless otherwise stated these are Rel-15 requirements.

[TS 36.331, clause 5.3.5.3]

If the *RRCConnectionReconfiguration* message does not include the *mobilityControlInfo* and the UE is able to comply with the configuration included in this message, the UE shall:

...

- 1> if the received *RRCConnectionReconfiguration* includes the *nr-Config* and it is set to *release*: or
- 1> if the received *RRCConnectionReconfiguration* includes *endc-ReleaseAndAdd* and it is set to *TRUE*:
 - 2> perform ENDC release as specified in TS38.331 [82], clause 5.3.5.10;

...

- 1> if the received *RRCConnectionReconfiguration* includes the *nr-SecondaryCellGroupConfig*:
 - 2> perform NR RRC Reconfiguration as specified in TS 38.331 [82], clause 5.3.5.5;

...

- 1> set the content of *RRCConnectionReconfigurationComplete* message as follows:

...

- 2> if the received *RRCConnectionReconfiguration* message included *nr-SecondaryCellGroupConfig*:
 - 3> include *scg-ConfigResponseNR* in accordance with TS 38.331 [82, 5.3.5.3];
- 1> submit the *RRCConnectionReconfigurationComplete* message to lower layers for transmission using the new configuration, upon which the procedure ends;

[TS 38.331, clause 5.3.5.3]

The UE shall perform the following actions upon reception of the *RRCReconfiguration*:

- 1> if the *RRCReconfiguration* includes the *secondaryCellGroup*:
 - 2> perform the cell group configuration for the SCG according to 5.3.5.5;
- 1> if the *RRCReconfiguration* message contains the *radioBearerConfig*:
 - 2> perform the radio bearer configuration according to 5.3.5.6;
- 1> if the *RRCReconfiguration* message includes the *measConfig*:
 - 2> perform the measurement configuration procedure as specified in 5.5.2;
- 1> if the UE is configured with E-UTRA *nr-SecondaryCellGroupConfig* (MCG is E-UTRA):
 - 2> if *RRCReconfiguration* was received via SRB1:
 - 2> else (*RRCReconfiguration* was received via SRB3):
 - 3> submit the *RRCReconfigurationComplete* message via SRB3 to lower layers for transmission using the new configuration;

NOTE: For EN-DC, in the case of SRB1, the random access is triggered by RRC layer itself as there is not necessarily other UL transmission. In the case of SRB3, the random access is triggered by the MAC layer due to arrival of *RRCReconfigurationComplete*.

1> else:

2> submit the *RRCReconfigurationComplete* message via SRB1 to lower layers for transmission using the new configuration;

...

[TS 38.331, clause 5.3.5.5.8]

The UE shall:

1> if the release is triggered by reception of the *sCellToReleaseList*:

2> for each *sCellIndex* value included in the *sCellToReleaseList*:

3> if the current UE configuration includes an SCell with value *sCellIndex*:

4> release the SCell;

[TS 38.331, clause 5.3.5.5.9]

The UE shall:

1> for each *sCellIndex* value included in the *sCellToAddModList* that is not part of the current UE configuration (SCell addition):

2> add the SCell, corresponding to the *sCellIndex*, in accordance with the *sCellConfigCommon* and *sCellConfigDedicated*;

2> configure lower layers to consider the SCell to be in deactivated state;

2> for each *measId* included in the *measIdList* within *VarMeasConfig*:

3> if SCells are not applicable for the associated measurement; and

3> if the concerned SCell is included in *cellsTriggeredList* defined within the *VarMeasReportList* for this *measId*:

4> remove the concerned SCell from *cellsTriggeredList* defined within the *VarMeasReportList* for this *measId*;

1> for each *sCellIndex* value included in the *sCellToAddModList* that is part of the current UE configuration (SCell modification):

2> modify the SCell configuration in accordance with the *sCellConfigDedicated*;

[TS 38.331, clause 5.5.4.7]

The UE shall:

1> consider the entering condition for this event to be satisfied when condition A6-1, as specified below, is fulfilled;

1> consider the leaving condition for this event to be satisfied when condition A6-2, as specified below, is fulfilled;

1> for this measurement, consider the (secondary) cell corresponding to the *measObjectNR* associated to this event to be the serving cell.

NOTE: The reference signal(s) of the neighbour(s) and the reference signal(s) of the SCell are both indicated in the associated *measObjectNR*.

Inequality A6-1 (Entering condition)

$$Mn + Ocn - Hys > Ms + Ocs + Off$$

Inequality A6-2 (Leaving condition)

$$Mn + Ocn + Hys < Ms + Ocs + Off$$

The variables in the formula are defined as follows:

Mn is the measurement result of the neighbouring cell, not taking into account any offsets.

Ocn is the cell specific offset of the neighbour cell (i.e. *cellIndividualOffset* as defined within the associated *measObjectNR*), and set to zero if not configured for the neighbour cell.

Ms is the measurement result of the serving cell, not taking into account any offsets.

Ocs is the cell specific offset of the serving cell (i.e. *cellIndividualOffset* as defined within the associated *measObjectNR*), and is set to zero if not configured for the serving cell.

Hys is the hysteresis parameter for this event (i.e. *hysteresis* as defined within *reportConfigNR* for this event).

Off is the offset parameter for this event (i.e. *a6-Offset* as defined within *reportConfigNR* for this event).

Mn, ***Ms*** are expressed in dBm in case of RSRP, or in dB in case of RSRQ and RS-SINR.

Ocn, ***Ocs***, ***Hys***, ***Off*** are expressed in dB.

[TS 38.331, clause 5.5.5]



Figure 5.5.5.1-1: Measurement reporting

The purpose of this procedure is to transfer measurement results from the UE to the network. The UE shall initiate this procedure only after successful security activation.

For the *measId* for which the measurement reporting procedure was triggered, the UE shall set the *measResults* within the *MeasurementReport* message as follows:

- 1> set the *measId* to the measurement identity that triggered the measurement reporting;
- 1> set the *measResultServingCell* within *measResultServingMOList* to include RSRP, RSRQ and the available SINR for each configured serving cell derived based on the *rsType* indicated in the associated *reportConfig*;
- 1> set the *measResultServingCell* within *measResultServingMOList* to include for each NR serving cell that is configured with *servingCellMO*, if any, the *servCellId*;
- 1> if the *reportConfig* associated with the *measId* that triggered the measurement reporting includes *reportQuantityRsIndexes* and *maxNrofRSIndexesToReport*:
 - 2> for each serving cell configured with *servingCellMO*, include beam measurement information according to the associated *reportConfig* as described in 5.5.5.2;
- ...
- 1> if there is at least one applicable neighbouring cell to report:

- 2> set the *measResultNeighCells* to include the best neighbouring cells up to *maxReportCells* in accordance with the following:
 - 3> if the *reportType* is set to *eventTriggered*:
 - 4> include the cells included in the *cellsTriggeredList* as defined within the *VarMeasReportList* for this *measId*;
 - 3> else:
 - 4> include the applicable cells for which the new measurement results became available since the last periodical reporting or since the measurement was initiated or reset;
 - 4> if *reportQuantityRsIndexes* and *maxNrofRSIndexesToReport* are configured, include beam measurement information as described in 5.5.5.2;
- 3> for each cell that is included in the *measResultNeighCells*, include the *physCellId*;
- 3> if the *reportType* is set to *eventTriggered*:
 - 4> for each included cell, include the layer 3 filtered measured results in accordance with the *reportConfig* for this *measId*, ordered as follows:
 - 5> if the *measObject* associated with this *measId* concerns NR:
 - 6> if *rsType* in the associated *reportConfig* is set to *ssb*:
 - 7> set *resultsSSB-Cell* within the *measResult* to include the SS/PBCH block based quantity(ies) indicated in the *reportQuantityCell* within the concerned *reportConfig*, in order of decreasing trigger quantity, i.e. the best cell is included first;
 - 8> if *reportQuantityRsIndexes* and *maxNrofRSIndexesToReport* are configured, include beam measurement information as described in 5.5.5.2;
 - 6> else if *rsType* in the associated *reportConfig* is set to *csi-rs*:
 - 7> set *resultsCSI-RS-Cell* within the *measResult* to include the CSI-RS based quantity(ies) indicated in the *reportQuantityCell* within the concerned *reportConfig*, in order of decreasing trigger quantity, i.e. the best cell is included first;
 - 8> if *reportQuantityRsIndexes* and *maxNrofRSIndexesToReport* are, include beam measurement information as described in 5.5.5.2;
 - 5> if the *measObject* associated with this *measId* concerns E-UTRA:
 - 6> set the *measResult* to include the quantity(ies) indicated in the *reportQuantity* within the concerned *reportConfigInterRAT* in order of decreasing E-UTRA trigger quantity, i.e. the best cell is included first;
- 1> increment the *numberOfReportsSent* as defined within the *VarMeasReportList* for this *measId* by 1;
- 1> stop the periodical reporting timer, if running;
- 1> if the *numberOfReportsSent* as defined within the *VarMeasReportList* for this *measId* is less than the *reportAmount* as defined within the corresponding *reportConfig* for this *measId*:
 - 2> start the periodical reporting timer with the value of *reportInterval* as defined within the corresponding *reportConfig* for this *measId*;
 - ...
- 1> if the UE is configured with EN-DC:
 - 2> if SRB3 is configured:
 - 3> submit the *MeasurementReport* message via SRB3 to lower layers for transmission, upon which the procedure ends;

2> else:

3> submit the *MeasurementReport* message via the EUTRA MCG embedded in E-UTRA RRC message *ULInformationTransferMRDC* as specified in TS 36.331 [10].

8.2.4.3.1.1.3 Test description

8.2.4.3.1.1.3.1 Pre-test conditions

System Simulator:

- E-UTRA Cell 1 is the PCell. NR Cell 1 is the PSCell and NR Cell 3 is the SCell to be added, NR Cell 12 is the intra-frequency neighbour cell of NR Cell 3;
- NR Cell 3 and NR Cell 12 are Inactive SCells according to TS 38.508-1 [4] clause 6.3.3.2.

UE:

None.

Preamble:

- The UE is in state RRC_CONNECTED using generic procedure parameter Connectivity (*EN-DC*) and DC bearers (*MCG(s) and SCG*) according to TS 38.508-1 [4], table 4.5.4.

8.2.4.3.1.1.3.2 Test procedure sequence

Table 8.2.4.3.1.1.3.2-1 and table 8.2.4.3.1.1.3.2-1A illustrates the downlink power levels to be applied for E-UTRA Cell 1, NR Cell 1, NR Cell 3 and NR Cell 12 at various time instants of the test execution. Row marked "T0" denotes the conditions after the preamble, while the configuration marked "T1" is applied at the point indicated in the Main behaviour description in Table 8.2.4.3.1.1.3.2-2.

Table 8.2.4.3.1.1.3.2-1: Power levels for conducted test environment

	Parameter	Unit	E-UTRA Cell 1	NR Cell 1	NR Cell 3	NR Cell 12	Remark
T0	Cell-specific RS EPRE	dBm/15 kHz	-79	-	-	-	Power levels are such that entry condition for event A6 is not satisfied for NR Cell 3 when being an SCell: $Mn + Ocn + Hys < Ms + Ocs + Off$ but satisfied for NR Cell 12 when being an SCell: $Mn + Ocn - Hys > Ms + Ocs + Off$
	SS/PBCH SSS EPRE	dBm/S CS	-	-79	-85	-97	
T1	Cell-specific RS EPRE	dBm/15 kHz	-79	-	-	-	Power levels are such that entry condition for event A6 is satisfied for NR Cell 3 when being an SCell: $Mn + Ocn - Hys > Ms + Ocs + Off$ but not satisfied for NR Cell 12 when being an SCell: $Mn + Ocn + Hys < Ms + Ocs + Off$
	SS/PBCH SSS EPRE	dBm/S CS	-	-79	-97	-85	

Table 8.2.4.3.1.1.3.2-1A: Power levels for OTA test environment

	Parameter	Unit	E-UTRA Cell 1	NR Cell 1	NR Cell 3	NR Cell 12	Remark
T0	Cell-specific RS EPRE	dBm/15 kHz	-96	-	-	-	Power levels are such that entry condition for event A6 is not satisfied for NR Cell 3 when being an SCell: $Mn + Ocn + Hys < Ms + Ocs + Off$ but satisfied for NR Cell 12 when being an SCell: $Mn + Ocn - Hys > Ms + Ocs + Off$
	SS/PBCH SSS EPRE	dBm/S CS	-	-91	-91	-100	

T1	Cell-specific RS EPRE	dBm/15 kHz	-96	-	-	-	Power levels are such that entry condition for event A6 is satisfied for NR Cell 3 when being an SCell: $Mn + Ocn - Hys > Ms + Ocs + Off$ but not satisfied for NR Cell 12 when being an SCell: $Mn + Ocn + Hys < Ms + Ocs + Off$
	SS/PBCH SSS EPRE	dBm/S CS	-	-91	-100	-91	

Table 8.2.4.3.1.1.3.2-2: Main behaviour

St	Procedure	Message Sequence		TP	Verdict
		U – S	Message		
1	SS transmits an <i>RRCConnectionReconfiguration</i> message containing <i>RRCReconfiguration</i> message to configure SCell (NR Cell 3) and SRB3.	<--	<i>RRCConnectionReconfiguration(RRCReconfiguration)</i>	-	-
2	The UE transmits an <i>RRCConnectionReconfigurationComplete</i> message containing <i>RRCReconfigurationComplete</i> message.	-->	<i>RRCConnectionReconfigurationComplete(RRCReconfigurationComplete)</i>	-	-
3	SS transmits an <i>RRCConnectionReconfiguration</i> message containing <i>RRCReconfiguration</i> message including <i>measConfig</i> to setup intra NR measurement and reporting for event A6	<--	<i>RRCConnectionReconfiguration(RRCReconfiguration)</i>	-	-
4	The UE transmits an <i>RRCConnectionReconfigurationComplete</i> message containing <i>RRCReconfigurationComplete</i> message.	-->	<i>RRCConnectionReconfigurationComplete(RRCReconfigurationComplete)</i>	-	-
5	SS re-adjusts the cell-specific reference signal level according to row "T1" in table 8.2.4.3.1.1.3.2-1/1A.	-	-	-	-
6	Check: Does the UE transmit a <i>MeasurementReport</i> message via SRB3 to report event A6 with the measured RSRP and RSRQ value for NR Cell 12?	-->	<i>MeasurementReport</i>	1	P
7	The SS transmits an <i>RRCReconfiguration</i> message including <i>sCellToReleaseList</i> with NR Cell 3 as SCell release and <i>sCellToAddModList</i> with NR Cell 12 as SCell addition via SRB3.	<--	<i>RRCReconfiguration</i>	-	-
8	The UE transmits an <i>RRCReconfigurationComplete</i> message on NR Cell 1.	-->	<i>RRCReconfigurationComplete</i>	-	-
9	Check: Does the UE transmit a <i>MeasurementReport</i> message via SRB3 within the next 10s to report event A6?	-->	<i>MeasurementReport</i>	2	F
10	SS re-adjusts the cell-specific reference signal level according to row "T0" in table 8.2.4.3.1.1.3.2-1/1A.	-	-	-	-
11	Check: Does the UE transmit a <i>MeasurementReport</i> message via SRB3 to report event A6 with the measured RSRP and RSRQ value for NR Cell 3?	-->	<i>MeasurementReport</i>	2	P

8.2.4.3.1.1.3.3 Specific message contents

Table 8.2.4.3.1.1.3.3-1: *RRCConnectionReconfiguration* (step 1, Table 8.2.4.3.1.1.3.2-2)

Derivation Path: TS 36.508 [7], Table 4.6.1-8 condition MCG_and_SCG.			
Information Element	Value/remark	Comment	Condition
<i>RRCConnectionReconfiguration</i> ::= SEQUENCE { criticalExtensions CHOICE {			

sCellConfigCommon	ServingCellConfigCommon		
sCellConfigDedicated	ServingCellConfig	TS 38.508-1 [4] table 4.6.3-167	
}			
}			
}			

Table 8.2.4.3.1.1.3.3-4: ServingCellConfigCommon (Table 8.2.4.3.1.1.3.3-3)

Derivation Path: TS 38.508-1 [4], Table 4.6.3-168.			
Information Element	Value/remark	Comment	Condition
ServingCellConfigCommon ::= SEQUENCE {			
PhysCellId	Physical Cell Identity of NR Cell 3		
}			

Table 8.2.4.3.1.1.3.3-5: RRCReconfiguration (step 3, Table 8.2.4.3.1.1.3.2-2)

Derivation Path: TS 38.508-1 [4], Table 4.6.1-13 with condition EN-DC_MEAS.

Table 8.2.4.3.1.1.3.3-6: MeasConfig (Table 8.2.4.3.1.1.3.3-5)

Derivation path: TS 38.508-1 [4], Table 4.6.3-69.			
Information Element	Value/Remark	Comment	Condition
measConfig ::= SEQUENCE {			
measObjectToAddModList SEQUENCE (SIZE (1..maxNrofObjectId)) OF MeasObjectToAddMod {	2 entries		
MeasObjectToAddMod[1] SEQUENCE {		entry 1	
measObjectId	1	NR Cell 1	
measObject CHOICE {			
measObjectNR	MeasObjectNR(60)	ssbFrequency IE equals the ARFCN for NR Cell 1 Thresh value set to -96dBm	
}			
}			
MeasObjectToAddMod[2] SEQUENCE {		entry 2	
measObjectId	2	NR Cell 3	
measObject CHOICE {			
measObjectNR	MeasObjectNR(67)	ssbFrequency IE equals the ARFCN for NR Cell 3 Thresh value set to -89dBm	FR1
	MeasObjectNR(62)	ssbFrequency IE equals the ARFCN for NR Cell 3 Thresh value set to -94dBm	FR2
}			
}			
reportConfigToAddModList SEQUENCE (SIZE (1..maxReportConfigId)) OF ReportConfigToAddMod {	1 entry		
ReportConfigToAddMod[1] SEQUENCE {		entry 1	
reportConfigId	1		
reportConfig CHOICE {			

reportConfigNR	ReportConfigNR(Delta(NRf2) – Delta(NRf1))	See Table 8.2.4.3.1.1.3.3-6A	
}			
}			
measIdToAddModList SEQUENCE (SIZE (1..maxMeasId)) OF MeasIdToAddMod {	1 entry		
MeasIdToAddMod[1] SEQUENCE {		entry 1	
measId	1		
measObjectId	2		
reportConfigId	1		
}			
}			
}			
NOTE 1: Delta(NRf1) and Delta(NRf2) is derived based on calibration procedure defined in the TS 38.508-1 [4], clause 6.1.3.3			

Table 8.2.4.3.1.1.3.3-6A: ReportConfigNR (Table 8.2.4.3.1.1.3.3-6)

Derivation path: TS 38.508-1 [4], Table 4.6.3-142 condition EVENT_A6			
Information Element	Value/remark	Comment	Condition
ReportConfigNR ::= SEQUENCE {			
reportType CHOICE {			
eventTriggered SEQUENCE {			
reportAmount	r1		
}			
}			
}			

Table 8.2.4.3.1.1.3.3-7: MeasurementReport (step 6, Table 8.2.4.3.1.1.3.2-2)

Derivation Path: TS 38.508-1 [4], Table 4.6.1-5A.			
Information Element	Value/remark	Comment	Condition
MeasurementReport ::= SEQUENCE {			
criticalExtensions CHOICE {			
measurementReport SEQUENCE {			
measResults SEQUENCE {			
measId	1		
measResultServingMOListSEQUENCE(SIZE (1..maxNrofServingCells)) OF MeasResultServMO {	2 entries		
MeasResultServMO[1] SEQUENCE {		entry 1	
servCellId	ServCellIndex of NR Cell 1		
measResultServingCell SEQUENCE {		Report NR Cell 1	
physCellId	physCellId of NR Cell 1		
measResult SEQUENCE {			
cellResults SEQUENCE {			
resultsSSB-Cell SEQUENCE {			
rsrp	(0..127)		
rsrq	(0..127)		
sinr	(0..127)		pc_ss_SINR_Meas
}	Not present		
}			
}			
}			
}			
}			
}			
}			
}			
MeasResultServMO[2] SEQUENCE {		entry 2	
servCellId	ServCellIndex of NR Cell 3		
measResultServingCell SEQUENCE {		Report NR Cell 3	
physCellId	physCellId of NR Cell 3		
measResult SEQUENCE {			

sCellToReleaseList SEQUENCE (SIZE (1..maxNrofSCells)) OF SCellIndex {	1 entry		
SCellIndex[1]	2	entry 1	
}			
}			

Note: ServingCellMO equal to the released SCell NR Cell 3.

Table 8.2.4.3.1.1.3.3-10: ServingCellConfigCommon (Table 8.2.4.3.1.1.3.3-9)

Derivation Path: TS 38.508-1 [4], Table 4.6.3-168.			
Information Element	Value/remark	Comment	Condition
ServingCellConfigCommon ::= SEQUENCE {			
PhysCellId	Physical Cell Identity of NR Cell 12		
}			

Table 8.2.4.3.1.1.3.3-11: MeasurementReport (step 11, Table 8.2.4.3.1.1.3.2-2)

Derivation Path: TS 38.508-1 [4], Table 4.6.1-5A.			
Information Element	Value/remark	Comment	Condition
MeasurementReport ::= SEQUENCE {			
criticalExtensions CHOICE {			
measurementReport SEQUENCE {			
measResults SEQUENCE {			
measId	1		
measResultServingMOList SEQUENCE(SIZE (1..maxNrofServingCells)) OF MeasResultServMO {	2 entries		
MeasResultServMO[1] SEQUENCE {		entry 1	
servCellId	ServCellIndex of NR Cell 1		
measResultServingCell SEQUENCE {		Report NR Cell 1	
physCellId	physCellId of NR Cell 1		
measResult SEQUENCE {			
cellResults SEQUENCE {			
resultsSSB-Cell SEQUENCE {			
rsrp	(0..127)		
rsrq	(0..127)		
sinr	(0..127)		pc_ss_SINR_Meas
Not present			
}			
}			
}			
MeasResultServMO[2] SEQUENCE {		entry 2	
servCellId	ServCellIndex of NR Cell 12		
measResultServingCell SEQUENCE {		Report NR Cell 12	
physCellId	physCellId of NR Cell 12		
measResult SEQUENCE {			
cellResults SEQUENCE {			
resultsSSB-Cell SEQUENCE {			
rsrp	(0..127)		
rsrq	(0..127)		
sinr	(0..127)		pc_ss_SINR_Meas
Not present			
}			
}			
}			
}			
}			
}			
}			

8.2.4.3.1.3.3.3 Specific message contents

Table 8.2.4.3.1.3.3-1: MeasConfig (Table 8.2.4.3.1.1.3.3-6)

Derivation path: TS 38.508-1 [4], Table 4.6.3-69.			
Information Element	Value/Remark	Comment	Condition
measConfig ::= SEQUENCE {			
measObjectToAddModList SEQUENCE (SIZE (1..maxNrofObjectId)) OF MeasObjectToAddMod {	2 entries		
MeasObjectToAddMod[1] SEQUENCE {		entry 1	
measObjectId	1	NR Cell 1	
measObject CHOICE {			
measObjectNR	MeasObjectNR(60)	ssbFrequency IE equals the ARFCN for NR Cell 1 Thresh value set to -96dBm	
}			
}			
MeasObjectToAddMod[2] SEQUENCE {		entry 2	
measObjectId	2	NR Cell 10	
measObject CHOICE {			
measObjectNR	MeasObjectNR(67)	ssbFrequency IE equals the ARFCN for NR Cell 10 Thresh value set to -89dBm	FR1
	MeasObjectNR(62)	ssbFrequency IE equals the ARFCN for NR Cell 10 Thresh value set to -94dBm	FR2
}			
}			
}			
reportConfigToAddModList SEQUENCE (SIZE (1..maxReportConfigId)) OF ReportConfigToAddMod {	1 entry		
ReportConfigToAddMod[1] SEQUENCE {		entry 1	
reportConfigId	1		
reportConfig CHOICE {			
reportConfigNR	ReportConfigNR(2)	TS 38.508-1 [4] table 4.6.3-142 condition EVENT_A6	FR1
reportConfigNR	ReportConfigNR(Delta(NRf2) – Delta(NRf1))	TS 38.508-1 [4] table 4.6.3-142 condition EVENT_A6	FR2
}			
}			
}			
measIdToAddModList SEQUENCE (SIZE (1..maxMeasId)) OF MeasIdToAddMod {	1 entry		
MeasIdToAddMod[1] SEQUENCE {		entry 1	
measId	1		
measObjectId	2		
reportConfigId	1		
}			
}			
}			

8.2.5 Reconfiguration Failure / Radio link failure

8.2.5.1 Radio link failure / PSCell addition failure

8.2.5.1.1 Radio link failure / Random access problem / EN-DC

8.2.5.1.1.1 Test Purpose (TP)

(1)

```
with { UE in RRC_CONNECTED state with EN-DC, and, MCG(s) (E-UTRA PDCP) and SCG }
ensure that {
  when { UE receives an IP Packet to loopback on SCG DRB and the SS does not respond to the
Scheduling Requests from UE }
  then { UE encounters random access problem and initiates the NR SCG failure information
procedure to report SCGFailureInformationNR with failure type randomAccessProblem }
}
```

8.2.5.1.1.2 Conformance requirements

References: The conformance requirements covered in the present TC are specified in: TS 36.331, clauses 5.6.13a.3, TS 38.331, clauses 5.3.10.3, 5.7.3.2, 5.7.3.3. Unless otherwise stated these are Rel-15 requirements.

[TS 36.331, clause 5.6.13a.3]

The UE shall set the contents of the *SCGFailureInformationNR* message as follows:

- 1> include *failureType* within *failureReportSCG-NR* and set it to indicate the SCG failure in accordance with TS 38.331 [82], clause 5.7.3.3;

...

The UE shall submit the *SCGFailureInformationNR* message to lower layers for transmission.

[TS 38.331, clause 5.3.10.3]

The UE shall:

...

- 1> upon random access problem indication from SCG MAC; or

...

- 3> consider radio link failure to be detected for the SCG i.e. SCG-RLF;
- 3> initiate the SCG failure information procedure as specified in 5.7.3 to report SCG radio link failure.

[TS 38.331, clause 5.7.3.2]

A UE initiates the procedure to report SCG failures when SCG transmission is not suspended and when one of the following conditions is met:

...

- 1> upon SCG configuration failure, in accordance with subclause 5.3.5.8.2;

...

Upon initiating the procedure, the UE shall:

- 1> suspend SCG transmission for all SRBs and DRBs;
- 1> reset SCG-MAC;
- 1> stop T304, if running;

1> if the UE is operating in EN-DC:

- 2> initiate transmission of the *SCGFailureInformationNR* message as specified in TS 36.331 [10], clause 5.6.13a.

[TS 38.331, clause 5.7.3.3]

The UE shall set the SCG failure type as follows:

...

1> else if the UE initiates transmission of the *SCGFailureInformationNR* message to provide random access problem indication from SCG MAC:

- 2> set the *failureType* as *randomAccessProblem*;

8.2.5.1.1.3 Test description

8.2.5.1.1.3.1 Pre-test conditions

System Simulator:

- E-UTRA Cell 1 is the PCell and NR Cell 1 is the PSCell.

UE:

- None.

Preamble:

- The UE is in state *RRC_CONNECTED* using generic procedure parameter *Connectivity (EN-DC)* and Bearers (*MCG(s) and SCG*) established and Test Loop Function (On) with UE test loop mode B according to TS 38.508-1 [4], clause 4.5.4.

8.2.5.1.1.3.2 Test procedure sequence

Table 8.2.5.1.1.3.2-1: Main behaviour

St	Procedure	Message Sequence		TP	Verdict
		U - S	Message		
1	The SS shall not respond to the Scheduling Requests for the IP Packet transmitted at next step (Note)	-	-	-	-
2	The SS transmits one IP Packet on SCG DRB	-	-	-	-
3	The SS shall not respond to the PRACH Preambles thereby simulating a random access problem.	-	-	-	-
4	Check: Does the UE transmit in the next 5 sec (arbitrary value) a <i>SCGFailureInformationNR</i> message with <i>failureType</i> set to ' <i>randomAccessProblem</i> '?	-->	<i>SCGFailureInformationNR</i>	1	P
Note: The UE initiates random access procedure once SR number of attempts reach <i>sr-transMax</i> .					

Table 8.2.5.1.1.3.2-2: Void

Table 8.2.5.1.1.3.2-3: Void

8.2.5.1.1.3.3 Specific message contents

Table 8.2.5.1.1.3.3-1: Void

Table 8.2.5.1.1.3.3-2: Void

Table 8.2.5.1.1.3.3-3: Void

Table 8.2.5.1.1.3.3-4: Void

Table 8.2.5.1.1.3.3-5: SCGFailureInformationNR (step 4, Table 8.2.5.1.1.3.2-1)

Derivation Path: TS 36.508 [7], Table 4.6.1-18AA			
Information Element	Value/remark	Comment	Condition
SCGFailureInformationNR-r15 ::= SEQUENCE {			
criticalExtensions CHOICE {			
c1 CHOICE {			
scgFailureInformationNR-r15 SEQUENCE {			
failureReportSCG-NR-r15 SEQUENCE {			
failureType-r15	randomAccessProblem		
measResultFreqListNR-r15	Not checked		
measResultSCG-r15	Not checked		
}			
nonCriticalExtension SEQUENCE {}			
}			
}			
}			

8.2.5.1.2 Radio link failure / Random access problem / NR-DC

8.2.5.1.2.1 Test Purpose (TP)

(1)

```

with { UE in NR RRC_CONNECTED state with NR-DC }
ensure that {
  when { UE receives an IP Packet to loopback on SCG DRB and the SS stops transmitting Timing
Advance Command and does not respond to the Scheduling Requests from UE }
  then { UE encounters random access problem and initiates the SCG failure information procedure
to report SCGFailureInformation with failure type randomAccessProblem }
}

```

8.2.5.1.2.2 Conformance requirements

References: The conformance requirements covered in the present TC are specified in: TS 38.331, clauses 5.7.3.2, 5.3.10.3, 5.7.3.3 and 5.7.3.5. Unless otherwise stated these are Rel-15 requirements.

[TS 38.331, clauses 5.7.3.2]

A UE initiates the procedure to report SCG failures when neither MCG nor SCG transmission is suspended and when one of the following conditions is met:

- 1> upon detecting radio link failure for the SCG, in accordance with subclause 5.3.10.3;

...

Upon initiating the procedure, the UE shall:

- 1> suspend SCG transmission for all SRBs and DRBs;
- 1> reset SCG MAC;

- 1> stop T304 for the SCG, if running;
- 1> stop conditional reconfiguration evaluation for CPC, if configured;
- 1> if the UE is in (NG)EN-DC:
 - 2> initiate transmission of the *SCGFailureInformationNR* message as specified in TS 36.331 [10], clause 5.6.13a.
- 1> else:
 - 2> initiate transmission of the *SCGFailureInformation* message in accordance with 5.7.3.5.

[TS 38.331, clause 5.3.10.3]

The UE shall:

...

- 1> upon consistent uplink LBT failure indication from SCG MAC:

...

- 3> consider radio link failure to be detected for the SCG, i.e. SCG RLF;
- 3> if MCG transmission is not suspended:
 - 4> initiate the SCG failure information procedure as specified in 5.7.3 to report SCG radio link failure.

[TS 38.331, clause 5.7.3.3]

The UE shall set the SCG failure type as follows:

1...

- 1> else if the UE initiates transmission of the *SCGFailureInformationNR* message to provide random access problem indication from SCG MAC:
 - 2> if the random access procedure was initiated for beam failure recovery:
 - 3> set the *failureType* as *other* and set the *failureType-v1610* as *beamFailureRecoveryFailure*;
 - 2> else:
 - 3> set the *failureType* as *randomAccessProblem*;

[TS 38.331, clause 5.7.3.5]

The UE shall set the contents of the *SCGFailureInformation* message as follows:

...

- 1> else if the UE initiates transmission of the *SCGFailureInformation* message to provide random access problem indication from SCG MAC:
 - 2> if the random access procedure was initiated for beam failure recovery:
 - 3> set the *failureType* as *other* and set the *failureType-v1610* as *beamFailureRecoveryFailure*;
 - 2> else:
 - 3> set the *failureType* as *randomAccessProblem*;

8.2.5.1.2.3 Test description

8.2.5.1.2.3.1 Pre-test conditions

System Simulator:

- NR Cell 1 is the PCell, NR Cell 10 is the PSCell
- System information combination NR-1 as defined in TS 38.508-1 [4] clause 4.4.3.1.2 is used in NR cell 1.

UE:

- None.

Preamble:

- The UE is in state NR RRC_CONNECTED using generic procedure parameter Connectivity (NR-DC) according to TS 38.508-1 [4], Table 4.5.1-1, and with UE test loop mode B activated, as defined in TS 38.508-1 [4], subclause 4.4A.

8.2.5.1.2.3.2 Test procedure sequence

Table 8.2.5.1.2.3.2-1: Main behaviour

St	Procedure	Message Sequence		TP	Verdict
		U - S	Message		
1	The SS shall not respond to the Scheduling Requests for the IP Packet transmitted at next step (Note)	-	-	-	-
2	The SS transmits one IP Packet on SCG DRB	-	-	-	-
3	The SS shall not respond to the PRACH Preambles thereby simulating a random access problem.	-	-	-	-
4	Check: Does the UE transmit in the next 5 sec (arbitrary value) a <i>SCGFailureInformation</i> message with <i>failureType</i> set to ' <i>randomAccessProblem</i> '?	-->	<i>SCGFailureInformation</i>	1	P

Note: The UE initiates random access procedure once SR number of attempts reach sr-transMax.

8.2.5.1.2.3.3 Specific message contents

Table 8.2.5.1.2.3.3-1: SCGFailureInformation (step 4, Table 8.2.5.1.2.3.2-1)

Derivation Path: TS 38.508-1 [4], Table 4.6.1-24A			
Information Element	Value/remark	Comment	Condition
SCGFailureInformation ::= SEQUENCE {			
criticalExtensions CHOICE {			
scgFailureInformation SEQUENCE {			
failureReportSCG	FailureReportSCG	Table 8.2.5.1.2.3.3-2	
nonCriticalExtension	Not checked		
}			
}			
}			

Table 8.2.5.1.2.3.3-2: FailureReportSCG (Table 8.2.5.1.2.3.3-1)

Derivation Path: TS 38.331[4], clause 6.2.2			
Information Element	Value/remark	Comment	Condition
FailureReportSCG ::= SEQUENCE {			
failureType	randomAccessProblem		

measResultFreqList	Not checked		
measResultSCG-Failure	Not checked		
}			

8.2.5.2 Radio link failure / PSCell out of sync indication

8.2.5.2.1 Radio link failure / PSCell out of sync indication / EN-DC

8.2.5.2.1.1 Test Purpose (TP)

(1)

```
with { UE in RRC_CONNECTED state with EN-DC, and, MCG(s) (E-UTRA PDCP) and SCG DRB established }
ensure that {
  when { UE receives N310 consecutive "out-of-sync" indications for the SpCell from lower layers due
to radio link failure }
  then { UE starts timer T310 for the corresponding SpCell, and, upon timer expiry initiates the
NR SCG failure information procedure to report SCGFailureInformationNR with failure type set to
't310-Expiry' }
}
```

8.2.5.2.1.2 Conformance requirements

References: The conformance requirements covered in the present test case are specified in: TS 36.331, clause 5.6.13a.3, TS 38.331, clauses 5.3.10.1, 5.3.10.3, 5.7.3.2, 5.7.3.3. Unless otherwise stated these are Rel-15 requirements.

[TS 36.331, clause 5.6.13a.3]

The UE shall set the contents of the *SCGFailureInformationNR* message as follows:

- 1> include *failureType* within *failureReportSCG-NR* and set it to indicate the SCG failure in accordance with TS 38.331 [82, 5.7.3.3];

...

The UE shall submit the *SCGFailureInformationNR* message to lower layers for transmission.

[TS 38.331, clause 5.3.10.1]

The UE shall:

- 1> upon receiving N310 consecutive "out-of-sync" indications for the SpCell from lower layers while T311 is not running;
- 2> start timer T310 for the corresponding SpCell.

[TS 38.331, clause 5.3.10.3]

The UE shall:

- 1> upon T310 expiry in PSCell; or

...

- 2> initiate the SCG failure information procedure as specified in 5.7.3 to report SCG radio link failure.

[TS 38.331, clause 5.7.3.2]

A UE initiates the procedure to report SCG failures when SCG transmission is not suspended and when one of the following conditions is met:

- 1> upon detecting radio link failure for the SCG, in accordance with subclause 5.3.10.3;

...

Upon initiating the procedure, the UE shall:

- 1> suspend SCG transmission for all SRBs and DRBs;
- 1> reset SCG-MAC;
- 1> stop T304, if running;
- 1> if the UE is operating in EN-DC:
 - 2> initiate transmission of the *SCGFailureInformationNR* message as specified in TS 36.331 [10, 5.6.13a].

[TS 38.331, clause 5.7.3.3]

The UE shall set the SCG failure type as follows:

- 1> if the UE initiates transmission of the *SCGFailureInformationNR* message due to T310 expiry:
 - 2> set the failureType as t310-Expiry;

8.2.5.2.1.3 Test description

8.2.5.2.1.3.1 Pre-test conditions

System Simulator:

- E-UTRA Cell 1 is the PCell and NR Cell 1 is the PSCell.

UE:

- None.

Preamble:

- The UE is in state RRC_CONNECTED using generic procedure parameter Connectivity (EN-DC) and DC Bearers (MCG(s) and SCG) on E-UTRA Cell 1 according to TS 38.508-1 [4], clause 4.5.4.

8.2.5.2.1.3.2 Test procedure sequence

Table 8.2.5.2.1.3.3-0A: RRCReconfiguration (Preamble)

Derivation Path: TS 38.508-1 [4], Table 4.6.1-13			
Information Element	Value/remark	Comment	Condition
RRCReconfiguration ::= SEQUENCE {			
criticalExtensions CHOICE {			
rrcReconfiguration SEQUENCE {			
secondaryCellGroup	CellGroupConfig	OCTET STRING	
}			
}			
}			

Table 8.2.5.2.1.3.3-0B: CellGroupConfig (Table 8.2.5.2.1.3.3-0A: RRCReconfiguration)

Derivation Path: TS 38.508-1 [4], Table 4.6.3-19			
Information Element	Value/remark	Comment	Condition
CellGroupConfig ::= SEQUENCE {			
spCellConfig SEQUENCE {			
spCellConfigDedicated	ServingCellConfig		
}			
}			

Table 8.2.5.2.1.3.3-0E: RadioLinkMonitoringConfig (Table 8.2.5.2.1.3.3-0D: BWP-DownlinkDedicated)

Derivation Path: TS 38.508-1 [4], Table 4.6.3-133			
Information Element	Value/remark	Comment	Condition
RadioLinkMonitoringConfig ::= SEQUENCE {			
failureDetectionResourcesToAddModList	1 entry		
SEQUENCE (SIZE(1..maxNrofFailureDetectionResources)) OF			
RadioLinkMonitoringRS {		entry 1	
RadioLinkMonitoringRS[1] SEQUENCE {			
radioLinkMonitoringRS-Id	0		
purpose	rlf		
detectionResource CHOICE {			
ssb-Index	1		
}			
}			
}			
failureDetectionResourcesToReleaseList	Not present		
beamFailureInstanceMaxCount	Not present		
beamFailureDetectionTimer	Not present		
}			

Table 8.2.5.2.1.3.2-1: Main behaviour

St	Procedure	Message Sequence		TP	Verdict
		U - S	Message		
1	The SS changes NR Cell 1 parameter to non-suitable "Off" in order to simulate radio link failure.	-	-	-	-
2	Void.	-	-	-	-
3	Check: Does the UE transmit in the next 5 sec (NOTE 1) a SCGFailureInformationNR message with failureType set to 't310-Expiry'?	-->	SCGFailureInformationNR	1	P
NOTE 1: The time of 5 sec is chosen arbitrary. When the UE will send the Failure report depends on (1) the values pre-set for N310 and T310 (see TS 38.508-1 [4], RLF-TimersAndConstants - set at the moment to 'n1' and 'ms1000' respectively), and, (2) the time it will take for the SS to complete step 1 and the UE to notice the change and perform internally all relevant to it actions. Because of the uncertainties associated with (2), and, the lower values used in typical network setting for (1), testing if the UE obeys the exact values of (1) is unreliable.					

Table 8.2.5.2.1.3.3-3: ServingCellConfig (Table 8.2.5.2.1.3.3-0B: CellGroupConfig)

Derivation Path: TS 38.508-1 [4], Table 4.6.3-167			
Information Element	Value/remark	Comment	Condition
ServingCellConfig ::= SEQUENCE {			
initialDownlinkBWP	BWP-DownlinkDedicated		
}			

Table 8.2.5.2.1.3.3-4: BWP-DownlinkDedicated (Table 8.2.5.2.1.3.3-0C: ServingCellConfig)

Derivation Path: TS 38.508-1 [4], Table 4.6.3-11			
Information Element	Value/remark	Comment	Condition
BWP-DownlinkDedicated ::= SEQUENCE {			
radioLinkMonitoringConfig	RadioLinkMonitoringConfig		
}			

8.2.5.2.1.3.3 Specific message contents

Table 8.2.5.2.1.3.3-1: SCGFailureInformationNR (step 3, Table 8.2.5.2.1.3.2-1)

Derivation Path: TS 36.508 [7], Table 4.6.1-18AA			
Information Element	Value/remark	Comment	Condition
SCGFailureInformationNR-r15 ::= SEQUENCE {			
criticalExtensions CHOICE {			
c1 CHOICE {			
scgFailureInformationNR-r15 SEQUENCE {			
failureReportSCG-NR-r15 SEQUENCE {			
failureType-r15	t310-Expiry		
measResultFreqListNR-r15	Not checked		
measResultSCG-r15	Not present		
}			
nonCriticalExtension SEQUENCE {}			
}			
}			
}			

8.2.5.2.2 Radio link failure / PSCell out of sync indication / NR-DC

8.2.5.2.2.1 Test Purpose (TP)

(1)

```

with { UE in NR RRC_CONNECTED state with NR-DC }
ensure that {
  when { UE detects out of sync on PSCell }
  then { UE initiates the NR SCG failure information procedure to report SCGFailureInformation
with failure type t310-Expiry }
}

```

8.2.5.2.2.2 Conformance requirements

References: The conformance requirements covered in the present TC are specified in: TS 38.331, clause 5.3.10.3, 5.7.3.2, 5.7.3.4 and 5.7.3.5. Unless otherwise stated these are Rel-15 requirements.

[TS 38.331, 5.3.10.3]

The UE shall:

1> upon T310 expiry in PSCell; or

...

2> else:

3> consider radio link failure to be detected for the SCG, i.e. SCG RLF;

3> if MCG transmission is not suspended:

4> initiate the SCG failure information procedure as specified in 5.7.3 to report SCG radio link failure.

3> else:

4> if the UE is in NR-DC:

5> initiate the connection re-establishment procedure as specified in 5.3.7;

4> else (the UE is in (NG)EN-DC):

5> initiate the connection re-establishment procedure as specified in TS 36.331 [10], clause 5.3.7;

[TS 38.331, clause 5.7.3.2]

A UE initiates the procedure to report SCG failures when neither MCG nor SCG transmission is suspended and when one of the following conditions is met:

1> upon detecting radio link failure for the SCG, in accordance with subclause 5.3.10.3;

...

Upon initiating the procedure, the UE shall:

...

1> if the UE is in (NG)EN-DC:

2> initiate transmission of the *SCGFailureInformationNR* message as specified in TS 36.331 [10], clause 5.6.13a.

1> else:

2> initiate transmission of the *SCGFailureInformation* message in accordance with 5.7.3.5.

[TS 38.331, clause 5.7.3.4]

The UE shall set the contents of the *MeasResultSCG-Failure* as follows:

1> for each *MeasObjectNR* configured on NR SCG for which a *measId* is configured and measurement results are available:

2> include an entry in *measResultPerMOList*;

2> if there is a *measId* configured with the *MeasObjectNR* and a *reportConfig* which has *rsType* set to *ssb*:

3> set *ssbFrequency* to the value indicated by *ssbFrequency* as included in the *MeasObjectNR*;

2> if there is a *measId* configured with the *MeasObjectNR* and a *reportConfig* which has *rsType* set to *csi-rs*:

3> set *refFreqCSI-RS* to the value indicated by *refFreqCSI-RS* as included in the associated measurement object;

2> if a serving cell is associated with the *MeasObjectNR*:

3> set *measResultServingCell* to include the available quantities of the concerned cell and in accordance with the performance requirements in TS 38.133 [14];

2> set the *measResultNeighCellList* to include the best measured cells, ordered such that the best cell is listed first, and based on measurements collected up to the moment the UE detected the failure, and set its fields as follows;

3> ordering the cells with sorting as follows:

4> based on SS/PBCH block if SS/PBCH block measurement results are available and otherwise based on CSI-RS;

4> using RSRP if RSRP measurement results are available, otherwise using RSRQ if RSRQ measurement results are available, otherwise using SINR;

3> for each neighbour cell included:

4> include the optional fields that are available.

NOTE: The measured quantities are filtered by the L3 filter as configured in the mobility measurement configuration. The measurements are based on the time domain measurement resource restriction, if configured. Blacklisted cells are not required to be reported.

2> if available, set the *locationInfo* as in 5.3.3.7.:

[TS 38.331, clause 5.7.3.5]

The UE shall set the contents of the *SCGFailureInformation* message as follows:

- 1> if the UE initiates transmission of the *SCGFailureInformation* message due to T310 expiry:
 - 2> set the *failureType* as *t310-Expiry*;
 - ...
- 1> include and set *MeasResultSCG-Failure* in accordance with 5.7.3.4;

8.2.5.2.2.3 Test description

8.2.5.2.2.3.1 Pre-test conditions

System Simulator:

- NR Cell 1 is the PCell and NR Cell 10 is the PSCell
- System information combination NR-1 as defined in TS 38.508-1 [4] clause 4.4.3.1.3 is used in NR cell 1.

UE:

- None.

Preamble:

- The UE is in state RRC_CONNECTED using generic procedure parameter Connectivity (*NR-DC*) with DC bearer(MCG and SCG) according to TS 38.508-1 [4], Table 4.5.1-1.

8.2.5.2.2.3.2 Test procedure sequence

Table 8.2.5.2.2.3.2-1: Main behaviour

St	Procedure	Message Sequence		TP	Verdict
		U - S	Message		
1	The SS changes NR Cell 10 power level to non-suitable " Off" in order to simulate radio link failure.	-	-	-	-
2	Check: Does the UE transmit in the next 5 sec (NOTE 1) a <i>SCGFailureInformation</i> message with <i>failureType</i> set to " <i>t310-Expiry</i> "?	-->	<i>SCGFailureInformation</i>	1	P
NOTE 1: The time of 5 sec is chosen arbitrary. When the UE will send the Failure report depends on (1) the values pre-set for N310 and T310 (see TS 38.508-1 [4], <i>RLF-TimersAndConstants</i> - set at the moment to 'n1' and 'ms1000' respectively), and, (2) the time it will take for the SS to complete step 1 and the UE to notice the change and perform internally all relevant to it actions. Because of the uncertainties associated with (2), and, the lower values used in typical network setting for (1), testing if the UE obeys the exact values of (1) is unreliable.					

8.2.5.2.2.3.3 Specific message contents

Table 8.2.5.2.2.3.3-1: RRCSetup(Preamble)

Derivation Path: TS 38.508-1 [4] table 4.6.1-21			
Information Element	Value/remark	Comment	Condition
RRCSetup ::= SEQUENCE {			
criticalExtensions CHOICE {			
rrcSetup SEQUENCE {			
masterCellGroup	CellGroupConfig with condition SRB1	OCTET STRING (CONTAINING CellGroupConfig)	
}			
}			

}			
---	--	--	--

Table 8.2.5.2.2.3.3-2: CellGroupConfig (Table 8.2.5.2.2.3.3-1)

Derivation Path: TS 38.508-1 [4], Table 4.6.3-19			
Information Element	Value/remark	Comment	Condition
CellGroupConfig ::= SEQUENCE {			
rlf-TimersAndConstants SEQUENCE {			
t311	ms10000		
}			
spCellConfigDedicated	ServingCellConfig		
}			

Table 8.2.5.2.2.3.3-3: ServingCellConfig (Table 8.2.5.2.2.3.3-2: CellGroupConfig)

Derivation Path: TS 38.508-1 [4], Table 4.6.3-167			
Information Element	Value/remark	Comment	Condition
ServingCellConfig ::= SEQUENCE {			
initialDownlinkBWP	BWP-DownlinkDedicated		
}			

Table 8.2.5.2.2.3.3-4: BWP-DownlinkDedicated (Table 8.2.5.2.2.3.3-3: ServingCellConfig)

Derivation Path: TS 38.508-1 [4], Table 4.6.3-11			
Information Element	Value/remark	Comment	Condition
BWP-DownlinkDedicated ::= SEQUENCE {			
radioLinkMonitoringConfig	RadioLinkMonitoringConfig		
}			

Table 8.2.5.2.2.3.3-5: RadioLinkMonitoringConfig (Table 8.2.5.2.2.3.3-4: BWP-DownlinkDedicated)

Derivation Path: TS 38.508-1 [4], Table 4.6.3-133			
Information Element	Value/remark	Comment	Condition
RadioLinkMonitoringConfig ::= SEQUENCE {			
failureDetectionResourcesToAddModList	1 entry		
SEQUENCE (SIZE(1..maxNrofFailureDetectionResources)) OF			
RadioLinkMonitoringRS {			
RadioLinkMonitoringRS[1] SEQUENCE {		entry 1	
radioLinkMonitoringRS-Id	0		
purpose	rlf		
detectionResource CHOICE {			
ssb-Index	SSB Index#n	SSB Index of NR Cell 10	
}			
}			
}			
failureDetectionResourcesToReleaseList	Not present		
beamFailureInstanceMaxCount	Not present		
beamFailureDetectionTimer	Not present		
}			

Table 8.2.5.2.2.3.3-6: SCGFailureInformation (step 2, Table 8.2.5.2.2.3.2-1)

Derivation Path: TS 38.508-1 [4], Table 4.6.1-24A			
Information Element	Value/remark	Comment	Condition
SCGFailureInformation ::= SEQUENCE {			
criticalExtensions CHOICE {			
scgFailureInformation SEQUENCE {			

FailureReportSCG SEQUENCE {			
failureType	t310-Expiry		
measResultFreqList	Not checked		
measResultSCG-Failure	Not present		
}			
nonCriticalExtension	Not checked		
}			
}			
}			

8.2.5.3 Radio link failure / rlc-MaxNumRetx failure

8.2.5.3.1 Radio link failure / rlc-MaxNumRetx failure / EN-DC

8.2.5.3.1.1 Test Purpose (TP)

(1)

```

with { UE in RRC_CONNECTED state with EN-DC MCG(s) (E-UTRA PDCP) and SCG DRB established }
ensure that {
  when { the transmitting side of the UE's AM RLC entity for the SCG DRB has retransmitted an RLC
SDU until RETX_COUNT = maxRetxThreshold }
  then { the UE shall transmit a SCGFailureInformationNR message with failureType set to 'rlc-
MaxNumRetx' }
}

```

8.2.5.3.1.2 Conformance requirements

References: The conformance requirements covered in the present test case are specified in: TS 38.322, clause 5.3.2, TS 36.331, clause 5.6.13a.3, TS 38.331, clauses 5.3.10.3, 5.7.3.2, 5.7.3.3. Unless otherwise stated these are Rel-15 requirements.

[TS 38.322, clause 5.3.2]

When an RLC SDU or an RLC SDU segment is considered for retransmission, the transmitting side of the AM RLC entity shall:

- if the RLC SDU or RLC SDU segment is considered for retransmission for the first time:
 - set the RETX_COUNT associated with the RLC SDU to zero.
- else, if it (the RLC SDU or the RLC SDU segment that is considered for retransmission) is not pending for retransmission already and the RETX_COUNT associated with the RLC SDU has not been incremented due to another negative acknowledgment in the same STATUS PDU:
 - increment the RETX_COUNT.
- if RETX_COUNT = maxRetxThreshold:
 - indicate to upper layers that max retransmission has been reached.

...

[TS 36.331, clause 5.6.13a.3]

The UE shall set the contents of the *SCGFailureInformationNR* message as follows:

- 1> include *failureType* within *failureReportSCG-NR* and set it to indicate the SCG failure in accordance with TS 38.331 [82clause, 5.7.3.3;

...

The UE shall submit the *SCGFailureInformationNR* message to lower layers for transmission.

[TS 38.331, clause 5.3.10.3]

The UE shall:

...

- 1> upon indication from SCG RLC that the maximum number of retransmissions has been reached:
 - 2> if CA duplication is configured and activated; and for the corresponding logical channel *allowedServingCells* only includes SCell(s):
 - 3> initiate the failure information procedure as specified in 5.7.5 to report RLC failure.
 - 2> else:
 - 3> consider radio link failure to be detected for the SCG i.e. SCG-RLF;
 - 3> initiate the SCG failure information procedure as specified in 5.7.3 to report SCG radio link failure.

...

- else3> consider radio link failure to be detected for the SCG i.e. SCG-RLF;

[TS 38.331, clause 5.7.3.2]

A UE initiates the procedure to report SCG failures when SCG transmission is not suspended and when one of the following conditions is met:

- 1> upon detecting radio link failure for the SCG, in accordance with subclause 5.3.10.3;
- 1> upon reconfiguration with sync failure of the SCG, in accordance with subclause 5.3.5.8.3;
- 1> upon SCG configuration failure, in accordance with subclause 5.3.5.8.2;
- 1> upon integrity check failure indication from SCG lower layers concerning SRB3.

Upon initiating the procedure, the UE shall:

- 1> suspend SCG transmission for all SRBs and DRBs;
- 1> reset SCG MAC;
- 1> stop T304 for the SCG, if running;
- 1> if the UE is in (NG)EN-DC:
 - 2> initiate transmission of the *SCGFailureInformationNR* message as specified in TS 36.331 [10], clause 5.6.13a.
- 1> else:
 - 2> initiate transmission of the *SCGFailureInformation* message in accordance with 5.7.3.5.

[TS 38.331, clause 5.7.3.3]

The UE shall set the SCG failure type as follows:

- 1> if the UE initiates transmission of the *SCGFailureInformationNR* message due to T310 expiry:
 - 2> set the *failureType* as t310-Expiry;
- 1> else if the UE initiates transmission of the *SCGFailureInformationNR* message to provide reconfiguration with sync failure information for an SCG:
 - 2> set the *failureType* as *synchReconfigFailure-SCG*;
- 1> else if the UE initiates transmission of the *SCGFailureInformationNR* message to provide random access problem indication from SCG MAC:

2> set the *failureType* as *randomAccessProblem*; 1> else if the UE initiates transmission of the *SCGFailureInformationNR* message to provide indication from SCG RLC that the maximum number of retransmissions has been reached:

2> set the *failureType* as *rlc-MaxNumRetx*;

1> else if the UE initiates transmission of the *SCGFailureInformationNR* message due to SRB3 integrity check failure:

2> set the *failureType* as *srb3-IntegrityFailure*;

1> else if the UE initiates transmission of the *SCGFailureInformationNR* message due to Reconfiguration failure of NR RRC reconfiguration message:

2> set the *failureType* as *scg-reconfigFailure*.

8.2.5.3.1.3 Test description

8.2.5.3.1.3.1 Pre-test conditions

System Simulator:

- E-UTRA Cell 1 is the PCell and NR Cell 1 is the PSCell.

UE:

- None.

Preamble:

- The UE is in state *RRC_CONNECTED* using generic procedure parameter *Connectivity (EN-DC)*, Bearers (*MCG(s) and SCG*) established and Test Loop Function (*On*) with UE test loop mode A (message condition UE TEST LOOP MODE A to return one UL PDCP SDU per DL PDCP SDU) according to TS 38.508-1 [4] the exception that ciphering algorithm 'nea0 (NULL)' is configured.
- The RLC Acknowledged Mode is enabled

8.2.5.3.1.3.2 Test procedure sequence

Table 8.2.5.3.1.3.2-1: Main behaviour

St	Procedure	Message Sequence		TP	Verdict
		U - S	Message		
1	The SS transmits AMD PDU#1 containing a complete RLC SDU#1 (on the SCG bearer).	<--	AMD PDU#1	-	-
1A	Void	-	-	-	-
1B	The UE transmits one AMD PDU#1 containing a complete RLC SDU#1 (on the SCG bearer).	-->	AMD PDU#1 (SN=0)	-	-
-	EXCEPTION: Steps 1C-3 are repeated <i>maxRetxThreshold</i> times NOTE: <i>maxRetxThreshold</i> is configured by <i>RLC-Config</i> .	-	-	-	-
1C	The SS transmits an RLC STATUS PDU. <i>ACK_SN</i> =1 and <i>NACK_SN</i> =0.	<--	STATUS PDU	-	-
2	Void	-	-	-	-
3	The UE transmits one AMD PDU#1 containing a complete RLC SDU#1 (on the SCG bearer).	-->	AMD PDU#1 (SN=0)	-	-
3A	The SS transmits an RLC STATUS PDU. <i>ACK_SN</i> =1 and <i>NACK_SN</i> =0.	<--	STATUS PDU	-	-
4	Check: Does the UE transmit in the next 5 sec (arbitrary value) a <i>SCGFailureInformationNR</i> message with <i>failureType</i> set to ' <i>rlc-MaxNumRetx</i> '?	-->	<i>SCGFailureInformationNR</i>	1	P

8.2.5.3.1.3.3 Specific message contents

Table 8.2.5.3.1.3.3-1: SCGFailureInformationNR (step 4, Table 8.2.5.3.1.3.2-1)

Derivation Path: TS 36.508 [7], Table 4.6.1-18AA			
Information Element	Value/remark	Comment	Condition
SCGFailureInformationNR-r15 ::= SEQUENCE {			
criticalExtensions CHOICE {			
c1 CHOICE {			
scgFailureInformationNR-r15 SEQUENCE {			
failureReportSCG-NR-r15 SEQUENCE {			
failureType-r15	rlc-MaxNumRetx		
measResultFreqListNR-r15	Not checked		
measResultSCG-r15	Not checked		
}			
nonCriticalExtension SEQUENCE {}			
}			
}			
}			

8.2.5.3.2 Radio link failure / rlc-MaxNumRetx failure / NR-DC

8.2.5.3.2.1 Test Purpose (TP)

(1)

```

with { UE in RRC_CONNECTED state with NR-DC }
ensure that {
  when { the transmitting side of the UE's AM RLC entity for the SCG DRB has retransmitted an RLC
SDU until RETX_COUNT = maxRetxThreshold }
  then { the UE shall transmit a SCGFailureInformation message with failureType set to 'rlc-
MaxNumRetx' }
}

```

8.2.5.3.2.2 Conformance requirements

References: The conformance requirements covered in the present test case are specified in: TS 38.322, clause 5.3.2, TS 38.331, clauses 5.3.10.3, 5.7.3.2, 5.7.3.5. Unless otherwise stated these are Rel-15 requirements.

[TS 38.322, clause 5.3.2]

When an RLC SDU or an RLC SDU segment is considered for retransmission, the transmitting side of the AM RLC entity shall:

- if the RLC SDU or RLC SDU segment is considered for retransmission for the first time:
 - set the RETX_COUNT associated with the RLC SDU to zero.
- else, if it (the RLC SDU or the RLC SDU segment that is considered for retransmission) is not pending for retransmission already and the RETX_COUNT associated with the RLC SDU has not been incremented due to another negative acknowledgment in the same STATUS PDU:
 - increment the RETX_COUNT.
- if RETX_COUNT = maxRetxThreshold:
 - indicate to upper layers that max retransmission has been reached.

...

[TS 38.331, clause 5.3.10.3]

The UE shall:

...

1> upon indication from SCG RLC that the maximum number of retransmissions has been reached; or

1> if connected as an IAB-node, upon BH RLF indication received on BAP entity from the SCG; or

1> upon consistent uplink LBT failure indication from SCG MAC:

2> if the indication is from SCG RLC and CA duplication is configured and activated for SCG, and for the corresponding logical channel *allowedServingCells* only includes SCell(s):

3> initiate the failure information procedure as specified in 5.7.5 to report RLC failure.

2> else:

3> consider radio link failure to be detected for the SCG, i.e. SCG RLF;

3> if MCG transmission is not suspended:

4> initiate the SCG failure information procedure as specified in 5.7.3 to report SCG radio link failure.

[TS 38.331, clause 5.7.3.2]

A UE initiates the procedure to report SCG failures when neither MCG nor SCG transmission is suspended and when one of the following conditions is met:

1> upon detecting radio link failure for the SCG, in accordance with subclause 5.3.10.3;

...

Upon initiating the procedure, the UE shall:

1> suspend SCG transmission for all SRBs, DRBs and, if any, BH RLC channels;

1> reset SCG MAC;

1> stop T304 for the SCG, if running;

1> stop conditional reconfiguration evaluation for CPC, if configured;

1> if the UE is in (NG)EN-DC:

2> initiate transmission of the *SCGFailureInformationNR* message as specified in TS 36.331 [10], clause 5.6.13a.

1> else:

2> initiate transmission of the *SCGFailureInformation* message in accordance with 5.7.3.5.

[TS 38.331, clause 5.7.3.5]

The UE shall set the contents of the *SCGFailureInformation* message as follows:

...

1> else if the UE initiates transmission of the *SCGFailureInformation* message to provide indication from SCG RLC that the maximum number of retransmissions has been reached:

2> set the *failureType* as *rlc-MaxNumRetx*;

...

The UE shall submit the *SCGFailureInformation* message to lower layers for transmission.

8.2.5.3.2.3 Test description

8.2.5.3.2.3.1 Pre-test conditions

System Simulator:

- NR Cell 1 is the PCell and NR Cell 10 is the PSCell.
- System information combination NR-1 as defined in TS 38.508-1 [4] clause 4.4.3.1.3 is used in NR cell 1.

UE:

- None.

Preamble:

- The UE is in state RRC_CONNECTED using generic procedure parameter Connectivity (NR-DC) with DC bearer(MCG and SCG), and Test Loop Function (On) with UE test loop mode A according to TS 38.508-1 [4], Table 4.5.1-1 with the exception that ciphering algorithm 'nea0 (NULL)' is configured.

8.2.5.3.2.3.2 Test procedure sequence

Table 8.2.5.3.2.3.2-1: Main behaviour

St	Procedure	Message Sequence		TP	Verdict
		U - S	Message		
1	The SS transmits AMD PDU#1 on the DRB associated with SCG	<--	AMD PDU#1	-	-
2	The UE transmits one AMD PDU#1	-->	AMD PDU#1 (SN=0)	-	-
-	EXCEPTION: Steps 3-4 are repeated maxRetxThreshold times	-	-	-	-
3	The SS transmits an RLC STATUS PDU. ACK_SN =1 and NACK_SN =0.	<--	STATUS PDU	-	-
4	The UE transmits one AMD PDU#1	-->	AMD PDU#1 (SN=0)	-	-
5	The SS transmits an RLC STATUS PDU. ACK_SN =1 and NACK_SN =0.	<--	STATUS PDU	-	-
6	Check: Does the UE transmit in the next 5 sec (arbitrary value) a SCGFailureInformation message with failureType set to 'rlc-MaxNumRetx'?	-->	SCGFailureInformation	1	P

8.2.5.3.2.3.3 Specific message contents

Table 8.2.5.3.2.3.3-1: SCGFailureInformation (step 6, Table 8.2.5.3.2.3.2-1)

Derivation Path: TS 38.508-1 [4], Table 4.6.1-24A			
Information Element	Value/remark	Comment	Condition
SCGFailureInformation ::= SEQUENCE {			
criticalExtensions CHOICE {			
scgFailureInformation SEQUENCE {			
failureReportSCG SEQUENCE {			
failureType	rlc-MaxNumRetx		
measResultFreqList	Not checked		
measResultSCG-Failure	Not present		
}			
nonCriticalExtension	Not checked		
}			
}			

8.2.5.3.3 Radio link failure / rlc-MaxNumRetx failure / NE-DC

8.2.5.3.3.1 Test Purpose (TP)

(1)

```
with { UE in NR RRC_CONNECTED state with NE-DC }
ensure that {
  when { the transmitting side of the UE's AM RLC entity for the SCG DRB has retransmitted an RLC
SDU until RETX_COUNT = maxRetxThreshold }
  then { the UE shall transmit a SCGFailureInformationEUTRA message with failureType set to 'rlc-
MaxNumRetx' }
}
```

8.2.5.3.3.2 Conformance requirements

References: The conformance requirements covered in the present test case are specified in: TS 36.331, clause 5.6.13.4, TS 38.331, clauses 5.7.3a. Unless otherwise stated these are Rel-16 requirements.

[TS 38.331, clause 5.7.3a]

A UE initiates the procedure to report EUTRA SCG failures when neither NR MCG nor EUTRA SCG transmission is suspended and in accordance with TS 36.331 [10] clause 5.6.13.2. Actions the UE shall perform upon initiating the procedure, other than related to the transmission of the SCGFailureInformationEUTRA message are specified in TS 36.331 [10] clause 5.6.13.2

The UE shall set the contents of the *SCGFailureInformationEUTRA* message as follows:

- 1> include *failureType* within *failureReportSCG-EUTRA* and set it to indicate the SCG failure in accordance with TS 36.331 [10] clause 5.6.13.4;

...

The UE shall submit the *SCGFailureInformationEUTRA* message to lower layers for transmission.

[TS 36.331, clause 5.6.13.2]

A UE initiates the procedure to report SCG failures when neither MCG nor SCG transmission is suspended and when one of the following conditions is met:

- 1> upon detecting radio link failure for the SCG, in accordance with 5.3.11; or
- 1> upon SCG change failure, in accordance with 5.3.5.7a; or

...

In case of DC, upon initiating the procedure, the UE shall:

...

- 1> if the UE is configured with NE-DC:
 - 2> initiate transmission of the *SCGFailureInformationEUTRA* message via the NR MCG as specified in TS 38.331 [82], clause 5.7.3a;

...

[TS 36.331, clause 5.6.13.4]

The UE shall:

...

- 1> else if SCG failure is due to indication from SCG RLC that the maximum number of retransmissions was reached:

2> consider the *failureType* to be *rlc-MaxNumRetx*;

...

8.2.5.3.3.3 Test description

8.2.5.3.3.3.1 Pre-test conditions

System Simulator:

- NR Cell 1 is the PCell and E-URTRA Cell 1 is the PSCell.
- System information combination NR-1 as defined in TS 38.508-1 [4] clause 4.4.3.1.3 is used in NR cell 1.

UE:

- None.

Preamble:

- The UE is in state RRC_CONNECTED using generic procedure parameter Connectivity (*NE-DC*) with DC bearer(MCG and SCG), and Test Loop Function (*On*) with UE test loop mode A according to TS 38.508-1 [4], Table 4.5.1-1 with the exception that ciphering algorithm 'nea0 (NULL)' is configured.

8.2.5.3.3.3.2 Test procedure sequence

Table 8.2.5.3.3.3.2-1: Main behaviour

St	Procedure	Message Sequence		TP	Verdict
		U - S	Message		
1	The SS transmits AMD PDU#1 on the DRB associated with SCG	<--	AMD PDU#1	-	-
2	The UE transmits one AMD PDU#1	-->	AMD PDU#1 (SN=0)	-	-
-	EXCEPTION: Steps 3-4 are repeated maxRetxThreshold times	-	-	-	-
3	The SS transmits an RLC STATUS PDU. ACK_SN =1 and NACK_SN =0.	<--	STATUS PDU	-	-
4	The UE transmits one AMD PDU#1	-->	AMD PDU#1 (SN=0)	-	-
5	The SS transmits an RLC STATUS PDU. ACK_SN =1 and NACK_SN =0.	<--	STATUS PDU	-	-
6	Check: Does the UE transmit in the next 5 sec (arbitrary value) a SCGFailureInformationEUTRA message with failureType set to 'rlc-MaxNumRetx'?	-->	SCGFailureInformationEUTRA	1	P

8.2.5.3.3.3.3 Specific message contents

Table 8.2.5.3.3.3.3-1: SCGFailureInformationEUTRA (step 6, Table 8.2.5.3.3.3.2-1)

Derivation Path: TS 38.508-1 [4], Table 4.6.1-24B			
Information Element	Value/remark	Comment	Condition
SCGFailureInformationEUTRA ::= SEQUENCE {			
criticalExtensions CHOICE {			
scgFailureInformationEUTRA SEQUENCE {			
FailureReportSCG-EUTRA SEQUENCE {			
failureType	rlc-MaxNumRetx		
measResultFreqListMRDC	Not checked		
measResultSCG-FailureMRDC	Not present		
}			
nonCriticalExtension	Not checked		

}			
}			
}			

8.2.5.4 Reconfiguration failure / SCG change failure

8.2.5.4.1 Reconfiguration failure / SCG change failure / EN-DC

8.2.5.4.1.1 Test Purpose (TP)

(1)

```

with { UE in RRC_CONNECTED state with EN-DC, and, MCG(s) (E-UTRA PDCP) and SCG DRB established }
ensure that {
  when { UE receives an RRCConnectionReconfiguration message with nr-Config IE containing NR
RRCReconfiguration message with reconfigurationWithSync for configured PSCell and if T304 of a
secondary cell group expires }
  then { UE initiates the NR SCG failure information procedure to report SCGFailureInformationNR
with failure type set to 'synchReconfigFailure-SCG' }
}

```

8.2.5.4.1.2 Conformance requirements

References: The conformance requirements covered in the present test case are specified in: TS 36.331, clause 5.6.13a.3, TS 38.331, clauses 5.3.5.3, 5.3.5.5.1, 5.3.5.5.2, 5.3.5.8.3, 5.7.3.2 and 5.7.3.3. Unless otherwise stated these are Rel-15 requirements.

[TS 36.331, clause 5.6.13a.3]

The UE shall set the contents of the *SCGFailureInformationNR* message as follows:

- 1> include *failureType* within *failureReportSCG-NR* and set it to indicate the SCG failure in accordance with TS 38.331 [82, 5.7.3.3];

...

The UE shall submit the *SCGFailureInformationNR* message to lower layers for transmission.

[TS 38.331, clause 5.3.5.3]

The UE shall perform the following actions upon reception of the *RRCReconfiguration*:

- 1> if the *RRCReconfiguration* includes the *secondaryCellGroup*:
 - 2> perform the cell group configuration for the SCG according to 5.3.5.5;
- ...
- 1> if the UE is configured with E-UTRA *nr-SecondaryCellGroupConfig* (MCG is E-UTRA):
 - 2> if *RRCReconfiguration* was received via SRB1:
 - 3> construct *RRCReconfigurationComplete* message and submit it via the EUTRA MCG embedded in E-UTRA RRC message *RRCConnectionReconfigurationComplete* as specified in TS 36.331 [10];
 - 3> if *reconfigurationWithSync* was included in *spCellConfig* of an SCG:
 - 4> initiate the random access procedure on the SpCell, as specified in TS 38.321 [3];

...

[TS 38.331, clause 5.3.5.5.1]

The network configures the UE with Master Cell Group (MCG), and zero or one Secondary Cell Group (SCG). For EN-DC, the MCG is configured as specified in TS 36.331 [10]. The network provides the configuration parameters for a cell group in the *CellGroupConfig* IE.

The UE performs the following actions based on a received *CellGroupConfig* IE:

- 1> if the *CellGroupConfig* contains the *spCellConfig* with *reconfigurationWithSync*:
 - 2> perform Reconfiguration with sync according to 5.3.5.5.2;

[TS 38.331, clause 5.3.5.5.2]

The UE shall perform the following actions to execute a reconfiguration with sync.

- 1> stop timer T310 for the corresponding SpCell, if running;
- 1> start timer T304 for the corresponding SpCell with the timer value set to *t304*, as included in the *reconfigurationWithSync*;

[TS 38.331, clause 5.3.5.8.3]

The UE shall:

- 1> else if T304 of a secondary cell group expires:
 - 2> release dedicated preambles provided in *rach-ConfigDedicated*, if configured;
 - 2> initiate the SCG failure information procedure as specified in subclause 5.7.3 to report SCG reconfiguration with sync failure, upon which the RRC reconfiguration procedure ends.

[TS 38.331, clause 5.7.3.2]

A UE initiates the procedure to report SCG failures when SCG transmission is not suspended and when one of the following conditions is met:

...

- 1> upon reconfiguration with sync failure of the SCG, in accordance with subclause 5.3.5.8.3;

...

Upon initiating the procedure, the UE shall:

- 1> suspend SCG transmission for all SRBs and DRBs;
- 1> reset SCG-MAC;
- 1> stop T304, if running;
- 1> if the UE is operating in EN-DC:
 - 2> initiate transmission of the *SCGFailureInformationNR* message as specified in TS 36.331 [10], clause 5.6.13a.

[TS 38.331, clause 5.7.3.3]

The UE shall set the SCG failure type as follows:

...

- 1> else if the UE initiates transmission of the *SCGFailureInformationNR* message to provide reconfiguration with sync failure information for an SCG:
 - 2> set the *failureType* as *synchReconfigFailure-SCG*;

8.2.5.4.1.3 Test description

8.2.5.4.1.3.1 Pre-test conditions

System Simulator:

- E-UTRA Cell 1 is the PCell and NR Cell 1 is the PSCell.

UE:

- None.

Preamble:

- The UE is in state RRC_CONNECTED using generic procedure parameter Connectivity (EN-DC) and DC Bearers (MCG(s) and SCG) on E-UTRA Cell 1 according to TS 38.508-1 [4], clause 4.5.4.

8.2.5.4.1.3.2 Test procedure sequence

Table 8.2.5.4.1.3.2-1: Main behaviour

St	Procedure	Message Sequence		TP	Verdict
		U - S	Message		
1	The SS transmits an <i>RRCConnectionReconfiguration</i> message containing NR <i>RRCReconfiguration</i> message to perform SCG change with <i>reconfigurationWithSync</i> with the same PSCell.	<--	<i>RRCConnectionReconfiguration</i> (<i>RRCReconfiguration</i>)	-	-
-	EXCEPTION: In parallel to the event described in step 2 the event described in Table 8.2.5.4.1.3.2-2 takes place.	-	-	-	-
2	Wait for t304 ms to ensure that T304 expires (the value is defined in <i>CellGroupConfig</i>). NOTE: SS does not respond to the UE transmitted RACH preambles on NR Cell 1	-	-	-	-
3	Check: Does the UE transmit on PCell (E-UTRA Cell 1) in the next 5 sec (arbitrary value) a <i>SCGFailureInformationNR</i> message with <i>failureType</i> set to ' <i>synchReconfigFailure-SCG</i> '?	-->	<i>SCGFailureInformationNR</i>	1	P

Table 8.2.5.4.1.3.2-2: Parallel behaviour

St	Procedure	Message Sequence		TP	Verdict
		U - S	Message		
1	The UE transmits an <i>RRCConnectionReconfigurationComplete</i> message containing NR <i>RRCReconfigurationComplete</i> message on E-UTRA Cell 1.	-->	<i>RRCConnectionReconfigurationComplete</i> (<i>RRCReconfigurationComplete</i>)	-	-

8.2.5.4.1.3.3 Specific message contents

Table 8.2.5.4.1.3.3-1: *RRCConnectionReconfiguration* (step 1, Table 8.2.5.4.1.3.2-1)

Derivation Path: TS 36.508 [7], Table 4.6.1-8, with condition EN-DC_EmbedNR_RRCRecon
--

Table 8.2.5.4.1.3.3-1A: RRCReconfiguration (Table 8.2.5.4.1.3.3-1)

Derivation Path: TS 38.508-1 [4], Table 4.6.1-13 with condition EN-DC			
Information Element	Value/remark	Comment	Condition
RRCReconfiguration ::= SEQUENCE {			
rrc-TransactionIdentifier			
criticalExtensions CHOICE {			
rrcReconfiguration SEQUENCE {			
secondaryCellGroup	CellGroupConfig		EN-DC
}			
}			
}			

Table 8.2.5.4.1.3.3-1B: CellGroupConfig (Table 8.2.5.4.1.3.3-1A)

Derivation Path: TS 38.508-1 [4], Table 4.6.3-19 with condition EN-DC			
Information Element	Value/remark	Comment	Condition
CellGroupConfig ::= SEQUENCE {			
spCellConfig SEQUENCE {			
reconfigurationWithSync SEQUENCE {			
spCellConfigCommon	ServingCellConfigCommon		
}			
}			
}			

Table 8.2.5.4.1.3.3-1C: ServingCellConfigCommon (Table 8.2.5.4.1.3.3-1B)

Derivation Path: TS 38.508-1 [4], Table 4.6.3-168			
Information Element	Value/remark	Comment	Condition
ServingCellConfigCommon ::= SEQUENCE {			
uplinkConfigCommon SEQUENCE {			
initialUplinkBWP	BWP-UplinkCommon		
}			
}			

Table 8.2.5.4.1.3.3-1D: BWP-UplinkCommon (Table 8.2.5.4.1.3.3-1C)

Derivation Path: TS 38.508-1 [4], Table 4.6.3-14			
Information Element	Value/remark	Comment	Condition
BWP-UplinkCommon ::= SEQUENCE {			
rach-ConfigCommon CHOICE {			
setup	RACH-ConfigCommon		
}			
}			

Table 8.2.5.4.1.3.3-1E: RACH-ConfigCommon (Table 8.2.5.4.1.3.3-1D)

Derivation Path: TS 38.508-1 [4], Table 4.6.3-128			
Information Element	Value/remark	Comment	Condition
RACH-ConfigCommon ::= SEQUENCE {			
rach-ConfigGeneric	RACH-ConfigGeneric		
}			

Table 8.2.5.4.1.3.3-1F: RACH-ConfigGeneric (Table 8.2.5.4.1.3.3-1E)

Derivation Path: TS 38.508-1 [4], Table 4.6.3-130			
Information Element	Value/remark	Comment	Condition
RACH-ConfigGeneric ::= SEQUENCE {			
preambleTransMax	n200		

}		
---	--	--

Table 8.2.5.4.1.3.3-2: SCGFailureInformationNR (step 3, Table 8.2.5.4.1.3.2-1)

Derivation Path: TS 36.508 [7], Table 4.6.1-18AA			
Information Element	Value/remark	Comment	Condition
SCGFailureInformationNR-r15 ::= SEQUENCE {			
criticalExtensions CHOICE {			
c1 CHOICE {			
scgFailureInformationNR-r15 SEQUENCE {			
failureReportSCG-NR-r15 SEQUENCE {			
failureType-r15	synchReconfigFailure-SCG		
measResultFreqListNR-r15	Not checked		
measResultSCG-r15	Not checked		
}			
nonCriticalExtension SEQUENCE {}			
}			
}			

8.2.5.4.2 Reconfiguration failure / SCG change failure / NR-DC

8.2.5.4.2.1 Test Purpose (TP)

(1)

```
with { UE in RRC_CONNECTED state with NR-DC }
ensure that {
  when { UE receives an RRCReconfiguration message with reconfigurationWithSync for configured PSCell and if T304 of a secondary cell group expires }
  then { UE initiates the SCG failure information procedure to report SCGFailureInformation with failure type set to 'synchReconfigFailure-SCG' }
}
```

8.2.5.4.2.2 Conformance requirements

References: The conformance requirements covered in the present test case are specified in: TS 38.331, clauses 5.3.5.5.1, 5.3.5.5.2, 5.3.5.8.3, 5.3.10.3, 5.7.3.2, 5.7.3.5. Unless otherwise stated these are Rel-15 requirements.

[TS 38.331, clause 5.3.5.5.1]

The UE performs the following actions based on a received *CellGroupConfig* IE:

- 1> if the *CellGroupConfig* contains the *spCellConfig* with *reconfigurationWithSync*:
- 2> perform Reconfiguration with sync according to 5.3.5.5.2;

[TS 38.331, clause 5.3.5.5.2]

The UE shall perform the following actions to execute a reconfiguration with sync.

...

- 1> start timer T304 for the corresponding SpCell with the timer value set to *t304*, as included in the *reconfigurationWithSync*;

[TS 38.331, clause 5.3.5.8.3]

The UE shall:

...

- 1> else if T304 of a secondary cell group expires:
 - 2> if MCG transmission is not suspended:
 - 3> release dedicated preambles provided in *rach-ConfigDedicated*, if configured;
 - 3> initiate the SCG failure information procedure as specified in subclause 5.7.3 to report SCG reconfiguration with sync failure, upon which the RRC reconfiguration procedure ends;

[TS 38.331, clause 5.7.3.2]

A UE initiates the procedure to report SCG failures when neither MCG nor SCG transmission is suspended and when one of the following conditions is met:

- 1> upon reconfiguration with sync failure of the SCG, in accordance with subclause 5.3.5.8.3;
- ...

Upon initiating the procedure, the UE shall:

- 1> suspend SCG transmission for all SRBs, DRBs and, if any, BH RLC channels;
- 1> reset SCG MAC;
- 1> stop T304 for the SCG, if running;
- 1> stop conditional reconfiguration evaluation for CPC, if configured;
- 1> if the UE is in (NG)EN-DC:
 - 2> initiate transmission of the *SCGFailureInformationNR* message as specified in TS 36.331 [10], clause 5.6.13a.
- 1> else:
 - 2> initiate transmission of the *SCGFailureInformation* message in accordance with 5.7.3.5.

[TS 38.331, clause 5.7.3.5]

The UE shall set the contents of the *SCGFailureInformation* message as follows:

- ...
- 1> else if the UE initiates transmission of the *SCGFailureInformation* message to provide reconfiguration with sync failure information for an SCG:
 - 2> set the failureType as synchReconfigFailure-SCG;
- ...

The UE shall submit the *SCGFailureInformation* message to lower layers for transmission.

8.2.5.4.2.3 Test description

8.2.5.4.2.3.1 Pre-test conditions

System Simulator:

- NR Cell 1 is the PCell and NR Cell 10 is the PSCell
- System information combination NR-1 as defined in TS 38.508-1 [4] clause 4.4.3.1.3 is used in NR cell 1.

UE:

- None.

Preamble:

- The UE is in state RRC_CONNECTED using generic procedure parameter Connectivity (NR-DC) with DC bearer(MCG and SCG) according to TS 38.508-1 [4], Table 4.5.1-1.

8.2.5.4.2.3.2 Test procedure sequence

Table 8.2.5.4.2.3.2-1: Main behaviour

St	Procedure	Message Sequence		TP	Verdict
		U - S	Message		
1	The SS transmits an <i>RRCReconfiguration</i> message to perform SCG change with <i>reconfigurationWithSync</i> with the same PSCell.	<--	<i>RRCReconfiguration</i>	-	-
-	EXCEPTION: In parallel to the event described in step 2 the event described in Table 8.2.5.4.2.3.2-2 takes place.	-	-	-	-
2	Wait for t304 ms to ensure that T304 expires (the value is defined in <i>CellGroupConfig</i>). NOTE: SS does not respond to the UE transmitted RACH preambles on NR Cell 10	-	-	-	-
3	Check: Does the UE transmit on PCell (NR Cell 1) in the next 5 sec (arbitrary value) a <i>SCGFailureInformation</i> message with <i>failureType</i> set to ' <i>synchReconfigFailure-SCG</i> '?	-->	<i>SCGFailureInformation</i>	1	P

Table 8.2.5.4.2.3.2-2: Parallel behaviour

St	Procedure	Message Sequence		TP	Verdict
		U - S	Message		
1	The UE transmits an <i>RRCReconfigurationComplete</i> message on NR Cell 1.	-->	<i>RRCReconfigurationComplete</i>	-	-

8.2.5.4.2.3.3 Specific message contents

Table 8.2.5.4.2.3.3-1: RRCReconfiguration (Table 8.2.5.4.2.3.2-1, Step 1)

Derivation Path: TS 38.508-1 [4], Table 4.6.1-13 with condition NR-DC_SCG			
Information Element	Value/remark	Comment	Condition
RRCReconfiguration ::= SEQUENCE {			
criticalExtensions CHOICE {			
rrcReconfiguration SEQUENCE {			
nonCriticalExtension SEQUENCE {			
masterCellGroup	Not present		
nonCriticalExtension SEQUENCE {			
nonCriticalExtension SEQUENCE {			
mrdc-SecondaryCellGroupConfig CHOICE {			
setup SEQUENCE {			
mrdc-SecondaryCellGroup CHOICE {			
nr-SCG	OCTET STRING (CONTAINING RRCReconfiguration specified in Table 8.2.5.4.2.3.3-2)		
}			
}			
}			
}			
}			
}			
}			

}			
}			
}			

Table 8.2.5.4.2.3.3-2: RRCReconfiguration (Table 8.2.5.4.2.3.3-1)

Derivation Path: TS 38.508-1 [4], Table 4.6.1-13 with condition NR-DC_SCG			
Information Element	Value/remark	Comment	Condition
RRCReconfiguration ::= SEQUENCE {			
rrc-TransactionIdentifier			
criticalExtensions CHOICE {			
rrcReconfiguration SEQUENCE {			
secondaryCellGroup	CellGroupConfig		
}			
}			
}			

Table 8.2.5.4.2.3.3-3: CellGroupConfig (Table 8.2.5.4.2.3.3-2)

Derivation Path: TS 38.508-1 [4], Table 4.6.3-19 with condition NR-DC_SCG			
Information Element	Value/remark	Comment	Condition
CellGroupConfig ::= SEQUENCE {			
spCellConfig SEQUENCE {			
reconfigurationWithSync SEQUENCE {			
spCellConfigCommon	ServingCellConfigCommon		
newUE-Identity	RNTI-Value with condition NR-DC_SCG		
t304	ms1000		
rach-ConfigDedicated	Not present		
}			
}			
}			

Table 8.2.5.4.2.3.3-4: ServingCellConfigCommon (Table 8.2.5.4.2.3.3-3)

Derivation Path: TS 38.508-1 [4], Table 4.6.3-168			
Information Element	Value/remark	Comment	Condition
ServingCellConfigCommon ::= SEQUENCE {			
uplinkConfigCommon SEQUENCE {			
initialUplinkBWP	BWP-UplinkCommon		
}			
}			

Table 8.2.5.4.2.3.3-5: BWP-UplinkCommon (Table 8.2.5.4.2.3.3-4)

Derivation Path: TS 38.508-1 [4], Table 4.6.3-14			
Information Element	Value/remark	Comment	Condition
BWP-UplinkCommon ::= SEQUENCE {			
rach-ConfigCommon CHOICE {			
setup	RACH-ConfigCommon		
}			
}			

Table 8.2.5.4.2.3.3-6: RACH-ConfigCommon (Table 8.2.5.4.2.3.3-5)

Derivation Path: TS 38.508-1 [4], Table 4.6.3-128			
Information Element	Value/remark	Comment	Condition
RACH-ConfigCommon ::= SEQUENCE {			
rach-ConfigGeneric	RACH-ConfigGeneric		

}		
---	--	--

Table 8.2.5.4.2.3.3-7: RACH-ConfigGeneric (Table 8.2.5.4.2.3.3-6)

Derivation Path: TS 38.508-1 [4], Table 4.6.3-130			
Information Element	Value/remark	Comment	Condition
RACH-ConfigGeneric ::= SEQUENCE {			
preambleTransMax	n200		
}			

Table 8.2.5.4.2.3.3-8: SCGFailureInformation (step 3, Table 8.2.5.4.2.3.2-1)

Derivation Path: TS 38.508-1 [4], Table 4.6.1-24A			
Information Element	Value/remark	Comment	Condition
SCGFailureInformation ::= SEQUENCE {			
criticalExtensions CHOICE {			
scgFailureInformation SEQUENCE {			
FailureReportSCG SEQUENCE {			
failureType	synchReconfigFailure-SCG		
measResultFreqList	Not checked		
measResultSCG-Failure	Not present		
}			
nonCriticalExtension	Not checked		
}			
}			

8.2.5.5 Reconfiguration failure / SCG Reconfiguration failure / SRB3

Note: Core specs requirements cannot be simulated and verified as conformance test.

8.2.5.5.1 Void

8.2.5.6 Reconfiguration failure / SCG Reconfiguration failure / SRB1

Note: Core specs requirements cannot be simulated and verified as conformance test.

8.2.5.6.1 Void

8.2.6 MR-DC RRC others

8.2.6.1 Failure information / RLC failure / SCG

8.2.6.1.1 Failure information / RLC failure / SCG / EN-DC

8.2.6.1.1.1 Failure information / RLC failure / SCG / EN-DC / Intra-band Contiguous CA

8.2.6.1.1.1.1 Test Purpose (TP)

(1)

```
with { UE in RRC_CONNECTED state with EN-DC, and, MCG(s) (E-UTRA PDCP) and SCG }
ensure that {
  when { an indication from SCG RLC that the maximum number of retransmissions has been reached and
  when CA duplication is configured and activated and for the corresponding logical channel
  allowedServingCells only includes SCell(s) }
```

```

    then { UE sends the FailureInformation message embedded in E-UTRA RRC message
    ULInformationTransferMRDC to report RLC failure }
  }

```

(2)

```

with { UE in RRC_CONNECTED state with EN-DC, and, MCG(s) (E-UTRA PDCP) and SCG and SRB3 configured }
ensure that {
  when { an indication from SCG RLC that the maximum number of retransmissions has been reached and
  when CA duplication is configured and activated and for the corresponding logical channel
  allowedServingCells only includes SCell(s) }
  then { UE initiates the failure information procedure to report RLC failure via SRB3 }
}

```

8.2.6.1.1.1.2 Conformance requirements

References: The conformance requirements covered in the current TC are specified in: TS 36.331, clause 5.3.5.3, TS 38.331, clauses 5.3.10.3, 5.7.5.2 and 5.7.5.3. Unless otherwise stated these are Rel-15 requirements.

[TS 36.331, clause 5.3.5.3]

If the *RRCCConnectionReconfiguration* message does not include the *mobilityControlInfo* and the UE is able to comply with the configuration included in this message, the UE shall:

...

1> if the received *RRCCConnectionReconfiguration* includes the *nr-RadioBearerConfig1*:

2> perform radio bearer configuration as specified in TS 38.331 [82], clause 5.3.5.6;

...

1> else:

2> submit the *RRCCConnectionReconfigurationComplete* message to lower layers for transmission using the new configuration, upon which the procedure ends;

[TS 38.331, clause 5.3.10.3]

The UE shall:

...

1> upon indication from SCG RLC that the maximum number of retransmissions has been reached:

2> if the indication is from SCG RLC and CA duplication is configured and activated; and for the corresponding logical channel *allowedServingCells* only includes SCell(s):

3> initiate the failure information procedure as specified in 5.7.5 to report RLC failure.

...

[TS 38.331, clause 5.7.5.2]

A UE initiates the procedure when there is a need inform the network about a failure detected by the UE. In particular, the UE initiates the procedure when the following condition is met:

1> upon detecting failure for an RLC bearer, in accordance with 5.3.10.3;

Upon initiating the procedure, the UE shall:

1> initiate transmission of the *FailureInformation* message as specified in 5.7.5.3;

[TS 38.331, clause 5.7.5.3]

The UE shall:

1> if initiated to provide RLC failure information, set *FailureInfoRLC-Bearer* as follows:

- 2> set *logicalChannelIdentity* to the logical channel identity of the failing RLC bearer;
- 2> set *cellGroupId* to the cell group identity of the failing RLC bearer;
- 2> set the *failureType* as *rlc-failure*;
- ...
- 1> else if used to inform the network about a failure for an SCG RLC bearer:
 - 2> if SRB3 is configured;
 - 3> submit the *FailureInformation* message to lower layers for transmission via SRB3;
 - 2> else;
 - 3> if the UE is in (NG)EN-DC:
 - 4> submit the *FailureInformation* message via E-UTRA embedded in E-UTRA RRC message *ULInformationTransferMRDC* as specified in TS 36.331 [10].
- ...

8.2.6.1.1.1.3 Test description

8.2.6.1.1.1.3.1 Pre-test conditions

System Simulator:

- EUTRA Cell 1 is the PCell, NR Cell 1 is the PSCell, NR Cell 3 is the SCell.

UE:

- None.

Preamble:

- The UE is in state RRC_CONNECTED using generic procedure parameter Connectivity (*EN-DC*), Bearers (*MCG(s)* and *SCG*) established according to TS 38.508-1 [4], clause 4.5.4, and with *UE test loop mode A prepared*, as defined in TS 38.508-1 [4], subclause 4.4A.

8.2.6.1.1.1.3.2 Test procedure sequence

Table 8.2.6.1.1.1.3.2-1: Main behaviour

St	Procedure	Message Sequence		TP	Verdict
		U - S	Message		
1	The SS transmits an <i>RRCConnectionReconfiguration</i> message to add SCell (NR Cell 3) and DRB #j for the UE.	<--	EUTRA RRC: <i>RRCConnectionReconfiguration</i>	-	-
2	The UE transmits an <i>RRCConnectionReconfigurationComplete</i> message	-->	EUTRA RRC: <i>RRCConnectionReconfigurationComplete</i>	-	-
2A	The SS transmits a SCell Activation/Deactivation MAC-CE to activate SCell (NR Cell 3).	<--	MAC PDU (SCell Activation/Deactivation MAC CE of one octet (C ₁ =1))	-	-
3	The SS transmits a CLOSE UE TEST LOOP message	<--	CLOSE UE TEST LOOP	-	-
4	The UE transmits a CLOSE UE TEST LOOP COMPLETE message.	-->	CLOSE UE TEST LOOP COMPLETE	-	-
5	The SS stops sending SCG RLC acknowledgments for the next RLC PDU on PSCell (NR Cell 1) and SCell (NR Cell 3)	-	-	-	-
6	The SS transmits one PDCP PDU to the UE on DRB #j.	<--	PDCP PDU	-	-

-	EXCEPTION: Steps 7-7A occur in any sequence.	-	-	-	-
7	The UE loops back the PDCP PDU on PSCell (NR Cell 1) on DRB #j	-->	PDCP PDU	-	-
7A	The UE loops back the PDCP PDU on SCell (NR Cell 3) on DRB #j	-->	PDCP PDU	-	-
8	Check: Does the UE transmit an <i>ULInformationTransferMRDC</i> message including <i>FailureInformation</i> with failureType set to 'rlc-failure'?	-->	EUTRA RRC: <i>ULInformationTransferMRDC (FailureInformation)</i>	1	P
9	Void				
10	The SS transmits an OPEN UE TEST LOOP message	<--	OPEN UE TEST LOOP	-	-
11	The UE transmits an OPEN UE TEST LOOP COMPLETE message.	-->	OPEN UE TEST LOOP COMPLETE	-	-
12	The SS transmits an <i>RRCCoReonfiguration</i> message to add SRB3 and re-establish SCell RLC entity of DRB #j for the UE	<--	EUTRA RRC: <i>RRCCoReonfiguration</i>	-	-
13	The UE transmits an <i>RRCCoReonfigurationComplete</i> message	-->	EUTRA RRC: <i>RRCCoReonfigurationComplete</i>	-	-
14	The SS transmits a CLOSE UE TEST LOOP message	<--	CLOSE UE TEST LOOP	-	-
15	The UE transmits a CLOSE UE TEST LOOP COMPLETE message.	-->	CLOSE UE TEST LOOP COMPLETE	-	-
16	The SS stops sending SCG RLC acknowledgments for the next RLC PDU on PSCell (NR Cell 1) and SCell (NR Cell 3)	-	-	-	-
17	The SS transmits one PDCP PDU to the UE on DRB #j.	<--	PDCP PDU	-	-
-	EXCEPTION: Steps 18-18A occur in any sequence.	-	-	-	-
18	The UE loops back the PDCP PDU on PSCell (NR Cell 1) on DRB #j	-->	PDCP PDU	-	-
18A	The UE loops back the PDCP PDU on SCell (NR Cell 3) on DRB #j	-->	PDCP PDU	-	-
19	Check: Does the UE transmit a <i>FailureInformation</i> with failureType set to 'rlc-failure'?	-->	NR RRC: <i>FailureInformation</i>	2	P

8.2.6.1.1.3.3 Specific message contents

Table 8.2.6.1.1.3.3-1: *RRCCoReonfiguration* (Step 1, Table 8.2.6.1.1.3.2-1)

Derivation Path: TS 36.508 [7] Table 4.6.1-8 with Condition EN-DC_EmbedNR_RRCRecon and EN-DC_EmbedNR_RBConfig			
Information Element	Value/remark	Comment	Condition
<i>RRCCoReonfiguration</i> ::= SEQUENCE {			
<i>criticalExtensions</i> CHOICE {			
c1 CHOICE {			
<i>rrcCoReonfiguration-r8</i> SEQUENCE {			
<i>nonCriticalExtension</i> SEQUENCE {			
<i>nonCriticalExtension</i> SEQUENCE {			
<i>nonCriticalExtension</i> SEQUENCE {			
<i>nonCriticalExtension</i> SEQUENCE {			
<i>nonCriticalExtension</i> SEQUENCE {			
<i>nonCriticalExtension</i> SEQUENCE {			
<i>nonCriticalExtension</i> SEQUENCE {			
<i>nr-Config-r15</i> CHOICE {			
<i>setup</i> SEQUENCE {			
<i>nr-SecondaryCellGroupConfig-r15</i>	OCTET STRING including <i>RRCCoReonfiguration</i>	Table 8.2.6.1.1.3.3-2	

}			
}			
}			

Table 8.2.6.1.1.1.3.3-4: PDCP-Config (Table 8.2.6.1.1.1.3.3-3)

Derivation Path: TS 38.508-1 [4], Table 4.6.3-99 with condition Split			
Information Element	Value/remark	Comment	Condition
PDCP-Config ::= SEQUENCE {			
moreThanOneRLC SEQUENCE {			
primaryPath SEQUENCE {			
logicalChannel	LogicalChannelIdentity with Condition DRB j	j is the ID of the DRB added in Table 8.2.6.1.1.1.3.3-3, which is allocated according to internal TTCN mapping	
}			
} pdcp-Duplication	True		
}			
}			

Table 8.2.6.1.1.1.3.3-5: RLC-BearerConfig-1 (Table 8.2.6.1.1.1.3.3-2)

Derivation Path: TS 38.508-1 [4], Table 4.6.3-148 with Condition AM			
Information Element	Value/remark	Comment	Condition
RLC-BearerConfig ::= SEQUENCE {			
logicalChannelIdentity	LogicalChannelIdentity with condition DRB j	ID of primary logical channel	
servedRadioBearer CHOICE {			
drb-Identity	DRB-Identity with condition DRB j		
}			
rlc-Config CHOICE {			
am SEQUENCE {			
ul-AM-RLC SEQUENCE {			
maxRetxThreshold	t32	To ensure RLC failure happens before RLF	
}			
}			
}			
mac-LogicalChannelConfig SEQUENCE {			
ul-SpecificParameters SEQUENCE {			
allowedServingCells SEQUENCE (SIZE (1..maxNrofServingCells-1)) OF ServCellIndex {	1 entry		
ServCellIndex[1]	ServCellIndex of NR Cell 1	entry 1	
}			
}			
}			
}			

Table 8.2.6.1.1.1.3.3-6: RLC-BearerConfig-2 (Table 8.2.6.1.1.1.3.3-2)

Derivation Path: TS 38.508-1 [4], Table 4.6.3-148 with Condition AM			
Information Element	Value/remark	Comment	Condition
RLC-BearerConfig ::= SEQUENCE {			
logicalChannelIdentity	LogicalChannelIdentity with condition DRB j+1	To ensure ID of secondary logical channel ID is	

		different with existing logical channel and the primary logical channel	
servedRadioBearer CHOICE {			
drb-Identity	DRB-Identity with condition DRB j		
}			
rlc-Config CHOICE {			
am SEQUENCE {			
ul-AM-RLC SEQUENCE {			
maxRetxThreshold	t1	To ensure RLC failure happens before RLF	
}			
}			
}			
mac-LogicalChannelConfig SEQUENCE {			
ul-SpecificParameters SEQUENCE {			
allowedServingCells SEQUENCE (SIZE (1..maxNrofServingCells-1)) OF ServCellIndex {	1 entry		
ServCellIndex[1]	ServCellIndex of NR Cell 3	entry 1	
}			
}			
}			
}			

Table 8.2.6.1.1.3.3-7: ULInformationTransferMRDC (Step 8, Table 8.2.6.1.1.3.2-1)

Derivation Path: TS 36.508 [7], Table 4.6.1-27			
Information Element	Value/remark	Comment	Condition
ULInformationTransferMRDC-r15 ::= SEQUENCE {			
criticalExtensions CHOICE {			
c1 CHOICE {			
ulInformationTransferMRDC-r15 SEQUENCE {			
ul-DCCH-MessageNR-r15	OCTET STRING including the <i>FailureInformation</i> .	Table 8.2.6.1.1.3.3-7	
}			
}			
}			
}			

Table 8.2.6.1.1.3.3-8: FailureInformation (Table 8.2.6.1.1.3.3-7 and Step 19, Table 8.2.6.1.1.3.2-1)

Derivation Path: TS 38.508-1 [4], Table 4.6.1-4			
Information Element	Value/remark	Comment	Condition
FailureInformation ::= SEQUENCE {			
criticalExtensions CHOICE {			
failureInformation SEQUENCE {			
failureInfoRLC-Bearer SEQUENCE {			
cellGroupId	CellGroupId as per TS 38.508-1 [4] Table 4.6.3-20 with condition EN-DC		
failureType	rlc-failure		
}			
}			
}			
}			

rlc-BearerToAddModList SEQUENCE (SIZE(1..maxLCH)) OF RLC-BearerConfig {	2 entries		
RLC-BearerConfig[1]	RLC-BearerConfig with conditions SRB3	entry 1	
RLC-BearerConfig[2]	RLC-BearerConfig-Reest	entry 2	
}			
mac-CellGroupConfig	Not present		
physicalCellGroupConfig	Not present		
spCellConfig	Not present		
}			

Table 8.2.6.1.1.1.3.3-12: RLC-BearerConfig-Reest (Table 8.2.6.1.1.1.3.3-11)

Derivation Path: TS 38.508-1 [4], Table 4.6.3-148 with Condition AM			
Information Element	Value/remark	Comment	Condition
RLC-BearerConfig ::= SEQUENCE {			
logicalChannelIdentity	LogicalChannelIdentity with condition DRB j+1	SCell RLC bearer of DRB #j	
servedRadioBearer	Not present		
reestablishRLC	true		
rlc-Config	Not present		
mac-LogicalChannelConfig	Not present		
}			

8.2.6.1.1.2 Failure information / RLC failure / SCG / EN-DC / Inter-band CA

8.2.6.1.1.2.1 Test Purpose (TP)

Same as TC 8.2.6.1.1.1 but applied to Inter-band CA case.

8.2.6.1.1.2.2 Conformance requirements

Same as TC 8.2.6.1.1.1 but applied to Inter-band CA case.

8.2.6.1.1.2.3 Test description

8.2.6.1.1.2.3.1 Pre-test conditions

Same as test case 8.2.6.1.1.1 with the following differences:

- CA configuration: Inter-band CA replaces Intra-band Contiguous CA.
- Cells configuration: NR Cell 10 replaces NR Cell 3.

8.2.6.1.1.2.3.2 Test procedure sequence

Same as test case 8.2.6.1.1.1 with the following differences:

- CA configuration: Inter-band CA replaces Intra-band Contiguous CA.
- Cells configuration: NR Cell 10 replaces NR Cell 3.

8.2.6.1.1.2.3.3 Specific message contents

Same as test case 8.2.6.1.1.1 with the following differences.

- CA configuration: Inter-band CA replaces Intra-band Contiguous CA.
- Cells configuration: NR Cell 10 replaces NR Cell 3.

8.2.6.1.1.3 Failure information / RLC failure / SCG / EN-DC / Intra-band non Contiguous CA

8.2.6.1.1.3.1 Test Purpose (TP)

Same as TC 8.2.6.1.1.1 but applied to Intra-band non Contiguous CA case.

8.2.6.1.1.3.2 Conformance requirements

Same as TC 8.2.6.1.1.1 but applied to Intra-band non Contiguous CA case.

8.2.6.1.1.3.3 Test description

8.2.6.1.1.3.3.1 Pre-test conditions

Same as test case 8.2.6.1.1.1 with the following differences:

- CA configuration: Intra-band non Contiguous CA replaces Intra-band Contiguous CA.

8.2.6.1.1.3.3.2 Test procedure sequence

Same as test case 8.2.6.1.1.1 with the following differences:

- CA configuration: Intra-band non Contiguous CA replaces Intra-band Contiguous CA.

8.2.6.1.1.3.3.3 Specific message contents

Same as test case 8.2.6.1.1.1 but applied to Intra-band non Contiguous CA case.

8.2.6.1.2 Failure information / RLC failure / SCG / NR-DC

8.2.6.1.2.1 Failure information / RLC failure / SCG / NR-DC / Intra-band Contiguous CA

8.2.6.1.2.1.1 Test Purpose (TP)

(1)

```
with { UE in NR RRC_CONNECTED state with NR-DC, and SCG }
ensure that {
  when { an indication from SCG RLC that the maximum number of retransmissions has been reached and
when CA duplication is configured and activated and for the corresponding logical channel
allowedServingCells only includes SCell(s) }
  then { UE sends the FailureInformation message embedded in ULInformationTransferMRDC to report
RLC failure for the SCG }
}
```

(2)

```
with { UE in NR RRC_CONNECTED state with NR-DC, and SRB3 configured }
ensure that {
  when { an indication from SCG RLC that the maximum number of retransmissions has been reached and
when CA duplication is configured and activated and for the corresponding logical channel
allowedServingCells only includes SCell(s) }
  then { UE sends the FailureInformation message over SRB3 to report RLC failure for the SCG }
}
```

8.2.6.1.2.1.2 Conformance requirements

References: The conformance requirements covered in the current TC are specified in: TS 36.331, clause 5.3.5.3, TS 38.331, clauses 5.3.10.3, 5.7.5.2 and 5.7.5.3. Unless otherwise stated these are Rel-15 requirements.

[TS 38.331, 5.3.5.3]

The UE shall perform the following actions upon reception of the *RRCReconfiguration*:

...

1> if the *RRCReconfiguration* includes the *secondaryCellGroup*:

2> perform the cell group configuration for the SCG according to 5.3.5.5;

1> if the *RRCReconfiguration* includes the *mrdc-SecondaryCellGroupConfig*:

2> if the *mrdc-SecondaryCellGroupConfig* is set to *setup*:

3> if the *mrdc-SecondaryCellGroupConfig* includes *mrdc-ReleaseAndAdd*:

4> perform MR-DC release as specified in clause 5.3.5.10;

3> if the received *mrdc-SecondaryCellGroup* is set to *nr-SCG*:

4> perform the RRC reconfiguration according to 5.3.5.3 for the *RRCReconfiguration* message included in *nr-SCG*;

...

1> if the *RRCReconfiguration* message includes the *radioBearerConfig*:

2> perform the radio bearer configuration according to 5.3.5.6;

...

1> set the content of the *RRCReconfigurationComplete* message as follows:

...

2> if the *RRCReconfiguration* message includes the *mrdc-SecondaryCellGroupConfig* with *mrdc-SecondaryCellGroup* set to *nr-SCG*:

3> include in the *nr-SCG-Response* the *RRCReconfigurationComplete* message;

...

1> else if the *RRCReconfiguration* message was received within the *nr-SCG* within *mrdc-SecondaryCellGroup* (UE in NR-DC, *mrdc-SecondaryCellGroup* was received in *RRCReconfiguration* via SRB1):

2> if *reconfigurationWithSync* was included in *spCellConfig* in *nr-SCG*:

3> initiate the Random Access procedure on the PSCell, as specified in TS 38.321 [3];

2> else

3> the procedure ends;

NOTE 2a: The order in which the UE sends the *RRCReconfigurationComplete* message and performs the Random Access procedure towards the SCG is left to UE implementation.

1> else if the *RRCReconfiguration* message was received via SRB3 (UE in NR-DC):

2> submit the *RRCReconfigurationComplete* message via SRB3 to lower layers for transmission using the new configuration;

1> else (*RRCReconfiguration* was received via SRB1):

2> submit the *RRCReconfigurationComplete* message via SRB1 to lower layers for transmission using the new configuration;

...

1> if *reconfigurationWithSync* was included in *spCellConfig* of an MCG or SCG, and when MAC of an NR cell group successfully completes a Random Access procedure triggered above;

2> stop timer T304 for that cell group;

- 2> apply the parts of the CSI reporting configuration, the scheduling request configuration and the sounding RS configuration that do not require the UE to know the SFN of the respective target SpCell, if any;
- 2> apply the parts of the measurement and the radio resource configuration that require the UE to know the SFN of the respective target SpCell (e.g. measurement gaps, periodic CQI reporting, scheduling request configuration, sounding RS configuration), if any, upon acquiring the SFN of that target SpCell;

...

[TS 38.331, clause 5.3.10.3]

The UE shall:

...

- 1> upon indication from SCG RLC that the maximum number of retransmissions has been reached:
 - 2> if the indication is from SCG RLC and CA duplication is configured and activated; and for the corresponding logical channel *allowedServingCells* only includes SCell(s):
 - 3> initiate the failure information procedure as specified in 5.7.5 to report RLC failure.

...

[TS 38.331, clause 5.7.5.2]

A UE initiates the procedure when there is a need inform the network about a failure detected by the UE. In particular, the UE initiates the procedure when the following condition is met:

- 1> upon detecting failure for an RLC bearer, in accordance with 5.3.10.3;

Upon initiating the procedure, the UE shall:

- 1> initiate transmission of the *FailureInformation* message as specified in 5.7.5.3;

[TS 38.331, clause 5.7.5.3]

The UE shall:

- 1> if initiated to provide RLC failure information, set *FailureInfoRLC-Bearer* as follows:
 - 2> set *logicalChannelIdentity* to the logical channel identity of the failing RLC bearer;
 - 2> set *cellGroupId* to the cell group identity of the failing RLC bearer;
 - 2> set the *failureType* as *rlc-failure*;

...

- 1> else if used to inform the network about a failure for an SCG RLC bearer:
 - 2> if SRB3 is configured;
 - 3> submit the *FailureInformation* message to lower layers for transmission via SRB3;
 - 2> else;

...

- 3> else if the UE is in NR-DC:
 - 4> submit the *FailureInformation* message via SRB1 embedded in NR RRC message *ULInformationTransferMRDC* as specified in clause 5.7.2a.3.

...

8.2.6.1.2.1.3 Test description

8.2.6.1.2.1.3.1 Pre-test conditions

System Simulator:

- NR Cell 1 is the PCell, NR Cell 10 is the PSCell, NR Cell 28 is the SCG SCell.
- System information combination NR-4 as defined in TS 38.508-1 [4] clause 4.4.3.1.2 is used in NR cells.

UE:

- None.

Preamble:

- The UE is in state RRC_CONNECTED using generic procedure parameter Connectivity (NR-DC) according to TS 38.508-1 [4], Table 4.5.1-1, and with UE test loop mode A prepared, as defined in TS 38.508-1 [4], subclause 4.4A.

8.2.6.1.2.1.3.2 Test procedure sequence

Table 8.2.6.1.2.1.3.2-1: Main behaviour

St	Procedure	Message Sequence		TP	Verdict
		U - S	Message		
1	The SS transmits an <i>RRCReconfiguration</i> message to add SCG SCell (NR Cell 28) and reconfigure SCG DRB #j with PDCP duplication for the UE.	<--	<i>RRCReconfiguration</i>	-	-
2	The UE transmits an <i>RRCReconfigurationComplete</i> message	-->	<i>RRCReconfigurationComplete</i>	-	-
3	The SS transmits a SCell Activation/Deactivation MAC-CE on PSCell (NR Cell 10) to activate SCG SCell (NR Cell 28).	<--	MAC PDU (SCell Activation/Deactivation MAC CE of one octet (C ₁ =1))	-	-
4	The SS transmits a CLOSE UE TEST LOOP message	<--	CLOSE UE TEST LOOP	-	-
5	The UE transmits a CLOSE UE TEST LOOP COMPLETE message.	-->	CLOSE UE TEST LOOP COMPLETE	-	-
6	The SS stops sending SCG RLC acknowledgments for the next RLC PDU on PSCell (NR Cell 10) and SCell (NR Cell 28)	-	-	-	-
7	The SS transmits one PDCP PDU to the UE on DRB #j.	<--	PDCP PDU	-	-
-	EXCEPTION: Steps 8-9 occur in any sequence.	-	-	-	-
8	The UE loops back the PDCP PDU on PSCell (NR Cell 10) on DRB #j	-->	PDCP PDU	-	-
9	The UE loops back the PDCP PDU on SCell (NR Cell 28) on DRB #j	-->	PDCP PDU	-	-
10	Check: Does the UE transmit an <i>ULInformationTransferMRDC</i> message including <i>FailureInformation</i> with failureType set to 'rlc-failure'?	-->	<i>ULInformationTransferMRDC</i> (<i>FailureInformation</i>)	1	P
11	The SS transmits an OPEN UE TEST LOOP message	<--	OPEN UE TEST LOOP	-	-
12	The UE transmits an OPEN UE TEST LOOP COMPLETE message.	-->	OPEN UE TEST LOOP COMPLETE	-	-
13	The SS transmits an <i>RRCReconfiguration</i> message to establish SRB3 for the UE	<--	<i>RRCReconfiguration</i>	-	-
14	The UE transmits an <i>RRCReconfigurationComplete</i> message	-->	<i>RRCReconfigurationComplete</i>	-	-
15	The SS transmits a CLOSE UE TEST LOOP message	<--	CLOSE UE TEST LOOP	-	-
16	The UE transmits a CLOSE UE TEST LOOP COMPLETE message.	-->	CLOSE UE TEST LOOP COMPLETE	-	-

17	The SS stops sending SCG RLC acknowledgments for the next RLC PDU on PSCell (NR Cell 10) and SCell (NR Cell 28)	-	-	-	-
18	The SS transmits one PDCP PDU to the UE on DRB #j.	<--	PDCP PDU	-	-
-	EXCEPTION: Steps 19-20 occur in any sequence.	-	-	-	-
19	The UE loops back the PDCP PDU on PSCell (NR Cell 10) on DRB #j	-->	PDCP PDU	-	-
20	The UE loops back the PDCP PDU on SCell (NR Cell 28) on DRB #j	-->	PDCP PDU	-	-
21	Check: Does the UE transmit a <i>FailureInformation</i> with failureType set to 'rlc-failure'?	-->	<i>FailureInformation</i>	2	P

8.2.6.1.2.1.3.3 Specific message contents

Table 8.2.6.1.2.1.3.3-1: RRCReconfiguration (Step 1, Table 8.2.6.1.2.1.3.2-1)

Derivation Path: TS 38.508-1 [4], Table 4.6.1-13 with condition NR-DC			
Information Element	Value/remark	Comment	Condition
RRCReconfiguration ::= SEQUENCE {			
criticalExtensions CHOICE {			
rrcReconfiguration SEQUENCE {			
radioBearerConfig	Not present		
nonCriticalExtension SEQUENCE {			
masterCellGroup	Not present		
nonCriticalExtension SEQUENCE {			
nonCriticalExtension SEQUENCE {			
mrdc-SecondaryCellGroupConfig CHOICE {			
setup SEQUENCE {			
mrdc-SecondaryCellGroup CHOICE {			
nr-SCG	RRCReconfiguration-SCG	OCTET STRING (CONTAINING RRCReconfiguration) Table 8.2.6.1.2.1.3.3-2	
}			
}			
}			
radioBearerConfig2	RadioBearerConfig-DRB(1, 0)	OCTET STRING (CONTAINING RadioBearerConfig) Table 8.2.6.1.2.1.3.3-3	
}			
}			
}			
}			
}			
}			

Table 8.2.6.1.2.1.3.3-2: RRCReconfiguration-SCG (Table 8.2.6.1.2.1.3.3-1)

Derivation Path: TS 38.331 [6], clause 6.2.2			
Information Element	Value/remark	Comment	Condition
RRCReconfiguration ::= SEQUENCE {			
criticalExtensions CHOICE {			
rrcReconfiguration SEQUENCE {			
radioBearerConfig	Not present		
secondaryCellGroup	CellGroupConfig	OCTET STRING (CONTAINING CellGroupConfig)	

		Table 8.2.6.1.2.1.3.3-4	
}			
}			
}			

Table 8.2.6.1.2.1.3.3-3: RadioBearerConfig-DRB(1, 0) (Table 8.2.6.1.2.1.3.3-2)

Derivation Path: TS 38.508-1 [4], Table 4.8.1-3			
Information Element	Value/remark	Comment	Condition
RadioBearerConfig ::= SEQUENCE {			
drb-ToAddModList SEQUENCE (SIZE (1..maxDRB)) OF DRB-ToAddMod {	1 entry		
DRB-ToAddMod[1] SEQUENCE {		entry 1	
pdcpc-Config	PDCP-Config	Table 8.2.6.1.2.1.3.3-5	
}			
}			
}			

Table 8.2.6.1.2.1.3.3-4: CellGroupConfig (Table 8.2.6.1.2.1.3.3-2)

Derivation Path: TS 38.508-1 [4], Table 4.6.3-19 with condition SCell_add			
Information Element	Value/remark	Comment	Condition
CellGroupConfig ::= SEQUENCE {			
cellGroupId	CellGroupId as per TS 38.508-1 [4] Table 4.6.3-20 condition NR-DC_SCG		
rlc-BearerToAddModList SEQUENCE (SIZE(1..max LC-ID)) OF RLC-BearerConfig {	2 entries		
RLC-BearerConfig[1]	RLC-BearerConfig-1	entry 1 Table 8.2.6.1.2.1.3.3-6 Primary RLC	
RLC-BearerConfig[2]	RLC-BearerConfig-2	entry 2 Table 8.2.6.1.2.1.3.3-7 Secondary RLC	
}			
sCellToAddModList SEQUENCE (SIZE (1..maxNrofSCells)) OF SCellConfig {	1 entry		
SCellConfig[1] SEQUENCE {		entry 1	
sCellIndex	SCellIndex for NR Cell 28		
sCellConfigCommon	ServingCellConfigCommon as per TS 38.508-1 [4] Table 4.6.3-168		
sCellConfigDedicated	ServingCellConfig as per TS 38.508-1 [4] Table 4.6.3-167		
}			
}			
}			

Table 8.2.6.1.2.1.3.3-5: PDCP-Config (Table 8.2.6.1.2.1.3.3-3)

Derivation Path: TS 38.508-1 [4], Table 4.6.3-99 with condition Split			
Information Element	Value/remark	Comment	Condition
PDCP-Config ::= SEQUENCE {			
moreThanOneRLC SEQUENCE {			
primaryPath SEQUENCE {			
cellGroup	1	SCG Cell Group Id	

logicalChannel	LogicalChannelIdentity with Condition DRB j	j is the ID of the SCG DRB, which is allocated according to internal TTCN mapping	
}			
pdcp-Duplication	True		
}			
}			

Table 8.2.6.1.2.1.3.3-6: RLC-BearerConfig-1 (Table 8.2.6.1.2.1.3.3-4)

Derivation Path: TS 38.508-1 [4], Table 4.6.3-148 with Condition AM			
Information Element	Value/remark	Comment	Condition
RLC-BearerConfig ::= SEQUENCE {			
logicalChannelIdentity	LogicalChannelIdentity with condition DRB j	ID of primary logical channel	
servedRadioBearer CHOICE {			
drb-Identity	DRB-Identity with condition DRB j		
}			
rlc-Config CHOICE {			
am SEQUENCE {			
ul-AM-RLC SEQUENCE {			
maxRetxThreshold	t32	To ensure RLC failure happens before RLF	
}			
}			
}			
mac-LogicalChannelConfig SEQUENCE {			
ul-SpecificParameters SEQUENCE {			
allowedServingCells SEQUENCE (SIZE (1..maxNrofServingCells-1)) OF ServCellIndex {	1 entry		
ServCellIndex[1]	ServCellIndex of NR Cell 10	entry 1	
}			
}			
}			
}			

Table 8.2.6.1.2.1.3.3-7: RLC-BearerConfig-2 (Table 8.2.6.1.2.1.3.3-4)

Derivation Path: TS 38.508-1 [4], Table 4.6.3-148 with Condition AM			
Information Element	Value/remark	Comment	Condition
RLC-BearerConfig ::= SEQUENCE {			
logicalChannelIdentity	LogicalChannelIdentity with condition DRB j+1	To ensure ID of secondary logical channel ID is different with existing logical channel and the primary logical channel	
servedRadioBearer CHOICE {			
drb-Identity	DRB-Identity with condition DRB j		
}			
rlc-Config CHOICE {			
am SEQUENCE {			
ul-AM-RLC SEQUENCE {			

maxRetxThreshold	t1	To ensure RLC failure happens before RLF	
}			
}			
}			
mac-LogicalChannelConfig SEQUENCE {			
ul-SpecificParameters SEQUENCE {			
allowedServingCells SEQUENCE (SIZE (1..maxNrofServingCells-1)) OF ServCellIndex {	1 entry		
ServCellIndex[1]	ServCellIndex of NR Cell 28	entry 1	
}			
}			
}			
}			
}			

Table 8.2.6.1.2.1.3.3-8: ULInformationTransferMRDC (Step 10, Table 8.2.6.1.2.1.3.2-1)

Derivation Path: TS 38.508-1 [4], Table 4.6.1-34			
Information Element	Value/remark	Comment	Condition
ULInformationTransferMRDC ::= SEQUENCE {			
criticalExtensions CHOICE {			
c1 CHOICE {			
ulInformationTransferMRDC SEQUENCE {			
ul-DCCH-MessageNR	OCTET STRING including the <i>FailureInformation</i> .	Table 8.2.6.1.2.1.3.3-9	
}			
}			
}			
}			

Table 8.2.6.1.2.1.3.3-9: FailureInformation (Table 8.2.6.1.2.1.3.3-8 and Step 21, Table 8.2.6.1.2.1.3.2-1)

Derivation Path: TS 38.508-1 [4], Table 4.6.1-4			
Information Element	Value/remark	Comment	Condition
FailureInformation ::= SEQUENCE {			
criticalExtensions CHOICE {			
failureInformation SEQUENCE {			
failureInfoRLC-Bearer SEQUENCE {			
cellGroupId	CellGroupId as per TS 38.508-1 [4] Table 4.6.3-20 with condition NR-DC_SCG		
failureType	rlc-failure		
}			
}			
}			
}			

Table 8.2.6.1.2.1.3.3-10: RRCReconfiguration (step 13, Table 8.2.6.1.2.1.3.2-1)

Derivation Path: TS 38.508-1 [4], Table 4.6.1-13 with condition NR-DC			
Information Element	Value/remark	Comment	Condition
RRCReconfiguration ::= SEQUENCE {			
criticalExtensions CHOICE {			
rrcReconfiguration SEQUENCE {			
radioBearerConfig	Not present		
nonCriticalExtension SEQUENCE {			
masterCellGroup	Not present		
nonCriticalExtension SEQUENCE {			

8.2.6.1.2.2 Failure information / RLC failure / SCG / NR-DC / Inter-band CA

8.2.6.1.2.2.1 Test Purpose (TP)

Same as TC 8.2.6.1.2.1 but applied to Inter-band CA case.

8.2.6.1.2.2.2 Conformance requirements

Same as TC 8.2.6.1.2.1 but applied to Inter-band CA case.

8.2.6.1.2.2.3 Test description

8.2.6.1.2.2.3.1 Pre-test conditions

Same as test case 8.2.6.1.2.1 with the following differences:

- CA configuration: Inter-band CA replaces Intra-band Contiguous CA.
- Cells configuration: NR Cell 10 and NR Cell 28 are in the different band.

8.2.6.1.2.2.3.2 Test procedure sequence

Same as test case 8.2.6.1.2.1 with the following differences:

- CA configuration: Inter-band CA replaces Intra-band Contiguous CA.
- Cells configuration: NR Cell 10 and NR Cell 28 are in the different band.

8.2.6.1.2.2.3.3 Specific message contents

Same as test case 8.2.6.1.2.1 with the following differences.

- CA configuration: Inter-band CA replaces Intra-band Contiguous CA.
- Cells configuration: NR Cell 10 and NR Cell 28 are in the different band.

8.2.6.1.2.3 Failure information / RLC failure / SCG / NR-DC / Intra-band non Contiguous CA

8.2.6.1.2.3.1 Test Purpose (TP)

Same as TC 8.2.6.1.2.1 but applied to Intra-band non Contiguous CA case.

8.2.6.1.2.3.2 Conformance requirements

Same as TC 8.2.6.1.2.1 but applied to Intra-band non Contiguous CA case.

8.2.6.1.2.3.3 Test description

8.2.6.1.2.3.3.1 Pre-test conditions

Same as test case 8.2.6.1.2.1 with the following differences:

- CA configuration: Intra-band non Contiguous CA replaces Intra-band Contiguous CA.

8.2.6.1.2.3.3.2 Test procedure sequence

Same as test case 8.2.6.1.2.1 with the following differences:

- CA configuration: Intra-band non Contiguous CA replaces Intra-band Contiguous CA.

8.2.6.1.2.3.3.3 Specific message contents

Same as test case 8.2.6.1.2.1 but applied to Intra-band non Contiguous CA case.

8.2.6.2 Processing delay

8.2.6.2.1 Processing delay / PSCell addition / SCG DRB / Success / Latency check / EN-DC

8.2.6.2.1.1 Test Purpose (TP)

(1)

```
with { UE in E-UTRA RRC_CONNECTED state }
ensure that {
  when { UE receives an RRCConnectionReconfiguration message to add PSCell with SCG DRB and after 20
subframes receives an UL grant }
  then { UE successfully configures the PSCell with SCG DRB and sends an
RRCConnectionReconfigurationComplete message }
}
```

(2)

```
with { UE in E-UTRA RRC_CONNECTED state }
ensure that {
  when { UE receives an UECapabilityEnquiry message requesting eutra-nr capabilities and after 80
subframes receives an UL grant }
  then { UE successfully transmits an UECapabilityInformation message }
}
```

8.2.6.2.1.2 Conformance requirements

References: The conformance requirements covered in the present TC are specified in: TS 36.331, clauses 5.3.5.3, , TS 38.331, clauses 5.3.10.3, 5.7.3.2, 5.7.3.3. Unless otherwise stated these are Rel-15 requirements.

[TS 36.331, clause 5.3.5.3]

If the *RRCConnectionReconfiguration* message does not include the *mobilityControlInfo* and the UE is able to comply with the configuration included in this message, the UE shall:

...

1> if the received *RRCConnectionReconfiguration* includes the *nr-SecondaryCellGroupConfig*:

2> perform NR RRC Reconfiguration as specified in TS 38.331 [82], clause 5.3.5.3;

1> if the received *RRCConnectionReconfiguration* includes the *nr-RadioBearerConfig1*:

2> perform radio bearer configuration as specified in TS 38.331 [82], clause 5.3.5.6;

...

1> set the content of *RRCConnectionReconfigurationComplete* message as follows:

...

2> if the received *RRCConnectionReconfiguration* message included *nr-SecondaryCellGroupConfig*:

3> include *scg-ConfigResponseNR* in accordance with TS 38.331 [82], clause 5.3.5.3;

...

1> else:

2> submit the *RRCConnectionReconfigurationComplete* message to lower layers for transmission using the new configuration, upon which the procedure ends;

[TS 36.331, clause 5.6.3.3]

The UE shall:

...

1> else, set the contents of *UECapabilityInformation* message as follows:

...

2> if the *ue-CapabilityRequest* includes *eutra-nr* and if the UE supports (NG)EN-DC or NE-DC:

3> include the UE radio access capabilities for EUTRA-NR within a *ue-CapabilityRAT-Container*, with the *rat-Type* set to *eutra-nr*;

3> include band combinations as specified in TS 38.331 [82], clause 5.6.1.4, considering the included *requestedFreqBandsNR-MRDC*, *requestedCapabilityNR* (if present) and *requestedCapabilityCommon* (if included);

1> submit the *UECapabilityInformation* message to lower layers for transmission, upon which the procedure ends;

[TS 36.331, clause 11.2]

The UE performance requirements for RRC procedures are specified in the following tables, by means of a value N:

N = the number of 1ms subframes from the end of reception of the E-UTRAN -> UE message on the UE physical layer up to when the UE shall be ready for the reception of uplink grant for the UE -> E-UTRAN response message with no access delay other than the TTI-alignment (e.g. excluding delays caused by scheduling, the random access procedure or physical layer synchronisation).

NOTE: No processing delay requirements are specified for RN-specific procedures.

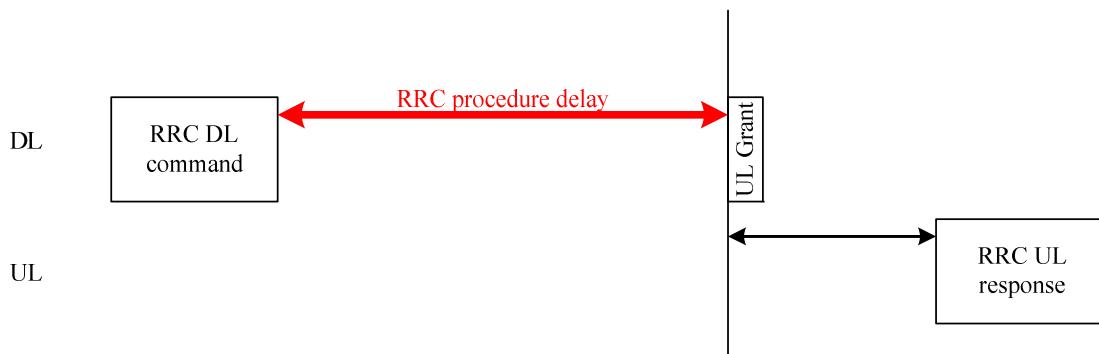

Figure 11.2-1: Illustration of RRC procedure delay

Table 11.2-1: UE performance requirements for RRC procedures for UEs other than NB-IoT UEs

Procedure title	E-UTRAN -> UE	UE -> E-UTRAN	N	Notes
RRC Connection Control Procedures				
RRC connection reconfiguration (NR SCG establishment/ /modification/release)	<i>RRConnectionReconfiguration</i>	<i>RRConnectionReconfigurationComplete</i>	20	
Other procedures				

Procedure title	E-UTRAN -> UE	UE -> E-UTRAN	N	Notes
UE capability transfer	<i>UECapabilityEnquiry</i>	<i>UECapabilityInformation</i>	10/ 80	N = 80 applies in case the UE has to report at least one of the following UE capabilities. - MR-DC band combinations. - NR band combinations - EUTRA feature sets

8.2.6.2.1.3 Test description

8.2.6.2.1.3.1 Pre-test conditions

System Simulator:

- E-UTRA Cell 1 is the PCell and NR Cell 1 is the PSCell.

UE:

- None.

Preamble:

- The UE is in state RRC_CONNECTED using generic procedure parameter Connectivity (*E-UTRA/EPC*) established and Test Loop Function (On) with UE test loop mode B according to TS 38.508-1 [4], clause 4.5.4.

8.2.6.2.1.3.2 Test procedure sequence

Table 8.2.6.2.1.3.2-1: Main behaviour

St	Procedure	Message Sequence		TP	Verdict
		U - S	Message		
1	The SS transmits an <i>RRCConnectionReconfiguration</i> message to add PSCell with SCG DRB	<--	E-UTRA RRC: <i>RRCConnectionReconfiguration</i>	-	-
2	Check: Does the UE transmit an <i>RRCConnectionReconfigurationComplete</i> message within 25 (FDD)/28 (TDD) subframes after successful completion of step 1? (Note 2)	-->	E-UTRA RRC: <i>RRCConnectionReconfigurationComplete</i>	1	P
2A	Void	-	-	-	-
3	The SS sends E-UTRA RRC <i>UECapabilityEnquiry</i> message including <i>RAT-Type eutra-nr</i> .	<--	E-UTRA RRC: <i>UECapabilityEnquiry</i>		
4	Check: Does the UE transmit an E-UTRA RRC <i>UECapabilityInformation</i> message within 85 (FDD)/88 (TDD) subframes after successful completion of step 3? (Note 2)	-->	E-UTRA RRC: <i>UECapabilityInformation</i>	2	P
Note 1: The SS is configured for RRC procedure delay testing according to TS 36.523-3 clause 7.12.1. Note 2: 5 (FDD) / 8 (TDD) subframes is added on top of RRC processing delay requirement, because UL grant is allocated for the next subframe after RRC procedure delay and because of transmission delay after UL grant. For TDD, consider the max 7 TTI transmission delay after UL grant.					

8.2.6.2.1.3.3 Specific message contents

Table 8.2.6.2.1.3.3-1: *RRCConnectionReconfiguration* (step 1, Table 8.2.6.2.1.3.2-1)

Derivation Path: TS 36.508 [7], Table 4.6.1-8 with Condition SCG-DRB(1,1)

Table 8.2.6.2.1.3.3-2: *UECapabilityEnquiry* (step 3, Table 8.2.6.2.1.3.2-1)

Derivation Path: TS 36.508 [7], Table 4.6.1-22 with Condition EN-DC			
Information Element	Value/remark	Comment	Condition
UECapabilityEnquiry ::= SEQUENCE {			
criticalExtensions CHOICE {			
c1 CHOICE {			
ueCapabilityEnquiry-r8 SEQUENCE {			
ue-CapabilityRequest SEQUENCE (SIZE	1 entry		
(1..maxRAT-Capabilities)) OF RAT-Type {			
RAT-Type[1]	eutra-nr		
}			
}			
}			
}			
}			

8.2.6.2.2 Processing delay / Latency check / NR-DC

8.2.6.2.2.1 Test Purpose (TP)

(1)

```

with { UE in NR RRC_CONNECTED state }
ensure that {
  when { UE receives an RRCReconfiguration message with nr-SCG IE to add an SCG and after 16ms
receives an UL grant }
  then { UE successfully transmits RRCReconfigurationComplete message }
}

```

(2)

```

with { UE in NR RRC_INACTIVE state and has sent an RRCResumeRequest message }
ensure that {
  when { UE receives RRCResume message and after 10ms receives an UL grant }
  then { UE successfully transmits RRCResumeComplete message }
}

```

8.2.6.2.2.2 Conformance requirements

References: The conformance requirements covered in the present TC are specified in: TS 38.331, clauses 5.3.5.3, 12. Unless otherwise stated these are Rel-15 requirements.

[TS 38.331, clause 5.3.5.3]

The UE shall perform the following actions upon reception of the *RRCReconfiguration*, or upon execution of the conditional reconfiguration (CHO or CPC):

...

1> if the received *RRCConnectionReconfiguration* includes the *nr-SecondaryCellGroupConfig*:

2> if the *mrdc-SecondaryCellGroupConfig* is set to *setup*:

1> if the received *RRCConnectionReconfiguration* includes the *nr-RadioBearerConfig1*:

2> perform radio bearer configuration as specified in TS 38.331 [82], clause 5.3.5.6;

...

3> if the received *mrdc-SecondaryCellGroup* is set to *nr-SCG*:

4> perform the RRC reconfiguration according to 5.3.5.3 for the *RRCReconfiguration* message included in *nr-SCG*;

1> set the content of the *RRCReconfigurationComplete* message as follows:

- ...
- 2> if the *RRCReconfiguration* message includes the *mrdc-SecondaryCellGroupConfig* with *mrdc-SecondaryCellGroup* set to *nr-SCG*:
 - 3> include in the *nr-SCG-Response* the *RRCReconfigurationComplete* message
- ...
- 1> else (*RRCReconfiguration* was received via SRB1):
 - 2> submit the *RRCReconfigurationComplete* message via SRB1 to lower layers for transmission using the new configuration;

[TS 38.331, clause 12]

The UE performance requirements for RRC procedures are specified in the following tables. The performance requirement is expressed as the time in [ms] from the end of reception of the network -> UE message on the UE physical layer up to when the UE shall be ready for the reception of uplink grant for the UE -> network response message with no access delay other than the TTI-alignment (e.g. excluding delays caused by scheduling, the random access procedure or physical layer synchronisation). In case the RRC procedure triggers BWP switching, the RRC procedure delay is the value defined in the following table plus the BWP switching delay defined in TS 38.133 [14], clause 8.6.3.

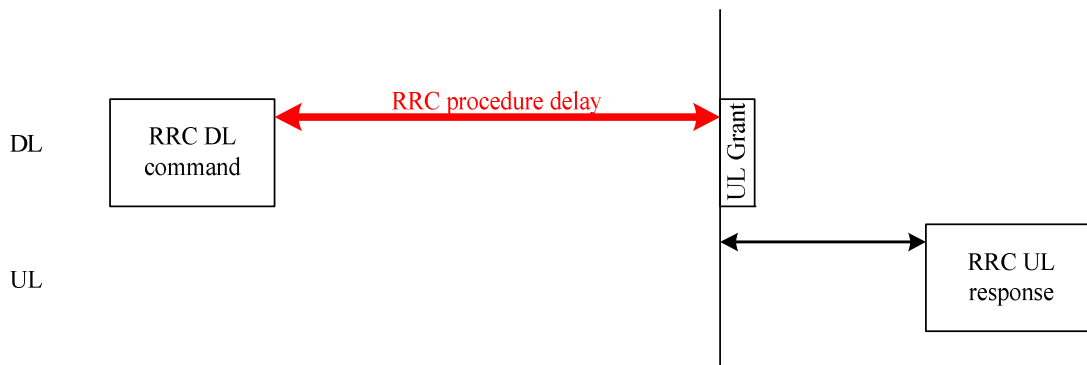

Figure 12.1-1: Illustration of RRC procedure delay

Table 12.1-1: UE performance requirements for RRC procedures for UEs

Procedure title:	Network -> UE	UE -> Network	Value [ms]	Notes
RRC Connection Control Procedures				
RRC reconfiguration (SCG establishment/ modification/ release)	<i>RRCReconfiguration</i>	<i>RRCReconfigurationComplete</i>	16	

Procedure title:	Network -> UE	UE -> Network	Value [ms]	Notes
RRC resume	<i>RRCResume</i>	<i>RRCResumeComplete</i>	6 or 10	Value=6 applies for a UE supporting reduced CP latency for the case of RRCResume message only including MAC and PHY configuration, reestablishPDCP and reestablishRLC for SRB2 and DRB(s), and no DRX, SPS, configured grant, CA or MIMO re-configuration will be triggered by this message. Further, the UL grant for transmission of RRCResumeComplete and the data is transmitted over common search space with DCI format 0_0. In this scenario, the RRC procedure delay [ms] can extend beyond the reception of the UL grant, up to 7 ms. For other cases, Value = 10 applies.

8.2.6.2.2.3 Test description

8.2.6.2.2.3.1 Pre-test conditions

System Simulator:

- NR Cell 1 is the PCell and NR Cell 10 is the PSCell.
- System information combination NR-1 as defined in TS 38.508-1 [4] clause 4.4.3.1.3 is used in NR cells.

UE:

- None.

Preamble:

- The UE is in state NR RRC_CONNECTED using generic procedure parameter Connectivity (NR), according to TS 38.508-1 [4], clause 4.5.4.

8.2.6.2.2.3.2 Test procedure sequence

Table 8.2.6.2.2.3.2-1: Main behaviour

St	Procedure	Message Sequence		TP	Verdict
		U - S	Message		
1	SS stops default uplink grant transmission.	-	-	-	-

2	The SS transmits an <i>RRCReconfiguration</i> message and a PDU SESSION MODIFICATION COMMAND to add <i>NR PSCell</i> with SCG DRB.	<--	NR RRC: <i>RRCReconfiguration</i> 5GMM: DL NAS TRANSPORT 5GSM: PDU SESSION MODIFICATION COMMAND	-	-
3	The SS starts transmitting a periodic DCI ($16 \cdot 2^\mu + 1 + \text{TDL}$) slots after step 2 to schedule PUSCH. (Note 1, Note 2)	-	-	-	-
4	Check: Does the UE transmit an <i>RRCReconfigurationComplete</i> message within ($16 \cdot 2^\mu + 1 + \text{TDL} + \text{K}_2$) slots after successful completion of step 2? (Note 1, Note 2, Note 3)	-->	<i>RRCReconfigurationComplete</i>	1	P
5	The UE transmits a <i>ULInformationTransfer</i> message and an PDU SESSION MODIFICATION COMPLETE message.	-->	NR RRC: <i>ULInformationTransfer</i> 5GMM: UL NAS TRANSPORT 5GSM: PDU SESSION MODIFICATION COMPLETE	-	-
-	EXCEPTION: Steps 6a1 to 6a7 describe behaviour that depends on UE capability; the "lower case letter" identifies a step sequence that takes place if a capability is supported	-	-	-	-
6a1	IF <i>pc_inactiveState</i> THEN the SS transmits an <i>RRCRelease</i> message with <i>suspendConfig</i> .	<--	NR RRC: <i>RRCRelease</i>	-	-
6a2	Wait 1s to let UE enter RRC_INACTIVE state.	-	-	-	-
6a3	The SS transmits a <i>Paging</i> message including a matched ng-5G-S-TMSI.	<--	NR RRC: <i>Paging</i>	-	-
6a4	The UE transmits an <i>RRCResumeRequest</i> message.	-->	NR RRC: <i>RRCResumeRequest</i>	-	-
6a5	The SS transmits an <i>RRCResume</i> message for the UE	<--	NR RRC: <i>RRCResume</i>	-	-
6a6	The SS starts transmitting a periodic DCI from ($10 \cdot 2^\mu + 1 + \text{T}_{\text{DL}}$) slots after step 6a5 to schedule PUSCH. (Note 1, Note 2)	-	-	-	-
6a7	Check: Does the UE transmit an <i>RRCResumeComplete</i> message within ($10 \cdot 2^\mu + 1 + \text{T}_{\text{DL}} + \text{K}_2$) slots after successful completion of step 6a5? (Note 1, Note 2, Note 3)	-->	NR RRC: <i>RRCResumeComplete</i>	2	P
<p>Note 1: TDL is the delay in slots to the next available DL slot suitable for the transmission of a DCI. Note 2: μ is the SCS index. $\mu = 0/1/2/3$ for SCS = 15kHz/30kHz/60kHz/120kHz respectively. Note 3: K2 is the offset (in slots) between DCI and the PUSCH it scheduled.</p>					

8.2.6.2.2.3.3 Specific message contents

Table 8.2.6.2.2.3.3-1: *RRCReconfiguration* (step 2, Table 8.2.6.2.2.3.2-1)

Derivation Path: TS 38.508-1 [4], Table 4.6.1-13 with condition NR-DC

Table 8.2.6.2.2.3.3-2: PDU SESSION MODIFICATION COMMAND (step 2, Table 8.2.6.2.2.3.2-1)

Derivation Path: TS 38.508-1 [4], Table 4.7.2-9.			
Information Element	Value/remark	Comment	Condition
PDU session ID	The same as the PDU session ID in PDU SESSION ESTABLISHMENT REQUEST associated with the Internet PDU session if available or with the first PDU session		
Authorized QoS rules	One entry		
QoS rule [1]	Reference QoS rule #5 as defined in TS 38.508-1 [4], Table 4.8.2.1-5.	QFI=5	

Authorized QoS flow descriptions	One entry		
QoS flow [1]	Reference QoS flow #5 as defined in TS 38.508-1 [4], Table 4.8.2.3-5.	QFI=5	

Table 8.2.6.2.2.3.3-3: RRCReconfigurationComplete (step 5, Table 8.2.6.2.2.3.2-1)

Derivation Path: TS 38.508 [4], Table 4.6.1-14 with condition NR-DC

Table 8.2.6.2.2.3.3-4: Paging (step 1, Table 8.2.6.2.2.3.2-1)

Derivation Path: TS 38.508-1 [4], Table 4.6.1-9 with condition NR_RRC_RESUME
--

Table 8.2.6.2.2.3.3-5: RRCResume (step 6a5, Table 8.2.6.2.2.3.2-1)

Derivation Path: TS 38.508-1 [4], Table 4.6.1-17			
Information Element	Value/remark	Comment	Condition
RRCResume ::= SEQUENCE {			
rrc-TransactionIdentifier	RRC-TransactionIdentifier		
criticalExtensions CHOICE {			
rrcResume SEQUENCE {			
nonCriticalExtension SEQUENCE {			
radioBearerConfig2	RadioBearerConfig according to Table 8.2.6.3.2.3.3-7		
sk-Counter	0		
nonCriticalExtension SEQUENCE{			
idleModeMeasurementReq-r16	Not Present		
restoreMCG-SCells-r16	Not Present		
restoreSCG-r16	True		
mrdc-SecondaryCellGroup-r16 CHOICE{			
nr-SCG-r16	According to TS 38.508-1[4], Table 4.6.1-13 with condition NR-DC_SCG		
eutra-SCG-r16	Not Present		
}			
needForGapsConfigNR-r16	Not Present		
}			
}			
}			
}			

Table 8.2.6.3.2.3.3-6: RRCResumeComplete (step 6a7, Table 8.2.6.2.2.3.2-1)

Derivation Path: TS 38.508-1 [4], Table 4.6.1-18			
Information Element	Value/remark	Comment	Condition
RRCResumeComplete ::= SEQUENCE {			
rrc-TransactionIdentifier	RRC-TransactionIdentifier		
criticalExtensions CHOICE {			
rrcResumeComplete SEQUENCE {			
nonCriticalExtension SEQUENCE {			
nonCriticalExtension SEQUENCE {			
idleMeasAvailable-r16	Not Present		
measResultIdleEUTRA-r16	Not Present		
measResultIdleNR-r16	Not Present		
scg-Response-r16 CHOICE{			
nr-SCG-Response	RRCReconfigurationComplete defined as per TS		
}			
}			
}			
}			

	38.508-1[4] Table 4.6.1-14 with condition NR-DC		
euTra-SCG-Response	Not Present		
}			
ue-MeasurementsAvailable-r16	Not Present		
mobilityHistoryAvail-r16	Not Present		
mobilityState-r16	Not Present		
needForGapsInfoNR-r16	Not Present		
nonCriticalExtension	Not Present		
}			
}			
}			
}			

Table 8.2.6.3.2.3.3-7: RadioBearerConfig (Table 8.2.6.2.2.3.3-5)

Derivation Path: TS 38.508 [4], Table 4.6.3-132 with condition DRBn and SecondaryKeys			
Information Element	Value/remark	Comment	Condition
RadioBearerConfig ::= SEQUENCE {			
drb-ToAddModList SEQUENCE (SIZE (1..maxDRB))	1 entry		
OF DRB-ToAddMod {			
DRB-ToAddMod SEQUENCE {			
cnAssociation	Not present		
drb-Identity	DRB-Identity using condition DRBn	n set to the SCG DRB identity	
reestablishPDCP	True		
recoverPDCP	Not present		
pdcp-Config	Not present		
daps-Config-r16	Not present		
}			
}			
}			

8.2.6.3 Idle/Inactive measurements

8.2.6.3.3 Idle/Inactive measurements / Inactive mode / NE-DC / SIB11 configuration

8.2.6.3.3.1 Test Purpose (TP)

(1)

```
with { UE in NR RRC_CONNECTED state }
ensure that {
  when { UE receives a RRCRelease message including measIdleConfig and suspendConfig, SIB11
including measIdleCarrierListEUTRA }
  then { UE enters RRC_INACTIVE state, performs measurements on E-UTRA cells and reports
measurement results in RRC_CONNECTED state }
}
```

(2)

```
with { UE in NR RRC_CONNECTED state }
ensure that {
  when { UE receives a RRCRelease message including measIdleConfig, SIB11 including
measIdleCarrierListEUTRA, T331 expires }
  then { UE enters RRC_INACTIVE state, UE does not report measurement results in RRC_CONNECTED
state after T331 expiration }
}
```

(3)

```
with { UE in NR RRC_CONNECTED state }
ensure that {
```

```

when { UE receives a RRCRelease message including measIdleConfig and suspendConfig, SIB11 does not
include measIdleCarrierListEUTRA }
  then { UE enters RRC_INACTIVE state, UE does not report measurement results in RRC_CONNECTED
state due to missing configuration }
}

```

8.2.6.3.3.2 Conformance requirements

References: The conformance requirements covered in the current TC is specified in: TS 38.331 clauses 5.3.8.3, 5.7.8.3, 5.7.8.1a and 5.7.8.2a. Unless otherwise stated, these are Rel-16 requirements.

[TS 38.331, clause 5.3.8.3]

- 1> if the *RRCRelease* includes the *measIdleConfig*:
 - 2> if T331 is running:
 - 3> stop timer T331;
 - 3> perform the actions as specified in 5.7.8.3;
 - 2> if the *measIdleConfig* is set to *setup*:
 - 3> store the received *measIdleDuration* in *VarMeasIdleConfig*;
 - 3> start timer T331 with the value set to *measIdleDuration*;
 - 3> if the *measIdleConfig* contains *measIdleCarrierListEUTRA*:
 - 4> store the received *measIdleCarrierListEUTRA* in *VarMeasIdleConfig*;

[TS 38.331, clause 5.7.8.3]

- 1> if T331 expires or is stopped:
 - 2> release the *VarMeasIdleConfig*.

NOTE: It is up to UE implementation whether to continue idle/inactive measurements according to SIB11 and SIB4 configurations or according to E-UTRA SIB5 and E-UTRA SIB24 configurations as specified in TS 36.331 [10] upon inter-RAT cell reselection to E-UTRA, after T331 has expired or stopped.

[TS 38.331, clause 5.7.8.1a]

While in *RRC_IDLE* or *RRC_INACTIVE*, and T331 is running, the UE shall:

- 1> if *VarMeasIdleConfig* includes neither a *measIdleCarrierListEUTRA* nor a *measIdleCarrierListNR* received from the *RRCRelease* message:
 - 2> if the UE supports *idleInactiveEUTRA-MeasReport*:
 - 3> if the SIB11 includes the *measIdleConfigSIB* and contains *measIdleCarrierListEUTRA*:
 - 4> store or replace the *measIdleCarrierListEUTRA* of *measIdleConfigSIB* of SIB11 within *VarMeasIdleConfig*;
 - 3> else:
 - 4> remove the *measIdleCarrierListEUTRA* in *VarMeasIdleConfig*, if stored;
- 1> perform measurements according to 5.7.8.2a.

[TS 38.331, clause 5.7.8.2a]

While in *RRC_IDLE* or *RRC_INACTIVE*, and T331 is running, the UE shall:

- 1> perform the measurements in accordance with the following:

- 2> if the *VarMeasIdleConfig* includes the *measIdleCarrierListEUTRA* and the *SIB1* contains *idleModeMeasurementsEUTRA*:
- 3> for each entry in *measIdleCarrierListEUTRA* within *VarMeasIdleConfig*:
- 4> if UE supports NE-DC between the serving carrier and the carrier frequency indicated by *carrierFreqEUTRA* within the corresponding entry:
- 5> perform measurements in the carrier frequency and bandwidth indicated by *carrierFreqEUTRA* and *allowedMeasBandwidth* within the corresponding entry;
- 5> if the *reportQuantitiesEUTRA* is set to *rsrq*:
- 6> consider RSRQ as the sorting quantity;
- 5> else:
- 6> consider RSRP as the sorting quantity;
- 5> if the *measCellListEUTRA* is included:
- 6> consider cells identified by each entry within the *measCellListEUTRA* to be applicable for idle/inactive mode measurement reporting;
- 5> else:
- 6> consider up to *maxCellMeasIdle* strongest identified cells, according to the sorting quantity, to be applicable for idle/inactive measurement reporting;
- 5> for all cells applicable for idle/inactive measurement reporting, derive measurement results for the measurement quantities indicated by *reportQuantitiesEUTRA*;
- 5> store the derived measurement results as indicated by *reportQuantitiesEUTRA* within the *measReportIdleEUTRA* in *VarMeasIdleReport* in decreasing order of the sorting quantity, i.e. the best cell is included first, as follows:
- 6> if *qualityThresholdEUTRA* is configured:
- 7> include the measurement results from the cells applicable for idle/inactive measurement reporting whose RSRP/RSRQ measurement results are above the value(s) provided in *qualityThresholdEUTRA*;
- 6> else:
- 7> include the measurement results from all cells applicable for idle/inactive measurement reporting;
- 2> if, as a result of the procedure in this subclause, the UE performs measurements in one or more carrier frequency indicated by *measIdleCarrierListNR* or *measIdleCarrierListEUTRA*:
- 3> store the cell measurement results for RSRP and RSRQ for the serving cell within *measResultServingCell* in the *measReportIdleNR* in *VarMeasIdleReport*.

NOTE 1: How the UE performs idle/inactive measurements is up to UE implementation as long as the requirements in TS 38.133 [14] are met for measurement reporting.

NOTE 2: The UE is not required to perform idle/inactive measurements on a given carrier if the SSB configuration of that carrier provided via dedicated signalling is different from the SSB configuration broadcasted in the serving cell, if any.

NOTE 3: How the UE prioritizes which frequencies to measure or report (in case it is configured with more frequencies than it can measure or report) is left to UE implementation.

8.2.6.3.3.3 Test Description

8.2.6.3.3.3.1 Pre-test conditions

System Simulator:

- NR Cell 1, serving cell. System information combination NR-7 defined in TS 38.508-1 [4] clause 4.4.3.1.2 is used together with SIB 11.
- E-UTRA Cell 1, suitable for inter-frequency measurements. System information combination 31 as defined in 36.508 [7] clause 4.4.3.1.1.

UE:

- None.

Preamble:

- The UE is in 5GS state 3N-A according to TS 38.508-1 [4], clause 4.4A.2 Table 4.4A.2-1.

8.2.6.3.3.3.2 Test procedure sequence

Table 8.2.6.3.3.3.2-1: Main behaviour

St	Procedure	Message Sequence		TP	Verdict
		U - S	Message		
1	The SS transmits <i>RRCRelease</i> message including <i>measIdleConfig</i> and <i>suspendConfig</i> to the UE.	<--	NR RRC: <i>RRCRelease</i>	-	-
2	Wait for 66 s for UE to enter RRC_INACTIVE mode and to perform measurements.	-	-	-	-
3	SS transmits <i>Paging</i> message to UE.	<--	NR RRC: <i>Paging</i>	-	-
4	UE transmits <i>RRCResumeRequest</i> message to SS.	-->	NR RRC: <i>RRCResumeRequest</i>	-	-
5	SS transmits <i>RRCResume</i> message to UE.	<--	NR RRC: <i>RRCResume</i>	-	-
6	UE transmits <i>RRCResumeComplete</i> message to SS.		NR RRC: <i>RRCResumeComplete</i>	-	-
7	The SS transmits <i>UEInformationRequest</i> message including <i>idleModeMeasurementReq</i> to the UE.	<--	NR RRC: <i>UEInformationRequest</i>	-	-
8	Check: Does the UE transmit <i>UEInformationResponse</i> including <i>measResultIdleEutra</i> ?	-->	NR RRC: <i>UEInformationResponse</i>	1	P
9	The SS transmits <i>RRCRelease</i> message including <i>measIdleConfig</i> and <i>suspendConfig</i> to the UE.	<--	NR RRC: <i>RRCRelease</i>	-	-
10	Wait for 130 s for UE to enter RRC_INACTIVE mode and T331 to expire.	-	-	-	-
11	SS transmits <i>Paging</i> message to UE.	<--	NR RRC: <i>Paging</i>	-	-
12	UE transmits <i>RRCResumeRequest</i> message to SS.	-->	NR RRC: <i>RRCResumeRequest</i>	-	-
13	SS transmits <i>RRCResume</i> message to UE.	<--	NR RRC: <i>RRCResume</i>	-	-
14	UE transmits <i>RRCResumeComplete</i> message to SS.		NR RRC: <i>RRCResumeComplete</i>	-	-
15	The SS transmits <i>UEInformationRequest</i> message including <i>idleModeMeasurementReq</i> to the UE.	<--	NR RRC: <i>UEInformationRequest</i>	-	-
16	Check: Does the UE transmit <i>UEInformationResponse</i> without <i>measResultIdleEUTRA</i> ?	-->	NR RRC: <i>UEInformationResponse</i>	2	P
17	The SS removes <i>measIdleCarrierListEUTRA</i> in SIB11.	-	-	-	-

18	The SS transmits a Short message on PDCCH using P-RNTI indicating a <i>systemInfoModification</i> .	-	PDCCH (DCI 1_0): Short Message	-	-
19	Wait for 2.1* modification period to allow the new system information to take effect.	-	-	-	-
20	The SS transmits <i>RRCRelease</i> message including <i>measIdleConfig</i> and <i>suspendConfig</i> to the UE.	<--	NR RRC: <i>RRCRelease</i>	-	-
21	Wait for 66 s for UE to enter RRC_INACTIVE mode and to perform measurements.	-	-	-	-
22	SS transmits <i>Paging</i> message to UE.	<--	NR RRC: <i>Paging</i>	-	-
23	UE transmits <i>RRCResumeRequest</i> message to SS.	-->	NR RRC: <i>RRCResumeRequest</i>	-	-
24	SS transmits <i>RRCResume</i> message to UE.	<--	NR RRC: <i>RRCResume</i>	-	-
25	UE transmits <i>RRCResumeComplete</i> message to SS.		NR RRC: <i>RRCResumeComplete</i>	-	-
26	The SS transmits <i>UEInformationRequest</i> message including <i>idleModeMeasurementReq</i> to the UE.	<--	NR RRC: <i>UEInformationRequest</i>	-	-
27	Check: Does the UE transmit <i>UEInformationResponse</i> without <i>measResultIdleEUTRA</i> ?	-->	NR RRC: <i>UEInformationResponse</i>	3	P

8.2.6.3.3.3.3 Specific message contents

Table 8.2.6.3.3.3-1: *RRCRelease* (steps 1, 13 and 28, Table 8.2.6.3.3.2-1)

Derivation Path: TS 38.508-1 [4], clause 4.6.1 table 4.6.1-16			
Information Element	Value/remark	Comment	Condition
<i>RRCRelease</i> ::= SEQUENCE {			
<i>rrc-TransactionIdentifier</i>	RRC-TransactionIdentifier		
criticalExtensions CHOICE {			
<i>rrcRelease</i> SEQUENCE {			
<i>suspendConfig</i>	SuspendConfig		
nonCriticalExtensions SEQUENCE {			
nonCriticalExtensions SEQUENCE {			
<i>measIdleConfig-r16</i> SetupRelease {			
setup	MeasIdleConfigDedicated		
}			
}			
}			
}			
}			
}			

Table 8.2.6.3.3.3-2: *SuspendConfig* (Table 8.2.6.3.3.3-1)

Derivation Path: TS 38.331 [12], clause 6.2.2			
Information Element	Value/remark	Comment	Condition
<i>SuspendConfig</i> ::= SEQUENCE {			
fullI-RNTI	I-RNTI-Value	38.508-1[4] Table 4.6.3-64	
shortI-RNTI	ShortI-RNTI-Value	38.508-1[4] Table 4.6.3-170	
<i>ran-PagingCycle</i>	rf32		
<i>ran-NotificationAreaInfo</i> CHOICE {			
cellList SEQUENCE (SIZE (1..maxPLMNIdentities)) OF PLMN-RAN-AreaCell {	2 entries		
PLMN-RAN-AreaCell[1] SEQUENCE {		entry 1	
plmn-Identity	PLMN1		

ran-AreaCells SEQUENCE (SIZE (1..32)) OF CellIdentity {	1 entry		
CellIdentity[1]	CellIdentity of NR Cell 1	entry 1	
}			
PLMN-RAN-AreaCell[2] SEQUENCE {		entry 2	
plmn-Identity	PLMN2		
ran-AreaCells SEQUENCE (SIZE (1..32)) OF CellIdentity {	1 entry		
CellIdentity[1]	CellIdentity of E-UTRA Cell 1	entry 1	
}			
}			
}			
t380	Not Present		
nextHopChainingCount	NextHopChainingCount	38.508-1[4] Table 4.6.3-83	
}			

Table 8.2.6.3.3.3-3: MeasIdleConfigDedicated (Table 8.2.6.3.3.3-1)

Derivation Path: TS 38.331 [12], clause 6.3.2			
Information Element	Value/remark	Comment	Condition
MeasIdleConfigDedicated-r16 ::= SEQUENCE {			
measIdleCarrierListNR-r16	Not Present		
measIdleCarrierListEUTRA-r16	Not Present		
measIdleDuration-r16	sec120		
validityAreaList-r16	Not Present		
}			

Table 8.2.6.3.3.3-4: RRCResumeRequest (Table 8.2.6.3.3.3-1)

Derivation Path: TS 38.508 [4], clause 4.6.1 table 4.6.1-19

Table 8.2.6.3.3.3-5: RRCResume (Table 8.2.6.3.3.3-1)

Derivation Path: TS 38.508 [4], clause 4.6.1 table 4.6.1-17

Table 8.2.6.3.3.3-6: RRCResumeComplete (Table 8.2.6.3.3.3-1)

Derivation Path: TS 38.508 [4], clause 4.6.1 table 4.6.1-18

Table 8.2.6.3.3.3-7: SIB11 (Table 8.2.6.3.3.3-1, steps 1 to 16)

Derivation Path: TS 38.331 [12], clause 6.3.1			
Information Element	Value/remark	Comment	Condition
SIB11-r16 ::= SEQUENCE {			
measIdleConfigSIB-r16 SEQUENCE {			
measIdleCarrierListNR-r16	Not Present		
measIdleCarrierListEUTRA-r16 SEQUENCE (SIZE (1..maxFreqIdle-r16)) OF MeasIdleCarrierEUTRA-r16 {	1 entry		
MeasIdleCarrierEUTRA-r16[1] SEQUENCE {		entry 1	
carrierFreqEUTRA-r16	ARFCN value corresponding to E-UTRA cell 1		
allowedMeasBandwidth-r16	mbw50		

measCellListEUTRA-r16 SEQUENCE (SIZE (1..maxCellMeasIdle-r16)) OF EUTRA-PhysCellIdRange {	1 entry		
EUTRA-PhysCellIdRange[1] SEQUENCE {		entry 1	
start	EUTRA-PhysCellId corresponding to E-UTRA cell 1		
}			
}			
reportQuantitiesEUTRA-r16	both		
qualityThresholdEUTRA-r16	Not Present		
}			
}			
}			
}			

Table 8.2.6.3.3.3-8: SIB11 (Table 8.2.6.3.3.3-1, steps 17 to 27)

Derivation Path: TS 38.331 [12], clause 6.3.1			
Information Element	Value/remark	Comment	Condition
SIB11-r16 ::= SEQUENCE {			
measIdleConfigSIB-r16 SEQUENCE {			
measIdleCarrierListNR-r16	Not Present		
measIdleCarrierListEUTRA-r16	Not Present		
}			
}			

Table 8.2.6.3.3.3-9: UEInformationRequest (Table 8.2.6.3.3.3-1)

Derivation Path: TS 38.508-1 [4], clause 4.6.1 table 4.6.1-32A with condition IDLE
--

Table 8.2.6.3.3.3-10: UEInformationResponse (Table 8.2.6.3.3.3-1)

Derivation Path: TS 38.508-1 [4], clause 4.6.1 table 4.6.1-32B			
Information Element	Value/remark	Comment	Condition
UEInformationResponse-r16 ::= SEQUENCE {			
criticalExtensions CHOICE {			
ueInformationResponse-r16 SEQUENCE {			
measResultIdleEUTRA-r16 SEQUENCE {			
measResultsPerCarrierListIdleEUTRA-r16 SEQUENCE (SIZE (1.. maxFreqIdle-r16)) OF MeasResultsPerCarrierIdleEUTRA-r16 {	1 entry		
MeasResultsPerCarrierIdleEUTRA-r16[1] SEQUENCE {		entry 1	
carrierFreqEUTRA-r16	ARFCN value corresponding to E-UTRA cell 1		
measResultsPerCellListIdleEUTRA-r16 SEQUENCE (SIZE (1..maxCellMeasIdle-r16)) OF MeasResultsPerCellIdleEUTRA-r16 {	1 entry		
MeasResultsPerCellIdleEUTRA-r16[1] SEQUENCE {		entry 1	
eutra-PhysCellId-r16	EUTRA-PhysCellId corresponding to E-UTRA cell 1		
measIdleResultEUTRA-r16 SEQUENCE {			
rsrp-ResultEUTRA-r16	INTEGER (0..97)		
rsrq-ResultEUTRA-r16	INTEGER (0..34)		
}			
}			
}			
}			

}			
}			
}			
}			

8.2.6.3.4 Idle/Inactive measurements / Inactive mode / NE-DC / RRCRelease configuration

8.2.6.3.4.1 Test Purpose (TP)

(1)

```
with { UE in NR RRC_CONNECTED state }
ensure that {
  when { UE receives a RRCRelease message including suspendConfig and measIdleConfig with
measIdleCarrierListEUTRA }
  then { UE enters RRC_INACTIVE state, performs measurements on E-UTRA cells and reports
measurement results in RRC_CONNECTED state }
}
```

(2)

```
with { UE in NR RRC_CONNECTED state }
ensure that {
  when { UE receives a RRCRelease message including suspendConfig and measIdleConfig with
measIdleCarrierListEUTRA, T331 expires }
  then { UE enters RRC_INACTIVE state, UE does not report measurement results in RRC_CONNECTED
state after T331 expiration }
}
```

(3)

```
with { UE in NR RRC_CONNECTED state }
ensure that {
  when { UE receives a RRCRelease message including suspendConfig and measIdleConfig without
measIdleCarrierListEUTRA }
  then { UE enters RRC_INACTIVE state, UE does not report measurement results in RRC_CONNECTED
state due to missing configuration }
}
```

8.2.6.3.4.2 Conformance requirements

References: The conformance requirements covered in the current TC is specified in: TS 38.331 clauses 5.3.8.3, 5.7.8.1, 5.7.8.1a, 5.7.8.2a, 5.7.8.3 and 5.7.10.3. Unless otherwise stated, these are Rel-16 requirements.

[TS 38.331, clause 5.3.8.3]

The UE shall:

- 1> if the *RRCRelease* includes the *measIdleConfig*:
 - 2> if T331 is running:
 - 3> stop timer T331;
 - 3> perform the actions as specified in 5.7.8.3;
 - 2> if the *measIdleConfig* is set to *setup*:
 - 3> store the received *measIdleDuration* in *VarMeasIdleConfig*;
 - 3> start timer T331 with the value set to *measIdleDuration*;
 - 3> if the *measIdleConfig* contains *measIdleCarrierListEUTRA*:
 - 4> store the received *measIdleCarrierListEUTRA* in *VarMeasIdleConfig*;

[TS 38.331, clause 5.7.8.1]

This procedure specifies the measurements to be performed and stored by a UE in RRC_IDLE and RRC_INACTIVE when it has an idle/inactive measurement configuration.

[TS 38.331, clause 5.7.8.1a]

The purpose of this procedure is to update the idle/inactive measurement configuration.

The UE initiates this procedure while T331 is running and one of the following conditions is met:

- 1> upon selecting a cell when entering RRC_IDLE or RRC-INACTIVE from RRC_CONNECTED or RRC_INACTIVE; or
- 1> upon update of system information (*SIB4*, or *SIB11*), e.g. due to intra-RAT cell (re)selection;

While in RRC_IDLE or RRC_INACTIVE, and T331 is running, the UE shall:

- 1> perform measurements according to 5.7.8.2a.

[TS 38.331, clause 5.7.8.2a]

When performing measurements on NR carriers according to this clause, the UE shall derive the cell quality as specified in 5.5.3.3 and consider the beam quality to be the value of the measurement results of the concerned beam, where each result is averaged as described in TS 38.215 [9].

While in RRC_IDLE or RRC_INACTIVE, and T331 is running, the UE shall:

- 1> perform the measurements in accordance with the following:
 - 2> if the *VarMeasIdleConfig* includes the *measIdleCarrierListEUTRA* and the *SIB1* contains *idleModeMeasurementsEUTRA*:
 - 3> for each entry in *measIdleCarrierListEUTRA* within *VarMeasIdleConfig*:
 - 4> if UE supports NE-DC between the serving carrier and the carrier frequency indicated by *carrierFreqEUTRA* within the corresponding entry:
 - 5> perform measurements in the carrier frequency and bandwidth indicated by *carrierFreqEUTRA* and *allowedMeasBandwidth* within the corresponding entry;
 - 5> if the *reportQuantitiesEUTRA* is set to *rsrq*:
 - 6> consider RSRQ as the sorting quantity;
 - 5> else:
 - 6> consider RSRP as the sorting quantity;
 - 5> if the *measCellListEUTRA* is included:
 - 6> consider cells identified by each entry within the *measCellListEUTRA* to be applicable for idle/inactive mode measurement reporting;
 - 5> else:
 - 6> consider up to *maxCellMeasIdle* strongest identified cells, according to the sorting quantity, to be applicable for idle/inactive measurement reporting;
 - 5> for all cells applicable for idle/inactive measurement reporting, derive measurement results for the measurement quantities indicated by *reportQuantitiesEUTRA*;
 - 5> store the derived measurement results as indicated by *reportQuantitiesEUTRA* within the *measReportIdleEUTRA* in *VarMeasIdleReport* in decreasing order of the sorting quantity, i.e. the best cell is included first, as follows:
 - 6> if *qualityThresholdEUTRA* is configured:

7> include the measurement results from the cells applicable for idle/inactive measurement reporting whose RSRP/RSRQ measurement results are above the value(s) provided in *qualityThresholdEUTRA*;

6> else:

7> include the measurement results from all cells applicable for idle/inactive measurement reporting;

2> if, as a result of the procedure in this subclause, the UE performs measurements in one or more carrier frequency indicated by *measIdleCarrierListNR* or *measIdleCarrierListEUTRA*:

3> store the cell measurement results for RSRP and RSRQ for the serving cell within *measResultServingCell* in the *measReportIdleNR* in *VarMeasIdleReport*.

NOTE 1: How the UE performs idle/inactive measurements is up to UE implementation as long as the requirements in TS 38.133 [14] are met for measurement reporting.

NOTE 2: The UE is not required to perform idle/inactive measurements on a given carrier if the SSB configuration of that carrier provided via dedicated signalling is different from the SSB configuration broadcasted in the serving cell, if any.

NOTE 3: How the UE prioritizes which frequencies to measure or report (in case it is configured with more frequencies than it can measure or report) is left to UE implementation.

[TS 38.331, clause 5.7.8.3]

The UE shall:

1> if T331 expires or is stopped:

2> release the *VarMeasIdleConfig*.

NOTE: It is up to UE implementation whether to continue idle/inactive measurements according to SIB11 and SIB4 configurations or according to E-UTRA SIB5 and E-UTRA SIB24 configurations as specified in TS 36.331 [10] upon inter-RAT cell reselection to E-UTRA, after T331 has expired or stopped.

[TS 38.331, clause 5.7.10.3]

Upon receiving the *UEInformationRequest* message, the UE shall, only after successful security activation:

1> if the *idleModeMeasurementReq* is included in the *UEInformationRequest* and the UE has stored *VarMeasIdleReport* that contains measurement information concerning cells other than the PCell:

2> set the *measResultIdleEUTRA* in the *UEInformationResponse* message to the value of *measReportIdleEUTRA* in the *VarMeasIdleReport*, if available;

2> discard the *VarMeasIdleReport* upon successful delivery of the *UEInformationResponse* message confirmed by lower layers;

8.2.6.3.4.3 Test Description

8.2.6.3.4.3.1 Pre-test conditions

System Simulator:

- NR Cell 1, serving cell. System information combination NR-7 defined in TS 38.508-1 [4] clause 4.4.3.1.2.
- E-UTRA Cell 1, suitable for inter-frequency measurements. System information combination 31 as defined in 36.508 [7] clause 4.4.3.1.1.

UE:

- None.

Preamble:

- The UE is in 5GS state 3N-A according to TS 38.508-1 [4], clause 4.4A.2 Table 4.4A.2-1.

8.2.6.3.4.3.2 Test procedure sequence

Table 8.2.6.3.4.3.2-1: Main behaviour

St	Procedure	Message Sequence		TP	Verdict
		U - S	Message		
1	The SS transmits <i>RRCRelease</i> message including <i>suspendConfig</i> and <i>measIdleConfig</i> to the UE.	<-	NR RRC: <i>RRCRelease</i>	-	-
2	Wait for 66 s for UE to enter RRC_INACTIVE mode and to perform measurements.	-	-	-	-
3	SS transmits <i>Paging</i> message to UE.	<--	NR RRC: <i>Paging</i>	-	-
4	UE transmits <i>RRCResumeRequest</i> message to SS.	-->	NR RRC: <i>RRCResumeRequest</i>	-	-
5	SS transmits <i>RRCResume</i> message to UE.	<--	NR RRC: <i>RRCResume</i>	-	-
6	UE transmits <i>RRCResumeComplete</i> message to SS.		NR RRC: <i>RRCResumeComplete</i>	-	-
7	The SS transmits <i>UEInformationRequest</i> message including <i>idleModeMeasurementReq</i> to the UE.	<-	NR RRC: <i>UEInformationRequest</i>	-	-
8	Check: Does the UE transmit <i>UEInformationResponse</i> including <i>measResultIdleEUTRA</i> ?	->	NR RRC: <i>UEInformationResponse</i>	1	P
9	The SS transmits <i>RRCRelease</i> message including <i>suspendConfig</i> and <i>measIdleConfig</i> to the UE.	<-	NR RRC: <i>RRCRelease</i>	-	-
10	Wait for 130 s for UE to enter RRC_INACTIVE mode and T331 to expire.	-	-	-	-
11	SS transmits <i>Paging</i> message to UE.	<--	NR RRC: <i>Paging</i>	-	-
12	UE transmits <i>RRCResumeRequest</i> message to SS.	-->	NR RRC: <i>RRCResumeRequest</i>	-	-
13	SS transmits <i>RRCResume</i> message to UE.	<--	NR RRC: <i>RRCResume</i>	-	-
14	UE transmits <i>RRCResumeComplete</i> message to SS.		NR RRC: <i>RRCResumeComplete</i>	-	-
15	The SS transmits <i>UEInformationRequest</i> message including <i>idleModeMeasurementReq</i> to the UE.	<-	NR RRC: <i>UEInformationRequest</i>	-	-
16	Check: Does the UE transmit <i>UEInformationResponse</i> without <i>measResultIdleEUTRA</i> ?	->	NR RRC: <i>UEInformationResponse</i>	2	P
17	The SS transmits <i>RRCRelease</i> message including <i>suspendConfig</i> and <i>measIdleConfig</i> without <i>measIdleCarrierListEUTRA</i> to the UE.	<-	NR RRC: <i>RRCRelease</i>	-	-
18	Wait for 66 s for UE to enter RRC_INACTIVE mode and to perform measurements.	-	-	-	-
19	SS transmits <i>Paging</i> message to UE.	<--	NR RRC: <i>Paging</i>	-	-
20	UE transmits <i>RRCResumeRequest</i> message to SS.	-->	NR RRC: <i>RRCResumeRequest</i>	-	-
21	SS transmits <i>RRCResume</i> message to UE.	<--	NR RRC: <i>RRCResume</i>	-	-
22	UE transmits <i>RRCResumeComplete</i> message to SS.		NR RRC: <i>RRCResumeComplete</i>	-	-
23	The SS transmits <i>UEInformationRequest</i> message including <i>idleModeMeasurementReq</i> to the UE.	<-	NR RRC: <i>UEInformationRequest</i>	-	-
24	Check: Does the UE transmit <i>UEInformationResponse</i> without <i>measResultIdleEUTRA</i> ?	->	NR RRC: <i>UEInformationResponse</i>	3	P

8.2.6.3.4.3.3 Specific message contents

Table 8.2.6.3.4.3.3-1: RRCRelease (steps 1, 13 and 28, Table 8.2.6.3.4.3.2-1)

Derivation Path: TS 38.508-1 [4], clause 4.6.1 table 4.6.1-16			
Information Element	Value/remark	Comment	Condition
RRCRelease ::= SEQUENCE {			
rrc-TransactionIdentifier	RRC-TransactionIdentifier		
criticalExtensions CHOICE {			
rrcRelease SEQUENCE {			
suspendConfig	SuspendConfig		
nonCriticalExtensions SEQUENCE {			
nonCriticalExtensions SEQUENCE {			
measIdleConfig-r16 SetupRelease {			
setup	MeasIdleConfigDedicated		
}			
}			
}			
}			
}			
}			

Table 8.2.6.3.4.3.3-2: SuspendConfig (Table 8.2.6.3.4.3.3-1)

Derivation Path: TS 38.331 [12], clause 6.2.2			
Information Element	Value/remark	Comment	Condition
SuspendConfig ::= SEQUENCE {			
fullI-RNTI	I-RNTI-Value	38.508-1[4] Table 4.6.3-64	
shortI-RNTI	ShortI-RNTI-Value	38.508-1[4] Table 4.6.3-170	
ran-PagingCycle	rf32		
ran-NotificationAreaInfo CHOICE {			
cellList SEQUENCE (SIZE (1..maxPLMNIdentities)) OF PLMN-RAN-AreaCell {	2 entries		
PLMN-RAN-AreaCell[1] SEQUENCE {		entry 1	
plmn-Identity	PLMN1		
ran-AreaCells SEQUENCE (SIZE (1..32)) OF CellIdentity {	1 entry		
CellIdentity[1]	CellIdentity of NR Cell 1	entry 1	
}			
}			
PLMN-RAN-AreaCell[2] SEQUENCE {		entry 2	
plmn-Identity	PLMN2		
ran-AreaCells SEQUENCE (SIZE (1..32)) OF CellIdentity {	1 entry		
CellIdentity[1]	CellIdentity of E-UTRA Cell 1	entry 1	
}			
}			
}			
t380	Not Present		
nextHopChainingCount	NextHopChainingCount	38.508-1[4] Table 4.6.3-83	
}			

Table 8.2.6.3.4.3.3-3: MeasIdleConfigDedicated (Table 8.2.6.3.4.3.3-1, steps 1 and 9)

Derivation Path: TS 38.331 [12], clause 6.3.2			
Information Element	Value/remark	Comment	Condition

MeasIdleConfigDedicated-r16 ::= SEQUENCE {			
measIdleCarrierListNR-r16	Not Present		
measIdleCarrierListEUTRA-r16 SEQUENCE (SIZE (1..maxFreqIdle-r16)) OF MeasIdleCarrierEUTRA-r16 {	1 entry		
MeasIdleCarrierEUTRA-r16[1] SEQUENCE {		entry 1	
carrierFreqEUTRA-r16	ARFCN value corresponding to E-UTRA cell 1		
allowedMeasBandwidth-r16	mbw50		
measCellListEUTRA-r16 SEQUENCE (SIZE (1..maxCellMeasIdle-r16)) OF EUTRA-PhysCellIdRange {	1 entry		
EUTRA-PhysCellIdRange[1] SEQUENCE {		entry 1	
start	EUTRA-PhysCellId corresponding to E-UTRA cell 1		
}			
}			
}			
reportQuatitiesEUTRA-r16	both		
qualityThresholdEUTRA-r16	Not Present		
}			
measIdleDuration-r16	sec120		
validityAreaList-r16	Not Present		
}			

Table 8.2.6.3.4.3.3-4: MeasIdleConfigDedicated (Table 8.2.6.3.4.3.3-1, step 17)

Derivation Path: TS 38.331 [12], clause 6.3.2			
Information Element	Value/remark	Comment	Condition
MeasIdleConfigDedicated-r16 ::= SEQUENCE {			
measIdleCarrierListNR-r16	Not Present		
measIdleCarrierListEUTRA-r16	Not Present		
measIdleDuration-r16	sec120		
validityAreaList-r16	Not Present		
}			

Table 8.2.6.3.4.3.3-5: RRCResumeRequest (Table 8.2.6.3.4.3.3-1)

Derivation Path: TS 38.508 [4], clause 4.6.1 table 4.6.1-19

Table 8.2.6.3.4.3.3-6: RRCResume (Table 8.2.6.3.4.3.3-1)

Derivation Path: TS 38.508 [4], clause 4.6.1 table 4.6.1-17

Table 8.2.6.3.4.3.3-7: RRCResumeComplete (Table 8.2.6.3.4.3.3-1)

Derivation Path: TS 38.508 [4], clause 4.6.1 table 4.6.1-18

Table 8.2.6.3.4.3.3-8: UEInformationRequest (Table 8.2.6.3.4.3.3-1)

Derivation Path: TS 38.508-1 [4], clause 4.6.1 table 4.6.1-32A with condition IDLE
--

Table 8.2.6.3.4.3.3-9: UEInformationResponse (Table 8.2.6.3.4.3.3-1)

Derivation Path: TS 38.508-1 [4], clause 4.6.1 table 4.6.1-32B			
Information Element	Value/remark	Comment	Condition
UEInformationResponse-r16 ::= SEQUENCE {			

criticalExtensions CHOICE {			
ueInformationResponse-r16 SEQUENCE {			
measResultIdleEUTRA-r16 SEQUENCE {			
measResultsPerCarrierListIdleEUTRA-r16 SEQUENCE (SIZE (1..maxFreqIdle-r16)) OF MeasResultsPerCarrierIdleEUTRA-r16 {	1 entry		
MeasResultsPerCarrierIdleEUTRA-r16[1] SEQUENCE {		entry 1	
carrierFreqEUTRA-r16	ARFCN value corresponding to E-UTRA cell 1		
measResultsPerCellListIdleEUTRA-r16 SEQUENCE (SIZE (1..maxCellMeasIdle-r16)) OF MeasResultsPerCellIdleEUTRA-r16 {	1 entry		
MeasResultsPerCellIdleEUTRA-r16[1] SEQUENCE {		entry 1	
eutra-PhysCellId-r16	EUTRA-PhysCellId corresponding to E-UTRA cell 1		
measIdleResultEUTRA-r16 SEQUENCE {			
rsrp-ResultEUTRA-r16	INTEGER (0..97)		
rsrq-ResultEUTRA-r16	INTEGER (0..34)		
}			
}			
}			
}			
}			

8.2.6.3.5 Idle/Inactive measurements / Idle mode / NE-DC / SIB11 configuration

8.2.6.3.5.1 Test Purpose (TP)

(1)

```
with { UE in NR RRC_CONNECTED state }
ensure that {
  when { UE receives a RRCRelease message including measIdleConfig and SIB11 including
measIdleCarrierListEUTRA }
  then { UE enters RRC_IDLE state, performs measurements on E-UTRA cells and reports measurement
results in RRC_CONNECTED state }
}
```

(2)

```
with { UE in NR RRC_CONNECTED state }
ensure that {
  when { UE receives a RRCRelease message including measIdleConfig, SIB11 including
measIdleCarrierListEUTRA, T331 expires }
  then { UE enters RRC_IDLE state, UE does not report measurement results in RRC_CONNECTED state
after T331 expiration }
}
```

(3)

```
with { UE in NR RRC_CONNECTED state }
ensure that {
  when { UE receives a RRCRelease message including measIdleConfig, SIB11 does not include
measIdleCarrierListEUTRA }
  then { UE enters RRC_IDLE state, UE does not report measurement results in RRC_CONNECTED state
due to missing configuration }
}
```

8.2.6.3.5.2 Conformance requirements

References: The conformance requirements covered in the current TC is specified in: TS 38.331 clauses 5.3.8.3, 5.7.8 and 5.7.10.3.

[TS 38.331, clause 5.3.8.3]

The UE shall:

- 1> if the *RRCRelease* includes the *measIdleConfig*:
 - 2> if T331 is running:
 - 3> stop timer T331;
 - 3> perform the actions as specified in 5.7.8.3;
 - 2> if the *measIdleConfig* is set to *setup*:
 - 3> store the received *measIdleDuration* in *VarMeasIdleConfig*;
 - 3> start timer T331 with the value set to *measIdleDuration*;

[TS 38.331, clause 5.7.8.1]

This procedure specifies the measurements to be performed and stored by a UE in RRC_IDLE and RRC_INACTIVE when it has an idle/inactive measurement configuration.

[TS 38.331, clause 5.7.8.1a]

The purpose of this procedure is to update the idle/inactive measurement configuration.

The UE initiates this procedure while T331 is running and one of the following conditions is met:

- 1> upon selecting a cell when entering RRC_IDLE or RRC-INACTIVE from RRC_CONNECTED or RRC_INACTIVE; or
- 1> upon update of system information (*SIB4*, or *SIB11*), e.g. due to intra-RAT cell (re)selection;

While in RRC_IDLE or RRC_INACTIVE, and T331 is running, the UE shall:

- 1> if *VarMeasIdleConfig* includes neither a *measIdleCarrierListEUTRA* nor a *measIdleCarrierListNR* received from the *RRCRelease* message:
 - 2> if the UE supports *idleInactiveEUTRA-MeasReport*:
 - 3> if the SIB11 includes the *measIdleConfigSIB* and contains *measIdleCarrierListEUTRA*:
 - 4> store or replace the *measIdleCarrierListEUTRA* of *measIdleConfigSIB* of SIB11 within *VarMeasIdleConfig*;
 - 3> else:
 - 4> remove the *measIdleCarrierListEUTRA* in *VarMeasIdleConfig*, if stored;

1> perform measurements according to 5.7.8.2a.

[TS 38.331, clause 5.7.8.2a]

When performing measurements on NR carriers according to this clause, the UE shall derive the cell quality as specified in 5.5.3.3 and consider the beam quality to be the value of the measurement results of the concerned beam, where each result is averaged as described in TS 38.215 [9].

While in RRC_IDLE or RRC_INACTIVE, and T331 is running, the UE shall:

- 1> perform the measurements in accordance with the following:

2> if, as a result of the procedure in this subclause, the UE performs measurements in one or more carrier frequency indicated by *measIdleCarrierListNR* or *measIdleCarrierListEUTRA*:

3> store the cell measurement results for RSRP and RSRQ for the serving cell within *measResultServingCell* in the *measReportIdleNR* in *VarMeasIdleReport*.

NOTE 1: How the UE performs idle/inactive measurements is up to UE implementation as long as the requirements in TS 38.133 [14] are met for measurement reporting.

NOTE 2: The UE is not required to perform idle/inactive measurements on a given carrier if the SSB configuration of that carrier provided via dedicated signalling is different from the SSB configuration broadcasted in the serving cell, if any.

NOTE 3: How the UE prioritizes which frequencies to measure or report (in case it is configured with more frequencies than it can measure or report) is left to UE implementation.

[TS 38.331, clause 5.7.8.3]

The UE shall:

1> if T331 expires or is stopped:

2> release the *VarMeasIdleConfig*.

NOTE: It is up to UE implementation whether to continue idle/inactive measurements according to SIB11 and SIB4 configurations or according to E-UTRA SIB5 and E-UTRA SIB24 configurations as specified in TS 36.331 [10] upon inter-RAT cell reselection to E-UTRA, after T331 has expired or stopped.

[TS 38.331, clause 5.7.10.3]

Upon receiving the *UEInformationRequest* message, the UE shall, only after successful security activation:

1> if the *idleModeMeasurementReq* is included in the *UEInformationRequest* and the UE has stored *VarMeasIdleReport* that contains measurement information concerning cells other than the PCell:

2> set the *measResultIdleNR* in the *UEInformationResponse* message to the value of *measReportIdleNR* in the *VarMeasIdleReport*, if available;

8.2.6.3.5.3 Test Description

8.2.6.3.5.3.1 Pre-test conditions

System Simulator:

- NR Cell 1
- E-UTRA Cell 1

UE:

- None.

Preamble:

- The UE is in 5GS state 3N-A according to TS 38.508-1 [4], clause 4.4A.2 Table 4.4A.2-1.

8.2.6.3.5.3.2 Test procedure sequence

Table 8.2.6.3.5.3.2-1: Main behaviour

St	Procedure	Message Sequence		TP	Verdict
		U - S	Message		
1	The SS transmits <i>RRCRelease</i> message including <i>measIdleConfig</i> to the UE.	<-	NR RRC: <i>RRCRelease</i>	-	-

2	Wait for 5 s for UE to enter RRC_IDLE mode and to perform measurements.	-	-	-	-
3-10	Steps 1 to 8 of procedure described in TS 38.508-1 table 4.5.4.2-3: NR RRC_CONNECTED are performed.	-	-	-	-
11	The SS transmits <i>UEInformationRequest</i> message including <i>idleModeMeasurementReq</i> to the UE.	<-	NR RRC: <i>UEInformationRequest</i>	-	-
12	Check: Does the UE transmit <i>UEInformationResponse</i> including <i>measResultIdleNR</i> ?	->	NR RRC: <i>UEInformationResponse</i>	1	P
13	The SS transmits <i>RRCRelease</i> message including <i>measIdleConfig</i> to the UE.	<-	NR RRC: <i>RRCRelease</i>	-	-
14	Wait for 11 s for UE to enter RRC_IDLE mode and T331 to expire.	-	-	-	-
15-22	Steps 1 to 8 of procedure described in TS 38.508-1 table 4.5.4.2-3: NR RRC_CONNECTED are performed.	-	-	-	-
23	The SS transmits <i>UEInformationRequest</i> message including <i>idleModeMeasurementReq</i> to the UE.	<-	NR RRC: <i>UEInformationRequest</i>	-	-
24	Check: Does the UE transmit <i>UEInformationResponse</i> including <i>measResultIdleNR</i> ?	->	NR RRC: <i>UEInformationResponse</i>	2	F
25	The SS removes <i>measIdleCarrierListEUTRA</i> in SIB11.	-	-	-	-
26	The SS transmits a Short message on PDCCH using P-RNTI indicating a <i>systemInfoModification</i> .	-	PDCCH (DCI 1_0): Short Message	-	-
27	Wait for 2.1* modification period to allow the new system information to take effect.	-	-	-	-
28	The SS transmits <i>RRCRelease</i> message including <i>measIdleConfig</i> to the UE.	<-	NR RRC: <i>RRCRelease</i>	-	-
29	Wait for 5 s for UE to enter RRC_IDLE mode and to perform measurements.	-	-	-	-
30-37	Steps 1 to 8 of procedure described in TS 38.508-1 table 4.5.4.2-3: NR RRC_CONNECTED are performed.	-	-	-	-
38	The SS transmits <i>UEInformationRequest</i> message including <i>idleModeMeasurementReq</i> to the UE.	<-	NR RRC: <i>UEInformationRequest</i>	-	-
39	Check: Does the UE transmit <i>UEInformationResponse</i> including <i>measResultIdleNR</i> ?	->	NR RRC: <i>UEInformationResponse</i>	3	F

8.2.6.3.5.3.3 Specific message contents

TBD

8.2.6.3.6 Idle/Inactive measurements / Idle mode / NE-DC / RRCRelease configuration

8.2.6.3.6.1 Test Purpose (TP)

(1)

```
with { UE in NR RRC_CONNECTED state }
ensure that {
  when { UE receives a RRCRelease message including measIdleConfig with measIdleCarrierListEUTRA }
  then { UE enters RRC_IDLE state, performs measurements on E-UTRA cells and reports measurement results in RRC_CONNECTED state }
}
```

(2)

```
with { UE in NR RRC_CONNECTED state }
```

```

ensure that {
  when { UE receives a RRCRelease message including measIdleConfig with measIdleCarrierListEUTRA,
T331 expires }
  then { UE enters RRC_IDLE state, UE does not report measurement results in RRC_CONNECTED state
after T331 expiration }
}

```

(3)

```

with { UE in NR RRC_CONNECTED state }
ensure that {
  when { UE receives a RRCRelease message including measIdleConfig without measIdleCarrierListEUTRA
}
  then { UE enters RRC_IDLE state, UE does not report measurement results in RRC_CONNECTED state
due to missing configuration }
}

```

8.2.6.3.6.2 Conformance requirements

References: The conformance requirements covered in the current TC is specified in: TS 38.331 clauses 5.3.8.3, 5.7.8 and 5.7.10.3.

[TS 38.331, clause 5.3.8.3]

The UE shall:

- 1> if the *RRCRelease* includes the *measIdleConfig*:
 - 2> if T331 is running:
 - 3> stop timer T331;
 - 3> perform the actions as specified in 5.7.8.3;
 - 2> if the *measIdleConfig* is set to *setup*:
 - 3> store the received *measIdleDuration* in *VarMeasIdleConfig*;
 - 3> start timer T331 with the value set to *measIdleDuration*;
 - 3> if the *measIdleConfig* contains *measIdleCarrierListEUTRA*:
 - 4> store the received *measIdleCarrierListEUTRA* in *VarMeasIdleConfig*;

[TS 38.331, clause 5.7.8.1]

This procedure specifies the measurements to be performed and stored by a UE in RRC_IDLE and RRC_INACTIVE when it has an idle/inactive measurement configuration.

[TS 38.331, clause 5.7.8.1a]

The purpose of this procedure is to update the idle/inactive measurement configuration.

The UE initiates this procedure while T331 is running and one of the following conditions is met:

- 1> upon selecting a cell when entering RRC_IDLE or RRC-INACTIVE from RRC_CONNECTED or RRC_INACTIVE; or
- 1> upon update of system information (*SIB4*, or *SIB11*), e.g. due to intra-RAT cell (re)selection;

While in RRC_IDLE or RRC_INACTIVE, and T331 is running, the UE shall:

- 1> perform measurements according to 5.7.8.2a.

[TS 38.331, clause 5.7.8.2a]

When performing measurements on NR carriers according to this clause, the UE shall derive the cell quality as specified in 5.5.3.3 and consider the beam quality to be the value of the measurement results of the concerned beam, where each result is averaged as described in TS 38.215 [9].

While in RRC_IDLE or RRC_INACTIVE, and T331 is running, the UE shall:

- 1> perform the measurements in accordance with the following:
 - 2> if, as a result of the procedure in this subclause, the UE performs measurements in one or more carrier frequency indicated by *measIdleCarrierListNR* or *measIdleCarrierListEUTRA*:
 - 3> store the cell measurement results for RSRP and RSRQ for the serving cell within *measResultServingCell* in the *measReportIdleNR* in *VarMeasIdleReport*.

NOTE 1: How the UE performs idle/inactive measurements is up to UE implementation as long as the requirements in TS 38.133 [14] are met for measurement reporting.

NOTE 2: The UE is not required to perform idle/inactive measurements on a given carrier if the SSB configuration of that carrier provided via dedicated signalling is different from the SSB configuration broadcasted in the serving cell, if any.

NOTE 3: How the UE prioritizes which frequencies to measure or report (in case it is configured with more frequencies than it can measure or report) is left to UE implementation.

[TS 38.331, clause 5.7.8.3]

The UE shall:

- 1> if T331 expires or is stopped:
- 2> release the *VarMeasIdleConfig*.

NOTE: It is up to UE implementation whether to continue idle/inactive measurements according to SIB11 and SIB4 configurations or according to E-UTRA SIB5 and E-UTRA SIB24 configurations as specified in TS 36.331 [10] upon inter-RAT cell reselection to E-UTRA, after T331 has expired or stopped.

[TS 38.331, clause 5.7.10.3]

Upon receiving the *UEInformationRequest* message, the UE shall, only after successful security activation:

- 1> if the *idleModeMeasurementReq* is included in the *UEInformationRequest* and the UE has stored *VarMeasIdleReport* that contains measurement information concerning cells other than the PCell:
- 2> set the *measResultIdleNR* in the *UEInformationResponse* message to the value of *measReportIdleNR* in the *VarMeasIdleReport*, if available;

8.2.6.3.6.3 Test Description

8.2.6.3.6.3.1 Pre-test conditions

System Simulator:

- NR Cell 1
- E-UTRA Cell 1

UE:

- None.

Preamble:

- The UE is in 5GS state 3N-A according to TS 38.508-1 [4], clause 4.4A.2 Table 4.4A.2-1.

8.2.6.3.6.3.2 Test procedure sequence

Table 8.2.6.3.6.3.2-1: Main behaviour

St	Procedure	Message Sequence		TP	Verdict
		U - S	Message		
1	The SS transmits <i>RRCRelease</i> message including <i>measIdleConfig</i> to the UE.	<-	NR RRC: <i>RRCRelease</i>	-	-
2	Wait for 5 s for UE to enter RRC_IDLE mode and to perform measurements.	-	-	-	-
3-10	Steps 1 to 8 of procedure described in TS 38.508-1 table 4.5.4.2-3: NR RRC_CONNECTED are performed.	-	-	-	-
11	The SS transmits <i>UEInformationRequest</i> message including <i>idleModeMeasurementReq</i> to the UE.	<-	NR RRC: <i>UEInformationRequest</i>	-	-
12	Check: Does the UE transmit <i>UEInformationResponse</i> including <i>measResultIdleNR</i> ?	->	NR RRC: <i>UEInformationResponse</i>	1	P
13	The SS transmits <i>RRCRelease</i> message including <i>measIdleConfig</i> to the UE.	<-	NR RRC: <i>RRCRelease</i>	-	-
14	Wait for 11 s for UE to enter RRC_IDLE mode and T331 to expire.	-	-	-	-
15-22	Steps 1 to 8 of procedure described in TS 38.508-1 table 4.5.4.2-3: NR RRC_CONNECTED are performed.	-	-	-	-
23	The SS transmits <i>UEInformationRequest</i> message including <i>idleModeMeasurementReq</i> to the UE.	<-	NR RRC: <i>UEInformationRequest</i>	-	-
24	Check: Does the UE transmit <i>UEInformationResponse</i> including <i>measResultIdleNR</i> ?	->	NR RRC: <i>UEInformationResponse</i>	2	F
25	The SS transmits <i>RRCRelease</i> message including <i>measIdleConfig</i> without <i>measIdleCarrierListEUTRA</i> to the UE.	<-	NR RRC: <i>RRCRelease</i>	-	-
26	Wait for 5 s for UE to enter RRC_IDLE mode and to perform measurements.	-	-	-	-
27-34	Steps 1 to 8 of procedure described in TS 38.508-1 table 4.5.4.2-3: NR RRC_CONNECTED are performed.	-	-	-	-
35	The SS transmits <i>UEInformationRequest</i> message including <i>idleModeMeasurementReq</i> to the UE.	<-	NR RRC: <i>UEInformationRequest</i>	-	-
36	Check: Does the UE transmit <i>UEInformationResponse</i> including <i>measResultIdleNR</i> ?	->	NR RRC: <i>UEInformationResponse</i>	3	F

8.2.6.3.6.3.3 Specific message contents

TBD

8.2.7

8.2.7.1

8.2.7.2 RRC Resume

8.2.7.2.1 RRC Resume / NR-DC

8.2.7.2.1.1 Test Purpose (TP)

(1)

```
with { UE in NR RRC_INACTIVE state and sends RRCResumeRequest message to resume RRC Connection }
ensure that {
  when { UE receives a RRCResume message including mrdc-SecondaryCellGroup set to nr-SCG }
  then { UE successfully transmits RRCResumeComplete message }
}
```

8.2.7.2.1.2 Conformance requirements

References: The conformance requirements covered in the present TC are specified in: TS 38.331, clauses 5.2.2.2, 5.3.13.2, 5.3.13.3 and 5.3.13.4. Unless otherwise stated these are Rel-15 requirements.

[TS 38.331, clause 5.2.2.2.2]

A modification period is used, i.e. updated SI message (other than SI message for ETWS, CMAS and positioning assistance data) is broadcasted in the modification period following the one where SI change indication is transmitted. The modification period boundaries are defined by SFN values for which $\text{SFN mod } m = 0$, where m is the number of radio frames comprising the modification period. The modification period is configured by system information. The UE receives indications about SI modifications and/or PWS notifications using Short Message transmitted with P-RNTI over DCI (see clause 6.5). Repetitions of SI change indication may occur within preceding modification period. SI change indication is not applicable for SI messages containing posSIBs.

UEs in RRC_IDLE or in RRC_INACTIVE shall monitor for SI change indication in its own paging occasion every DRX cycle. UEs in RRC_CONNECTED shall monitor for SI change indication in any paging occasion at least once per modification period if the UE is provided with common search space, including *pagingSearchSpace*, *searchSpaceSIB1* and *searchSpaceOtherSystemInformation*, on the active BWP to monitor paging, as specified in TS 38.213 [13], clause 13.

[38.331, clause 5.3.13.2]

The UE initiates the procedure when upper layers or AS (when responding to RAN paging or upon triggering RNA updates while the UE is in RRC_INACTIVE) requests the resume of a suspended RRC connection.

The UE shall ensure having valid and up to date essential system information as specified in clause 5.2.2.2 before initiating this procedure.

Upon initiation of the procedure, the UE shall:

- 1> if the resumption of the RRC connection is triggered by response to NG-RAN paging:
 - 2> select '0' as the Access Category;
 - 2> perform the unified access control procedure as specified in 5.3.14 using the selected Access Category and one or more Access Identities provided by upper layers;
 - 3> if the access attempt is barred, the procedure ends;
- 1> else if the resumption of the RRC connection is triggered by upper layers:
 - 2> if the upper layers provide an Access Category and one or more Access Identities:

- 3> perform the unified access control procedure as specified in 5.3.14 using the Access Category and Access Identities provided by upper layers;
- 4> if the access attempt is barred, the procedure ends;
- 2> if the resumption occurs after release with redirect with *mpsPriorityIndication*:
 - 3> set the resumeCause to mps-PriorityAccess;
- 2> else:
 - 3> set the *resumeCause* in accordance with the information received from upper layers;

...

- 1> initiate transmission of the *RRCResumeRequest* message or *RRCResumeRequest1* in accordance with 5.3.13.3.

[38.331, clause 5.3.13.3]

The UE shall set the contents of *RRCResumeRequest* or *RRCResumeRequest1* message as follows:

- 1> if field *useFullResumeID* is signalled in *SIB1*:
 - 2> select *RRCResumeRequest1* as the message to use;
 - 2> set the *resumeIdentity* to the stored *fullI-RNTI* value;
- 1> else:
 - 2> select *RRCResumeRequest* as the message to use;
 - 2> set the *resumeIdentity* to the stored *shortI-RNTI* value;
- 1> restore the RRC configuration, RoHC state, the stored QoS flow to DRB mapping rules and the K_{gNB} and K_{RRCint} keys from the stored UE Inactive AS context except for the following:
 - masterCellGroup;
 - mrdc-SecondaryCellGroup, if stored; and
 - pdcp-Config;
- 1> set the *resumeMAC-I* to the 16 least significant bits of the MAC-I calculated:
 - 2> over the ASN.1 encoded as per clause 8 (i.e., a multiple of 8 bits) *VarResumeMAC-Input*;
 - 2> with the K_{RRCint} key in the UE Inactive AS Context and the previously configured integrity protection algorithm; and
 - 2> with all input bits for COUNT, BEARER and DIRECTION set to binary ones;
- 1> derive the K_{gNB} key based on the current K_{gNB} key or the NH, using the stored *nextHopChainingCount* value, as specified in TS 33.501 [11];
- 1> derive the K_{RRCenc} key, the K_{RRCint} key, the K_{UPint} key and the K_{UPenc} key;
- 1> configure lower layers to apply integrity protection for all radio bearers except SRB0 using the configured algorithm and the K_{RRCint} key and K_{UPint} key derived in this subclause immediately, i.e., integrity protection shall be applied to all subsequent messages received and sent by the UE;

NOTE 1: Only DRBs with previously configured UP integrity protection shall resume integrity protection.

- 1> configure lower layers to apply ciphering for all radio bearers except SRB0 and to apply the configured ciphering algorithm, the K_{RRCenc} key and the K_{UPenc} key derived in this subclause, i.e. the ciphering configuration shall be applied to all subsequent messages received and sent by the UE;
- 1> re-establish PDCP entities for SRB1;

1> resume SRB1;

1> submit the selected message *RRCResumeRequest* or *RRCResumeRequest1* for transmission to lower layers.

NOTE 2: Only DRBs with previously configured UP ciphering shall resume ciphering.

If lower layers indicate an integrity check failure while T319 is running, perform actions specified in 5.3.13.5.

The UE shall continue cell re-selection related measurements as well as cell re-selection evaluation. If the conditions for cell re-selection are fulfilled, the UE shall perform cell re-selection as specified in 5.3.13.6.

[38.331, clause 5.3.13.4]

The UE shall:

...

1> if the *RRCResume* includes the *mrdc-SecondaryCellGroup*:

2> if the received *mrdc-SecondaryCellGroup* is set to *nr-SCG*:

3> perform the RRC reconfiguration according to 5.3.5.3 for the *RRCReconfiguration* message included in *nr-SCG*;

...

1> enter RRC_CONNECTED;

1> indicate to upper layers that the suspended RRC connection has been resumed;

1> stop the cell re-selection procedure;

1> consider the current cell to be the PCell;

1> set the content of the of *RRCResumeComplete* message as follows:

...

2> if the *RRCResume* message includes *mrdc-SecondaryCellGroup* set to *nr-SCG*:

3> include in the *nr-SCG-Response* the SCG *RRCReconfigurationComplete* message;

...

1> submit the *RRCResumeComplete* message to lower layers for transmission;

1> the procedure ends.

8.2.7.2.1.3 Test description

8.2.7.2.1.3.1 Pre-test conditions

System Simulator:

- NR Cell 1 is the PCell, NR Cell 10 is the PSCell.
- System information combination NR-1 as defined in TS 38.508-1 [4] clause 4.4.3.1.2 is used in NR cell.

UE:

- None.

Preamble:

- The UE is in state RRC_CONNECTED using generic procedure parameter Connectivity (*NR-DC*) and Bearers (*MCG and SCG*) established according to TS 38.508-1 [4] Table 4.5.1-1.

8.2.7.2.1.3.2 Test procedure sequence

Table 8.2.7.2.1.3.2-1: Main behaviour

St	Procedure	Message Sequence		TP	Verdict
		U - S	Message		
1	The SS transmits an <i>RRCRelease</i> message with <i>suspendConfig</i> .	<--	NR RRC: <i>RRCRelease</i>	-	-
2	The SS waits for 5 sec and transmits a <i>Paging</i> message including a matched identity (correct <i>fullI-RNTI</i>).	<--	NR RRC: <i>Paging</i>	-	-
3	UE transmits an <i>RRCResumeRequest</i> message by setting <i>resumeIdentity</i> to the stored <i>shortI-RNTI</i> value.	-->	NR RRC: <i>RRCResumeRequest</i>	-	-
4	The SS transmits an <i>RRCResume</i> message.	<--	NR RRC: <i>RRCResume</i>	-	-
5	The UE transmits an <i>RRCResumeComplete</i> message.	-->	NR RRC: <i>RRCResumeComplete</i>	1	P

8.2.7.2.1.3.3 Specific message contents

Table 8.2.7.2.1.3.3-1: *RRCRelease* (step 1, Table 8.2.7.2.1.3.2-1)

Derivation Path: TS 38.508-1 [4] Table 4.6.1-16 with condition NR_RRC_INACTIVE
--

Table 8.2.7.2.1.3.3-2: *Paging* (step 2, Table 8.2.7.2.1.3.2-1)

Derivation Path: TS 38.508-1 [4], Table 4.6.1-9 with condition NR_RRC_RESUME
--

Table 8.2.7.2.1.3.3-3: *RRCResume* (step 4, Table 8.2.7.2.1.3.2-1)

Derivation Path: TS 38.508-1 [4], Table 4.6.1-17			
Information Element	Value/remark	Comment	Condition
<i>RRCResume</i> ::= SEQUENCE {			
<i>rrc-TransactionIdentifier</i>	RRC-TransactionIdentifier		
criticalExtensions CHOICE {			
<i>rrcResume</i> SEQUENCE {			
nonCriticalExtension SEQUENCE {			
<i>radioBearerConfig2</i>	RadioBearerConfig according to Table 8.2.7.2.1.3.3-5		
sk-Counter	0		
nonCriticalExtension SEQUENCE {			
<i>idleModeMeasurementReq-r16</i>	Not Present		
<i>restoreMCG-SCells-r16</i>	Not Present		
<i>restoreSCG-r16</i>	True		
<i>mrhc-SecondaryCellGroup-r16</i> CHOICE {			
nr-SCG-r16	According to TS 38.508-1[4], Table 4.6.1-13 with condition NR-DC_SCG		
}			
}			
}			
<i>needForGapsConfigNR-r16</i>	Not Present		
}			
}			

Table 8.2.7.2.1.3.3-4: *RRCResumeComplete* (step 5, Table 8.2.7.2.1.3.2-1)

Derivation Path: TS 38.508-1 [4], Table 4.6.1-18
--

Information Element	Value/remark	Comment	Condition
RRCResumeComplete ::= SEQUENCE {			
rrc-TransactionIdentifier	RRC-TransactionIdentifier		
criticalExtensions CHOICE {			
rrcResumeComplete SEQUENCE {			
nonCriticalExtension SEQUENCE {			
idleMeasAvailable-r16	Not Present		
measResultIdleEUTRA-r16	Not Present		
measResultIdleNR-r16	Not Present		
scg-Response-r16 CHOICE{			
nr-SCG-Response	RRCReconfigurationComplete defined as per TS 38.508-1[4] Table 4.6.1-14 with condition NR-DC		
eutra-SCG-Response	Not Present		
}			
ue-MeasurementsAvailable-r16	Not Present		
mobilityHistoryAvail-r16	Not Present		
mobilityState-r16	Not Present		
needForGapsInfoNR-r16	Not Present		
nonCriticalExtension	Not Present		
}			
}			
}			
}			

Table 8.2.7.2.1.3.3-5: RadioBearerConfig (Table 8.2.7.2.1.3.2-3)

Derivation Path: TS 38.508 [4], Table 4.6.3-132 with condition DRBn and SecondaryKeys			
Information Element	Value/remark	Comment	Condition
RadioBearerConfig ::= SEQUENCE {			
drb-ToAddModList SEQUENCE (SIZE (1..maxDRB)) OF DRB-ToAddMod {	1 entry		
DRB-ToAddMod SEQUENCE {			
cnAssociation	Not present		
drb-Identity	DRB-Identity using condition DRBn	n set to the SCG DRB identity	
reestablishPDCP	True		
recoverPDCP	Not present		
pdcp-Config	Not present		
daps-Config-r16	Not present		
}			
}			
}			

9 Mobility management

9.1 5GS mobility management

9.1.1 Primary authentication and key agreement

9.1.1.1 EAP based primary authentication and key agreement / EAP-AKA' related procedures

9.1.1.1.1 Test Purpose (TP)

(1)

```
with { the UE in 5GMM-REGISTERED-INITIATED state }
ensure that {
  when { the SS sends an EAP-Request/AKA'-Identity message within AUTHENTICATION REQUEST }
  then { the UE sends an EAP-Response/AKA'-Identity message within AUTHENTICATION RESPONSE }
}
```

(2)

```
with { the UE in 5GMM-REGISTERED-INITIATED state }
ensure that {
  when { the SS sends the EAP-request/AKA'-challenge message within AUTHENTICATION REQUEST with the
sequence number in AUTN is not correct }
  then { the UE sends an EAP-response/AKA'-synchronization-failure message within AUTHENTICATION
RESPONSE }
}
```

(3)

```
with { the UE in 5GMM-REGISTERED-INITIATED state }
ensure that {
  when { the SS sends an EAP-request/AKA'-challenge message within AUTHENTICATION REQUEST }
  then { the UE sends an EAP-response/AKA'-challenge message within AUTHENTICATION RESPONSE }
}
```

(4)

```
with { the UE in 5GMM-REGISTERED-INITIATED state and SS initiates an EAP based primary
authentication and key agreement procedure }
ensure that {
  when { the SS sends an EAP-success message within AUTHENTICATION RESULT }
  then { the UE considers the procedure complete and authentication procedure succeed }
}
```

9.1.1.1.2 Conformance requirements

References: The conformance requirements covered in the present TC are specified in: TS 24.501 clauses 5.4.1.2.2.3, 5.4.1.2.2.4, 5.4.1.2.2.6B, 5.4.1.2.2.8.

[TS 24.501, clause 5.4.1.2.2.6B (TP1)]

Upon receipt of the AUTHENTICATION REQUEST message with EAP-Request/Identity message the UE shall send an AUTHENTICATION RESPONSE message with EAP-Response/Identity to the network. In the EAP-Response/Identity message, the UE shall provide the requested identity according to 3GPP TS 33.501 [24] annex F.2, in the UE identity in the EAP-Response/Identity message as specified in IETF RFC 5448 [40].

Upon receipt of the AUTHENTICATION REQUEST message with EAP-Request/AKA'-Identity message the UE shall send an AUTHENTICATION RESPONSE message with EAP-Response/AKA'-Identity to the network. Based on the attribute received in the EAP-Request/AKA'-Identity, the UE shall provide the requested identity according to 3GPP TS 33.501 [24] annex F.2, in the EAP-Response/AKA'-Identity message, as specified in IETF RFC 5448 [40].

If the EAP-Request/AKA'-Identity carries the AT_PERMANENT_REQ, the UE shall respond with EAP-Response/AKA'-Client-Error with the error code "unable to process packet".

[TS 24.501, clause 5.4.1.2.2.4 (TP2)]

If a USIM is present, the SNN check fails or the UE does not accept AUTN during handling of the EAP-request/AKA'-challenge message as specified in IETF RFC 5448 [40], the UE shall send an EAP-response/AKA'-authentication-reject message as specified in IETF RFC 5448 [40].

If a USIM is present, the SNN check is successful but the UE detects that the sequence number in AUTN is not correct during handling of the EAP-request/AKA'-challenge message as specified in IETF RFC 5448 [40], the UE shall send an EAP-response/AKA'-synchronization-failure message as specified in IETF RFC 5448 [40].

If a USIM is present, the SNN check is successful, the sequence number in AUTN is correct and the UE detects another error during handling of the EAP-request/AKA'-challenge message as specified in IETF RFC 5448 [40], the UE shall send an EAP-response/AKA'-client-error message as specified in IETF RFC 5448 [40].

If a USIM is not present, the UE shall send an EAP-response/AKA'-client-error message as specified in IETF RFC 5448 [40].

For any of the above, the UE shall start timer T3520 when the AUTHENTICATION RESPONSE message containing the EAP-response message is sent. Furthermore, the UE shall stop any of the retransmission timers that are running (e.g. T3510, T3517 or T3521). Upon receiving an AUTHENTICATION REQUEST message with the EAP message IE containing an EAP-request/AKA'-challenge from the network, the UE shall stop timer T3520, if running, and then process the EAP-request/AKA'-challenge information as normal.

[TS 24.501, clause 5.4.1.2.2.3 (TP3)]

If a USIM is present and the SNN check is successful, the UE shall handle the EAP-request/AKA'-challenge message as specified in IETF RFC 5448 [40]. The USIM shall derive CK and IK and compute the authentication response (RES) using the 5G authentication challenge data received from the ME, and pass RES to the ME. The ME shall derive CK' and IK' from CK and IK, and EMSK from CK' and IK'. Furthermore, the ME may generate K_{AUSF} from the EMSK, the K_{SEAF} from the K_{AUSF} , and the K_{AMF} from the ABBA received together with the EAP-request/AKA'-challenge message, and the K_{SEAF} as described in 3GPP TS 33.501 [24], and create a partial native 5G NAS security context identified by the ngKSI value received together with the EAP-request/AKA'-challenge message in clause 5.4.1.2.4.2 in the volatile memory of the ME. If the K_{AMF} and the partial native 5G NAS security context are created, the ME shall store the K_{AMF} in the created partial native 5G NAS security context, and shall send an EAP-response/AKA'-challenge message as specified in IETF RFC 5448 [40].

If the EAP-request/AKA'-challenge message contains AT_RESULT_IND attribute, the UE may include AT_RESULT_IND attribute in the EAP-response/AKA'-challenge message as specified in IETF RFC 5448 [40].

[TS 24.501, clause 5.4.1.2.2.8 (TP4)]

Upon receiving an EAP-success message, if the ME has not generated a partial native 5G NAS security context as described in subclause 5.4.1.2.2.3, the ME shall:

- a) generate the K_{AUSF} from the EMSK, the K_{SEAF} from the K_{AUSF} , and the K_{AMF} from the ABBA that was received with the EAP-success message, and the K_{SEAF} as described in 3GPP TS 33.501 [24];
- b) create a partial native 5G NAS security context identified by the ngKSI value in the volatile memory of the ME;
and
- c) store the K_{AMF} in the created partial native 5G NAS security context.

The UE shall consider the procedure complete.

9.1.1.1.3 Test description

9.1.1.1.3.1 Pre-test conditions

System Simulator:

- NGC Cell A is configured according to table 6.3.2.2-1 in TS 38.508-1 [4].

UE:

- None

Preamble:

- The UE is in state Switched OFF Mode (state ON-B) according to TS 38.508-1 [4].

9.1.1.1.3.2 Test procedure sequence

Table 9.1.1.1.3.2-1: Main behaviour

St	Procedure	Message Sequence		TP	Verdict
		U - S	Message		
1	The UE is switched on.	-	-	-	-
2-4	The UE establishes RRC connection and initiates registration procedure by executing steps 2-4 of Table 4.5.2.2-2 in TS 38.508-1 [4].	-	-	-	-
5	SS transmits an AUTHENTICATION REQUEST message with an EAP-Request/AKA'-Identity message.	<--	5GMM: AUTHENTICATION REQUEST		
6	Check: Does the UE respond with an AUTHENTICATION RESPONSE message, with an EAP-Response/AKA'-Identity message?	-->	5GMM: AUTHENTICATION RESPONSE	1	P
7	SS transmits an AUTHENTICATION REQUEST message with an EAP-Request/AKA'-challenge message which contains a not correct sequence number.	<--	5GMM: AUTHENTICATION REQUEST	-	-
8	Check: Does the UE respond with an AUTHENTICATION RESPONSE message, with an EAP-Response/AKA'-synchronization-failure?	-->	5GMM: AUTHENTICATION RESPONSE	2	P
9	SS transmits a correct AUTHENTICATION REQUEST message with an EAP-Request/AKA'-challenge message.	<--	5GMM: AUTHENTICATION REQUEST	-	-
10	Check: Does the UE respond with a correct AUTHENTICATION RESPONSE message, with an EAP-Response/AKA'-challenge message?	-->	5GMM: AUTHENTICATION RESPONSE	3	P
11	SS transmits an AUTHENTICATION RESULT message with an EAP-success message.	<--	5GMM: AUTHENTICATION RESULT	-	-
12-18	The registration procedure is performed by executing steps 8-14 of Table 4.5.2.2-2 in TS 38.508-1 [4].	-	-	-	-
19	Check: Does the UE transmits a REGISTRATION COMPLETE message?	-->	5GMM: REGISTRATION COMPLETE	4	P
20	Steps 19a1 of Table 4.5.2.2-2 in TS 38.508-1 [4] are performed	-	-	-	-

9.1.1.1.3.3 Specific message contents

Table 9.1.1.1.3.3-1: Message AUTHENTICATION REQUEST (step 5, Table 9.1.1.1.3.2-1)

Derivation path: TS 38.508-1 [4], table 4.7.1-1			
Information Element	Value/Remark	Comment	Condition
EAP message	EAP-request/AKA'-Identity	See Table 9.1.1.1.3.3-7	EAP-AKA

Table 9.1.1.1.3.3-2: Message AUTHENTICATION RESPONSE (step 6, Table 9.1.1.1.3.2-1)

Derivation path: TS 38.508-1 [4], table 4.7.1-2			
Information Element	Value/Remark	Comment	Condition

EAP message	EAP-response/AKA'-Identity	See Table 9.1.1.1.3.3-8	EAP-AKA
-------------	----------------------------	-------------------------	----------------

Table 9.1.1.1.3.3-3: Message AUTHENTICATION REQUEST (step 7, Table 9.1.1.1.3.2-1)

Derivation path: TS 38.508-1 [4], table 4.7.1-1			
Information Element	Value/Remark	Comment	Condition
EAP message	EAP-request/AKA'-challenge	The sequence number in AUTN is not correct	EAP-AKA

Table 9.1.1.1.3.3-4: Message AUTHENTICATION RESPONSE (step 8, Table 9.1.1.1.3.2-1)

Derivation path: TS 38.508-1 [4], table 4.7.1-2			
Information Element	Value/Remark	Comment	Condition
EAP message	EAP-response/AKA'-synchronization-failure		EAP-AKA

Table 9.1.1.1.3.3-5: Message AUTHENTICATION RESPONSE (step 10, Table 9.1.1.1.3.2-1)

Derivation path: TS 38.508-1 [4], table 4.7.1-2			
Information Element	Value/Remark	Comment	Condition
EAP message	EAP-Response/AKA'-Challenge	RES* equal to the XRES* calculated in the SS with the parameters provided/indicated in the AUTHENTICATION REQUEST	EAP-AKA

Table 9.1.1.1.3.3-6: Message AUTHENTICATION RESULT (step 11, Table 9.1.1.1.3.2-1)

Derivation path: TS 38.508-1 [4], table 4.7.1-3			
Information Element	Value/Remark	Comment	Condition
EAP message	EAP-Success		EAP-AKA

Table 9.1.1.1.3.3-7: Message EAP-Request/AKA'-Identity (Table 9.1.1.1.3.3-1)

Derivation Path: IETF RFC 4187 [30] clause 9.1, RFC 3748 [32] clause 4			
Information Element	Value/Remark	Comment	Condition
Code	1	Request	
Length	Set to length of EAP packet		
Data			
AT_ANY_ID_REQ	AT_ANY_ID_REQ_Def	See Table 9.1.1.1.3.3-9	

Table 9.1.1.1.3.3-8: Message EAP-Response/AKA'-Identity (Table 9.1.1.1.3.3-2)

Derivation Path: IETF RFC 4187 [30] clause 9.2, RFC 3748 [32] clause 4			
Information Element	Value/Remark	Comment	Condition
Code	2	Response	
Length	Set to length of EAP packet		
Data			
AT_IDENTITY	AT_IDENTITY_Def	See Table 9.1.1.1.3.3-10	

Table 9.1.1.1.3.3-9: AT_ANY_ID_REQ_Def (Table 9.1.1.1.3.3-7)

Derivation Path: IETF RFC 4187 [30] clause 10.3			
Information Element	Value/remark	Comment	Condition
AT_ANY_ID_REQ	'0000 1101'B	13	
Length	'0000 0001'B	1	
Reserved	'0000 0000 0000 0000'B		

Table 9.1.1.1.3.3-10: AT_IDENTITY_Def (Table 9.1.1.1.3.3-8)

Derivation Path: IETF RFC 4187 [30] clause 10.5			
Information Element	Value/remark	Comment	Condition
AT_IDENTITY	'0000 1110'B	14	
Length	Set to the Length of AT_IDENTITY attribute in 4 bytes		
Actual Identity Length	Set to the actual length of 'identity' in bytes excluding any appended all zero bytes at end		
Identity	Value generated according to TS 24.501 [28] clause 9.11.3.4 and shall be a multiple of 4 bytes (appended with 1,2 or 3 bytes of all zero bits when necessary)	SUCI of the UE	

9.1.1.2 EAP based primary authentication and key agreement / Reject

9.1.1.2.1 Test Purpose (TP)

(1)

```
with {the UE in 5GMM-REGISTERED-INITIATED state }
ensure that {
  when { the SS sends the EAP-request/AKA'-challenge message within AUTHENTICATION REQUEST with
incorrect SNN }
  then { the UE sends an EAP-response/AKA'-authentication-reject message within AUTHENTICATION
RESPONSE}
}
```

(2)

```
with {the UE in 5GMM-REGISTERED-INITIATED state }
ensure that {
  when { the SS sends an EAP-Request/AKA'-notification message within AUTHENTICATION REQUEST }
  then { the UE sends an EAP-Response/AKA'-notification message within AUTHENTICATION RESPONSE }
}
```

(3)

```
with {the UE in 5GMM-REGISTERED-INITIATED state and SS initiates an EAP based primary authentication
and key agreement procedure}
ensure that {
  when { the SS sends an EAP-failure message within AUTHENTICATION REJECT }
  then { the UE deletes the stored 5G-GUTI, TAI list, last visited registered TAI and ngKSI and
enter state 5GMM-DEREGISTERED, the USIM is considered invalid until switching off the UE }
}
```

9.1.1.2.2 Conformance requirements

References: The conformance requirements covered in the current TC are specified in: TS 24.501, clauses 5.4.1.2.2.4, 5.4.1.2.2.6, and 5.4.1.2.2.11.

[TS 24.501, clause 5.4.1.2.2.4]

If a USIM is present, the SNN check fails or the UE does not accept AUTN during handling of the EAP-request/AKA'-challenge message as specified in IETF RFC 5448 [40], the UE shall send an EAP-response/AKA'-authentication-reject message as specified in IETF RFC 5448 [40].

If a USIM is present, the SNN check is successful but the UE detects that the sequence number in AUTN is not correct during handling of the EAP-request/AKA'-challenge message as specified in IETF RFC 5448 [40], the UE shall send an EAP-response/AKA'-synchronization-failure message as specified in IETF RFC 5448 [40].

If a USIM is present, the SNN check is successful, the sequence number in AUTN is correct and the UE detects another error during handling of the EAP-request/AKA'-challenge message as specified in IETF RFC 5448 [40], the UE shall send an EAP-response/AKA'-client-error message as specified in IETF RFC 5448 [40].

If a USIM is not present, the UE shall send an EAP-response/AKA'-client-error message as specified in IETF RFC 5448 [40].

For any of the above, the UE shall start timer T3520 when the AUTHENTICATION RESPONSE message containing the EAP-response message is sent. Furthermore, the UE shall stop any of the retransmission timers that are running (e.g. T3510, T3517 or T3521). Upon receiving an AUTHENTICATION REQUEST message with the EAP message IE containing an EAP-request/AKA'-challenge from the network, the UE shall stop timer T3520, if running, and then process the EAP-request/AKA'-challenge information as normal.

[TS 24.501, clause 5.4.1.2.2.6]

Upon receiving an EAP-request/AKA'-notification message, the UE shall send an EAP-response/AKA'-notification message as specified in IETF RFC 5448 [40].

[TS 24.501, clause 5.4.1.2.2.11]

Upon receiving an EAP-failure message, the UE shall delete the partial native 5G NAS security context if any was created as described in subclause 5.4.1.2.2.3.

The UE shall consider the procedure complete.

If the EAP-failure message is received in an AUTHENTICATION REJECT message:

- the UE shall set the update status to 5U3 ROAMING NOT ALLOWED, delete the stored 5G-GUTI, TAI list, last visited registered TAI and ngKSI. The USIM shall be considered invalid until switching off the UE or the UICC containing the USIM is removed; and
- if the UE is operating in single-registration mode, the UE shall handle 4G-GUTI, last visited registered TAI, TAI list and eKSI as specified in 3GPP TS 24.301 [15] for the case when the authentication procedure is not accepted by the network. The USIM shall be considered as invalid also for non-EPS services until switching off or the UICC containing the USIM is removed.

If the AUTHENTICATION REJECT message is received by the UE, the UE shall abort any 5GMM signalling procedure, stop any of the timers T3510, T3517 or T3521 (if they were running) and enter state 5GMM-DEREGISTERED.

9.1.1.2.3 Test description

9.1.1.2.3.1 Pre-test conditions

System Simulator:

- NGC Cell A "Serving cell" TS 38.508-1 [4] Table 6.2.2.1-3

UE:

- None

Preamble:

- The UE is in state Switched OFF (state 0N-B) according to TS 38.508-1 [4].

9.1.1.2.3.2 Test procedure sequence

Table 9.1.1.2.3.2-1: Main behaviour

St	Procedure	Message Sequence		TP	Verdict
		U – S	Message		
1	The UE is switched on.	-	-	-	-
2-4	The UE executes steps 2-4 of Table 4.5.2.2-2 in TS38.508-1 [4].	-	-	-	-
5	The SS transmits "EAP-request/AKA'-challenge" message in AUTHENTICATION REQUEST with incorrect SNN.		5GMM: AUTHENTICATION REQUEST	-	-
6	Check: Does the UE transmit an "EAP-response/AKA'-authentication-reject" message in AUTHENTICATION RESPONSE?		5GMM: AUTHENTICATION RESPONSE	1	P
6A	The SS transmits "EAP-failure" message within AUTHENTICATION RESULT message.	<--	5GMM: AUTHENTICATION RESULT	-	-
7	The SS transmits "EAP-request/AKA'-challenge" message in AUTHENTICATION REQUEST.		5GMM: AUTHENTICATION REQUEST	-	-
8	The UE transmit an "EAP-response/AKA'-challenge" message in AUTHENTICATION RESPONSE.		5GMM: AUTHENTICATION RESPONSE	-	-
9	The SS transmits "EAP- request /AKA'-notification" message in AUTHENTICATION REQUEST.		5GMM: AUTHENTICATION REQUEST	-	-
10	Check: Does the UE transmit an "EAP-response/AKA'-notification" message in AUTHENTICATION RESPONSE?		5GMM: AUTHENTICATION RESPONSE	2	P
11	The SS transmits an "EAP-failure" message within AUTHENTICATION REJECT	<--	5GMM: AUTHENTICATION REJECT	-	-
12	SS releases the RRC connection	-	-	-	-
13	Check: Does the UE transmit an RRCSetupRequest message for initial registration procedure within the next 30 seconds?	-->	NR RRC: RRCSetupRequest	3	F
14	The UE is switched off by executing generic procedure in Table 4.9.6.4-1 in TS 38.508-1 [4].	-	-	-	-
15	The UE is switched on.	-	-	-	-
16	Check: Does the UE transmit a REGISTRATION REQUEST message?	-->	5GMM: REGISTRATION REQUEST	3	P
17	The UE executes steps 5-20a1 of Table 4.5.2.2-2 in TS38.508-1 [4] complete registration procedure.	-	-	-	-

9.1.1.2.3.3 Specific message contents

Table 9.1.1.2.3.3-1: AUTHENTICATION REQUEST (step 5, Table 9.1.1.2.3.2-1)

Derivation path: TS 38.508-1 [4], table 4.7.1-1			
Information Element	Value/Remark	Comment	Condition
Extended protocol discriminator	5GMM		
Security header type	'0000'B	Plain 5GS NAS message, not security protected	
Spare half octet	'0000'B		
EAP message	"EAP-request/AKA'-challenge"	SNN in EAP message is incorrect or does not match with the	

		PLMN identity saved in the UE.	
NOTE: This message is sent within SECURITY PROTECTED 5GS NAS MESSAGE message with Integrity protected and ciphered.			

Table 9.1.1.2.3.3-2: AUTHENTICATION RESPONSE (step 6, Table 9.1.1.2.3.2-1)

Derivation path: TS 38.508-1 [4], table 4.7.1-2			
Information Element	Value/Remark	Comment	Condition
Extended protocol discriminator	5GMM		
Security header type	'0000'B	Plain 5GS NAS message, not security protected	
Spare half octet	'0000'B		
EAP message	"EAP-response/AKA'-authentication-reject "		
NOTE: This message is sent within SECURITY PROTECTED 5GS NAS MESSAGE message with Integrity protected and ciphered.			

Table 9.1.1.2.3.3-2A: AUTHENTICATION RESULT (step 6A, Table 9.1.1.2.3.2-1)

Derivation path: TS 38.508-1 [4], table 4.7.1-3			
Information Element	Value/Remark	Comment	Condition
Extended protocol discriminator	5GMM		
Security header type	'0000'B	Plain 5GS NAS message, not security protected	
Spare half octet	'0000'B		
ngKSI	The same value as the last AUTHENTICATION REQUEST message		
Spare half octet	'0000'B		
EAP message	EAP-failure	EAP-failure	
ABBA	'0000 0000 0000 0000'B		
NOTE: This message is sent within SECURITY PROTECTED 5GS NAS MESSAGE message with Integrity protected and ciphered.			

Table 9.1.1.2.3.3-3: AUTHENTICATION RESPONSE (step 8, Table 9.1.1.2.3.2-1)

Derivation path: TS 38.508-1 [4], table 4.7.1-2			
Information Element	Value/Remark	Comment	Condition
Extended protocol discriminator	5GMM		
Security header type	'0000'B	Plain 5GS NAS message, not security protected	
Spare half octet	'0000'B		
EAP message	"EAP-request/AKA'-challenge"		
NOTE: This message is sent within SECURITY PROTECTED 5GS NAS MESSAGE message with Integrity protected and ciphered.			

Table 9.1.1.2.3.3-4: AUTHENTICATION REQUEST (step 9, Table 9.1.1.2.3.2-1)

Derivation path: TS 38.508-1 [4], table 4.7.1-1			
Information Element	Value/Remark	Comment	Condition
Extended protocol discriminator	5GMM		
Security header type	'0000'B	Plain 5GS NAS	

		message, not security protected	
Spare half octet	'0000'B		
EAP message	"EAP-request /AKA'-notification"	See Table 9.1.1.2.3.3-8	
NOTE: This message is sent within SECURITY PROTECTED 5GS NAS MESSAGE message with Integrity protected and ciphered.			

Table 9.1.1.2.3.3-5: AUTHENTICATION RESPONSE (step 10, Table 9.1.1.2.3.2-1)

Derivation path: TS 38.508-1 [4], table 4.7.1-2			
Information Element	Value/Remark	Comment	Condition
Extended protocol discriminator	5GMM		
Security header type	'0000'B	Plain 5GS NAS message, not security protected	
Spare half octet	'0000'B		
EAP message	"EAP-response/AKA'-notification"	See Table 9.1.1.2.3.3-9	
NOTE: This message is sent within SECURITY PROTECTED 5GS NAS MESSAGE message with Integrity protected and ciphered.			

Table 9.1.1.2.3.3-6: AUTHENTICATION REJECT (step 11, Table 9.1.1.2.3.2-1)

Derivation path: TS 38.508-1 [4], table 4.7.1-5			
Information Element	Value/Remark	Comment	Condition
Extended protocol discriminator	5GMM		
Security header type	'0000'B	Plain 5GS NAS message, not security protected	
Spare half octet	'0000'B		
EAP message	EAP-failure	EAP-failure	
NOTE: This message is sent within SECURITY PROTECTED 5GS NAS MESSAGE message with Integrity protected and ciphered.			

Table 9.1.1.2.3.3-7: REGISTRATION REQUEST (step16, Table 9.1.1.2.3.2-1)

Derivation path: TS 38.508-1 [4], table 4.7.1-6			
Information Element	Value/Remark	Comment	Condition
5GS registration type	'0000 0010'B	Initial registration	
ngKSI			
NAS key set identifier	'111'B	no key is available	
TSC	Any allowed value	TSC does not apply for NAS key set identifier value "111"	
Last visited registered TAI	Not present		
5GS mobile identity	SUCI of the UE		

Table 9.1.1.2.3.3-8: EAP-Request/AKA'-Notification (Table 9.1.1.2.3.3-4)

Derivation Path: IETF RFC 4187 [30] clause 9.10, RFC 3748 [32] clause 4			
Information Element	Value/Remark	Comment	Condition

Code	1	Request	
Length	Set to length of EAP packet		
Data			
AT_NOTIFICATION	AT_NOTIFICATION_Def	See Table 9.1.1.2.3.3-10	

Table 9.1.1.2.3.3-9: EAP-Response/AKA'-Notification (Table 9.1.1.2.3.2-5)

Derivation Path: IETF RFC 4187 [30] clause 9.11, RFC 3748 [32] clause 4			
Information Element	Value/Remark	Comment	Condition
Code	2	Response	
Length	Set to length of EAP packet		
Data	Not present		

Table 9.1.1.2.3.3-10: AT_NOTIFICATION_Def (Table 9.1.1.2.3.3-8)

Derivation Path: IETF RFC 4187 [30] clause 10.19			
Information Element	Value/remark	Comment	Condition
AT_NOTIFICATION	'0000 1100'B	12	
Length	'0000 0001'B	1	
Notification Code	'0100 0000 0000 0000'B	Set to "General failure"	

9.1.1.3 EAP based primary authentication and key agreement / EAP message transport / Abnormal

9.1.1.3.1 Test Purpose (TP)

(1)

```
with { the UE in 5GMM-REGISTERED-INITIATED state }
ensure that {
  when { the SS sends the EAP-request/AKA'-challenge message within AUTHENTICATION REQUEST with
ngKSI is already in use }
  then { the UE sends an AUTHENTICATION FAILURE message with 5GMM cause #71 "ngKSI already in use"
}
}
```

(2)

```
with { the UE in 5GMM-REGISTERED-INITIATED state }
ensure that {
  when { the third time SS sends the EAP-request/AKA'-challenge message within AUTHENTICATION
REQUEST with ngKSI is already in use }
  then { the UE locally releases the RRC connection and treats the active cell as barred }
}
```

(3)

```
with { the UE in 5GMM-REGISTERED-INITIATED state, the SS sends the EAP-request/AKA'-challenge
message within AUTHENTICATION REQUEST with ngKSI is already in use and the UE sends an
AUTHENTICATION FAILURE message }
```

```

ensure that {
  when { T3520 times out }
  then { the UE locally releases the RRC connection and treats the active cell as barred }
}

```

(4)

Void

(5)

```

with { the UE in 5GMM-REGISTERED state and initiates a mobility registration update procedure }
ensure that {
  when { the SS sends the EAP-request/AKA'-challenge message within AUTHENTICATION REQUEST and the
  UE fails on transmission of AUTHENTICATION RESPONSE message with the indication from lower layers }
  then { the UE re-initiate the mobility registration update procedure }
}

```

9.1.1.3.2 Conformance requirements

References: The conformance requirements covered in the present TC are specified in: TS 24.501 clauses 5.4.1.2.4.5. Unless otherwise stated these are Rel-15 requirements.

[TS 24.501, clause 5.4.1.2.4.5 (TP1, TP2, TP3, TP4, TP5)]

The following abnormal cases can be identified:

- a) Authentication failure (5GMM cause #71 "ngKSI already in use").

The UE shall send an AUTHENTICATION FAILURE message, with 5GMM cause #71 "ngKSI already in use", to the network and start the timer T3520 (see example in figure 5.4.1.3.7.1). Furthermore, the UE shall stop any of the retransmission timers that are running (e.g. T3510, T3517 or T3521). Upon the first receipt of an AUTHENTICATION FAILURE message from the UE with 5GMM cause #71 "ngKSI already in use", the network performs necessary actions to select a new ngKSI and send the same EAP-request message to the UE.

NOTE 1: Upon receipt of an AUTHENTICATION FAILURE message from the UE with 5GMM cause #71 "ngKSI already in use", the network can also re-initiate the EAP based primary authentication and key agreement procedure (see subclause 5.4.1.2.2.2).

Upon receiving a new AUTHENTICATION REQUEST message with the EAP message IE containing an EAP-request message from the network, the UE shall stop timer T3520, if running, process the EAP-request message as normal.

If the network is validated successfully (an AUTHENTICATION REQUEST message that contains a valid ngKSI and EAP-request message is received), the UE shall send the AUTHENTICATION RESPONSE message to the network and shall start any retransmission timers (e.g. T3510, T3517 or T3521) if they were running and stopped when the UE received the first failed AUTHENTICATION REQUEST message.

- b) Transmission failure of AUTHENTICATION RESPONSE message or AUTHENTICATION FAILURE message indication from lower layers (if the EAP based primary authentication and key agreement procedure is triggered by a registration procedure for mobility and periodic registration update).

The UE shall stop the timer T3520, if running, and re-initiate the registration procedure for mobility and periodic registration update.

- c) Transmission failure of AUTHENTICATION RESPONSE message or AUTHENTICATION FAILURE message indication with TAI change from lower layers (if the EAP based primary authentication and key agreement procedure is triggered by a service request procedure).

The UE shall stop the timer T3520, if running.

If the current TAI is not in the TAI list, the EAP based primary authentication and key agreement procedure shall be aborted and a registration procedure for mobility and periodic registration update shall be initiated.

If the current TAI is still part of the TAI list, it is up to the UE implementation how to re-run the ongoing procedure that triggered the EAP based primary authentication and key agreement procedure.

...

- e) Network failing the authentication check.

If the UE deems that the network has failed the authentication check, then it shall request RRC to locally release the RRC connection and treat the active cell as barred (see 3GPP TS 38.304 [28]). The UE shall start any retransmission timers (e.g. T3510, T3517 or T3521), if they were running and stopped when the UE received the first AUTHENTICATION REQUEST message containing an ngKSI that was already in use.

For item e, whether or not the UE is registered for emergency services:

The UE shall stop timer T3520, if the timer is running and the UE enters 5GMM-IDLE mode, e.g. upon detection of a lower layer failure, release of the N1 NAS signalling connection, or as the result of an inter-system change in 5GMM-CONNECTED mode from N1 mode to S1 mode.

The UE shall deem that the network has failed the authentication check or assume that the authentication is not genuine and proceed as described in item e above if any of the following occurs:

- the timer T3520 expires;
- the UE detects any combination of the EAP-based authentication failures: transmission of AUTHENTICATION FAILURE message with 5GMM cause #71 "ngKSI already in use", transmission of AUTHENTICATION RESPONSE message with an EAP-response message after detecting an error as described in subclause 5.4.1.2.2.4 or with an EAP-response message after not accepting of the server certificate as described in subclause 5.4.1.2.3.1, during three consecutive authentication challenges. The EAP-request/AKA'-challenge challenges shall be considered as consecutive only, if the EAP-request/AKA'-challenge challenges causing the second and third EAP-based authentication failure are received by the UE, while the timer T3520 started after the previous EAP-based authentication failure is running. Not accepting of the server certificate shall be considered as consecutive only, if the EAP-request messages causing the second and third not accepting of the server certificate are received by the UE, while the timer T3520 started after the previous EAP request message causing the previous not accepting of the server certificate is running.

NOTE 2: Reception of an EAP-failure message is not considered when determining the three consecutive authentication challenges or three consecutive not accepting of the server certificate.

...

9.1.1.3.3 Test description

9.1.1.3.3.1 Pre-test conditions

System Simulator:

- NGC Cell A, NGC Cell B, NGC Cell C and NGC Cell D are configured according to table 6.3.2.2-1 in TS 38.508-1 [4].
- System information combination NR-2 as defined in TS 38.508-1 [4] clause 4.4.3.1.2 is used.

UE:

- None

Preamble:

- The UE is in state Switched OFF Mode (state 0N-B) according to TS 38.508-1 [4].

9.1.1.3.3.2 Test procedure sequence

Table 9.1.1.3.3.2-1: Main behaviour

St	Procedure	Message Sequence	TP	Verdict
----	-----------	------------------	----	---------

		U - S	Message		
1	The SS configures: - NGC Cell A as the "Serving cell". - NGC Cell B, NGC Cell C and NGC Cell D as a "Non-suitable 'Off' cell".	-	-	-	-
-	The following messages are to be observed on NGC Cell A unless explicitly stated otherwise.	-	-	-	-
2	The UE is switched on.	-	-	-	-
3-5	The UE establishes RRC connection by executing steps 2-4 of Table 4.5.2.2-2 in TS 38.508-1 [4] and transmits a REGISTRATION REQUEST message.	-->	5GMM: REGISTRATION REQUEST	-	-
6	SS transmits the EAP-request/AKA'-challenge message within an AUTHENTICATION REQUEST message, with ngKSI is already in use in the UE to initiate an EAP-AKA' procedure.	<--	5GMM: AUTHENTICATION REQUEST	-	-
7	Check: Does the UE respond with an AUTHENTICATION FAILURE message, with 5GMM cause "ngKSI already in use"?	-->	5GMM: AUTHENTICATION FAILURE	1	P
8	SS transmits the EAP-request/AKA'-challenge message within an AUTHENTICATION REQUEST message, with ngKSI is already in use in the UE to initiate an EAP-AKA' procedure.	<--	5GMM: AUTHENTICATION REQUEST	-	-
9	Check: Does the UE respond with an AUTHENTICATION FAILURE message, with 5GMM cause "ngKSI already in use"?	-->	5GMM: AUTHENTICATION FAILURE	1	P
10	The SS configures: - NGC Cell B as the "Serving cell". - NGC Cell A as a "Suitable neighbour intra-frequency cell".	-	-	-	-
11	SS transmits the EAP-request/AKA'-challenge message within an AUTHENTICATION REQUEST message, with ngKSI is already in use in the UE to initiate an EAP-AKA' procedure.	<--	5GMM: AUTHENTICATION REQUEST	-	-
11a	EXCEPTION: The UE may send an AUTHENTICATION FAILURE before locally releasing the RRC Connection	-->	5GMM: AUTHENTICATION FAILURE	-	-
-	The following messages are to be observed on NGC Cell B unless explicitly stated otherwise.	-	-	-	-
12-14	The UE establishes RRC connection by executing steps 2-4 of Table 4.5.2.2-2 in TS 38.508-1 [4].	-	-	-	-
15	Check: Does the UE transmit a REGISTRATION REQUEST message with the 5GS registration type IE setting as Initial registration?	-->	5GMM: REGISTRATION REQUEST	2	P
16	SS transmits the EAP-request/AKA'-challenge message within an AUTHENTICATION REQUEST message, with ngKSI is already in use in the UE to initiate an EAP-AKA' procedure.	<--	5GMM: AUTHENTICATION REQUEST	-	-
17	The UE responds with an AUTHENTICATION FAILURE message, with 5GMM cause "ngKSI already in use".	-->	5GMM: AUTHENTICATION FAILURE	-	-
17A	The SS starts timer of t_Waits=T3520.	-	-	-	-
18	The SS configures: - NGC Cell C as the "Serving cell". - NGC Cell B as a "Suitable neighbour intra-frequency cell". - NGC Cell A as the "Non-suitable 'Off' cell".	-	-	-	-

19	SS responds nothing and waits for the expiration of t_Waits.	-	-	-	-
-	The following messages are to be observed on NGC Cell C unless explicitly stated otherwise.	-	-	-	-
20-22	The UE establishes RRC connection by executing steps 2-4 of Table 4.5.2.2-2 in TS 38.508-1 [4].	-	-	-	-
23	Check: Does the UE transmit a REGISTRATION REQUEST message with the 5GS registration type IE setting as Initial registration?	-->	5GMM: REGISTRATION REQUEST	3	P
24-39a1	The registration procedure is successfully completed by executing steps 5 to 20a1 of the generic procedure in TS 38.508-1 [4] Table 4.5.2.2-2.	-	-	-	-
-	The UE is in end state Registered, Idle Mode (1N-A) on NGC Cell C according to TS 38.508-1 [4].	-	-	-	-
40-44	Void	-	-	-	-
45	The SS configures: - NGC Cell D as the "Serving cell", and the tracking area of NGC Cell D is not in the list of tracking areas that the UE previously registered. - NGC Cell C as the "Non-suitable 'Off' cell". - NGC Cell B as the "Non-suitable 'Off' cell".	-	-	-	-
46-47	Void	-	-	-	-
-	The following messages are to be observed on Cell D unless explicitly stated otherwise.	-	-	-	-
48-50	The UE establishes RRC connection by executing steps 2-4 of Table 4.5.2.2-2 in TS 38.508-1 [4].	-	-	-	-
51	The UE transmit a REGISTRATION REQUEST message with the 5GS registration type IE setting as Mobility registration updating.	-->	5GMM: REGISTRATION REQUEST	-	-
52	The SS cuts off the UL grant and RA Response. (Note 1)	-	-	-	-
53	SS transmits the EAP-request/AKA'-challenge message within a correct AUTHENTICATION REQUEST message to initiate an EAP-AKA' procedure.	<--	5GMM: AUTHENTICATION REQUEST	-	-
54	SS starts a timer t_Delay = 10s. (Note 2)	-	-	-	-
55	SS locally releases the RRC connection and waits for the expiration of t_Delay.	-	-	-	-
56	The SS turn on the UL grant and RA Response.	-	-	-	-
57-59	The UE establishes RRC connection by executing steps 1-3 of Table 4.9.5.2.2-1 in TS 38.508-1 [4].	-	-	-	-
60	Check: Does the UE transmit a REGISTRATION REQUEST message with the 5GS registration type IE setting as mobility registration updating?	-->	5GMM: REGISTRATION REQUEST	5	P
61-63a1	The registration procedure is successfully completed by executing steps 4 to 6a1 of the generic procedure in TS 38.508-1 [4] Table 4.9.5.2.2-1.	-	-	-	-
Note 1:	For transmission of the AUTHENTICATION RESPONSE message, the UE needs to initiate RACH to get UL grant. Since not RA Response, registration failure due to lower layer failure will occur, then timer T3511 will be started.				
Note 2:	Timer t_Delay is derived from timer T3511. During timer t_Delay, UE fails on transmission of the AUTHENTICATION RESPONSE message with the indication from lower layers.				

9.1.1.3.3.3 Specific message contents

Table 9.1.1.3.3.3-1: AUTHENTICATION REQUEST (step 6, 8, 11 and 16, Table 9.1.1.3.3.2-1)

Derivation path: TS 38.508-1 [4], table 4.7.1-1			
Information Element	Value/Remark	Comment	Condition
ngKSI	ngKSI	SS shall use the ngKSI is already in use in the UE	

Table 9.1.1.3.3.3-2: AUTHENTICATION FAILURE (step 7, 9, 11a1 and 17, Table 9.1.1.3.3.2-1)

Derivation path: TS 38.508-1 [4], table 4.7.1-4			
Information Element	Value/Remark	Comment	Condition
5GMM cause	'0100 0111'B	ngKSI already in use	

Table 9.1.1.3.3.3-3: REGISTRATION REQUEST (step 15 and step 23, Table 9.1.1.3.3.2-1)

Derivation path: TS 38.508-1 [4], table 4.7.1-6			
Information Element	Value/Remark	Comment	Condition
5GS registration type	'001'B	Initial registration	

Table 9.1.1.3.3.3-4: REGISTRATION REQUEST (step 51 and step 60, Table 9.1.1.3.3.2-1)

Derivation path: TS 38.508-1 [4], table 4.7.1-6			
Information Element	Value/Remark	Comment	Condition
5GS registration type	'010'B	Mobility registration updating	

Table 9.1.1.3.3.3-5: AUTHENTICATION REQUEST (step 53, Table 9.1.1.3.3.2-1)

Derivation path: TS 38.508-1 [4], table 4.7.1-1			
Information Element	Value/Remark	Comment	Condition
ngKSI	ngKSI	Different from the ngKSI assigned in step 24.	

9.1.1.4 5G AKA based primary authentication and key agreement / 5G-AKA related procedures

9.1.1.4.1 Test Purpose (TP)

(1)

```
with { the UE in 5GMM-REGISTERED-INITIATED state }
ensure that {
  when { the SS initiates a 5G AKA based primary authentication and key agreement procedure by
    sending AUTHENTICATION REQUEST with invalid MAC code }
  then { the UE sends an AUTHENTICATION FAILURE message to the network, with the 5GMM cause #20
    "MAC failure" }
}
```

(2)

```
with { the UE in 5GMM-REGISTERED-INITIATED state }
ensure that {
  when { the SS initiates a 5G AKA based primary authentication and key agreement procedure by
    sending AUTHENTICATION REQUEST with the "separation bit" in the AMF field of AUTN supplied by the
    core network is set to 0 }
  then { the UE sends an AUTHENTICATION FAILURE message to the network, with the 5GMM cause #26
    "non-5G authentication unacceptable" }
}
```

(3)

```
with { the UE in 5GMM-REGISTERED-INITIATED state }
ensure that {
  when { the SS initiates a 5G AKA based primary authentication and key agreement procedure by
    sending AUTHENTICATION REQUEST with the sequence number SQN to be out of range }
  then { the UE sends an AUTHENTICATION FAILURE message to the network, with the 5GMM cause #21
    "synch failure" and a re-synchronization token AUTS provided by the USIM }
}
```

(4)

```
with { the UE in 5GMM-REGISTERED-INITIATED state }
ensure that {
  when { the SS initiates a 5G AKA based primary authentication and key agreement procedure by
    sending AUTHENTICATION REQUEST }
  then { the UE process the 5G authentication challenge data and respond with an AUTHENTICATION
    RESPONSE message }
}
```

(5)

```
with { the UE in 5GMM-REGISTERED-INITIATED state and sends out an AUTHENTICATION RESPONSE message }
ensure that {
  when { the SS proceeds with the registration procedure }
  then { the UE consider the authentication procedure complete and succeed }
}
```

9.1.1.4.2 Conformance requirements

References: The conformance requirements covered in the present TC are specified in: TS 24.501 clauses 5.4.1.3.3, 5.4.1.3.6, 5.4.1.3.7. Unless otherwise stated these are Rel-15 requirements.

[TS 24.501, clause 5.4.1.3.3]

The UE shall respond to an AUTHENTICATION REQUEST message. With the exception of the cases described in subclause 5.4.1.3.5, the UE shall process the 5G authentication challenge data and respond with an AUTHENTICATION RESPONSE message to the network.

Upon a successful 5G authentication challenge, the new K_{AMF} calculated from the 5G authentication challenge data shall be stored in a new 5G NAS security context in the volatile memory of the ME.

[TS 24.501, clause 5.4.1.3.6]

In the 5G authentication challenge, the UE shall check the 5G authentication challenge data (RAND, AUTN and ngKSI) received in the AUTHENTICATION REQUEST message to verify authenticity of the 5G core network.

The ME shall check that ngKSI received in the AUTHENTICATION REQUEST message is not already in use. The ME shall forward the RAND and AUTN to the USIM to check.

The UE may reject the core network due to an incorrect AUTN or ngKSI parameter. If the UE has to reject the 5G authentication challenge, the UE shall return AUTHENTICATION FAILURE message to the network with a cause value indicating the reason for the failure (see 3GPP TS 33.501 [24]).

Incorrect 5G authentication challenge data contains four possible causes for authentication failure:

a) MAC code failure:

If the UE finds the MAC code (supplied by the core network in the AUTN parameter) to be invalid, the UE shall send an AUTHENTICATION FAILURE message to the network, with the 5GMM cause #20 "MAC failure". The UE shall then follow the procedure described in subclause 5.4.1.3.7, item c.

b) Non-5G authentication unacceptable:

If the UE finds that the "separation bit" in the AMF field of AUTN supplied by the core network is set to 0, the UE shall send an AUTHENTICATION FAILURE message to the network, with the 5GMM cause #26 "non-5G authentication unacceptable" (see subclause 6.1.3 in 3GPP TS 33.501 [24]). The UE shall then follow the procedure described in subclause 5.4.1.3.7, item d.

...

d) SQN failure:

If the UE finds the sequence number SQN (supplied by the core network in the AUTN parameter) to be out of range, the UE shall send an AUTHENTICATION FAILURE message to the network, with the 5GMM cause #21 "synch failure" and a re-synchronization token AUTS provided by the USIM (see 3GPP TS 33.102 [23]). The UE shall then follow the procedure described in subclause 5.4.1.3.7, item f.

[TS 24.501, clause 5.4.1.3.7]

c) Authentication failure (5GMM cause #20 "MAC failure").

The UE shall send an AUTHENTICATION FAILURE message, with 5GMM cause #20 "MAC failure" according to subclause 5.4.1.3.6, to the network and start timer T3520 (see example in figure 5.4.1.3.7.1). Furthermore, the UE shall stop any of the retransmission timers that are running (e.g. T3510, T3517 or T3521). Upon the first receipt of an AUTHENTICATION FAILURE message from the UE with 5GMM cause #20 "MAC failure", the network may initiate the identification procedure described in subclause 5.4.3. This is to allow the network to obtain the SUCI from the UE. The network may then check that the 5G-GUTI originally used in the 5G authentication challenge corresponded to the correct SUPI. Upon receipt of the IDENTITY REQUEST message from the network, the UE shall proceed as specified in subclause 5.4.3.3.

NOTE 1: Upon receipt of an AUTHENTICATION FAILURE message from the UE with 5GMM cause #20 "MAC failure", the network may also terminate the 5G AKA based primary authentication and key agreement procedure (see subclause 5.4.1.3.5).

If the mapping of 5G-GUTI to SUPI in the network was incorrect, the network should respond by sending a new AUTHENTICATION REQUEST message to the UE. Upon receiving the new AUTHENTICATION REQUEST message from the network, the UE shall stop the timer T3520, if running, and then process the 5G challenge information as normal. If the mapping of 5G-GUTI to SUPI in the network was correct, the network should terminate the 5G AKA based primary authentication and key agreement procedure by sending an AUTHENTICATION REJECT message (see subclause 5.4.1.3.5).

If the network is validated successfully (an AUTHENTICATION REQUEST message that contains a valid SQN and MAC is received), the UE shall send the AUTHENTICATION RESPONSE message to the network and shall start any retransmission timers (e.g. T3510, T3517 or T3521) if they were running and stopped when the UE received the first failed AUTHENTICATION REQUEST message.

If the UE receives the second AUTHENTICATION REQUEST message, and the MAC value cannot be resolved, the UE shall follow the procedure specified in this subclause, item c, starting again from the beginning, or if the message contains a UMTS authentication challenge, the UE shall follow the procedure specified in item d. If the SQN is invalid, the UE shall proceed as specified in item f.

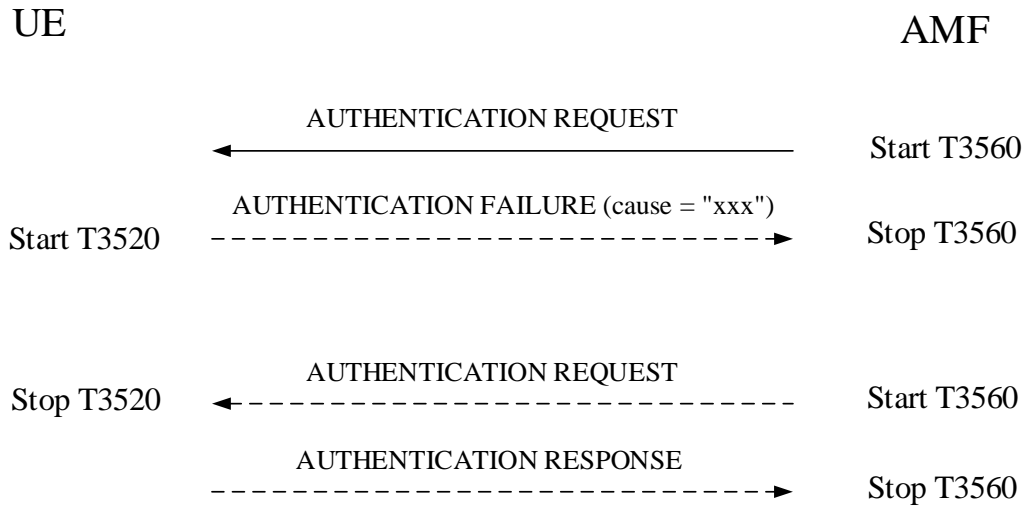

Figure 5.4.1.3.7.1: Authentication failure during 5G AKA based primary authentication and key agreement procedure

d) Authentication failure (5GMM cause #26 "non-5G authentication unacceptable").

The UE shall send an AUTHENTICATION FAILURE message, with 5GMM cause #26 "non-5G authentication unacceptable", to the network and start the timer T3520 (see example in figure 5.4.1.3.7.1). Furthermore, the UE shall stop any of the retransmission timers that are running (e.g. T3510, T3517 or T3521). Upon the first receipt of an AUTHENTICATION FAILURE message from the UE with 5GMM cause #26 "non-5G authentication unacceptable", the network may initiate the identification procedure described in subclause 5.4.3. This is to allow the network to obtain the SUCI from the UE. The network may then check that the 5G-GUTI originally used in the 5G authentication challenge corresponded to the correct SUPI. Upon receipt of the IDENTITY REQUEST message from the network, the UE shall proceed as specified in subclause 5.4.3.3.

NOTE 2: Upon receipt of an AUTHENTICATION FAILURE message from the UE with 5GMM cause #26 "non-5G authentication unacceptable", the network may also terminate the 5G AKA based primary authentication and key agreement procedure (see subclause 5.4.1.3.5).

If the mapping of 5G-GUTI to SUPI in the network was incorrect, the network should respond by sending a new AUTHENTICATION REQUEST message to the UE. Upon receiving the new AUTHENTICATION REQUEST message from the network, the UE shall stop the timer T3520, if running, and then process the 5G challenge information as normal. If the mapping of 5G-GUTI to SUPI in the network was correct, the network should terminate the 5G AKA based primary authentication and key agreement authentication procedure by sending an AUTHENTICATION REJECT message (see subclause 5.4.1.3.5).

...

f) Authentication failure (5GMM cause #21 "synch failure").

The UE shall send an AUTHENTICATION FAILURE message, with 5GMM cause #21 "synch failure", to the network and start the timer T3520 (see example in figure 5.4.1.3.7.1). Furthermore, the UE shall stop any of the retransmission timers that are running (e.g. T3510, T3517 or T3521). Upon the first receipt of an AUTHENTICATION FAILURE message from the UE with the 5GMM cause #21 "synch failure", the network shall use the returned AUTS parameter from the authentication failure parameter IE in the AUTHENTICATION FAILURE message, to re-synchronise. The re-synchronisation procedure requires the AMF to delete all unused authentication vectors for that SUPI and obtain new vectors from the UDM/AUSF. When re-synchronisation is

complete, the network shall initiate the 5G AKA based primary authentication and key agreement procedure. Upon receipt of the AUTHENTICATION REQUEST message, the UE shall stop the timer T3520, if running.

NOTE 4: Upon receipt of two consecutive AUTHENTICATION FAILURE messages from the UE with 5GMM cause #21 "synch failure", the network may terminate the 5G AKA based primary authentication and key agreement procedure by sending an AUTHENTICATION REJECT message.

If the network is validated successfully (a new AUTHENTICATION REQUEST message is received which contains a valid SQN and MAC) while T3520 is running, the UE shall send the AUTHENTICATION RESPONSE message to the network and shall start any retransmission timers (e.g. T3510, T3517 or T3521), if they were running and stopped when the UE received the first failed AUTHENTICATION REQUEST message.

Upon receipt of an AUTHENTICATION REJECT message, the UE shall perform the actions as specified in subclause 5.4.1.3.5.

9.1.1.4.3 Test description

9.1.1.4.3.1 Pre-test conditions

System Simulator:

- NR cell A.

UE:

- None.

Preamble:

- the UE is in state Switched OFF (state 0N-B) according to TS 38.508-1 [4].

9.1.1.4.3.2 Test procedure sequence

Table 9.1.1.4.3.2-1: Main behaviour

St	Procedure	Message Sequence		TP	Verdict
		U - S	Message		
1	Switch the UE on	-	-	-	-
2-4	The UE establishes RRC connection and initiates registration procedure by executing steps 2-4 of Table 4.5.2.2-2 in TS 38.508-1 [4].	-	-	-	-
5	The SS transmits an AUTHENTICATION REQUEST message which contains an invalid MAC code.	<--	AUTHENTICATION REQUEST	-	-
6	Check: Does the UE respond with an AUTHENTICATION FAILURE message with 5GMM cause "MAC failure"?	-->	AUTHENTICATION FAILURE	1	P
7	SS transmits a correct AUTHENTICATION REQUEST message with RAND different to the one send in Step 5	<--	AUTHENTICATION REQUEST	-	-
8	Check: Does the UE respond with a correct AUTHENTICATION RESPONSE message with RES* that is equal to the XRES* calculated in the SS?	-->	AUTHENTICATION RESPONSE	4	P
9	SS transmits a NAS SECURITY MODE COMMAND message including the ngKSI of the new 5G NAS security context (as provided in step 7), to proceed with the registration procedure.	<--	SECURITY MODE COMMAND	-	-
10	Check: Does the UE respond with NAS SECURITY MODE COMPLETE message integrity protected and ciphered with the new 5G NAS security context identified by the ngKSI received in the SECURITY MODE	-->	SECURITY MODE COMPLETE	5	P

	COMMAND message in step 9.				
11-20a1	Steps 10-19a1 of the generic procedure (TS 38.508-1 Table 4.5.2.2-2 [4]) are executed to successfully complete the registration procedure.	-	-	-	-
21	Switch off UE in RRC_CONNECTED as described in TS 38.508-1 [4] subclause 4.9.6.3	-	-	-	-
22-25	Steps 1-4 above are repeated	-	-	-	-
26	SS transmits an AUTHENTICATION REQUEST message with "separation bit" in the AMF field is 0.	<--	AUTHENTICATION REQUEST	-	-
27	Check: Does the UE respond with an AUTHENTICATION FAILURE message, with 5GMM cause " Non-5G authentication unacceptable "?	-->	AUTHENTICATION FAILURE	2	P
28	SS transmits a correct AUTHENTICATION REQUEST message with RAND different to the one send in Step 26	<--	AUTHENTICATION REQUEST	-	-
29	Check: Does the UE respond with a correct AUTHENTICATION RESPONSE message with RES* that is equal to the XRES* calculated in the SS?	-->	AUTHENTICATION RESPONSE	4	P
30-41a1	Steps 8-19a1 of the generic procedure (TS 38.508-1 Table 4.5.2.2-2 [4]) are executed to successfully complete the registration procedure.	-	-	-	-
42	Switch off UE in RRC_CONNECTED as described in TS 38.508-1 [4] subclause 4.9.6.3	-	-	-	-
43-46	Steps 1-4 above are repeated	-	-	-	-
47	SS transmits AUTHENTICATION REQUEST message with the AMF field in the IE "Authentication parameter AUTN" set to "AMF _{RESYNCH} " value to trigger SQN re-synchronisation procedure in test USIM	<--	AUTHENTICATION REQUEST	-	-
48	Check: Does the UE respond with an AUTHENTICATION FAILURE message, with 5GMM cause "Synch failure" and Authentication failure parameter?	-->	AUTHENTICATION FAILURE	3	P
49	SS transmits a correct AUTHENTICATION REQUEST message with RAND different to the one send in Step 47.	<--	AUTHENTICATION REQUEST	-	-
50	Check: Does the UE respond with a correct AUTHENTICATION RESPONSE message with RES* that is equal to the XRES* calculated in the SS?	-->	AUTHENTICATION RESPONSE	4	P
51-62a1	Steps 8-19a1 of the generic procedure (TS 38.508-1 Table 4.5.2.2-2 [4]) are executed to successfully complete the registration procedure.	-	-	-	-

9.1.1.4.3.3 Specific message contents

Table 9.1.1.4.3.3-1: AUTHENTICATION RESPONSE (step 8, step 29 and step 50, Table 9.1.1.4.3.2-1)

Derivation path: TS 38.508, Table 4.7.1-2			
Information Element	Value/remark	Comment	Condition
Authentication response parameter	RES* equal to the XRES* calculated in the SS with the parameters provided/indicated in the AUTHENTICATION REQUEST		

Table 9.1.1.4.3.3-2: AUTHENTICATION REQUEST (step 5, Table 9.1.1.4.3.2-1)

Derivation path: TS 38.508, Table 4.7.1-1			
Information Element	Value/remark	Comment	Condition
Authentication parameter AUTN	Invalid MAC	SS shall calculate the correct MAC value as specified in TS 33.102 and use any different value, e.g. correct_MAC+5.	

Table 9.1.1.4.3.3-3: AUTHENTICATION FAILURE (step 6, Table 9.1.1.4.3.2-1)

Derivation path: TS 38.508, Table 4.7.1-4			
Information Element	Value/remark	Comment	Condition
5GMM cause	'0001 0100'B	MAC failure	

Table 9.1.1.4.3.3-4: AUTHENTICATION REQUEST (step 26, Table 9.1.1.4.3.2-1)

Derivation path: TS 38.508, Table 4.7.1-1			
Information Element	Value/remark	Comment	Condition
Authentication parameter AUTN	"separation bit"=0	The "separation bit" in the AMF field of AUTN supplied by the core network is 0.	

Table 9.1.1.4.3.3-5: AUTHENTICATION FAILURE (step 27, Table 9.1.1.4.3.2-1)

Derivation path: TS 38.508, Table 4.7.1-4			
Information Element	Value/remark	Comment	Condition
5GMM cause	'0001 1010'B	Non-5G authentication unacceptable	

Table 9.1.1.4.3.3-6: AUTHENTICATION REQUEST (step 47, Table 9.1.1.4.3.2-1)

Derivation path: TS 38.508, Table 4.7.1-1			
Information Element	Value/remark	Comment	Condition
Authentication parameter AUTN	AMF field set to "AMF _{RESYNCH} ", AMF _{RESYNCH} = '1111 1111 1111 1111'B	AMF _{RESYNCH} see TS 34.108, 8.1.2.2	

Table 9.1.1.4.3.3-7: AUTHENTICATION FAILURE (step 48, Table 9.1.1.4.3.2-1)

Derivation path: TS 38.508, Table 4.7.1-4			
Information Element	Value/remark	Comment	Condition
5GMM cause	'0001 0101'B	Synch failure	
Authentication failure parameter	AUTS	AUTS see TS 34.108, 8.1.2.2	

9.1.1.5 5G AKA based primary authentication and key agreement / Reject

9.1.1.5 Test Purpose (TP)

(1)

```
with { the UE in 5GMM-REGISTERED-INITIATED state and SS initiates a 5G AKA based primary
authentication and key agreement procedure }
ensure that {
  when { the SS sends an a AUTHENTICATION REJECT message }
  then { the UE deletes the stored 5G-GUTI, last visited registered TAI and ngKSI and enter state
5GMM-DEREGISTERED, the USIM is considered invalid until switching off the UE. }
}
```

9.1.1.5.2 Conformance requirements

References: The conformance requirements covered in the current TC are specified in: TS 24.501 clauses 5.4.1.3.5. Unless otherwise stated these are Rel-15 requirements.

[TS 24.501, clause 5.4.1.3.5]

If the authentication response (RES) returned by the UE is not valid, the network response depends upon the type of identity used by the UE in the initial NAS message, that is:

- if the 5G-GUTI was used; or
- if the SUCI was used.

If the 5G-GUTI was used, the network should initiate an identification procedure to retrieve SUCI from the UE and restart the 5G AKA based primary authentication and key agreement procedure with the received SUCI.

If the SUCI was used for identification in the initial NAS message or in a restarted 5G AKA based primary authentication and key agreement procedure, or the network decides not to initiate the identification procedure to retrieve SUCI from the UE after an unsuccessful 5G AKA based primary authentication and key agreement procedure, the network should send an AUTHENTICATION REJECT message to the UE.

Upon receipt of an AUTHENTICATION REJECT message,

- 1) if the message has been successfully integrity checked by the NAS, the UE shall set the update status to 5U3 ROAMING NOT ALLOWED, delete the stored 5G-GUTI, TAI list, last visited registered TAI and ngKSI.

In case of PLMN, the USIM shall be considered invalid until switching off the UE or the UICC containing the USIM is removed. In case of SNPN, the entry of the "list of subscriber data" with the SNPN identity of the current SNPN shall be considered invalid until the UE is switched off or the entry is updated.

- The UE shall set:

- i) the counter for "SIM/USIM considered invalid for GPRS services" events and the counter for "SIM/USIM considered invalid for 5GS services over non-3GPP access" events in case of PLMN; or
- ii) the counter for "the entry for the current SNPN considered invalid for 3GPP access" events in case of SNPN;

to UE implementation-specific maximum value. If the UE maintains a counter for "SIM/USIM considered invalid for non-GPRS services", then the UE shall set this counter to UE implementation-specific maximum value; and

- if the UE is operating in single-registration mode, the UE shall handle 4G-GUTI, TAI list and eKSI as specified in 3GPP TS 24.301 [15] for the case when the authentication procedure is not accepted by the network. The USIM shall be considered as invalid also for non-EPS services until switching off or the UICC containing the USIM is removed.

- 2) if the message is received without integrity protection, the UE shall start timer T3247 with a random value uniformly drawn from the range between 30 minutes and 60 minutes, if the timer is not running (see subclause 5.3.20). Additionally, the UE shall:

- a) if the message is received over 3GPP access, and the counter for "SIM/USIM considered invalid for GPRS services" events or the counter for "the entry for the current SNPN considered invalid for 3GPP access" events has a value less than a UE implementation-specific maximum value, proceed as specified in subclause 5.3.20, list item 1)-a) of clause 5.3.20.2 (if the UE is not SNPN enabled or is not operating in SNPN access mode) or list item a) of clause 5.30.20.3 (if the UE is operating in SNPN access mode) for the case that the 5GMM cause value received is #3;
- b) if the message is received over non-3GPP access, and the counter for "SIM/USIM considered invalid for 5GS services over non-3GPP access" events has a value less than a UE implementation-specific maximum value, proceed as specified in subclause 5.3.20, list item 1)-b) of clause 5.3.20.2 for the case that the 5GMM cause value received is #3.
- c) otherwise
- i) if the 5GMM cause value is received over 3GPP access, the UE shall:
- set the update status for 3GPP access to 5U3 ROAMING NOT ALLOWED, delete for 3GPP access only the stored 5G-GUTI, TAI list, last visited registered TAI and ngKSI. The USIM shall be considered invalid for 5GS services via 3GPP access and non-EPS service until switching off the UE or the UICC containing the USIM is removed or the entry of the "list of subscriber data" with the SNPN identity of the current SNPN shall be considered invalid for 3GPP access until the UE is switched off or the entry is updated.
 - The UE shall set the counter for "SIM/USIM considered invalid for GPRS services" events or the counter for "the entry for the current SNPN considered invalid for 3GPP access" events to UE implementation-specific maximum value. If the UE maintains a counter for "SIM/USIM considered invalid for non-GPRS services", then the UE shall set this counter to UE implementation-specific maximum value.
 - If the UE is operating in single-registration mode, the UE shall handle 4G-GUTI, TAI list and eKSI as specified in 3GPP TS 24.301 [15] for the case when the authentication procedure is not accepted by the network. The USIM shall be considered as invalid also for non-EPS services until switching off or the UICC containing the USIM is removed; and
- ii) if the 5GMM cause value is received over non-3GPP access, the UE shall:
- set the update status for non-3GPP access to 5U3 ROAMING NOT ALLOWED, delete for non-3GPP access only the stored 5G-GUTI, TAI list, last visited registered TAI and ngKSI. The USIM shall be considered invalid for 5GS services via non-3GPP access until switching off the UE or the UICC containing the USIM is removed.
- The UE shall set the counter for "SIM/USIM considered invalid for 5GS services over non-3GPP access" events to UE implementation-specific maximum value.

If the AUTHENTICATION REJECT message is received by the UE, the UE shall abort any 5GMM signalling procedure, stop any of the timers T3510, T3516, T3517, T3519 or T3521 (if they were running), enter state 5GMM-DEREGISTERED and delete any stored SUCI.

Depending on local requirements or operator preference for emergency services, if the UE initiates a registration procedure with 5GS registration type IE set to "emergency registration" and the AMF is configured to allow emergency registration without user identity, the AMF needs not follow the procedures specified for the authentication failure in the present subclause. The AMF may continue a current 5GMM specific procedure.

9.1.1.5.3 Test description

9.1.1.5.3.1 Pre-test conditions

System Simulator:

- NGC Cell A "Serving cell" TS 38.508-1 [4] Table 6.2.2.1-3

UE:

- None

Preamble:

- The UE is in state Switched OFF (state ON-B) according to TS 38.508-1 [4].

9.1.1.5.3.2 Test procedure sequence

Table 9.1.1.5.3.2-1: Main behaviour

St	Procedure	Message Sequence		TP	Verdict
		U - S	Message		
1	The UE is switched on.	-	-	-	-
2-4	The UE executes steps 2-4 of Table 4.5.2.2-2 in TS38.508-1 [4].	-	-	-	-
5	The SS transmits an AUTHENTICATION REQUEST message		5GMM: AUTHENTICATION REQUEST	-	-
6	The UE transmits an AUTHENTICATION RESPONSE		5GMM: AUTHENTICATION RESPONSE	-	-
7	The SS transmits an AUTHENTICATION REJECT message	<--	5GMM: AUTHENTICATION REJECT	-	-
8	SS releases the RRC connection	-	-	-	-
9	Check: Does the UE transmit an RRCSetupRequest message for initial registration procedure within the next 30 seconds?	-->	NR RRC: RRCSetupRequest	1	F
10	The UE is switched off by executing generic procedure in Table 4.9.6.4-1 in TS 38.508-1 [4].	-	-	-	-
11	The UE is switched on.	-	-	-	-
12	Check: Does the UE transmit a REGISTRATION REQUEST message?	-->	5GMM: REGISTRATION REQUEST	1	P
13-28a 1	The UE executes steps 5-20a1 of Table 4.5.2.2-2 in TS 38.508-1 [4] complete registration procedure.	-	-	-	-

9.1.1.5.3.3 Specific message contents

Table 9.1.1.5.3.3-1: REGISTRATION REQUEST (step 4, Table 9.1.1.5.3.2-1)

Derivation path: TS 38.508-1 [4], table 4.7.1-6			
Information Element	Value/Remark	Comment	Condition
5GS registration type			
5GS registration type value	'001'B	initial registration	

Table 9.1.1.5.3.3-2: REGISTRATION REQUEST (step 12, Table 9.1.1.5.3.2-1)

Derivation path: TS 38.508-1 [4], table 4.7.1-6			
Information Element	Value/Remark	Comment	Condition
5GS registration type			
5GS registration type value	'001'B	initial registration	
ngKSI	'111'	no key is available	
5GS mobile identity	SUCI of the UE	a freshly generated SUCI	
Last visited registered TAI	Not present		

9.1.1.6 5G AKA based primary authentication and key agreement / Abnormal

9.1.1.6 Test Purpose (TP)

(1)

```
with { the UE in 5GMM-REGISTERED-INITIATED state }
ensure that {
  when { the SS initiates a 5G AKA based primary authentication and key agreement procedure by
    sending AUTHENTICATION REQUEST with ngKSI is already in use }
    then { the UE sends an AUTHENTICATION FAILURE message to the network, with the 5GMM cause #71
      "ngKSI already in use" }
}
```

(2)

```
with { the UE in 5GMM-REGISTERED-INITIATED state }
ensure that {
  when { the third time SS initiates 5G AKA based primary authentication and key agreement procedure
    by sending AUTHENTICATION REQUEST with ngKSI is already in use }
    then { the UE locally releases the RRC connection and treats the active cell as barred }
}
```

(3)

```
with { the UE in 5GMM-REGISTERED-INITIATED state, the SS sends an AUTHENTICATION REQUEST with ngKSI
  is already in use and the UE sends an AUTHENTICATION FAILURE message }
ensure that {
  when { T3520 times out }
    then { the UE locally releases the RRC connection and treats the active cell as barred }
}
```

(4)

Void

(5)

```
with { the UE in 5GMM-REGISTERED state and initiates a mobility registration update procedure }
ensure that {
  when { the SS initiates a 5G AKA based primary authentication and key agreement procedure by
    sending AUTHENTICATION REQUEST and the UE fails on transmission of AUTHENTICATION RESPONSE message
    with the indication from lower layers }
    then { the UE re-initiate the mobility registration update procedure }
}
```

9.1.1.6.2 Conformance requirements

References: The conformance requirements covered in the current TC are specified in: TS 24.501 clauses 5.4.1.3.7. Unless otherwise stated these are Rel-15 requirements.

[TS 24.501, clause 5.4.1.3.7]

- e) Authentication failure (5GMM cause #71 "ngKSI already in use").

The UE shall send an AUTHENTICATION FAILURE message, with 5GMM cause #71 "ngKSI already in use", to the network and start the timer T3520 (see example in figure 5.4.1.3.7.1). Furthermore, the UE shall stop any of the retransmission timers that are running (e.g. T3510, T3517 or T3521). Upon the first receipt of an AUTHENTICATION FAILURE message from the UE with 5GMM cause #71 "ngKSI already in use", the network performs necessary actions to select a new ngKSI and send the same 5G authentication challenge to the UE.

...

- g) Network failing the authentication check.

If the UE deems that the network has failed the authentication check, then it shall request RRC to locally release the RRC connection and treat the active cell as barred (see 3GPP TS 38.304 [28]). The UE shall start any

retransmission timers (e.g. T3510, T3517 or T3521), if they were running and stopped when the UE received the first AUTHENTICATION REQUEST message containing an incorrect authentication challenge data causing authentication failure.

- h) Transmission failure of AUTHENTICATION RESPONSE message or AUTHENTICATION FAILURE message indication from lower layers (if the 5G AKA based primary authentication and key agreement procedure is triggered by a registration procedure for mobility and periodic registration update).

The UE shall stop the timer T3520, if running, and re-initiate the registration procedure for mobility and periodic registration update.

...

- i) Transmission failure of AUTHENTICATION RESPONSE message or AUTHENTICATION FAILURE message indication with TAI change from lower layers (if the 5G AKA based primary authentication and key agreement procedure is triggered by a service request procedure).

The UE shall stop the timer T3520, if running.

If the current TAI is not in the TAI list, the 5G AKA based primary authentication and key agreement procedure shall be aborted and a registration procedure for mobility and periodic registration update shall be initiated.

If the current TAI is still part of the TAI list, it is up to the UE implementation how to re-run the ongoing procedure that triggered the 5G AKA based primary authentication and key agreement procedure.

...

For items c, d, e, and f whether or not the UE is registered for emergency services:

...

The UE shall deem that the network has failed the authentication check or assume that the authentication is not genuine and proceed as described in item g above if any of the following occurs:

- the timer T3520 expires;
- the UE detects any combination of the 5G authentication failures: 5GMM causes #20 "MAC failure", #21 "synch failure", #26 "non-5G authentication unacceptable" or #71 "ngKSI already in use", during three consecutive authentication challenges. The 5G authentication challenges shall be considered as consecutive only, if the 5G authentication challenges causing the second and third 5G authentication failure are received by the UE, while the timer T3520 started after the previous 5G authentication failure is running.

9.1.1.6.3 Test description

9.1.1.6.3.1 Pre-test conditions

System Simulator:

- NGC Cell A, NGC Cell B, NGC Cell C and NGC Cell D are configured according to table 6.3.2.2-1 in TS 38.508-1 [4].
- The SS configures the NGC Cell A as the "Serving cell" and other NGC Cells as "Non-suitable "Off" cell".
- System information combination NR-2 as defined in TS 38.508-1 [4] clause 4.4.3.1.2 is used.

UE:

- None.

Preamble:

- The UE is in test state 0N-B on NGC Cell A according to TS 38.508-1 [4]. The ngKSI-1 has been assigned and security context has been established.

9.1.1.6.3.2 Test procedure sequence

Table 9.1.1.6.3.2-1: Main behaviour

St	Procedure	Message Sequence		TP	Verdict
		U - S	Message		
-	The following messages are to be observed on NGC Cell A unless explicitly stated otherwise.	-	-	-	-
0	The UE is switched on.	-	-	-	-
0A	The UE establishes RRC connection by executing steps 2-4 of Table 4.5.2.2-2 in TS 38.508-1 [4] and transmits a REGISTRATION REQUEST message.	-->	5GMM: REGISTRATION REQUEST	-	-
1	The SS initiates a 5G AKA based primary authentication and key agreement procedure by sending AUTHENTICATION REQUEST with ngKSI is already in use (ngKSI-1).	<--	5GMM: AUTHENTICATION REQUEST	-	-
2	Check: Does the UE send an AUTHENTICATION FAILURE message to the network, with the 5GMM cause #71 "ngKSI already in use"?	-->	5GMM: AUTHENTICATION FAILURE	1	P
3	The SS initiates a 5G AKA based primary authentication and key agreement procedure by sending AUTHENTICATION REQUEST with ngKSI is already in use (ngKSI-1).	<--	5GMM: AUTHENTICATION REQUEST	-	-
4	Check: Does the UE send an AUTHENTICATION FAILURE message to the network, with the 5GMM cause #71 "ngKSI already in use"?	-->	5GMM: AUTHENTICATION FAILURE	1	P
5	Void	-	-	-	-
6	The SS initiates a 5G AKA based primary authentication and key agreement procedure by sending AUTHENTICATION REQUEST with ngKSI is already in use (ngKSI-1).	<--	5GMM: AUTHENTICATION REQUEST	-	-
6a1	EXCEPTION: The UE may send an AUTHENTICATION FAILURE before locally releasing the RRC Connection.	-->	5GMM: AUTHENTICATION FAILURE	-	-
6A	Check: Does the UE transmit a RRCSetupRequest on NGC Cell A in the next 30 seconds? (Note 1)	-->	5G RRC: RRCSetupRequest	2	F
6B	The SS configures: -NGC Cell B as the "Serving cell". -NGC Cell A as a "Suitable neighbour intra-frequency cell".	-	-	-	-
-	The following messages are to be observed on NGC Cell B unless explicitly stated otherwise.	-	-	-	-
7-9	The UE establishes RRC connection by executing steps 2-4 of Table 4.5.2.2-2 in TS 38.508-1 [4].	-	-	-	-
10	Check: Does the UE transmit a REGISTRATION REQUEST message with the 5GS registration type IE setting as initial registration?	-->	5GMM: REGISTRATION REQUEST	2	P
11	The SS initiates a 5G AKA based primary authentication and key agreement procedure by sending AUTHENTICATION REQUEST with ngKSI is already in use (ngKSI-1).	<--	5GMM: AUTHENTICATION REQUEST	-	-
12	The UE sends an AUTHENTICATION FAILURE message to the network, with the 5GMM cause #71 "ngKSI already in use".	-->	5GMM: AUTHENTICATION FAILURE	-	-
12 A	SS starts timer of t_Waits=T3520.	-	-	-	-
13	Void	-	-	-	-
14	SS waits for the expiration of t_Waits.	-	-	-	-
14 A	Check: Does the UE transmit a RRCSetupRequest on NGC Cell B in the next 30 seconds? (Note 1)	-->	5G RRC: RRCSetupRequest	2	F

14 B	The SS configures: -NGC Cell C as the "Serving cell". -NGC Cell B as a "Suitable neighbour intra-frequency cell". -NGC Cell A as a "Non-suitable "Off" cell"	-	-	-	-
-	The following messages are to be observed on NGC Cell C unless explicitly stated otherwise.	-	-	-	-
15- 17	The UE establishes RRC connection by executing steps 2-4 of Table 4.5.2.2-2 in TS38.508-1 [4].	-	-	-	-
18	Check: Does the UE transmit a REGISTRATION REQUEST message with the 5GS registration type IE setting as initial registration?	-->	5GMM: REGISTRATION REQUEST	3	P
19- 34a 1	Steps 5-20a1 of Table 4.5.2.2-2 of the generic procedure in TS 38.508-1 [4] are performed.	-	-	-	-
35- 39	Void				
40	The SS configures: - NGC Cell D as the "Serving cell". - NGC Cell C as a "Non-suitable "Off" cell ". - NGC Cell B as a "Non-suitable "Off" cell ".	-	-	-	-
41- 42	Void				
-	The following messages are to be observed on NGC Cell D unless explicitly stated otherwise.	-	-	-	-
43- 45	The UE establishes RRC connection by executing steps 2-4 of Table 4.5.2.2-2 in TS 38.508-1 [4].	-	-	-	-
46	The UE transmit a REGISTRATION REQUEST message with the 5GS registration type IE setting as Mobility registration updating.	-->	5GMM: REGISTRATION REQUEST	-	-
47	The SS cuts off the UL grant and RA Response, so that the UE cannot send the AUTHENTICATION RESPONSE to SS.	-	-	-	-
48	SS transmits an AUTHENTICATION REQUEST message with ngKSI-2 to initiate the 5G-AKA procedure.	<--	5GMM: AUTHENTICATION REQUEST	-	-
49	SS starts timer of t_Delay =10s. (Note2).	-	-	-	-
50	SS performs local release.	-	-	-	-
51	Check whether t_Delay is still running, if it's running, then waiting for timeout.	-	-	-	-
52	SS configures the RA Response.	-	-	-	-
53	Check: Does the test result of generic test procedure in TS 38.508-1 [4] subclause 4.9.5 indicate that the UE is camped on NGC Cell D, with 'connected without release'?	-	-	5	P
<p>Note 1: If the cell is not barred, after the transmission of REGISTRATION REQUEST, the UE will start T3510 and T3511. After 25s (T3510+T3511), the UE shall send REGISTRATION REQUEST.</p> <p>Note 2: To send the AUTHENTICATION RESPONSE, the UE will initiate RACH to get UL grant. Since there is no RA Response, registration failure due to lower layer failure will occur, then T3511 will start. Timer t_Delay is derived from T3511. During timer t_Delay, UE fails on transmission of AUTHENTICATION RESPONSE message with the indication from lower layers.</p>					

9.1.1.6.3.3 Specific message contents

Table 9.1.1.6.3.3-1: AUTHENTICATION REQUEST (step 1, step 3, step 6 and step 11, Table 9.1.1.6.3.2-1)

Derivation path: TS 38.508-1 [4], table 4.7.1-1			
Information Element	Value/Remark	Comment	Condition
ngKSI	ngKSI-1	The same with the	

		ng-KSI assigned in Preamble.	
--	--	------------------------------	--

Table 9.1.1.6.3.3-2: AUTHENTICATION FAILURE (step 2, step 4, step 6a1 and step 12, Table 9.1.1.6.3.2-1)

Derivation path: TS 38.508-1 [4], table 4.7.1-4			
Information Element	Value/Remark	Comment	Condition
5GMM cause	'0100 0111'B	ngKSI already in use	

Table 9.1.1.6.3.3-3: AUTHENTICATION REQUEST (step 48, Table 9.1.1.6.3.2-1)

Derivation path: TS 38.508-1 [4], table 4.7.1-1			
Information Element	Value/Remark	Comment	Condition
ngKSI	ngKSI-2	Different from the ng-KSI assigned in step 19	

Table 9.1.1.6.3.3-4: REGISTRATION REQUEST (step 10 and step 18, Table 9.1.1.6.3.2-1)

Derivation path: TS 38.508-1 [4], table 4.7.1-6			
Information Element	Value/Remark	Comment	Condition
5GS registration type			
5GS registration type value	'001'B	initial registration	

Table 9.1.1.6.3.3-5: REGISTRATION REQUEST (step 46, Table 9.1.1.6.3.2-1)

Derivation path: TS 38.508-1 [4], table 4.7.1-6			
Information Element	Value/Remark	Comment	Condition
5GS registration type			
5GS registration type value	'010'B	mobility registration updating	

9.1.2 Security mode control

9.1.2.1 NAS security mode command

9.1.2.1.1 Test Purpose (TP)

(1)

```
with { the UE is in 5GMM-REGISTERED-INITIATED state and the SS initiates the NAS security mode control procedure by sending a SECURITY MODE COMMAND message during initial registration procedure }
ensure that {
  when { the UE receives an integrity protected SECURITY MODE COMMAND message including not matching replayed security capabilities }
  then { the UE send a SECURITY MODE REJECT message and does not start applying the NAS security in both UL and DL }
}
```

(2)

```
with { the UE is in 5GMM-REGISTERED-INITIATED state and the SS initiates the NAS security mode control procedure by sending a SECURITY MODE COMMAND message during initial registration procedure }
ensure that {
  when { the UE receives an integrity protected SECURITY MODE COMMAND message including IMEISV request }
}
```

```
    then { the UE send an integrity protected and ciphered SECURITY MODE COMPLETE message including  
IMEISV and starts applying the NAS Security in both UL and DL }  
    }
```

9.1.2.1.2 Conformance requirements

References: The conformance requirements covered in the present test case are specified in: TS 24.501, clauses 5.4.2.1, 5.4.2.3 and 5.4.2.5. Unless otherwise stated these are Rel-15 requirements.

[TS 24.501, clause 5.4.2.1]

The purpose of the NAS security mode control procedure is to take a 5G NAS security context into use, and initialise and start NAS signalling security between the UE and the AMF with the corresponding 5G NAS keys and 5G NAS security algorithms.

Furthermore, the network may also initiate the security mode control procedure in the following cases:

- a) in order to change the 5G NAS security algorithms for a current 5G NAS security context already in use;
- b) in order to change the value of uplink NAS COUNT used in the latest SECURITY MODE COMPLETE message as described in 3GPP TS 33.501 [24], subclause 6.9.4.4.
- c) in order to provide the Selected EPS NAS security algorithms to the UE.

For restrictions concerning the concurrent running of a security mode control procedure with other security related procedures in the AS or inside the core network see 3GPP TS 33.501 [24], subclause 6.9.5.

[TS 24.501, clause 5.4.2.3]

Upon receipt of the SECURITY MODE COMMAND message, the UE shall check whether the security mode command can be accepted or not. This is done by performing the integrity check of the message, and by checking that the received Replayed UE security capabilities IE has not been altered compared to the latest values that the UE sent to the network.

When the SECURITY MODE COMMAND message includes an EAP-success message the UE handles the EAP-success message and the ABBA as described in subclause 5.4.1.2.2.8 and 5.4.1.2.3.1.

If:

- a) the UE is registered for emergency services, performing initial registration for emergency services or establishing an emergency PDU session; or
- b) the W-AGF acts on behalf of the FN-RG;

and the SECURITY MODE COMMAND message is received with ngKSI value "000" and 5G-IA0 and 5G-EA0 as selected 5G NAS security algorithms, the UE shall locally derive and take in use 5G NAS security context. The UE shall delete existing current 5G NAS security context.

The UE shall accept a SECURITY MODE COMMAND message indicating the "null integrity protection algorithm" 5G-IA0 as the selected 5G NAS integrity algorithm only if the message is received when the UE is registered for emergency services, performing initial registration for emergency services or establishing an emergency PDU session or when the W-AGF acts on behalf of the FN-RG.

If the type of security context flag included in the SECURITY MODE COMMAND message is set to "native security context" and if the ngKSI matches a valid non-current native 5G NAS security context held in the UE while the UE has a mapped 5G NAS security context as the current 5G NAS security context, the UE shall take the non-current native 5G NAS security context into use which then becomes the current native 5G NAS security context and delete the mapped 5G NAS security context.

The UE shall ignore the Replayed S1 UE security capabilities IE if this IE is included in the SECURITY MODE COMMAND message.

If the SECURITY MODE COMMAND message can be accepted, the UE shall take the 5G NAS security context indicated in the message into use. The UE shall in addition reset the uplink NAS COUNT counter if:

- a) the SECURITY MODE COMMAND message is received in order to take a 5G NAS security context into use created after a successful execution of the 5G AKA based primary authentication and key agreement procedure or the EAP based primary authentication and key agreement procedure; or
- b) the SECURITY MODE COMMAND message received includes the type of security context flag set to "mapped security context" in the NAS key set identifier IE the ngKSI does not match the current 5G NAS security context, if it is a mapped 5G NAS security context.

If the SECURITY MODE COMMAND message can be accepted and a new 5G NAS security context is taken into use and SECURITY MODE COMMAND message does not indicate the "null integrity protection algorithm" 5G-IA0 as the selected NAS integrity algorithm, the UE shall:

- if the SECURITY MODE COMMAND message has been successfully integrity checked using an estimated downlink NAS COUNT equal to 0, then the UE shall set the downlink NAS COUNT of this new 5G NAS security context to 0;
- otherwise the UE shall set the downlink NAS COUNT of this new 5G NAS security context to the downlink NAS COUNT that has been used for the successful integrity checking of the SECURITY MODE COMMAND message.

If the SECURITY MODE COMMAND message includes the horizontal derivation parameter indicating " K'_{AMF} derivation is required", the UE shall derive a new K'_{AMF} , as specified in 3GPP TS 33.501 [24] for K_{AMF} to K'_{AMF} derivation in mobility, and set both uplink and downlink NAS COUNTs to zero. When the new 5G NAS security context is taken into use for current access and the UE is registered with the same PLMN over the 3GPP access and the non-3GPP access:

- a) the UE is in 5GMM-IDLE mode over the non-current access, the AMF and the UE shall activate the new 5G NAS security context over the non-current access as described in 3GPP TS 33.501 [24]. The AMF and the UE shall set the downlink NAS COUNT and uplink NAS COUNT to zero for the non-current access; or
- b) the UE is in 5GMM-CONNECTED mode over the non-current access, the AMF shall send the SECURITY MODE COMMAND message over the non-current access to activate the new 5G NAS security context that was activated over the current access as described in 3GPP TS 33.501 [24]. The AMF shall include the same ngKSI in the SECURITY MODE COMMAND message to identify the new 5G NAS security context.

If the SECURITY MODE COMMAND message includes the horizontal derivation parameter indicating " K_{AMF} derivation is not required" or the Additional 5G security parameters IE is not included in the message, the UE is registered with the same PLMN over the 3GPP access and non-3GPP access, then after the completion of a security mode control procedure over the current access:

- a) the UE is in 5GMM-IDLE mode over the non-current access, the AMF and the UE shall activate the new 5G NAS security context for the non-current access. If a primary authentication and key agreement procedure was completed before the security mode control procedure, the AMF and the UE shall set the downlink NAS COUNT and uplink NAS COUNT to zero for the non-current access, otherwise the downlink NAS COUNT and uplink NAS COUNT for the non-3GPP access are not changed; or
- b) the UE is in 5GMM-CONNECTED mode over the non-current access, the AMF shall send the SECURITY MODE COMMAND message over the non-current access to activate the new 5G NAS security context that was activated over the current access as described in 3GPP TS 33.501 [24]. The AMF shall include the same ngKSI in the SECURITY MODE COMMAND message to identify the new 5G NAS security context.

If the SECURITY MODE COMMAND message can be accepted, the UE shall send a SECURITY MODE COMPLETE message integrity protected with the selected 5GS integrity algorithm and the 5G NAS integrity key based on the K_{AMF} or mapped K'_{AMF} if the type of security context flag is set to "mapped security context" indicated by the ngKSI. When the SECURITY MODE COMMAND message includes the type of security context flag set to "mapped security context" in the NAS key set identifier IE, then the UE shall check whether the SECURITY MODE COMMAND message indicates the ngKSI of the current 5GS security context, if it is a mapped 5G NAS security context, in order not to re-generate the K'_{AMF} .

Furthermore, if the SECURITY MODE COMMAND message can be accepted, the UE shall cipher the SECURITY MODE COMPLETE message with the selected 5GS ciphering algorithm and the 5GS NAS ciphering key based on the K_{AMF} or mapped K'_{AMF} indicated by the ngKSI. The UE shall set the security header type of the message to "integrity protected and ciphered with new 5G NAS security context".

From this time onward the UE shall cipher and integrity protect all NAS signalling messages with the selected 5GS integrity and ciphering algorithms.

If the AMF indicated in the SECURITY MODE COMMAND message that the IMEISV is requested:

- 1) if the UE has an IMEISV, the UE shall include its IMEISV in the SECURITY MODE COMPLETE message; or
- 2) if the 5G-CRG or the W-AGF acting on behalf of the FN-CRG do not have an IMEISV, the 5G-CRG or the W-AGF acting on behalf of the FN-CRG shall include the 5G-CRG's cable modem MAC address or the FN-CRG's cable modem MAC address in the SECURITY MODE COMPLETE message.

If, during an ongoing registration procedure or service request procedure, the SECURITY MODE COMMAND message includes the Additional 5G security information IE with the RINMR bit set to "Retransmission of the initial NAS message requested", the UE shall include the entire unciphered REGISTRATION REQUEST message or SERVICE REQUEST message, which the UE had previously included in the NAS message container IE of the initial NAS message (i.e. REGISTRATION REQUEST message or SERVICE REQUEST message, respectively), in the NAS message container IE of the SECURITY MODE COMPLETE message.

If, prior to receiving the SECURITY MODE COMMAND message, the UE without a valid 5G NAS security context had sent a REGISTRATION REQUEST message the UE shall include the entire REGISTRATION REQUEST message in the NAS message container IE of the SECURITY MODE COMPLETE message as described in subclause 4.4.6.

If the UE operating in the single-registration mode receives the Selected EPS NAS security algorithms IE, the UE shall use the IE according to 3GPP TS 33.501 [24].

For a UE operating in single-registration mode with N26 interface supported in the network, after an inter-system change from S1 mode to N1 mode in 5GMM-CONNECTED mode, the UE shall set the value of the Selected EPS NAS security algorithms IE in the 5G NAS security context to the NAS security algorithms that were received from the source MME when the UE was in S1 mode.

[TS 24.501, clause 5.4.2.5]

If the security mode command cannot be accepted, the UE shall send a SECURITY MODE REJECT message. The SECURITY MODE REJECT message contains a 5GMM cause that typically indicates one of the following cause values:

- #23 UE security capabilities mismatch.
- #24 security mode rejected, unspecified.

If the UE detects that the received Replayed UE security capabilities IE has been altered compared to the latest values that the UE sent to the network, the UE shall set the cause value to #23 "UE security capabilities mismatch".

Upon receipt of the SECURITY MODE REJECT message, the AMF shall stop timer T3560. The AMF shall also abort the ongoing procedure that triggered the initiation of the NAS security mode control procedure.

Both the UE and the AMF shall apply the 5G NAS security context in use before the initiation of the security mode control procedure, if any, to protect the SECURITY MODE REJECT message and any other subsequent messages according to the rules in subclause 4.4.4 and 4.4.5.

9.1.2.1.3 Test description

9.1.2.1.3.1 Pre-test conditions

System Simulator:

- NGC Cell A.

UE:

- None.

Preamble:

- The procedure defined in subclause 4.9.8 in 38.508-1 [4] has been performed to ensure that the UE does not have a valid 5G NAS security context
- The UE is in state 0-A on NGC Cell A according to TS 38.508-1 [4].

9.1.2.1.3.2 Test procedure sequence

Table 9.1.2.1.3.2-1: Main behaviour

St	Procedure	Message Sequence		TP	Verdict
		U - S	Message		
1	The UE is switched on.	-	-	-	-
2-2E	Steps 1-6 of the generic procedure for UE registration specified in TS 38.508-1 [4] table 4.5.2.2-2 are performed.	-	-	-	-
3	The SS transmits a SECURITY MODE COMMAND message to activate NAS security. It is integrity protected and includes unmatched replayed security capabilities.	<--	SECURITY MODE COMMAND	-	-
4	Check: Does the UE transmit a SECURITY MODE REJECT message with cause'#23: UE security capabilities mismatch'?	-->	SECURITY MODE REJECT	1	P
5	The SS transmits an IDENTITY REQUEST message (Security not applied).	<--	IDENTITY REQUEST	-	-
6	Check: Does the UE transmit a non security protected IDENTITY RESPONSE message?	-->	IDENTITY RESPONSE	1	P
7	The SS transmits a SECURITY MODE COMMAND message to activate NAS security. It is integrity protected and includes IMEISV.	<--	SECURITY MODE COMMAND	-	-
8	Check: Does the UE transmit a SECURITY MODE COMPLETE message and does it establish the initial security configuration?	-->	SECURITY MODE COMPLETE	2	P
9a1-9Ja1	Steps 9a1-19a1 of the generic procedure for UE registration specified in TS 38.508-1 [4] table 4.5.2.2-2 are performed.	-	-	-	-
10	The SS transmits an IDENTITY REQUEST message (Security protected as per the algorithms specified in step 7).	<-	IDENTITY REQUEST	-	-
11	Check: Does the UE transmit an IDENTITY RESPONSE message (Security Protected as per the algorithms specified in step 7)?	->	IDENTITY RESPONSE	2	P

9.1.2.1.3.3 Specific message contents

Table 9.1.2.1.3.3-1: SECURITY MODE COMMAND (Step 3, Table 9.1.2.1.3.2-1)

Derivation path: TS 38.508-1 [4],table 4.7.1-25			
Information Element	Value/Remark	Comment	Condition
Replayed UE security capabilities	Set to mismatch the security capability of UE under test		

Table 9.1.2.1.3.3-2: SECURITY MODE REJECT (Step 4, Table 9.1.2.1.3.2-1)

Derivation path: TS 38.508-1 [4],table 4.7.1-27			
Information Element	Value/Remark	Comment	Condition
5GMM cause	#23		

Table 9.1.2.1.3.3-3: IDENTITY REQUEST (Step 5, Table 9.1.2.1.3.2-1)

Derivation path: TS 38.508-1 [4],table 4.7.1-21			
Information Element	Value/Remark	Comment	Condition
Identity type	'0001'B	SUCI	

Table 9.1.2.1.3.3-4: IDENTITY RESPONSE (Step 6, Table 9.1.2.1.3.2-1)

Derivation path: TS 38.508-1 [4],table 4.7.1-22			
Information Element	Value/Remark	Comment	Condition
Mobile identity			
Type of identity	'001'B	SUCI	

Table 9.1.2.1.3.3-5: SECURITY MODE COMMAND (Step 7, Table 9.1.2.1.3.2-1)

Derivation path: TS 38.508-1 [4], table 4.7.1-25			
Information Element	Value/Remark	Comment	Condition
Selected NAS security algorithms			
Type of ciphering algorithm	Set according to PIXIT parameter for default ciphering algorithm if it is set to a value different to 5G-EA0, or, set to any value different to 5G-EA0 otherwise	Non-zero ciphering algorithm	
IMEISV request	Present		

Table 9.1.2.1.3.3-6: SECURITY MODE COMPLETE (Step 8, Table 9.1.2.1.3.2-1)

Derivation path: TS 38.508-1 [4], table 4.7.1-26			
Information Element	Value/Remark	Comment	Condition
IMEISV	Present		

Table 9.1.2.1.3.3-7: IDENTITY REQUEST (Step 10, Table 9.1.2.1.3.2-1)

Derivation path: TS 38.508-1 [4],table 4.7.1-21			
Information Element	Value/Remark	Comment	Condition
Identity type	'0011'B	IMEI	

Table 9.1.2.1.3.3-8: IDENTITY RESPONSE (Step 11, Table 9.1.2.1.3.2-1)

Derivation path: TS 38.508-1 [4],table 4.7.1-22			
Information Element	Value/Remark	Comment	Condition
Mobile identity			
Type of identity	'011'B	IMEI	

9.1.2.2 Protection of initial NAS signalling messages

9.1.2.2.1 Test Purpose (TP)

(1)

```
with { the UE is switched-off with no valid 5G NAS security context }
ensure that {
  when { the UE is switched on }
  then {the UE sends a REGISTRATION REQUEST message including cleartext IEs only }
}
```

(2)

```

with { the UE is in 5GMM-REGISTERED-INITIATED state }
ensure that {
  when { the UE is activating a 5G NAS security context resulting from a security mode control
procedure }
  then {the UE sends SECURITY MODE COMPLETE message with the entire REGISTRATION REQUEST message }
}

```

9.1.2.2.2 Conformance requirements

References: The conformance requirements covered in the present test case are specified in: TS 24.501, clauses 4.4.6 and 5.5.1. Unless otherwise stated these are Rel-15 requirements.

[TS 24.501, clause 4.4.6]

The 5GS supports protection of initial NAS messages as specified in 3GPP TS 33.501 [24]. The protection of initial NAS messages applies to the REGISTRATION REQUEST and SERVICE REQUEST message, and is achieved as follows:

- a) If the UE does not have a valid 5G NAS security context, the UE sends a REGISTRATION REQUEST message including cleartext IEs only. After activating a 5G NAS security context resulting from a security mode control procedure:
 - 1) if the UE needs to send non-cleartext IEs, the UE shall include the entire REGISTRATION REQUEST message (i.e. containing both cleartext IEs and non-cleartext IEs) in the NAS message container IE and shall include the NAS message container IE in the SECURITY MODE COMPLETE message;
 - 2) if the UE does not need to send non-cleartext IEs, the UE shall include the entire REGISTRATION REQUEST message (i.e. containing cleartext IEs only) in the NAS message container IE and shall include the NAS message container IE in the SECURITY MODE COMPLETE message.
- b) If the UE has a valid 5G NAS security context and the UE needs to send non-cleartext IEs in a REGISTRATION REQUEST or SERVICE REQUEST message, the UE includes the entire REGISTRATION REQUEST or SERVICE REQUEST message (i.e. containing both cleartext IEs and non-cleartext IEs) in the NAS message container IE and shall cipher the value part of the NAS message container IE. The UE shall then send a REGISTRATION REQUEST or SERVICE REQUEST message containing the cleartext IEs and the NAS message container IE.

When the initial NAS message is a REGISTRATION REQUEST message, the cleartext IEs are:

- Extended protocol discriminator;
- Security header type;
- Spare half octet;
- Registration request message identity;
- 5GS registration type;
- ngKSI;
- 5GS mobile identity;
- UE security capability;
- Additional GUTI;
- UE status; and
- EPS NAS message container.

...

When the UE sends a REGISTRATION REQUEST or SERVICE REQUEST message that includes a NAS message container IE, the UE shall set the security header type of the initial NAS message to "integrity protected".

If the UE does not need to send non-plaintext IEs in the initial NAS message, the UE shall send the initial NAS message i.e. REGISTRATION REQUEST or SERVICE REQUEST message with plaintext IEs only i.e. without including the NAS message container IE in the initial NAS message.

[TS 24.501, clause 5.5.1]

...

If the UE does not have a valid 5G NAS security context, the UE shall send the REGISTRATION REQUEST message without including the NAS message container IE. The UE shall include the entire REGISTRATION REQUEST message (i.e. containing plaintext IEs and non-plaintext IEs) in the NAS message container IE that is sent as part of the SECURITY MODE COMPLETE message as described in subclauses 4.4.6 and 5.2.4.

9.1.2.2.3 Test description

9.1.2.2.3.1 Pre-test conditions

System Simulator:

- NGC Cell A.

UE:

- None.

Preamble:

- The UE is in state 0-A on NGC Cell A according to TS 38.508-1 [4].
- The procedure defined in subclause 4.9.8 in TS 38.508-1 [4] has been performed to ensure that the UE does not have a valid 5G NAS security context.

9.1.2.2.3.2 Test procedure sequence

Table 9.1.2.2.3.2-1: Main behaviour

St	Procedure	Message Sequence		TP	Verdict
		U - S	Message		
1	The UE is switched on.	-	-	-	-
2-4	Steps 1-3 of the generic procedure for UE registration specified in TS 38.508-1 [4] table 4.5.2.2-2 are performed.	-	-	-	-
5	Check: Does the UE transmit an <i>RRCSetupComplete</i> message and a REGISTRATION REQUEST message?	-->	REGISTRATION REQUEST	1	P
6	The SS transmits a <i>DLInformationTransfer</i> message and an AUTHENTICATION REQUEST message.	<--	AUTHENTICATION REQUEST		
7	The UE transmits an <i>ULInformationTransfer</i> message and an AUTHENTICATION RESPONSE message.	-->	AUTHENTICATION RESPONSE		
8	The SS transmits a <i>DLInformationTransfer</i> message and a SECURITY MODE COMMAND message.	<--	SECURITY MODE COMMAND		
9	Check: Does the UE transmit an <i>ULInformationTransfer</i> message and a SECURITY MODE COMPLETE message?	-->	SECURITY MODE COMPLETE	2	P
10-20	Steps 10-20a1 of the generic procedure for UE registration specified in TS 38.508-1 [4] table 4.5.2.2-2 are performed.	-	-	-	-

9.1.2.2.3.3 Specific message contents

Table 9.1.2.2.3.3-1: REGISTRATION REQUEST (Step 5, Table 9.1.2.2.3.2-1)

Derivation path: TS 38.508-1 [4], table 4.7.1-6 using condition NON_CLEARTEXT_IE = FALSE
--

Table 9.1.2.2.3.3-2: REGISTRATION REQUEST (Step 9, Table 9.1.2.2.3.2-1)

Derivation path: TS 38.508-1 [4], table 4.7.1-6 using condition CIPHERED_MESSAGE
--

Table 9.1.2.2.3.3-3: SECURITY MODE COMPLETE (Step 9, Table 9.1.2.2.3.2-1)

Derivation path: TS 38.508-1 [4], table 4.7.1-26			
Information Element	Value/Remark	Comment	Condition
NAS message container	Contents of Table 9.1.2.2.3.3-2	The entire REGISTRATION REQUEST message.	

9.1.2.3 Integrity protection / Correct functionality of 5G NAS integrity algorithm / SNOW3G

9.1.2.3.1 Test Purpose (TP)

(1)

```

with { successful completion of 5G authentication and key agreement (AKA) procedure }
ensure that {
  when { UE receives a an integrity protected SECURITY MODE COMMAND message instructing to start
integrity protection using algorithm SNOW3G }
  then { UE transmits an integrity protected SECURITY MODE COMPLETE using SNOW3G and starts
applying the NAS Integrity protection in both UL and DL }
}

```

(2)

```

with { Integrity protection successful started by executing Security Mode Procedure }
ensure that {
  when { UE receives an IDENTITY REQUEST message (requested identification parameter is not SUCI),
without integrity protected }
  then { UE does not transmit IDENTITY Response }
}

```

9.1.2.3.2 Conformance requirements

References: The conformance requirements covered in the current TC are specified in: TS 24.501 clause 4.4.4.1, 4.4.4.2, 5.4.2.1, 5.4.2.2 and 5.4.2.3. Unless otherwise stated these are Rel-15 requirements.

[TS 24.501, clause 4.4.4.1]

For the UE, integrity protected signalling is mandatory for the 5GMM NAS messages once a valid 5G NAS security context exists and has been taken into use. For the network, integrity protected signalling is mandatory for the 5GMM NAS messages once a secure exchange of 5GS NAS messages has been established for the NAS signalling connection. Integrity protection of all NAS signalling messages is the responsibility of the NAS. It is the network which activates integrity protection.

[TS 24.501, clause 4.4.4.2]

Once the secure exchange of NAS messages has been established, the receiving 5GMM entity in the UE shall not process any NAS signalling messages unless they have been successfully integrity checked by the NAS. If NAS signalling messages, having not successfully passed the integrity check, are received, then the NAS in the UE shall discard that message. The processing of the SECURITY MODE COMMAND message that has not successfully passed

the integrity check is specified in subclause 5.4.2.5. If any NAS signalling message is received as not integrity protected even though the secure exchange of NAS messages has been established by the network, then the NAS shall discard this message.

[TS 24.501, clause 5.4.2.1]

The purpose of the NAS security mode control procedure is to take a 5G NAS security context into use, and initialise and start NAS signalling security between the UE and the AMF with the corresponding 5G NAS keys and 5G NAS security algorithms.

[TS 24.501, clause 5.4.2.2]

The AMF initiates the NAS security mode control procedure by sending a SECURITY MODE COMMAND message to the UE and starting timer T3560 (see example in figure 5.4.2.2).

The AMF shall reset the downlink NAS COUNT counter and use it to integrity protect the initial SECURITY MODE COMMAND message if the security mode control procedure is initiated:

- a) to take into use the security context created after a successful execution of the 5G AKA based primary authentication and key agreement procedure or the EAP based primary authentication and key agreement procedure; or

...

The AMF shall send the SECURITY MODE COMMAND message uncyphered, but shall integrity protect the message with the 5G NAS integrity key based on K_{AMF} or mapped K'_{AMF} indicated by the ngKSI included in the message. The AMF shall set the security header type of the message to "integrity protected with new 5G NAS security context".

...

The AMF shall include the replayed security capabilities of the UE (including the security capabilities with regard to NAS, RRC and UP (user plane) ciphering as well as NAS and RRC integrity, and other possible target network security capabilities, i.e. E-UTRAN if the UE included them in the message to network), the selected 5GS ciphering and integrity algorithms and the ngKSI.

[TS 24.501, clause 5.4.2.3]

Upon receipt of the SECURITY MODE COMMAND message, the UE shall check whether the security mode command can be accepted or not. This is done by performing the integrity check of the message, and by checking that the received Replayed UE security capabilities IE has not been altered compared to the latest values that the UE sent to the network.

...

If the type of security context flag included in the SECURITY MODE COMMAND message is set to "native security context" and if the ngKSI matches a valid non-current native 5G NAS security context held in the UE while the UE has a mapped 5G NAS security context as the current 5G NAS security context, the UE shall take the non-current native 5G NAS security context into use which then becomes the current native 5G NAS security context and delete the mapped 5G NAS security context.

...

If the SECURITY MODE COMMAND message can be accepted, the UE shall take the 5G NAS security context indicated in the message into use. The UE shall in addition reset the uplink NAS COUNT counter if:

- a) the SECURITY MODE COMMAND message is received in order to take a 5G NAS security context into use created after a successful execution of the 5G AKA based primary authentication and key agreement procedure or the EAP based primary authentication and key agreement procedure; or
- b) the SECURITY MODE COMMAND message received includes the type of security context flag set to "mapped security context" in the NAS key set identifier IE the ngKSI does not match the current 5G NAS security context, if it is a mapped 5G NAS security context.

...

If the SECURITY MODE COMMAND message can be accepted, the UE shall send a SECURITY MODE COMPLETE message integrity protected with the selected 5GS integrity algorithm and the 5G NAS integrity key based on the K_{AMF} or mapped K'_{AMF} if the type of security context flag is set to "mapped security context" indicated by the ngKSI. When the SECURITY MODE COMMAND message includes the type of security context flag set to "mapped security context" in the NAS key set identifier IE, then the UE shall check whether the SECURITY MODE COMMAND message indicates the ngKSI of the current 5GS security context, if it is a mapped 5G NAS security context, in order not to re-generate the K'_{AMF} .

...

From this time onward the UE shall cipher and integrity protect all NAS signalling messages with the selected 5GS integrity and ciphering algorithms.

9.1.2.3.3 Test description

9.1.2.3.3.1 Pre-test conditions

System Simulator:

- NGC Cell A.

UE:

- None.

Preamble:

- The UE is in state Switched OFF (state 0N-B) according to TS 38.508-1 [4].

9.1.2.3.3.2 Test procedure sequence

Table 9.1.2.3.3.2-1: Main behaviour

St	Procedure	Message Sequence		TP	Verdict
		U - S	Message		
1	The UE is switched on.	-	-	-	-
2-6	Steps 2-6 of the generic procedure for UE registration specified in TS 38.508-1 [4] table 4.5.2.2-2 are performed.	-	-	-	-
7	The SS transmits a SECURITY MODE COMMAND message to activate NAS security. It is integrity protected.	<--	SECURITY MODE COMMAND	-	-
8	Check: Does the UE transmit a SECURITY MODE COMPLETE message and starts applying the NAS Integrity protection in both UL and DL?	-->	SECURITY MODE COMPLETE	1	P
9-18a1	Steps 10-19a1 of the generic procedure for UE registration specified in TS 38.508-1 [4] table 4.5.2.2-2 are performed.	-	-	-	-
19	The SS transmits an IDENTITY REQUEST message with Integrity protected and with default ciphering	<--	IDENTITY REQUEST	-	-
20	Check: Does the UE transmit an IDENTITY RESPONSE message with Integrity Protected and with default ciphering?	-->	IDENTITY RESPONSE	1	P
21	The SS transmits an IDENTITY REQUEST message (not Integrity protected)	<--	IDENTITY REQUEST	-	-
22	Check: Does the UE transmit an IDENTITY RESPONSE message within the next 5 seconds?	-->	IDENTITY RESPONSE	2	F

9.1.2.3.3.3 Specific message contents

Table 9.1.2.3.3-1: SECURITY MODE COMMAND (Step 7, Table 9.1.2.3.3.2-1)

Derivation path: TS 38.508-1 [4],table 4.7.1-25			
Information Element	Value/Remark	Comment	Condition
Selected NAS security algorithms			
Type of integrity protection algorithm	'0001'B	5G integrity algorithm 128-5G-IA1 [SNOW3G]	

9.1.2.4 Integrity protection / Correct functionality of 5G NAS integrity algorithm / AES

9.1.2.4.1 Test Purpose (TP)

(1)

```

with { successful completion of 5G authentication and key agreement (AKA) procedure }
ensure that {
  when { UE receives a an integrity protected SECURITY MODE COMMAND message instructing to start
integrity protection using algorithm AES }
  then { UE transmits an integrity protected SECURITY MODE COMPLETE using AES and starts applying
the NAS Integrity protection in both UL and DL }
}

```

(2)

```

with { Integrity protection successful started by executing Security Mode Procedure }
ensure that {
  when { UE receives an IDENTITY REQUEST message (requested identification parameter is not SUCI),
without integrity protected }
  then { UE does not transmit IDENTITY Response }
}

```

9.1.2.4.2 Conformance requirements

Same Conformance requirements as in clause 9.1.2.3.2.

9.1.2.4.3 Test description

9.1.2.4.3.1 Pre-test conditions

Same Pre-test conditions as in clause 9.1.2.3.3.1.

9.1.2.4.3.2 Test procedure sequence

Same Test procedure sequence as in table 9.1.2.3.3.2-1, except the integrity protection algorithm is AES.

9.1.2.4.3.3 Specific message contents

Table 9.1.2.4.3.3-1: SECURITY MODE COMMAND (Step 7)

Derivation path: TS 38.508-1 [4],table 4.7.1-25			
Information Element	Value/Remark	Comment	Condition
Selected NAS security algorithms			
Type of integrity protection algorithm	'0010'B	5G integrity algorithm 128-5G-IA2 [AES]	

9.1.2.5 Integrity protection / Correct functionality of 5G NAS integrity algorithm / ZUC

9.1.2.5.1 Test Purpose (TP)

(1)

```
with { successful completion of 5G authentication and key agreement (AKA) procedure }
ensure that {
  when { UE receives a an integrity protected SECURITY MODE COMMAND message instructing to start
integrity protection using algorithm ZUC }
  then { UE transmits an integrity protected SECURITY MODE COMPLETE using ZUC and starts applying
the NAS Integrity protection in both UL and DL }
}
```

(2)

```
with { Integrity protection successful started by executing Security Mode Procedure }
ensure that {
  when { UE receives an IDENTITY REQUEST message (requested identification parameter is not SUCI),
without integrity protected }
  then { UE does not transmit IDENTITY Response }
}
```

9.1.2.5.2 Conformance requirements

Same Conformance requirements as in clause 9.1.2.3.2.

9.1.2.5.3 Test description

9.1.2.5.3.1 Pre-test conditions

Same Pre-test conditions as in clause 9.1.2.3.3.1.

9.1.2.5.3.2 Test procedure sequence

Same Test procedure sequence as in table 9.1.2.3.3.2-1, except the integrity protection algorithm is ZUC.

9.1.2.5.3.3 Specific message contents

Table 9.1.2.5.3.3-1: SECURITY MODE COMMAND (Step 7)

Derivation path: TS 38.508-1 [4],table 4.7.1-25			
Information Element	Value/Remark	Comment	Condition
Selected NAS security algorithms			
Type of integrity protection algorithm	'0011'B	5G integrity algorithm 128-5G-IA3 [ZUC]	

9.1.2.6 Ciphering and deciphering / Correct functionality of 5G NAS encryption algorithm / SNOW3G

9.1.2.6.1 Test Purpose (TP)

(1)

```
with { successful completion of 5G authentication and key agreement (AKA) procedure }
ensure that {
  when { UE receives a SECURITY MODE COMMAND instructing to start ciphering using algorithm SNOW3G }
  then { UE sends a SECURITY MODE COMPLETE message ciphered with SNOW3G and starts applying the
NAS ciphering in both UL and DL }
}
```

9.1.2.6.2 Conformance requirements

References: The conformance requirements covered in the current TC are specified in: TS 24.501 clause 5.4.2.1, 5.4.2.2 and 5.4.2.3. Unless otherwise stated these are Rel-15 requirements.

[TS 24.501, clause 5.4.2.1]

The purpose of the NAS security mode control procedure is to take a 5G NAS security context into use, and initialise and start NAS signalling security between the UE and the AMF with the corresponding 5G NAS keys and 5G NAS security algorithms.

[TS 24.501, clause 5.4.2.2]

The AMF initiates the NAS security mode control procedure by sending a SECURITY MODE COMMAND message to the UE and starting timer T3560 (see example in figure 5.4.2.2).

The AMF shall reset the downlink NAS COUNT counter and use it to integrity protect the initial SECURITY MODE COMMAND message if the security mode control procedure is initiated:

- a) to take into use the security context created after a successful execution of the 5G AKA based primary authentication and key agreement procedure or the EAP based primary authentication and key agreement procedure; or

...

The AMF shall send the SECURITY MODE COMMAND message uncyphered, but shall integrity protect the message with the 5G NAS integrity key based on K_{AMF} or mapped K'_{AMF} indicated by the ngKSI included in the message. The AMF shall set the security header type of the message to "integrity protected with new 5G NAS security context".

...

The AMF shall include the replayed security capabilities of the UE (including the security capabilities with regard to NAS, RRC and UP (user plane) ciphering as well as NAS and RRC integrity, and other possible target network security capabilities, i.e. E-UTRAN if the UE included them in the message to network), the selected 5GS ciphering and integrity algorithms and the ngKSI.

[TS 24.501, clause 5.4.2.3]

Upon receipt of the SECURITY MODE COMMAND message, the UE shall check whether the security mode command can be accepted or not. This is done by performing the integrity check of the message, and by checking that the received Replayed UE security capabilities IE has not been altered compared to the latest values that the UE sent to the network.

...

If the type of security context flag included in the SECURITY MODE COMMAND message is set to "native security context" and if the ngKSI matches a valid non-current native 5G NAS security context held in the UE while the UE has a mapped 5G NAS security context as the current 5G NAS security context, the UE shall take the non-current native 5G NAS security context into use which then becomes the current native 5G NAS security context and delete the mapped 5G NAS security context.

...

If the SECURITY MODE COMMAND message can be accepted, the UE shall take the 5G NAS security context indicated in the message into use. The UE shall in addition reset the uplink NAS COUNT counter if:

- a) the SECURITY MODE COMMAND message is received in order to take a 5G NAS security context into use created after a successful execution of the 5G AKA based primary authentication and key agreement procedure or the EAP based primary authentication and key agreement procedure; or
- b) the SECURITY MODE COMMAND message received includes the type of security context flag set to "mapped security context" in the NAS key set identifier IE the ngKSI does not match the current 5G NAS security context, if it is a mapped 5G NAS security context.

...

If the SECURITY MODE COMMAND message can be accepted, the UE shall send a SECURITY MODE COMPLETE message integrity protected with the selected 5GS integrity algorithm and the 5G NAS integrity key based on the K_{AMF} or mapped K'_{AMF} if the type of security context flag is set to "mapped security context" indicated by the ngKSI. When the SECURITY MODE COMMAND message includes the type of security context flag set to "mapped security context" in the NAS key set identifier IE, then the UE shall check whether the SECURITY MODE COMMAND message indicates the ngKSI of the current 5GS security context, if it is a mapped 5G NAS security context, in order not to re-generate the K'_{AMF} .

Furthermore, if the SECURITY MODE COMMAND message can be accepted, the UE shall cipher the SECURITY MODE COMPLETE message with the selected 5GS ciphering algorithm and the 5GS NAS ciphering key based on the K_{AMF} or mapped K'_{AMF} indicated by the ngKSI. The UE shall set the security header type of the message to "integrity protected and ciphered with new 5G NAS security context".

From this time onward the UE shall cipher and integrity protect all NAS signalling messages with the selected 5GS integrity and ciphering algorithms

9.1.2.6.3 Test description

9.1.2.6.3.1 Pre-test conditions

System Simulator:

- NGC Cell A.

UE:

- None.

Preamble:

- The UE is in state Switched OFF (state 0N-B) according to TS 38.508-1 [4].

9.1.2.6.3.2 Test procedure sequence

Table 9.1.2.6.3.2-1: Main behaviour

St	Procedure	Message Sequence		TP	Verdict
		U - S	Message		
1	The UE is switched on.	-	-	-	-
2-6	Steps 2-6 of the generic procedure for UE registration specified in TS 38.508-1 [4] subclause 4.5.2.3 are performed.	-	-	-	-
7	The SS transmits a SECURITY MODE COMMAND message to activate NAS security.	<--	SECURITY MODE COMMAND	-	-
8	Check: Does the UE transmit a SECURITY MODE COMPLETE message ciphered and starts applying the NAS ciphering in both UL and DL?	-->	SECURITY MODE COMPLETE	1	P
9-18a1	Steps 10-19a1 of the generic procedure for UE registration specified in TS 38.508-1 [4] table 4.5.2.2-2 are performed.	-	-	-	-
19	The SS transmits an IDENTITY REQUEST message Ciphered	<--	IDENTITY REQUEST	-	-
20	Check: Does the UE transmit an IDENTITY RESPONSE message Ciphered?	-->	IDENTITY RESPONSE	1	P

9.1.2.6.3.3 Specific message contents

Table 9.1.2.6.3.3-1: SECURITY MODE COMMAND (Step 7, Table 9.1.2.6.3.2-1)

Derivation path: TS 38.508-1 [4],table 4.7.1-25

Information Element	Value/Remark	Comment	Condition
Selected NAS security algorithms			
Type of ciphering algorithm	'0001'B	5G encryption algorithm 128-5G-EA1 [SNOW3G]	

9.1.2.7 Ciphering and deciphering / Correct functionality of 5G NAS encryption algorithm / AES

9.1.2.7.1 Test Purpose (TP)

(1)

```
with { successful completion of 5G authentication and key agreement (AKA) procedure }
ensure that {
  when { UE receives a SECURITY MODE COMMAND instructing to start ciphering using algorithm AES }
  then { UE sends a SECURITY MODE COMPLETE message ciphered with AES and starts applying the NAS
  ciphering in both UL and DL }
}
```

9.1.2.7.2 Conformance requirements

Same conformance requirement as in clause 9.1.2.6.2.

9.1.2.7.3 Test description

9.1.2.7.3.1 Pre-test conditions

Same Pre-test conditions as in clause 9.1.2.6.3.1.

9.1.2.7.3.2 Test procedure sequence

Same Test procedure sequence as in Table 9.1.2.6.3.2-1, except the ciphering algorithm is AES.

9.1.2.7.3.3 Specific message contents

Table 9.1.2.7.3.3-1: SECURITY MODE COMMAND (Step 7)

Derivation path: TS 38.508-1 [4],table 4.7.1-25			
Information Element	Value/Remark	Comment	Condition
Selected NAS security algorithms			
Type of ciphering algorithm	'0010'B	5G encryption algorithm 128-5G-EA2 [AES]	

9.1.2.8 Ciphering and deciphering / Correct functionality of 5G NAS encryption algorithm / ZUC

9.1.2.8.1 Test Purpose (TP)

(1)

```
with { successful completion of 5G authentication and key agreement (AKA) procedure }
ensure that {
  when { UE receives a SECURITY MODE COMMAND instructing to start ciphering using algorithm ZUC }
  then { UE sends a SECURITY MODE COMPLETE message ciphered with ZUC and starts applying the NAS
  ciphering in both UL and DL }
}
```

9.1.2.8.2 Conformance requirements

Same conformance requirement as in clause 9.1.2.6.2.

9.1.2.8.3 Test description

9.1.2.8.3.1 Pre-test conditions

Same Pre-test conditions as in clause 9.1.2.6.3.1.

9.1.2.8.3.2 Test procedure sequence

Same Test procedure sequence as in Table 9.1.2.6.3.2-1, except the ciphering algorithm is ZUC.

9.1.2.8.3.3 Specific message contents

Table 9.1.2.8.3.3-1: SECURITY MODE COMMAND (Step 7)

Derivation path: TS 38.508-1 [4],table 4.7.1-25			
Information Element	Value/Remark	Comment	Condition
Selected NAS security algorithms			
Type of ciphering algorithm	'0011'B	5G encryption algorithm 128-5G-EA3 [ZUC]	

9.1.3 Identification

9.1.3.1 Identification procedure

9.1.3.1.1 Test Purpose (TP)

(1)

```
with { The UE is in 5GMM-REGISTERED-INITIATED state and the SS sends an IDENTITY REQUEST message }
ensure that {
  when { UE detects transmission failure of IDENTITY RESPONSE message }
  then { The UE re-initiates the Initial registration procedure }
}
```

(2)

```
with { The UE is in 5GMM-CONNECTED mode and the SS sends an IDENTITY REQUEST message }
ensure that {
  when { The UE receives the unprotected IDENTITY REQUEST message with identity type as SUCI }
  then { UE transmits the IDENTITY RESPONSE message with identity type set to SUCI }
}
```

(3)

```
with { The UE is in 5GMM-CONNECTED mode and the SS sends an IDENTITY REQUEST message }
ensure that {
  when { the UE receives an IDENTITY REQUEST with identity type set as IMEISV }
  then { UE transmits an IDENTITY RESPONSE with identity type set as IMEISV }
}
```

(4)

```
with { The UE is in 5GMM-CONNECTED mode and the SS sends an IDENTITY REQUEST message }
ensure that {
  when { the UE receives an IDENTITY REQUEST with identity type set as "IMEI" }
  then { UE transmits an IDENTITY RESPONSE with identity type set as "IMEI" }
}
```

(5)

```

with { The UE is in 5GMM-CONNECTED mode and the SS sends an IDENTITY REQUEST message }
ensure that {
  when { the UE receives an IDENTITY REQUEST with identity type set as "5G-GUTI" and has no valid
5G-GUTI available }
    then { UE transmits an IDENTITY RESPONSE with identity type set as "No identity" }
}

```

9.1.3.1.2 Conformance requirements

References: The conformance requirements covered in the present TC are specified in: TS 24.501, clauses 5.4.3.3, 4.4.4.3 and 5.4.3.5. Unless otherwise stated these are Rel-15 requirements.

[TS 24.501, clause 5.4.3.3]

A UE shall be ready to respond to an IDENTITY REQUEST message at any time whilst in 5GMM-CONNECTED mode.

Upon receipt of the IDENTITY REQUEST message:

- a) if the Identity type IE in the IDENTITY REQUEST message is not set to "SUCI", the UE shall send an IDENTITY RESPONSE message to the network. The IDENTITY RESPONSE message shall contain the identification parameters as requested by the network; and
- b) if the Identity type IE in the IDENTITY REQUEST message is set to "SUCI", the UE shall:
 - 1) if timer T3519 is not running, generate a fresh SUCI as specified in 3GPP TS 33.501 [24], send an IDENTITY RESPONSE message with the SUCI, start timer T3519 and store the value of the SUCI sent in the IDENTITY RESPONSE message; and
 - 2) if timer T3519 is running, send an IDENTITY RESPONSE message with the stored SUCI.

[TS 24.501, clause 4.4.4.3]

Except the messages listed below, no NAS signalling messages shall be processed by the receiving 5GMM entity in the AMF or forwarded to the 5GSM entity, unless the secure exchange of NAS messages has been established for the NAS signalling connection:

- a) REGISTRATION REQUEST;
- b) IDENTITY RESPONSE (if requested identification parameter is SUCI);
- c) AUTHENTICATION RESPONSE;
- d) AUTHENTICATION FAILURE;
- e) SECURITY MODE REJECT;
- f) DEREGISTRATION REQUEST; and
- g) DEREGISTRATION ACCEPT;

NOTE 1: The REGISTRATION REQUEST message is sent by the UE without integrity protection, if the registration procedure is initiated due to an inter-system change in 5GMM-IDLE mode and no current 5G NAS security context is available in the UE. The other messages are accepted by the AMF without integrity protection, as in certain situations they are sent by the UE before security can be activated.

NOTE 2: The DEREGISTRATION REQUEST message can be sent by the UE without integrity protection, e.g. if the UE is registered for emergency services and there is no shared 5G NAS security context available, or if due to user interaction a registration procedure is cancelled before the secure exchange of NAS messages has been established. For these cases the network can attempt to use additional criteria (e.g. whether the UE is subsequently still performing periodic registration update or still responding to paging) before marking the UE as 5GMM-DEREGISTERED.

Integrity protection is never applied directly to 5GSM messages, but to the 5GMM message in which the 5GSM message is included.

Once a current 5G NAS security context exists, until the secure exchange of NAS messages has been established for the NAS signalling connection, the receiving 5GMM entity in the AMF shall process the following NAS signalling messages, even if the MAC included in the message fails the integrity check or cannot be verified, as the 5G NAS security context is not available in the network:

- a) REGISTRATION REQUEST;
- b) IDENTITY RESPONSE (if requested identification parameter is SUCI);
- c) AUTHENTICATION RESPONSE;
- d) AUTHENTICATION FAILURE;
- e) SECURITY MODE REJECT;
- f) DEREGISTRATION REQUEST;
- g) DEREGISTRATION ACCEPT; and
- h) SERVICE REQUEST;
- ...

[TS 24.501, clause 5.4.3.5]

The following abnormal cases can be identified:

- a) Transmission failure of the IDENTITY RESPONSE message (if the identification procedure is triggered by a registration procedure).

The UE shall re-initiate the registration procedure.

- b) Requested identity is not available

If the UE cannot encode the requested identity in the IDENTITY RESPONSE message, e.g. because no valid USIM is available, then it shall encode the identity type as "No identity".

9.1.3.1.3 Test description

9.1.3.1.3.1 Pre test conditions

System Simulator:

- NGC Cell A is configured as "Serving cell" according to TS 38.508-1 [4] Table 6.3.2.2-1.
- System information combination NR-1 as defined in TS 38.508-1 [4] clause 4.4.3.1.2 is used.

UE:

None.

Preamble:

- The UE is in state Switched OFF (State 0N-B) as per TS 38.508-1 [4] Table 4.4A.2-0.

9.1.3.1.3.2 Test procedure sequence

Table 9.1.3.1.3.2-1: Main behaviour

St	Procedure	Message Sequence		TP	Verdict
		U - S	Message		
-	Void	-	-	-	-
1	The UE is switched on.	-	-	-	-
2-4	The UE establishes RRC connection by	-	-	-	-

	executing steps 2-4 of Table 4.5.2.2-2 in TS 38.508-1 [4].				
5	SS is configured to not allocate any UL grant and RA Response, so that the UE cannot send the IDENTITY RESPONSE to SS.	-	-	-	-
6	The SS transmits an IDENTITY REQUEST requesting SUCI in the IE identity type.	<--	IDENTITY REQUEST	-	-
6A	SS starts timer of T3511 (Note 1).	-	-	-	-
6B	SS locally releases the RRC connection.	-	-	-	-
6C	Wait for T3511 to time out.	-	-	-	-
6D	SS configures the RA Response.	-	-	-	-
7-9	The UE establishes RRC connection by executing steps 2-4 of Table 4.5.2.2-2 in TS 38.508-1 [4]. (Note 2)	-	-	1	P
10	The SS transmits an unprotected IDENTITY REQUEST requesting SUCI in the IE identity type.	<--	IDENTITY REQUEST	-	-
11	Check: Does the UE respond with an IDENTITY RESPONSE message with IE identity type set to "SUCI"?	-->	IDENTITY RESPONSE	2	P
11 A	The SS transmits a REGISTRATION REJECT (Cause #3, illegal UE).	<--	REGISTRATION REJECT	-	-
11 B	The SS releases the RRC.	-	-	-	-
11 C	The UE is Switched OFF.	-	-	-	-
11 D	The UE is Switched ON.	-	-	-	-
12-24	Steps 1–13 of Table 4.5.2.2-2 in TS 38.508-1 [4] are performed.	-			
25	The SS transmits an IDENTITY REQUEST requesting 5G-GUTI in the IE identity type.	<--	IDENTITY REQUEST	-	-
26	Check: Does the UE respond with an IDENTITY RESPONSE message with IE identity type set to "No identity"?	-->	IDENTITY RESPONSE	5	P
27-29 Ba 1	Steps 14-19a1 of Table 4.5.2.2-2 in TS 38.508-1 [4] are performed.	-	-	-	-
30	The SS transmits an IDENTITY REQUEST requesting IMEISV in the IE identity type.	<--	IDENTITY REQUEST	-	-
31	Check: Does the UE respond with an IDENTITY RESPONSE message with IE identity type set to IMEISV?	-->	IDENTITY RESPONSE	3	P
32	The SS transmits an IDENTITY REQUEST requesting IMEI in the IE identity type.	<--	IDENTITY REQUEST	-	-
33	Check: Does the UE respond with an IDENTITY RESPONSE message with IE identity type set to IMEI?	-->	IDENTITY RESPONSE	4	P
34-35	Void	-	-	-	-
Note 1: To send the IDENTITY RESPONSE, the UE will initiate RACH to get UL grant. Since there is no RA Response, registration failure due to lower layer failure will occur, then T3511 will start.					
Note 2: The UL grant is restarted in step 8.					

9.1.3.1.3.3 Specific message contents

Table 9.1.3.1.3.3-1: IDENTITY REQUEST (step 6, 10 Table 9.1.3.1.3.2-1)

Derivation Path: TS 38.508-1 [4], Table 4.7.1-21			
Information Element	Value/remark	Comment	Condition

Identity type	'001'B	SUCI	
---------------	--------	------	--

Table 9.1.3.1.3.3-2: IDENTITY RESPONSE (step 11 Table 9.1.3.1.3.2-1)

Derivation Path: TS 38.508-1 [4], Table 4.7.1-22			
Information Element	Value/remark	Comment	Condition
Identity type	'001'B	SUCI	

Table 9.1.3.1.3.3-3: IDENTITY REQUEST (step 30 Table 9.1.3.1.3.2-1)

Derivation Path: TS 38.508-1 [4], Table 4.7.1-21			
Information Element	Value/remark	Comment	Condition
Identity type	'101'B	IMEISV	

Table 9.1.3.1.3.3-4: IDENTITY RESPONSE (step 31 Table 9.1.3.1.3.2-1)

Derivation Path: TS 38.508-1 [4], Table 4.7.1-22			
Information Element	Value/remark	Comment	Condition
Identity type	'101'B	IMEISV	

Table 9.1.3.1.3.3-5: IDENTITY REQUEST (step 32 Table 9.1.3.1.3.2-1)

Derivation Path: TS 38.508-1 [4], Table 4.7.1-21			
Information Element	Value/remark	Comment	Condition
Identity type	'011'B	IMEI	

Table 9.1.3.1.3.3-6: IDENTITY RESPONSE (step 33 Table 9.1.3.1.3.2-1)

Derivation path: TS 38.508-1 [4], Table 4.7.1-22			
Information Element	Value/remark	Comment	Condition
Identity type	'011'B	IMEI	

Table 9.1.3.1.3.3-7: IDENTITY REQUEST (step 25 Table 9.1.3.1.3.2-1)

Derivation Path: TS 38.508-1 [4], Table 4.7.1-21			
Information Element	Value/remark	Comment	Condition
Identity type	'010'B	5G-GUTI	

Table 9.1.3.1.3.3-8: IDENTITY RESPONSE (step 26 Table 9.1.3.1.3.2-1)

Derivation Path: TS 38.508-1 [4], Table 4.7.1-22			
Information Element	Value/remark	Comment	Condition
Identity type	'000'B	No Identity	

Table 9.1.3.1.3.3-9: Void**Table 9.1.3.1.3.3-10: REGISTRATION REJECT (step 11A Table 9.1.3.1.3.2-1)**

Derivation Path: TS 38.508-1 [4], Table 4.7.1-9			
Information Element	Value/remark	Comment	Condition
5GMM cause	'00000011'B	Illegal UE	

9.1.4 Generic UE configuration update

9.1.4.1 Generic UE configuration update / New 5G-GUTI, NITZ, registration requested, network slicing indication, new allowed NSSAI / Acknowledgement from the UE

9.1.4.1.1 Test Purpose (TP)

(1)

```
with { UE in 5GMM-REGISTERED state }
ensure that {
  when { UE receives a new 5G-GUTI in the CONFIGURATION UPDATE COMMAND message and acknowledgement
from the UE is requested }
  then { UE sends a CONFIGURATION UPDATE COMPLETE message and UE shall consider new 5G-GUTI as
valid }
}
```

(2)

```
with { UE in 5GMM-REGISTERED state }
ensure that {
  when { UE receives a NITZ information in the CONFIGURATION UPDATE COMMAND message and
acknowledgement from the UE is not requested }
  then { UE updates NITZ information }
}
```

(3)

```
with { UE in 5GMM-REGISTERED state }
ensure that {
  when { UE receives CONFIGURATION UPDATE COMMAND message indicating "registration requested" and
contains no other parameters }
  then { UE deletes any stored allowed NSSAI for this PLMN and then release the existing N1 NAS
signalling connection, starts a mobility registration procedure }
}
```

(4)

```
with { UE in 5GMM-REGISTERED state }
ensure that {
  when { UE receives a new allowed NSSAI in the CONFIGURATION UPDATE COMMAND message and
registration is not requested }
  then { UE replaces any stored allowed NSSAI for this PLMN with new allowed NSSAI }
}
```

(5)

```
with { UE in 5GMM-REGISTERED state }
ensure that {
  when { UE receives a Network Slicing subscription change indication set to "Network slicing
subscription changed" in the CONFIGURATION UPDATE COMMAND message and registration is not requested
}
  then { UE deletes the network slicing information for each and every PLMN except for the current
PLMN and default configured NSSAI }
}
```

9.1.4.1.2 Conformance requirements

References: The conformance requirements covered in the present TC are specified in: TS 24.501, clause 4.6.2.2, 5.4.4.1, 5.4.4.2, 5.4.4.3, 5.5.1.2.2 and 5.5.1.3.2. Unless otherwise stated these are Rel-15 requirements.

[TS 24.501 clause 4.6.2.2]

If available, the configured NSSAI(s) shall be stored in a non-volatile memory in the ME as specified in annex C.

...

If the UE receives the CONFIGURATION UPDATE COMMAND message indicating "registration requested" and contains no other parameters (see subclauses 5.4.4.2 and 5.4.4.3), the UE shall delete any stored allowed NSSAI for this PLMN, and delete any stored mapping of each S-NSSAI of the allowed NSSAI to the S-NSSAI(s) of the HPLMN, if available;

...

- d) When the UE receives the Network slicing indication IE with the Network slicing subscription change indication set to "Network slicing subscription changed" in the REGISTRATION ACCEPT message or in the CONFIGURATION UPDATE COMMAND message, the UE shall delete the network slicing information for each of the PLMNs that the UE has slicing information stored for (excluding the current PLMN). The UE shall not delete the default configured NSSAI. Additionally, the UE shall update the network slicing information for the current PLMN (if received) as specified above in bullets a), b) and c):

[TS 24.501 clause 5.4.4.1]

The purpose of this procedure is to:

- a) allow the AMF to update the UE configuration for access and mobility management-related parameters decided and provided by the AMF by providing new parameter information within the command; or
- b) request the UE to perform a registration procedure for mobility and periodic registration update towards the network to update access and mobility management-related parameters decided and provided by the AMF (see subclause 5.5.1.3).

This procedure is initiated by the network and can only be used when the UE has an established 5GMM context, and the UE is in 5GMM-CONNECTED mode. When the UE is in 5GMM-IDLE mode, the AMF may use the paging or notification procedure to initiate the generic UE configuration update procedure. The AMF can request a confirmation response in order to ensure that the parameter has been updated by the UE.

This procedure shall be initiated by the network to assign a new 5G-GUTI to the UE after a successful service request procedure invoked as a response to a paging request from the network and before the release of the N1 NAS signalling connection. If the service request procedure was triggered due to 5GSM downlink signalling pending, the procedure for assigning a new 5G-GUTI can be initiated by the network after the transport of the 5GSM downlink signalling.

The following parameters are supported by the generic UE configuration update procedure without the need to request the UE to perform the registration procedure for mobility and periodic registration update:

- a) 5G-GUTI;
- b) TAI list;
- c) Service area list;
- d) Network identity and time zone information (Full name for network, short name for network, local time zone, universal time and local time zone, network daylight saving time);
- e) LADN information;
- f) Rejected NSSAI;
- g) Network slicing indication;
- h) Operator-defined access category definitions; and
- i) SMS indication.

The following parameters can be sent to the UE with or without a request to perform the registration procedure for mobility and periodic registration update:

- a) Allowed NSSAI; or
- b) Configured NSSAI.

The following parameter is sent to the UE with a request to perform the registration procedure for mobility and periodic registration update:

- a) MICO indication.

The following parameters are sent over 3GPP access only:

- a) LADN information;
- b) MICO indication;
- c) TAI list; and
- d) Service area list.

The following parameters are managed and sent per access type i.e., independently over 3GPP access or non 3GPP access:

- a) Allowed NSSAI; and
- b) Rejected NSSAI (when the NSSAI is rejected for the current registration area).

The following parameters are managed commonly and sent over 3GPP access or non 3GPP access:

- a) 5G-GUTI;
- b) Network identity and time zone information;
- c) Rejected NSSAI (when the NSSAI is rejected for the current PLMN);
- d) Configured NSSAI; and
- e) SMS indication.

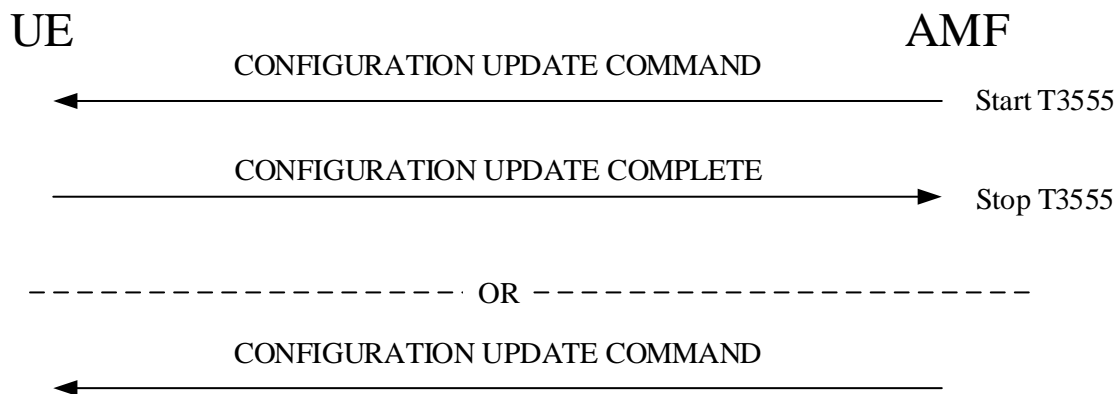

Figure 5.4.4.1.1: Generic UE configuration update procedure

[TS 24.501 clause 5.4.4.2]

The AMF shall initiate the generic UE configuration update procedure by sending the CONFIGURATION UPDATE COMMAND message to the UE.

The AMF shall in the CONFIGURATION UPDATE COMMAND message either:

- a) include one or more of the following parameters: 5G-GUTI, TAI list, allowed NSSAI that may include the mapped S-NSSAI(s), LADN information, service area list, MICO indication NITZ information, configured NSSAI that may include the mapped S-NSSAI(s), rejected NSSAI, network slicing indication, operator-defined access category definitions or SMS indication;
- b) include the Configuration update indication IE with the Registration requested bit set to "registration requested";
or
- c) include a combination of both a) and b).

If an acknowledgement from the UE is requested, the AMF shall indicate "acknowledgement requested" in the Acknowledgement bit of the Configuration update indication IE in the CONFIGURATION UPDATE COMMAND message and shall start timer T3555. Acknowledgement shall be requested for all parameters except when only NITZ is included.

To initiate parameter re-negotiation between the UE and network, the AMF shall indicate "registration requested" in the Registration requested bit of the Configuration update indication IE in the CONFIGURATION UPDATE COMMAND message.

If a new allowed NSSAI information or AMF re-configuration of supported S-NSSAIs requires an AMF relocation, the AMF shall indicate "registration requested" in the Registration requested bit of the Configuration update indication IE and include the Allowed NSSAI IE in the CONFIGURATION UPDATE COMMAND message.

If the AMF includes a new configured NSSAI in the CONFIGURATION UPDATE COMMAND message and the new configured NSSAI requires an AMF relocation as specified in 3GPP TS 23.501 [8], the AMF shall indicate "registration requested" in the Registration requested bit of the Configuration update indication IE in the message.

If the AMF indicates "registration requested" in the Registration requested bit of the Configuration update indication IE, acknowledgement shall be requested.

If changes to the allowed NSSAI require the UE to initiate a registration procedure, but the AMF is unable to determine an allowed NSSAI for the UE as specified in 3GPP TS 23.501 [8], the CONFIGURATION UPDATE COMMAND message shall indicate "registration requested" in the Registration requested bit of the Configuration update indication IE, and shall not contain any other parameters.

If the AMF needs to update the LADN information, the AMF shall include the LADN information in the LADN information IE of the CONFIGURATION UPDATE COMMAND message.

During an established 5GMM context, the network may send none, one, or more CONFIGURATION UPDATE COMMAND messages to the UE. If more than one CONFIGURATION UPDATE COMMAND message is sent, the messages need not have the same content.

[TS 24.501 clause 5.4.4.3]

Upon receiving the CONFIGURATION UPDATE COMMAND message, the UE shall stop timer T3346 if running and use the contents to update appropriate information stored within the UE.

If "acknowledgement requested" is indicated in the Acknowledgement bit of the Configuration update indication IE in the CONFIGURATION UPDATE COMMAND message, the UE shall send a CONFIGURATION UPDATE COMPLETE message.

If the UE receives a new 5G-GUTI in the CONFIGURATION UPDATE COMMAND message, the UE shall consider the new 5G-GUTI as valid, the old 5G-GUTI as invalid, stop timer T3519 if running, and delete any stored SUCI; otherwise, the UE shall consider the old 5G-GUTI as valid. The UE shall provide the 5G-GUTI to the lower layer of 3GPP access if the CONFIGURATION UPDATE COMMAND message is sent over the non-3GPP access, and the UE is in 5GMM-REGISTERED in both 3GPP access and non-3GPP access in the same PLMN.

If the UE receives a new TAI list in the CONFIGURATION UPDATE COMMAND message, the UE shall consider the new TAI list as valid and the old TAI list as invalid; otherwise, the UE shall consider the old TAI list as valid.

If the UE receives a new service area list in the CONFIGURATION UPDATE COMMAND message, the UE shall consider the new service area list as valid and the old service area list as invalid; otherwise, the UE shall consider the old service area list, if any, as valid.

If the UE receives new NITZ information in the CONFIGURATION UPDATE COMMAND message, the UE considers the new NITZ information as valid and the old NITZ information as invalid; otherwise, the UE shall consider the old NITZ information as valid.

If the UE receives a LADN information IE in the CONFIGURATION UPDATE COMMAND message, the UE shall consider the old LADN information as invalid and the new LADN information as valid, if any; otherwise, the UE shall consider the old LADN information as valid.

If the UE receives a new allowed NSSAI for the associated access type in the CONFIGURATION UPDATE COMMAND message, the UE shall consider the new allowed NSSAI as valid for the associated access type, store the allowed NSSAI for the associated access type as specified in subclause 4.6.2.2 and consider the old allowed NSSAI for

the associated access type as invalid; otherwise, the UE shall consider the old Allowed NSSAI as valid for the associated access type.

If the UE receives a new configured NSSAI in the CONFIGURATION UPDATE COMMAND message, the UE shall consider the new configured NSSAI for the registered PLMN as valid and the old configured NSSAI for the registered PLMN as invalid; otherwise, the UE shall consider the old configured NSSAI for the registered PLMN as valid. The UE shall store the new configured NSSAI as specified in subclause 4.6.2.2.

If the UE receives the Network slicing indication IE in the CONFIGURATION UPDATE COMMAND message with the Network slicing subscription change indication set to "Network slicing subscription changed", the UE shall delete the network slicing information for each and every PLMN except for the current PLMN as specified in subclause 4.6.2.2.

If the UE receives Operator-defined access category definitions IE in the CONFIGURATION UPDATE COMMAND message and the Operator-defined access category definitions IE contains one or more operator-defined access category definitions, the UE shall delete any operator-defined access category definitions stored for the RPLMN and shall store the received operator-defined access category definitions for the RPLMN. If the UE receives the Operator-defined access category definitions IE in the CONFIGURATION UPDATE COMMAND message and the Operator-defined access category definitions IE contains no operator-defined access category definitions, the UE shall delete any operator-defined access category definitions stored for the RPLMN. If the CONFIGURATION UPDATE COMMAND message does not contain the Operator-defined access category definitions IE, the UE shall not delete the operator-defined access category definitions stored for the RPLMN.

If the UE receives the SMS indication IE in the CONFIGURATION UPDATE COMMAND message with the SMS availability indication set to:

- a) "SMS over NAS not available", the UE shall consider that SMS over NAS transport is not allowed by the network; and
- b) "SMS over NAS available", the UE may request the use of SMS over NAS transport by performing a registration procedure for mobility and periodic registration update as specified in subclause 5.5.1.3, after the completion of the generic UE configuration update procedure.

If the CONFIGURATION UPDATE COMMAND message indicates "registration requested" in the Registration requested bit of the Configuration update indication IE and:

- a) contains no other parameters or contains at least one of the following parameters: a new allowed NSSAI, a new configured NSSAI or the Network slicing subscription change indication, and:
 - 1) an emergency PDU session exists, the UE shall, after the completion of the generic UE configuration update procedure and the release of the emergency PDU session, release the existing N1 NAS signalling connection, and start a registration procedure for mobility and periodic registration update as specified in subclause 5.5.1.3; or
 - 2) no emergency PDU Session exists, the UE shall, after the completion of the generic UE configuration update procedure and the release of the existing N1 NAS signalling connection, start a registration procedure for mobility and periodic registration update as specified in subclause 5.5.1.3; or
- b) an MICO indication is included without a new allowed NSSAI or a new configured NSSAI, the UE shall, after the completion of the generic UE configuration update procedure, start a registration procedure for mobility and registration update as specified in subclause 5.5.1.3 to re-negotiate MICO mode with the network.

The UE receiving the rejected NSSAI in the CONFIGURATION UPDATE COMMAND message takes the following actions based on the rejection cause in the rejected NSSAI:

"S-NSSAI not available in the current PLMN"

The UE shall add the rejected S-NSSAI(s) in the rejected NSSAI for the current PLMN as specified in subclause 4.6.2.2 and not attempt to use this S-NSSAI in the current PLMN until switching off the UE or the UICC containing the USIM is removed.

"S-NSSAI not available in the current registration area"

The UE shall add the rejected S-NSSAI(s) in the rejected NSSAI for the current registration area as specified in subclause 4.6.2.2 and not attempt to use this S-NSSAI in the current registration area until switching off the UE, the UE moving out of the current registration area or the UICC containing the USIM is removed.

[TS 24.501 clause 5.5.1.2.2]

The subset of allowed NSSAI provided in the requested NSSAI consists of one or more S-NSSAIs in the allowed NSSAI for the current PLMN.

NOTE 3: How the UE selects the subset of configured NSSAI or allowed NSSAI to be provided in the requested NSSAI is implementation specific. The UE can take preferences indicated by the upper layers (e.g. policies, applications) into account.

NOTE 4: The number of S-NSSAI(s) included in the requested NSSAI cannot exceed eight.

If the UE initiates an initial registration for emergency services or needs to prolong the established NAS signalling connection after the completion of the initial registration procedure (e.g. due to uplink signalling pending), the UE shall set the Follow-on request indicator to 1.

[TS 24.501 clause 5.5.1.3.2]

For a REGISTRATION REQUEST message with a 5GS registration type IE indicating "mobility registration updating", UE shall include the requested NSSAI containing the S-NSSAI(s) corresponding to the slices to which the UE intends to register with and shall include the mapped S-NSSAI(s) for the requested NSSAI, if available, in the REGISTRATION REQUEST message. If the UE has allowed NSSAI or configured NSSAI for the current PLMN, the requested NSSAI shall be either:

- a) the configured NSSAI for the current PLMN, or a subset thereof as described below, if the UE has no allowed NSSAI for the current PLMN;
- b) the allowed NSSAI for the current PLMN, or a subset thereof as described below, if the UE has an allowed NSSAI for the current PLMN; or
- c) the allowed NSSAI for the current PLMN, or a subset thereof as described below, plus one or more S-NSSAIs from the configured NSSAI for which no corresponding S-NSSAI is present in the allowed NSSAI and those are neither in the rejected NSSAI for the current PLMN nor in the rejected NSSAI for the current registration area.

If the UE has neither allowed NSSAI for the current PLMN nor configured NSSAI for the current PLMN and has a default configured NSSAI, the UE shall:

- a) include the S-NSSAI(s) in the Requested NSSAI IE of the REGISTRATION REQUEST message using the default configured NSSAI; and
- b) include the Network slicing indication IE with the Default configured NSSAI indication bit set to "Requested NSSAI created from default configured NSSAI" in the REGISTRATION REQUEST message.

If the UE has no allowed NSSAI for the current PLMN, no configured NSSAI for the current PLMN, and no default configured NSSAI, the UE shall not include a requested NSSAI in the REGISTRATION REQUEST message.

The subset of configured NSSAI provided in the requested NSSAI consists of one or more S-NSSAIs in the configured NSSAI applicable to this PLMN, if the S-NSSAI is neither in the rejected NSSAIs for the current PLMN nor in the rejected NSSAI for the current registration area.

The subset of allowed NSSAI provided in the requested NSSAI consists of one or more S-NSSAIs in the allowed NSSAI for this PLMN.

NOTE 3: How the UE selects the subset of configured NSSAI or allowed NSSAI to be provided in the requested NSSAI is implementation specific. The UE can take preferences indicated by the upper layers (e.g. policies, applications) into account.

NOTE 4: The number of S-NSSAI(s) included in the requested NSSAI cannot exceed eight.

9.1.4.1.3 Test description

9.1.4.1.3.1 Pre-test conditions

System Simulator:

- NGC Cell A configured according to Table 6.3.2.2-1 and Table 6.3.2.2-3 in 38.508-1 [4] belongs to Home PLMN and set as serving cell;
- NGC Cell G configured according to Table 6.3.2.2-1 and Table 6.3.2.2-3 in 38.508-1 [4] and set as Non-Suitable "Off" cell.
- System information combination NR-4 as defined in TS 38.508[4] clause 4.4.3.1.2 is used.

UE:

- UE is configured with NSSAI associated with HPLMN and with 5G-GUTI assigned.
- The UE is equipped with a USIM configuration as defined in TS 38.508-1 [4] Table 6.4.1-22.

Preamble:

- The UE is in state 3N-A on NGC cell A according to TS 38.508-1 [4].

9.1.4.1.3.2 Test procedure sequence

Table 9.1.4.1.3.2-1: Main behaviour

St	Procedure	Message Sequence		TP	Verdict
		U - S	Message		
1	The SS transmits a CONFIGURATION UPDATE COMMAND message including a new 5G-GUTI.	<--	CONFIGURATION UPDATE COMMAND	-	-
2	Check: Does UE transmit a CONFIGURATION UPDATE COMPLETE message?	-->	CONFIGURATION UPDATE COMPLETE	1	P
3	The SS transmits an <i>RRCRelease</i> message.	-	-	-	-
4	The SS transmits a <i>Paging</i> message with the new 5G-GUTI.	-	-	-	-
5-11	Steps 2 to 8 of the generic procedure for NR_RRC_CONNECTED specified in TS 38.508-1 [4] subclause 4.5.4.2-3 are performed.	-	-	1	P
12	The SS transmits a CONFIGURATION UPDATE COMMAND message including NITZ information.	<--	CONFIGURATION UPDATE COMMAND	-	-
13	Check: Does the UE transmit a CONFIGURATION UPDATE COMPLETE message within the expiry of T3555?	-->	CONFIGURATION UPDATE COMPLETE	2	F
14	Check: Using MMI/AT command verify the NITZ update on the UE.	-	-	2	P
15	Switch off procedure in RRC_Connected specified in TS 38.508-1 [4] subclause 4.9.6.3 is performed.	-	-	-	-
16	The UE is switched On.	-	-	-	-
17-30	Steps 1 to13 of the generic procedure for NR RRC_IDLE specified in TS 38.508-1 [4] subclause 4.5.2 are performed.	-	-	-	-
31	The SS transmits a REGISTRATION ACCEPT message including Configured NSSAI.	<--	REGISTRATION ACCEPT	-	-
31A – 31E	Steps 15 to 19a1 of the generic procedure for NR RRC_IDLE as specified in TS 38.508-1 [4] subclause 4.5.2.2-2 with 'connected without release' are performed.	-	-	-	-
32	The SS transmits a CONFIGURATION	<--	CONFIGURATION UPDATE	-	-

	UPDATE COMMAND message including registration requested IE.		COMMAND		
32A	The UE transmits a CONFIGURATION UPDATE COMPLETE message.	-->	CONFIGURATION UPDATE COMPLETE	-	-
32B	SS releases the RRC connection.	-	-	-	-
33	Check: Does UE transmit a REGISTRATION REQUEST message with registration type value set to "Mobility" and including the Requested NSSAI?	-->	REGISTRATION REQUEST	3	P
34-42	Void.	-	-	-	-
43	The SS transmits a REGISTRATION ACCEPT message including Allowed NSSAI.	<--	REGISTRATION ACCEPT	-	-
44	The UE transmits an <i>ULInformationTransfer</i> message and a REGISTRATION COMPLETE message.	-->	REGISTRATION COMPLETE	-	-
44A	The SS transmits an <i>RRCRelease</i> message.	-	-	-	-
45	Check: Using MMI/AT command (+C5GNSSAIRDP) verify the update of allowed NSSAI.	-	-	3	P
45A – 45H	Steps 1 to 8 of the generic procedure for NR RRC_CONNECTED specified in TS 38.508-1 [4] subclause 4.5.4.2-3 are performed.	-	-	-	-
46	The SS transmits a CONFIGURATION UPDATE COMMAND message including a new allowed NSSAI list.	<--	CONFIGURATION UPDATE COMMAND	-	-
47	The UE transmits a CONFIGURATION UPDATE COMPLETE message.	-->	CONFIGURATION UPDATE COMPLETE	-	-
48	Check: Using MMI/AT command (+C5GNSSAIRDP) verify the update of allowed NSSAI.	-	-	4	P
48A	SS releases the RRC connection.	-	-	-	-
49	The SS configures NGC Cell A as the "Non-suitable "Off" cell" and NGC Cell G as the "Serving cell".	-	-	-	-
50-52	Steps 2-4 of Table 4.5.2.2-2 of the generic procedure in TS 38.508-1 [4] are performed.	-	-	-	-
-	EXCEPTION: Steps 53A1 to 53A9 are performed if 5GS registration type is set as Initial Registration in step 52	-	-	-	-
53A1-53A9	Steps 5 to 13 of the generic test procedure in TS 38.508-1 [4] Table 4.5.2.2-2 are performed on NGC Cell G.	-	-	-	-
53a1-63	Void	-	-	-	-
64	The SS transmits a REGISTRATION ACCEPT message including Allowed and Configured NSSAIs.	<--	REGISTRATION ACCEPT	-	-
-	EXCEPTION: Steps 65a1 to 65b describe behaviour that depends on events happening prior to their execution; the "lower case letter" identifies a step sequence that take place if a specific prior event takes place.	-	-	-	-
65a1-65a5a1	IF 5GS registration type is set as Initial Registration in step 52, THEN Steps 15 to 19a1 of the generic test procedure in TS 38.508-1 [4] Table 4.5.2.2-2 are performed on NGC Cell G.	-	-	-	-
65b	IF 5GS registration type is set as Mobility Registration in step 52, THEN UE transmits an <i>ULInformationTransfer</i> message and a REGISTRATION COMPLETE message on NGC Cell G.	-->	REGISTRATION COMPLETE	-	-
65	Void.	-	-	-	-
66	The SS transmits a CONFIGURATION	<--	CONFIGURATION UPDATE	-	-

	UPDATE COMMAND message with Network slicing subscription changed.		COMMAND		
67	The UE transmits a CONFIGURATION UPDATE COMPLETE message.	-->	CONFIGURATION UPDATE COMPLETE	-	-
67A	Void	-	-	-	-
67B	SS releases the RRC connection.	-	-	-	-
68	Check: Using MMI/AT command (+C5GNSSAIRDP) verify the update of allowed NSSAI.	-	-	5	P
68A - 68H	Steps 1 to 8 of the NR RRC_CONNECTED procedure in TS 38.508-1 [4] Table 4.5.4.2-3 are executed.	-	-	-	-
69	The SS transmits NSSAI DELETE REQUEST message to delete the Default Configured NSSAI list.	<--	NSSAI DELETE REQUEST	-	-
70	UE transmits NSSAI DELETE RESPONSE message.	-->	NSSAI DELETE RESPONSE	-	-
71	The SS transmits an RRCRelease message.	<--	-	-	-

9.1.4.1.3.3 Specific message contents

Table 9.1.4.1.3.3-1: CONFIGURATION UPDATE COMMAND (step 1, Table 9.1.4.1.3.2-1)

Derivation path: TS 38.508-1 [4], Table 4.7.1-19			
Information Element	Value/remark	Comment	Condition
Configuration update indication	0001	Acknowledgement (ACK) requested	
5G-GUTI	Other than the default value		

Table 9.1.4.1.3.3-2: CONFIGURATION UPDATE COMMAND (step 12, Table 9.1.4.1.3.2-1)

Derivation path: TS 38.508-1 [4], Table 4.7.1-19			
Information Element	Value/remark	Comment	Condition
Full name for network	"C63A9BED0CB7CB31D98C56B3DD70" O	"FullName12345678", Note 1	
Short name for network	"5367B85D8EC966" O	"SName123", Note 1	
Local time zone	"40" O	"GMT+1", Note 1, Note 2	
Universal time and local time zone	"xx211331832540" O	"<Current Year> 31 December 13:38:52 GMT+1", Note 1, Note 2, Note 3	
Network daylight saving time	"01" O	"+1 hour adjustment for Daylight Saving Time", Note 1	
Note 1: Hard coded values have been chosen to allow for consistent/comparable SS behaviour.			
Note 2: Daylight Saving Time is included in the Local Time Zone.			
Note 3: Current Year is derived by the SS.			

Table 9.1.4.1.3.3-3: REGISTRATION ACCEPT (step 31, Table 9.1.4.1.3.2-1)

Derivation path: TS 38.508-1 [4], Table 4.7.1-7			
Information Element	Value/remark	Comment	Condition
5GS registration result value	'001'B	3GPP access	
Configured NSSAI			
S-NSSAI IEI		S-NSSAI value 2	
Length of S-NSSAI contents	'00000010'B	SST	
SST	'00000001'B	2	
SD	Not Present		

Mapped configured SST	Not Present		
Mapped configured SD	Not Present		
S-NSSAI IEI		S-NSSAI value 3	
Length of S-NSSAI contents	'00000001'B	SST	
SST	'00000011'B	3	
SD	Not Present		
Mapped configured SST	Not Present		
Mapped configured SD	Not Present		

Table 9.1.4.1.3.3-4: CONFIGURATION UPDATE COMMAND (step 32, Table 9.1.4.1.3.2-1)

Derivation path: TS 38.508-1 [4], Table 4.7.1-19			
Information Element	Value/remark	Comment	Condition
Configuration update indication	001	Registration and Acknowledgement (ACK) requested	

Table 9.1.4.1.3.3-5: REGISTRATION REQUEST (step 33, Table 9.1.4.1.3.2-1)

Derivation path: TS 38.508-1 [4], Table 4.7.1-6			
Information Element	Value/remark	Comment	Condition
5GS registration type value	'010'B		MOBILITY
Requested NSSAI			
S-NSSAI IEI		S-NSSAI value 2 (Note 1)	
Length of S-NSSAI contents	'00000001'B	SST	
SST	'00000010'B	2	
SD	Not Present		
Mapped configured SST	Not Present		
Mapped configured SD	Not Present		
S-NSSAI IEI		S-NSSAI value 3 (Note 1)	
Length of S-NSSAI contents	'00000001'B	SST	
SST	'00000011'B	3	
SD	Not Present		
Mapped configured SST	Not Present		
Mapped configured SD	Not Present		
Note 1: the Requested NSSAI IE may include either S-NSSAI value 2, or S-NSSAI value 3, or S-NSSAI value 2 and S-NSSAI value 3.			

Table 9.1.4.1.3.3-6: REGISTRATION ACCEPT (step 43, Table 9.1.4.1.3.2-1)

Derivation path: TS 38.508-1 [4], Table 4.7.1-7			
Information Element	Value/remark	Comment	Condition
5GS registration result value	'001'B	3GPP access	
Allowed NSSAI			
S-NSSAI IEI		S-NSSAI value 1	
Length of S-NSSAI contents	'00000001'B	SST	
SST	'00000001'B	1	
SD	Not Present		
Mapped configured SST	Not Present		
Mapped configured SD	Not Present		
S-NSSAI IEI		S-NSSAI value 2	
Length of S-NSSAI contents	'00000001'B	SST	
SST	'00000010'B	2	
SD	Not Present		
Mapped configured SST	Not Present		
Mapped configured SD	Not Present		
S-NSSAI IEI		S-NSSAI value 3	
Length of S-NSSAI contents	'00000001'B	SST	
SST	'00000011'B	3	
SD	Not Present		

Mapped configured SST	Not Present		
Mapped configured SD	Not Present		

Table 9.1.4.1.3.3-7: CONFIGURATION UPDATE COMMAND (step 46, Table 9.1.4.1.3.2-1)

Derivation path: TS 38.508-1 [4], Table 4.7.1-19			
Information Element	Value/remark	Comment	Condition
Configuration update indication	0001	Acknowledgement (ACK) requested	
Allowed NSSAI			
S-NSSAI IEI		S-NSSAI value 1	
Length of S-NSSAI contents	'00000001'B	SST	
SST	'00000001'B	1	
SD	Not Present		
Mapped configured SST	Not Present		
Mapped configured SD	Not Present		
S-NSSAI IEI		S-NSSAI value 2	
Length of S-NSSAI contents	'00000001'B	SST	
SST	'00000010'B	2	
SD	Not Present		
Mapped configured SST	Not Present		
Mapped configured SD	Not Present		

Table 9.1.4.1.3.3-8: REGISTRATION ACCEPT (step 64, Table 9.1.4.1.3.2-1)

Derivation path: TS 38.508-1 [4], Table 4.7.1-7			
Information Element	Value/remark	Comment	Condition
5GS registration result value	'001'B	3GPP access	
Configured NSSAI			
S-NSSAI IEI		S-NSSAI value 2	
Length of S-NSSAI contents	'00000001'B	SST	
SST	'00000010'B	2	
SD	Not Present		
Mapped configured SST	Not Present		
Mapped configured SD	Not Present		
S-NSSAI IEI		S-NSSAI value 3	
Length of S-NSSAI contents	'00000001'B	SST	
SST	'00000011'B	3	
SD	Not Present		
Mapped configured SST	Not Present		
Mapped configured SD	Not Present		

Table 9.1.4.1.3.3-9: CONFIGURATION UPDATE COMMAND (step 66, Table 9.1.4.1.3.2-1)

Derivation path: TS 38.508-1 [4], Table 4.7.1-19			
Information Element	Value/remark	Comment	Condition
Configuration update indication	0001	Acknowledgement (ACK) requested	
Network slicing indication	0001	Network slicing subscription changed	

Table 9.1.4.1.3.3-10: NSSAI DELETE REQUEST (step 69, Table 9.1.4.1.3.2-1)

Derivation path: TS 38.509 Table 6.7.1			
Information Element	Value/remark	Comment	Condition
Protocol discriminator	1111		
Skip indicator	0000		
Message type	'10100110'B		
Delete NSSAI type	'00000001'B	Delete Configured NSSAI	

Configured NSSAI	00000000		
------------------	----------	--	--

Table 9.1.4.1.3.3-11: NSSAI DELETE RESPONSE (step 70, Table 9.1.4.1.3.2-1)

Derivation path: TS 38.509 Table 6.7.1			
Information Element	Value/remark	Comment	Condition
Protocol discriminator	1111		
Skip indicator	0000		
Message type	'10100111'B		

9.1.5 Registration

9.1.5.1 Initial registration

9.1.5.1.1 Initial registration / Success / 5G-GUTI reallocation, last visited TAI

9.1.5.1.1.1 Test Purpose (TP)

(1)

```
with { the UE is 5GMM-REGISTERED state with no valid 5G-GUTI but available SUCI }
ensure that {
  when { the UE is switched off and switched on }
  then { the UE sends a REGISTRATION REQUEST message including the SUCI in the 5GS mobile identity IE }
}
```

(2)

```
with { the UE is 5GMM-REGISTERED state with a cell belong to a non-equivalent PLMN with assigned 5G-GUTI and last visited registered TAI }
ensure that {
  when { the UE is switched off and switched on with a cell belong to another PLMN }
  then { the UE sends a REGISTRATION REQUEST message including the 5G-GUTI assigned by the last PLMN in the 5GS mobile identity IE and the last visited registered TAI }
}
```

(3)

```
with { the UE is 5GMM-REGISTERED state with a cell belong to an equivalent PLMN with assigned 5G-GUTI }
ensure that {
  when { the UE is switched off and switched on with a cell belong to another PLMN }
  then { the UE sends a REGISTRATION REQUEST message including the 5G-GUTI assigned by the equivalent PLMN in the 5GS mobile identity IE }
}
```

(4)

```
with { the UE is 5GMM-REGISTERED state with an assigned 5G-GUTI }
ensure that {
  when { the UE is switched off and switched on with a cell belong to the same PLMN }
  then { the UE sends a REGISTRATION REQUEST message including the 5G-GUTI assigned by the last registered PLMN in the 5GS mobile identity IE }
}
```

9.1.5.1.1.2 Conformance requirements

References: The conformance requirements covered in the current TC are specified in: TS 24.501 clauses 5.5.1.2.2 and 5.5.1.2.4. Unless otherwise stated these are Rel-15 requirements.

[TS 24.501, clause 5.5.1.2.2]

The UE initiates the registration procedure for initial registration by sending a REGISTRATION REQUEST message to the AMF, starting timer T3510. If timer T3502 is currently running, the UE shall stop timer T3502. If timer T3511 is currently running, the UE shall stop timer T3511.

During initial registration the UE handles the 5GS mobile identity IE in the following order:

- b) if the UE holds a valid 5G-GUTI that was previously assigned, over 3GPP access or non-3GPP access, by the same PLMN with which the UE is performing the registration, the UE shall indicate the 5G-GUTI in the 5GS mobile identity IE;
- c) if the UE holds a valid 5G-GUTI that was previously assigned, over 3GPP access or non-3GPP access, by an equivalent PLMN, the UE shall indicate the 5G-GUTI in the 5GS mobile identity IE;
- d) if the UE holds a valid 5G-GUTI that was previously assigned, over 3GPP access or non-3GPP, by any other PLMN, the UE shall indicate the 5G-GUTI in the 5GS mobile identity IE;
- e) if a SUCI is available the UE shall include the SUCI in the 5GS mobile identity IE; and

...

If the SUCI is included in the 5GS mobile identity IE and the timer T3519 is not running, the UE shall start timer T3519 and store the value of the SUCI sent in the REGISTRATION REQUEST message. The UE shall include the stored SUCI in the REGISTRATION REQUEST message while timer T3519 is running.

...

If the last visited registered TAI is available, the UE shall include the last visited registered TAI in the REGISTRATION REQUEST message.

9.1.5.1.1.3 Test description

9.1.5.1.1.3.1 Pre-test conditions

System Simulator:

- NGC Cell A, NGC Cell C and NGC Cell H are configured according to Table 6.3.2.2-1 and Table 6.3.2.2-3 in 38.508-1 [4].

UE:

- None.

Preamble:

- The UE is in test state 0N-B according to TS 38.508-1 [4].

9.1.5.1.1.3.2 Test procedure sequence

Table 9.1.5.1.1.3.2-1: Main behaviour

St	Procedure	Message Sequence		TP	Verdict
		U – S	Message		
1	The SS configures: - NGC Cell A as the "Serving cell". - NGC Cell H and NGC Cell C as the "Non-Suitable "off" cell".	-	-	-	-
2	The UE is switched on.	-	-	-	-
-	The following messages are to be observed on NGC Cell A unless explicitly stated otherwise.	-	-	-	-
3-5	The UE establishes RRC connection by executing steps 2-4 of Table 4.5.2.2-2 in TS38.508-1 [4].	-	-	-	-
6	SS transmits an REGISTRATION REJECT message with the 5GMM cause IE setting as	<--	REGISTRATION REJECT	-	-

	"Illegal UE". NOTE1: 5G-GUTI-1 should be deleted, then UE has no valid 5G-GUTI but available SUCI now.				
7	The generic test procedure in TS 38.508-1 Table 4.9.6.4-1 of Switch off procedure in State DEREGISTERED are performed.				
8	The UE is brought back to operation or the USIM is inserted.				
9-11	The UE establishes RRC connection by executing steps 2-4 of Table 4.5.2.2-2 in TS38.508-1 [4].	-	-	-	-
12	Check: Does the UE transmit an REGISTRATION REQUEST message including the SUCI in the 5GS mobile identity IE?	-->	REGISTRATION REQUEST	1	P
13-21	Steps 5-13 of Table 4.5.2.2-2 of the generic procedure in TS 38.508-1 [4] are performed.	-	-	-	-
22	SS transmits an REGISTRATION ACCEPT message with a new assigned 5G-GUTI-2.	<--	REGISTRATION ACCEPT	-	-
23-27a 1	Steps 15-19a1 of Table 4.5.2.2-2 of the generic procedure in TS 38.508-1 [4] are performed with ' <i>connected without release</i> '.	-	-	-	-
28	The generic test procedure in TS 38.508-1 Table 4.9.6.3-1 of Switch off procedure in RRC_CONNECTED are performed.	-	-	-	-
29	The SS configures: - NGC Cell H as the "Serving cell". - NGC Cell A and NGC Cell C as a "Non-Suitable "off" cell".	-	-	-	-
30	The UE is brought back to operation or the USIM is inserted.	-	-	-	-
-	The following messages are to be observed on NGC Cell H unless explicitly stated otherwise.	-	-	-	-
31-33	The UE establishes RRC connection by executing steps 2-4 of Table 4.5.2.2-2 in TS38.508-1 [4].	-	-	-	-
34	Check: Does the UE transmit an REGISTRATION REQUEST message including the 5G-GUTI-2 assigned by the last PLMN in the 5GS mobile identity IE and the last visited registered TAI?	-->	REGISTRATION REQUEST	2	P
35-43	Steps 5-13 of Table 4.5.2.2-2 of the generic procedure in TS 38.508-1 [4] are performed.	-	-	-	-
44	SS transmits an REGISTRATION ACCEPT message with a new assigned 5G-GUTI-3 and the PLMN of NGC Cell A as Equivalent PLMNs.	<--	REGISTRATION ACCEPT	-	-
45-49a 1	Steps 15-19a1 of Table 4.5.2.2-2 of the generic procedure in TS 38.508-1 [4] are performed with ' <i>connected without release</i> '.	-	-	-	-
50	The generic test procedure in TS 38.508-1 Table 4.9.6.3-1 of Switch off procedure in RRC_CONNECTED is performed.	-	-	-	-
51	The SS configures: - NGC Cell A as the "Serving cell". - NGC Cell H and NGC Cell C as a "Non-Suitable "off" cell".	-	-	-	-

52	The UE is brought back to operation or the USIM is inserted.	-	-	-	-
-	The following messages are to be observed on NGC Cell A unless explicitly stated otherwise.	-	-	-	-
53-55	The UE establishes an RRC connection by executing steps 2-4 of Table 4.5.2.2-2 in TS38.508-1 [4].	-	-	-	-
56	Check: Does the UE transmit an REGISTRATION REQUEST message including the 5G-GUTI-3 assigned by the equivalent PLMN in the 5GS mobile identity IE?	-->	REGISTRATION REQUEST	3	P
57-65	Steps 5-13 of Table 4.5.2.2-2 of the generic procedure in TS 38.508-1 [4] are performed.	-	-	-	-
66	SS transmits an REGISTRATION ACCEPT message with a new assigned 5G-GUTI-4.	<--	REGISTRATION ACCEPT	-	-
67-71a1	Steps 15-19a1 of Table 4.5.2.2-2 of the generic procedure in TS 38.508-1 [4] are performed with ' <i>connected without release</i> '.	-	-	-	-
72	The generic test procedure in TS 38.508-1 Table 4.9.6.3-1 of Switch off procedure in RRC_CONNECTED is performed.	-	-	-	-
73	The SS configures: - NGC Cell C as the "Serving cell". - NGC Cell A and NGC Cell H as a "Non-Suitable off cell".	-	-	-	-
74	The UE is brought back to operation or the USIM is inserted.	-	-	-	-
-	The following messages are to be observed on NGC Cell C unless explicitly stated otherwise.	-	-	-	-
75-77	The UE establishes an RRC connection by executing steps 2-4 of Table 4.5.2.2-2 in TS38.508-1 [4].	-	-	-	-
78	Check: Does the UE transmit an REGISTRATION REQUEST message including the 5G-GUTI-4 assigned by last registered PLMN in the 5GS mobile identity IE?	-->	REGISTRATION REQUEST	4	P
79-94	Steps 5-20 of Table 4.5.2.2-2 of the generic procedure in TS 38.508-1 [4] are performed.	-	-	-	-

9.1.5.1.1.3.3 Specific message contents

Table 9.1.5.1.1.3.3-1: Message REGISTRATION REJECT (step 6, Table 9.1.5.1.1.3.2-1)

Derivation path: TS 38.508-1 [4], table 4.7.1-9			
Information Element	Value/Remark	Comment	Condition
5GMM cause	'0000 0011'B	Illegal UE	

Table 9.1.5.1.1.3.3-2: Message REGISTRATION REQUEST (step 12, Table 9.1.5.1.1.3.2-1)

Derivation path: TS 38.508-1 [4], table 4.7.1-6			
Information Element	Value/Remark	Comment	Condition
5GS registration type	'0000 0001'B	Initial registration	
5GS mobile identity	SUCI	The SUCI of UE	

Table 9.1.5.1.1.3.3-3: Message REGISTRATION ACCEPT (step 22, Table 9.1.5.1.1.3.2-1)

Derivation path: TS 38.508-1 [4], table 4.7.1-7			
Information Element	Value/Remark	Comment	Condition
5G-GUTI	5G-GUTI-2		

Table 9.1.5.1.1.3.3-4: Message REGISTRATION REQUEST (step 34, Table 9.1.5.1.1.3.2-1)

Derivation path: TS 38.508-1 [4], table 4.7.1-6			
Information Element	Value/Remark	Comment	Condition
5GS registration type	'0000 0001'B	Initial registration	
5GS mobile identity	5G-GUTI-2		
Last visited registered TAI	TAI-1	TAI of NGC Cell A	

Table 9.1.5.1.1.3.3-5: Message REGISTRATION ACCEPT (step 44, Table 9.1.5.1.1.3.2-1)

Derivation path: TS 38.508-1 [4], table 4.7.1-7			
Information Element	Value/Remark	Comment	Condition
5G-GUTI	5G-GUTI-3		
Equivalent PLMNs	The PLMN ID of NGC Cell A		

Table 9.1.5.1.1.3.3-6: Message REGISTRATION REQUEST (step 56, Table 9.1.5.1.1.3.2-1)

Derivation path: TS 38.508-1 [4], table 4.7.1-6			
Information Element	Value/Remark	Comment	Condition
5GS registration type	'0000 0001'B	Initial registration	
5GS mobile identity	5G-GUTI-3		
Last visited registered TAI	TAI-8	TAI of NGC Cell H	

Table 9.1.5.1.1.3.3-7: Message REGISTRATION ACCEPT (step 66, Table 9.1.5.1.1.3.2-1)

Derivation path: TS 38.508-1 [4], table 4.7.1-7			
Information Element	Value/Remark	Comment	Condition
5G-GUTI	5G-GUTI-4		

Table 9.1.5.1.1.3.3-8: Message REGISTRATION REQUEST (step 78, Table 9.1.5.1.1.3.2-1)

Derivation path: TS 38.508-1 [4], table 4.7.1-6			
Information Element	Value/Remark	Comment	Condition
5GS registration type	'0000 0001'B	Initial registration	
5GS mobile identity	5G-GUTI-4		
Last visited registered TAI	TAI-1	TAI of NGC Cell A	

9.1.5.1.2 Initial registration / 5GS services / Equivalent PLMN list handling

9.1.5.1.2.1 Test Purpose (TP)

(1)

```

with { The UE in 5GMM-REGISTERED-INITIATED state }
ensure that {
  when { UE receives a REGISTRATION ACCEPT with a new set of Equivalent PLMNs, then after Switch OFF
and Switch ON }
  then { The UE deletes the old equivalent PLMN list and uses the new equivalent PLMN list }
}

```

(2)

```

with { The UE in 5GMM-REGISTERED-INITIATED state }
ensure that {
  when { UE receives a REGISTRATION ACCEPT that does not include Equivalent PLMNs, then after Switch
OFF and Switch ON }
    then { UE deletes the old equivalent PLMN list }
}

```

(3)

```

with { The UE in 5GMM-REGISTERED-INITIATED state }
ensure that {
  when { the UE receives a REGISTRATION ACCEPT that includes equivalent PLMN list, and the UE
detects that an entry in the equivalent PLMN list is also present in forbidden PLMN list }
    then { UE deletes the entry in equivalent PLMN list that is also present in forbidden PLMN list }
}
}

```

9.1.5.1.2.2 Conformance requirements

References: The conformance requirements covered in the present TC are specified in: TS 24.501, clauses 5.5.1.2.4 and 5.5.1.3.4. Unless otherwise stated these are Rel-15 requirements.

[TS 24.501, clause 5.5.1.2.4]

...

The AMF may also include a list of equivalent PLMNs in the REGISTRATION ACCEPT message. Each entry in the list contains a PLMN code (MCC+MNC). The UE shall store the list as provided by the network, and if the initial registration procedure is not for emergency services, the UE shall remove from the list any PLMN code that is already in the list of "forbidden PLMNs". In addition, the UE shall add to the stored list the PLMN code of the registered PLMN that sent the list. The UE shall replace the stored list on each receipt of the REGISTRATION ACCEPT message. If the REGISTRATION ACCEPT message does not contain a list, then the UE shall delete the stored list.

...

[TS 24.501, clause 5.5.1.3.4]

...

The AMF may also include a list of equivalent PLMNs in the REGISTRATION ACCEPT message. Each entry in the list contains a PLMN code (MCC+MNC). The UE shall store the list as provided by the network, and if there is no emergency PDU session established, the UE shall remove from the list any PLMN code that is already in the list of "forbidden PLMNs". If the UE is not registered for emergency services and there is an emergency PDU session established, the UE shall remove from the list of equivalent PLMNs any PLMN code present in the "forbidden PLMNs list" when the emergency PDU session is released. In addition, the UE shall add to the stored list the PLMN code of the registered PLMN that sent the list. The UE shall replace the stored list on each receipt of the REGISTRATION ACCEPT message. If the REGISTRATION ACCEPT message does not contain a list, then the UE shall delete the stored list.

...

9.1.5.1.2.3 Test description

9.1.5.1.2.3.1 Pre-test conditions

System Simulator:

- NGC Cell A and NGC Cell E and NGC Cell F are configured according to Table 6.3.2.2-1 and Table 6.3.2.2-3 in TS 38.508-1 [4].
- NGC Cell F is configured with NR frequency NRF3.
- System information combination NR-4 as defined in TS 38.508 [4] clause 4.4.3.1.2 is used.

UE:

None.

Preamble:

- The UE is in state Switched OFF (State 0-A) as per TS 38.508-1 [4] Table 4.4A.2-0.

9.1.5.1.2.3.2 Test procedure sequence

Table 9.1.5.1.2.3.2-1: Main behaviour

St	Procedure	Message Sequence		TP	Verdict
		U - S	Message		
1	The SS configures: - NGC Cell F as the "Serving cell". - NGC Cell E as the "Non-Suitable "off" cell". - NGC Cell A as the "Non-Suitable "off" cell".	-	-	-	-
2	The UE is Switched ON	-	-	-	-
-	The following messages are to be observed on NGC Cell F unless explicitly stated otherwise	-	-	-	-
3-14	Steps 2-13 of Table 4.5.2.2-2 of the generic procedure in TS 38.508-1 [4] are performed.	-	-	-	-
15	SS transmits a REGISTRATION ACCEPT message with PLMN ID of NGC Cell A included in the Equivalent PLMNs IE	<--	REGISTRATION ACCEPT	-	-
16-20a1	Steps 15-19a1 of Table 4.5.2.2-2 of the generic procedure in TS 38.508-1 [4] are performed.	-	-	-	-
21	The UE is switched off by executing generic procedure in Table 4.9.6.3-1 in TS 38.508-1 [4]	-	-	-	-
22	The UE is Switched ON	-	-	-	-
23-34	Steps 2-13 of Table 4.5.2.2-2 of the generic procedure in TS 38.508-1 [4] are performed.	-	-	-	-
35	SS transmits a REGISTRATION ACCEPT message with PLMN ID of NGC Cell E included in the Equivalent PLMNs IE	<--	REGISTRATION ACCEPT	-	-
36-40a1	Steps 15-19a1 of Table 4.5.2.2-2 of the generic procedure in TS 38.508-1 [4] are performed.	-	-	-	-
41	The UE is switched off by executing generic procedure in Table 4.9.6.3-1 in TS 38.508-1 [4].	-	-	-	-
42	The SS configures: - NGC Cell F as the "Non-Suitable "off" cell". - NGC Cell E as the "Suitable neighbour cell". - NGC Cell A as the "Serving cell".	-	-	-	-
43	The UE is Switched ON.	-	-	-	-
-	The following messages are to be observed on NGC Cell E unless explicitly stated otherwise	-	-	-	-
44-62a1	Steps 2-20a1 of Table 4.5.2.2-2 of the generic procedure in TS 38.508-1 [4] are performed.	-	-	1	P
63	The UE is switched off by executing generic procedure in Table 4.9.6.1-1 in TS 38.508-1 [4].	-	-	-	-
63A	The SS configures: - NGC Cell F as the "Serving cell". - NGC Cell E as the "Non-Suitable "off" cell". - NGC Cell A as the "Suitable neighbour cell".	-	-	-	-
64	The UE is Switched ON	-	-	-	-
-	The following messages are to be observed on NGC Cell A unless explicitly stated otherwise	-	-	-	-
64A	Steps 2-19a1 of Table 4.5.2.2-2 of the generic procedure in TS 38.508-1 [4] are performed.	-	-	2	P

64 B	The UE is switched off by executing generic procedure in Table 4.9.6.3-1 in TS 38.508-1 [4].	-	-	-	-
64 C	The SS configures: - NGC Cell A as the "Non-Suitable "off" cell".	-	-	-	-
64 D	The UE is Switched ON.	-	-	-	-
65- 76	Steps 2-13 of Table 4.5.2.2-2 of the generic procedure in TS 38.508-1 [4] are performed.	-	-	2	P
76 A	Void.	-	-	-	-
77	SS transmits a REGISTRATION REJECT with cause #11 (PLMN not allowed)	<--	REGISTRATION REJECT	-	-
78	The SS releases the RRC connection	-	-	-	-
79	The SS configures: - NGC Cell A as the "Serving cell". - NGC Cell E as the "Non-Suitable "off" cell ". - NGC Cell F as the "Non-Suitable "off" cell ".	-	-	-	-
-	The following messages are to be observed on NGC Cell A unless explicitly stated otherwise	-	-	-	-
80- 93	Steps 2-13 of Table 4.5.2.2- 2 of the generic procedure in TS 38.508-1 [4] are performed.	-	-	-	-
94	SS transmits a REGISTRATION ACCEPT message with PLMN ID of NGC Cell E and NGC Cell F included in the Equivalent PLMNs IE	<--	REGISTRATION ACCEPT	-	-
95- 99a 1	Steps 15-19a1 of Table 4.5.2.2-2 of the generic procedure in TS 38.508-1 [4] are performed.	-	-	-	-
100	The UE is switched off by executing generic procedure in Table 4.9.6.3-1 in TS 38.508-1 [4].	-	-	-	-
101	The SS configures: - NGC Cell A as the "Non-Suitable "off" cell ". - NGC Cell E as the "Suitable neighbour cell". - NGC Cell F as the "Serving cell".	-	-	-	-
-	The following messages are to be observed on NGC Cell E unless explicitly stated otherwise	-	-	-	-
102	The UE is Switched ON	-	-	-	-
103 - 121 a1	Steps 2-20a1 of Table 4.5.2.2-2 of the generic procedure in TS 38.508-1 [4] are performed.	-	-	3	P
122	The UE is switched off by executing generic procedure in Table 4.9.6.1-1 in TS 38.508-1 [4].	-	-	-	-
123	The SS configures: - NGC Cell A as the "Non-Suitable "off" cell ". - NGC Cell E as the "Non-Suitable "off" cell ". - NGC Cell F as the "Serving cell".	-	-	-	-
124	The UE is Switched ON	-	-	-	-
-	The user is prompted to manually select PLMN of NGC Cell F	-	-	-	-
-	The following messages are to be observed on NGC Cell F unless explicitly stated otherwise	-	-	-	-
125 - 143 a1	Steps 2-20a1 of Table 4.5.2.2-2 of the generic procedure in TS 38.508-1 [4] are performed.	-	-	-	-
144	The user sets the UE in Automatic PLMN selection mode.	-	-	-	-
145	Wait for 300s to allow the UE to switch to automatic PLMN selection mode.	-	-	-	-

9.1.5.1.2.3.3 Specific message contents

Table 9.1.5.1.2.3.3-1: REGISTRATION ACCEPT (step 15 Table 9.1.5.1.2.3.2-1)

Derivation Path: TS 38.508-1 [4], Table 4.7.1-7			
Information Element	Value/remark	Comment	Condition
Equivalent PLMNs	MCC/MNC=MCC/MNC in USIM	PLMN ID of NGC Cell A	

Table 9.1.5.1.2.3.3-2: REGISTRATION ACCEPT (step 35 Table 9.1.5.1.2.3.2-1)

Derivation Path: TS 38.508-1 [4], Table 4.7.1-7			
Information Element	Value/remark	Comment	Condition
Equivalent PLMNs	MCC=002, MNC=101	PLMN ID of NGC Cell E	

Table 9.1.5.1.2.3.3-3: REGISTRATION ACCEPT (step 94 Table 9.1.5.1.2.3.2-1)

Derivation Path: TS 38.508-1 [4], Table 4.7.1-7			
Information Element	Value/remark	Comment	Condition
Equivalent PLMNs	MCC=003, MNC=101 and MCC=002, MNC=101	PLMN ID of NGC Cell F and PLMN ID of NGC Cell E	

Table 9.1.5.1.2.3.3-4: REGISTRATION REJECT (step 77 Table 9.1.5.1.2.3.2-1)

Derivation Path: TS 38.508-1 [4], Table 4.7.1-9			
Information Element	Value/remark	Comment	Condition
5GMM Cause	'0000 1011'B	PLMN not allowed	

9.1.5.1.3 Initial registration / 5GS services / NSSAI handling

9.1.5.1.3.1 Test Purpose (TP)

(1)

```

with { UE has sent a REGISTRATION REQUEST message including Requested NSSAI}
ensure that {
  when { UE receives REGISTRATION ACCEPT message with Allowed NSSAI }
  then { UE shall replace any stored allowed NSSAI for the current PLMN with new allowed NSSAI for the current PLMN }
}

```

(2)

```

with { UE has sent a REGISTRATION REQUEST message including Requested NSSAI}
ensure that {
  when { UE receives REGISTRATION ACCEPT message with Rejected NSSAI with reject cause "S-NSSAI not available in the current PLMN" }
  then { UE shall add the rejected S-NSSAI(s) in the rejected NSSAI for the current PLMN and not attempt to use the Rejected NSSAI in the current PLMN until switching off the UE or the UICC containing the USIM is removed }
}

```

(3)

```

with { UE receives REGISTRATION ACCEPT message with Rejected NSSAI with reject cause "S-NSSAI not available in the current PLMN" }
ensure that {
  when { UE has been switched off, then switched on }
  then { UE shall delete the stored Rejected NSSAI and shall send the NSSAI in Requested NSSAI IE of the REGISTRATION REQUEST message as per the configured and Allowed NSSAI for current PLMN }
}

```

```

    }

```

(4)

```

with { UE has sent a REGISTRATION REQUEST message including Requested NSSAI}
ensure that {
  when { UE receives REGISTRATION ACCEPT message with Rejected NSSAI with reject cause "S-NSSAI not
  available in the current registration area" }
  then { UE shall add the rejected S-NSSAI(s) in the rejected NSSAI for the current PLMN and
  registration area combination and not attempt to use the Rejected NSSAI in the current registration
  area until switching off the UE, the UE moving out of the current registration area or the UICC
  containing the USIM is removed }
}

```

(5)

```

with { UE receives REGISTRATION ACCEPT message with Rejected NSSAI with reject cause "S-NSSAI not
  available in the current registration area" }
ensure that {
  when { UE has been moved out of the current registration area }
  then { UE shall delete the stored Rejected NSSAI for the current PLMN as well as registration
  area combination and shall send the NSSAI in Requested NSSAI IE of the REGISTRATION REQUEST message
  as per the configured and Allowed NSSAI for current PLMN }
}

```

9.1.5.1.3.2 Conformance requirements

References: The conformance requirements covered in the present TC are specified in: TS 24.501 [22], clause 5.5.1.2.2 and 5.5.1.2.4. Unless otherwise stated these are Rel-15 requirements.

[TS 24.501 clause 5.5.1.2.2]

The UE shall include the requested NSSAI containing the S-NSSAI(s) corresponding to the slice(s) to which the UE intends to register and shall include the mapped S-NSSAI(s) for the requested NSSAI, if available, in the REGISTRATION REQUEST message. If the UE has allowed NSSAI or configured NSSAI for the current PLMN, the requested NSSAI shall be either:

- a) the configured NSSAI for the current PLMN, or a subset thereof as described below, if the UE has no allowed NSSAI for the current PLMN;
- b) the allowed NSSAI for the current PLMN, or a subset thereof as described below, if the UE has an allowed NSSAI for the current PLMN; or
- c) the allowed NSSAI for the current PLMN, or a subset thereof as described below, plus one or more S-NSSAIs from the configured NSSAI for which no corresponding S-NSSAI is present in the allowed NSSAI and those are neither in the rejected NSSAI for the current PLMN nor in the rejected NSSAI for the current area.

If the UE has neither allowed NSSAI for the current PLMN nor configured NSSAI for the current PLMN and has a default configured NSSAI, the UE shall:

- a) include the S-NSSAI(s) in the Requested NSSAI IE of the REGISTRATION REQUEST message using the default configured NSSAI; and
- b) include the Network slicing indication IE with the Default configured NSSAI indication bit set to "Requested NSSAI created from default configured NSSAI" in the REGISTRATION REQUEST message.

If the UE has no allowed NSSAI for the current PLMN, no configured NSSAI for the current PLMN, and no default configured NSSAI, the UE shall not include a requested NSSAI in the REGISTRATION message.

The subset of configured NSSAI provided in the requested NSSAI consists of one or more S-NSSAIs in the configured NSSAI applicable to the current PLMN, if the S-NSSAI is neither in the rejected NSSAI for the current PLMN nor in the rejected NSSAI for the current PLMN and registration area combination.

The subset of allowed NSSAI provided in the requested NSSAI consists of one or more S-NSSAIs in the allowed NSSAI for the current PLMN.

NOTE 3: How the UE selects the subset of configured NSSAI or allowed NSSAI to be provided in the requested NSSAI is implementation specific. The UE can take preferences indicated by the upper layers (e.g. policies, application) into account.

NOTE 4: The number of S-NSSAI(s) included in the requested NSSAI cannot exceed eight.

[TS 24.501 clause 5.5.1.2.4]

The AMF shall include the allowed NSSAI for the current PLMN and shall include the mapped S-NSSAI for the allowed NSSAI contained from the UE if available, in the REGISTRATION ACCEPT message if the UE included the requested NSSAI in the REGISTRATION REQUEST message and the AMF allows one or more S-NSSAIs in the requested NSSAI. The AMF may also include rejected NSSAI in the REGISTRATION ACCEPT message. Rejected NSSAI contains S-NSSAI(s) which was included in the requested NSSAI but rejected by the network associated with rejection cause(s).

The AMF may include a new configured NSSAI for the current PLMN in the REGISTRATION ACCEPT message if:

- a) the REGISTRATION REQUEST message did not include the requested NSSAI;
- b) the REGISTRATION REQUEST message included the requested NSSAI containing an S-NSSAI that is not valid in the serving PLMN; or
- c) the REGISTRATION REQUEST message included the Network slicing indication IE with the Default configured NSSAI indication bit set to "Requested NSSAI created from default configured NSSAI".

If a new configured NSSAI for the current PLMN is included in the REGISTRATION ACCEPT message, the AMF shall also include the mapped NSSAI(s) for the configured NSSAI for the current PLMN if available in the REGISTRATION ACCEPT message. In this case the AMF shall start timer T3550 and enter state 5GMM-COMMON-PROCEDURE-INITIATED as described in subclause 5.1.3.2.3.3.

The AMF shall include the Network slicing indication IE with the Network slicing subscription change indication set to "Network slicing subscription changed" in the REGISTRATION ACCEPT message if the UDM has indicated that the subscription data for network slicing has changed. In this case the AMF shall start timer T3550 and enter state 5GMM-COMMON-PROCEDURE-INITIATED as described in subclause 5.1.3.2.3.3.

The UE receiving the rejected NSSAI in the REGISTRATION ACCEPT message takes the following actions based on the rejection cause in the rejected NSSAI:

"S-NSSAI not available in the current PLMN"

The UE shall add the rejected S-NSSAI(s) in the rejected NSSAI for the current PLMN as specified in subclause 4.6.2.2 and not attempt to use this S-NSSAI in the current PLMN until switching off the UE or the UICC containing the USIM is removed.

"S-NSSAI not available in the current registration area"

The UE shall add the rejected S-NSSAI(s) in the rejected NSSAI for the current registration area as specified in subclause 4.6.2.2 and not attempt to use this S-NSSAI in the current registration area until switching off the UE, the UE moving out of the current registration area or the UICC containing the USIM is removed.

If the UE did not include the requested NSSAI in the REGISTRATION REQUEST message or none of the requested NSSAI are present in the subscribed S-NSSAIs, and one or more subscribed S-NSSAIs (containing one or more S-NSSAIs each of which may be associated with a new S-NSSAI) marked as default are available, the AMF shall put the subscribed S-NSSAIs marked as default in the allowed NSSAI of the REGISTRATION ACCEPT message. The AMF shall determine a registration area such that all S-NSSAIs of the allowed NSSAI are available in the registration area.

9.1.5.1.3.3 Test description

9.1.5.1.3.3.1 Pre-test conditions

System Simulator:

- NGC Cell A belongs to Home PLMN and TAI-1 and set as serving cell;

- NGC Cell B belongs to Home PLMN and TAI-2 and set as Non-Suitable “Off” cell.
- NGC Cell C belongs to Home PLMN and TAI-3 and set as Non-Suitable “Off” cell.

UE:

- UE is previously registered on NGC Cell A using default message contents according to TS 38.508-1 [4];
- Empty URSP Configuration.

Preamble:

- The UE is in state Switched OFF (state 0N-B) according to TS 38.508-1 [4].

9.1.5.1.3.3.2 Test procedure sequence

Table 9.1.5.1.3.3.2-1: Main behaviour

St	Procedure	Message Sequence		TP	Verdict
		U - S	Message		
1	The UE is switched on.	-	-	-	-
2	Check: Does UE transmit a REGISTRATION REQUEST message?	-->	REGISTRATION REQUEST	-	-
3-11	Steps 5 to 13 of the generic procedure for NR RRC_IDLE specified in TS 38.508-1 subclause 4.5.2 are performed.	-	-	-	-
12	The SS transmits a REGISTRATION ACCEPT message including Allowed NSSAI and Configured NSSAI.	<--	REGISTRATION ACCEPT	-	-
13-18	Steps 15 to 20a1 of the generic procedure for NR RRC_IDLE specified in TS 38.508-1 subclause 4.5.2 are performed.	-	-	-	-
19	Switch off procedure in RRC_IDLE specified in TS 38.508-1 subclause 4.9.6.1 is performed.	-	-	-	-
20	The UE is brought back to operation or the USIM is inserted.	-	-	-	-
21	Check: Does UE transmit a REGISTRATION REQUEST message including Requested NSSAI?	-->	REGISTRATION REQUEST	1	P
22-30	Steps 5 to 13 of the generic procedure for NR RRC_IDLE specified in TS 38.508-1 subclause 4.5.2 are performed.	-	-	-	-
31	The SS transmits a REGISTRATION ACCEPT message including Allowed NSSAI and Rejected NSSAI.	<--	REGISTRATION ACCEPT	-	-
32-37	Steps 15 to 20a1 of the generic procedure for NR RRC_IDLE specified in TS 38.508-1 subclause 4.5.2 are performed.	-	-	-	-
38	The SS configures NGC Cell A as a “Non-suitable “Off” cell” and NGC Cell C as the “Serving cell”.	-	-	-	-
39	Check: Does UE transmit a REGISTRATION REQUEST message including Requested NSSAI on NGC Cell C?	-->	REGISTRATION REQUEST	2	P
40-48	Void.	-	-	-	-
49	The SS transmits a REGISTRATION ACCEPT message including Allowed NSSAI.	<--	REGISTRATION ACCEPT	-	-
50	The UE transmits a REGISTRATION COMPLETE message.	-->	REGISTRATION COMPLETE	-	-
51	The SS transmits an <i>RRCRelease</i> message.	-	-	-	-
52	Check: Is S-NSSAI=2 in the Rejected NSSAI list with cause “S-NSSAI not available in the current PLMN” associated with current PLMN using AT/MMI?	-	-	2	P

53	Switch off procedure in RRC_IDLE specified in TS 38.508-1 subclause 4.9.6.1 is performed.	-	-	-	-
54	The UE is brought back to operation or the USIM is inserted.	-	-	-	-
55	Check: Does UE transmit a REGISTRATION REQUEST message including Requested NSSAI?	-->	REGISTRATION REQUEST	3	P
56-64	Steps 5 to 13 of the generic procedure for NR RRC_IDLE specified in TS 38.508-1 subclause 4.5.2 are performed.	-	-	-	-
65	The SS transmits a REGISTRATION ACCEPT message including Allowed NSSAI and Rejected NSSAI.	<--	REGISTRATION ACCEPT	-	-
66-71a1	Steps 15 to 20a1 of the generic procedure for NR RRC_IDLE specified in TS 38.508-1 subclause 4.5.2 are performed.	-	-	-	-
-	EXCEPTION: Step 71Aa1 describes behaviour depending on UE implementation; the "lower case letter" identifies a step sequence that take place if the UE performs a specific action.	-	-	-	-
71Aa1	If $pc_noOf_PDUsNewConnection > 0$ THEN generic procedure for NR RRC_IDLE Extension specified in TS 38.508-1 subclause Table 4.5.2.2-4 are performed.	-	-	-	-
72	Check: Is S-NSSAI=2 removed from the Rejected NSSAI list associated with current PLMN?	-	-	3	P
72A	Check: Is S-NSSAI=1 in the Rejected NSSAI list with cause "S-NSSAI not available in the current registration area" associated with current PLMN and registration area combination using AT/MMI?	-	-	4	P
73	The SS configures NGC Cell C as the "Non-suitable "Off" cell" and NGC Cell B as the "Serving cell".	-	-	-	-
74	Wait for 34s for FR1 or 130s for FR2 to allow UE to recognise the change, then the generic test procedure in TS 38.508-1 Table 4.9.4.2.2-1 is performed to indicate that UE camp on Cell B. (Note 1).	-	-	-	-
75-86	Void	-	-	-	-
87	Check: Is S-NSSAI=1 in the Rejected NSSAI list with cause "S-NSSAI not available in the current registration area" associated with current PLMN and registration area combination using AT/MMI?	-	-	4	P
88	The SS configures NGC Cell B as the "Non-suitable "Off" cell" and NGC Cell A as the "Serving cell".	-	-	-	-
89	Check: Does UE transmit a REGISTRATION REQUEST message including Requested NSSAI?	-->	REGISTRATION REQUEST	5	P
90-98	Void	-	-	-	-
99	The SS transmits a REGISTRATION ACCEPT message including Allowed NSSAI.	<--	REGISTRATION ACCEPT	-	-
100	The UE transmits a REGISTRATION COMPLETE message.	-->	REGISTRATION COMPLETE	-	-
101	The SS transmits an <i>RRCRelease</i> message.	-	-	-	-
102	Check: Is S-NSSAI=1 removed from the Rejected NSSAI list associated with current PLMN and registration area combination?	-	-	5	P
Note 1: The wait time for reselection to a newly detected intra frequency cell is selected to cover T_{detect,NR_Intra} ($25 \cdot 1280ms = 32s$ for FR1 and $25 \cdot 4 \cdot 1280ms = 128s$ for FR2) + T_{SI-NR} (1.28s for FR1 and FR2) = 33.28s					

rounded up to 34s for FR1 and 129.28s rounded up to 130s for FR2.

9.1.5.1.3.3.3 Specific message contents

Table 9.1.5.1.3.3.3-1: REGISTRATION REQUEST (step 2, Table 9.1.5.1.3.3.2-1)

Derivation path: TS 38.508-1 Table 4.7.1-6			
Information Element	Value/remark	Comment	Condition
5GS registration type value	'001'B	Initial registration	
Requested NSSAI		Note	
S-NSSAI IEI		S-NSSAI value 1	Note
Length of S-NSSAI contents	'00000001'B	SST	
SST	'00000001'B	SST value 1	
SD	Not Present		
Mapped configured SST	Not Present		
Mapped configured SD	Not Present		
Note:	S-NSSAI =1 will be always included from the allowed NSSAI list associated with PLMN of NCG Cell A by the UE but may include other S-NSSAI from Configured NSSAI list associated with PLMN of NCG Cell A if configured in the UE. See TS 24.501 clause 5.5.1.2.1		

Table 9.1.5.1.3.3.3-2: REGISTRATION ACCEPT (step 12, Table 9.1.5.1.3.3.2-1)

Derivation path: TS 38.508-1 Table 4.7.1-7			
Information Element	Value/remark	Comment	Condition
5GS registration result value	'001'B	3GPP access	
Allowed NSSAI			
S-NSSAI IEI		S-NSSAI value 1	
Length of S-NSSAI contents	'00000001'B	SST	
SST	'00000010'B	SST value 2	
SD	Not Present		
Mapped configured SST	Not Present		
Mapped configured SD	Not Present		
Configured NSSAI			
S-NSSAI IEI		S-NSSAI value 1	
Length of S-NSSAI contents	'00000001'B	SST	
SST	'00000001'B	SST value 1	
SD	Not Present		
Mapped configured SST	Not Present		
Mapped configured SD	Not Present		
S-NSSAI IEI		S-NSSAI value 2	
Length of S-NSSAI contents	'00000001'B	SST	
SST	'00000010'B	SST value 2	
SD	Not Present		
Mapped configured SST	Not Present		
Mapped configured SD	Not Present		

Table 9.1.5.1.3.3.3-3: PDU SESSION ESTABLISHMENT ACCEPT (step 14 , Table 9.1.5.1.3.3.2-1)

Derivation path: TS 38.508-1 clause 4.7.2-2			
Information Element	Value/remark	Comment	Condition
S-NSSAI			
Length of S-NSSAI contents	'0000 0001'B	SST	
SST	'0000 0010'B	SST value 2	

Table 9.1.5.1.3.3.3-4: REGISTRATION REQUEST (step 21, Table 9.1.5.1.3.3.2-1)

Derivation path: TS 38.508-1 Table 4.7.1-6			
Information Element	Value/remark	Comment	Condition
5GS registration type value	'001'B	Initial registration	
Requested NSSAI		Note	
S-NSSAI IEI		S-NSSAI value 1	

Length of S-NSSAI contents	'00000001'B	SST	
SST	'00000010'B	SST value 2	
SD	Not Present		
Mapped configured SST	Not Present		
Mapped configured SD	Not Present		
S-NSSAI IEI		S-NSSAI value 2	Note
Length of S-NSSAI contents	'00000001'B	SST	
SST	'00000001'B	SST value 1	
SD	Not Present		
Mapped configured SST	Not Present		
Mapped configured SD	Not Present		
Note:	S-NSSAI =2 will be always included by the UE from the allowed NSSAI list associated with PLMN of NCG Cell A but may include S-NSSAI =1 from Configured NSSAI list associated with PLMN of NCG Cell A. See TS 24.501 sub-clause 5.5.1.2.1		

Table 9.1.5.1.3.3.3-5: REGISTRATION ACCEPT (step 31, Table 9.1.5.1.3.3.2-1)

Derivation path: TS 38.508-1 Table 4.7.1-7			
Information Element	Value/remark	Comment	Condition
5GS registration result value	'001'B	3GPP access	
Allowed NSSAI		Note	
S-NSSAI IEI		S-NSSAI value 1	Note
Length of S-NSSAI contents	'00000001'B	SST	
SST	'00000001'B	SST value 1	
SD	Not Present		
Mapped configured SST	Not Present		
Mapped configured SD	Not Present		
Rejected NSSAI			
Rejected S-NSSAI-1		Rejected S-NSSAI value 1	
Cause value	'0000'B	S-NSSAI not available in the current PLMN	
SST	'00000010'B	SST value 2	
SD	Not Present		
Note:	If UE has requested only S-NSSAI =2 in step 21 and S-NSSAI =2 is added in the Rejected NSSAI list by the SS then AMF/SS can include default subscribed S-NSSAIs in the allowed NSSAI of REGISTRATION ACCEPT message, see TS 24.501 sub-clause 5.5.1.2.4.		

Table 9.1.5.1.3.3.3-6: REGISTRATION REQUEST (step 39, Table 9.1.5.1.3.3.2-1)

Derivation path: TS 38.508-1 Table 4.7.1-6			
Information Element	Value/remark	Comment	Condition
5GS registration type value	'010'B	mobility registration updating	
Requested NSSAI			
S-NSSAI IEI		S-NSSAI value 1	
Length of S-NSSAI contents	'00000001'B	SST	
SST	'00000001'B	SST value 1	
SD	Not Present		
Mapped configured SST	Not Present		
Mapped configured SD	Not Present		

Table 9.1.5.1.3.3.3-7: REGISTRATION ACCEPT (step 49, Table 9.1.5.1.3.3.2-1)

Derivation path: TS 38.508-1 Table 4.7.1-7			
Information Element	Value/remark	Comment	Condition
5GS registration result value	'001'B	3GPP access	
Allowed NSSAI			
S-NSSAI IEI		S-NSSAI value 1	
Length of S-NSSAI contents	'00000001'B	SST	

SST	'00000001'B	SST value 1	
SD	Not Present		
Mapped configured SST	Not Present		
Mapped configured SD	Not Present		

Table 9.1.5.1.3.3.3-8: REGISTRATION REQUEST (step 55, Table 9.1.5.1.3.3.2-1)

Derivation path: TS 38.508-1 Table 4.7.1-6			
Information Element	Value/remark	Comment	Condition
5GS registration type value	'001'B	Initial registration	
Requested NSSAI		Note	
S-NSSAI IEI		S-NSSAI value 1	Note
Length of S-NSSAI contents	'00000001'B	SST	
SST	'00000001'B	SST value 1	
SD	Not Present		
Mapped configured SST	Not Present		
Mapped configured SD	Not Present		
S-NSSAI IEI		S-NSSAI value 1	
Length of S-NSSAI contents	'00000001'B	SST	
SST	'00000010'B	SST value 2	
SD	Not Present		
Mapped configured SST	Not Present		
Mapped configured SD	Not Present		
Note:	S-NSSAI =1 will be always included by the UE from the allowed NSSAI list associated with PLMN of NCG Cell C but may include S-NSSAI =2 from Configured NSSAI list associated with PLMN of NCG Cell C. See TS 24.501 sub-clause 5.5.1.2.1		

Table 9.1.5.1.3.3.3-9: REGISTRATION ACCEPT (step 65, Table 9.1.5.1.3.3.2-1)

Derivation path: TS 38.508-1 Table 4.7.1-7			
Information Element	Value/remark	Comment	Condition
5GS registration result value	'001'B	3GPP access	
TAI list			
Type of list	'01'B	list of TACs belonging to one PLMN, with consecutive TAC values	
Number of elements	'00001'B	2 Elements	
TAC	PLMN =MCC/MNC stored in EF _{IMSI} TAC 1 = 2	TAI-2, TAI-3	
Allowed NSSAI			
S-NSSAI IEI		S-NSSAI value 1	
Length of S-NSSAI contents	'00000001'B	SST	
SST	'00000010'B	SST value 2	
SD	Not Present		
Mapped configured SST	Not Present		
Mapped configured SD	Not Present		
Rejected NSSAI			
Rejected S-NSSAI-1		Rejected S-NSSAI value 1	
Cause value	'0001'B	S-NSSAI not available in the current registration area	
SST	'00000001'B	SST value 1	
SD	Not Present		
Note:	If UE has requested only S-NSSAI =1 in step 55 and S-NSSAI =1 is added in the Rejected NSSAI list by the SS then AMF/SS can include default subscribed S-NSSAIs in the allowed NSSAI of REGISTRATION ACCEPT message, see TS 24.501 sub-clause 5.5.1.2.4.		

Table 9.1.5.1.3.3.3-10: PDU SESSION ESTABLISHMENT ACCEPT (step 67 , Table 9.1.5.1.3.3.2-1)

Derivation path: TS 38.508-1 clause 4.7.2-2			
Information Element	Value/remark	Comment	Condition
S-NSSAI			
Length of S-NSSAI contents	'0000 0001'B	SST	
SST	'0000 0010'B	SST value 2	

Table 9.1.5.1.3.3.3-11: Void**Table 9.1.5.1.3.3.3-12: Void****Table 9.1.5.1.3.3.3-13: REGISTRATION REQUEST (step 89, Table 9.1.5.1.3.3.2-1)**

Derivation path: TS 38.508-1 Table 4.7.1-6			
Information Element	Value/remark	Comment	Condition
5GS registration type value	'010'B	mobility registration updating	
Requested NSSAI		Note	
S-NSSAI IEI		S-NSSAI value 1	
Length of S-NSSAI contents	'00000001'B	SST	
SST	'00000010'B	SST value 2	
SD	Not Present		
Mapped configured SST	Not Present		
Mapped configured SD	Not Present		
S-NSSAI IEI		S-NSSAI value 1	
Length of S-NSSAI contents	'00000001'B	SST	
SST	'00000001'B	SST value 1	
SD	Not Present		
Mapped configured SST	Not Present		
Mapped configured SD	Not Present		
Note:	S-NSSAI =2 will be always included by the UE from the allowed NSSAI list associated with PLMN of NCG Cell A but may include S-NSSAI =1 from Configured NSSAI list associated with PLMN of NCG Cell A. See TS 24.501 sub-clause 5.5.1.2.1		

Table 9.1.5.1.3.3.3-14: REGISTRATION ACCEPT (step 99, Table 9.1.5.1.3.3.2-1)

Derivation path: TS 38.508-1 Table 4.7.1-7			
Information Element	Value/remark	Comment	Condition
5GS registration result value	'001'B	3GPP access	
Allowed NSSAI			
S-NSSAI IEI		S-NSSAI value 1	
Length of S-NSSAI contents	'00000001'B	SST	
SST	'00000010'B	SST value 2	
SD	Not Present		
Mapped configured SST	Not Present		
Mapped configured SD	Not Present		
S-NSSAI IEI		S-NSSAI value 2	Note
Length of S-NSSAI contents	'00000001'B	SST	
SST	'00000001'B	SST value 1	
SD	Not Present		
Mapped configured SST	Not Present		
Mapped configured SD	Not Present		
Note:	SS will send allowed NSSAIs based on the Requested NSSAIs sent by UE in step 89.		

9.1.5.1.3a Initial registration / 5GS services / NSSAI handling / NSSAI storage

9.1.5.1.3a.1 Test Purpose (TP)

(1)

```
with { UE is switched off with a valid USIM inserted }
ensure that {
  when { UE has configured NSSAI associated with HPLMN, configured NSSAI associated with a current
  PLMN with mapping to the Configured NSSAI for the HPLMN and UE is powered up or switched on }
  then { UE transmits REGISTRATION REQUEST message with Requested NSSAI using the configured NSSAI
  associated with current PLMN and mapping of each S-NSSAI of the requested NSSAI to the S-NSSAIs of
  the configured NSSAI for the HPLMN }
}
```

(2)

```
with { UE is switched off with a valid USIM inserted }
ensure that {
  when { UE has neither allowed NSSAI for the current PLMN nor configured NSSAI for the current PLMN
  and has a default configured NSSAI and UE is powered up or switched on }
  then { UE transmits REGISTRATION REQUEST message with Requested NSSAI using the default
  configured NSSAI and also includes Network slicing indication IE with the Default configured NSSAI
  indication bit set to "Requested NSSAI created from default configured NSSAI" }
}
```

(3)

```
with { UE is switched off with a valid USIM inserted }
ensure that {
  when { UE has no allowed NSSAI for the current PLMN, no configured NSSAI for the current PLMN, and
  no configured NSSAI not associated with a PLMN and UE is powered up or switched on }
  then { UE transmits REGISTRATION REQUEST message and does not include a Requested NSSAI }
}
```

9.1.5.1.3a.2 Conformance requirements

References: The conformance requirements covered in the present TC are specified in: TS 24.501, clause 5.5.1.2.2 and 5.5.1.2.4.

[TS 24.501 clause 5.5.1.2.2]

5.5.1.2.1 General

This procedure can be used by a UE for initial registration for 5GS services.

...

The UE shall include the requested NSSAI containing the S-NSSAI(s) corresponding to the slice(s) to which the UE wants to register and shall include the mapping of the requested NSSAI which is the mapping of each S-NSSAI of the requested NSSAI to the S-NSSAI(s) of the HPLMN, if available, in the REGISTRATION REQUEST message. If the UE has allowed NSSAI or configured NSSAI for the current PLMN, the requested NSSAI shall be either:

- a) the configured NSSAI for the current PLMN, or a subset thereof as described below, if the UE has no allowed NSSAI for the current PLMN;
- b) the allowed NSSAI for the current PLMN, or a subset thereof as described below, if the UE has an allowed NSSAI for the current PLMN; or
- c) the allowed NSSAI for the current PLMN, or a subset thereof as described below, plus one or more S-NSSAIs from the configured NSSAI for which no corresponding S-NSSAI is present in the allowed NSSAI and those are neither in the rejected NSSAI for the current PLMN nor in the rejected NSSAI for the current PLMN and registration area combination.

If the UE has neither allowed NSSAI for the current PLMN nor configured NSSAI for the current PLMN and has a default configured NSSAI, the UE shall:

- a) include the S-NSSAI(s) in the Requested NSSAI IE of the REGISTRATION REQUEST message using the default configured NSSAI; and
- b) include the Network slicing indication IE with the Default configured NSSAI indication bit set to "Requested NSSAI created from default configured NSSAI" in the REGISTRATION REQUEST message.

If the UE has no allowed NSSAI for the current PLMN, no configured NSSAI for the current PLMN, and no default configured NSSAI, the UE shall not include a requested NSSAI in the REGISTRATION message.

The subset of configured NSSAI provided in the requested NSSAI consists of one or more S-NSSAIs in the configured NSSAI applicable to the current PLMN, if the S-NSSAI is neither in the rejected NSSAI for the current PLMN nor in the rejected NSSAI for the current PLMN and registration area combination.

The subset of allowed NSSAI provided in the requested NSSAI consists of one or more S-NSSAIs in the allowed NSSAI for the current PLMN.

NOTE 3: How the UE selects the subset of configured NSSAI or allowed NSSAI to be provided in the requested NSSAI is implementation.

NOTE 4: The number of S-NSSAI(s) included in the requested NSSAI cannot exceed eight.

[TS 24.501 clause 5.5.1.2.4]

The AMF shall include the allowed NSSAI for the current PLMN and shall include the mapping of each S-NSSAI of the allowed NSSAI to the S-NSSAI(s) of the HPLMN contained in the requested NSSAI from the UE if available, in the REGISTRATION ACCEPT message if the UE included the requested NSSAI in the REGISTRATION REQUEST message and the AMF allows one or more S-NSSAIs in the requested NSSAI. The AMF may also include rejected NSSAI in the REGISTRATION ACCEPT message. Rejected NSSAI contains S-NSSAI(s) which was included in the requested NSSAI but rejected by the network associated with rejection cause(s).

The AMF may include a new configured NSSAI for the current PLMN in the REGISTRATION ACCEPT message if:

- a) the REGISTRATION REQUEST message did not include the requested NSSAI;
- b) the REGISTRATION REQUEST message included the requested NSSAI containing an S-NSSAI that is not valid in the serving PLMN; or
- c) the REGISTRATION REQUEST message included the Network slicing indication IE with the Default configured NSSAI indication bit set to "Requested NSSAI created from default configured NSSAI".

If a new configured NSSAI for the current PLMN is included in the REGISTRATION ACCEPT message, the AMF shall also include the mapping of the configured NSSAI for the current PLMN the S-NSSAI(s) of the to HPLMN if available in the REGISTRATION ACCEPT message. In this case the AMF shall start timer T3550 and enter state 5GMM-COMMON-PROCEDURE-INITIATED as described in subclause 5.1.3.2.3.3.

The AMF shall include the Network slicing indication IE with the Network slicing subscription change indication set to "Network slicing subscription changed" in the REGISTRATION ACCEPT message if the UDM has indicated that the subscription data for network slicing has changed. In this case the AMF shall start timer T3550 and enter state 5GMM-COMMON-PROCEDURE-INITIATED as described in subclause 5.1.3.2.3.3.

The UE receiving the rejected NSSAI in the REGISTRATION ACCEPT message takes the following actions based on the rejection cause in the rejected NSSAI:

"S-NSSAI not available in the current PLMN"

The UE shall add the rejected S-NSSAI(s) in the rejected NSSAI for the current PLMN as specified in subclause 4.6.2.2 and not attempt to use this S-NSSAI in the current PLMN until switching off the UE or the UICC containing the USIM is removed.

"S-NSSAI not available in the current registration area"

The UE shall add the rejected S-NSSAI(s) in the rejected NSSAI for the current PLMN and registration area combination as specified in subclause 4.6.2.2 and not attempt to use this S-NSSAI in the current registration area until switching off the UE, the UE moving out of the current registration area or the UICC containing the USIM is removed.

If the UE did not include the requested NSSAI in the REGISTRATION REQUEST message or none of the requested NSSAI are present in the subscribed S-NSSAIs, and one or more subscribed S-NSSAIs (containing one or more S-NSSAIs each of which may be associated with a new S-NSSAI) marked as default are available, the AMF shall put the subscribed S-NSSAIs marked as default in the allowed NSSAI of the REGISTRATION ACCEPT message. The AMF shall determine a registration area such that all S-NSSAIs of the allowed NSSAI are available in the registration area.

9.1.5.1.3a.3 Test description

9.1.5.1.3a.3.1 Pre-test conditions

System Simulator:

- NGC Cell G is configured according to Table 6.3.2.2-1 and Table 6.3.2.2-3 in 38.508-1 [4] except that frequency NRf1 replaces NRf2.
- NGC Cell G belongs to VPLMN, TAI-7 and set as serving cell.

UE:

- None

Preamble:

- The UE is in state Switched OFF (state 0N-B) according to TS 38.508-1 [4] and camped on NGC Cell A HPLMN.

9.1.5.1.3a.3.2 Test procedure sequence

Table 9.1.5.1.3a.3.2-1: Main behaviour

St	Procedure	Message Sequence		TP	Verdict
		U - S	Message		
1	The UE is switched on.			-	-
2	The UE transmits REGISTRATION REQUEST message on NGC Cell G.	-->	REGISTRATION REQUEST	-	-
3-11	Steps 5 to 13 of the generic procedure for NR RRC_IDLE specified in TS 38.508-1 subclause 4.5.2.2-2 are performed.	-	-	-	-
12	The SS transmits REGISTRATION ACCEPT message including Configured and Allowed NSSAI lists.	<--	REGISTRATION ACCEPT	-	-
13-18	Steps 15 to 20a1 of the generic procedure for NR RRC_IDLE specified in TS 38.508-1 subclause 4.5.2.2-2 are performed with ' <i>connected without release</i> '.	-	-	-	-
19	The SS transmits NSSAI DELETE REQUEST message to delete the Allowed NSSAI list for all PLMNs (MCC-MNC =000-000) and for 3GPP access so UE has only configured NSSAI.	<--	NSSAI DELETE REQUEST	-	-
20	UE transmits NSSAI DELETE RESPONSE message.	-->	NSSAI DELETE RESPONSE	-	-
21	The SS transmits an <i>RRCRelease</i> message.	-	-	-	-
22	Switch off procedure in RRC_Idle specified in TS 38.508-1 subclause 4.9.6.1 is performed.	-	-	-	-
23	The UE is brought back to operation or the USIM is inserted.	-	-	-	-
24	Check: Does UE transmit a REGISTRATION REQUEST message including Requested NSSAI?	-->	REGISTRATION REQUEST	1	P
25-33	Steps 5 to 13 of the generic procedure for NR RRC_IDLE specified in TS 38.508-1 subclause 4.5.2.2-2 are performed.	-	-	-	-
34	The SS transmits a REGISTRATION ACCEPT	<--	REGISTRATION ACCEPT	-	-

	message including Allowed NSSAI.				
35-40	Steps 15 to 20a1 of the generic procedure for NR RRC_IDLE specified in TS 38.508-1 subclause 4.5.2.2-2 are performed with 'connected without release'.	-	-	-	-
41	The SS transmits NSSAI DELETE REQUEST message to delete the Default Configured NSSAI list.	<--	NSSAI DELETE REQUEST	-	-
42	UE transmits NSSAI DELETE RESPONSE message.	-->	NSSAI DELETE RESPONSE	-	-
43	Use AT command and set Default Configured NSSAI to 1 & 2.	-	-	-	-
44	The SS transmits NSSAI DELETE REQUEST message to delete the Configured NSSAI list for all PLMNs (MCC-MNC =000-000).	<--	NSSAI DELETE REQUEST	-	-
45	UE transmits NSSAI DELETE RESPONSE message.	-->	NSSAI DELETE RESPONSE	-	-
46	The SS transmits NSSAI DELETE REQUEST message to delete the Allowed NSSAI list for all PLMNs (MCC-MNC =000-000).	<--	NSSAI DELETE REQUEST	-	-
47	UE transmits NSSAI DELETE RESPONSE message.	-->	NSSAI DELETE RESPONSE	-	-
48	The SS transmits an <i>RRCRelease</i> message.	-	-	-	-
49	Switch off procedure in RRC_Idle specified in TS 38.508-1 subclause 4.9.6.1 is performed	-	-	-	-
50	The UE is brought back to operation or the USIM is inserted.	-	-	-	-
51	Check: Does UE transmit a REGISTRATION REQUEST message including Requested NSSAI?	-->	REGISTRATION REQUEST	2	P
52-60	Steps 5 to 13 of the generic procedure for NR RRC_IDLE specified in TS 38.508-1 subclause 4.5.2.2-2 are performed.	-	-	-	-
61	The SS transmits a REGISTRATION ACCEPT message including Allowed NSSAI.	<--	REGISTRATION ACCEPT	-	-
62-67	Steps 15 to 20a1 of the generic procedure for NR RRC_IDLE specified in TS 38.508-1 subclause 4.5.2.2-2 are performed with 'connected without release'.	-	-	-	-
68	The SS transmits NSSAI DELETE REQUEST message to delete the Default Configured NSSAI list.	<--	NSSAI DELETE REQUEST	-	-
69	UE transmits NSSAI DELETE RESPONSE message.	-->	NSSAI DELETE RESPONSE	-	-
70	The SS transmits NSSAI DELETE REQUEST message to delete the Configured NSSAI list for all PLMNs (MCC-MNC =000-000).	<--	NSSAI DELETE REQUEST	-	-
71	UE transmits NSSAI DELETE RESPONSE message.	-->	NSSAI DELETE RESPONSE	-	-
72	The SS transmits NSSAI DELETE REQUEST message to delete the Allowed NSSAI list for all PLMNs (MCC-MNC =000-000).	<--	NSSAI DELETE REQUEST	-	-
73	UE transmits NSSAI DELETE RESPONSE message.	-->	NSSAI DELETE RESPONSE	-	-
74	The SS transmits an <i>RRCRelease</i> message.	-	-	-	-
75	Switch off procedure in RRC_Idle specified in TS 38.508-1 subclause 4.9.6.1 is performed.	-	-	-	-
76	The UE is brought back to operation or the USIM is inserted.	-	-	-	-
77	Check: Does UE transmit a REGISTRATION REQUEST message not including Requested NSSAI?	-->	REGISTRATION REQUEST	3	P
78-93	Steps 5 to 20a1 of the generic procedure for NR RRC_IDLE specified in TS 38.508-1 subclause 4.5.2.2-2 are performed.	-	-	-	-

9.1.5.1.3a.3.3 Specific message contents

Table 9.1.5.1.3a.3.3-1: REGISTRATION ACCEPT (Preamble)

Derivation path: TS 38.508-1 Table 4.7.1-7			
Information Element	Value/remark	Comment	Condition
5GS registration result value	'001'B	3GPP access	
Allowed NSSAI			
S-NSSAI IEI		S-NSSAI value 1	
Length of S-NSSAI contents	'0000001'B	SST	
SST	'0000001'B	1	
SD	Not Present		
Mapped configured SST	Not Present		
Mapped configured SD	Not Present		
Configured NSSAI			
S-NSSAI IEI		S-NSSAI value 1	
Length of S-NSSAI contents	'0000001'B	SST	
SST	'0000001'B	1	
SD	Not Present		
Mapped configured SST	Not Present		
Mapped configured SD	Not Present		
S-NSSAI IEI		S-NSSAI value 2	
Length of S-NSSAI contents	'0000001'B	SST	
SST	'0000010'B	2	
SD	Not Present		
Mapped configured SST	Not Present		
Mapped configured SD	Not Present		

Table 9.1.5.1.3a.3.3-2: REGISTRATION ACCEPT (step 12, Table 9.1.5.1.3a.3.2-1)

Derivation path: TS 38.508-1 Table 4.7.1-7			
Information Element	Value/remark	Comment	Condition
5GS registration result value	'001'B	3GPP access	
Allowed NSSAI			
S-NSSAI IEI		S-NSSAI value 1	
Length of S-NSSAI contents	'0000001'B	SST	
SST	'0000100'B	4	
SD	Not Present		
Mapped configured SST	Not Present		
Mapped configured SD	Not Present		
Configured NSSAI			
S-NSSAI IEI		S-NSSAI value 1	
Length of S-NSSAI contents	'0000010'B	SST and mapped configured SST	
SST	'0000100'B	4	
SD	Not Present		
Mapped configured SST	'0000001'B	1	
Mapped configured SD	Not Present		
S-NSSAI IEI		S-NSSAI value 2	
Length of S-NSSAI contents	'0000010'B	SST and mapped configured SST	
SST	'0000101'B	5	
SD	Not Present		
Mapped configured SST	'0000010'B	2	
Mapped configured SD	Not Present		

Table 9.1.5.1.3a.3.3-2A: PDU SESSION ESTABLISHMENT ACCEPT (step 14 , Table 9.1.5.1.3a.3.2-1)

Derivation path: TS 38.508-1 clause 4.7.2-2			
Information Element	Value/remark	Comment	Condition
S-NSSAI			
Length of S-NSSAI contents	'0000 0001'B	SST	
SST	'0000 0100'B	SST value 4	

Table 9.1.5.1.3a.3.3-3: NSSAI DELETE REQUEST (step 19, Table 9.1.5.1.3a.3.2-1)

Derivation path: TS 38.509 Table 6.7.1			
Information Element	Value/remark	Comment	Condition
Protocol discriminator	1111		
Skip indicator	0000		
Message type	'10000110'		
Delete NSSAI type	'00000010'	Delete Allowed NSSAI	
Allowed NSSAI	000000	All PLMNs (3 Octets)	
	00	3GPP access	

Table 9.1.5.1.3a.3.3-4: NSSAI DELETE RESPONSE (step 20, Table 9.1.5.1.3a.3.2-1)

Derivation path: TS 38.509 Table 6.7.1			
Information Element	Value/remark	Comment	Condition
Protocol discriminator	1111		
Skip indicator	0000		
Message type	'10100111'		

Table 9.1.5.1.3a.3.3-5: REGISTRATION REQUEST (step 24, Table 9.1.5.1.3a.3.2-1)

Derivation path: TS 38.508-1 Table 4.7.1-6			
Information Element	Value/remark	Comment	Condition
5GS registration type value	'001'B	Initial registration	
Requested NSSAI		Note	
S-NSSAI IE1		S-NSSAI value 1	
Length of S-NSSAI contents	'00000010'B	SST and mapped configured SST	
SST	'00000100'B	4	
SD	Not Present		
Mapped configured SST	'00000001'B	1	
Mapped configured SD	Not Present		
S-NSSAI IE2		S-NSSAI value 2	
Length of S-NSSAI contents	'00000010'B	SST and mapped configured SST	
SST	'00000101'B	5	
SD	Not Present		
Mapped configured SST	'00000010'B	2	
Mapped configured SD	Not Present		
Note: UE may include S-NSSAI 4 or 5 or both 4 and 5 from the configured NSSAI list associated with NGC cell G.			

Table 9.1.5.1.3a.3.3-6: REGISTRATION ACCEPT (step 34, Table 9.1.5.1.3a.3.2-1)

Derivation path: TS 38.508-1 [4], Table 4.7.1-7			
Information Element	Value/remark	Comment	Condition
5GS registration result value	'001'B	3GPP access	
Allowed NSSAI		Note	
S-NSSAI IE1		S-NSSAI value 1	
Length of S-NSSAI contents	'00000010'B	SST and mapped configured SST	
SST	'00000100'B	4	
SD	Not Present		
Mapped configured SST	'00000001'B	1	
Mapped configured SD	Not Present		
S-NSSAI IE2		S-NSSAI value 2	
Length of S-NSSAI contents	'00000010'B	SST and mapped configured SST	
SST	'00000101'B	5	

SD	Not Present		
Mapped configured SST	'00000010'B	2	
Mapped configured SD	Not Present		
Note: SS will send Allowed NSSAIs based on the Requested NSSAI sent by UE in step 24.			

Table 9.1.5.1.3a.3.3-6A: PDU SESSION ESTABLISHMENT ACCEPT (step 36, Table 9.1.5.1.3a.3.2-1)

Derivation path: TS 38.508-1 clause 4.7.2-2			
Information Element	Value/remark	Comment	Condition
S-NSSAI			
Length of S-NSSAI contents	'0000 0010'B	SST	
SST	'0000 0100'B	SST value 4	
Mapped configured SST	'00000001'B	mapped configured SST value 1	

Table 9.1.5.1.3a.3.3-7: NSSAI DELETE REQUEST (step 41, Table 9.1.5.1.3a.3.2-1)

Derivation path: TS 38.509 Table 6.7.1			
Information Element	Value/remark	Comment	Condition
Protocol discriminator	1111		
Skip indicator	0000		
Message type	'10000110'		
Delete NSSAI type	'00000000'	Delete Default Configured NSSAI	

Table 9.1.5.1.3a.3.3-8: NSSAI DELETE RESPONSE (step 42, Table 9.1.5.1.3a.3.2-1)

Derivation path: TS 38.509 Table 6.7.1			
Information Element	Value/remark	Comment	Condition
Protocol discriminator	1111		
Skip indicator	0000		
Message type	'10100111'		

Table 9.1.5.1.3a.3.3-9: NSSAI DELETE REQUEST (step 44, Table 9.1.5.1.3a.3.2-1)

Derivation path: TS 38.509 Table 6.7.1			
Information Element	Value/remark	Comment	Condition
Protocol discriminator	1111		
Skip indicator			
Message type	'10000110'		
Delete NSSAI type	'00000001'	Delete Configured NSSAI	
Configured NSSAI	00000000	All PLMNs	

Table 9.1.5.1.3a.3.3-10: NSSAI DELETE RESPONSE (step 45, Table 9.1.5.1.3a.3.2-1)

Derivation path: TS 38.509 Table 6.7.1			
Information Element	Value/remark	Comment	Condition
Protocol discriminator	1111		
Skip indicator	0000		
Message type	'10100111'		

Table 9.1.5.1.3a.3.3-11: NSSAI DELETE REQUEST (step 46, Table 9.1.5.1.3a.3.2-1)

Derivation path: TS 38.509 Table 6.7.1			
Information Element	Value/remark	Comment	Condition
Protocol discriminator	1111		
Skip indicator	0000		

Message type	'10000110'		
Delete NSSAI type	'00000010'	Delete Allowed NSSAI	
Allowed NSSAI	000000	All PLMNs (3 Octets)	
	00	3GPP access	

Table 9.1.5.1.3a.3.3-12: NSSAI DELETE RESPONSE (step 47, Table 9.1.5.1.3a.3.2-1)

Derivation path: TS 38.509 Table 6.7.1			
Information Element	Value/remark	Comment	Condition
Protocol discriminator	1111		
Skip indicator	0000		
Message type	'10100111'		

Table 9.1.5.1.3a.3.3-13: REGISTRATION REQUEST (step 51, Table 9.1.5.1.3a.3.2-1)

Derivation path: TS 38.508-1 Table 4.7.1-6			
Information Element	Value/remark	Comment	Condition
5GS registration type value	'001'B	Initial registration	
Requested NSSAI		Note	
S-NSSAI IEI		S-NSSAI value 1	
Length of S-NSSAI contents	'00000001'B	SST	
SST	'00000001'B	1	
SD	Not Present		
Mapped configured SST	Not Present		
Mapped configured SD	Not Present		
S-NSSAI IEI		S-NSSAI value 2	
Length of S-NSSAI contents	'00000001'B	SST	
SST	'00000010'B	2	
SD	Not Present		
Mapped configured SST	Not Present		
Mapped configured SD	Not Present		
Network slicing indication			
Default configured NSSAI indication	1	Requested NSSAI created from default configured NSSAI	

Note: UE may include either 1 or 2 or both 1 and 2 NSSAIs.

Table 9.1.5.1.3a.3.3-14: REGISTRATION ACCEPT (step 61, Table 9.1.5.1.3a.3.2-1)

Derivation path: TS 38.508-1 [4], Table 4.7.1-7			
Information Element	Value/remark	Comment	Condition
5GS registration result value	'001'B	3GPP access	
Allowed NSSAI		Note	
S-NSSAI IEI		S-NSSAI value 1	
Length of S-NSSAI contents	'00000010'B	SST and mapped configured SST	
SST	'00000001'B	1	
SD	Not Present		
Mapped configured SST	'00000001'B		
Mapped configured SD	Not Present		
S-NSSAI IEI		S-NSSAI value 2	
Length of S-NSSAI contents	'00000010'B	SST and mapped configured SST	
SST	'00000010'B	2	
SD	Not Present		
Mapped configured SST	'00000010'B		
Mapped configured SD	Not Present		

Note: SS will send Allowed NSSAIs based on the Requested NSSAI sent by UE in Step 51

Table 9.1.5.1.3a.3.3-15: NSSAI DELETE REQUEST (step 68, Table 9.1.5.1.3a.3.2-1)

Derivation path: TS 38.509 Table 6.7.1			
Information Element	Value/remark	Comment	Condition
Protocol discriminator	1111		
Skip indicator	0000		
Message type	'10000110'		
Delete NSSAI type	'00000000'	Delete Default Configured NSSAI	

Table 9.1.5.1.3a.3.3-16: NSSAI DELETE RESPONSE (step 69, Table 9.1.5.1.3a.3.2-1)

Derivation path: TS 38.509 Table 6.7.1			
Information Element	Value/remark	Comment	Condition
Protocol discriminator	1111		
Skip indicator	0000		
Message type	'10100111'		

Table 9.1.5.1.3a.3.3-17: NSSAI DELETE REQUEST (step 70, Table 9.1.5.1.3a.3.2-1)

Derivation path: TS 38.509 Table 6.7.1			
Information Element	Value/remark	Comment	Condition
Protocol discriminator	1111		
Skip indicator	0000		
Message type	'10000110'		
Delete NSSAI type	'00000001'	Delete Configured NSSAI	
Configured NSSAI	000000	All PLMNs (3 Octets)	

Table 9.1.5.1.3a.3.3-18: NSSAI DELETE RESPONSE (step 71, Table 9.1.5.1.3a.3.2-1)

Derivation path: TS 38.509 Table 6.7.1			
Information Element	Value/remark	Comment	Condition
Protocol discriminator	1111		
Skip indicator	0000		
Message type	'10100111'		

Table 9.1.5.1.3a.3.3-19: NSSAI DELETE REQUEST (step 72, Table 9.1.5.1.3a.3.2-1)

Derivation path: TS 38.509 Table 6.7.1			
Information Element	Value/remark	Comment	Condition
Protocol discriminator	1111		
Skip indicator	0000		
Message type	'10000110'		
Delete NSSAI type	'00000010'	Delete Allowed NSSAI	
Allowed NSSAI	000000	All PLMNs (3 Octets)	
	00	3GPP access	

Table 9.1.5.1.3a.3.3-20: NSSAI DELETE RESPONSE (step 73, Table 9.1.5.1.3a.3.2-1)

Derivation path: TS 38.509 Table 6.7.1			
Information Element	Value/remark	Comment	Condition
Protocol discriminator	1111		
Skip indicator	0000		
Message type	'10100111'		

Table 9.1.5.1.3a.3.3-21: REGISTRATION REQUEST (step 77, Table 9.1.5.1.3a.3.2-1)

Derivation path: TS 38.508-1 Table 4.7.1-6			
Information Element	Value/remark	Comment	Condition
5GS registration type value	'001'B	Initial registration	
Requested NSSAI	Not Present		

9.1.5.1.4 Initial registration / 5GS services / MICO mode / TAI list handling

9.1.5.1.4.1 Test Purpose (TP)

(1)

```
with { The UE is in 5GMM-DEREGISTERED state and is switched off }
ensure that {
  when { the UE supports MICO mode and requests the use of MICO mode}
  then { the UE includes the MICO indication IE in the REGISTRATION REQUEST message }
}
```

(2)

```
with { The UE has received REGISTRATION ACCEPT message }
ensure that {
  when { the REGISTRATION ACCEPT message included MICO indication IE indicating "all PLMN
registration area allocated" }
  then { the UE treats all TAIs in the current PLMN as a registration area and deletes its old TAI
list }
}
```

(3)

```
with { The UE detecting a better NG cell in same PLMN }
ensure that {
  when { the UE treats all TAIs in the current PLMN as a registration area and has deleted its old
TAI list as a result of REGISTRATION ACCEPT message included MICO indication IE indicating "all PLMN
registration area allocated" }
  then { the UE does not perform the REGISTRATION procedure for mobility }
}
```

(4)

```
with { The UE detecting a better NG cell in a different PLMN }
ensure that {
  when { the UE transmits the REGISTRATION REQUEST }
  then { the UE sets the IE 5GS registration type to "mobility registration updating" and performs
a REGISTRATION procedure for Mobility }
}
```

9.1.5.1.4.2 Conformance requirements

References: The conformance requirements covered in the present TC are specified in: TS 24.501, clause 5.5.1.2.2 and 5.5.1.2.4. Unless otherwise stated these are Rel-15 requirements.

[TS 24.501, clause 5.5.1.2.2]

...

If the UE supports MICO mode and requests the use of MICO mode, then the UE shall include the MICO indication IE in the REGISTRATION REQUEST message.

...

[TS 24.501, clause 5.5.1.2.4]

...

The AMF shall include the MICO indication IE in the REGISTRATION ACCEPT message only if the MICO indication IE was included in the REGISTRATION REQUEST message, the AMF supports and accepts the use of MICO mode. If the AMF supports and accepts the use of MICO mode, the AMF may indicate "all PLMN registration area allocated" in the MICO indication IE in the REGISTRATION ACCEPT message. If "all PLMN registration area allocated" is indicated in the MICO indication IE, the AMF shall not assign and include the TAI list in the REGISTRATION ACCEPT message. If the REGISTRATION ACCEPT message included an MICO indication IE indicating "all PLMN registration area allocated", the UE shall treat all TAIs in the current PLMN as a registration area and delete its old TAI list.

...

9.1.5.1.4.3 Test description

9.1.5.1.4.3.1 Pre-test conditions

System Simulator:

- NGC Cell A, NGC Cell C and NGC Cell E are configured according to Table 6.3.2.2-1 and Table 6.3.2.2-3 in TS 38.508-1 [4].

UE:

None.

Preamble:

- The UE is in state Switched OFF (State 0-A) as per TS 38.508-1 [4] Table 4.4A.2-0.

9.1.5.1.4.3.2 Test procedure sequence

Table 9.1.5.1.4.3.2-1: Main behaviour

St	Procedure	Message Sequence		TP	Verdict
		U - S	Message		
0	The SS configures: - NGC Cell A as the "Non-suitable "Off" cell". - NGC Cell C as the "Non-suitable "Off" cell". - NGC Cell E as the "Non-suitable "Off" cell".				
1	The UE is switched ON				
2	The user requests enabling of MICO mode by MMI or AT command	-		-	-
3	The SS configures: - NGC Cell A as the "Serving cell". - NGC Cell C as the "Non-suitable "Off" cell". - NGC Cell E as the "Non-suitable "Off" cell".	-		-	-
4-6	The UE establishes an RRC connection by executing steps 2–4 of Table 4.5.2.2-2 in TS38.508-1 [4].	-		-	-
7	Check: Does the UE transmit a REGISTRATION REQUEST message including IE MICO indication	-->	REGISTRATION REQUEST	1	P
8-16	Steps 5-13 of Table 4.5.2.2-2 of the generic procedure in TS 38508-1 [4] are performed	-		-	-
17	SS transmits a REGISTRATION ACCEPT message that includes IE MICO indication	<--	REGISTRATION ACCEPT	-	-
18	The SS releases the RRC Connection	-		-	-
19	The SS configures: - NGC Cell A as the "Non-suitable "Off" cell". - NGC Cell C as the "Serving cell". - NGC Cell E as the "Non-suitable "Off" cell".	-			
20	Check: Does the UE transmit a RRCSetupRequest on NGC Cell C? This is checked for 60s	-->	NR RRC: RRCSetupRequest	2,3	F

21	The SS configures: - NGC Cell A as the "Non-suitable "Off" cell". - NGC Cell C as the "Non-suitable "Off" cell". - NGC Cell E as the "Serving cell".	-		-	-
	The following messages are to be observed on NGC Cell E unless explicitly stated otherwise				
22-24	The UE establishes an RRC connection by executing steps 2–4 of Table 4.5.2.2-2 in TS38.508-1 [4].	-		-	-
25	Check: Does the UE transmit a REGISTRATION REQUEST message with IE 5GS registration type set to "mobility registration updating"	-->	REGISTRATION REQUEST	4	P
26-27	Steps 4–5 of Table 4.9.5.2.2-1 in TS38.508-1 [4] are performed				

9.1.5.1.4.3.3 Specific message contents

Table 9.1.5.1.4.3.3-1: REGISTRATION REQUEST (step 6 Table 9.1.5.1.4.3.2-1)

Derivation Path: TS 38.508-1 [4], Table 4.7.1-6			
Information Element	Value/remark	Comment	Condition
5GS registration type			
5GS registration type value	'001'B	Initial registration	INITIAL
MICO indication	'0000'B		

Table 9.1.5.1.4.3.3-2: REGISTRATION ACCEPT (step 16 Table 9.1.5.1.4.3.2-1)

Derivation Path: TS 38.508 [4], Table 4.7.1-7			
Information Element	Value/remark	Comment	Condition
MICO Indication	'0001'B	All PLMN registration area allocated	
TAI list	Not present		

Table 9.1.5.1.4.3.3-3: REGISTRATION REQUEST (step 23 Table 9.1.5.1.4.3.2-1)

Derivation Path: TS 38.508-1 [4], Table 4.7.1-6			
Information Element	Value/remark	Comment	Condition
5GS registration type			
5GS registration type value	'010'B	Mobility registration updating	MOBILITY

9.1.5.1.5 Initial registration / Abnormal / Failure after 5 attempts

9.1.5.1.5.1 Test Purpose (TP)

(1)

```
with { The UE in 5GMM-REGISTERED-INITIATED state and T3510 timer expired }
ensure that {
  when { T3511 timer expires and registration attempt counter is less than 5 }
  then { UE restarts the initial registration procedure }
}
```

(2)

```
with { The UE in 5GMM-REGISTERED-INITIATED state }
ensure that {
```

```

when { The NAS signalling connection is released before the REGISTRATION ACCEPT or REGISTRATION
REJECT message is received }
  then { UE restarts the initial registration procedure }
}

```

(3)

```

with { The UE has sent initial REGISTRAION REQUEST message }
ensure that {
  when { UE receives a REGISTRATION REJECT message including 5GMM cause value #95 and the UE updates
the registration counter to 5 }
  then { UE deletes 5G-GUTI, last visited TAI and ngKSI, performs a PLMN selection after timer
T3502 timeout }
}

```

9.1.5.1.5.2 Conformance requirements

References: The conformance requirements covered in the present TC are specified in: TS 24.501, clauses 5.5.1.1 5.5.1.2.7, and 10.2. Unless otherwise stated these are Rel-15 requirements.

[TS 24.501, clause 5.5.1.1]

Additionally, the registration attempt counter shall be reset when the UE is in sub state 5GMM-DEREGISTERED.ATTEMPTING-REGISTRATION or 5GMM-REGISTERED.ATTEMPTING-REGISTRATION-UPDATE, and:

- a new tracking area is entered;
- timer T3502 expires; or
- timer T3346 is started.

[TS 24.501, clause 5.5.1.2.7]

The following abnormal cases can be identified:

...

c) T3510 timeout.

The UE shall abort the registration procedure for initial registration and the NAS signalling connection, if any, shall be released locally if the initial registration request is not for emergency services. The UE shall proceed as described below.

d) REGISTRATION REJECT message, other 5GMM cause values than those treated in subclause 5.5.1.2.5, and cases of 5GMM cause value #22, if considered as abnormal cases according to subclause 5.5.1.2.5.

If the registration request is not an initial registration request for emergency services, upon reception of the 5GMM causes #95, #96, #97, #99 and #111 the UE should set the registration attempt counter to 5.

The UE shall proceed as described below.

e) Lower layer failure or release of the NAS signalling connection received from lower layers before the REGISTRATION ACCEPT or REGISTRATION REJECT message is received.

The UE shall abort the registration procedure for initial registration and proceed as described below.

...

For the cases c, d and e, the UE shall proceed as follows:

Timer T3510 shall be stopped if still running.

If the registration procedure is neither an initial registration for emergency services nor for establishing an emergency PDU session with registration type not set to "emergency registration", the registration attempt counter shall be incremented, unless it was already set to 5.

If the registration attempt counter is less than 5:

- if the initial registration request is not for emergency services, timer T3511 is started and the state is changed to 5GMM-DEREGISTERED.ATTEMPTING-REGISTRATION. When timer T3511 expires the registration procedure for initial registration shall be restarted, if still required.

If the registration attempt counter is equal to 5

- the UE shall delete 5G-GUTI, TAI list, last visited TAI, list of equivalent PLMNs and ngKSI, start timer T3502 and shall set the 5GS update status to 5U2 NOT UPDATED. The state is changed to 5GMM-DEREGISTERED.ATTEMPTING-REGISTRATION or optionally to 5GMM-DEREGISTERED.PLMN-SEARCH in order to perform a PLMN selection according to 3GPP TS 23.122 [5].

[TS 24.501, clause 10.2]

Table 10.2.1: Timers of 5GS mobility management – UE side

TIMER NUM.	TIMER VALUE	STATE	CAUSE OF START	NORMAL STOP	ON EXPIRY
T3510	15s	5GMM-REGISTERED-INITIATED	Transmission of REGISTRATION REQUEST message	REGISTRATION ACCEPT message received or REGISTRATION REJECT message received	Start T3511 or T3502 as specified in subclause 5.5.1.2.7 if T3510 expired during registration procedure for initial registration. Start T3511 or T3502 as specified in subclause 5.5.1.3.7 if T3510 expired during the registration procedure for mobility and periodic registration update
T3502	Default 12 min. NOTE 1	5GMM-REGISTERED	At registration failure and the attempt counter is equal to 5	Transmission of REGISTRATION REQUEST message	Initiation of the registration procedure, if still required

TIMER NUM.	TIMER VALUE	STATE	CAUSE OF START	NORMAL STOP	ON EXPIRY
T3511	10s	5GMM- DEREGISTERED. ATTEMPTING- REGISTRATION 5GMM- REGISTERED.A TTEMPTING- REGISTRATION -UPDATE 5GMM- REGISTERED.N ORMAL- SERVICE	At registration failure due to lower layer failure, T3510 timeout or registration rejected with other 5GMM cause values than those treated in subclause 5.5.1.2.5 for initial registration or subclause 5.5.1.3.5 for mobility and periodic registration	Transmission of REGISTRATION REQUEST message 5GMM- CONNECTED mode entered (NOTE 5)	Retransmission of the REGISTRATION REQUEST, if still required

9.1.5.1.5.3 Test description

9.1.5.1.5.3.1 Pre-test conditions

System Simulator:

- NGC Cell A is configured according to Table 6.3.2.2-1 in TS 38.508-1 [4].

UE:

None.

Preamble:

- The UE is in state 0-A according to TS 38.508-1 [4] Table 4.4A.2-0.

9.1.5.1.5.3.2 Test procedure sequence

Table 9.1.5.1.5.3.2-1: Main behaviour

St	Procedure	Message Sequence		TP	Verdict
		U - S	Message		
1	The SS configures: - NGC Cell A as the "Serving cell".	-	-	-	-
-	The following messages are to be observed on NGC Cell A unless explicitly stated otherwise.	-	-	-	-
2	The UE is switched on.	-	-	-	-
3-5	Steps 2-4 of Table 4.5.2.2-2 of the generic procedure in TS 38.508-1 [4] are performed and the UE transmits a REGISTRATION REQUEST with IE 5GS registration type set	-->	REGISTRATION REQUEST	-	-

	to “initial registration”.				
6	The SS waits 25 seconds (15 seconds T3510 and 10 seconds T3511). (UE’s registration attempt counter = 1)	-	-	-	-
7	Check: Does the UE transmit a REGISTRATION REQUEST message with IE 5GS registration type set to “initial registration”?	-->	REGISTRATION REQUEST	1	P
8	The SS releases the RRC connection.	-	-	-	-
8A	The SS waits 10 seconds (T3511). (UE’s registration attempt counter = 2)				
9-11	Steps 2-4 of Table 4.5.2.2-2 of the generic procedure in TS 38.508-1 [4] are performed. Check: Does the UE transmit a REGISTRATION REQUEST message with IE 5GS registration type set to “initial registration”?	-->	REGISTRATION REQUEST	2	P
12-16	Steps 5-9 of Table 4.5.2.2-2 of the generic procedure in TS 38.508-1 [4] are performed.	-	-	-	-
17	The SS transmits a REGISTRATION REJECT with cause #95 (Semantically incorrect message). (UE’s registration attempt counter = 5)	<--	REGISTRATION REJECT	-	-
17A	The SS releases the RRC connection.	-	-	-	-
	EXCEPTION: Steps 17Aa1 and 17Ab1 describes behaviour that depends on the UE capability; the "lower case letter" identifies a step sequence that take place if a capability is supported				
17Aa1	IF the UE transmits a REGISTRATION REQUEST message with IE 5GS registration type set to “initial registration” 10s after step 17A.	-->	REGISTRATION REQUEST	-	-
17Ab1	ELSE Check: Does the UE transmit a REGISTRATION REQUEST message with IE 5GS registration type set to “initial registration” after 12 minutes after step 17A? (UE’s registration attempt counter has been reset to 0 after expiry of T3502)	-->	REGISTRATION REQUEST	3	P
18	Void	-	-	-	-
19-34	Steps 5-20a1 of Table 4.5.2.2-2 of the generic procedure in TS 38.508-1 [4] are performed.	-	-	-	-

9.1.5.1.5.3.3 Specific message contents

Table 9.1.5.1.5.3.3-1: REGISTRATION REJECT (step 17, Table 9.1.5.1.5.3.2-1)

Derivation path: TS 38.508-1 [4], Table 4.7.1-9			
Information Element	Value/remark	Comment	Condition
5GMM cause	'01011111'B	Cause #95 (Semantically incorrect message)	

Table 9.1.5.1.5.3.3-2: REGISTRATION REQUEST (step 18, Table 9.1.5.1.5.3.2-1)

Derivation path: TS 38.508-1 [4], Table 4.7.1-6			
Information Element	Value/remark	Comment	Condition
ngKSI			
NAS key set identifier	'111'B	no key is available	
TSC	Any allowed value	TSC does not apply for NAS key set identifier value "111"	
5GS mobile identity	SUCI		
Last visited registered TAI	Not present		

Table 9.1.5.1.5.3.3-3: Void

9.1.5.1.6 Initial registration / Rejected / Illegal UE

9.1.5.1.6.1 Test Purpose (TP)

(1)

```

with { the UE in 5GMM-REGISTERED-INITIATED state }
ensure that {
  when { the SS sends a REGISTRATION REJECT message to the UE including an appropriate 5GMM cause value #3 (Illegal UE) }
then { the UE deletes the stored 5G-GUTI, last visited registered TAI and ngKSI, deletes the list of equivalent PLMNs and enter state 5GMM-DEREGISTERED, the USIM is considered invalid until switching off the UE }
}

```

9.1.5.1.6.2 Conformance requirements

References: The conformance requirements covered in the present TC are specified in: TS 24.501 clause 5.5.1.2.5.

[TS 24.501, clause 5.5.1.2.5]

If the initial registration request cannot be accepted by the network, the AMF shall send a REGISTRATION REJECT message to the UE including an appropriate 5GMM cause value.

If the initial registration request is rejected due to general NAS level mobility management congestion control, the network shall set the 5GMM cause value to #22 "congestion" and assign a back-off timer T3346.

The UE shall take the following actions depending on the 5GMM cause value received in the REGISTRATION REJECT message.

#3 (Illegal UE); or

#6 (Illegal ME).

The UE shall set the 5GS update status to 5U3 ROAMING NOT ALLOWED (and shall store it according to subclause 5.1.3.2.2) and shall delete any 5G-GUTI, last visited registered TAI, TAI list and ngKSI. The UE shall consider the USIM as invalid for 5GS services until switching off or the UICC containing the USIM is removed. The UE shall delete the list of equivalent PLMNs and enter the state 5GMM-DEREGISTERED.

If the UE is operating in single-registration mode, the UE shall handle the EMM parameters EMM state, EPS update status, 4G-GUTI, TAI list and eKSI as specified in 3GPP TS 24.301 [15] for the case when the EPS attach request procedure is rejected with the EMM cause with the same value. The USIM shall be considered as invalid also for non-EPS services until switching off or the UICC containing the USIM is removed.

If the UE also supports the registration procedure over the other access, the UE shall in addition handle 5GMM parameters and 5GMM state for this access, as described for this 5GMM cause value.

9.1.5.1.6.3 Test description

9.1.5.1.6.3.1 Pre-test conditions

System Simulator:

- NGC Cell A is configured according to table 6.3.2.2-1 in TS 38.508-1 [4].

UE:

None.

Preamble:

- The UE is in state Switched OFF (state 0N-B) according to TS 38.508-1 [4].

9.1.5.1.6.3.2 Test procedure sequence

Table 9.1.5.1.6.3.2-1: Main behaviour

St	Procedure	Message Sequence		TP	Verdict
		U - S	Message		
1	The SS configures: - NGC cell A as the "Serving cell".	-	-	-	-
-	The following messages are to be observed on NGC Cell A unless explicitly stated otherwise.	-	-	-	-
2	The UE is switched on.	-	-	-	-
3-14	Steps 2-13 of Table 4.5.2.2-2 of the generic procedure in TS 38.508-1 [4] are performed.	-	-	-	-
15	The SS transmits a REGISTRATION REJECT message with the 5GMM cause set to 'Illegal UE' as specified.	<--	5GMM: REGISTRATION REJECT	-	-
16	The SS releases the RRC connection.	-	-	-	-
17	Check: Does the UE transmit an REGISTRATION REQUEST message on NGC cell A in the next 30 seconds?	-->	5GMM: REGISTRATION REQUEST	1	F
18	The user initiates Registration Request by MMI or by AT command.	-	-	-	-
19	Check: Does the UE transmit the	-->	5GMM: REGISTRATION	1	F

	REGISTRATION REQUEST message in the next 30 seconds?		REQUEST		
20	If possible (see ICS) switch off is performed or the USIM is removed. Otherwise the power is removed.	-	-	-	-
21	The UE is brought back to operation or the USIM is inserted. The UE is powered on or switched on.	-	-	-	-
22	Check: Does the UE transmit an REGISTRATION REQUEST message on NGC Cell A?	-->	5GMM: REGISTRATION REQUEST	1	P
23-38	Steps 5-20 of Table 4.5.2.2-2 of the generic procedure in TS 38.508-1 [4] are performed on NGC Cell A.	-	-	-	-

9.1.5.1.6.3.3 Specific message contents

Table 9.1.5.1.6.3.3-1: REGISTRATION REJECT (step 15, Table 9.1.5.1.6.3.2-1)

Derivation Path: TS 38.508-1 Table 4.7.1-9			
Information Element	Value/remark	Comment	Condition
5GMM cause	'0000 0011'B	Illegal UE	

Table 9.1.5.1.6.3.3-2: REGISTRATION REQUEST (step 22, Table 9.1.5.1.6.3.2-1)

Derivation path: TS 38.508-1 [4], table 4.7.1-6			
Information Element	Value/Remark	Comment	Condition
ngKSI			
NAS key set identifier	'111'B	no key is available (UE to network)	
TSC	Any allowed value	TSC does not apply for NAS key set identifier value "111"	
5GS mobile identity	The valid SUCI	.	
Last visited registered TAI	Not present		

9.1.5.1.7 Void

9.1.5.1.8 Initial registration / Rejected / Serving network not authorized

9.1.5.1.8.1 Test Purpose (TP)

(1)

```
with { The UE has sent initial REGISTRATION REQUEST message }
ensure that {
  when { the UE receives a REGISTRATION REJECT with cause #73 (Serving network not authorized) }
  then { the UE stores the PLMN identity in the "forbidden PLMN list" and does not attempt to
register on a cell belong to that PLMN }
}
```

9.1.5.1.8.2 Conformance requirements

References: The conformance requirements covered in the present TC are specified in: TS 24.501, clauses 5.5.1.2.5.

[TS 24.501, clause 5.5.1.2.5]

[Rel-15]

If the initial registration request cannot be accepted by the network, the AMF shall send a REGISTRATION REJECT message to the UE including an appropriate 5GMM cause value.

If the initial registration request is rejected due to general NAS level mobility management congestion control, the network shall set the 5GMM cause value to #22 "congestion" and assign a back-off timer T3346.

The UE shall take the following actions depending on the 5GMM cause value received in the REGISTRATION REJECT message.

#3 (Illegal UE); or

#6 (Illegal ME).

....

#73 (Serving network not authorized).

The UE shall set the 5GS update status to 5U2 NOT UPDATED, reset the registration attempt counter, store the PLMN identity in the "forbidden PLMN list" and enter state 5GMM-DEREGISTERED.PLMN-SEARCH in order to perform a PLMN selection according to 3GPP TS 23.122 [5].

[Rel-16]

The UE shall take the following actions depending on the 5GMM cause value received in the REGISTRATION REJECT message.

#3 (Illegal UE); or

#6 (Illegal ME).

...

#73 (Serving network not authorized).

This cause value received from a cell belonging to an SNPN is considered as an abnormal case and the behaviour of the UE is specified in subclause 5.5.1.2.7.

The UE shall set the 5GS update status to 5U3 ROAMING NOT ALLOWED (and shall store it according to subclause 5.1.3.2.2) and shall delete any 5G-GUTI, last visited registered TAI, TAI list and ngKSI. The UE shall delete the list of equivalent PLMNs, reset the registration attempt counter, store the PLMN identity in the forbidden PLMN list as specified in subclause 5.3.13A, and enter state 5GMM-DEREGISTERED.PLMN-SEARCH in order to perform a PLMN selection according to 3GPP TS 23.122 [5]. If the message has been successfully integrity checked by the NAS, the UE shall set the PLMN-specific attempt counter and the PLMN-specific attempt counter for non-3GPP access for that PLMN to the UE implementation-specific maximum value.

If the message was received via 3GPP access and the UE is operating in single-registration mode, the UE shall in addition set the EPS update status to EU3 ROAMING NOT ALLOWED and shall delete any 4G-GUTI, last visited registered TAI, TAI list and eKSI. Additionally, the UE shall reset the attach attempt counter and enter the state EMM-DEREGISTERED.

9.1.5.1.8.3 Test description

9.1.5.1.8.3.1 Pre-test conditions

System Simulator:

- 3 NGC Cells NGC Cell E, NGC Cell I and NGC Cell A are configured as specified in TS 38.508-1 [4] table 6.3.2.2-1 and table 6.3.2.2-3.

UE:

- The UE is in Automatic PLMN selection mode.

Preamble:

- NGC Cell E is set to “Serving Cell”.
- NGC Cell I is set to “Non-suitable "Off" cell”.
- NGC Cell A is set to “Non-suitable "Off" cell”.
- The UE is in state ON-B with a successful registration on NGC Cell E according to 38.508-1 [4].

9.1.5.1.8.3.2 Test procedure sequence

Table 9.1.5.1.8.3.2-1: Main behaviour

St	Procedure	Message Sequence		TP	Verdict
		U - S	Message		
1	The UE is switched on	-	-	-	-
2-9	Steps 2-9 of Table 4.5.2.2-2 in TS38.508-1 [4] are performed on NGC Cell E.	-	-	-	-
10	The SS transmits a REGISTRATION REJECT with cause #73 (Serving network not authorized).	<--	REGISTRATION REJECT	-	-
11	The SS releases the RRC connection	-	-	-	-
11 A	The SS configures - NGC Cell I as “Suitable neighbour cell”	-	-	-	-
12	Check: Does the UE send in the next 30 sec a request for RRC connection establishment on Cell E or Cell I.	-->	NR RRC: RRCSetupRequest	1	F
13	The SS configures - NGC Cell A as “Serving Cell”	-	-	-	-
14	Check: Does the UE perform Registration procedure on NGC Cell A as specified in TS 38.508-1 [4] subclause 4.5.2? (Note 1)	-	-	1	P
14 A	Switch off procedure in RRC_IDLE specified in TS 38.508-1 subclause 4.9.6.1 is performed.	-	-	-	-
15	The SS configures - NGC Cell A as “Non-suitable "Off" cell” - NGC Cell I as “Non-suitable "Off" cell”	-	-	-	-
15 A	The UE is brought back to operation or the USIM is inserted. The UE is powered on or switched on.	-	-	-	-
16	Set the UE in manual PLMN selection mode or request a PLMN search.	-	-	-	-
17	The user selects the PLMN of NGC Cell E.	-	-	-	-
18	The UE performs Registration procedure on NGC Cell E as specified in TS 38.508-1 [4]	-	-	-	-

	subclause 4.5.2.				
19	Set the UE in Automatic PLMN selection mode.	-	-	-	-
20	Wait for 300s to allow the UE to switch to automatic PLMN selection mode.	-	-	-	-
Note 1: For Rel-16 or later Releases UE, the REGISTRATION REQUEST message shall be sent without integrity protection.					

9.1.5.1.8.3.3 Specific message contents

Table 9.1.5.1.8.3.3-1: REGISTRATION REJECT (step 10 Table 9.1.5.1.8.3.2-1)

Derivation Path: TS 38.508-1 [4], Table 4.7.1-9			
Information Element	Value/remark	Comment	Condition
5GMM cause	'01001001'B	Cause #73 (Serving network not authorized)	

9.1.5.1.9 Initial registration / Abnormal / Change of cell into a new tracking area

9.1.5.1.9.1 Test Purpose (TP)

(1)

```
with { the UE in 5GMM-REGISTERED-INITIATED state }
ensure that {
  when { the UE changes into a new tracking area before UE receives the REGISTRATION ACCEPT message }
then { the UE shall abort the registration procedure for initial registration and re-initiate it immediately }
}
```

9.1.5.1.9.2 Conformance requirements

References: The conformance requirements covered in the present TC are specified in: TS 24.501, clause 5.5.1.2.7.

[TS 24.501, clause 5.5.1.2.7]

The following abnormal cases can be identified:

...

h) Change of cell into a new tracking area.

If a cell change into a new tracking area occurs before the registration procedure for initial registration is completed, the registration procedure for initial registration shall be aborted and re-initiated immediately. If a tracking area border is crossed when the REGISTRATION ACCEPT message has been received but before a REGISTRATION COMPLETE message is sent, the registration procedure for initial registration shall be re-initiated. If a 5G-GUTI was allocated during the registration procedure, this 5G-GUTI shall be used in the registration procedure.

9.1.5.1.9.3 Test description

9.1.5.1.9.3.1 Pre-test conditions

System Simulator:

- NGC Cell A is configured according to Table 6.3.2.2-1 in TS 38.508-1 [4].
- The defaultPagingCycle in SIB1 of NGC Cell A shall be set as rf32.

UE:

- the UE is previously registered on NGC, and when on NGC, the UE is last authenticated and registered on NGC cell A using default message contents according to TS 38.508-1 [4].

Preamble:

- The UE is in state Switched OFF (state 0N-B) according to TS 38.508-1 [4].

9.1.5.1.9.3.2 Test procedure sequence

Table 9.1.5.1.9.3.2-1: Main behaviour

St	Procedure	Message Sequence		TP	Verdict
		U - S	Message		
1	Void.	-	-	-	-
2	The UE is switched on.	-	-	-	-
3-14	Steps 2–13 of Table 4.5.2.2-2 in TS38.508-1 [4] are performed.	-	-	-	-
15	SS does not send REGISTRATION ACCEPT to the UE and update TAC value in SIB1.	-	-	-	-
15A	Void.	-	-	-	-
16	The SS notifies the UE of change of System Information on NGC Cell A by sending Short Message on PDCCH using P-RNTI.	<--	NR RRC: <i>Paging</i>	-	-
16A-28	Void.	-	-	-	-
29	Check: Does the UE transmit an REGISTRATION REQUEST message before the 15 second timer (T3510) started in step 5 expires?	-	5GMM: REGISTRATION REQUEST	1	P
29A1	The SS transmits a REGISTRATION ACCEPT message.	<--	REGISTRATION ACCEPT	-	-
29A2	The UE transmits a REGISTRATION COMPLETE message.	-->	REGISTRATION COMPLETE	-	-
30-32	Steps 19a1-19Aa2 of Table 4.5.2.2-2 of the generic procedure in TS 38.508-1 [4] are performed.	-	-	-	-

9.1.5.1.9.3.3 Specific message contents

Table 9.1.5.1.9.3.3-0A: SIB1 of NGC Cell A (preamble)

Derivation Path: TS 38.508-1 [4], Table 4.6.1-28			
Information Element	Value/remark	Comment	Condition

SIB1 ::= SEQUENCE {			
servingCellConfigCommon SEQUENCE {			
pcch-Config SEQUENCE {			
defaultPagingCycle	rf32		
}			
}			
}			

Table 9.1.5.1.9.3.3-0: SIB1 of NGC Cell A (step 15, Table 9.1.5.1.9.3.2-1)

Derivation Path: TS 38.508-1 [4], Table 4.6.1-28			
Information Element	Value/remark	Comment	Condition
SIB1 ::= SEQUENCE {			
cellAccessRelatedInfo SEQUENCE {			
PLMN-IdentityInfoList SEQUENCE {			
trackingAreaCode	2		
}			
}			
}			

Table 9.1.5.1.9.3.3-1: Void

Table 9.1.5.1.9.3.3-1A: Void

Table 9.1.5.1.9.3.3-2: REGISTRATION REQUEST (step 29, Table 9.1.5.1.9.3.2-1)

Derivation path: TS 38.508-1 [4], table 4.7.1-6			
Information Element	Value/Remark	Comment	Condition
5GS registration type		.	
5GS registration type value	'001'B	Initial registration	

9.1.5.1.10 Initial registration / Rejected / PLMN not allowed

9.1.5.1.10.1 Test Purpose (TP)

(1)

```

with { the UE in 5GMM-REGISTERED-INITIATED state }
ensure that {
  when { the SS sends a REGISTRATION REJECT message to the UE including an appropriate 5GMM cause
value #11 (PLMN not allowed) }
  then { the UE deletes any 5G-GUTI, last visited registered TAI and ngKSI, deletes the list of
equivalent PLMNs, stores the PLMN identity in the "forbidden PLMN list" and performs a PLMN
selection }
}

```

9.1.5.1.10.2 Conformance requirements

References: The conformance requirements covered in the current TC are specified in: TS 24.501 clauses 5.5.1.2.5. Unless otherwise stated these are Rel-15 requirements.

[TS 24.501, clause 5.5.1.2.5]

If the initial registration request cannot be accepted by the network, the AMF shall send a REGISTRATION REJECT message to the UE including an appropriate 5GMM cause value.

...

The UE shall take the following actions depending on the 5GMM cause value received in the REGISTRATION REJECT message.

...

#11 (PLMN not allowed).

The UE shall set the 5GS update status to 5U3 ROAMING NOT ALLOWED (and shall store it according to subclause 5.1.3.2.2) and shall delete any 5G-GUTI, last visited registered TAI, TAI list and ngKSI. The UE shall delete the list of equivalent PLMNs and reset the registration attempt counter and store the PLMN identity in the "forbidden PLMN list". The UE shall enter state 5GMM-DEREGISTERED.PLMN-SEARCH and perform a PLMN selection according to 3GPP TS 23.122 [5]. If the message has been successfully integrity checked by the NAS, the UE shall set the PLMN-specific attempt counter and the PLMN-specific attempt counter for non-3GPP access for that PLMN to the UE implementation-specific maximum value.

9.1.5.1.10.3 Test description

9.1.5.1.10.3.1 Pre-test conditions

System Simulator:

- NGC cell G and NGC cell I.
- The NGC cells are configured according to Table 6.3.2.2-1 and Table 6.3.2.2-3 in 38.508-1 [4], except replacing NRF3 with NRF1;

UE:

- the UE is previously registered on NGC, and when on NGC, the UE is last authenticated and registered on NGC cell G using default message contents according to TS 38.508-1 [4];

Preamble:

- The UE is in state ON-B according to TS 38.508-1 [4].

9.1.5.1.10.3.2 Test procedure sequence

Table 9.1.5.1.10.3.2-1: Main behaviour

St	Procedure	Message Sequence		TP	Verdict
		U – S	Message		
1	The SS configures: - NGC Cell G as the "Serving cell". - NGC Cell I as a "Non-Suitable Off cell".	-	-	-	-
2	Void				
	The following messages are to be observed on Cell G unless explicitly stated otherwise.	-	-	-	-
3	The UE is switched on.	-	-	-	-
4-11	Steps 2-9 of Table 4.5.2.2-2 of the generic procedure in TS 38.508-1 [4] are performed.	-	-	-	-
12	The SS transmits an REGISTRATION REJECT message including an appropriate 5GMM cause value #11 (PLMN not allowed).	<--	5GMM: REGISTRATION REJECT	-	-
13	The SS releases the RRC connection.	-	-	-	-
14	Check: Does the UE transmit an REGISTRATION REQUEST message on NGC cell G in the next 90 seconds?	-->	5GMM: REGISTRATION REQUEST	1	F
15	The generic test procedure in TS 38.508-1 Table 4.9.6.4-1 of Switch off procedure in State DEREGISTERED are performed.	-	-	-	-
16	The UE is brought back to operation or the USIM is inserted. The UE is powered on or switched on.	-	-	-	-
17	Check: Does the UE transmit an REGISTRATION REQUEST message in the next 30 seconds?	-->	5GMM: REGISTRATION REQUEST	1	F
18	The SS configures: -NGC Cell G as the "Serving cell"	-	-	-	-

	-NGC Cell I as a "Suitable neighbour cell".				
19	Void				
-	The following messages are to be observed on NGC Cell I unless explicitly stated otherwise.	-	-	-	-
20-22	The UE establishes RRC connection by executing steps 2-4 of Table 4.5.2.2-2 in TS 38.508-1 [4].	-	-	-	-
23	Check: Does the UE transmit an REGISTRATION REQUEST message as specified?	-->	5GMM: REGISTRATION REQUEST	1	P
24-39a1	Steps 5-19a1 of Table 4.5.2.2-2 of the generic procedure in TS 38.508-1 [4] are performed.	-	-	-	-
40	The generic test procedure in TS 38.508-1 Table 4.9.6.3-1 of Switch off procedure in RRC_CONNECTED are performed.	-	-	-	-
40A	The SS configures: -NGC Cell G as the "Serving cell" -NGC Cell I as a "Non-Suitable "off" cell ".				
40B	The UE is brought back to operation or the USIM is inserted. The UE is powered on or switched on.	-	-	-	-
40C	The user sets the UE in manual PLMN selection mode or requests a PLMN search.	-	-	-	-
41	The user selects PLMN of NGC Cell I.	-	-	-	-
42-60a1	Steps 2 to 20a1 of the registration procedure described in TS 38.508-1 [4] subclause 4.5.2 are performed on NGC Cell G.	-	-	-	-
61	The user sets the UE in Automatic PLMN selection mode.	-	-	-	-
62	Wait for 300s to allow the UE to switch to automatic PLMN selection mode.	-	-	-	-

9.1.5.1.10.3.3 Specific message contents

Table 9.1.5.1.10.3.3-1: Message REGISTRATION REJECT (step 12, Table 9.1.5.1.10.3.2-1)

Derivation path: TS 38.508-1 [4], table 4.7.1-9			
Information Element	Value/Remark	Comment	Condition
5GMM cause	'00001011'B	#11 "PLMN not allowed"	

Table 9.1.5.1.10.3.3-2: Message REGISTRATION REQUEST (step 23, Table 9.1.5.1.10.3.2-1)

Derivation path: TS 38.508-1 [4], table 4.7.1-6			
Information Element	Value/Remark	Comment	Condition
ngKSI			
NAS key set identifier	'111'B	no key is available (UE to network)	
TSC	Any allowed value	TSC does not apply for NAS key set identifier value "111"	
5GS mobile identity	The valid SUCI	.	
Last visited registered TAI	Not present		

9.1.5.1.11 Initial registration / Rejected / Tracking area not allowed

9.1.5.1.11.1 Test Purpose (TP)

(1)

```
with { the UE in 5GMM-REGISTERED-INITIATED state }
ensure that {
  when { the SS sends a REGISTRATION REJECT message to the UE including an appropriate 5GMM cause
value #12 (Tracking area not allowed)}
    then { the UE deletes any 5G-GUTI, last visited registered TAI and ngKSI, stores the current TAI
in the list of "5GS forbidden tracking areas for regional provision of service". }
}
```

(2)

```
with { the UE is in 5GMM-DEREGISTERED.LIMITED-SERVICE state and the TAI of the current cell belongs
to the list of "forbidden tracking areas for regional provision of service"}
ensure that {
  when { the UE enters a cell belonging to a tracking area not in the list of "forbidden tracking
areas for regional provision of service"}
    then { the UE attempts to registration }
}
```

(3)

```
with { the UE is in 5GMM-DEREGISTERED.LIMITED-SERVICE state and the list of "forbidden tracking
areas for regional provision of service" contains more than one TAI}
ensure that {
  when { the UE selects a cell belonging to one of the TAIs in the list of "forbidden tracking areas
for regional provision of service" }
    then { the UE does not attempt to registration }
}
```

(4)

```
with { the UE is switched off or the UICC containing the USIM is removed }
ensure that {
  when { UE is powered on in the cell belonging to the TAI which was in the list of "forbidden
tracking areas for regional provision of service" before the UE was switched off or the USIM is
inserted again on that cell }
    then { UE performs registration on that cell }
}
```

9.1.5.1.11.2 Conformance requirements

References: The conformance requirements covered in the current TC are specified in: TS 24.501, clauses 5.5.1.2.5, 5.1.3.2.2.

[TS 24.501, clause 5.5.1.2.5]

If the initial registration request cannot be accepted by the network, the AMF shall send a REGISTRATION REJECT message to the UE including an appropriate 5GMM cause value.

If the initial registration request is rejected due to general NAS level mobility management congestion control, the network shall set the 5GMM cause value to #22 "congestion" and assign a back-off timer T3346.

The UE shall take the following actions depending on the 5GMM cause value received in the REGISTRATION REJECT message.

...

#12 (Tracking area not allowed).

The UE shall set the 5GS update status to 5U3 ROAMING NOT ALLOWED (and shall store it according to subclause 5.1.3.2.2) and shall delete 5G-GUTI, last visited registered TAI, TAI list and ngKSI. Additionally, the UE shall reset the registration attempt counter.

The UE shall store the current TAI in the list of "5GS forbidden tracking areas for regional provision of service" and enter the state 5GMM-DEREGISTERED.LIMITED-SERVICE.

[TS 24.501, clause 5.1.3.2.2]

In order to describe the detailed UE behaviour, the 5GS update (5U) status pertaining to a specific subscriber is defined.

If the UE is not SNPN enabled or the UE is not operating in SNPN access mode (see 3GPP TS 23.501 [8]), the 5GS update status is stored in a non-volatile memory in the USIM if the corresponding file is present in the USIM, else in the non-volatile memory in the ME, as described in annex C.

If the UE is operating in SNPN access mode, the 5GS update status for each SNPN whose SNPN identity is included in the "list of subscriber data" configured in the ME (see 3GPP TS 23.122 [5]) is stored in the non-volatile memory in the ME as described in annex C.

The 5GS update status value is changed only after the execution of a registration, network-initiated de-registration, 5GS based primary authentication and key agreement, service request or paging procedure.

5U1: UPDATED

The last registration attempt was successful.

5U2: NOT UPDATED

The last registration attempt failed procedurally, e.g. no response or reject message was received from the AMF.

5U3: ROAMING NOT ALLOWED

The last registration, service request, or registration for mobility or periodic registration update attempt was correctly performed, but the answer from the AMF was negative (because of roaming or subscription restrictions).

[TS 24.501, clause 5.3.13]

The UE shall store a list of "5GS forbidden tracking areas for roaming", as well as a list of "5GS forbidden tracking areas for regional provision of service". Within the 5GS, these lists are managed independently per access type, i.e., 3GPP access or non-3GPP access. These lists shall be erased when

- a) the UE is switched off or the UICC containing the USIM is removed or an entry of the "list of subscriber data" with the SNPN identity of the current SNPN is updated; and
- b) periodically (with a period in the range 12 to 24 hours).

Over 3GPP access, when the lists are erased, the UE performs cell selection according to 3GPP TS 38.304 [28]. A tracking area shall be removed from the list of "5GS forbidden tracking areas for roaming", as well as the list of "5GS forbidden tracking areas for regional provision of service", if the UE receives the tracking area in the TAI list or the Service area list of "allowed tracking areas" in REGISTRATION ACCEPT message or a CONFIGURATION UPDATE COMMAND message. The UE shall not remove the tracking area from "5GS forbidden tracking areas for roaming" or "5GS forbidden tracking areas for regional provision of service" if the UE is registered for emergency services.

In N1 mode, the UE shall update the suitable list whenever a REGISTRATION REJECT, SERVICE REJECT or DEREGISTRATION REQUEST message is received with the 5GMM cause #12 "tracking area not allowed", #13 "roaming not allowed in this tracking area", or #15 "no suitable cells in tracking area".

Each list shall accommodate 40 or more TAIs. When the list is full and a new entry has to be inserted, the oldest entry shall be deleted.

9.1.5.1.11.3 Test description

9.1.5.1.11.3.1 Pre-test conditions

System Simulator:

- NGC Cell A (home PLMN) and NGC Cell B (home PLMN, another TA) are configured according to Table 6.3.2.2-1 in TS 38.508-1 [4].

- System information combination NR-2 in accordance with TS 38.508-1 [4] sub-clause 4.4.3.1.2 is used in NGC Cell A and NGC Cell B.
- The UE is last authenticated and registered on NGC Cell A.

Preamble:

- The UE is in state Switched OFF (state 0N-B) according to TS 38.508-1 [4].

9.1.5.1.11.3.2 Test procedure sequence

Table 9.1.5.1.11.3.2-1: Main behaviour

St	Procedure	Message Sequence		TP	Verdict
		U - S	Message		
1	The SS configures: - NGC Cell A as the "Serving cell". - NGC Cell B as "Non-suitable "Off" cell".	-	-	-	-
2	The UE is switched on.	-	-	-	-
3-14	Steps 2-13 of Table 4.5.2.2-2 of the generic procedure in TS 38.508-1 [4] are performed.	-	-	-	-
15	The SS transmits a REGISTRATION REJECT message, 5GMM cause value = #12 "Tracking area not allowed".	<--	REGISTRATION REJECT	-	-
16	The SS releases the RRC connection.	-	-	-	-
17	Check: Does the UE transmit the REGISTRATION REQUEST message on NGC Cell A in the next 30 seconds?	-->	REGISTRATION REQUEST	1	F
18	The SS reconfigures: - NGC cell B as the "Serving cell". - NGC cell A as a "Non-suitable "Off" cell".	-	-	-	-
19	Check: Does the UE transmit the REGISTRATION REQUEST message on NGC Cell B?	-->	REGISTRATION REQUEST	1,2	P
20-26	Steps 5 to 11 from procedure in TS 38.508-1 [4] Table 4.5.2.2-2 are performed.	-	-	-	-
27	The SS transmits a REGISTRATION REJECT message, 5GMM cause value = #12 "Tracking area not allowed".	<--	REGISTRATION REJECT	-	-
28	The SS releases the RRC connection.	-	-	-	-
28 A	The SS reconfigures: - NGC cell A as a "Suitable neighbour intra-frequency cell".	-	-	-	-
29	Check: Does the UE transmit the REGISTRATION REQUEST message in the next 30 seconds on NGC Cell A or NGC Cell B?	-->	REGISTRATION REQUEST	1,3	F
30	Switch off UE in State Deregistered as described in TS38.508-1 [4] subclause 4.9.6.4.	-	-	-	-
31	The SS reconfigures: - NGC cell A as the "Serving cell". - NGC cell B as "Non-suitable "Off" cell".	-	-	-	-
32	Switch on UE.	-	-	-	-
33	Check: Does the UE transmit a REGISTRATION REQUEST message on NGC Cell A?	-->	REGISTRATION REQUEST	4	P
34-49a 1	Steps 5-20a1 of Table 4.5.2.2-2 in TS38.508-1 [4] are performed.	-	-	-	-

9.1.5.1.11.3.3 Specific message contents

Table 9.1.5.1.11.3.3-1: REGISTRATION REJECT (step 15, step 27, Table 9.1.5.1.11.3.2-1)

Derivation path: TS 38.508-1 [4] table 4.7.1-9			
Information Element	Value/remark	Comment	Condition
5GMM cause	'00001100'B	#12 "Tracking area not allowed"	

Table 9.1.5.1.11.3.3-2: REGISTRATION REQUEST (step 19, step33, Table 9.1.5.1.11.3.2-1)

Derivation path: TS 38.508-1 [4] table 4.7.1-6			
Information Element	Value/Remark	Comment	Condition
ngKSI			
NAS key set identifier	'111'B	no key is available	
TSC	Any allowed value	TSC does not apply for NAS key set identifier value "111"	
5GS mobile identity	The valid SUCI	Only SUCI is available.	
Last visited registered TAI	Not present		

9.1.5.1.12 Initial registration / Rejected / Roaming not allowed in this tracking area

9.1.5.1.12.1 Test Purpose (TP)

(1)

```

with { the UE in 5GMM-REGISTERED-INITIATED state }
ensure that {
  when { the SS sends a REGISTRATION REJECT message to the UE including an appropriate 5GMM cause value #13 (Roaming not allowed in this tracking area)
  then { the UE deletes any 5G-GUTI, last visited registered TAI and ngKSI, deletes the list of equivalent PLMNs, stores the current TAI in the list of "5GS forbidden tracking areas for roaming" }
}

```

(2)

```

with { the initial registration request cannot be accepted by the network }
ensure that {
  when { the SS sends a REGISTRATION REJECT message to the UE including an appropriate 5GMM cause value #13 (Roaming not allowed in this tracking area)}
  then { The UE performs a PLMN selection }
}

```

(3)

```

with { the UE is in 5GMM-DEREGISTERED.LIMITED-SERVICE or 5GMM-DEREGISTERED.PLMN-SEARCH state and the TAI of the current cell belongs to the list of "forbidden tracking areas for roaming"}
ensure that {
  when { the UE enters a cell belonging to a tracking area not in the list of "forbidden tracking areas for roaming"}
  then { the UE attempts to registration }
}

```

(4)

```

with { the UE is in 5GMM-DEREGISTERED.LIMITED-SERVICE or 5GMM-DEREGISTERED.PLMN-SEARCH state and the list of "forbidden tracking areas for roaming" contains more than one TAI}
ensure that {
  when { the UE selects a cell belonging to one of the TAIs in the list of "forbidden tracking areas for roaming" }
  then { the UE does not attempt to registration }
}

```

(5)

```

with { the UE is switched off or the UICC containing the USIM is removed }
ensure that {
  when { UE is powered on in the cell belonging to the TAI which was in the list of "forbidden
tracking areas for roaming" before the UE was switched off or the USIM is inserted again on that
cell }
    then { UE performs registration on that cell }
}

```

9.1.5.1.12.2 Conformance requirements

References: The conformance requirements covered in the current TC are specified in: TS 24.501 clauses 5.5.1.2.5, 5.1.3.2.1, 5.1.3.2.2, TS 23.122 clauses 3.1.

[TS 24.501, clause 5.5.1.2.5]

If the initial registration request cannot be accepted by the network, the AMF shall send a REGISTRATION REJECT message to the UE including an appropriate 5GMM cause value.

If the initial registration request is rejected due to general NAS level mobility management congestion control, the network shall set the 5GMM cause value to #22 "congestion" and assign a back-off timer T3346.

The UE shall take the following actions depending on the 5GMM cause value received in the REGISTRATION REJECT message.

...

#13 (Roaming not allowed in this tracking area).

The UE shall set the 5GS update status to 5U3 ROAMING NOT ALLOWED (and shall store it according to subclause 5.1.3.2.2) and shall delete 5G-GUTI, last visited registered TAI, TAI list and ngKSI. Additionally, the UE shall delete the list of equivalent PLMNs and reset the registration attempt counter.

The UE shall store the current TAI in the list of "5GS forbidden tracking areas for roaming" and enter the state 5GMM-DEREGISTERED.LIMITED-SERVICE or optionally 5GMM-DEREGISTERED.PLMN-SEARCH. The UE shall perform a PLMN selection according to 3GPP TS 23.122 [5].

...

[TS 24.501, clause 5.1.3.2.1.3.3]

The sub state 5GMM-DEREGISTERED.LIMITED-SERVICE is chosen in the UE, when it is known that a selected cell for 3GPP access or TA for non-3GPP access is unable to provide normal service (e.g. the selected cell over 3GPP access is in a forbidden PLMN or is in a forbidden tracking area or TA for non-3GPP access is forbidden).

[TS 24.501, clause 5.1.3.2.1.3.5]

The sub state 5GMM-DEREGISTERED.PLMN-SEARCH is chosen in the UE, if the UE is searching for PLMNs. This sub state is left either when a cell has been selected (the new sub state is NORMAL-SERVICE or LIMITED-SERVICE) or when it has been concluded that no cell is available at the moment (the new sub state is NO-CELL-AVAILABLE).

This sub state is not applicable to non-3GPP access.

[TS 24.501, clause 5.1.3.2.2]

In order to describe the detailed UE behaviour, the 5GS update (5U) status pertaining to a specific subscriber is defined.

If the UE is not SNPN enabled or the UE is not operating in SNPN access mode (see 3GPP TS 23.501 [8]), the 5GS update status is stored in a non-volatile memory in the USIM if the corresponding file is present in the USIM, else in the non-volatile memory in the ME, as described in annex C.

If the UE is operating in SNPN access mode, the 5GS update status for each SNPN whose SNPN identity is included in the "list of subscriber data" configured in the ME (see 3GPP TS 23.122 [5]) is stored in the non-volatile memory in the ME as described in annex C.

The 5GS update status value is changed only after the execution of a registration, network-initiated de-registration, 5GS based primary authentication and key agreement, service request or paging procedure.

5U1: UPDATED

The last registration attempt was successful.

5U2: NOT UPDATED

The last registration attempt failed procedurally, e.g. no response or reject message was received from the AMF.

5U3: ROAMING NOT ALLOWED

The last registration, service request, or registration for mobility or periodic registration update attempt was correctly performed, but the answer from the AMF was negative (because of roaming or subscription restrictions).

[TS 23.122, clause 3.1]

The tracking area is added to the list of "5GS forbidden tracking areas for roaming" which is stored in the MS. The MS shall then search for a suitable cell in the same PLMN but belonging to a tracking area which is not in the "5GS forbidden tracking areas for roaming" list.

9.1.5.1.12.3 Test description

9.1.5.1.12.3.1 Pre-test conditions

System Simulator:

- NGC cell C (MCC/MNC=MCC/MNC in USIM), NGC cell E (visited PLMN, mcc=002, mnc=101) and NGC cell I (visited PLMN, mcc=002, mnc=101, another TA) are configured according to Table 6.3.2.2-1 and Table 6.3.2.2-3 in TS 38.508-1 [4], except replacing NRf3 with NRf2.

UE:

- The UE is last authenticated and registered on NGC Cell E.

Preamble:

- The UE is in state Switched OFF (state ON-B) according to TS 38.508-1 [4] Table 4.4A.2-0.

9.1.5.1.12.3.2 Test procedure sequence

Table 9.1.5.1.12.3.2-1: Main behaviour

St	Procedure	Message Sequence		TP	Verdict
		U - S	Message		
1	The SS configures: - NGCCell E as the "Serving cell". - Other NGC cells as "Non-suitable "Off" cell".	-	-	-	-
2	The UE is switched on.	-	-	-	-
3-14	Steps 2-13 of Table 4.5.2.2-2 of the generic procedure in TS 38.508-1 [4] are performed.	-	-	-	-
15	The SS transmits a REGISTRATION REJECT message, 5GMM cause value = #13 "roaming not allowed in this tracking area".	<--	REGISTRATION REJECT	-	-
16	The SS releases the RRC connection.	-	-	-	-
17	Check: Does the UE transmit the REGISTRATION REQUEST message on NGC Cell E in the next 30 seconds?	-->	REGISTRATION REQUEST	1	F
18	The SS reconfigures: - NGC cell I as the "Serving cell". - NGC cell E as a " Non-suitable "Off" cell", - NGC cell C as "Non-suitable "Off" cell".	-	-	-	-

19	Check: Does the UE transmit the REGISTRATION REQUEST message on NGC Cell I?	-->	REGISTRATION REQUEST	1,3	P
20-26	Steps 5 to 11 from procedure in TS 38.508-1 [4] Table 4.5.2.2-2 are performed.	-	-	-	-
27	The SS transmits a REGISTRATION REJECT message, 5GMM cause value = #13 "roaming not allowed in this tracking area".	<--	REGISTRATION REJECT	-	-
28	The SS releases the RRC connection.	-	-	-	-
29	Check: Does the UE transmit the REGISTRATION REQUEST message in the next 30 seconds on NGC cell I?	-->	REGISTRATION REQUEST	4	F
30	Switch off UE in State Deregistered as described in TS38.508-1 [4] subclause 4.9.6.4.	-	-	-	-
31	The SS reconfigures: - NGC cell E as the "Serving cell". - Other NGC cells as "Non-suitable "Off" cell".	-	-	-	-
32	Switch on UE.	-	-	-	-
33	Check: Does the UE transmit the REGISTRATION REQUEST message on NGC Cell E?	-->	REGISTRATION REQUEST	5	P
34-42	Steps 5 to 13 from procedure in TS 38.508-1 [4] Table 4.5.2.2-2 are performed.	-	-	-	-
43	The SS transmits a REGISTRATION REJECT message, 5GMM cause value = #13 "roaming not allowed in this tracking area".	<--	REGISTRATION REJECT	-	-
44	The SS releases the RRC connection.	-	-	-	-
45	The SS reconfigures: - NGC Cell C as the "Serving cell", - Other NGC cells as "Non-suitable "Off" cell".	-	-	-	-
46	Check: Does the UE transmit the REGISTRATION REQUEST message on NGC Cell C?	-->	REGISTRATION REQUEST	2	P
47-62a1	Steps 5–20a1 of Table 4.5.2.2-2 in TS38.508-1 [4] are performed.	-	-	-	-

9.1.5.1.12.3.3 Specific message contents

Table 9.1.5.1.12.3.3-1: REGISTRATION REJECT (step 15, step 27, step 43, Table 9.1.5.1.12.3.2-1)

Derivation path: TS 38.508-1 [4] table 4.7.1-9			
Information Element	Value/remark	Comment	Condition
5GMM cause	'00001101'B	#13 "roaming not allowed in this tracking area"	

Table 9.1.5.1.12.3.3-2: REGISTRATION REQUEST (step 19, step 33, step 46, Table 9.1.5.1.12.3.2-1)

Derivation path: TS 38.508-1 [4] table 4.7.1-6			
Information Element	Value/Remark	Comment	Condition
ngKSI			
NAS key set identifier	'111'B	no key is available	
TSC	Any allowed value	TSC does not apply for NAS key set identifier value "111"	
5GS mobile identity	The valid SUCI	Only SUCI is available.	
Last visited registered TAI	Not present		

9.1.5.1.13 Initial registration / Rejected / No suitable cells in tracking area

9.1.5.1.13.1 Test Purpose (TP)

(1)

```

with { the UE has sent initial REGISTRAION REQUEST message }
ensure that {
  when { the UE receives a REGISTRATION REJECT with cause #15 (No suitable cells in tracking area)}
  then { the UE sets the 5GS update status to 5U3 ROAMING NOT ALLOWED and delete any 5G-GUTI, last
visited registered TAI, TAI list and ngKSI }
}

```

(2)

```

with { the UE is in 5GMM-DEREGISTERED.LIMITED-SERVICE state and the current TAI in the list of
"forbidden tracking areas for roaming"}
ensure that {
  when { the UE re-selects a cell that belongs to the TAI where UE was rejected }
  then { the UE does not attempt to perform registration}
}

```

(3)

```

with { the UE has sent initial REGISTRAION REQUEST message }
ensure that {
  when { the UE receives a REGISTRATION REJECT with cause #15 (No suitable cells in tracking area)}
  then { the UE searches for a suitable cell in another tracking area }
}

```

9.1.5.1.13.2 Conformance requirements

References: The conformance requirements covered in the present TC are specified in: TS 24.501, clauses 5.5.1.2.5. Unless otherwise stated these are Rel-15 requirements.

[TS 24.501, clause 5.5.1.2.5]

If the initial registration request cannot be accepted by the network, the AMF shall send a REGISTRATION REJECT message to the UE including an appropriate 5GMM cause value.

If the initial registration request is rejected due to general NAS level mobility management congestion control, the network shall set the 5GMM cause value to #22 "congestion" and assign a back-off timer T3346.

The UE shall take the following actions depending on the 5GMM cause value received in the REGISTRATION REJECT message.

#3 (Illegal UE); or

#6 (Illegal ME).

....

#15 (No suitable cells in tracking area);

The UE shall set the 5GS update status to 5U3 ROAMING NOT ALLOWED (and shall store it according to subclause 5.1.3.2.2) and shall delete any 5G-GUTI, TAI list and ngKSI. Additionally, the UE shall reset the registration attempt counter.

The UE shall store the current TAI in the list of "5GS forbidden tracking areas for roaming" and enter the state 5GMM-DEREGISTERED.LIMITED-SERVICE. The UE shall search for a suitable cell in another tracking area according to 3GPP TS 38.304 [15].

9.1.5.1.13.3 Test description

9.1.5.1.13.3.1 Pre-test conditions

System Simulator:

- 3 cells, NGC Cell A and NGC Cell B belonging to TAI-1, NGC Cell C is in TAI-2. All Cells in the same PLMN.

UE:

- None.

Preamble:

- The UE is switched OFF.
- NGC Cell A is set to "Serving Cell".
- NGC Cell B is set to "Non-suitable "Off" cell".
- NGC Cell C is set to "Non-suitable "Off" cell".

9.1.5.1.13.3.2 Test procedure sequence

Table 9.1.5.1.13.3.2-1: Main behaviour

St	Procedure	Message Sequence		TP	Verdict
		U - S	Message		
1	The UE is switched on	-	-	-	-
2-9	Steps 2-9 of Table 4.5.2.2-2 in TS38.508-1 [4] are performed on NGC Cell A.	-	-	-	-
10	The SS transmits a REGISTRATION REJECT with cause #15 (No suitable cells in tracking area).	<--	REGISTRATION REJECT	-	-
11	The SS releases the RRC connection	-	-	-	-
12	Check: Does the UE transmit a REGISTRATION REQUEST message on NGC Cell A in the next 30 seconds?	-->	REGISTRATION REQUEST	1	F
12 A	The SS configures - NGC Cell B as "Serving Cell" - NGC Cell A and Cell C as "Non-suitable "Off" cell"				
12 B	Check: Does the UE transmit a REGISTRATION REQUEST message on NGC Cell B in the next 30 seconds?	-->	REGISTRATION REQUEST	2	F
13	The SS configures - NGC Cell C as "Serving Cell" - NGC Cell A and Cell B as "Non-suitable "Off" cell"	-	-	-	-
14	Check: Does the UE transmit a REGISTRATION REQUEST message on NGC Cell C?	-->	REGISTRATION REQUEST	3	P
15- 29	Steps 5-19a1 of Table 4.5.2.2-2 in TS38.508-1 [4] are performed.	-	-	-	-

9.1.5.1.13.3.3 Specific message contents

Table 9.1.5.1.13.3.3-1: REGISTRATION REJECT (step 10 Table 9.1.5.1.13.3.2-1)

Derivation Path: TS 38.508-1 [4], Table 4.7.1-9			
Information Element	Value/remark	Comment	Condition
5GMM cause	'00001111'B	Cause #15(No suitable cells in	

		tracking area)	
--	--	----------------	--

Table 9.1.5.1.13.3.3-2: REGISTRATION REQUEST (step 14 Table 9.1.5.1.13.3.2-1)

Derivation Path: TS 38.508-1 [4], Table 4.7.1-6			
Information Element	Value/remark	Comment	Condition
ngKSI			
NAS key set identifier	'111'B	"No key is available"	
5GS mobile identity			
Type of identity	'001'B	5GS mobile identity is SUCI, 5G-GUTI has been deleted after receiving REGISTRATION REJECT at step 10.	
Last visited registered TAI	Not present	TAI has been deleted after receiving REGISTRATION REJECT at step 10.	

Table 9.1.5.1.13.3.3-3: Void

9.1.5.1.14 Initial registration / Rejected / Congestion / Abnormal / T3346

9.1.5.1.14.1 Test Purpose (TP)

(1)

```
with { The UE has sent initial REGISTRAION REQUEST message }
ensure that {
  when { UE receives a REGISTRATION REJECT with cause #22 (Congestion) with T3346 included and the
  UE is NOT configured for High Priority Access in the selected PLMN }
  then { UE does not start the Initial registration until T3346 expires }
}
```

(2)

```
with { The UE has received initial REGISTRATION REJECT with T3346 included }
ensure that {
  when { upon expiry of T3346 }
  then { UE starts the Initial registration procedure }
}
```

(3)

Void

(4)

```
with { The UE has received initial REGISTRATION REJECT with T3346 included }
ensure that {
  when { the timer T3346 is running and the UE detects a cell better than serving cell on a PLMN
  other than serving cells PLMN (S criterion for detected cell > S criterion for serving cell )
  then { UE starts the Initial registration procedure on the detected cell }
}
```

(5)

```

with { The UE has received initial REGISTRATION REJECT with T3346 included }
ensure that {
  when { the timer T3346 is running and the UE detects a cell better than serving cell on same PLMN
as serving cell (S criterion for detected cell > S criterion for serving cell)}
  then { UE starts the Initial registration procedure on the detected cell after T3346 expiry }
}

```

9.1.5.1.14.2 Conformance requirements

References: The conformance requirements covered in the present TC are specified in: TS 24.501, clauses 5.2.2.3.3, 5.5.1.2.5 and 5.5.1.2.7. Unless otherwise stated these are Rel-15 requirements.

[TS 24.501, clause 5.5.1.2.5]

If the initial registration request cannot be accepted by the network, the AMF shall send a REGISTRATION REJECT message to the UE including an appropriate 5GMM cause value.

If the initial registration request is rejected due to general NAS level mobility management congestion control, the network shall set the 5GMM cause value to #22 "congestion" and assign a back-off timer T3346.

The UE shall take the following actions depending on the 5GMM cause value received in the REGISTRATION REJECT message.

#3 (Illegal UE);

#6 (Illegal ME); or

....

#22 (Congestion).

If the T3346 value IE is present in the REGISTRATION REJECT message and the value indicates that this timer is neither zero nor deactivated, the UE shall proceed as described below; otherwise it shall be considered as an abnormal case and the behaviour of the UE for this case is specified in subclause 5.5.1.2.7.

The UE shall abort the initial registration procedure, set the 5GS update status to 5U2 NOT UPDATED and enter state 5GMM-DEREGISTERED.ATTEMPTING-REGISTRATION.

The UE shall stop timer T3346 if it is running.

If the REGISTRATION REJECT message is integrity protected, the UE shall start timer T3346 with the value provided in the T3346 value IE.

If the REGISTRATION REJECT message is not integrity protected, the UE shall start timer T3346 with a random value from the default range specified in 3GPP TS 24.008 [12].

The UE stays in the current serving cell and applies the normal cell reselection process. The initial registration procedure is started if still needed when timer T3346 expires or is stopped.

#27 (N1 mode not allowed).

The UE capable of S1 mode shall disable the N1 mode capability for both 3GPP access and non-3GPP access (see subclause 4.9).

Other values are considered as abnormal cases. The behaviour of the UE in those cases is specified in subclause 5.5.1.2.7.

[TS 24.501, clause 5.5.1.2.7]

The following abnormal cases can be identified:

a) Timer T3346 is running.

The UE shall not start the registration procedure for initial registration unless:

1) the UE is a UE configured for high priority access in selected PLMN; or

- 2) the UE needs to perform the registration procedure for initial registration for emergency services.

The UE stays in the current serving cell and applies the normal cell reselection process.

NOTE 1: It is considered an abnormal case if the UE needs to initiate a registration procedure for initial registration while timer T3346 is running independent on whether timer T3346 was started due to an abnormal case or a non-successful case.

[TS 24.501, clause 5.2.2.3.3]

The UE in 3GPP access:

- a) ...
- b) ...
- c) shall initiate an initial registration procedure when entering a new PLMN, if timer T3346 is running and the new PLMN is not equivalent to the PLMN where the UE started timer T3346, the PLMN identity of the new cell is not in the forbidden PLMN lists and the tracking area is not in one of the lists of 5GS forbidden tracking areas;

9.1.5.1.14.3 Test description

9.1.5.1.14.3.1 Pre-test conditions

System Simulator:

- NGC Cell A, NGC Cell B and NGC Cell E are configured according to Table 6.3.2.2-1 and Table 6.3.2.2-3 in TS 38.508-1 [4].
- System information combination NR-2 as defined in TS 38.508 [4] clause 4.4.3.1.2 is used.

UE:

None.

Preamble:

- The UE is in state Switched OFF (State 0-A) as per TS 38.508-1 [4] Table 4.4A.2-0.

9.1.5.1.14.3.2 Test procedure sequence

Table 9.1.5.1.14.3.2-1: Main behaviour

St	Procedure	Message Sequence		TP	Verdict
		U - S	Message		
0	The SS configures: - NGC Cell A as the "Non-suitable "Off" cell". - NGC Cell B as the "Non-suitable "Off" cell". - NGC Cell E as the "Serving cell".	-		-	
0A	The UE is Switched/Powerd ON	-	-	-	-
1-12	Steps 2-13 of Table 4.5.2.2-2 of the generic procedure in TS 38.508-1 [4] are performed.	-		-	-
13	SS transmits a REGISTRATION REJECT message with cause #22 (Congestion) and	<--	REGISTRATION REJECT	-	-

	T3346 set to 3 minutes. (Note 1)				
14	The SS releases the RRC connection	-		-	-
15	Check: Does the UE transmit a RRCSetupRequest on NGC Cell E within T3346 of Step 13? (Note 1)	-->	NR RRC: RRCSetupRequest	1	F
16	Check: Does the UE transmit a REGISTRATION REQUEST on NGC Cell E	-->	5GMM: REGISTRATION REQUEST	2	P
17-25	Void				
26	SS transmits a REGISTRATION REJECT message with cause #22 (Congestion) and T3346 set to 3 minutes. (Note 1)	<--	REGISTRATION REJECT	-	-
27	The SS releases the RRC connection	-			
28	The SS configures: - NGC Cell A as the "Non-suitable "Off" cell". - NGC Cell B as the "Serving cell". - NGC Cell E as the "Non-suitable "Off" cell".				
29	Check: Does the UE transmit a REGISTRATION REQUEST on NGC Cell B within T3346 of Step 26? (Note 1)	-->	5GMM: REGISTRATION REQUEST	4	P
30-31	Void	-	-	-	-
32-38	Steps 5-11 of Table 4.5.2.2-2 of the generic procedure in TS 38.508-1 [4] are performed.				
39	SS transmits a REGISTRATION REJECT message with cause #22 (Congestion) and T3346 set to 3 minutes. (Note 1)	<--	REGISTRATION REJECT	-	-
40	The SS releases the RRC connection	-		-	-
41	The SS configures: - NGC Cell A as the "Serving cell". - NGC Cell B as the "Non-suitable "Off" cell". - NGC Cell E as the "Non-suitable "Off" cell".				
42	Check: Does the UE transmit a RRCSetupRequest on NGC Cell A within T3346 of Step 39?	-->	NR RRC: RRCSetupRequest	5	F

	(Note 1)				
43	Check: Does the UE transmit a REGISTRATION REQUEST on NGC Cell A	-->	5GMM: REGISTRATION REQUEST	5	P
44-74b1	Void	-	-	-	-
75-90a1	Steps 5-20a1 of Table 4.5.2.2-2 of the generic procedure in TS 38.508-1 [4] are performed.	-	-	-	-
Note 1: T3346 is set to 3 minutes. This is checked for 3 minutes less tolerance.					

9.1.5.1.14.3.3 Specific message contents

Table 9.1.5.1.14.3.3-1: REGISTRATION REJECT (steps 13, 26, 39 Table 9.1.5.1.14.3.2-1)

Derivation Path: TS 38.508-1 [4], Table 4.7.1-9			
Information Element	Value/remark	Comment	Condition
5GMM cause	'00010110'B	Cause #22 (Congestion)	
T3346 Value	'00100011'B	3 minutes	

Table 9.1.5.1.14.3.3-2: Void

9.1.5.1.15 Initial registration / Success / Extended and spare fields in CAG information list

9.1.5.1.15.1 Test Purpose (TP)

```

with { UE is powered on and has sent a REGISTRATION REQUEST message }
ensure that {
  when { UE receives extended and spare fields in CAG information list IE in REGISTRATION ACCEPT
that it does not comprehend }
  then { the UE ignores the contents of these octets and transmits REGISTRATION COMPLETE }
}

```

9.1.5.1.15.2 Conformance requirements

References: the conformance requirements covered in the current TC are specified in TS 24.007 [40], clause 11.2.2.1, and TS 24.501 [22] clauses 5.5.1.2.2, 5.5.1.2.3, and 5.5.1.2.4. Unless otherwise stated these are Rel-15 requirements.

[TS 24.007, clause 11.2.2.1]

According to this description method, the IE is presented in its maximum format, i.e., T, TV, TLV or TLV-E, in a picture representing the bits in a table, each line representing an octet. Bits appear in the occidental order, i.e., from left of the page to right of the page, and from top of the page to bottom of the page.

Boxes so delimited contains typically the field name, possibly an indication of which bits in the field are in the box, and possibly a value (e.g., for spare bits).

A specific method can be used in the IE description to describe a branching structure, i.e., a structure variable according to the value of particular fields in the IE. This design is unusual outside type 4 and type 6 IEs, and as, a design rule, should be used only in type 4 and type 6 IEs.

- a) The octet number of an octet within the IE is defined typically in the table. It consists of a positive integer, possibly of an additional letter, and possibly of an additional asterisk, see clause f). The positive integer identifies one octet or a group of octets.

- b) Each octet group is a self-contained entity. The internal structure of an octet group may be defined in alternative ways.

...

- f) Optional octets are marked with asterisks (*). As a design rule, the presence or absence of an optional octet should be determinable from information in the IE and preceding the optional octet. Care should be taken not to introduce ambiguities with optional octets.
- g) At the end of the IE, additional octets may be added in later versions of the protocols also without using the mechanisms defined in c) and d). Equipment shall be prepared to receive such additional octets; the contents of these octets shall be ignored. However the length indicated in the formal description of the messages and of the individual information elements only takes into account this version of the protocols.

[TS 24.501, clause 5.5.1.2.2]

The UE in state 5GMM-DEREGISTERED shall initiate the registration procedure for initial registration by sending a REGISTRATION REQUEST message to the AMF,

- a) when the UE performs initial registration for 5GS services;
- b) when the UE performs initial registration for emergency services;
- c) when the UE performs initial registration for SMS over NAS; and
- d) when the UE moves from GERAN to NG-RAN coverage or the UE moves from a UTRAN to NG-RAN coverage.

with the following clarifications to initial registration for emergency services:

- a) the UE shall not initiate an initial registration for emergency services over the current access, if the UE is already registered for emergency services over the non-current access, unless the initial registration has to be initiated to perform handover of an existing emergency PDU session from the non-current access to the current access; and

NOTE 1: Transfer of an existing emergency PDU session between 3GPP access and non-3GPP access is needed e.g. if the UE determines that the current access is no longer available.

- b) the UE can only initiate an initial registration for emergency services over non-3GPP access if it cannot register for emergency services over 3GPP access.

The UE initiates the registration procedure for initial registration by sending a REGISTRATION REQUEST message to the AMF, starting timer T3510. If timer T3502 is currently running, the UE shall stop timer T3502. If timer T3511 is currently running, the UE shall stop timer T3511.

During initial registration the UE handles the 5GS mobile identity IE in the following order:

- a) Void
- b) if the UE holds a valid 5G-GUTI that was previously assigned, over 3GPP access or non-3GPP access, by the same PLMN with which the UE is performing the registration, the UE shall indicate the 5G-GUTI in the 5GS mobile identity IE;
- c) if the UE holds a valid 5G-GUTI that was previously assigned, over 3GPP access or non-3GPP access, by an equivalent PLMN, the UE shall indicate the 5G-GUTI in the 5GS mobile identity IE;
- d) if the UE holds a valid 5G-GUTI that was previously assigned, over 3GPP access or non-3GPP, by any other PLMN, the UE shall indicate the 5G-GUTI in the 5GS mobile identity IE;
- e) if a SUCI is available the UE shall include the SUCI in the 5GS mobile identity IE; and
- f) if the UE does not hold a valid 5G-GUTI or SUCI, and is initiating the registration procedure for emergency services, the PEI shall be included in the 5GS mobile identity IE.

If the SUCI is included in the 5GS mobile identity IE and the timer T3519 is not running, the UE shall start timer T3519 and store the value of the SUCI sent in the REGISTRATION REQUEST message. The UE shall include the stored SUCI in the REGISTRATION REQUEST message while timer T3519 is running.

If the UE is operating in the dual-registration mode and it is in EMM state EMM-REGISTERED, the UE shall include the UE status IE with the EMM registration status set to "UE is in EMM-REGISTERED state".

NOTE 2: Inclusion of the UE status IE with this setting corresponds to the indication that the UE is "moving from EPC" as specified in 3GPP TS 23.502 [9].

If the last visited registered TAI is available, the UE shall include the last visited registered TAI in the REGISTRATION REQUEST message.

If the UE requests the use of SMS over NAS, the UE shall include the 5GS update type IE in the REGISTRATION REQUEST message with the SMS requested bit set to "SMS over NAS supported". When the 5GS update type IE is included in the REGISTRATION REQUEST for reasons other than requesting the use of SMS over NAS, and the UE does not need to register for SMS over NAS, the UE shall set the SMS requested bit of the 5GS update type IE to "SMS over NAS not supported" in the REGISTRATION REQUEST message.

If the UE supports MICO mode and requests the use of MICO mode, then the UE shall include the MICO indication IE in the REGISTRATION REQUEST message.

If the UE needs to use the UE specific DRX parameters, the UE shall include the Requested DRX parameters IE in the REGISTRATION REQUEST message.

If the UE needs to request LADN information for specific LADN DNN(s) or indicates a request for LADN information as specified in 3GPP TS 23.501 [8], the UE shall include the LADN indication IE in the REGISTRATION REQUEST message and:

- request specific LADN DNNs by including a LADN DNN value in the LADN indication IE for each LADN DNN for which the UE requests LADN information; or
- to indicate a request for LADN information by not including any LADN DNN value in the LADN indication IE.

The UE shall include the requested NSSAI containing the S-NSSAI(s) corresponding to the slice(s) to which the UE intends to register with and shall include the mapped S-NSSAI(s) for the requested NSSAI, if available, in the REGISTRATION REQUEST message. If the UE has allowed NSSAI or configured NSSAI for the current PLMN, the requested NSSAI shall be either:

- a) the configured NSSAI for the current PLMN, or a subset thereof as described below, if the UE has no allowed NSSAI for the current PLMN;
- b) the allowed NSSAI for the current PLMN, or a subset thereof as described below, if the UE has an allowed NSSAI for the current PLMN; or
- c) the allowed NSSAI for the current PLMN, or a subset thereof as described below, plus one or more S-NSSAIs from the configured NSSAI for which no corresponding S-NSSAI is present in the allowed NSSAI and those are neither in the rejected NSSAI for the current PLMN nor in the rejected NSSAI for the current registration area.

If the UE has neither allowed NSSAI for the current PLMN nor configured NSSAI for the current PLMN and has a default configured NSSAI, the UE shall:

- a) include the S-NSSAI(s) in the Requested NSSAI IE of the REGISTRATION REQUEST message using the default configured NSSAI; and
- b) include the Network slicing indication IE with the Default configured NSSAI indication bit set to "Requested NSSAI created from default configured NSSAI" in the REGISTRATION REQUEST message.

If the UE has no allowed NSSAI for the current PLMN, no configured NSSAI for the current PLMN, and no default configured NSSAI, the UE shall not include a requested NSSAI in the REGISTRATION message.

The subset of configured NSSAI provided in the requested NSSAI consists of one or more S-NSSAIs in the configured NSSAI applicable to the current PLMN, if the S-NSSAI is neither in the rejected NSSAI for the current PLMN nor in the rejected NSSAI for the current registration area.

The subset of allowed NSSAI provided in the requested NSSAI consists of one or more S-NSSAIs in the allowed NSSAI for the current PLMN.

NOTE 3: How the UE selects the subset of configured NSSAI or allowed NSSAI to be provided in the requested NSSAI is implementation specific. The UE can take preferences indicated by the upper layers (e.g. policies, applications) into account.

NOTE 4: The number of S-NSSAI(s) included in the requested NSSAI cannot exceed eight.

If the UE initiates an initial registration for emergency services or needs to prolong the established NAS signalling connection after the completion of the initial registration procedure (e.g. due to uplink signalling pending), the UE shall set the Follow-on request indicator to 1.

If the UE supports S1 mode, the UE shall:

- set the S1 mode bit to "S1 mode supported" in the 5GMM capability IE of the REGISTRATION REQUEST message;
- include the S1 UE network capability IE in the REGISTRATION REQUEST message; and
- if the UE supports sending an ATTACH REQUEST message containing a PDN CONNECTIVITY REQUEST message with request type set to "handover" to transfer a PDU session from N1 mode to S1 mode, set the HO attach bit to "attach request message containing PDN connectivity request with request type set to handover to transfer PDU session from N1 mode to S1 mode supported" in the 5GMM capability IE of the REGISTRATION REQUEST message.

If the UE supports the LTE positioning protocol (LPP) in N1 mode as specified in 3GPP TS 36.355 [26], the UE shall set the LPP bit to "LPP in N1 mode supported" in the 5GMM capability IE of the REGISTRATION REQUEST message.

If the UE has one or more stored UE policy sections identified by a UPSI with the PLMN ID part indicating the HPLMN or the selected PLMN, the UE shall include the UE STATE INDICATION message (see annex D) in the Payload container IE of the REGISTRATION REQUEST message.

If the UE does not have a valid 5G NAS security context, the UE shall send the REGISTRATION REQUEST message without including the NAS message container IE. The UE shall set the Payload container type IE to "UE policy container" and include the entire REGISTRATION REQUEST message (i.e. containing cleartext IEs and non-cleartext IEs, if any) in the NAS message container IE that is sent as part of the SECURITY MODE COMPLETE message as described in subclauses 4.4.6 and 5.4.2.3.

NOTE 1: In this version of the protocol, the UE can only include the Payload container IE in the REGISTRATION REQUEST message to carry a payload of type "UE policy container".

If the UE has a valid 5G NAS security context and the UE needs to send non-cleartext IEs, the UE shall send a REGISTRATION REQUEST message including the NAS message container IE as described in subclause 4.4.6. If the UE does not need to send non-cleartext IEs, the UE shall send a REGISTRATION REQUEST message without including the NAS message container IE.

If the REGISTRATION REQUEST message includes a NAS message container IE, the AMF shall process the REGISTRATION REQUEST message that is obtained from the NAS message container IE as described in subclause 4.4.6.

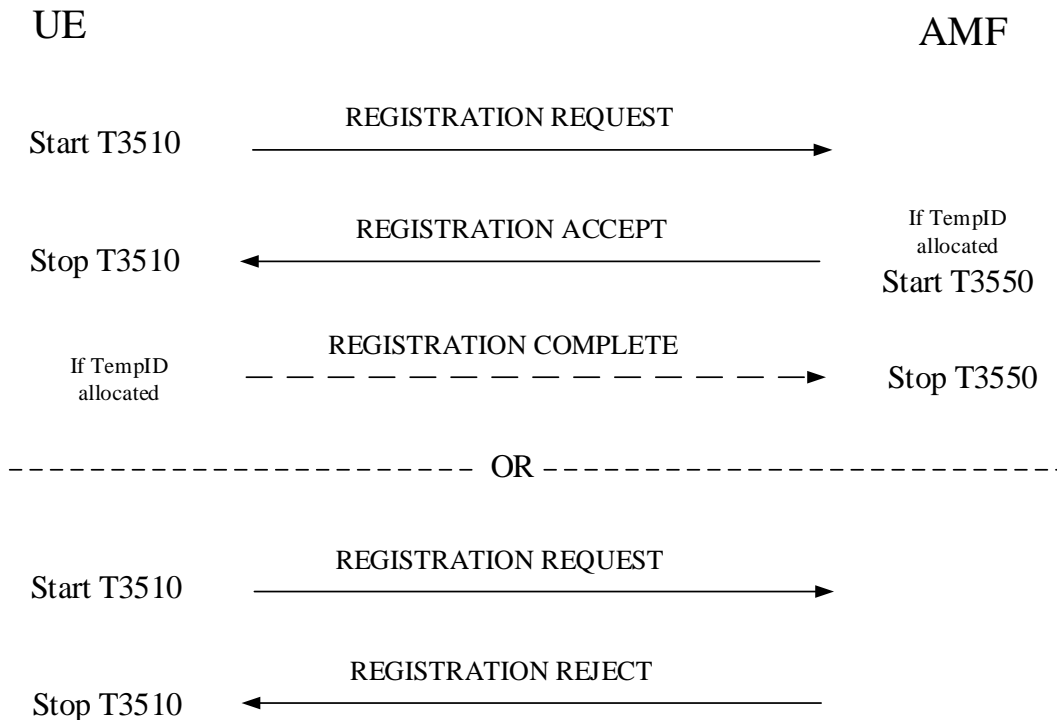

Figure 5.5.1.2.2.1: Registration procedure for initial registration

[TS 24.501, clause 5.5.1.2.3]

The network may initiate 5GMM common procedures, e.g. the identification, authentication and security procedures during the registration procedure, depending on the information received in the REGISTRATION REQUEST message.

During a registration procedure with 5GS registration type IE set to "emergency registration", if the AMF is configured to support emergency registration for unauthenticated SUCIs, the AMF may choose to skip the authentication procedure even if no 5G NAS security context is available and proceed directly to the execution of the security mode control procedure.

[TS 24.501, clause 5.5.1.2.4]

During a registration procedure with 5GS registration type IE set to "emergency registration", the AMF shall not check for mobility and access restrictions, regional restrictions or subscription restrictions, when processing the REGISTRATION REQUEST message.

If the initial registration request is accepted by the network, the AMF shall send a REGISTRATION ACCEPT message to the UE.

For each of the information elements: 5GMM capability, S1 UE network capability, and UE security capability, the AMF shall store all octets received from the UE in the REGISTRATION REQUEST message, up to the maximum length defined for the respective information element.

NOTE 1: This information is forwarded to the new AMF during inter-AMF handover or to the new MME during inter-system handover to S1 mode.

The AMF shall assign and include a TAI list as a registration area the UE is registered to in the REGISTRATION ACCEPT message. The UE, upon receiving a REGISTRATION ACCEPT message, shall delete its old TAI list and store the received TAI list. If the REGISTRATION REQUEST message was received over non-3GPP access, the AMF shall include only the N3GPP TAI in the TAI list.

NOTE 2: The N3GPP TAI is operator-specific.

The AMF may include service area restrictions in the Service area list IE in the REGISTRATION ACCEPT message. The UE, upon receiving a REGISTRATION ACCEPT message with the service area restrictions shall act as described in subclause 5.3.5.

The AMF may also include a list of equivalent PLMNs in the REGISTRATION ACCEPT message. Each entry in the list contains a PLMN code (MCC+MNC). The UE shall store the list as provided by the network, and if the initial registration procedure is not for emergency services, the UE shall remove from the list any PLMN code that is already in the list of "forbidden PLMNs". In addition, the UE shall add to the stored list the PLMN code of the registered PLMN that sent the list. The UE shall replace the stored list on each receipt of the REGISTRATION ACCEPT message. If the REGISTRATION ACCEPT message does not contain a list, then the UE shall delete the stored list.

If the initial registration procedure is not for emergency services, and if the PLMN identity of the registered PLMN is a member of the list of "forbidden PLMNs", any such PLMN identity shall be deleted from the corresponding list(s).

If the Service area list IE is not included in the REGISTRATION ACCEPT message, any tracking area in the registered PLMN and its equivalent PLMN(s) in the registration area is considered as an allowed tracking area as described in subclause 5.3.5.

If the REGISTRATION REQUEST message contains the LADN indication IE, based on the LADN indication IE, UE subscription information, UE location and local configuration about LADN and:

- if the LADN indication IE includes requested LADN DNNs, the UE subscribed DNN list includes the requested LADN DNNs or the wildcard DNN, and the LADN service area of the requested LADN DNN has an intersection with the current registration area, the AMF shall determine the requested LADN DNNs included in the LADN indication IE as LADN DNNs for the UE;
- if no requested LADN DNNs included in the LADN indication IE and the wildcard DNN is included in the UE subscribed DNN list, the AMF shall determine the LADN DNN(s) configured in the AMF whose LADN service area has an intersection with the current registration area as LADN DNNs for the UE; or
- if no requested LADN DNNs included in the LADN indication IE and the wildcard DNN is not included in the UE subscribed DNN list, the AMF shall determine the LADN DNN(s) included in the UE subscribed DNN list whose LADN service area has an intersection with the current registration area as LADN DNNs for the UE.

If the LADN indication IE is not included in the REGISTRATION REQUEST message, the AMF shall determine the LADN DNN(s) included in the UE subscribed DNN list whose service area has an intersection with the current registration area as LADN DNNs for the UE, except for the wildcard DNN included in the UE subscribed DNN list.

The AMF shall include the LADN information which consists of the determined LADN DNNs for the UE and LADN service area(s) available in the current registration area in the LADN information IE of the REGISTRATION ACCEPT message.

The UE, upon receiving the REGISTRATION ACCEPT message with the LADN information, shall store the received LADN information. If there exists one or more LADN DNNs which are included in the LADN indication IE of the REGISTRATION REQUEST message and are not included in the LADN information IE of the REGISTRATION ACCEPT message, the UE considers such LADN DNNs as not available in the current registration area.

The 5G-GUTI reallocation shall be part of the initial registration procedure. During the initial registration procedure, if the AMF has not allocated a new 5G-GUTI by the generic UE configuration update procedure, the AMF shall include in the REGISTRATION ACCEPT message the new assigned 5G-GUTI together with the assigned TAI list.

If a 5G-GUTI or the SOR transparent container IE is included in the REGISTRATION ACCEPT message, the AMF shall start timer T3550 and enter state 5GMM-COMMON-PROCEDURE-INITIATED as described in subclause 5.1.3.2.3.3.

If the Operator-defined access category definitions IE or the Extended emergency number list IE is included in the REGISTRATION ACCEPT message, the AMF shall start timer T3550 and enter state 5GMM-COMMON-PROCEDURE-INITIATED as described in subclause 5.1.3.2.3.3.

The AMF shall include the MICO indication IE in the REGISTRATION ACCEPT message only if the MICO indication IE was included in the REGISTRATION REQUEST message, the AMF supports and accepts the use of MICO mode. If the AMF supports and accepts the use of MICO mode, the AMF may indicate "all PLMN registration area allocated" in the MICO indication IE in the REGISTRATION ACCEPT message. If "all PLMN registration area allocated" is indicated in the MICO indication IE, the AMF shall not assign and include the TAI list in the REGISTRATION ACCEPT message. If the REGISTRATION ACCEPT message included an MICO indication IE

indicating "all PLMN registration area allocated", the UE shall treat all TAIs in the current PLMN as a registration area and delete its old TAI list.

The AMF shall include the T3512 value IE in the REGISTRATION ACCEPT message only if the REGISTRATION REQUEST message was sent over the 3GPP access.

The AMF shall include the non-3GPP de-registration timer value IE in the REGISTRATION ACCEPT message only if the REGISTRATION REQUEST message was sent for the non-3GPP access.

Upon receipt of the REGISTRATION ACCEPT message, the UE shall reset the registration attempt counter, enter state 5GMM-REGISTERED and set the 5GS update status to 5U1 UPDATED.

If the REGISTRATION ACCEPT message included a T3512 value IE, the UE shall use the value in the T3512 value IE as periodic registration update timer (T3512).

If the REGISTRATION ACCEPT message included a non-3GPP de-registration timer value IE, the UE shall use the value in non-3GPP de-registration timer value IE as non-3GPP de-registration timer.

If the REGISTRATION ACCEPT message contained a 5G-GUTI, the UE shall return a REGISTRATION COMPLETE message to the AMF to acknowledge the received 5G-GUTI, stop timer T3519 if running, and delete any stored SUCI. The UE shall provide the 5G-GUTI to the lower layer of 3GPP access if the REGISTRATION ACCEPT message is sent over the non-3GPP access, and the UE is in 5GMM-REGISTERED in both 3GPP access and non-3GPP access in the same PLMN.

If the REGISTRATION ACCEPT message contains the Network slicing indication IE with the Network slicing subscription change indication set to "Network slicing subscription changed", or contains a configured NSSAI IE with a new configured NSSAI for the current PLMN and optionally the mapped S-NSSAI(s) for the configured NSSAI for the current PLMN, the UE shall return a REGISTRATION COMPLETE message to the AMF to acknowledge the successful update of the network slicing information.

If the REGISTRATION ACCEPT message contains the Operator-defined access category definitions IE or the Extended emergency number list IE or both, the UE shall return a REGISTRATION COMPLETE message to the AMF to acknowledge reception of the operator-defined access category definitions or the extended local emergency numbers list or both.

Upon receiving a REGISTRATION COMPLETE message, the AMF shall stop timer T3550 and change to state 5GMM-REGISTERED. The 5G-GUTI, if sent in the REGISTRATION ACCEPT message, shall be considered as valid.

9.1.5.1.15.3 Test description

9.1.5.1.15.3.1 Pre-test conditions

System Simulator:

- NGC Cell A

UE:

- The UE is configured to initiate 5GS registration.
- The UE is previously registered on NGC Cell A using default message contents according to TS 38.508-1 [4].

Preamble:

- The UE is in state Switched OFF (state 0N-B) according to TS 38.508-1 [4].

9.1.5.1.15.3.2 Test procedure sequence

Table 9.1.5.1.15.3.2-1: Main behaviour

St	Procedure	Message Sequence		TP	Verdict
		U - S	Message		
1	The UE is switched on.	-	-	-	-

2-14	Steps 1-13 of the generic procedure for NR RRC_IDLE as specified in TS 38.508-1 [4] Table 4.5.2.2-2 are performed.	-	-	-	-
15	The SS transmits REGISTRATION ACCEPT with additional octets included that the UE does not comprehend.	<--	REGISTRATION ACCEPT	-	-
16	Check: Does the UE transmit a REGISTRATION COMPLETE message?	-->	REGISTRATION COMPLETE	1	P
17a 1- 18a 1	Steps 19a1-20a1 of Table 4.5.2.2-2 of the generic procedure in TS 38.508-1 [4] are performed.	-	-	-	-

9.1.5.1.15.3.3 Specific message contents

Table 9.1.5.1.15.3.3-1: Message REGISTRATION ACCEPT (step 15, Table 9.1.5.1.15.3.2-1)

Derivation Path: TS 38.508-1 [4] Table 4.7.1-7			
Information Element	Value/remark	Comment	Condition
CAG information list	'0111 0101 0000 0000 0000 0000'B	A CAG list with zero entries (i.e. only octets 1, 2, and 3 are present, octet 1 is equal to the CAG information list IEI of 0x75, and the length of CAG information list contents as represented by octets 2 and 3 is equal to 0). This octet was defined in Rel-16, and so to a Rel-15 UE it appears as an extended octet that it does not understand. Because CAG as a feature is also not defined prior to Rel-16, no procedures will be triggered by sending a blank CAG list to a Rel-15 UE.	Rel-15

9.1.5.2 Mobility and periodic registration update

9.1.5.2.1 Mobility registration update / TAI list handling

9.1.5.2.1.1 Test Purpose (TP)

(1)

```
with { UE in state 5GMM-REGISTERED, and 5GMM-IDLE mode over 3GPP access }
ensure that {
  when { UE detects entering a tracking area which is not in the list of forbidden TAs and is not in
the list of tracking areas that the UE previously registered in the AMF }
```

```

    then { UE initiates and successfully completes the registration procedure for mobility
registration update }
}

```

(2)

```

with { UE in state 5GMM-REGISTERED, and 5GMM-IDLE mode over 3GPP access }
ensure that {
  when { UE detects entering a tracking area which is not in the list of forbidden TAs and is in the
list of tracking areas that the UE previously registered in the AMF }
  then { UE does not initiate the registration procedure for mobility registration update }
}

```

(3)

```

with { UE in state 5GMM-REGISTERED, and 5GMM-IDLE mode over 3GPP access }
ensure that {
  when { UE receives a new TAI list during a mobility registration update procedure }
  then { UE shall delete its old TAI list and store the received TAI list }
}

```

9.1.5.2.1.2 Conformance requirements

References: The conformance requirements covered in the present TC are specified in: TS 24.501, clauses 5.5.1.3.2, 5.5.1.3.4. Unless otherwise stated these are Rel-15 requirements.

[TS 24.501, clause 5.5.1.3.2]

The UE in state 5GMM-REGISTERED shall initiate the registration procedure for mobility and periodic registration update by sending a REGISTRATION REQUEST message to the AMF,

- a) when the UE detects entering a tracking area that is not in the list of tracking areas that the UE previously registered in the AMF;

...

If case b) is the only reason for initiating the registration procedure for mobility and periodic registration update, the UE shall indicate "periodic registration updating" in the 5GS registration type IE; otherwise the UE shall indicate "mobility registration updating".

...

After sending the REGISTRATION REQUEST message to the AMF the UE shall start timer T3510. If timer T3502 is currently running, the UE shall stop timer T3502. If timer T3511 is currently running, the UE shall stop timer T3511.

If the last visited registered TAI is available, the UE shall include the last visited registered TAI in the REGISTRATION REQUEST message.

The UE shall handle the 5GS mobility identity IE in the REGISTRATION REQUEST message as follows:

...

- b) for all other cases, if the UE holds a valid 5G-GUTI, the UE shall indicate the 5G-GUTI in the 5GS mobile identity IE.

...

When the registration procedure for mobility and periodic registration update is initiated in 5GMM-IDLE mode, the UE may include a PDU session status IE in the REGISTRATION REQUEST message, indicating which PDU sessions associated with the access type the REGISTRATION REQUEST message is sent over are active in the UE.

...

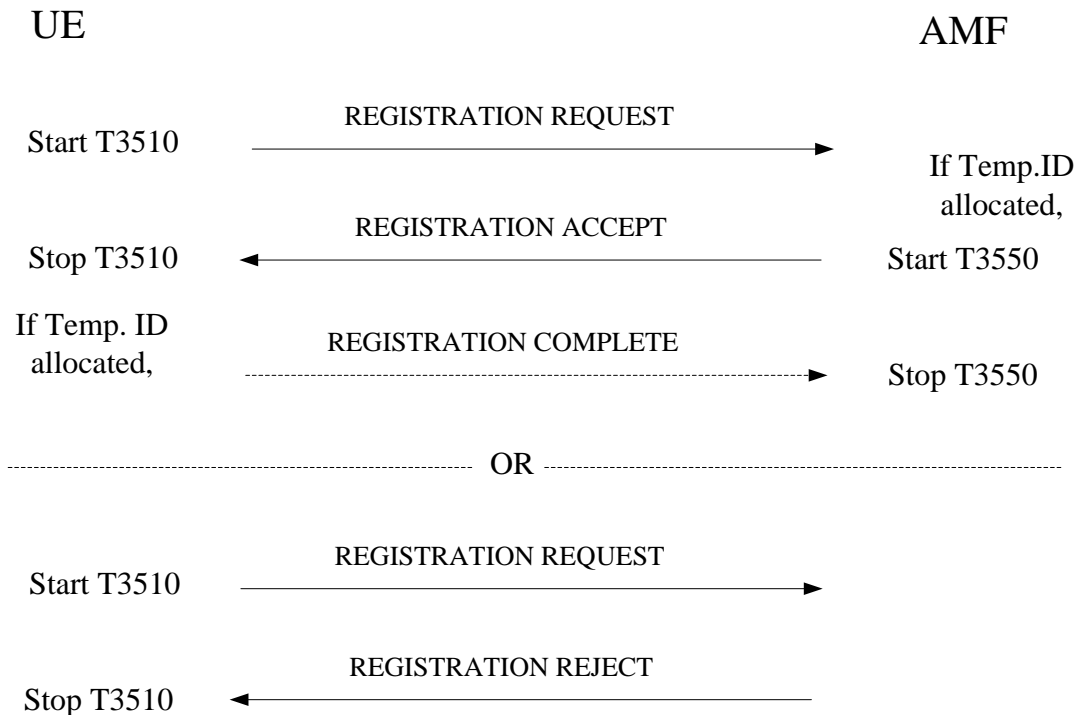

Figure 5.5.1.3.2.1: Registration procedure for mobility and periodic registration update

[TS 24.501, clause 5.5.1.3.4]

The AMF shall assign and include a TAI list as a registration area the UE is registered to in the REGISTRATION ACCEPT message. The UE, upon receiving a REGISTRATION ACCEPT message, shall delete its old TAI list and store the received TAI list. If the REGISTRATION REQUEST message was received over non-3GPP access, the AMF shall include only the N3GPP TAI in the TAI list.

...

Upon receipt of the REGISTRATION ACCEPT message, the UE shall reset the registration attempt counter, enter state 5GMM-REGISTERED and set the 5GS update status to 5U1 UPDATED.

...

If the REGISTRATION ACCEPT message contains a 5G-GUTI, the UE shall return a REGISTRATION COMPLETE message to the AMF to acknowledge the received 5G-GUTI, stop timer T3519 if running, and delete any stored SUCI.

9.1.5.2.1.3 Test description

9.1.5.2.1.3.1 Pre-test conditions

System Simulator:

- 3 cells, NGC Cell A, and NGC Cell B and NGC Cell D belonging to the same PLMN and different TA in accordance with TS 38.508-1 [4] Table 6.3.2.2-1
- System information combination NR-2 as defined in TS 38.508-1 [4], sub-clause 4.4.3.1.2 is used in all cells when active.

UE:

None.

Preamble:

- The UE is in test state 1N-A as defined in 38.508-1 [4], subclause 4.4A on NGC Cell A.
- During the initial registration:
 - In the list of tracking areas provided by the AMF (IE 'TAI list') contains only the TAI of NGC Cell A.

9.1.5.2.1.3.2 Test procedure sequence

Table 9.1.5.2.1.3.2-1: Main behaviour

St	Procedure	Message Sequence		TP	Verdict
		U - S	Message		
1	The SS configures: - NGC Cell B as "Serving cell" - NGC Cell A as "Non-suitable "Off" cell".	-	-	-	-
2	Check: Does the UE perform on NGC Cell B the Registration procedure for mobility registration update by executing the Test procedure to check that UE is camped on a new cell belonging to a new TA as specified in TS 38.508-1 [4] subclause 4.9.5? NOTE: During the procedure the SS assigns a TAI list containing the TAI of NGC Cell B and NGC Cell D.	-	-	1	-
3	The SS configures: - NGC Cell D as "Serving cell" - NGC Cell B as "Non-suitable "Off" cell".	-	-	-	-
4	Check: Does the UE send in the next 30 sec a request for RRC connection establishment.	-->	NR RRC: RRCSetupRequest	2	F
5	Check: Does the result of generic test procedure in TS 38.508-1 [4] subclause 4.9.4 indicate that the UE is in 5GC RRC_IDLE state on the NGC Cell D?	-	-	2	-
6	The SS configures: - NGC Cell A as "Serving cell" - NGC Cell D as "Non-suitable "Off" cell".	-	-	-	-
7	Check: Does the UE perform on NGC Cell A the Registration procedure for mobility registration update as specified in TS 38.508-1 [4] subclause 4.9.5, ' <i>connected without release</i> '?	-	-	3	-

9.1.5.2.1.3.3 Specific message contents

Table 9.1.5.2.1.3.3-1: REGISTRATION REQUEST (step 2, Table 9.1.5.2.1.3.2-1; step 3, TS 38.508-1 [4] Table 4.9.5.2.2-1)

Derivation path: TS 38.508-1 [4], Table 4.7.1-6.			
Information Element	Value/remark	Comment	Condition
5GS registration type	'00xxx010'	mobility registration updating x - not checked	
5GS mobile identity	Active 5G-GUTI assigned in the preamble		
5GMM capability	Any value		
Last visited registered TAI	The TAI of the NGC Cell A, see TS 38.508-1 [4] Table 6.3.2.2-1		
S1 UE network capability	If included then Any value	Shall be included if S1 mode	

		indicated as supported in the IE '5GMM capability'	
--	--	--	--

Table 9.1.5.2.1.3.3-2: REGISTRATION ACCEPT (step 2, Table 9.1.5.2.1.3.2-1; step 4, TS 38.508-1 [4] Table 4.9.5.2.2-1)

Derivation path: TS 38.508-1 [4], Table 4.7.1-7.			
Information Element	Value/remark	Comment	Condition
5GS registration result			
5GS registration result value	'001'	3GPP access	
SMS allowed	'0'	SMS over NAS not allowed	
5G-GUTI	A 5G-GUTI different to the one provided by the UE in the REGISTRATION REQUEST		
TAI list			
Type of list	"00"	list of TACs belonging to one PLMN, with non-consecutive TAC values	
MCC	The MCC of the PLMN to which the NGC Cell A, NGC Cell B and NGC Cell D belong to, see TS 38.508-1 [4] Table 6.3.2.2-1		
MNC	The MNC of the PLMN to which the NGC Cell A, NGC Cell B and NGC Cell D belong to, see TS 38.508-1 [4] Table 6.3.2.2-1		
TAC 1	The TAI of the NGC Cell B, see TS 38.508-1 [4] Table 6.3.2.2-1		
TAC 2	The TAI of the NGC Cell D, see TS 38.508-1 [4] Table 6.3.2.2-1		
PDU session status	If PDU session status was included in the REGISTRATION REQUEST, the indicated as active PDN sessions shall be confirmed as active		

Table 9.1.5.2.1.3.3-3: REGISTRATION REQUEST (step 7, Table 9.1.5.2.1.3.2-1; step 3, TS 38.508-1 [4] Table 4.9.5.2.2-1)

Derivation path: TS 38.508-1 [4], Table 4.7.1-6.			
Information Element	Value/remark	Comment	Condition
5GS registration type	'00xxx010'	mobility registration updating x - not checked	
5GS mobile identity	Active 5G-GUTI assigned in Table 9.1.5.2.1.3.3-2: REGISTRATION ACCEPT		

5GMM capability	Any value		
Last visited registered TAI	The TAI of the NGC Cell D, see TS 38.508-1 [4] Table 6.3.2.2-1		
S1 UE network capability	If included then Any value	Shall be included if S1 mode indicated as supported in the IE '5GMM capability'	

Table 9.1.5.2.1.3.3-4: REGISTRATION ACCEPT (step 7, Table 9.1.5.2.1.3.2-1; step 4, TS 38.508-1 [4] Table 4.9.5.2.2-1)

Derivation path: TS 38.508-1 [4], Table 4.7.1-7.			
Information Element	Value/remark	Comment	Condition
5GS registration result			
5GS registration result value	'001'	3GPP access	
SMS allowed	'0'	SMS over NAS not allowed	
5G-GUTI	Active 5G-GUTI assigned in the preamble		
TAI list			
Type of list	"00"	list of TACs belonging to one PLMN, with non-consecutive TAC values	
MCC	The MCC of the PLMN to which the NGC Cell A, NGC Cell B and NGC Cell D belong to, see TS 38.508-1 [4] Table 6.3.2.2-1		
MNC	The MNC of the PLMN to which the NGC Cell A, NGC Cell B and NGC Cell D belong to, see TS 38.508-1 [4] Table 6.3.2.2-1		
TAC 1	The TAI of the NGC Cell A, see TS 38.508-1 [4] Table 6.3.2.2-1		
PDU session status	If PDU session status was included in the REGISTRATION REQUEST, the indicated as active PDU sessions shall be confirmed as active		

9.1.5.2.2 Periodic registration update / Accepted

9.1.5.2.2.1 Test Purpose (TP)

(1)

```

with { the UE in 5GMM-REGISTERED state and 5GMM-IDLE mode over 3GPP access }
ensure that {
  when { the periodic registration updating timer T3512 expires }
  then { the UE initiates the registration procedure for mobility and periodic registration update
and indicates "periodic registration updating" in the 5GS registration type IE }
}

```

(2)

```

with { the UE in 5GMM-REGISTERED-INITIATED state }
ensure that {
  when { the UE receives an REGISTRATION ACCEPT message included a new T3512 value IE }
  then { the UE uses the new value in T3512 value IE as periodic registration update timer (T3512) }
}

```

9.1.5.2.2.2 Conformance requirements

References: The conformance requirements covered in the present TC are specified in: TS 24.501, clauses 5.5.1.3.1, 5.5.1.3.2 and 5.5.1.3.4. Unless otherwise stated these are Rel-15 requirements.

[TS 24.501, clause 5.5.1.3.1]

This procedure is used by a UE for both mobility and periodic registration update of 5GS services. This procedure, when used for periodic registration update of 5GS services, is performed only in 3GPP access.

This procedure used for periodic registration update of 5GS services is controlled in the UE by timer T3512. When timer T3512 expires, the registration procedure for mobility and periodic registration area updating is started. Start and reset of timer T3512 is described in subclause 10.2.

[TS 24.501, clause 5.5.1.3.2]

The UE in state 5GMM-REGISTERED shall initiate the registration procedure for mobility and periodic registration update by sending a REGISTRATION REQUEST message to the AMF,

- a) when the UE detects entering a tracking area that is not in the list of tracking areas that the UE previously registered in the AMF;
- b) when the periodic registration updating timer T3512 expires;

...

If item b) is the only reason for initiating the registration procedure for mobility and periodic registration update, the UE shall indicate "periodic registration updating" in the 5GS registration type IE; otherwise the UE shall indicate "mobility registration updating".

...

[TS 24.501, clause 5.5.1.3.4]

...

If the REGISTRATION ACCEPT message included a T3512 value IE, the UE shall use the value in T3512 value IE as periodic registration update timer (T3512). If the T3512 value IE is not included, the UE shall use the value currently stored, e.g. from a prior REGISTRATION ACCEPT message.

...

9.1.5.2.2.3 Test description

9.1.5.2.2.3.1 Pre-test conditions

System Simulator:

- NGC Cell A.

UE:

- None.

Preamble:

- The UE is in state ON-B on NGC Cell A according to TS 38.508-1 [4].

9.1.5.2.2.3.2 Test procedure sequence

Table 9.1.5.2.2.3.2-1: Main behaviour

St	Procedure	Message Sequence		TP	Verdict
		U - S	Message		
1	The UE is switched on.	-	-	-	-
2-14	Steps 1-13 of the generic procedure for UE registration specified in TS 38.508-1 [4] table 4.5.2.2-2 are performed.	-	-	-	-
15	The SS transmits a REGISTRATION ACCEPT message.	<--	REGISTRATION ACCEPT	-	-
16-21	Steps 15-20a1 of the generic procedure for UE registration specified in TS 38.508-1 [4] table 4.5.2.2-2 are performed.	-	-	-	-
22	The SS waits 3 minutes. (Expire of T3512)	-	-	-	-
23	Check: Does the UE transmit a REGISTRATION REQUEST message with the 5GS registration type IE indicating "periodic registration updating"?	-->	REGISTRATION REQUEST	1	P
24	The SS transmits a REGISTRATION ACCEPT message including T3512 value IE.	<--	REGISTRATION ACCEPT	-	-
24 A	The UE transmits a REGISTRATION COMPLETE message.	-->	REGISTRATION COMPLETE	-	-
25	The SS releases the RRC connection.	-	-	-	-
26	The SS waits 1 minute. (Expire of T3512)	-	-	-	-
27	Check: Does the UE transmit a REGISTRATION REQUEST message?	-->	REGISTRATION REQUEST	2	P
28	The SS transmits a REGISTRATION ACCEPT message.	<--	REGISTRATION ACCEPT	-	-
29	The UE transmits a REGISTRATION COMPLETE message. (NOTE 1)	-->	REGISTRATION COMPLETE	-	-

NOTE 1: the UE finishes in State 3N-A with T3540 started.

9.1.5.2.2.3.3 Specific message contents

Table 9.1.5.2.2.3.3-1: REGISTRATION ACCEPT (Step 15, Table 9.1.5.2.2.3.2-1)

Derivation path: TS 38.508-1 [4], table 4.7.1-7			
Information Element	Value/Remark	Comment	Condition
T3512 value			
Unit	'101'B	value is incremented in multiples of 1 minute	
Timer value	'0 0011'B	3 minutes	

Table 9.1.5.2.2.3.3-2: REGISTRATION REQUEST (Steps 23 & 27, Table 9.1.5.2.2.3.2-1)

Derivation path: TS 38.508-1 [4], table 4.7.1-6			
Information Element	Value/Remark	Comment	Condition
5GS registration type			
5GS registration type value	'011'B	periodic registration updating	

Table 9.1.5.2.2.3.3-3: REGISTRATION ACCEPT (Step 24, Table 9.1.5.2.2.3.2-1)

Derivation path: TS 38.508-1 [4], table 4.7.1-7			
Information Element	Value/Remark	Comment	Condition
T3512 value			

Unit	'101'B	value is incremented in multiples of 1 minute	
Timer value	'0 0001'B	1 minute	

9.1.5.2.3

9.1.5.2.4 Mobility registration update / The lower layer requests NAS signalling connection recovery

9.1.5.2.4.1 Test Purpose (TP)

(1)

```

with { UE in state 5GMM-REGISTERED, and 5GMM-CONNECTED mode over 3GPP access and does not have
signalling or user uplink data pending }
ensure that {
  when { UE receives an indication of "RRC Connection failure" from the lower layers }
  then { UE initiates and successfully completes the registration procedure for mobility
registration update }
}

```

9.1.5.2.4.2 Conformance requirements

References: The conformance requirements covered in the present TC are specified in: TS 24.501, clauses 5.5.1.3.2, 5.5.1.3.4. Unless otherwise stated these are Rel-15 requirements.

[TS 24.501, clause 5.5.1.3.2]

The UE in state 5GMM-REGISTERED shall initiate the registration procedure for mobility and periodic registration update by sending a REGISTRATION REQUEST message to the AMF,

...

f) when the UE receives an indication of "RRC Connection failure" from the lower layers and does not have signalling or user uplink data pending (i.e. when the lower layer requests NAS signalling connection recovery);

...

If case b) is the only reason for initiating the registration procedure for mobility and periodic registration update, the UE shall indicate "periodic registration updating" in the 5GS registration type IE; otherwise the UE shall indicate "mobility registration updating".

...

After sending the REGISTRATION REQUEST message to the AMF the UE shall start timer T3510. If timer T3502 is currently running, the UE shall stop timer T3502. If timer T3511 is currently running, the UE shall stop timer T3511.

If the last visited registered TAI is available, the UE shall include the last visited registered TAI in the REGISTRATION REQUEST message.

The UE shall handle the 5GS mobility identity IE in the REGISTRATION REQUEST message as follows:

...

b) for all other cases, if the UE holds a valid 5G-GUTI, the UE shall indicate the 5G-GUTI in the 5GS mobile identity IE.

...

When the registration procedure for mobility and periodic registration update is initiated in 5GMM-IDLE mode, the UE may include a PDU session status IE in the REGISTRATION REQUEST message, indicating which PDU sessions associated with the access type the REGISTRATION REQUEST message is sent over are active in the UE.

...

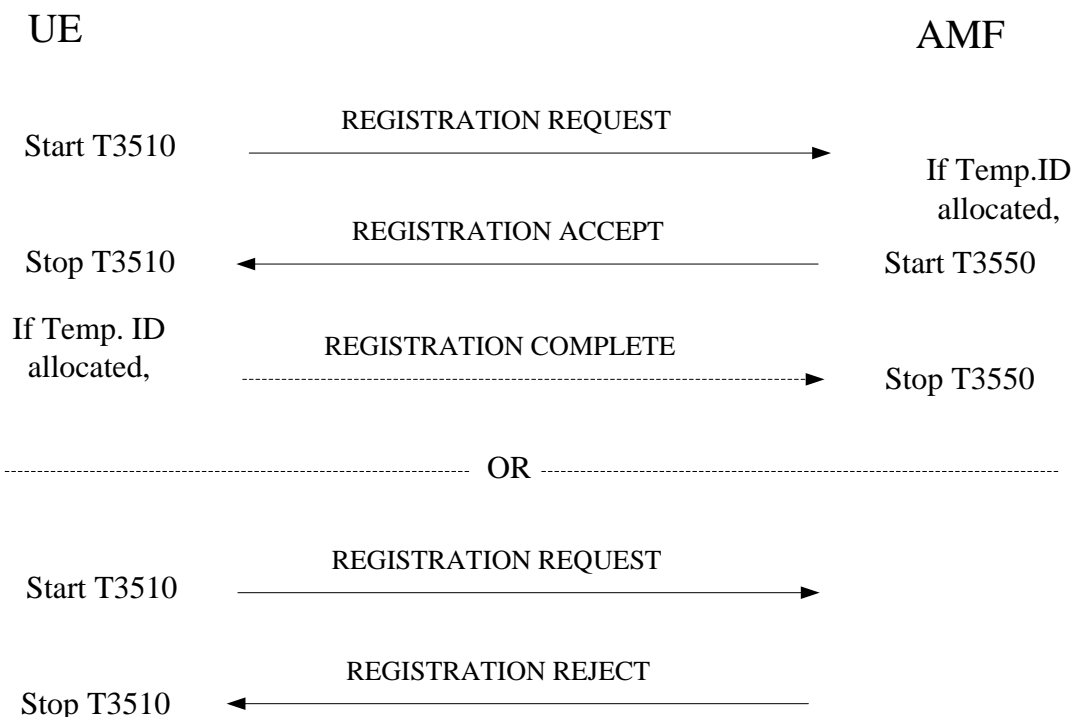

Figure 5.5.1.3.2.1: Registration procedure for mobility and periodic registration update

[TS 24.501, clause 5.5.1.3.4]

Upon receipt of the REGISTRATION ACCEPT message, the UE shall reset the registration attempt counter, enter state 5GMM-REGISTERED and set the 5GS update status to 5U1 UPDATED.

...

If the REGISTRATION ACCEPT message contains a 5G-GUTI, the UE shall return a REGISTRATION COMPLETE message to the AMF to acknowledge the received 5G-GUTI, stop timer T3519 if running, and delete any stored SUCI.

9.1.5.2.4.3 Test description

9.1.5.2.4.3.1 Pre-test conditions

System Simulator:

- NGC Cell A, default system information in accordance with TS 38.508-1 [4] sub-clause 4.4.3.1.2.

UE:

- None.

Preamble:

- Cell configuration in accordance with TS 38.508-1 [4] Table 6.3.2.2-1:
 - NGC Cell A "Serving cell"
- The UE is in test state 3N-A as defined in TS 38.508-1 [4], subclause 4.4A.2 on NGC Cell A.

9.1.5.2.4.3.2 Test procedure sequence

Table 9.1.5.2.4.3.2-1: Main behaviour

St	Procedure	Message Sequence		TP	Verdict
		U - S	Message		
1	The SS configures: - NGC Cell A as "Non-suitable "off" cell" in order to simulate radio link failure. (NOTE 1)	-	-	-	-
2	Wait for T=T310+T311+1.2 sec. (NOTE 1)	-	-	-	-
3	The SS configures: - NGC Cell A as "Serving cell".	-	-	-	-
4	Check: Does the UE perform on NGC Cell A the Registration procedure for mobility registration update by executing the Test procedure to check that UE is camped on a new cell belonging to a new TA as specified in TS 38.508-1 [4] subclause 4.9.5.2.2-1, 'connected without release'? (NOTE 2)	-	-	1	-
NOTE 1: Steps 1-2 simulate the RRC connection failure needed in order for the UE "NAS layer" to receive an indication of "RRC Connection failure" from the lower layers. This is based on requirements specified in TS 38.331 [12], subclauses 5.3.10.1, 5.3.10.3, 5.3.11. A 1s delay is added to allow for N310 consecutive "out-of-sync" indications and 0.2s is added for timer tolerance. Note that N310, T310, N311, T311 values are set in TS 38.508-1 [4], Table 4.6.3-150, <i>RLF-TimersAndConstants</i> .					
NOTE 2: the UE finishes in State 3N-A with T3540 started					

9.1.5.2.4.3.3 Specific message contents

Table 9.1.5.2.4.3.3-1: REGISTRATION REQUEST (step 4, Table 9.1.5.2.4.3.2-1; step 3, TS 38.508-1 [4] Table 4.9.5.2.2-1)

Derivation Path: TS 38.508-1 [4], Table 4.7.1-6.			
Information Element	Value/remark	Comment	Condition
5GS registration type	'00xxx010'	mobility registration updating x - not checked	
5GS mobile identity	Active 5G-GUTI assigned in the preamble		
5GMM capability	Any value		
Last visited registered TAI	The TAI of the NGC Cell A, see TS 38.508-1 [4] Table 6.3.2.2-1		
S1 UE network capability	If included then Any value	Shall be included if S1 mode indicated as supported in the IE '5GMM capability'	

Table 9.1.5.2.4.3.3-2: REGISTRATION ACCEPT (step 4, Table 9.1.5.2.4.3.2-1; step 4, TS 38.508-1 [4] Table 4.9.5.2.2-1)

Derivation Path: TS 38.508-1 [4], Table 4.7.1-7.			
Information Element	Value/remark	Comment	Condition
5GS registration result			
5GS registration result value	'001'	3GPP access	
SMS allowed	'0'	SMS over NAS not allowed	
5G-GUTI	Active 5G-GUTI assigned		

	in the preamble		
TAI list			
Type of list	"00"	list of TACs belonging to one PLMN, with non-consecutive TAC values	
MCC	The MCC of the PLMN to which the NGC Cell A, NGC Cell B and NGC Cell D belong to, see TS 38.508-1 [4] Table 6.3.2.2-1		
MNC	The MNC of the PLMN to which the NGC Cell A, NGC Cell B and NGC Cell D belong to, see TS 38.508-1 [4] Table 6.3.2.2-1		
TAC 1	The TAI of the NGC Cell A, see TS 38.508-1 [4] Table 6.3.2.2-1		
PDU session status	If PDU session status was included in the REGISTRATION REQUEST, the indicated as active PDN sessions shall be confirmed as active		

9.1.5.2.5 Void

9.1.5.2.6 Void

9.1.5.2.7 Mobility and periodic registration update / Rejected / UE identity cannot be derived by the network

9.1.5.2.7.1 Test Purpose (TP)

(1)

```

with { UE in state 5GMM-REGISTERED on an NGC cell }
ensure that {
  when { UE initiates a Mobility and periodic registration procedure on an NGC cell and receives a
REGISTRATION REJECT message including 5GMM cause value #9 (UE identity cannot be derived by the
network) }
  then { UE deletes any 5G-GUTI, last visited registered TAI and ngKSI, enters the state 5GMM-
DEREGISTERED 5U2 NOT UPDATED, and, subsequently automatically initiates the initial registration
procedure }
}

```

9.1.5.2.7.2 Conformance requirements

References: The conformance requirements covered in the present TC are specified in: TS 24.501, clause 5.5.1.3.5. Unless otherwise stated these are Rel-15 requirements.

[TS 24.501, clause 5.5.1.3.5]

If the mobility and periodic registration update request cannot be accepted by the network, the AMF shall send a REGISTRATION REJECT message to the UE including an appropriate 5GMM cause value.

The UE shall take the following actions depending on the 5GMM cause value received in the REGISTRATION REJECT message.

...

#9 (UE identity cannot be derived by the network).

The UE shall set the 5GS update status to 5U2 NOT UPDATED (and shall store it according to subclause 5.1.3.2.2) and shall delete any 5G-GUTI, last visited registered TAI, TAI list and ngKSI. The UE shall enter the state 5GMM-DEREGISTERED.

If the rejected request was not for initiating an emergency PDU session, the UE shall subsequently, automatically initiate the initial registration procedure.

9.1.5.2.7.3 Test description

9.1.5.2.7.3.1 Pre test conditions

System Simulator:

- 1 cell
- NGC Cell A as defined in TS 38.508-1 [4] Table 6.3.2.2-1. Default system information combination as defined in TS 38.508-1 [4], sub-clause 4.4.3.1.2.

UE:

None.

Preamble:

- The UE is brought to state 1N-A, RRC_IDLE Connectivity (NR), in accordance with the procedure described in TS 38.508-1 [4], Table 4.5.2.2-2. 5G-GUTI and ngKSI are assigned and security context established.

9.1.5.2.7.2 Test procedure sequence

Table 9.1.5.2.7.3.2-1: Main behaviour

St	Procedure	Message Sequence		TP	Verdict
		U - S	Message		
1	SS waits for 30s (T3512 expiry)	-	-	-	-
2	The UE transmit a REGISTRATION REQUEST message with the 5GS registration type IE indicating "periodic registration updating".	-->	REGISTRATION REQUEST	-	-
3	The SS transmits a REGISTRATION REJECT message including 5GMM cause value #9 (UE identity cannot be derived by the network).	<--	REGISTRATION REJECT	-	-
4	SS releases the RRC connection.	-	-	-	-
5	Check: Does the UE perform initial registration on NGC Cell A as specified in TS 38.508-1 [4], Table 4.5.2.2-2? The UE does not provide 5G-GUTI, last visited registered TAI or ngKSI.	-	-	1	P

9.1.5.2.7.3.3 Specific message contents

Table 9.1.5.2.7.3.3-1: REGISTRATION ACCEPT (Preamble; TS 38.508-1 [4] Table 4.5.2.2-2)

Derivation path: TS 38.508-1 [4], Table 4.7.1-7.			
Information Element	Value/remark	Comment	Condition
T3512 value			
Unit	'100'B	value is incremented in multiples of 30 seconds	

Timer value	'0 0001'B	30 seconds	
-------------	-----------	------------	--

Table 9.1.5.2.7.3.3-2: REGISTRATION REQUEST (step 2, Table 9.1.5.2.7.3.2-1)

Derivation Path: TS 38.508-1 [4], Table 4.7.1-6.			
Information Element	Value/remark	Comment	Condition
5GS registration type	'00xxx011'	periodic registration updating x - not checked	
ngKSI	Active ngKSI assigned in the Preamble		
5GS mobile identity	Active 5G-GUTI assigned in the Preamble		
Last visited registered TAI	The TAI of the NGC Cell A, see TS 38.508-1 [4] Table 6.3.2.2-1		

Table 9.1.5.2.7.3.3-3: REGISTRATION REJECT (step 3, Table 9.1.5.2.7.3.2-1)

Derivation Path: TS 38.508-1 [4], Table 4.7.1-9.			
Information Element	Value/remark	Comment	Condition
5GMM cause	'0000 1001'B	#9 - UE identity cannot be derived by the network	

Table 9.1.5.2.7.3.3-4: REGISTRATION REQUEST (step 5, Table 9.1.5.2.7.3.2-1; step 4, TS 38.508-1 [4] Table 4.5.2.2-2)

Derivation Path: TS 38.508-1 [4], Table 4.7.1-6, condition NON_CLEARTEXT_IE			
Information Element	Value/remark	Comment	Condition
5GS registration type	'00xxx001'	Initial registration x - not checked	
ngKSI	'111'	no key is available	
5GS mobile identity	SUCI		
Non-current native NAS key set identifier	Not present		
Last visited registered TAI	Not present		
Additional GUTI	Not present		
NAS message container	Not included		

Table 9.1.5.2.7.3.3-5: SECURITY MODE COMPLETE (step 5, Table 9.1.5.2.7.3.2-1; step 9, TS 38.508-1 [4] Table 4.5.2.2-2)

Derivation Path: TS 38.508-1 [4], Table 4.7.1-26, condition RINMR_INDICATED.
--

9.1.5.2.8 Mobility and periodic registration update / Rejected / Implicitly de-registered

9.1.5.2.8.1 Test Purpose (TP)

(1)

```
with { UE in state 5GMM-REGISTERED on an NGC cell }
ensure that {
  when { UE initiates a Mobility and periodic registration procedure on an NGC cell and receives a
REGISTRATION REJECT message including 5GMM cause value #10 (implicitly de-registered) }
  then { UE deletes any partial native 5G security context, enters the state 5GMM-
DEREGISTERED.NORMAL-SERVICE, and, initiates a new registration procedure for initial registration }
}
```

9.1.5.2.8.2 Conformance requirements

References: The conformance requirements covered in the present TC are specified in: TS 24.501, clause 5.5.1.3.5. Unless otherwise stated these are Rel-15 requirements.

[TS 24.501, clause 5.5.1.3.5]

If the mobility and periodic registration update request cannot be accepted by the network, the AMF shall send a REGISTRATION REJECT message to the UE including an appropriate 5GMM cause value.

The UE shall take the following actions depending on the 5GMM cause value received in the REGISTRATION REJECT message.

...

#10 (implicitly de-registered).

The UE shall enter the state 5GMM-DEREGISTERED.NORMAL-SERVICE. The UE shall delete any mapped 5G security context or partial native 5G security context.

If the registration rejected request was not for initiating an emergency PDU session, the UE shall perform a new registration procedure for initial registration.

9.1.5.2.8.3 Test description

9.1.5.2.8.3.1 Pre test conditions

System Simulator:

- 2 cells, NGC Cell A, and NGC Cell B belonging to the same PLMN and different TA in accordance with TS 38.508-1 [4] Table 6.3.2.2-1. Default system information combination as defined in TS 38.508-1 [4], sub-clause 4.4.3.1.2 is used in all cells when active.

UE:

None.

Preamble:

- Cell configuration in accordance with TS 38.508-1 [4] Table 6.2.2.1-3:
 - NGC Cell A "Serving cell"
 - NGC Cell B "Non-suitable "Off" cell"
- The UE is in test state 1N-A as defined in 38.508-1 [4], subclause 4.4A.2 on NGC Cell A.
 - During the initial registration:
 - In the list of tracking areas provided by the AMF (IE 'TAI list') contains only the TAI of NGC Cell A.

9.1.5.2.8.2 Test procedure sequence

Table 9.1.5.2.8.3.2-1: Main behaviour

St	Procedure	Message Sequence		TP	Verdict
		U - S	Message		
1	The SS configures: - NGC Cell B as "Serving cell" - NGC Cell A as "Non-Suitable "Off" cell".	-	-	-	-
-	EXCEPTION: Unless otherwise stated the following messages are exchange on NGC Cell B.	-	-	-	-

2	The UE transmits an REGISTRATION REQUEST message indicating "mobility registration updating".	-->	5GMM: REGISTRATION REQUEST	-	-
3	The SS transmits an AUTHENTICATION REQUEST message to establish a new security context.	<--	5GMM: AUTHENTICATION REQUEST	-	-
4	The UE transmits an AUTHENTICATION RESPONSE message.	-->	5GMM: AUTHENTICATION RESPONSE	-	-
5	The SS transmits a REGISTRATION REJECT message including 5GMM cause value #10 (implicitly de-registered) prior to initiating a SMC to take into account the created during the steps 3-4 partial native 5G security context. (NOTE 1)	<--	REGISTRATION REJECT	-	-
6	SS releases the RRC connection.	-	-	-	-
7-9	Steps 1-3 from the generic procedure for UE initial Registration as specified in TS 38.508-1 [4], subclause 4.5.2, Table 4.5.2.2-2 (connectivity <i>NR</i>) take place.	-	-	-	-
10	Check: Does the UE send a REGISTRATION REQUEST message, 5GS registration type IE set to Initial registration?	-->	5GMM: REGISTRATION REQUEST	1	P
11	The SS transmits a SECURITY MODE COMMAND message indicating the ngKSI of the partial native 5G security context assigned in the AUTHENTICATION REQUEST message sent in step 3.	<--	5GMM: SECURITY MODE COMMAND	-	-
12	The UE transmits a SECURITY MODE REJECT message.	-->	5GMM: SECURITY MODE REJECT	1	P
13-27a 1	Steps 5-19a1 from the generic procedure for UE initial Registration as specified in TS 38.508-1 [4], subclause 4.5.2, Table 4.5.2.2-2 (connectivity <i>NR</i>) take place.	-	-	-	-
NOTE 1: This 5GMM cause is sent to the UE either if the network has implicitly de-registered the UE, e.g. after the implicit de-registration timer has expired, or if the 5GMM context data related to the subscription does not exist in the AMF e.g. because of a AMF restart, or because of a registration request for mobility or registration update is routed to a new AMF (see TS 24.301 [22], subclause A.1). The latter is an example when the serving AMF will not initiate a security mode control procedure after the primary authentication and key agreement procedure.					

9.1.5.2.8.3.3 Specific message contents

Table 9.1.5.2.8.3.3-1: REGISTRATION REQUEST (step 2, Table 9.1.5.2.8.3.2-1)

Derivation Path: TS 38.508-1 [4], Table 4.7.1-6.			
Information Element	Value/remark	Comment	Condition
5GS registration type	'00xxx010'	mobility registration updating x - not checked	
ngKSI	Active ngKSI assigned in the Preamble		
5GS mobile identity	Active 5G-GUTI assigned in the Preamble		
Last visited registered TAI	The TAI of the NGC Cell A, see TS 38.508-1 [4] Table 6.3.2.2-1		

Table 9.1.5.2.8.3.3-2: REGISTRATION REJECT (step 5, Table 9.1.5.2.8.3.2-1)

Derivation Path: TS 38.508-1 [4], Table 4.7.1-9.			
Information Element	Value/remark	Comment	Condition
5GMM cause	'0000 1010'B	#10 - implicitly de-	

		registered	
--	--	------------	--

Table 9.1.5.2.8.3.3-3: REGISTRATION REQUEST (step 10, Table 9.1.5.2.8.3.2-1)

Derivation path: TS 38.508-1 [4], Table 4.7.1-6.			
Information Element	Value/remark	Comment	Condition
5GS registration type	'00xxx001'	Initial registration x - not checked	
ngKSI	ngKSI assigned in the preamble	Native current security context is still present	
5GS mobile identity	Active 5G-GUTI assigned in the preamble		
Non-current native NAS key set identifier	Not present	partial native 5G security context has been deleted	
Last visited registered TAI	The TAI of the NGC Cell A, see TS 38.508-1 [4] Table 6.3.2.2-1		

Table 9.1.5.2.8.3.3-4: SECURITY MODE COMMAND (step 11, Table 9.1.5.2.8.3.2-1)

Derivation Path: TS 38.508-1 [4], Table 4.7.1-25.			
Information Element	Value/remark	Comment	Condition
ngKSI	The ngKSI of the partial native 5G security context assigned in the AUTHENTICATION REQUEST message sent in step 3		

Table 9.1.5.2.8.3.3-5: SECURITY MODE REJECT (step 12, Table 9.1.5.2.8.3.2-1)

Derivation Path: TS 38.508-1 [4], Table 4.7.1-25.			
Information Element	Value/remark	Comment	Condition
5GMM cause	'0001 1000'	#24 - Security mode rejected, unspecified	

9.1.5.2.9 Void

9.1.6 De-registration

9.1.6.1 UE-initiated de-registration

9.1.6.1.1 UE-initiated de-registration / Switch off / Abnormal / De-registration and 5GMM common procedure collision

9.1.6.1.1.1 Test Purpose (TP)

(1)

```

with { the UE in 5GMM-REGISTERED state }
ensure that {
  when { the UE is switched off }
  then { the UE shall send DEREGISTRATION REQUEST message with De-registration type IE indicated
to "Switch off" }
}

```

(2)

```

with { the UE in 5GMM-DEREGISTERED-INITIATED state }
ensure that {
  when { the UE receives a DEREGISTRATION REQUEST message before the UE-initiated de-registration
procedure has been completed }
    then { the UE ignores the message and shall continue de-registration procedure }
}

```

(3)

```

with { the UE in 5GMM-DEREGISTERED-INITIATED state }
ensure that {
  when { the UE receives a 5GMM common procedure before the UE-initiated de-registration procedure
has been completed }
    then { the UE ignores the message and shall continue de-registration procedure }
}

```

(4)

```

with { the UE supports remove USIM without power down and in 5GMM-REGISTERED state }
ensure that {
  when { the USIM is removed from the UE }
    then { the UE shall send DEREGISTRATION REQUEST message with De-registration type IE indicated
to "Switch off" }
}

```

9.1.6.1.1.2 Conformance requirements

References: The conformance requirements covered in the present TC are specified in: TS 24.501, clauses 5.5.2.1, 5.5.2.2.1 and 5.5.2.2.6. Unless otherwise stated these are Rel-15 requirements.

[TS 24.501, clause 5.5.2.1]

The de-registration procedure is used:

- a) by the UE to de-register for 5GS services over 3GPP access when the UE is registered over 3GPP access;;
- b) by the UE to de-register for 5GS services over 3GPP access, non-3GPP access, or both when the UE is registered in the same PLMN over both accesses;
- c) by the network to inform the UE that it is deregistered for 5GS services over 3GPP access when the UE is registered over 3GPP access;
- d) by the network to inform the UE that it is deregistered for 5GS services over 3GPP access, non-3GPP access, or both when the UE is registered in the same PLMN over both accesses; and
- e) by the network to inform the UE to re-register to the network.

The de-registration procedure with appropriate de-registration type shall be invoked by the UE:

- a) if the UE is switched off; and
- b) as part of the eCall inactivity procedure defined in subclause 5.5.3.

The de-registration procedure with appropriate de-registration type shall be invoked by the network:

- a) if the network informs whether the UE should re-register to the network.

The de-registration procedure with appropriate access type shall be invoked by the UE:

- a) if the UE wants to de-register for 5GS services over 3GPP access when the UE is registered over 3GPP access;
or
- b) the UE wants to de-register for 5GS services over 3GPP access, non-3GPP access, or both when the UE is registered in the same PLMN over both accesses.

If the de-registration procedure is triggered due to USIM removal, the UE shall indicate "switch off" in the de-registration type IE.

If the de-registration procedure is requested by the UDM for a UE that has an emergency PDU session, the AMF shall not send a DEREGISTRATION REQUEST message to the UE.

If the de-registration procedure for 5GS services is performed, the PDU sessions, if any, for this particular UE are released locally without peer-to-peer signalling between the UE and the network.

The UE is allowed to initiate the de-registration procedure even if the timer T3346 is running.

NOTE: When the UE has no PDU sessions over non-3GPP access, or the UE moves all the PDU sessions over a non-3GPP access to a 3GPP access, the UE and the AMF need not initiate de-registration over the non-3GPP access.

The AMF shall provide the UE with a non-3GPP de-registration timer.

[TS 24.501, clause 5.5.2.2.1]

The de-registration procedure is initiated by the UE by sending a DEREGISTRATION REQUEST message (see example in figure 5.5.2.2.1). The De-registration type IE included in the message indicates whether the de-registration procedure is due to a "switch off" or not. The access type included in the message indicates whether the de-registration procedure is:

- a) for 5GS services over 3GPP access when the UE is registered over 3GPP access only;
- b) for 5GS services over non-3GPP access when the UE is registered over non-3GPP access only; or
- c) for 5GS services over 3GPP access, non-3GPP access or both 3GPP access and non-3GPP access when the UE is registered in the same PLMN over both accesses.

If the UE has a valid 5G-GUTI, the UE shall populate the 5GS mobile identity IE with the valid 5G-GUTI. If the UE does not have a valid 5G-GUTI, the UE shall populate the 5GS mobile identity IE with its SUCI.

If the UE does not have a valid 5G-GUTI and it does not have a valid SUCI, then the UE shall populate the 5GS mobile identity IE with its PEI.

If the de-registration request is not due to switch off and the UE is in the state 5GMM-REGISTERED or 5GMM-REGISTERED-INITIATED, timer T3521 shall be started in the UE after the DEREGISTRATION REQUEST message has been sent. The UE shall enter the state 5GMM-DEREGISTERED-INITIATED.

If the UE is to be switched off, the UE shall try for a period of 5 seconds to send the DEREGISTRATION REQUEST message. During this period, the UE may be switched off as soon as the DEREGISTRATION REQUEST message has been sent.

[TS 24.501, clause 5.5.2.2.6]

...

- d) De-registration procedure collision.

De-registration containing de-registration type "switch off":

- If the UE receives a DEREGISTRATION REQUEST message before the UE-initiated de-registration procedure has been completed, this message shall be ignored and the UE-initiated de-registration procedure shall continue.

Otherwise:

- If the UE receives a DEREGISTRATION REQUEST message before the UE-initiated de-registration procedure has been completed, it shall treat the message as specified in subclause 5.5.2.3.2 with the following modification:
 - If the DEREGISTRATION REQUEST message received by the UE contains de-registration type "re-registration required", and the UE-initiated de-registration procedure is with de-registration type "normal de-registration", the UE need not initiate the registration procedure for initial registration.

e) De-registration and 5GMM common procedure collision.

De-registration containing de-registration type "switch off":

- If the UE receives a message used in a 5GMM common procedure before the de-registration procedure has been completed, this message shall be ignored and the de-registration procedure shall continue.

Otherwise:

- If the UE receives a message used in a 5GMM common procedure before the de-registration procedure has been completed, both the 5GMM common procedure and the de-registration procedure shall continue.

9.1.6.1.1.3 Test description

9.1.6.1.1.3.1 Pre-test conditions

System Simulator:

- NGC Cell A.

UE:

- None.

Preamble:

- The UE is in state 3N-A on NGC Cell A according to TS 38.508-1 [4].

9.1.6.1.1.3.2 Test procedure sequence

Table 9.1.6.1.1.3.2-1: Main behaviour

St	Procedure	Message Sequence		TP	Verdict
		U - S	Message		
0	SS stops sending RLC acknowledgments.	-	-	-	-
1	Cause switch off	-	-	-	-
2	Check: Does the UE transmit a DEREGISTRATION REQUEST with the De-registration type IE indicating "switch off"?	-->	DEREGISTRATION REQUEST	1	P
3	The SS transmits a DEREGISTRATION REQUEST message.	<--	DEREGISTRATION REQUEST	-	-
3A	SS resumes sending RLC acknowledgments	-	-	-	-
4	Check: Does the UE transmit a DEREGISTRATION ACCEPT message within 6 seconds (T3522)?	-->	DEREGISTRATION ACCEPT	2	F
5	The SS releases the RRC connection.	-	-	-	-
6	Switch on the UE	-	-	-	-
7	The UE performs Registration procedure as specified in TS 38.508-1 [4] subclause 4.5.2 with ' <i>connected without release</i> '.	-	-	-	-
7A	SS stops sending RLC acknowledgments.	-	-	-	-
8	Cause switch off.	-	-	-	-
9	The UE transmits a DEREGISTRATION REQUEST with the De-registration type IE indicating "switch off".	-->	DEREGISTRATION REQUEST	-	-
10	The SS transmits an IDENTITY REQUEST message.	<--	IDENTITY REQUEST	-	-
10 A	SS resumes sending RLC acknowledgments				
11	Check: Does the UE transmit an IDENTITY RESPONSE message within 6 seconds (T3570)?	-->	IDENTITY RESPONSE	3	F
12	The SS releases the RRC connection.	-	-	-	-

-	EXCEPTION: Steps 13a1 to 13a4 describe behaviour that depends on the UE capability; the "lower case letter" identifies a step sequence that take place if the UE supports remove USIM without power down: pc_USIM_Removal = TRUE [29]	-	-	-	-
13a1	Switch on the UE	-	-	-	-
13a2	The UE performs Registration procedure as specified in TS 38.508-1 [4] subclause 4.5.2 with 'connected without release'.	-	-	-	-
13a3	Cause removal of USIM from the UE without powering down.	-	-	-	-
13a4	Check: Does the UE transmit a DEREGISTRATION REQUEST with the De-registration type IE indicating "switch off"?	-->	DEREGISTRATION REQUEST	4	P

9.1.6.1.1.3.3 Specific message contents

Table 9.1.6.1.1.3.3-1: DEREGISTRATION REQUEST (Steps 2, 9 and 13a4, Table 9.1.6.1.1.3.2-1)

Derivation path: TS 38.508-1 [4], table 4.7.1-12			
Information Element	Value/Remark	Comment	Condition
De-registration type			
Switch off	'1'B		

9.1.6.1.2 UE-initiated de-registration / Normal de-registration / Abnormal / Transmission failure without TAI change from lower layers, de-registration and 5GMM common procedure collision, T3521 timeout

9.1.6.1.2.1 Test Purpose (TP)

(1)

```
with { the UE in 5GMM-REGISTERED state }
ensure that {
  when { the UE initiates "normal de-registration" type deregistration from 5GS services over 3GPP access }
  then { the UE sends DEREGISTRATION REQUEST message with De-registration type IE indicated to "Normal de-registration" and starts timer T3521 }
}
```

(2)

```
with { the UE in 5GMM-DEREGISTERED-INTIATED state }
ensure that {
  when { Transmission failure of DEREGISTRATION REQUEST message indication without TAI change from lower layers }
  then { the UE restarts the de-registration procedure }
}
```

(3)

```
with { the UE in 5GMM-DEREGISTERED-INTIATED state }
ensure that {
  when { the UE receives a message used in a 5GMM common procedure before the de-registration procedure has been completed }
  then { both the 5GMM common procedure and the de-registration procedure shall continue }
}
```

(4)

```
with { the UE in 5GMM-DEREGISTERED-INTIATED state }
```

```

ensure that {
  when { the first four expiries of the timer T3521 }
  then { the UE shall retransmit the DEREGISTRATION REQUEST message and shall reset and restart
timer T3521 }
}

```

(5)

```

with { the UE in 5GMM-DEREGISTERED-INTIATED state }
ensure that {
  when { On the fifth expiry of timer T3521 }
  then { the detach procedure shall be aborted and the UE performs local detach }
}

```

9.1.6.1.2.2 Conformance requirements

References: The conformance requirements covered in the current TC are specified in: TS 24.501 clause 5.5.2.2.6 and TS 38.331 clause 5.7.2.4. Unless otherwise stated these are Rel-15 requirements.

[TS 24.501, clause 5.5.2.2.6]

c) T3521 timeout.

On the first four expiries of the timer, the UE shall retransmit the DEREGISTRATION REQUEST message and shall reset and restart timer T3521. On the fifth expiry of timer T3521, the de-registration procedure shall be aborted and the UE proceeds as follows:

- 1) if the de-registration procedure was performed due to disabling of 5GS services, the UE shall enter the 5GMM-NULL state; or
- 2) if the de-registration type "normal de-registration" was requested for reasons other than disabling of 5GS services, the UE shall enter the 5GMM-DEREGISTERED state.

...

e) De-registration and 5GMM common procedure collision.

De-registration containing de-registration type "switch off":

- If the UE receives a message used in a 5GMM common procedure before the de-registration procedure has been completed, this message shall be ignored and the de-registration procedure shall continue.

Otherwise:

- If the UE receives a message used in a 5GMM common procedure before the de-registration procedure has been completed, both the 5GMM common procedure and the de-registration procedure shall continue.

h) Transmission failure of DEREGISTRATION REQUEST message indication without TAI change from lower layers.

The UE shall restart the de-registration procedure.

[TS 38.331, clause 5.7.2.4]

The UE shall:

- 1> if AS security is not started and radio link failure occurs before the successful delivery of ULInformationTransfer messages has been confirmed by lower layers; or
- 1> if mobility (i.e. handover, RRC connection re-establishment) occurs before the successful delivery of ULInformationTransfer messages has been confirmed by lower layers:
- 2> inform upper layers about the possible failure to deliver the information contained in the concerned ULInformationTransfer messages.

9.1.6.1.2.3 Test description

9.1.6.1.2.3.1 Pre-test conditions

System Simulator:

- NGC Cell A and NGC Cell B
- Both cells are configured as per table 6.3.2.2-1 TS 38.508-1 [4] with the below exceptions

Table 9.1.6.1.2.3.1–1: Cell configuration

NGC Cell	TAC	TAI
B	1	TAI-1

UE:

- None.

Preamble:

- the UE is in state 3N-A on NGC Cell A according to TS 38.508-1 [4].

9.1.6.1.2.3.2 Test procedure sequence

Table 9.1.6.1.2.3.2-1: Main behaviour

St	Procedure	Message Sequence		TP	Verdict
		U - S	Message		
0	The SS configures: - NGC Cell B as "Suitable neighbour cell".				
0A	SS transmits NR RRCReconfigurationmessage to configure specific maxRetxThreshold for NGC Cell A.	<--	NR RRC: RRCReconfiguration	-	-
0B	The UE transmits NR RRCReconfigurationComplete message.	-->	NR RRC: RRCReconfigurationComplete	-	-
1	The SS is configured not send RLC ACK for the message sent in step 2.	-	-	-	-
1A	AT or MMI command to cause UE to initiate de-registration.	-	-	-	-
-	The following messages are to be observed on Cell A unless explicitly stated otherwise.	-	-	-	-
2	Does the UE transmit a DEREGISTRATION REQUEST message with De-registration type IE indicating "Normal de-registration"? The UE starts timer T3521.	-->	5GMM: DEREGISTRATION REQUEST	1	P
3	Void	-	-	-	-
3A	The SS transmits an RRCReconfiguration message including reconfigurationWithSync with rach-ConfigDedicated to order the UE to perform intra-frequency handover to NGC Cell B.	<--	NR RRC: RRCReconfiguration	-	-
-	The following messages are to be observed on Cell B unless explicitly stated otherwise.	-	-	-	-
3B	The UE transmits an RRCReconfigurationComplete message.	-->	NR RRC: RRCReconfigurationComplete	-	-
4	Check: Does the UE restart the de-registration procedure by sending DEREGISTRATION REQUEST message? Timer T3521 is started.	-->	5GMM: DEREGISTRATION REQUEST	2	P
4A	The SS configures:	-	-	-	-

	- NGC Cell A as "Non-suitable "Off" cell".				
5	With T3521 still running the SS shall send AUTHENTICATION REQUEST.	<--	5GMM: AUTHENTICATION REQUEST	-	-
6	Check: Does the UE transmit an AUTHENTICATION RESPONSE message?	-->	5GMM: AUTHENTICATION RESPONSE	3	P
7	SS responds with DEREGISTRATION ACCEPT message.	<--	5GMM: DEREGISTRATION ACCEPT	-	-
8	The SS releases the RRC connection.	-	-	-	-
9	AT or MMI command to cause UE to initiate registration.	-	-	-	-
10-24a4	Steps 2-19a1 of Table 4.5.2.2-2 of the generic procedure in TS 38.508-1 [4] are performed to complete the registration.	-	-	-	-
25	Cause UE to initiate de-registration.	-	-	-	-
26	Check: Does the UE transmit a DEREGISTRATION REQUEST message with De-registration type IE indicating "Normal de-registration"? The UE starts timer T3521.	-->	5GMM: DEREGISTRATION REQUEST	1	P
27	SS does not respond to the DEREGISTRATION REQUEST message.	-	-	-	-
28	Check: When the timer T3521 expires does the UE re-transmit DEREGISTRATION REQUEST message? Timer T3521 is re-started (1 st expiry).	-->	5GMM: DEREGISTRATION REQUEST	4	P
29	The SS does not respond to the DEREGISTRATION REQUEST message.	-	-	-	-
30	Check: When the timer T3521 expires does the UE re-transmit DEREGISTRATION REQUEST message? Timer T3521 is re-started (2 nd expiry).	-->	5GMM: DEREGISTRATION REQUEST	4	P
31	The SS does not respond to the DEREGISTRATION REQUEST message.	-	-	-	-
32	Check: When the timer T3521 expires does the UE re-transmit DEREGISTRATION REQUEST message? Timer T3521 is re-started (3 rd expiry).	-->	5GMM: DEREGISTRATION REQUEST	4	P
33	The SS does not respond to the DEREGISTRATION REQUEST message.	-	-	-	-
34	Check: When the timer T3521 expires does the UE re-transmit DEREGISTRATION REQUEST message? Timer T3521 is re-started (4 th expiry).	-->	5GMM: DEREGISTRATION REQUEST	4	P
35	The SS does not respond to the DEREGISTRATION REQUEST message.	-	-	-	-
36	Check: When the timer T3521 expires does the UE re-transmit DEREGISTRATION REQUEST message in 10s? The UE shall abort the de-registration procedure and enter the 5GMM-DEREGISTERED (5 th expiry).	-->	5GMM: DEREGISTRATION REQUEST	5	F
Note: T3521 value is specified as 15s in TS 24.501 [22].					

9.1.6.1.2.3.3 Specific message contents

Table 9.1.6.1.2.3.3-0A: RRCReconfiguration (step 0A Table 9.1.6.1.2.3.2-1)

Derivation Path: TS 38.508-1 [4], Table 4.6.1-13			
Information Element	Value/remark	Comment	Condition
RRCReconfiguration ::= SEQUENCE {			
criticalExtensions CHOICE {			
rrcReconfiguration SEQUENCE {			
nonCriticalExtension SEQUENCE {			
masterCellGroup	CellGroupConfig with condition SRB2_DRB1	OCTET STRING (CONTAINING	

	configured in the preamble	CellGroupConfig)	
}			
}			
}			
}			

Table 9.1.6.1.2.3.3-0B: CellGroupConfig (Table 9.1.6.1.2.3.3-0A)

Derivation Path: TS 38.508-1 [4], Table 4.6.1-19			
Information Element	Value/remark	Comment	Condition
CellGroupConfig ::= SEQUENCE {			
rlc-BearerToAddModList SEQUENCE (SIZE(1..maxLCH)) OF RLC-BearerConfig {	1 entry		SRB2_DRB 1
RLC-Bearer-Config[1]	RLC-BearerConfig with condition SRB2		
}			
}			

Table 9.1.6.1.2.3.3-0C: RLC-BearerConfig (Table 9.1.6.1.2.3.3-0B)

Derivation Path: TS 38.508-1 [4], Table 4.6.3-148			
Information Element	Value/remark	Comment	Condition
RLC-BearerConfig ::= SEQUENCE {			
rlc-Config	RLC-Config using condition AM		AM
}			

Table 9.1.6.1.2.3.3-0D: RLC-Config (Table 9.1.6.1.2.3.3-0C)

Derivation Path: TS 38.508-1 [4], Table 4.6.3-149			
Information Element	Value/remark	Comment	Condition
RLC-Config ::= CHOICE {			
am SEQUENCE {			AM
ul-AM-RLC SEQUENCE {			
maxRetxThreshold	t32		
}			
}			

Table 9.1.6.1.2.3.3-1: DEREGISTRATION REQUEST (steps 2, 4, 26, 28, 30, 32 and 34, Table 9.1.6.1.2.3.2-1)

Derivation path: TS 38.508-1 [4], Table 4.7.1-12			
Information Element	Value/remark	Comment	Condition
De-registration type			
Switch off	'0'B	Normal de-registration	
Access type	'01'B	3GPP access	

Table 9.1.6.1.2.3.3-2: RRCReconfiguration-HO (step 3A Table 9.1.6.1.2.3.2-1)

Derivation path: TS 38.508-1 [4] Table 4.8.1-1A with condition RBCConfig_KeyChange			
--	--	--	--

9.1.6.1.3 UE-initiated de-registration / Abnormal / Change of cell into a new tracking area

9.1.6.1.3.1 Test Purpose (TP)

(1)

```
with { UE in 5GMM-DEREGISTERED-INITIATED state and de-registration request is not due to switch off }
ensure that {
  when { UE changes into a new tracking area that is not in the stored TAI list }
  then { UE aborts the de-registration procedure and initiates a mobility registration procedure }
}
```

(2)

```
with { UE in 5GMM-REGISTERED-INITIATED state for a mobility registration procedure due to change of cell into a new tracking area list during UE-initiated de-registration procedure }
ensure that {
  when { UE receives REGISTRATION ACCEPT message }
  then { UE re-initiates the de-registration procedure after completing the mobility registration procedure }
}
```

(3)

Void

9.1.6.1.3.2 Conformance requirements

References: The conformance requirements covered in the present TC are specified in: TS 24.501, clause 5.5.2.2.6. Unless otherwise stated these are Rel-15 requirements.

[TS 24.501 clause 5.5.2.2.6]

The following abnormal cases can be identified:

...

- f) Change of cell into a new tracking area.

If a cell change into a new tracking area that is not in the stored TAI list occurs before the UE-initiated de-registration procedure is completed, the de-registration procedure shall be aborted and re-initiated after successfully performing a registration procedure for mobility or periodic update used for mobility (i.e. the 5GS registration type IE set to "mobility registration updating" in the REGISTRATION REQUEST message). If the de-registration procedure was initiated due to removal of the USIM or the UE is to be switched off, the UE shall abort the de-registration procedure and enter the state 5GMM-DEREGISTERED.

9.1.6.1.3.3 Test description

9.1.6.1.3.3.1 Pre-test conditions

System Simulator:

- NGC Cell A belongs to Home PLMN and TAI-1 and set as serving cell;
- NGC Cell B belongs to Home PLMN and TAI-2 and set as Non-suitable "Off" cell.

UE:

- None;

Preamble:

- The UE is in state 3N-A on NGC cell A according to TS 38.508-1 [4].

9.1.6.1.3.3.2 Test procedure sequence

Table 9.1.6.1.3.3.2-1: Main behaviour

St	Procedure	Message Sequence		TP	Verdict
		U - S	Message		
-	The following messages are to be observed on NGC Cell A unless explicitly stated otherwise.	-	-	-	-
1	Cause UE to de-register for non Switch off reason using MMI or AT commands.	-	-	-	-
2	The UE transmits DEREGISTRATION REQUEST message. (The UE starts timer T3521)	-->	DEREGISTRATION REQUEST		
3	The SS does not respond to DEREGISTRATION REQUEST message.	-	-	-	-
4	The SS configures NGC Cell A as the "Suitable neighbour intra-frequency cell " and NGC Cell B as the "Serving cell". Note: T3521 value is specified as 15s in TS 24.501 [22] and it is assumed that SS can configure cells within this time.	-	-	-	-
5	The SS transmits an RRCReconfiguration message on NGC Cell A to order the UE to perform intra-frequency handover to NGC Cell B.	-	-	-	-
6	The UE transmits a RRCReconfigurationComplete message on NGC Cell B to confirm the successful completion of the intra frequency handover.	-	-	-	-
-	The following messages are to be observed on NGC Cell B unless explicitly stated otherwise.	-	-	-	-
7	Check: Does the UE transmit a REGISTRATION REQUEST message with registration type value set to "mobility registration updating"	-->	REGISTRATION REQUEST	1	P
8-9	Steps 4 to 5 of the generic procedure in TS 38.508-1 [4] subclause 4.9.5.2.2	-	-	-	-
10-22	Void				
23	Check: Does the UE transmit DEREGISTRATION REQUEST message?	-->	DEREGISTRATION REQUEST	2	P
24	The SS transmits DEREGISTRATION ACCEPT message.	<--	DEREGISTRATION ACCEPT	-	-
25	The SS transmits an <i>RRCRelease</i> message.	-	-	-	-
26	Check: Does the test result of the generic procedure in TS 38.508-1 [4] subclause 4.9.13 indicates that the UE doesn't responds to paging when paged with NG-5G-S-TMSI?	-	-	2	P
27-35	Void	-	-	-	-

9.1.6.1.3.3.3 Specific message contents

Table 9.1.6.1.3.3.3-1: DEREGISTRATION REQUEST (steps 2 and 23, Table 9.1.6.1.3.3.2-1)

Derivation path: TS 38.508-1 [4], Table 4.7.1-12			
Information Element	Value/remark	Comment	Condition
De-registration type			
Switch off	'0'B	Normal de-registration	
Re-registration required	'0'B	Spare bit	
Access type	'01'B	3GPP access	

5GS mobile identity	5G-GUTI	Same value as assigned in REGISTRATION ACCEPT	
---------------------	---------	---	--

Table 9.1.6.1.3.3.3-2: RRCReconfiguration-HO (step 5, Table 9.1.6.1.3.3.2-1)

Derivation Path: TS 38.508-1 [4], Table 4.8.1-1A with condition RBCConfig_KeyChange

Table 9.1.6.1.3.3.3-3: Void

Table 9.1.6.1.3.3.3-4: Void

Table 9.1.6.1.3.3.3-5: Void

Table 9.1.6.1.3.3.3-6: Void)

Table 9.1.6.1.3.3.3-7: REGISTRATION REQUEST (step 7, Table 9.1.6.1.3.3.2-1)

Derivation path: TS 38.508-1 [4], Table 4.7.1-6			
Information Element	Value/remark	Comment	Condition
5GS registration type value	'010'B		Mobility

Table 9.1.6.1.3.3.3-8: Void

9.1.6.1.4 Void

9.1.6.2 Network-initiated de-registration

9.1.6.2.1 Network-initiated de-registration / De-registration for 3GPP access / Re-registration required

9.1.6.2.1.1 Test Purpose (TP)

(1)

```
with { the UE in 5GMM-REGISTERED state }
ensure that {
  when { the SS sends a DEREGISTRATION REQUEST message indicates "re-registration required" and the
de-registration request is for 3GPP access }
  then { the UE sends a DEREGISTRATION ACCEPT message to the network and releases the existing NAS
signalling connection, then initiates an initial registration and also re-establishes any previously
established PDU sessions. }
}
```

9.1.6.2.1.2 Conformance requirements

References: The conformance requirement covered in the present TC is specified in: 3GPP TS 24.501 clauses 5.5.2.3.2. Unless otherwise stated these are Rel-15 requirements.

[TS 24.501 clause 5.5.2.3.2]

NOTE 1: When the de-registration type indicates "re-registration required", user interaction is necessary in some cases when the UE cannot re-establish the PDU session (s), if any, automatically.

...

Upon sending a DEREGISTRATION ACCEPT message, the UE shall delete the rejected NSSAI as specified in subclause 4.6.2.2.

If the de-registration type indicates "re-registration required", then the UE shall ignore the 5GMM cause IE if received.

If the de-registration type indicates "re-registration not required", the UE shall take the actions depending on the received 5GMM cause value:

#3 (Illegal UE);

...

As an implementation option, the UE may enter the state 5GMM-DEREGISTERED.PLMN-SEARCH in order to perform a PLMN selection according to 3GPP TS 23.122 [5].

9.1.6.2.1.3 Test description

9.1.6.2.1.3.1 Pre-test conditions

System Simulator:

- NGC Cell A.

UE:

- None.

Preamble:

- the UE is in state 3N-A on NGC Cell A according to TS 38.508-1 [4].

9.1.6.2.1.3.2 Test procedure sequence

Table 9.1.6.2.1.3.2-1: Main behaviour

St	Procedure	Message Sequence		TP	Verdict
		U - S	Message/PDU/SDU		
1	The SS transmits a DEREGISTRATION REQUEST with indicates "re-registration required".	<--	DEREGISTRATION REQUEST	-	-
2	Check: Does the UE transmits a DEREGISTRATION ACCEPT message?	-->	DEREGISTRATION ACCEPT	1	P
3	The SS releases RRC connection.	-	-	-	-
4	The UE transmits an <i>RRCSetupRequest</i> message.	-->	NR RRC: RRCSetupRequest	-	-
5	The SS transmits an <i>RRCSetup</i> message.	<--	NR RRC: RRCSetup	-	-
6	Check: Does the UE transmits an <i>RRCSetupComplete</i> message and REGISTRATION REQUEST message with registration type set to "initial registration".	-->	NR RRC: RRCSetupComplete 5GMM: REGISTRATION REQUEST	1	P
7-23	Steps 5-20 of Table 4.5.2.2-2 of the generic procedure in TS 38.508-1 [4] are performed.	-	-	-	-

9.1.6.2.1.3.3 Specific message contents

Table 9.1.6.2.1.3.3-1: DEREGISTRATION REQUEST (step 1, Table 9.1.6.2.1.3.2-1)

Derivation path: TS 38.508-1 [4] Table 4.7.1-14			
Information Element	Value/Remark	Comment	Condition
DEREGISTRATION type			
Switch off	'0'B	Normal de-registration	
Re-registration required	'1'B	re-registration required	

Access type	'01'B	3GPP access	
-------------	-------	-------------	--

9.1.6.2.2 Network-initiated de-registration / De-registration for 3GPP access / Re-registration not required

9.1.6.2.2.1 Test Purpose (TP)

(1)

```
with { the UE in 5GMM-REGISTERED state }
ensure that {
  when { the SS sends a DEREGISTRATION REQUEST message indicates no 5GMM cause IE, "re-registration not required" and the de-registration request is for 3GPP access }
  then { the UE deletes 5G-GUTI, TAI list, last visited registered TAI, list of equivalent PLMNs, ngKSI, sends a DEREGISTRATION ACCEPT message enter the state 5GMM-DEREGISTERED for 3GPP access }
}
```

9.1.6.2.2.2 Conformance requirements

References: The conformance requirements covered in the current TC are specified in: TS 24.501 clauses 5.5.2.3.2 and 5.5.2.3.4. Unless otherwise stated these are Rel-15 requirements.

[TS 24.501, clause 5.5.2.3.2]

Upon receiving the DEREGISTRATION REQUEST message, if the DEREGISTRATION REQUEST message indicates "re-registration not required" and the de-registration request is for 3GPP access, the UE shall perform a local release of the PDU sessions over 3GPP access, if any. The UE shall send a DEREGISTRATION ACCEPT message to the network and enter the state 5GMM-DEREGISTERED for 3GPP access.

[TS 24.501, clause 5.5.2.3.4]

- b) DEREGISTRATION REQUEST, other 5GMM cause values than those treated in subclause 5.5.2.3.2, cases of 5GMM cause value#11, #22 and #72 that are considered as abnormal cases according to subclause 5.5.2.3.2 or no 5GMM cause IE is included, and the De-registration type IE indicates "re-registration not required".

The UE shall delete 5G-GUTI, TAI list, last visited registered TAI, list of equivalent PLMNs, ngKSI, shall set the 5GS update status to 5U2 NOT UPDATED and shall start timer T3502.

A UE not supporting S1 mode may enter the state 5GMM-DEREGISTERED.PLMN-SEARCH in order to perform a PLMN selection according to 3GPP TS 23.122 [5]; otherwise the UE shall enter the state 5GMM-DEREGISTERED.ATTEMPTING-REGISTRATION.

9.1.6.2.2.3 Test description

9.1.6.2.2.3.1 Pre-test conditions

System Simulator:

- NGC Cell A.

UE:

- the UE is previously registered on 5GC, and when on 5GC, the UE is last authenticated and registered on NGC cell A using default message contents according to TS 38.508-1 [4];

Preamble:

- The UE is in state 3N-A on NGC Cell A according to TS 38.508-1 [4].
- The T3502 in UE set to 2 minutes.

9.1.6.2.2.3.2 Test procedure sequence

Table 9.1.6.2.2.3.2-1: Main behaviour

St	Procedure	Message Sequence		TP	Verdict
		U – S	Message		
1	SS sends a DEREGISTRATION REQUEST message indicates no 5GMM cause IE, "re-registration not required" and the de-registration request is for 3GPP access	<--	5GMM: DEREGISTRATION REQUEST	-	-
2	Check: Does the UE transmit a DEREGISTRATION ACCEPT message? Note: Now UE should start timer T3502.	-->	5GMM: DEREGISTRATION ACCEPT	1	P
3	The SS releases the RRC connection.	-	-	-	-
4	The SS waits 2 mins for T3502 to expire.	-	-	-	-
5-22a 1	Does the UE performs Steps 2-19a1 of Table 4.5.2.2-2 of the generic procedure in TS 38.508-1 [4]?	-	-	1	P

9.1.6.2.2.3.3 Specific message contents

Table 9.1.6.2.2.3.3-1: Message REGISTRATION ACCEPT (preamble)

Derivation path: TS 38.508-1 [4], Table 4.7.1-7			
Information Element	Value/remark	Comment	Condition
T3502 Value	2mins		
Timer value	'0 0010'B	The timer value is 2mins.	
Unit	'001'B		

Table 9.1.6.2.2.3.3-2: Message DEREGISTRATION REQUEST (step 1, Table 9.1.6.2.2.3.2-1)

Derivation path: TS 38.508-1 [4], Table 4.7.1-12			
Information Element	Value/remark	Comment	Condition
De-registration type			
Switch off	'0'B	Normal de-registration	
Re-registration required	'0'B	re-registration not required	
Access type	'01'B	3GPP access	
5GMM cause	Not Present		

Table 9.1.6.2.2.3.3-3: Message REGISTRATION REQUEST (step7, Table 9.1.6.2.2.3.2-1)

Derivation path: TS 38.508-1 [4], table 4.7.1-6			
Information Element	Value/Remark	Comment	Condition
ngKSI			
NAS key set identifier	'111'B	no key is available (UE to network)	
TSC	Any allowed value	TSC does not apply for NAS key set identifier value "111"	
5GS mobile identity	The valid SUCI		
Last visited registered TAI	Not present		

9.1.7 Service request

9.1.7.1 Service request / Idle mode uplink user data transport / Rejected / Restricted service area, abnormal / T3517, T3525

9.1.7.1.1 Test Purpose (TP)

(1)

```
with { the UE is in 5GMM-REGISTERED state and 5GMM-IDLE mode over 3GPP access }
ensure that {
when { UE has uplink user data pending }
then { the UE sends a SERVICE REQUEST message }
}
```

(2)

```
with { the UE sent a SERVICE REQUEST message }
ensure that {
when { UE receives a SERVICE REJECT message including an appropriate 5GMM cause value #28(Restricted
service area) }
then { the UE performs the mobility registration update procedure }
}
```

(3)

```
with { the UE is in 5GMM-REGISTERED state and the UE has triggered the SERVICE REQUEST in 5GMM-IDLE
mode }
ensure that {
when { T3517 expired}
then { the UE increases the service request attempt counter, aborts the procedure and release
locally any resources allocated for the service request procedure }
}
```

(4)

```
with { the UE is in 5GMM-REGISTERED state and 5GMM-IDLE mode }
ensure that {
when { the service request attempt counter is equal to 5}
then { the UE starts timer T3525 and not attempts service request until expiry of T3525}
}
```

9.1.7.1.2 Conformance requirements

References: The conformance requirements covered in the current TC are specified in: TS 24.501, clause 5.6.1.1, 5.6.1.5 and 5.6.1.7. Unless otherwise stated these are Rel-15 requirements.

[TS 24.501, clause 5.6.1.1]

The purpose of the service request procedure is to change the 5GMM mode from 5GMM-IDLE to 5GMM-CONNECTED mode, and/or to request the establishment of user-plane resources for PDU sessions which are established without user-plane resources. In latter case, the 5GMM mode can be the 5GMM-IDLE mode or the 5GMM-CONNECTED mode if the UE requires to establish user-plane resources for PDU sessions.

...

The UE shall invoke the service request procedure when:

...

d) the UE, in 5GMM-IDLE mode over 3GPP access, has uplink user data pending;

...

If one of the above criteria to invoke the service request procedure is fulfilled, then the service request procedure shall only be initiated by the UE when the following conditions are fulfilled:

- its 5GS update status is 5U1 UPDATED, and the TAI of the current serving cell is included in the TAI list; and
- no 5GMM specific procedure is ongoing.

The UE shall not invoke the service request procedure when the UE is in the state 5GMM-SERVICE-REQUEST-INITIATED.

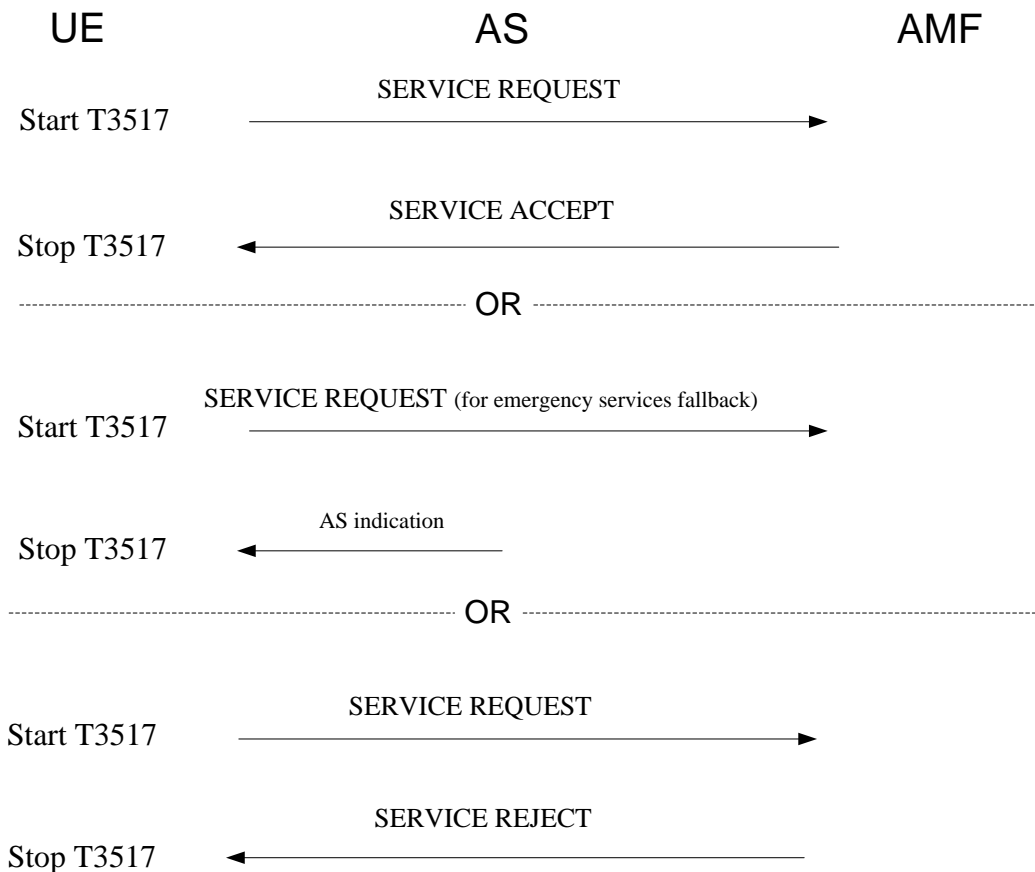

Figure 5.6.1.1.1: Service Request procedure

[TS 24.501, clause 5.6.1.5]

If the service request cannot be accepted, the network shall return a SERVICE REJECT message to the UE including an appropriate 5GMM cause value and stop timer T3517.

...

If the AMF determines that the UE is in a non-allowed area or is not in an allowed area as specified in subclause 5.3.5, then:

- if the service type IE in the SERVICE REQUEST message is set to "signalling" or "data", the AMF shall send a SERVICE REJECT message with the 5GMM cause value set to #28 "Restricted service area";

...

The UE shall take the following actions depending on the 5GMM cause value received in the SERVICE REJECT message.

- #28 (Restricted service area).

The UE shall enter the state 5GMM-REGISTERED.NON-ALLOWED-SERVICE, and perform the registration procedure for mobility and periodic registration update unless the service type IE in the SERVICE REQUEST message was set to "elevated signalling" (see subclause 5.3.5 and 5.5.1.3).

If the service type IE in the SERVICE REQUEST message was set to "elevated signalling", the UE shall not re-initiate service request procedure until the UE enters an allowed area or leaves a non-allowed area, except for emergency services, high priority access or responding to paging or notification.

[TS 24.501, clause 5.6.1.7]

The following abnormal cases can be identified:

- a) T3517 expired.

The UE shall enter the state 5GMM-REGISTERED.

If the UE triggered the service request procedure in 5GMM-IDLE mode and the service type of the SERVICE REQUEST message was not set to "emergency services fallback", then the 5GMM sublayer shall increment the service request attempt counter, abort the procedure and release locally any resources allocated for the service request procedure. The service request attempt counter shall not be incremented, if:

- 1) the service request procedure is initiated to establish an emergency PDU session;
- 2) the UE has an emergency PDU session established;
- 3) the UE is a UE configured for high priority access in selected PLMN; or
- 4) the service request is initiated in response to paging or notification from the network.

If the service request attempt counter is greater than or equal to 5, the UE shall start timer T3525. Additionally, if the service request was initiated for an MO MMTEL voice call, a notification that the service request was not accepted due to the UE having started timer T3525 shall be provided to the upper layers.

NOTE 1: This can result in the upper layers requesting implementation specific mechanisms, e.g. the MMTEL voice call being attempted to another IP-CAN, or establishment of a CS voice call (if supported and not already attempted in the CS domain).

The UE shall not attempt service request until expiry of timer T3525 unless:

- 1) the service request is initiated in response to paging or notification from the network;
- 2) the UE is a UE configured for high priority access in selected PLMN;
- 3) the service request is initiated to establish an emergency PDU session;
- 4) the UE has an emergency PDU session established; or
- 5) the UE is registered in a new PLMN.

NOTE 2: The NAS signalling connection can also be released if the UE deems that the network has failed the authentication check as specified in subclause 5.4.1.3.7.

9.1.7.1.3 Test description

9.1.7.1.3.1 Pre-test conditions

System Simulator:

- NGC Cell A.

UE:

- None.

Preamble:

- The UE is in state 3N-A with UE test loop mode B active (T_delay_modeB = 5) according to TS 38.508-1 [4].

9.1.7.1.3.2 Test procedure sequence

Table 9.1.7.1.3.2-1: Main behaviour

St	Procedure	Message Sequence		TP	Verdict
		U - S	Message		
1	The SS configures: - NGC Cell A as the "Serving cell".	-	-	-	-
2	The SS transmits one IP Packet to the UE.	<--	IP packet	-	-
3	The SS waits 1 second after the IP packet has been transmitted in step 2 and then transmits an RRCRelease message. (Note 1)	-	-	-	-
4	Check: Does UE transmit a SERVICE REQUEST message with Service type IE set to 'data'? (Note 2)	-->	SERVICE REQUEST	1	P
5	The SS transmits a SERVICE REJECT message with 5GMM cause = "Restricted service area".	<--	SERVICE REJECT	-	-
6-7	Void	-	-	-	-
7AA	The SS starts timer 5 sec. Note: An arbitrary chosen timer to avoid message crossing.	-	-	-	-
	EXCEPTION: Steps 7ABa1 to 7ABb3 describe behaviour that depends on the UE implementation; the "lower case letter" identifies a step sequence that take place if the UE is implemented in a certain way.	-	-	-	-
7ABa1	UE transmit REGISTRATION REQUEST message. NOTE: Allowed for Rel-15 UEs.	-->	REGISTRATION REQUEST	2	P
7ABa2	Stop timer 5 sec.	-	-	-	-
7ABb1	Timer 5 sec expires.	-	-	-	-
7ABb2	The SS releases the RRC connection.	-	-	-	-
7ABb3	Check: Does the UE transmit REGISTRATION REQUEST over a new signalling connection?	-->	REGISTRATION REQUEST	2	P
7AC-7B	Void				

8A	SS stops transmitting UL grant.	-	-	-	-
8B	The SS sends a REGISTRATION ACCEPT message	<--	REGISTRATION ACCEPT	-	-
8C	SS transmits one UL grant, for the UE to transmit the REGISTRATION COMPLETE message at step 8D.	-	-	-	-
8D	The UE sends a REGISTRATION COMPLETE.	-->	REGISTRATION COMPLETE	-	-
8E	The SS releases the RRC connection.	-	-	-	-
8F	The SS resumes UL grant transmission.	-	-	-	-
8G	The UE transmits a SERVICE REQUEST message over a new signalling connection.	-->	SERVICE REQUEST	-	-
8H	The SS does not respond to SERVICE REQUEST message. Note: The UE locally releases the signalling connection after T3517 expiry.	-	-	-	-
-	EXCEPTION: Steps 9 to 10 are repeated for 4 times.	-	-	-	-
9	Check: Does the UE transmits a SERVICE REQUEST message after T3517 expiry but before 60s over a new signalling connection?	-->	SERVICE REQUEST	3	P
10	The SS does not respond to SERVICE REQUEST message. Note: The UE locally releases the signalling connection after T3517 expiry.	-	-	-	-
11	Check: Does the UE transmits a SERVICE REQUEST message within 60 seconds (minimum value of T3525) over a new signalling connection?	-->	SERVICE REQUEST	3,4	F
12A	The SS starts timer 10 sec after Step 11 to see if UE performs the optional Steps listed below.	-	-	-	-
	EXCEPTION: Steps 12Aa1 to 12Aa6 describe behaviour that depends on the UE implementation; the "lower case letter" identifies a step sequence that take place if the UE is implemented in a certain way.	-	-	-	-
12Aa1	The UE transmits a SERVICE REQUEST message after T3525 expiry over a new signalling connection.	-->	SERVICE REQUEST	-	-
12Aa2-12Aa4	Steps 5 to 7 of the NR RRC_CONNECTED procedure in TS 38.508-1 [4] Table 4.5.4.2-3 are executed.	-	-	-	-
-	EXCEPTION: Steps 12Aa5 and 12Aa6 can occur in any order.	-	-	-	-
12Aa5	The UE transmits an RRCReconfigurationComplete message.	-->	NR RRC: RRCReconfigurationComplete	-	-
12Aa6	The UE loop backs the IP packet received in step 2 on the DRB associated with the default PDU session.	-	-	-	-
<p>Note 1: The 1 second delay is used to secure that the UE have received and forwarded the IP Packet transmitted by the SS in step 2 to the UE test loop function before the RRCRelease message is sent by the SS in step 3.</p> <p>Note 2: Triggered when timer T_delay_modeB (IP PDU delay time) expires and pending uplink data exist in buffered PDCP SDUs according to TS 38.509 [6] clause 5.3.4.2.3 and TS 36.509 [8] clause 5.4.4.3.</p>					

9.1.7.1.3.3 Specific message contents

Table 9.1.7.1.3.3-1: ACTIVATE TEST MODE (preamble)

Derivation Path: TS 38.508-1 [4]			
Information Element	Value/remark	Comment	Condition
Protocol discriminator	1 1 1 1		
Skip indicator	0 0 0 0		
Message type	1 0 0 0 0 1 0 0		
UE test loop mode	0 0 0 0 0 0 0 1	UE test loop mode B	UE TEST LOOP MODE B

Table 9.1.7.1.3.3-2: CLOSE UE TEST LOOP (preamble)

Derivation Path: TS 38.508-1 [4]			
Information Element	Value/remark	Comment	Condition
Protocol discriminator	1 1 1 1		
Skip indicator	0 0 0 0		
Message type	1 0 0 0 0 0 0 0		
UE test loop mode	0 0 0 0 0 0 0 1	UE test loop mode B	UE TEST LOOP MODE B
UE test loop mode B LB setup			
IP PDU delay	0 0 0 0 0 1 0 1	5 seconds	

Table 9.1.7.1.3.3-3: SERVICE REQUEST (steps 4, 8G and 9, Table 9.1.7.1.3.2-1)

Derivation Path: TS 38.508-1 [4] Table 4.7.1-16			
Information Element	Value/remark	Comment	Condition
Service type			
Service type value	'0001'B	data	
Uplink data status		Indicates data present for the PDU session with the DL IP packet looped back. The other bits are not checked.	Not allowed to be sent in cleartext and shall only be included in the complete SERVICE REQUEST message in the NAS message container IE.

Table 9.1.7.1.3.3-4: SERVICE REJECT (step 5, Table 9.1.7.1.3.2-1)

Derivation Path: TS 38.508-1 [4] Table 4.7.1-18			
---	--	--	--

Information Element	Value/remark	Comment	Condition
5GMM cause	'0001 1100'B	Restricted service area	

Table 9.1.7.1.3.3-5: REGISTRATION REQUEST (steps 7ABa1 and 7ABb3, Table 9.1.7.1.3.2-1)

Derivation Path: TS 38.508-1 [4] Table 4.7.1-6			
Information Element	Value/remark	Comment	Condition
5GS registration type	'010'B	mobility registration updating	

9.1.7.2 Service request / Connected mode user data transport / Abnormal / T3517

9.1.7.2.1 Test Purpose (TP)

(1)

```
with { the UE is in 5GMM-REGISTERED state and 5GMM-CONNECTED mode over 3GPP access }
ensure that {
  when { the UE has user data pending due to no user-plane resources established for PDU session(s)
used for user data transport }
  then { the UE sends a SERVICE REQUEST message }
}
```

(2)

```
with { the UE sends a SERVICE REQUEST message in 5GMM-CONNECTED mode }
ensure that {
  when { T3517 expired }
  then { the UE stays in 5GMM-CONNECTED mode }
}
```

9.1.7.2.2 Conformance requirements

References: The conformance requirements covered in the current TC are specified in: TS 24.501 clauses 5.6.1.1, 5.6.1.2 and 5.6.1.7. Unless otherwise stated these are Rel-15 requirements.

[TS 24.501, clause 5.6.1.1]

The purpose of the service request procedure is to change the 5GMM mode from 5GMM-IDLE to 5GMM-CONNECTED mode, and/or to request the establishment of user-plane resources for PDU sessions which are established without user-plane resources. In latter case, the 5GMM mode can be the 5GMM-IDLE mode or the 5GMM-CONNECTED mode if the UE requires to establish user-plane resources for PDU sessions.

NOTE 1: The lower layer indicates when the user-plane resources for PDU sessions are successfully established or released.

This procedure is used when:

...

- the UE has user data pending over 3GPP access and the UE is in 5GMM-IDLE or 5GMM-CONNECTED mode over 3GPP access;

The UE shall invoke the service request procedure when:

...

e) the UE, in 5GMM-CONNECTED mode or in 5GMM-CONNECTED mode with RRC inactive indication, has user data pending due to no user-plane resources established for PDU session(s) used for user data transport;

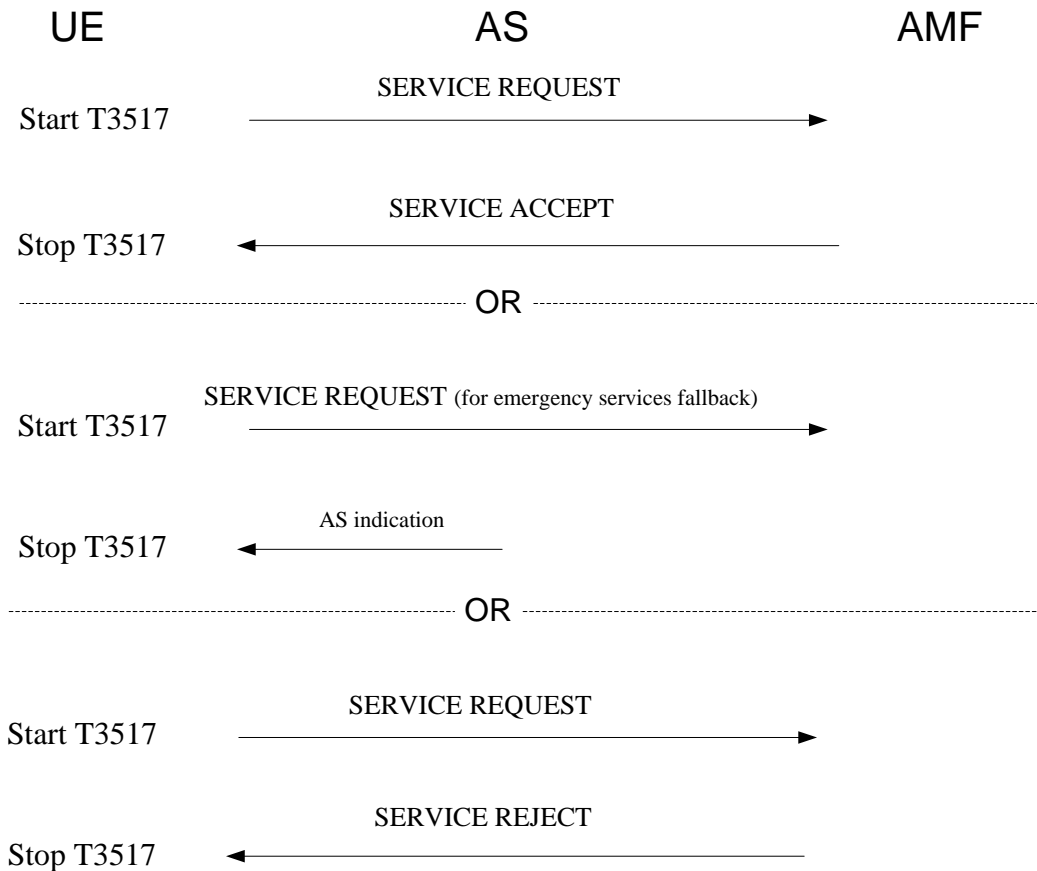

Figure 5.6.1.1.1: Service Request procedure

[TS 24.501, clause 5.6.1.2]

The UE initiates the service request procedure by sending a SERVICE REQUEST message to the AMF and starts timer T3517.

...

For cases d) and e) in subclause 5.6.1.1, the Uplink data status IE shall be included in the SERVICE REQUEST message to indicate the PDU session(s) the UE has pending user data to be sent. If the UE is not a UE configured for high priority access in selected PLMN:

- a) if there exists an emergency PDU session which is indicated in the Uplink data status IE the service type IE in the SERVICE REQUEST message shall be set to "emergency services"; or
- b) otherwise, the service type IE in the SERVICE REQUEST message shall be set to "data".

...

The Uplink data status IE may be included in the SERVICE REQUEST message to indicate which PDU session(s) associated with the access type the SERVICE REQUEST message is sent over have pending user data to be sent.

...

[TS 24.501, clause 5.6.1.7]

The following abnormal cases can be identified:

a) T3517 expired.

The UE shall enter the state 5GMM-REGISTERED.

If the UE triggered the service request procedure in 5GMM-IDLE mode and the service type of the SERVICE REQUEST message was not set to "emergency services fallback", then the 5GMM sublayer shall increment the service request attempt counter, abort the procedure and release locally any resources allocated for the service request procedure. The service request attempt counter shall not be incremented, if:

- 1) the service request procedure is initiated to establish an emergency PDU session;
- 2) the UE has an emergency PDU session established;
- 3) the UE is a UE configured for high priority access in selected PLMN; or
- 4) the service request is initiated in response to paging or notification from the network.

If the service request attempt counter is greater than or equal to 5, the UE shall start timer T3525. Additionally, if the service request was initiated for an MO MMTEL voice call, a notification that the service request was not accepted due to the UE having started timer T3525 shall be provided to the upper layers.

NOTE 1: This can result in the upper layers requesting implementation specific mechanisms, e.g. the MMTEL voice call being attempted to another IP-CAN, or establishment of a CS voice call (if supported and not already attempted in the CS domain).

The UE shall not attempt service request until expiry of timer T3525 unless:

- 1) the service request is initiated in response to paging or notification from the network;
- 2) the UE is a UE configured for high priority access in selected PLMN;
- 3) the service request is initiated to establish an emergency PDU session;
- 4) the UE has an emergency PDU session established; or
- 5) the UE is registered in a new PLMN.

NOTE 2: The NAS signalling connection can also be released if the UE deems that the network has failed the authentication check as specified in subclause 5.4.1.3.7.

...

9.1.7.2.3 Test description

9.1.7.2.3.1 Pre-test conditions

System Simulator:

- NGC Cell A

UE:

- None.

Preamble:

- the UE is in 5GS state 3N-A with at least one PDU session (with PDU session ID X where $1 \leq X \leq 15$) active according to TS 38.508-1 [4], clause 4.4A.3 Table 4.4A.3-1. and using the message condition UE TEST LOOP MODE B prepared according to TS 38.508-1 [4]. DRB n is defined as default DRB for the PDU session X.

9.1.7.2.3.2 Test procedure sequence

Table 9.1.7.2.3.2-1: Main behaviour

St	Procedure	Message Sequence		TP	Verdict
		U – S	Message		
1	Void.				
1A	Cause the UE to request establishment of PDU session Y to the DN. (Note 1)	-	-	-	-
1B	The UE transmits a PDU SESSION ESTABLISHMENT REQUEST message. (Note 2)	-->	NR 5GSM: PDU SESSION ESTABLISHMENT REQUEST	-	-
1C	SS transmits a PDU SESSION ESTABLISHMENT ACCEPT message. (Note 2)	<--	NR 5GSM: PDU SESSION ESTABLISHMENT ACCEPT	-	-
1D	The SS transmits a CLOSE UE TEST LOOP message with IP PDU delay set to 1 second.	<--	CLOSE UE TEST LOOP	-	-
1E	The UE transmits a CLOSE UE TEST LOOP COMPLETE message.	-->	CLOSE UE TEST LOOP COMPLETE	-	-
1F	The SS transmits one IP PDU on PDU session X.	<--	-	-	-
2	The SS transmits an <i>RRCReconfiguration</i> message to release User-plane resources for the PDU session X.	<--	NR RRC: RRCReconfiguration	-	-
3	The UE transmits an <i>RRCReconfigurationComplete</i> message.	-->	NR RRC: RRCReconfigurationComplete	-	-
4	Check: Does the UE transmit a <i>SERVICE REQUEST</i> message?	-->	NR 5GMM: SERVICE REQUEST	1	P
5	The SS does not respond to the <i>SERVICE REQUEST</i> message.	-	-	-	-
6	Wait for T3517 seconds (Note 3).	-	-	-	-
7	The UE transmit a <i>SERVICE REQUEST</i> message.	-->	NR 5GMM: SERVICE REQUEST	-	-
8	The SS sends an IDENTITY REQUEST message.	<--	NR 5GMM: IDENTITY REQUEST	-	-
9	Check: Does the UE transmit an IDENTITY RESPONSE message?.	-->	NR 5GMM: IDENTITY RESPONSE	2	P
10	The SS transmits an <i>RRCReconfiguration</i> message Piggybacked with SERVICE ACCEPT message to setup User-plane resources for the PDU session X.	<--	NR RRC: RRCReconfiguration NR 5GMM: SERVICE ACCEPT		
	EXCEPTION: Steps 11 and 13 can occur in any order	-	-	-	-
11	The UE transmits an <i>RRCReconfigurationComplete</i> message	-->	NR RRC: RRCReconfigurationComplete	-	-
12	Void.	-	-	-	-
13	The UE loop back the IP PDU on PDU session X.	-	-	-	-
Note 1: The request to establish a PDU session may be performed by MMI or AT command.					
Note 2: The reason to establish PDU session Y is to avoid that, after release user-plane resource for PDU session X in step 2-3, the UE can still be in 5GMM-CONNECTED mode as TP1 said. Otherwise, if the UE has only PDU session X, then according to TS 38.331 clause 5.3.1.1, UE has to release both SRB2 and DRB of PDU session X, then go to 5GMM-IDLE mode which violate TP1.					
Note 3: T3517 expires after 15 seconds.					

9.1.7.2.3.3 Specific message contents

Table 9.1.7.2.3.3-0: PDU SESSION ESTABLISHMENT ACCEPT (step 1C, Table 9.1.7.2.3.2-1)

Derivation path: TS 38.508-1 [4], Table 4.7.2-2			
Information Element	Value/remark	Comment	Condition
Authorized QoS rules	5GC QoS rule of the Config#1 in Table 4.8.4-		

	1		
Mapped EPS bearer contexts			
Mapped EPS bearer context			
Mapped EPS QoS parameters	EPC default bearer context of the Config#1 in Table 4.8.4-1		
DNN	The same DNN value as sent in the UL NAS TRANSPORT message at step 1B		

Table 9.1.7.2.3.3-1: RRCReconfiguration (step 2, Table 9.1.7.2.3.2-1)

Derivation Path: TS 38.508-1 [4], Table 4.6.1-13			
Information Element	Value/remark	Comment	Condition
RRCReconfiguration ::= SEQUENCE {			
criticalExtensions CHOICE {			
rrcReconfiguration SEQUENCE {			
radioBearerConfig	RadioBearerConfig		
masterCellGroup	MasterCellGroup		
}			
}			
}			

Table 9.1.7.2.3.3-2a: RadioBearerConfig (Table 9.1.7.2.3.3-1)

Derivation Path: TS 38.508-1 [4], Table 4.6.3-132			
Information Element	Value/remark	Comment	Condition
RadioBearerConfig ::= SEQUENCE {			
drb-ToReleaseList SEQUENCE (SIZE (1..maxDRB)) OF DRB-Identity {	1 entry		
DRB-Identity[1]	DRB configured in the preamble	entry 1	
}			
}			

Table 9.1.7.2.3.3-2b: MasterCellGroup (Table 9.1.7.2.3.3-1)

Derivation path: TS 38.508-1 [4], Table 4.6.3-19			
Information Element	Value/remark	Comment	Condition
CellGroupConfig ::= SEQUENCE {			
rlc-BearerToAddModList	Not present		
rlc-BearerToReleaseList SEQUENCE (SIZE(1..maxLC-ID)) OF LogicalChannelIdentity {	1 entry		
logicalChannelIdentity[1]	Logical channel identity corresponding to DRB configured in the preamble	entry 1	
}			
mac-CellGroupConfig	Not present		
physicalCellGroupConfig	Not present		
spCellConfig	Not present		
}			

Table 9.1.7.2.3.3-3: SERVICE REQUEST (step 4, 7, Table 9.1.7.2.3.2-1)

Derivation path: TS 38.508-1 [4], table 4.7.1-16			
Information Element	Value/Remark	Comment	Condition
Service type	'0001'B	data	
Uplink data status PSI(X)	'1'B	PSI(X) is set to 1 indicates that uplink data are pending for the PDU session X activated in preamble.	

Table 9.1.7.2.3.3-4: IDENTITY REQUEST (step 8, Table 9.1.7.2.3.2-1)

Derivation Path: TS 38.508-1 [4] table 4.7.1-21			
Information Element	Value/remark	Comment	Condition
Identity type	'0010'B	5G-GUTI	

Table 9.1.7.2.3.3-5: IDENTITY RESPONSE (step 9, Table 9.1.7.2.3.2-1)

Derivation Path: TS 38.508-1 [4] table 4.7.1-22			
Information Element	Value/remark	Comment	Condition
Mobile identity	5G-GUTI		

Table 9.1.7.2.3.3-6: RRCReconfiguration (step 10, Table 9.1.7.2.3.2-1)

Derivation Path: TS 38.508-1 [4], Table 4.6.1-13			
Information Element	Value/remark	Comment	Condition
RRCReconfiguration ::= SEQUENCE { criticalExtensions CHOICE { rrcReconfiguration SEQUENCE { radioBearerConfig	RadioBearerConfig with conditions DRB configured in the preamble		
nonCriticalExtension SEQUENCE { masterCellGroup	CellGroupConfig with condition DRB configured in the preamble	OCTET STRING (CONTAINING CellGroupConfig)	
}			
}			
}			
}			

Table 9.1.7.2.3.3-7: SERVICE ACCEPT (step 10, Table 9.1.7.2.3.2-1)

Derivation path: TS 38.508-1 [4], table 4.7.1-17			
Information Element	Value/Remark	Comment	Condition
PDU session reactivation result PSI(X)	'0'B	PSI(X) is set to 0 indicates that establishment of user-plane resource of the PDU session X activated in preamble is successful.	

9.1.8 SMS over NAS

9.1.8.1 SMS over NAS / MO and MT SMS over NAS / Idle mode

9.1.8.1.1 Test Purpose (TP)

(1)

```
with { the UE in switched off state with valid USIM inserted }
ensure that {
  when { the UE requests initial registration for SMS over NAS }
  then { the UE shall send REGISTRATION REQUEST message with SMS requested bit of the 5GS update
type IE "SMS over NAS supported" }
}
```

(2)

```
with { the UE in 5GMM-REGISTERED state }
ensure that {
  when { the UE initiates a periodic registration update and the requirements to use SMS over NAS
transport have not changed in the UE}
  then { the UE sets the SMS requested bit of the 5GS update type IE in the REGISTRATION REQUEST
message to the same value as indicated by the UE in the last REGISTRATION REQUEST message }
}
```

(3)

```
with { the UE in 5GMM_Connected state with NR RRC_IDLE mode and the UE has sent a SERVICE REQUEST
message triggered by initiating MO SMS}
ensure that {
  when { UE receives a SERVICE ACCEPT message from SS }
  then { UE sends CP-DATA containing RP-DATA RPDU (SMS SUBMIT TPDU) encapsulated in an Uplink NAS
transport message }
}
```

(4)

```
with { UE has sent CP-DATA containing an RP-DATA RPDU (SMS SUBMIT TPDU) encapsulated in an Uplink
NAS transport message }
ensure that {
  when { UE receives a CP-DATA containing an RP-ACK RPDU encapsulated in a Downlink NAS transport
message }
  then { UE sends a CP-ACK encapsulated in an Uplink NAS Transport message }
}
```

(5)

```
with { the UE in 5GMM-REGISTERED state with NR RRC_IDLE mode, UE has received a paging request and
UE has completed a SERVICE REQUEST procedure}
ensure that {
  when { UE receives a CP-DATA containing an RP-DATA RPDU (SMS DELIVER TPDU) encapsulated in a
Downlink NAS transport message }
  then { UE sends a CP-ACK encapsulated in an Uplink NAS transport message followed by a CP-DATA
containing an RP-ACK RPDU encapsulated in an Uplink NAS transport message}
}
```

9.1.8.1.2 Conformance requirements

References: The conformance requirements covered in the present TC are specified in: TS 24.501, clause 5.5.1.2.2, 5.5.1.2.4, 5.5.1.3.2, 5.5.1.3.4, 9.11.3.6 and 9.11.3.9A. Unless otherwise stated these are Rel-15 requirements.

[TS 24.501 clause 5.5.1.2.2]

The UE in state 5GMM-DEREGISTERED shall initiate the registration procedure for initial registration by sending a REGISTRATION REQUEST message to the AMF,

- a) when the UE performs initial registration for 5GS services;

- b) when the UE performs initial registration for emergency services;
- c) when the UE performs initial registration for SMS over NAS; and
- d) when the UE moves from GERAN to NG-RAN coverage or the UE moves from a UTRAN to NG-RAN coverage.

...

The UE initiates the registration procedure for initial registration by sending a REGISTRATION REQUEST message to the AMF, starting timer T3510. If timer T3502 is currently running, the UE shall stop timer T3502. If timer T3511 is currently running, the UE shall stop timer T3511.

...

If the UE requests the use of SMS over NAS, the UE shall include the 5GS update type IE in the REGISTRATION REQUEST message with the SMS requested bit set to “SMS over NAS supported”. When the 5GS update type IE is included in the REGISTRATION REQUEST for reasons other than requesting the use of SMS over NAS, and the UE does not need to register for SMS over NAS, the UE shall set the SMS requested bit of the 5GS update type IE to “SMS over NAS not supported” in the REGISTRATION REQUEST message.

[TS 24.501 clause 5.5.1.2.4]

If the initial registration request is accepted by the network, the AMF shall send a REGISTRATION ACCEPT message to the UE.

...

If the 5GS update type IE was included in the REGISTRATION REQUEST message with the SMS requested bit set to “SMS over NAS supported”, and SMSF selection is successful, then the AMF shall send the REGISTRATION ACCEPT message after the SMSF has confirmed that the activation of the SMS service was successful. When sending the REGISTRATION ACCEPT message, the AMF shall:

- a) set the SMS allowed bit of the 5GS registration result IE to “SMS over NAS allowed” in the REGISTRATION ACCEPT message, if the UE has set the SMS requested bit of the 5GS registration type IE to “SMS over NAS supported” in the REGISTRATION REQUEST message and the network allows the use of SMS over NAS for the UE; and
- b) store the SMSF address and the value of the SMS allowed bit of the 5GS registration result IE in the UE 5GMM context and consider the UE available for SMS over NAS.

[TS 24.501 clause 5.5.1.3.2]

The UE in state 5GMM-REGISTERED shall initiate the registration procedure for mobility and periodic registration update by sending a REGISTRATION REQUEST message to the AMF,

- 1) when the UE needs to register for SMS over NAS, indicate a change in the requirements to use SMS over NAS, or de-register from SMS over NAS;

...

The UE in state 5GMM-REGISTERED shall initiate the registration procedure for mobility and periodic update by sending a REGISTRATION REQUEST message to the AMF when the UE needs to request the use of SMS over NAS transport or the current requirements to use SMS over NAS transport change in the UE. The UE shall set the SMS requested bit of the 5GS update type IE in the REGISTRATION REQUEST message as specified in subclause 5.5.1.2.2.

When initiating a registration procedure for mobility and periodic registration update and the UE needs to send the 5GS update type IE for a reason different than indicating a change in requirement to use SMS over NAS, the UE shall set the SMS requested bit of the 5GS update type IE in the REGISTRATION REQUEST message to the same value as indicated by the UE in the last REGISTRATION REQUEST message.

If the UE no longer requires the use of SMS over NAS, then the UE shall include the 5GS update type IE in the REGISTRATION REQUEST message with the SMS requested bit set to “SMS over NAS not supported”.

[TS 24.501 clause 5.5.1.3.4]

If the registration update request has been accepted by the network, the AMF shall send a REGISTRATION ACCEPT message to the UE.

...

If the 5GS update type IE was included in the REGISTRATION REQUEST message with the SMS requested bit set to "SMS over NAS not supported" and:

- a) the SMSF address is stored in the UE 5GMM context and:
 - 1) the UE is considered available for SMS over NAS; or
 - 2) the UE is considered not available for SMS over NAS and the SMSF has confirmed that the activation of the SMS service is successful; or
- b) the SMSF address is not stored in the UE 5GMM context, the SMSF selection is successful and the SMSF has confirmed that the activation of the SMS service is successful;

then the AMF shall set the SMS allowed bit of the 5GS registration result IE in the REGISTRATION ACCEPT message as specified in subclause 5.5.1.2.4. If the UE 5GMM context does not contain an SMSF address or the UE is not considered available for SMS over NAS, then the AMF shall:

- a) store the SMSF address in the UE 5GMM context if not stored already; and
- b) store the value of the SMS allowed bit of the 5GS registration result IE in the UE 5GMM context and consider the UE available for SMS over NAS.

If SMSF selection in the AMF or SMS activation via the SMSF is not successful, or the AMF does not allow the use of SMS over NAS, then the AMF shall set the SMS allowed bit of the 5GS registration result IE to "SMS over NAS not allowed" in the REGISTRATION ACCEPT message.

If the 5GS update type IE was included in the REGISTRATION REQUEST message with the SMS requested bit set to "SMS over NAS not supported", then the AMF shall:

- a) mark the 5GMM context to indicate that the UE is not available for SMS over NAS; and

NOTE 2: The AMF can notify the SMSF that the UE is deregistered from SMS over NAS based on local configuration.

- b) set the SMS allowed bit of the 5GS registration result IE to "SMS over NAS not supported" in the REGISTRATION ACCEPT message.

When the UE receives the REGISTRATION ACCEPT message, if the UE is also registered over another access to the same PLMN, the UE considers the value indicated by the SMS allowed bit of the 5GS registration result IE as applicable for both accesses over which the UE is registered.

[TS 24.501 clause 9.11.3.6]

The purpose of the 5GS registration result information element is to specify the result of a registration procedure.

The 5GS registration result information element is coded as shown in figure 9.11.3.6.1 and table 9.11.3.6.1.

The 5GS registration result is a type 4 information element with a length of 3 octets.

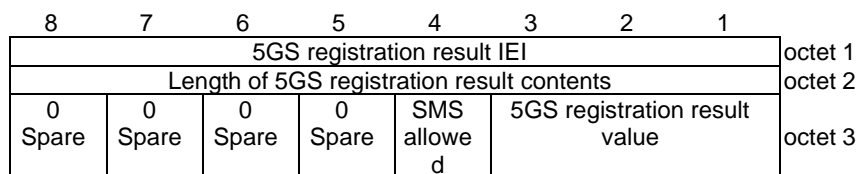

Figure 9.11.3.6.1: 5GS registration result information element

Table 9.11.3.6.1: 5GS registration result information element

5GS registration result value (octet 3, bits 1 to 3)
--

Bits			
3	2	1	
0	0	1	3GPP access
0	1	0	Non-3GPP access
0	1	1	3GPP access and non-3GPP access
1	1	1	reserved
All other values are unused and shall be treated as "3GPP access", if received by the UE.			
SMS over NAS transport allowed (SMS allowed) (octet 3, bit 4)			
Bit			
4			
0	SMS over NAS not allowed		
1	SMS over NAS allowed		
Bits 5 to 8 of octet 3 are spare and shall be coded as zero.			

[TS 24.501 clause 9.11.3.9A]

The purpose of the 5GS update type IE is to allow the UE to provide additional information to the network when performing a registration procedure.

The 5GS update type information element is coded as shown in figure 9.11.3.9A.1 and table 9.11.3.9A.1.

The 5GS update type is a type 4 information element.

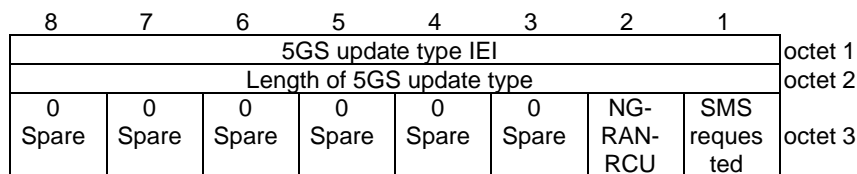

Figure 9.11.3.9A.1: 5GS update type information element

Table 9.11.3.9A.1: 5GS update type information element

SMS over NAS transport requested (SMS requested) (octet 3, bit 1)	
Bit	
1	
0	SMS over NAS not supported
1	SMS over NAS supported
NG-RAN Radio Capability Update (NG-RAN-RCU) (octet 3, bit 2)	
Bits	
2	
0	NG-RAN radio capability update not needed
1	NG-RAN radio capability update needed
Bits 3 to 8 of octet 3 are spare and shall be coded as zero.	

9.1.8.1.3 Test description

9.1.8.1.3.1 Pre-test conditions

System Simulator:

NGC Cell A belongs to Home PLMN and TAI1;

UE:

The UE does not have any stored SMS message.

Preamble:

The UE is in state Switched OFF (state 0N-B) according to TS 38.508-1 [4].

9.1.8.1.3.2 Test procedure sequence

Table 9.1.8.1.3.2-1: Main behaviour

St	Procedure	Message Sequence		TP	Verdict
		U - S	Message		
1	The UE is switched ON.	-	-	-	-
2 - 4	UE establishes RRC connection by executing steps 2-4 of Table 4.5.2.2-2 in TS 38.508-1 [4].	-	-	-	-
5	Check: Does UE transmit a REGISTRATION REQUEST message including 5GS update type IE with SMS requested bit set to "SMS over NAS supported"?	-->	REGISTRATION REQUEST	1	P
6 - 14	Steps 5 to 13 of Table 4.5.2.2-2 of the generic procedure in TS 38.508-1 [4] are performed.	-	-	-	-
15	SS transmits REGISTRATION ACCEPT message including 5GS registration result with SMS allowed bit set to "SMS over NAS allowed" and T3512 value set to 3 minutes.	<--	REGISTRATION ACCEPT	-	-
16 - 21a 1	Steps 15 to 20a1 of Table 4.5.2.2-2 of the generic procedure in TS 38.508-1 [4].	-	-	-	-
21 A	Wait for the expiry of T3512.	-	-	-	-
22 - 24	UE establishes RRC connection by executing steps 2-4 of Table 4.5.2.2-2 in TS 38.508-1 [4].	-	-	-	-
25	Check: Does UE perform periodic Registration, including 5GS update type IE with SMS requested bit set to "SMS over NAS supported"?	-->	REGISTRATION REQUEST	2	P
26 - 34	Void.	-	-	-	-
35	SS transmits REGISTRATION ACCEPT message including 5GS registration result with SMS allowed bit set to "SMS over NAS allowed" and T3512 value set to 3 minutes.	<--	REGISTRATION ACCEPT	-	-
35 A	The UE transmits a REGISTRATION COMPLETE message.	-->	REGISTRATION COMPLETE	-	-
36	The SS transmits an <i>RRCRelease</i> message.	-	-	-	-
37	Sending of a 160 character MO SMS is initiated at the UE via MMI or AT command.	-	-	-	-
38	The UE establishes RRC connection and transmits a SERVICE REQUEST message by executing steps 2-4 of Table 4.5.4.2-2 in TS 38.508-1 [4].	-->	SERVICE REQUEST		
39 - 42	Steps 5 to 8 of Table 4.5.4.2-3 of the generic procedure in TS 38.508-1 [4] are performed.	-	-	-	-
43	The UE transmits a CP-DATA containing an RP-DATA RPDU (SMS SUBMIT TPDU) encapsulated in an Uplink NAS transport message.	-->	UPLINK NAS TRANSPORT	3	P
44	The SS transmits a CP-ACK encapsulated in a Downlink NAS Transport message.	<--	DOWNLINK NAS TRANSPORT	-	-
45	The SS transmits a CP-DATA containing an RP-ACK RPDU encapsulated in a Downlink NAS transport message	<--	DOWNLINK NAS TRANSPORT	-	-
46	Check: Does the UE transmit a CP-ACK encapsulated in an Uplink NAS Transport message?	-->	UPLINK NAS TRANSPORT	4	P
47	The SS transmits an <i>RRCRelease</i> message	-	-	-	-

48	The SS pages the UE using NG-5G-S-TMSI.	-	-	-	-
49	The UE establishes RRC connection and transmits a SERVICE REQUEST message by executing steps 2-4 of Table 4.5.4.2-3 in TS 38.508-1 [4].	-->	SERVICE REQUEST	-	-
50-53	Steps 5 to 8 of Table 4.5.4.2-3 of the generic procedure in TS 38.508-1 [4] are performed.	-	-	-	-
54	The SS transmits a CP-DATA containing a RP-DATA RPDU (SMS DELIVER TPDU) encapsulated in a Downlink NAS transport message to the UE.	<--	DOWNLINK NAS TRANSPORT	-	-
55	Check: Does the UE transmit a CP-ACK encapsulated in an Uplink NAS transport message?	-->	UPLINK NAS TRANSPORT	5	P
56	Check: Does the UE transmit a CP-DATA containing a RP-ACK RPDU encapsulated in an Uplink NAS transport message?	-->	UPLINK NAS TRANSPORT	5	P
57	The SS transmits a CP-ACK encapsulated in a Downlink NAS transport message to the UE.	<--	DOWNLINK NAS TRANSPORT	-	-

9.1.8.1.3.3 Specific message contents

Table 9.1.8.1.3.3-1: REGISTRATION REQUEST (step 5, Table 9.1.8.1.3.2-1)

Derivation path: TS 38.508-1 [4], Table 4.7.1-6			
Information Element	Value/remark	Comment	Condition
5GS registration type			
5GS registration type value	'001'B		INITIAL
5GS update type			
SMS requested	SMS over NAS supported		

Table 9.1.8.1.3.3-2: REGISTRATION ACCEPT (steps 15 and 35, Table 9.1.8.1.3.2-1)

Derivation path: TS 38.508-1 [4], Table 4.7.1-7			
Information Element	Value/remark	Comment	Condition
5GS registration result			
SMS allowed	SMS over NAS allowed		
T3512 value			
Timer value	'00011'B		
Unit	'101'B		

Table 9.1.8.1.3.3-3: REGISTRATION REQUEST (step 25, Table 9.1.8.1.3.2-1)

Derivation path: TS 38.508-1 [4], Table 4.7.1-6			
Information Element	Value/remark	Comment	Condition
5GS registration type			
5GS registration type value	'011'B		PERIODIC
5GS update type			
SMS requested	SMS over NAS supported		

Table 9.1.8.1.3.3-3A: SERVICE REQUEST (step 38, Table 9.1.8.1.3.2-1)

Derivation path: TS 38.508-1 [4], Table 4.7.1-16			
Information Element	Value/remark	Comment	Condition
Service type			
Service type value	'0000'B	signalling	

Table 9.1.8.1.3.3-4: UL NAS TRANSPORT (step 43, Table 9.1.8.1.3.2-1)

Derivation path: TS 38.508-1 [4], Table 4.7.1-10			
Information Element	Value/remark	Comment	Condition
Payload container type	'0010'B	SMS	
Payload container	CP-DATA	RP-DATA RPDU	

Table 9.1.8.1.3.3-5: DL NAS TRANSPORT (step 44, Table 9.1.8.1.3.2-1)

Derivation path: TS 38.508-1 [4], Table 4.7.1-11			
Information Element	Value/remark	Comment	Condition
Payload container type	'0010'B	SMS	
Payload container	CP-ACK		

Table 9.1.8.1.3.3-6: DL NAS TRANSPORT (step 45, Table 9.1.8.1.3.2-1)

Derivation path: TS 38.508-1 [4], Table 4.7.1-11			
Information Element	Value/remark	Comment	Condition
Payload container type	'0010'B	SMS	
Payload container	CP-DATA	RP-ACK RPDU	

Table 9.1.8.1.3.3-7: UL NAS TRANSPORT (step 46, Table 9.1.8.1.3.2-1)

Derivation path: TS 38.508-1 [4], Table 4.7.1-10			
Information Element	Value/remark	Comment	Condition
Payload container type	'0010'B	SMS	
Payload container	CP-ACK		

Table 9.1.8.1.3.3-8: DL NAS TRANSPORT (step 54, Table 9.1.8.1.3.2-1)

Derivation path: TS 38.508-1 [4], Table 4.7.1-11			
Information Element	Value/remark	Comment	Condition
Payload container type	'0010'B	SMS	
Payload container	CP-DATA	RP-DATA	

Table 9.1.8.1.3.3-9: UL NAS TRANSPORT (step 55, Table 9.1.8.1.3.2-1)

Derivation path: TS 38.508-1 [4], Table 4.7.1-10			
Information Element	Value/remark	Comment	Condition
Payload container type	'0010'B	SMS	
Payload container	CP-ACK		

Table 9.1.8.1.3.3-10: UL NAS TRANSPORT (step 56, Table 9.1.8.1.3.2-1)

Derivation path: TS 38.508-1 [4], Table 4.7.1-10			
Information Element	Value/remark	Comment	Condition
Payload container type	'0010'B	SMS	
Payload container	CP-DATA	RP-ACK	

Table 9.1.8.1.3.3-11: DL NAS TRANSPORT (step 57, Table 9.1.8.1.3.2-1)

Derivation path: TS 38.508-1 [4], Table 4.7.1-11			
Information Element	Value/remark	Comment	Condition
Payload container type	'0010'B	SMS	
Payload container	CP-ACK		

9.1.8.2 SMS over NAS / Multiple MO and MT SMS over NAS / Connected mode

9.1.8.2.1 Test Purpose (TP)

(1)

```
with { the UE is in 5GMM-REGISTERED state and 5GMM-CONNECTED mode over 3GPP access }
ensure that {
  when { a Multiple MO SMS is initiated at the UE }
  then { UE sends CP-DATA containing RP-DATA RPDU (SMS SUBMIT TPDU) encapsulated in an Uplink NAS transport message }
}
```

(2)

```
with { UE has sent CP-DATA containing an RP-DATA RPDU (SMS SUBMIT TPDU) encapsulated in an Uplink NAS transport message and has another MO SMS to send }
ensure that {
  when { UE receives a CP-DATA containing an RP-ACK RPDU encapsulated in a Downlink NAS transport message }
  then { UE does not send a final CP-ACK before it sends a CP-DATA containing the successive RP-DATA RPDU (SMS SUBMIT TPDU) encapsulated in an Uplink NAS transport message }
}
```

(3)

```
with { UE has sent CP-DATA containing an RP-DATA RPDU (SMS SUBMIT TPDU) encapsulated in an Uplink NAS transport message and has no further MO SMS to send }
ensure that {
  when { UE receives a CP-DATA containing an RP-ACK RPDU encapsulated in a Downlink NAS transport message }
  then { UE sends a CP-ACK encapsulated in an Uplink NAS transport message }
}
```

(4)

```
with { the UE is in 5GMM-REGISTERED state and 5GMM-CONNECTED mode over 3GPP access }
ensure that {
  when { UE receives a CP-DATA containing an RP-DATA RPDU (SMS DELIVER TPDU) encapsulated in a Downlink NAS transport message, and subsequently a second CP-DATA containing an RP-DATA RPDU (SMS DELIVER TPDU) encapsulated in a Downlink NAS transport message with different transaction identifier }
  then { UE sends twice a CP-ACK encapsulated in an Uplink NAS transport message followed by a CP-DATA containing an RP-ACK RPDU encapsulated in an Uplink NAS transport message }
}
```

9.1.8.2.2 Conformance requirements

References: The conformance requirements covered in the present TC are specified in: TS 24.501 clause 4.5.4.2, and TS 24.011 clause 9.11.3.9A. Unless otherwise stated these are Rel-15 requirements.

[TS 24.501 clause 4.5.4.2]

If the lower layers indicate that the access attempt is allowed, the NAS shall take the following action depending on the event which triggered the access attempt:

- a) if the event which triggered the access attempt was an MO-MMTEL-voice-call-started indication, an MO-MMTEL-video-call-started indication or an MO-SMSoIP-attempt-started indication, the NAS shall notify the upper layers that the access attempt is allowed;
- b) if the event which triggered the access attempt was a request from upper layers to send a mobile originated SMS over NAS, 5GMM shall initiate the NAS transport procedure as specified in subclause 5.4.5 to send the SMS in an UL NAS TRANSPORT message;

[TS 24.011 clause 5.4]

In the case of a SMS transfer via the PS domain, when the MS chooses to use the same PS signalling connection (in Iu mode and in S1 mode if packet-switched service is used); or in the case of a SMS transfer via the PS domain in A/Gb mode; or in the case of SMS transfer through the EPS, or in the case of SMS transfer in N1 mode, then:

- the MS shall transmit the CP-DATA for the successive RPDU and shall not transmit the final CP-ACK for the current SMS (i.e. the one that acknowledges the CP-DATA that carried the RP-ACK);
- the Transaction Identifier used for the successive RPDU shall be different to that used for the current RPDU; and
- the MS shall not transmit the CP-DATA for the successive RPDU before the final CP-DATA (i.e. the one that carried the RP-ACK) has been received.

NOTE: When an MS sends successive memory available notifications and/or mobile originated short messages on different RR connections (in A/Gb mode) or signalling connections (in Iu mode and S1 mode), the MS is strongly recommended to use different Transaction Identifiers for the old and new MM connections.

It is possible that the final CP-ACK of a short message transfer may not be received (e.g. due to transmission errors and/or hand overs).

For mobile terminated transfers, if the CP-ACK is lost, the reception of a CP-DATA with a different transaction identifier and carrying an RPDU shall be interpreted as the implicit reception of the awaited CP-ACK followed by the reception of the new CP-DATA message.

For mobile originated transfers, if the CP-ACK is lost or not sent by the MS, the following events shall be interpreted as the implicit reception of the awaited CP-ACK:

- in the case of a SMS transfer via the CS domain,, the reception of a CM SERVICE REQUEST followed by a CP-DATA with a different transaction identifier and carrying an RPDU; or
- in the case of a SMS transfer via the PS domain, the reception of a CP-DATA with a different transaction identifier and carrying an RPDU.

9.1.8.2.3 Test description

9.1.8.2.3.1 Pre-test conditions

System Simulator:

NGC Cell A belongs to Home PLMN and TAI1.

UE:

The UE does not have any stored SMS message.

Preamble:

The UE is in state 3N-A, registered with "SMS over NAS supported".

9.1.8.2.3.2 Test procedure sequence

Table 9.1.8.2.3.2-1: Main behaviour

St	Procedure	Message Sequence		TP	Verdict
		U - S	Message		
1	Sending of 3 MO SMS as multiple SMS is initiated at the UE via MMI or AT command	-	-	-	-
2	Check: Does the UE transmit a CP-DATA containing an RP-DATA RPDU (SMS SUBMIT TPDU) encapsulated in an Uplink NAS transport message?	-->	UPLINK NAS TRANSPORT	1	P
3	The SS transmits a CP-ACK encapsulated in a Downlink NAS Transport message.	<<--	DOWNLINK NAS TRANSPORT	-	-
4	The SS transmits a CP-DATA containing an RP-ACK RPDU encapsulated in a Downlink	<<--	DOWNLINK NAS TRANSPORT	-	-

	NAS transport message				
5	Check: Does the UE transmit a CP-ACK encapsulated in an Uplink NAS Transport message before the CP-DATA in step 6 is transmitted?	-->	UPLINK NAS TRANSPORT	2	F
6	Check: Does the UE transmit a CP-DATA containing an RP-DATA RPDU (SMS SUBMIT TPDU) encapsulated in an Uplink NAS transport message?	-->	UPLINK NAS TRANSPORT	2	P
7	The SS transmits a CP-ACK encapsulated in a Downlink NAS Transport message.	<--	DOWNLINK NAS TRANSPORT	-	-
8	The SS transmits a CP-DATA containing an RP-ACK RPDU encapsulated in a Downlink NAS transport message	<--	DOWNLINK NAS TRANSPORT	-	-
9	Check: Does the UE transmit a CP-ACK encapsulated in an Uplink NAS Transport message before the CP-DATA in step 10 is transmitted?	-->	UPLINK NAS TRANSPORT	2	F
10	Check: Does the UE transmit a CP-DATA containing an RP-DATA RPDU (SMS SUBMIT TPDU) encapsulated in an Uplink NAS transport message?	-->	UPLINK NAS TRANSPORT	2	P
11	The SS transmits a CP-ACK encapsulated in a Downlink NAS Transport message.	<--	DOWNLINK NAS TRANSPORT	-	-
12	The SS transmits a CP-DATA containing an RP-ACK RPDU encapsulated in a Downlink NAS transport message	<--	DOWNLINK NAS TRANSPORT	-	-
13	Check: Does the UE transmit a CP-ACK encapsulated in an Uplink NAS Transport message?	-->	UPLINK NAS TRANSPORT	3	P
14	The SS transmits a CP-DATA containing an RP-DATA RPDU (SMS DELIVER TPDU) encapsulated in a Downlink NAS transport message to the UE.	<--	DOWNLINK NAS TRANSPORT	-	-
15	Check: Does the UE transmit a CP-ACK encapsulated in an Uplink NAS transport message?	-->	UPLINK NAS TRANSPORT	4	P
16	Check: Does the UE transmit a CP-DATA containing an RP-ACK RPDU encapsulated in an Uplink NAS transport message?	-->	UPLINK NAS TRANSPORT	4	P
17	The SS transmits a CP-DATA containing an RP-DATA RPDU (SMS DELIVER TPDU) encapsulated in a Downlink NAS transport message to the UE.	<--	DOWNLINK NAS TRANSPORT	-	-
18	Check: Does the UE transmit a CP-ACK encapsulated in an Uplink NAS transport message?	-->	UPLINK NAS TRANSPORT	4	P
19	Check: Does the UE transmit a CP-DATA containing an RP-ACK RPDU encapsulated in an Uplink NAS transport message?	-->	UPLINK NAS TRANSPORT	4	P
20	The SS transmits a CP-ACK encapsulated in a Downlink NAS transport message to the UE.	<--	DOWNLINK NAS TRANSPORT	-	-

9.1.8.2.3.3 Specific message contents

Table 9.1.8.2.3.3-1: UL NAS TRANSPORT (step 2, Table 9.1.8.2.3.2-1)

Derivation path: TS 38.508-1 [4], Table 4.7.1-10			
Information Element	Value/remark	Comment	Condition
Payload container type	'0010'B	SMS	
Payload container	CP-DATA	RP-DATA RPDU TI used in steps 2, 3 and 4 shall be x1.	

Table 9.1.8.2.3.3-2: DL NAS TRANSPORT (step 3, Table 9.1.8.2.3.2-1)

Derivation path: TS 38.508-1 [4], Table 4.7.1-11			
Information Element	Value/remark	Comment	Condition
Payload container type	'0010'B	SMS	
Payload container	CP-ACK		

Table 9.1.8.2.3.3-3: DL NAS TRANSPORT (step 4, Table 9.1.8.2.3.2-1)

Derivation path: TS 38.508-1 [4], Table 4.7.1-11			
Information Element	Value/remark	Comment	Condition
Payload container type	'0010'B	SMS	
Payload container	CP-DATA	RP-ACK RPDU	

Table 9.1.8.2.3.3-4: UL NAS TRANSPORT (step 6, Table 9.1.8.2.3.2-1)

Derivation path: TS 38.508-1 [4], Table 4.7.1-10			
Information Element	Value/remark	Comment	Condition
Payload container type	'0010'B	SMS	
Payload container	CP-DATA	RP-DATA RPDU TI used in steps 6, 7 and 8 shall be x2, with x1 <> x2 (see step 2).	

Table 9.1.8.2.3.3-5: DL NAS TRANSPORT (step 7, Table 9.1.8.2.3.2-1)

Derivation path: TS 38.508-1 [4], Table 4.7.1-11			
Information Element	Value/remark	Comment	Condition
Payload container type	'0010'B	SMS	
Payload container	CP-ACK		

Table 9.1.8.2.3.3-6: DL NAS TRANSPORT (step 8, Table 9.1.8.2.3.2-1)

Derivation path: TS 38.508-1 [4], Table 4.7.1-11			
Information Element	Value/remark	Comment	Condition
Payload container type	'0010'B	SMS	
Payload container	CP-DATA	RP-ACK RPDU	

Table 9.1.8.2.3.3-7: UL NAS TRANSPORT (step 10, Table 9.1.8.2.3.2-1)

Derivation path: TS 38.508-1 [4], Table 4.7.1-10			
Information Element	Value/remark	Comment	Condition
Payload container type	'0010'B	SMS	
Payload container	CP-DATA	RP-DATA RPDU TI used in steps 10, 11, 12 and 13 shall be x3, with x3 <> x2 (see step 6).	

Table 9.1.8.2.3.3-8: DL NAS TRANSPORT (step 11, Table 9.1.8.2.3.2-1)

Derivation path: TS 38.508-1 [4], Table 4.7.1-11			
--	--	--	--

Information Element	Value/remark	Comment	Condition
Payload container type	'0010'B	SMS	
Payload container	CP-ACK		

Table 9.1.8.2.3.3-9: DL NAS TRANSPORT (step 12, Table 9.1.8.2.3.2-1)

Derivation path: TS 38.508-1 [4], Table 4.7.1-11			
Information Element	Value/remark	Comment	Condition
Payload container type	'0010'B	SMS	
Payload container	CP-DATA	RP-ACK RPDU	

Table 9.1.8.2.3.3-10: UL NAS TRANSPORT (step 13, Table 9.1.8.2.3.2-1)

Derivation path: TS 38.508-1 [4], Table 4.7.1-10			
Information Element	Value/remark	Comment	Condition
Payload container type	'0010'B	SMS	
Payload container	CP-ACK		

Table 9.1.8.2.3.3-11: DL NAS TRANSPORT (step 14, Table 9.1.8.2.3.2-1)

Derivation path: TS 38.508-1 [4], Table 4.7.1-11			
Information Element	Value/remark	Comment	Condition
Payload container type	'0010'B	SMS	
Payload container	CP-DATA	RP-DATA RPDU TI used in steps 14, 15 and 16 is y1.	

Table 9.1.8.2.3.3-12: UL NAS TRANSPORT (step 15, Table 9.1.8.2.3.2-1)

Derivation path: TS 38.508-1 [4], Table 4.7.1-10			
Information Element	Value/remark	Comment	Condition
Payload container type	'0010'B	SMS	
Payload container	CP-ACK		

Table 9.1.8.2.3.3-13: UL NAS TRANSPORT (step 16, Table 9.1.8.2.3.2-1)

Derivation path: TS 38.508-1 [4], Table 4.7.1-10			
Information Element	Value/remark	Comment	Condition
Payload container type	'0010'B	SMS	
Payload container	CP-DATA	RP-ACK RPDU	

Table 9.1.8.2.3.3-14: DL NAS TRANSPORT (step 17, Table 9.1.8.2.3.2-1)

Derivation path: TS 38.508-1 [4], Table 4.7.1-11			
Information Element	Value/remark	Comment	Condition
Payload container type	'0010'B	SMS	
Payload container	CP-DATA	RP-DATA RPDU TI used in steps 17, 18, 19 and 20 is y2, with y2 <> y1 (see step 14).	

Table 9.1.8.2.3.3-15: UL NAS TRANSPORT (step 18, Table 9.1.8.2.3.2-1)

Derivation path: TS 38.508-1 [4], Table 4.7.1-10			
Information Element	Value/remark	Comment	Condition
Payload container type	'0010'B	SMS	
Payload container	CP-ACK		

Table 9.1.8.2.3.3-16: UL NAS TRANSPORT (step 19, Table 9.1.8.2.3.2-1)

Derivation path: TS 38.508-1 [4], Table 4.7.1-10			
Information Element	Value/remark	Comment	Condition
Payload container type	'0010'B	SMS	
Payload container	CP-DATA	RP-ACK RPDU	

Table 9.1.8.2.3.3-17: DL NAS TRANSPORT (step 20, Table 9.1.8.2.3.2-1)

Derivation path: TS 38.508-1 [4], Table 4.7.1-11			
Information Element	Value/remark	Comment	Condition
Payload container type	'0010'B	SMS	
Payload container	CP-ACK		

9.1.9 RACS

9.1.9.1 RACS / Network assigned UE radio capability ID

9.1.9.1.1 Test Purpose (TP)

(1)

```
with { UE is switched on and the UE has an applicable UE radio capability ID for the current UE
radio configuration for the selected network }
ensure that {
  when { the UE performs an initial registration procedure }
  then { the UE includes the UE radio capability ID in the REGISTRATION REQUEST message }
}
```

(2)

```
with { UE in state 5GMM-REGISTERED and 5GMM-IDLE mode and having assigned a new UE Radio Capability
ID in the Registration Accept message }
ensure that {
  when { UE enters a new tracking area that is not in the list of tracking areas that the UE
previously registered in the AMF }
  then { UE sends REGISTRATION REQUEST message including the new UE radio capability ID }
}
```

9.1.9.1.2 Conformance requirements

References: The conformance requirements covered in the current TC are specified in: TS 24.501, clauses 4.16, 5.4.4.1, 5.4.4.2, 5.4.4.3, 5.4.4.4, 5.5.1.3.2

[TS 24.501, clause 4.16]

UE radio capability signalling optimisation (RACS) is a feature that is optional at both the UE and the network and which aims to optimise the transmission of UE radio capability over the radio interface (see 3GPP TS 23.501 [8]). RACS works by assigning an identifier to represent a set of UE radio capabilities. This identifier is called the UE radio capability ID. A UE radio capability ID can be either manufacturer-assigned or network-assigned. The UE radio capability ID is an alternative to the signalling of the radio capabilities container over the radio interface.

In this release of the specification, RACS is applicable to neither NB-N1 mode nor non-3GPP access.

If the UE supports RACS:

- a) the UE shall indicate support for RACS by setting the RACS bit to "RACS supported" in the 5GMM capability IE of the REGISTRATION REQUEST message;
- b) if the UE performs a registration procedure for initial registration and the UE has an applicable UE radio capability ID for the current UE radio configuration in the selected network, the UE shall include the UE radio capability ID in the UE radio capability ID IE as a non-cleartext IE in the REGISTRATION REQUEST message. If both a network-assigned UE radio capability ID and a manufacturer-assigned UE Radio Capability ID are applicable, the UE shall include the network-assigned UE radio capability ID in the REGISTRATION REQUEST message;

...

- g) if the UE performs a registration procedure for mobility and periodic registration update due to entering a tracking area that is not in the list of tracking areas that the UE previously registered in the AMF and the UE has an applicable UE radio capability ID for the current UE radio configuration in the selected network, the UE shall include the UE radio capability ID in the UE radio capability ID IE as a non-cleartext IE in the REGISTRATION REQUEST message. If both a network-assigned UE radio capability ID and a manufacturer-assigned UE Radio Capability ID are applicable, the UE shall include the network-assigned UE radio capability ID in the REGISTRATION REQUEST message.

If the network supports RACS:

- a) the network may assign a network-assigned UE radio capability ID to a UE which supports RACS by including a UE radio capability ID IE in the REGISTRATION ACCEPT message or in the CONFIGURATION UPDATE COMMAND message;

[TS 24.501, clause 5.4.4.1]

The purpose of this procedure is to:

- a) allow the AMF to update the UE configuration for access and mobility management-related parameters decided and provided by the AMF by providing new parameter information within the command; or
- b) request the UE to perform a registration procedure for mobility and periodic registration update towards the network to update access and mobility management-related parameters decided and provided by the AMF (see subclause 5.5.1.3).

...

9.1.9.1.3 Test description

9.1.9.1.3.1 Pre-test conditions

System Simulator:

- NGC Cell A configured according to Table 6.3.2.2-1 and Table 6.3.2.2-3 in 38.508-1 [4] belongs to Home PLMN and set as serving cell;
- NGC Cell B configured according to Table 6.3.2.2-1 and Table 6.3.2.2-3 in 38.508-1 [4] and set as Non-Suitable "Off" cell.
- System information combination NR-2 as defined in TS 38.508[4] clause 4.4.3.1.2 is used.

UE:

- UE is previously registered on NGC Cell A using default message contents according to TS 38.508-1 [4];

Preamble:

- The UE is in state Switched OFF (State 0N-B) as per TS 38.508-1 [4] Table 4.4A.2-0.

9.1.9.1.3.2 Test procedure sequence

Table 9.1.9.1.3.2-1: Main behaviour

St	Procedure	Message Sequence		TP	Verdict
		U – S	Message		
1	The UE is switched on.	-	-	-	-
2	Check: Does the UE transmit REGISTRATION REQUEST message including the UE radio capability ID 1?	-->	REGISTRATION REQUEST	1	P
3-11	Steps 5-13 of Table 4.5.2.2-2 of the generic procedure in TS 38.508-1 [4] are performed.	-	-	-	-
12	SS transmits a REGISTRATION ACCEPT message with a new UE radio capability ID 2.	<--	REGISTRATION ACCEPT	-	-
13-18	Steps 15-20a1 of Table 4.5.2.2-2 of the generic procedure in TS 38.508-1 [4] are performed.	-	-	-	-
19	The SS configures NGC Cell A as the "Suitable Neighbour intra-frequency cell" and NGC Cell B as the "Serving cell".	-	-	-	-
20	Check: Does the UE perform on NGC Cell B the Registration procedure for mobility registration update by executing the Test procedure to check that UE is camped on a new cell belonging to a new TA as specified in TS 38.508-1 [4] subclause 4.9.5 including the new UE radio capability ID 2 in the REGISTRATION REQUEST message?	-	-	2	P

9.1.9.1.3.3 Specific message contents

Table 9.1.9.1.3.3-1: REGISTRATION REQUEST (Preamble)

Derivation path: TS 38.508-1 [4], Table 4.7.1-6			
Information Element	Value/Remark	Comment	Condition
5GS registration type	'0000 0001'B	Initial registration	
5GMM capability			
RACS	'1'B	RACS supported	

Table 9.1.9.1.3.3-2: REGISTRATION ACCEPT (Preamble)

Derivation path: TS 38.508-1 [4], Table 4.7.1-7			
Information Element	Value/Remark	Comment	Condition
UE radio capability ID	'01000000000010'H	Type Field (TF): 1 Version ID: 00 Radio Configuration Identifier (RCI): 000000000001	

Table 9.1.9.1.3.3-3: REGISTRATION REQUEST (Step 2, Table 9.1.9.1.3.2-1)

Derivation path: TS 38.508-1 [4], Table 4.7.1-6			
Information Element	Value/Remark	Comment	Condition
5GS registration type	'0000 0001'B	Initial registration	
UE radio capability ID	'01000000000010'H	Type Field (TF): 1 Version ID: 00 Radio Configuration Identifier (RCI): 000000000001	

Table 9.1.9.1.3.3-4: REGISTRATION ACCEPT (Step 12, Table 9.1.9.1.3.2-1)

Derivation path: TS 38.508-1 [4], Table 4.7.1-7			
Information Element	Value/Remark	Comment	Condition
UE radio capability ID	'01000000000020'H	Type Field (TF): 1 Version ID: 00 Radio Configuration Identifier (RCI): 000000000002	

Table 9.1.9.1.3.3-5: REGISTRATION REQUEST (Step 20, Table 9.1.9.1.3.2-1)

Derivation path: TS 38.508-1 [4], Table 4.7.1-6			
Information Element	Value/Remark	Comment	Condition
5GS registration type	'00000010'B	mobility registration updating	
UE radio capability ID	'010000000020'H	Type Field (TF): 1 Radio Configuration Identifier (RCI): 000000000002	

9.1.9.2 RACS / UE configuration update / UE radio capability ID

9.1.9.2.1 Test Purpose (TP)

(1)

```
with { UE in 5GMM-REGISTERED state and a UE Radio Capability ID assigned in REGISTRATION ACCEPT message }
ensure that {
  when { UE receives CONFIGURATION UPDATE COMMAND with new UE Radio Capability ID and acknowledgement requested }
  then { UE sends CONFIGURATION UPDATE COMPLETE message }
}
```

(2)

```
with { UE in state 5GMM-REGISTERED, and 5GMM-IDLE mode over 3GPP access and assigned a new UE Radio Capability ID in CONFIGURATION UPDATE COMMAND }
ensure that {
  when { UE enters a new tracking area that is not in the list of tracking areas that the UE previously registered in the AMF }
  then { UE sends REGISTRATION REQUEST message including the new UE radio capability ID }
}
```

9.1.9.2.2 Conformance requirements

References: The conformance requirements covered in the current TC are specified in: TS 24.501, clauses 4.16, 5.4.4.1, 5.4.4.2, 5.4.4.3, 5.4.4.4, 5.5.1.3.2

[TS 24.501, clause 4.16]

UE radio capability signalling optimisation (RACS) is a feature that is optional at both the UE and the network and which aims to optimise the transmission of UE radio capability over the radio interface (see 3GPP TS 23.501 [8]). RACS works by assigning an identifier to represent a set of UE radio capabilities. This identifier is called the UE radio capability ID. A UE radio capability ID can be either manufacturer-assigned or network-assigned. The UE radio capability ID is an alternative to the signalling of the radio capabilities container over the radio interface.

In this release of the specification, RACS is applicable to neither NB-N1 mode nor non-3GPP access.

If the UE supports RACS:

- a) the UE shall indicate support for RACS by setting the RACS bit to "RACS supported" in the 5GMM capability IE of the REGISTRATION REQUEST message;

- b) if the UE performs a registration procedure for initial registration and the UE has an applicable UE radio capability ID for the current UE radio configuration in the selected network, the UE shall include the UE radio capability ID in the UE radio capability ID IE as a non-clear-text IE in the REGISTRATION REQUEST message. If both a network-assigned UE radio capability ID and a manufacturer-assigned UE Radio Capability ID are applicable, the UE shall include the network-assigned UE radio capability ID in the REGISTRATION REQUEST message;

...

- d) upon receiving a network-assigned UE radio capability ID in the REGISTRATION ACCEPT message or the CONFIGURATION UPDATE COMMAND message, the UE shall store the network-assigned UE radio capability ID and the PLMN ID or SNPN identity of the serving network along with a mapping to the current UE radio configuration in its non-volatile memory as specified in annex C. The UE shall be able to store at least the last 16 received network-assigned UE radio capability IDs with the associated PLMN ID or SNPN identity and the mapping to the corresponding UE radio configuration;

...

- g) if the UE performs a registration procedure for mobility and periodic registration update due to entering a tracking area that is not in the list of tracking areas that the UE previously registered in the AMF and the UE has an applicable UE radio capability ID for the current UE radio configuration in the selected network, the UE shall include the UE radio capability ID in the UE radio capability ID IE as a non-clear-text IE in the REGISTRATION REQUEST message. If both a network-assigned UE radio capability ID and a manufacturer-assigned UE Radio Capability ID are applicable, the UE shall include the network-assigned UE radio capability ID in the REGISTRATION REQUEST message.

If the network supports RACS:

- a) the network may assign a network-assigned UE radio capability ID to a UE which supports RACS by including a UE radio capability ID IE in the REGISTRATION ACCEPT message or in the CONFIGURATION UPDATE COMMAND message;

[TS 24.501, clause 5.4.4.1]

The purpose of this procedure is to:

- a) allow the AMF to update the UE configuration for access and mobility management-related parameters decided and provided by the AMF by providing new parameter information within the command; or
- b) request the UE to perform a registration procedure for mobility and periodic registration update towards the network to update access and mobility management-related parameters decided and provided by the AMF (see subclause 5.5.1.3).

...

[TS 24.501, clause 5.4.4.2]

The AMF shall initiate the generic UE configuration update procedure by sending the CONFIGURATION UPDATE COMMAND message to the UE.

The AMF shall in the CONFIGURATION UPDATE COMMAND message either:

- a) include one or more of the following parameters: 5G-GUTI, TAI list, allowed NSSAI that may include the mapped S-NSSAI(s), LADN information, service area list, MICO indication, NITZ information, configured NSSAI that may include the mapped S-NSSAI(s), rejected NSSAI, network slicing subscription change indication, operator-defined access category definitions, SMS indication, service gap time value, "CAG information list", UE radio capability ID, 5GS registration result, UE radio capability ID deletion indication or truncated 5G-S-TMSI configuration;
- b) include the Configuration update indication IE with the Registration requested bit set to "registration requested";
or
- c) include a combination of both a) and b).

If an acknowledgement from the UE is requested, the AMF shall indicate "acknowledgement requested" in the Acknowledgement bit of the Configuration update indication IE in the CONFIGURATION UPDATE

COMMAND message and shall start timer T3555. Acknowledgement shall be requested for all parameters except when only NITZ is included.

[TS 24.501, clause 5.4.4.3]

Upon receiving the CONFIGURATION UPDATE COMMAND message, the UE shall stop timer T3346 if running and use the contents to update appropriate information stored within the UE.

If "acknowledgement requested" is indicated in the Acknowledgement bit of the Configuration update indication IE in the CONFIGURATION UPDATE COMMAND message, the UE shall send a CONFIGURATION UPDATE COMPLETE message.

...

If the UE is not in NB-N1 mode, the UE has set the RACS bit to "RACS supported" in the 5GMM capability IE of the REGISTRATION REQUEST message and the CONFIGURATION UPDATE COMMAND message includes:

- a) a UE radio capability ID deletion indication IE set to "Network-assigned UE radio capability IDs deletion requested", the UE shall delete any network-assigned UE radio capability IDs associated with the RPLMN or RSNPN stored at the UE; and
- b) a UE radio capability ID IE, the UE shall store the UE radio capability ID as specified in annex C

9.1.9.2.3 Test description

9.1.9.2.3.1 Pre-test conditions

System Simulator:

- NGC Cell A configured according to Table 6.3.2.2-1 and Table 6.3.2.2-3 in 38.508-1 [4] belongs to Home PLMN and set as serving cell;
- NGC Cell B configured according to Table 6.3.2.2-1 and Table 6.3.2.2-3 in 38.508-1 [4] and set as Non-Suitable "Off" cell.
- System information combination NR-2 as defined in TS 38.508[4] clause 4.4.3.1.2 is used.

UE:

None

Preamble:

- The UE is in state 3N-A on NGC cell A according to TS 38.508-1 [4].

9.1.9.2.3.2 Test procedure sequence

Table 9.1.9.2.3.2-1: Main behaviour

St	Procedure	Message Sequence		TP	Verdict
		U – S	Message		
1	The SS transmits CONFIGURATION UPDATE COMMAND including a new UE Radio Capability ID	<--	CONFIGURATION UPDATE COMMAND	-	-
2	Check: Does UE transmit CONFIGURATION UPDATE COMPLETE	-->	CONFIGURATION UPDATE COMPLETE	1	P
3	The SS transmits an <i>RRRelease</i> message.	-	-	-	-
4	The SS configures NGC Cell A as the "Non-suitable cell" and NGC Cell B as the "Serving cell".	-	-	-	-
5	Check: Does the UE perform on NGC Cell B the Registration procedure for mobility registration update by executing the Test procedure to check that UE is camped on a	-	-	2	P

	new cell belonging to a new TA as specified in TS 38.508-1 [4] subclause 4.9.5?			
--	---	--	--	--

9.1.9.2.3.3 Specific message contents

Table 9.1.9.2.3.3-1: REGISTRATION REQUEST (Preamble)

Derivation path: TS 38.508-1 [4], Table 4.7.1-6			
Information Element	Value/Remark	Comment	Condition
5GS registration type	'0000 0001'B	Initial registration	
5GMM capability			
RACS	'1'B	RACS supported	

Table 9.1.9.2.3.3-2: REGISTRATION ACCEPT (Preamble)

Derivation path: TS 38.508-1 [4], Table 4.7.1-7			
Information Element	Value/Remark	Comment	Condition
UE radio capability ID	'01000000000050'H	Type Field (TF): 1 Version ID: '00'H Radio Configuration Identifier (RCI): 0000000005	

Table 9.1.9.2.3.3-3: CONFIGURATION UPDATE COMMAND (step 1, Table 9.1.9.2.3.2-1)

Derivation path: TS 38.508-1 [4], Table 4.7.1-19			
Information Element	Value/Remark	Comment	Condition
Configuration update indication	'11010001'B	Acknowledgement Requested	
UE radio capability ID	'01000000000070'H	Type Field (TF): '1'H Version ID: '00'H Radio Configuration Identifier (RCI): '0000000007'H	

Table 9.1.9.2.3.3-4: REGISTRATION REQUEST (step 5, Table 9.1.9.2.3.2-1)

Derivation path: TS 38.508-1 [4], Table 4.7.1-6			
Information Element	Value/Remark	Comment	Condition
5GS registration type	'00000010'B	mobility registration updating	
UE radio capability ID	'01000000000070'H	Type Field (TF): '1'H Version ID: '00'H Radio Configuration Identifier (RCI): '0000000007'H	

9.1.9.3 RACS / PLMN change within registration area / From NW assigned to Manufacturer assigned UE Radio Capability ID

9.1.9.3.1 Test Purpose (TP)

(1)

with { UE in state 5GMM-REGISTERED and 5GMM-IDLE mode and NW has not assigned a UE Radio Capability ID in the Registration Accept message }
ensure that {

```

when { UE enters a new tracking area that is not in the list of tracking areas that the UE
previously registered in the AMF }
  then { UE sends REGISTRATION REQUEST message including the manufacturer-assigned UE Radio
Capability ID }
}

```

(2)

```

with { UE in state 5GMM-REGISTERED and 5GMM-IDLE mode and having assigned a new UE Radio Capability
ID in the Registration Accept message }
ensure that {
  when { UE moves to cell belong to another equivalent PLMN }
  then { UE sends REGISTRATION REQUEST message including the manufacturer-assigned UE Radio
Capability ID }
}

```

9.1.9.3.2 Conformance requirements

References: The conformance requirements covered in the current TC are specified in: TS 24.501, clauses 4.16, 5.5.1.3 [TS 24.501, clause 4.16]

UE radio capability signalling optimisation (RACS) is a feature that is optional at both the UE and the network and which aims to optimise the transmission of UE radio capability over the radio interface (see 3GPP TS 23.501 [8]). RACS works by assigning an identifier to represent a set of UE radio capabilities. This identifier is called the UE radio capability ID. A UE radio capability ID can be either manufacturer-assigned or network-assigned. The UE radio capability ID is an alternative to the signalling of the radio capabilities container over the radio interface.

In this release of the specification, RACS is applicable to neither NB-N1 mode nor non-3GPP access.

If the UE supports RACS:

- a) the UE shall indicate support for RACS by setting the RACS bit to "RACS supported" in the 5GMM capability IE of the REGISTRATION REQUEST message;
- b) if the UE performs a registration procedure for initial registration and the UE has an applicable UE radio capability ID for the current UE radio configuration in the selected network, the UE shall include the UE radio capability ID in the UE radio capability ID IE as a non-clear-text IE in the REGISTRATION REQUEST message. If both a network-assigned UE radio capability ID and a manufacturer-assigned UE Radio Capability ID are applicable, the UE shall include the network-assigned UE radio capability ID in the REGISTRATION REQUEST message;
- ...
- e) the UE shall not use a network-assigned UE radio capability ID assigned by a PLMN in PLMNs equivalent to the PLMN which assigned it;
- f) upon receiving a UE radio capability ID deletion indication IE set to "Network-assigned UE radio capability IDs deletion requested" in the REGISTRATION ACCEPT message or the CONFIGURATION UPDATE COMMAND message, the UE shall delete all network-assigned UE radio capability IDs stored at the UE for the serving network, initiate a registration procedure for mobility and periodic registration update and include an applicable manufacturer-assigned UE radio capability ID for the current UE radio configuration, if available at the UE, in the UE radio capability ID IE of the REGISTRATION REQUEST message; and
- g) if the UE performs a registration procedure for mobility and periodic registration update due to entering a tracking area that is not in the list of tracking areas that the UE previously registered in the AMF and the UE has an applicable UE radio capability ID for the current UE radio configuration in the selected network, the UE shall include the UE radio capability ID in the UE radio capability ID IE as a non-clear-text IE in the REGISTRATION REQUEST message. If both a network-assigned UE radio capability ID and a manufacturer-assigned UE Radio Capability ID are applicable, the UE shall include the network-assigned UE radio capability ID in the REGISTRATION REQUEST message.

If the network supports RACS:

- a) the network may assign a network-assigned UE radio capability ID to a UE which supports RACS by including a UE radio capability ID IE in the REGISTRATION ACCEPT message or in the CONFIGURATION UPDATE COMMAND message;

[TS 24.501, clause 5.5.1.3]

When the UE is not in NB-N1 mode, if the UE supports RACS, the UE shall:

- a) set the RACS bit to "RACS supported" in the 5GMM capability IE of the REGISTRATION REQUEST message;
- b) if the UE has an applicable network-assigned UE radio capability ID for the current UE radio configuration in the selected PLMN or SNPN, include the applicable network-assigned UE radio capability ID in the UE radio capability ID IE of the REGISTRATION REQUEST message; and
- c) if the UE:
 - 1) does not have an applicable network-assigned UE radio capability ID for the current UE radio configuration in the selected PLMN or SNPN; and
 - 2) has an applicable manufacturer-assigned UE radio capability ID for the current UE radio configuration, include the applicable manufacturer-assigned UE radio capability ID in the UE radio capability ID IE of the REGISTRATION REQUEST message.

...

9.1.9.3.3 Test description

9.1.9.3.3.1 Pre-test conditions

System Simulator:

- NGC Cell A configured according to Table 6.3.2.2-1 and Table 6.3.2.2-3 in 38.508-1 [4] belongs to Home PLMN and set as serving cell;
- NGC Cell B and NGC Cell E configured according to Table 6.3.2.2-1 and Table 6.3.2.2-3 in 38.508-1 [4] and set as Non-Suitable "Off" cell.
- System information combination NR-2 as defined in TS 38.508[4] clause 4.4.3.1.2 is used.

UE:

- UE is previously registered on NGC Cell A using default message contents according to TS 38.508-1 [4];

Preamble:

- The UE is in test state (State 1N-A) as per TS 38.508-1 [4] Table 4.4A.2-0.

9.1.9.3.3.2 Test procedure sequence

Table 9.1.9.3.3.2-1: Main behaviour

St	Procedure	Message Sequence		TP	Verdict
		U – S	Message		
1	The SS configures: - NGC Cell B as the "Serving cell". - NGC Cell A, and NGC Cell E as a "Non-suitable 'Off' cell".	-	-	-	-
-	The following messages are to be observed on NGC Cell B unless explicitly stated otherwise	-	-	-	-
2	Check: Does the UE transmit REGISTRATION REQUEST message including manufactured-assigned UE Radio Capability ID?	-->	REGISTRATION REQUEST	1	P
3	SS transmits a REGISTRATION ACCEPT message with a Network assigned UE radio capability ID and with PLMN ID of NGC Cell E included in the Equivalent PLMNs IE.	<--	REGISTRATION ACCEPT	-	-

4	The UE transmits a REGISTRATION COMPLETE message.	-->	REGISTRATION COMPLETE	-	-
5	The SS releases the RRC connection.	-	-	-	-
6	The SS configures: - NGC Cell E as the "Serving cell". - NGC Cell A, and NGC Cell B as a "Non-suitable 'Off' cell".	-	-	-	-
-	The following messages are to be observed on NGC Cell E unless explicitly stated otherwise	-	-	-	-
7	Check: Does the UE transmit REGISTRATION REQUEST message including manufactured-assigned UE Radio Capability ID?	-->	REGISTRATION REQUEST	2	P
8	SS transmits a REGISTRATION ACCEPT message with a Network assigned UE radio capability ID.	<--	REGISTRATION ACCEPT	-	-
9	The UE transmits a REGISTRATION COMPLETE message.	-->	REGISTRATION COMPLETE	-	-

9.1.9.3.3.3 Specific message contents

Table 9.1.9.3.3.3-1: REGISTRATION REQUEST (Preamble)

Derivation path: TS 38.508-1 [4], Table 4.7.1-6			
Information Element	Value/Remark	Comment	Condition
5GS registration type	'0000 0001'B	Initial registration	
5GMM capability			
RACS	'1'B	RACS supported	

Table 9.1.9.3.3.3-2: REGISTRATION ACCEPT (Preamble)

Derivation path: TS 38.508-1 [4], Table 4.7.1-7			
Information Element	Value/Remark	Comment	Condition
UE radio capability ID	Not Present	Network Radio capability ID is not assigned	

Table 9.1.9.3.3.3-3: REGISTRATION REQUEST (Step 2, Table 9.1.9.3.3.2-1)

Derivation path: TS 38.508-1 [4], Table 4.7.1-6			
Information Element	Value/Remark	Comment	Condition
5GS registration type	'0000 0010'B	mobility registration updating	
UE radio capability ID	'X0XXXXXXXXXXXXXXXXXXXX'H	Type Field (TF): 0 Vendor ID: XXXXXXXXXX(Note) Radio Configuration Identifier (RCI): XXXXXXXXXXXX	
Note: Vendor ID is assigned by Internet Assigned Numbers Authority as per TS 23.003 [34], cl.29.2. The value is not checked.			

Table 9.1.9.3.3.3-4: REGISTRATION ACCEPT (Step 3, Table 9.1.9.3.3.2-1)

Derivation path: TS 38.508-1 [4], Table 4.7.1-7			
Information Element	Value/Remark	Comment	Condition
UE radio capability ID	'01000000000010'H	Type Field (TF): 1Version ID: 00 Radio Configuration Identifier (RCI): 000000000001	
Equivalent PLMNs	MCC=002, MNC=101	PLMN ID of NGC Cell E	

Table 9.1.9.3.3-5: REGISTRATION REQUEST (Step 7, Table 9.1.9.3.3-1)

Derivation path: TS 38.508-1 [4], Table 4.7.1-6			
Information Element	Value/Remark	Comment	Condition
5GS registration type	'0000 0010'B	mobility registration updating	
UE radio capability ID	'X0XXXXXXXXXXXXXXXXXXXX'H	Type Field (TF): 0 Vendor ID: XXXXXXXX(Note) Radio Configuration Identifier (RCI): XXXXXXXXXXXX	
Note: Vendor ID is assigned by Internet Assigned Numbers Authority as per TS 23.003 [34], cl.29.2.The value is not checked.			

Table 9.1.9.1.3-6: REGISTRATION ACCEPT (Step 8, Table 9.1.9.3.3-1)

Derivation path: TS 38.508-1 [4], Table 4.7.1-7			
Information Element	Value/Remark	Comment	Condition
UE radio capability ID	'01000000000010'H	Type Field (TF): 1 Version ID: 00 Radio Configuration Identifier (RCI): 000000000001	

9.1.9.4 RACS / USIM change / Handling of URCID

9.1.9.4.1 Test Purpose (TP)

(1)

```

with { UE in state 5GMM-REGISTERED and 5GMM-IDLE mode and having assigned a UE Radio Capability ID
in the REGISTRATION ACCEPT message }
ensure that {
  when { UE is powered on or switched on with USIM having different SUPI }
  then { UE does not include the UE radio capability ID in the REGISTRATION REQUEST message }
}

```

9.1.9.4.2 Conformance requirements

References: The conformance requirements covered in the present TC are specified in: TS 24.501, clause 4.16, Annex C.

[TS 24.501, clause 4.16]

UE radio capability signalling optimisation (RACS) is a feature that is optional at both the UE and the network and which aims to optimise the transmission of UE radio capability over the radio interface (see 3GPP TS 23.501 [8]). RACS works by assigning an identifier to represent a set of UE radio capabilities. This identifier is called the UE radio capability ID. A UE radio capability ID can be either manufacturer-assigned or network-assigned. The UE radio capability ID is an alternative to the signalling of the radio capabilities container over the radio interface.

In this release of the specification, RACS is applicable to neither NB-N1 mode nor non-3GPP access.

If the UE supports RACS:

- a) the UE shall indicate support for RACS by setting the RACS bit to "RACS supported" in the 5GMM capability IE of the REGISTRATION REQUEST message;
- b) if the UE performs a registration procedure for initial registration and the UE has an applicable UE radio capability ID for the current UE radio configuration in the selected network, the UE shall include the UE radio capability ID in the UE radio capability ID IE as a non-cleartext IE in the REGISTRATION REQUEST

message. If both a network-assigned UE radio capability ID and a manufacturer-assigned UE Radio Capability ID are applicable, the UE shall include the network-assigned UE radio capability ID in the REGISTRATION REQUEST message;

If the network supports RACS:

- a) the network may assign a network-assigned UE radio capability ID to a UE which supports RACS by including a UE radio capability ID IE in the REGISTRATION ACCEPT message or in the CONFIGURATION UPDATE COMMAND message;

[TS 24.501, Annex C]

The following 5GMM parameters shall be stored in a non-volatile memory in the ME together with the SUPI from the USIM:

- configured NSSAI(s);
- NSSRG information;
- NSSAI inclusion mode(s);
- MPS indicator;
- MCS indicator;
- operator-defined access category definitions;
- network-assigned UE radio capability IDs;

...

Each network-assigned UE radio capability ID is stored together with a PLMN identity of the PLMN that provided it as well as a mapping to the corresponding UE radio configuration, and is valid in that PLMN. A network-assigned UE radio capability ID can only be used if the SUPI from the USIM matches the SUPI stored in the non-volatile memory of the ME, else the UE shall delete the network-assigned UE radio capability ID.

9.1.9.4.3 Test description

9.1.9.4.3.1 Pre-test conditions

System Simulator:

- NGC Cell A configured according to Table 6.3.2.2-1 and Table 6.3.2.2-3 in 38.508-1 [4] belongs to Home PLMN and set as serving cell;

UE:

- The UE is equipped with a USIM containing default values (as per 38.508-1 [4])

Preamble:

- The UE is in test state 1N-A as defined in 38.508-1 [4], subclause 4.4A.2 on NGC Cell A.

9.1.9.4.3.2 Test procedure sequence

Table 9.1.9.4.3.2-1: Main behaviour

St	Procedure	Message Sequence		TP	Verdict
		U - S	Message		
1	The generic test procedure in TS 38.508-1 [4] Table 4.9.6.1-1 of Switch off procedure in RRC_IDLE are performed.	-	-	-	-
2	The UE is brought back to operation with USIM configuration 25 as defined in TS 38.508-1 [4]	-	-	-	-

	Table 6.4.1-25.				
3	Check: Does the UE transmit an REGISTRATION REQUEST message without including UE radio capability ID?	-->	REGISTRATION REQUEST	1	P
4-19a 1	Steps 5-20a1 of Table 4.5.2.2-2 of the generic procedure in TS 38.508-1 [4] are performed.	-	-	-	-

9.1.9.4.3.3 Specific message contents

Table 9.1.9.4.3.3-1: REGISTRATION REQUEST (Preamble)

Derivation path: TS 38.508-1 [4], Table 4.7.1-6			
Information Element	Value/Remark	Comment	Condition
5GS registration type	'0000 0001'B	Initial registration	
5GMM capability			
RACS	'1'B	RACS supported	

Table 9.1.9.4.3.3-2: REGISTRATION ACCEPT (Preamble)

Derivation path: TS 38.508-1 [4], Table 4.7.1-7			
Information Element	Value/Remark	Comment	Condition
UE radio capability ID	'01000000000010'H	Type Field (TF): 1 Version ID: 00 Radio Configuration Identifier (RCI): 000000000001	

Table 9.1.9.4.3.3-3: REGISTRATION REQUEST (step 3, Table 9.1.9.4.3.2-1)

Derivation path: TS 38.508-1 [4], Table 4.7.1-6			
Information Element	Value/Remark	Comment	Condition
5GS registration type	'00000001'B	Initial registration	
UE radio capability ID	Not present		

9.1.9.5 RACS / Handling of delete indication for NW assigned UE radio capability ID

9.1.9.5.1 Test Purpose (TP)

(1)

```
with { UE in 5GMM-REGISTERED state and a UE Radio Capability ID assigned in REGISTRATION ACCEPT message }
ensure that {
  when { UE receives CONFIGURATION UPDATE COMMAND with UE radio capability ID deletion indication and indicating "registration requested" }
  then { UE deletes any stored Network-assigned UE radio capability IDs and then releases the existing N1 NAS signalling connection, starts a mobility registration procedure and does not include any Network-assigned UE radio capability IDs in the REGISTRATION REQUEST message }
}
```

(2)

```
with { UE in state 5GMM-REGISTERED, and 5GMM-IDLE mode over 3GPP access and assigned a new UE Radio Capability ID, enters a new tracking area that is not in the list of tracking areas that the UE previously registered in the AMF }
ensure that {
  when { UE receives REGISTRATION ACCEPT message with UE radio capability ID deletion indication }
  then { UE deletes the stored Network-assigned UE radio capability ID and initiate a registration procedure for mobility and periodic registration update over the existing N1 NAS signalling connection}
}
```

}

9.1.9.5.2 Conformance requirements

References: The conformance requirements covered in the current TC are specified in: TS 24.501, clauses 4.16, 5.4.4.1, 5.4.4.2, 5.4.4.3, 5.5.1.2.4. Unless otherwise stated these are Rel-16 requirements.

[TS 24.501, clause 4.16]

UE radio capability signalling optimisation (RACS) is a feature that is optional at both the UE and the network and which aims to optimise the transmission of UE radio capability over the radio interface (see 3GPP TS 23.501 [8]). RACS works by assigning an identifier to represent a set of UE radio capabilities. This identifier is called the UE radio capability ID. A UE radio capability ID can be either manufacturer-assigned or network-assigned. The UE radio capability ID is an alternative to the signalling of the radio capabilities container over the radio interface.

In this release of the specification, RACS is applicable to neither NB-N1 mode nor non-3GPP access.

If the UE supports RACS:

- a) the UE shall indicate support for RACS by setting the RACS bit to "RACS supported" in the 5GMM capability IE of the REGISTRATION REQUEST message;
- b) if the UE performs a registration procedure for initial registration and the UE has an applicable UE radio capability ID for the current UE radio configuration in the selected network, the UE shall include the UE radio capability ID in the UE radio capability ID IE as a non-clear-text IE in the REGISTRATION REQUEST message. If both a network-assigned UE radio capability ID and a manufacturer-assigned UE Radio Capability ID are applicable, the UE shall include the network-assigned UE radio capability ID in the REGISTRATION REQUEST message;
- ...
- d) upon receiving a network-assigned UE radio capability ID in the REGISTRATION ACCEPT message or the CONFIGURATION UPDATE COMMAND message, the UE shall store the network-assigned UE radio capability ID and the PLMN ID or SNPN identity of the serving network along with a mapping to the current UE radio configuration in its non-volatile memory as specified in annex C. The UE shall be able to store at least the last 16 received network-assigned UE radio capability IDs with the associated PLMN ID or SNPN identity and the mapping to the corresponding UE radio configuration;
- ...
- f) upon receiving a UE radio capability ID deletion indication IE set to "delete network-assigned UE radio capability IDs" in the REGISTRATION ACCEPT message or the CONFIGURATION UPDATE COMMAND message, the UE shall delete all network-assigned UE radio capability IDs stored at the UE for the serving network, initiate a registration procedure for mobility and periodic registration update and include an applicable manufacturer-assigned UE radio capability ID for the current UE radio configuration, if available at the UE, in the UE radio capability ID IE of the REGISTRATION REQUEST message; and
- g) if the UE performs a registration procedure for mobility and periodic registration update due to entering a tracking area that is not in the list of tracking areas that the UE previously registered in the AMF and the UE has an applicable UE radio capability ID for the current UE radio configuration in the selected network, the UE shall include the UE radio capability ID in the UE radio capability ID IE as a non-clear-text IE in the REGISTRATION REQUEST message. If both a network-assigned UE radio capability ID and a manufacturer-assigned UE Radio Capability ID are applicable, the UE shall include the network-assigned UE radio capability ID in the REGISTRATION REQUEST message.

If the network supports RACS:

- a) the network may assign a network-assigned UE radio capability ID to a UE which supports RACS by including a UE radio capability ID IE in the REGISTRATION ACCEPT message or in the CONFIGURATION UPDATE COMMAND message;

[TS 24.501, clause 5.4.4.1]

The purpose of this procedure is to:

- a) allow the AMF to update the UE configuration for access and mobility management-related parameters decided and provided by the AMF by providing new parameter information within the command; or
- b) request the UE to perform a registration procedure for mobility and periodic registration update towards the network to update access and mobility management-related parameters decided and provided by the AMF (see subclause 5.5.1.3).

...

[TS 24.501, clause 5.4.4.2]

The AMF shall initiate the generic UE configuration update procedure by sending the CONFIGURATION UPDATE COMMAND message to the UE.

The AMF shall in the CONFIGURATION UPDATE COMMAND message either:

- a) include one or more of the following parameters: 5G-GUTI, TAI list, allowed NSSAI that may include the mapped S-NSSAI(s), LADN information, service area list, MICO indication, NITZ information, configured NSSAI that may include the mapped S-NSSAI(s), rejected NSSAI, network slicing subscription change indication, operator-defined access category definitions, SMS indication, service gap time value, "CAG information list", UE radio capability ID, 5GS registration result, UE radio capability ID deletion indication or truncated 5G-S-TMSI configuration;
- b) include the Configuration update indication IE with the Registration requested bit set to "registration requested"; or
- c) include a combination of both a) and b).

If an acknowledgement from the UE is requested, the AMF shall indicate "acknowledgement requested" in the Acknowledgement bit of the Configuration update indication IE in the CONFIGURATION UPDATE COMMAND message and shall start timer T3555. Acknowledgement shall be requested for all parameters except when only NITZ is included.

...

If the AMF includes a UE radio capability ID deletion indication IE in the CONFIGURATION UPDATE COMMAND message, the AMF shall indicate "registration requested" in the Registration requested bit of the Configuration update indication IE.

...

If the UE is not in NB-N1 mode and the UE supports RACS, the AMF may include either a UE radio capability ID IE or a UE radio capability ID deletion indication IE in the CONFIGURATION UPDATE COMMAND message.

...

[TS 24.501, clause 5.4.4.3]

Upon receiving the CONFIGURATION UPDATE COMMAND message, the UE shall stop timer T3346 if running and use the contents to update appropriate information stored within the UE.

If "acknowledgement requested" is indicated in the Acknowledgement bit of the Configuration update indication IE in the CONFIGURATION UPDATE COMMAND message, the UE shall send a CONFIGURATION UPDATE COMPLETE message.

...

If the CONFIGURATION UPDATE COMMAND message indicates "registration requested" in the Registration requested bit of the Configuration update indication IE and:

...

- d) a UE radio capability ID deletion indication IE set to "Network-assigned UE radio capability IDs deletion requested" is included, and:
 - 1) the UE is not in NB-N1 mode;

- 2) a new allowed NSSAI, a new configured NSSAI or a Network slicing subscription change indication is not included; and
- 3) the UE has set the RACS bit to "RACS supported" in the 5GMM capability IE of the REGISTRATION REQUEST message,

the UE shall, after the completion of the generic UE configuration update procedure, start a registration procedure for mobility and registration update as specified in subclause 5.5.1.3.

...

If the UE is not in NB-N1 mode, the UE has set the RACS bit to "RACS supported" in the 5GMM capability IE of the REGISTRATION REQUEST message and the CONFIGURATION UPDATE COMMAND message includes:

- a) a UE radio capability ID deletion indication IE set to "Network-assigned UE radio capability IDs deletion requested", the UE shall delete any network-assigned UE radio capability IDs associated with the RPLMN or RSNPN stored at the UE; and
- b) a UE radio capability ID IE, the UE shall store the UE radio capability ID as specified in annex C

[TS 24.501, clause 5.5.1.2.4]

If the UE is not in NB-N1 mode, the UE has set the RACS bit to "RACS supported" in the 5GMM Capability IE of the REGISTRATION REQUEST message and the REGISTRATION ACCEPT message includes:

- a) a UE radio capability ID deletion indication IE set to "Network-assigned UE radio capability IDs deletion requested", the UE shall delete any network-assigned UE radio capability IDs associated with the RPLMN or RSNPN stored at the UE, then the UE shall, after the completion of the ongoing registration procedure, initiate a registration procedure for mobility and periodic registration update as specified in subclause 5.5.1.3.2 over the existing N1 NAS signalling connection; and
- b) a UE radio capability ID IE, the UE shall store the UE radio capability ID as specified in annex C.

9.1.9.5.3 Test description

9.1.9.5.3.1 Pre-test conditions

System Simulator:

- NGC Cell A configured according to Table 6.3.2.2-1 and Table 6.3.2.2-3 in 38.508-1 [4] belongs to Home PLMN and set as serving cell;
- NGC Cell B configured according to Table 6.3.2.2-1 and Table 6.3.2.2-3 in 38.508-1 [4] and set as Non-Suitable "Off" cell.
- System information combination NR-2 as defined in TS 38.508[4] clause 4.4.3.1.2 is used.

UE:

None

Preamble:

- The UE is in state 3N-A on NGC cell A according to TS 38.508-1 [4].

9.1.9.5.3.2 Test procedure sequence

Table 9.1.9.5.3.2-1: Main behaviour

St	Procedure	Message Sequence		TP	Verdict
		U – S	Message		
1	The SS transmits CONFIGURATION UPDATE COMMAND including UE radio capability ID deletion indication.	<--	CONFIGURATION UPDATE COMMAND	-	-

2	Check: Does UE transmit CONFIGURATION UPDATE COMPLETE	-->	CONFIGURATION UPDATE COMPLETE	-	-
3	SS releases the RRC connection.	-	-	-	-
4	Check: Does UE transmit a REGISTRATION REQUEST message and does not include any Network-assigned UE radio capability ID?	-->	REGISTRATION REQUEST	1	P
5	The SS transmits a REGISTRATION ACCEPT message including a UE radio capability ID.	<--	REGISTRATION ACCEPT	-	-
6	The UE transmits an <i>ULInformationTransfer</i> message and a REGISTRATION COMPLETE message.	-->	REGISTRATION COMPLETE	-	-
7	The SS transmits an <i>RRCRelease</i> message.	-	-	-	-
8	The SS configures NGC Cell A as the "Non-suitable Off cell" and NGC Cell B as the "Serving cell".	-	-	-	-
9	The UE initiates a Registration procedure for mobility registration update by transmitting a REGISTRATION REQUEST message on NGC Cell B and includes the UE radio capability ID assigned at step 5.	-->	REGISTRATION REQUEST	-	-
10	The SS transmits REGISTRATION ACCEPT message including UE radio capability ID deletion indication.	<--	REGISTRATION ACCEPT	-	-
11	The UE transmits an <i>ULInformationTransfer</i> message and a REGISTRATION COMPLETE message.	-->	REGISTRATION COMPLETE	-	-
12	Check: Does UE transmit a REGISTRATION REQUEST message and does not include any Network-assigned UE radio capability ID?	-->	REGISTRATION REQUEST	2	P
13	The SS transmits a REGISTRATION ACCEPT message.	<--	REGISTRATION ACCEPT	-	-
14	The UE transmits an <i>ULInformationTransfer</i> message and a REGISTRATION COMPLETE message.	-->	REGISTRATION COMPLETE	-	-
15	The SS transmits an <i>RRCRelease</i> message.	-	-	-	-

9.1.9.5.3.3 Specific message contents

Table 9.1.9.5.3.3-1: REGISTRATION REQUEST (Preamble)

Derivation path: TS 38.508-1 [4], Table 4.7.1-6			
Information Element	Value/Remark	Comment	Condition
5GS registration type	'0000 0001'B	Initial registration	
5GMM capability			
RACS	'1'B	RACS supported	

Table 9.1.9.5.3.3-2: REGISTRATION ACCEPT (Preamble)

Derivation path: TS 38.508-1 [4], Table 4.7.1-7			
Information Element	Value/Remark	Comment	Condition
UE radio capability ID	'01000000000010'H	Type Field (TF): 1 Version ID: 00 Radio Configuration Identifier (RCI): 0000000001	

Table 9.1.9.5.3.3-3: CONFIGURATION UPDATE COMMAND (step 1, Table 9.1.9.5.3.2-1)

Derivation path: TS 38.508-1 [4], Table 4.7.1-19			
Information Element	Value/Remark	Comment	Condition
Configuration update indication	'11010011'B	Registration and Acknowledgement (ACK) requested	

UE radio capability ID deletion indication	001	Network-assigned UE radio capability IDs deletion requested	
--	-----	---	--

Table 9.1.9.5.3.3-4: REGISTRATION REQUEST (step 4 and 12, Table 9.1.9.5.3.2-1)

Derivation path: TS 38.508-1 [4], Table 4.7.1-6			
Information Element	Value/Remark	Comment	Condition
5GS registration type	'0000 0001'B	mobility registration updating	
UE radio capability ID	Not present or 'x0xxxxxxxxxxxxxxxxx'H	Manufacturer assigned UE radio capability ID, If present	

Table 9.1.9.5.3.3-5: REGISTRATION ACCEPT (step 5, Table 9.1.9.5.3.2-1)

Derivation path: TS 38.508-1 [4], Table 4.7.1-7			
Information Element	Value/Remark	Comment	Condition
UE radio capability ID	'01000000000020'H	Type Field (TF): 1 Version ID: 00 Radio Configuration Identifier (RCI): 00000000002	

Table 9.1.9.2.3.3-6: REGISTRATION REQUEST (step 9, Table 9.1.9.2.3.2-1)

Derivation path: TS 38.508-1 [4], Table 4.7.1-6			
Information Element	Value/Remark	Comment	Condition
5GS registration type	'00000010'B	mobility registration updating	
UE radio capability ID	'01000000000020'H	Type Field (TF): '1'H Version ID: 00 Radio Configuration Identifier (RCI): '00000000002'H	

Table 9.1.9.5.3.3-7: REGISTRATION ACCEPT (step 10, Table 9.1.9.5.3.2-1)

Derivation path: TS 38.508-1 [4], Table 4.7.1-7			
Information Element	Value/Remark	Comment	Condition
UE radio capability ID deletion indication	001	Network-assigned UE radio capability IDs deletion requested	

Table 9.1.9.5.3.3-8: REGISTRATION ACCEPT (step 13, Table 9.1.9.5.3.2-1)

Derivation path: TS 38.508-1 [4], Table 4.7.1-7			
Information Element	Value/Remark	Comment	Condition
UE radio capability ID	Not Present		

9.1.9.6 RACS / Change in radio capability / NW assigned URCID

9.1.9.6.1 Test Purpose (TP)

(1)

```

with { UE in 5GMM-REGISTERED state, and 5GMM-IDLE mode over 3GPP access and a UE Radio Capability ID
assigned in REGISTRATION ACCEPT message }
ensure that {
  when { radio configuration at the UE changes}
    then { UE initiate a registration procedure for mobility and periodic registration update over
the existing N1 NAS signalling connection, and includes the 5GS update type IE in the REGISTRATION
REQUEST message with the NG-RAN-RCU bit set to "UE radio capability update needed" and uses the
network assigned ID }
}

```

9.1.9.6.2 Conformance requirements

References: The conformance requirements covered in the current TC are specified in: TS 24.501, clauses 4.16, 5.5.1.3.2

[TS 24.501, clause 4.16]

UE radio capability signalling optimisation (RACS) is a feature that is optional at both the UE and the network and which aims to optimise the transmission of UE radio capability over the radio interface (see 3GPP TS 23.501 [8]). RACS works by assigning an identifier to represent a set of UE radio capabilities. This identifier is called the UE radio capability ID. A UE radio capability ID can be either manufacturer-assigned or network-assigned. The UE radio capability ID is an alternative to the signalling of the radio capabilities container over the radio interface.

In this release of the specification, RACS is applicable to neither NB-N1 mode nor non-3GPP access.

If the UE supports RACS:

- a) the UE shall indicate support for RACS by setting the RACS bit to "RACS supported" in the 5GMM capability IE of the REGISTRATION REQUEST message;
- c) if the radio configuration at the UE changes (for instance because the UE has disabled a specific radio capability) then:
 - 1) if the UE has an applicable UE radio capability ID for the new UE radio configuration, the UE shall initiate a registration procedure for mobility and periodic registration update. The UE shall include the applicable UE radio capability ID in the UE radio capability ID IE of the REGISTRATION REQUEST message and shall include the 5GS update type IE in the REGISTRATION REQUEST message with the NG-RAN-RCU bit set to "UE radio capability update needed". If both a network-assigned UE radio capability ID and a manufacturer-assigned UE Radio Capability ID are applicable, the UE shall include the network-assigned UE radio capability ID in the REGISTRATION REQUEST message; and
 - 2) if the UE does not have an applicable UE radio capability ID for the new UE radio configuration, the UE shall initiate a registration procedure for mobility and periodic registration update and include the 5GS update type IE in the REGISTRATION REQUEST message with the NG-RAN-RCU bit set to "UE radio capability update needed";

NOTE: Performing the registration procedure for mobility and periodic registration update and including the 5GS update type IE in the REGISTRATION REQUEST message with the NG-RAN-RCU bit set to "UE radio capability update needed" without a UE radio capability ID included in the REGISTRATION REQUEST message can trigger the network to assign a new UE radio capability ID to the UE.

...

If the network supports RACS:

- a) the network may assign a network-assigned UE radio capability ID to a UE which supports RACS by including a UE radio capability ID IE in the REGISTRATION ACCEPT message or in the CONFIGURATION UPDATE COMMAND message;

[TS 24.501, clause 5.5.1.3.2]

- m) when the UE needs to indicate PDU session status to the network after performing a local release of PDU session(s) as specified in subclauses 6.4.1.5 and 6.4.3.5;
- n) when the UE in 5GMM-IDLE mode changes the radio capability for NG-RAN or E-UTRAN;

...

For case n), the UE shall include the 5GS update type IE in the REGISTRATION REQUEST message with the NG-RAN-RCU bit set to " UE radio capability update needed". Additionally, if the UE is not in NB-N1 mode, the UE supports RACS and the UE has an applicable UE radio capability ID for the new UE radio configuration in the serving PLMN or SNPN, the UE shall include the applicable UE radio capability ID in the UE radio capability ID of the REGISTRATION REQUEST message.

...

If the UE is not in NB-N1 mode and the UE has set the RACS bit to "RACS supported" in the 5GMM Capability IE of the REGISTRATION REQUEST message, the AMF may include either a UE radio capability ID IE or a UE radio capability ID deletion indication IE in the REGISTRATION ACCEPT message. If the UE radio capability ID IE or the UE radio capability ID deletion indication IE is included in the REGISTRATION ACCEPT message, the AMF shall start timer T3550 and enter state 5GMM-COMMON-PROCEDURE-INITIATED as described in subclause 5.1.3.2.3.3.

...

9.1.9.6.3 Test description

9.1.9.6.3.1 Pre-test conditions

System Simulator:

- NGC Cell A configured according to Table 6.3.2.2-1 and Table 6.3.2.2-3 in 38.508-1 [4] belongs to Home PLMN and set as serving cell;

UE:

None

Preamble:

- The UE is in state 1N-A on NGC cell A according to TS 38.508-1 [4].

9.1.9.6.3.2 Test procedure sequence

Table 9.1.9.6.3.2-1: Main behaviour

St	Procedure	Message Sequence		TP	Verdict
		U – S	Message		
1	Cause the UE to change the radio capability configuration. (Note 1)	-	-	-	-
2	Check: Does the UE transmit REGISTRATION REQUEST message including 'NG-RAN-RCU' bit and the UE radio capability ID#1 (assigned during preamble)?	-->	REGISTRATION REQUEST	1	P
3	SS transmits a REGISTRATION ACCEPT message with a UE radio capability ID 2.	<--	REGISTRATION ACCEPT	-	-
4	The UE transmits a REGISTRATION COMPLETE message.	-->	REGISTRATION COMPLETE	-	-
Note 1: The request to change radio capability configuration be performed by MMI or AT Command.					

9.1.9.6.3.3 Specific message contents

Table 9.1.9.6.3.3-1: REGISTRATION REQUEST (Preamble)

Derivation path: TS 38.508-1 [4], Table 4.7.1-6			
Information Element	Value/Remark	Comment	Condition
5GS registration type	'0000 0001'B	Initial registration	
5GMM capability			
RACS	'1'B	RACS supported	

Table 9.1.9.6.3.3-2: REGISTRATION REQUEST (Step 2, Table 9.1.9.6.3.2-1)

Derivation path: TS 38.508-1 [4], Table 4.7.1-6			
Information Element	Value/Remark	Comment	Condition
5GS registration type	'0000 0010'B	mobility registration updating	
UE radio capability ID	'01000000000010'H	Type Field (TF): 1 Version ID: 00 Radio Configuration Identifier (RCI): 00000000001	
5GS update type			
NG-RAN-RCU	UE radio capability update needed		

Table 9.1.9.6.3.3-3: REGISTRATION ACCEPT (Step 3, Table 9.1.9.6.3.2-1)

Derivation path: TS 38.508-1 [4], Table 4.7.1-7			
Information Element	Value/Remark	Comment	Condition
UE radio capability ID	'01000000000010'H	Type Field (TF): 1 Version ID: 00 Radio Configuration Identifier (RCI): 00000000001	

9.1.9.7 RACS / Inter-system mobility registration update / Handling of UE radio capability ID

9.1.9.7.1 Test Purpose (TP)

(1)

```

with { UE in state EMM-REGISTERED and EMM-IDLE on an E-UTRA cell and has been previously registered
on 5GC, UE supporting S1 and N1 and operating in single-registration mode, NWK supporting Single-
registration mode with N26 interface and a UE Radio Capability ID assigned in the ATTACH ACCEPT
message}
ensure that {
  when { UE detects a suitable NGC cell after the serving E-UTRA cell becomes not suitable }
  then { UE performs a Inter-system change from S1 mode to N1 mode by initiating and successfully
completing a mobility and periodic registration update procedure, and includes the UE radio
capability ID in the REGISTRATION REQUEST message }
}

```

(2)

```

with { UE in state 5GMM-REGISTERED and 5GMM-IDLE on a 5GC NR cell and has been previously registered
on EPC as well, UE supporting S1 and N1 and operating in single-registration mode, NWK supporting
Single-registration mode with N26 interface, having assigned a new UE Radio Capability ID in the
Registration Accept message }
ensure that {
  when { UE detects a suitable EPC E-UTRA cell after the serving NGC cell becomes not suitable }
  then { UE performs a Inter-system change from N1 mode to S1 mode by initiating and successfully
completing a TAU procedure, and the UE shall include a UE radio capability information update needed
IE in the TRACKING AREA UPDATE REQUEST message. }
}

```

}

9.1.9.7.2 Conformance requirements

References: The conformance requirements covered in the current TC are specified in: TS 24.501, clauses 4.16, 5.4.4.1, 5.4.4.2, 5.4.4.3, 5.5.1.2.4. Unless otherwise stated these are Rel-16 requirements.

[TS 24.501, clause 4.16]

UE radio capability signalling optimisation (RACS) is a feature that is optional at both the UE and the network and which aims to optimise the transmission of UE radio capability over the radio interface (see 3GPP TS 23.501 [8]). RACS works by assigning an identifier to represent a set of UE radio capabilities. This identifier is called the UE radio capability ID. A UE radio capability ID can be either manufacturer-assigned or network-assigned. The UE radio capability ID is an alternative to the signalling of the radio capabilities container over the radio interface.

In this release of the specification, RACS is applicable to neither NB-N1 mode nor non-3GPP access.

If the UE supports RACS:

- a) the UE shall indicate support for RACS by setting the RACS bit to "RACS supported" in the 5GMM capability IE of the REGISTRATION REQUEST message;
- b) if the UE performs a registration procedure for initial registration and the UE has an applicable UE radio capability ID for the current UE radio configuration in the selected network, the UE shall include the UE radio capability ID in the UE radio capability ID IE as a non-clear-text IE in the REGISTRATION REQUEST message. If both a network-assigned UE radio capability ID and a manufacturer-assigned UE Radio Capability ID are applicable, the UE shall include the network-assigned UE radio capability ID in the REGISTRATION REQUEST message;
- ...
- d) upon receiving a network-assigned UE radio capability ID in the REGISTRATION ACCEPT message or the CONFIGURATION UPDATE COMMAND message, the UE shall store the network-assigned UE radio capability ID and the PLMN ID or SNPN identity of the serving network along with a mapping to the current UE radio configuration in its non-volatile memory as specified in annex C. The UE shall be able to store at least the last 16 received network-assigned UE radio capability IDs with the associated PLMN ID or SNPN identity and the mapping to the corresponding UE radio configuration;
- ...
- f) upon receiving a UE radio capability ID deletion indication IE set to "delete network-assigned UE radio capability IDs" in the REGISTRATION ACCEPT message or the CONFIGURATION UPDATE COMMAND message, the UE shall delete all network-assigned UE radio capability IDs stored at the UE for the serving network, initiate a registration procedure for mobility and periodic registration update and include an applicable manufacturer-assigned UE radio capability ID for the current UE radio configuration, if available at the UE, in the UE radio capability ID IE of the REGISTRATION REQUEST message; and
- g) if the UE performs a registration procedure for mobility and periodic registration update due to entering a tracking area that is not in the list of tracking areas that the UE previously registered in the AMF and the UE has an applicable UE radio capability ID for the current UE radio configuration in the selected network, the UE shall include the UE radio capability ID in the UE radio capability ID IE as a non-clear-text IE in the REGISTRATION REQUEST message. If both a network-assigned UE radio capability ID and a manufacturer-assigned UE Radio Capability ID are applicable, the UE shall include the network-assigned UE radio capability ID in the REGISTRATION REQUEST message.

If the network supports RACS:

- a) the network may assign a network-assigned UE radio capability ID to a UE which supports RACS by including a UE radio capability ID IE in the REGISTRATION ACCEPT message or in the CONFIGURATION UPDATE COMMAND message;

[TS 24.501, clause 5.5.1.2.4]

If the UE is not in NB-N1 mode, the UE has set the RACS bit to "RACS supported" in the 5GMM Capability IE of the REGISTRATION REQUEST message and the REGISTRATION ACCEPT message includes:

- a) a UE radio capability ID deletion indication IE set to "Network-assigned UE radio capability IDs deletion requested", the UE shall delete any network-assigned UE radio capability IDs associated with the RPLMN or RSNPN stored at the UE, then the UE shall, after the completion of the ongoing registration procedure, initiate a registration procedure for mobility and periodic registration update as specified in subclause 5.5.1.3.2 over the existing N1 NAS signalling connection; and
- b) a UE radio capability ID IE, the UE shall store the UE radio capability ID as specified in annex C.
- c) if the UE:
 - 1) does not have an applicable network-assigned UE radio capability ID for the current UE radio configuration in the selected PLMN or SNPN; and
 - 2) has an applicable manufacturer-assigned UE radio capability ID for the current UE radio configuration, include the applicable manufacturer-assigned UE radio capability ID in the UE radio capability ID IE of the REGISTRATION REQUEST message.

[TS 24.301, clause 5.3.20]

UE radio capability signalling optimisation (RACS) is a feature that is optional at both the UE and the network and which aims to optimise the transmission of UE radio capability over the radio interface (see 3GPP TS 23.401 [10]). RACS works by assigning an identifier to represent a set of UE radio capabilities. This identifier is called the UE radio capability ID. A UE radio capability ID can be either manufacturer-assigned or network-assigned. The UE radio capability ID is an alternative to the signalling of the radio capabilities container over the radio interface.

In this release of the specification, RACS is not applicable to NB-S1 mode.

If the UE supports RACS:

- the UE shall indicate support for RACS by setting the RACS bit to "RACS supported" in the UE network capability IE of the ATTACH REQUEST and TRACKING AREA UPDATE REQUEST messages;
- if the UE performs an attach procedure and the UE has an applicable UE radio capability ID for the current UE radio configuration in the selected network, the UE shall include the UE radio capability ID availability IE in the ATTACH REQUEST message and set the IE to "UE radio capability ID available";
- if the UE performs a tracking area updating procedure and the UE has an applicable UE radio capability ID for the current UE radio configuration in the selected network, the UE shall include the UE radio capability ID availability IE in the TRACKING AREA UPDATE REQUEST message and set the IE to "UE radio capability ID available";
- If the UE is requested to provide its UE radio capability ID by the network during a security mode control procedure, the UE shall include its UE radio capability ID in the UE radio capability ID IE of the SECURITY MODE COMPLETE message. If both a network-assigned UE radio capability ID and a manufacturer-assigned UE radio capability ID are applicable, the UE shall include the network-assigned UE radio capability ID in the SECURITY MODE COMPLETE message;
- if the radio configuration at the UE changes (for instance because the UE has disabled a specific radio capability) then:
 - a) if the UE has an applicable UE radio capability ID for the new UE radio configuration, the UE shall initiate a tracking area updating procedure, include a UE radio capability information update needed IE in the TRACKING AREA UPDATE REQUEST message and include a UE radio capability ID availability IE set to "UE radio capability ID available" in the TRACKING AREA UPDATE REQUEST message. If both a network-assigned UE radio capability ID and a manufacturer-assigned UE Radio Capability ID are applicable, the UE shall include the network-assigned UE radio capability ID in the TRACKING AREA UPDATE REQUEST message; and
 - b) if the UE does not have an applicable UE radio capability ID for the new UE radio configuration, the UE shall initiate a tracking area updating procedure and shall include a UE radio capability information update needed IE in the TRACKING AREA UPDATE REQUEST message;

NOTE: Performing the tracking area updating procedure with the UE radio capability information update needed IE included in the TRACKING AREA UPDATE REQUEST message and without the UE radio capability ID availability IE set to "UE radio capability ID available" in the TRACKING AREA UPDATE REQUEST message as specified in b) above can trigger the network to assign a new UE radio capability ID to the UE.

....

[TS 24.301, clause 5.5.3.3.2]

The UE operating in CS/PS mode 1 or CS/PS mode 2, in state EMM-REGISTERED, shall initiate the combined tracking area updating procedure:

...

zf) in WB-S1 mode, when the applicable UE radio capability ID for the current UE radio configuration changes due to a reselection to a new PLMN or a revocation of the network-assigned UE radio capability IDs by the serving PLMN; or

...

For cases n, zc, ze and zf, the UE shall include a UE radio capability information update needed IE in the TRACKING AREA UPDATE REQUEST message.

...

9.1.9.7.3 Test description

9.1.9.7.3.1 Pre-test conditions

System Simulator:

- 2 cells
- NGC Cell A as defined in TS 38.508-1 [4] Table 6.3.2.2-1. System information combination NR-6 as defined in TS 38.508-1 [4], subclause 4.4.3.1.2.
- E-UTRA Cell A as defined in TS 36.508 [7] Table 6.3.2.2-1. System information combination 31 as defined in TS 36.508 [7], subclause 4.4.3.1.1.

UE:

None.

Preamble:

- With NGC Cell A "Serving cell" and E-UTRA Cell A "Non-suitable "Off" cell", the UE is brought to state ON-B as defined in 38.508-1 [4], subclause 4.4A on NGC Cell A.
- With E-UTRA Cell A "Serving cell" and NGC Cell A "Non-suitable "Off" cell", the UE is brought to state RRC_IDLE using generic procedure parameters Connectivity (*E-UTRA/EPC*) and Unrestricted nr PDN (*On*)in accordance with the procedure described in TS 38.508-1 [4], clause 4.5.2.

9.1.9.7.3.2 Test procedure sequence

Table 9.1.9.7.3.2-1: Main behaviour

St	Procedure	Message Sequence		TP	Verdict
		U - S	Message		
1	The SS configures: - NGC Cell A as "Serving cell" - E-UTRA Cell A as "Non-suitable "off" cell".	-	-	-	-
2	Check: Does the UE perform test procedure	-	-	1	-

	for UE Tracking area updating for Inter-system change from S1 mode to N1 mode in 5GMM/EMM-IDLE mode as described in TS 38.508-1 [4], Table 4.9.9.2.2-1 on NGC Cell A?				
3	The SS configures: - E-UTRA Cell A as "Serving cell" - NGC Cell A as "Non-suitable "off" cell".	-	-	-	-
4	Check: Does the UE perform Test procedure for UE Tracking area updating for Inter-system change from N1 mode to S1 mode in 5GMM/EMM-IDLE mode as described in TS 38.508-1 [4], Table 4.9.7.2.2-1, ' <i>connected without release</i> ' on E-UTRA Cell A?	-	-	2	-

9.1.9.7.3.3 Specific message contents

Table 9.1.9.7.3.3-1: ATTACH ACCEPT (Preamble)

Derivation path: TS 36.508, Table 4.7.2-1			
Information Element	Value/Remark	Comment	Condition
UE radio capability ID	'01000000000010'H	Type Field (TF): 1 Version ID: 00 Radio Configuration Identifier (RCI): 00000000001	

Table 9.1.9.7.3.3-2: REGISTRATION REQUEST (step 2, Table 9.1.9.7.3.2-1; step 3, TS 38.508-1 [4], Table 4.9.9.2.2-1)

Derivation path: TS 38.508-1 [4], Table 4.7.1-6			
Information Element	Value/Remark	Comment	Condition
5GS registration type	'010'B	Mobility registration updating	
5GMM capability			
RACS	'1'B	RACS supported	
UE radio capability ID	'01000000000010'H	Type Field (TF): 1 Version ID: 00 Radio Configuration Identifier (RCI): 00000000001	

Table 9.1.9.7.3.3-3: REGISTRATION ACCEPT (step 2, Table 9.1.9.7.3.2-1; step 10, TS 38.508-1 [4], Table 4.9.9.2.2-1)

Derivation path: TS 38.508-1 [4], Table 4.7.1-7			
Information Element	Value/Remark	Comment	Condition
UE radio capability ID	'01000000000020'H	Type Field (TF): 1 Version ID: 00 Radio Configuration Identifier (RCI): 00000000002	

Table 9.1.9.7.3.3-4: TRACKING AREA UPDATE REQUEST (step 4, Table 9.1.9.7.3.2-1; step 3, TS 38.508-1 [4], Table 4.9.7.2.2-1)

Derivation path: TS 38.508-1 [4], Table 4.7.1-6			
Information Element	Value/Remark	Comment	Condition
UE radio capability information update needed	'0001'B	UE radio capability information update needed	

9.1.10 Network slice-specific authentication and authorization

9.1.10.1 NSSAA / EAP message transport / Success

9.1.10.1.1 Test Purpose (TP)

(1)

```
with { UE in 5GMM-DEREGISTERED state and supports network slice-specific authentication and
authorization }
ensure that {
  when { UE is switched on }
  then { UE transmits REGISTRATION REQUEST message with NSSAA bit in the 5GMM capability IE set to
"network slice-specific authentication and authorization supported" }
}
```

(2)

```
with { UE is in 5GMM-REGISTERED state }
ensure that {
  when { SS sends NETWORK SLICE-SPECIFIC AUTHENTICATION COMMAND message with EAP message IE set to
EAP-request message }
  then { UE sends NETWORK SLICE-SPECIFIC AUTHENTICATION COMPLETE message with EAP message IE set
to the EAP-response message }
}
```

(3)

```
with { UE is in 5GMM-REGISTERED state }
ensure that {
  when { SS sends NETWORK SLICE-SPECIFIC AUTHENTICATION COMMAND message }
  then { UE sends NETWORK SLICE-SPECIFIC AUTHENTICATION COMPLETE message with S-NSSAI IE set to
the S-NSSAI value received in NETWORK SLICE-SPECIFIC AUTHENTICATION COMMAND message }
}
```

(4)

```
with { UE is in 5GMM-REGISTERED state }
ensure that {
  when { SS sends CONFIGURATION UPDATE COMMAND message with allowed NSSAI for which the network
slice-specific authentication and authorization has been successfully performed }
  then { UE considers the new allowed NSSAI as valid and store the allowed NSSAI }
}
```

(5)

```
with { UE in 5GMM-REGISTERED-INITIATED state }
ensure that {
  when { SS sends REGISTRATION ACCEPT message with pending NSSAI and "NSSAA to be performed"
indicator set to indicate that the network slice-specific authentication and authorization procedure
will be performed }
  then { UE shall store the S-NSSAI(s) in the pending NSSAI }
}
```

(6)

```
with { UE in 5GMM-REGISTERED state and configured with allowed NSSAI }
ensure that {
  when { UE receives CONFIGURATION UPDATE COMMAND message with allowed NSSAI which the network
slice-specific authentication and authorization has been successfully performed }
  then { UE considers the new allowed NSSAI as valid and considers the old allowed NSSAI as
invalid }
}
```

9.1.10.1.2 Conformance requirements

References: The conformance requirements covered in the present TC are specified in: TS 24.501, clause 5.4.4.3, 5.4.7.2.2, 5.5.1.2.2, 5.5.1.2.4 and TS 23.502, clause 4.2.9.2. Unless otherwise stated these are Rel-16 requirements.

[TS 24.501 clause 5.4.4.3]

If the UE receives a new allowed NSSAI for the associated access type in the CONFIGURATION UPDATE COMMAND message, the UE shall consider the new allowed NSSAI as valid for the associated access type, store the allowed NSSAI for the associated access type as specified in subclause 4.6.2.2 and consider the old allowed NSSAI for the associated access type as invalid; otherwise, the UE shall consider the old Allowed NSSAI as valid for the associated access type.

[TS 24.501 clause 5.4.7.2.2]

When the upper layers provide an EAP-response message associated with the HPLMN S-NSSAI, the UE shall create a NETWORK SLICE-SPECIFIC AUTHENTICATION COMPLETE message.

The UE shall set the EAP message IE of the NETWORK SLICE-SPECIFIC AUTHENTICATION COMPLETE message to the EAP-response message.

The UE shall set the S-NSSAI IE of the NETWORK SLICE-SPECIFIC AUTHENTICATION COMPLETE message to the HPLMN S-NSSAI associated with the EAP-response message.

The UE shall send the NETWORK SLICE-SPECIFIC AUTHENTICATION COMPLETE message. Apart from this action, the network slice-specific authentication and authorization procedure is transparent to the 5GMM layer of the UE.

[TS 24.501 clause 5.5.1.2.2]

The UE initiates the registration procedure for initial registration by sending a REGISTRATION REQUEST message to the AMF, starting timer T3510. If timer T3502 is currently running, the UE shall stop timer T3502. If timer T3511 is currently running, the UE shall stop timer T3511.

...

If the UE supports network slice-specific authentication and authorization, the UE shall set the NSSAA bit to "network slice-specific authentication and authorization supported" in the 5GMM capability IE of the REGISTRATION REQUEST message.

[TS 24.501 clause 5.5.1.2.4]

If the UE indicated the support for network slice-specific authentication and authorization, and if the Requested NSSAI IE includes one or more S-NSSAIs subject to network slice-specific authentication and authorization, the AMF shall in the REGISTRATION ACCEPT message include:

- a) the allowed NSSAI containing the S-NSSAI(s) or the mapped S-NSSAI(s), if any:
 - 1) which are not subject to network slice-specific authentication and authorization and are allowed by the AMF;
or
 - 2) for which the network slice-specific authentication and authorization has been successfully performed;
- b) optionally, the rejected NSSAI;
- c) pending NSSAI containing one or more S-NSSAIs for which network slice-specific authentication and authorization will be performed or is ongoing, and one or more S-NSSAIs from the pending NSSAI which the AMF provided to the UE during the previous registration procedure for which network slice-specific authentication and authorization will be performed or is ongoing, if any; and
- d) the "NSSAA to be performed" indicator in the 5GS registration result IE set to indicate that the network slice-specific authentication and authorization procedure will be performed by the network, if the allowed NSSAI is not included in the REGISTRATION ACCEPT message.

If the UE indicated the support for network slice-specific authentication and authorization, and if:

- a) the UE did not include the requested NSSAI in the REGISTRATION REQUEST message or none of the S-NSSAIs in the requested NSSAI in the REGISTRATION REQUEST message are allowed;
- b) all subscribed S-NSSAIs marked as default are subject to network slice-specific authentication and authorization; and
- c) the network slice-specific authentication and authorization procedure has not been successfully performed for any of the subscribed S-NSSAIs marked as default,

the AMF shall in the REGISTRATION ACCEPT message include:

- a) the "NSSAA to be performed" indicator in the 5GS registration result IE to indicate that the network slice-specific authentication and authorization procedure will be performed by the network;
- b) pending NSSAI containing one or more subscribed S-NSSAIs marked as default for which network slice-specific authentication and authorization will be performed or is ongoing and one or more S-NSSAIs from the pending NSSAI which the AMF provided to the UE during the previous registration procedure for which network slice-specific authentication and authorization will be performed or is ongoing (if any); and
- c) optionally, the rejected NSSAI.

If the UE indicated the support for network slice-specific authentication and authorization, and if:

- a) the UE did not include the requested NSSAI in the REGISTRATION REQUEST message or none of the S-NSSAIs in the requested NSSAI in the REGISTRATION REQUEST message are allowed; and
- b) one or more subscribed S-NSSAIs marked as default are not subject to network slice-specific authentication and authorization or the network slice-specific authentication and authorization procedure has been successfully performed for one or more subscribed S-NSSAIs marked as default;

the AMF shall in the REGISTRATION ACCEPT message include:

- a) pending NSSAI containing one or more subscribed S-NSSAIs marked as default for which network slice-specific authentication and authorization will be performed or is ongoing (if any) and one or more S-NSSAIs from the pending NSSAI which the AMF provided to the UE during the previous registration procedure for which network slice-specific authentication and authorization will be performed or is ongoing (if any);
- b) allowed NSSAI containing S-NSSAI(s) for the current PLMN each of which corresponds to a subscribed S-NSSAI marked as default which are not subject to network slice-specific authentication and authorization or for which the network slice-specific authentication and authorization has been successfully performed;
- c) allowed NSSAI containing one or more subscribed S-NSSAIs marked as default, as the mapped S-NSSAI(s) for the allowed NSSAI in roaming scenarios, which are not subject to network slice-specific authentication and authorization or for which the network slice-specific authentication and authorization has been successfully performed; and
- d) optionally, the rejected NSSAI.

When the REGISTRATION ACCEPT message includes a pending NSSAI, the pending NSSAI shall contain all S-NSSAIs for which network slice-specific authentication and authorization will be performed or is ongoing from the requested NSSAI of the REGISTRATION REQUEST message that was received over the 3GPP access, non-3GPP access, or both the 3GPP access and non-3GPP access

...

The UE that has indicated the support for network slice-specific authentication and authorization receiving the pending NSSAI in the REGISTRATION ACCEPT message shall store the S-NSSAI(s) in the pending NSSAI as specified in subclause 4.6.2.2. If the registration area contains TAIs belonging to different PLMNs, which are equivalent PLMNs, the UE shall store the received pending NSSAI for each of the equivalent PLMNs as specified in subclause 4.6.2.2. If the pending NSSAI is not included in the REGISTRATION ACCEPT message and the "NSSAA to be performed" indicator is not set to "Network slice-specific authentication and authorization is to be performed" in the 5GS registration result IE of the REGISTRATION ACCEPT message, then the UE shall delete the pending NSSAI for the current PLMN or SNPN, if existing, as specified in subclause 4.6.2.2.

[TS 23.502 clause 4.2.9.2]

19a. [Conditional] If a new Allowed NSSAI (i.e. including any new S-NSSAIs in a Requested NSSAI for which the NSSAA procedure succeeded and/or excluding any S-NSSAI(s) in the existing Allowed NSSAI for the UE for which the procedure has failed) and/or new Rejected S-NSSAIs (i.e. including any S-NSSAI(s) in the existing Allowed NSSAI for the UE for which the procedure has failed, or any new requested S-NSSAI(s) for which the NSSAA procedure failed) need to be delivered to the UE, or if the AMF re-allocation is required, the AMF initiates the UE Configuration Update procedure, for each Access Type, as described in clause 4.2.4.2. If the Network Slice-Specific Re-Authentication and Re-Authorization fails and there are PDU session(s) established that are associated with the S-NSSAI for which the NSSAA procedure failed, the AMF shall initiate the PDU Session Release procedure as specified in clause 4.3.4 to release the PDU sessions with the appropriate cause value.

9.1.10.1.3 Test description

9.1.10.1.3.1 Pre-test conditions

System Simulator:

NGC Cell A belongs to Home PLMN and TAI1 and set as serving cell;

UE:

None.

Preamble:

The UE is in state Switched OFF (state 0N-B) according to TS 38.508-1 [4].

9.1.10.1.3.2 Test procedure sequence

Table 9.1.10.1.3.2-1: Main behaviour

St	Procedure	Message Sequence		TP	Verdict
		U - S	Message		
1	The UE is switched on.	-	-	-	-
2	Check: Does UE transmit a REGISTRATION REQUEST message including NSSAA bit?	-->	REGISTRATION REQUEST	1	P
3-11	Steps 5 to 13 of the generic procedure for NR RRC_IDLE specified in TS 38.508-1 subclause 4.5.2 are performed.	-	-	-	-
12	The SS transmits a REGISTRATION ACCEPT message including Pending NSSAI.	<--	REGISTRATION ACCEPT	-	-
13	The UE transmits an <i>ULInformationTransfer</i> message and a REGISTRATION COMPLETE message.	-->	REGISTRATION COMPLETE	-	-
	EXCEPTION: Step 14a1 is performed if $pc_noOf_PDUsSameConnection > 0$.				
14a1	The generic procedure for UE-requested PDU session establishment, specified in subclause 4.5A.2, takes place performing establishment of UE-requested PDU session(s) with $ExpectedNumberOfNewPDUSessions = pc_noOf_PDUsSameConnection$.	-	-	-	-
15	The SS transmits a NETWORK SLICE-SPECIFIC AUTHENTICATION COMMAND message with an EAP-Request message.	<--	5GMM: NETWORK SLICE-SPECIFIC AUTHENTICATION COMMAND	-	-
16	Check: Does the UE respond with a NETWORK SLICE-SPECIFIC AUTHENTICATION COMPLETE message, with an EAP-Response message and NSSAI?	-->	5GMM: NETWORK SLICE-SPECIFIC AUTHENTICATION COMPLETE	2, 3	P
17	The SS transmits a NETWORK SLICE-SPECIFIC AUTHENTICATION RESULT message with an EAP-success message.	<--	5GMM: NETWORK SLICE-SPECIFIC AUTHENTICATION RESULT	-	-
18	The SS transmits a CONFIGURATION	<--	CONFIGURATION UPDATE	-	-

	UPDATE COMMAND message including a new allowed NSSAI list.		COMMAND		
19	The UE transmits a CONFIGURATION UPDATE COMPLETE message.	-->	CONFIGURATION UPDATE COMPLETE	-	-
20	SS releases the RRC connection	-	-	-	-
21	Void	-	-	-	-
22	Check: Does UE transmit a REGISTRATION REQUEST message including S-NSSAI=1 but not including S-NSSAI=2 in Request NSSAI list?	-->	REGISTRATION REQUEST	4,5,6	P
23	The SS transmits a REGISTRATION REJECT message.	<--	REGISTRATION REJECT		
24	The SS releases the RRC connection				

9.1.10.1.3.3 Specific message contents

Table 9.1.10.1.3.3-1: REGISTRATION REQUEST (step 2, Table 9.1.10.1.3.2-1)

Derivation path: TS 38.508-1 Table 4.7.1-6			
Information Element	Value/remark	Comment	Condition
5GS registration type value	'001'B	Initial registration	
5GMM capability NSSAA	'1'B	Network slice-specific authentication and authorization supported	

Table 9.1.10.1.3.3-2: REGISTRATION ACCEPT (step 12, Table 9.1.10.1.3.2-1)

Derivation path: TS 38.508-1 Table 4.7.1-7			
Information Element	Value/remark	Comment	Condition
5GS registration result			
5GS registration result value	'001'B	3GPP access	
NSSAA Performed	'1'B	Network slice-specific authentication and authorization is to be performed	
Allowed NSSAI			
S-NSSAI IEI		S-NSSAI value 3	
Length of S-NSSAI contents	'0000001'B	SST	
SST	'0000011'B	SST value 3	
SD	Not Present		
Mapped configured SST	Not Present		
Mapped configured SD	Not Present		
Configured NSSAI			
S-NSSAI IEI		S-NSSAI value 1	
Length of S-NSSAI contents	'0000001'B	SST	
SST	'0000001'B	SST value 1	
SD	Not Present		
Mapped configured SST	Not Present		
Mapped configured SD	Not Present		
S-NSSAI IEI		S-NSSAI value 2	
Length of S-NSSAI contents	'0000001'B	SST	
SST	'0000010'B	SST value 2	
SD	Not Present		
Mapped configured SST	Not Present		
Mapped configured SD	Not Present		
Pending NSSAI			
S-NSSAI IEI		S-NSSAI value 1	
Length of S-NSSAI contents	'0000001'B	SST	
SST	'0000001'B	SST value 1	
SD	Not Present		

Mapped configured SST	Not Present		
Mapped configured SD	Not Present		
S-NSSAI IEI		S-NSSAI value 1	
Length of S-NSSAI contents	'00000001'B	SST	
SST	'00000010'B	SST value 2	
SD	Not Present		
Mapped configured SST	Not Present		
Mapped configured SD	Not Present		

Table 9.1.10.1.3.3-3: NETWORK SLICE-SPECIFIC AUTHENTICATION COMMAND (step 15, Table 9.1.10.1.3.2-1)

Derivation Path: TS 38.508-1 Table 4.7.1-31			
Information Element	Value/remark	Comment	Condition
S-NSSAI			
S-NSSAI IEI		S-NSSAI value 1	
Length of S-NSSAI contents	'00000001'B	SST	
SST	'00000001'B	SST value 1	
SD	Not Present		
Mapped configured SST	Not Present		
Mapped configured SD	Not Present		

Table 9.1.10.1.3.3-4: NETWORK SLICE-SPECIFIC AUTHENTICATION COMPLETE (step 16, Table 9.1.10.1.3.2-1)

Derivation Path: TS 38.508-1 Table 4.7.1-32			
Information Element	Value/remark	Comment	Condition
S-NSSAI			
S-NSSAI IEI		S-NSSAI value 1	
Length of S-NSSAI contents	'00000001'B	SST	
SST	'00000001'B	SST value 1	
SD	Not Present		
Mapped configured SST	Not Present		
Mapped configured SD	Not Present		

Table 9.1.10.1.3.3-5: NETWORK SLICE-SPECIFIC AUTHENTICATION RESULT (step 17, Table 9.1.10.1.3.2-1)

Derivation Path: TS 38.508-1, Table 4.7.1-33			
Information Element	Value/remark	Comment	Condition
S-NSSAI	Set according to specific message content		
S-NSSAI IEI		S-NSSAI value 1	
Length of S-NSSAI contents	'00000001'B	SST	
SST	'00000001'B	SST value 1	
SD	Not Present		
Mapped configured SST	Not Present		
Mapped configured SD	Not Present		
EAP message	EAP-Success		

Table 9.1.10.1.3.3-6: CONFIGURATION UPDATE COMMAND (step 18, Table 9.1.10.1.3.2-1)

Derivation path: TS 38.508-1, Table 4.7.1-19			
Information Element	Value/remark	Comment	Condition
Configuration update indication	0011	Acknowledgement requested Registration Requested	
Allowed NSSAI			
S-NSSAI IEI		S-NSSAI value 1	
Length of S-NSSAI contents	'00000001'B	SST	

SST	'00000001'B	SST value 1	
SD	Not Present		
Mapped configured SST	Not Present		
Mapped configured SD	Not Present		

Table 9.1.10.1.3.3-7: REGISTRATION REQUEST (step 22, Table 9.1.10.1.3.2-1)

Derivation path: TS 38.508-1 Table 4.7.1-6			
Information Element	Value/remark	Comment	Condition
5GS registration type value	'010'B	Mobility	
5GMM capability			
NSSAA	'1'B	Network slice-specific authentication and authorization supported	
S-NSSAI IEI		S-NSSAI value 1	
Length of S-NSSAI contents	'00000001'B	SST	
SST	'00000001'B	SST value 1	
SD	Not Present		
Mapped configured SST	Not Present		
Mapped configured SD	Not Present		

Table 9.1.10.1.3.3-8: REGISTRATION REJECT (step 23, Table 9.1.10.1.3.2-1)

Derivation Path: TS 38.508-1 Table 4.7.1-9			
Information Element	Value/remark	Comment	Condition
5GMM cause	'0000 0011'B	Illegal UE	

9.1.10.2 Network slice-specific authentication and authorization / EAP message transport / Abnormal

9.1.10.2.1 Test Purpose (TP)

(1)

```

with { the UE in 5GMM-DEREGISTERED-INITIATED state }
ensure that {
  when { SS sends NETWORK SLICE-SPECIFIC AUTHENTICATION COMMAND message }
  then { the UE shall ignore the NETWORK SLICE-SPECIFIC AUTHENTICATION COMMAND message and proceed
with the de-registration procedure }
}

```

9.1.10.2.2 Conformance requirements

References: The conformance requirements covered in the present TC are specified in: TS 24.501, clause 5.4.7.2.4. Unless otherwise stated these are Rel-16 requirements.

[TS 24.501 clause 5.4.7.2.4]

The following abnormal cases can be identified:

- a) Transmission failure of the NETWORK SLICE-SPECIFIC AUTHENTICATION COMPLETE message with TAI change from lower layers

If the current TAI is not in the TAI list, the network slice-specific authentication and authorization procedure shall be aborted and a registration procedure for mobility and periodic registration update indicating "mobility registration updating" in the 5GS registration type IE of the REGISTRATION REQUEST message shall be initiated.

If the current TAI is still part of the TAI list, it is up to the UE implementation how to re-run the ongoing procedure that triggered the network slice-specific authentication and authorization procedure.

- b) Transmission failure of NETWORK SLICE-SPECIFIC AUTHENTICATION COMPLETE message indication without TAI change from lower layers

It is up to the UE implementation how to re-run the ongoing procedure that triggered the network slice-specific authentication and authorization procedure.

- c) Network slice-specific authentication and authorization procedure and de-registration procedure collision

If the UE receives NETWORK SLICE-SPECIFIC AUTHENTICATION COMMAND message after sending a DEREGISTRATION REQUEST message and the access type included in the DEREGISTRATION REQUEST message is the same as the access in which the NETWORK SLICE-SPECIFIC AUTHENTICATION COMMAND message is received, then the UE shall ignore the NETWORK SLICE-SPECIFIC AUTHENTICATION COMMAND message and proceed with the de-registration procedure. Otherwise, the UE shall proceed with both procedures.

9.1.10.2.3 Test description

9.1.10.2.3.1 Pre-test conditions

System Simulator:

NGC Cell A;

UE:

None.

Preamble:

The UE is in state Switched OFF (state ON-B) according to TS 38.508-1 [4].

9.1.10.2.3.2 Test procedure sequence

Table 9.1.10.2.3.2-1: Main behaviour

St	Procedure	Message Sequence		TP	Verdict
		U - S	Message		
1	The UE is switched on.	-	-	-	-
2	Check: Does UE transmit a REGISTRATION REQUEST message including NSSAA bit?	-->	REGISTRATION REQUEST	1	P
3-11	Steps 5 to 13 of the generic procedure for NR RRC_IDLE specified in TS 38.508-1 subclause 4.5.2 are performed.	-	-	-	-
12	The SS transmits a REGISTRATION ACCEPT message including Pending NSSAI and T3512 value IE.	<--	REGISTRATION ACCEPT	-	-
13	The UE transmits an <i>ULInformationTransfer</i> message and a REGISTRATION COMPLETE message.	-->	REGISTRATION COMPLETE	-	-
	EXCEPTION: Step 14a1 is performed if <i>pc_noOf_PDUsSameConnection</i> > 0.				
14a1	The generic procedure for UE-requested PDU session establishment, specified in subclause 4.5A.2, takes place performing establishment of UE-requested PDU session(s) with <i>ExpectedNumberOfNewPDUSessions</i> = <i>pc_noOf_PDUsSameConnection</i> .	-	-	-	-
15	Cause UE De-Registration by AT or MMI command	-	-	-	-
16	Check: Does the UE transmit a DEREGISTRATION REQUEST with the De-registration type IE indicating "normal de-registration"?	-->	DEREGISTRATION REQUEST	-	-

17	The SS transmits a NETWORK SLICE-SPECIFIC AUTHENTICATION COMMAND message.	<--	NETWORK SLICE-SPECIFIC AUTHENTICATION COMMAND	-	-
18	Check: Does the UE transmit a NETWORK SLICE-SPECIFIC AUTHENTICATION COMPLETE message within 5 seconds	-->	NETWORK SLICE-SPECIFIC AUTHENTICATION COMPLETE	1	F
19	The SS transmits DEREGISTRATION ACCEPT message.	<--	DEREGISTRATION ACCEPT	-	-
20	The SS transmits an <i>RRCRelease</i> message.	-	-	-	-
21	Check: Does the test result of the generic procedure in TS 38.508-1 [4] subclause 4.9.13 indicates that the UE doesn't responds to paging when paged with NG-5G-S-TMSI?	-	-	1	P

9.1.10.2.3.3 Specific message contents

Table 9.1.10.2.3.3-1: REGISTRATION ACCEPT (step 12, Table 9.1.10.2.3.2-1)

Derivation path: TS 38.508-1 Table 4.7.1-7			
Information Element	Value/remark	Comment	Condition
5GS registration result			
5GS registration result value	'001'B	3GPP access	
NSSAA Performed	'1'B	Network slice-specific authentication and authorization is to be performed	
Configured NSSAI			
S-NSSAI IEI		S-NSSAI value 1	
Length of S-NSSAI contents	'00000001'B	SST	
SST	'00000001'B	SST value 1	
SD	Not Present		
Mapped configured SST	Not Present		
Mapped configured SD	Not Present		
S-NSSAI IEI		S-NSSAI value 2	
Length of S-NSSAI contents	'00000001'B	SST	
SST	'00000010'B	SST value 2	
SD	Not Present		
Mapped configured SST	Not Present		
Mapped configured SD	Not Present		
Pending NSSAI			
S-NSSAI IEI		S-NSSAI value 1	
Length of S-NSSAI contents	'00000001'B	SST	
SST	'00000001'B	SST value 1	
SD	Not Present		
Mapped configured SST	Not Present		
Mapped configured SD	Not Present		
S-NSSAI IEI		S-NSSAI value 1	
Length of S-NSSAI contents	'00000001'B	SST	
SST	'00000010'B	SST value 2	
SD	Not Present		
Mapped configured SST	Not Present		
Mapped configured SD	Not Present		
T3512 value	Not Present		

Table 9.1.10.2.3.3-1A: DEREGISTRATION REQUEST (step 16, Table 9.1.10.2.3.2-1)

Derivation path: TS 38.508-1 [4], Table 4.7.1-12			
Information Element	Value/remark	Comment	Condition
De-registration type			
Switch off	'0'B	Normal de-registration	
Access type	'01'B	3GPP access	

Table 9.1.10.2.3.3-2: NETWORK SLICE-SPECIFIC AUTHENTICATION COMMAND (step 17, Table 9.1.10.2.3.2-1)

Derivation Path: TS 38.508-1 Table 4.7.1-31			
Information Element	Value/remark	Comment	Condition
S-NSSAI			
S-NSSAI IEI		S-NSSAI value 1	
Length of S-NSSAI contents	'00000001'B	SST	
SST	'00000001'B	SST value 1	
SD	Not Present		
Mapped configured SST	Not Present		
Mapped configured SD	Not Present		

9.1.10.3 NSSAA / Initial registration / Rejected NSSAI, pending NSSAI

9.1.10.3.1 Test Purpose (TP)

(1)

```
with { UE has sent REGISTRATION REQUEST message with NSSAA bit and Request NSSAI }
ensure that {
  when { SS sends REGISTRATION ACCEPT message contains rejected NSSAI with rejection cause of "S-
  NSSAI not available due to the failed or revoked network slice-specific authentication and
  authorization" }
  then { UE stores the rejected S-NSSAI(s) in the rejected NSSAI and shall not attempt to use this
  S-NSSAI in the current PLMN over any access }
}
```

(2)

```
with { UE receives rejected NSSAI in the REGISTRATION ACCEPT message with rejection cause of "S-
  NSSAI not available due to the failed or revoked network slice-specific authentication and
  authorization" }
ensure that {
  when { UE is switched off and switched on }
  then { UE deletes the stored Rejected NSAAI for the current PLMN }
}
```

(3)

```
with { UE receives rejected NSSAI in the REGISTRATION ACCEPT message with rejection cause of "S-
  NSSAI not available due to the failed or revoked network slice-specific authentication and
  authorization" }
ensure that {
  when { The UICC containing the USIM is removed }
  then { UE deletes the stored Rejected NSAAI for the current PLMN }
}
```

(4)

```
with { UE stores pending NSSAI }
ensure that {
  when { SS sends REGISTRATION ACCEPT message with the pending NSSAI is not included and "NSSAA to
  be performed" indicator is not set to "Network slice-specific authentication and authorization is to
  be performed" }
  then { deletes the stored pending NSSAI for the current PLMN }
}
```

9.1.10.3.2 Conformance requirements

References: The conformance requirements covered in the present TC are specified in: TS 24.501, clause 5.5.1.2.4.

[TS 24.501 clause 5.5.1.2.4]

If the REGISTRATION ACCEPT message contains the Network slicing indication IE with the Network slicing subscription change indication set to "Network slicing subscription changed", or contains a configured NSSAI IE with a new configured NSSAI for the current PLMN and optionally the mapped S-NSSAI(s) for the configured NSSAI for the

current PLMN, the UE shall return a REGISTRATION COMPLETE message to the AMF to acknowledge the successful update of the network slicing information.

...

The AMF shall include the allowed NSSAI for the current PLMN and shall include the mapped S-NSSAI(s) for the allowed NSSAI contained in the requested NSSAI from the UE if available, in the REGISTRATION ACCEPT message if the UE included the requested NSSAI in the REGISTRATION REQUEST message and the AMF allows one or more S-NSSAIs in the requested NSSAI.

The AMF may also include rejected NSSAI in the REGISTRATION ACCEPT message. Rejected NSSAI contains S-NSSAI(s) which was included in the requested NSSAI but rejected by the network associated with rejection cause(s) with the following restrictions:

- a) rejected NSSAI for the current PLMN or SNPN shall not include an S-NSSAI for the current PLMN or SNPN which is associated to multiple mapped S-NSSAIs and some of these mapped S-NSSAIs are not allowed; and
- b) rejected NSSAI for the current registration area shall not include an S-NSSAI for the current PLMN or SNPN which is associated to multiple mapped S-NSSAIs and some of these mapped S-NSSAIs are not allowed.

NOTE 6: The UE can avoid requesting an S-NSSAI associated with a mapped S-NSSAI, which was included in the previous requested NSSAI but neither in the allowed NSSAI nor in the rejected NSSAI in the consequent registration procedures.

If the UE indicated the support for network slice-specific authentication and authorization, and if the Requested NSSAI IE includes one or more S-NSSAIs subject to network slice-specific authentication and authorization, the AMF shall in the REGISTRATION ACCEPT message include:

- a) the allowed NSSAI containing the S-NSSAI(s) or the mapped S-NSSAI(s), if any:
 - 1) which are not subject to network slice-specific authentication and authorization and are allowed by the AMF; or
 - 2) for which the network slice-specific authentication and authorization has been successfully performed;
- b) optionally, the rejected NSSAI;
- c) pending NSSAI containing one or more S-NSSAIs for which network slice-specific authentication and authorization will be performed or is ongoing, and one or more S-NSSAIs from the pending NSSAI which the AMF provided to the UE during the previous registration procedure for which network slice-specific authentication and authorization will be performed or is ongoing, if any; and
- d) the "NSSAA to be performed" indicator in the 5GS registration result IE set to indicate whether network slice-specific authentication and authorization procedure will be performed by the network, if the allowed NSSAI is not included in the REGISTRATION ACCEPT message.

If the UE indicated the support for network slice-specific authentication and authorization, and if:

- a) the UE did not include the requested NSSAI in the REGISTRATION REQUEST message or none of the S-NSSAIs in the requested NSSAI in the REGISTRATION REQUEST message are allowed;
- b) all subscribed S-NSSAIs marked as default are subject to network slice-specific authentication and authorization;
- c) the network slice-specific authentication and authorization procedure has not been successfully performed for any of the subscribed S-NSSAIs marked as default; and
- d) the network slice-specific authentication and authorization procedure has not failed or been revoked for all subscribed S-NSSAI marked as default;

the AMF shall in the REGISTRATION ACCEPT message include:

- a) the "NSSAA to be performed" indicator in the 5GS registration result IE to indicate whether network slice-specific authentication and authorization procedure will be performed by the network; and
- b) pending NSSAI containing one or more subscribed S-NSSAIs marked as default for which network slice-specific authentication and authorization will be performed or is ongoing and one or more S-NSSAIs from the

pending NSSAI which the AMF provided to the UE during the previous registration procedure for which network slice-specific authentication and authorization will be performed or is ongoing (if any).

If the UE indicated the support for network slice-specific authentication and authorization, and if:

- a) the UE did not include the requested NSSAI in the REGISTRATION REQUEST message or none of the S-NSSAIs in the requested NSSAI in the REGISTRATION REQUEST message are allowed; and
- b) one or more subscribed S-NSSAIs marked as default are not subject to network slice-specific authentication and authorization or the network slice-specific authentication and authorization procedure has been successfully performed for one or more subscribed S-NSSAIs marked as default;

the AMF shall in the REGISTRATION ACCEPT message include:

- a) pending NSSAI containing one or more subscribed S-NSSAIs marked as default for which network slice-specific authentication and authorization will be performed or is ongoing (if any) and one or more S-NSSAIs from the pending NSSAI which the AMF provided to the UE during the previous registration procedure for which network slice-specific authentication and authorization will be performed or is ongoing (if any);
- b) allowed NSSAI containing S-NSSAI(s) for the current PLMN each of which corresponds to a subscribed S-NSSAI marked as default which are not subject to network slice-specific authentication and authorization or for which the network slice-specific authentication and authorization has been successfully performed; and
- c) allowed NSSAI containing one or more subscribed S-NSSAIs marked as default, as the mapped S-NSSAI(s) for the allowed NSSAI in roaming scenarios, which are not subject to network slice-specific authentication and authorization or for which the network slice-specific authentication and authorization has been successfully performed.

When the REGISTRATION ACCEPT message includes a pending NSSAI, the pending NSSAI shall contain all S-NSSAIs for which network slice-specific authentication and authorization will be performed or is ongoing from the requested NSSAI of the REGISTRATION REQUEST message that was received over the 3GPP access, non-3GPP access, or both the 3GPP access or non-3GPP access.

The AMF may include a new configured NSSAI for the current PLMN in the REGISTRATION ACCEPT message if:

- a) the REGISTRATION REQUEST message did not include the requested NSSAI;
- b) the REGISTRATION REQUEST message included the requested NSSAI containing an S-NSSAI that is not valid in the serving PLMN;
- c) the REGISTRATION REQUEST message included the requested NSSAI containing S-NSSAI(s) with incorrect mapped S-NSSAI(s); or
- d) the REGISTRATION REQUEST message included the Network slicing indication IE with the Default configured NSSAI indication bit set to "Requested NSSAI created from default configured NSSAI".

If a new configured NSSAI for the current PLMN is included in the REGISTRATION ACCEPT message, the AMF shall also include the mapped S-NSSAI(s) for the configured NSSAI for the current PLMN if available in the REGISTRATION ACCEPT message. In this case the AMF shall start timer T3550 and enter state 5GMM-COMMON-PROCEDURE-INITIATED as described in subclause 5.1.3.2.3.3.

If the UE requests ciphering keys for ciphered broadcast assistance data in the REGISTRATION REQUEST message and the AMF has valid ciphering key data applicable to the UE's subscription and current tracking area, then the AMF shall include the ciphering key data in the Ciphering key data IE of the REGISTRATION ACCEPT message.

The AMF shall include the Network slicing indication IE with the Network slicing subscription change indication set to "Network slicing subscription changed" in the REGISTRATION ACCEPT message if the UDM has indicated that the subscription data for network slicing has changed. In this case the AMF shall start timer T3550 and enter state 5GMM-COMMON-PROCEDURE-INITIATED as described in subclause 5.1.3.2.3.3.

The UE that has indicated the support for network slice-specific authentication and authorization receiving the pending NSSAI in the REGISTRATION ACCEPT message shall store the S-NSSAI(s) in the pending NSSAI as specified in subclause 4.6.2.2. If the registration area contains TAIs belonging to different PLMNs, which are equivalent PLMNs, the UE shall store the received pending NSSAI for each of the equivalent PLMNs as specified in subclause 4.6.2.2. If the pending NSSAI is not included in the REGISTRATION ACCEPT message and the "NSSAI to be performed"

indicator is not set to "Network slice-specific authentication and authorization is to be performed" in the 5GS registration result IE of the REGISTRATION ACCEPT message, then the UE shall delete the pending NSSAI for the current PLMN or SNPN, if existing, as specified in subclause 4.6.2.2.

The UE receiving the rejected NSSAI in the REGISTRATION ACCEPT message takes the following actions based on the rejection cause in the rejected S-NSSAI(s):

"S-NSSAI not available in the current PLMN or SNPN"

The UE shall add the rejected S-NSSAI(s) in the rejected NSSAI for the current PLMN as specified in subclause 4.6.2.2 and shall not attempt to use this S-NSSAI(s) in the current PLMN until switching off the UE, the UICC containing the USIM is removed, the entry of the "list of subscriber data" with the SNPN identity of the current SNPN is updated, or the rejected S-NSSAI(s) are removed or deleted as described in subclause 4.6.2.2.

"S-NSSAI not available in the current registration area"

The UE shall add the rejected S-NSSAI(s) in the rejected NSSAI for the current registration area as specified in subclause 4.6.2.2 and shall not attempt to use this S-NSSAI(s) in the current registration area until switching off the UE, the UE moving out of the current registration area, the UICC containing the USIM is removed, the entry of the "list of subscriber data" with the SNPN identity of the current SNPN is updated, or the rejected S-NSSAI(s) are removed or deleted as described in subclause 4.6.2.2.

"S-NSSAI not available due to the failed or revoked network slice-specific authentication and authorization"

The UE shall store the rejected S-NSSAI(s) in the rejected NSSAI for the failed or revoked NSSAA as specified in subclause 4.6.2.2 and shall not attempt to use this S-NSSAI in the current PLMN over any access until switching off the UE, the UICC containing the USIM is removed, the entry of the "list of subscriber data" with the SNPN identity of the current SNPN is updated, or the rejected S-NSSAI(s) are removed or deleted as described in subclause 4.6.1 and 4.6.2.2.

If the UE sets the NSSAA bit in the 5GMM capability IE to "Network slice-specific authentication and authorization not supported", and:

- a) if the Requested NSSAI IE only includes the S-NSSAI(s) subject to network slice-specific authentication and authorization and one or more subscribed S-NSSAIs (containing one or more S-NSSAIs each of which may be associated with a new S-NSSAI) marked as default which are not subject to network slice-specific authentication and authorization are available, the AMF shall in the REGISTRATION ACCEPT message include:
 - 1) the allowed NSSAI containing S-NSSAI(s) for the current PLMN each of which corresponds to a subscribed S-NSSAI marked as default which are not subject to network slice-specific authentication and authorization;
 - 2) the allowed NSSAI containing the subscribed S-NSSAIs marked as default, as the mapped S-NSSAI(s) for the allowed NSSAI in roaming scenarios, which are not subject to network slice-specific authentication and authorization; and
 - 3) the rejected NSSAI containing the S-NSSAI(s) subject to network slice specific authentication and authorization with the rejection cause indicating "S-NSSAI not available in the current PLMN or SNPN", except if the S-NSSAI(s) is associated to multiple mapped S-NSSAIs and some of these mapped S-NSSAIs are not subject to NSSAA; or
- b) if the Requested NSSAI IE includes one or more S-NSSAIs subject to network slice-specific authentication and authorization, the AMF shall in the REGISTRATION ACCEPT message include:
 - 1) the allowed NSSAI containing the S-NSSAI(s) or the mapped S-NSSAI(s) which are not subject to network slice-specific authentication and authorization; and
 - 2) the rejected NSSAI containing:
 - i) the S-NSSAI(s) subject to network slice specific authentication and authorization with the rejection cause indicating "S-NSSAI not available in the current PLMN or SNPN", except if the S-NSSAI is associated to multiple mapped S-NSSAIs and some of these mapped S-NSSAIs are not subject to NSSAA; and

- ii) the S-NSSAI(s) which was included in the requested NSSAI but rejected by the network associated with the rejection cause indicating "S-NSSAI not available in the current PLMN or SNPN" or the rejection cause indicating "S-NSSAI not available in the current registration area", if any.

If the UE does not indicate support for network slice-specific authentication and authorization, and if:

- a) the UE did not include the requested NSSAI in the REGISTRATION REQUEST message; or
- b) none of the S-NSSAIs in the requested NSSAI in the REGISTRATION REQUEST message are allowed;

and one or more subscribed S-NSSAIs (containing one or more S-NSSAIs each of which may be associated with a new S-NSSAI) marked as default which are not subject to network slice-specific authentication and authorization are available, the AMF shall:

- a) put the allowed S-NSSAI(s) for the current PLMN each of which corresponds to a subscribed S-NSSAI marked as default and not subject to network slice-specific authentication and authorization in the allowed NSSAI of the REGISTRATION ACCEPT message;
- b) put the subscribed S-NSSAIs marked as default and not subject to network slice-specific authentication and authorization, as the mapped S-NSSAI(s) for the allowed NSSAI in roaming scenarios, in the allowed NSSAI of the REGISTRATION ACCEPT message; and
- c) determine a registration area such that all S-NSSAIs of the allowed NSSAI are available in the registration area.

If the REGISTRATION ACCEPT message contains the Network slicing indication IE with the Network slicing subscription change indication set to "Network slicing subscription changed", the UE shall delete the network slicing information for each and every PLMN except for the current PLMN as specified in subclause 4.6.2.2.

If the REGISTRATION ACCEPT message contains the allowed NSSAI, then the UE shall store the included allowed NSSAI together with the PLMN identity of the registered PLMN and the registration area as specified in subclause 4.6.2.2. If the registration area contains TAIs belonging to different PLMNs, which are equivalent PLMNs, the UE shall store the received allowed NSSAI in each of allowed NSSAIs which are associated with each of the PLMNs.

If the REGISTRATION ACCEPT message contains a configured NSSAI IE with a new configured NSSAI for the current PLMN and optionally the mapped S-NSSAI(s) for the configured NSSAI for the current PLMN, the UE shall store the contents of the configured NSSAI IE as specified in subclause 4.6.2.2.

If the REGISTRATION ACCEPT message:

- a) includes the "NSSAA to be performed" indicator in the 5GS registration result IE;
- b) includes a pending NSSAI; and
- c) does not include an allowed NSSAI,

the UE shall not initiate a:

- a) 5GSM procedure except for emergency services or high priority access until the UE receives an allowed NSSAI; and
- b) service request procedure except for cases f) and i) in subclause 5.6.1.1.

...

If required by operator policy, the AMF shall include the NSSAI inclusion mode IE in the REGISTRATION ACCEPT message (see table 4.6.2.3.1 of subclause 4.6.2.3). Upon receipt of the REGISTRATION ACCEPT message:

- a) if the message includes the NSSAI inclusion mode IE, the UE shall operate in the NSSAI inclusion mode indicated in the NSSAI inclusion mode IE over the current access within the current PLMN and its equivalent PLMN(s), if any, in the current registration area; or
- b) otherwise:
 - 1) if the UE has NSSAI inclusion mode for the current PLMN and access type stored in the UE, the UE shall operate in the stored NSSAI inclusion mode;

- 2) if the UE does not have NSSAI inclusion mode for the current PLMN and the access type stored in the UE and if the UE is performing the registration procedure over:
- i) 3GPP access, the UE shall operate in NSSAI inclusion mode D in the current PLMN and the current access type;
 - ii) untrusted non-3GPP access, the UE shall operate in NSSAI inclusion mode B in the current PLMN and the current access type; or
 - iii) trusted non-3GPP access, the UE shall operate in NSSAI inclusion mode D in the current PLMN and the current access type; or
- 3) if the 5G-RG does not have NSSAI inclusion mode for the current PLMN and wireline access stored in the 5G-RG, and the 5G-RG is performing the registration procedure over wireline access, the 5G-RG shall operate in NSSAI inclusion mode B in the current PLMN and the current access type.

9.1.10.3.3 Test description

9.1.10.3.3.1 Pre-test conditions

System Simulator:

NGC Cell A belongs to Home PLMN and TAI1 and set as serving cell;

UE:

None.

Preamble:

The UE is in state Switched OFF (state 0N-B) according to TS 38.508-1 [4].

9.1.10.3.3.2 Test procedure sequence

Table 9.1.10.3.3.2-1: Main behaviour

St	Procedure	Message Sequence		TP	Verdict
		U - S	Message		
1	The UE is switched on.	-	-	-	-
2	The UE transmits a REGISTRATION REQUEST message including NSSAA bit	-->	REGISTRATION REQUEST	-	-
3-11	Steps 5 to 13 of the generic procedure for NR RRC_IDLE specified in TS 38.508-1 subclause 4.5.2 are performed.	-	-	-	-
12	The SS transmits a REGISTRATION ACCEPT message including Rejected S-NSSAI=1	<--	REGISTRATION ACCEPT	-	-
13	The UE transmits an <i>ULInformationTransfer</i> message and a REGISTRATION COMPLETE message.	-->	REGISTRATION COMPLETE	-	-
	EXCEPTION: Step 14a1 is performed if $pc_noOf_PDU_SessionsSameConnection > 0$.				
14a1	The generic procedure for UE-requested PDU session establishment, specified in subclause 4.5A.2, takes place performing establishment of UE-requested PDU session(s) with $ExpectedNumberOfNewPDUSessions = pc_noOf_PDU_SessionsSameConnection$.	-	-	-	-
15	Check: Is S-NSSAI=1 in the Rejected NSSAI list with cause 'S-NSSAI not available due to the failed or revoked network slice-specific authentication and authorization' associated with current PLMN using AT/MMI command (+C5GNSSAIRDP)?	-	-	1	P

16	Cause the UE to request establishment of PDU session with S-NSSAI=1.(Note 1)				
17	Check: Does the UE transmit a PDU SESSION ESTABLISHMENT REQUEST message within 5 seconds?	-->	5GMM: UL NAS TRANSPORT 5GSM: PDU SESSION ESTABLISHMENT REQUEST	1	F
18	Switch off procedure in RRC_CONNECTED specified in TS 38.508-1 subclause 4.9.6.3 is performed.	-	-	-	-
19	The SS configures NGC Cell A as the "Non-suitable OFF cell"				
20	The UE is switched on.	-	-	-	-
21	Check: Is S-NSSAI=1 in the Rejected NSSAI list with cause 'S-NSSAI not available due to the failed or revoked network slice-specific authentication and authorization' associated with current PLMN using AT/MMI command (+C5GNSSAIRDP)?	-	-	2	F
22	The SS configures NGC Cell A as the "Serving cell".				
23	The UE transmits a REGISTRATION REQUEST message including NSSAA bit	-->	REGISTRATION REQUEST	-	-
24-32	Steps 5 to 13 of the generic procedure for NR RRC_IDLE specified in TS 38.508-1 subclause 4.5.2 are performed.	-	-	-	-
33	The SS transmits a REGISTRATION ACCEPT message including Rejected S-NSSAI=2 and Pending S-NSSAI-1.	<--	REGISTRATION ACCEPT	-	-
34	The UE transmits an <i>ULInformationTransfer</i> message and a REGISTRATION COMPLETE message.	-->	REGISTRATION COMPLETE	-	-
	EXCEPTION: Step 35a1 is performed if $pc_noOf_PDUsSameConnection > 0$.				
35a1	The generic procedure for UE-requested PDU session establishment, specified in subclause 4.5A.2, takes place performing establishment of UE-requested PDU session(s) with $ExpectedNumberOfNewPDUSessions = pc_noOf_PDUsSameConnection$.	-	-	-	-
36	Check: Is S-NSSAI=2 in the Rejected NSSAI list with cause 'S-NSSAI not available due to the failed or revoked network slice-specific authentication and authorization' associated with current PLMN using AT/MMI command (+C5GNSSAIRDP)?	-	-	3	P
37	The SS releases the RRC connection.	-	-	-	-
	EXCEPTION: Steps 38a1 to 38b2 take place depending upon UE implementation; the "lower case letter" identifies a step sequence that take place if a particular implementation is under test.				
38a1	If $pc_USIM_Removal = TRUE$, cause removal of USIM from the UE without powering down.	-	-	-	-
38a2a1-38a2a4	Steps 1a2 to 1a5 of generic procedure for Switch off in RRC_IDLE specified in TS 38.508-1 subclause 4.9.6.1 is performed.	-	-	-	-
38a3	The SS configures NGC Cell A as the "Non-suitable OFF cell"	-	-	-	-
38a4	The USIM is inserted into the UE.	-	-	-	-
38a5	Check: Using AT/MMI command (+C5GNSSAIRDP) verify that S-NSSAI=2 is not in the Rejected NSSAI list associated with current PLMN	-	-	3	P
38a6	The SS configures NGC Cell A as the "Serving cell".	-	-	-	-

38b 1	Else The UE is switched off by executing generic procedure in Table 4.9.6.1 as specified in TS 38.508-1 [4].	-	-	-	-
38b 2	The UE is switched on.	-	-	-	-
39	The UE transmits a REGISTRATION REQUEST message including NSSAA bit	-->	REGISTRATION REQUEST	-	-
40- 48	Steps 5 to 13 of the generic procedure for NR RRC_IDLE specified in TS 38.508-1 subclause 4.5.2 are performed.	-	-	-	-
49	The SS transmits a REGISTRATION ACCEPT message not including Pending S-NSSAI=1	<--	REGISTRATION ACCEPT	-	-
50	The UE transmits an <i>ULInformationTransfer</i> message and a REGISTRATION COMPLETE message.	-->	REGISTRATION COMPLETE	-	-
	EXCEPTION: Step 51a1 is performed if $pc_noOf_PDUsSameConnection > 0$.				
51a 1	The generic procedure for UE-requested PDU session establishment, specified in subclause 4.5A.2, takes place performing establishment of UE-requested PDU session(s) with $ExpectedNumberOfNewPDUSessions = pc_noOf_PDUsSameConnection$.	-	-	-	-
52	Cause the UE to request establishment of PDU session with S-NSSAI=1.(Note 1)	-	-	-	-
53	message with the S-NSSAI IE set to 1?	-->	5GMM: UL NAS TRANSPORT 5GSM: PDU SESSION ESTABLISHMENT REQUEST	4	P
54	The SS transmits PDU SESSION ESTABLISHMENT REJECT message with 5GSM cause #26.	<--	PDU SESSION ESTABLISHMENT REJECT		
55	SS transmits an RRCRelease message to release RRC connection and move the UE to RRC_IDLE.	<--	NR RRC: RRCRelease	-	-
Note1: The request to establish a PDU session may be performed by MMI or AT Command.					

9.1.10.3.3.3 Specific message contents

Table 9.1.10.3.3.3-1: REGISTRATION REQUEST (steps 2, 23 and 39, Table 9.1.10.3.3.2-1)

Derivation path: TS 38.508-1 Table 4.7.1-6			
Information Element	Value/remark	Comment	Condition
5GS registration type value	'001'B	Initial registration	
5GMM capability			
NSSAA	'1'B	Network slice-specific authentication and authorization supported	

Table 9.1.10.3.3.3-2: REGISTRATION ACCEPT (step 12, Table 9.1.10.3.3.3-1)

Derivation path: TS 38.508-1 Table 4.7.1-7			
Information Element	Value/remark	Comment	Condition
5GS registration result			
5GS registration result value	'001'B	3GPP access	
NSSAA Performed	'1'B	Network slice-specific authentication and authorization is to be performed	
Allowed NSSAI			
S-NSSAI IEI		S-NSSAI value 2	
Length of S-NSSAI contents	'0000001'B	SST	
SST	'00000010'B	SST value 2	

SD	Not Present		
Mapped configured SST	Not Present		
Mapped configured SD	Not Present		
S-NSSAI IEI		S-NSSAI value 3	
Length of S-NSSAI contents	'0000001'B	SST	
SST	'00000011'B	SST value 3	
SD	Not Present		
Mapped configured SST	Not Present		
Mapped configured SD	Not Present		
S-NSSAI IEI		S-NSSAI value 4	
Length of S-NSSAI contents	'0000001'B	SST	
SST	'0000100'B	SST value 4	
SD	Not Present		
Mapped configured SST	Not Present		
Mapped configured SD	Not Present		
Rejected NSSAI			
S-NSSAI IEI		S-NSSAI value 1	
Length of rejected S-NSSAI	'0001'B	SST	
Cause value	'0010'B	S-NSSAI not available due to the failed or revoked network slice-specific authentication and authorization.	
SST	'0000001'B	SST value 1	
SD	Not Present		

Table 9.1.10.3.3-3: REGISTRATION ACCEPT (step 33, Table 9.1.10.3.3-1)

Derivation path: TS 38.508-1 Table 4.7.1-7			
Information Element	Value/remark	Comment	Condition
5GS registration result			
5GS registration result value	'001'B	3GPP access	
NSSAA Performed	'1'B	Network slice-specific authentication and authorization is to be performed	
Allowed NSSAI			
S-NSSAI IEI		S-NSSAI value 3	
Length of S-NSSAI contents	'0000001'B	SST	
SST	'00000011'B	SST value 3	
SD	Not Present		
Mapped configured SST	Not Present		
Mapped configured SD	Not Present		
S-NSSAI IEI		S-NSSAI value 4	
Length of S-NSSAI contents	'0000001'B	SST	
SST	'0000100'B	SST value 4	
SD	Not Present		
Mapped configured SST	Not Present		
Mapped configured SD	Not Present		
Configured NSSAI			
S-NSSAI IEI		S-NSSAI value 1	
Length of S-NSSAI contents	'0000001'B	SST	
SST	'0000001'B	SST value 1	
SD	Not Present		
Mapped configured SST	Not Present		
Mapped configured SD	Not Present		
Pending NSSAI			
S-NSSAI IEI		S-NSSAI value 1	
Length of S-NSSAI contents	'0000001'B	SST	
SST	'0000001'B	SST value 1	
SD	Not Present		
Mapped configured SST	Not Present		

Mapped configured SD	Not Present		
Rejected NSSAI			
S-NSSAI IEI		S-NSSAI value 2	
Length of rejected S-NSSAI	'0001'B	SST	
Cause value	'0010'B	S-NSSAI not available due to the failed or revoked network slice-specific authentication and authorization.	
SST	'00000010'B	SST value 2	
SD	Not Present		

Table 9.1.10.3.3.3-4: REGISTRATION ACCEPT (step 49, Table 9.1.10.3.3.3-1)

Derivation path: TS 38.508-1 Table 4.7.1-7			
Information Element	Value/remark	Comment	Condition
5GS registration result			
5GS registration result value	'001'B	3GPP access	
NSSAA Performed	'0'B	Network slice-specific authentication and authorization is not to be performed	
Configured NSSAI			
S-NSSAI IEI		S-NSSAI value 1	
Length of S-NSSAI contents	'00000001'B	SST	
SST	'00000001'B	SST value 1	
SD	Not Present		
Mapped configured SST	Not Present		
Mapped configured SD	Not Present		
T3512 value			
Unit	'101'B	value is incremented in multiples of 1 minute	
Timer value	'0 0001'B	1 minute	
SD	Not Present		

Table 9.1.10.3.3.3-5: UL NAS TRANSPORT (step 53, Table 9.1.10.3.3.3-1)

Derivation path: TS 38.508-1 Table 4.7.1-10			
Information Element	Value/remark	Comment	Condition
S-NSSAI			
S-NSSAI IEI		S-NSSAI value 1	
Length of S-NSSAI contents	'0000 0001'B	SST	
SST	'0000 0001'B	SST value 1	

9.1.10.4 NSSAA / Initial registration / Reject

9.1.10.4.1 Test Purpose (TP)

(1)

```

with { UE in 5GMM-REGISTERED-INITIATED state }
ensure that {
  when { UE receives a REGISTRATION REJECT with cause #62 "No network slices available" }
  then { UE abort the initial registration procedure, set the 5GS update status to 5U2 NOT
UPDATED, enter state 5GMM-DEREGISTERED.NORMAL-SERVICE or 5GMM-DEREGISTERED.PLMN-SEARCH and reset the
registration attempt counter }

```

}

(2)

```
with { UE in 5GMM-REGISTERED-INITIATED state }
ensure that {
  when { UE receives the rejected NSSAI in the REGISTRATION REJECT message with rejection cause of
  "S-NSSAI not available due to the failed or revoked network slice-specific authentication and
  authorization" }
  then { UE stores the rejected NSSAI and doesn't attempt to use this S-NSSAI in the current PLMN
  over any access }
```

9.1.10.4.2 Conformance requirements

References: The conformance requirements covered in the present TC are specified in: TS 24.501, clause 5.5.1.2.5.

[TS 24.501 clause 5.5.1.2.5]

If the initial registration request is rejected because:

- a) all the S-NSSAI(s) included in the requested NSSAI are either rejected for the current PLMN, rejected for the current registration area, or rejected for the failed or revoked NSSAAs; and
- b) the UE set the NSSAA bit in the 5GMM capability IE to:
 - 1) "Network slice-specific authentication and authorization supported" and:
 - i) there are no subscribed S-NSSAIs marked as default;
 - ii) all subscribed S-NSSAIs marked as default are not allowed; or
 - iii) network slice-specific authentication and authorization has failed or been revoked for all subscribed S-NSSAIs marked as default and based on network local policy, the network decides not to initiate the network slice-specific re-authentication and re-authorization procedures for any subscribed S-NSSAI marked as default requested by the UE; or
 - 2) "Network slice-specific authentication and authorization not supported"; and
 - i) there are no subscribed S-NSSAIs which are marked as default; or
 - ii) all subscribed S-NSSAIs marked as default are either not allowed or are subject to network slice-specific authentication and authorization;

the network shall set the 5GMM cause value to #62 "No network slices available". If the UE had included requested NSSAI in the REGISTRATION REQUEST message, then the network shall include the rejected S-NSSAI(s) in the Rejected NSSAI IE of the REGISTRATION REJECT message. Otherwise, the network may include the rejected NSSAI.

...

#62 (No network slices available).

The UE shall abort the initial registration procedure, set the 5GS update status to 5U2 NOT UPDATED and enter state 5GMM-DEREGISTERED.NORMAL-SERVICE or 5GMM-DEREGISTERED.PLMN-SEARCH. Additionally, the UE shall reset the registration attempt counter.

The UE receiving the rejected NSSAI in the REGISTRATION REJECT message takes the following actions based on the rejection cause in the rejected S-NSSAI(s):

"S-NSSAI not available in the current PLMN or SNPN"

The UE shall store the rejected S-NSSAI(s) in the rejected NSSAI for the current PLMN or SNPN as specified in subclause 4.6.2.2 and shall not attempt to use this S-NSSAI(s) in the current PLMN or SNPN until switching off the UE, the UICC containing the USIM is removed, an entry of the "list of subscriber data" with the SNPN identity of the current SNPN is updated, or the rejected S-NSSAI(s) are removed as described in subclause 4.6.2.2.

"S-NSSAI not available in the current registration area"

The UE shall store the rejected S-NSSAI(s) in the rejected NSSAI for the current registration area as described in subclause 4.6.2.2 and shall not attempt to use this S-NSSAI(s) in the current registration area until switching off the UE, the UE moving out of the current registration area, the UICC containing the USIM is removed, the entry of the "list of subscriber data" with the SNPN identity of the current SNPN is updated, or the rejected S-NSSAI(s) are removed or deleted as described in subclause 4.6.2.2.

"S-NSSAI not available due to the failed or revoked network slice-specific authentication and authorization"

The UE shall store the rejected S-NSSAI(s) in the rejected NSSAI for the failed or revoked NSSAI as specified in subclause 4.6.2.2 and shall not attempt to use this S-NSSAI in the current PLMN over any access until switching off the UE, the UICC containing the USIM is removed, the entry of the "list of subscriber data" with the SNPN identity of the current SNPN is updated, or the rejected S-NSSAI(s) are removed or deleted as described in subclause 4.6.1 and 4.6.2.2.

9.1.10.4.3 Test description

9.1.10.4.3.1 Pre-test conditions

System Simulator:

NGC Cell A belongs to Home PLMN and TAI1 and set as serving cell;

NGC Cell B belongs to Home PLMN and TAI-2 and set as Non-Suitable "Off" cell.

UE:

None.

Preamble:

The UE is in state Switched OFF (state ON-B) according to TS 38.508-1 [4].

9.1.10.4.3.2 Test procedure sequence

Table 9.1.10.4.3.2-1: Main behaviour

St	Procedure	Message Sequence		TP	Verdict
		U - S	Message		
1	The SS configures: - NGC cell A as the "Serving cell".	-	-	-	-
-	The following messages are to be observed on NGC Cell A unless explicitly stated otherwise.	-	-	-	-
2	The UE is switched on.	-	-	-	-
3-14	Steps 2-13 of Table 4.5.2.2-2 of the generic procedure in TS 38.508-1 [4] are performed.	-	-	-	-
15	The SS transmits a REGISTRATION REJECT message with the 5GMM cause set to #62 "No network slices available"	<--	5GMM: REGISTRATION REJECT	-	-
16	The SS releases the RRC connection.	-	-	-	-
17	Check: Does the UE transmit an REGISTRATION REQUEST message on NGC cell A in the next 90 seconds?	-->	5GMM: REGISTRATION REQUEST	1	F
18	The SS configures NGC Cell A as a "Non-suitable OFF cell" and NGC Cell B as the "Serving cell".	-	-	-	-
19	The UE transmits a REGISTRATION REQUEST message	-->	REGISTRATION REQUEST	-	-
20-28	Steps 5 to 13 of the generic procedure for NR RRC_IDLE specified in TS 38.508-1 subclause 4.5.2 are performed.	-	-	-	-
29	The SS transmits a REGISTRATION ACCEPT	<--	REGISTRATION ACCEPT	-	-

	message including Configured S-NSSAI=2 IE				
30	The UE transmits an <i>ULInformationTransfer</i> message and a REGISTRATION COMPLETE message.	-->	REGISTRATION COMPLETE	-	-
	EXCEPTION: Step 31a1 is performed if <i>pc_noOf_PDUsSameConnection</i> > 0.				
31a1	The generic procedure for UE-requested PDU session establishment, specified in subclause 4.5A.2, takes place performing establishment of UE-requested PDU session(s) with <i>ExpectedNumberOfNewPDUSessions</i> = <i>pc_noOf_PDUsSameConnection</i> .	-	-	-	-
32	Cause the UE to request establishment of PDU session with S-NSSAI=1.(Note 1)	-	-	-	-
33	Check: Does the UE transmit an <i>RRCSetupRequest</i> message within 5 seconds?	-->	NR RRC: <i>RRCSetupRequest</i>	2	F
Note1: The request to establish a PDU session may be performed by MMI or AT Command.					

9.1.10.4.3.3 Specific message contents

Table 9.1.10.4.3.3-1: REGISTRATION REJECT (step 15, Table 9.1.10.4.3.2-1)

Derivation Path: TS 38.508-1 Table 4.7.1-9			
Information Element	Value/remark	Comment	Condition
5GMM cause	'0011 1110'B	No network slices available	
Rejected NSSAI			
S-NSSAI IEI		S-NSSAI value 1	
Length of rejected S-NSSAI	'0001'B	SST	
Cause value	'0010'B	S-NSSAI not available due to the failed or revoked network slice-specific authentication and authorization.	
SST	'00000001'B	SST value 1	
SD	'FFFFFF'H	no SD value associated with the SST	

Table 9.1.10.4.3.3-1a: REGISTRATION REQUEST (step 19, Table 9.1.10.4.3.2-1)

Derivation Path: TS 38.508-1 Table 4.7.1-6			
Information Element	Value/remark	Comment	Condition
5GS registration type			
5GS registration type value	'001'B	Initial registration	

Table 9.1.10.4.3.3-2: REGISTRATION ACCEPT (step 29, Table 9.1.10.4.3.2-1)

Derivation path: TS 38.508-1 Table 4.7.1-7			
Information Element	Value/remark	Comment	Condition
5GS registration result			
5GS registration result value	'001'B	3GPP access	
NSSAA Performed	'1'B	Network slice-specific authentication and authorization is to be performed	
Configured NSSAI			
S-NSSAI IEI		S-NSSAI value 2	
Length of S-NSSAI contents	'00000001'B	SST	
SST	'00000010'B	SST value 2	
SD	Not Present		
Mapped configured SST	Not Present		

Mapped configured SD	Not Present		
----------------------	-------------	--	--

9.1.10.5

9.1.10.6 NSSAA / UE configuration update / Rejected NSSAI

9.1.10.6.1 Test Purpose (TP)

(1)

```
with { UE is in 5GMM-REGISTERED state and NSSAA failure }
ensure that {
  when { SS sends the rejected NSSAI in the CONFIGURATION UPDATE COMMAND message with rejection
cause of "S-NSSAI not available due to the failed or revoked network slice-specific authentication
and authorization" }
  then { UE adds the rejected S-NSSAI(s) in the rejected NSSAI and shall not attempt to use this
S-NSSAI in the current PLMN over any access }
}
```

(2)

```
with { UE receives the rejected NSSAI in the CONFIGURATION UPDATE COMMAND message with rejection
cause of "S-NSSAI not available due to the failed or revoked network slice-specific authentication
and authorization" }
ensure that {
  when { UE has been switched off, then switched on }
  then { UE deletes the stored Rejected NSAAI for the current PLMN }
}
```

(3)

```
with { UE receives the rejected NSSAI in the CONFIGURATION UPDATE COMMAND message with rejection
cause of "S-NSSAI not available due to the failed or revoked network slice-specific authentication
and authorization" }
ensure that {
  when { The UICC containing the USIM is removed }
  then { UE deletes the stored Rejected NSAAI for the current PLMN }
}
```

9.1.10.6.2 Conformance requirements

References: The conformance requirements covered in the present TC are specified in: TS 24.501, clause 5.4.4.3, 5.4.7.2.2, 5.5.1.2.2, 5.5.1.2.4 and TS 23.502, clause 4.2.9.2. Unless otherwise stated these are Rel-16 requirements.

[TS 24.501 clause 5.4.4.3]

The UE receiving the rejected NSSAI in the CONFIGURATION UPDATE COMMAND message takes the following actions based on the rejection cause in the rejected S-NSSAI(s):

"S-NSSAI not available in the current PLMN or SNPN"

The UE shall add the rejected S-NSSAI(s) in the rejected NSSAI for the current PLMN as specified in subclause 4.6.2.2 and shall not attempt to use this S-NSSAI(s) in the current PLMN until switching off the UE, the UICC containing the USIM is removed, the entry of the "list of subscriber data" with the SNPN identity of the current SNPN is updated, or the rejected S-NSSAI(s) are removed or deleted as described in subclause 4.6.2.2.

"S-NSSAI not available in the current registration area"

The UE shall add the rejected S-NSSAI(s) in the rejected NSSAI for the current registration area as specified in subclause 4.6.2.2 and shall not attempt to use this S-NSSAI(s) in the current registration area until switching off the UE, the UE moving out of the current registration area, the UICC containing the USIM is removed, the entry of the "list of subscriber data" with the SNPN identity of the current SNPN is updated, or the rejected S-NSSAI(s) are removed or deleted as described in subclause 4.6.2.2.

"S-NSSAI not available due to the failed or revoked network slice-specific authentication and authorization"

The UE shall add the rejected S-NSSAI(s) in the rejected NSSAI for the failed or revoked NSSAA as specified in subclause 4.6.2.2 and shall not attempt to use this S-NSSAI in the current PLMN over any access until switching off the UE, the UICC containing the USIM is removed, the entry of the "list of subscriber data" with the SNPN identity of the current SNPN is updated, or the rejected S-NSSAI(s) are removed or deleted as described in subclause 4.6.1 and 4.6.2.2.

9.1.10.6.3 Test description

9.1.10.6.3.1 Pre-test conditions

System Simulator:

NGC Cell A belongs to Home PLMN and TAI1 and set as serving cell;

UE:

None.

Preamble:

The UE is in state Switched OFF (state 0N-B) according to TS 38.508-1 [4].

9.1.10.6.3.2 Test procedure sequence

Table 9.1.10.6.3.2-1: Main behaviour

St	Procedure	Message Sequence		TP	Verdict
		U - S	Message		
1	The UE is switched on.	-	-	-	-
2	The UE transmits a REGISTRATION REQUEST message including NSSAA bit	-->	REGISTRATION REQUEST	-	-
3-11	Steps 5 to 13 of the generic procedure for NR RRC_IDLE specified in TS 38.508-1 subclause 4.5.2 are performed.	-	-	-	-
12	The SS transmits a REGISTRATION ACCEPT message including Allowed NSSAI and Pending NSSAI	<--	REGISTRATION ACCEPT	-	-
13	The UE transmits an <i>ULInformationTransfer</i> message and a REGISTRATION COMPLETE message.	-->	REGISTRATION COMPLETE	-	-
-	EXCEPTION: Step 14a1 is performed if $pc_noOf_PDUsSameConnection > 0$.	-	-	-	-
14a1	The generic procedure for UE-requested PDU session establishment, specified in subclause 4.5A.2, takes place performing establishment of UE-requested PDU session(s) with $ExpectedNumberOfNewPDUSessions = pc_noOf_PDUsSameConnection$.	-	-	-	-
15	The SS transmits a NETWORK SLICE-SPECIFIC AUTHENTICATION COMMAND message with an EAP-Request message.	<--	5GMM: NETWORK SLICE-SPECIFIC AUTHENTICATION COMMAND		
16	The UE responds with a NETWORK SLICE-SPECIFIC AUTHENTICATION COMPLETE message, with an EAP-Response message and NSSAI	-->	5GMM: NETWORK SLICE-SPECIFIC AUTHENTICATION COMPLETE		
17	The SS transmits a NETWORK SLICE-SPECIFIC AUTHENTICATION RESULT message with an EAP-failure message.	<--	5GMM: NETWORK SLICE-SPECIFIC AUTHENTICATION RESULT		
18	The SS transmits a CONFIGURATION UPDATE COMMAND message including a new rejected NSSAI list.	<--	CONFIGURATION UPDATE COMMAND	-	-

19	The UE transmits a CONFIGURATION UPDATE COMPLETE message.	-->	CONFIGURATION UPDATE COMPLETE	-	-
20	The SS transmits an <i>RRCRelease</i> message.	-	-	-	-
21	Check: Is S-NSSAI=2 in the Rejected NSSAI list with cause 'S-NSSAI not available due to the failed or revoked network slice-specific authentication and authorization' associated with current PLMN using AT/MMI command (+C5GNSSAIRDP)?	-	-	1	P
22	Cause the UE to request establishment of PDU session with S-NSSAI=2.(Note 1)	-	-	-	-
23	Check: Does the UE transmit an <i>RRCSetupRequest</i> message?	-->	NR RRC: <i>RRCSetupRequest</i>	1	F
24	Switch off procedure in <i>RRC_IDLE</i> specified in TS 38.508-1 subclause 4.9.6.1 is performed.	-	-	-	-
25	The SS configures NGC Cell A as the "Non-suitable cell"	-	-	-	-
26	The UE is switched on.	-	-	-	-
27	Check: Using AT/MMI command (+C5GNSSAIRDP) verify that S-NSSAI=2 is not in the Rejected NSSAI list associated with current PLMN	-	-	2	P
27	The SS configures NGC Cell A as the "Serving cell".	-	-	-	-
-	EXCEPTION: Steps 28a1 to 28a27 take place if <i>pc_USIM_Removal</i> = TRUE	-	-	-	-
28a1-21	Steps 2 to 22 above are repeated	-	-	-	-
28a22	Cause removal of USIM from the UE without powering down.	-	-	-	-
28a23	Steps 1a2 to 1a5 of generic procedure for Switch off in <i>RRC_IDLE</i> specified in TS 38.508-1[4], subclause 4.9.6.1 is performed.	-	-	-	-
28a24	The SS configures NGC Cell A as the "Non-suitable cell"	-	-	-	-
28a25	The USIM is inserted into the UE.	-	-	-	-
28a26	Check: Using AT/MMI command (+C5GNSSAIRDP) verify that S-NSSAI=2 is not in the Rejected NSSAI list associated with current PLMN	-	-	3	P
28a27	The SS configures NGC Cell A as the "Serving cell".	-	-	-	-
29-47	Steps 2 to 20a1 of the generic procedure for NR <i>RRC_IDLE</i> specified in TS 38.508-1 subclause 4.5.2 are performed.	-	-	-	-
Note1: The request to establish a PDU session may be performed by MMI or AT Command.					

9.1.10.6.3.3 Specific message contents

Table 9.1.10.6.3.3-1: REGISTRATION REQUEST (step 2, Table 9.1.10.6.3.2-1)

Derivation path: TS 38.508-1 Table 4.7.1-6			
Information Element	Value/remark	Comment	Condition
5GS registration type value	'001'B	Initial registration	
5GMM capability			
NSSAA	'1'B	Network slice-specific authentication and authorization supported	

Table 9.1.10.6.3.3-2: REGISTRATION ACCEPT (step 12, Table 9.1.10.6.3.2-1)

Derivation path: TS 38.508-1 Table 4.7.1-7			
Information Element	Value/remark	Comment	Condition
5GS registration result			
5GS registration result value	'001'B	3GPP access	
NSSAA Performed	'1'B	Network slice-specific authentication and authorization is to be performed	
Allowed NSSAI			
Allowed NSSAI IEI		NSSAI value 1	
Length of Allowed NSSAI	'0000 0010'B	2 octets	
Length of S-NSSAI contents	'00000001'B	SST	
SST	'00000001'B	SST value 1	
SD	Not Present		
Mapped configured SST	Not Present		
Mapped configured SD	Not Present		
Configured NSSAI		2 S-NSSAI	
S-NSSAI IEI		NSSAI value 2	
Length of Configured NSSAI	'0000 010'B	2 octets	
Length of S-NSSAI contents	'00000001'B	SST	
SST	'00000001'B	SST value 1	
SD	Not Present		
Mapped configured SST	Not Present		
Mapped configured SD	Not Present		
Length of S-NSSAI contents	'00000001'B	SST	
SST	'00000010'B	SST value 2	
SD	Not Present		
Mapped configured SST	Not Present		
Mapped configured SD	Not Present		
Pending NSSAI			
Pending NSSAI IEI		NSSAI value 3	
Length of Pending NSSAI contents	'0000 0010'B	2 octets	
Length of S-NSSAI contents	'00000001'B	SST	
SST	'00000010'B	SST value 2	
SD	Not Present		
Mapped configured SST	Not Present		
Mapped configured SD	Not Present		

Table 9.1.10.6.3.3-3: NETWORK SLICE-SPECIFIC AUTHENTICATION COMMAND (step 15, Table 9.1.10.6.3.2-1)

Derivation Path: TS 38.508-1 Table 4.7.1-31			
Information Element	Value/remark	Comment	Condition
S-NSSAI			
Length of S-NSSAI contents	'00000001'B	SST	
SST	'00000010'B	SST value 2	
SD	Not Present		
Mapped configured SST	Not Present		
Mapped configured SD	Not Present		

Table 9.1.10.6.3.3-4: NETWORK SLICE-SPECIFIC AUTHENTICATION COMPLETE (step 16, Table 9.1.10.6.3.2-1)

Derivation Path: TS 38.508-1 Table 4.7.1-32			
Information Element	Value/remark	Comment	Condition
S-NSSAI IEI		S-NSSAI value 2	
Length of S-NSSAI contents	'00000001'B	SST	
SST	'00000010'B	SST value 2	
SD	Not Present		
Mapped configured SST	Not Present		

Mapped configured SD	Not Present		
----------------------	-------------	--	--

Table 9.1.10.6.3.3-5: NETWORK SLICE-SPECIFIC AUTHENTICATION RESULT (step 17, Table 9.1.10.6.3.2-1)

Derivation Path: TS 38.508-1, Table 4.7.1-33			
Information Element	Value/remark	Comment	Condition
S-NSSAI	Set according to specific message content		
S-NSSAI IEI		S-NSSAI value 2	
Length of S-NSSAI contents	'00000001'B	SST	
SST	'00000010'B	SST value 2	
SD	Not Present		
Mapped configured SST	Not Present		
Mapped configured SD	Not Present		
EAP message	EAP-failure		

Table 9.1.10.6.3.3-6: CONFIGURATION UPDATE COMMAND (step 18, Table 9.1.10.6.3.2-1)

Derivation path: TS 38.508-1, Table 4.7.1-19			
Information Element	Value/remark	Comment	Condition
Configuration update indication	0001	Acknowledgement requested	
Rejected NSSAI			
Rejected NSSAI IEI		Rejected S-NSSAI value 1	
Length of Rejected NSSAI contents	'00000101'B	5 octets	
Length of rejected S-NSSAI[1]	'0100'B	4 octest	
Cause value	'0010'B	S-NSSAI not available due to the failed or revoked network slice-specific authentication and authorization	
SST	'00000010'B	2	
SD	Not present		

9.1.11 SNPN / Mobility management aspects

9.1.11.1 SNPN / Initial registration / Rejected / Temporarily not authorized for this SNPN

9.1.11.1.1 Test Purpose (TP)

(1)

```

with { UE in Automatic SNPN selection mode and a SNPN cell is available for which an entry exists in the "list of subscriber data" and the UE in 5GMM-REGISTERED-INITIATED state }
ensure that {
  when { the SS sends a REGISTRATION REJECT message to the UE including an appropriate 5GMM cause value #74 (Temporarily not authorized for this SNPN) }
  then { the UE deletes any 5G-GUTI, last visited registered TAI and ngKSI, and stores the SNPN identity in the "temporarily forbidden SNPNs" }
}

```

(2)

```

with { the initial registration request cannot be accepted by the network }
ensure that {
  when { the SS sends a REGISTRATION REJECT message to the UE including an appropriate 5GMM cause value #74 (Temporarily not authorized for this SNPN) }
}

```

```

then { The UE stores the SNPN identity in the "temporarily forbidden SNPNs" and does not remove it
at least until 60 minutes or the UE is switched off }
}

```

(3)

```

with { the UE is in 5GMM-DEREGISTERED.PLMN-SEARCH state and the SNPN identity of the current cell
belongs to the list of "temporarily forbidden SNPNs" }
ensure that {
  when { the UE enters a cell belonging to a SNPN cell for which an entry exists in the "list of
subscriber data" }
    then { the UE attempts registration on the SNPN cell }
}

```

9.1.11.1.2 Conformance requirements

References: The conformance requirements covered in the current TC are specified in: TS 24.501 clauses 5.5.1.2.5, 5.1.3.2.1, 5.1.3.2.2, TS 23.122 clause 4.9.3.0. Unless otherwise stated these are Rel-16 requirements.

[TS 24.501, clause 5.5.1.2.5]

If the initial registration request cannot be accepted by the network, the AMF shall send a REGISTRATION REJECT message to the UE including an appropriate 5GMM cause value.

If the initial registration request is rejected due to general NAS level mobility management congestion control, the network shall set the 5GMM cause value to #22 "congestion" and assign a back-off timer T3346.

The UE shall take the following actions depending on the 5GMM cause value received in the REGISTRATION REJECT message.

...

#74 (Temporarily not authorized for this SNPN).

5GMM cause #74 is only applicable when received from a cell belonging to an SNPN. 5GMM cause #74 received from a cell not belonging to an SNPN is considered as an abnormal case and the behaviour of the UE is specified in subclause 5.5.1.2.7.

The UE shall set the 5GS update status to 5U3 ROAMING NOT ALLOWED (and shall store it according to subclause 5.1.3.2.2) and shall delete any 5G-GUTI, last visited registered TAI, TAI list and ngKSI. The UE shall reset the registration attempt counter and store the SNPN identity in the "temporarily forbidden SNPNs" list for the specific access type for which the message was received. The UE shall enter state 5GMM-DEREGISTERED.PLMN-SEARCH and perform an SNPN selection according to 3GPP TS 23.122 [5]. If the message has been successfully integrity checked by the NAS, the UE shall set the SNPN-specific attempt counter for 3GPP access and the SNPN-specific attempt counter for non-3GPP access for the current SNPN to the UE implementation-specific maximum value.

If the message has been successfully integrity checked by the NAS and the UE also supports the registration procedure over the other access to the same SNPN, the UE shall in addition handle 5GMM parameters and 5GMM state for this access, as described for this 5GMM cause value.

NOTE 4: When 5GMM cause #74 is received over 3GPP access, the term "other access" in "the UE also supports the registration procedure over the other access to the same SNPN" is used to express access to SNPN services via a PLMN.

...

[TS 24.501, clause 5.1.3.2.1.3.5]

The substate 5GMM-DEREGISTERED.PLMN-SEARCH is chosen in the UE, if the UE is searching for PLMNs or SNPNs. This substate is left either when a cell has been selected (the new substate is NORMAL-SERVICE or LIMITED-SERVICE) or when it has been concluded that no cell is available at the moment (the new substate is NO-CELL-AVAILABLE).

This substate is not applicable to non-3GPP access.

[TS 24.501, clause 5.1.3.2.2]

In order to describe the detailed UE behaviour, the 5GS update (5U) status pertaining to a specific subscriber is defined.

If the UE is not operating in SNPN access operation mode (see 3GPP TS 23.501 [8]), the 5GS update status is stored in a non-volatile memory in the USIM if the corresponding file is present in the USIM, else in the non-volatile memory in the ME, as described in annex C.

If the UE is operating in SNPN access operation mode, the 5GS update status for each SNPN whose SNPN identity is included in the "list of subscriber data" configured in the ME (see 3GPP TS 23.122 [5]) is stored in the non-volatile memory in the ME as described in annex C.

The 5GS update status value is changed only after the execution of a registration, network-initiated de-registration, 5GS based primary authentication and key agreement, service request, paging procedure or due to change in TAI which does not belong to the current registration area while T3346 is running.

5U1: UPDATED

The last registration attempt was successful.

5U2: NOT UPDATED

The last registration attempt failed procedurally, e.g. no response or reject message was received from the AMF.

5U3: ROAMING NOT ALLOWED

The last registration, service request, or registration for mobility or periodic registration update attempt was correctly performed, but the answer from the AMF was negative (because of roaming or subscription restrictions).

[TS 23.122, clause 4.9.3.0]

The ME is configured with a "list of subscriber data" containing zero or more entries. Each entry of the "list of subscriber data" consists of:

...The MS shall maintain a list of "temporarily forbidden SNPNS" and a list of "permanently forbidden SNPNS" in the ME. Each entry of those lists consists of an SNPN identity.

The MS shall add an SNPN to the list of "temporarily forbidden SNPNS", if a message with cause value #74 "Temporarily not authorized for this SNPN" (see 3GPP TS 24.501 [64]) is received by the MS in response to an LR request from the SNPN. In addition, if:

- the message is integrity-protected; or
- the message is not integrity-protected, and the value of the SNPN-specific attempt counter for that SNPN is equal to the MS implementation specific maximum value as defined in 3GPP TS 24.501 [64];

then the MS shall start an MS implementation specific timer not shorter than 60 minutes. The MS shall remove an SNPN from the list of "temporarily forbidden SNPNS", if:

- a) there is a successful LR after a subsequent manual selection of the SNPN;
- b) the MS implementation specific timer not shorter than 60 minutes expires;
- c) the timer T3247 expires and the value of the SNPN-specific attempt counter for that SNPN is less than the MS implementation specific maximum value as defined in 3GPP TS 24.501 [64];
- d) the MS is switched off; or
- e) an entry of the "list of subscriber data" with the SNPN identity of the SNPN is updated or the USIM is removed if:
 - EAP based primary authentication and key agreement procedure using EAP-AKA'; or
 - 5G AKA based primary authentication and key agreement procedure;was performed in the selected SNPN.

If an SNPN is removed from the list of "temporarily forbidden SNPNs" list, the MS shall stop the MS implementation specific timer not shorter than 60 minutes, if running.

9.1.11.1.3 Test description

9.1.11.1.3.1 Pre-test conditions

System Simulator:

- 2 SNPN cells NGC Cell A and NGC Cell B are configured according to Table 6.3.2.2-1 broadcasting default SNPN IDs as indicated in TS 38.508-1 [4] Table 4.4.2-4.
- System information combination NR-12 as defined in TS 38.508-1 [4] clause 4.4.3.1.2 is used in NGC Cells.

UE:

- The UE is in Automatic SNPN selection mode.
- The UE is provisioned with a "list of subscriber data" to allow access to SNPN identified by NGC Cell A and NGC Cell B.

Preamble:

- Ensure that the UE has cleared the Registered SNPN. And the UE is in state Switched OFF (state 0-A).

9.1.11.1.3.2 Test procedure sequence

Table 9.1.11.1.3.2-1: Main behaviour

St	Procedure	Message Sequence		TP	Verdict
		U - S	Message		
1	The SS configures: - NGC Cell A as the "Serving cell". - NGC Cell B as "Non-suitable cell".	-	-	-	-
2	The UE is switched on.	-	-	-	-
3-14	Steps 2-13 of Table 4.5.2.2-2 of the generic procedure in TS 38.508-1 [4] are performed	-	-	-	-
15	The SS transmits a REGISTRATION REJECT message, 5GMM cause value = #74 "Temporarily not authorized for this SNPN".	<--	REGISTRATION REJECT	-	-
16	The SS starts timer 1 = 60 min.	-	-	-	-
17	The SS releases the RRC connection.	-	-	-	-
18	Check: Does the UE transmit the REGISTRATION REQUEST message on NGC Cell A in the next 60 seconds?	-->	REGISTRATION REQUEST	1	F
19	The SS reconfigures: - NGC cell B as the "Serving cell".	-	-	-	-
20	Check: Does the UE transmit the REGISTRATION REQUEST message on NGC Cell B?	-->	REGISTRATION REQUEST	3	P
21-27	Steps 5 to 11 from procedure in TS 38.508-1 [4] Table 4.5.2.2-2 are performed.	-	-	-	-
28	The SS transmits a REGISTRATION REJECT message, 5GMM cause value = #74 "Temporarily not authorized for this SNPN".	<--	REGISTRATION REJECT	-	-
29	The SS releases the RRC connection.	-	-	-	-
30	The SS reconfigures: - NGC cell B as the " Non-suitable cell".	-	-	-	-
31	Check: Does the UE transmit the REGISTRATION REQUEST message on NGC Cell A in the next 60 seconds?	-->	REGISTRATION REQUEST	2	F
32	The SS stops timer 1.	-	-	-	-
33	The UE is switched OFF	-	-	-	-
34	The UE is Switched ON	-	-	-	-

35	Check: Does the UE transmit the REGISTRATION REQUEST message on NGC Cell A?	-->	REGISTRATION REQUEST	2	P
36-51	Steps 5-20a1 of Table 4.5.2.2-2 of the generic procedure in TS 38.508-1 [4] are performed on NGC Cell A.	-	-	-	-

9.1.11.1.3.3 Specific message contents

Table 9.1.11.1.3.3-1: REGISTRATION REJECT (step 15 and step 28, Table 9.1.11.1.3.2-1)

Derivation path: TS 38.508-1 [4] table 4.7.1-9			
Information Element	Value/remark	Comment	Condition
5GMM cause	'01001010'B	#74 "Temporarily not authorized for this SNPN"	

Table 9.1.11.1.3.3-2: REGISTRATION REQUEST (step 20 and step 35, Table 9.1.11.1.3.2-1)

Derivation path: TS 38.508-1 [4] table 4.7.1-6			
Information Element	Value/Remark	Comment	Condition
ngKSI			
NAS key set identifier	'111'B	no key is available	
TSC	Any allowed value	TSC does not apply for NAS key set identifier value "111"	
5GS mobile identity	The valid SUCI	Only SUCI is available.	
Last visited registered TAI	Not present		

9.1.11.2 SNPN / Initial registration / Rejected / Permanently not authorized for this SNPN

9.1.11.2.1 Test Purpose (TP)

(1)

```
with { UE in Automatic SNPN selection mode and a and SNPN cell is available for which an entry exists in the "list of subscriber data" and the UE in 5GMM-REGISTERED-INITIATED state }
ensure that {
  when { the SS sends a REGISTRATION REJECT message to the UE including an appropriate 5GMM cause value #75 (Permanently not authorized for this SNPN) }
  then { the UE deletes any 5G-GUTI, last visited registered TAI and ngKSI, and store the SNPN identity in the "permanently forbidden SNPNs" }
}
```

(2)

```
with { the UE is in 5GMM-DEREGISTERED.PLMN-SEARCH state }
ensure that {
  when { User manually selects the SNPN cell which belongs to the "permanently forbidden SNPNs" list }
  then { the UE attempts registration on the SNPN cell }
}
```

9.1.11.2.2 Conformance requirements

References: The conformance requirements covered in the current TC are specified in: TS 24.501 clauses 5.5.1.2.5, 5.1.3.2.1, 5.1.3.2.2, TS 23.122 clause 4.9.3.0. Unless otherwise stated these are Rel-16 requirements.

[TS 24.501, clause 5.5.1.2.5]

If the initial registration request cannot be accepted by the network, the AMF shall send a REGISTRATION REJECT message to the UE including an appropriate 5GMM cause value.

If the initial registration request is rejected due to general NAS level mobility management congestion control, the network shall set the 5GMM cause value to #22 "congestion" and assign a back-off timer T3346.

The UE shall take the following actions depending on the 5GMM cause value received in the REGISTRATION REJECT message.

...

#75 (Permanently not authorized for this SNPN).

5GMM cause #75 is only applicable when received from a cell belonging to an SNPN with a globally-unique SNPN identity. 5GMM cause #75 received from a cell not belonging to an SNPN or a cell belonging to an SNPN with a non-globally-unique SNPN identity is considered as an abnormal case and the behaviour of the UE is specified in subclause 5.5.1.2.7.

The UE shall set the 5GS update status to 5U3 ROAMING NOT ALLOWED (and shall store it according to subclause 5.1.3.2.2) and shall delete any 5G-GUTI, last visited registered TAI, TAI list and ngKSI. The UE shall reset the registration attempt counter and store the SNPN identity in the "permanently forbidden SNPNs" list for the specific access type for which the message was received and, if the UE supports access to an SNPN using credentials from a credentials holder, the selected entry of the "list of subscriber data" or the selected PLMN subscription. If the registration request is not for onboarding services in SNPN, the UE shall enter state 5GMM-DEREGISTERED.PLMN-SEARCH and perform an SNPN selection according to 3GPP TS 23.122 [5]. If the registration request is for onboarding services in SNPN, the UE shall enter state 5GMM-DEREGISTERED.PLMN-SEARCH and perform an SNPN selection for onboarding services according to 3GPP TS 23.122 [5]. If the message has been successfully integrity checked by the NAS, the UE shall set the SNPN-specific attempt counter for 3GPP access and the SNPN-specific attempt counter for non-3GPP access for the current SNPN to the UE implementation-specific maximum value.

If the message has been successfully integrity checked by the NAS and the UE also supports the registration procedure over the other access to the same SNPN, the UE shall in addition handle 5GMM parameters and 5GMM state for this access, as described for this 5GMM cause value.

NOTE 6: When 5GMM cause #75 is received over 3GPP access, the term "other access" in "the UE also supports the registration procedure over the other access to the same SNPN" is used to express access to SNPN services via a PLMN.

...

[TS 24.501, clause 5.1.3.2.1.3.5]

The substate 5GMM-DEREGISTERED.PLMN-SEARCH is chosen in the UE, if the UE is searching for PLMNs or SNPNs. This substate is left either when a cell has been selected (the new substate is NORMAL-SERVICE or LIMITED-SERVICE) or when it has been concluded that no cell is available at the moment (the new substate is NO-CELL-AVAILABLE).

This substate is not applicable to non-3GPP access.

[TS 24.501, clause 5.1.3.2.2]

In order to describe the detailed UE behaviour, the 5GS update (5U) status pertaining to a specific subscriber is defined.

If the UE is not operating in SNPN access operation mode (see 3GPP TS 23.501 [8]), the 5GS update status is stored in a non-volatile memory in the USIM if the corresponding file is present in the USIM, else in the non-volatile memory in the ME, as described in annex C.

If the UE is operating in SNPN access operation mode, the 5GS update status for each SNPN whose SNPN identity is included in the "list of subscriber data" configured in the ME (see 3GPP TS 23.122 [5]) is stored in the non-volatile memory in the ME as described in annex C.

The 5GS update status value is changed only after the execution of a registration, network-initiated de-registration, 5GS based primary authentication and key agreement, service request, paging procedure or due to change in TAI which does not belong to the current registration area while T3346 is running.

5U1: UPDATED

The last registration attempt was successful.

5U2: NOT UPDATED

The last registration attempt failed procedurally, e.g. no response or reject message was received from the AMF.

5U3: ROAMING NOT ALLOWED

The last registration, service request, or registration for mobility or periodic registration update attempt was correctly performed, but the answer from the AMF was negative (because of roaming or subscription restrictions).

[TS 23.122, clause 4.9.3.0]

The ME is configured with a "list of subscriber data" containing zero or more entries. Each entry of the "list of subscriber data" consists of:

... The MS shall add an SNPN to the list of "permanently forbidden SNPNS" which is, if the MS supports access to an SNPN using credentials from a credentials holder, associated with the selected entry of the "list of subscriber data" or the selected PLMN subscription, if a message with cause value #75 "Permanently not authorized for this SNPN" (see 3GPP TS 24.501 [64]) is received by the MS in response to an LR request from the SNPN.

The MS shall remove an SNPN from the list of "permanently forbidden SNPNS" which is, if the MS supports access to an SNPN using credentials from a credentials holder, associated with the selected entry of the "list of subscriber data" or the selected PLMN subscription, if:

- a) there is a successful LR after a subsequent manual selection of the SNPN;
- b) the MS is configured to use timer T3245 and timer T3245 expires;
- c) the MS is not configured to use timer T3245, the timer T3247 expires and the value of the SNPN-specific attempt counter for that SNPN is less than the MS implementation specific maximum value as defined in 3GPP TS 24.501 [64] ;
- d) an entry of the "list of subscriber data" with the subscribed SNPN identity identifying the SNPN is updated or the USIM is removed if:
 - EAP based primary authentication and key agreement procedure using EAP-AKA'; or
 - 5G AKA based primary authentication and key agreement procedure;
 was performed in the selected SNPN; or
- e) the selected entry of the "list of subscriber data" is updated or USIM is removed for the selected PLMN subscription.

9.1.11.2.3 Test description

9.1.11.2.3.1 Pre-test conditions

System Simulator:

- SNPN cell NGC Cell A is configured according to Table 6.3.2.2-2 broadcasting globally-unique SNPN IDs as per Table 9.1.11.2.3.1-1.

Table 9.1.11.2.3.1–1: SNPN Identifier

cell ID	Network Identifier (NID)	
	Assignment mode	NID value
NGC Cell A	0	1

- System information combination NR-12 as defined in TS 38.508-1 [4] clause 4.4.3.1.2 is used in the NGC Cell.

UE:

- The UE is in Automatic SNPN selection mode.
- The UE is provisioned with a “list of subscriber data” to allow access to SNPN identified by NGC Cell A.

Preamble:

- NGC Cell A is set to “Serving Cell”.
- The UE is in state Switched OFF (state 0-A).

9.1.11.2.3.2 Test procedure sequence

Table 9.1.11.2.3.2-1: Main behaviour

St	Procedure	Message Sequence		TP	Verdict
		U - S	Message		
1	The UE is switched on.	-	-	-	-
2-13	Steps 2-13 of Table 4.5.2.2-2 of the generic procedure in TS 38.508-1 [4] are performed	-	-	-	-
14	The SS transmits a REGISTRATION REJECT message, 5GMM cause value = #75 "Permanently not authorized for this SNPN".	<--	REGISTRATION REJECT	-	-
15	The SS releases the RRC connection.	-	-	-	-
16	Check: Does the UE transmit the REGISTRATION REQUEST message on NGC Cell A in the next 60 seconds?	-->	REGISTRATION REQUEST	1	F
17	The UE is made to perform manual SNPN search and select SNPN identified by NGC Cell A.				
18	Check: Does the UE transmit the REGISTRATION REQUEST message on NGC Cell A?	-->	REGISTRATION REQUEST	2	P
19-34a1	Steps 5-20a1 of Table 4.5.2.2-2 of the generic procedure in TS 38.508-1 [4] are performed on NGC Cell A.	-	-	-	-
35	The user sets the UE in Automatic SNPN/Network selection mode.	-	-	-	-

9.1.11.2.3.3 Specific message contents

Table 9.1.11.2.3.3-1: REGISTRATION REJECT (step 14, Table 9.1.11.2.3.2-1)

Derivation path: TS 38.508-1 [4] table 4.7.1-9			
Information Element	Value/remark	Comment	Condition
5GMM cause	'01001011'B	#75 "Permanently not authorized for this SNPN"	

Table 9.1.11.2.3.3-2: REGISTRATION REQUEST (step 18, Table 9.1.11.2.3.2-1)

Derivation path: TS 38.508-1 [4] table 4.7.1-6			
Information Element	Value/Remark	Comment	Condition
ngKSI			
NAS key set identifier	'111'B	no key is available	
TSC	Any allowed value	TSC does not apply for NAS key set identifier value	

		"111"	
5GS mobile identity	The valid SUCI	Only SUCI is available.	
Last visited registered TAI	Not present		

9.1.11.3 SNPN / EAP based primary authentication and key agreement / EAP-AKA' related procedures

9.1.11.3.1 Test Purpose (TP)

(1)

```
with { the UE in 5GMM-REGISTERED-INITIATED state }
ensure that {
  when { the SS sends an EAP-request/AKA'-challenge message within AUTHENTICATION REQUEST }
  then { the UE sends an EAP-response/AKA'-challenge message within AUTHENTICATION RESPONSE }
}
```

(2)

```
with { the UE in 5GMM-REGISTERED-INITIATED state and SS initiates an EAP based primary
authentication and key agreement procedure }
ensure that {
  when { the SS sends an EAP-success message within AUTHENTICATION RESULT }
  then { the UE considers the procedure complete and authentication procedure succeed }
}
```

(3)

```
with { the UE in 5GMM-REGISTERED-INITIATED state and SS initiates an EAP based primary
authentication and key agreement procedure}
ensure that {
  when { the SS sends an EAP-failure message within AUTHENTICATION REJECT }
  then { the UE shall consider the entry of the "list of subscriber data" with/without the SNPN
identity of the current SNPN as invalid for 3GPP access until the UE is switched off or the entry is
updated, and the USIM is considered invalid until switching off the UE }
}
```

9.1.11.3.2 Conformance requirements

References: The conformance requirements covered in the present TC are specified in: TS 24.501 clauses 5.4.1.2.2.3, 5.4.1.2.2.8, 5.4.1.2.2.11 , 9.12.1

[TS 24.501, clause 5.4.1.2.2.3]

If a USIM is present and the SNN check is successful, the UE shall handle the EAP-request/AKA'-challenge message as specified in IETF RFC 5448 [40]. The USIM shall derive CK and IK and compute the authentication response (RES) using the 5G authentication challenge data received from the ME, and pass RES to the ME. The ME shall derive CK' and IK' from CK and IK, and EMSK from CK' and IK'. Furthermore, the ME may generate K_{AUSF} from the EMSK, the K_{SEAF} from the K_{AUSF} , and the K_{AMF} from the ABBA received together with the EAP-request/AKA'-challenge message, and the K_{SEAF} as described in 3GPP TS 33.501 [24], and create a partial native 5G NAS security context identified by the ngKSI value received together with the EAP-request/AKA'-challenge message in subclause 5.4.1.2.4.2 in the volatile memory of the ME. If the K_{AMF} and the partial native 5G NAS security context are created, the ME shall store the K_{AMF} in the created partial native 5G NAS security context, and shall send an EAP-response/AKA'-challenge message as specified in IETF RFC 5448 [40].

If the EAP-request/AKA'-challenge message contains AT_RESULT_IND attribute, the UE may include AT_RESULT_IND attribute in the EAP-response/AKA'-challenge message as specified in IETF RFC 5448 [40].

[TS 24.501, clause 5.4.1.2.2.8]

Upon receiving an EAP-success message, if the ME has not generated a partial native 5G NAS security context as described in subclause 5.4.1.2.2.3, the ME shall:

- a) generate the K_{AUSF} from the EMSK, the K_{SEAF} from the K_{AUSF} , and the K_{AMF} from the ABBA that was received with the EAP-success message, and the K_{SEAF} as described in 3GPP TS 33.501 [24];
- b) create a partial native 5G NAS security context identified by the ngKSI value in the volatile memory of the ME; and
- c) store the K_{AMF} in the created partial native 5G NAS security context.

The UE shall consider the procedure complete.

[TS 24.501, clause 5.4.1.2.2.11]

Upon receiving an EAP-failure message, the UE shall delete the partial native 5G NAS security context if any was created as described in subclause 5.4.1.2.2.3.

The UE shall consider the procedure complete.

If the EAP-failure message is received in an AUTHENTICATION REJECT message:

- 1) if the AUTHENTICATION REJECT message has been successfully integrity checked by the NAS:
 - The UE shall set the update status to 5U3 ROAMING NOT ALLOWED, delete the stored 5G-GUTI, TAI list, last visited registered TAI and ngKSI;

In case of PLMN, the USIM shall be considered invalid until switching off the UE or the UICC containing the USIM is removed;

In case of SNPN, the entry of the "list of subscriber data" with the SNPN identity of the current SNPN shall be considered invalid until the UE is switched off or the entry is updated. Additionally, the UE shall consider the USIM as invalid for the current SNPN until switching off or the UICC containing the USIM is removed;
 - The UE shall set:
 - i) the counter for "SIM/USIM considered invalid for GPRS services" events, the counter for "USIM considered invalid for 5GS services over non-3GPP access" events, and the counter for "SIM/USIM considered invalid for non-GPRS services" events if maintained by the UE, in case of PLMN; or
 - ii) the counter for "the entry for the current SNPN considered invalid for 3GPP access" events and the counter for "the entry for the current SNPN considered invalid for non-3GPP access" events in case of SNPN;

to UE implementation-specific maximum value;

[TS 24.501, clause 9.12.1]

The serving network name (SNN) is used:

- in the Network name field of the AT_KDF_INPUT attribute defined in IETF RFC 5448 [40];
- in K_{AUSF} derivation function as specified in 3GPP TS 33.501 [24] annex A; and
- in RES* and XRES* derivation function as specified in 3GPP TS 33.501 [24] annex A.

SNN shall contain a UTF-8 string without terminating null characters.

SNN is of maximum length of 1020 octets.

SNN consists of SNN-service-code and SNN-network-identifier, delimited by a colon.

SNN-network-identifier identifies the serving PLMN or the serving SNPN.

MCC and MNC in the SNN-PLMN-ID are MCC and MNC of the serving PLMN. If the MNC of the serving PLMN has two digits, then a zero is added at the beginning.

MCC and MNC in the SNN-SNPN-ID are MCC and MNC of the serving SNPN. If the MNC of the serving SNPN has two digits, then a zero is added at the beginning.

SNN-NID contains an NID in hexadecimal digits.

ABNF syntax of SNN is specified in table 9.12.1.1

Table 9.12.1.1: ABNF syntax of SNN

```

SNN = SNN-service-code ":" SNN-network-identifier
SNN-service-code = %x35.47 ; "5G"
SNN-network-identifier = SNN-PLMN-ID / SNN-SNPN-ID
SNN-PLMN-ID = SNN-mnc-string SNN-mnc-digits "." SNN-mcc-string SNN-mcc-digits "." SNN-3gppnetwork-
string "." SNN-org-string ; applicable when not operating in SNPN access operation mode.
SNN-SNPN-ID = SNN-mnc-string SNN-mnc-digits "." SNN-mcc-string SNN-mcc-digits "." SNN-3gppnetwork-
string "." SNN-org-string ":" SNN-NID ; applicable when operating in SNPN access operation mode.
SNN-mnc-digits = DIGIT DIGIT DIGIT ; MNC of the PLMN ID
SNN-mcc-digits = DIGIT DIGIT DIGIT ; MCC of the PLMN ID
SNN-mnc-string = %x6d.6e.63 ; "mnc" in lower case
SNN-mcc-string = %x6d.63.63 ; "mcc" in lower case
SNN-3gppnetwork-string = %x33.67.70.70.6e.65.74.77.6f.72.6b ; "3gppnetwork" in lower case
SNN-org-string = %x6f.72.67 ; "org" in lower case
SNN-NID = 11SNN-hexadecimal-digit ; NID in hexadecimal digits
SNN-hexadecimal-digit = DIGIT / %x41 / %x42 / %x43 / %x44 / %x45 / %x46

```

NOTE: SNN-service-code allows for distinguishing of ANID specified in 3GPP TS 24.302 [16] and SNN as either of SNN or ANID can be carried in the AT_KDF_INPUT attribute.

EXAMPLE 1: In case of a PLMN, if PLMN ID contains MCC = 234 and MNC = 15, SNN is 5G:mnc015.mcc234.3gppnetwork.org.

EXAMPLE 2: In case of an SNPN, if SNPN ID contains a PLMN ID of MCC = 234 and MNC = 15 and an NID of 123456ABCDEH, SNN is 5G:mnc015.mcc234.3gppnetwork.org:123456ABCDE.

9.1.11.3.3 Test description

9.1.11.3.3.1 Pre-test conditions

System Simulator:

- SNPN cell NGC Cell is configured according to Table 6.3.2.2-1 broadcasting default SNPN ID as indicated in TS 38.508-1 [4] Table 4.4.2-4.
- System information combination NR-12 as defined in TS 38.508-1 [4] clause 4.4.3.1.2 is used in NGC Cells.

UE:

- The UE is in Automatic SNPN selection mode.
- The UE is provisioned with a “list of subscriber data” to allow access to SNPN identified by NGC Cell A.

Preamble:

- NGC Cell A is set to “Serving Cell”.
- The UE is in state Switched OFF (state 0-A).

9.1.11.3.3.2 Test procedure sequence

Table 9.1.11.3.3.2-1: Main behaviour

St	Procedure	Message Sequence		TP	Verdict
		U - S	Message		
1	The UE is switched on.	-	-	-	-
2-4	The UE establishes RRC connection and initiates registration procedure by executing steps 2-4 of Table 4.5.2.2-2 in TS 38.508-1 [4].	-	-	-	-
5	SS transmits a correct AUTHENTICATION REQUEST message with an EAP-Request/AKA'-challenge message.	<--	5GMM: AUTHENTICATION REQUEST	-	-
6	Check: Does the UE respond with a correct AUTHENTICATION RESPONSE message, with an EAP-Response/AKA'-challenge message?	-->	5GMM: AUTHENTICATION RESPONSE	1	P
7	The SS transmits an "EAP-failure" message within AUTHENTICATION REJECT	<--	5GMM: AUTHENTICATION REJECT	-	-
8	SS releases the RRC connection	-	-	-	-
9	Check: Does the UE transmit an RRCSetupRequest message for initial registration procedure within the next 30 seconds?	-->	NR RRC: RRCSetupRequest	3	F
10	The UE is switched off by executing generic procedure in Table 4.9.6.4-1 in TS 38.508-1 [4].	-	-	-	-
11	The UE is switched on.	-	-	-	-
12-14	The UE establishes RRC connection and initiates registration procedure by executing steps 2-4 of Table 4.5.2.2-2 in TS 38.508-1 [4].	-	-	-	-
15	SS transmits a correct AUTHENTICATION REQUEST message with an EAP-Request/AKA'-challenge message.	<--	5GMM: AUTHENTICATION REQUEST	-	-
16	Check: Does the UE respond with a correct AUTHENTICATION RESPONSE message, with an EAP-Response/AKA'-challenge message?	-->	5GMM: AUTHENTICATION RESPONSE	1	P
17	SS transmits an AUTHENTICATION RESULT message with an EAP-success message.	<--	5GMM: AUTHENTICATION RESULT	-	-
18-24	The registration procedure is performed by executing steps 8-14 of Table 4.5.2.2-2 in TS 38.508-1 [4].	-	-	-	-
25	Check: Does the UE transmits a REGISTRATION COMPLETE message?	-->	5GMM: REGISTRATION COMPLETE	2	P
26	Steps 19a1 of Table 4.5.2.2-2 in TS 38.508-1 [4] are performed	-	-	-	-

9.1.11.3.3.3 Specific message contents

Table 9.1.11.3.3.3-1: Message AUTHENTICATION RESPONSE (step 6, 16, Table 9.1.11.3.3.2-1)

Derivation path: TS 38.508-1 [4], table 4.7.1-2			
Information Element	Value/Remark	Comment	Condition
EAP message	EAP-Response/AKA'-Challenge	RES* equal to the XRES* calculated in the SS with the parameters provided/indicated in the AUTHENTICATION REQUEST	EAP-AKA

Table 9.1.11.3.3.3-2: Message AUTHENTICATION RESULT (step 17, Table 9.1.11.3.3.2-1)

Derivation path: TS 38.508-1 [4], table 4.7.1-3			
Information Element	Value/Remark	Comment	Condition
EAP message	EAP-Success		EAP-AKA

Table 9.1.11.3.3.3-3: AUTHENTICATION REJECT (step 7, Table 9.1.11.3.3.2-1)

Derivation path: TS 38.508-1 [4], table 4.7.1-5			
Information Element	Value/Remark	Comment	Condition
Extended protocol discriminator	5GMM		
Security header type	'0000'B	Plain 5GS NAS message, not security protected	
Spare half octet	'0000'B		
EAP message	EAP-failure	EAP-failure	
NOTE:	This message is sent within SECURITY PROTECTED 5GS NAS MESSAGE message with Integrity protected and ciphered.		

9.1.12 NSAC / Mobility management aspects

9.1.12.1 NSAC / Initial registration / Back-off timer

9.1.12.1.1 Test Purpose (TP)

(1)

```
with { UE in UE in 5GMM-DEREGISTERED state }
ensure that {
  when { UE is switched on }
  then { UE transmits REGISTRATION REQUEST message with ER-NSSAI bit set to "Extended rejected NSSAI supported" in the 5GMM capability IE }
}
```

(2)

```
with { UE in 5GMM-REGISTERED-INITIATED state }
ensure that {
  when { UE receives the rejected NSSAI in the REGISTRATION ACCEPT message with the rejection cause of "S-NSSAI not available due to maximum number of UEs reached" and the back-off timer value received along with the S-NSSAI is not zero }
  then { UE shall stores the rejected NSSAI and start the timer T3526 }
}
```

(3)

```
with { UE in 5GMM-REGISTERED state and UE stores one or more S-NSSAIs in the rejected NSSAI with the rejection cause "S-NSSAI not available due to maximum number of UEs reached" }
ensure that {
  when { The timer T3526 associated with the S-NSSAI expires }
  then { UE remove the S-NSSAI from the rejected NSSAI for the maximum number of UEs reached }
}
```

(4)

```
with { UE in 5GMM-REGISTERED state and UE stores one or more S-NSSAIs in the rejected NSSAI with the rejection cause "S-NSSAI not available due to maximum number of UEs reached" }
ensure that {
  when { UE is switched off }
  then { UE remove the S-NSSAI from the rejected NSSAI for the maximum number of UEs reached }
}
```

9.1.12.1.2 Conformance requirements

References: The conformance requirements covered in the current TC are specified in: TS 24.501 clauses 5.5.1.2.2, 5.5.1.2.4 and 10.2. Unless otherwise stated these are Rel-17 requirements.

[TS 24.501 clause 5.5.1.2.2]

The UE initiates the registration procedure for initial registration by sending a REGISTRATION REQUEST message to the AMF, starting timer T3510. If timer T3502 is currently running, the UE shall stop timer T3502. If timer T3511 is currently running, the UE shall stop timer T3511.

...

The UE shall set the ER-NSSAI bit to "Extended rejected NSSAI supported" in the 5GMM capability IE of the REGISTRATION REQUEST message.

[TS 24.501 clause 5.5.1.2.4]

If the UE supports extended rejected NSSAI and the AMF determines that maximum number of UEs reached for one or more S-NSSAI(s) in the requested NSSAI as specified in subclause 4.6.2.5, the AMF shall include the rejected NSSAI containing one or more S-NSSAIs with the rejection cause "S-NSSAI not available due to maximum number of UEs reached" in the Extended rejected NSSAI IE in the REGISTRATION ACCEPT message. In addition, the AMF may include a back-off timer value for each S-NSSAI with the rejection cause "S-NSSAI not available due to maximum number of UEs reached" included in the Extended rejected NSSAI IE of the REGISTRATION ACCEPT message. To avoid that large numbers of UEs simultaneously initiate deferred requests, the network should select the value for the backoff timer for each S-NSSAI for the informed UEs so that timeouts are not synchronised.

...

The UE receiving the rejected NSSAI in the REGISTRATION ACCEPT message takes the following actions based on the rejection cause in the rejected S-NSSAI(s):

"S-NSSAI not available in the current PLMN or SNPN"

The UE shall add the rejected S-NSSAI(s) in the rejected NSSAI for the current PLMN or SNPN as specified in subclause 4.6.2.2 and shall not attempt to use this S-NSSAI(s) in the current PLMN or SNPN until switching off the UE, the UICC containing the USIM is removed, the entry of the "list of subscriber data" with the SNPN identity of the current SNPN is updated, or the rejected S-NSSAI(s) are removed or deleted as described in subclause 4.6.2.2.

"S-NSSAI not available in the current registration area"

The UE shall add the rejected S-NSSAI(s) in the rejected NSSAI for the current registration area as specified in subclause 4.6.2.2 and shall not attempt to use this S-NSSAI(s) in the current registration area until switching off the UE, the UE moving out of the current registration area, the UICC containing the USIM is removed, the entry of the "list of subscriber data" with the SNPN identity of the current SNPN is updated, or the rejected S-NSSAI(s) are removed or deleted as described in subclause 4.6.2.2.

"S-NSSAI not available due to the failed or revoked network slice-specific authentication and authorization"

The UE shall store the rejected S-NSSAI(s) in the rejected NSSAI for the failed or revoked NSSAI as specified in subclause 4.6.2.2 and shall not attempt to use this S-NSSAI in the current PLMN or SNPN over any access until switching off the UE, the UICC containing the USIM is removed, the entry of the "list of subscriber data" with the SNPN identity of the current SNPN is updated, or the rejected S-NSSAI(s) are removed or deleted as described in subclause 4.6.1 and 4.6.2.2.

"S-NSSAI not available due to maximum number of UEs reached"

Unless the back-off timer value received along with the S-NSSAI is zero, the UE shall add the rejected S-NSSAI(s) in the rejected NSSAI for the maximum number of UEs reached as specified in subclause 4.6.2.2 and shall not attempt to use this S-NSSAI in the current PLMN or SNPN over the current access until switching off the UE, the UICC containing the USIM is removed, the entry of the "list of subscriber data" with the SNPN identity of the current SNPN is updated, or the rejected S-NSSAI(s) are removed as described in subclause 4.6.2.2.

NOTE 15: If the back-off timer value received along with the S-NSSAI in the rejected NSSAI for the maximum number of UEs reached is zero as specified in subclause 10.5.7.4a of TS 24.008, the UE does not consider the S-NSSAI as the rejected S-NSSAI.

If there is one or more S-NSSAIs in the rejected NSSAI with the rejection cause "S-NSSAI not available due to maximum number of UEs reached", then for each S-NSSAI, the UE shall behave as follows:

- a) stop the timer T3526 associated with the S-NSSAI, if running;
- b) start the timer T3526 with:
 - 1) the back-off timer value received along with the S-NSSAI, if a back-off timer value is received along with the S-NSSAI that is neither zero nor deactivated; or
 - 2) an implementation specific back-off timer value, if no back-off timer value is received along with the S-NSSAI; and
- c) remove the S-NSSAI from the rejected NSSAI for the maximum number of UEs reached when the timer T3526 associated with the S-NSSAI expires.

[TS 24.501, clause 10.2]

Table 10.2.1: Timers of 5GS mobility management – UE side

TIMER NUM.	TIMER VALUE	STATE	CAUSE OF START	NORMAL STOP	ON EXPIRY
T3526	NOTE 9	5GMM- DEREGISTERED 5GMM- REGISTERED	Rejected S-NSSAI with rejection cause "maximum number of UEs per network slice reached" received.	The associated rejected S-NSSAI for the maximum number of UEs reached as specified in subclause 4.6.2.2 deleted.	Remove the S-NSSAI in the rejected NSSAI for the maximum number of UEs reached associated with the T3526 timer.
... NOTE 9: The value of this timer is provided by the network operator during the registration procedure or the generic UE configuration update procedure along with the rejected S-NSSAI with rejection cause "maximum number of UEs per network slice reached". The default value of this timer is implementation specific with a minimum value of 12 minutes and used if the network does not provide a value in the REGISTRATION ACCEPT message, the REGISTRATION REJECT message, or the CONFIGURATION UPDATE COMMAND message along with the rejected S-NSSAI with rejection cause "maximum number of UEs per network slice reached". ...					

9.1.12.1.3 Test description

9.1.12.1.3.1 Pre-test conditions

System Simulator:

- NGC Cell A belongs to Home PLMN and TAI1 and set as serving cell;

UE:

- UE is previously registered on NGC Cell A using default message contents according to TS 38.508-1 [4];

Preamble:

The UE is in state Switched OFF (state 0N-B) according to TS 38.508-1 [4].

9.1.12.1.3.2 Test procedure sequence

Table 9.1.12.1.3.2-1: Main behaviour

St	Procedure	Message Sequence		TP	Verdict
		U - S	Message		
1	The UE is switched on.	-	-	-	-
2	Check: Does UE transmit a REGISTRATION REQUEST message including ER-NSSAI bit?	-->	REGISTRATION REQUEST	1	P
3-11	Steps 5 to 13 of the generic procedure for NR RRC_IDLE specified in TS 38.508-1 subclause 4.5.2 are performed.	-	-	-	-
12	The SS transmits a REGISTRATION ACCEPT message including S-NSSAI=1 in extended rejected NSSAI with back-off timer set to 60 seconds and S-NSSAI=2 in extended rejected NSSAI with back-off timer set to 1 hour Note: Now UE should start timer T3526 associated with S-NSSAI=1 and T3526 associated with S-NSSAI=2.	<--	REGISTRATION ACCEPT	-	-
13	The UE transmits an <i>ULInformationTransfer</i> message and a REGISTRATION COMPLETE message.	-->	REGISTRATION COMPLETE	-	-
	EXCEPTION: Step 14a1 is performed if <i>pc_noOf_PDUsSameConnection</i> > 0.				
14a1	The generic procedure for UE-requested PDU session establishment, specified in subclause 4.5A.2, takes place performing establishment of UE-requested PDU session(s) with <i>ExpectedNumberOfNewPDUSessions</i> = <i>pc_noOf_PDUsSameConnection</i> .	-	-	-	-
15	SS releases the RRC connection	-	-	-	-
16	Check: Are S-NSSAI=1 and S-NSSAI=2 in the Rejected NSSAI list with cause 'S-NSSAI not available due to maximum number of UEs reached' associated with current PLMN using AT/MMI command (+C5GNSSAIRDP)?	-	-	2	P
17	Cause the UE to request establishment of PDU session with S-NSSAI=1.(Note 1)	-	-	-	-
18	Check: Does the UE transmit an RRCSetupRequest message within T3526 associated with S-NSSAI=1 in the next 15 seconds?	-->	NR RRC: RRCSetupRequest	2	F
19	Cause the UE to request establishment of PDU session with S-NSSAI=2.(Note 1)	-	-	-	-
20	Check: Does the UE transmit an RRCSetupRequest message within T3526 associated with S-NSSAI=2 in the next 15 seconds?	-->	NR RRC: RRCSetupRequest	2	F
21	Wait for the expiry of T3526 associated with S-NSSAI=1.	-	-	-	-
22	Check: Using AT/MMI command (+C5GNSSAIRDP) verify that S-NSSAI=1 is not in the Rejected NSSAI list associated with current PLMN	-	-	3	P
23	Switch off procedure in RRC_IDLE specified in TS 38.508-1 subclause 4.9.6.1 is performed.	-	-	-	-
24	The SS configures NGC Cell A as the "Non-suitable cell"	-	-	-	-
25	The UE is switched on.(Note2)	-	-	-	-
26	Check: Using AT/MMI command (+C5GNSSAIRDP) verify that S-NSSAI=2 is not in the Rejected NSSAI list associated with current PLMN			4	P
27	The SS configures NGC Cell A as the "Serving cell".	-	-	-	-
28-	Steps 2 to 20a1 of the generic procedure for	-	-	-	-

46	NR RRC_IDLE specified in TS 38.508-1 subclause 4.5.2 are performed.			
Note1: The request to establish a PDU session may be performed by MMI or AT Command. Note2: UE is switched on before the expiry of T3526 associated with S-NSSAI=2				

9.1.12.1.3.3 Specific message contents

Table 9.1.12.1.3.3-1: REGISTRATION REQUEST (step 2, Table 9.1.12.1.3.2-1)

Derivation path: TS 38.508-1 Table 4.7.1-6			
Information Element	Value/remark	Comment	Condition
5GS registration type value	'001'B	Initial registration	
5GMM capability			
ER-NSSAI	'1'B	Extended rejected NSSAI supported	

Table 9.1.12.1.3.3-2: REGISTRATION ACCEPT (step 12, Table 9.1.12.1.3.2-1)

Derivation path: TS 38.508-1 Table 4.7.1-7			
Information Element	Value/remark	Comment	Condition
5GS registration result			
5GS registration result value	'001'B	3GPP access	
Allowed NSSAI			
S-NSSAI IEI		S-NSSAI value 3	
Length of S-NSSAI contents	'0000001'B	SST	
SST	'0000011'B	SST value 3	
SD	Not Present		
Mapped configured SST	Not Present		
Mapped configured SD	Not Present		
Configured NSSAI			
S-NSSAI IEI		S-NSSAI value 1	
Length of S-NSSAI contents	'0000001'B	SST	
SST	'0000001'B	SST value 1	
SD	Not Present		
Mapped configured SST	Not Present		
Mapped configured SD	Not Present		
S-NSSAI IEI		S-NSSAI value 2	
Length of S-NSSAI contents	'0000001'B	SST	
SST	'0000010'B	SST value 2	
SD	Not Present		
Mapped configured SST	Not Present		
Mapped configured SD	Not Present		
Extended rejected NSSAI			
Length of Extended rejected NSSAI contents	2 entries		
Partial extended rejected NSSAI list		entry 1	
Type of list	'001'B	S-NSSAIs with back-off timer	
Number of elements	'0000'B	1 element	
Back-off timer value	'10000010'B	60 seconds	
Rejected S-NSSAI 1		S-NSSAI value 1	
Length of rejected S-NSSAI	'0000001'B	SST	
Cause value	'0011'B	S-NSSAI not available due to maximum number of UEs reached	
SST	'0000001'B	SST value 1	
SD	Not Present		
Mapped HPLMN SST	Not present		
Mapped HPLMN SD	Not present		
Partial extended rejected NSSAI list		entry 2	
Type of list	'001'B	S-NSSAIs with back-off timer	
Number of elements	'0000'B	1 element	

Back-off timer value	'00100001'B	1 hour	
Rejected S-NSSAI 1		S-NSSAI value 2	
Length of rejected S-NSSAI	'00000001'B	SST	
Cause value	'0011'B	S-NSSAI not available due to maximum number of UEs reached	
SST	'00000010'B	SST value 2	
SD	Not Present		
Mapped HPLMN SST	Not present		
Mapped HPLMN SD	Not present		

9.1.12.2 NSAC / Initial registration / Back-off timer is not provided or zero

9.1.12.2.1 Test Purpose (TP)

(1)

```
with { UE in 5GMM-REGISTERED-INITIATED state }
ensure that {
  when { UE receives the rejected NSSAI in the REGISTRATION ACCEPT message with the rejection cause of "S-NSSAI not available due to maximum number of UEs reached" and the back-off timer value is not provided }
  then { UE shall start the timer T3526 with an implementation specific value with minimum 12 minuts }
}
```

(2)

```
with { UE in 5GMM-REGISTERED-INITIATED state }
ensure that {
  when { UE receives the rejected NSSAI in the REGISTRATION ACCEPT message with the rejection cause of "S-NSSAI not available due to maximum number of UEs reached" and the back-off timer value the back-off timer value received along with the S-NSSAI is zero }
  then { UE shall not consider the S-NSSAI as the rejected S-NSSAI }
}
```

9.1.12.1.2 Conformance requirements

References: The conformance requirements covered in the current TC are specified in: TS 24.501 clauses 5.5.1.2.4 and 10.2. Unless otherwise stated these are Rel-17 requirements.

[TS 24.501 clause 5.5.1.2.4]

If the UE supports extended rejected NSSAI and the AMF determines that maximum number of UEs reached for one or more S-NSSAI(s) in the requested NSSAI as specified in subclause 4.6.2.5, the AMF shall include the rejected NSSAI containing one or more S-NSSAIs with the rejection cause "S-NSSAI not available due to maximum number of UEs reached" in the Extended rejected NSSAI IE in the REGISTRATION ACCEPT message. In addition, the AMF may include a back-off timer value for each S-NSSAI with the rejection cause "S-NSSAI not available due to maximum number of UEs reached" included in the Extended rejected NSSAI IE of the REGISTRATION ACCEPT message. To avoid that large numbers of UEs simultaneously initiate deferred requests, the network should select the value for the backoff timer for each S-NSSAI for the informed UEs so that timeouts are not synchronised.

...

The UE receiving the rejected NSSAI in the REGISTRATION ACCEPT message takes the following actions based on the rejection cause in the rejected S-NSSAI(s):

"S-NSSAI not available in the current PLMN or SNPN"

The UE shall add the rejected S-NSSAI(s) in the rejected NSSAI for the current PLMN or SNPN as specified in subclause 4.6.2.2 and shall not attempt to use this S-NSSAI(s) in the current PLMN or SNPN until switching off the UE, the UICC containing the USIM is removed, the entry of the "list of subscriber data" with the SNPN identity of the current SNPN is updated, or the rejected S-NSSAI(s) are removed or deleted as described in subclause 4.6.2.2.

"S-NSSAI not available in the current registration area"

The UE shall add the rejected S-NSSAI(s) in the rejected NSSAI for the current registration area as specified in subclause 4.6.2.2 and shall not attempt to use this S-NSSAI(s) in the current registration area until switching off the UE, the UE moving out of the current registration area, the UICC containing the USIM is removed, the entry of the "list of subscriber data" with the SNPN identity of the current SNPN is updated, or the rejected S-NSSAI(s) are removed or deleted as described in subclause 4.6.2.2.

"S-NSSAI not available due to the failed or revoked network slice-specific authentication and authorization"

The UE shall store the rejected S-NSSAI(s) in the rejected NSSAI for the failed or revoked NSSAA as specified in subclause 4.6.2.2 and shall not attempt to use this S-NSSAI in the current PLMN or SNPN over any access until switching off the UE, the UICC containing the USIM is removed, the entry of the "list of subscriber data" with the SNPN identity of the current SNPN is updated, or the rejected S-NSSAI(s) are removed or deleted as described in subclause 4.6.1 and 4.6.2.2.

"S-NSSAI not available due to maximum number of UEs reached"

Unless the back-off timer value received along with the S-NSSAI is zero, the UE shall add the rejected S-NSSAI(s) in the rejected NSSAI for the maximum number of UEs reached as specified in subclause 4.6.2.2 and shall not attempt to use this S-NSSAI in the current PLMN or SNPN over the current access until switching off the UE, the UICC containing the USIM is removed, the entry of the "list of subscriber data" with the SNPN identity of the current SNPN is updated, or the rejected S-NSSAI(s) are removed as described in subclause 4.6.2.2.

NOTE 15: If the back-off timer value received along with the S-NSSAI in the rejected NSSAI for the maximum number of UEs reached is zero as specified in subclause 10.5.7.4a of TS 24.008, the UE does not consider the S-NSSAI as the rejected S-NSSAI.

If there is one or more S-NSSAIs in the rejected NSSAI with the rejection cause "S-NSSAI not available due to maximum number of UEs reached", then for each S-NSSAI, the UE shall behave as follows:

- a) stop the timer T3526 associated with the S-NSSAI, if running;
- b) start the timer T3526 with:
 - 1) the back-off timer value received along with the S-NSSAI, if a back-off timer value is received along with the S-NSSAI that is neither zero nor deactivated; or
 - 2) an implementation specific back-off timer value, if no back-off timer value is received along with the S-NSSAI; and
- c) remove the S-NSSAI from the rejected NSSAI for the maximum number of UEs reached when the timer T3526 associated with the S-NSSAI expires.

[TS 24.501, clause 10.2]

Table 10.2.1: Timers of 5GS mobility management – UE side

TIMER NUM.	TIMER VALUE	STATE	CAUSE OF START	NORMAL STOP	ON EXPIRY
T3526	NOTE 9	5GMM- DEREGISTERED 5GMM- REGISTERED	Rejected S-NSSAI with rejection cause "maximum number of UEs per network slice reached" received.	The associated rejected S-NSSAI for the maximum number of UEs reached as specified in subclause 4.6.2.2 deleted.	Remove the S-NSSAI in the rejected NSSAI for the maximum number of UEs reached associated with the T3526 timer.

TIMER NUM.	TIMER VALUE	STATE	CAUSE OF START	NORMAL STOP	ON EXPIRY
... NOTE 9: The value of this timer is provided by the network operator during the registration procedure or the generic UE configuration update procedure along with the rejected S-NSSAI with rejection cause "maximum number of UEs per network slice reached". The default value of this timer is implementation specific with a minimum value of 12 minutes and used if the network does not provide a value in the REGISTRATION ACCEPT message, the REGISTRATION REJECT message, or the CONFIGURATION UPDATE COMMAND message along with the rejected S-NSSAI with rejection cause "maximum number of UEs per network slice reached". ...					

9.1.12.2.3 Test description

9.1.12.2.3.1 Pre-test conditions

System Simulator:

NGC Cell A belongs to Home PLMN and TAI1 and set as serving cell;

UE:

- UE is previously registered on NGC Cell A using default message contents according to TS 38.508-1 [4];

Preamble:

The UE is in state Switched OFF (state ON-B) according to TS 38.508-1 [4].

9.1.12.2.3.2 Test procedure sequence

Table 9.1.12.2.3.2-1: Main behaviour

St	Procedure	Message Sequence		TP	Verdict
		U - S	Message		
1	The UE is switched on.	-	-	-	-
2	The UE transmits a REGISTRATION REQUEST message including ER-NSSAI bit	-->	REGISTRATION REQUEST	-	-
3-11	Steps 5 to 13 of the generic procedure for NR RRC_IDLE specified in TS 38.508-1 subclause 4.5.2 are performed.	-	-	-	-
12	The SS transmits a REGISTRATION ACCEPT message including S-NSSAI=1 in extended rejected NSSAI without back-off timer and S-NSSAI=2 in extended rejected NSSAI with back-off timer set to zero Note: Now UE should start timer T3526 associated with S-NSSAI=1	<--	REGISTRATION ACCEPT	-	-
13	The UE transmits an <i>ULInformationTransfer</i> message and a REGISTRATION COMPLETE message.	-->	REGISTRATION COMPLETE	-	-
	EXCEPTION: Step 14a1 is performed if $pc_noOf_PDUsSameConnection > 0$.				
14a1	The generic procedure for UE-requested PDU session establishment, specified in subclause 4.5A.2, takes place performing establishment of UE-requested PDU session(s) with $ExpectedNumberOfNewPDUSessions = pc_noOf_PDUsSameConnection$.	-	-	-	-
15	SS releases the RRC connection	-	-	-	-
16	Check: Is S-NSSAI=1 in the Rejected NSSAI list with cause 'S-NSSAI not available due to maximum number of UEs reached' associated with current PLMN using AT/MMI command (+C5GNSSAIRDP)?	-	-	1	P

17	Cause the UE to request establishment of PDU session with S-NSSAI=1.(Note 1)	-	-	-	-
18	Check: Does the UE transmit an RRCSetupRequest message within T3526 associated with S-NSSAI=1 in the next 30 seconds?	-->	NR RRC: RRCSetupRequest	1	F
19	Check: Using AT/MMI command (+C5GNSSAIRDP) verify that S-NSSAI=2 is not in the Rejected NSSAI list associated with current PLMN			2	P
Note1: The request to establish a PDU session may be performed by MMI or AT Command.					

9.1.12.2.3.3 Specific message contents

Table 9.1.12.2.3.3-1: REGISTRATION REQUEST (step 2, Table 9.1.12.2.3.2-1)

Derivation path: TS 38.508-1 Table 4.7.1-6			
Information Element	Value/remark	Comment	Condition
5GS registration type value	'001'B	Initial registration	
5GMM capability			
ER-NSSAI	'1'B	Extended rejected NSSAI supported	

Table 9.1.12.2.3.3-2: REGISTRATION ACCEPT (step 12, Table 9.1.12.2.3.2-1)

Derivation path: TS 38.508-1 Table 4.7.1-7			
Information Element	Value/remark	Comment	Condition
5GS registration result			
5GS registration result value	'001'B	3GPP access	
Allowed NSSAI			
S-NSSAI IEI		S-NSSAI value 3	
Length of S-NSSAI contents	'0000001'B	SST	
SST	'00000011'B	SST value 3	
SD	Not Present		
Mapped configured SST	Not Present		
Mapped configured SD	Not Present		
Configured NSSAI			
S-NSSAI IEI		S-NSSAI value 1	
Length of S-NSSAI contents	'0000001'B	SST	
SST	'0000001'B	SST value 1	
SD	Not Present		
Mapped configured SST	Not Present		
Mapped configured SD	Not Present		
S-NSSAI IEI		S-NSSAI value 2	
Length of S-NSSAI contents	'0000001'B	SST	
SST	'00000010'B	SST value 2	
SD	Not Present		
Mapped configured SST	Not Present		
Mapped configured SD	Not Present		
Extended rejected NSSAI			
Length of Extended rejected NSSAI contents	2 entries		
Partial extended rejected NSSAI list		entry 1	
Type of list	'000'B	S-NSSAI without any associated back-off timer value	
Number of elements	'0000'B	1 element	
Rejected S-NSSAI 1		S-NSSAI value 1	
Length of rejected S-NSSAI	'00000001'B	SST	
Cause value	'0011'B	S-NSSAI not available due to maximum number of UEs reached	

SST	'00000001'B	SST value 1	
SD	Not Present		
Mapped HPLMN SST	Not present		
Mapped HPLMN SD	Not present		
Partial extended rejected NSSAI list		entry 2	
Type of list	'001'B	S-NSSAIs with back-off timer	
Number of elements	'0000'B	1 element	
Back-off timer value	'00000000'B	0	
Rejected S-NSSAI 1		S-NSSAI value 2	
Length of rejected S-NSSAI	'00000001'B	SST	
Cause value	'0011'B	S-NSSAI not available due to maximum number of UEs reached	
SST	'00000010'B	SST value 2	
SD	Not Present		
Mapped HPLMN SST	Not present		
Mapped HPLMN SD	Not present		

9.1.12.3 NSAC / Initial registration / Rejected / equivalent PLMNs

9.1.12.3.1 Test Purpose (TP)

(1)

```
with { UE in 5GMM-REGISTERED-INITIATED state}
ensure that {
  when { UE receives the rejected NSSAI in the REGISTRATION REJECT message with rejection cause of
  "S-NSSAI not available due to maximum number of UEs reached"}
  then { UE shall stores the rejected NSSAI and start the timer T3526}
}
```

(2)

```
with { UE receives rejected NSSAI with rejection cause of "S-NSSAI not available due to maximum
number of UEs reached"}
ensure that {
  when { UE selectes to the equivalent PLMN in the same registration area}
  then { UE shall treat the received rejected NSSAI for the maximum number of UEs reached as
applicable to equivalent PLMNs}
}
```

(3)

```
with { UE receives rejected NSSAI with rejection cause of "S-NSSAI not available due to maximum
number of UEs reached"}
ensure that {
  when { UE timer T3526 expires}
  then { Remove the S-NSSAI in the rejected NSSAI for the maximum number of UEs reached and
initiates a registration procedure}
}
```

9.1.12.3.2 Conformance requirements

References: The conformance requirements covered in the current TC are specified in: TS 24.501, clauses 5.5.1.2.5, 4.6.1. Unless otherwise stated these are Rel-17 requirements

[TS 24.501, clause 5.5.1.2.5]

#62 (No network slices available).

The UE shall abort the initial registration procedure, set the 5GS update status to 5U2 NOT UPDATED and enter state 5GMM-DEREGISTERED. ATTEMPTING-REGISTRATION or 5GMM-DEREGISTERED.PLMN-SEARCH. Additionally, the UE shall reset the registration attempt counter.

The UE receiving the rejected NSSAI in the REGISTRATION REJECT message takes the following actions based on the rejection cause in the rejected S-NSSAI(s):

"S-NSSAI not available in the current PLMN or SNPN"

The UE shall store the rejected S-NSSAI(s) in the rejected NSSAI for the current PLMN or SNPN as specified in subclause 4.6.2.2 and shall not attempt to use this S-NSSAI(s) in the current PLMN or SNPN until switching off the UE, the UICC containing the USIM is removed, an entry of the "list of subscriber data" with the SNPN identity of the current SNPN is updated, or the rejected S-NSSAI(s) are removed or deleted as described in subclause 4.6.2.2.

"S-NSSAI not available in the current registration area"

The UE shall store the rejected S-NSSAI(s) in the rejected NSSAI for the current registration area as described in subclause 4.6.2.2 and shall not attempt to use this S-NSSAI(s) in the current registration area until switching off the UE, the UE moving out of the current registration area, the UICC containing the USIM is removed, the entry of the "list of subscriber data" with the SNPN identity of the current SNPN is updated, or the rejected S-NSSAI(s) are removed or deleted as described in subclause 4.6.2.2.

"S-NSSAI not available due to the failed or revoked network slice-specific authentication and authorization"

The UE shall store the rejected S-NSSAI(s) in the rejected NSSAI for the failed or revoked NSSAI as specified in subclause 4.6.2.2 and shall not attempt to use this S-NSSAI in the current PLMN or SNPN over any access until switching off the UE, the UICC containing the USIM is removed, the entry of the "list of subscriber data" with the SNPN identity of the current SNPN is updated, or the rejected S-NSSAI(s) are removed or deleted as described in subclause 4.6.1 and 4.6.2.2.

"S-NSSAI not available due to maximum number of UEs reached"

Unless the back-off timer value received along with the S-NSSAI is zero, the UE shall add the rejected S-NSSAI(s) in the rejected NSSAI for the maximum number of UEs reached as specified in subclause 4.6.2.2 and shall not attempt to use this S-NSSAI in the current PLMN or SNPN over the current access until switching off the UE, the UICC containing the USIM is removed, the entry of the "list of subscriber data" with the SNPN identity of the current SNPN is updated, or the rejected S-NSSAI(s) are removed as described in subclause 4.6.2.2.

NOTE 6: If the back-off timer value received along with the S-NSSAI in the rejected NSSAI for the maximum number of UEs reached is zero as specified in subclause 10.5.7.4a of TS 24.008, the UE does not consider the S-NSSAI as the rejected S-NSSAI.

If there is one or more S-NSSAIs in the rejected NSSAI with the rejection cause "S-NSSAI not available due to maximum number of UEs reached", then for each S-NSSAI, the UE shall behave as follows:

- a) stop the timer T3526 associated with the S-NSSAI, if running;
- b) start the timer T3526 with:
 - 1) the back-off timer value received along with the S-NSSAI, if a back-off timer value is received along with the S-NSSAI that is neither zero nor deactivated; or
 - 2) an implementation specific back-off timer value, if no back-off timer value is received along with the S-NSSAI; and
- c) remove the S-NSSAI from the rejected NSSAI for the maximum number of UEs reached when the timer T3526 associated with the S-NSSAI expires.

If the UE has an allowed NSSAI or configured NSSAI that contains S-NSSAI(s) which are not included in the rejected NSSAI the UE may stay in the current serving cell, apply the normal cell reselection process and start an initial registration with a requested NSSAI that includes any S-NSSAI from the allowed NSSAI or the configured NSSAI that is not in the rejected NSSAI. Otherwise the UE may perform a PLMN selection or SNPN selection according to 3GPP TS 23.122 [5] and additionally, the UE may disable the N1 mode capability for the current PLMN or SNPN if the UE does not have an allowed NSSAI and each S-NSSAI in configured NSSAI, if available, was rejected with cause "S-NSSAI not available in the current PLMN or SNPN" or "S-NSSAI not available due to the failed or revoked network slice-specific authentication and authorization" as described in subclause 4.9.

If the UE has neither allowed NSSAI for the current PLMN or SNPN nor configured NSSAI for the current PLMN or SNPN and,

- 1) if at least one S-NSSAI in the default configured NSSAI is not rejected, the UE may stay in the current serving cell, apply the normal cell reselection process, and start an initial registration with a requested NSSAI with that default configured NSSAI; or
- 2) if all the S-NSSAI(s) in the default configured NSSAI are rejected and at least one S-NSSAI is rejected due to "S-NSSAI not available in the current registration area",
 - i) if the REGISTRATION REJECT message is integrity protected and the UE is not operating in SNPN access operation mode, the UE shall store the current TAI in the list of "5GS forbidden tracking areas for roaming" and enter the state 5GMM-DEREGISTERED.LIMITED-SERVICE; or
 - ii) if the REGISTRATION REJECT message is integrity protected and the UE is operating in SNPN access operation mode, the UE shall store the current TAI in the list of "5GS forbidden tracking areas for roaming" for the current SNPN and enter the state 5GMM-DEREGISTERED.LIMITED-SERVICE.

Otherwise, the UE may perform a PLMN selection or SNPN selection according to 3GPP TS 23.122 [5] and additionally, the UE may disable the N1 mode capability for the current PLMN or SNPN if each S-NSSAI in the default configured NSSAI was rejected with cause "S-NSSAI not available in the current PLMN or SNPN" or "S-NSSAI not available due to the failed or revoked network slice-specific authentication and authorization" as described in subclause 4.9.

If the UE has neither allowed NSSAI for the current PLMN or SNPN nor configured NSSAI for the current PLMN or SNPN and has rejected NSSAI for the reached maximum number of UEs, and the UE wants to obtain services in the current serving cell without performing a PLMN selection or SNPN selection, the UE may stay in the current serving cell and attempt to use the rejected S-NSSAI(s) for the maximum number of UEs reached in the current serving cell after the rejected S-NSSAI(s) are removed as described in subclause 4.6.2.2.

If the message was received via 3GPP access and the UE is operating in single-registration mode, the UE shall in addition set the EPS update status to EU2 NOT UPDATED, reset the attach attempt counter and enter the state EMM-DEREGISTERED.

[TS 24.501, clause 4.1.6.2]

The rejected NSSAI for the maximum number of UEs reached is applicable for the whole registered PLMN or SNPN, and the access type over which the rejected NSSAI was sent. The AMF shall send a rejected NSSAI including S-NSSAI(s) with the rejection cause "S-NSSAI not available due to maximum number of UEs reached", when one or more S-NSSAI(s) are indicated that the maximum number of UEs has been reached. If the timer T3526 associated with the S-NSSAI(s) was started upon reception of the rejected NSSAI for the maximum number of UEs reached, the UE may remove the S-NSSAI(s) from the rejected NSSAI including S-NSSAI(s) with the rejection cause "S-NSSAI not available due to maximum number of UEs reached", if the timer T3526 associated with the S-NSSAI(s) expires. If one or more S-NSSAI(s) are removed from the rejected NSSAI for the maximum number of UEs reached, the timer T3526 associated with the removed S-NSSAI(s) shall be stopped, if running. The UE shall not stop the timer T3526 if the UE selects an E-UTRA cell connected to EPC.

If the UE receives a rejected NSSAI for the maximum number of UEs reached, the registration area contains TAIs belonging to different PLMNs, which are equivalent PLMNs, the UE shall treat the received rejected NSSAI for the maximum number of UEs reached as applicable to these equivalent PLMNs when the UE is in this registration area.

[TS 24.501, clause 10.2]

Table 10.2.1: Timers of 5GS mobility management – UE side

TIMER NUM.	TIMER VALUE	STATE	CAUSE OF START	NORMAL STOP	ON EXPIRY
T3502	Default 12 min. NOTE 1	5GMM-DEREGISTERED 5GMM-REGISTERED	At registration failure and the attempt counter is equal to 5	Transmission of REGISTRATION REQUEST message	Initiation of the registration procedure, if still required
...					

TIMER NUM.	TIMER VALUE	STATE	CAUSE OF START	NORMAL STOP	ON EXPIRY
T3526	NOTE 9	5GMM- DEREGISTERED 5GMM- REGISTERED	Rejected S-NSSAI with rejection cause "maximum number of UEs per network slice reached" received.	The associated rejected S-NSSAI for the maximum number of UEs reached as specified in subclause 4.6.2.2 deleted.	Remove the S-NSSAI in the rejected NSSAI for the maximum number of UEs reached associated with the T3526 timer.

9.1.12.3.3 Test description

9.1.12.3.3.1 Pre-test conditions

System Simulator:

- NGC Cell A (home PLMN) and NGC Cell E are configured according to Table 6.3.2.2-1 in TS 38.508-1 [4].
- System information combination NR-2 in accordance with TS 38.508-1 [4] sub-clause 4.4.3.1.2 is used in NGC Cell A and NGC Cell E.
- The UE is last authenticated and registered on NGC Cell A and Cell E PLMN is provided as equivalent PLMN.

Preamble:

- The UE is in state Switched OFF (state 0N-B) according to TS 38.508-1 [4].

9.1.12.3.3.2 Test procedure sequence

Table 9.1.12.3.3.2-1: Main behaviour

St	Procedure	Message Sequence		TP	Verdict
		U - S	Message		
1	The SS configures: - NGC Cell A as the "Serving cell". - NGC Cell E as "Non-suitable "Off" cell".	-	-	-	-
2	The UE is switched on.	-	-	-	-
3-14	Steps 2-13 of Table 4.5.2.2-2 of the generic procedure in TS 38.508-1 [4] are performed.	-	-	-	-
15	The SS transmits a REGISTRATION REJECT message, 5GMM cause value = #62 "No network slices available" and rejection cause in the Extended rejected S-NSSAI is set = '0011'B "S-NSSAI not available due to maximum number of UEs reached", T3526 is not present default value of 12 minutes is applied.	<--	REGISTRATION REJECT	-	-
16	SS starts timer of t_Waits= T3526.	-	-	-	-
17	The SS releases the RRC connection.	-	-	-	-
18	Check: Does the UE transmit the REGISTRATION REQUEST message on NGC Cell A in the next 30 seconds?	-->	REGISTRATION REQUEST	1	F
19	The SS reconfigures: - NGC cell E as the "Serving cell". - NGC cell A as a "Non-suitable "Off" cell".	-	-	-	-
20	Check: Does the UE transmit the REGISTRATION REQUEST message on NGC Cell E in the next 60 seconds?	-->	REGISTRATION REQUEST	2	F
21	SS waits for the expiration of t_Waits..	-	-	-	-
22	Check: Does the UE transmit a REGISTRATION REQUEST message on NGC Cell A?	-->	REGISTRATION REQUEST	3	P

23-38a1	Steps 5-20a1 of Table 4.5.2.2-2 in TS38.508-1 [4] are performed.	-	-	-	-
---------	--	---	---	---	---

9.1.12.3.3.3 Specific message contents

Table 9.1.12.3.3.3-1: REGISTRATION REJECT (step 15, Table 9.1.12.3.3.2-1)

Derivation path: TS 38.508-1 [4] table 4.7.1-9			
Information Element	Value/remark	Comment	Condition
5GMM cause	'0011 1110'B	#62 "No network slices available"	
Extended rejected NSSAI			
Extended rejected NSSAI IEI			
Length of Extended rejected NSSAI contents	'0101'B		
Length of Extended rejected S-NSSAI	'0100'B	SST	
Cause value	'0011'B	S-NSSAI not available due to maximum number of UEs reached.	
SST	'00000001'B	SST value 1	
SD	'FFFFFF'H	no SD value associated with the SST	

9.2 5GS Non-3GPP Access Mobility Management

9.2.1 Primary authentication and key agreement procedure

9.2.1.1 EAP based primary authentication and key agreement

9.2.1.1.1 Test Purpose (TP)

Same TP's as clause 9.1.1.1.1

9.2.1.1.2 Conformance requirements

Same Conformance requirements as in clause 9.1.1.1.2.

9.2.1.1.3 Test description

9.2.1.1.3.1 Pre-test conditions

System Simulator:

- WLAN Cell 27

UE:

- None.

Preamble:

- The UE is in state Switched OFF (state 0W-B) according to TS 38.508-1 [4].

9.2.1.1.3.2 Test procedure sequence

Table 9.2.1.1.3.2-1: Main behaviour

St	Procedure	Message Sequence		TP	Verdict
		U - S	Message		
1	Switch the UE on	-	-	-	-
2-4	The UE initiates establishment of an IPsec tunnel and registration procedure by executing steps 1-3 of Table 4.5.2.2-3 in TS 38.508-1 [4].	-	-	-	-
5	SS transmits an AUTHENTICATION REQUEST message with an EAP-Request/AKA'-Identity message.	<--	5GMM: AUTHENTICATION REQUEST		
6	Check: Does the UE respond with an AUTHENTICATION RESPONSE message, with an EAP-Response/AKA'-Identity message?	-->	5GMM: AUTHENTICATION RESPONSE	1	P
7	SS transmits an AUTHENTICATION REQUEST message with an EAP-Request/AKA'-challenge message which contains a not correct sequence number.	<--	5GMM: AUTHENTICATION REQUEST	-	-
8	Check: Does the UE respond with an AUTHENTICATION RESPONSE message, with an EAP-Response/AKA'-synchronization-failure?	-->	5GMM: AUTHENTICATION RESPONSE	2	P
9	SS transmits a correct AUTHENTICATION REQUEST message with an EAP-Request/AKA'-challenge message.	<--	5GMM: AUTHENTICATION REQUEST	-	-
10	Check: Does the UE respond with a correct AUTHENTICATION RESPONSE message, with an EAP-Request/AKA'-challenge message?	-->	5GMM: AUTHENTICATION RESPONSE	3	P
11	SS transmits an AUTHENTICATION RESULT message with an EAP-success message.	<--	5GMM: AUTHENTICATION RESULT	-	-
12-14	The registration procedure is performed by executing steps 6-8 of Table 4.5.2.2-3 in TS 38.508-1 [4].	-	-	-	-
15	Check: Does the UE transmits a REGISTRATION COMPLETE message?	-->	5GMM: REGISTRATION COMPLETE	4	P
16	The registration procedure is successfully completed by executing steps 10 of Table 4.5.2.2-3 in TS 38.508-1 [4].	-	-	-	-

9.2.1.1.3.3 Specific message contents

Table 9.2.1.1.3.3-1: Message AUTHENTICATION REQUEST (step 5, Table 9.2.1.1.3.2-1)

Derivation path: TS 38.508-1 [4], table 4.7.1-1			
Information Element	Value/Remark	Comment	Condition
EAP message	EAP-request/AKA'-Identity	See Table 4.7.3.2-7 in TS 38.508-1 [4].	EAP-AKA

Table 9.2.1.1.3.3-2: Message AUTHENTICATION RESPONSE (step 6, Table 9.2.1.1.3.2-1)

Derivation path: TS 38.508-1 [4], table 4.7.1-2			
Information Element	Value/Remark	Comment	Condition
EAP message	EAP-response/AKA'-Identity	See Table 4.7.3.2-8 in TS 38.508-1 [4].	EAP-AKA

Table 9.2.1.1.3.3-3: Message AUTHENTICATION REQUEST (step 7, Table 9.2.1.1.3.2-1)

Derivation path: TS 38.508-1 [4], table 4.7.1-1			
Information Element	Value/Remark	Comment	Condition
EAP message	EAP-request/AKA'-challenge	The sequence number in AUTN is not correct	EAP-AKA

Table 9.2.1.1.3.3-4: Message AUTHENTICATION RESPONSE (step 8, Table 9.2.1.1.3.2-1)

Derivation path: TS 38.508-1 [4], table 4.7.1-2			
Information Element	Value/Remark	Comment	Condition
EAP message	EAP-response/AKA'-synchronization-failure	See Table 4.7.3.2-5 in TS 38.508-1 [4].	EAP-AKA

Table 9.2.1.1.3.3-5: Message AUTHENTICATION RESPONSE (step 10, Table 9.2.1.1.3.2-1)

Derivation path: TS 38.508-1 [4], table 4.7.1-2			
Information Element	Value/Remark	Comment	Condition
EAP message	EAP-Response/AKA'-Challenge	RES* equal to the XRES* calculated in the SS with the parameters provided/indicated in the AUTHENTICATION REQUEST	EAP-AKA

Table 9.2.1.1.3.3-6: Message AUTHENTICATION RESULT (step 11, Table 9.2.1.1.3.2-1)

Derivation path: TS 38.508-1 [4], table 4.7.1-3			
Information Element	Value/Remark	Comment	Condition
EAP message	EAP-Success		EAP-AKA

9.2.1.2 5G AKA based primary authentication and key agreement

9.2.1.2.1 Test Purpose (TP)

Same Test purpose as in clause 9.1.1.4.1

9.2.1.2.2 Conformance requirements

Same Conformance requirements as in clause 9.1.1.4.2

9.2.1.2.3 Test description

9.2.1.2.3.1 Pre-test conditions

System Simulator:

- WLAN Cell 27

UE:

- None.

Preamble:

- The UE is in state Switched OFF (state 0W-B) according to TS 38.508-1 [4].

9.2.1.2.3.2 Test procedure sequence

Table 9.2.1.2.3.2-1: Main behaviour

St	Procedure	Message Sequence		TP	Verdict
		U - S	Message		
1	Switch the UE on	-	-	-	-
2-4	The UE initiates establishment of an IPsec tunnel and registration procedure by executing steps 1-3 of Table 4.5.2.2-3 in TS 38.508-1 [4].	-	-	-	-
5	The SS transmits an AUTHENTICATION REQUEST message which contains an invalid MAC code.	<--	AUTHENTICATION REQUEST	-	-
6	Check: Does the UE respond with an AUTHENTICATION FAILURE message with 5GMM cause "MAC failure"?	-->	AUTHENTICATION FAILURE	1	P
7	SS transmits a correct AUTHENTICATION REQUEST message with RAND different to the one send in Step 5	<--	AUTHENTICATION REQUEST	-	-
8	Check: Does the UE respond with a correct AUTHENTICATION RESPONSE message with RES* that is equal to the XRES* calculated in the SS?	-->	AUTHENTICATION RESPONSE	4	P
9	SS transmits a NAS SECURITY MODE COMMAND message including the ngKSI of the new 5G NAS security context (as provided in step 7), to proceed with the registration procedure.	<--	SECURITY MODE COMMAND	-	-
10	Check: Does the UE respond with NAS SECURITY MODE COMPLETE message integrity protected and ciphered with the new 5G NAS security context identified by the ngKSI received in the SECURITY MODE COMMAND message in step 9.	-->	SECURITY MODE COMPLETE	5	P
11	Steps 10 of the generic procedure (TS 38.508-1 Table 4.5.2.2-3 [4]) are executed to successfully complete the registration procedure.	-	-	-	-
12	Switch off procedure in Ipsec_SA_Established specified in TS 38.508-1 [4] subclause 4.9.6.5 is performed.	-	-	-	-
13-16	Steps 1-4 above are repeated	-	-	-	-
17	SS transmits an AUTHENTICATION REQUEST message with "separation bit" in the AMF field is 0.	<--	AUTHENTICATION REQUEST	-	-
18	Check: Does the UE respond with an AUTHENTICATION FAILURE message, with 5GMM cause " Non-5G authentication unacceptable "?	-->	AUTHENTICATION FAILURE	2	P
19	SS transmits a correct AUTHENTICATION REQUEST message with RAND different to the one send in Step 22	<--	AUTHENTICATION REQUEST	-	-
20	Check: Does the UE respond with a correct AUTHENTICATION RESPONSE message with RES* that is equal to the XRES* calculated in the SS?	-->	AUTHENTICATION RESPONSE	4	P
21	Step 10 of the generic procedure (TS 38.508-1 Table 4.5.2.2-3 [4]) are executed to	-	-	-	-

	successfully complete the registration procedure.				
22	Switch off procedure in Ipsec_SA_Established specified in TS 38.508-1 [4] subclause 4.9.6.5 is performed.	-	-	-	-
23-26	Steps 1-4 above are repeated	-	-	-	-
27	SS transmits AUTHENTICATION REQUEST message with the AMF field in the IE "Authentication parameter AUTN" set to "AMF _{RESYNCH} " value to trigger SQN re-synchronisation procedure in test USIM	<--	AUTHENTICATION REQUEST	-	-
28	Check: Does the UE respond with an AUTHENTICATION FAILURE message, with 5GMM cause "Synch failure" and Authentication failure parameter?	-->	AUTHENTICATION FAILURE	3	P
29	SS transmits a correct AUTHENTICATION REQUEST message with RAND different to the one send in Step 32.	<--	AUTHENTICATION REQUEST	-	-
30	Check: Does the UE respond with a correct AUTHENTICATION RESPONSE message with RES* that is equal to the XRES* calculated in the SS?	-->	AUTHENTICATION RESPONSE	4	P
31	Step 10 of the generic procedure (TS 38.508-1 Table 4.5.2.2-3 [4]) are executed to successfully complete the registration procedure.	-	-	-	-

9.2.1.2.3.3 Specific message contents

Table 9.2.1.2.3.3-1: AUTHENTICATION RESPONSE (step 8, step 20 and step 30, Table 9.2.1.2.3.2-1)

Derivation path: TS 38.508, Table 4.7.1-2			
Information Element	Value/remark	Comment	Condition
Authentication response parameter	RES* equal to the XRES* calculated in the SS with the parameters provided/indicated in the AUTHENTICATION REQUEST		

Table 9.2.1.2.3.3-2: AUTHENTICATION REQUEST (step 5, Table 9.2.1.2.3.2-1)

Derivation path: TS 38.508, Table 4.7.1-1			
Information Element	Value/remark	Comment	Condition
Authentication parameter AUTN	Invalid MAC	SS shall calculate the correct MAC value as specified in TS 33.102 and use any different value, e.g. correct_MAC+5.	

Table 9.2.1.2.3.3-3: AUTHENTICATION FAILURE (step 6, Table 9.2.1.2.3.2-1)

Derivation path: TS 38.508, Table 4.7.1-4			
Information Element	Value/remark	Comment	Condition
5GMM cause	'0001 0100'B	MAC failure	

Table 9.2.1.2.3.3-4: AUTHENTICATION REQUEST (step 17, Table 9.2.1.2.3.2-1)

Derivation path: TS 38.508, Table 4.7.1-1			
Information Element	Value/remark	Comment	Condition
Authentication parameter AUTN	"separation bit"=0	The "separation bit" in the AMF field of AUTN supplied by the core network is 0.	

Table 9.2.1.2.3.3-5: AUTHENTICATION FAILURE (step 18, Table 9.2.1.2.3.2-1)

Derivation path: TS 38.508, Table 4.7.1-4			
Information Element	Value/remark	Comment	Condition
5GMM cause	'0001 1010'B	Non-5G authentication unacceptable	

Table 9.2.1.2.3.3-6: AUTHENTICATION REQUEST (step 27, Table 9.2.1.2.3.2-1)

Derivation path: TS 38.508, Table 4.7.1-1			
Information Element	Value/remark	Comment	Condition
Authentication parameter AUTN	AMF field set to "AMF _{RESYNCH} ", AMF _{RESYNCH} = '1111 1111 1111 1111'B	AMF _{RESYNCH} see TS 34.108, 8.1.2.2	

Table 9.2.1.2.3.3-7: AUTHENTICATION FAILURE (step 28, Table 9.2.1.2.3.2-1)

Derivation path: TS 38.508, Table 4.7.1-4			
Information Element	Value/remark	Comment	Condition
5GMM cause	'0001 0101'B	Synch failure	
Authentication failure parameter	AUTS	AUTS see TS 34.108, 8.1.2.2	

9.2.2 Security Mode Control

9.2.2.1 NAS security mode command

9.2.2.1.1 Test Purpose (TP)

(1)

```
with { the UE is in 5GMM-REGISTERED-INITIATED state and the SS initiates the NAS security mode control procedure by sending a SECURITY MODE COMMAND message during initial registration procedure }
ensure that {
  when { the UE receives an integrity protected SECURITY MODE COMMAND message including not matching replayed security capabilities }
  then { the UE send a SECURITY MODE REJECT message and does not start applying the NAS security in both UL and DL }
}
```

(2)

```
with { the UE is in 5GMM-REGISTERED-INITIATED state and the SS initiates the NAS security mode control procedure by sending a SECURITY MODE COMMAND message during initial registration procedure }
ensure that {
  when { the UE receives an integrity protected SECURITY MODE COMMAND message including IMEISV request }
}
```

```
    then { the UE send an integrity protected and ciphered SECURITY MODE COMPLETE message including
IMEISV and starts applying the NAS Security in both UL and DL }
}
```

9.2.2.1.2 Conformance requirements

References: The conformance requirements covered in the present test case are specified in: TS 24.501, clauses 5.4.2.1, 5.4.2.3 and 5.4.2.5. Unless otherwise stated these are Rel-15 requirements.

[TS 24.501, clause 5.4.2.1]

The purpose of the NAS security mode control procedure is to take a 5G NAS security context into use, and initialise and start NAS signalling security between the UE and the AMF with the corresponding 5G NAS keys and 5G NAS security algorithms.

Furthermore, the network may also initiate the security mode control procedure in the following cases:

- a)- in order to change the 5G NAS security algorithms for a current 5G NAS security context already in use;
- b) in order to change the value of uplink NAS COUNT used in the latest SECURITY MODE COMPLETE message as described in 3GPP TS 33.501 [24], subclause 6.9.4.4; and
- c) in order to provide the Selected EPS NAS security algorithms to the UE

For restrictions concerning the concurrent running of a security mode control procedure with other security related procedures in the AS or inside the core network see 3GPP TS 33.501 [24], subclause 6.9.5.

[TS 24.501, clause 5.4.2.3]

Upon receipt of the SECURITY MODE COMMAND message, the UE shall check whether the security mode command can be accepted or not. This is done by performing the integrity check of the message, and by checking that the received Replayed UE security capabilities IE has not been altered compared to the latest values that the UE sent to the network.

When the SECURITY MODE COMMAND message includes an EAP-success message the UE handles the EAP-success message and the ABBA as described in subclause 5.4.1.2.2.8.

If the UE is registered for emergency services, performing initial registration for emergency services or establishing an emergency PDU session and the SECURITY MODE COMMAND message is received with ngKSI value "000" and 5G-IA0 and 5G-EA0 as selected 5G NAS security algorithms, the UE shall locally derive and take in use 5G NAS security context. The UE shall delete existing current 5G NAS security context.

The UE shall ignore the Replayed S1 UE security capabilities IE if this IE is included in the SECURITY MODE COMMAND message.

The UE shall accept a SECURITY MODE COMMAND message indicating the "null integrity protection algorithm" 5G-EA0 as the selected 5G NAS integrity algorithm only if the message is received when the UE is registered for emergency services, performing initial registration for emergency services or establishing an emergency PDU session.

If the type of security context flag included in the SECURITY MODE COMMAND message is set to "native security context" and if the ngKSI matches a valid non-current native 5G NAS security context held in the UE while the UE has a mapped 5G NAS security context as the current 5G NAS security context, the UE shall take the non-current native 5G NAS security context into use which then becomes the current native 5G NAS security context and delete the mapped 5G NAS security context.

If the SECURITY MODE COMMAND message can be accepted, the UE shall take the 5G NAS security context indicated in the message into use. The UE shall in addition reset the uplink NAS COUNT counter if:

- a) the SECURITY MODE COMMAND message is received in order to take a 5G NAS security context into use created after a successful execution of the 5G AKA based primary authentication and key agreement procedure or the EAP based primary authentication and key agreement procedure; or
- b) the SECURITY MODE COMMAND message received includes the type of security context flag set to "mapped security context" in the NAS key set identifier IE the ngKSI does not match the current 5G NAS security context, if it is a mapped 5G NAS security context.

If the SECURITY MODE COMMAND message can be accepted and a new 5G NAS security context is taken into use and SECURITY MODE COMMAND message does not indicate the "null integrity protection algorithm" 5G-IA0 as the selected NAS integrity algorithm, the UE shall:

- if the SECURITY MODE COMMAND message has been successfully integrity checked using an estimated downlink NAS COUNT equal to 0, then the UE shall set the downlink NAS COUNT of this new 5G NAS security context to 0;
- otherwise the UE shall set the downlink NAS COUNT of this new 5G NAS security context to the downlink NAS COUNT that has been used for the successful integrity checking of the SECURITY MODE COMMAND message.

If the SECURITY MODE COMMAND message includes the horizontal derivation parameter indicating "K_{AMF} derivation is required", the UE shall derive a new K'_{AMF}, as specified in 3GPP TS 33.501 [24] for K_{AMF} to K'_{AMF} derivation in mobility, and set both uplink and downlink NAS COUNTs to zero. When the new 5G NAS security context is taken into use for current access and the UE is registered with the same PLMN over the 3GPP access and the non-3GPP access:

- a) the UE is in 5GMM-IDLE mode over the non-current access, the AMF and the UE shall activate the new 5G NAS security context over the non-current access as described in 3GPP TS 33.501 [24]. The AMF and the UE shall set the downlink NAS COUNT and uplink NAS COUNT to zero for the non-current access; or
- b) the UE is in 5GMM-CONNECTED mode over the non-current access, the AMF shall send the SECURITY MODE COMMAND message over the non-current access to activate the new 5G NAS security context that was activated over the current access as described in 3GPP TS 33.501 [24]. The AMF shall include the same ngKSI in the SECURITY MODE COMMAND message to identify the new 5G NAS security context.

If the SECURITY MODE COMMAND message includes the horizontal derivation parameter indicating "K_{AMF} derivation is not required" or the Additional 5G security parameters IE is not included in the message, the UE is registered with the same PLMN over the 3GPP access and non-3GPP access, then after the completion of a security mode control procedure over the current access:

- a) the UE is in 5GMM-IDLE mode over the non-current access, the AMF and the UE shall activate the new 5G NAS security context for the non-current access. If a primary authentication and key agreement procedure was completed before the security mode control procedure, the AMF and the UE shall set the downlink NAS COUNT and uplink NAS COUNT to zero for the non-current access, otherwise the downlink NAS COUNT and uplink NAS COUNT for the non-3GPP access are not changed; or
- b) the UE is in 5GMM-CONNECTED mode over the non-current access, the AMF shall send the SECURITY MODE COMMAND message over the non-current access to activate the new 5G NAS security context that was activated over the current access as described in 3GPP TS 33.501 [24]. The AMF shall include the same ngKSI in the SECURITY MODE COMMAND message to identify the new 5G NAS security context.

If the SECURITY MODE COMMAND message can be accepted, the UE shall send a SECURITY MODE COMPLETE message integrity protected with the selected 5GS integrity algorithm and the 5G NAS integrity key based on the K_{AMF} or mapped K'_{AMF} if the type of security context flag is set to "mapped security context" indicated by the ngKSI. When the SECURITY MODE COMMAND message includes the type of security context flag set to "mapped security context" in the NAS key set identifier IE, then the UE shall check whether the SECURITY MODE COMMAND message indicates the ngKSI of the current 5GS security context, if it is a mapped 5G NAS security context, in order not to re-generate the K'_{AMF}.

Furthermore, if the SECURITY MODE COMMAND message can be accepted, the UE shall cipher the SECURITY MODE COMPLETE message with the selected 5GS ciphering algorithm and the 5GS NAS ciphering key based on the K_{AMF} or mapped K'_{AMF} indicated by the ngKSI. The UE shall set the security header type of the message to "integrity protected and ciphered with new 5G NAS security context".

From this time onward the UE shall cipher and integrity protect all NAS signalling messages with the selected 5GS integrity and ciphering algorithms.

If the AMF indicated in the SECURITY MODE COMMAND message that the IMEISV is requested, the UE shall include its IMEISV in the SECURITY MODE COMPLETE message.

If, during an ongoing registration procedure or service request procedure, the SECURITY MODE COMMAND message includes the Additional 5G security information IE with the RINMR bit set to "Retransmission of the initial

NAS message requested", the UE shall include the entire uncyphered REGISTRATION REQUEST message or SERVICE REQUEST message, which the UE had previously included in the NAS message container IE of the initial NAS message (i.e. REGISTRATION REQUEST message or SERVICE REQUEST message, respectively), in the NAS message container IE of the SECURITY MODE COMPLETE message.

If, prior to receiving the SECURITY MODE COMMAND message, the UE without a valid 5GS NAS security context had sent a REGISTRATION REQUEST message the UE shall include the entire REGISTRATION REQUEST message in the NAS message container IE of the SECURITY MODE COMPLETE message as described in subclause 4.4.6.

If the UE operating in the single-registration mode receives the Selected EPS NAS security algorithms IE, the UE shall use the IE according to 3GPP TS 33.501 [24].

For a UE operating in single-registration mode with N26 interface supported in the network, after an inter-system change from S1 mode to N1 mode in 5GMM-CONNECTED mode, the UE shall set the value of the Selected EPS NAS security algorithms IE in the 5G NAS security context to the NAS security algorithms that were received from the source MME when the UE was in S1 mode.

[TS 24.501, clause 5.4.2.5]

If the security mode command cannot be accepted, the UE shall send a SECURITY MODE REJECT message. The SECURITY MODE REJECT message contains a 5GMM cause that typically indicates one of the following cause values:

#23 UE security capabilities mismatch.

#24 security mode rejected, unspecified.

If the UE detects that the received Replayed UE security capabilities IE has been altered compared to the latest values that the UE sent to the network, the UE shall set the cause value to #23 "UE security capabilities mismatch".

Upon receipt of the SECURITY MODE REJECT message, the AMF shall stop timer T3560. The AMF shall also abort the ongoing procedure that triggered the initiation of the NAS security mode control procedure.

Both the UE and the AMF shall apply the 5G NAS security context in use before the initiation of the security mode control procedure, if any, to protect the SECURITY MODE REJECT message and any other subsequent messages according to the rules in subclause 4.4.4 and 4.4.5.

9.2.2.1.3 Test description

9.2.2.1.3.1 Pre-test conditions

System Simulator:

- WLAN Cell 27

UE:

- None.

Preamble:

- The UE is in state Switched OFF (state 0-A) according to TS 38.508-1 [4].

9.2.2.1.3.2 Test procedure sequence

Table 9.2.2.1.3.2-1: Main behaviour

St	Procedure	Message Sequence		TP	Verdict
		U - S	Message		
1	The UE is switched on.	-	-	-	-
1A	The UE transmits a REGISTRATION REQUEST message.	-->	REGISTRATION REQUEST	-	-

1B	The SS transmits an AUTHENTICATION REQUEST message including EAP-Request/AKA'-Challenge or 5G AKA Challenge.	<--	AUTHENTICATION REQUEST	-	-
1C	The UE transmits an AUTHENTICATION RESPONSE message including EAP-Response/AKA'-Challenge or 5G AKA Response.	-->	AUTHENTICATION RESPONSE	-	-
1D	The SS transmits a SECURITY MODE COMMAND message including EAP-Success if EAP-AKA' used.	<--	SECURITY MODE COMMAND	-	-
1E	The UE transmits a SECURITY MODE COMPLETE message.	-->	SECURITY MODE COMPLETE	-	-
1F	The SS transmits a REGISTRATION REJECT message with the cause value set to #6 Illegal ME as default.	<--	REGISTRATION REJECT	-	-
1G	The UE is switched off.	-	-	-	-
1H	The UE is switched on.	-	-	-	-
2-6	Steps 1-5 of the generic procedure for UE registration specified in TS 38.508-1 [4] table 4.5.2.2-3 are performed.	-	-	-	-
7	The SS transmits a SECURITY MODE COMMAND message to activate NAS security. It is integrity protected and includes unmatched replayed security capabilities.	<--	SECURITY MODE COMMAND	-	-
8	Check: Does the UE transmit a SECURITY MODE REJECT message with cause'#23: UE security capabilities mismatch'?	-->	SECURITY MODE REJECT	1	P
9	The SS transmits an IDENTITY REQUEST message (Security not applied).	<--	IDENTITY REQUEST	-	-
10	Check: Does the UE transmit a non-security protected IDENTITY RESPONSE message?	-->	IDENTITY RESPONSE	1	P
11	The SS transmits a SECURITY MODE COMMAND message to activate NAS security. It is integrity protected and includes IMEISV.	<--	SECURITY MODE COMMAND	-	-
12	Check: Does the UE transmit a SECURITY MODE COMPLETE message and does it establish the initial security configuration?	-->	SECURITY MODE COMPLETE	2	P
13-15	Steps 8-10 of the generic procedure for UE registration specified in TS 38.508-1 [4] table 4.5.2.2-3 are performed.	-	-	-	-
16	The SS transmits an IDENTITY REQUEST message (Security protected as per the algorithms specified in step 11).	<-	IDENTITY REQUEST	-	-
17	Check: Does the UE transmit an IDENTITY RESPONSE message (Security Protected as per the algorithms specified in step 11)?	->	IDENTITY RESPONSE	2	P
Note 1: The UE establishes an IPsec tunnel in parallel to 5GC registration steps 4 to 12 as per the IKEv2 protocol as defined in 3GPP TS 23.502 [31] clause 4.12.2.2 figure 4.12.2.2-1.					

9.2.2.1.3.3 Specific message contents

Table 9.2.2.1.3.3-0: REGISTRATION REJECT (Step 1F, Table 9.2.2.1.3.2-1)

Derivation path: TS 38.508-1 [4],table 4.7.1-9			
Information Element	Value/Remark	Comment	Condition
5GMM cause	'00000110'B	Illegal ME	

Table 9.2.2.1.3.3-1: SECURITY MODE COMMAND (Step 7, Table 9.2.2.1.3.2-1)

Derivation path: TS 38.508-1 [4],table 4.7.1-25			
Information Element	Value/Remark	Comment	Condition
Replayed UE security capabilities	Set to mismatch the security capability of UE		

	under test		
--	------------	--	--

Table 9.2.2.1.3.3-2: SECURITY MODE REJECT (Step 8, Table 9.2.2.1.3.2-1)

Derivation path: TS 38.508-1 [4],table 4.7.1-27			
Information Element	Value/Remark	Comment	Condition
5GMM cause	#23		

Table 9.2.2.1.3.3-3: IDENTITY REQUEST (Step 9, Table 9.2.2.1.3.2-1)

Derivation path: TS 38.508-1 [4],table 4.7.1-21			
Information Element	Value/Remark	Comment	Condition
Identity type	'0001'B	SUCI	

Table 9.2.2.1.3.3-4: IDENTITY RESPONSE (Step 10, Table 9.2.2.1.3.2-1)

Derivation path: TS 38.508-1 [4],table 4.7.1-22			
Information Element	Value/Remark	Comment	Condition
Mobile identity			
Type of identity	'001'B	SUCI	

Table 9.2.2.1.3.3-5: SECURITY MODE COMMAND (Step 11, Table 9.2.2.1.3.2-1)

Derivation path: TS 38.508-1 [4], table 4.7.1-25			
Information Element	Value/Remark	Comment	Condition
Selected NAS security algorithms			
Type of ciphering algorithm	Set according to PIXIT parameter for default ciphering algorithm if it is set to a value different to 5G-EA0, or, set to any value different to 5G-EA0 otherwise	Non-zero ciphering algorithm	
IMEISV request	Present		

Table 9.2.2.1.3.3-6: SECURITY MODE COMPLETE (Step 12, Table 9.2.2.1.3.2-1)

Derivation path: TS 38.508-1 [4], table 4.7.1-26			
Information Element	Value/Remark	Comment	Condition
IMEISV	Present		

Table 9.2.2.1.3.3-7: IDENTITY REQUEST (Step 16, Table 9.2.2.1.3.2-1)

Derivation path: TS 38.508-1 [4],table 4.7.1-21			
Information Element	Value/Remark	Comment	Condition
Identity type	'0011'B	IMEI	

Table 9.2.2.1.3.3-8: IDENTITY RESPONSE (Step 17, Table 9.2.2.1.3.2-1)

Derivation path: TS 38.508-1 [4],table 4.7.1-22			
Information Element	Value/Remark	Comment	Condition
Mobile identity			
Type of identity	'011'B	IMEI	

9.2.2.2 Protection of initial NAS signalling messages

9.2.2.2.1 Test Purpose (TP)

Same Test purpose as in clause 9.1.2.2.1

9.2.2.2.2 Conformance requirements

Same conformance requirements as in clause 9.1.2.2.2

9.2.2.2.3 Test description

9.2.2.2.3.1 Pre-test conditions

System Simulator:

- WLAN Cell 27.

UE:

- None.

Preamble:

- The UE is in state 0W-B on WLAN Cell 27 according to TS 38.508-1 [4].

9.2.2.2.3.2 Test procedure sequence

Table 9.2.2.2.3.2-1: Main behaviour

St	Procedure	Message Sequence		TP	Verdict
		U - S	Message		
1	The UE is switched on.	-	-	-	-
1A	The UE transmits a REGISTRATION REQUEST message.	-->	REGISTRATION REQUEST	-	-
1B	The SS transmits an AUTHENTICATION REQUEST message including EAP-Request/AKA'-Challenge or 5G AKA Challenge.	<--	AUTHENTICATION REQUEST	-	-
1C	The UE transmits an AUTHENTICATION RESPONSE message including EAP-Response/AKA'-Challenge or 5G AKA Response.	-->	AUTHENTICATION RESPONSE	-	-
1D	The SS transmits a SECURITY MODE COMMAND message including EAP-Success if EAP-AKA' used.	<--	SECURITY MODE COMMAND	-	-
1E	The UE transmits a SECURITY MODE COMPLETE message.	-->	SECURITY MODE COMPLETE	-	-
1F	The SS transmits a REGISTRATION REJECT message with the cause value set to #6 Illegal ME as default.	<--	REGISTRATION REJECT	-	-
1G	The UE is switched off.	-	-	-	-
1H	The UE is switched on.	-	-	-	-
2-3	Steps 1-2 of the generic procedure for UE registration specified in TS 38.508-1 [4] table 4.5.2.2-3 are performed.	-	-	-	-
-	Exception: The UE establishes an IPsec tunnel in parallel to 5GC registration steps 4 to 8 as per the IKEv2 protocol as defined in 3GPP TS 23.502 [31] clause 4.12.2.2 figure 4.12.2.2-1.	-	-	-	-
4	The UE transmits a REGISTRATION	-->	REGISTRATION REQUEST	1	P

	REQUEST message.				
5	The SS transmits a <i>DLInformationTransfer</i> message and an AUTHENTICATION REQUEST message.	<--	AUTHENTICATION REQUEST	-	-
6	The UE transmits an <i>ULInformationTransfer</i> message and an AUTHENTICATION RESPONSE message.	-->	AUTHENTICATION RESPONSE	-	-
7	The SS transmits a <i>DLInformationTransfer</i> message and a SECURITY MODE COMMAND message.	<--	SECURITY MODE COMMAND		
8	The UE transmits an <i>ULInformationTransfer</i> message and a SECURITY MODE COMPLETE message.	-->	SECURITY MODE COMPLETE	2	P
9-11	Steps 8-10 of the generic procedure for UE registration specified in TS 38.508-1 [4] table 4.5.2.2-3 are performed.	-	-	-	-

9.2.2.2.3.3 Specific message contents

Table 9.2.2.2.3.3-0: REGISTRATION REJECT (Step 1F, Table 9.2.2.2.3.2-1)

Derivation path: TS 38.508-1 [4],table 4.7.1-9			
Information Element	Value/Remark	Comment	Condition
5GMM cause	'00000110'B	Illegal ME	

Table 9.2.2.2.3.3-1: REGISTRATION REQUEST (Step 4, Table 9.2.2.2.3.2-1)

Derivation path: TS 38.508-1 [4],table 4.7.1-6 using condition NON_CLEARTEXT_IE			
Information Element	Value/Remark	Comment	Condition

Table 9.2.2.2.3.3-2: SECURITY MODE COMPLETE (Step 8, Table 9.2.2.2.3.2-1)

Derivation path: TS 38.508-1 [4],table 4.7.1-26			
Information Element	Value/Remark	Comment	Condition
NAS message container	Contents of Table 9.2.2.2.3.3-3		

Table 9.2.2.2.3.3-3: REGISTRATION REQUEST (Step 8, Table 9.2.2.2.3.2-1)

Derivation path: TS 38.508-1 [4],table 4.7.1-6 using condition CIPHERED_MESSAGE			
Information Element	Value/Remark	Comment	Condition

9.2.3 Void

9.2.4 Generic UE configuration

9.2.4.1 Generic UE configuration update

9.2.4.1.1 Test Purpose (TP)

(1)

```

with { UE in 5GMM-REGISTERED state }
ensure that {
  when { UE receives a new 5G-GUTI in the CONFIGURATION UPDATE COMMAND message and acknowledgement
from the UE is requested }
  then { UE sends a CONFIGURATION UPDATE COMPLETE message and UE shall consider new 5G-GUTI as
valid }

```

}

(2)

```
with { UE in 5GMM-REGISTERED state }
ensure that {
  when { UE receives a NITZ information in the CONFIGURATION UPDATE COMMAND message and
  acknowledgement from the UE is not requested }
  then { UE updates NITZ information }
}
```

(3)

```
with { UE in 5GMM-REGISTERED state }
ensure that {
  when { UE receives CONFIGURATION UPDATE COMMAND message indicating "registration requested" and
  contains no other parameters }
  then { UE deletes any stored allowed NSSAI for this PLMN and then release the existing N1 NAS
  signalling connection, starts a mobility registration procedure }
}
```

(4)

```
with { UE in 5GMM-REGISTERED state }
ensure that {
  when { UE receives a new allowed NSSAI in the CONFIGURATION UPDATE COMMAND message and
  registration is not requested }
  then { UE replaces any stored allowed NSSAI for this PLMN with new allowed NSSAI }
}
```

9.2.4.1.2 Conformance requirements

References: The conformance requirements covered in the present TC are specified in: TS 24.501, clause 4.6.2.2, 5.4.4.1, 5.4.4.2 and 5.4.4.3. Unless otherwise stated these are Rel-15 requirements.

[TS 24.501 clause 4.6.2.2]

If available, the configured NSSAI(s) shall be stored in a non-volatile memory in the ME as specified in annex C.

...

If the UE receives the CONFIGURATION UPDATE COMMAND message indicating "registration requested" and contains no other parameters (see subclauses 5.4.4.2 and 5.4.4.3), the UE shall delete any stored allowed NSSAI for this PLMN, and delete any stored mapping of each S-NSSAI of the allowed NSSAI to the S-NSSAI(s) of the HPLMN, if available;

...

- d) When the UE receives the Network slicing indication IE with the Network slicing subscription change indication set to "Network slicing subscription changed" in the REGISTRATION ACCEPT message or in the CONFIGURATION UPDATE COMMAND message, the UE shall delete the network slicing information for each of the PLMNs that the UE has slicing information stored for (excluding the current PLMN). The UE shall not delete the default configured NSSAI. Additionally, the UE shall update the network slicing information for the current PLMN (if received) as specified above in bullets a), b) and c):

[TS 24.501 clause 5.4.4.1]

The purpose of this procedure is to:

- a) allow the AMF to update the UE configuration for access and mobility management-related parameters decided and provided by the AMF by providing new parameter information within the command; or
- b) request the UE to perform a registration procedure for mobility and periodic registration update towards the network to update access and mobility management-related parameters decided and provided by the AMF (see subclause 5.5.1.3).

This procedure is initiated by the network and can only be used when the UE has an established 5GMM context, and the UE is in 5GMM-CONNECTED mode. When the UE is in 5GMM-IDLE mode, the AMF may use the paging or

notification procedure to initiate the generic UE configuration update procedure. The AMF can request a confirmation response in order to ensure that the parameter has been updated by the UE.

This procedure shall be initiated by the network to assign a new 5G-GUTI to the UE after a successful service request procedure invoked as a response to a paging request from the network and before the release of the N1 NAS signalling connection. If the service request procedure was triggered due to 5GSM downlink signalling pending, the procedure for assigning a new 5G-GUTI can be initiated by the network after the transport of the 5GSM downlink signalling.

The following parameters are supported by the generic UE configuration update procedure without the need to request the UE to perform the registration procedure for mobility and periodic registration update:

- a) 5G-GUTI;
- b) TAI list;
- c) Service area list;
- d) Network identity and time zone information (Full name for network, short name for network, local time zone, universal time and local time zone, network daylight saving time);
- e) LADN information;
- f) Rejected NSSAI;r
- g) Network slicing indication;
- h) Operator-defined access category definitions; and
- i) SMS indication.

The following parameters can be sent to the UE with or without a request to perform the registration procedure for mobility and periodic registration update:

- a) Allowed NSSAI; or
- b) Configured NSSAI.

The following parameter is sent to the UE with a request to perform the registration procedure for mobility and periodic registration update:

- a) MICO indication.

The following parameters are sent over 3GPP access only:

- a) LADN information;
- b) MICO indication;
- c) TAI list; and
- d) Service area list.

The following parameters are managed and sent per access type i.e., independently over 3GPP access or non 3GPP access:

- a) Allowed NSSAI; and
- b) Rejected NSSAI (when the NSSAI is rejected for the current registration area).

The following parameters are managed commonly and sent over 3GPP access or non 3GPP access:

- a) 5G-GUTI;
- b) Network identity and time zone information;
- c) Rejected NSSAI (when the NSSAI is rejected for the current PLMN);
- d) Configured NSSAI; and

e) SMS indication.

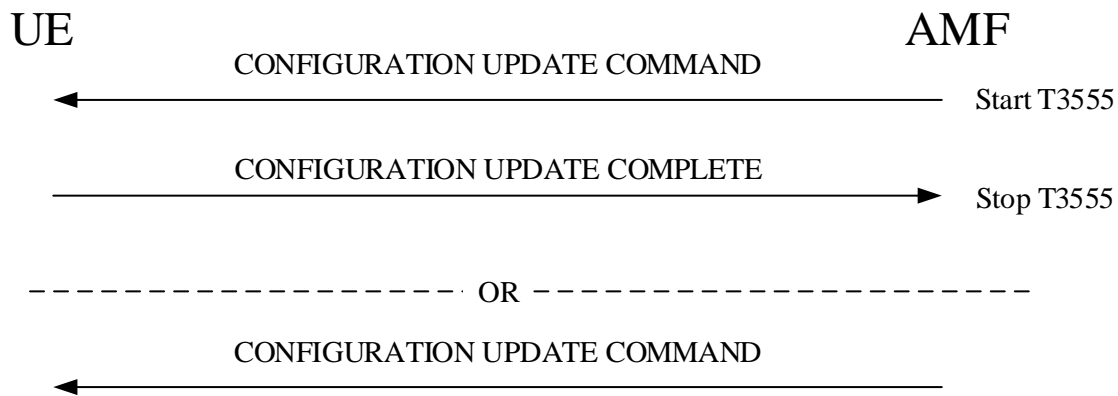

Figure 5.4.4.1.1: Generic UE configuration update procedure

[TS 24.501 clause 5.4.4.2]

The AMF shall initiate the generic UE configuration update procedure by sending the CONFIGURATION UPDATE COMMAND message to the UE.

The AMF shall in the CONFIGURATION UPDATE COMMAND message either:

- a) include one or more of the following parameters: 5G-GUTI, TAI list, allowed NSSAI that may include the mapped S-NSSAI(s), LADN information, service area list, MICO indication NITZ information, configured NSSAI that may include the mapped S-NSSAI(s), rejected NSSAI, network slicing indication, operator-defined access category definitions or SMS indication;
- b) include the Configuration update indication IE with the Registration requested bit set to "registration requested";
or
- c) include a combination of both a) and b).

If an acknowledgement from the UE is requested, the AMF shall indicate "acknowledgement requested" in the Acknowledgement bit of the Configuration update indication IE in the CONFIGURATION UPDATE COMMAND message and shall start timer T3555. Acknowledgement shall be requested for all parameters except when only NITZ is included.

To initiate parameter re-negotiation between the UE and network, the AMF shall indicate "registration requested" in the Registration requested bit of the Configuration update indication IE in the CONFIGURATION UPDATE COMMAND message.

If a new allowed NSSAI information or AMF re-configuration of supported S-NSSAIs requires an AMF relocation, the AMF shall indicate "registration requested" in the Registration requested bit of the Configuration update indication IE and include the Allowed NSSAI IE in the CONFIGURATION UPDATE COMMAND message.

If the AMF includes a new configured NSSAI in the CONFIGURATION UPDATE COMMAND message and the new configured NSSAI requires an AMF relocation as specified in 3GPP TS 23.501 [8], the AMF shall indicate "registration requested" in the Registration requested bit of the Configuration update indication IE in the message.

If the AMF indicates "registration requested" in the Registration requested bit of the Configuration update indication IE, acknowledgement shall be requested.

If changes to the allowed NSSAI require the UE to initiate a registration procedure, but the AMF is unable to determine an allowed NSSAI for the UE as specified in 3GPP TS 23.501 [8], the CONFIGURATION UPDATE COMMAND message shall indicate "registration requested" in the Registration requested bit of the Configuration update indication IE, and shall not contain any other parameters.

If the AMF needs to update the LADN information, the AMF shall include the LADN information in the LADN information IE of the CONFIGURATION UPDATE COMMAND message.

During an established 5GMM context, the network may send none, one, or more CONFIGURATION UPDATE COMMAND messages to the UE. If more than one CONFIGURATION UPDATE COMMAND message is sent, the messages need not have the same content.

[TS 24.501 clause 5.4.4.3]

Upon receiving the CONFIGURATION UPDATE COMMAND message, the UE shall stop timer T3346 if running and use the contents to update appropriate information stored within the UE.

If "acknowledgement requested" is indicated in the Acknowledgement bit of the Configuration update indication IE in the CONFIGURATION UPDATE COMMAND message, the UE shall send a CONFIGURATION UPDATE COMPLETE message.

If the UE receives a new 5G-GUTI in the CONFIGURATION UPDATE COMMAND message, the UE shall consider the new 5G-GUTI as valid, the old 5G-GUTI as invalid, stop timer T3519 if running, and delete any stored SUCI; otherwise, the UE shall consider the old 5G-GUTI as valid. The UE shall provide the 5G-GUTI to the lower layer of 3GPP access if the CONFIGURATION UPDATE COMMAND message is sent over the non-3GPP access, and the UE is in 5GMM-REGISTERED in both 3GPP access and non-3GPP access in the same PLMN.

If the UE receives a new TAI list in the CONFIGURATION UPDATE COMMAND message, the UE shall consider the new TAI list as valid and the old TAI list as invalid; otherwise, the UE shall consider the old TAI list as valid.

If the UE receives a new service area list in the CONFIGURATION UPDATE COMMAND message, the UE shall consider the new service area list as valid and the old service area list as invalid; otherwise, the UE shall consider the old service area list, if any, as valid.

If the UE receives new NITZ information in the CONFIGURATION UPDATE COMMAND message, the UE considers the new NITZ information as valid and the old NITZ information as invalid; otherwise, the UE shall consider the old NITZ information as valid.

If the UE receives a LADN information IE in the CONFIGURATION UPDATE COMMAND message, the UE shall consider the old LADN information as invalid and the new LADN information as valid, if any; otherwise, the UE shall consider the old LADN information as valid.

If the UE receives a new allowed NSSAI for the associated access type in the CONFIGURATION UPDATE COMMAND message, the UE shall consider the new allowed NSSAI as valid for the associated access type, store the allowed NSSAI for the associated access type as specified in subclause 4.6.2.2 and consider the old allowed NSSAI for the associated access type as invalid; otherwise, the UE shall consider the old Allowed NSSAI as valid for the associated access type.

If the UE receives a new configured NSSAI in the CONFIGURATION UPDATE COMMAND message, the UE shall consider the new configured NSSAI for the registered PLMN as valid and the old configured NSSAI for the registered PLMN as invalid; otherwise, the UE shall consider the old configured NSSAI for the registered PLMN as valid. The UE shall store the new configured NSSAI as specified in subclause 4.6.2.2.

If the UE receives the Network slicing indication IE in the CONFIGURATION UPDATE COMMAND message with the Network slicing subscription change indication set to "Network slicing subscription changed", the UE shall delete the network slicing information for each and every PLMN except for the current PLMN as specified in subclause 4.6.2.2.

If the UE receives Operator-defined access category definitions IE in the CONFIGURATION UPDATE COMMAND message and the Operator-defined access category definitions IE contains one or more operator-defined access category definitions, the UE shall delete any operator-defined access category definitions stored for the RPLMN and shall store the received operator-defined access category definitions for the RPLMN. If the UE receives the Operator-defined access category definitions IE in the CONFIGURATION UPDATE COMMAND message and the Operator-defined access category definitions IE contains no operator-defined access category definitions, the UE shall delete any operator-defined access category definitions stored for the RPLMN. If the CONFIGURATION UPDATE COMMAND message does not contain the Operator-defined access category definitions IE, the UE shall not delete the operator-defined access category definitions stored for the RPLMN.

If the UE receives the SMS indication IE in the CONFIGURATION UPDATE COMMAND message with the SMS availability indication set to:

- a) "SMS over NAS not available", the UE shall consider that SMS over NAS transport is not allowed by the network; and

- b) "SMS over NAS available", the UE may request the use of SMS over NAS transport by performing a registration procedure for mobility and periodic registration update as specified in subclause 5.5.1.3, after the completion of the generic UE configuration update procedure.

If the CONFIGURATION UPDATE COMMAND message indicates "registration requested" in the Registration requested bit of the Configuration update indication IE and:

- a) contains no other parameters or contains at least one of the following parameters: a new allowed NSSAI, a new configured NSSAI or the Network slicing subscription change indication, and:
 - 1) an emergency PDU session exists, the UE shall, after the completion of the generic UE configuration update procedure and the release of the emergency PDU session, release the existing N1 NAS signalling connection, and start a registration procedure for mobility and periodic registration update as specified in subclause 5.5.1.3; or
 - 2) no emergency PDU Session exists, the UE shall, after the completion of the generic UE configuration update procedure and the release of the existing N1 NAS signalling connection, start a registration procedure for mobility and periodic registration update as specified in subclause 5.5.1.3; or
- b) an MICO indication is included without a new allowed NSSAI or a new configured NSSAI, the UE shall, after the completion of the generic UE configuration update procedure, start a registration procedure for mobility and registration update as specified in subclause 5.5.1.3 to re-negotiate MICO mode with the network.

The UE receiving the rejected NSSAI in the CONFIGURATION UPDATE COMMAND message takes the following actions based on the rejection cause in the rejected NSSAI:

"S-NSSAI not available in the current PLMN"

The UE shall add the rejected S-NSSAI(s) in the rejected NSSAI for the current PLMN as specified in subclause 4.6.2.2 and not attempt to use this S-NSSAI in the current PLMN until switching off the UE or the UICC containing the USIM is removed.

"S-NSSAI not available in the current registration area"

The UE shall add the rejected S-NSSAI(s) in the rejected NSSAI for the current registration area as specified in subclause 4.6.2.2 and not attempt to use this S-NSSAI in the current registration area until switching off the UE, the UE moving out of the current registration area or the UICC containing the USIM is removed.

9.2.4.1.3 Test description

9.2.4.1.3.1 Pre-test conditions

System Simulator:

- WLAN Cell 27

UE:

- None.

Preamble:

- The UE is in state 3W-A on WLAN Cell 27 according to TS 38.508-1 [4].

9.2.4.1.3.2 Test procedure sequence

Table 9.2.4.1.3.2-1: Main behaviour

St	Procedure	Message Sequence		TP	Verdict
		U - S	Message		
1	The SS transmits a CONFIGURATION UPDATE COMMAND message including a new 5G-GUTI.	<--	CONFIGURATION UPDATE COMMAND	-	-

2	Check: Does UE transmit a CONFIGURATION UPDATE COMPLETE message?	-->	CONFIGURATION UPDATE COMPLETE	1	P
3	The SS transmits an IDENTITY REQUEST requesting 5G-GUTI in the IE identity type	<--	IDENTITY REQUEST	-	-
4	Check: Does the UE respond with an IDENTITY RESPONSE message with including the new 5G-GUTI assigned in step 1 in the 5GS mobile identity IE?	-->	IDENTITY RESPONSE	1	P
5	The SS transmits a CONFIGURATION UPDATE COMMAND message including NITZ information.	<--	CONFIGURATION UPDATE COMMAND	-	-
6	Check: Does the UE transmit a CONFIGURATION UPDATE COMPLETE message within the expiry of T3555?	-->	CONFIGURATION UPDATE COMPLETE	2	F
7	Check: Using MMI/AT command verify the NITZ update on the UE.	-	-	2	P
8	Switch off procedure in Ipsec_SA_Established specified in TS 38.508-1 [4] subclause 4.9.6.5 is performed.	-	-	-	-
9	The UE is switched On.	-	-	-	-
10-16	Steps 1 to 7 of the generic procedure for WLAN Ipsec_SA_Released specified in TS 38.508-1 [4] subclause 4.5.2 are performed.	-	-	-	-
17	The SS transmits a REGISTRATION ACCEPT message including Configured NSSAI.	<--	REGISTRATION ACCEPT	-	-
17A - 17B	Steps 9 to 10 of the generic procedure for WLAN Ipsec_SA_Released specified in TS 38.508-1 [4] subclause 4.5.2 are performed.	-	-	-	-
18	The SS transmits a CONFIGURATION UPDATE COMMAND message including registration requested IE.	<--	CONFIGURATION UPDATE COMMAND	-	-
19	The UE transmits a CONFIGURATION UPDATE COMPLETE message.	-->	CONFIGURATION UPDATE COMPLETE	-	-
19A	The generic procedure for SS-requested IPsec Secure tunnel disconnection, specified in subclause 4.5A.3 of TS 38.508-1 [4], takes place performing disconnection of security association.	-	-	-	-
20	Check: Does UE transmit a REGISTRATION REQUEST message with registration type value set to "Mobility" and including the Requested NSSAI?	-->	REGISTRATION REQUEST	3	P
21-25	Void	-	-	-	-
26	The SS transmits a REGISTRATION ACCEPT message including Allowed NSSAI.	<--	REGISTRATION ACCEPT	-	-
27	The UE transmits a REGISTRATION COMPLETE message.	-	REGISTRATION COMPLETE	-	-
27A	The generic procedure for SS-requested IPsec Secure tunnel disconnection, specified in subclause 4.5A.3 of TS 38.508-1 [4], takes place performing disconnection of security association.	-	-	-	-
28	Check: Using MMI/AT command (+C5GNSSAIRDP) verify the update of allowed NSSAI.	-	-	3	P
28A - 28B	Steps 1 to 2 of the generic procedure for WLAN IPsec_SA_Established specified in TS 38.508-1 [4] subclause 4.5.4.2-4 are performed.	-	-	-	-
29	The SS transmits a CONFIGURATION UPDATE COMMAND message including a	<--	CONFIGURATION UPDATE COMMAND	-	-

	new allowed NSSAI list.				
30	The UE transmits a CONFIGURATION UPDATE COMPLETE message.	-->	CONFIGURATION UPDATE COMPLETE	-	-
31	Check: Using MMI/AT command (+C5GNSSAIRDP) verify the update of allowed NSSAI.	-	-	4	P
32	The SS transmits NSSAI DELETE REQUEST message to delete the Default Configured NSSAI list.	<--	NSSAI DELETE REQUEST	-	-
33	UE transmits NSSAI DELETE RESPONSE message.	-->	NSSAI DELETE RESPONSE	-	-
34	SS releases the RRC connection.	-	-	-	-

9.2.4.1.3.3 Specific message contents

Table 9.2.4.1.3.3-1: CONFIGURATION UPDATE COMMAND (step 1, Table 9.2.4.1.3.2-1)

Derivation path: TS 38.508-1 [4], Table 4.7.1-19			
Information Element	Value/remark	Comment	Condition
Configuration update indication	0001	Acknowledgement (ACK) requested	
5G-GUTI	Other than the default value		

Table 9.2.4.1.3.3-2: IDENTITY REQUEST (step 3, Table 9.2.4.1.3.2-1)

Derivation Path: TS 38.508-1 [4], Table 4.7.1-21			
Information Element	Value/remark	Comment	Condition
Identity type	'010'B	5G-GUTI	

Table 9.2.4.1.3.3-3: IDENTITY RESPONSE (step 4, Table 9.2.4.1.3.2-1)

Derivation Path: TS 38.508-1 [4], Table 4.7.1-22			
Information Element	Value/remark	Comment	Condition
mobile identity IE	5G-GUTI assigned in step 1	5G-GUTI	

Table 9.2.4.1.3.3-4: CONFIGURATION UPDATE COMMAND (step 5, Table 9.2.4.1.3.2-1)

Derivation path: TS 38.508-1 [4], Table 4.7.1-19			
Information Element	Value/remark	Comment	Condition
Full name for network	Present		
Universal time and local time zone	"xx211331832540" O	"<Current Year> 31 December 13:38 52 GMT+1", Note 1, Note 2, Note 3	
Note 1: Hard coded values have been chosen to allow for consistent/comparable SS behaviour.			
Note 2: Daylight Saving Time is included in the Local Time Zone.			
Note 3: Current Year is derived by the SS.			

Table 9.2.4.1.3.3-5: REGISTRATION ACCEPT (step 17, Table 9.2.4.1.3.2-1)

Derivation path: TS 38.508-1 [4], Table 4.7.1-7			
Information Element	Value/remark	Comment	Condition
5GS registration result value	'010'B	Non-3GPP access	
Configured NSSAI			
S-NSSAI IEI		S-NSSAI value 2	
Length of S-NSSAI contents	'00000001'B	SST	
SST	'00000001'B	2	

SD	Not Present		
Mapped configured SST	Not Present		
Mapped configured SD	Not Present		
S-NSSAI IEI		S-NSSAI value 3	
Length of S-NSSAI contents	'0000001'B	SST	
SST	'00000010'B	3	
SD	Not Present		
Mapped configured SST	Not Present		
Mapped configured SD	Not Present		

Table 9.2.4.1.3.3-6: CONFIGURATION UPDATE COMMAND (step 18, Table 9.2.4.1.3.2-1)

Derivation path: TS 38.508-1 [4], Table 4.7.1-19			
Information Element	Value/remark	Comment	Condition
Configuration update indication	0010	Registration requested	

Table 9.2.4.1.3.3-7: REGISTRATION REQUEST (step 20, Table 9.2.4.1.3.2-1)

Derivation path: TS 38.508-1 [4], Table 4.7.1-6			
Information Element	Value/remark	Comment	Condition
5GS registration type value	'010'B		MOBILITY
Requested NSSAI			
S-NSSAI IEI		S-NSSAI value 2	
Length of S-NSSAI contents	'0000001'B	SST	
SST	'00000010'B	2	
SD	Not Present		
Mapped configured SST	Not Present		
Mapped configured SD	Not Present		
S-NSSAI IEI		S-NSSAI value 3	
Length of S-NSSAI contents	'0000001'B	SST	
SST	'00000011'B	3	
SD	Not Present		
Mapped configured SST	Not Present		
Mapped configured SD	Not Present		

Table 9.2.4.1.3.3-8: REGISTRATION ACCEPT (step 26, Table 9.2.4.1.3.2-1)

Derivation path: TS 38.508-1 [4], Table 4.7.1-7			
Information Element	Value/remark	Comment	Condition
5GS registration result value	'010'B	Non-3GPP access	
Allowed NSSAI			
S-NSSAI IEI		S-NSSAI value 1	
Length of S-NSSAI contents	'0000001'B	SST	
SST	'0000001'B	1	
SD	Not Present		
Mapped configured SST	Not Present		
Mapped configured SD	Not Present		
S-NSSAI IEI		S-NSSAI value 2	
Length of S-NSSAI contents	'0000001'B	SST	
SST	'00000010'B	2	
SD	Not Present		
Mapped configured SST	Not Present		
Mapped configured SD	Not Present		
S-NSSAI IEI		S-NSSAI value 3	
Length of S-NSSAI contents	'0000001'B	SST	
SST	'00000011'B	3	
SD	Not Present		
Mapped configured SST	Not Present		
Mapped configured SD	Not Present		

Table 9.2.4.1.3.3-9: CONFIGURATION UPDATE COMMAND (step 30, Table 9.2.4.1.3.2-1)

Derivation path: TS 38.508-1 [4], Table 4.7.1-19			
Information Element	Value/remark	Comment	Condition
Configuration update indication	0001	Acknowledgement (ACK) requested	
Allowed NSSAI			
S-NSSAI IEI		S-NSSAI value 1	
Length of S-NSSAI contents	'00000001'B	SST	
SST	'00000001'B	1	
SD	Not Present		
Mapped configured SST	Not Present		
Mapped configured SD	Not Present		
S-NSSAI IEI		S-NSSAI value 2	
Length of S-NSSAI contents	'00000001'B	SST	
SST	'00000010'B	2	
SD	Not Present		
Mapped configured SST	Not Present		
Mapped configured SD	Not Present		

Table 9.2.4.1.3.3-10: NSSAI DELETE REQUEST (step 32, Table 9.2.4.1.3.2-1)

Derivation path: TS 38.509 Table 6.7.1			
Information Element	Value/remark	Comment	Condition
Protocol discriminator	1111		
Skip indicator	0000		
Message type	'10100110'B		
Delete NSSAI type	'00000001'B	Delete Configured NSSAI	
Configured NSSAI	00000000		

Table 9.2.4.1.3.3-11: NSSAI DELETE RESPONSE (step 33, Table 9.2.4.1.3.2-1)

Derivation path: TS 38.509 Table 6.7.2			
Information Element	Value/remark	Comment	Condition
Protocol discriminator	1111		
Skip indicator	0000		
Message type	'10100111'B		

9.2.5 Registration

9.2.5.1 Initial Registration

9.2.5.1.1 Initial registration / Success / 5G-GUTI reallocation, Last visited TAI

9.2.5.1.1.1 Test Purpose (TP)

(1)

```
with { the UE has no valid 5G-GUTI but available SUCI and switched off }
ensure that {
  when { the UE is switched on }
  then { the UE sends a REGISTRATION REQUEST message including the SUCI in the 5GS mobile identity IE }
}
```

(2)

```
with { the UE is 5GMM-REGISTERED state with assigned 5G-GUTI and last visited registered TAI and switched off }
ensure that {
```

```

when { the UE is switched on }
then { the UE sends a REGISTRATION REQUEST message including the 5G-GUTI assigned previously in
the 5GS mobile identity IE and the last visited registered TAI }
}

```

9.2.5.1.1.2 Conformance requirements

References: The conformance requirements covered in the current TC are specified in: TS 24.501 clauses 5.5.1.2.2 and 5.5.1.2.4. Unless otherwise stated these are Rel-15 requirements.

[TS 24.501, clause 5.5.1.2.2]

The UE initiates the registration procedure for initial registration by sending a REGISTRATION REQUEST message to the AMF, starting timer T3510. If timer T3502 is currently running, the UE shall stop timer T3502. If timer T3511 is currently running, the UE shall stop timer T3511.

During initial registration the UE handles the 5GS mobile identity IE in the following order:

...

- b) if the UE holds a valid 5G-GUTI that was previously assigned, over 3GPP access or non-3GPP access, by the same PLMN with which the UE is performing the registration, the UE shall indicate the 5G-GUTI in the 5GS mobile identity IE;
- c) if the UE holds a valid 5G-GUTI that was previously assigned, over 3GPP access or non-3GPP access, by an equivalent PLMN, the UE shall indicate the 5G-GUTI in the 5GS mobile identity IE;
- d) if the UE holds a valid 5G-GUTI that was previously assigned, over 3GPP access or non-3GPP, by any other PLMN, the UE shall indicate the 5G-GUTI in the 5GS mobile identity IE;
- e) if a SUCI is available the UE shall include the SUCI in the 5GS mobile identity IE; and

If the SUCI is included in the 5GS mobile identity IE and the timer T3519 is not running, the UE shall start timer T3519 and store the value of the SUCI sent in the REGISTRATION REQUEST message. The UE shall include the stored SUCI in the REGISTRATION REQUEST message while timer T3519 is running.

...

If the last visited registered TAI is available, the UE shall include the last visited registered TAI in the REGISTRATION REQUEST message.

[TS 24.501, clause 5.5.1.2.4]

The 5G-GUTI reallocation shall be part of the initial registration procedure. During the initial registration procedure, if the AMF has not allocated a new 5G-GUTI by the generic UE configuration update procedure, the AMF shall include in the REGISTRATION ACCEPT message the new assigned 5G-GUTI together with the assigned TAI list.

9.2.5.1.1.3 Test description

9.2.5.1.1.3.1 Pre-test conditions

System Simulator:

- WLAN Cell 27

UE:

- None.

Preamble:

- The UE is in state Switched OFF (state 0W-B) according to TS 38.508-1 [4].

9.2.5.1.1.3.2 Test procedure sequence

Table 9.2.5.1.1.3.2-1: Main behaviour

St	Procedure	Message Sequence		TP	Verdict
		U – S	Message		
1	The UE is switched on.	-	-	-	-
2-8	UE establishes an IPSEC SA and trigger 5GMM Registration procedure by executing steps 1 to 7 of Table 4.5.2.2-3 in TS38.508-1 [4].	-	-	-	-
9	SS transmits an REGISTRATION REJECT message with the 5GMM cause IE setting as "Illegal ME". NOTE1: 5G-GUTI-1 should be deleted, then UE has no valid 5G-GUTI but available SUCI now.	<--	REGISTRATION REJECT	-	-
10	The generic procedure for SS-requested IPsec Secure tunnel disconnection, specified in subclause 4.5A.3 of TS 38.508-1 [4], takes place performing disconnection of security association.	-	-	-	-
11	If possible (see ICS) switch off is performed or the USIM is removed. Otherwise the power is removed.	-	-	-	-
12	The UE is brought back to operation or the USIM is inserted.	-	-	-	-
13-23	Steps 1-11 of Table 4.5.2.2-2 of the generic procedure in TS 38.508-1 [4] are performed	-	-	1	P
24	If possible (see ICS) switch off is performed or the USIM is removed. Otherwise the power is removed.	-	-	-	-
25	The UE is brought back to operation or the USIM is inserted.	-	-	-	-
26-35	Steps 1-11 of Table 4.5.2.2-2 of the generic procedure in TS 38.508-1 [4] are performed	-	-	2	P

9.2.5.1.1.3.3 Specific message contents

Table 9.2.5.1.1.3.3-1: Message REGISTRATION REJECT (step 9, Table 9.2.5.1.1.3.2-1)

Derivation path: TS 38.508-1 [4], table 4.7.1-9			
Information Element	Value/Remark	Comment	Condition
5GMM cause	'0000 0011'B	Illegal UE	

Table 9.2.5.1.1.3.3-2: Message REGISTRATION REQUEST (step 15, Table 9.2.5.1.1.3.2-1)

Derivation path: TS 38.508-1 [4], table 4.7.1-6			
Information Element	Value/Remark	Comment	Condition
5GS registration type	'0000 0001'B	Initial registration	
5GS mobile identity	SUCI	The SUCI of UE	

Table 9.2.5.1.1.3.3-3: Message REGISTRATION ACCEPT (step 21, Table 9.2.5.1.1.3.2-1)

Derivation path: TS 38.508-1 [4], table 4.7.1-7			
Information Element	Value/Remark	Comment	Condition
5G-GUTI	5G-GUTI-2		

Table 9.2.5.1.1.3.3-4: Message REGISTRATION REQUEST (step 34, Table 9.2.5.1.1.3.2-1)

Derivation path: TS 38.508-1 [4], table 4.7.1-6			
---	--	--	--

Information Element	Value/Remark	Comment	Condition
5GS registration type	'0000 0001'B	Initial registration	
5GS mobile identity	5G-GUTI-2		
Last visited registered TAI	TAI-1	N3GPP TAI	

9.2.5.1.2 Initial registration / 5GS services / NSSAI handling

9.2.5.1.2.1 Test Purpose (TP)

(1)

```
with { UE has sent a REGISTRATION REQUEST message including requested NSSAI}
ensure that {
  when { UE receives REGISTRATION ACCEPT message with allowed NSSAI }
  then { UE shall replace any stored allowed NSSAI for the current PLMN with new allowed NSSAI for
the current PLMN }
}
```

(2)

```
with { UE has sent a REGISTRATION REQUEST message including Requested NSSAI}
ensure that {
  when { UE receives REGISTRATION ACCEPT message with Rejected NSSAI with reject cause "S-NSSAI not
available in the current PLMN" }
  then { UE shall add the rejected S-NSSAI(s) in the rejected NSSAI for the current PLMN and not
attempt to use the Rejected NSSAI in the current PLMN until switching off the UE or the UICC
containing the USIM is removed }
}
```

(3)

```
with { UE receives REGISTRATION ACCEPT message with Rejected NSSAI with reject cause "S-NSSAI not
available in the current PLMN" }
ensure that {
  when { UE has been switched off, then switched on }
  then { UE shall delete the stored Rejected NSAAI and shall send the NSSAI in Requested NSSAI IE
of the REGISTRATION REQUEST message as per the configured and Allowed NSSAI for current PLMN }
}
```

(4)

```
with { UE has sent a REGISTRATION REQUEST message including Requested NSSAI}
ensure that {
  when { UE receives REGISTRATION ACCEPT message with Rejected NSSAI with reject cause "S-NSSAI not
available in the current registration area" }
  then { UE shall add the rejected S-NSSAI(s) in the rejected NSSAI for the current PLMN and
registration area combination and not attempt to use the Rejected NSSAI in the current registration
area until switching off the UE, the UE moving out of the current registration area or the UICC
containing the USIM is removed }
}
```

9.2.5.1.2.2 Conformance requirements

References: The conformance requirements covered in the present TC are specified in: TS 24.501, clause 5.5.1.2.2 and 5.5.1.2.4. Unless otherwise stated these are Rel-15 requirements.

[TS 24.501 clause 5.5.1.2.2]

5.5.1.2.1 General

This procedure can be used by a UE for initial registration for 5GS services.

...

The UE shall include the requested NSSAI containing the S-NSSAI(s) corresponding to the slice(s) to which the UE wants to register and shall include the mapping of the requested NSSAI which is the mapping of each S-NSSAI of the

requested NSSAI to the S-NSSAI(s) of the HPLMN, if available, in the REGISTRATION REQUEST message. If the UE has allowed NSSAI or configured NSSAI for the current PLMN, the requested NSSAI shall be either:

- a) the configured NSSAI for the current PLMN, or a subset thereof as described below, if the UE has no allowed NSSAI for the current PLMN;
- b) the allowed NSSAI for the current PLMN, or a subset thereof as described below, if the UE has an allowed NSSAI for the current PLMN; or
- c) the allowed NSSAI for the current PLMN, or a subset thereof as described below, plus one or more S-NSSAIs from the configured NSSAI for which no corresponding S-NSSAI is present in the allowed NSSAI and those are neither in the rejected NSSAI for the current PLMN nor in the rejected NSSAI for the current PLMN and registration area combination.

If the UE has neither allowed NSSAI for the current PLMN nor configured NSSAI for the current PLMN and has a default configured NSSAI, the UE shall:

- a) include the S-NSSAI(s) in the Requested NSSAI IE of the REGISTRATION REQUEST message using the default configured NSSAI; and
- b) include the Network slicing indication IE with the Default configured NSSAI indication bit set to "Requested NSSAI created from default configured NSSAI" in the REGISTRATION REQUEST message.

If the UE has no allowed NSSAI for the current PLMN, no configured NSSAI for the current PLMN, and no default configured NSSAI, the UE shall not include a requested NSSAI in the REGISTRATION message.

The subset of configured NSSAI provided in the requested NSSAI consists of one or more S-NSSAIs in the configured NSSAI applicable to the current PLMN, if the S-NSSAI is neither in the rejected NSSAI for the current PLMN nor in the rejected NSSAI for the current PLMN and registration area combination.

The subset of allowed NSSAI provided in the requested NSSAI consists of one or more S-NSSAIs in the allowed NSSAI for the current PLMN.

NOTE 3: How the UE selects the subset of configured NSSAI or allowed NSSAI to be provided in the requested NSSAI is implementation.

NOTE 4: The number of S-NSSAI(s) included in the requested NSSAI cannot exceed eight.

[TS 24.501 clause 5.5.1.2.4]

The AMF shall include the allowed NSSAI for the current PLMN and shall include the mapping of each S-NSSAI of the allowed NSSAI to the S-NSSAI(s) of the HPLMN contained in the requested NSSAI from the UE if available, in the REGISTRATION ACCEPT message if the UE included the requested NSSAI in the REGISTRATION REQUEST message and the AMF allows one or more S-NSSAIs in the requested NSSAI. The AMF may also include rejected NSSAI in the REGISTRATION ACCEPT message. Rejected NSSAI contains S-NSSAI(s) which was included in the requested NSSAI but rejected by the network associated with rejection cause(s).

The AMF may include a new configured NSSAI for the current PLMN in the REGISTRATION ACCEPT message if:

- a) the REGISTRATION REQUEST message did not include the requested NSSAI;
- b) the REGISTRATION REQUEST message included the requested NSSAI containing an S-NSSAI that is not valid in the serving PLMN; or
- c) the REGISTRATION REQUEST message included the Network slicing indication IE with the Default configured NSSAI indication bit set to "Requested NSSAI created from default configured NSSAI".

If a new configured NSSAI for the current PLMN is included in the REGISTRATION ACCEPT message, the AMF shall also include the mapping of the configured NSSAI for the current PLMN the S-NSSAI(s) of the HPLMN if available in the REGISTRATION ACCEPT message. In this case the AMF shall start timer T3550 and enter state 5GMM-COMMON-PROCEDURE-INITIATED as described in subclause 5.1.3.2.3.3.

The AMF shall include the Network slicing indication IE with the Network slicing subscription change indication set to "Network slicing subscription changed" in the REGISTRATION ACCEPT message if the UDM has indicated that the subscription data for network slicing has changed. In this case the AMF shall start timer T3550 and enter state 5GMM-COMMON-PROCEDURE-INITIATED as described in subclause 5.1.3.2.3.3.

The UE receiving the rejected NSSAI in the REGISTRATION ACCEPT message takes the following actions based on the rejection cause in the rejected NSSAI:

"S-NSSAI not available in the current PLMN"

The UE shall add the rejected S-NSSAI(s) in the rejected NSSAI for the current PLMN as specified in subclause 4.6.2.2 and not attempt to use this S-NSSAI in the current PLMN until switching off the UE or the UICC containing the USIM is removed.

"S-NSSAI not available in the current registration area"

The UE shall add the rejected S-NSSAI(s) in the rejected NSSAI for the current PLMN and registration area combination as specified in subclause 4.6.2.2 and not attempt to use this S-NSSAI in the current registration area until switching off the UE, the UE moving out of the current registration area or the UICC containing the USIM is removed.

If the UE did not include the requested NSSAI in the REGISTRATION REQUEST message or none of the requested NSSAI are present in the subscribed S-NSSAIs, and one or more subscribed S-NSSAIs (containing one or more S-NSSAIs each of which may be associated with a new S-NSSAI) marked as default are available, the AMF shall put the subscribed S-NSSAIs marked as default in the allowed NSSAI of the REGISTRATION ACCEPT message. The AMF shall determine a registration area such that all S-NSSAIs of the allowed NSSAI are available in the registration area.

9.2.5.1.2.3 Test description

9.2.5.1.2.3.1 Pre-test conditions

System Simulator:

- WLAN Cell 27

UE:

- UE is previously registered on WLAN Cell 27 using default message contents according to TS 38.508-1 [4];
- Empty URSP Configuration.

Preamble:

- The UE is in state Switched OFF (state 0W-B) according to TS 38.508-1 [4].

9.2.5.1.2.3.2 Test procedure sequence

Table 9.2.5.1.2.3.2-1: Main behaviour

St	Procedure	Message Sequence		TP	Verdict
		U - S	Message		
1	The UE is switched on.	-	-	-	-
-	Exception: The UE establishes an IPsec tunnel in parallel to 5GC registration steps 2 to 6 as per the IKEv2 protocol as defined in 3GPP TS 23.502 [33] clause 4.12.2.2 figure 4.12.2.2-1.	-	-	-	-
2	Check: Does UE transmit a REGISTRATION REQUEST message?	-->	REGISTRATION REQUEST	-	-
3-6	Steps 4 to 7 of the generic procedure for WLAN Ipsec_SA_Released specified in TS 38.508-1 subclause 4.5.2 are performed.	-	-	-	-
7	The SS transmits a REGISTRATION ACCEPT message including Allowed NSSAI and Configured NSSAI.	<--	REGISTRATION ACCEPT	-	-
8	Step 10 of the generic procedure for WLAN Ipsec_SA_Released specified in TS 38.508-1 subclause 4.5.2 are performed.	-	-	-	-

9	Switch off procedure in WLAN Ipsec_SA_Established specified in TS 38.508-1 subclause 4.9.6.5 is performed.	-	-	-	-
10	The UE is brought back to operation or the USIM is inserted.	-	-	-	-
-	Exception: The UE establishes an IPsec tunnel in parallel to 5GC registration steps 11 to 15 as per the IKEv2 protocol as defined in 3GPP TS 23.502 [33] clause 4.12.2.2 figure 4.12.2.2-1.	-	-	-	-
11	Check: Does UE transmit a REGISTRATION REQUEST message including Requested NSSAI?	-->	REGISTRATION REQUEST	1	P
12-15	Steps 4 to 7 of the generic procedure for WLAN Ipsec_SA_Released specified in TS 38.508-1 subclause 4.5.2 are performed.	-	-	-	-
16	The SS transmits a REGISTRATION ACCEPT message including Allowed NSSAI and Rejected NSSAI.	<--	REGISTRATION ACCEPT	-	-
17	Step 10 of the generic procedure for WLAN Ipsec_SA_Released specified in TS 38.508-1 subclause 4.5.2 are performed.	-	-	-	-
18	Switch off procedure in WLAN Ipsec_SA_Established specified in TS 38.508-1 subclause 4.9.6.5 is performed.	-	-	-	-
-	Exception: The UE establishes an IPsec tunnel in parallel to 5GC registration steps 19 to 23 as per the IKEv2 protocol as defined in 3GPP TS 23.502 [33] clause 4.12.2.2 figure 4.12.2.2-1.	-	-	-	-
19	Check: Does UE transmit a REGISTRATION REQUEST message including Requested NSSAI?	-->	REGISTRATION REQUEST	2	P
20-23	Steps 4 to 7 of the generic procedure for WLAN Ipsec_SA_Released specified in TS 38.508-1 subclause 4.5.2 are performed.	-	-	-	-
24	The SS transmits a REGISTRATION ACCEPT message including Allowed NSSAI.	<--	REGISTRATION ACCEPT	-	-
25	The UE transmits a REGISTRATION COMPLETE message.	-->	REGISTRATION COMPLETE	-	-
26	Step 10 of the generic procedure for WLAN Ipsec_SA_Released specified in TS 38.508-1 subclause 4.5.2 are performed.	-	-	-	-
27	Check: Is S-NSSAI=2 in the Rejected NSSAI list with cause "S-NSSAI not available in the current PLMN" associated with current PLMN using AT/MMI?	-	-	2	P
28	Switch off procedure in WLAN Ipsec_SA_Established specified in TS 38.508-1 subclause 4.9.6.5 is performed.	-	-	-	-
29	The UE is brought back to operation or the USIM is inserted	-	-	-	-
-	Exception: The UE establishes an IPsec tunnel in parallel to 5GC registration steps 30 to 34 as per the IKEv2 protocol as defined in 3GPP TS 23.502 [33] clause 4.12.2.2 figure 4.12.2.2-1.	-	-	-	-
30	Check: Does UE transmit a REGISTRATION REQUEST message including Requested NSSAI?	-->	REGISTRATION REQUEST	3	P
31-34	Steps 4 to 7 of the generic procedure for WLAN Ipsec_SA_Released specified in TS 38.508-1 subclause 4.5.2 are performed.	-	-	-	-
35	The SS transmits a REGISTRATION ACCEPT message including Allowed NSSAI and Rejected NSSAI.	<--	REGISTRATION ACCEPT	-	-
36	Step 10 of the generic procedure for WLAN	-	-	-	-

	Ipsec_SA_Released specified in TS 38.508-1 subclause 4.5.2 are performed.				
37	Check: Is S-NSSAI=2 removed from the Rejected NSSAI list associated with current PLMN?	-	-	3	P
37A	Check: Is S-NSSAI=1 in the Rejected NSSAI list with cause "S-NSSAI not available in the current registration area" associated with current PLMN and registration area combination using AT/MMI?	-	-	4	P
38	Switch off procedure in WLAN Ipsec_SA_Established specified in TS 38.508-1 subclause 4.9.6.5 is performed.	-	-	-	-
39	The UE is brought back to operation or the USIM is inserted	-	-	-	-
-	Exception: The UE establishes an IPsec tunnel in parallel to 5GC registration steps 40 to 44 as per the IKEv2 protocol as defined in 3GPP TS 23.502 [33] clause 4.12.2.2 figure 4.12.2.2-1.	-	-	-	-
40	Check: Does UE transmit a REGISTRATION REQUEST message including Requested NSSAI?	-->	REGISTRATION REQUEST	4	P
41-44	Steps 4 to 7 of the generic procedure for WLAN Ipsec_SA_Released specified in TS 38.508-1 subclause 4.5.2 are performed.	-	-	-	-
45	The SS transmits a REGISTRATION ACCEPT message including Allowed NSSAI.	<--	REGISTRATION ACCEPT	-	-
46	The UE transmits a REGISTRATION COMPLETE message.	-->	REGISTRATION COMPLETE	-	-
47	Check: Is S-NSSAI=1 in the Rejected NSSAI list with cause "S-NSSAI not available in the current registration area" associated with current PLMN and registration area combination using AT/MMI?	-	-	4	P

9.2.5.1.2.3.3 Specific message contents

Table 9.2.5.1.2.3.3-1: REGISTRATION REQUEST (step 2, Table 9.2.5.1.2.3.2-1)

Derivation path: TS 38.508-1 Table 4.7.1-6			
Information Element	Value/remark	Comment	Condition
5GS registration type value	'001'B	Initial registration	
Requested NSSAI		Note	
S-NSSAI IEI		S-NSSAI value 1	Note
Length of S-NSSAI contents	'00000001'B	SST	
SST	'00000001'B	1	
SD	Not Present		
Mapped configured SST	Not Present		
Mapped configured SD	Not Present		
Note:	S-NSSAI =1 will be always included from the allowed NSSAI list associated with PLMN of WLAN Cell 27 by the UE but may include other S-NSSAI from Configured NSSAI list associated with PLMN of NCG WLAN Cell 27 if configured in the UE. See TS 24.501 sub-clause 5.5.1.2.1		

Table 9.2.5.1.2.3.3-2: REGISTRATION ACCEPT (step 7, Table 9.2.5.1.2.3.2-1)

Derivation path: TS 38.508-1 Table 4.7.1-7			
Information Element	Value/remark	Comment	Condition
5GS registration result value	'010'B	Non 3GPP access	
Allowed NSSAI			
S-NSSAI IEI		S-NSSAI value 1	
Length of S-NSSAI contents	'00000001'B	SST	
SST	'00000010'B	2	
SD	Not Present		

Mapped configured SST	Not Present		
Mapped configured SD	Not Present		
Configured NSSAI			
S-NSSAI IEI		S-NSSAI value 1	
Length of S-NSSAI contents	'00000001'B	SST	
SST	'00000001'B	1	
SD	Not Present		
Mapped configured SST	Not Present		
Mapped configured SD	Not Present		
S-NSSAI IEI		S-NSSAI value 2	
Length of S-NSSAI contents	'00000001'B	SST	
SST	'00000010'B	2	
SD	Not Present		
Mapped configured SST	Not Present		
Mapped configured SD	Not Present		

Table 9.2.5.1.2.3.3-3: PDU SESSION ESTABLISHMENT ACCEPT (step 10, Table 9.2.5.1.2.3.2-1)

Derivation path: TS 38.508-1 clause 4.7.2-2			
Information Element	Value/remark	Comment	Condition
S-NSSAI			
Length of S-NSSAI contents	'0000 0001'B	SST	
SST	'0000 0010'B	SST value 2	

Table 9.2.5.1.2.3.3-4: REGISTRATION REQUEST (step 11, Table 9.2.5.1.2.3.2-1)

Derivation path: TS 38.508-1 Table 4.7.1-6			
Information Element	Value/remark	Comment	Condition
5GS registration type value	'001'B	Initial registration	
Requested NSSAI		Note	
S-NSSAI IEI		S-NSSAI value 1	
Length of S-NSSAI contents	'00000001'B	SST	
SST	'00000010'B	2	
SD	Not Present		
Mapped configured SST	Not Present		
Mapped configured SD	Not Present		
S-NSSAI IEI		S-NSSAI value 2	Note
Length of S-NSSAI contents	'00000001'B	SST	
SST	'00000001'B	1	
SD	Not Present		
Mapped configured SST	Not Present		
Mapped configured SD	Not Present		
Note:	S-NSSAI =2 will be always included by the UE from the allowed NSSAI list associated with PLMN of NCG WLAN Cell 27 but may include S-NSSAI =1 from Configured NSSAI list associated with PLMN of NCG WLAN Cell 27. See TS 24.501 sub-clause 5.5.1.2.1		

Table 9.2.5.1.2.3.3-5: REGISTRATION ACCEPT (step 16, Table 9.2.5.1.2.3.2-1)

Derivation path: TS 38.508-1 Table 4.7.1-7			
Information Element	Value/remark	Comment	Condition
5GS registration result value	'010'B	Non 3GPP access	
Allowed NSSAI		Note	
S-NSSAI IEI		S-NSSAI value 1	Note
Length of S-NSSAI contents	'00000001'B	SST	
SST	'00000001'B	1	
SD	Not Present		
Mapped configured SST	Not Present		
Mapped configured SD	Not Present		
Rejected NSSAI			
Rejected S-NSSAI-1		Rejected S-NSSAI value 1	
Cause value	'0000'B	S-NSSAI not	

		available in the current PLMN	
SST	'00000010'B	2	
SD	Not Present		
Note:	If UE has requested only S-NSSAI =2 in step 22 and S-NSSAI =2 is added in the Rejected NSSAI list by the SS then AMF/SS can include default subscribed S-NSSAIs in the allowed NSSAI of REGISTRATION ACCEPT message, see TS 24.501 sub-clause 5.5.1.2.4.		

Table 9.2.5.1.2.3.3-6: REGISTRATION REQUEST (step 19, Table 9.2.5.1.2.3.2-1)

Derivation path: TS 38.508-1 Table 4.7.1-6			
Information Element	Value/remark	Comment	Condition
5GS registration type value	'001'B	Initial registration	
Requested NSSAI			
S-NSSAI IEI		S-NSSAI value 1	
Length of S-NSSAI contents	'00000001'B	SST	
SST	'00000001'B	1	
SD	Not Present		
Mapped configured SST	Not Present		
Mapped configured SD	Not Present		

Table 9.2.5.1.2.3.3-7: REGISTRATION ACCEPT (step 24, Table 9.2.5.1.2.3.2-1)

Derivation path: TS 38.508-1 Table 4.7.1-7			
Information Element	Value/remark	Comment	Condition
5GS registration result value	'010'B	Non 3GPP access	
Allowed NSSAI			
S-NSSAI IEI		S-NSSAI value 1	
Length of S-NSSAI contents	'00000001'B	SST	
SST	'00000001'B	1	
SD	Not Present		
Mapped configured SST	Not Present		
Mapped configured SD	Not Present		

Table 9.2.5.1.2.3.3-8: REGISTRATION REQUEST (step 30, Table 9.2.5.1.2.3.2-1)

Derivation path: TS 38.508-1 Table 4.7.1-6			
Information Element	Value/remark	Comment	Condition
5GS registration type value	'001'B	Initial registration	
Requested NSSAI		Note	
S-NSSAI IEI		S-NSSAI value 1	Note
Length of S-NSSAI contents	'00000001'B	SST	
SST	'00000001'B	1	
SD	Not Present		
Mapped configured SST	Not Present		
Mapped configured SD	Not Present		
S-NSSAI IEI		S-NSSAI value 1	
Length of S-NSSAI contents	'00000001'B	SST	
SST	'00000010'B	2	
SD	Not Present		
Mapped configured SST	Not Present		
Mapped configured SD	Not Present		
Note:	S-NSSAI =1 will be always included by the UE from the allowed NSSAI list associated with PLMN of NCG Cell C but may include S-NSSAI =2 from Configured NSSAI list associated with PLMN of NCG Cell C. See TS 24.501 sub-clause 5.5.1.2.1		

Table 9.2.5.1.2.3.3-9: REGISTRATION ACCEPT (step 35, Table 9.2.5.1.2.3.2-1)

Derivation path: TS 38.508-1 Table 4.7.1-7			
Information Element	Value/remark	Comment	Condition
5GS registration result value	'010'B	Non 3GPP access	

TAI list			
Type of list	'01'B	list of TACs belonging to one PLMN, with consecutive TAC values	
Number of elements	'00001'B	2 Elements	
TAC	PLMN =MCC/MNC stored in EF _{IMSI} TAC 1 = 2	TAI2, TAI 3	
Allowed NSSAI			
S-NSSAI IEI		S-NSSAI value 1	
Length of S-NSSAI contents	'00000001'B	SST	
SST	'00000010'B	2	
SD	Not Present		
Mapped configured SST	Not Present		
Mapped configured SD	Not Present		
Rejected NSSAI			
Rejected S-NSSAI-1		Rejected S-NSSAI value 1	
Cause value	'0001'B	S-NSSAI not available in the current registration area	
SST	'00000001'B	1	
SD	Not Present		
Note:	If UE has requested only S-NSSAI =1 in step 57 and S-NSSAI =1 is added in the Rejected NSSAI list by the SS then AMF/SS can include default subscribed S-NSSAIs in the allowed NSSAI of REGISTRATION ACCEPT message, see TS 24.501 sub-clause 5.5.1.2.4.		

Table 9.2.5.1.2.3.3-10: PDU SESSION ESTABLISHMENT ACCEPT (step 36, Table 9.2.5.1.2.3.2-1)

Derivation path: TS 38.508-1 clause 4.7.2-2			
Information Element	Value/remark	Comment	Condition
S-NSSAI			
Length of S-NSSAI contents	'0000 0001'B	SST	
SST	'0000 0010'B	SST value 2	

Table 9.2.5.1.2.3.3-11: REGISTRATION REQUEST (step 40, Table 9.2.5.1.2.3.2-1)

Derivation path: TS 38.508-1 Table 4.7.1-6			
Information Element	Value/remark	Comment	Condition
5GS registration type value	'001'B	initial registration	
Requested NSSAI		Note	
S-NSSAI IEI		S-NSSAI value 1	
Length of S-NSSAI contents	'00000001'B	SST	
SST	'00000001'B	2	
SD	Not Present		
Mapped configured SST	Not Present		
Mapped configured SD	Not Present		

Table 9.2.5.1.2.3.3-12: REGISTRATION ACCEPT (step 45, Table 9.2.5.1.2.3.2-1)

Derivation path: TS 38.508-1 Table 4.7.1-7			
Information Element	Value/remark	Comment	Condition
5GS registration result value	'010'B	Non 3GPP access	
Allowed NSSAI			
S-NSSAI IEI		S-NSSAI value 1	
Length of S-NSSAI contents	'00000010'B	SST	
SST	'00000001'B	2	
SD	Not Present		
Mapped configured SST	Not Present		
Mapped configured SD	Not Present		

9.2.5.1.3 Void

9.2.5.1.4 Initial registration / Rejected / Congestion / Abnormal cases / T3346

9.2.5.1.4.1 Test Purpose (TP)

(1)

```

with { The UE has sent initial REGISTRAION REQUEST message }
ensure that {
  when { UE receives a REGISTRATION REJECT with cause #22 (Congestion) with T3346 included and the
  UE is NOT configured for High Priority Access }
  then { UE does not start the Initial registration until T3346 expires }
}

```

(2)

```

with { The UE has received initial REGISTRATION REJECT with T3346 included }
ensure that {
  when { upon expiry of T3346 }
  then { UE starts the Initial registration procedure }
}

```

(3)

```

with { The UE has received initial REGISTRATION REJECT with T3346 included }
ensure that {
  when { the timer T3346 is running and the UE needs to perform initial registration for emergency
  services }
  then { UE starts the Initial registration procedure }
}

```

9.2.5.1.4.2 Conformance requirements

References: The conformance requirements covered in the present TC are specified in: TS 24.501, clauses 5.5.1.2.5 and 5.5.1.2.7 and TS 24.301, clause 5.5.1.2.5. Unless otherwise stated these are Rel-15 requirements.

[TS 24.501, clause 5.5.1.2.5]

If the initial registration request cannot be accepted by the network, the AMF shall send a REGISTRATION REJECT message to the UE including an appropriate 5GMM cause value.

If the initial registration request is rejected due to general NAS level mobility management congestion control, the network shall set the 5GMM cause value to #22 "congestion" and assign a back-off timer T3346.

The UE shall take the following actions depending on the 5GMM cause value received in the REGISTRATION REJECT message.

#3 (Illegal UE); or

#6 (Illegal ME).

...

#22 (Congestion).

If the T3346 value IE is present in the REGISTRATION REJECT message and the value indicates that this timer is neither zero nor deactivated, the UE shall proceed as described below; otherwise it shall be considered as an abnormal case and the behaviour of the UE for this case is specified in subclause 5.5.1.2.7.

The UE shall abort the initial registration procedure, set the 5GS update status to 5U2 NOT UPDATED and enter state 5GMM-DEREGISTERED.ATTEMPTING-REGISTRATION.

The UE shall stop timer T3346 if it is running.

If the REGISTRATION REJECT message is integrity protected, the UE shall start timer T3346 with the value provided in the T3346 value IE.

If the REGISTRATION REJECT message is not integrity protected, the UE shall start timer T3346 with a random value from the default range specified in 3GPP TS 24.008 [12].

The UE stays in the current serving cell and applies the normal cell reselection process. The initial registration procedure is started if still needed when timer T3346 expires or is stopped.

If the UE is operating in single-registration mode, the UE shall handle the EMM parameters EMM state, EPS update status, and attach attempt counter as specified in 3GPP TS 24.301 [15] for the case when the EPS attach request procedure is rejected with the EMM cause with the same value.

...

Other values are considered as abnormal cases. The behaviour of the UE in those cases is specified in subclause 5.5.1.2.7.

[TS 24.501, clause 5.5.1.2.7]

The following abnormal cases can be identified:

- a) Timer T3346 is running.

The UE shall not start the registration procedure for initial registration unless:

- 1) the UE is a UE configured for high priority access in selected PLMN;
- 2) the UE needs to perform the registration procedure for initial registration for emergency services; or
- 3) the UE receives a DEREGISTRATION REQUEST message with the "re-registration required" indication.

The UE stays in the current serving cell and applies the normal cell reselection process.

NOTE 1: It is considered an abnormal case if the UE needs to initiate a registration procedure for initial registration while timer T3346 is running independent on whether timer T3346 was started due to an abnormal case or a non-successful case.

[TS 24.301, clause 5.5.1.2.5]

...

#22 (Congestion);

If the T3346 value IE is present in the ATTACH REJECT message and the value indicates that this timer is neither zero nor deactivated, the UE shall proceed as described below; otherwise it shall be considered as an abnormal case and the behaviour of the UE for this case is specified in subclause 5.5.1.2.6.

The UE shall abort the attach procedure, reset the attach attempt counter, set the EPS update status to EU2 NOT UPDATED and enter state EMM-DEREGISTERED.ATTEMPTING-TO-ATTACH.

The UE shall stop timer T3346 if it is running.

If the ATTACH REJECT message is integrity protected, the UE shall start timer T3346 with the value provided in the T3346 value IE.

If the ATTACH REJECT message is not integrity protected, the UE shall start timer T3346 with a random value from the default range specified in 3GPP TS 24.008 [13].

The UE stays in the current serving cell and applies the normal cell reselection process. The attach procedure is started if still needed when timer T3346 expires or is stopped.

If A/Gb mode or Iu mode is supported by the UE, the UE shall in addition handle the GMM parameters GMM state, GPRS update status and GPRS attach attempt counter as specified in 3GPP TS 24.008 [13] for the case when the normal attach procedure is rejected with the GMM cause with the same value.

If the UE is operating in single-registration mode, the UE shall in addition handle the 5GMM parameters as specified in 3GPP TS 24.501 [54] for the case when the initial registration procedure is rejected with the 5GMM cause with the same value.

...

9.2.5.1.4.3 Test description

9.2.5.1.4.3.1 Pre-test conditions

System Simulator:

- WLAN Cell 27

UE:

None.

Preamble:

- The UE is in state Switched OFF (State 0W-A as per TS 38.508-1 [4] Table 4.4A.2-0).

9.2.5.1.4.3.2 Test procedure sequence

Table 9.2.5.1.4.3.2-1: Main behaviour

St	Procedure	Message Sequence		TP	Verdict
		U - S	Message		
1	UE is switched on.	-	-	-	-
2-8	Steps 1-7 of Table 4.5.2.2-3 of the generic procedure in TS 38.508-1 [4] are performed.	-	-	-	-
9	SS transmits a REGISTRATION REJECT message with cause #22 (Congestion) and T3346 set to 3 minutes. (Note 1)	<--	REGISTRATION REJECT	-	-
10	The generic procedure for SS-requested IPsec Secure tunnel disconnection, specified in subclause 4.5A.3 of TS 38.508-1 [4], takes place performing disconnection of security association.	-	-	-	-
11	Check: Does the UE initiate IPsec secure tunnel as per 3GPP TS 24.502 [33] clause 7.3.2 within T3346 minutes of Step 9? (Note 1)	-	-	1	F
12-18	Steps 1-7 of Table 4.5.2.2-3 of the generic procedure in TS 38.508-1 [4] are performed.	-	-	2	P
19	SS transmits a REGISTRATION REJECT message with cause #22 (Congestion) and T3346 set to 3 minutes. (Note 1)	<--	REGISTRATION REJECT	-	-
20	The generic procedure for SS-requested IPsec Secure tunnel disconnection, specified in subclause 4.5A.3 of TS 38.508-1 [4], takes place performing disconnection of security association.	-	-	-	-
21	The UE is made to establish an Emergency PDU session. (Note 2)	-	-	-	-
22-32	Steps 1-11a1 of Table 4.5.2.2-3 of the generic procedure in TS 38.508-1 [4] are performed, REGISTRATION REQUEST message with IE 5GS registration type set to "Emergency registration" or "Initial registration". (Note 3)	-	-	3	P

Note 1: T3346 is set to 3 minutes. This is checked for 3 minutes less tolerance.
 Note 2: This can be done by an AT/MMI command.
 Note 3: 5GS registration type can set to either "Initial registration" according to TS 24.501 clause 5.2.2.3.3 or "Emergency registration" according to TS 24.501 clause 5.5.1.2.

9.2.5.1.4.3.3 Specific message contents

Table 9.2.5.1.4.3.3-1: REGISTRATION REJECT (steps 9, 19 Table 9.2.5.1.4.3.2-1)

Derivation Path: TS 38.508-1 [4], Table 4.7.1-9			
Information Element	Value/remark	Comment	Condition
5GMM cause	'0001 0110'B	Cause #22 (Congestion)	
T3346 Value	'00100011'B	3 minutes	

Table 9.2.5.1.4.3.3-2: REGISTRATION REQUEST (step 25 Table 9.2.5.1.4.3.2-1)

Derivation Path: TS 38.508-1 [4], Table 4.7.1-6, Condition EMERGENCY or INITIAL.

9.2.5.2 Mobility Registration

9.2.5.2.1 Void

9.2.5.2.2 Mobility registration update/Change of SMS over NAS capability

9.2.5.2.2.1 Test Purpose (TP)

(1)

```
with { UE in state 5GMM-REGISTERED, and 5GMM-IDLE mode over non 3GPP access }
ensure that {
  when { UE needs to change the SMS over NAS capability }
  then { UE initiates and successfully completes the registration procedure for mobility
registration update }
}
```

9.2.5.2.2.2 Conformance requirements

References: The conformance requirements covered in the present TC are specified in: TS 24.501 [22], subclause 5.5.1.3.2. Unless otherwise stated these are Rel-15 requirements.

[TS 24.501, clause 5.5.1.3.2]

The UE in state 5GMM-REGISTERED shall initiate the registration procedure for mobility and periodic registration update by sending a REGISTRATION REQUEST message to the AMF,

...

- 1) when the UE needs to register for SMS over NAS, indicate a change in the requirements to use SMS over NAS, or de-register from SMS over NAS;

...

For a REGISTRATION REQUEST message with a 5GS registration type IE indicating "mobility registration updating", UE shall include the requested NSSAI containing the S-NSSAI(s) corresponding to the slices to which the UE intends to register with and shall include the mapped S-NSSAI(s) for the requested NSSAI, if available, in the REGISTRATION REQUEST message. If the UE has allowed NSSAI or configured NSSAI for the current PLMN, the requested NSSAI shall be either:

- a) the configured NSSAI for the current PLMN, or a subset thereof as described below, if the UE has no allowed NSSAI for the current PLMN;
- b) the allowed NSSAI for the current PLMN, or a subset thereof as described below, if the UE has an allowed NSSAI for the current PLMN; or
- c) the allowed NSSAI for the current PLMN, or a subset thereof as described below, plus one or more S-NSSAIs from the configured NSSAI for which no corresponding S-NSSAI is present in the allowed NSSAI and those are neither in the rejected NSSAI for the current PLMN nor in the rejected NSSAI for the current registration area.

If the UE has neither allowed NSSAI for the current PLMN nor configured NSSAI for the current PLMN and has a default configured NSSAI, the UE shall:

- a) include the S-NSSAI(s) in the Requested NSSAI IE of the REGISTRATION REQUEST message using the default configured NSSAI; and
- b) include the Network slicing indication IE with the Default configured NSSAI indication bit set to "Requested NSSAI created from default configured NSSAI" in the REGISTRATION REQUEST message.

If the UE has no allowed NSSAI for the current PLMN, no configured NSSAI for the current PLMN, and no default configured NSSAI, the UE shall not include a requested NSSAI in the REGISTRATION REQUEST message.

The subset of configured NSSAI provided in the requested NSSAI consists of one or more S-NSSAIs in the configured NSSAI applicable to this PLMN, if the S-NSSAI is neither in the rejected NSSAIs for the current PLMN nor in the rejected NSSAI for the current registration area.

The subset of allowed NSSAI provided in the requested NSSAI consists of one or more S-NSSAIs in the allowed NSSAI for this PLMN.

NOTE 3: How the UE selects the subset of configured NSSAI or allowed NSSAI to be provided in the requested NSSAI is implementation specific. The UE can take preferences indicated by the upper layers (e.g. policies, applications) into account.

9.2.5.2.2.3 Test description

9.2.5.2.2.3.1 Pre-test conditions

System Simulator:

WLAN Cell 27

UE:

UE is enabled for SMS over NAS

Preamble:

The UE is in state 3W-A with PDU session Active state according to TS 38.508-1 [4]SMS over NAS allowed.

9.2.5.2.1.3.2 Test procedure sequence

Table 9.2.5.2.1.3.2-1: Main behaviour

St	Procedure	Message Sequence		TP	Verdict
		U - S	Message		
1	Make the UE deregister the SMS over NAS (NOTE 1)	-	-	-	-
2	The UE transmits an REGISTRATION REQUEST message indicating "mobility registration updating".	-->	5GMM: REGISTRATION REQUEST	1	P
3	SS sends a REGISTRATION ACCEPT message	<--	5GMM: REGISTRATION ACCEPT	-	-
4	Check: Does the UE send a REGISTRATION COMPLETE?	-->	5GMM: REGISTRATION COMPLETE	-	-

Note 1: This can be done by MMI or AT command +C5GUSMS

9.2.5.2.1.3.3 Specific message contents

Table 9.2.5.2.1.3.3-1: REGISTRATION REQUEST (preamble)

Derivation path: TS 38.508-1 [4], Table 4.7.1-6			
Information Element	Value/remark	Comment	Condition
5GS registration type			
5GS registration type value	'001'B		INITIAL
5GS update type			
SMS requested	SMS over NAS supported		

Table 9.2.5.2.1.3.3-2: REGISTRATION ACCEPT (preamble)

Derivation path: TS 38.508-1 [4], Table 4.7.1-7			
Information Element	Value/remark	Comment	Condition
5GS registration result			
SMS allowed	SMS over NAS allowed		
T3512 value			
Timer value	'00011'B		
Unit	'101'B		

Table 9.2.5.2.1.3.3-3: REGISTRATION REQUEST (Table 9.2.5.2.1.3.2-1, step 2)

Derivation path: TS 38.508-1 [4], Table 4.7.1-6			
Information Element	Value/remark	Comment	Condition
5GS registration type			
5GS registration type value	'010'B		MOBILITY
5GS update type			
SMS requested	SMS over NAS not supported		

9.2.6 De-registration

9.2.6.1 UE-initiated de-registration

9.2.6.1.1 UE-initiated de-registration / switch off

9.2.6.1.1.1 Test Purpose (TP)

(1)

```

with { the UE in 5GMM-REGISTERED state }
ensure that {
  when { the UE is switched off }
  then { the UE shall send DEREGISTRATION REQUEST message with De-registration type IE indicated
to "Switch off" }
}

```

(2)

```

with { the UE supports remove USIM without power down and in 5GMM-REGISTERED state }
ensure that {
  when { the USIM is removed from the UE }
  then { the UE shall send DEREGISTRATION REQUEST message with De-registration type IE indicated
to "Switch off" }
}

```

(3)

```

with { the UE in 5GMM-DEREGISTERED-INITIATED state }
ensure that {
  when { the first four expiries of the timer T3521 }
  then { the UE shall retransmit the DEREGISTRATION REQUEST message and shall reset and restart
timer T3521 }
}

```

(4)

```

with { the UE in 5GMM-DEREGISTERED-INITIATED state }
ensure that {
  when { On the fifth expiry of timer T3521 }
  then { the deregistration procedure shall be aborted and the UE perform local detach }
}

```

9.2.6.1.1.2 Conformance requirements

References: The conformance requirements covered in the present TC are specified in: TS 24.501, clauses 5.5.2.1, 5.5.2.2.1 and 5.5.2.2.6. Unless otherwise stated these are Rel-15 requirements.

[TS 24.501, clause 5.5.2.1]

The de-registration procedure is used:

- a) by the UE to de-register for 5GS services over 3GPP access when the UE is registered over 3GPP access;;
- b) by the UE to de-register for 5GS services over 3GPP access, non-3GPP access, or both when the UE is registered in the same PLMN over both accesses;
- c) by the network to inform the UE that it is deregistered for 5GS services over 3GPP access when the UE is registered over 3GPP access;
- d) by the network to inform the UE that it is deregistered for 5GS services over 3GPP access, non-3GPP access, or both when the UE is registered in the same PLMN over both accesses; and
- e) by the network to inform the UE to re-register to the network.

The de-registration procedure with appropriate de-registration type shall be invoked by the UE:

- a) if the UE is switched off; and
- b) as part of the eCall inactivity procedure defined in subclause 5.5.3.

The de-registration procedure with appropriate de-registration type shall be invoked by the network:

- a) if the network informs whether the UE should re-register to the network.

The de-registration procedure with appropriate access type shall be invoked by the UE:

- a) if the UE wants to de-register for 5GS services over 3GPP access when the UE is registered over 3GPP access; or
- b) the UE wants to de-register for 5GS services over 3GPP access, non-3GPP access, or both when the UE is registered in the same PLMN over both accesses.

If the de-registration procedure is triggered due to USIM removal, the UE shall indicate "switch off" in the de-registration type IE.

If the de-registration procedure is requested by the UDM for a UE that has an emergency PDU session, the AMF shall not send a DEREGISTRATION REQUEST message to the UE.

If the de-registration procedure for 5GS services is performed, the PDU sessions, if any, for this particular UE are released locally without peer-to-peer signalling between the UE and the network.

The UE is allowed to initiate the de-registration procedure even if the timer T3346 is running.

NOTE: When the UE has no PDU sessions over non-3GPP access, or the UE moves all the PDU sessions over a non-3GPP access to a 3GPP access, the UE and the AMF need not initiate de-registration over the non-3GPP access.

The AMF shall provide the UE with a non-3GPP de-registration timer.

[TS 24.501, clause 5.5.2.2.1]

The de-registration procedure is initiated by the UE by sending a DEREGISTRATION REQUEST message (see example in figure 5.5.2.2.1). The De-registration type IE included in the message indicates whether the de-registration procedure is due to a "switch off" or not. The access type included in the message indicates whether the de-registration procedure is:

- a) for 5GS services over 3GPP access when the UE is registered over 3GPP access only;
- b) for 5GS services over non-3GPP access when the UE is registered over non-3GPP access only; or
- c) for 5GS services over 3GPP access, non-3GPP access or both 3GPP access and non-3GPP access when the UE is registered in the same PLMN over both accesses.

If the UE has a valid 5G-GUTI, the UE shall populate the 5GS mobile identity IE with the valid 5G-GUTI. If the UE does not have a valid 5G-GUTI, the UE shall populate the 5GS mobile identity IE with its SUCI.

If the UE does not have a valid 5G-GUTI and it does not have a valid SUCI, then the UE shall populate the 5GS mobile identity IE with its PEI.

If the de-registration request is not due to switch off and the UE is in the state 5GMM-REGISTERED or 5GMM-REGISTERED-INITIATED, timer T3521 shall be started in the UE after the DEREGISTRATION REQUEST message has been sent. The UE shall enter the state 5GMM-DEREGISTERED-INITIATED.

If the UE is to be switched off, the UE shall try for a period of 5 seconds to send the DEREGISTRATION REQUEST message. During this period, the UE may be switched off as soon as the DEREGISTRATION REQUEST message has been sent.

[TS 24.501, clause 5.5.2.2.6]

...

- c) T3521 timeout.

On the first four expiries of the timer, the UE shall retransmit the DEREGISTRATION REQUEST message and shall reset and restart timer T3521. On the fifth expiry of timer T3521, the de-registration procedure shall be aborted and the UE proceeds as follows:

9.2.6.1.1.3 Test description

9.2.6.1.1.3.1 Pre-test conditions

System Simulator:

- WLAN Cell 27.

UE:

- None.

Preamble:

- The UE is in state 3W-A on WLAN Cell 27 according to 38.508-1 [4].

9.2.6.1.1.3.2 Test procedure sequence

Table 9.2.6.1.1.3.2-1: Main behaviour

St	Procedure	Message Sequence		TP	Verdict
		U - S	Message		
1	Cause switch off	-	-	-	-
2	Check: Does the UE transmit a DEREGISTRATION REQUEST with the De-registration type IE indicating "switch off"?	-->	DEREGISTRATION REQUEST	1	P
3	SS Transmits DEREGISTRATION ACCEPT	<--	DEREGISTRATION ACCEPT	-	-
4	The generic procedure for SS-requested IPsec Secure tunnel disconnection, specified in subclause 4.5A.3 of TS 38.508-1 [4], takes place performing disconnection of security association.	-	-	-	-
5	The UE is switched on.	-	-	-	-
6-15	The registration procedure is completed by executing steps 1-10 of the UE registration procedure in TS 38.508-1 [4] table 4.5.2.2-3.	-	-	-	-
16	Cause UE to initiate deregistration.	-	-	-	-
17	The UE transmits UE transmit a DEREGISTRATION REQUEST message. The UE starts timer T3521.	-->	DEREGISTRATION REQUEST	-	-
18	The SS does not respond to the DEREGISTRATION REQUEST message.	-	-	-	-
19	Check: When the timer T3521 expires does the UE re-transmit DETACH REQUEST message. Timer T3421 is re-started (1 st expiry).	-->	DEREGISTRATION REQUEST	3	P
20	The SS does not respond to the DEREGISTRATION REQUEST message.	-	-	-	-
21	Check: When the timer T3521 expires does the UE re-transmit DEREGISTRATION REQUEST message. Timer T3521 is re-started (2 nd expiry).	-->	DEREGISTRATION REQUEST	3	P
22	The SS does not respond to the DEREGISTRATION REQUEST message.	-	-	-	-
23	Check: When the timer T3521 expires does the UE re-transmit DEREGISTRATION REQUEST message. Timer T3521 is re-started (3 rd expiry).	-->	DEREGISTRATION REQUEST	3	P
24	The SS does not respond to the DEREGISTRATION REQUEST message.	-	-	-	-
25	Check: When the timer T3521 expires does the UE re-transmit DEREGISTRATION REQUEST message. Timer T3521 is re-started (4 th expiry).	-->	DEREGISTRATION REQUEST	3	P
26	The SS does not respond to the DETACH REQUEST message.	-	-	-	-
27	When the timer T3521 expires the UE aborts the detach procedure and performs a local detach (5 th expiry).	-	-	4	P
28	SS Transmits PDU SESSION MODIFICATION COMMAND	<--	PDU SESSION MODIFICATION COMMAND	-	-
29	Check: Does the UE transmit a PDU SESSION MODIFICATION COMPLETE?	-->	PDU SESSION MODIFICATION COMPLETE	4	F
30	The generic procedure for SS-requested IPsec Secure tunnel disconnection, specified in subclause 4.5A.3 of TS 38.508-1 [4], takes place performing disconnection of security association.	-	-	-	-
-	EXCEPTION: Steps 31 to 46 shall be implemented if the UE supports remove USIM	-	-	-	-

	without power down: pc_USIM_Removal = TRUE [29]				
31	The UE is switched off.	-	-	-	-
32	The UE is switched on.	-	-	-	-
33-42	The registration procedure is completed by executing steps 1-10 of the UE registration procedure in TS 38.508-1 [4] table 4.5.2.2-3.	-	-	-	-
43	Cause removal of USIM from the UE without powering down.	-	-	-	-
44	Check: Does the UE transmit a DEREGISTRATION REQUEST with the De-registration type IE indicating "switch off"?	-->	DEREGISTRATION REQUEST	2	P
45	SS Transmits DEREGISTRATION ACCEPT	<--	DEREGISTRATION ACCEPT	-	-
46	The generic procedure for SS-requested IPsec Secure tunnel disconnection, specified in subclause 4.5A.3 of TS 38.508-1 [4], takes place performing disconnection of security association.	-	-	-	-

9.2.6.1.1.3.3 Specific message contents

Table 9.2.6.1.1.3.3-1: DEREGISTRATION REQUEST (Step 1 and step 44, Table 9.2.6.1.1.3.2-1)

Derivation path: TS 38.508-1 [4], table 4.7.1-12			
Information Element	Value/Remark	Comment	Condition
De-registration type			
Switch off	'1'B		

9.2.6.2 Network-initiated de-registration

9.2.6.2.1 Network-initiated de-registration / De-registration for Non-3GPP access / Re-registration required

9.2.6.2.1.1 Test Purpose (TP)

(1)

```

with { the UE in 5GMM-REGISTERED state }
ensure that {
  when { the SS sends a DEREGISTRATION REQUEST message indicates "re-registration required" and the
de-registration request is for non 3GPP access }
  then { the UE sends a DEREGISTRATION ACCEPT message to the network and releases the existing NAS
signalling connection, then initiates an initial registration and also re-establishes any previously
established PDU sessions }
}

```

9.2.6.2.1.2 Conformance requirements

References: The conformance requirement covered in the present TC is specified in: 3GPP TS 24.501 clauses 5.5.2.3.2. Unless otherwise stated these are Rel-15 requirements.

[TS 24.501 clause 5.5.2.3.2]

NOTE 1: When the de-registration type indicates "re-registration required", user interaction is necessary in some cases when the UE cannot re-establish the PDU session (s), if any, automatically.

...

Upon sending a DEREGISTRATION ACCEPT message, the UE shall delete the rejected NSSAI as specified in subclause 4.6.2.2.

If the de-registration type indicates "re-registration required", then the UE shall ignore the 5GMM cause IE if received.

If the de-registration type indicates "re-registration not required", the UE shall take the actions depending on the received 5GMM cause value:

#3 (Illegal UE);

#6 (Illegal ME); or

#7 (5GS services not allowed).

The UE shall set the 5GS update status to 5U3 ROAMING NOT ALLOWED (and shall store it according to subclause 5.1.3.2.2) and shall delete any 5G-GUTI, last visited registered TAI, TAI list and ngKSI. The UE shall consider the USIM as invalid for 5GS services until switching off or the UICC containing the USIM is removed. The UE shall delete the list of equivalent PLMNs and shall enter the state 5GMM-DEREGISTERED.

If the UE is operating in single-registration mode, the UE shall handle the EMM parameters EMM state, EPS update status, 4G-GUTI, last visited registered TAI, TAI list and eKSI as specified in 3GPP TS 24.301 [15] for the case when a DETACH REQUEST is received with the EMM cause with the same value and with detach type set to "re-attach not required".

NOTE 2: The possibility to configure a UE so that the radio transceiver for a specific radio access technology is not active, although it is implemented in the UE, is out of scope of the present specification.

If the UE also supports the registration procedure over the other access, the UE shall in addition handle 5GMM parameters and 5GMM state for this access, as described for this 5GMM cause value.

...

#72 (Non-3GPP access to 5GCN not allowed).

The UE shall set the 5GS update status to 5U3 ROAMING NOT ALLOWED (and shall store it according to subclause 5.1.3.2.2) and shall delete 5G-GUTI, last visited registered TAI, TAI list and ngKSI. Additionally, the UE shall reset the registration attempt counter and enter the state 5GMM-DEREGISTERED.

NOTE 3: The 5GMM sublayer states, the 5GMM parameters and the registration status are managed per access type independently, i.e. 3GPP access or non-3GPP access (see subclauses 4.7.2 and 5.1.3).

The UE shall disable the N1 mode capability for non-3GPP access (see subclause 4.9.3).

As an implementation option, the UE may enter the state 5GMM-DEREGISTERED.PLMN-SEARCH in order to perform a PLMN selection according to 3GPP TS 23.122 [5].

9.2.6.2.1.3 Test description

9.2.6.2.1.3.1 Pre-test conditions

System Simulator:

- WLAN Cell 27.

UE:

- None.

Preamble:

- the UE is in state 3W-A on WLAN Cell 27 according to TS 38.508-1 [4].

9.2.6.2.1.3.2 Test procedure sequence

Table 9.2.6.2.1.3.2-1: Main behaviour

St	Procedure	Message Sequence	TP	Verdict
----	-----------	------------------	----	---------

		U - S	Message/PDU/SDU		
1	The SS transmits a DEREGISTRATION REQUEST with indicates "re-registration required".	<--	DEREGISTRATION REQUEST	-	-
2	Check: Does the UE transmits a DEREGISTRATION ACCEPT message?	-->	DEREGISTRATION ACCEPT	1	P
3	The generic procedure for SS-requested IPsec Secure tunnel disconnection, specified in subclause 4.5A.3 of TS 38.508-1 [4], takes place performing disconnection of security association.	-	-	-	-
-	EXCEPTION: step 4 describes a behaviour which depends on the UE capability	-	-	-	-
4	IF NOT pc_Automatic_Re_registration, the user initiates a registration by MMI.	-	-	-	-
6-15	The registration procedure is completed by executing steps 1-10 of the UE registration procedure in TS 38.508-1 [4] table 4.5.2.2-3.	-	-	1	P

9.2.6.2.1.3.3 Specific message contents

Table 9.2.6.2.1.3.3-1: DEREGISTRATION REQUEST (step 1, Table 9.2.6.2.1.3.2-1)

Derivation path: TS 38.508-1 [4] Table 4.7.1-14			
Information Element	Value/Remark	Comment	Condition
DEREGISTRATION type			
Switch off	'0'B	Normal de-registration	
Re-registration required	'1'B	re-registration required	
Access type	'10'B	Non 3GPP access	
5GMM cause	'0000 0011'B	Cause #3 (Illegal UE)	

Table 9.2.6.2.1.3.3-2: REGISTRATION REQUEST (step 8, Table 9.2.6.2.1.3.2-1)

Derivation path: TS 38.508-1 [4] Table 4.7.1-6			
Information Element	Value/remark	Comment	Condition
5GS mobile identity	The valid 5G-GUTI that UE holds		

9.2.6.2.2 Network-initiated de-registration / De-registration for Non 3GPP access / Re-registration not required

9.2.6.2.2.1 Test Purpose (TP)

(1)

```

with { the UE in 5GMM-REGISTERED state }
ensure that {
  when { the SS sends a DEREGISTRATION REQUEST message indicates no 5GMM cause IE, ""re-registration not required"" and the de-registration request is for npn-3GPP access and 5GMM cause value is not included }
  then { the UE deletes 5G-GUTI, TAI list, last visited registered TAI, list of equivalent PLMNs, ngKSI, sends a DEREGISTRATION ACCEPT message enter the state 5GMM-DEREGISTERED for non 3GPP access }
}
    
```

(2)

```

with { the UE in 5GMM-REGISTERED state }
ensure that {
  when { the SS sends a DEREGISTRATION REQUEST message indicates no 5GMM cause IE, "re-registration
not required" and the de-registration request is for non-3GPP access and 5GMM cause value set to #7
  5GS services not allowed }
  then { the UE deletes 5G-GUTI, TAI list, last visited registered TAI, list of equivalent PLMNs,
ngKSI, consider the USIM as invalid for 5GS services until switching off or the UICC containing the
USIM is removed, sends a DEREGISTRATION ACCEPT message enter the state 5GMM-DEREGISTERED for Non
3GPP access }
}

```

(3)

```

with { the UE in 5GMM-REGISTERED state }
ensure that {
  when { the SS sends a DEREGISTRATION REQUEST message indicates no 5GMM cause IE, "re-registration
not required" and the de-registration request is for non-3GPP access and 5GMM cause value set to #72
  Non-3GPP access to 5GCN not allowed }
  then { the UE deletes 5G-GUTI, TAI list, last visited registered TAI, ngKSI, disable the N1 mode
capability for non-3GPP access, sends a DEREGISTRATION ACCEPT message enter the state 5GMM-
DEREGISTERED for Non 3GPP access }
}

```

9.2.6.2.2.2 Conformance requirements

References: The conformance requirements covered in the current TC are specified in: TS 24.501 clauses 5.5.2.3.2 and 5.5.2.3.4. Unless otherwise stated these are Rel-15 requirements.

[TS 24.501, clause 5.5.2.3.2]

Upon receiving the DEREGISTRATION REQUEST message, if the DEREGISTRATION REQUEST message indicates "re-registration not required" and the de-registration request is for 3GPP access, the UE shall release locally the PDU sessions over 3GPP access, if any. The UE shall send a DEREGISTRATION ACCEPT message to the network and enter the state 5GMM-DEREGISTERED for 3GPP access.

...

If the de-registration type indicates "re-registration not required", the UE shall take the actions depending on the received 5GMM cause value:

...

#7 (5GS services not allowed).

The UE shall set the 5GS update status to 5U3 ROAMING NOT ALLOWED (and shall store it according to subclause 5.1.3.2.2) and shall delete any 5G-GUTI, last visited registered TAI, TAI list and ngKSI. The UE shall consider the USIM as invalid for 5GS services until switching off or the UICC containing the USIM is removed. The UE shall delete the list of equivalent PLMNs and shall enter the state 5GMM-DEREGISTERED.

If the UE is operating in single-registration mode, the UE shall handle the EMM parameters EMM state, EPS update status, 4G-GUTI, last visited registered TAI, TAI list and eKSI as specified in 3GPP TS 24.301 [15] for the case when a DETACH REQUEST is received with the EMM cause with the same value and with detach type set to "re-attach not required".

NOTE 2: The possibility to configure a UE so that the radio transceiver for a specific radio access technology is not active, although it is implemented in the UE, is out of scope of the present specification.

If the UE also supports the registration procedure over the other access, the UE shall in addition handle 5GMM parameters and 5GMM state for this access, as described for this 5GMM cause value.

...

#72 (Non-3GPP access to 5GCN not allowed).

The UE shall set the 5GS update status to 5U3 ROAMING NOT ALLOWED (and shall store it according to subclause 5.1.3.2.2) and shall delete 5G-GUTI, last visited registered TAI, TAI list and ngKSI. Additionally, the UE shall reset the registration attempt counter and enter the state 5GMM-DEREGISTERED.

NOTE 3: The 5GMM sublayer states, the 5GMM parameters and the registration status are managed per access type independently, i.e. 3GPP access or non-3GPP access (see subclauses 4.7.2 and 5.1.3).

The UE shall disable the N1 mode capability for non-3GPP access (see subclause 4.9.3).

As an implementation option, the UE may enter the state 5GMM-DEREGISTERED.PLMN-SEARCH in order to perform a PLMN selection according to 3GPP TS 23.122 [5].

[TS 24.501, clause 5.5.2.3.4]

- b) DEREGISTRATION REQUEST, other 5GMM cause values than those treated in subclause 5.5.2.3.2 or no 5GMM cause IE is included, and the De-registration type IE indicates "re-registration not required".

The UE shall delete 5G-GUTI, TAI list, last visited registered TAI, list of equivalent PLMNs, ngKSI, shall set the 5GS update status to 5U2 NOT UPDATED and shall start timer T3502.

A UE not supporting S1 mode may enter the state 5GMM-DEREGISTERED.PLMN-SEARCH in order to perform a PLMN selection according to 3GPP TS 23.122 [5]; otherwise the UE shall enter the state 5GMM-DEREGISTERED.ATTEMPTING-REGISTRATION.

A UE operating in single-registration mode shall:

- enter the state 5GMM-DEREGISTERED and attempt to select E-UTRAN radio access technology and proceed with the appropriate EMM specific procedures. In this case, the UE may disable N1 mode capability (see subclause 4.9); or
- enter the state 5GMM-DEREGISTERED.PLMN-SEARCH in order to perform a PLMN selection according to 3GPP TS 23.122 [5].

A UE operating in single-registration mode shall set the EPS update status to EU2 NOT UPDATED and shall delete the EMM parameters 4G-GUTI, last visited registered TAI, TAI list and eKSI and shall enter the state EMM-DEREGISTERED.

9.2.6.2.2.3 Test description

9.2.6.2.2.3.1 Pre-test conditions

System Simulator:

- WLAN Cell 27.

UE:

- None

Preamble:

- The UE is in state 3W-A on WLAN Cell 27 according to TS 38.508-1 [4].

9.2.6.2.2.3.2 Test procedure sequence

Table 9.2.6.2.2.3.2-1: Main behaviour

St	Procedure	Message Sequence		TP	Verdict
		U – S	Message		
1	SS sends a DEREGISTRATION REQUEST message indicates no 5GMM cause IE, "re-registration not required" and the de-registration request is for non 3GPP access	<--	NR 5GMM: DEREGISTRATION REQUEST	-	-
2	Check: Does the UE transmit an DEREGISTRATION ACCEPT message?	-->	NR 5GMM: DEREGISTRATION ACCEPT	1	P
3	The generic procedure for SS-requested IPsec Secure tunnel disconnection, specified in subclause 4.5A.3 of TS 38.508-1 [4], takes	-	-	-	-

	place performing disconnection of security association.				
4	Cause UE to initiate registration.	-	-	-	-
5-15	The registration procedure is completed by executing steps 1-10 of the UE registration procedure in TS 38.508-1 [4] table 4.5.2.2-3.	-	-	1	P
16	SS sends a DEREGISTRATION REQUEST message indicates no 5GMM cause IE, "re-registration not required", 5GMM Cause set to #7 (5GS services not allowed) and the de-registration request is for non 3GPP access	<--	NR 5GMM: DEREGISTRATION REQUEST	-	-
17	Check: Does the UE transmit an DEREGISTRATION ACCEPT message?	-->	NR 5GMM: DEREGISTRATION ACCEPT	2	P
18	The generic procedure for SS-requested IPsec Secure tunnel disconnection, specified in subclause 4.5A.3 of TS 38.508-1 [4], takes place performing disconnection of security association.	-	-	-	-
19	Check for 60 seconds if UE initiates Registration procedure	-	NR 5GMM: REGISTRATION REQUEST	2	F
20	The UE is switched off.	-	-	-	-
21	The UE is switched on.	-	-	-	-
22-31	The registration procedure is completed by executing steps 1-10 of the UE registration procedure in TS 38.508-1 [4] table 4.5.2.2-3.	-	-	-	-
32	SS sends a DEREGISTRATION REQUEST message indicates no 5GMM cause IE, "re-registration not required", 5GMM Cause set to #72 (Non-3GPP access to 5GCN not allowed) and the de-registration request is for non 3GPP access	<--	NR 5GMM: DEREGISTRATION REQUEST	-	-
33	Check: Does the UE transmit an DEREGISTRATION ACCEPT message?	-->	NR 5GMM: DEREGISTRATION ACCEPT	3	P
34	The generic procedure for SS-requested IPsec Secure tunnel disconnection, specified in subclause 4.5A.3 of TS 38.508-1 [4], takes place performing disconnection of security association.	-	-	-	-
35	Check for 60 seconds if UE initiates Registration procedure	-	NR 5GMM: REGISTRATION REQUEST	3	F
36	The UE is switched off.	-	-	-	-

9.2.6.2.2.3.3 Specific message contents

Table 9.2.6.2.2.3.3-1: Message DEREGISTRATION REQUEST (step 1, Table 9.2.6.2.2.3.2-1)

Derivation path: TS 38.508-1 [4], Table 4.7.1-12			
Information Element	Value/remark	Comment	Condition
De-registration type			
Switch off	'0'B	Normal de-registration	
Re-registration required	'0'B	re-registration not required	
Access type	'01'B	3GPP access	
5GMM cause	Not Present		

Table 9.2.6.2.2.3.3-2: Message REGISTRATION REQUEST (step 8, Table 9.2.6.2.2.3.2-1)

Derivation path: TS 38.508-1 [4], table 4.7.1-6			
Information Element	Value/Remark	Comment	Condition
ngKSI			
NAS key set identifier	'111'B	no key is available	

		(UE to network)	
TSC	Any allowed value	TSC does not apply for NAS key set identifier value "111"	
5GS mobile identity	The valid SUCI		
Last visited registered TAI	Not present		

Table 9.2.6.2.2.3.3-2: Message ATTACH REQUEST (step 28, Table 9.2.6.2.2.3.2-1)

Derivation Path: TS 36.508 [7], Table 4.7.2-4			
Information Element	Value/remark	Comment	Condition
NAS key set identifier			
NAS key set identifier	'111'B	no key is available	
TSC	Any allowed value	TSC does not apply for NAS key set identifier value "111".	
Old GUTI or IMSI	IMSI1		
Last visited registered TAI	Not present		

9.2.7 Service request

9.2.7.1 Service request / IDLE mode uplink user data transport / Rejected / Restricted service area, Abnormal / T3517

9.2.7.1.1 Test Purpose (TP)

Same test purposes as clause 9.1.7.1.1

9.2.7.1.2 Conformance requirements

Same conformance requirements as in clause 9.1.7.1.2

9.2.7.1.3 Test description

9.2.7.1.3.1 Pre-test conditions

System Simulator:

- WLAN Cell 27

UE:

- None.

Preamble:

- The UE is in state 3W-A with PDU session Active state according to TS 38.508-1 [4]

9.2.7.1.3.2 Test procedure sequence

Table 9.2.7.1.3.2-1: Main behaviour

St	Procedure	Message Sequence		TP	Verdict
		U - S	Message		
1	The generic procedure for SS-requested IPsec Secure tunnel disconnection, specified in subclause 4.5A.3 of TS 38.508-1 [4], takes place performing disconnection of security association.	-	-	-	-
2	Trigger UE to initiate IPsec SA (Note 1)	-	-	-	-
-	Exception: In parallel to steps 3, the UE initiates an IPsec security association and one child security association as defined in TS 24.502 [35] clause 7.3.2	-	-	-	-
3	Check: Does UE transmit a SERVICE REQUEST message with Service type IE set to 'data'?	-->	SERVICE REQUEST	1	P
4	The SS transmits a SERVICE REJECT message with 5GMM cause = "Restricted service area".	<<--	SERVICE REJECT	-	-
5-6	Void.	-	-	-	-
6A	The SS starts timer 5 sec. Note: An arbitrary chosen timer to avoid message crossing.	-	-	-	-
-	EXCEPTION: Steps 6Ba1 to 6Bb3 describe behaviour that depends on the UE implementation; the "lower case letter" identifies a step sequence that take place if the UE is implemented in a certain way.	-	-	-	-
-	Exception: In parallel to steps 6Ba1 to 8B, the UE initiates an IPsec security association as defined in TS 24.502 [35] clause 7.3.2	-	-	-	-
6Ba1	Check: Does the UE transmit REGISTRATION REQUEST for mobility registration? NOTE: Allowed for Rel-15 UEs.	-->	REGISTRATION REQUEST	2	P
6Ba2	Stop timer 5 sec.	-	-	-	-
6Bb1	Timer 5 sec expires.	-	-	-	-
6Bb2	The generic procedure for SS-requested IPsec Secure tunnel disconnection, specified in subclause 4.5A.3 of TS 38.508-1 [4], takes place performing disconnection of security association.	-	-	-	-
6Bb3	Check: Does the UE transmit REGISTRATION REQUEST for mobility registration over a new signalling connection?	-->	REGISTRATION REQUEST	2	P
7-8	Void.	-	-	-	-
8A	SS stops transmitting UL grant.	-	-	-	-
8B	SS sends a REGISTRATION ACCEPT message containing a 5G-GUTI.	<<--	REGISTRATION ACCEPT	-	-
8C	SS transmits one UL grant, for the UE to transmit the REGISTRATION COMPLETE message at step 8D.	-	-	-	-
8D	The UE send a REGISTRATION COMPLETE.	-->	REGISTRATION COMPLETE	-	-

8E	The generic procedure for SS-requested IPsec Secure tunnel disconnection, specified in subclause 4.5A.3 of TS 38.508-1 [4], takes place performing disconnection of security association.	-	-	-	-
8F	The SS resumes UL grant transmission.	-	-	-	-
8G	The UE transmits a SERVICE REQUEST message over a new signalling connection.	-->	SERVICE REQUEST	-	-
8H	The SS does not respond to SERVICE REQUEST message. Note: The UE locally releases the signalling connection after T3517 expiry.	-	-	-	-
-	EXCEPTION: Steps 9 to 10 are repeated for 4 times.	-	-	-	-
9	Check: does the UE transmits a SERVICE REQUEST message after T3517 expiry but before 60s over a new signalling connection?	-->	SERVICE REQUEST	3	P
10	The SS does not respond to SERVICE REQUEST message. Note: The UE locally releases the signalling connection after T3517 expiry.	-->	SERVICE REQUEST	-	-
11	Check: Does the UE transmits a SERVICE REQUEST message within 60 seconds (minimum value of T3525) over a new signalling connection?	-->	SERVICE REQUEST	3,4	F
12	The SS starts timer 10 sec after Step 11 to see if UE performs the optional Steps listed below.	-	-	-	-
-	EXCEPTION: Steps 12a1 to 12a7a2 describe behaviour that depends on the UE implementation; the "lower case letter" identifies a step sequence that take place if the UE is implemented in a certain way.	-	-	-	-
12a1	Trigger UE to initiate IPsec SA (Note 1)	-	-	-	-
	Exception: In parallel to steps 12a2 to 12a5, the UE initiates an IPsec security association and one child security association as defined in TS 24.502 [35] clause 7.3.2	-	-	-	-
12a2	The UE transmits a SERVICE REQUEST message after T3525 expiry over a new signalling connection.	-->	SERVICE REQUEST	-	-
12a3-12a7a2	Steps 5 to 9a2 of the NR RRC_CONNECTED procedure in TS 38.508-1 [4] Table 4.5.4.2-3 are executed.	-	-	-	-
Note 1: This could be done by e.g. MMI or by AT command +CGACT.					

9.2.7.1.3.3 Specific message contents

Table 9.2.7.1.3.3-3: SERVICE REQUEST (steps 3, 8G and 9, Table 9.2.7.1.3.2-1)

Derivation Path: TS 38.508-1 [4] Table 4.7.1-16			
Information Element	Value/remark	Comment	Condition
Service type			
Service type value	'0001'B	data	

Table 9.2.7.1.3.3-4: SERVICE REJECT (step 4, Table 9.2.7.1.3.2-1)

Derivation Path: TS 38.508-1 [4] Table 4.7.1-18

Information Element	Value/remark	Comment	Condition
5GMM cause	'0001 1100'B	Restricted service area	

9.2.7.2 Service request / CMM CONNECTED mode/uplink user data transport / Abnormal / T3517

9.2.7.2.1 Test Purpose (TP)

(1)

```
with { the UE is in 5GMM-REGISTERED state and 5GMM-CONNECTED mode over 3GPP access }
ensure that {
  when { the UE has user data pending due to no user-plane resources established for PDU session(s)
        used for user data transport }
    then { the UE sends a SERVICE REQUEST message }
}
```

(2)

```
with { the UE sends a SERVICE REQUEST message in 5GMM-CONNECTED mode }
ensure that {
  when { T3517 expired }
    then { the UE stays in 5GMM-CONNECTED mode }
}
```

9.2.7.2.2 Conformance requirements

Same conformance requirements as in clause 9.1.7.2.2

9.2.7.2.3 Test description

9.2.7.2.3.1 Pre-test conditions

System Simulator:

- WLAN Cell 27

UE:

- None.

Preamble:

- The UE is in state 3W-A with PDU session (with PDU session ID X where $1 \leq X \leq 15$) Active state according to TS 38.508-1 [4]

9.2.7.2.3.2 Test procedure sequence

Table 9.2.7.2.3.2-1: Main behaviour

St	Procedure	Message Sequence		TP	Verdict
		U – S	Message		
1	The SS initiated child SA deletion procedure sec tunnel as defined in TS 24.502 [33] clause 7.7.2	-	-	-	-
2	Trigger UE to send a ICMP ECHO REQUEST (pc_IPv4 = TRUE)_or ICMPv6 ECHO REQUEST (pc_IPv6 = TRUE) (Note 2)	-	-	-	-

3	The UE transmits a SERVICE REQUEST message.	-->	NR 5GMM: SERVICE REQUEST	1	P
4	The SS does not respond to the SERVICE REQUEST message.	-	-	-	-
5	Wait for T3517 seconds (Note 1).	-	-	-	-
6	The UE transmit a SERVICE REQUEST message.	-->	NR 5GMM: SERVICE REQUEST	-	-
7	The SS sends an IDENTITY REQUEST message.	<--	NR 5GMM: IDENTITY REQUEST	-	-
8	Check: Does the UE transmit an IDENTITY RESPONSE message?	-->	NR 5GMM: IDENTITY RESPONSE	2	P
-	Exception: In parallel to steps 9, the SS initiates one child security association as defined in TS 24.502 [33] clause 7.5	-	-	-	-
9	The SS transmits SERVICE ACCEPT message to setup User-plane resources for the PDU session X.	<--	NR 5GMM: SERVICE ACCEPT		
-	EXCEPTION: Steps 10a1 to 10b2 describe behaviour that depends on the UE implementation; the "lower case letter" identifies a step sequence that take place depending on the UE implementation.	-	-	-	-
10a1	IF (pc_IPv4 = TRUE) THEN, check that the UE sends an ICMP Echo request to the SS?	-->	ICMP ECHO REQUEST	1	P
10a2	The SS sends an ICMP Echo reply	<--	ICMP ECHO REPLY	-	
10b1	ELSE IF (pc_IPv4 = FALSE AND pc_IPv6 = TRUE) THEN, check the UE sends an ICMPv6 Echo request to the SS?	-->	ICMPv6 ECHO REQUEST	1	P
10b2	The SS sends an ICMPv6 Echo reply	<--	ICMPv6 ECHO REPLY	-	-
Note 1: T3517 expires after 15 seconds.					
Note 2: This could be done by a MMI command					

9.2.7.2.3.3 Specific message contents

Table 9.2.7.2.3.3-1: SERVICE REQUEST (step 3, 6, Table 9.2.7.2.3.2-1)

Derivation path: TS 38.508-1 [4], table 4.7.1-16			
Information Element	Value/Remark	Comment	Condition
Service type	'0001'B	data	
Uplink data status			
PSI(X)	'1'B	PSI(X) is set to 1 indicates that uplink data are pending for the PDU session X activated in preamble.	

Table 9.2.7.2.3.3-2: IDENTITY REQUEST (step 7, Table 9.2.7.2.3.2-1)

Derivation Path: TS 38.508-1 [4] table 4.7.1-21			
Information Element	Value/remark	Comment	Condition
Identity type	'0010'B	5G-GUTI	

Table 9.2.7.2.3.3-3: IDENTITY RESPONSE (step 8, Table 9.2.7.2.3.2-1)

Derivation Path: TS 38.508-1 [4] table 4.7.1-22			
Information Element	Value/remark	Comment	Condition
Mobile identity	5G-GUTI		

Table 9.2.7.2.3.3-4: SERVICE ACCEPT (step 9, Table 9.2.7.2.3.2-1)

Derivation path: TS 38.508-1 [4], table 4.7.1-17			
Information Element	Value/Remark	Comment	Condition
PDU session reactivation result			
PSI(X)	'0'B	PSI(X) is set to 0 indicates that establishment of user-plane resource of the PDU session X activated in preamble is successful.	

9.2.8 SMS over NAS

9.2.8.1 SMS over NAS / MO SMS over NAS - 5GMM-Idle mode

9.2.8.1.1 Test Purpose (TP)

(1)

```
with { the UE in switched off state with valid USIM inserted }
ensure that {
  when { the UE requests initial registration for SMS over NAS }
  then { the UE shall send REGISTRATION REQUEST message with SMS requested bit of the 5GS
registration type IE "SMS over NAS supported" }
}
```

(2)

```
with { the UE in 5GMM_Connected state with 5GMM-Idle mode and the UE has sent a SERVICE REQUEST
message triggered by initiating MO SMS}
ensure that {
  when { UE receives a SERVICE ACCEPT message from SS }
  then { UE sends CP-DATA containing RP-DATA RPDU (SMS SUBMIT TPDU) encapsulated in an Uplink NAS
transport message }
}
```

(3)

```
with { UE has sent CP-DATA containing an RP-DATA RPDU (SMS SUBMIT TPDU) encapsulated in an Uplink
NAS transport message }
ensure that {
  when { UE receives a CP-DATA containing an RP-ACK RPDU encapsulated in a Downlink NAS transport
message }
  then { UE sends a CP-ACK encapsulated in an Uplink NAS Transport message }
```

9.2.8.1.2 Conformance requirements

Same conformance requirements as in clause 9.2.8.1.2

9.2.8.1.3 Test description

9.2.8.1.3.1 Pre-test conditions

System Simulator:

WLAN Cell 27;

UE:

The UE does not have any stored SMS message.

Preamble:

The UE is in state Switched OFF (state-0W-B) according to TS 38.508-1 [4].

9.2.8.1.3.2 Test procedure sequence

Table 9.2.8.1.3.2-1: Main behaviour

St	Procedure	Message Sequence		TP	Verdict
		U - S	Message		
1	The UE is switched ON	-	-	-	-
2-3	Steps 1-2 of the generic procedure for UE registration specified in TS 38.508-1 [4] table 4.5.2.2-3 are performed.	-	-	-	-
-	Exception: The UE establishes an IPsec tunnel in parallel to 5GC registration steps 4 to 8 as per the IKEv2 protocol as defined in 3GPP TS 23.502 [31] clause 4.12.2.2 figure 4.12.2.2-1.	-	-	-	-
4	Check: Does UE transmit a REGISTRATION REQUEST message including 5GS update type IE with SMS requested bit set to "SMS over NAS supported"?	-->	REGISTRATION REQUEST	1	P
5 - 8	Steps 4-5 of the generic procedure for UE registration specified in TS 38.508-1 [4] table 4.5.2.2-3 are performed.	-	-	-	-
9	SS transmits REGISTRATION ACCEPT message including 5GS registration result with SMS allowed bit set to "SMS over NAS allowed".	<--	REGISTRATION ACCEPT	-	-
10 - 12	Steps 9-11 of the generic procedure for UE registration specified in TS 38.508-1 [4] table 4.5.2.2-3 are performed.	-	-	-	-
13	Sending of a 160 character MO SMS is initiated at the UE via MMI or AT command	-	-	-	-
14	UE transmits establishes a IPSEC SA and NAS signalling connection as per generic procedure in table 4.5A.4.2.2-1 of 38.508-1 [4].	-	-	-	-
15	Check: Does the UE transmit a CP-DATA containing an RP-DATA RPDU (SMS SUBMIT TPDU) encapsulated in an Uplink NAS transport message?	-->	UPLINK NAS TRANSPORT	2	P
16	The SS transmits a CP-ACK encapsulated in a Downlink NAS Transport message.	<--	DOWNLINK NAS TRANSPORT	-	-
17	The SS transmits a CP-DATA containing an RP-ACK RPDU encapsulated in a Downlink NAS transport message	<--	DOWNLINK NAS TRANSPORT	-	-
18	Check: Does the UE transmit a CP-ACK encapsulated in an Uplink NAS Transport message?	-->	UPLINK NAS TRANSPORT	3	P

9.2.8.1.3.3 Specific message contents

Table 9.2.8.1.3.3-1: REGISTRATION REQUEST (step 4, Table 9.2.8.1.3.2-1)

Derivation path: TS 38.508-1 [4], Table 4.7.1-6			
Information Element	Value/remark	Comment	Condition
5GS registration type			
5GS registration type value	'001'B		INITIAL

5GS update type			
SMS requested	SMS over NAS supported		

Table 9.2.8.1.3.3-2: REGISTRATION ACCEPT (step 9, Table 9.2.8.1.3.2-1)

Derivation path: TS 38.508-1 [4], Table 4.7.1-7			
Information Element	Value/remark	Comment	Condition
5GS registration result			
SMS allowed	SMS over NAS allowed		
T3512 value			
Timer value	'00011'B		
Unit	'101'B		

Table 9.2.8.1.3.3-3: UL NAS TRANSPORT (step 15, Table 9.2.8.1.3.2-1)

Derivation path: TS 38.508-1 [4], Table 4.7.1-10			
Information Element	Value/remark	Comment	Condition
Payload container type	'0010'B	SMS	
Payload container	CP-DATA	RP-DATA RPDU	

Table 9.2.8.1.3.3-3a:Message CP-DATA (step 15, Table 9.2.8.1.3.2-1)

Information Element	Value/remark	Comment	Condition
CP-User data	RP-DATA		

Table 9.2.8.1.3.3-4: DL NAS TRANSPORT (step 16, Table 9.2.8.1.3.2-1)

Derivation path: TS 38.508-1 [4], Table 4.7.1-11			
Information Element	Value/remark	Comment	Condition
Payload container type	'0010'B	SMS	
Payload container	CP-ACK		

Table 9.2.8.1.3.3-5: DL NAS TRANSPORT (step 17, Table 9.2.8.1.3.2-1)

Derivation path: TS 38.508-1 [4], Table 4.7.1-11			
Information Element	Value/remark	Comment	Condition
Payload container type	'0010'B	SMS	
Payload container	CP-DATA	RP-ACK RPDU	

Table 9.2.8.1.3.3-5a:Message CP-DATA (step 17, Table 9.2.8.1.3.2-1)

Information Element	Value/remark	Comment	Condition
CP-User data	RP-DATA		

Table 9.2.8.1.3.3-6: UL NAS TRANSPORT (step 18, Table 9.2.8.1.3.2-1)

Derivation path: TS 38.508-1 [4], Table 4.7.1-10			
Information Element	Value/remark	Comment	Condition
Payload container type	'0010'B	SMS	
Payload container	CP-ACK		

9.3 Inter-system mobility

9.3.1 5GS-EPC Inter-system mobility

9.3.1.1 Inter-system mobility registration update / Single-registration mode with N26 / 5GMM-IDLE / 5GC to EPC

9.3.1.1.1 Test Purpose (TP)

(1)

```

with { UE in state 5GMM-REGISTERED and 5GMM-IDLE on a 5GC NR cell and has been previously registered
on EPC as well, UE supporting S1 and N1 and operating in single-registration mode, NWK supporting
Single-registration mode with N26 interface }
ensure that {
  when { UE detects a suitable EPC E-UTRA cell after the serving NGC cell becomes not suitable }
  then { UE performs a Inter-system change from N1 mode to S1 mode by initiating and successfully
completing a TAU procedure, mapped EPC context used }
}

```

9.3.1.1.2 Conformance requirements

References: The conformance requirements covered in the present TC are specified in: TS 24.501 [22], subclause 5.1.4.2; TS 24.301 [21], subclause 4.4.2.3. Unless otherwise stated these are Rel-15 requirements.

[TS 24.501, subclause 5.1.4.2]

At Inter-system change from N1 mode to S1 mode when there is at least one active PDU session for which interworking with EPS is supported as specified in subclause 6.1.4.1, the UE shall enter sub states EMM-REGISTERED.NORMAL-SERVICE and 5GMM-REGISTERED.NO-CELL-AVAILABLE and initiate a tracking area updating procedure (see 3GPP TS 24.301 [15]).

[TS 24.301, subclause 4.4.2.3]

During Inter-system change from N1 mode to S1 mode in 5GMM-IDLE mode, if the UE is operating in the single-registration mode and:

- 1) if the tracking area updating procedure is initiated as specified in 3GPP TS 24.501 [54], the UE shall transmit a TRACKING AREA UPDATE REQUEST message integrity protected with the current 5G NAS security context and the UE shall derive a mapped EPS security context (see subclause 8.6.1 of 3GPP TS 33.501 [56]). The UE shall include the eKSI indicating the 5G NAS security context value in the TRACKING AREA UPDATE REQUEST message.

After receiving the TRACKING AREA UPDATE REQUEST message including the eKSI, the MME forwards the TRACKING AREA UPDATE REQUEST message to the source AMF, if possible, to obtain the mapped EPS security context from the AMF as specified in 3GPP TS 33.501 [56]. The MME re-establishes the secure exchange of NAS messages by either:

- replying with a TRACKING AREA UPDATE ACCEPT message that is integrity protected and ciphered using the mapped EPS NAS security context. From this time onward, all NAS messages exchanged between the UE and the MME are sent integrity protected and except for the messages specified in subclause 4.4.5, all NAS messages exchanged between the UE and the MME are sent ciphered; or

9.3.1.1.3 Test description

9.3.1.1.3.1 Pre test conditions

System Simulator:

- 2 cells

- NGC Cell A as defined in TS 38.508-1 [4] Table 6.3.2.2-1. System information combination NR-6 as defined in TS 38.508-1 [4], subclause 4.4.3.1.2.
- E-UTRA Cell A as defined in TS 36.508 [7] Table 6.3.2.2-1. System information combination 31 as defined in TS 36.508 [7], subclause 4.4.3.1.1.

UE:

- None.

Preamble:

- With E-UTRA Cell A "Serving cell" and NGC Cell A "Non-suitable "Off" cell", the UE is brought to state RRC_IDLE using generic procedure parameters Connectivity (*E-UTRA/EPC*) and Unrestricted nr PDN (*On*) in accordance with the procedure described in TS 38.508-1 [4], clause 4.5.2. 4G GUTI and eKSI are assigned and security context established
 - the UE is switched-off
- With NGC Cell A "Serving cell" and E-UTRA Cell A "Non-suitable "Off" cell", the UE is brought to state IN-A, RRC_IDLE Connectivity (NR), in accordance with the procedure described in TS 38.508-1 [4], Table 4.5.2.2-2. 5G-GUTI and ngKSI are assigned and security context established.

9.3.1.1.2 Test procedure sequence

Table 9.3.1.1.3.2-1: Main behaviour

St	Procedure	Message Sequence		TP	Verdict
		U - S	Message		
1	The SS configures: - E-UTRA Cell A as "Serving cell" - NGC Cell A as "Non-suitable "off" cell".	-	-	-	-
2	Check: Does the UE perform on the E-UTRA Cell A the TAU procedure for Inter-system change from N1 mode to S1 mode in 5GMM/EMM-IDLE mode as described in TS 38.508-1 [4], Table 4.9.7.2.2-1, 'connected without release'?	-	-	1	-
3	At the end of this test procedure sequence, the UE is in end state E-UTRA connected (E2_T3440) according to TS 36.508 [7].	-	-	-	-

9.3.1.1.3.3 Specific message contents

None.

9.3.1.2 Inter-system mobility registration update / Single-registration mode with N26 / 5GMM-IDLE / EPC to 5GC

9.3.1.2.1 Test Purpose (TP)

(1)

```

with { UE in state EMM-REGISTERED and EMM-IDLE on an E-UTRA cell and has been previously registered
on 5GC, UE supporting S1 and N1 and operating in single-registration mode, NWK supporting Single-
registration mode with N26 interface }
ensure that {
  when { UE detects a suitable NGC cell after the serving E-UTRA cell becomes not suitable }
  then { UE performs a Inter-system change from S1 mode to N1 mode by initiating and successfully
completing a mobility and periodic registration update procedure, mapped 5GC context used }
}
    
```

9.3.1.2.2 Conformance requirements

References: The conformance requirements covered in the present TC are specified in: TS 24.501 [22], subclauses 4.4.2.1, 4.4.2.5, 5.1.4.2, 5.5.1.3.2; TS 24.301 [21], subclause 5.5.5. Unless otherwise stated these are Rel-15 requirements.

[TS 24.501, subclause 4.4.2.1]

Before security can be activated, the AMF and the UE need to establish a 5G NAS security context. Usually, the 5G NAS security context is created as the result of a primary authentication and key agreement procedure between the AMF and the UE. A new 5G NAS security context may also be created during an N1 mode to N1 mode handover. Alternatively, during inter-system change from S1 mode to N1 mode, the AMF not supporting interworking without N26 and the UE operating in single-registration mode may derive a mapped 5G NAS security context from an EPS security context that has been established while the UE was in S1 mode.

...

The key set identifier ngKSI is assigned by the AMF either during the primary authentication and key agreement procedure or, for the mapped 5G NAS security context, during the inter-system change. The ngKSI consists of a value and a type of security context parameter indicating whether a 5G NAS security context is a native 5G NAS security context or a mapped 5G NAS security context. When the 5G NAS security context is a native 5G NAS security context, the ngKSI has the value of KSI_{AMF} , and when the current 5G NAS security context is of type mapped, the ngKSI has the value of KSI_{ASME} .

The 5G NAS security context which is indicated by an ngKSI can be taken into use to establish the secure exchange of NAS messages when a new N1 NAS signalling connection is established without executing a new primary authentication and key agreement procedure (see subclause 5.4.1) or when the AMF initiates a security mode control procedure. For this purpose, the initial NAS messages (i.e. REGISTRATION REQUEST, DEREGISTRATION REQUEST, SERVICE REQUEST and CONTROL PLANE SERVICE REQUEST) and the SECURITY MODE COMMAND message contain an ngKSI in the NAS key set identifier IE indicating the current 5G NAS security context used to integrity protect the NAS message.

[TS 24.501, subclause 4.4.2.5]

Secure exchange of NAS messages via a NAS signalling connection is usually established by the AMF during the registration procedure by initiating a security mode control procedure. After successful completion of the security mode control procedure, all NAS messages exchanged between the UE and the AMF are sent integrity protected using the current 5G security algorithms, and except for the messages specified in subclause 4.4.5, all NAS messages exchanged between the UE and the AMF are sent ciphered using the current 5G security algorithms.

...

During inter-system change from S1 mode to N1 mode in 5GMM-IDLE mode, if the UE is operating in single-registration mode and:

- ...b) if the UE has no valid native 5G NAS security context, the UE shall send the REGISTRATION REQUEST message without integrity protection and encryption.

After receiving the REGISTRATION REQUEST message without integrity protection and encryption:

- 1) if N26 interface is supported:
 - i) if an EPS security context received from the source MME does not include the NAS security algorithms set to EIA0 and EEA0, the AMF shall either create a fresh mapped 5G NAS security context (see subclause 8.6.2 of 3GPP TS 33.501 [24]) or trigger a primary authentication and key agreement procedure to create a fresh native 5G NAS security context; or

...

The newly created 5G NAS security context is taken into use by initiating a security mode control procedure and this context becomes the current 5G NAS security context in both the UE and the AMF. This re-establishes the secure exchange of NAS messages.

[TS 24.501, subclause 5.1.4.2]

At inter-system change from S1 mode to N1 mode, the UE shall enter sub states 5GMM-REGISTERED.NORMAL-SERVICE and EMM-REGISTERED.NO-CELL-AVAILABLE and initiate a registration procedure for mobility and periodic registration update indicating "mobility registration updating" in the 5GS registration type IE of the REGISTRATION REQUEST message (see subclause 5.5.1.3).

[TS 24.501, subclause 5.5.1.3.2]

The UE in state 5GMM-REGISTERED shall initiate the registration procedure for mobility and periodic registration update by sending a REGISTRATION REQUEST message to the AMF,

...

e) upon Inter-system change from S1 mode to N1 mode;

...

If case b) is the only reason for initiating the registration procedure for mobility and periodic registration update, the UE shall indicate "periodic registration updating" in the 5GS registration type IE; otherwise the UE shall indicate "mobility registration updating".

If the UE indicates "mobility registration updating" in the 5GS registration type IE and the UE supports S1 mode, the UE shall:

- set the S1 mode bit to "S1 mode supported" in the 5GMM capability IE of the REGISTRATION REQUEST message;
- include the S1 UE network capability IE in the REGISTRATION REQUEST message; and
- if the UE supports sending an ATTACH REQUEST message containing a PDN CONNECTIVITY REQUEST message with request type set to "handover" to transfer a PDU session from N1 mode to S1 mode, set the HO attach bit to "attach request message containing PDN connectivity request with request type set to handover to transfer PDU session from N1 mode to S1 mode supported" in the 5GMM capability IE of the REGISTRATION REQUEST message.

...

If the last visited registered TAI is available, the UE shall include the last visited registered TAI in the REGISTRATION REQUEST message.

The UE shall handle the 5GS mobility identity IE in the REGISTRATION REQUEST message as follows:

- a) if the UE is operating in the single-registration mode, performs Inter-system change from S1 mode to N1 mode, and the UE holds a valid 4G-GUTI, the UE shall include the 5G-GUTI mapped from the 4G-GUTI as specified in 3GPP TS 23.003 [4] in the 5GS mobility identity IE. Additionally, if the UE holds a valid 5G-GUTI, the UE shall include the 5G-GUTI in the Additional GUTI IE in the REGISTRATION REQUEST message in the following order:
 - 1) a valid 5G-GUTI that was previously assigned by the same PLMN with which the UE is performing the registration, if available;
 - 2) a valid 5G-GUTI that was previously assigned by an equivalent PLMN, if available; and
 - 3) a valid 5G-GUTI that was previously assigned by any other PLMN, if available; and

...

If the UE operating in the single-registration mode performs Inter-system change from S1 mode to N1 mode, the UE:

- a) shall include the UE status IE with the EMM registration status set to "UE is in EMM-REGISTERED state" in the REGISTRATION REQUEST message;

NOTE 1: Inclusion of the UE status IE with this setting corresponds to the indication that the UE is "moving from EPC" as specified in 3GPP TS 23.502 [9], subclause 4.11.1.3.3 and 4.11.2.3.

- b) may include the PDU session status IE in the REGISTRATION REQUEST message indicating the status of the PDU session(s) mapped during the Inter-system change from S1 mode to N1 mode from the PDN connection(s) for which the EPS indicated that interworking to 5GS is supported, if any (see subclause 6.1.4.1); and
- c) shall include a TRACKING AREA UPDATE REQUEST message as specified in 3GPP TS 24.301 [15] in the IE in the REGISTRATION REQUEST message.

...

The UE shall send the REGISTRATION REQUEST message including the NAS message container IE as described in subclause 4.4.6:

...

- b) when the UE is sending the message after an Inter-system change from S1 mode to N1 mode in 5GMM-IDLE mode and the UE has a valid 5G NAS security context and needs to send non-plaintext IEs.

[TS 24.301, subclause 5.5.5]

The tracking area updating procedure is used to construct a TRACKING AREA UPDATE REQUEST message for the inter-system change from S1 mode to N1 mode for further security verification by the MME.

The TRACKING AREA UPDATE REQUEST message is created by EMM by request of 5GMM which further includes the message in the REGISTRATION REQUEST message as described in 3GPP TS 24.501 [54].

The TRACKING AREA UPDATE REQUEST message shall contain only mandatory information elements.

The UE shall set the EPS update type IE in the TRACKING AREA UPDATE REQUEST message to "TA updating".

If the UE has a current EPS security context, the UE shall include the eKSI (either KSI_{ASME} or KSI_{SGSN}) in the NAS Key Set Identifier IE in the TRACKING AREA UPDATE REQUEST message. Otherwise, the UE shall set the NAS Key Set Identifier IE to the value "no key is available". If the UE has a current EPS security context, the UE shall integrity protect the TRACKING AREA UPDATE REQUEST message with the current EPS security context and increase the uplink NAS COUNT by one. Otherwise the UE shall not integrity protect the TRACKING AREA UPDATE REQUEST message. The UE shall set associated GUTI in the Old GUTI IE.

When the UE is in EMM-REGISTERED.NO-CELL-AVAILABLE substate and needs to construct the TRACKING AREA UPDATE REQUEST message for inter-system change from S1 mode to N1 mode, the UE shall consider that the tracking area updating procedure is not initiated and the UE shall remain in EMM-REGISTERED.NO-CELL-AVAILABLE state.

9.3.1.2.3 Test description

9.3.1.2.3.1 Pre test conditions

System Simulator:

- 2 cells
 - NGC Cell A as defined in TS 38.508-1 [4] Table 6.3.2.2-1. System information combination NR-6 as defined in TS 38.508-1 [4], subclause 4.4.3.1.2.
 - E-UTRA Cell A as defined in TS 36.508 [7] Table 6.3.2.2-1. System information combination 31 as defined in TS 36.508 [7], subclause 4.4.3.1.1.

UE:

None.

Preamble:

- With NGC Cell A "Serving cell" and E-UTRA Cell A "Non-suitable "Off" cell", the UE is switched on and when it initiates the initial registration procedure then it is rejected as specified in subclause 4.9.8 Procedure for

Registration Reject. This is made to ensure that the UE does not have a valid native 5G NAS security context for the rest of the test case.

- the UE is switched-off.
- With E-UTRA Cell A "Serving cell" and NGC Cell A "Non-suitable "Off" cell", the UE is brought to state RRC_IDLE using generic procedure parameters Connectivity (*E-UTRA/EPC*) and Unrestricted nr PDN (*On*) in accordance with the procedure described in TS 38.508-1 [4], clause 4.5.2. 4G GUTI and eKSI are assigned and security context established.

9.3.1.2.3.2 Test procedure sequence

Table 9.3.1.2.3.2-1: Main behaviour

St	Procedure	Message Sequence		TP	Verdict
		U - S	Message		
1	The SS configures: - NGC Cell A as "Serving cell" - E-UTRA Cell A as "Non-suitable "off" cell".	-	-	-	-
2	Check: Does the UE perform on the NGC Cell A the Test procedure for UE Tracking area updating for Inter-system change from S1 mode to N1 mode in 5GMM/EMM-IDLE mode as described in TS 38.508-1 [4], Table 4.9.9.2.2-1 with the exception that the SS does not initiate the primary authentication and key agreement procedure described in steps 4-5 (NOTE 1), ' <i>connected without release</i> '?	-	-	1	-

NOTE 1: This is required to allow for the verification of the UE using mapped 5GC context as per TP1.

9.3.1.2.3.3 Specific message contents

Table 9.3.1.2.3.3-1: REGISTRATION REQUEST (Preamble; TS 38.508-1 [4], Table 4.5.2.2-2)

Derivation Path: TS 38.508-1 [4], Table 4.7.1-6			
Information Element	Value/remark	Comment	Condition
5GMM capability			
S1 mode (octet 3, bit 1)	'1'B	S1 mode supported	
S1 UE network capability			
All octets with the exception of octet 9, bit 6	Not checked		
N1 mode supported (N1 mode) (octet 9, bit 6)	'1'B	N1 mode supported	

Table 9.3.1.2.3.3-2: REGISTRATION REJECT (Preamble; step 8, TS 38.508-1 [4], Table 4.9.8.2.2-1)

Derivation path: TS 38.508-1 [4], Table 4.9.8.2.3-1			
Information Element	Value/remark	Comment	Condition
5GMM cause	'0000 0011'B	Illegal UE	

Table 9.3.1.2.3.3-3: Message ATTACH REQUEST (Preamble; step 4, TS 38.508-1 [4], Table 4.5.2.2-5)

Derivation Path: TS 36.508 [7], Table 4.7.2-4 with condition NR			
Information Element	Value/remark	Comment	Condition
NAS key set identifier			
NAS key set identifier	'111'B	no key is available	
TSC	Any allowed value	TSC does not apply for NAS key	

		set identifier value "111".	
Old GUTI or IMSI	IMSI1		
Last visited registered TAI	Not present		

Table 9.3.1.2.3.3-4: REGISTRATION REQUEST (step 2, Table 9.3.1.2.3.2-1; step 1, TS 38.508-1 [4] Table 4.9.9.2.2-1)

Derivation Path: TS 38.508-1 [4], Table 4.7.1-6 with condition NOT NON_CLEARTEXT_IE

Table 9.3.1.2.3.3-5: TRACKING AREA UPDATE REQUEST (9.3.1.2.3.3-4)

Derivation path: TS 38.508-1 [4], Table 4.9.9.2.3-2			
Information Element	Value/remark	Comment	Condition
NAS key set identifier			
NAS key set identifier	the eKSI for the current EPS security context		
TSC	'0'B	native (current) EPS security context	

Table 9.3.1.2.3.3-6: SECURITY MODE COMMAND (step 2, Table 9.3.1.2.3.2-1; step 6, TS 38.508-1 [4] Table 4.9.9.2.2-1)

Derivation Path: TS 38.508-1 [4], Table 4.7.1-25.			
Information Element	Value/remark	Comment	Condition
ngKSI			
NAS key set identifier	KS _{ASME} that was created when the UE last registered to EPS		
TSC	'1'B	mapped security context (for KS _{ASME})	

9.3.1.3 Inter-system mobility and periodic registration update / Rejected / Single-registration mode with N26 / Handling of EPC relevant parameters

9.3.1.3.1 Test Purpose (TP)

(1)

```

with { UE in state 5GMM-REGISTERED on an NGC cell, UE supporting S1 and N1 and operating in single-
registration mode, NWK supporting Single-registration mode with N26 interface }
ensure that {
  when { UE initiates a Mobility and periodic registration procedure on an NGC cell and receives a
REGISTRATION REJECT message including 5GMM cause value #9 (UE identity cannot be derived by the
network) }
  then { UE deletes the EPS relevant parameters 4G-GUTI, last visited registered TAI and eKSI and
enters the state EMM-DEREGISTERED, and, subsequently, when it finds a suitable E-UTRA cell it moves
to it and automatically initiates an attach procedure }
}

```

9.3.1.3.2 Conformance requirements

References: The conformance requirements covered in the present TC are specified in: TS 24.501 [22], subclause 5.5.1.3.5, TS 24.301 [21], clause 5.5.3.2.5. Unless otherwise stated these are Rel-15 requirements.

[TS 24.501, subclause 5.5.1.3.5]

If the mobility and periodic registration update request cannot be accepted by the network, the AMF shall send a REGISTRATION REJECT message to the UE including an appropriate 5GMM cause value.

The UE shall take the following actions depending on the 5GMM cause value received in the REGISTRATION REJECT message.

...

#9 (UE identity cannot be derived by the network).

...

If the UE is operating in single-registration mode, the UE shall handle the EMM parameters EMM state, EPS update status, 4G-GUTI, last visited registered TAI, TAI list and eKSI as specified in 3GPP TS 24.301 [15] for the case when the normal tracking area updating procedure is rejected with the EMM cause with the same value.

[TS 24.301, subclause 5.5.3.2.5]

If the tracking area updating cannot be accepted by the network, the MME sends a TRACKING AREA UPDATE REJECT message to the UE including an appropriate EMM cause value.

...

#9 (UE identity cannot be derived by the network);

The UE shall set the EPS update status to EU2 NOT UPDATED (and shall store it according to subclause 5.1.3.3) and shall delete any GUTI, last visited registered TAI, TAI list and eKSI. The UE shall enter the state EMM-DEREGISTERED.

If the rejected request was not for initiating a PDN connection for emergency bearer services, the UE shall subsequently, automatically initiate the attach procedure.

9.3.1.3.3 Test description

9.3.1.3.3.1 Pre test conditions

System Simulator:

- 2 cells
- NGC Cell A as defined in TS 38.508-1 [4] Table 6.3.2.2-1. System information combination NR-6 as defined in TS 38.508-1 [4], subclause 4.4.3.1.2.
- E-UTRA Cell A as defined in TS 36.508 [7] Table 6.3.2.2-1. System information combination 31 as defined in TS 36.508 [7], subclause 4.4.3.1.1.

UE:

None.

Preamble:

- With E-UTRA Cell A "Serving cell" and NGC Cell A "Non-suitable "Off" cell", the UE is brought to state RRC_IDLE using generic procedure parameters Connectivity (*E-UTRA/EPC*) and Unrestricted nr PDN (*On*) in accordance with the procedure described in TS 38.508-1 [4], clause 4.5.2. 4G GUTI and eKSI are assigned and security context established

- the UE is switched-off
- With NGC Cell A "Serving cell" and E-UTRA Cell A "Non-suitable "Off" cell", the UE is brought to state IN-A, RRC_IDLE Connectivity (NR), in accordance with the procedure described in TS 38.508-1 [4], Table 4.5.2.2-2. 5G-GUTI and ngKSI are assigned and security context established.

9.3.1.3.3.2 Test procedure sequence

Table 9.3.1.3.3.2-1: Main behaviour

St	Procedure	Message Sequence		TP	Verdict
		U - S	Message		
1	Wait for 25 seconds (expiry of T3512 periodic registration update timer, the value of 30 sec is provided during the initial registration in the Preamble).	-	-	-	-
2	The UE transmit a REGISTRATION REQUEST message with the 5GS registration type IE indicating "periodic registration updating".	-->	REGISTRATION REQUEST	-	-
3	The SS configures: - E-UTRA Cell A "Suitable neighbour inter-frequency cell".	-	-	-	-
4	The SS transmits a REGISTRATION REJECT message including 5GMM cause value #9 (UE identity cannot be derived by the network).	<--	REGISTRATION REJECT	-	-
4A	The SS configures: - NGC Cell A as "Non-Suitable "Off" cell".	-	-	-	-
5	Check: Does the UE perform on the E-UTRA Cell A an attach procedure as described in TS 38.508-1 [4], Table 4.5.2.2-1? The UE does not provide 4G-GUTI or 4G eKSI; nor last visited registered TAI.	-	-	1	-

9.3.1.3.3.3 Specific message contents

Table 9.3.1.3.3.3-1: REGISTRATION ACCEPT (Preamble; TS 38.508-1 [4] Table 4.5.2.2-2)

Derivation path: TS 38.508-1 [4], Table 4.7.1-7.			
Information Element	Value/remark	Comment	Condition
T3512 value			
Unit	'100'B	value is incremented in multiples of 30 seconds	
Timer value	'0 0001'B	30 seconds	

Table 9.3.1.3.3.3-2: REGISTRATION REQUEST (step 2, Table 9.3.1.3.3.2-1)

Derivation Path: TS 38.508-1 [4], Table 4.7.1-6.			
Information Element	Value/remark	Comment	Condition
5GS registration type	'00xxx011'	periodic registration updating x - not checked	
ngKSI	Active ngKSI assigned in the Preamble		
5GS mobile identity	Active 5G-GUTI assigned in the Preamble		
Last visited registered TAI	The TAI of the NGC Cell A, see TS 38.508-1 [4] Table 6.3.2.2-1		

Table 9.3.1.3.3.3-3: REGISTRATION REJECT (step 4, Table 9.3.1.3.3.2-1)

Derivation Path: TS 38.508-1 [4], Table 4.7.1-9.			
Information Element	Value/remark	Comment	Condition
5GMM cause	'0000 1001'B	#9 - UE identity cannot be derived by the network	

Table 9.3.1.3.3.3-4: ATTACH REQUEST (step 5, Table 9.3.1.3.3.2-1; step 5, TS 38.508-1 [4] Table 4.5.2.2-1)

Derivation Path: TS 36.508 [7], Table 4.7.2-4.			
Information Element	Value/remark	Comment	Condition
NAS key set identifier	'111'	no key is available	
EPS mobile identity	IMSI		
Old P-TMSI signature	Not present		
Last visited registered TAI	Not present		
Old location area identification	Not checked		
Old GUTI type	Not present		

10 Session management

10.1 5GS session management

10.1.1 PDU session authentication and authorization

10.1.1.1 PDU session authentication and authorization / During the UE-requested PDU session procedure

10.1.1.1.1 Test Purpose (TP)

(1)

```
with { UE is establishing UE-requested PDU session by sending PDU Session establishment Request message }
ensure that {
  when { UE receives a PDU SESSION AUTHENTICATION COMMAND message }
  then { UE transmits a PDU SESSION AUTHENTICATION COMPLETE message }
}
```

(2)

```
with { PDU session authentication and authorization procedure is performed during the UE-requested PDU session establishment procedure }
ensure that {
  when { UE receives EAP-failure message in the PDU SESSION ESTABLISHMENT REJECT message }
  then { UE consider that the PDU session is not established }
}
```

(3)

```
with { PDU session authentication and authorization procedure is performed during the UE-requested PDU session establishment procedure }
ensure that {
  when { UE receives EAP-success message in the PDU SESSION ESTABLISHMENT ACCEPT message }
```

```
then { UE consider that the PDU session is established }  
}
```

10.1.1.1.2 Conformance requirements

References: The conformance requirements covered in the present TC are specified in: TS 24.501, clause 6.3.1.2.1, 6.3.1.2.2 and 6.4.1.4. Unless otherwise stated these are Rel-15 requirements.

[TS 24.501 clause 6.3.1.2.1]

In order to initiate the PDU EAP message reliable transport procedure, the SMF shall create a PDU SESSION AUTHENTICATION COMMAND message.

The SMF shall set the PTI IE of the PDU SESSION AUTHENTICATION COMMAND message to "No procedure transaction identity assigned".

The SMF shall set the EAP message IE of the PDU SESSION AUTHENTICATION COMMAND message to the EAP-request message provided by the DN or generated locally.

The SMF shall send the PDU SESSION AUTHENTICATION COMMAND message, and the SMF shall start timer T3590 (see example in figure 6.3.1.1).

Upon receipt of a PDU SESSION AUTHENTICATION COMMAND message and a PDU session ID, using the NAS transport procedure as specified in subclause 5.4.5, the UE passes to the upper layers the EAP message received in the EAP message IE of the PDU SESSION AUTHENTICATION COMMAND message. Apart from this action, the authentication and authorization procedure initiated by the DN is transparent to the 5GSM layer of the UE.

[TS 24.501 clause 6.3.1.2.2]

When the upper layers provide an EAP-response message responding to the received EAP-request message, the UE shall create a PDU SESSION AUTHENTICATION COMPLETE message.

The UE shall set the EAP message IE of the PDU SESSION AUTHENTICATION COMPLETE message to the EAP-response message.

The UE shall transport the PDU SESSION AUTHENTICATION COMPLETE message and the PDU session ID, using the NAS transport procedure as specified in subclause 5.4.5. Apart from this action, the authentication and authorization procedure initiated by the DN is transparent to the 5GSM layer of the UE.

Upon receipt of a PDU SESSION AUTHENTICATION COMPLETE message, the SMF shall stop timer T3590 and provides the EAP message received in the EAP message IE of the PDU SESSION AUTHENTICATION COMPLETE message to the DN or handles it locally.

[TS 24.501 clause 6.4.1.4]

If the connectivity with the requested DN is rejected by the network, the SMF shall create a SM PDU SESSION ESTABLISHMENT REJECT message.

The SMF shall set the 5GSM cause IE of the PDU SESSION ESTABLISHMENT REJECT message to indicate the reason for rejecting the PDU session establishment.

The 5GSM cause IE typically indicates one of the following SM cause values:

- #8 operator determined barring;
- #26 insufficient resources;
- #27 missing or unknown DNN;
- #28 unknown PDU session type;
- #29 user authentication or authorization failed;

10.1.1.1.3 Test description

10.1.1.1.3.1 Pre-test conditions

System Simulator:

NGC Cell A

UE:

None.

Preamble:

The UE is in state 1N-A with PDU session Active state using the generic procedure NR RRC_IDLE according to TS 38.508-1 [4].

10.1.1.1.3.2 Test procedure sequence

Table 10.1.1.1.3.2-1: Main behaviour

St	Procedure	Message Sequence		TP	Verdict
		U - S	Message		
1	Cause the UE to request connectivity to an additional PDU session. (see Note 1)	-	-	-	-
2-2A	Steps 2-3 of the generic procedure for NR RRC_Connected specified in TS 38.508-1 [4] Table 4.5.4.2-3 are performed.	-	-	-	-
2B	The UE transmits an <i>RRCSetupComplete</i> message and a SERVICE REQUEST message with service type IE set to "signalling".	-->	SERVICE REQUEST	-	-
3-3A	Steps 5 and 6 of the generic procedure for NR RRC_Connected specified in TS 38.508-1 [4] Table 4.5.4.2-3 are performed.	-	-	-	-
4	The SS transmits an <i>RRCReconfiguration</i> message and a SERVICE ACCEPT message to establish SRB2 and DRB.	<--	NR RRC: RRCReconfiguration 5GMM: SERVICE ACCEPT	-	-
4A	The UE transmits an <i>RRCReconfigurationComplete</i> message.	-->	NR RRC: RRCReconfigurationComplete	-	-
5	The UE transmits a PDU SESSION ESTABLISHMENT REQUEST message to request an additional PDU session. Note: PDU SESSION ESTABLISHMENT REQUEST is included in UL NAS transport. UL NAS transport message is included in dedicatedNAS-Message of <i>ULInformationTransfer</i> message. DNN information is included in UL NAS transport message.	-->	5GMM: UL NAS TRANSPORT 5GSM: PDU SESSION ESTABLISHMENT REQUEST	-	-
6	The SS transmits PDU SESSION AUTHENTICATION COMMAND including an EAP-Request message.	<--	PDU SESSION AUTHENTICATION COMMAND		
7	Check: Does the UE transmit a PDU SESSION AUTHENTICATION COMPLETE containing EAP-Response message?	-->	PDU SESSION AUTHENTICATION COMPLETE	1	P
8	The SS transmits PDU SESSION ESTABLISHMENT REJECT message with 5GSM cause #29 including an EAP-Failure message.	<--	PDU SESSION ESTABLISHMENT REJECT		
9	The SS releases the RRC connection.	-		-	-
10	Cause the UE to request connectivity to an additional PDU session. (see Note 1)	-	-	-	-
11-11A	Steps 2-3 of the generic procedure for NR RRC_Connected specified in TS 38.508-1 [4] Table 4.5.4.2-3 are performed.	-	-	-	-
11B	The UE transmits an <i>RRCSetupComplete</i> message and a SERVICE REQUEST message with service type IE set to "signalling".	-->	SERVICE REQUEST	-	-

12-12A	Steps 5 and 6 of the generic procedure for NR RRC_Connected specified in TS 38.508-1 [4] Table 4.5.4.2-3 are performed.	-	-	-	-
13	The SS transmits an RRCReconfiguration message and a SERVICE ACCEPT message to establish SRB2 and DRB.	<--	NR RRC: RRCReconfiguration 5GMM: SERVICE ACCEPT	-	-
13A	The UE transmits an RRCReconfigurationComplete message.	-->	NR RRC: RRCReconfigurationComplete	-	-
14	The UE transmits a PDU SESSION ESTABLISHMENT REQUEST message to request an additional PDU session. Note: PDU SESSION ESTABLISHMENT REQUEST is included in UL NAS transport. UL NAS transport message is included in dedicatedNAS-Message of ULInformationTransfer message DNN information is included in UL NAS transport message.	-->	5GMM: UL NAS TRANSPORT 5GSM: PDU SESSION ESTABLISHMENT REQUEST	2	P
15	The SS transmits PDU SESSION AUTHENTICATION COMMAND including an EAP-Request message.	<--	PDU SESSION AUTHENTICATION COMMAND		
16	Check: Does the UE transmit a PDU SESSION AUTHENTICATION COMPLETE containing EAP-Response message?	-->	PDU SESSION AUTHENTICATION COMPLETE	-	-
17	The SS transmits RRCReconfiguration message containing PDU SESSION ESTABLISHMENT ACCEPT message containing an EAP-Success message.	<--	PDU SESSION ESTABLISHMENT ACCEPT		
18	The UE transmits RRCReconfigurationComplete message to confirm the establishment of DRB.	-	-	3	P
-	EXCEPTION: Step 19a1 describes behaviour depending UE implementation; the "lower case letter" identifies a step sequence that take place if the UE performs a specific action.	-	-	-	-
19a1	If initiated by the UE, the generic procedure for IP address allocation in the user plane, specified in clause 4.5A.3 of TS 38.508-1 [4], takes place performing IP address allocation in the user plane.	-	-	-	-
20	The SS releases the RRC connection.	-		-	-
Note 1: The request of connectivity to an additional PDU session may be performed by MMI or AT command +CGACT.					

10.1.1.1.3.3 Specific message contents

Table 10.1.1.1.3.3-1: Void

Table 10.1.1.1.3.3-2: Void

Table 10.1.1.1.3.3-3: PDU SESSION ESTABLISHMENT REQUEST (step 5 and 14, Table 10.1.1.1.3.2-1)

Derivation path: TS 38.508-1 [4], Table 4.7.2-1			
Information Element	Value/remark	Comment	Condition
PDU session ID	PSI-1	UE assigns a particular PSI not yet used between 1 and 15	
PTI	PTI-1	UE assigns a particular PTI not yet used between 1 and 254	

Table 10.1.1.1.3.3-4: UL NAS Transport (step 5 and 14, Table 10.1.1.1.3.2-1)

Derivation path: TS 38.508-1 [4], Table 4.7.1-10			
Information Element	Value/remark	Comment	Condition
Payload container type	'0001'B	N1 SM information	
PDU session ID	PSI-1		
Request type	'001'B	Initial request	
S-NSSAI	Not Present		
DNN	DNN-1 (New DNN name)	The requested DNN is different from default DNN.	

Table 10.1.1.1.3.3-5: PDU SESSION ESTABLISHMENT REJECT (step 8, Table 10.1.1.1.3.2-1)

Derivation path: TS 38.508-1 [4], Table 4.7.2-3			
Information Element	Value/remark	Comment	Condition
PDU session ID	PSI-1		
PTI	PTI-1		
5GSM cause	'00011101'	User authentication or authorization failed	

Table 10.1.1.1.3.3-6: PDU SESSION ESTABLISHMENT ACCEPT (step 17, Table 10.1.1.1.3.2-1)

Derivation path: TS 38.508-1 [4], Table 4.7.2-2			
Information Element	Value/remark	Comment	Condition
PDU session ID	PSI-1		
PTI	PTI-1		
Authorized QoS rules			
QoS rule			
QoS rule identifier	'0000 0001'B		
Rule operation code	'001'B	Create new QoS rule	
DQR bit	'1'B	The QoS rule is the default QoS rule.	
Number of packet filters	'0001'B	1 packet filter	
Packet filter list	See table 4.8.2.1-1	Packet filter list #1	
Packet filter direction	'11'B	bidirectional	
Packet filter identifier	'0000'B	Id 0	
Component type 1 ID	'0000 0001'B	Match-all type	

QoS rule precedence	'0000 0000'B	0	
QoS flow identifier (QFI)	'00 0011'B	QFI 3	
EAP message	Set according to TS 38.508-1 [4] Table 4.7.3.2-3	EAP-Success	
QoS flow description			
QFI	'00 0011'B	QFI 3	
Operation code	'001'B	Create new QoS flow description	
E bit	'1'B	Parameters list is included	
Number of parameters	'00 0001'B	1 parameters	
5QI	'0000 1001'B	5QI 9	
DNN	DNN-1		

10.1.1.2 PDU session authentication and authorization / After the UE-requested PDU session procedure

10.1.1.2.1 Test Purpose (TP)

(1)

```
with { the UE is in 5GMM-REGISTERED state with an established PDU session }
ensure that {
  when { UE receives a PDU SESSION AUTHENTICATION COMMAND message }
  then { UE transmits a PDU SESSION AUTHENTICATION COMPLETE message }
}
```

(2)

```
with { PDU session authentication and authorization procedure is performed after the UE-requested
PDU session establishment procedure }
ensure that {
  when { UE receives EAP-failure message in the PDU SESSION RELEASE COMMAND message }
  then { the 5GSM state of the UE is PDU SESSION INACTIVE state }
}
```

(3)

```
with { PDU session authentication and authorization procedure is performed after the UE-requested
PDU session establishment procedure }
ensure that {
  when { UE receives EAP-success message in the PDU SESSION AUTHENTICATION RESULT message }
  then { the 5GSM state of the UE is PDU SESSION ACTIVE state }
}
```

10.1.1.2.2 Conformance requirements

References: The conformance requirements covered in the present TC are specified in: TS 24.501, clause 6.3.1.1, clause 6.3.1.2.1, 6.3.1.2.2 and 6.3.1.3.1. Unless otherwise stated these are Rel-15 requirements.

[TS 24.501 clause 6.3.1.1]

The purpose of the PDU session authentication and authorization procedure is to enable the DN:

- a) to authenticate the upper layers of the UE, when establishing the PDU session;
- b) to authorize the upper layers of the UE, when establishing the PDU session;
- c) both of the above; or
- d) to re-authenticate the upper layers of the UE after establishment of the PDU session.

The PDU session authentication and authorization procedure can be performed only during or after the UE-requested PDU session procedure establishing a non-emergency PDU session. The PDU session authentication and authorization procedure shall not be performed during or after the UE-requested PDU session establishment procedure establishing an emergency PDU session.

The network authenticates the UE using the Extensible Authentication Protocol (EAP) as specified in IETF RFC 3748 [32].

EAP has defined four types of EAP messages:

- a) an EAP-request message;
- b) an EAP-response message;
- c) an EAP-success message; and
- d) an EAP-failure message.

The EAP-request message is transported from the network to the UE using the PDU SESSION AUTHENTICATION COMMAND message of the PDU EAP message reliable transport procedure.

The EAP-response message to the EAP-request message is transported from the UE to the network using the PDU SESSION AUTHENTICATION COMPLETE message of the PDU EAP message reliable transport procedure.

If the PDU session authentication and authorization procedure is performed during the UE-requested PDU session establishment procedure:

- a) and the DN authentication of the UE completes successfully, the EAP-success message is transported from the network to the UE as part of the UE-requested PDU session establishment procedure in the PDU SESSION ESTABLISHMENT ACCEPT message.
- b) and the DN authentication of the UE completes unsuccessfully, the EAP-failure message is transported from the network to the UE as part of the UE-requested PDU session establishment procedure in the PDU SESSION ESTABLISHMENT REJECT message.

If the PDU session authentication and authorization procedure is performed after the UE-requested PDU session establishment procedure:

- a) and the DN authentication of the UE completes successfully, the EAP-success message is transported from the network to the UE using the PDU SESSION AUTHENTICATION RESULT message of the PDU EAP result message transport procedure.
- b) and the DN authentication of the UE completes unsuccessfully, the EAP-failure message is transported from the network to the UE using the PDU SESSION RELEASE COMMAND message of the network-requested PDU session release procedure.

There can be several rounds of exchange of an EAP-request message and a related EAP-response message for the DN to complete the authentication and authorization of the request for a PDU session (see example in figure 6.3.1.1).

The SMF shall set the authenticator retransmission timer specified in IETF RFC 3748 [34] subclause 4.3 to infinite value.

NOTE: The PDU session authentication and authorization procedure provides a reliable transport of EAP messages and therefore retransmissions at the EAP layer of the SMF do not occur.

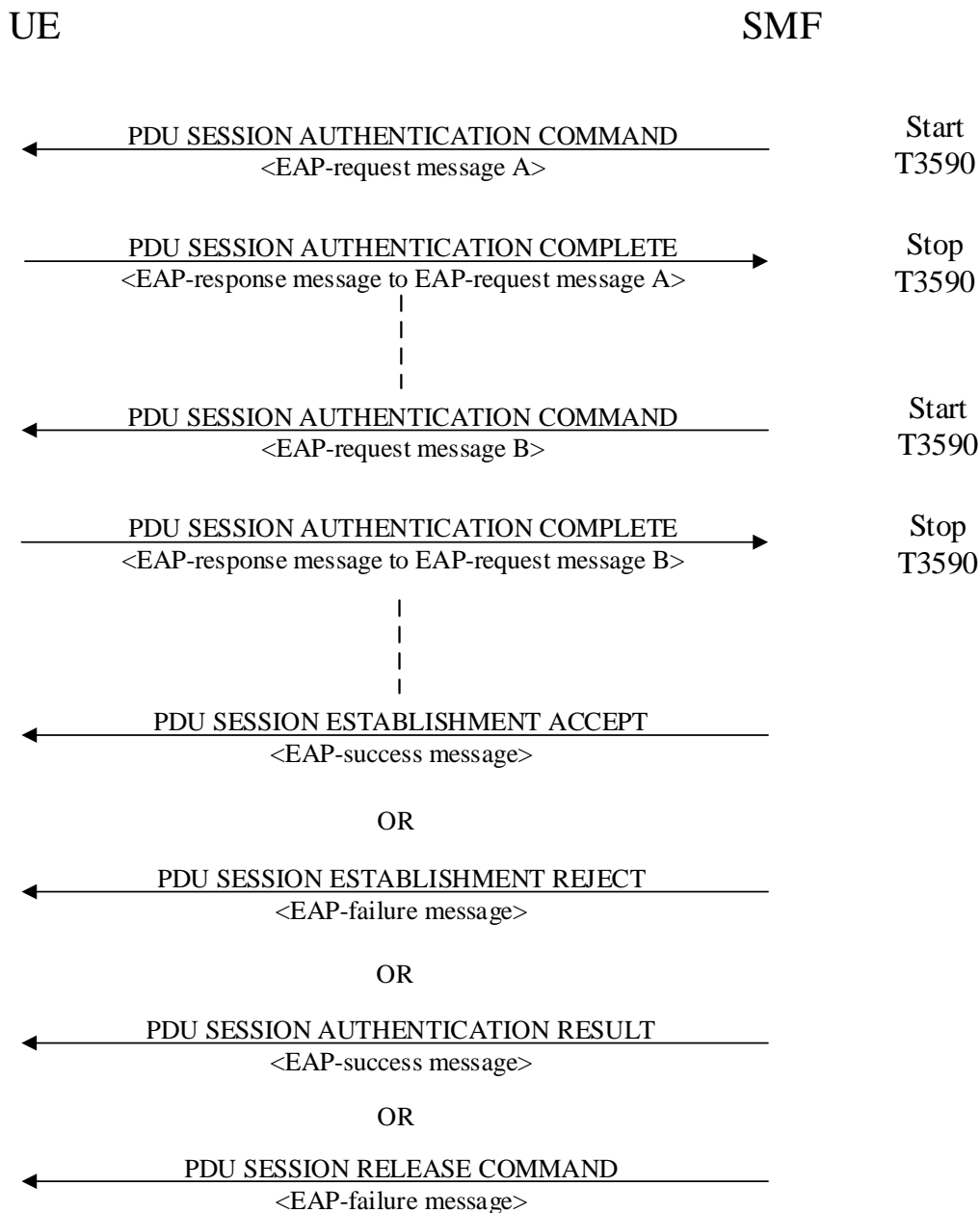

Figure 6.3.1.1: PDU session authentication and authorization procedure

[TS 24.501 clause 6.3.1.2.1]

In order to initiate the PDU EAP message reliable transport procedure, the SMF shall create a PDU SESSION AUTHENTICATION COMMAND message.

The SMF shall set the PTI IE of the PDU SESSION AUTHENTICATION COMMAND message to "No procedure transaction identity assigned".

The SMF shall set the EAP message IE of the PDU SESSION AUTHENTICATION COMMAND message to the EAP-request message provided by the DN or generated locally.

The SMF shall send the PDU SESSION AUTHENTICATION COMMAND message, and the SMF shall start timer T3590 (see example in figure 6.3.1.1).

Upon receipt of a PDU SESSION AUTHENTICATION COMMAND message and a PDU session ID, using the NAS transport procedure as specified in subclause 5.4.5, the UE passes to the upper layers the EAP message received in the

EAP message IE of the PDU SESSION AUTHENTICATION COMMAND message. Apart from this action, the authentication and authorization procedure initiated by the DN is transparent to the 5GSM layer of the UE.

[TS 24.501 clause 6.3.1.2.2]

When the upper layers provide an EAP-response message responding to the received EAP-request message, the UE shall create a PDU SESSION AUTHENTICATION COMPLETE message.

The UE shall set the EAP message IE of the PDU SESSION AUTHENTICATION COMPLETE message to the EAP-response message.

The UE shall transport the PDU SESSION AUTHENTICATION COMPLETE message and the PDU session ID, using the NAS transport procedure as specified in subclause 5.4.5. Apart from this action, the authentication and authorization procedure initiated by the DN is transparent to the 5GSM layer of the UE.

Upon receipt of a PDU SESSION AUTHENTICATION COMPLETE message, the SMF shall stop timer T3590 and provides the EAP message received in the EAP message IE of the PDU SESSION AUTHENTICATION COMPLETE message to the DN or handles it locally.

[TS 24.501 clause 6.3.1.3.1]

In order to initiate the PDU EAP result message transport procedure, the SMF shall create a PDU SESSION AUTHENTICATION RESULT message.

The SMF shall set the PTI IE of the PDU SESSION AUTHENTICATION RESULT message to "No procedure transaction identity assigned".

The SMF shall set the EAP message IE of the PDU SESSION AUTHENTICATION RESULT message to the EAP-success message provided by the DN.

The SMF shall send the PDU SESSION AUTHENTICATION RESULT message.

Upon receipt of a PDU SESSION AUTHENTICATION RESULT message and a PDU session ID, using the NAS transport procedure as specified in subclause 5.4.5, the UE passes to the upper layers the EAP message received in the EAP message IE of the PDU SESSION AUTHENTICATION RESULT message. Apart from this action, the authentication and authorization procedure initiated by the DN is transparent to the 5GSM layer of the UE.

10.1.1.2.3 Test description

10.1.1.2.3.1 Pre-test conditions

System Simulator:

NGC Cell A

UE:

None.

Preamble:

The UE is in state 3N-A, on NGC Cell A with at least one PDU Session X ($1 \leq X \leq 15$) active according to TS 38.508-1 [4].

10.1.1.2.3.2 Test procedure sequence

Table 10.1.1.2.3.2-1: Main behaviour

St	Procedure	Message Sequence		TP	Verdict
		U - S	Message		
0A	Cause the UE to request establishment of PDU session Y to the DN.(Note 1)	-		-	-
0B	The PDU session establishment procedure as specified in TS 38.508-1 [4] subclause 4.5A.2 take place.	-		-	-
1	The SS transmits PDU SESSION	<--	PDU SESSION	-	-

	AUTHENTICATION COMMAND including an EAP-Request message.		AUTHENTICATION COMMAND		
2	Check: Does the UE transmit a PDU SESSION AUTHENTICATION COMPLETE containing EAP-Response message?	-->	PDU SESSION AUTHENTICATION COMPLETE	1	P
3	The SS transmits PDU SESSION AUTHENTICATION RESULT message containing an EAP-Success message.	<--	PDU SESSION AUTHENTICATION RESULT	-	-
4	The SS transmits PDU SESSION AUTHENTICATION COMMAND including an EAP-Request message.	<--	PDU SESSION AUTHENTICATION COMMAND	-	-
5	Check: Does the UE transmit a PDU SESSION AUTHENTICATION COMPLETE containing EAP-Response message?	-->	PDU SESSION AUTHENTICATION COMPLETE	3	P
6 - 17	Void	-	-	-	-
18	Check: Does the UE perform PDU session release procedure defined in clause 4.9.21 of TS 38.508-1 [4] with PDU SESSION RELEASE COMMAND including 5GSM cause #29 "user authentication or authorization failed"?	-	-	2-	P
19	Void	-	-	-	-
Note 1: The request of connectivity to an additional PDU session may be performed by MMI or AT command.					

10.1.1.2.3.3 Specific message contents

Table 10.1.1.2.3.3-1: PDU SESSION ESTABLISHMENT ACCEPT (step 0B, Table 10.1.1.2.3.2-1; step 3, Table 4.5A.2.2.2-1, TS 38.508-1 [4])

Derivation path: TS 38.508-1 [4], Table 4.7.2-2			
Information Element	Value/remark	Comment	Condition
Authorized QoS rules	5GC QoS rule of the Config#1 in Table 4.8.4-1		
Mapped EPS bearer contexts			
Mapped EPS bearer context			
Mapped EPS QoS parameters	EPC default bearer context of the Config#1 in Table 4.8.4-1		
DNN	The same DNN value as sent in the UL NAS TRANSPORT message at (step 0B, Table 10.1.1.2.3.2-1; step 2a1, Table 4.5A.2.2.2-2, TS 38.508-1[4])		

Table 10.1.1.2.3.3-2: Void

Table 10.1.1.2.3.3-2A: PDU SESSION AUTHENTICATION RESULT (step 3, Table 10.1.1.2.3.2-1)

Derivation Path: TS 38.508-1 table 4.7.2-6			
Information Element	Value/remark	Comment	Condition
EAP message	EAP-success	See TS 24.501	

		[25] subclause 9.11.2.2	
--	--	----------------------------	--

Table 10.1.1.2.3.3-3: Void**Table 10.1.1.2.3.3-3A: Void****Table 10.1.1.2.3.3-4: Void****Table 10.1.1.2.3.3-5: PDU SESSION RELEASE COMMAND (step 18, Table 10.1.1.2.3.2-1; step 1, TS 36.508 [4] Table 4.9.21.2.2-1)**

Derivation Path: TS 38.508-1 [4] Table 4.7.2-14			
Information Element	Value/remark	Comment	Condition
PDU session ID	The same ID as the ID of PDU session which UE request in step 13 in Table 10.1.1.2.3.2-1		
5GSM cause	'0001 1101'B	user authentication or authorization failed	
Back-off timer value	'1010 0000'B	0 minutes	
EAP Message	EAP-Failure	See TS 24.501 [25] subclause 9.11.2.2	

10.1.2 Network-requested PDU session modification

10.1.2.1 Network-requested PDU session modification / Accepted

10.1.2.1.1 Test Purpose (TP)

(1)

```

with { the UE in 5GMM-REGISTERED state with an established PDU session }
ensure that {
  when { the UE receives a PDU SESSION MODIFICATION COMMAND message }
  then { UE sends a PDU SESSION MODIFICATION COMPLETE message and modifies the PDU session accordingly }
}

```

(2)

```

with { the UE in 5GMM-REGISTERED state with an established PDU session has been modified }
ensure that {
  when { the UE has IP packets for transmission where each IP packet matches the modified packet filters configured in the UL TFTs for the PDU session }
  then { the UE evaluates the packet filters in the correct evaluation order and transmits IP packets in uplink on the dedicated PDU session associated with the matched packet filter }
}

```

10.1.2.1.2 Conformance requirements

References: The conformance requirements covered in the present TC are specified in: TS 24.501, clauses 6.3.2.3 and TS 24.008, clause 10.5.6.12. Unless otherwise stated these are Rel-15 requirements.

[TS 24.501, clause 6.3.2.3]

Upon receipt of the PDU SESSION MODIFICATION COMMAND message, if the UE provided a DNN during the PDU session establishment, the UE shall stop timer T3396, if it is running for the DNN provided by the UE. If the UE did not provide a DNN during the PDU session establishment and the request type was different from "initial emergency request" and different from "existing emergency PDU session", the UE shall stop the timer T3396 associated with no DNN if it is running. If the PDU SESSION MODIFICATION COMMAND message was received for an emergency PDU session, the UE shall not stop the timer T3396 associated with no DNN if it is running.

Upon receipt of the PDU SESSION MODIFICATION COMMAND message, if the UE provided an S-NSSAI and a DNN during the PDU session establishment, the UE shall stop timer T3584, if it is running for the same [S-NSSAI, DNN] combination provided by the UE. If the UE did not provide an S-NSSAI during the PDU session establishment, the UE shall stop timer T3584, if it is running for the same [no S-NSSAI, DNN] combination provided by the UE. If the UE provided neither a DNN nor an S-NSSAI during the PDU session establishment, the UE shall stop timer T3584, if it is running for the same [no S-NSSAI, no DNN] combination provided by the UE.

Upon receipt of the PDU SESSION MODIFICATION COMMAND message, if the UE provided an S-NSSAI during the PDU session establishment, the UE shall stop timer T3585, if it is running for the S-NSSAI provided by the UE. If the UE did not provide an S-NSSAI during the PDU session establishment and the request type was different from "initial emergency request" and different from "existing emergency PDU session", the UE shall stop the timer T3585 associated with no S-NSSAI if it is running. If the PDU SESSION MODIFICATION COMMAND message was received for an emergency PDU session, the UE shall not stop the timer T3585 associated with no S-NSSAI if it is running.

NOTE 1: Upon receipt of the PDU SESSION MODIFICATION COMMAND message for a PDU session, if the UE provided a DNN (or no DNN) and an S-NSSAI (or no S-NSSAI) when the PDU session is established, timer T3396 associated with the DNN (or no DNN, if no DNN was provided by the UE) is running, and timer T3584 associated with the DNN (or no DNN, if no DNN was provided by the UE) and the S-NSSAI (or no S-NSSAI, if no S-NSSAI was provided by the UE) is running, then the UE stops both the timer T3396 and the timer T3584.

NOTE 2: Upon receipt of the PDU SESSION MODIFICATION COMMAND message for a PDU session, if the UE provided a DNN (or no DNN) and an S-NSSAI (or no S-NSSAI) when the PDU session is established, timer T3585 associated with the S-NSSAI (or no S-NSSAI, if no S-NSSAI was provided by the UE) is running, and timer T3584 associated with the DNN (or no DNN, if no DNN was provided by the UE) and the S-NSSAI (or no S-NSSAI, if no S-NSSAI was provided by the UE) is running, then the UE stops both the timer T3585 and the timer T3584.

If the PDU SESSION MODIFICATION COMMAND message includes the Authorized QoS rules IE, the UE shall process the QoS rules sequentially starting with the first QoS rule.

The UE shall replace the stored authorized QoS rules, authorized QoS flow descriptions and session-AMBR of the PDU session with the received value(s), if any, in the PDU SESSION MODIFICATION COMMAND message.

If the PDU SESSION MODIFICATION COMMAND message includes a Mapped EPS bearer contexts IE, the UE shall check each mapped EPS bearer context for different types of errors as follows:

NOTE 3: An error detected in a mapped EPS bearer context does not cause the UE to discard the Authorized QoS rules IE and Authorized QoS flow descriptions IE included in the PDU SESSION MODIFICATION COMMAND message, if any.

a) Semantic error in the mapped EPS bearer operation:

- 1) operation code = "Create new EPS bearer" and there is already an existing mapped EPS bearer context with the same EPS bearer identity associated with any PDU session.
- 2) operation code = "Delete existing EPS bearer" and there is no existing mapped EPS bearer context with the same EPS bearer identity associated with the PDU session that is being modified.
- 3) operation code = "Modify existing EPS bearer" and there is no existing mapped EPS bearer context with the same EPS bearer identity associated with the PDU session that is being modified.

In case 1, if the existing mapped EPS bearer context is associated with the PDU session that is being modified, the UE shall not diagnose an error, further process the create request and, if it was process successfully, delete the old EPS bearer context.

In case 2, the UE shall not diagnose an error, further process the delete request and, if it was processed successfully, consider the mapped EPS bearer context as successfully deleted.

Otherwise, after sending the PDU SESSSION MODIFICATION COMPLETE for the ongoing PDU session modification procedure, the UE shall initiate a PDU session modification procedure by sending a PDU SESSION MODIFICATION REQUEST message to delete the mapped EPS bearer context with 5GSM cause #85 "Invalid mapped EPS bearer identity".

b) if the mapped EPS bearer context includes a traffic flow template, the UE shall check the traffic flow template for different types of TFT IE errors as follows:

2) Semantic errors in TFT operations:

- i) TFT operation = "Create a new TFT" when there is already an existing TFT for the EPS bearer context.
- ii) When the TFT operation is an operation other than "Create a new TFT" and there is no TFT for the EPS bearer context.
- iii) TFT operation = "Delete packet filters from existing TFT" when it would render the TFT empty.
- iv) TFT operation = "Delete existing TFT" for a dedicated EPS bearer context.

In case iv, after sending the PDU SESSSION MODIFICATION COMPLETE for the ongoing PDU session modification procedure, the UE shall initiate a PDU session modification procedure by sending a PDU SESSION MODIFICATION REQUEST message to delete the mapped EPS bearer context with 5GSM cause #41 "semantic error in the TFT operation".

In the other cases the UE shall not diagnose an error and perform the following actions to resolve the inconsistency:

In case i, the UE shall further process the new activation request and, if it was processed successfully, delete the old TFT.

In case ii, the UE shall:

- process the new request and if the TFT operation is "Delete existing TFT" or "Delete packet filters from existing TFT", and if no error according to items b, c, and d was detected, consider the TFT as successfully deleted;
- process the new request as an activation request, if the TFT operation is "Add packet filters in existing TFT" or "Replace packet filters in existing TFT".

In case iii, if the packet filters belong to a dedicated EPS bearer context, the UE shall process the new deletion request and, if no error according to items b, c, and d was detected, after sending the PDU SESSSION MODIFICATION COMPLETE for the ongoing PDU session modification procedure, the UE shall initiate a PDU session modification procedure by sending a PDU SESSION MODIFICATION REQUEST message to delete the mapped EPS bearer context with 5GSM cause #41 "semantic error in the TFT operation".

In case iii, if the packet filters belong to the default EPS bearer context, the UE shall process the new deletion request and if no error according to items b, c, and d was detected then delete the existing TFT, this corresponds to using match-all packet filter for the default EPS bearer context.

2) Syntactical errors in TFT operations:

- i) When the TFT operation = "Create a new TFT", "Add packet filters in existing TFT", "Replace packet filters in existing TFT" or "Delete packet filters from existing TFT" and the packet filter list in the TFT IE is empty.
- ii) TFT operation = "Delete existing TFT" or "No TFT operation" with a non-empty packet filter list in the TFT IE.
- iii) TFT operation = "Replace packet filters in existing TFT" when the packet filter to be replaced does not exist in the original TFT.

- iv) TFT operation = "Delete packet filters from existing TFT" when the packet filter to be deleted does not exist in the original TFT.
- v) TFT operation = "Delete packet filters from existing TFT" with a packet filter list also including packet filters in addition to the packet filter identifiers.
- vi) When there are other types of syntactical errors in the coding of the TFT IE, such as a mismatch between the number of packet filters subfield, and the number of packet filters in the packet filter list.

In case iii, the UE shall not diagnose an error, further process the replace request and, if no error according to items c and d was detected, include the packet filters received to the existing TFT.

In case iv, the UE shall not diagnose an error, further process the deletion request and, if no error according to items c and d was detected, consider the respective packet filter as successfully deleted.

Otherwise, after sending the PDU SESSSION MODIFICATION COMPLETE for the ongoing PDU session modification procedure, the UE shall initiate a PDU session modification procedure by sending a PDU SESSION MODIFICATION REQUEST message to delete the mapped EPS bearer context with 5GSM cause #42 "syntactical error in the TFT operation".

3) Semantic errors in packet filters:

- i) When a packet filter consists of conflicting packet filter components which would render the packet filter ineffective, i.e. no IP packet will ever fit this packet filter. How the UE determines a semantic error in a packet filter is outside the scope of the present document.
- ii) When the resulting TFT, which is assigned to a dedicated EPS bearer context, does not contain any packet filter applicable for the uplink direction among the packet filters created on request from the network.

After sending the PDU SESSSION MODIFICATION COMPLETE for the ongoing PDU session modification procedure, the UE shall initiate a PDU session modification procedure by sending a PDU SESSION MODIFICATION REQUEST message to delete the mapped EPS bearer context with 5GSM cause #44 "semantic errors in packet filter(s)".

4) Syntactical errors in packet filters:

- i) When the TFT operation = "Create a new TFT", "Add packet filters to existing TFT", and two or more packet filters in the resultant TFT would have identical packet filter identifiers.
- ii) When the TFT operation = "Create a new TFT", "Add packet filters to existing TFT" or "Replace packet filters in existing TFT", and two or more packet filters among all TFTs associated with this PDN connection would have identical packet filter precedence values.
- iii) When there are other types of syntactical errors in the coding of packet filters, such as the use of a reserved value for a packet filter component identifier.

In case i, if two or more packet filters with identical packet filter identifiers are contained in the new request, after sending the PDU SESSSION MODIFICATION COMPLETE for the ongoing PDU session modification procedure, the UE shall initiate a PDU session modification procedure by sending a PDU SESSION MODIFICATION REQUEST message to delete the mapped EPS bearer context with 5GSM cause #45 "syntactical error in packet filter(s)". Otherwise, the UE shall not diagnose an error, further process the new request and, if it was processed successfully, delete the old packet filters which have the identical packet filter identifiers.

In case ii, if the old packet filters do not belong to the default EPS bearer context, the UE shall not diagnose an error, shall further process the new request and, if it was processed successfully, shall delete the old packet filters which have identical filter precedence values.

In case ii, if one or more old packet filters belong to the default EPS bearer context, after sending the PDU SESSSION MODIFICATION COMPLETE for the ongoing PDU session modification procedure, the UE shall initiate a PDU session modification procedure by sending a PDU SESSION MODIFICATION REQUEST message to delete the mapped EPS bearer context with 5GSM cause #45 "syntactical errors in packet filter(s)".

Otherwise, after sending the PDU SESSION MODIFICATION COMPLETE for the ongoing PDU session modification procedure, the UE shall initiate a PDU session modification procedure by sending a PDU SESSION MODIFICATION REQUEST message to delete the mapped EPS bearer context with 5GSM cause #45 "syntactical error in packet filter(s)".

And if a new EPS bearer identity parameter in authorized QoS flow descriptions IE is received for a QoS flow which can be transferred to EPS, the UE shall update the association between the QoS flow and the mapped EPS bearer context, based on the new EPS bearer identity and the mapped EPS bearer contexts. If the "Delete existing EPS bearer" operation code in the Mapped EPS bearer contexts IE was received, the UE shall discard the association between the QoS flow and the corresponding mapped EPS bearer context.

Upon receipt of a PDU SESSION MODIFICATION COMMAND message and a PDU session ID, using the NAS transport procedure as specified in subclause 5.4.5, if the UE accepts the PDU SESSION MODIFICATION COMMAND message, the UE considers the PDU session as modified and the UE shall create a PDU SESSION MODIFICATION COMPLETE message.

If the PDU SESSION MODIFICATION COMMAND message contains the PTI value allocated in the UE-requested PDU session modification procedure, the UE shall stop the timer T3581. The UE should ensure that the PTI value assigned to this procedure is not released immediately.

NOTE 4: The way to achieve this is implementation dependent. For example, the UE can ensure that the PTI value assigned to this procedure is not released during the time equal to or greater than the default value of timer T3591.

While the PTI value is not released, the UE regards any received PDU SESSION MODIFICATION COMMAND message with the same PTI value as a network retransmission (see subclause 7.3.1).

If the selected SSC mode of the PDU session is "SSC mode 3" and the PDU SESSION MODIFICATION COMMAND message includes 5GSM cause #39 "reactivation requested", the UE can provide to the upper layers the PDU session address lifetime if received in the PDU session address lifetime PCO parameter of the Extended protocol configuration options IE of the PDU SESSION MODIFICATION COMMAND message. After the completion of the network-requested PDU session modification procedure, the UE should re-initiate the UE-requested PDU session establishment procedure with a new PDU session ID as specified in subclause 6.4.1 for:

- a) the PDU session type associated with the present PDU session;
- b) the SSC mode associated with the present PDU session;
- c) the DNN associated with the present PDU session; and
- d) the S-NSSAI associated with (if available in roaming scenarios) a mapped S-NSSAI if provided in the UE-requested PDU session establishment procedure of the present PDU session.

The UE shall include the PDU session ID of the old PDU session which is about to get released in the old PDU session ID IE of the UL NAS TRANSPORT message that transports the PDU SESSION ESTABLISHMENT REQUEST message.

NOTE 5: The UE is expected to maintain the PDU session for which the PDU SESSION MODIFICATION COMMAND message including 5GSM cause #39 "reactivation requested" is received during the time indicated by the PDU session address lifetime value or until receiving an indication from upper layers (e.g. that the old PDU session is no more needed).

If the selected PDU session type of the PDU session is "Unstructured" or "Ethernet", the UE supports inter-system change from N1 mode to S1 mode, the UE does not support establishment of a PDN connection for the PDN type set to "non-IP" in S1 mode, and the parameters list field of one or more authorized QoS flow descriptions received in the authorized QoS flow descriptions IE of the PDU SESSION MODIFICATION COMMAND message contains an EPS bearer identity (EBI) then the UE shall locally remove the EPS bearer identity (EBI) from the parameters list field of such one or more authorized QoS flow descriptions.

If the Always-on PDU session indication IE is included in the PDU SESSION MODIFICATION COMMAND message and:

- a) the value of the IE is set to "Always-on PDU session required", the UE shall consider the established PDU session as an always-on PDU session; or

- b) the value of the IE is set to "Always-on PDU session not allowed", the UE shall not consider the established PDU session as an always-on PDU session.

If the UE does not receive the Always-on PDU session indication IE in the PDU SESSION MODIFICATION COMMAND message:

- a) if the network-requested PDU session modification procedure is triggered by a UE-requested PDU session modification procedure upon the first inter-system change from S1 mode to N1 mode for a PDN connection established when in S1 mode, the UE shall not consider the modified PDU session as an always-on PDU session; or
- b) otherwise:
- 1) if the UE has received the Always-on PDU session indication IE with the value set to "Always-on PDU session required" for this PDU session, the UE shall consider the PDU session as an always-on PDU session; or
 - 2) otherwise the UE shall not consider the PDU session as an always-on PDU session.

The UE shall transport the PDU SESSION MODIFICATION COMPLETE message and the PDU session ID, using the NAS transport procedure as specified in subclause 5.4.5.

After sending the PDU SESSION MODIFICATION COMPLETE message, if the "Create new EPS bearer" operation code in the mapped EPS bearer contexts IE was received in the PDU SESSION MODIFICATION COMMAND message and there is neither a corresponding authorized QoS flow descriptions IE in the PDU SESSION MODIFICATION COMMAND message nor an existing QoS flow description corresponding to the EPS bearer identity included in the mapped EPS bearer context, the UE shall send a PDU SESSION MODIFICATION REQUEST message including a mapped EPS bearer contexts IE to delete the mapped EPS bearer context.

Upon receipt of a PDU SESSION MODIFICATION COMPLETE message, the SMF shall stop timer T3591 and shall consider the PDU session as modified. If the selected SSC mode of the PDU session is "SSC mode 3" and the PDU SESSION MODIFICATION COMMAND message included 5GSM cause #39 "reactivation requested", the SMF shall start timer T3593. If the PDU Session Address Lifetime value is sent to the UE in the PDU SESSION MODIFICATION COMMAND message then timer T3593 shall be started with the same value, otherwise it shall use a default value.

[TS 24.008, clause 10.5.6.12]

The purpose of the *traffic flow template* information element is to specify the TFT parameters and operations for a PDP context. In addition, this information element may be used to transfer extra parameters to the network (e.g. the Authorization Token; see 3GPP TS 24.229 [95]). The TFT may contain packet filters for the downlink direction, the uplink direction or packet filters that are applicable to both directions. The packet filters determine the traffic mapping to PDP contexts. The downlink packet filters shall be used by the network and the uplink packet filters shall be used by the MS. A packet filter that is applicable to both directions shall be used by the network as a downlink packet filter and by the MS as an uplink packet filter.

The *traffic flow template* is a type 4 information element with a minimum length of 3 octets. The maximum length for the IE is 257 octets.

NOTE 1: The IE length restriction is due to the maximum length that can be encoded in a single length octet.

NOTE 2: A maximum size IPv4 packet filter can be 32 bytes. Therefore, 7 maximum size IPv4 type packet filters, plus the last packet filter which can contain max 30 octets can fit into one TFT IE, i.e. if needed not all packet filter components can be defined into one message. A maximum size IPv6 packet filter can be 60 bytes. Therefore, only 4 maximum size IPv6 packet filters can fit into one TFT IE. However, using "Add packet filters to existing TFT", it's possible to create a TFT data structure including 16 maximum size IPv4 or IPv6 filters.

The *traffic flow template* information element is coded as shown in figure 10.5.144/3GPP TS 24.008 and table 10.5.162/3GPP TS 24.008.

NOTE 3: The 3GPP TS 24.301 [120] reuses the traffic flow template information element for the purpose of the traffic flow aggregate description, where the use of individual TFT parameters, e.g. the packet filter identifier in the parameter list, can differ from this specification.

8	7	6	5	4	3	2	1
---	---	---	---	---	---	---	---

Traffic flow template IEI			Octet 1
Length of traffic flow template IE			Octet 2
TFT operation code	E bit	Number of packet filters	Octet 3
Packet filter list			Octet 4
			Octet z
Parameters list			Octet z+1
			Octet v

Figure 10.5.144/3GPP TS 24.008: *Traffic flow template information element*

8	7	6	5	4	3	2	1	
0	0	0	0	Packet filter identifier 1				Octet 4
Spare								
0	0	0	0	Packet filter identifier 2				Octet 5
Spare								
...								
0	0	0	0	Packet filter identifier N				Octet N+3
Spare								

Figure 10.5.144a/3GPP TS 24.008: *Packet filter list* when the TFT operation is "delete packet filters from existing TFT" (z=N+3)

8	7	6	5	4	3	2	1	
0	0	Packet filter direction 1		Packet filter identifier 1				Octet 4
Spare								
Packet filter evaluation precedence 1								Octet 5
Length of Packet filter contents 1								Octet 6
Packet filter contents 1								Octet 7
								Octet m
0	0	Packet filter direction 2		Packet filter identifier 2				Octet m+1
Spare								
Packet filter evaluation precedence 2								Octet m+2
Length of Packet filter contents 2								Octet m+3
Packet filter contents 2								Octet m+4
								Octet n
...								Octet n+1
								Octet y
0	0	Packet filter direction N		Packet filter identifier N				Octet y+1
Spare								
Packet filter evaluation precedence N								Octet y+2
Length of Packet filter contents N								Octet y+3
Packet filter contents N								Octet y+4
								Octet z

Figure 10.5.144b/3GPP TS 24.008: *Packet filter list* when the TFT operation is "create new TFT", or "add packet filters to existing TFT" or "replace packet filters in existing TFT"

8	7	6	5	4	3	2	1	
Parameter identifier 1								Octet z+1
Length of Parameter contents 1								Octet z+2
Parameter contents 1								Octet z+3
								Octet k
Parameter identifier 2								Octet k+1
Length of Parameter contents 2								Octet k+2
Parameter contents 2								Octet k+3
								Octet p
...								Octet p+1
								Octet q
Parameter identifier N								Octet q+1
Length of Parameter contents N								Octet q+2

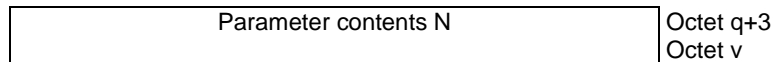
Figure 10.5.144c/3GPP TS 24.008: *Parameters list*Table 10.5.162/3GPP TS 24.008: *Traffic flow template information element*

<p>TFT operation code (octet 3)</p> <p>Bits</p> <p>8 7 6</p> <p>0 0 0 Ignore this IE</p> <p>0 0 1 Create new TFT</p> <p>0 1 0 Delete existing TFT</p> <p>0 1 1 Add packet filters to existing TFT</p> <p>1 0 0 Replace packet filters in existing TFT</p> <p>1 0 1 Delete packet filters from existing TFT</p> <p>1 1 0 No TFT operation</p> <p>1 1 1 Reserved</p> <p>The TFT operation code "No TFT operation" shall be used if a <i>parameters list</i> is included but no <i>packet filter list</i> is included in the <i>traffic flow template</i> information element.</p> <p>The TFT operation code "Ignore this IE" shall be used by the MS if the Traffic flow aggregate information element has presence requirement "M" in a message, but the information element does not serve any useful purpose in the specific procedure for which the message is sent (see 3GPP TS 24.301 [120], subclauses 6.5.3.2 and 6.5.4.2). If the TFT operation code indicates "Ignore this IE", the MS shall also set the E bit and the number of packet filters to zero.</p> <p>If the TFT operation code is set to "Ignore this IE" and the E bit and the number of packet filters to zero, then the network shall ignore the contents of the traffic flow template information element.</p> <p>E bit (bit 5 of octet 3)</p> <p>The <i>E bit</i> indicates if a <i>parameters list</i> is included in the TFT IE and it is encoded as follows:</p> <p>0 <i>parameters list</i> is not included</p> <p>1 <i>parameters list</i> is included</p> <p>Number of packet filters (octet 3)</p> <p>The <i>number of packet filters</i> contains the binary coding for the number of packet filters in the <i>packet filter list</i>. The <i>number of packet filters</i> field is encoded in bits 4 through 1 of octet 3 where bit 4 is the most significant and bit 1 is the least significant bit. For the "delete existing TFT" operation and for the "no TFT operation", the <i>number of packet filters</i> shall be coded as 0. For all other operations, the number of packet filters shall be greater than 0 and less than or equal to 15.</p> <p>Packet filter list (octets 4 to z)</p> <p>The <i>packet filter list</i> contains a variable number of packet filters. For the "delete existing TFT" operation and the "no TFT operation", the <i>packet filter list</i> shall be empty.</p> <p>For the "delete packet filters from existing TFT" operation, the <i>packet filter list</i> shall contain a variable number of packet filter identifiers. This number shall be derived from the coding of the <i>number of packet filters</i> field in octet 3.</p> <p>For the "create new TFT", "add packet filters to existing TFT" and "replace packet filters in existing TFT" operations, the <i>packet filter list</i> shall contain a variable number of packet filters. This number shall be derived from the coding of the <i>number of packet filters</i> field in octet 3.</p> <p>Each packet filter is of variable length and consists of</p> <ul style="list-style-type: none"> - a packet filter identifier and direction (1 octet); - a packet filter evaluation precedence (1 octet); - the length of the packet filter contents (1 octet); and - the packet filter contents itself (v octets).
--

The *packet filter identifier* field is used to identify each packet filter in a TFT. The least significant 4 bits are used.

The *packet filter direction* is used to indicate, in bits 5 and 6, for what traffic direction the filter applies:

00 - pre Rel-7 TFT filter
 01 - downlink only
 10 - uplink only
 11 - bidirectional
 Bits 8 through 7 are spare bits.

The *packet filter evaluation precedence* field is used to specify the precedence for the packet filter among all packet filters in all TFTs associated with this PDP address. Higher the value of the *packet filter evaluation precedence* field, lower the precedence of that packet filter is. The first bit in transmission order is the most significant bit.

The *length of the packet filter contents* field contains the binary coded representation of the length of the *packet filter contents* field of a packet filter. The first bit in transmission order is the most significant bit.

The *packet filter contents* field is of variable size and contains a variable number (at least one) of *packet filter components*. Each *packet filter component* shall be encoded as a sequence of a one octet *packet filter component type identifier* and a fixed length *packet filter component value* field. The *packet filter component type identifier* shall be transmitted first.

In each packet filter, there shall not be more than one occurrence of each packet filter component type. Among the "IPv4 remote address type" and "IPv6 remote address type" packet filter components, only one shall be present in one packet filter. Among the "single local port type" and "local port range type" packet filter components, only one shall be present in one packet filter. Among the "single remote port type" and "remote port range type" packet filter components, only one shall be present in one packet filter.

The term *local* refers to the MS and the term *remote* refers to an external network entity.

Packet filter component type identifier

Bits

8	7	6	5	4	3	2	1	
0	0	0	1	0	0	0	0	IPv4 remote address type
0	0	0	1	0	0	0	1	IPv4 local address type
0	0	1	0	0	0	0	0	IPv6 remote address type
0	0	1	0	0	0	0	1	IPv6 remote address/prefix length type
0	0	1	0	0	0	1	1	IPv6 local address/prefix length type
0	0	1	1	0	0	0	0	Protocol identifier/Next header type
0	1	0	0	0	0	0	0	Single local port type
0	1	0	0	0	0	0	1	Local port range type
0	1	0	1	0	0	0	0	Single remote port type
0	1	0	1	0	0	0	1	Remote port range type
0	1	1	0	0	0	0	0	Security parameter index type
0	1	1	1	0	0	0	0	Type of service/Traffic class type
1	0	0	0	0	0	0	0	Flow label type
1	0	0	0	0	0	0	1	Destination MAC address type
1	0	0	0	0	0	1	0	Source MAC address type
1	0	0	0	0	0	1	1	802.1Q C-TAG VID type
1	0	0	0	1	0	0	0	802.1Q S-TAG VID type
1	0	0	0	1	0	1	0	802.1Q C-TAG PCP/DEI type
1	0	0	0	1	1	0	0	802.1Q S-TAG PCP/DEI type
1	0	0	0	1	1	1	1	Ethertype type

All other values are reserved.

The description and valid combinations of packet filter component type identifiers in a packet filter are defined in 3GPP TS 23.060 [74] subclause 15.3.2.

For "IPv4 remote address type", the *packet filter component value* field shall be encoded as a sequence of a four octet *IPv4 address* field and a four octet *IPv4 address mask* field. The *IPv4 address* field shall be transmitted first.

For "IPv4 local address type", the *packet filter component value* field shall be encoded as defined for "IPv4 remote address type".
Both the MS and network indication for support of the Local address in TFTs are required to use this packet filter component.

For "IPv6 remote address type", the *packet filter component value* field shall be encoded as a sequence of a sixteen octet *IPv6 address* field and a sixteen octet *IPv6 address mask* field. The *IPv6 address* field shall be transmitted first.

For "IPv6 remote address/prefix length type", the *packet filter component value* field shall be encoded as a sequence of a sixteen octet *IPv6 address* field and one octet *prefix length* field. The *IPv6 address* field shall be transmitted first.
This parameter shall be used, instead of IPv6 remote address type, when both the MS and network indication for support of the Local address in TFT are present.

For "IPv6 local address/prefix length type", the *packet filter component value* field shall be encoded as defined for "IPv6 remote address /prefix length".
Both the MS and network indication for support of the Local address in TFTs are required to use this packet filter component.

NOTE: Local IP address and mask can be used when IPv6 prefix delegation is used (see 3GPP TS 23.060 [74] subclause 9.2.1.2).

For "Protocol identifier/Next header type", the *packet filter component value* field shall be encoded as one octet which specifies the IPv4 protocol identifier or IPv6 next header.

For "Single local port type" and "Single remote port type", the *packet filter component value* field shall be encoded as two octet which specifies a port number.

For "Local port range type" and "Remote port range type", the *packet filter component value* field shall be encoded as a sequence of a two octet *port range low limit* field and a two octet *port range high limit* field. The *port range low limit* field shall be transmitted first.

For "Security parameter index", the *packet filter component value* field shall be encoded as four octet which specifies the IPsec security parameter index.

For "Type of service/Traffic class type", the *packet filter component value* field shall be encoded as a sequence of a one octet *Type-of-Service/Traffic Class* field and a one octet *Type-of-Service/Traffic Class mask* field. The *Type-of-Service/Traffic Class* field shall be transmitted first.

For "Flow label type", the *packet filter component value* field shall be encoded as three octet which specifies the IPv6 flow label. The bits 8 through 5 of the first octet shall be spare whereas the remaining 20 bits shall contain the IPv6 flow label.
Parameters list (octets z+1 to v)

For "destination MAC address type" and "source MAC address type", the *packet filter component value* field shall be encoded as 6 octets which specify a MAC address.

For "802.1Q C-TAG VID type", the *packet filter component value* field shall be encoded as two octets which specify the VID of the customer-VLAN tag (C-TAG). The bits 8 through 5 of the first octet shall be spare whereas the remaining 12 bits shall contain the VID.

For "802.1Q S-TAG VID type", the *packet filter component value* field shall be encoded as two octets which specify the VID of the service-VLAN tag (S-TAG). The bits 8 through 5 of the first octet shall be spare whereas the remaining 12 bits shall contain the VID.

For "802.1Q C-TAG PCP/DEI type", the *packet filter component value* field shall be

encoded as one octet which specifies the 802.1Q C-TAG PCP and DEI. The bits 8 through 5 of the octet shall be spare, the bits 4 through 2 contain the PCP and bit 1 contains the DEI.

For "802.1Q S-TAG PCP/DEI type", the *packet filter component value* field shall be encoded as one octet which specifies the 802.1Q S-TAG PCP. The bits 8 through 5 of the octet shall be spare, the bits 4 through 2 contain the PCP and bit 1 contains the DEI.

For "ethertype type", the *packet filter component value* field shall be encoded as two octets which specify an ethertype.

The *parameters list* contains a variable number of parameters that may be transferred. If the *parameters list* is included, the *E bit* is set to 1; otherwise, the *E bit* is set to 0.

Each parameter included in the *parameters list* is of variable length and consists of:

- a parameter identifier (1 octet);
- the length of the parameter contents (1 octet); and
- the parameter contents itself (v octets).

The *parameter identifier* field is used to identify each parameter included in the *parameters list* and it contains the hexadecimal coding of the parameter identifier. Bit 8 of the *parameter identifier* field contains the most significant bit and bit 1 contains the least significant bit. In this version of the protocol, the following parameter identifiers are specified:

- 01H (Authorization Token);
- 02H (Flow Identifier); and
- 03H (Packet Filter Identifier).

If the *parameters list* contains a parameter identifier that is not supported by the receiving entity the corresponding parameter shall be discarded. The *length of parameter contents* field contains the binary coded representation of the length of the *parameter contents* field. The first bit in transmission order is the most significant bit.

When the *parameter identifier* indicates Authorization Token, the *parameter contents* field contains an authorization token, as specified in 3GPP TS 29.207 [100]. The first octet is the most significant octet of the authorization token and the last octet is the least significant octet of the authorization token.

The *parameters list* shall be coded in a way that an Authorization Token (i.e. a parameter with identifier 01H) is always followed by one or more Flow Identifiers (i.e. one or more parameters with identifier 02H).

If the *parameters list* contains two or more consecutive Authorization Tokens without any Flow Identifiers in between, the receiver shall treat this as a semantical TFT error.

When the *parameter identifier* indicates Flow Identifier, the *parameter contents* field contains the binary representation of a flow identifier. The Flow Identifier consists of four octets. Octets 1 and 2 contains the Media Component number as specified in 3GPP TS 29.207 [100]. Bit 1 of octet 2 is the least significant bit, and bit 8 of octet 1 is the most significant bit. Octets 3 and 4 contains the IP flow number as specified in 3GPP TS 29.207 [100]. Bit 1 of octet 4 is the least significant bit, and bit 8 of octet 3 is the most significant bit.

When the *parameter identifier* indicates Packet Filter Identifier, the *parameter contents* field contains the binary representation of one or more packet filter identifiers. Each packet filter identifier is encoded in one octet, in the 4 least significant bits. This parameter is used by the MS and the network to identify one or more packet filters in a TFT when modifying the QoS of a PDP context without modifying the packet filter itself.

10.1.2.1.3 Test description

10.1.2.1.3.1 Pre-test conditions

System Simulator:

- NGC Cell A.

UE:

- None.

Preamble:

- The UE is in state 3N-A on NGC Cell A with at least one PDU session for Internet active according to TS 38.508-1 [4], clause 4.4A.3 Table 4.4A.3-1 and using the message condition UE TEST LOOP MODE B active.

10.1.2.1.3.2 Test procedure sequence

Table 10.1.2.1.3.2-1: Main behaviour

St	Procedure	Message Sequence		TP	Verdict
		U - S	Message		
1	The SS transmits a PDU session modification command message with PDU session ID IE is set to the same value as the first PDU session ID for Internet in the PDU SESSION ESTABLISHMENT REQUEST message. This message is included in a DLInformationTransfer message.	<--	PDU SESSION MODIFICATION COMMAND	-	-
2	Check: Does the UE transmit a PDU session modification complete?	-->	PDU SESSION MODIFICATION COMPLETE	1	P
3	The SS transmits one IP Packet matching with new packet filter (reference packet filter list #2).	-	-	-	-
4	Check: Does UE send the IP Packet on the data radio bearer associated with the PDU QoS rule?	-	-	2	P

10.1.2.1.3.3 Specific message contents

Table 10.1.2.1.3.3-1: PDU SESSION MODIFICATION COMMAND (Step 1, Table 10.1.2.1.3.2-1)

Derivation path: TS 38.508-1 [4], table 4.7.2-9			
Information Element	Value/Remark	Comment	Condition
PDU session ID	The value the first PDU session ID for Internet indicated in PDU SESSION ESTABLISHMENT REQUEST message in the preamble		
Authorized QoS rules	Reference QoS rule #3 as defined in 38.508-1 [4] table 4.8.2.1-3.		

10.1.2.2 Network-requested PDU session modification / Abnormal / PDU session in state PDU SESSION INACTIVE

10.1.2.2.1 Test Purpose (TP)

(1)

```
with { the UE in PDU SESSION ACTIVE state and 5GMM-CONNECTED mode }
ensure that {
  when { the UE receives a PDU SESSION MODIFICATION COMMAND message include the PDU session ID which
  belong to any PDU session in PDU SESSION INACTIVE state in UE }
  then { UE sends a 5GSM STATUS message and set the 5GSM cause to #43: invalid PDU session
  identity }
}
```

10.1.2.2.2 Conformance requirements

References: The conformance requirements covered in the present TC are specified in: TS 24.501, clauses 6.3.2.6 and 7.3.2. Unless otherwise stated these are Rel-15 requirements.

[TS 24.501, clause 6.3.2.6]

The following abnormal cases can be identified:

- a) PDU session inactive for the received PDU session ID.

If the PDU session ID in the PDU SESSION MODIFICATION COMMAND message belongs to any PDU session in state PDU SESSION INACTIVE in the UE, the UE shall set the 5GSM cause IE to #43 "Invalid PDU session identity" in the 5GSM STATUS message, and set the PDU session ID to the received PDU session ID in the UL NAS TRANSPORT message as specified in subclause 5.4.5.

[TS 24.501, clause 7.3.2]

The following UE procedures shall apply for handling an unknown, erroneous, or unforeseen PDU session identity received in the header of a 5GSM message:

- a) If the UE receives a 5GSM message which includes an unassigned or reserved PDU session identity value, the UE shall ignore the message.
- b) If the UE receives a 5GSM message which includes a PDU session identity belonging to any PDU session in state PDU SESSION INACTIVE in the UE, the UE shall respond with a 5GSM STATUS message including 5GSM cause #43 "invalid PDU session identity".

10.1.2.2.3 Test description

10.1.2.2.3.1 Pre-test conditions

System Simulator:

- NGC Cell A.

UE:

- None.

Preamble:

- The UE is in state 3N-A on NGC Cell A with at least one PDU session for Internet active according to 38.508-1 [4]

10.1.2.2.3.2 Test procedure sequence

Table 10.1.2.2.3.2-1: Main behaviour

St	Procedure	Message Sequence		TP	Verdict
		U - S	Message		
0A	Cause the UE to request establishment of PDU session Y to the DN. (Note 1)	-	-	-	-
0B	The PDU session establishment procedure as specified in TS 38.508-1 [4] subclause 4.5A.2 takes place	-	-	-	-
1	The generic test procedure in TS 38.508-1 clause 4.9.21 for PDU Session Release is performed message with PDU session ID IE is set to the same value as the first PDU session ID for Internet in PDU SESSION ESTABLISHMENT REQUEST message in preamble.	-	-	-	-
2	Void	-		-	-
3	The SS transmits a PDU session modification command message with PDU session ID IE is set to the same value in PDU SESSION RELEASE COMMAND message. This message is included in a DLInformationTransfer message.	<--	PDU SESSION MODIFICATION COMMAND	-	-
4	Check: Does the UE transmit a 5GSM STATUS with the 5GSM cause IE indicating #43 "invalid PDU session identity"?	-->	5GSM STATUS	1	P

Note 1: The request of connectivity to an additional PDU session may be performed by MMI or AT command.

10.1.2.2.3.3 Specific message contents

Table 10.1.2.2.3.3-1: PDU SESSION MODIFICATION COMMAND (Step 3, Table 10.1.2.2.3.2-1)

Derivation path: TS 38.508-1 [4], table 4.7.2-9			
Information Element	Value/Remark	Comment	Condition
PDU session ID	The same value in PDU SESSION RELEASE COMMAND message		

Table 10.1.2.2.3.3-2: 5GSM STATUS (Step 4, Table 10.1.2.2.3.2-1)

Derivation path: TS 38.508-1 [4], table 4.7.2-16			
Information Element	Value/Remark	Comment	Condition
PDU session ID	The same value as the value set in PDU SESSION modification command message		
5GSM cause	'00101011'B	Invalid PDU session identity	

Table 10.1.2.2.3.3-3: PDU SESSION RELEASE COMMAND (Step 1, Table 10.1.2.2.3.2-1; step 1, TS 36.508 [4] Table 4.9.21.2.2-1)

Derivation path: TS 38.508-1 [4], table 4.7.2-14			
Information Element	Value/Remark	Comment	Condition
PDU session ID	The value of the first PDU session ID for Internet indicated in PDU		

	SESSION ESTABLISHMENT REQUEST message in preamble		
--	---	--	--

10.1.3 Network-requested PDU session release

10.1.3.1 Void

10.1.3.2 Network-requested PDU session release / Insufficient resources, insufficient resources for specific slice and DNN, abnormal / Invalid PDU session identity

10.1.3.2.1 Test Purpose (TP)

(1)

```
with { UE is in PDU SESSION ACTIVE state }
ensure that {
  when { UE receives a PDU SESSION RELEASE COMMAND message including 5GSM cause #26 "insufficient
resources" and the Back-off timer value that indicates neither zero nor deactivated }
  then { UE does not send a PDU SESSION ESTABLISHMENT REQUEST until timer T3396 expires or timer
T3396 is stopped }
}
```

(2)

```
with { UE is in PDU SESSION ACTIVE state }
ensure that {
  when { UE receives a PDU SESSION RELEASE COMMAND message including 5GSM cause #26 "insufficient
resources" and the Back-off timer value that indicates zero }
  then { UE sends a PDU SESSION ESTABLISHMENT REQUEST message }
}
```

(3)

```
with { UE is in PDU SESSION ACTIVE state }
ensure that {
  when { UE receives a PDU SESSION RELEASE COMMAND message including 5GSM cause #26 "insufficient
resources" and the Back-off timer value that indicates deactivated }
  then { UE does not send a PDU SESSION ESTABLISHMENT REQUEST message until the UE is switched off
or the USIM is removed }
}
```

(4)

```
with { UE is in PDU SESSION ACTIVE state }
ensure that {
  when { UE receives a PDU SESSION RELEASE COMMAND message including 5GSM cause #67 "insufficient
resources for specific slice and DNN" and the Back-off timer value that indicates neither zero nor
deactivated }
  then { UE does not send a PDU SESSION ESTABLISHMENT REQUEST message for the same [S-NSSAI, DNN]
combination until timer T3584 expires }
}
```

(5)

```
with { UE is in PDU SESSION ACTIVE state }
ensure that {
  when { UE receives a PDU SESSION RELEASE COMMAND message including 5GSM cause #67 "insufficient
resources for specific slice and DNN" and the Back-off timer value that indicates zero }
  then { UE sends a PDU SESSION ESTABLISHMENT REQUEST message for the same [S-NSSAI, DNN]
combination }
}
```

(6)

```

with { UE is in PDU SESSION ACTIVE state }
ensure that {
  when { UE receives a PDU SESSION RELEASE COMMAND message including 5GSM cause #67 "insufficient
resources for specific slice and DNN" and the Back-off timer value that indicates deactivated }
  then { UE does not send a PDU SESSION ESTABLISHMENT REQUEST message for the same [S-NSSAI, DNN]
combination until the UE is switched off or the USIM is removed }
}

```

(7)

```

with { UE is in PDU SESSION ACTIVE state }
ensure that {
  when { UE receives a PDU SESSION RELEASE COMMAND message, in which the PDU session ID belongs to
any PDU session in state PDU SESSION INACTIVE in the UE }
  then { UE sends 5GSM STATUS message including 5GSM cause #43 "Invalid PDU session identity" }
}

```

10.1.3.2.2 Conformance requirements

References: The conformance requirements covered in the current TC are specified in: TS 24.501, clause 6.3.3.2 and 6.3.3.3. Unless otherwise stated these are Rel-15 requirements.

[TS 24.501, clause 6.3.3.2]

In order to initiate the network-requested PDU session release procedure, the SMF shall create a PDU SESSION RELEASE COMMAND message.

The SMF shall set the SM cause IE of the PDU SESSION RELEASE COMMAND message to indicate the reason for releasing the PDU session.

The SM cause IE typically indicates one of the following SM cause values:

#26 insufficient resources;

...

#67 insufficient resources for specific slice and DNN;

...

The SMF may include a Back-off timer value IE in the PDU SESSION RELEASE COMMAND message when the 5GSM cause value #26 "insufficient resources" is included in the PDU SESSION RELEASE COMMAND message. If the 5GSM cause value is #26 "insufficient resources" and the PDU SESSION RELEASE COMMAND message is sent to a UE configured for high priority access in selected PLMN or the request type was set to "initial emergency request" or "existing emergency PDU session" for the establishment of the PDU session, the network shall not include a Back-off timer value IE.

The SMF may include a Back-off timer value IE in the PDU SESSION RELEASE COMMAND message when the 5GSM cause value #67 "insufficient resources for specific slice and DNN" is included in the PDU SESSION RELEASE COMMAND message. If the 5GSM cause value is #67 "insufficient resources for specific slice and DNN" and the PDU SESSION RELEASE COMMAND message is sent to a UE configured for high priority access in selected PLMN or the request type was set to "initial emergency request" or "existing emergency PDU session" for the establishment of the PDU session, the network shall not include a Back-off timer value IE.

[TS 24.501, clause 6.3.3.3]

Upon receipt of a PDU SESSION RELEASE COMMAND message and a PDU session ID, using the NAS transport procedure as specified in subclause 5.4.5, the UE considers the PDU session as released and the UE shall create a PDU SESSION RELEASE COMPLETE message.

...

If the PDU SESSION RELEASE COMMAND message includes 5GSM cause #26 "insufficient resources" and the Back-off timer value IE, the UE shall take different actions depending on the timer value received for timer T3396 in the Back-off timer value:

- a) If the timer value indicates neither zero nor deactivated and a DNN was provided during the PDU session establishment, the UE shall stop timer T3396 associated with the corresponding DNN, if it is running. If the timer value indicates neither zero nor deactivated and no DNN was provided during the PDU session establishment and the request type was different from "initial emergency request" and different from "existing emergency PDU session", the UE shall stop timer T3396 associated with no DNN if it is running. The UE shall then start timer T3396 with the value provided in the Back-off timer value IE and:
- 1) shall not send a PDU SESSION ESTABLISHMENT REQUEST message or PDU SESSION MODIFICATION REQUEST message with exception of those identified in subclause 6.4.2.1, for the same DNN that was sent by the UE, until timer T3396 expires or timer T3396 is stopped; and
 - 2) shall not send a PDU SESSION ESTABLISHMENT REQUEST message without an DNN and with request type different from "initial emergency request" and different from "existing emergency PDU session", or a PDU SESSION MODIFICATION REQUEST message with exception of those identified in subclause 6.4.2.1, for a non-emergency PDU session established without an DNN provided by the UE, if no DNN was provided during the PDU session establishment and the request type was different from "initial emergency request" and different from "existing emergency PDU session", until timer T3396 expires or timer T3396 is stopped.

The UE shall not stop timer T3396 upon a PLMN change or inter-system change;

- b) if the timer value indicates that this timer is deactivated and a DNN was provided during the PDU session establishment, the UE shall stop timer T3396 associated with the corresponding DNN, if it is running. If the timer value indicates that this timer is deactivated and no DNN was provided during the PDU session establishment and the request type was different from "initial emergency request" and different from "existing emergency PDU session", the UE shall stop timer T3396 associated with no DNN if it is running. The UE:
- 1) shall not send a PDU SESSION ESTABLISHMENT REQUEST message or PDU SESSION MODIFICATION REQUEST message with exception of those identified in subclause 6.4.2.1, for the same DNN until the UE is switched off or the USIM is removed, or the UE receives a PDU SESSION MODIFICATION COMMAND message for the same DNN from the network or a PDU SESSION RELEASE COMMAND message including 5GSM cause #39 "reactivation requested" for the same DNN from the network; and
 - 2) shall not send a PDU SESSION ESTABLISHMENT REQUEST message without an DNN and with request type different from "initial emergency request" and different from "existing emergency PDU session", or a PDU SESSION MODIFICATION REQUEST message with exception of those identified in subclause 6.4.2.1, for a non-emergency PDU session established without an DNN provided by the UE, if no DNN was provided during the PDU session establishment and the request type was different from "initial emergency request" and different from "existing emergency PDU session", until the UE is switched off or the USIM is removed, or the UE receives a PDU SESSION MODIFICATION COMMAND message for a non-emergency PDU session established without an DNN provided by the UE, or a PDU SESSION RELEASE COMMAND message including 5GSM cause IE set to 5GSM cause #39 "reactivation requested" for a non-emergency PDU session established without an DNN provided by the UE.

The timer T3396 remains deactivated upon a PLMN change or inter-system change; and

- c) if the timer value indicates zero, the UE:
- 1) shall stop timer T3396 associated with the corresponding DNN, if running, and may send a PDU SESSION ESTABLISHMENT REQUEST message or PDU SESSION MODIFICATION REQUEST message for the same DNN; and
 - 2) if no DNN was provided during the PDU session establishment and the request type was different from "initial emergency request" and different from "existing emergency PDU session", the UE shall stop timer T3396 associated with no DNN, if running, and may send a PDU SESSION ESTABLISHMENT REQUEST message without a DNN, or a PDU SESSION MODIFICATION REQUEST message without an DNN provided by the UE.

If the PDU SESSION RELEASE COMMAND message includes 5GSM cause #26 "insufficient resources" and the Back-off timer value IE is not included, then the UE may send a PDU SESSION ESTABLISHMENT REQUEST message or PDU SESSION MODIFICATION REQUEST message for the same DNN or without a DNN.

When the timer T3396 is running or the timer is deactivated, the UE is allowed to initiate a PDU session establishment procedure for emergency services.

If the timer T3396 is running when the UE enters state 5GMM-DEREGISTERED, the UE remains switched on, and the USIM in the UE remains the same, then timer T3396 is kept running until it expires or it is stopped.

If the UE is switched off when the timer T3396 is running, and if the USIM in the UE remains the same when the UE is switched on, the UE shall behave as follows:

- let t_1 be the time remaining for T3396 timeout at switch off and let t be the time elapsed between switch off and switch on. If t_1 is greater than t , then the timer shall be restarted with the value $t_1 - t$. If t_1 is equal to or less than t , then the timer need not be restarted. If the UE is not capable of determining t , then the UE shall restart the timer with the value t_1 .

If the 5GSM cause value is #67 "insufficient resources for specific slice and DNN" and the Back-off timer value IE is included, the UE shall take different actions depending on the timer value received for timer T3584 in the Back-off timer value:

- a) If the timer value indicates neither zero nor deactivated, the UE shall stop timer T3584 associated with the same [S-NSSAI, DNN] combination as that the UE provided when the PDU session is established, if it is running. The UE shall then start timer T3584 with the value provided in the Back-off timer value IE.

The UE shall not send another PDU SESSION ESTABLISHMENT REQUEST message with request type different from "initial emergency request" and different from "existing emergency PDU session", or PDU SESSION MODIFICATION REQUEST message with exception of those identified in subclause 6.4.2.1, for the same [S-NSSAI, DNN] combination that was sent by the UE, until timer T3584 expires or timer T3584 is stopped;

The UE shall not stop timer T3584 upon a PLMN change or inter-system change;

- b) if the timer value indicates that this timer is deactivated, the UE shall stop timer T3584 associated with the same [S-NSSAI, DNN] combination as that the UE provided when the PDU session is established, if it is running.

The UE shall not send another PDU SESSION ESTABLISHMENT REQUEST message with request type different from "initial emergency request" and different from "existing emergency PDU session", or PDU SESSION MODIFICATION REQUEST message with exception of those identified in subclause 6.4.2.1, for the same [S-NSSAI, DNN] combination that was sent by the UE, until the UE is switched off or the USIM is removed, or the UE receives a PDU SESSION MODIFICATION REQUEST message for the same [S-NSSAI, DNN] combination from the network or a PDU SESSION RELEASE COMMAND message including 5GSM cause #39 "reactivation requested" for the same [S-NSSAI, DNN] combination from the network; and

The timer T3584 remains deactivated upon a PLMN change or inter-system change; and

- c) if the timer value indicates zero, the UE shall stop timer T3584 associated with the same [S-NSSAI, DNN] combination that was sent by the UE, if running, and may send another PDU SESSION ESTABLISHMENT REQUEST message or PDU SESSION MODIFICATION REQUEST message for the same [S-NSSAI, DNN] combination.

If the 5GSM cause value is #67 "insufficient resources for specific slice and DNN" and the Back-off timer value IE is not included, then the UE may send another PDU SESSION ESTABLISHMENT REQUEST message or PDU SESSION MODIFICATION REQUEST message for the same [S-NSSAI, DNN] combination.

When the timer T3584 is running or the timer is deactivated, the UE is allowed to initiate a PDU session establishment procedure for emergency services.

If the timer T3584 is running when the UE enters state 5GMM-DEREGISTERED, the UE remains switched on, and the USIM in the UE remains the same, then timer T3584 is kept running until it expires or it is stopped.

If the UE is switched off when the timer T3584 is running, and if the USIM in the UE remains the same when the UE is switched on, the UE shall behave as follows:

- let t_1 be the time remaining for T3584 timeout at switch off and let t be the time elapsed between switch off and switch on. If t_1 is greater than t , then the timer shall be restarted with the value $t_1 - t$. If t_1 is equal to or less than t , then the timer need not be restarted. If the UE is not capable of determining t , then the UE shall restart the timer with the value t_1 .

[TS 24.501, clause 6.3.3.6]

The following abnormal cases can be identified:

- a) PDU session inactive for the received PDU session ID.

If the PDU session ID in the PDU SESSION RELEASE COMMAND message belongs to any PDU session in state PDU SESSION INACTIVE in the UE, the UE shall include the 5GSM cause #43 "Invalid PDU session identity" in the 5GSM STATUS message, and set the PDU session ID to the received PDU session ID in the UL NAS TRANSPORT message as specified in subclause 5.4.5.

[TS 24.501, clause B.1]

Cause #43 –Invalid PDU session identity

This 5GSM cause is used by the network or the UE to indicate that the PDU session identity value provided to it is not a valid value or the PDU session identified by the PDU session identity IE in the request or the command is not active.

[24.501, clause 7.3.2]

...

The following UE procedures shall apply for handling an unknown, erroneous, or unforeseen PDU session identity received in the header of a 5GSM message:

- a) If the UE receives a 5GSM message which includes an unassigned or reserved PDU session identity value, the UE shall ignore the message.
- b) If the UE receives a 5GSM message which includes a PDU session identity belonging to any PDU session in state PDU SESSION INACTIVE in the UE, the UE shall respond with a 5GSM STATUS message including 5GSM cause #43 "invalid PDU session identity".

10.1.3.2.3 Test description

10.1.3.2.3.1 Pre-test conditions

System Simulator:

- NGC Cell A.

UE:

None.

Preamble:

- The UE is in state 3N-A on NGC Cell A according to TS 38.508-1 [4].

10.1.3.2.3.2 Test procedure sequence

Table 10.1.3.2.3.2-1: Main behaviour

St	Procedure	Message Sequence		TP	Verdict
		U – S	Message		
1	Cause the UE to request establishment of PDU session without DNN.(Note 1)	-	-	-	-
2	The PDU session establishment procedure as specified in TS 38.508-1 [4] subclause 4.5A.2 take place.	-	-	-	-
3	The generic test procedure in TS 38.508-1 Table 4.9.21.2.2-1 of Procedure for PDU Session Release is performed.	-	-	-	-
4	Void	-	-	-	-

5	Cause the UE to request establishment of PDU session without DNN within 2 minutes of Step 3 (Note 1)	-	-	-	-
6	Check: Does the UE transmit a PDU SESSION ESTABLISHMENT REQUEST message before timer T3396 has expired?	-->	5GMM: UL NAS TRANSPORT 5GSM: PDU SESSION ESTABLISHMENT REQUEST	1	F
7	Cause the UE to request establishment of PDU session without DNN after 2 minutes since Step 3.(Note 1)	-	-	-	-
8	Check: Does the UE transmit a PDU SESSION ESTABLISHMENT REQUEST message?	-->	5GMM: UL NAS TRANSPORT 5GSM: PDU SESSION ESTABLISHMENT REQUEST	1	P
9	The SS transmits a PDU SESSION ESTABLISHMENT ACCEPT message.	<--	5GMM: DL NAS TRANSPORT 5GSM: PDU SESSION ESTABLISHMENT ACCEPT	-	-
10	The generic test procedure in TS 38.508-1 Table 4.9.21.2.2-1 of Procedure for PDU Session Release is performed	-	-	-	-
11	Void	-	-	-	-
12	Cause the UE to request establishment of PDU session without DNN.(Note 1)	-	-	-	-
13	Check: Does the UE transmit a PDU SESSION ESTABLISHMENT REQUEST message?	-->	5GMM: UL NAS TRANSPORT 5GSM: PDU SESSION ESTABLISHMENT REQUEST	2	P
14	The SS transmits a PDU SESSION ESTABLISHMENT ACCEPT message.	<--	5GMM: DL NAS TRANSPORT 5GSM: PDU SESSION ESTABLISHMENT ACCEPT	-	-
15	The generic test procedure in TS 38.508-1 Table 4.9.21.2.2-1 of Procedure for PDU Session Release is performed	-	-	-	-
16	Void	-	-	-	-
17	Cause the UE to request establishment of PDU session without DNN.(Note 1)	-	-	-	-
18	Check: Does the UE transmit a PDU SESSION ESTABLISHMENT REQUEST message in 5 seconds?	-->	5GMM: UL NAS TRANSPORT 5GSM: PDU SESSION ESTABLISHMENT REQUEST	3	F
19	Switch off UE in RRC CONNECTED as described in TS38.508-1 [4] subclause 4.9.6.3	-	-	-	-
20	Switch on UE.	-	-	-	-
21	The general procedure is completed by executing of the UE registration procedure in TS 38.508-1 [4] table 4.5.2.2-2 , ' <i>connected without release</i> '.	-	-	-	-
22	Cause the UE to request establishment of PDU session without DNN.(Note 1)	-	-	-	-
23	Check: Does the UE transmit a PDU SESSION ESTABLISHMENT REQUEST message?	-->	5GMM: UL NAS TRANSPORT 5GSM: PDU SESSION ESTABLISHMENT REQUEST	3	P
24	The SS transmits a PDU SESSION ESTABLISHMENT ACCEPT message.	<--	5GMM: DL NAS TRANSPORT 5GSM: PDU SESSION ESTABLISHMENT ACCEPT	-	-
25	Cause the UE to request establishment of PDU session with [S-NSSAI, DNN] combination.(Note 1)	-	-	-	-
26	The PDU session establishment procedure as specified in TS 38.508-1 [4] subclause 4.5A.2 take place.	-	-	-	-
27	The generic test procedure in TS 38.508-1 Table 4.9.21.2.2-1 of Procedure for PDU Session Release is performed	-	-	-	-
28	Void	-	-	-	-
29	Cause the UE to request establishment of PDU session with the same [S-NSSAI, DNN] combination as the PDU session established at step 26 within 2 minutes of Step 27.(Note 1)	-	-	-	-
30	Check: Does the UE transmit a PDU SESSION ESTABLISHMENT REQUEST	-->	5GMM: UL NAS TRANSPORT 5GSM: PDU SESSION	4	F

	before timer T3584 has expired?		ESTABLISHMENT REQUEST		
31	Cause the UE to request establishment of PDU session with the same [S-NSSAI, DNN] combination as the PDU session established at step 26 after 2 minutes since Step 27.(Note 1)	-	-	-	-
32	Check: Does the UE transmit a PDU SESSION ESTABLISHMENT REQUEST?	-->	5GMM: UL NAS TRANSPORT 5GSM: PDU SESSION ESTABLISHMENT REQUEST	4	P
33	The SS transmits a PDU SESSION ESTABLISHMENT ACCEPT message.	<--	5GMM: DL NAS TRANSPORT 5GSM: PDU SESSION ESTABLISHMENT ACCEPT	-	-
34	The generic test procedure in TS 38.508-1 Table 4.9.21.2.2-1 of Procedure for PDU Session Release is performed	-	-	-	-
35	Void	-	-	-	-
36	Cause the UE to request establishment of PDU session with the same [S-NSSAI, DNN] combination as the PDU session established at step 26.(Note 1)	-	-	-	-
37	Check: Does the UE transmit a PDU SESSION ESTABLISHMENT REQUEST?	-->	5GMM: UL NAS TRANSPORT 5GSM: PDU SESSION ESTABLISHMENT REQUEST	5	P
38	The SS transmits a PDU SESSION ESTABLISHMENT ACCEPT message.	<--	5GMM: DL NAS TRANSPORT 5GSM: PDU SESSION ESTABLISHMENT ACCEPT	-	-
39	The generic test procedure in TS 38.508-1 Table 4.9.21.2.2-1 of Procedure for PDU Session Release is performed	-	-	-	-
40	Void	-	-	-	-
41	Cause the UE to request establishment of PDU session with the same [S-NSSAI, DNN] combination as the PDU session established at step 26.(Note 1)	-	-	-	-
42	Check: Does the UE transmit a PDU SESSION ESTABLISHMENT REQUEST in 5 seconds?	-->	5GMM: UL NAS TRANSPORT 5GSM: PDU SESSION ESTABLISHMENT REQUEST	6	F
43	The SS transmits a PDU SESSION RELEASE COMMAND including the PDU session ID UE requested in step 42.	<--	5GMM: DL NAS TRANSPORT 5GSM: PDU SESSION RELEASE COMMAND	-	-
44	Check: Does the UE transmit a 5GSM STATUS message with value #43?	-->	5GSM: UL NAS TRANSPORT 5GSM: 5GSM STATUS	7	P
45	Switch off UE in RRC CONNECTED as described in TS38.508-1 [4] subclause 4.9.6.3	-	-	-	-
46	Switch on UE.	-	-	-	-
47	The general procedure is completed by executing of the UE registration procedure in TS 38.508-1 [4] table 4.5.2.2-2 , 'connected without release'.	-	-	-	-
48	Cause the UE to request establishment of PDU session with the same [S-NSSAI, DNN] combination as the PDU session established at step 26.(Note 1)	-	-	-	-
49	Check: Does the UE transmit a PDU SESSION ESTABLISHMENT REQUEST?	-->	5GMM: UL NAS TRANSPORT 5GSM: PDU SESSION ESTABLISHMENT REQUEST	6	P
50	The SS transmits a PDU SESSION ESTABLISHMENT ACCEPT message.	<--	5GMM: DL NAS TRANSPORT 5GSM: PDU SESSION ESTABLISHMENT ACCEPT	-	-

Note 1: The request to establish a PDU session may be performed by MMI or AT Command.

Table 10.1.3.2.3.2-2: Void**Table 10.1.3.2.3.2-3: Void**

10.1.3.2.3.3 Specific message contents

Table 10.1.3.2.3.3-1: UL NAS TRANSPORT (step 2, 8, 13 and 23, Table 10.1.3.2.3.2-1; step 2a1, Table 4.5A.2.2.2-2, TS 38.508-1[4]); step 2a1, Table 4.5A.2.2.2-2, TS 38.508-1 [4])

Derivation Path: TS 38.508-1 [4] Table 4.7.1-10			
Information Element	Value/remark	Comment	Condition
Payload container type	'0001'B	N1 SM information	
Payload container	PDU SESSION ESTABLISHMENT REQUEST		
DNN	Not present		

Table 10.1.3.2.3.3-1A: PDU SESSION ESTABLISHMENT ACCEPT (step 2, 9, 14 and 24, Table 10.1.3.2.3.2-1; step 3, Table 4.5A.2.2.2-1, TS 38.508-1 [4])

Derivation path: TS 38.508-1 [4], Table 4.7.2-2			
Information Element	Value/remark	Comment	Condition
Authorized QoS rules	5GC QoS rule of the Config#1 in Table 4.8.4-1		
Mapped EPS bearer contexts			
Mapped EPS bearer context			
Mapped EPS QoS parameters	EPC default bearer context of the Config#1 in Table 4.8.4-1		
DNN	The DNN/APN ID of the Config#1 in Table 4.8.4-1		

Table 10.1.3.2.3.3-2: PDU SESSION RELEASE COMMAND (step 3, Table 10.1.3.2.3.2-1; step 1, Table 4.9.21.2.2-1, TS 38.508-1 [4])

Derivation Path: TS 38.508-1 [4] Table 4.7.2-14			
Information Element	Value/remark	Comment	Condition
PDU session ID	The same ID as the ID of PDU session which UE request in step 2 in Table 10.1.3.2.3.2-1		
5GSM cause	'0001 1010'B	insufficient resources	
Back-off timer value	'1010 0010'B	2 minutes	

Table 10.1.3.2.3.3-3: Void

Table 10.1.3.2.3.3-4: PDU SESSION RELEASE COMMAND (step 10, Table 10.1.3.2.3.2-1; step 1, Table 4.9.21.2.2-1, TS 38.508-1 [4])

Derivation Path: TS 38.508-1 [4] Table 4.7.2-14			
Information Element	Value/remark	Comment	Condition
PDU session ID	The same ID as the ID of PDU session which UE request in step 8 in Table 10.1.3.2.3.2-1		
5GSM cause	'0001 1010'B	insufficient resources	
Back-off timer value	'1010 0000'B	0 minutes	

Table 10.1.3.2.3.3-5: PDU SESSION RELEASE COMMAND (step 15, Table 10.1.3.2.3.2-1; step 1, Table 4.9.21.2.2-1, TS 38.508-1 [4])

Derivation Path: TS 38.508-1 [4] Table 4.7.2-14			
Information Element	Value/remark	Comment	Condition
PDU session ID	The same ID as the ID of PDU session which UE request in step 13 in Table 10.1.3.2.3.2-1		
5GSM cause	'0001 1010'B	insufficient resources	
Back-off timer value	'1110 0000'B	deactivated	

Table 10.1.3.2.3.3-6: UL NAS TRANSPORT (step 26, Table 10.1.3.2.3.2-1)

Derivation Path: TS 38.508-1 [4] Table 4.7.1-10			
Information Element	Value/remark	Comment	Condition
Payload container type	'0001'B	N1 SM information	
Payload container	PDU SESSION ESTABLISHMENT REQUEST		
S-NSSAI	present		
DNN	present		

Table 10.1.3.2.3.3-6A: PDU SESSION ESTABLISHMENT ACCEPT (step 26, 33, 38, and 50, Table 10.1.3.2.3.2-1; step 3, Table 4.5A.2.2.2-1, TS 38.508-1 [4])

Derivation path: TS 38.508-1 [4], Table 4.7.2-2			
Information Element	Value/remark	Comment	Condition
Authorized QoS rules	5GC QoS rule of the Config#1 in Table 4.8.4-1		
Mapped EPS bearer contexts			
Mapped EPS bearer context			
Mapped EPS QoS parameters	EPC default bearer context of the Config#1 in Table 4.8.4-1		
DNN	The same DNN value as sent in the UL NAS TRANSPORT message		

	at (step 26, 33, 38, and 50, Table 10.1.3.2.3.2-1; step 2a1, Table 4.5A.2.2.2-2, TS 38.508-1 [4])		
--	---	--	--

Table 10.1.3.2.3.3-7: PDU SESSION RELEASE COMMAND (step 27, Table 10.1.3.2.3.2-1; step 1, Table 4.9.21.2.2-1, TS 38.508-1 [4])

Derivation Path: TS 38.508-1 [4] Table 4.7.2-14			
Information Element	Value/remark	Comment	Condition
PDU session ID	The same ID as the ID of PDU session which UE request in step 26 in Table 10.1.3.2.3.2-1		
5GSM cause	'0100 0011'B	insufficient resources for specific slice and DNN	
Back-off timer value	'1010 0010'B	2 minutes	

Table 10.1.3.2.3.3-8: UL NAS TRANSPORT (step 32, 37 and 49, Table 10.1.3.2.3.2-1)

Derivation Path: TS 38.508-1 [4] Table 4.7.1-10			
Information Element	Value/remark	Comment	Condition
Payload container type	'0001'B	N1 SM information	
Payload container	PDU SESSION ESTABLISHMENT REQUEST		
S-NSSAI	The same S-NSSAI as the S-NSSAI of the PDU session which UE request at step 26		
DNN	The same DNN as the DNN of the PDU session which UE request at step 26		

Table 10.1.3.2.3.3-9: PDU SESSION RELEASE COMMAND (step 34, Table 10.1.3.2.3.2-1; step 1, Table 4.9.21.2.2-1, TS 38.508-1 [4])

Derivation Path: TS 38.508-1 [4] Table 4.7.2-14			
Information Element	Value/remark	Comment	Condition
PDU session ID	The same ID as the ID of PDU session which UE request in step 32 in Table 10.1.3.2.3.2-1		
5GSM cause	'0100 0011'B	insufficient resources for specific slice and DNN	
Back-off timer value	'1010 0000'B	0 minutes	

Table 10.1.3.2.3.3-10: PDU SESSION RELEASE COMMAND (step 39, Table 10.1.3.2.3.2-1; step 1, Table 4.9.21.2.2-1, TS 38.508-1 [4])

Derivation Path: TS 38.508-1 [4] Table 4.7.2-14			
---	--	--	--

Information Element	Value/remark	Comment	Condition
PDU session ID	The same ID as the ID of PDU session which UE request in step 37 in Table 10.1.3.2.3.2-1		
5GSM cause	'0100 0011'B	insufficient resources for specific slice and DNN	
Back-off timer value	'1110 0000'B	deactivated	

Table 10.1.3.2.3.3-11: PDU SESSION RELEASE COMMAND (step 43, Table 10.1.3.2.3.2-1; step 1, Table 4.9.21.2.2-1, TS 38.508-1 [4])

Derivation Path: TS 38.508-1 [4] Table 4.7.2-14			
Information Element	Value/remark	Comment	Condition
PDU session ID	The same ID as the ID of PDU session which UE request in step 37 in Table 10.1.3.2.3.2-1		
5GSM cause	'0010 0100'B	#36 regular deactivation	

Table 10.1.3.2.3.3-11A: UL NAS TRANSPORT (step 44, Table 10.1.3.2.3.2-1)

Derivation Path: TS 38.508-1 [4] Table 4.7.1-10			
Information Element	Value/remark	Comment	Condition
PDU session ID	The same ID as the ID of PDU session which UE request in step 37 in Table 10.1.3.2.3.2-1		
Payload container type	'0001'B	N1 SM information	
Payload container	5GSM STATUS		

Table 10.1.3.2.3.3-12: 5GSM STATUS (Table 10.1.3.2.3.3-11A)

Derivation Path: TS 38.508-1 [4] Table 4.7.2-16			
Information Element	Value/remark	Comment	Condition
5GSM cause	'0010 1011'B	#43 Invalid PDU session identity	

10.1.4 UE-requested PDU session establishment

10.1.4.1 UE-requested PDU session establishment / Abnormal / T3580

10.1.4.1.1 Test Purpose (TP)

(1)

with { the UE in 5GMM-REGISTERED state and at least one PDU session has been established. the SS sends PDU SESSION RELEASE COMMAND with #39 "reactivation requested", and the UE has sent a PDU SESSION ESTABLISHMENT REQUEST message }

ensure that {

when { On the 1st, 2nd, 3rd, 4th expiry of timer T3580 }

```

    then { the UE retransmits PDU SESSION ESTABLISHMENT REQUEST message and the PDU session
    information which was transported together with the initial transmission of the PDU SESSION
    ESTABLISHMENT REQUEST message }
  }

```

(2)

```

with { the UE in 5GMM-REGISTERED state and has sent a PDU SESSION ESTABLISHMENT REQUEST message }
ensure that {
  when { on the maximum 5th expiry of timer T3580 }
  then { the UE aborts the procedure }
}

```

10.1.4.1.2 Conformance requirements

References: The conformance requirements covered in the present TC are specified in: TS 24.501, clause 6.4.1.6. Unless otherwise stated these are Rel-15 requirements.

[TS 24.501, clause 6.4.1.6]

The following abnormal cases can be identified:

a) Expiry of timer T3580

The UE shall, on the first expiry of the timer T3580, retransmit the PDU SESSION ESTABLISHMENT REQUEST message and the PDU session information which was transported together with the initial transmission of the PDU SESSION ESTABLISHMENT REQUEST message and shall reset and start timer T3580, if still needed. This retransmission can be repeated up to four times, i.e. on the fifth expiry of timer T3580, the UE shall abort the procedure, release the allocated PTI and enter the state PROCEDURE TRANSACTION INACTIVE.

10.1.4.1.3 Test description

10.1.4.1.3.1 Pre-test conditions

System Simulator:

- NGC Cell A.

UE:

- None.

Preamble:

- The UE is in state 3N-A on NGC Cell A with at least one PDU session X ($1 \leq X \leq 15$) active according to 38.508-1 [4].

10.1.4.1.3.2 Test procedure sequence

Table 10.1.4.1.3.2-1: Main behaviour

St	Procedure	Message Sequence		TP	Verdict
		U - S	Message		
0A	Cause the UE to request establishment of PDU session Y to the DN. (Note 3)	-	-	-	-
0B	The PDU session establishment procedure as specified in TS 38.508-1 [4] subclause 4.5A.2 takes place	-	-	-	-
1	The generic test procedure in TS 38.508-1 clause 4.9.21 for PDU Session Release is performed with PDU SESSION RELEASE COMMAND message includes 5GSM cause #39 "reactivation requested" to release PDU	-	-	-	-

	session X.				
2-15	Void.	-	-	-	-
16	The UE transmits a PDU SESSION ESTABLISHMENT REQUEST message and the S-NSSAI and DNN in UL NAS TRANSPORT message are the same values as released (Note 2).	-->	5GMM: UL NAS TRANSPORT 5GSM: PDU SESSION ESTABLISHMENT REQUEST	-	-
17	The SS waits 16 seconds (T3580).	-	-	-	-
18	Check: Does the UE re-transmit the PDU SESSION ESTABLISHMENT REQUEST message and the S-NSSAI and DNN in UL NAS TRANSPORT message are the same values as sent in step 16?	-->	5GMM: UL NAS TRANSPORT 5GSM: PDU SESSION ESTABLISHMENT REQUEST	1	P
19	The SS waits 16 seconds (2 nd expiry of T3580).	-	-	-	-
20	Check: Does the UE re-transmit the PDU SESSION ESTABLISHMENT REQUEST message and the S-NSSAI and DNN in UL NAS TRANSPORT message are the same values as sent in step 16?	-->	5GMM: UL NAS TRANSPORT 5GSM: PDU SESSION ESTABLISHMENT REQUEST	1	P
21	The SS waits 16 seconds (3 rd expiry of T3580).	-	-	-	-
22	Check: Does the UE re-transmit the PDU SESSION ESTABLISHMENT REQUEST message and the S-NSSAI and DNN in UL NAS TRANSPORT message are the same values as sent in step 16?	-->	5GMM: UL NAS TRANSPORT 5GSM: PDU SESSION ESTABLISHMENT REQUEST	1	P
23	The SS waits 16 seconds (4 th expiry of T3580).	-	-	-	-
24	Check: Does the UE re-transmit the PDU SESSION ESTABLISHMENT REQUEST message and the S-NSSAI and DNN in UL NAS TRANSPORT message are the same values as sent in step 16?	-->	5GMM: UL NAS TRANSPORT 5GSM: PDU SESSION ESTABLISHMENT REQUEST	1	P
25	The SS waits 16 seconds (5 th expiry of T3580).	-	-	-	-
26	Check: Does the UE re-transmit the PDU SESSION ESTABLISHMENT REQUEST message and the S-NSSAI and DNN in UL NAS TRANSPORT message are the same values as sent in step 16 in the next 20 seconds? (Note 1)	-->	5GMM: UL NAS TRANSPORT 5GSM: PDU SESSION ESTABLISHMENT REQUEST	2	F
<p>Note 1: The 20 seconds is chosen randomly as long as it is greater than T3580 = 16 seconds. Note 2 : At step 16 the SS waits for 1s for the UE to transmit the PDU Session Establishment REQ. Upon expiry of 1s, the PDU Session Establishment may be performed by MMI or AT command. Note 3: The request of connectivity to an additional PDU session may be performed by MMI or AT command.</p>					

10.1.4.1.3.3 Specific message contents

Table 10.1.4.1.3.3-0: PDU SESSION ESTABLISHMENT ACCEPT (preamble; step 3, Table 4.5A.2.2.2-1, TS 38.508-1 [4])

Derivation path: TS 38.508-1 [4], Table 4.7.2-2			
Information Element	Value/remark	Comment	Condition
Authorized QoS rules	5GC QoS rule of the Config#n in TS 38.508-1[4], Table 4.8.4-1	'n' in QoS rule#n corresponds to the default PDU session type as set in the PICS pc_APN_Default_Configuration	
Mapped EPS bearer contexts			
Mapped EPS bearer context			
Mapped EPS QoS parameters	EPC default bearer context of the Config#1 in Table 4.8.4-1		

DNN	The same DNN value as sent in the UL NAS TRANSPORT message during (preamble; step 2a1, Table 4.5A.2.2.2-2, TS 38.508-1 [4])		
-----	---	--	--

Table 10.1.4.1.3.3-1: PDU SESSION RELEASE COMMAND (Step 1, Table 10.1.4.1.3.2-1; step 1, TS 38.508-1 [4] Table 4.9.21.2.2-1)

Derivation path: TS 38.508-1 [4], table 4.7.2-14			
Information Element	Value/Remark	Comment	Condition
PDU session ID	X	ID of the active PDU session in preamble	
5GSM cause	'0010 0111'B	Reactivation requested	

Table 10.1.4.1.3.3-2: UL NAS TRANSPORT (Step 16, 18, 20, 22, 24 Table 10.1.4.1.3.2-1)

Derivation path: TS 38.508-1 [4], table 4.7.1-10			
Information Element	Value/Remark	Comment	Condition
S-NSSAI	Same as the S-NSSAI of PDU session X in the Preamble	"OMIT" can be a value for S-NSSAI	
DNN	Same as the DNN of PDU session X in the Preamble	"OMIT" can be a value for DNN	

Table 10.1.4.1.3.3-3: UL NAS TRANSPORT (Preamble, step 2a1, Table 4.5A.2.2.2-2, TS 38.508-1 [4])

Derivation Path: TS 38.508-1 [4] Table 4.7.1-10			
Information Element	Value/remark	Comment	Condition
S-NSSAI	Record value if present, otherwise record as "OMIT"	TTCN recorded the value to compare with value of same IE in step 16,18, 20, 22, 24	
DNN	Record value if present, otherwise record as "OMIT"	TTCN recorded the value to compare with value of same IE in step 16,18, 20, 22, 24	

10.1.5 UE-requested PDU session modification

10.1.5.1 UE-requested PDU session modification

10.1.5.1.1 Test Purpose (TP)

(1)

```

with { UE in PDU SESSION ACTIVE state and in 5GMM-CONNECTED mode }
ensure that {
  when { UE is requested to modify of PDU session }
  then { UE sends a PDU SESSION MODIFICATION REQUEST message }
}

```

10.1.5.1.2 Conformance requirements

References: The conformance requirements covered in the present TC are specified in: TS 24.501, clause 6.4.2.1 and 6.4.2.2. Unless otherwise stated these are Rel-15 requirements.

[TS 24.501, clause 6.4.2.1]

The purpose of the UE-requested PDU session modification procedure is:

- a) to enable the UE to request modification of a PDU session;
- b) to indicate a change of 3GPP PS data off UE status for a PDU session;
- c) to revoke the previously indicated support for reflective QoS;
- d) to request specific QoS handling and segregation of service data flows;
- e) to indicate to the network the relevant 5GSM parameters and capabilities (e.g. the UE's 5GSM capabilities, whether the UE supports more than 16 packet filters, the maximum data rate per UE for user-plane integrity protection supported by the UE for uplink and the maximum data rate per UE for user-plane integrity protection supported by the UE for downlink) for a PDN connection established when in S1 mode, after the first inter-system change from S1 mode to N1 mode, if the UE is operating in single-registration mode in the network supporting N26 interface; or
- f) to delete one or more mapped EPS bearer contexts.

NOTE: The UE does not request a PDU session modification for an LADN when the UE is located outside the LADN service area.

[TS 24.501, clause 6.4.2.2]

In order to initiate the UE-requested PDU session modification procedure, the UE shall create a PDU SESSION MODIFICATION REQUEST message.

The UE shall allocate a PTI value currently not used and shall set the PTI IE of the PDU SESSION MODIFICATION REQUEST message to the allocated PTI value.

The UE shall not perform the UE-requested PDU session modification procedure for an emergency PDU session.

The UE shall not perform the UE-requested PDU session modification procedure for a PDU session for LADN when the UE is located outside the LADN service area.

If the UE requests a specific QoS handling, the UE shall include the requested QoS rules IE indicating requested QoS rules and the requested QoS flow descriptions IE indicating requested QoS flow descriptions for the specific QoS handling. The QoS rules IE includes the packet filters which describe the service data flows requested by the UE. The specific QoS parameters requested by the UE is specified in the QoS flow descriptions IE. If the UE requests the network to bind specific service data flows to a dedicated QoS flow, the UE shall create a new QoS rule by setting the rule operation code to "Create new QoS rule" and shall set the segregation bit to "Segregation requested" for the corresponding QoS rule in the QoS rules IE. The UE shall set the QRI values to "no QoS rule identifier assigned" in the requested QoS rules IE, if the QoS rules are newly created; otherwise, the UE shall set the QRI values to those of the existing QoS rules for which the specific QoS handling applies. The UE shall set the QFI values to "no QoS flow identifier assigned" in the requested QoS flow descriptions IE, if the QoS flow descriptions are newly created; otherwise, the UE shall set the QFI values to the QFIs of the existing QoS flow descriptions for which the specific QoS handling applies.

...

If the UE is performing the PDU session modification procedure to request the deletion of a non-default QoS rule due to errors in QoS operations or packet filters, the UE shall include the 5GSM cause IE in the PDU SESSION MODIFICATION REQUEST message as described in subclause 6.4.1.3.

Even if the timer T3396, T3584, or T3585 is running or is deactivated, the UE shall indicate a change of 3GPP PS data off UE status associated to a PDU session, by including the extended protocol configuration options IE in the PDU SESSION MODIFICATION REQUEST message and setting the 3GPP PS data off UE status.

For a PDN connection established when in S1 mode, after the first inter-system change from S1 mode to N1 mode, if the UE is operating in single-registration mode in the network supporting N26 interface and the UE requests the PDU session to be an always-on PDU session in the 5GS, the UE shall include the Always-on PDU session requested IE and set the value of the IE to "Always-on PDU session requested" in the PDU SESSION MODIFICATION REQUEST message.

The UE shall transport the PDU SESSION MODIFICATION REQUEST message, the PDU session ID, and the request type set to "modification request", using the NAS transport procedure as specified in subclause 5.4.5, and the UE shall start timer T3581 (see example in figure 6.4.2.2.1).

10.1.5.1.3 Test description

10.1.5.1.3.1 Pre-test conditions

System Simulator:

- NGC Cell A.

UE:

- None.

Preamble:

- The UE is in state 3N-A on NGC Cell A with PDU SESSION ACTIVE according to TS 38.508-1 [4].

10.1.5.1.3.2 Test procedure sequence

Table 10.1.5.1.3.2-1: Main behaviour

St	Procedure	Message Sequence		TP	Verdict
		U - S	Message		
1	Cause the UE to pdu session modification with the previously established PDN session at preamble. (see Note)	-	-	-	-
2	Check: Does the UE transmit a PDU SESSION MODIFICATION REQUEST message?	-->	PDU SESSION MODIFICATION REQUEST	1	P
3	The SS transmits an PDU SESSION MODIFICATION COMMAND message.	<--	PDU SESSION MODIFICATION COMMAND	-	-
4	the UE transmit an PDU SESSION MODIFICATION COMPLETE message.	-->	PDU SESSION MODIFICATION COMPLETE	-	-

Note: The request of pdu session modification may be performed by MMI or AT command.

10.1.5.1.3.3 Specific message contents

Table 10.1.5.1.3.3-1: PDU SESSION MODIFICATION COMMAND (step 3, Table 10.1.5.1.3.2-1)

Derivation path: TS 38.508-1, Table 4.7.2-9			
Information Element	Value/remark	Comment	Condition
PDU session ID	The value indicated in PDU SESSION MODIFICATION REQUEST		
PTI	The value indicated in PDU SESSION MODIFICATION REQUEST		
Authorized QoS rules	According to QoS rule #n as defined in TS 38.508-1 [4], Table 4.8.4-1 except for Rule operation	'n' in QoS rule#n corresponds to the default PDU session type as	

	code set to '100'B and QoS rule precedence set to '0000 0010'- see TS 38.508-1 [4] , clause 4.8.2.1	set in the PICS pc_APN_Default_Configuration	
--	---	--	--

10.1.6 UE-requested PDU session release

10.1.6.1 UE-requested PDU session release / Abnormal / Collision with network-requested PDU session modification procedure

10.1.6.1.1 Test Purpose (TP)

(1)

```

with { the UE is in PDU SESSION ACTIVE state and has sent a PDU SESSION RELEASE REQUEST message }
ensure that {
  when { UE receives a PDU SESSION MODIFICATION COMMAND message indicating a PDU session that UE wants to release }
  then { the UE ignores the PDU SESSION MODIFICATION COMMAND message and proceed with the PDU session release procedure }
}

```

10.1.6.1.2 Conformance requirements

References: The conformance requirements covered in the current TC are specified in: TS 24.501, clause 6.4.3.2, 6.4.3.3 and 6.4.3.5. Unless otherwise stated these are Rel-15 requirements.

[TS 24.501, clause 6.4.3.2]

In order to initiate the UE-requested PDU session release procedure, the UE shall create a PDU SESSION RELEASE REQUEST message.

The UE may set the 5GSM cause IE of the PDU SESSION RELEASE REQUEST message to indicate the reason for releasing the PDU session.

The 5GSM cause IE typically indicates one of the following 5GSM cause values:

- #36 regular deactivation;
- #41 Semantic error in the TFT operation;
- #42 Syntactical error in the TFT operation;
- #44 Semantic errors in packet filter(s);
- #45 Syntactical error in packet filter(s).

The UE shall allocate a PTI value currently not used and shall set the PTI IE of the PDU SESSION RELEASE REQUEST message to the allocated PTI value.

The UE shall transport the PDU SESSION RELEASE REQUEST message and the PDU session ID, using the NAS transport procedure as specified in subclause 5.4.5, and the UE shall start timer T3582 (see example in figure 6.4.3.2.1).

[TS 24.501, clause 6.4.3.3]

Upon receipt of a PDU SESSION RELEASE REQUEST message and a PDU session ID, if the SMF accepts the request to release the PDU session, and shall perform the network-requested PDU session release procedure as specified in subclause 6.3.3.

[TS 24.501, clause 6.4.3.5]

The following abnormal cases can be identified:

b) Collision of UE-requested PDU session release procedure and network-requested PDU session modification procedure.

When the UE receives a PDU SESSION MODIFICATION COMMAND message during the UE-requested PDU session release procedure, and the PDU session indicated in PDU SESSION MODIFICATION COMMAND message is the PDU session that the UE had requested to release, the UE shall ignore the PDU SESSION MODIFICATION COMMAND message and proceed with the PDU session release procedure.

10.1.6.1.3 Test description

10.1.6.1.3.1 Pre-test conditions

System Simulator:

- NGC Cell A.

UE:

None.

Preamble:

The UE is in state 3N-A on NGC Cell A according to TS 38.508-1 [4].

10.1.6.1.3.2 Test procedure sequence

Table 10.1.6.1.3.2-1: Main behaviour

St	Procedure	Message Sequence		TP	Verdict
		U - S	Message		
1	Cause the UE to request establishment of PDU session to the DN.(Note 1)	-	-	-	-
2	The PDU session establishment procedure as specified in TS 38.508-1 [4] subclause 4.5A.2 take place.	-	-	-	-
3	Cause the UE to request release of PDU session established during step 2.(Note 2)	-	-	-	-
4	The UE transmits a PDU SESSION RELEASE REQUEST message.	-->	PDU SESSION RELEASE REQUEST	-	-
5	The SS transmits a PDU SESSION MODIFICATION COMMAND message.	<--	PDU SESSION MODIFICATION COMMAND	-	-
6	Check: Does the UE transmit a PDU SESSION MODIFICATION COMPLETE or PDU SESSION MODIFICATION COMMAND REJECT message in the next 3 seconds?	-	-	1	F
7	Check: Does the UE perform PDU session release procedure defined in clause 4.9.21 of TS 38.508-1 [4]?	-	-	1	P
8	Void	-	-		

Note 1: The request to establish a PDU session may be performed by MMI or AT command.

Note 2: The request to release a PDU session may be performed by MMI.

10.1.6.1.3.3 Specific message contents

Table 10.1.6.1.3.3-0: PDU SESSION ESTABLISHMENT ACCEPT (Step 2, Table 10.1.6.1.3.2-1)

Derivation path: TS 38.508-1 [4], Table 4.7.2-2			
Information Element	Value/remark	Comment	Condition
Authorized QoS rules	5GC QoS rule of the Config#1 in Table 4.8.4-1		
Mapped EPS bearer contexts			
Mapped EPS bearer context			
Mapped EPS QoS parameters	EPC default bearer context of the Config#1 in Table 4.8.4-1		
DNN	The same DNN value as sent in the UL NAS TRANSPORT message at (step 2, Table 10.1.6.1.3.2-1; step 2a1, Table 4.5A.2.2.2-2, TS 38.508-1 [4])		

Table 10.1.6.1.3.3-1: PDU SESSION RELEASE REQUEST (step 4, Table 10.1.6.1.3.2-1)

Derivation Path: TS 38.508-1 [4] Table 4.7.2-12			
Information Element	Value/remark	Comment	Condition
PDU session ID	Set to the ID UE requested in step 2 in Table 10.1.6.1.3.2-1		
PTI	Any value from 1 to 254		

Table 10.1.6.1.3.3-2: PDU SESSION MODIFICATION COMMAND (step 5, Table 10.1.6.1.3.2-1)

Derivation Path: TS 38.508-1 [4] Table 4.7.2-9			
Information Element	Value/remark	Comment	Condition
PDU session ID	Set to the ID UE requested in step 2 in Table 10.1.6.1.3.2-1		
PTI	'0000 0000'B	No procedure transaction identity assigned	

Table 10.1.6.1.3.3-3: PDU SESSION RELEASE COMMAND (step 7, Table 10.1.6.1.3.2-1; step 1, TS 36.508 [4] Table 4.9.21.2.2-1)

Derivation Path: TS 38.508-1 [4] Table 4.7.2-14			
---	--	--	--

Information Element	Value/remark	Comment	Condition
PDU session ID	Same ID as the ID UE requested in step 2 in Table 10.1.6.1.3.2-1		
PTI	The value indicated in PDU SESSION RELEASE REQUEST		
5GSM cause	'0010 0100'B	#36 regular deactivation	

Table 10.1.6.1.3.3-4: PDU SESSION RELEASE COMPLETE (step 8, Table 10.1.6.1.3.2-1; step 2, TS 36.508 [4] Table 4.9.21.2.2-1)

Derivation Path: TS 38.508-1 [4] Table 4.7.2-15			
Information Element	Value/remark	Comment	Condition
PDU session ID	Same ID as the ID UE requested in step 2 in Table 10.1.6.1.3.2-1		
PTI	The value indicated in PDU SESSION RELEASE REQUEST		

10.1.6.2 UE-requested PDU session release / Abnormal / Collision with network-requested PDU session release procedure

10.1.6.2.1 Test Purpose (TP)

(1)

```

with { the UE is in PDU SESSION ACTIVE state and transported the PDU SESSION RELEASE REQUEST message }
ensure that {
  when { UE receives a PDU SESSION RELEASE COMMAND message with the PTI IE set to "No procedure
transaction identity assigned" indicating a PDU session that UE wants to release }
  then { the UE aborts the UE-requested PDU session release procedure and proceeds with the
network-requested PDU session release procedure }
}

```

10.1.6.2.2 Conformance requirements

References: The conformance requirements covered in the current TC are specified in: TS 24.501, clause 6.4.3.2, 6.4.3.3 and 6.4.3.5. Unless otherwise stated these are Rel-15 requirements.

[TS 24.501, clause 6.4.3.2]

In order to initiate the UE-requested PDU session release procedure, the UE shall create a PDU SESSION RELEASE REQUEST message.

The UE may set the 5GSM cause IE of the PDU SESSION RELEASE REQUEST message to indicate the reason for releasing the PDU session.

The 5GSM cause IE typically indicates one of the following 5GSM cause values:

- #36 regular deactivation;
- #41 Semantic error in the TFT operation;
- #42 Syntactical error in the TFT operation;
- #44 Semantic errors in packet filter(s);
- #45 Syntactical error in packet filter(s).

The UE shall allocate a PTI value currently not used and shall set the PTI IE of the PDU SESSION RELEASE REQUEST message to the allocated PTI value.

The UE shall transport the PDU SESSION RELEASE REQUEST message and the PDU session ID, using the NAS transport procedure as specified in subclause 5.4.5, and the UE shall start timer T3582 (see example in figure 6.4.3.2.1).

[TS 24.501, clause 6.4.3.3]

Upon receipt of a PDU SESSION RELEASE REQUEST message and a PDU session ID, if the SMF accepts the request to release the PDU session, and shall perform the network-requested PDU session release procedure as specified in subclause 6.3.3.

[TS 24.501, clause 6.4.3.5]

The following abnormal cases can be identified:

...

- c) Collision of UE-requested PDU session release procedure and network-requested PDU session release procedure.

When the UE receives a PDU SESSION RELEASE COMMAND message with the PTI IE set to "No procedure transaction identity assigned" during the UE-requested PDU session release procedure, and the PDU session indicated in the PDU SESSION RELEASE COMMAND message is the same as the PDU session that the UE requests to release, the UE shall abort the UE-requested PDU session release procedure and proceed with the network-requested PDU session release procedure.

10.1.6.2.3 Test description

10.1.6.2.3.1 Pre-test conditions

System Simulator:

- NGC Cell A.

UE:

None.

Preamble:

- The UE is in state 3N-A on NGC Cell A according to TS 38.508-1 [4].

10.1.6.2.3.2 Test procedure sequence

Table 10.1.6.2.3.2-1: Main behaviour

St	Procedure	Message Sequence		TP	Verdict
		U - S	Message		
1	Cause the UE to request establishment of PDU	-	-	-	-

	session to the DN.(Note 1)				
2	The PDU session establishment procedure as specified in TS 38.508-1 [4] subclause 4.5A.2 take place.	-	-	-	-
3	Cause the UE to request release of PDU session established during step 2.(Note 2)	-	-	-	-
4	The UE transmits a PDU SESSION RELEASE REQUEST message.	-->	PDU SESSION RELEASE REQUEST	-	-
5	Check: Does the UE perform PDU session release procedure defined in clause 4.9.21 of TS 38.508-1 [4]?	-	-	1	P
6	Void	-	-	-	-
Note 1: The request to establish a PDU session may be performed by MMI or AT command. Note 2: The request to release a PDU session may be performed by MMI.					

10.1.6.2.3.3 Specific message contents

Table 10.1.6.2.3.3-0: PDU SESSION ESTABLISHMENT ACCEPT (Step 2, Table 10.1.6.2.3.2-1)

Derivation path: TS 38.508-1 [4], Table 4.7.2-2			
Information Element	Value/remark	Comment	Condition
Authorized QoS rules	5GC QoS rule of the Config#1 in Table 4.8.4-1		
Mapped EPS bearer contexts			
Mapped EPS bearer context			
Mapped EPS QoS parameters	EPC default bearer context of the Config#1 in Table 4.8.4-1		
DNN	The same DNN value as sent in the UL NAS TRANSPORT message at (step 2, Table 10.1.6.2.3.2-1; step 2a1, Table 4.5A.2.2.2-2, TS 38.508-1 [4])		

Table 10.1.6.2.3.3-1: PDU SESSION RELEASE REQUEST (step 4, Table 10.1.6.2.3.2-1)

Derivation Path: TS 38.508-1 [4] Table 4.7.2-12			
Information Element	Value/remark	Comment	Condition
PDU session ID	Set to the ID UE requested in step 2 in Table 10.1.6.2.3.2-1		
PTI	Any value from 1 to 254		

Table 10.1.6.2.3.3-2: PDU SESSION RELEASE COMMAND (step 5, Table 10.1.6.2.3.2-1; step 1, TS 36.508 [4] Table 4.9.21.2.2-1)

Derivation Path: TS 38.508-1 [4] Table 4.7.2-14			
Information Element	Value/remark	Comment	Condition
PDU session ID	Set to the ID UE requested in step 2 in Table 10.1.6.2.3.2-1		
PTI	'0000 0000'B	No procedure transaction identity assigned	
5GSM cause	'0010 0100'B	#36 regular deactivation	

Table 10.1.6.2.3.3-3: PDU SESSION RELEASE COMPLETE (step 6, Table 10.1.6.2.3.2-1; step 2, TS 36.508 [4] Table 4.9.21.2.2-1)

Derivation Path: TS 38.508-1 [4] Table 4.7.2-15			
Information Element	Value/remark	Comment	Condition
PDU session ID	Set to the ID UE requested in step 2 in Table 10.1.6.2.3.2-1		
PTI	'0000 0000'B	unassigned	

10.1.7 Network-requested PDU session release

10.1.7.1 SNPN / Network-requested PDU session release / Accepted / Insufficient resources / T3396, Accepted / Insufficient resources for specific slice and DNN / T3584

10.1.7.1.1 Test Purpose (TP)

(1)

```

with { UE is in PDU SESSION ACTIVE state }
ensure that {
  when { UE receives a PDU SESSION RELEASE COMMAND message including 5GSM cause #26 "insufficient resources" and the Back-off timer value that indicates deactivated }
  then { UE does not send a PDU SESSION ESTABLISHMENT REQUEST message until the UE is switched off, the USIM is removed, the entry in the "list of subscriber data" for the current SNPN is updated }
}

```

(2)

```

with { UE is in PDU SESSION ACTIVE state }
ensure that {
  when { UE receives a PDU SESSION RELEASE COMMAND message including 5GSM cause #67 "insufficient resources for specific slice and DNN" and the Back-off timer value that indicates deactivated }
  then { UE does not send a PDU SESSION ESTABLISHMENT REQUEST message for the same [S-NSSAI, DNN] combination until the UE is switched off, the USIM is removed, the entry in the "list of subscriber data" for the current SNPN is updated }
}

```

10.1.7.1.2 Conformance requirements

References: The conformance requirements covered in the current TC are specified in: TS 24.501, clause 6.2.7, 6.4.3.3 and 6.4.3.5. Unless otherwise stated these are Rel-15 requirements.

[TS 24.501, clause 6.2.7]

The network may detect and start performing DNN based congestion control when one or more DNN congestion criteria as specified in 3GPP TS 23.501 [8] are met. If the UE does not provide a DNN for a non-emergency PDU session, then the network uses the selected DNN.

In the UE, 5GS session management timers T3396 for DNN based congestion control are started and stopped on a per DNN basis except for an LADN DNN in case of PLMN. For an LADN DNN, 5GS session management timers T3396 for DNN based congestion control is applied to the registered PLMN and its equivalent PLMNs. In the UE, 5GS session management timers T3396 for DNN based congestion control are started and stopped on a per DNN and SNPN basis in case of SNPN. Upon receipt of a 5GMM message or 5GSM message from the network for which the UE needs to stop the running timers T3396 associated with an LADN DNN as specified in subclause 5.5.2.3.2, 6.3.2.3, 6.3.3.3, 6.4.1.4.2 and 6.4.1.4.2, only the running timer T3396 associated with the LADN DNN for the current PLMN and equivalent PLMNs is stopped.

The DNN associated with T3396 is the DNN provided by the UE during the PDU session establishment. If no DNN is provided by the UE along the PDU SESSION ESTABLISHMENT REQUEST, then T3396 is associated with no DNN. For this purpose, the UE shall memorize the DNN provided to the network during the PDU session establishment. The timer T3396 associated with no DNN will never be started due to any 5GSM procedure related to an emergency PDU session. If the timer T3396 associated with no DNN is running, it does not affect the ability of the UE to request an emergency PDU session.

If T3396 is running or is deactivated, then the UE is neither allowed to initiate the PDU session establishment procedure nor the PDU session modification procedure for the respective DNN or without a DNN unless the UE is a UE configured for high priority access in selected PLMN or to report a change of 3GPP PS data off UE status.

[TS 24.501, clause 6.3.3.2]

In order to initiate the network-requested PDU session release procedure, the SMF shall create a PDU SESSION RELEASE COMMAND message.

The SMF shall set the 5GSM cause IE of the PDU SESSION RELEASE COMMAND message to indicate the reason for releasing the PDU session.

The 5GSM cause IE typically indicates one of the following 5GSM cause values:

- #8 operator determined barring;
- #26 insufficient resources;
- #29 user authentication or authorization failed;
- #36 regular deactivation;
- #38 network failure;
- #39 reactivation requested;
- #46 out of LADN service area;
- #67 insufficient resources for specific slice and DNN;
- #69 insufficient resources for specific slice.

If the selected SSC mode of the PDU session is "SSC mode 2" and the SMF requests the relocation of SSC mode 2 PDU session anchor with different PDU sessions as specified in 3GPP TS 23.502 [9], the SMF shall include 5GSM cause #39 "reactivation requested".

If the network-requested PDU session release procedure is triggered by a UE-requested PDU session release procedure, the SMF shall set the PTI IE of the PDU SESSION RELEASE COMMAND message to the PTI of the PDU SESSION RELEASE REQUEST message received as part of the UE-requested PDU session release procedure.

If the network-requested PDU session release procedure is not triggered by a UE-requested PDU session release procedure, the SMF shall set the PTI IE of the PDU SESSION RELEASE COMMAND message to "No procedure transaction identity assigned".

Based on the local policy and user's subscription data, if the SMF decides to release the PDU session after determining:

- a) the UE has moved between a tracking area in NB-N1 mode and a tracking area in WB-N1 mode;
- b) the UE has moved between a tracking area in NB-S1 mode and a tracking area in WB-N1 mode;
- c) the UE has moved between a tracking area in WB-S1 mode and a tracking area in NB-N1 mode; or
- d) a PDU session is not only for control plane CIoT 5GS optimization any more,

the SMF shall:

- a) include the 5GSM cause value #39 "reactivation requested" in the 5GSM cause IE of the PDU SESSION RELEASE COMMAND message; or
- b) include a 5GSM cause value other than #39 "reactivation requested" in the 5GSM cause IE of the PDU SESSION RELEASE COMMAND message.

NOTE: The included 5GSM cause value is up to the network implementation.

If the SMF receives UE presence in LADN service area from the AMF indicating that the UE is out of the LADN service area and the SMF decides to release the PDU session, the SMF shall include the 5GSM cause value #46 "out of LADN service area" in the 5GSM cause IE of the PDU SESSION RELEASE COMMAND message. Upon receipt of the 5GSM cause value #46 "out of LADN service area" in the 5GSM cause IE of the PDU SESSION RELEASE COMMAND message, the UE shall release the PDU session.

The SMF may include a Back-off timer value IE in the PDU SESSION RELEASE COMMAND message when the 5GSM cause value #26 "insufficient resources" is included in the PDU SESSION RELEASE COMMAND message. If the 5GSM cause value is #26 "insufficient resources" and the PDU SESSION RELEASE COMMAND message is sent to a UE configured for high priority access in selected PLMN or the request type was set to "initial emergency request" or "existing emergency PDU session" for the establishment of the PDU session, the network shall not include a Back-off timer value IE.

The SMF may include a Back-off timer value IE in the PDU SESSION RELEASE COMMAND message when the 5GSM cause value #67 "insufficient resources for specific slice and DNN" is included in the PDU SESSION RELEASE COMMAND message. If the 5GSM cause value is #67 "insufficient resources for specific slice and DNN" and the PDU SESSION RELEASE COMMAND message is sent to a UE configured for high priority access in selected PLMN or the request type was set to "initial emergency request" or "existing emergency PDU session" for the establishment of the PDU session, the network shall not include a Back-off timer value IE.

The SMF may include a Back-off timer value IE in the PDU SESSION RELEASE COMMAND message when the 5GSM cause #69 "insufficient resources for specific slice" is included in the PDU SESSION RELEASE COMMAND message. If the 5GSM cause value is #69 "insufficient resources for specific slice" and the PDU SESSION RELEASE COMMAND message is sent to a UE configured for high priority access in selected PLMN or the request type was set to "initial emergency request" or "existing emergency PDU session" for the establishment of the PDU session, the network shall not include a Back-off timer value IE.

The SMF shall send:

- a) the PDU SESSION RELEASE COMMAND message; and
- b) the N1 SM delivery skip allowed indication:
 - 1) if the SMF allows the AMF to skip sending the N1 SM container to the UE and the 5GSM cause IE is not set to #39 "reactivation requested"; or
 - 2) if the SMF allows the AMF to skip sending the N1 SM container to the UE and the Access type IE is not included

towards the AMF, and the SMF shall start timer T3592 (see example in figure 6.3.3.2.1).

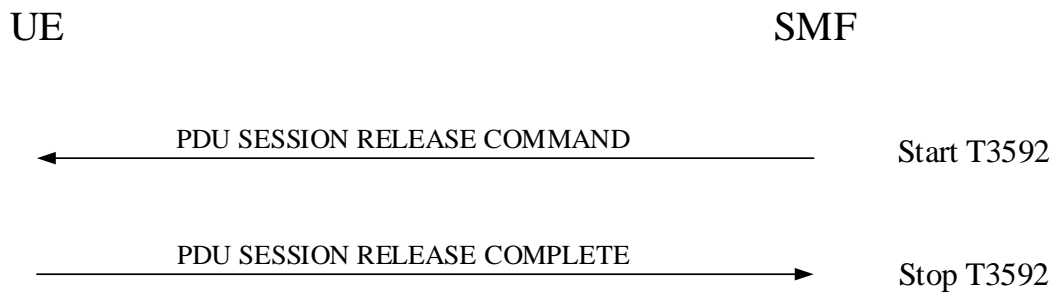

Figure 6.3.3.2.1: Network-requested PDU session release procedure

[TS 24.501, clause 6.3.3.3]

If the PDU SESSION RELEASE COMMAND message includes 5GSM cause #26 "insufficient resources" and the Back-off timer value IE, the UE shall ignore the 5GSM congestion re-attempt indicator IE provided by the network, if any, and the UE shall take different actions depending on the timer value received for timer T3396 in the Back-off timer value:

...

- b) if the timer value indicates that this timer is deactivated and a DNN was provided during the PDU session establishment, the UE shall stop timer T3396 associated with the corresponding DNN, if it is running. If the timer value indicates that this timer is deactivated and no DNN was provided during the PDU session establishment and the request type was different from "initial emergency request" and different from "existing emergency PDU session", the UE shall stop timer T3396 associated with no DNN if it is running. The UE:
 - 1) shall not send a PDU SESSION ESTABLISHMENT REQUEST message or PDU SESSION MODIFICATION REQUEST message with exception of those identified in subclause 6.4.2.1, for the same DNN until the UE is switched off, the USIM is removed, the entry in the "list of subscriber data" for the current SNPN is updated, or the UE receives a PDU SESSION MODIFICATION COMMAND message for the same DNN from the network, or a PDU SESSION RELEASE COMMAND message without the Back-off timer value IE or including 5GSM cause #39 "reactivation requested" for the same DNN from the network; and
 - 2) shall not send a PDU SESSION ESTABLISHMENT REQUEST message without an DNN and with request type different from "initial emergency request" and different from "existing emergency PDU session", or a PDU SESSION MODIFICATION REQUEST message with exception of those identified in subclause 6.4.2.1, for a non-emergency PDU session established without an DNN provided by the UE, if no DNN was provided during the PDU session establishment and the request type was different from "initial emergency request" and different from "existing emergency PDU session", until the UE is switched off, the USIM is removed, the entry in the "list of subscriber data" for the current SNPN is updated, or the UE receives a PDU SESSION MODIFICATION COMMAND message for a non-emergency PDU session established without an DNN provided by the UE, or a PDU SESSION RELEASE COMMAND message without the Back-off timer value IE or including 5GSM cause #39 "reactivation requested" for a non-emergency PDU session established without an DNN provided by the UE.

The timer T3396 remains deactivated upon a PLMN change or inter-system change; and

...

If the 5GSM cause value is #69 "insufficient resources for specific slice" and the Back-off timer value IE is included, the UE shall take different actions depending on the timer value received for timer T3585 in the Back-off timer value:

...

- b) if the timer value indicates that this timer is deactivated and an S-NSSAI was provided during the PDU session establishment, the UE shall stop timer T3585 associated with the S-NSSAI of the PDU session, if it is running. If the timer value indicates that this timer is deactivated and no S-NSSAI was provided during the PDU session establishment and the request type was different from "initial emergency request" and different from "existing emergency PDU session", the UE shall stop timer T3585 associated with no S-NSSAI if it is running. In addition:
- 1) if an S-NSSAI was provided by the UE during the PDU session establishment, the UE shall not send another PDU SESSION ESTABLISHMENT REQUEST, or PDU SESSION MODIFICATION REQUEST with exception of those identified in subclause 6.4.2.1, for the S-NSSAI of the PDU session until the UE is switched off, the USIM is removed, the entry in the "list of subscriber data" for the current SNPN is updated, or a PDU SESSION RELEASE COMMAND message without the Back-off timer value IE or including 5GSM cause #39 "reactivation requested" for the S-NSSAI of the PDU session from the network; and
 - 2) if the request type was different from "initial emergency request" and from "existing emergency PDU session", and an S-NSSAI was not provided by the UE during the PDU session establishment, the UE shall not send another PDU SESSION ESTABLISHMENT REQUEST message without an S-NSSAI and with request type different from "initial emergency request" and different from "existing emergency PDU session", or another PDU SESSION MODIFICATION REQUEST message with exception of those identified in subclause 6.4.2.1, for a non-emergency PDU session established without an S-NSSAI provided by the UE, , until the UE is switched off, the USIM is removed, the entry in the "list of subscriber data" for the current SNPN is updated, or a PDU SESSION RELEASE COMMAND message without the Back-off timer value IE or including 5GSM cause #39 "reactivation requested" for a non-emergency PDU session established without an S-NSSAI provided by the UE.

The timer T3585 remains deactivated upon a PLMN change or inter-system change; and

10.1.7.1.3 Test description

10.1.7.1.3.1 Pre-test conditions

System Simulator:

- NGC Cell A.

UE:

- The UE is provisioned with a "list of subscriber data" to allow access to SNPN identified by NGC Cell A.

Preamble:

The UE is in state 3N-A on NGC Cell A according to TS 38.508-1 [4].

10.1.7.1.3.2 Test procedure sequence

Table 10.1.7.1.3.2-1: Main behaviour

St	Procedure	Message Sequence		TP	Verdict
		U - S	Message		
1	Check: Does the UE perform PDU session release procedure defined in clause 4.9.21 of TS 38.508-1 [4]?	-	-	-	-
2	SS releases the RRC connection	-	-	-	-
3	Cause the UE to request the PDU Session establishment on the DNN of the released PDU session in Step 1(Note 1)	-	-	-	-
4	Check: Does the UE transmit an RRCSetupRequest message for PDU Session Establishment procedure within the next 30 seconds?	-->	NR RRC: RRCSetupRequest	1	F
5	The UE is provisioned with a "list of subscriber	-	-	-	-

	data" to allow access to SNPN identified by NGC Cell A (Note 2)				
6	Cause the UE to request the PDU Session establishment on the DNN of the released PDU session in Step 1(Note 1)	-	-	-	-
7	The PDU session establishment procedure as specified in TS 38.508-1 [4] subclause 4.5A.2 takes place .	-	-	1	P
8	Check: Does the UE perform PDU session release procedure defined in clause 4.9.21 of TS 38.508-1 [4]?	-	-	-	-
9	SS releases the RRC connection	-	-	-	-
10	Cause the UE to request the PDU Session establishment on the DNN of the released PDU session in Step 8 (Note 1)	-	-	-	-
11	Check: Does the UE transmit an RRCSetupRequest message for PDU Session Establishment procedure within the next 30 seconds?	-->	NR RRC: RRCSetupRequest	2	F
12	The UE is provisioned with a "list of subscriber data" to allow access to SNPN identified by NGC Cell A (Note 2)	-	-	-	-
13	Cause the UE to request the PDU Session establishment on the DNN of the released PDU session in Step 1(Note 1)	-	-	-	-
14	The PDU session establishment procedure as specified in TS 38.508-1 [4] subclause 4.5A.2 takes place .	-	-	2	P
Note 1: The request of PDU session establishment may be performed by MMI or AT command.					
Note 2: The request to provision with a "list of subscriber data" may be performed by MMI or AT command.					

10.1.7.1.3.3 Specific message contents

Table 10.1.7.1.3.3-1: PDU SESSION RELEASE COMMAND (step 1, Table 10.1.7.1.3.2-1; step 1, TS 36.508 [4] Table 4.9.21.2.2-1)

Derivation Path: TS 38.508-1 [4] Table 4.7.2-14			
Information Element	Value/remark	Comment	Condition
5GSM cause	'0001 1010'B	#26 "insufficient resources"	
Back-off timer value	Deactivated	Set to deactivated	

Table 10.1.7.1.3.3-2: PDU SESSION RELEASE COMPLETE (step 1, 8, Table 10.1.7.1.3.2-1; step 2, TS 36.508 [4] Table 4.9.21.2.2-1)

Derivation Path: TS 38.508-1 [4] Table 4.7.2-15			
Information Element	Value/remark	Comment	Condition
PDU session ID	The value indicated in PDU SESSION RELEASE REQUEST		
PTI	The value indicated in PDU SESSION RELEASE REQUEST		

Table 10.1.7.1.3.3-3: PDU SESSION RELEASE COMMAND (step 8, Table 10.1.7.1.3.2-1; step 1, TS 36.508 [4] Table 4.9.21.2.2-1)

Derivation Path: TS 38.508-1 [4] Table 4.7.2-14			
Information Element	Value/remark	Comment	Condition
5GSM cause	'0100 0011'B	#67 "insufficient resources for specific slice and DNN"	

Back-off timer value	Deactivated	Set to deactivated	
----------------------	-------------	--------------------	--

10.1.8

10.1.8.1 NSAC / PDU session establishment reject / Maximum number of PDU sessions reached / Back-off timer is neither zero nor deactivated

10.1.8.1.1 Test Purpose (TP)

(1)

```
with { UE is establishing UE-requested PDU session by sending PDU Session establishment Request message with S-NSSAI }
ensure that {
  when { UE receives PDU SESSION ESTABLISHMENT REJECT with 5GSM cause value #69 "insufficient resources for specific slice" and Back-off timer value which is neither zero nor deactivated }
  then { UE shall start timer T3585 and shall not send another PDU SESSION ESTABLISHMENT REQUEST message for the same S-NSSAI }
}
```

(2)

```
with { The timer T3585 associated with a S-NSSAI is running }
ensure that {
  when { UE is switched off and switched on }
  then { UE shall restart the timer T3585 if the time remaining for T3585 timeout at switch off is greater than the time elapsed between switch off and switch on }
}
```

(3)

```
with { UE in 5GMM-REGISTERED state }
ensure that {
  when { The timer T3585 associated with the S-NSSAI expires }
  then { UE could initiate PDU session establishment request with the S-NSSAI }
}
```

(4)

```
with { UE is establishing UE-requested PDU session by sending PDU Session establishment Request message with no S-NSSAI provided }
ensure that {
  when { UE receives PDU SESSION ESTABLISHMENT REJECT with 5GSM cause value #69 "insufficient resources for specific slice" and Back-off timer value which is neither zero nor deactivated }
  then { UE shall start timer T3585 and shall not send another PDU SESSION ESTABLISHMENT REQUEST message without an S-NSSAI }
}
```

10.1.8.1.2 Conformance requirements

References: The conformance requirements covered in the present TC are specified in: TS 24.501, clause 4.6.3.1, clause 6.4.1.4.2. Unless otherwise stated these are Rel-17 requirements.

[TS 24.501, clause 4.6.3.1]

A serving PLMN or the HPLMN, or SNPN can perform network slice admission control for the S-NSSAI(s) subject to NSAC to monitor and control the total number of established PDU sessions per network slice. The SMF performs network slice admission control on the S-NSSAI during the PDU session establishment procedure. If the maximum number of PDU sessions on a network slice associated with an S-NSSAI has been already reached, the SMF rejects the PDU session establishment request using S-NSSAI based congestion control as specified in subclause 6.2.8 and 6.4.1.4.2.

The SMF performs network slice admission control on the S-NSSAI for a PDU session that is associated with the non-3GPP access, when the UE requests to transfer a session from the non-3GPP access to the 3GPP access with the Allowed PDU session status IE as described in subclause 5.6.1.4. If the maximum number of PDU sessions on a

network slice associated with an S-NSSAI has been already reached, the SMF rejects the request to establish the user-plane resources (see 3GPP TS 29.502 [20A]).

Based on operator policy, the session management based network slice admission control is not applicable for the PDU session for emergency services, or the session management based network slice admission control result is ignored for the PDU session for emergency services.

Based on operator policy, the session management based network slice admission control is not applicable for the PDU session for priority services, or the session management based network slice admission control result is ignored for the PDU session for priority services.

NOTE: How the SMF determines that the PDU session is used for priority services is outside the scope of this release of the present document.

The session management based network slice admission control is not applicable to PDU session established for onboarding services in SNPN.

NOTE 1: For the MA PDU session during the PDU session establishment procedure, the SMF performs network slice admission control only when it is newly established over the associated access type.

NOTE 2: For a set of redundant PDU sessions, the SMF performs network slice admission control for each PDU session independently.

[TS 24.501, clause 6.4.1.4.2]

If:

- the 5GSM cause value #69 "insufficient resources for specific slice" and the Back-off timer value IE are included in the PDU SESSION ESTABLISHMENT REJECT message; or
- an indication that the 5GSM message was not forwarded due to S-NSSAI only based congestion control is received along a Back-off timer value and a PDU SESSION ESTABLISHMENT REQUEST message with the PDU session ID IE set to the PDU session ID of the PDU session;

the UE shall ignore the Re-attempt indicator IE provided by the network, if any, and take different actions depending on the timer value received for timer T3585 in the Back-off timer value IE or depending on the Back-off timer value received from the 5GMM sublayer (if the UE is a UE configured for high priority access in selected PLMN, exceptions are specified in subclause 6.2.8):

- a) If the timer value indicates neither zero nor deactivated and an S-NSSAI was provided during the PDU session establishment and the request type was different from "initial emergency request" and different from "existing emergency PDU session", the UE shall stop timer T3585 associated with the corresponding S-NSSAI, if it is running. If the timer value indicates neither zero nor deactivated and no S-NSSAI was provided during the PDU session establishment and the request type was different from "initial emergency request" and different from "existing emergency PDU session", the UE shall stop timer T3585 associated with no S-NSSAI if it is running. The timer T3585 to be stopped includes the timer T3585 applied for all the PLMNs, if running, and the timer T3585 applied for the registered PLMN, if running. The UE shall then start timer T3585 with the value provided in the Back-off timer value IE or with the Back-off timer value received from the 5GMM sublayer and:
 - 1) shall not send another PDU SESSION ESTABLISHMENT REQUEST message with request type different from "initial emergency request" and different from "existing emergency PDU session", or another PDU SESSION MODIFICATION REQUEST message with exception of those identified in subclause 6.4.2.1, for a non-emergency PDU session for the same S-NSSAI that was sent by the UE, until timer T3585 expires or timer T3585 is stopped; and
 - 2) shall not send another PDU SESSION ESTABLISHMENT REQUEST message without an S-NSSAI and with request type different from "initial emergency request" and different from "existing emergency PDU session", or another PDU SESSION MODIFICATION REQUEST message with exception of those identified in subclause 6.4.2.1, for a non-emergency PDU session established without an S-NSSAI provided by the UE, if no S-NSSAI was provided during the PDU session establishment and the request type was different from "initial emergency request" and different from "existing emergency PDU session", until timer T3585 expires or timer T3585 is stopped.

The UE shall not stop timer T3585 upon a PLMN change or inter-system change;

- b) if the timer value indicates that this timer is deactivated and an S-NSSAI was provided during the PDU session establishment and the request type was different from "initial emergency request" and different from "existing emergency PDU session", the UE shall stop timer T3585 associated with the corresponding S-NSSAI, if it is running. If the timer value indicates that this timer is deactivated and no S-NSSAI was provided during the PDU session establishment and the request type was different from "initial emergency request" and different from "existing emergency PDU session", the UE shall stop timer T3585 associated with no S-NSSAI if it is running. The timer T3585 to be stopped includes the timer T3585 applied for all the PLMNs, if running, and the timer T3585 applied for the registered PLMN, if running. The UE:
- 1) shall not send another PDU SESSION ESTABLISHMENT REQUEST message with request type different from "initial emergency request" and different from "existing emergency PDU session", or another PDU SESSION MODIFICATION REQUEST with exception of those identified in subclause 6.4.2.1, for a non-emergency PDU session for the same S-NSSAI until the UE is switched off, the USIM is removed, the entry in the "list of subscriber data" for the current SNPN is updated if the UE does not support access to an SNPN using credentials from a credentials holder, or the selected entry of the "list of subscriber data" is updated if the UE supports access to an SNPN using credentials from a credentials holder, or the UE receives a PDU SESSION MODIFICATION COMMAND message for a non-emergency PDU session for the same S-NSSAI from the network, or a PDU SESSION AUTHENTICATION COMMAND message for a non-emergency PDU session for the same S-NSSAI from the network, or a PDU SESSION RELEASE COMMAND message without the Back-off timer value IE for the same S-NSSAI from the network; and
 - 2) shall not send another PDU SESSION ESTABLISHMENT REQUEST message without an S-NSSAI and with request type different from "initial emergency request" and different from "existing emergency PDU session", or another PDU SESSION MODIFICATION REQUEST message with exception of those identified in subclause 6.4.2.1, for a non-emergency PDU session established without an S-NSSAI provided by the UE, if no S-NSSAI was provided during the PDU session establishment and the request type was different from "initial emergency request" and different from "existing emergency PDU session", until the UE is switched off, the USIM is removed, the entry in the "list of subscriber data" for the current SNPN is updated if the UE does not support access to an SNPN using credentials from a credentials holder, or the selected entry of the "list of subscriber data" is updated if the UE supports access to an SNPN using credentials from a credentials holder, or the UE receives a PDU SESSION MODIFICATION COMMAND message for a non-emergency PDU session established without an S-NSSAI provided by the UE, or a PDU SESSION AUTHENTICATION COMMAND message for a non-emergency PDU session established without an S-NSSAI provided by the UE, or a PDU SESSION RELEASE COMMAND message without the Back-off timer value IE for a non-emergency PDU session established without an S-NSSAI provided by the UE.

The timer T3585 remains deactivated upon a PLMN change or inter-system change; and

- c) if the timer value indicates zero, the UE:
- 1) shall stop timer T3585 associated with the corresponding S-NSSAI (including the timer T3585 applied for all the PLMNs, if running, and the timer T3585 applied for the registered PLMN, if running), if running, and may send another PDU SESSION ESTABLISHMENT REQUEST message or PDU SESSION MODIFICATION REQUEST message for the same S-NSSAI; and
 - 2) if no S-NSSAI was provided during the PDU session establishment and the request type was different from "initial emergency request" and different from "existing emergency PDU session", the UE shall stop timer T3585 associated with no S-NSSAI, if running, and may send another PDU SESSION ESTABLISHMENT REQUEST message without an S-NSSAI (including the timer T3585 applied for all the PLMNs, if running, and the timer T3585 applied for the registered PLMN, if running), or another PDU SESSION MODIFICATION REQUEST message without an S-NSSAI provided by the UE.

If the 5GSM congestion re-attempt indicator IE with the ABO bit set to "The back-off timer is applied in all PLMNs" is included in the PDU SESSION ESTABLISHMENT REJECT message with the 5GSM cause value #69 "insufficient resources for specific slice", then the UE shall apply the timer T3585 for all the PLMNs. Otherwise, the UE shall apply the timer T3585 for the registered PLMN. Additionally, if the 5GSM congestion re-attempt indicator IE with the CATBO bit set to "The back-off timer is applied in the current access type" is included in the PDU SESSION ESTABLISHMENT REJECT message with the 5GSM cause value #69 "insufficient resources for specific slice", then the UE shall apply the timer T3585 for the current access type. Otherwise, the UE shall apply the timer T3585 for both 3GPP access type and non-3GPP access type.

If the Back-off timer value IE is not included or no Back-off timer value is received from the 5GMM sublayer, then the UE may send another PDU SESSION ESTABLISHMENT REQUEST message or PDU SESSION MODIFICATION REQUEST message for the same S-NSSAI or without an S-NSSAI.

When the timer T3585 is running or the timer is deactivated, the UE is allowed to initiate a PDU session establishment procedure for emergency services.

If the timer T3585 is running when the UE enters state 5GMM-DEREGISTERED, the UE remains switched on, and the USIM in the UE (if any) remains the same and the entry in the "list of subscriber data" to which timer T3585 is associated (if any) is not updated, then timer T3585 is kept running until it expires or it is stopped.

If the UE is switched off when the timer T3585 is running, and if the USIM in the UE (if any) remains the same and the entry in the "list of subscriber data" to which timer T3585 is associated (if any) is not updated when the UE is switched on, the UE shall behave as follows:

let t_1 be the time remaining for T3585 timeout at switch off and let t be the time elapsed between switch off and switch on. If t_1 is greater than t , then the timer shall be restarted with the value $t_1 - t$. If t_1 is equal to or less than t , then the timer need not be restarted. If the UE is not capable of determining t , then the UE shall restart the timer with the value t_1 .

NOTE: As described in this subclause, upon PLMN change or inter-system change, the UE does not stop the timer T3584 or T3585. This means the timer T3584 or T3585 can still be running or be deactivated for the given 5GSM procedure, the PLMN, the S-NSSAI and optionally the DNN combination when the UE returns to the PLMN or when it performs inter-system change back from S1 mode to N1 mode. Thus the UE can still be prevented from sending another PDU SESSION ESTABLISHMENT REQUEST or PDU SESSION MODIFICATION REQUEST message in the PLMN for the same S-NSSAI and optionally the same DNN.

Upon PLMN change, if T3584 is running or is deactivated for an S-NSSAI, a DNN, and old PLMN, but T3584 is not running and is not deactivated for the S-NSSAI, the DNN, and new PLMN, then the UE is allowed to send a PDU SESSION ESTABLISHMENT REQUEST message for the same S-NSSAI and the same DNN in the new PLMN.

Upon PLMN change, if T3585 is running or is deactivated for an S-NSSAI and old PLMN, but T3585 is not running and is not deactivated for the S-NSSAI and new PLMN, then the UE is allowed to send a PDU SESSION ESTABLISHMENT REQUEST message for the same S-NSSAI in the new PLMN.

10.1.8.1.3 Test description

10.1.8.1.3.1 Pre-test conditions

System Simulator:

- NGC Cell A.

UE:

- None.

Preamble:

- The UE is in state 3N-A on NGC Cell A according to TS 38.508-1 [4].

10.1.8.1.3.2 Test procedure sequence

Table 10.1.8.1.3.2-1: Main behaviour

St	Procedure	Message Sequence		TP	Verdict
		U - S	Message		
1	Cause the UE to request establishment of PDU session with S-NSSAI. Note: This step is triggered by MMI or AT command.	-	-	-	-
2	The UE transmits an	-->	NR RRC: ULInformationTransfer	-	-

	ULInformationTransfer message and a PDU SESSION ESTABLISHMENT REQUEST message with S-NSSAI.		5GMM: UL NAS TRANSPORT 5GSM: PDU SESSION ESTABLISHMENT REQUEST		
3	The SS transmits PDU SESSION ESTABLISHMENT REJECT message with 5GSM cause value #69 and Back-off timer value which is neither zero nor deactivated	<--	PDU SESSION ESTABLISHMENT REJECT	-	-
4	Check: Does the UE transmit a PDU SESSION ESTABLISHMENT REQUEST message with S-NSSAI within 60 seconds?	-->	NR RRC: ULInformationTransfer 5GMM: UL NAS TRANSPORT 5GSM: PDU SESSION ESTABLISHMENT REQUEST	1	F
5	The SS transmits an <i>RRCRelease</i> message.	<--	NR RRC: <i>RRCRelease</i>	-	-
6	The UE is switched off by executing generic procedure in Table 4.9.6.1-1 in TS 38.508-1 [4]	-	-	-	-
7	The UE is switched on	-	-	-	-
8	The general procedure is completed by executing of the UE registration procedure in TS 38.508-1 [4] table 4.5.2.2-2 , 'connected without release'.	-	-	-	-
9	Cause the UE to request establishment of PDU session with the same S-NSSAI as step 1. Note: This step is triggered by MMI or AT command.	-	-	-	-
10	Check: Does the UE transmit a PDU SESSION ESTABLISHMENT REQUEST message with S-NSSAI within 60 seconds?	-->	NR RRC: ULInformationTransfer 5GMM: UL NAS TRANSPORT 5GSM: PDU SESSION ESTABLISHMENT REQUEST	2	F
11	Cause the UE to request establishment of PDU session with the same S-NSSAI as step 1 after 1 minute since step 10. Note: This step is triggered by MMI or AT command.	-	-	-	-
12	Check: Does the UE transmit a PDU SESSION ESTABLISHMENT REQUEST message with S-NSSAI within 60 seconds?	-->	5GMM: UL NAS TRANSPORT 5GSM: PDU SESSION ESTABLISHMENT REQUEST	2,3	P
13	The SS transmits a PDU SESSION ESTABLISHMENT ACCEPT message.	<--	5GMM: DL NAS TRANSPORT 5GSM: PDU SESSION ESTABLISHMENT ACCEPT	-	-
14	Cause the UE to request establishment of PDU session without S-NSSAI. Note: This step is triggered by MMI or AT command.	-	-	-	-
15	The UE transmits an ULInformationTransfer message and a PDU SESSION ESTABLISHMENT REQUEST message without S-NSSAI.	-->	NR RRC: ULInformationTransfer 5GMM: UL NAS TRANSPORT 5GSM: PDU SESSION ESTABLISHMENT REQUEST	-	-
16	The SS transmits PDU SESSION ESTABLISHMENT REJECT message with 5GSM cause value #69 and Back-off timer value which is neither zero nor deactivated	<--	PDU SESSION ESTABLISHMENT REJECT	-	-
17	Check: Does the UE transmit a PDU SESSION ESTABLISHMENT REQUEST message without S-NSSAI within 60 seconds?	-->	NR RRC: ULInformationTransfer 5GMM: UL NAS TRANSPORT 5GSM: PDU SESSION ESTABLISHMENT REQUEST	4	F
18	The SS transmits an <i>RRCRelease</i> message.	<--	NR RRC: <i>RRCRelease</i>	-	-

10.1.8.1.3.3 Specific message contents

Table 10.1.8.1.3.3-1: UL NAS TRANSPORT (step 2, step 12, Table 10.1.8.1.3.2-1)

Derivation Path: TS 38.508-1 [4] table 4.7.1-10, condition INITIAL_PDU_REQUEST.			
Information Element	Value/remark	Comment	Condition

S-NSSAI	present		
---------	---------	--	--

Table 10.1.8.1.3.3-2: PDU SESSION ESTABLISHMENT REJECT (step 3, step 16, Table 10.1.8.1.3.2-1)

Derivation path: TS 38.508-1 [4], Table 4.7.2-3			
Information Element	Value/remark	Comment	Condition
5GSM cause	'0100 0101'	insufficient resources for specific slice	
Back-off timer value	'1010 0011'B	3 minutes	

Table 10.1.8.1.3.3-3: PDU SESSION ESTABLISHMENT ACCEPT (step 13, Table 10.1.8.1.3.2-1)

Derivation path: TS 38.508-1 clause 4.7.2-2			
Information Element	Value/remark	Comment	Condition
S-NSSAI	The same S-NSSAI as the S-NSSAI of the PDU session which UE request at step 11		

Table 10.1.8.1.3.3-4: UL NAS TRANSPORT (step 15, Table 10.1.8.1.3.2-1)

Derivation Path: TS 38.508-1 [4] table 4.7.1-10, condition INITIAL_PDU_REQUEST.

10.1.8.2 NSAC / PDU session establishment reject / Maximum number of PDU sessions reached / Back-off timer is deactivated

10.1.8.2.1 Test Purpose (TP)

(1)

```
with { UE is establishing UE-requested PDU session by sending PDU Session establishment Request message with S-NSSAI }
ensure that {
  when { UE receives PDU SESSION ESTABLISHMENT REJECT with 5GSM cause value #69 "insufficient resources for specific slice" and Back-off timer value which is deactivated }
  then { UE shall not send another PDU SESSION ESTABLISHMENT REQUEST message for the same S-NSSAI until UE is switched off, the USIM is removed, the entry in the "list of subscriber data" for the current SNPN is updated if the UE does not support access to an SNPN using credentials from a credentials holder }
}
```

(2)

```
with { UE is establishing UE-requested PDU session by sending PDU Session establishment Request message with S-NSSAI }
ensure that {
  when { UE receives PDU SESSION ESTABLISHMENT REJECT with 5GSM cause value #69 "insufficient resources for specific slice" and Back-off timer value which is deactivated }
  then { UE shall not send another PDU SESSION ESTABLISHMENT REQUEST message for the same S-NSSAI until UE receives a PDU SESSION MODIFICATION COMMAND message for the same S-NSSAI }
}
```

(3)

```
with { UE is establishing UE-requested PDU session by sending PDU Session establishment Request message with S-NSSAI }
ensure that {
  when { UE receives PDU SESSION ESTABLISHMENT REJECT with 5GSM cause value #69 "insufficient resources for specific slice" and Back-off timer value which is deactivated }
  then { UE shall not send another PDU SESSION ESTABLISHMENT REQUEST message for the same S-NSSAI until UE receives a PDU SESSION AUTHENTICATION COMMAND message for the same S-NSSAI }
}
```

(4)

```

with { UE is establishing UE-requested PDU session by sending PDU Session establishment Request
message with S-NSSAI }
ensure that {
  when { UE receives PDU SESSION ESTABLISHMENT REJECT with 5GSM cause value #69 "insufficient
resources for specific slice" and Back-off timer value which is deactivated }
  then { UE shall not send another PDU SESSION ESTABLISHMENT REQUEST message for the same S-NSSAI
until UE receives a PDU SESSION RELEASE COMMAND message without the Back-off timer value IE for the
same S-NSSAI }
}

```

10.1.8.2.2 Conformance requirements

References: The conformance requirements covered in the present TC are specified in: TS 24.501, clause 4.6.3.1, clause 6.4.1.4.2. Unless otherwise stated these are Rel-17 requirements.

[TS 24.501, clause 4.6.3.1]

A serving PLMN or the HPLMN, or SNPN can perform network slice admission control for the S-NSSAI(s) subject to NSAC to monitor and control the total number of established PDU sessions per network slice. The SMF performs network slice admission control on the S-NSSAI during the PDU session establishment procedure. If the maximum number of PDU sessions on a network slice associated with an S-NSSAI has been already reached, the SMF rejects the PDU session establishment request using S-NSSAI based congestion control as specified in subclause 6.2.8 and 6.4.1.4.2.

The SMF performs network slice admission control on the S-NSSAI for a PDU session that is associated with the non-3GPP access, when the UE requests to transfer a session from the non-3GPP access to the 3GPP access with the Allowed PDU session status IE as described in subclause 5.6.1.4. If the maximum number of PDU sessions on a network slice associated with an S-NSSAI has been already reached, the SMF rejects the request to establish the user-plane resources (see 3GPP TS 29.502 [20A]).

Based on operator policy, the session management based network slice admission control is not applicable for the PDU session for emergency services, or the session management based network slice admission control result is ignored for the PDU session for emergency services.

Based on operator policy, the session management based network slice admission control is not applicable for the PDU session for priority services, or the session management based network slice admission control result is ignored for the PDU session for priority services.

NOTE: How the SMF determines that the PDU session is used for priority services is outside the scope of this release of the present document.

The session management based network slice admission control is not applicable to PDU session established for onboarding services in SNPN.

NOTE 1: For the MA PDU session during the PDU session establishment procedure, the SMF performs network slice admission control only when it is newly established over the associated access type.

NOTE 2: For a set of redundant PDU sessions, the SMF performs network slice admission control for each PDU session independently.

[TS 24.501, clause 6.4.1.4.2]

If:

- the 5GSM cause value #69 "insufficient resources for specific slice" and the Back-off timer value IE are included in the PDU SESSION ESTABLISHMENT REJECT message; or
- an indication that the 5GSM message was not forwarded due to S-NSSAI only based congestion control is received along a Back-off timer value and a PDU SESSION ESTABLISHMENT REQUEST message with the PDU session ID IE set to the PDU session ID of the PDU session;

the UE shall ignore the Re-attempt indicator IE provided by the network, if any, and take different actions depending on the timer value received for timer T3585 in the Back-off timer value IE or depending on the Back-off timer value

received from the 5GMM sublayer (if the UE is a UE configured for high priority access in selected PLMN, exceptions are specified in subclause 6.2.8):

- a) If the timer value indicates neither zero nor deactivated and an S-NSSAI was provided during the PDU session establishment and the request type was different from "initial emergency request" and different from "existing emergency PDU session", the UE shall stop timer T3585 associated with the corresponding S-NSSAI, if it is running. If the timer value indicates neither zero nor deactivated and no S-NSSAI was provided during the PDU session establishment and the request type was different from "initial emergency request" and different from "existing emergency PDU session", the UE shall stop timer T3585 associated with no S-NSSAI if it is running. The timer T3585 to be stopped includes the timer T3585 applied for all the PLMNs, if running, and the timer T3585 applied for the registered PLMN, if running. The UE shall then start timer T3585 with the value provided in the Back-off timer value IE or with the Back-off timer value received from the 5GMM sublayer and:
 - 1) shall not send another PDU SESSION ESTABLISHMENT REQUEST message with request type different from "initial emergency request" and different from "existing emergency PDU session", or another PDU SESSION MODIFICATION REQUEST message with exception of those identified in subclause 6.4.2.1, for a non-emergency PDU session for the same S-NSSAI that was sent by the UE, until timer T3585 expires or timer T3585 is stopped; and
 - 2) shall not send another PDU SESSION ESTABLISHMENT REQUEST message without an S-NSSAI and with request type different from "initial emergency request" and different from "existing emergency PDU session", or another PDU SESSION MODIFICATION REQUEST message with exception of those identified in subclause 6.4.2.1, for a non-emergency PDU session established without an S-NSSAI provided by the UE, if no S-NSSAI was provided during the PDU session establishment and the request type was different from "initial emergency request" and different from "existing emergency PDU session", until timer T3585 expires or timer T3585 is stopped.

The UE shall not stop timer T3585 upon a PLMN change or inter-system change;

- b) if the timer value indicates that this timer is deactivated and an S-NSSAI was provided during the PDU session establishment and the request type was different from "initial emergency request" and different from "existing emergency PDU session", the UE shall stop timer T3585 associated with the corresponding S-NSSAI, if it is running. If the timer value indicates that this timer is deactivated and no S-NSSAI was provided during the PDU session establishment and the request type was different from "initial emergency request" and different from "existing emergency PDU session", the UE shall stop timer T3585 associated with no S-NSSAI if it is running. The timer T3585 to be stopped includes the timer T3585 applied for all the PLMNs, if running, and the timer T3585 applied for the registered PLMN, if running. The UE:
 - 1) shall not send another PDU SESSION ESTABLISHMENT REQUEST message with request type different from "initial emergency request" and different from "existing emergency PDU session", or another PDU SESSION MODIFICATION REQUEST with exception of those identified in subclause 6.4.2.1, for a non-emergency PDU session for the same S-NSSAI until the UE is switched off, the USIM is removed, the entry in the "list of subscriber data" for the current SNPN is updated if the UE does not support access to an SNPN using credentials from a credentials holder, or the selected entry of the "list of subscriber data" is updated if the UE supports access to an SNPN using credentials from a credentials holder, or the UE receives a PDU SESSION MODIFICATION COMMAND message for a non-emergency PDU session for the same S-NSSAI from the network, or a PDU SESSION AUTHENTICATION COMMAND message for a non-emergency PDU session for the same S-NSSAI from the network, or a PDU SESSION RELEASE COMMAND message without the Back-off timer value IE for the same S-NSSAI from the network; and
 - 2) shall not send another PDU SESSION ESTABLISHMENT REQUEST message without an S-NSSAI and with request type different from "initial emergency request" and different from "existing emergency PDU session", or another PDU SESSION MODIFICATION REQUEST message with exception of those identified in subclause 6.4.2.1, for a non-emergency PDU session established without an S-NSSAI provided by the UE, if no S-NSSAI was provided during the PDU session establishment and the request type was different from "initial emergency request" and different from "existing emergency PDU session", until the UE is switched off, the USIM is removed, the entry in the "list of subscriber data" for the current SNPN is updated if the UE does not support access to an SNPN using credentials from a credentials holder, or the selected entry of the "list of subscriber data" is updated if the UE supports access to an SNPN using credentials from a credentials holder, or the UE receives a PDU SESSION MODIFICATION COMMAND message for a non-emergency PDU session established without an S-NSSAI provided by the UE, or a PDU SESSION AUTHENTICATION COMMAND message for a non-emergency PDU session established without an S-NSSAI provided by the UE, or a PDU SESSION RELEASE COMMAND message without the

Back-off timer value IE for a non-emergency PDU session established without an S-NSSAI provided by the UE.

The timer T3585 remains deactivated upon a PLMN change or inter-system change; and

c) if the timer value indicates zero, the UE:

- 1) shall stop timer T3585 associated with the corresponding S-NSSAI (including the timer T3585 applied for all the PLMNs, if running, and the timer T3585 applied for the registered PLMN, if running), if running, and may send another PDU SESSION ESTABLISHMENT REQUEST message or PDU SESSION MODIFICATION REQUEST message for the same S-NSSAI; and
- 2) if no S-NSSAI was provided during the PDU session establishment and the request type was different from "initial emergency request" and different from "existing emergency PDU session", the UE shall stop timer T3585 associated with no S-NSSAI, if running, and may send another PDU SESSION ESTABLISHMENT REQUEST message without an S-NSSAI (including the timer T3585 applied for all the PLMNs, if running, and the timer T3585 applied for the registered PLMN, if running), or another PDU SESSION MODIFICATION REQUEST message without an S-NSSAI provided by the UE.

If the 5GSM congestion re-attempt indicator IE with the ABO bit set to "The back-off timer is applied in all PLMNs" is included in the PDU SESSION ESTABLISHMENT REJECT message with the 5GSM cause value #69 "insufficient resources for specific slice", then the UE shall apply the timer T3585 for all the PLMNs. Otherwise, the UE shall apply the timer T3585 for the registered PLMN. Additionally, if the 5GSM congestion re-attempt indicator IE with the CATBO bit set to "The back-off timer is applied in the current access type" is included in the PDU SESSION ESTABLISHMENT REJECT message with the 5GSM cause value #69 "insufficient resources for specific slice", then the UE shall apply the timer T3585 for the current access type. Otherwise, the UE shall apply the timer T3585 for both 3GPP access type and non-3GPP access type.

If the Back-off timer value IE is not included or no Back-off timer value is received from the 5GMM sublayer, then the UE may send another PDU SESSION ESTABLISHMENT REQUEST message or PDU SESSION MODIFICATION REQUEST message for the same S-NSSAI or without an S-NSSAI.

When the timer T3585 is running or the timer is deactivated, the UE is allowed to initiate a PDU session establishment procedure for emergency services.

If the timer T3585 is running when the UE enters state 5GMM-DEREGISTERED, the UE remains switched on, and the USIM in the UE (if any) remains the same and the entry in the "list of subscriber data" to which timer T3585 is associated (if any) is not updated, then timer T3585 is kept running until it expires or it is stopped.

If the UE is switched off when the timer T3585 is running, and if the USIM in the UE (if any) remains the same and the entry in the "list of subscriber data" to which timer T3585 is associated (if any) is not updated when the UE is switched on, the UE shall behave as follows:

let t_1 be the time remaining for T3585 timeout at switch off and let t be the time elapsed between switch off and switch on. If t_1 is greater than t , then the timer shall be restarted with the value $t_1 - t$. If t_1 is equal to or less than t , then the timer need not be restarted. If the UE is not capable of determining t , then the UE shall restart the timer with the value t_1 .

NOTE: As described in this subclause, upon PLMN change or inter-system change, the UE does not stop the timer T3584 or T3585. This means the timer T3584 or T3585 can still be running or be deactivated for the given 5GSM procedure, the PLMN, the S-NSSAI and optionally the DNN combination when the UE returns to the PLMN or when it performs inter-system change back from S1 mode to N1 mode. Thus the UE can still be prevented from sending another PDU SESSION ESTABLISHMENT REQUEST or PDU SESSION MODIFICATION REQUEST message in the PLMN for the same S-NSSAI and optionally the same DNN.

Upon PLMN change, if T3584 is running or is deactivated for an S-NSSAI, a DNN, and old PLMN, but T3584 is not running and is not deactivated for the S-NSSAI, the DNN, and new PLMN, then the UE is allowed to send a PDU SESSION ESTABLISHMENT REQUEST message for the same S-NSSAI and the same DNN in the new PLMN.

Upon PLMN change, if T3585 is running or is deactivated for an S-NSSAI and old PLMN, but T3585 is not running and is not deactivated for the S-NSSAI and new PLMN, then the UE is allowed to send a PDU SESSION ESTABLISHMENT REQUEST message for the same S-NSSAI in the new PLMN.

10.1.8.2.3 Test description

10.1.8.2.3.1 Pre-test conditions

System Simulator:

- NGC Cell A.

UE:

- None.

Preamble:

- The UE is in state 3N-A on NGC Cell A according to TS 38.508-1 [4].

10.1.8.2.3.2 Test procedure sequence

Table 10.1.8.2.3.2-1: Main behaviour

St	Procedure	Message Sequence		TP	Verdict
		U - S	Message		
1	Cause the UE to request establishment of PDU session with S-NSSAI. Note: This step is triggered by MMI or AT command.	-	-	-	-
2	The UE transmits an ULInformationTransfer message and a PDU SESSION ESTABLISHMENT REQUEST message with S-NSSAI.	-->	NR RRC: ULInformationTransfer 5GMM: UL NAS TRANSPORT 5GSM: PDU SESSION ESTABLISHMENT REQUEST	-	-
3	The SS transmits PDU SESSION ESTABLISHMENT REJECT message with 5GSM cause value #69 and Back-off timer value which is deactivated	<<--	PDU SESSION ESTABLISHMENT REJECT	-	-
4	Cause the UE to request establishment of PDU session with the same S-NSSAI as step 1. Note: This step is triggered by MMI or AT command.	-	-	-	-
5	Check: Does the UE transmit a PDU SESSION ESTABLISHMENT REQUEST message with S-NSSAI within 60 seconds?	-->	NR RRC: ULInformationTransfer 5GMM: UL NAS TRANSPORT 5GSM: PDU SESSION ESTABLISHMENT REQUEST	1,2, 3,4	F
6	The SS transmits an <i>RRCRelease</i> message.	<<--	NR RRC: <i>RRCRelease</i>	-	-
7	The UE is switched off by executing generic procedure in Table 4.9.6.1-1 in TS 38.508-1 [4]	-	-	-	-
8	The UE is switched on	-	-	-	-
9	The general procedure is completed by executing of the UE registration procedure in TS 38.508-1 [4] table 4.5.2.2-2 , 'connected without release'.	-	-	-	-
10	Cause the UE to request establishment of PDU session with the same S-NSSAI as step 1. Note: This step is triggered by MMI or AT command.	-	-	-	-
11	Check: Does the UE transmit a PDU SESSION ESTABLISHMENT REQUEST message with S-NSSAI within 60 seconds?	-->	NR RRC: ULInformationTransfer 5GMM: UL NAS TRANSPORT 5GSM: PDU SESSION ESTABLISHMENT REQUEST	1	P
12	The SS transmits PDU SESSION ESTABLISHMENT REJECT message with 5GSM cause value #69 and Back-off timer	<<--	PDU SESSION ESTABLISHMENT REJECT	-	-

	value which is deactivated				
13	The SS transmits a PDU SESSION MODIFICATION COMMAND message.	<--	PDU SESSION MODIFICATION COMMAND	-	-
14	The UE transmits a PDU SESSION MODIFICATION COMPLETE message.	-->	PDU SESSION MODIFICATION COMPLETE	-	-
15	Cause the UE to request establishment of PDU session with the same S-NSSAI as step 1. Note: This step is triggered by MMI or AT command.	-	-	-	-
16	Check: Does the UE transmit a PDU SESSION ESTABLISHMENT REQUEST message with S-NSSAI within 60 seconds?	-->	NR RRC: ULInformationTransfer 5GMM: UL NAS TRANSPORT 5GSM: PDU SESSION ESTABLISHMENT REQUEST	2	P
17	The SS transmits PDU SESSION ESTABLISHMENT REJECT message with 5GSM cause value #69 and Back-off timer value which is deactivated	<--	PDU SESSION ESTABLISHMENT REJECT		
18	The SS transmits PDU SESSION AUTHENTICATION COMMAND including an EAP-Request message.	<--	PDU SESSION AUTHENTICATION COMMAND	-	-
19	The UE transmits a PDU SESSION AUTHENTICATION COMPLETE containing EAP-Response message.	-->	PDU SESSION AUTHENTICATION COMPLETE	-	-
20	The SS transmits PDU SESSION AUTHENTICATION RESULT message containing an EAP-Success message.	<--	PDU SESSION AUTHENTICATION RESULT	-	-
21	Cause the UE to request establishment of PDU session with the same S-NSSAI as step 1. Note: This step is triggered by MMI or AT command.	-	-		
22	Check: Does the UE transmit a PDU SESSION ESTABLISHMENT REQUEST message with S-NSSAI within 60 seconds?	-->	NR RRC: ULInformationTransfer 5GMM: UL NAS TRANSPORT 5GSM: PDU SESSION ESTABLISHMENT REQUEST	3	P
23	The SS transmits PDU SESSION ESTABLISHMENT REJECT message with 5GSM cause value #69 and Back-off timer value which is deactivated	<--	PDU SESSION ESTABLISHMENT REJECT	-	-
24	The SS transmits a PDU SESSION RELEASE COMMAND without Back-off timer value IE for the same S-NSSAI as step 1.	<--	5GMM: DL NAS TRANSPORT 5GSM: PDU SESSION RELEASE COMMAND	-	-
25	The UE transmits a PDU SESSION RELEASE COMPLETE message	-->	5GMM: UL NAS TRANSPORT 5GSM: PDU SESSION RELEASE COMPLETE	-	-
26	Cause the UE to request establishment of PDU session with the same S-NSSAI as step 1. Note: This step is triggered by MMI or AT command.	-	-	-	-
27	Check: Does the UE transmit a PDU SESSION ESTABLISHMENT REQUEST message with S-NSSAI within 60 seconds?	-->	NR RRC: ULInformationTransfer 5GMM: UL NAS TRANSPORT 5GSM: PDU SESSION ESTABLISHMENT REQUEST	4	P
28	The SS transmits a PDU SESSION ESTABLISHMENT ACCEPT message.	<--	5GMM: DL NAS TRANSPORT 5GSM: PDU SESSION ESTABLISHMENT ACCEPT	-	-

10.1.8.2.3.3 Specific message contents

Table 10.1.8.2.3.3-1: UL NAS TRANSPORT (step 2, step 11, step 16, step 22, step 27, Table 10.1.8.2.3.2-1)

Derivation Path: TS 38.508-1 [4] table 4.7.1-10, condition INITIAL_PDU_REQUEST.

Information Element	Value/remark	Comment	Condition
S-NSSAI	present		

Table 10.1.8.2.3.3-2: PDU SESSION ESTABLISHMENT REJECT (step 3, step 12, step 17, step 23 ,Table 10.1.8.2.3.2-1)

Derivation path: TS 38.508-1 [4], Table 4.7.2-3			
Information Element	Value/remark	Comment	Condition
5GSM cause	'0100 0101'	insufficient resources for specific slice	
Back-off timer value	'1110 0000'B	deactivated	

Table 10.1.8.2.3.3-3: PDU SESSION ESTABLISHMENT ACCEPT (step 28, Table 10.1.8.2.3.2-1)

Derivation path: TS 38.508-1 clause 4.7.2-2			
Information Element	Value/remark	Comment	Condition
S-NSSAI	The same S-NSSAI as the S-NSSAI of the PDU session which UE request at step 10		

Table 10.1.8.2.3.3-4: PDU SESSION AUTHENTICATION RESULT (step 20, Table 10.1.8.2.3.2-1)

Derivation Path: TS 38.508-1 table 4.7.2-6			
Information Element	Value/remark	Comment	Condition
EAP message	EAP-success	See TS 24.501 [25] subclause 9.11.2.2	

10.1.8.3 NSAC / PDU session establishment reject / Maximum number of PDU sessions reached / Back-off timer is zero or not included

10.1.8.3.1 Test Purpose (TP)

(1)

```
with { UE is establishing UE-requested PDU session by sending PDU Session establishment Request message with S-NSSAI }
ensure that {
  when { UE receives PDU SESSION ESTABLISHMENT REJECT with 5GSM cause value #69 "insufficient resources for specific slice" and Back-off timer value set to zero }
  then { UE could send another PDU SESSION ESTABLISHMENT REQUEST message for the same S-NSSAI }
}
```

(2)

```
with { UE is establishing UE-requested PDU session by sending PDU Session establishment Request message with no S-NSSAI provided }
ensure that {
  when { UE receives PDU SESSION ESTABLISHMENT REJECT with 5GSM cause value #69 "insufficient resources for specific slice" and Back-off timer value set to zero }
  then { UE could send another PDU SESSION ESTABLISHMENT REQUEST message without an S-NSSAI }
}
```

(3)

```
with { UE is establishing UE-requested PDU session by sending PDU Session establishment Request message with S-NSSAI }
ensure that {
```

```

when { UE receives PDU SESSION ESTABLISHMENT REJECT with 5GSM cause value #69 "insufficient
resources for specific slice" and Back-off timer value IE is not included }
  then { UE could send another PDU SESSION ESTABLISHMENT REQUEST message for the same S-NSSAI }

```

10.1.8.3.2 Conformance requirements

References: The conformance requirements covered in the present TC are specified in: TS 24.501, clause 4.6.3.1, clause 6.4.1.4.2. Unless otherwise stated these are Rel-17 requirements.

[TS 24.501, clause 4.6.3.1]

A serving PLMN or the HPLMN, or SNPN can perform network slice admission control for the S-NSSAI(s) subject to NSAC to monitor and control the total number of established PDU sessions per network slice. The SMF performs network slice admission control on the S-NSSAI during the PDU session establishment procedure. If the maximum number of PDU sessions on a network slice associated with an S-NSSAI has been already reached, the SMF rejects the PDU session establishment request using S-NSSAI based congestion control as specified in subclause 6.2.8 and 6.4.1.4.2.

The SMF performs network slice admission control on the S-NSSAI for a PDU session that is associated with the non-3GPP access, when the UE requests to transfer a session from the non-3GPP access to the 3GPP access with the Allowed PDU session status IE as described in subclause 5.6.1.4. If the maximum number of PDU sessions on a network slice associated with an S-NSSAI has been already reached, the SMF rejects the request to establish the user-plane resources (see 3GPP TS 29.502 [20A]).

Based on operator policy, the session management based network slice admission control is not applicable for the PDU session for emergency services, or the session management based network slice admission control result is ignored for the PDU session for emergency services.

Based on operator policy, the session management based network slice admission control is not applicable for the PDU session for priority services, or the session management based network slice admission control result is ignored for the PDU session for priority services.

NOTE: How the SMF determines that the PDU session is used for priority services is outside the scope of this release of the present document.

The session management based network slice admission control is not applicable to PDU session established for onboarding services in SNPN.

NOTE 1: For the MA PDU session during the PDU session establishment procedure, the SMF performs network slice admission control only when it is newly established over the associated access type.

NOTE 2: For a set of redundant PDU sessions, the SMF performs network slice admission control for each PDU session independently.

[TS 24.501, clause 6.4.1.4.2]

If:

- the 5GSM cause value #69 "insufficient resources for specific slice" and the Back-off timer value IE are included in the PDU SESSION ESTABLISHMENT REJECT message; or
- an indication that the 5GSM message was not forwarded due to S-NSSAI only based congestion control is received along a Back-off timer value and a PDU SESSION ESTABLISHMENT REQUEST message with the PDU session ID IE set to the PDU session ID of the PDU session;

the UE shall ignore the Re-attempt indicator IE provided by the network, if any, and take different actions depending on the timer value received for timer T3585 in the Back-off timer value IE or depending on the Back-off timer value received from the 5GMM sublayer (if the UE is a UE configured for high priority access in selected PLMN, exceptions are specified in subclause 6.2.8):

- a) If the timer value indicates neither zero nor deactivated and an S-NSSAI was provided during the PDU session establishment and the request type was different from "initial emergency request" and different from "existing emergency PDU session", the UE shall stop timer T3585 associated with the corresponding S-NSSAI, if it is running. If the timer value indicates neither zero nor deactivated and no S-NSSAI was provided during the PDU session establishment and the request type was different from "initial emergency request" and different from

"existing emergency PDU session", the UE shall stop timer T3585 associated with no S-NSSAI if it is running. The timer T3585 to be stopped includes the timer T3585 applied for all the PLMNs, if running, and the timer T3585 applied for the registered PLMN, if running. The UE shall then start timer T3585 with the value provided in the Back-off timer value IE or with the Back-off timer value received from the 5GMM sublayer and:

- 1) shall not send another PDU SESSION ESTABLISHMENT REQUEST message with request type different from "initial emergency request" and different from "existing emergency PDU session", or another PDU SESSION MODIFICATION REQUEST message with exception of those identified in subclause 6.4.2.1, for a non-emergency PDU session for the same S-NSSAI that was sent by the UE, until timer T3585 expires or timer T3585 is stopped; and
- 2) shall not send another PDU SESSION ESTABLISHMENT REQUEST message without an S-NSSAI and with request type different from "initial emergency request" and different from "existing emergency PDU session", or another PDU SESSION MODIFICATION REQUEST message with exception of those identified in subclause 6.4.2.1, for a non-emergency PDU session established without an S-NSSAI provided by the UE, if no S-NSSAI was provided during the PDU session establishment and the request type was different from "initial emergency request" and different from "existing emergency PDU session", until timer T3585 expires or timer T3585 is stopped.

The UE shall not stop timer T3585 upon a PLMN change or inter-system change;

- b) if the timer value indicates that this timer is deactivated and an S-NSSAI was provided during the PDU session establishment and the request type was different from "initial emergency request" and different from "existing emergency PDU session", the UE shall stop timer T3585 associated with the corresponding S-NSSAI, if it is running. If the timer value indicates that this timer is deactivated and no S-NSSAI was provided during the PDU session establishment and the request type was different from "initial emergency request" and different from "existing emergency PDU session", the UE shall stop timer T3585 associated with no S-NSSAI if it is running. The timer T3585 to be stopped includes the timer T3585 applied for all the PLMNs, if running, and the timer T3585 applied for the registered PLMN, if running. The UE:

- 1) shall not send another PDU SESSION ESTABLISHMENT REQUEST message with request type different from "initial emergency request" and different from "existing emergency PDU session", or another PDU SESSION MODIFICATION REQUEST with exception of those identified in subclause 6.4.2.1, for a non-emergency PDU session for the same S-NSSAI until the UE is switched off, the USIM is removed, the entry in the "list of subscriber data" for the current SNPN is updated if the UE does not support access to an SNPN using credentials from a credentials holder, or the selected entry of the "list of subscriber data" is updated if the UE supports access to an SNPN using credentials from a credentials holder, or the UE receives a PDU SESSION MODIFICATION COMMAND message for a non-emergency PDU session for the same S-NSSAI from the network, or a PDU SESSION AUTHENTICATION COMMAND message for a non-emergency PDU session for the same S-NSSAI from the network, or a PDU SESSION RELEASE COMMAND message without the Back-off timer value IE for the same S-NSSAI from the network; and
- 2) shall not send another PDU SESSION ESTABLISHMENT REQUEST message without an S-NSSAI and with request type different from "initial emergency request" and different from "existing emergency PDU session", or another PDU SESSION MODIFICATION REQUEST message with exception of those identified in subclause 6.4.2.1, for a non-emergency PDU session established without an S-NSSAI provided by the UE, if no S-NSSAI was provided during the PDU session establishment and the request type was different from "initial emergency request" and different from "existing emergency PDU session", until the UE is switched off, the USIM is removed, the entry in the "list of subscriber data" for the current SNPN is updated if the UE does not support access to an SNPN using credentials from a credentials holder, or the selected entry of the "list of subscriber data" is updated if the UE supports access to an SNPN using credentials from a credentials holder, or the UE receives a PDU SESSION MODIFICATION COMMAND message for a non-emergency PDU session established without an S-NSSAI provided by the UE, or a PDU SESSION AUTHENTICATION COMMAND message for a non-emergency PDU session established without an S-NSSAI provided by the UE, or a PDU SESSION RELEASE COMMAND message without the Back-off timer value IE for a non-emergency PDU session established without an S-NSSAI provided by the UE.

The timer T3585 remains deactivated upon a PLMN change or inter-system change; and

- c) if the timer value indicates zero, the UE:

- 1) shall stop timer T3585 associated with the corresponding S-NSSAI (including the timer T3585 applied for all the PLMNs, if running, and the timer T3585 applied for the registered PLMN, if running), if running, and

may send another PDU SESSION ESTABLISHMENT REQUEST message or PDU SESSION MODIFICATION REQUEST message for the same S-NSSAI; and

- 2) if no S-NSSAI was provided during the PDU session establishment and the request type was different from "initial emergency request" and different from "existing emergency PDU session", the UE shall stop timer T3585 associated with no S-NSSAI, if running, and may send another PDU SESSION ESTABLISHMENT REQUEST message without an S-NSSAI (including the timer T3585 applied for all the PLMNs, if running, and the timer T3585 applied for the registered PLMN, if running), or another PDU SESSION MODIFICATION REQUEST message without an S-NSSAI provided by the UE.

If the 5GSM congestion re-attempt indicator IE with the ABO bit set to "The back-off timer is applied in all PLMNs" is included in the PDU SESSION ESTABLISHMENT REJECT message with the 5GSM cause value #69 "insufficient resources for specific slice", then the UE shall apply the timer T3585 for all the PLMNs. Otherwise, the UE shall apply the timer T3585 for the registered PLMN. Additionally, if the 5GSM congestion re-attempt indicator IE with the CATBO bit set to "The back-off timer is applied in the current access type" is included in the PDU SESSION ESTABLISHMENT REJECT message with the 5GSM cause value #69 "insufficient resources for specific slice", then the UE shall apply the timer T3585 for the current access type. Otherwise, the UE shall apply the timer T3585 for both 3GPP access type and non-3GPP access type.

If the Back-off timer value IE is not included or no Back-off timer value is received from the 5GMM sublayer, then the UE may send another PDU SESSION ESTABLISHMENT REQUEST message or PDU SESSION MODIFICATION REQUEST message for the same S-NSSAI or without an S-NSSAI.

When the timer T3585 is running or the timer is deactivated, the UE is allowed to initiate a PDU session establishment procedure for emergency services.

If the timer T3585 is running when the UE enters state 5GMM-DEREGISTERED, the UE remains switched on, and the USIM in the UE (if any) remains the same and the entry in the "list of subscriber data" to which timer T3585 is associated (if any) is not updated, then timer T3585 is kept running until it expires or it is stopped.

If the UE is switched off when the timer T3585 is running, and if the USIM in the UE (if any) remains the same and the entry in the "list of subscriber data" to which timer T3585 is associated (if any) is not updated when the UE is switched on, the UE shall behave as follows:

let t_1 be the time remaining for T3585 timeout at switch off and let t be the time elapsed between switch off and switch on. If t_1 is greater than t , then the timer shall be restarted with the value $t_1 - t$. If t_1 is equal to or less than t , then the timer need not be restarted. If the UE is not capable of determining t , then the UE shall restart the timer with the value t_1 .

NOTE: As described in this subclause, upon PLMN change or inter-system change, the UE does not stop the timer T3584 or T3585. This means the timer T3584 or T3585 can still be running or be deactivated for the given 5GSM procedure, the PLMN, the S-NSSAI and optionally the DNN combination when the UE returns to the PLMN or when it performs inter-system change back from S1 mode to N1 mode. Thus the UE can still be prevented from sending another PDU SESSION ESTABLISHMENT REQUEST or PDU SESSION MODIFICATION REQUEST message in the PLMN for the same S-NSSAI and optionally the same DNN.

Upon PLMN change, if T3584 is running or is deactivated for an S-NSSAI, a DNN, and old PLMN, but T3584 is not running and is not deactivated for the S-NSSAI, the DNN, and new PLMN, then the UE is allowed to send a PDU SESSION ESTABLISHMENT REQUEST message for the same S-NSSAI and the same DNN in the new PLMN.

Upon PLMN change, if T3585 is running or is deactivated for an S-NSSAI and old PLMN, but T3585 is not running and is not deactivated for the S-NSSAI and new PLMN, then the UE is allowed to send a PDU SESSION ESTABLISHMENT REQUEST message for the same S-NSSAI in the new PLMN.

10.1.8.3.3 Test description

10.1.8.3.3.1 Pre-test conditions

System Simulator:

- NGC Cell A.

UE:

- None.

Preamble:

- The UE is in state 3N-A on NGC Cell A according to TS 38.508-1 [4].

10.1.8.3.3.2 Test procedure sequence

Table 10.1.8.3.3.2-1: Main behaviour

St	Procedure	Message Sequence		TP	Verdict
		U - S	Message		
1	Cause the UE to request establishment of PDU session with S-NSSAI. Note: This step is triggered by MMI or AT command.	-	-	-	-
2	The UE transmits an ULInformationTransfer message and a PDU SESSION ESTABLISHMENT REQUEST message with S-NSSAI.	-->	NR RRC: ULInformationTransfer 5GMM: UL NAS TRANSPORT 5GSM: PDU SESSION ESTABLISHMENT REQUEST	-	-
3	The SS transmits PDU SESSION ESTABLISHMENT REJECT message with 5GSM cause value #69 and Back-off timer value which is set to zero.	<<--	PDU SESSION ESTABLISHMENT REJECT	-	-
4	Check: Does the UE transmit a PDU SESSION ESTABLISHMENT REQUEST message with S-NSSAI within 60 seconds?	-->	NR RRC: ULInformationTransfer 5GMM: UL NAS TRANSPORT 5GSM: PDU SESSION ESTABLISHMENT REQUEST	1	P
5	The SS transmits a PDU SESSION ESTABLISHMENT ACCEPT message.	<<--	5GMM: DL NAS TRANSPORT 5GSM: PDU SESSION ESTABLISHMENT ACCEPT	-	-
6	The generic test procedure in TS 38.508-1 Table 4.9.21.2.2-1 of Procedure for PDU Session Release is performed.	-	-	-	-
7	Cause the UE to request establishment of PDU session without S-NSSAI. Note: This step is triggered by MMI or AT command.	-	-	-	-
8	The UE transmits an ULInformationTransfer message and a PDU SESSION ESTABLISHMENT REQUEST message without S-NSSAI.	-->	NR RRC: ULInformationTransfer 5GMM: UL NAS TRANSPORT 5GSM: PDU SESSION ESTABLISHMENT REQUEST	-	-
9	The SS transmits PDU SESSION ESTABLISHMENT REJECT message with 5GSM cause value #69 and Back-off timer value which is set to zero.	<<--	PDU SESSION ESTABLISHMENT REJECT	-	-
10	Check: Does the UE transmit a PDU SESSION ESTABLISHMENT REQUEST message without S-NSSAI within 60 seconds?	-->	NR RRC: ULInformationTransfer 5GMM: UL NAS TRANSPORT 5GSM: PDU SESSION ESTABLISHMENT REQUEST	2	P
11	The SS transmits a PDU SESSION ESTABLISHMENT ACCEPT message.	<<--	5GMM: DL NAS TRANSPORT 5GSM: PDU SESSION ESTABLISHMENT ACCEPT	-	-
12	The generic test procedure in TS 38.508-1 Table 4.9.21.2.2-1 of Procedure for PDU Session Release is performed.	-	-	-	-
13	Cause the UE to request establishment of PDU session with S-NSSAI. Note: This step is triggered by MMI or AT command.	-	-	-	-
14	The UE transmits an ULInformationTransfer message and a PDU SESSION ESTABLISHMENT REQUEST message with S-NSSAI.	-->	NR RRC: ULInformationTransfer 5GMM: UL NAS TRANSPORT 5GSM: PDU SESSION ESTABLISHMENT REQUEST	-	-
15	The SS transmits PDU SESSION	<<--	PDU SESSION ESTABLISHMENT	-	-

	ESTABLISHMENT REJECT message with 5GSM cause value #69 and and Back-off timer value IE is not included.		REJECT		
16	Check: Does the UE transmit a PDU SESSION ESTABLISHMENT REQUEST message with S-NSSAI within 60 seconds?	-->	NR RRC: ULInformationTransfer 5GMM: UL NAS TRANSPORT 5GSM: PDU SESSION ESTABLISHMENT REQUEST	3	P
17	The SS transmits a PDU SESSION ESTABLISHMENT ACCEPT message.	<--	5GMM: DL NAS TRANSPORT 5GSM: PDU SESSION ESTABLISHMENT ACCEPT	-	-

10.1.8.3.3.3 Specific message contents

Table 10.1.8.3.3.3-1: UL NAS TRANSPORT (step 2, step 4, step 14, step 16, Table 10.1.8.3.3.2-1)

Derivation Path: TS 38.508-1 [4] table 4.7.1-10, condition INITIAL_PDU_REQUEST.			
Information Element	Value/remark	Comment	Condition
S-NSSAI	present		

Table 10.1.8.1.3.3-2: PDU SESSION ESTABLISHMENT REJECT (step 3, step 9, Table 10.1.8.3.3.2-1)

Derivation path: TS 38.508-1 [4], Table 4.7.2-3			
Information Element	Value/remark	Comment	Condition
5GSM cause	'0100 0101'	insufficient resources for specific slice	
Back-off timer value	'1010 0000'B	0 minutes	

Table 10.1.8.1.3.3-3: PDU SESSION ESTABLISHMENT ACCEPT (step 5, step 17, Table 10.1.8.3.3.2-1)

Derivation path: TS 38.508-1 clause 4.7.2-2			
Information Element	Value/remark	Comment	Condition
S-NSSAI	The same S-NSSAI as the S-NSSAI of the PDU session which UE request at step 1		

Table 10.1.8.1.3.3-4: PDU SESSION ESTABLISHMENT REJECT (step 15, Table 10.1.8.3.3.2-1)

Derivation path: TS 38.508-1 [4], Table 4.7.2-3			
Information Element	Value/remark	Comment	Condition
5GSM cause	'0100 0101'	insufficient resources for specific slice	
Back-off timer value	Not present		

Table 10.1.8.3.3.3-5: UL NAS TRANSPORT (step 8, step 10, Table 10.1.8.3.3.2-1)

Derivation Path: TS 38.508-1 [4] table 4.7.1-10, condition INITIAL_PDU_REQUEST.			
---	--	--	--

10.2 EN-DC session management

10.2.1 Network initiated procedures

10.2.1.1 Default EPS bearer context activation

10.2.1.1.1 Test Purpose (TP)

(1)

```
with { UE has sent a PDN CONNECTIVITY REQUEST message }
ensure that {
  when { UE receives an RRCConnectionReconfiguration message including an ACTIVATE DEFAULT EPS
  BEARER CONTEXT REQUEST message with IE Procedure transaction identity matching the PDN CONNECTIVITY
  REQUEST message and including the Extended APN-AMBR IE }
  then { UE transmits an ACTIVATE DEFAULT EPS BEARER CONTEXT ACCEPT message and enters BEARER
  CONTEXT ACTIVE state }
}
```

10.2.1.1.2 Conformance requirements

References: The conformance requirements covered in the present TC are specified in: TS 24.301, clause 6.4.1.3, 8.3.6.17 and 9.9.4.29. Unless otherwise stated these are Rel-15 requirements.

[TS 24.301, clause 6.4.1.3]

Upon receipt of the ACTIVATE DEFAULT EPS BEARER CONTEXT REQUEST message, if the UE provided an APN for the establishment of the PDN connection, the UE shall stop timer T3396 if it is running for the APN provided by the UE. If the UE did not provide an APN for the establishment of the PDN connection and the request type was different from "emergency" and from "handover of emergency bearer services", the UE shall stop the timer T3396 associated with no APN if it is running. If the ACTIVATE DEFAULT EPS BEARER CONTEXT REQUEST message was received in response to a request for an emergency PDN connection, the UE shall not stop the timer T3396 associated with no APN if it is running. For any case, the UE shall then send an ACTIVATE DEFAULT EPS BEARER CONTEXT ACCEPT message and enter the state BEARER CONTEXT ACTIVE. When the default bearer is activated as part of the attach procedure, the UE shall send the ACTIVATE DEFAULT EPS BEARER CONTEXT ACCEPT message together with ATTACH COMPLETE message. When the default bearer is activated as the response to the stand-alone PDN CONNECTIVITY REQUEST message, the UE shall send the ACTIVATE DEFAULT EPS BEARER CONTEXT ACCEPT message alone.

If a WLAN offload indication information element is included in the ACTIVATE DEFAULT EPS BEARER CONTEXT REQUEST message, the UE shall store the WLAN offload acceptability values for this PDN connection and use the E-UTRAN offload acceptability value to determine whether this PDN connection is offloadable to WLAN or not.

The UE checks the PTI in the ACTIVATE DEFAULT EPS BEARER CONTEXT REQUEST message to identify the UE requested PDN connectivity procedure to which the default bearer context activation is related (see subclause 6.5.1).

If the UE receives a serving PLMN rate control IE in the ACTIVATE DEFAULT EPS BEARER CONTEXT REQUEST message, the UE shall store the serving PLMN rate control IE value and use the stored serving PLMN rate control value as the maximum allowed limit of uplink User data container IEs included in ESM DATA TRANSPORT messages for the corresponding PDN connection in accordance with 3GPP TS 23.401 [10].

If the UE receives an APN rate control parameters container in the protocol configuration options IE or extended protocol configuration options IE in the ACTIVATE DEFAULT EPS BEARER CONTEXT REQUEST message, the UE shall store the APN rate control parameters value and use the stored APN rate control parameters value as the maximum allowed limit of uplink user data related to the APN indicated in the ACTIVATE DEFAULT EPS BEARER CONTEXT REQUEST message in accordance with 3GPP TS 23.401 [10]. If the UE has a previously stored APN rate control parameters value for this APN, the UE shall replace the stored APN rate control parameters value for this APN with the received APN rate control parameters value.

If the UE receives an additional APN rate control parameters for exception data container in the protocol configuration options IE or extended protocol configuration options IE in the ACTIVATE DEFAULT EPS BEARER CONTEXT REQUEST message, the UE shall store the additional APN rate control parameters for exception data value and use the

stored additional APN rate control parameters for exception data value as the maximum allowed limit of uplink exception data related to the APN indicated in the ACTIVATE DEFAULT EPS BEARER CONTEXT REQUEST message in accordance with 3GPP TS 23.401 [10]. If the UE has a previously stored additional APN rate control parameters for exception data value for this APN, the UE shall replace the stored additional APN rate control parameters for exception data value for this APN with the received additional APN rate control parameters for exception data value.

If the UE receives non-IP Link MTU parameter or IPv4 Link MTU parameter of the protocol configuration options IE in the ACTIVATE DEFAULT EPS BEARER CONTEXT REQUEST message, the UE shall pass the received Non-IP Link MTU or IPv4 Link MTU to the upper layer.

NOTE: The Non-IP Link MTU and the IPv4 Link MTU size correspond to the maximum length of user data that can be sent either in the user data container in the ESM DATA TRANSPORT message or via S1-U interface.

If the UE receives a session-AMBR and QoS rule(s), which correspond to the default EPS bearer of the PDN connectivity being activated, in the protocol configuration options IE or the extended protocol configuration options IE in the ACTIVATE DEFAULT EPS BEARER CONTEXT REQUEST message, the UE stores the session-AMBR and QoS rule(s) for use during inter-system change from S1 mode to N1 mode.

Upon receipt of the ACTIVATE DEFAULT EPS BEARER CONTEXT ACCEPT message, the MME shall enter the state BEARER CONTEXT ACTIVE and stop the timer T3485, if the timer is running. If the PDN CONNECTIVITY REQUEST message included a low priority indicator set to "MS is configured for NAS signalling low priority", the MME shall store the NAS signalling low priority indication within the default EPS bearer context.

[TS 24.301, clause 8.3.6.17]

This IE shall be included in the message only if the network wishes to transmit the APN-AMBR values to the UE for possible uplink policy enforcement and at least one of the values to be transmitted exceeds the maximum value specified in the APN aggregate maximum bit rate information element in subclause 9.9.4.2.

[TS 24.301, clause 9.9.4.29]

The purpose of the extended APN aggregate maximum bit rate information element is to indicate the initial subscribed APN-AMBR with a value higher than 65280 Mbps when the UE establishes a PDN connection or to indicate the new APN-AMBR with a value higher than 65280 Mbps if it is changed by the network.

The receiving entity shall ignore the bit rate values which are included in the extended APN aggregate maximum bit rate information element and not higher than 65280 Mbps.

The extended APN aggregate maximum bit rate information element is coded as shown in figure 9.9.4.29.1 and table 9.9.4.29.1.

The extended APN aggregate maximum bit rate is a type 4 information element with a length of 8 octets.

8	7	6	5	4	3	2	1	
Extended APN aggregate maximum bit rate IEI								octet 1
Length of extended APN aggregate maximum bit rate contents								octet 2
Unit for extended APN-AMBR for downlink								octet 3
Extended APN-AMBR for downlink								octet 4
Extended APN-AMBR for downlink (continued)								octet 5
Unit for extended APN-AMBR for uplink								octet 6
Extended APN-AMBR for uplink								octet 7
Extended APN-AMBR for uplink (continued)								octet 8

Figure 9.9.4.29.1: Extended APN aggregate maximum bit rate information element

Table 9.9.4.29.1: Extended APN aggregate maximum bit rate information element

Unit for extended APN-AMBR for downlink (octet 3)	
0 0 0 0 0 0 0 0	value is not used
0 0 0 0 0 0 0 1	value is not used
0 0 0 0 0 0 1 0	value is not used
0 0 0 0 0 0 1 1	value is incremented in multiples of 4 Mbps
0 0 0 0 0 1 0 0	value is incremented in multiples of 16 Mbps
0 0 0 0 0 1 0 1	value is incremented in multiples of 64 Mbps
0 0 0 0 0 1 1 0	value is incremented in multiples of 256 Mbps
0 0 0 0 0 1 1 1	value is incremented in multiples of 1 Gbps
0 0 0 0 1 0 0 0	value is incremented in multiples of 4 Gbps
0 0 0 0 1 0 0 1	value is incremented in multiples of 16 Gbps
0 0 0 0 1 0 1 0	value is incremented in multiples of 64 Gbps
0 0 0 0 1 0 1 1	value is incremented in multiples of 256 Gbps
0 0 0 0 1 1 0 0	value is incremented in multiples of 1 Tbps
0 0 0 0 1 1 0 1	value is incremented in multiples of 4 Tbps
0 0 0 0 1 1 1 0	value is incremented in multiples of 16 Tbps
0 0 0 0 1 1 1 1	value is incremented in multiples of 64 Tbps
0 0 0 1 0 0 0 0	value is incremented in multiples of 256 Tbps
0 0 0 1 0 0 0 1	value is incremented in multiples of 1 Pbps
0 0 0 1 0 0 1 0	value is incremented in multiples of 4 Pbps
0 0 0 1 0 0 1 1	value is incremented in multiples of 16 Pbps
0 0 0 1 0 1 0 0	value is incremented in multiples of 64 Pbps
0 0 0 1 0 1 0 1	value is incremented in multiples of 256 Pbps
Other values shall be interpreted as multiples of 256 Pbps in this version of the protocol.	
Extended APN-AMBR for downlink (octets 4 and 5)	
Octets 4 and 5 represent the binary coded value of extended APN-AMBR for downlink in units defined by octet 3	
Unit for extended APN-AMBR for uplink (octet 6)	
The coding is identical to that of the unit for extended APN-AMBR for downlink (octet 3)	
Extended APN-AMBR for uplink (octets 7 and 8)	
Octets 7 and 8 represent the binary coded value of extended APN-AMBR for uplink in units defined by octet 6.	

10.2.1.1.3 Test description

10.2.1.1.3.1 Pre-test conditions

System Simulator:

- E-UTRA Cell 1 is the PCell and NR Cell 1 is the PSCell.

UE:

None.

Preamble:

- The UE is in RRC_IDLE state on E-UTRA Cell 1 using generic procedure parameter Connectivity (*E-UTRA/EPC*) established according to TS 38.508-1 [4].

10.2.1.1.3.2 Test procedure sequence

Table 10.2.1.1.3.2-1: Main behaviour

St	Procedure	Message Sequence		TP	Verdict
		U - S	Message		
1	Cause the UE to request connectivity to an additional PDN (see Note 1)	-	-	-	-
2	UE transmit an <i>RRConnectionRequest</i> message with <i>establishmentCause</i> set to 'mo-Data' followed by a SERVICE REQUEST message.	-->	SERVICE REQUEST	-	-
3	The SS establishes SRB2 and DRB associated with default EPS bearer context (a first PDN obtained during the attach procedure).	-	-	-	-
4	The UE transmit a PDN CONNECTIVITY REQUEST message as specified to request an additional PDN.	-->	PDN CONNECTIVITY REQUEST	-	-
5	The SS transmits an <i>RRConnectionReconfiguration</i> message containing NR <i>RRReconfiguration</i> message to add <i>NR PSCell</i> with SCG DRB. The <i>RRConnectionReconfiguration</i> message contains ACTIVATE DEFAULT EPS BEARER CONTEXT REQUEST message containing Extended APN-AMBR IE.	<--	RRC: RRConnectionReconfiguration((RRCReconfiguration) NAS: ACTIVATE DEFAULT EPS BEARER CONTEXT REQUEST	-	-
6	The UE transmits an <i>RRConnectionReconfigurationComplete</i> message to confirm the establishment of default bearer.	-->	RRC: RRConnectionReconfigurationComplete (RRReconfigurationComplete)	-	-
-	EXCEPTION: In parallel to the event described in step 7 below, if initiated by the UE the generic procedure for IP address allocation in the U-plane specified in TS 36.508 subclause 4.5A.1 takes place performing IP address allocation in the U-plane.	-	-	-	-
7	The UE transmits ACTIVATE DEFAULT EPS BEARER CONTEXT ACCEPT message.	-->	RRC: ULInformationTransfer NAS: ACTIVATE DEFAULT EPS BEARER CONTEXT ACCEPT	1	P

Note 1: The request of connectivity to an additional PDN may be performed by MMI or AT command.

10.2.1.1.3.3 Specific message contents

Table 10.2.1.1.3.3-1: PDN CONNECTIVITY REQUEST (step 4, Table 10.2.1.1.3.2-1)

Derivation path: TS 36.508 [7], Table 4.7.3-20			
Information Element	Value/remark	Comment	Condition
Protocol discriminator	ESM		
EPS bearer identity	0	No EPS bearer identity assigned	
Procedure transaction identity	PTI-1	UE assigns a particular PTI not yet used between 1 and 254	
Access point name	APN-1(New PDN name)	The requested PDN is different from default PDN	

Table 10.2.1.1.3.3-2: ACTIVATE DEFAULT EPS BEARER CONTEXT REQUEST (step 5, Table 10.2.1.1.3.2-1)

Derivation Path: TS 36.508 [7], Table 4.7.3-6			
Information Element	Value/remark	Comment	Condition
Protocol discriminator	ESM		
EPS bearer identity	6		
Procedure transaction identity	PTI-1	SS re-uses the particular PTI defined by UE for this present additional PDN connectivity request procedure.	
EPS QoS			
QCI	8		
Maximum bit rate for uplink	384 kbps		
Maximum bit rate for downlink	'11111110'B (8640 kbps)		
Guaranteed bit rate for uplink	128 kbps		
Guaranteed bit rate for downlink	128 kbps		
Maximum bit rate for uplink (extended)	0		
Maximum bit rate for downlink (extended)	'1111010'B (256 Mbps)		
Guaranteed bit rate for uplink (extended)	0		
Guaranteed bit rate for downlink (extended)	0		
Maximum bit rate for uplink (extended-2)	0		
Maximum bit rate for downlink (extended-2)	'1110110'B (10 Gbps)		
Guaranteed bit rate for uplink (extended-2)	0		
Guaranteed bit rate for downlink (extended-2)	0		
APN-AMBR			
APN-AMBR for downlink	'11111110'B (8640 kbps)		
APN-AMBR for uplink	'11111110'B (8640 kbps)		
APN-AMBR for downlink (extended)	'1111010' B(256 Mbps)		
APN-AMBR for uplink (extended)	'1111010' B(256 Mbps)		
APN-AMBR for downlink (extended-2)	'11111110'B (65280 Mbps)		
APN-AMBR for uplink (extended-2)	0		
Access point name	APN-1	SS re-uses the particular APN defined by UE for this present additional PDN connectivity request procedure	
Extended APN-AMBR			
Unit for extended APN-AMBR for downlink	'00000111'B (value is incremented in multiples of 1 Gbps)		
Extended APN-AMBR for downlink	'0000000010000000' (128 Gbps)		
Unit for extended APN-AMBR for uplink	0		
Extended APN-AMBR for uplink	0		

10.2.1.2 Dedicated EPS bearer context activation

10.2.1.2.1 Test Purpose (TP)

(1)

```

with { UE in EMM-REGISTERED state }
ensure that {
  when { UE receives an ACTIVATE DEDICATED EPS BEARER CONTEXT REQUEST message, including the
Extended EPS QoS IE, linked to the existing default EPS bearer }
  then { UE transmits an ACTIVATE DEDICATED EPS BEARER CONTEXT ACCEPT }
}

```

(2)

```
with { the UE in BEARER CONTEXT ACTIVE STATE and in EMM-CONNECTED mode }
ensure that {
  when { the UE receives a MODIFY EPS BEARER CONTEXT REQUEST message including the Extended EPS QoS
and Extended APN-AMBR IEs }
    then { UE transmits a MODIFY EPS BEARER CONTEXT ACCEPT }
}
```

10.2.1.2.2 Conformance requirements

References: The conformance requirements covered in the present TC are specified in: TS 24.301, clauses 6.4.2.3, 6.4.3.1, 6.4.3.2, 6.4.3.3, 8.3.3.11, 9.9.4.29 and 9.9.4.30. Unless otherwise stated these are Rel-15 requirements.

[TS 24.301, clause 6.4.2.3]

Upon receipt of the ACTIVATE DEDICATED EPS BEARER CONTEXT REQUEST message, if the UE provided an APN for the establishment of the PDN connection, the UE shall stop timer T3396, if it is running for the APN provided by the UE. If the UE did not provide an APN for the establishment of the PDN connection and the request type was different from "emergency" and from "handover of emergency bearer services", the UE shall stop the timer T3396 associated with no APN if it is running. If the ACTIVATE DEDICATED EPS BEARER CONTEXT REQUEST message was received for an emergency PDN connection, the UE shall not stop the timer T3396 associated with no APN if it is running. For any case, the UE shall then check the received TFT before taking it into use, send an ACTIVATE DEDICATED EPS BEARER CONTEXT ACCEPT message and enter the state BEARER CONTEXT ACTIVE. The ACTIVATE DEDICATED EPS BEARER CONTEXT ACCEPT message shall include the EPS bearer identity.

The linked EPS bearer identity included in the ACTIVATE DEDICATED EPS BEARER CONTEXT REQUEST message indicates to the UE to which default bearer, IP address and PDN the dedicated bearer is linked.

If the ACTIVATE DEDICATED EPS BEARER CONTEXT REQUEST message contains a PTI value other than "no procedure transaction identity assigned" and "reserved" (see 3GPP TS 24.007 [12]), the UE uses the PTI to identify the UE requested bearer resource allocation procedure or the UE requested bearer resource modification procedure to which the dedicated bearer context activation is related.

[TS 24.301, clause 6.4.3.1]

The purpose of the EPS bearer context modification procedure is to modify an EPS bearer context with a specific QoS and TFT, or re-negotiate header compression configuration associated to an EPS bearer context. The EPS bearer context modification procedure is initiated by the network, but it may also be initiated as part of the UE requested bearer resource allocation procedure or the UE requested bearer resource modification procedure.

The network may also initiate the EPS bearer context modification procedure to update the APN-AMBR of the UE, for instance after an inter-system handover. See 3GPP TS 23.401 [10] annex E.

[TS 24.301, clause 6.4.3.2]

The MME shall initiate the EPS bearer context modification procedure by sending a MODIFY EPS BEARER CONTEXT REQUEST message to the UE, starting the timer T3486, and entering the state BEARER CONTEXT MODIFY PENDING (see example in figure 6.4.3.2.1).

The MME shall include an EPS bearer identity that identifies the EPS bearer context to be modified in the MODIFY EPS BEARER CONTEXT REQUEST message.

[TS 24.301, clause 6.4.3.3]

Upon receipt of the MODIFY EPS BEARER CONTEXT REQUEST message, if the UE provided an APN for the establishment of the PDN connection, the UE shall stop timer T3396, if it is running for the APN provided by the UE. If the UE did not provide an APN for the establishment of the PDN connection and the request type was different from "emergency" and from "handover of emergency bearer services", the UE shall stop the timer T3396 associated with no APN if it is running. If the MODIFY EPS BEARER CONTEXT REQUEST message was received for an emergency PDN connection, the UE shall not stop the timer T3396 associated with no APN if it is running. For any case, the UE shall then check the received TFT before taking it into use and send a MODIFY EPS BEARER CONTEXT ACCEPT message to the MME.

If the MODIFY EPS BEARER CONTEXT REQUEST message contains a PTI value other than "no procedure transaction identity assigned" and "reserved" (see 3GPP TS 24.007 [12]), the UE uses the PTI to identify the UE requested bearer resource allocation procedure or the UE requested bearer resource modification procedure to which the EPS bearer context modification is related (see subclause 6.5.3 and subclause 6.5.4).

If the MODIFY EPS BEARER CONTEXT REQUEST message contains a PTI value other than "no procedure transaction identity assigned" and "reserved" (see 3GPP TS 24.007 [12]) and the PTI is associated to a UE requested bearer resource allocation procedure or a UE requested bearer resource modification procedure, the UE shall release the traffic flow aggregate description associated to the PTI value provided.

...

Upon receipt of the MODIFY EPS BEARER CONTEXT ACCEPT message, the MME shall stop the timer T3486 and enter the state BEARER CONTEXT ACTIVE.

[TS 24.301, clause 8.3.3.11]

This IE shall be included in the message only if the network wishes to transmit the maximum and guaranteed bit rate values to the UE and at least one of the values to be transmitted exceeds the maximum value specified in the EPS quality of service information element in subclause 9.9.4.3

[TS 24.301, clause 9.9.4.29]

The purpose of the extended APN aggregate maximum bit rate information element is to indicate the initial subscribed APN-AMBR with a value higher than 65280 Mbps when the UE establishes a PDN connection or to indicate the new APN-AMBR with a value higher than 65280 Mbps if it is changed by the network.

The receiving entity shall ignore the bit rate values which are included in the extended APN aggregate maximum bit rate information element and not higher than 65280 Mbps.

The extended APN aggregate maximum bit rate information element is coded as shown in figure 9.9.4.29.1 and table 9.9.4.29.1.

The extended APN aggregate maximum bit rate is a type 4 information element with a length of 8 octets

[TS 24.301, clause 9.9.4.30]

The purpose of the Extended EPS quality of service information element is to indicate for an EPS bearer context the maximum bit rates for uplink and downlink and the guaranteed bit rates for uplink and downlink, if at least one of the bit rates has a value higher than 10 Gbps.

The Extended EPS quality of service information element is coded as shown in figure 9.9.4.30.1 and table 9.9.4.30.1. For uplink and downlink, if sending entity only has to indicate one bit rate (i.e., with a value higher than 10 Gbps), it shall encode the other bit rate (i.e., with a value smaller or equal to 10 Gbps) as "00000000". The receiving entity shall ignore the bit rate which is included in the extended quality of service information element and has a value smaller or equal to 10 Gbps.

10.2.1.2.3 Test description

10.2.1.2.3.1 Pre-test conditions

System Simulator:

- E-UTRA Cell 1 is the PCell and NR Cell 1 is the PSCell.

UE:

- None.

Preamble:

- The UE is in RRC_IDLE state on E-UTRA Cell 1 using generic procedure parameter Connectivity (*E-UTRA/EPC*) according to TS 38.508-1 [4].

10.2.1.2.3.2 Test procedure sequence

Table 10.2.1.2.3.2-1: Main behaviour

St	Procedure	Message Sequence		TP	Verdict
		U - S	Message		
1-6	Steps 1 to 6 of generic procedure defined in clause 4.5.4 in TS 38.508-1 [4].	-	-	-	-
7	The SS configures a dedicated EPS bearer associated with the default EPS bearer context by sending ACTIVATE DEDICATED EPS BEARER CONTEXT REQUEST including the Extended QoS IE. (See Note 1 and Note 2).	<--	NAS: ACTIVATE DEDICATED EPS BEARER CONTEXT REQUEST	-	-
8	Check: Does the UE transmit an ACTIVATE DEDICATED EPS BEARER CONTEXT ACCEPT message as specified?	-->	ACTIVATE DEDICATED EPS BEARER CONTEXT ACCEPT	1	P
9	The SS transmits a MODIFY EPS BEARER CONTEXT REQUEST message with Extended EPS QoS and Extended APN-AMBR IEs. This message is included in a DLInformationTransfer message.	<--	MODIFY EPS BEARER CONTEXT REQUEST	-	-
10	Check: Does the UE transmit a MODIFY EPS BEARER CONTEXT ACCEPT message?	-->	MODIFY EPS BEARER CONTEXT ACCEPT	2	P
Note 1: The ACTIVATE DEDICATED EPS BEARER CONTEXT REQUEST message is included in a <i>RRCConnectionReconfiguration</i> message including a DRB setup for the same EPS bearer ID.					
Note 2: The <i>RRCConnectionReconfiguration</i> uses the condition for DC bearer MCG and SCG					

10.2.1.2.3.3 Specific message contents

Table 10.2.1.2.3.3-1: ACTIVATE DEDICATED EPS BEARER CONTEXT REQUEST (step 7, Table 10.2.1.2.3.2-1)

Derivation Path: TS 38.508-1 [4], Table 4.5.4.3-1			
Information Element	Value/remark	Comment	Condition
Protocol discriminator	ESM		
EPS bearer identity	6		
Procedure transaction identity	'0000 0000'B	No procedure transaction identity assigned	
EPS QoS			
QCI	8		
Maximum bit rate for uplink	'01101000'B (384) kbps		
Maximum bit rate for downlink	'11111110'B (8640) kbps		
Guaranteed bit rate for uplink	'01001000'B (128) kbps		
Guaranteed bit rate for downlink	'01001000'B (128) kbps		
Maximum bit rate for uplink (extended)	0		
Maximum bit rate for downlink (extended)	'1111010'B (256) Mbps		
Guaranteed bit rate for uplink (extended)	0		
Guaranteed bit rate for downlink (extended)	0		
Maximum bit rate for uplink (extended-2)	0		
Maximum bit rate for downlink (extended-2)	'11110110'B (10) Gbps		
Guaranteed bit rate for uplink (extended-2)	0		
Guaranteed bit rate for downlink (extended-2)	0		
Extended EPS QoS			
Unit for maximum bit rate	'00000111' (value is incremented in multiples of 1 Gbps)		
Maximum bit rate for uplink	'0000000000000000'B		
Maximum bit rate for downlink	'0000000000001100'B (12) Gbps		
Unit for guaranteed bit rate	'00000000'B		
Guaranteed bit rate for uplink	'00000000'B		
Guaranteed bit rate for downlink	'00000000'B		

Table 10.2.1.2.3.3-2: MODIFY EPS BEARER CONTEXT REQUEST (step 9, Table 10.2.1.2.3.2-1)

Derivation path: TS 36.508 [7], Table 4.7.3-18			
Information Element	Value/Remark	Comment	Condition
New EPS QoS			
QCI	8		
Maximum bit rate for uplink	'01101000'B (384 kbps)		
Maximum bit rate for downlink	'11111110'B (8640 kbps)		
Guaranteed bit rate for uplink	'01001000'B (128 kbps)		
Guaranteed bit rate for downlink	'01001000'B (128 kbps)		
Maximum bit rate for uplink (extended)	0		
Maximum bit rate for downlink (extended)	'11111010'B (256 Mbps)		
Guaranteed bit rate for uplink (extended)	0		
Guaranteed bit rate for downlink (extended)	0		
Maximum bit rate for uplink (extended-2)	0		
Maximum bit rate for downlink (extended-2)	'11110110'B (10 Gbps)		
Guaranteed bit rate for uplink (extended-2)	0		
Guaranteed bit rate for downlink (extended-2)	0		
APN-AMBR			
APN-AMBR for downlink	'11111110'B (8640 kbps)		
APN-AMBR for uplink	'11111110'B (8640 kbps)		
APN-AMBR for downlink (extended)	'11111010' B(256 Mbps)		
APN-AMBR for uplink (extended)	'11111010' B(256 Mbps)		
APN-AMBR for downlink (extended-2)	'11111110'B (65280 Mbps)		
APN-AMBR for uplink (extended-2)	0		
Extended APN-AMBR			
Unit for extended APN-AMBR for downlink	'00000111'B (value is incremented in multiples of 1 Gbps)		
Extended APN-AMBR for downlink	'0000000010000000' (128 Gbps)		
Unit for extended APN-AMBR for uplink	0		
Extended APN-AMBR for uplink	0		
Extended EPS QoS			
Unit for maximum bit rate	'00000111' (value is incremented in multiples of 1 Gbps)		
Maximum bit rate for uplink	'0000000000000000'B		
Maximum bit rate for downlink	'0000000000001110'B		
Unit for guaranteed bit rate	'00000000'B		
Guaranteed bit rate for uplink	'00000000'B		
Guaranteed bit rate for downlink	'00000000'B		

10.2.2 UE initiated procedures

10.2.2.1 EPS bearer resource allocation / modification

10.2.2.1.1 Test Purpose (TP)

(1)

```
with { UE in PROCEDURE TRANSACTION INACTIVE state and in EMM-IDLE mode }
ensure that {
  when { UE is requested to allocate bearer resource using Extended EPS QoS }
  then { UE sends a BEARER RESOURCE ALLOCATION REQUEST including the Extended EPS QoS IE }
}
```

(2)

```
with { UE has sent the BEARER RESOURCE ALLOCATION REQUEST message }
ensure that {
  when { UE receives an ACTIVATE DEDICATED EPS BEARER CONTEXT REQUEST message with the procedure transaction identity (PTI) indicated in the BEARER RESOURCE ALLOCATION REQUEST message }
}
```

```

    then { UE sends an ACTIVATE DEDICATED EPS BEARER CONTEXT ACCEPT message }
  }

```

(3)

```

with { UE in PROCEDURE TRANSACTION INACTIVE state and in EMM-CONNECTED mode }
ensure that {
  when { UE is requested to modify of bearer resource corresponding to the dedicated bearer using
    Extended EPS QoS }
    then { UE sends a BEARER RESOURCE MODIFICATION REQUEST message including the Extended EPS QoS IE
  }
}

```

(4)

```

with { UE having sent the BEARER RESOURCE MODIFICATION REQUEST message }
ensure that {
  when { UE receives an MODIFY EPS BEARER CONTEXT REQUEST message with the procedure transaction
    identity (PTI) indicated in the BEARER RESOURCE MODIFICATION REQUEST message }
    then { UE sends a MODIFY EPS BEARER CONTEXT ACCEPT message }
  }
}

```

10.2.2.1.2 Conformance requirements

References: The conformance requirements covered in the present TC are specified in: TS 24.301, clauses 6.4.2.3, 6.5.3.2, 6.5.3.3, 6.5.4.2, 6.5.4.3, 8.3.8, 8.3.10 and 9.9.4.30. Unless otherwise stated these are Rel-15 requirements.

[TS 24.301, clause 6.4.2.3]

The linked EPS bearer identity included in the ACTIVATE DEDICATED EPS BEARER CONTEXT REQUEST message indicates to the UE to which default bearer, IP address and PDN the dedicated bearer is linked.

If the ACTIVATE DEDICATED EPS BEARER CONTEXT REQUEST message contains a PTI value other than "no procedure transaction identity assigned" and "reserved" (see 3GPP TS 24.007 [12]), the UE uses the PTI to identify the UE requested bearer resource allocation procedure or the UE requested bearer resource modification procedure to which the dedicated bearer context activation is related.

[TS 24.301, clause 6.5.3.2]

In order to request the allocation of bearer resources for one traffic flow aggregate, the UE shall send a BEARER RESOURCE ALLOCATION REQUEST message to the MME, start timer T3480 and enter the state PROCEDURE TRANSACTION PENDING (see example in figure 6.5.3.2.1).

The UE shall include the EPS bearer identity of the default EPS bearer associated with the requested bearer resource in the Linked EPS bearer identity IE. The UE shall set the TFT operation code in the Traffic flow aggregate IE to "Create new TFT". The packet filters in the Traffic flow aggregate IE shall include at least one packet filter applicable for the uplink direction. In the Required traffic flow QoS IE, the UE shall indicate a QCI and, if the UE also includes a GBR, the additional GBR required for the traffic flow aggregate.

[TS 24.301, clause 6.5.3.3]

If the bearer resource allocation requested is accepted by the network, the MME shall initiate either a dedicated EPS bearer context activation procedure or an EPS bearer context modification procedure. Upon receipt of an ACTIVATE DEDICATED EPS BEARER CONTEXT REQUEST or MODIFY EPS BEARER CONTEXT REQUEST message with a PTI which matches the value used for the BEARER RESOURCE ALLOCATION REQUEST message, the UE shall stop timer T3480 and enter the state PROCEDURE TRANSACTION INACTIVE. The UE should ensure that the procedure transaction identity (PTI) assigned to this procedure is not released immediately. The way to achieve this is implementation dependent. While the PTI value is not released, the UE regards any received ACTIVATE DEDICATED EPS BEARER CONTEXT REQUEST or MODIFY EPS BEARER CONTEXT REQUEST message with the same PTI value as a network retransmission (see subclause 7.3.1).

If the ACTIVATE DEDICATED EPS BEARER CONTEXT REQUEST message is received, the UE shall verify that the EPS bearer identity given in the EPS bearer identity IE is not already used by any EPS bearer context. The UE shall then proceed as described in subclause 6.4.2.3 or subclause 6.4.2.4.

[TS 24.301, clause 6.5.4.2]

In order to request the modification of bearer resources for one traffic flow aggregate, the UE shall send a BEARER RESOURCE MODIFICATION REQUEST message to the MME, start timer T3481 and enter the state PROCEDURE TRANSACTION PENDING (see example in figure 6.5.4.2.1).

[TS 24.301, clause 6.5.4.3]

Upon receipt of the BEARER RESOURCE MODIFICATION REQUEST message, the MME checks whether the resources requested by the UE can be established, modified or released by verifying the EPS bearer identity given in the EPS bearer identity for packet filter IE.

If the bearer resource modification requested is accepted by the network, the MME shall initiate either a dedicated EPS bearer context activation procedure, an EPS bearer context modification procedure or an EPS bearer context deactivation procedure.

...

Upon receipt of an ACTIVATE DEDICATED EPS BEARER CONTEXT REQUEST, MODIFY EPS BEARER CONTEXT REQUEST or DEACTIVATE EPS BEARER CONTEXT REQUEST message with a PTI which matches the value used for the BEARER RESOURCE MODIFICATION REQUEST message, the UE shall stop timer T3481 and enter the state PROCEDURE TRANSACTION INACTIVE. The UE should ensure that the procedure transaction identity (PTI) assigned to this procedure is not released immediately. The way to achieve this is implementation dependent. While the PTI value is not released, the UE regards any received ACTIVATE DEDICATED EPS BEARER CONTEXT REQUEST or MODIFY EPS BEARER CONTEXT REQUEST message with the same PTI value as a network retransmission (see subclause 7.3.1).

- i) If the ACTIVATE DEDICATED EPS BEARER CONTEXT REQUEST message is received, the UE shall verify that the EPS bearer identity given in the EPS bearer identity IE is not already used by any EPS bearer context. The UE shall then proceed as described in subclause 6.4.2.3 or subclause 6.4.2.4.

[TS 24.301, clause 8.3.8]

This IE shall be included in the message only if the UE wishes to transmit the maximum and guaranteed bit rate values to the network and at least one of the values to be transmitted exceeds the maximum value specified in the EPS quality of service information element in subclause 9.9.4.3.

[TS 24.301, clause 8.3.10]

This IE shall be included in the message only if the UE wishes to transmit the maximum and guaranteed bit rate values to the network and at least one of the values to be transmitted exceeds the maximum value specified in the EPS quality of service information element in subclause 9.9.4.3.

[TS 24.301, clause 9.9.4.30]

The purpose of the Extended quality of service information element is to indicate for an EPS bearer context the maximum bit rates for uplink and downlink and the guaranteed bit rates for uplink and downlink, if at least one of the bit rates has a value higher than 10 Gbps.

The Extended quality of service information element is coded as shown in figure 9.9.4.30.1 and table 9.9.4.30.1. For uplink and downlink, if the sending entity only has to indicate one bit rate (i.e., with a value higher than 10 Gbps), it shall encode the other bit rate (i.e., with a value smaller or equal to 10 Gbps) as "00000000". The receiving entity shall ignore a bit rate which is included in the extended quality of service information element and has a value smaller or equal to 10 Gbps.

The Extended quality of service is a type 4 information element with a length of 12 octets.

	8	7	6	5	4	3	2	1	
Extended quality of service IEI									octet 1
Length of Extended quality of service contents									octet 2
Unit for maximum bit rate									octet 3
Maximum bit rate for uplink									octet 4

Maximum bit rate for uplink (continued)	octet 5
Maximum bit rate for downlink	octet 6
Maximum bit rate for downlink (continued)	octet 7
Unit for guaranteed bit rate	octet 8
Guaranteed bit rate for uplink	octet 9
Guaranteed bit rate for uplink (continued)	octet 10
Guaranteed bit rate for downlink	octet 11
Guaranteed bit rate for downlink (continued)	octet 12

Figure 9.9.4.30.1: Extended quality of service information element

Table 9.9.4.30.1: Extended quality of service information element

Unit for maximum bit rate (octet 3)

0 0 0 0 0 0 0 0	value is not used
0 0 0 0 0 0 0 1	value is incremented in multiples of 200 kbps
0 0 0 0 0 0 1 0	value is incremented in multiples of 1 Mbps
0 0 0 0 0 0 1 1	value is incremented in multiples of 4 Mbps
0 0 0 0 0 1 0 0	value is incremented in multiples of 16 Mbps
0 0 0 0 0 1 0 1	value is incremented in multiples of 64 Mbps
0 0 0 0 0 1 1 0	value is incremented in multiples of 256 Mbps
0 0 0 0 0 1 1 1	value is incremented in multiples of 1 Gbps
0 0 0 0 1 0 0 0	value is incremented in multiples of 4 Gbps
0 0 0 0 1 0 0 1	value is incremented in multiples of 16 Gbps
0 0 0 0 1 0 1 0	value is incremented in multiples of 64 Gbps
0 0 0 0 1 0 1 1	value is incremented in multiples of 256 Gbps
0 0 0 0 1 1 0 0	value is incremented in multiples of 1 Tbps
0 0 0 0 1 1 0 1	value is incremented in multiples of 4 Tbps
0 0 0 0 1 1 1 0	value is incremented in multiples of 16 Tbps
0 0 0 0 1 1 1 1	value is incremented in multiples of 64 Tbps
0 0 0 1 0 0 0 0	value is incremented in multiples of 256 Tbps
0 0 0 1 0 0 0 1	value is incremented in multiples of 1 Pbps
0 0 0 1 0 0 1 0	value is incremented in multiples of 4 Pbps
0 0 0 1 0 0 1 1	value is incremented in multiples of 16 Pbps
0 0 0 1 0 1 0 0	value is incremented in multiples of 64 Pbps
0 0 0 1 0 1 0 1	value is incremented in multiples of 256 Pbps

Other values shall be interpreted as multiples of 256 Pbps in this version of the protocol.

Maximum bit rate for uplink (octets 4 and 5)

Octets 4 and 5 represent the binary coded value of maximum bit rate for uplink in units defined by octet 3.

Maximum bit rate for downlink (octets 6 and 7)

Octets 6 and 7 represent the binary coded value of maximum bit rate for downlink in units defined by octet 3.

ETSI

Unit for guaranteed bit rate (octet 8)

10.2.2.1.3 Test description

10.2.2.1.3.1 Pre-test conditions

System Simulator:

- E-UTRA Cell 1 and NR Cell 1.

UE:

- None.

Preamble:

- The UE is in state RRC_IDLE using generic procedure parameter Connectivity (*E-UTRA/EPC*) established according to TS 38.508-1 [4], clause 4.5.2.

10.2.2.1.3.2 Test procedure sequence

Table 10.2.2.1.3.2-1: Main behaviour

St	Procedure	Message Sequence		TP	Verdict
		U - S	Message		
1	Cause the UE to request bearer resource allocation of dedicated EPS bearer associated with non-IMS PDN connectivity if pc_MULTI_PDN=TRUE else first PDN connectivity. (Note 1).	-	-	-	-
2	The UE transmits a SERVICE REQUEST message.	-->	SERVICE REQUEST	-	-
3	The SS establishes SRB2 and the MCG DRBs associated with the default EPS bearer context activated during the preamble.	-	-	-	-
4	Check: Does the UE transmit a BEARER RESOURCE ALLOCATION REQUEST message?	-->	BEARER RESOURCE ALLOCATION REQUEST	1	P
5	The SS transmits an ACTIVATE DEDICATED EPS BEARER CONTEXT REQUEST message and establishes a RLC-AM SCG DRB bearer using MCG_and_SCG condition.	<--	ACTIVATE DEDICATED EPS BEARER CONTEXT REQUEST	-	-
6	Check: Does the UE transmit an ACTIVATE DEDICATED EPS BEARER CONTEXT ACCEPT message?	-->	ACTIVATE DEDICATED EPS BEARER CONTEXT ACCEPT	2	P
7	Cause the UE to request bearer resource modification of dedicated EPS bearer associated with non-IMS PDN connectivity if pc_MULTI_PDN=TRUE else first PDN connectivity. (Note 2).	-	-	-	-
8	Check: Does the UE transmit a BEARER RESOURCE MODIFICATION REQUEST message?	-->	BEARER RESOURCE MODIFICATION REQUEST	3	P
9	The SS transmits an MODIFY EPS BEARER CONTEXT REQUEST message.	<--	MODIFY EPS BEARER CONTEXT REQUEST	-	-
10	Check: Does the UE transmit an MODIFY EPS BEARER CONTEXT ACCEPT message?	-->	MODIFY EPS BEARER CONTEXT ACCEPT	4	P
Note 1: The request is assumed to be triggered by AT command +CGDSCONT, and +CGACT (activated).					
Note 2: The request is assumed to be triggered by AT command +CGCMOD.					

10.2.2.1.3.3 Specific message contents

Table 10.2.2.1.3.3-1: Message BEARER RESOURCE ALLOCATION REQUEST (step 4, Table 10.2.2.1.3.2-1)

Derivation path: TS 36.508 [7], Table 4.7.3-6B			
Information Element	Value/Remark	Comment	Condition
Linked EPS bearer identity	12		
	5		IMS_PDN_ONLY
EPS QoS			
QCI	1		
Maximum bit rate for uplink	384 kbps		
Maximum bit rate for downlink	'11111110'B (8640 kbps)		
Guaranteed bit rate for uplink	128 kbps		
Guaranteed bit rate for downlink	128 kbps		
Maximum bit rate for uplink (extended)	0		
Maximum bit rate for downlink (extended)	'11111010'B (256 Mbps)		
Guaranteed bit rate for uplink (extended)	0		
Guaranteed bit rate for downlink (extended)	0		
Maximum bit rate for uplink (extended-2)	0		
Maximum bit rate for downlink (extended-2)	'11110110'B (10 Gbps)		
Guaranteed bit rate for uplink (extended-2)	0		
Guaranteed bit rate for downlink (extended-2)	0		
Extended EPS QoS			
Unit for maximum bit rate	Any value(Note1)		
Maximum bit rate for uplink	'00000000'B		
Maximum bit rate for downlink	Any value(Note1)		
Unit for guaranteed bit rate	'00000000'B		
Guaranteed bit rate for uplink	'00000000'B		
Guaranteed bit rate for downlink	'00000000'B		
Note1: The product of Unit for maximum bit rate and maximum bit rate for downlink should be 12Gbps.			

Condition	Explanation
IMS_PDN_ONLY	IMS_PDN only available

Table 10.2.2.1.3.3-2: Message ACTIVATE DEDICATED EPS BEARER CONTEXT REQUEST (step 5, Table 10.2.2.1.3.2-1)

Derivation path: TS 38.508-1 [4], Table 4.5.4.3-1 , condition UE-INITIATED			
Information Element	Value/Remark	Comment	Condition
EPS bearer identity	6		
EPS QoS			
QCI	1		
Maximum bit rate for uplink	384 kbps		
Maximum bit rate for downlink	'11111110'B (8640 kbps)		
Guaranteed bit rate for uplink	128 kbps		
Guaranteed bit rate for downlink	128 kbps		
Maximum bit rate for uplink (extended)	0		
Maximum bit rate for downlink (extended)	'11111010'B (256 Mbps)		
Guaranteed bit rate for uplink (extended)	0		
Guaranteed bit rate for downlink (extended)	0		
Maximum bit rate for uplink (extended-2)	0		
Maximum bit rate for downlink (extended-2)	'11110110'B (10 Gbps)		
Guaranteed bit rate for uplink (extended-2)	0		
Guaranteed bit rate for downlink (extended-2)	0		
Extended EPS QoS			
Unit for maximum bit rate	'00000111' (value is incremented in multiples of 1 Gbps)		
Maximum bit rate for uplink	'00000000'B		

Maximum bit rate for downlink	'0000000000001100' B (12 Gbps)		
Unit for guaranteed bit rate	'00000000'B		
Guaranteed bit rate for uplink	'00000000'B		
Guaranteed bit rate for downlink	'00000000'B		

Table 10.2.2.1.3.3-3: Message BEARER RESOURCE MODIFICATION REQUEST (step 8, Table 10.2.2.1.3.2-1)

Derivation path: TS 36.508 [7], Table 4.7.3-8			
Information Element	Value/Remark	Comment	Condition
EPS bearer identity for packet filter	6		
Required traffic flow QoS			
QCI	1		
Maximum bit rate for uplink	384 kbps		
Maximum bit rate for downlink	'11111110'B (8640 kbps)		
Guaranteed bit rate for uplink	128 kbps		
Guaranteed bit rate for downlink	128 kbps		
Maximum bit rate for uplink (extended)	0		
Maximum bit rate for downlink (extended)	'1111010'B (256 Mbps)		
Guaranteed bit rate for uplink (extended)	0		
Guaranteed bit rate for downlink (extended)	0		
Maximum bit rate for uplink (extended-2)	0		
Maximum bit rate for downlink (extended-2)	'11110110'B (10 Gbps)		
Guaranteed bit rate for uplink (extended-2)	0		
Guaranteed bit rate for downlink (extended-2)	0		
Extended EPS QoS			
Unit for maximum bit rate	Any value (Note1)		
Maximum bit rate for uplink	'00000000'B		
Maximum bit rate for downlink	Any value (Note1)		
Unit for guaranteed bit rate	'00000000'B		
Guaranteed bit rate for uplink	'00000000'B		
Guaranteed bit rate for downlink	'00000000'B		

Note1: The product of Unit for maximum bit rate and maximum bit rate for downlink should be 16Gbps.

Table 10.2.2.1.3.3-4: Message MODIFY EPS BEARER CONTEXT REQUEST (step 7, Table 10.2.2.1.3.2-1)

Derivation path: TS 36.508 [7], Table 4.7.3-18, condition UE-INITIATED			
Information Element	Value/Remark	Comment	Condition
EPS bearer identity	6		
Linked EPS bearer identity	12		
	5		IMS_PD ONLY
New EPS QoS			
QCI	1		
Maximum bit rate for uplink	384 kbps		
Maximum bit rate for downlink	'11111110'B (8640 kbps)		
Guaranteed bit rate for uplink	128 kbps		
Guaranteed bit rate for downlink	128 kbps		
Maximum bit rate for uplink (extended)	0		
Maximum bit rate for downlink (extended)	'1111010'B (256 Mbps)		
Guaranteed bit rate for uplink (extended)	0		
Guaranteed bit rate for downlink (extended)	0		
Maximum bit rate for uplink (extended-2)	0		
Maximum bit rate for downlink (extended-2)	'11110110'B (10 Gbps)		
Guaranteed bit rate for uplink (extended-2)	0		
Guaranteed bit rate for downlink (extended-2)	0		
APN-AMBR			
APN-AMBR for downlink	'11111110'B (8640 kbps)		
APN-AMBR for uplink	'11111110'B (8640 kbps)		
APN-AMBR for downlink (extended)	'1111010' B(256 Mbps)		
APN-AMBR for uplink (extended)	'1111010' B(256 Mbps)		

APN-AMBR for downlink (extended-2)	'11111110'B (65280 Mbps)		
APN-AMBR for uplink (extended-2)	0		
Extended APN-AMBR			
Unit for extended APN-AMBR for downlink	'00000111'B (value is incremented in multiples of 1 Gbps)		
Extended APN-AMBR for downlink	'0000000010000000' (128 Gbps)		
Unit for extended APN-AMBR for uplink	0		
Extended APN-AMBR for uplink	0		
Extended EPS QoS			
Unit for maximum bit rate	'00000111' (value is incremented in multiples of 1 Gbps)		
Maximum bit rate for uplink	'00000000'B		
Maximum bit rate for downlink	'0000000000010000' B (16 Gbps)		
Unit for guaranteed bit rate	'00000000'B		
Guaranteed bit rate for uplink	'00000000'B		
Guaranteed bit rate for downlink	'00000000'B		

Condition	Explanation
IMS_PDN_ONLY	IMS_PDN only available

10.3 5GS Non-3GPP Access Session Management

10.3.1 PDU session authentication and authorization

10.3.1.1 PDU session authentication and authorization / during the UE-requested PDU session procedure

10.3.1.1.1 Test Purpose (TP)

Same Test Purpose as in clause 10.1.1.1.1

10.3.1.1.2 Conformance requirements

Same conformance requirements as in clause 10.1.1.1.2

10.3.1.1.3 Test description

10.3.1.1.3.1 Pre-test conditions

System Simulator:

WLAN Cell 27

UE:

None.

Preamble:

The UE is in state 1W-A with PDU session Active state according to TS 38.508-1 [4].

10.3.1.1.3.2 Test procedure sequence

Table 10.3.1.1.3.2-1: Main behaviour

St	Procedure	Message Sequence		TP	Verdict
		U - S	Message		
1	Cause the UE to request connectivity to an additional PDU session. (see Note 1)	-	-	-	-
2	UE transmits establishes a IPSEC SA and NAS signalling connection as per generic procedure in table 4.5A.4.2.2-1 of 38.508-1 [4].	-	-	-	-
3	The UE transmits a PDU SESSION ESTABLISHMENT REQUEST message to request an additional PDU session. Note: PDU SESSION ESTABLISHMENT REQUEST is included in UL NAS transport. UL NAS transport message is included in dedicatedNAS-Message of <i>ULInformationTransfer</i> message. DNN information is included in UL NAS transport message.	-->	5GMM: UL NAS TRANSPORT 5GSM: PDU SESSION ESTABLISHMENT REQUEST	-	-
4	The SS transmits PDU SESSION AUTHENTICATION COMMAND including an EAP-Request message.	<--	PDU SESSION AUTHENTICATION COMMAND		
5	Check: Does the UE transmit a PDU SESSION AUTHENTICATION COMPLETE containing EAP-Response message?	-->	PDU SESSION AUTHENTICATION COMPLETE	1	P
6	The SS transmits PDU SESSION ESTABLISHMENT REJECT message with 5GSM cause #29 including an EAP-Failure message.	<--	PDU SESSION ESTABLISHMENT REJECT		
7	The generic procedure for SS-requested IPsec Secure tunnel disconnection, specified in subclause 4.5A.3 of TS 38.508-1 [4], takes place performing disconnection of security association.	-		-	-
8	Cause the UE to request connectivity to an additional PDU session. (see Note 1)	-	-	-	-
9	UE transmits establishes a IPSEC SA and NAS signalling connection as per generic procedure in table 4.5A.4.2.2-1 of 38.508-1 [4].	-	-	-	-
10	The UE transmits a PDU SESSION ESTABLISHMENT REQUEST message to request an additional PDU session. Note: PDU SESSION ESTABLISHMENT REQUEST is included in UL NAS transport. UL NAS transport message is included in dedicatedNAS-Message of <i>ULInformationTransfer</i> message. DNN information is included in UL NAS transport message.	-->	5GMM: UL NAS TRANSPORT 5GSM: PDU SESSION ESTABLISHMENT REQUEST	2	P
11	The SS transmits PDU SESSION AUTHENTICATION COMMAND including an EAP-Request message.	<--	PDU SESSION AUTHENTICATION COMMAND		
12	Check: Does the UE transmit a PDU SESSION AUTHENTICATION COMPLETE containing EAP-Response message?	-->	PDU SESSION AUTHENTICATION COMPLETE	-	-
13	The SS establishes an IPsec child security association according to the IKEv2 specification in RFC 7296 [32]	-	-	-	
14	The SS transmits PDU SESSION ESTABLISHMENT ACCEPT message containing an EAP-Success message.	<--	PDU SESSION ESTABLISHMENT ACCEPT		

15	SS Transmits PDU SESSION MODIFICATION COMMAND	<--	PDU SESSION MODIFICATION COMMAND	-	-
	Check: Does the UE transmit a PDU SESSION MODIFICATION COMPLETE?	-->	PDU SESSION MODIFICATION COMPLETE	3	P
-	EXCEPTION: Step 16a1 describes behaviour depending UE implementation; the "lower case letter" identifies a step sequence that take place if the UE performs a specific action.	-	-	-	-
16a1	If initiated by the UE, the generic procedure for IP address allocation in the user plane, specified in subclause 4.5.6, takes place performing IP address allocation in the user plane.	-	-	-	-
Note 1: The request of connectivity to an additional PDU session may be performed by MMI or AT command +CGACT.					

10.3.1.1.3.3 Specific message contents

Table 10.3.1.1.3.3-1: Void**Table 10.3.1.1.3.3-2: Void****Table 10.3.1.1.3.3-3: PDU SESSION ESTABLISHMENT REQUEST (step 3 and 10, Table 10.3.1.1.3.2-1)**

Derivation path: TS 38.508-1 [4], Table 4.7.2-1			
Information Element	Value/remark	Comment	Condition
PDU session ID	PSI-1	UE assigns a particular PSI not yet used between 1 and 15	
PTI	PTI-1	UE assigns a particular PTI not yet used between 1 and 254	

Table 10.3.1.1.3.3-4: UL NAS Transport (step 3 and 10, Table 10.3.1.1.3.2-1)

Derivation path: TS 38.508-1 [4], Table 4.7.1-10			
Information Element	Value/remark	Comment	Condition
Payload container type	'0001'B	N1 SM information	
PDU session ID	PSI-1		
Request type	'001'B	Initial request	
S-NSSAI	Not Present		
DNN	DNN-1 (New DNN name)	The requested DNN is different from default DNN.	

Table 10.3.1.1.3.3-5: PDU SESSION ESTABLISHMENT REJECT (step 6, Table 10.3.1.1.3.2-1)

Derivation path: TS 38.508-1 [4], Table 4.7.2-3			
Information Element	Value/remark	Comment	Condition

PDU session ID	PSI-1		
PTI	PTI-1		
5GSM cause	'00011101'	User authentication or authorization failed	

Table 10.3.1.1.3.3-6: PDU SESSION ESTABLISHMENT ACCEPT (step 14, Table 10.3.1.1.3.2-1)

Derivation path: TS 38.508-1 [4], Table 4.7.2-2			
Information Element	Value/remark	Comment	Condition
PDU session ID	PSI-1		
PTI	PTI-1		
EAP message	Set according to TS 38.508-1 [4] Table 4.7.3.2-3	EAP-Success	
QoS flow description			
QFI	'00 0011'B	QFI 3	
Operation code	'001'B	Create new QoS flow description	
E bit	'1'B	Parameters list is included	
Number of parameters	'00 0001'B	1 parameters	
5QI	'0000 1001'B	5QI 9	
DNN	DNN-1		

10.3.2 Network-requested PDU session modification

10.3.2.1 Network-requested PDU session modification /Accepted/Rejected

10.3.2.1.1 Test Purpose (TP)

(1)

```

with { the UE in PDU SESSION ACTIVE state and 5GMM-CONNECTED mode }
ensure that {
  when { the UE receives a PDU SESSION MODIFICATION COMMAND message include the PDU session ID which
does not belong to any PDU session in PDU SESSION ACTIVE state in UE }
  then { UE sends a PDU SESSION MODIFICATION COMMAND REJECT message and set the 5GSM cause to #43:
invalid PDU session identity }
}

```

(2)

```

with { the UE in PDU SESSION ACTIVE state and 5GMM-CONNECTED mode }
ensure that {
  when { the UE receives a PDU SESSION MODIFICATION COMMAND message include the PDU session ID which
belongs to a PDU session in PDU SESSION ACTIVE state in UE }
}

```

```
    then { UE sends a PDU SESSION MODIFICATION COMMAND REJECT message and set the 5GSM cause to #43:
invalid PDU session identity }
    }
```

10.3.2.1.2 Conformance requirements

References: The conformance requirements covered in the present TC are specified in: TS 24.501, clauses 6.3.2.2, 6.3.2.4. Unless otherwise stated these are Rel-15 requirements.

[TS 24.501, clause 6.3.2.2]

In order to initiate the network-requested PDU session modification procedure, the SMF shall create a PDU SESSION MODIFICATION COMMAND message.

If the authorized QoS rules of the PDU session is modified, the SMF shall set the authorized QoS rules IE of the PDU SESSION MODIFICATION COMMAND message to the authorized QoS rules of the PDU session. The SMF shall ensure that the number of the packet filters used in the authorized QoS rules of the PDU Session does not exceed the maximum number of packet filters supported by the UE for the PDU session. The SMF may bind service data flows for which the UE has requested traffic segregation to a dedicated QoS flow for the PDU session, if possible. Otherwise the SMF may bind the service data flows to an existing QoS flow. The SMF shall use only one dedicated QoS flow for traffic segregation. If the UE has requested traffic segregation for multiple service data flows with different QoS handling, the SMF shall bind all these service data flows to a single QoS flow. If the SMF allows traffic segregation for service data flows in a QoS rule, then the SMF shall create a new authorized QoS rule for these service data flows and shall delete packet filters corresponding to these service data flows from the other authorized QoS rules.

If the authorized QoS flow descriptions of the PDU session is modified, the SMF shall set the authorized QoS flow descriptions IE of the PDU SESSION MODIFICATION COMMAND message to the authorized QoS flow descriptions of the PDU session.

If SMF creates a new authorized QoS rule for a new QoS flow, then SMF shall include the authorized QoS flow description for that QoS flow in the authorized QoS flow descriptions IE of the PDU SESSION MODIFICATION COMMAND message, if:

- a) the newly created authorized QoS rules is for a new GBR QoS flow;
- b) the QFI of the new QoS flow is not the same as the 5QI of the QoS flow identified by the QFI; or
- c) the new QoS flow can be mapped to an EPS bearer as specified in subclause 4.11.2 of 3GPP TS 23.502 [9].

If the session-AMBR of the PDU session is modified, the SMF shall set the selected Session-AMBR IE of the PDU SESSION MODIFICATION COMMAND message to the session-AMBR of the PDU session.

If interworking with EPS is supported for the PDU session and if the mapped EPS bearer contexts of the PDU session is modified, the SMF shall set the mapped EPS bearer contexts IE of the PDU SESSION MODIFICATION COMMAND message to the mapped EPS bearer contexts of the PDU session. If the association between a QoS flow and the mapped EPS bearer context is changed, the SMF shall set the EPS bearer identity parameter in authorized QoS flow descriptions IE of the PDU SESSION MODIFICATION COMMAND message to the new EPS bearer identity associated with the QoS flow.

If the network-requested PDU session modification procedure is triggered by a UE-requested PDU session modification procedure and the PDU SESSION MODIFICATION REQUEST message includes a 5GSM capability IE, the SMF shall:

- a) if the RQoS bit is set to:
 - 1) "Reflective QoS supported", consider that the UE supports reflective QoS for this PDU session; or
 - 2) "Reflective QoS not supported", consider that the UE does not support reflective QoS for this PDU session; and;
- b) if the MH6-PDU bit is set to:
 - 1) "Multi-homed IPv6 PDU session supported", consider that this PDU session is supported to use multiple IPv6 prefixes; or

- 2) "Multi-homed IPv6 PDU session not supported", consider that this PDU session is not supported to use multiple IPv6 prefixes.

If the SMF considers that reflective QoS is supported for QoS flows belonging to this PDU session, the SMF may include the RQ timer IE set to an RQ timer value in the PDU SESSION MODIFICATION COMMAND message.

If the network-requested PDU session modification procedure is triggered by a UE-requested PDU session modification procedure, the PDU session type is "IPv4", "IPv6", "IPv4v6" or "Ethernet" and the PDU SESSION MODIFICATION REQUEST message includes a Maximum number of supported packet filters IE, the SMF shall consider this number as the maximum number of packet filters that can be supported by the UE for this PDU session. Otherwise the SMF considers that the UE supports 16 packet filters for this PDU session.

For a PDN connection established when in S1 mode, upon the first inter-system change from S1 mode to N1 mode, if the network-requested PDU session modification procedure is triggered by a UE-requested PDU session modification procedure, the SMF shall consider that the maximum data rate per UE for user-plane integrity protection supported by the UE for uplink and the maximum data rate per UE for user-plane integrity protection supported by the UE for downlink are valid for the lifetime of the PDU session.

For a PDN connection established when in S1 mode, upon the first inter-system change from S1 mode to N1 mode, if the network-requested PDU session modification procedure is triggered by a UE-requested PDU session modification procedure and the SMF determines, based on local policies or configurations in the SMF and the Always-on PDU session requested IE in the PDU SESSION MODIFICATION REQUEST message (if available), that either:

- a) the requested PDU session needs to be an always-on PDU session, the SMF shall include the Always-on PDU session indication IE in the PDU SESSION MODIFICATION COMMAND message and shall set the value to "Always-on PDU session required"; or
- b) the requested PDU session shall not be an always-on PDU session and:
 - i) if the UE included the Always-on PDU session requested IE, the SMF shall include the Always-on PDU session indication IE in the PDU SESSION MODIFICATION COMMAND message and shall set the value to "Always-on PDU session not allowed"; or
 - ii) if the UE did not include the Always-on PDU session requested IE, the SMF shall not include the Always-on PDU session indication IE in the PDU SESSION MODIFICATION COMMAND message.

If the value of the RQ timer is set to "deactivated" or has a value of zero, the UE considers that RQoS is not applied for this PDU session and remove the derived QoS rule(s) associated with the PDU session, if any.

If the network-requested PDU session modification procedure is triggered by a UE-requested PDU session modification procedure, the SMF shall set the PTI IE of the PDU SESSION MODIFICATION COMMAND message to the PTI of the PDU SESSION MODIFICATION REQUEST message received as part of the UE-requested PDU session modification procedure.

If the network-requested PDU session modification procedure is not triggered by a UE-requested PDU session modification procedure, the SMF shall set the PTI IE of the PDU SESSION MODIFICATION COMMAND message to "No procedure transaction identity assigned".

If the selected SSC mode of the PDU session is "SSC mode 3" and the SMF requests the relocation of SSC mode 3 PDU session anchor with multiple PDU sessions as specified in 3GPP TS 23.502 [9], the SMF shall include 5GSM cause #39 "reactivation requested" , in the PDU SESSION MODIFICATION COMMAND message, and may include the PDU session address lifetime in a PDU session address lifetime PCO parameter in the Extended protocol configuration options IE of the PDU SESSION MODIFICATION COMMAND message.

The SMF shall send the PDU SESSION MODIFICATION COMMAND message, and the SMF shall start timer T3591 (see example in figure 6.3.2.2.1).

- NOTE: If the SMF requests the relocation of SSC mode 3 PDU session anchor with multiple PDU sessions as specified in 3GPP TS 23.502 [9], the reallocation requested indication indicating whether the SMF is to be reallocated or the SMF is to be reused is provided to the AMF.

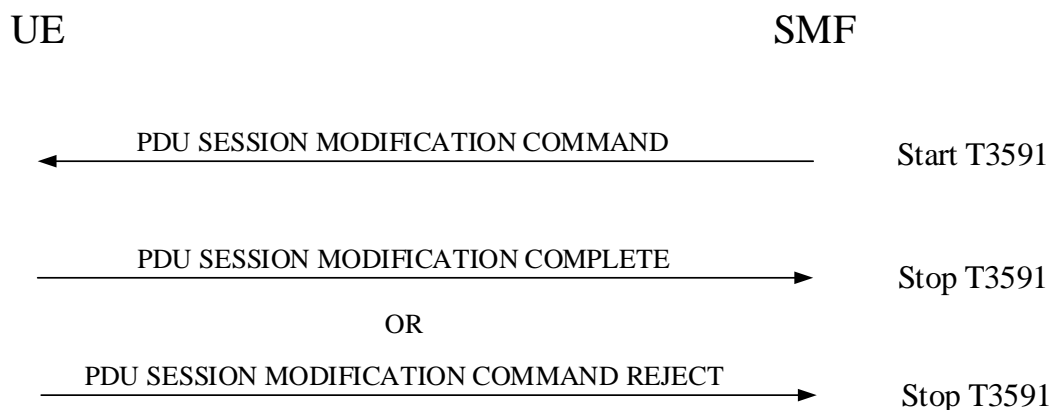

Figure 6.3.2.2.1: Network-requested PDU session modification procedure

[TS 24.501, clause 6.3.2.4]

Upon receipt of a PDU SESSION MODIFICATION COMMAND message and a PDU session ID, using the NAS transport procedure as specified in subclause 5.4.5, if the UE rejects the PDU SESSION MODIFICATION COMMAND message, the UE shall create a PDU SESSION MODIFICATION COMMAND REJECT message.

If the PDU SESSION MODIFICATION COMMAND message contains the PTI value allocated in the UE-requested PDU session modification procedure, the UE shall release the PTI indicated by the PTI IE and shall stop the timer T3581.

The UE shall set the 5GSM cause IE of the PDU SESSION MODIFICATION COMMAND REJECT message to indicate the reason for rejecting the PDU session modification.

The 5GSM cause IE typically indicates one of the following 5GSM cause values:

- #26 insufficient resources;
- #43 invalid PDU session identity;
- #44 semantic error in packet filter(s);
- #45 syntactical error in packet filter(s);
- #83 semantic error in the QoS operation; or
- #84 syntactical error in the QoS operation.

10.3.2.1.3 Test description

10.3.2.1.3.1 Pre-test conditions

System Simulator:

WLAN Cell 27

UE:

None.

Preamble:

The UE is in state 3W-A on WLAN Cell 27 with PDU session Active state according to TS 38.508-1 [4].

10.3.2.1.3.2 Test procedure sequence

Table 10.3.2.1.3.2-1: Main behaviour

St	Procedure	Message Sequence		TP	Verdict
		U - S	Message		
1	The SS transmits a PDU session modification command message with PDU session ID IE is set to a different value from the value set in PDU SESSION ESTABLISHMENT REQUEST message. This message is included in a DLInformationTransfer message.	<--	PDU SESSION MODIFICATION COMMAND	-	-
2	Check: Does the UE transmit a PDU session modification reject with the 5GSM cause IE indicating #43 "invalid PDU session identity"?	-->	PDU SESSION MODIFICATION REJECT	1	P
3	The SS transmits a PDU session modification command message with PDU session ID IE is the value set in PDU SESSION ESTABLISHMENT REQUEST message. This message is included in a DLInformationTransfer message.	<--	PDU SESSION MODIFICATION COMMAND	-	-
4	Check: Does the UE transmit a PDU session modification complete?	-->	PDU SESSION MODIFICATION COMPLETE	2	P

10.3.2.1.3.3 Specific message contents

Table 10.3.2.1.3.3-1: PDU SESSION MODIFICATION COMMAND (Step 1, Table 10.3.2.1.3.2-1)

Derivation path: TS 38.508-1 [4], table 4.7.2-9			
Information Element	Value/Remark	Comment	Condition
PDU session ID	The different value from the value set in PDU SESSION ESTABLISHMENT REQUEST message in preamble		

Table 10.3.2.1.3.3-2: PDU SESSION MODIFICATION REJECT (Step 2, Table 10.3.2.1.3.2-1)

Derivation path: TS 38.508-1 [4], table 4.7.2-8			
Information Element	Value/Remark	Comment	Condition
PDU session ID	The same value as the value set in PDU SESSION modification command message		
5GSM cause	'00101011'B	Invalid PDU session identity	

Table 10.3.2.1.3.3-1: PDU SESSION MODIFICATION COMMAND (Step 3, Table 10.3.2.1.3.2-1)

Derivation path: TS 38.508-1 [4], table 4.7.2-9			
Information Element	Value/Remark	Comment	Condition
PDU session ID	The value set in PDU SESSION ESTABLISHMENT REQUEST message in preamble		

Authorized QoS rules	Reference QoS rule #3 as defined in 38.508-1 [4]Table 4.8.2.1-1.		
----------------------	--	--	--

10.3.3 Network-requested PDU session Release

10.3.3.1 Network-requested PDU session release / accepted/ with and without reactivation

10.3.3.1.1 Test Purpose (TP)

(1)

```
with { the UE in PDU SESSION ACTIVE state }
ensure that {
  when { the UE receives a PDU SESSION RELEASE COMMAND message includes 5GSM cause #39 "reactivation requested" }
  then { the UE re-initiates a PDU SESSION establishment procedure for the same [S-NSSAI, DNN] combination provided in PDU session establishment procedure }
}
```

(2)

```
with { UE is in PDU SESSION ACTIVE state }
ensure that {
  when { UE receives a PDU SESSION RELEASE COMMAND message including 5GSM cause #26 "insufficient resources" and the Back-off timer value that indicates deactivated }
  then { UE does not send a PDU SESSION ESTABLISHMENT REQUEST message until the UE is switched off or the USIM is removed }
}
```

10.3.3.1.2 Conformance requirements

References: The conformance requirements covered in the present TC are specified in: TS 24.501, clauses 6.3.3.2, 6.3.3.3. Unless otherwise stated these are Rel-15 requirements.

[TS 24.501, clause 6.3.3.2]

In order to initiate the network-requested PDU session release procedure, the SMF shall create a PDU SESSION RELEASE COMMAND message.

The SMF shall set the SM cause IE of the PDU SESSION RELEASE COMMAND message to indicate the reason for releasing the PDU session.

The SM cause IE typically indicates one of the following SM cause values:

#26 insufficient resources;

...

The SMF may include a Back-off timer value IE in the PDU SESSION RELEASE COMMAND message when the 5GSM cause value #26 "insufficient resources" is included in the PDU SESSION RELEASE COMMAND message. If the 5GSM cause value is #26 "insufficient resources" and the PDU SESSION RELEASE COMMAND message is sent to a UE configured for high priority access in selected PLMN or the request type was set to "initial emergency request" or "existing emergency PDU session" for the establishment of the PDU session, the network shall not include a Back-off timer value IE.

The SMF may include a Back-off timer value IE in the PDU SESSION RELEASE COMMAND message when the 5GSM cause value #67 "insufficient resources for specific slice and DNN" is included in the PDU SESSION RELEASE COMMAND message. If the 5GSM cause value is #67 "insufficient resources for specific slice and DNN" and the PDU SESSION RELEASE COMMAND message is sent to a UE configured for high priority access in selected PLMN or the request type was set to "initial emergency request" or "existing emergency PDU session" for the establishment of the PDU session, the network shall not include a Back-off timer value IE.

[TS 24.501, clause 6.3.3.3]

Upon receipt of a PDU SESSION RELEASE COMMAND message and a PDU session ID, using the NAS transport procedure as specified in subclause 5.4.5, the UE considers the PDU session as released and the UE shall create a PDU SESSION RELEASE COMPLETE message.

If the PDU SESSION RELEASE COMMAND message contains the PTI value allocated in the UE-requested PDU session release procedure, the UE shall stop the timer T3582. The UE should ensure that the PTI value assigned to this procedure is not released immediately.

NOTE 1: The way to achieve this is implementation dependent. For example, the UE can ensure that the PTI value assigned to this procedure is not released during the time equal to or greater than the default value of timer T3592.

While the PTI value is not released, the UE regards any received PDU SESSION RELEASE COMMAND message with the same PTI value as a network retransmission (see subclause 7.3.1).

If the PDU SESSION RELEASE COMMAND message includes 5GSM cause #39 "reactivation requested", then after completion of the network-requested PDU session release procedure, the UE should re-initiate the UE-requested PDU session establishment procedure as specified in subclause 6.4.1 for:

- a) the PDU session type associated with the released PDU session;
- b) the SSC mode associated with the released PDU session;
- c) the DNN associated with the released PDU session; and
- d) the S-NSSAI associated with (if available in roaming scenarios) a mapped S-NSSAI if provided in the UE-requested PDU session establishment procedure of the released PDU session.

If the PDU SESSION RELEASE COMMAND message includes 5GSM cause #39 "reactivation requested" and the UE provided an S-NSSAI during the PDU session establishment, the UE shall stop timer T3585 if it is running for the S-NSSAI provided by the UE. The UE should then re-initiate the UE requested PDU session establishment procedure for the same S-NSSAI. If the UE did not provide an S-NSSAI during the PDU session establishment and the request type was different from "initial emergency request" and different from "existing emergency PDU session", the UE shall stop the timer T3585 associated with no S-NSSAI if it is running, and should re-initiate the UE requested PDU session establishment procedure without including an S-NSSAI. If the PDU SESSION RELEASE COMMAND message was received for an emergency PDU session, the UE shall not stop the timer T3585 associated with no S-NSSAI if it is running.

If the PDU SESSION RELEASE COMMAND message includes 5GSM cause #39 "reactivation requested" and the UE provided a DNN during the PDU session establishment, the UE shall stop timer T3396 if it is running for the DNN provided by the UE. The UE should then re-initiate the UE requested PDU session establishment procedure for the same DNN. If the UE did not provide a DNN during the PDU session establishment and the request type was different from "initial emergency request" and different from "existing emergency PDU session", the UE shall stop the timer T3396 associated with no DNN if it is running, and should re-initiate the UE requested PDU session establishment procedure without including a DNN. If the PDU SESSION RELEASE COMMAND message was received for an emergency PDU session, the UE shall not stop the timer T3396 associated with no DNN if it is running.

If the PDU SESSION RELEASE COMMAND message includes 5GSM cause #39 "reactivation requested" and the UE provided an S-NSSAI and a DNN during the PDU session establishment, the UE shall stop timer T3584 if it is running for the same [S-NSSAI, DNN] combination provided by the UE. The UE should then re-initiate the UE requested PDU session establishment procedure for the same [S-NSSAI, DNN] combination. If the UE did not provide an S-NSSAI during the PDU session establishment, the UE shall stop the timer T3584 associated with [no S-NSSAI, DNN] if it is running, and should re-initiate the UE requested PDU session establishment procedure with the same DNN but without an S-NSSAI. If the UE did not provide a DNN during the PDU session establishment and the request type was different from "initial emergency request" and different from "existing emergency PDU session", the UE shall stop the timer T3584 associated with [S-NSSAI, no DNN] if it is running, and should re-initiate the UE requested PDU session establishment procedure with the same S-NSSAI but without a DNN. If the PDU SESSION RELEASE COMMAND message was received for an emergency PDU session, the UE shall not stop the timer T3584 associated with [S-NSSAI, no DNN] if it is running. If the UE provided neither a DNN nor an S-NSSAI during the PDU session establishment and the request type was different from "initial emergency request" and different from "existing emergency PDU session", the UE shall stop the timer T3584 associated with [no S-NSSAI, no DNN] if it is running, and should re-initiate the UE requested PDU session establishment procedure without an S-NSSAI and a DNN. If the PDU SESSION RELEASE

COMMAND message was received for an emergency PDU session, the UE shall not stop the timer T3584 associated with [no S-NSSAI, no DNN] if it is running.

NOTE 2: User interaction is necessary in some cases when the UE cannot re-initiate the UE-requested PDU session establishment procedure automatically.

NOTE 3: If the PDU SESSION RELEASE COMMAND message includes 5GSM cause #39 "reactivation requested" for a PDU session, the UE provided a DNN (or no DNN) and an S-NSSAI (or no S-NSSAI) when the PDU session is established, timer T3396 associated with the DNN (or no DNN, if no DNN was provided by the UE) is running, and timer T3584 associated with the DNN (or no DNN, if no DNN was provided by the UE) and the S-NSSAI (or no S-NSSAI, if no S-NSSAI was provided by the UE) is running, then the UE stops both the timer T3396 and the timer T3584.

NOTE 4: If the PDU SESSION RELEASE COMMAND message includes 5GSM cause #39 "reactivation requested" for a PDU session, the UE provided a DNN (or no DNN) and an S-NSSAI (or no S-NSSAI) when the PDU session is established, timer T3585 associated with the S-NSSAI (or no S-NSSAI, if no S-NSSAI was provided by the UE) is running, and timer T3584 associated with the DNN (or no DNN, if no DNN was provided by the UE) and the S-NSSAI (or no S-NSSAI, if no S-NSSAI was provided by the UE) is running, then the UE stops both the timer T3585 and the timer T3584.

10.3.3.1.3 Test description

10.3.3.1.3.1 Pre-test conditions

System Simulator:

- WLAN Cell 27

UE:

- None.

Preamble:

- The UE is in state 3W-A on WLAN Cell 27 according to TS 38.508-1 [4].

10.3.3.1.3.2 Test procedure sequence

Table 10.3.3.1.3.2-1: Main behaviour

St	Procedure	Message Sequence		TP	Verdict
		U - S	Message		
1	The SS transmits a PDU SESSION RELEASE COMMAND including 5GSM cause #39 "reactivation requested" with PDU session ID IE is set to the same value in PDU SESSION ESTABLISHMENT REQUEST message in preamble.	<--	5GMM: DL NAS TRANSPORT 5GSM: PDU SESSION RELEASE COMMAND	-	-
2	Check: Does the UE transmit a PDU SESSION ESTABLISHMENT REQUEST and the S-NSSAI and DNN in UL NAS TRANSPORT message are the same values in UL NAS TRANSPORT message in preamble?	-->	5GMM: UL NAS TRANSPORT 5GSM: PDU SESSION ESTABLISHMENT REQUEST	1	P
3	The SS transmits an PDU SESSION ESTABLISHMENT ACCEPT	<--	5GMM: DL NAS TRANSPORT 5GSM: PDU SESSION ESTABLISHMENT ACCEPT		
4	The SS transmits a PDU SESSION RELEASE COMMAND including 5GSM cause #26 "insufficient resources" and T3396 value (deactivated).	<--	5GMM: DL NAS TRANSPORT 5GSM: PDU SESSION RELEASE COMMAND	-	-
5	The UE transmits a PDU SESSION RELEASE	-->	5GMM: UL NAS TRANSPORT	-	-

	COMPLETE message.		5GSM: PDU SESSION RELEASE COMPLETE		
6	Cause the UE to request establishment of PDU session without DNN.(Note 1)	-		-	-
7	Check: Does the UE transmit a PDU SESSION ESTABLISHMENT REQUEST message?	-->	5GMM: UL NAS TRANSPORT 5GSM: PDU SESSION ESTABLISHMENT REQUEST	2	F
8	Switch off procedure in Ipsec_SA_Established specified in TS 38.508-1 [4] subclause 4.9.6.5 is performed.	-			
9	Switch on UE.	-			
10	The general procedure is completed by executing of the UE registration procedure in TS 38.508-1 [4] table 4.5.2.2-3 , 'connected without release'.	-			
11	Cause the UE to request establishment of PDU session without DNN.(Note 1)	-		-	-
12	Check: Does the UE transmit a PDU SESSION ESTABLISHMENT REQUEST message?	-->	5GMM: UL NAS TRANSPORT 5GSM: PDU SESSION ESTABLISHMENT REQUEST	3	P
13	The SS transmits a PDU SESSION ESTABLISHMENT ACCEPT message.	<--	5GMM: DL NAS TRANSPORT 5GSM: PDU SESSION ESTABLISHMENT ACCEPT	-	-
Note 1: The request to establish a PDU session may be performed by MMI or AT command.					

10.3.3.1.3.3 Specific message contents

Table 10.3.3.1.3.3-1: PDU SESSION RELEASE COMMAND (Step 1, Table 10.3.3.1.3.2-1)

Derivation path: TS 38.508-1 [4], table 4.7.2-14			
Information Element	Value/Remark	Comment	Condition
PDU session ID	The same value indicated in PDU SESSION ESTABLISHMENT REQUEST message in preamble		
5GSM cause	'00100111'B	Reactivation requested	

Table 10.3.3.1.3.3-2: UL NAS TRANSPORT (Step 2, Table 10.3.3.1.3.2-1)

Derivation path: TS 38.508-1 [4], table 4.7.1-10			
Information Element	Value/Remark	Comment	Condition
S-NSSAI	The same value indicated in UL NAS TRANSPORT message in preamble		If present in UL NAS TRANSPORT message in preamble
	Not present		If not present in UL NAS TRANSPORT message in preamble
DNN	The same value indicated in UL NAS TRANSPORT message in preamble		If present in UL NAS TRANSPORT message

			in preamble
	Not present		If not present in UL NAS TRANSPORT message in preamble

Table 10.3.3.1.3.3-3: PDU SESSION RELEASE COMMAND (step 4, Table 10.3.3.1.3.2-1)

Derivation Path: TS 38.508-1 [4] Table 4.7.2-14			
Information Element	Value/remark	Comment	Condition
PDU session ID	The same ID as the ID of PDU session which UE request in step 13 in Table 10.1.3.2.3.2-1		
5GSM cause	'0001 1010'B	insufficient resources	
Back-off timer value	'1110 0000'B	deactivated	

10.3.4 UE-requested PDU session establishment

10.3.4.1 UE-requested PDU session establishment / Abnormal / T3580

10.3.4.1.1 Test Purpose (TP)

Same test purpose as in clause 10.1.4.2.1

10.3.4.1.2 Conformance requirements

Same conformance requirements as in clause 10.1.4.2.2

10.3.4.1.3 Test description

10.3.4.1.3.1 Pre-test conditions

System Simulator:

- WLAN Cell 27

UE:

- None.

Preamble:

- The UE is in state Switched OFF [State 0-A as per TS 38.508-1 [4] Table 4.4A.2-0].

10.3.4.1.3.2 Test procedure sequence

Table 10.3.4.1.3.2-1: Main behaviour

St	Procedure	Message Sequence		TP	Verdict
		U - S	Message		
1	UE is switched on	-	-	-	-

2-10	Steps 1-9 of Table 4.5.2.2-3 of the generic procedure in TS 38.508-1 [4] are performed.	-	-	-	-
11	The UE transmits a PDU SESSION ESTABLISHMENT REQUEST message to request an additional PDU session.	-->	PDU SESSION ESTABLISHMENT REQUEST	-	-
-	EXCEPTION: Steps 12-13 shall be repeated for 4 times	-	-	-	-
12	The SS waits 16 seconds (T3580).	-	-	-	-
13	The UE transmits a PDU SESSION ESTABLISHMENT REQUEST message to request an additional PDU session. (Attempt counter = 5)	-->	PDU SESSION ESTABLISHMENT REQUEST	1	P
15	The UE transmits a PDU SESSION ESTABLISHMENT REQUEST message to request an additional PDU session.	-->	PDU SESSION ESTABLISHMENT REQUEST	2	F

10.3.4.1.3.3 Specific message contents

None.

10.3.5 UE-requested PDU session modification

10.3.5.1 UE-requested PDU session modification/Success

10.3.5.1.1 Test Purpose (TP)

(1)

```
with { UE in PDU SESSION ACTIVE state and in 5GMM-CONNECTED mode }
ensure that {
  when { UE is requested to modify of PDU session }
  then { UE sends a PDU SESSION MODIFICATION REQUEST message }
}
```

10.3.5.1.2 Conformance requirements

Same conformance requirements as in clause 10.1.5.1.2

10.3.5.1.3 Test description

10.3.5.1.3.1 Pre-test conditions

System Simulator:

- WLAN Cell 27.

UE:

- None.

Preamble:

- The UE is in state 3W-A on WLAN Cell 27 with PDU SESSION ACTIVE according to TS 38.508-1 [4].

10.3.5.1.3.2 Test procedure sequence

Same test procedure sequence as in clause 10.1.5.1.3.2

10.3.5.1.3.3 Specific message contents

Same specific message contents as in clause 10.1.5.1.3.3

10.3.6 UE-requested PDU session release

10.3.6.1 UE-requested PDU session release / Abnormal / Collision with network-requested PDU session modification procedure

10.3.6.1.1 Test Purpose (TP)

(1)

```

with { the UE is in PDU SESSION ACTIVE state and has sent a PDU SESSION RELEASE REQUEST message }
ensure that {
  when { UE receives a PDU SESSION MODIFICATION COMMAND message indicating a PDU session that UE
wants to release }
  then { the UE ignores the PDU SESSION MODIFICATION COMMAND message and proceed with the PDU
session release procedure }
}

```

10.3.6.1.2 Conformance requirements

Same conformance requirements as in clause 10.1.6.1.2

10.3.6.1.3 Test description

10.3.6.1.3.1 Pre-test conditions

System Simulator:

- WLAN Cell 27.

UE:

None.

Preamble:

- The UE is in state 3W-A on WLAN Cell 27 according to TS 38.508-1 [4].

10.3.6.1.3.2 Test procedure sequence

Table 10.3.6.1.3.2-1: Main behaviour

St	Procedure	Message Sequence		TP	Verdict
		U - S	Message		
1	Cause the UE to request establishment of PDU session to the DN.(Note 1)	-	-	-	-
2	New PDU session establishment procedure is performed as per generic procedure in clause 4.5A.2A of TS 38.508-1 [4]	-	-	-	-
3	Cause the UE to request release of PDU session established during preamble.(Note 2)	-	-	-	-
4	The UE transmits a PDU SESSION RELEASE REQUEST message.	-->	5GMM: UL NAS TRANSPORT 5GSM: PDU SESSION	-	-

			RELEASE REQUEST		
5	The SS transmits a PDU SESSION MODIFICATION COMMAND message.	<--	5GMM: DL NAS TRANSPORT 5GSM: PDU SESSION MODIFICATION COMMAND	-	-
6	The SS transmits a PDU SESSION RELEASE COMMAND message.	<--	5GMM: DL NAS TRANSPORT 5GSM: PDU SESSION RELEASE COMMAND	-	-
7	Check: Does the UE transmit PDU SESSION RELEASE COMPLETE message?	-->	5GMM: UL NAS TRANSPORT 5GSM: PDU SESSION RELEASE COMPLETE	1	P
8	The SS deletes the payload associated with IPSec child security association according to the IKEv2 specification in RFC 7296 [32]	-	-	-	-
Note 1: The request to establish a PDU session may be performed by MMI or AT command.					
Note 2: The request to release a PDU session may be performed by MMI or AT command.					

10.3.6.1.3.3 Specific message contents

Table 10.3.6.1.3.3-1: PDU SESSION RELEASE REQUEST (step 4, Table 10.3.6.1.3.2-1)

Derivation Path: TS 38.508-1 [4] Table 4.7.2-12			
Information Element	Value/remark	Comment	Condition
PDU session ID	Set to the ID UE requested in step 2 in Table 10.3.6.1.3.2-1		
PTI	Any value from 1 to 254		

Table 10.3.6.1.3.3-2: PDU SESSION MODIFICATION COMMAND (step 5, Table 10.3.6.1.3.2-1)

Derivation Path: TS 38.508-1 [4] Table 4.7.2-9			
Information Element	Value/remark	Comment	Condition
PDU session ID	Set to the ID UE requested in step 2 in Table 10.3.6.1.3.2-1		
PTI	'0000 0000'B	No procedure transaction identity assigned	

Table 10.3.6.1.3.3-3: PDU SESSION RELEASE COMMAND (step 6, Table 10.3.6.1.3.2-1)

Derivation Path: TS 38.508-1 [4] Table 4.7.2-14			
Information Element	Value/remark	Comment	Condition
PDU session ID	Set to the ID UE requested in step 2 in Table 10.3.6.1.3.2-1		

PTI	The value indicated in PDU SESSION RELEASE REQUEST		
5GSM cause	'0010 0100'B	#36 regular deactivation	

Table 10.3.6.1.3.3-4: PDU SESSION RELEASE COMPLETE (step 7, Table 10.3.6.1.3.2-1)

Derivation Path: TS 38.508-1 [4] Table 4.7.2-15			
Information Element	Value/remark	Comment	Condition
PDU session ID	Set to the ID UE requested in step 2 in Table 10.3.6.1.3.2-1		
PTI	The value indicated in PDU SESSION RELEASE REQUEST		

11 Multi-layer and Services

11.1 5GS / EPS Fallback

11.1.1 MO MMTEL voice call setup from NR RRC_IDLE / EPS Fallback with redirection / Single registration mode with N26 interface / Success

11.1.1.1 Test Purpose (TP)

(1)

```

with { UE supporting both S1 mode and N1 mode and operating in single-registration mode and the
Network having indicated "interworking without N26 interface not supported" and the UE in NR
RRC_IDLE state }
ensure that {
  when { User initiates an MMTEL call and the UE completes Access control and checking in 5GMM-IDLE
mode }
  then { UE requests the establishment of an MMTEL call by transmitting an RRCSetupRequest message
with establishmentCause set to 'mo-VoiceCall' and a SERVICE REQUEST message with Service type set to
'data' }
}

```

(2)

```

with { UE being in NR RRC_CONNECTED state after having requested an MMTEL call establishment and the
MO IMS voice session establishment has been initiated }
ensure that {
  when { UE receives an RRCRelease message which includes redirectedCarrierInfo indicating
redirection to E-UTRA }
  then {UE selects the E-UTRA cell, performs a TAU procedure, and, successfully completes the
MMTEL call setup in EPS }
}

```

11.1.1.2 Conformance requirements

References: The conformance requirements covered in the present TC are specified in: TS 24.501, clauses 4.5.4.1, 5.6.1.2 and TS 38.331: clauses 5.3.3.2, 5.3.3.3. Unless otherwise stated these are Rel-15 requirements.

[TS 24.501, clause 4.5.4.1]

When the UE is in 5GMM-IDLE mode, upon receiving a request from the upper layers for an access attempt, the NAS shall categorize the access attempt into access identities and an access category following subclause 4.5.2, table 4.5.2.1 and table 4.5.2.2, and subclause 4.5.3, and provide the applicable access identities and the access category to the lower layers for the purpose of access control checking. In this request to the lower layer the NAS can also provide to the lower layer the RRC establishment cause determined as specified in subclause 4.5.6 of this specification.

NOTE 1: The access barring check is performed by the lower layers.

NOTE 2: As an implementation option, the NAS can provide the RRC establishment cause to the lower layers after being informed by the lower layers that the access attempt is allowed.

If the UE has uplink user data pending for one or more PDU sessions when it builds a REGISTRATION REQUEST or SERVICE REQUEST message as initial NAS message, the UE shall indicate the respective PDU sessions in the Uplink data status IE as specified in subclause 5.5.1.3.2 and 5.6.1.2, regardless of the access category for which the access barring check is performed.

NOTE 3: The UE indicates pending user data for all the respective PDU sessions, even if barring timers are running for some of the corresponding access categories.

If the lower layers indicate that the access attempt is allowed, the NAS shall initiate the procedure to send the initial NAS message for the access attempt.

[TS 24.501, clause 5.6.1.2]

For cases d) and e) in subclause 5.6.1.1, the Uplink data status IE shall be included in the SERVICE REQUEST message to indicate the PDU session(s) the UE has pending user data to be sent. If the UE is not a UE configured for high priority access in selected PLMN:

- a) if there exists an emergency PDU session which is indicated in the Uplink data status IE the service type IE in the SERVICE REQUEST message shall be set to "emergency services"; or
- b) otherwise, the service type IE in the SERVICE REQUEST message shall be set to "data".

[TS 38.331, clause 5.3.3.2]

The UE initiates the procedure when upper layers request establishment of an RRC connection while the UE is in RRC_IDLE and it has acquired essential system information as described in 5.2.2.1.

The UE shall ensure having valid and up to date essential system information as specified in clause 5.2.2.2 before initiating this procedure.

Upon initiation of the procedure, the UE shall:

- 1> if the upper layers provide an Access Category and one or more Access Identities upon requesting establishment of an RRC connection:
 - 2> perform the unified access control procedure as specified in 5.3.14 using the Access Category and Access Identities provided by upper layers;

[TS 38.331, clause 5.3.3.3]

The UE shall set the contents of *RRCSetupRequest* message as follows:

- 1> set the *ue-Identity* as follows:
 - 2> if upper layers provide a 5G-S-TMSI:
 - 3> set the *ue-Identity* to *ng-5G-S-TMSI-Part1*;
 - 2> else:
 - 3> draw a 39-bit random value in the range $0..2^{39}-1$ and set the *ue-Identity* to this value;

NOTE 1: Upper layers provide the *5G-S-TMSI* if the UE is registered in the TA of the current cell.

1> set the *establishmentCause* in accordance with the information received from upper layers;

The UE shall submit the *RRCSetupRequest* message to lower layers for transmission.

11.1.1.3 Test Description

11.1.1.3.1 Pre-test conditions

System Simulator:

- NR Cell 1 is configured according to TS 38.508-1 [4] Table 4.4.2-3 and is connected to 5GC.
- E-UTRA Cell 1 is configured to TS 36.508 [7] Table 4.4.2-2 and is connected to EPC.
- System information for the NR Cell 1 in accordance with combination NR-6 in TS 38.508-1 [4] sub-clause 4.4.3.1.2, and, for the E-UTRA Cell 1 in accordance with system information combination 31 as defined in TS 36.508 [7], subclause 4.4.3.1.1.
- N26 interface is configured.
- Power levels are constant and as defined in Tables 11.1.1.3.1-1/2.

Table 11.1.1.3.1-1: Time instances of cell power level and parameter changes for conducted test environment

	Parameter name	Unit	NR Cell 1	E-UTRA Cell 1	Remark
T0	SS/PBCH SSS EPRE	dBm/SCS	-88		
	RS EPRE	dBm/15kHz		-85	

Table 11.1.1.3.1-2: Time instances of cell power level and parameter changes for OTA test environment

	Parameter name	Unit	NR Cell 1	E-UTRA Cell 1	Remark
T0	SS/PBCH SSS EPRE	dBm/SCS	-82	-	
	RS EPRE	dBm/15kHz	-	-96	

UE:

The UE is configured to use IMS preconditions

Preamble:

- With E-UTRA Cell 1 "Serving cell" and NR Cell 1 "Non-suitable "Off" cell" in accordance with TS 38.508-1 [4], Table 6.2.2.1-3, the UE is brought to state RRC_IDLE using generic procedure parameters Connectivity (*E-UTRA/EPC*) and Unrestricted nr PDN (*On*) in accordance with the procedure described in TS 38.508-1 [4], clause 4.5.2. 4G GUTI and eKSI are assigned and security context established
- The UE is switched-off
- With E-UTRA Cell 1 "Non-suitable "Off" cell" and NR Cell 1 "Serving cell" in accordance with TS 38.508-1 [4], Table 6.2.2.1-3, the UE is brought to state 1N-A, RRC_IDLE Connectivity (NR), in accordance with the procedure described in TS 38.508-1 [4], Table 4.5.2.2-2. 5G-GUTI and ngKSI are assigned and security context established.

11.1.1.3.2 Test procedure sequence

Table 11.1.1.3.2-1: Main behaviour

St	Procedure	Message Sequence		TP	Verdict
		U - S	Message		
0	Void	-	-	-	-
1	Make the UE attempt an MTSI MO Speech Call (Note 1).	-	-	-	-
2	Check: Does the UE send NR RRCSetupRequest with EstablishmentCause set to 'mo-VoiceCall'?	-->	NR RRC: RRCSetupRequest	1	P
3	SS transmits an NR RRCSetup message	<--	NR RRC: RRCSetup	-	-
4	Check: Does the UE transmit an NR RRCSetupComplete message to confirm the successful completion of the connection establishment including initiation of 5GSM procedure by including the SERVICE REQUEST message with Service Type set to 'data'?	-->	NR RRC: RRCSetupComplete 5GSM: SERVICE REQUEST	1	P
4A	Set the power levels according to "T0" as per Table 11.1.1.3.1-1/2.	-	-	-	-
5-8	Steps 5-8 of expected sequence from Table 4.5.4.2-3 as defined in TS 38.508-1 [4] are performed.	-	-	-	-
9-13	Steps 1-5 of expected sequence from A.9.1 as defined in TS 34.229-5 [41] are performed for initiating an MTSI MO speech call.	-	-	-	-
14	SS transmits RRCRelease message indicating redirection to E-UTRA Cell 1.	<--	NR RRC: RRCRelease	-	-
15-20	UE performs generic procedure as defined in TS 38.508-1 [4], Table 4.9.7.2.2-1 Steps 1-6 for N1 to S1 Inter mode change with condition 'connected without release' & 'mapped 5G security context'.	-	-	-	-
21-24	Generic Test Procedure as defined in Steps 5-8 of TS 36.508-1 [4] Table 4.5A.6.3-1 is performed to establish radio bearer corresponding to IMS PDN.	-	-	-	-
-	EXCEPTION: Steps 25a1-25a2 describe a step sequence depending on UE implementation.	-	-	-	-
25a1-25a2	The UE may perform steps 1-2 according to TS 34.229-1 subclause C.46 to perform IMS re-registration on EUTRAN.	-	-	-	-
26	The SS configures a new RLC-UM data radio bearer with condition DRB (0,1), associated with the dedicated EPS bearer context. RRCConnectionReconfiguration message contains the ACTIVATE DEDICATED EPS BEARER CONTEXT REQUEST message. EPS bearer context #4 (QCI 1) according to table 6.6.2-1: Reference dedicated EPS bearer contexts.	<--	RRC: RRCConnectionReconfiguration NAS: ACTIVATE DEDICATED EPS BEARER CONTEXT REQUEST	-	-
-	EXCEPTION: In parallel to the events described in steps 27-28 the steps specified in table 11.1.1.3.2-2 will take place.	-	-	-	-
27	The UE transmits an RRCConnectionReconfigurationComplete message to confirm the establishment of the new data radio bearer, associated with the dedicated EPS bearer.	-->	RRC: RRCConnectionReconfigurationComplete	-	-
28	The UE transmits an ACTIVATE DEDICATED EPS BEARER CONTEXT ACCEPT message.	-->	RRC: ULInformationTransfer NAS:ACTIVATE DEDICATED EPS BEARER CONTEXT ACCEPT	-	-

29	UE is triggered by MMI to release the call.	-	-	-	-
30-33	Follow the Test Steps 2-5 as defined in TS 34.229-1 [35] subclause C.32 for Generic test procedure for MO release of IMS call followed by EPS Bearer Deactivation.	-	-	-	-
34	SS transmits <i>RRCConnectionRelease</i> message indicating redirection to NR Cell 1.	<--	RRC: RRCConnectionRelease	-	-
35	Generic Test procedure for Tracking area updating / Inter-system change from S1 mode to N1 mode in 5GMM/EMM-IDLE mode with <i>connected without release</i> is present as mentioned in TS 38.508-1 [4] Table 4.9.9.2.2-1 is performed with condition "Mapped EPS security context.	-	-	-	-
36-37	IF UE performed IMS re-registration over E-UTRAN in Steps 25a1-25a2, THEN the UE may perform IMS re-registration on NR Cell1 as per Annex A.12 of TS 34.229-5 [41]	-	-	-	-
38	Generic Procedure as defined in TS 38.508-1 [4] Table 4.9.6.3-1A to switch off the UE in NR RRC_CONNECTED mode with T3540 started is performed.	-	-	-	-
Note 1: UE is configured such that Access Control check passes for MO MMTEL Voice call.					

Table 11.1.1.3.2-2: Parallel behaviour

St	Procedure	Message Sequence		TP	Verdict
		U - S	Message		
1-5	Steps 1 to 5 of the Generic test procedure for setting up MTSI MO speech call - EPS fallback according TS 34.229-5 [41] subclause A.9.2 take place.	-	-	-	-
6	Step 6 of the Generic test procedure for setting up MTSI MO speech call - EPS fallback according TS 34.229-5 [41] subclause A.9.2 takes place.	-	-	2	P

11.1.1.3.3 Specific message contents

Table 11.1.1.3.3-1: RRCSetupRequest (step 2, table 11.1.1.3.2-1)

Derivation Path: TS 38.508-1 [4] Table 4.6.1-23			
Information Element	Value/remark	Comment	Condition
RRCSetupRequest ::= SEQUENCE {			
rrcSetupRequest SEQUENCE {			
establishmentCause	mo-VoiceCall		
}			
}			

Table 11.1.1.3.3-2: SERVICE REQUEST (step 4, table 11.1.1.3.2-1)

Derivation path: TS 38.508-1 [4] Table 4.7.1-16			
Information Element	Value/Remark	Comment	Condition
Service type	'0001'B	data	
Uplink data status	Present	PSI bit corresponding to IMS PDN needs to be set	

Table 11.1.1.3.3-3: RRCRelease (step 14, table 11.1.1.3.2-1)

Derivation path: TS 38.508-1 [4] Table 4.6.1-16			
Information Element	Value/Remark	Comment	Condition
RRCRelease ::= SEQUENCE {			
criticalExtensions CHOICE {			
rrcRelease SEQUENCE {			
redirectedCarrierInfo CHOICE {			
eutra SEQUENCE {			
eutraFrequency	Downlink EARFCN of EUTRA cell 1		
cnType	epc		
}			
}			
}			
}			
}			

Table 11.1.1.3.3-4: RRCConnectionRelease (step 34, table 11.1.1.3.2-1)

Derivation path: TS 36.508 [4] Table 4.6.1-15			
Information Element	Value/Remark	Comment	Condition
RRCConnectionRelease ::= SEQUENCE {			
criticalExtensions CHOICE {			
c1 CHOICE {			
rrcConnectionRelease-r8 SEQUENCE {			
redirectedCarrierInfo SEQUENCE {			
nr-r15 ::= SEQUENCE {			
carrierFreq-r15	Downlink NR SSB ARFCN of cell NR Cell 1		TS 38.508-1 [4] cl.6.2.3.1
subcarrierSpacingSSB-r15			
}			
}			
}			
}			
}			
}			

11.1.1a MO MMTEL enhanced voice service call setup from NR RRC_IDLE / EPS Fallback with redirection / Single registration mode with N26 interface / Success

11.1.1a.1 Test Purpose (TP)

(1)

```

with { UE supporting both S1 mode and N1 mode and configured to use preconditions and configured to use the EVS default configuration and the UE is in NR RRC_IDLE state }
ensure that {
  when { UE is being made to initiate a voice call }
    then { UE requests the establishment of a voice call by transmitting an RRCSetupRequest message with establishmentCause set to 'mo-VoiceCall' and a SERVICE REQUEST message with Service type set to 'data' }
}

```

(2)

```

with { UE being in NR RRC_CONNECTED state after having requested a voice call establishment and the MO IMS voice session establishment has been initiated }
ensure that {
  when { UE receives an RRCRelease message which includes redirectedCarrierInfo indicating redirection to E-UTRA }
}

```

```

    then {UE selects the E-UTRA cell, performs a TAU procedure, and, successfully completes the
    voice call setup in EPS using EVS}
    }

```

11.1.1a.2 Conformance requirements

References: The conformance requirements covered in the present TC are specified in: TS 38.331 clause 5.3.3.3, TS 24.501 clause 5.6.1.2 and TS 26.114 clause 5.2.1.1.

[TS 38.331, clause 5.3.3.3]

The UE shall set the contents of *RRCSetupRequest* message as follows:

...

- 1> set the *establishmentCause* in accordance with the information received from upper layers;

The UE shall submit the *RRCSetupRequest* message to lower layers for transmission.

[TS 24.501, clause 5.6.1.2]

For cases d) and e) in subclause 5.6.1.1, the Uplink data status IE shall be included in the SERVICE REQUEST message to indicate the PDU session(s) the UE has pending user data to be sent. If the UE is not a UE configured for high priority access in selected PLMN:

...

- b) otherwise, the service type IE in the SERVICE REQUEST message shall be set to "data".

[TS 26.114, clause 5.2.1.1]

MTSI clients in terminals offering speech communication shall support narrowband, wideband and super-wideband communication.

...

MTSI clients in terminals offering super-wideband or fullband speech communication shall support:

- EVS codec ...

11.1.1a.3 Test Description

11.1.1a.3.1 Pre-test conditions

System Simulator:

- NR Cell 1, E-UTRA Cell 1.
- System information for the NR Cell 1 in accordance with combination NR-6 in TS 38.508-1 [4] sub-clause 4.4.3.1.2, and, for the E-UTRA Cell 1 in accordance with system information combination 31 as defined in TS 36.508 [7], subclause 4.4.3.1.1.
- Power levels are constant and as defined in Tables 11.1.1a.3.1-1/2.

Table 11.1.1a.3.1-1: Time instances of cell power level and parameter changes for FR1

	Parameter name	Unit	NR Cell 1	E-UTRA Cell 1	Remark
T0	SS/PBCH SSS EPRE	dBm/SCS	-88		
	RS EPRE	dBm/15kHz		-85	

Table 11.1.1a.3.1-2: Time instances of cell power level and parameter changes for FR2

	Parameter name	Unit	NR Cell 1	E-UTRA Cell 1	Remark
T0	SS/PBCH SSS EPRE	dBm/SCS	-82	-	
	RS EPRE	dBm/15kHz	-	-85	

UE:

- The UE contains either ISIM and USIM applications or only USIM application on UICC.
- The UE is configured to register for IMS after switch on.
- The UE is configured to use preconditions.

Preamble:

- With E-UTRA Cell 1 "Serving cell" and NR Cell 1 "Non-suitable "Off" cell" in accordance with TS 38.508-1 [4], Table 6.2.2.1-3, the UE is brought to state RRC_IDLE using generic procedure parameters Connectivity (*E-UTRA/EPC*) and Unrestricted nr PDN (*On*) in accordance with the procedure described in TS 38.508-1 [4], clause 4.5.2. 4G GUTI and eKSI are assigned and security context established.
- the UE is switched-off.
- With E-UTRA Cell 1 "Non-suitable "Off" cell" and NR Cell 1 "Serving cell" in accordance with TS 38.508-1 [4], Table 6.2.2.1-3, the UE is brought to state 1N-A, RRC_IDLE Connectivity (*NR/5GC*), in accordance with the procedure described in TS 38.508-1 [4], Table 4.5.2.2-2. 5G-GUTI and ngKSI are assigned and security context established.

11.1.1a.3.2 Test procedure sequence

Table 11.1.1a.3.2-1: Main behaviour

St	Procedure	Message Sequence		TP	Verdict
		U - S	Message		
1	Make the UE attempt an IMS voice call.	-	-	-	-
2	Check: Does the UE send NR RRCSetupRequest with EstablishmentCause set to 'mo-VoiceCall'?	-->	NR RRC: RRCSetupRequest	1	P
3	SS transmits an NR <i>RRCSetup</i> message	<--	NR RRC: RRCSetup	-	-
4	Check: Does the UE transmit an NR <i>RRCSetupComplete</i> message to confirm the successful completion of the connection establishment including initiation of 5GSM procedure by including the SERVICE REQUEST message with <i>Service Type</i> set to 'data'?	-->	NR RRC: <i>RRCSetupComplete</i> 5GSM: SERVICE REQUEST	1	P
5	Set the power levels according to "T0" as per Table 11.1.1a.3.1-1/2.	-	-	-	-
6-9	Steps 5-8 of expected sequence from Table 4.5.4.2-3 as defined in TS 38.508-1 [4] are performed.	-	-	-	-
10-14	Steps 1-5 of expected sequence from A.4.1a as defined in TS 34.229-5 [41] are performed for initiating an MTSI MO speech call.	-	-	-	-
15	SS transmits <i>RRCRelease</i> message indicating	<--	NR RRC: RRCRelease	-	-

	redirection to E-UTRA Cell 1.				
16-21	UE performs generic procedure as defined in TS 38.508-1 [4], Table 4.9.7.2.2-1 Steps 1-6 for N1 to S1 Inter mode change with condition 'connected without release' & 'mapped 5G security context'.	-	-	-	-
22-25	Generic Test Procedure as defined in Steps 5-8 of TS 36.508-1 [4] Table 4.5A.6.3-1 is performed to establish radio bearer corresponding to IMS PDN.	-	-	-	-
26	The SS configures a new RLC-UM data radio bearer with condition DRB (0,1), associated with the dedicated EPS bearer context. <i>RRCConnectionReconfiguration</i> message contains the ACTIVATE DEDICATED EPS BEARER CONTEXT REQUEST message. EPS bearer context #4 (QCI 1) according to table 6.6.2-1: Reference dedicated EPS bearer contexts.	<--	RRC: RRCConnectionReconfiguration NAS: ACTIVATE DEDICATED EPS BEARER CONTEXT REQUEST	-	-
-	EXCEPTION: In parallel to the events described in steps 27-28 the steps specified in table 11.1.1.3.2-2 will take place.	-	-	-	-
27	The UE transmits an <i>RRCConnectionReconfigurationComplete</i> message to confirm the establishment of the new data radio bearer, associated with the dedicated EPS bearer.	-->	RRC: RRCConnectionReconfigurationC omplete	-	-
28	The UE transmits an ACTIVATE DEDICATED EPS BEARER CONTEXT ACCEPT message.	-->	RRC: ULInformationTransfer NAS:ACTIVATE DEDICATED EPS BEARER CONTEXT ACCEPT	-	-
29	UE is triggered by MMI to release the call.	-	-	-	-
30-33	Follow the Test Steps 2-5 as defined in TS 34.229-1 [35] subclause C.32 for Generic test procedure for MO release of IMS call followed by EPS Bearer Deactivation.	-	-	-	-
34	SS transmits <i>RRCConnectionRelease</i> message indicating redirection to NR Cell 1.	<--	RRC: RRCConnectionRelease	-	-
35	Generic Test procedure for Tracking area updating / Inter-system change from S1 mode to N1 mode in 5GMM/EMM-IDLE mode with <i>connected without release</i> is present as mentioned in TS 38.508-1 [4] Table 4.9.9.2.2-1 is performed with condition "Mapped EPS security context.	-	-	-	-
38	Generic Procedure as defined in TS 38.508-1 [4] Table 4.9.6.3-1A to switch off the UE in NR RRC_CONNECTED mode with T3540 started is performed.	-	-	-	-

Table 11.1.1a.3.2-2: Parallel behaviour

St	Procedure	Message Sequence		TP	Verdict
		U - S	Message		
1-6	Steps 6-11 of expected sequence from A.4.1a as defined in TS 34.229-5 [41] are performed for initiating an MTSI MO speech call.	-	-	-	-
7	Step 12 of expected sequence from A.4.1a as defined in TS 34.229-5 [41] is performed for initiating an MTSI MO speech call.	-	-	2	P

11.1.1a.3.3 Specific message contents

Table 11.1.1a.3.3-1: RRCSetupRequest (step 2, table 11.1.1a.3.2-1)

Derivation Path: TS 38.508-1 [4] Table 4.6.1-23			
Information Element	Value/remark	Comment	Condition
RRCSetupRequest ::= SEQUENCE {			
rrcSetupRequest SEQUENCE {			
establishmentCause	mo-VoiceCall		
}			
}			

Table 11.1.1a.3.3-2: SERVICE REQUEST (step 4, table 11.1.1a.3.2-1)

Derivation path: TS 38.508-1 [4] Table 4.7.1-16			
Information Element	Value/Remark	Comment	Condition
Service type	'0001'B	data	
Uplink data status	Present	PSI bit corresponding to IMS PDN needs to be set	

Table 11.1.1a.3.3-3: RRCRelease (step 15, table 11.1.1a.3.2-1)

Derivation path: TS 38.508-1 [4] Table 4.6.1-16			
Information Element	Value/Remark	Comment	Condition
RRCRelease ::= SEQUENCE {			
criticalExtensions CHOICE {			
rrcRelease SEQUENCE {			
redirectedCarrierInfo CHOICE {			
eutra SEQUENCE {			
eutraFrequency	Downlink EARFCN of EUTRA cell 1		
cnType	epc		
}			
}			
}			
}			
}			

Table 11.1.1a.3.3-4: RRCConnectionRelease (step 34, table 11.1.1a.3.2-1)

Derivation path: TS 36.508 [4] Table 4.6.1-15			
Information Element	Value/Remark	Comment	Condition
RRCConnectionRelease ::= SEQUENCE {			
criticalExtensions CHOICE {			
c1 CHOICE {			
rrcConnectionRelease-r8 SEQUENCE {			
redirectedCarrierInfo SEQUENCE {			
nr-r15 SEQUENCE {			
carrierFreq-r15	Downlink NR SSB ARFCN of cell NR Cell 1		TS 38.508-1 [4] cl.6.2.3.1
subcarrierSpacingSSB-r15			
}			
}			
}			
}			
}			
}			

11.1.2 MO MMTEL voice call setup from NR RRC_IDLE / EPS Fallback with redirection / Single registration mode without N26 interface / Success

11.1.2.1 Test Purpose (TP)

(1)

```
with {UE supporting both S1 mode and N1 mode and operating in single-registration mode, and, the Network has indicated "interworking without N26 interface supported", and, the UE is in NR RRC_IDLE state}
ensure that {
  when {User initiates a MMTEL call and the UE completes Access control and checking in 5GMM-IDLE mode}
  then {UE requests the establishment of a MMTEL call by transmitting an RRCSetupRequest message with establishmentCause set to 'mo-VoiceCall', and, a SERVICE REQUEST message with Service type set to 'data'}
}
```

(2)

```
with {the UE is NR RRC_CONNECTED state after having requested a MMTEL call establishment and the MO IMS voice session establishment has been initiated}
ensure that {
  when {the UE receives a RRCRelease message which includes redirectedCarrierInfo indicating redirection to eutra}
  then {the UE selects the E-UTRA cell, performs an ATTACH or a TAU procedure, and, successfully completes the MO MMTEL call setup in EPS}
}
```

11.1.2.2 Conformance requirements

References: The conformance requirements covered in the current TC are specified in: TS23.502, clauses 4.11.2.2, 4.13.6.1; TS 24.501, clauses 4.5.4.1, 4.8.2.3; TS 38.331, clause 5.3.11. Unless otherwise stated these are Rel-15 requirements.

[TS 23.502, clause 4.11.2.2]

The following procedure is used by UEs in single-registration or dual registration mode on mobility from 5GS to EPS.

In the case of network sharing the UE selects the target PLMN ID according to clause 5.18.3 of TS 23.501 [2].

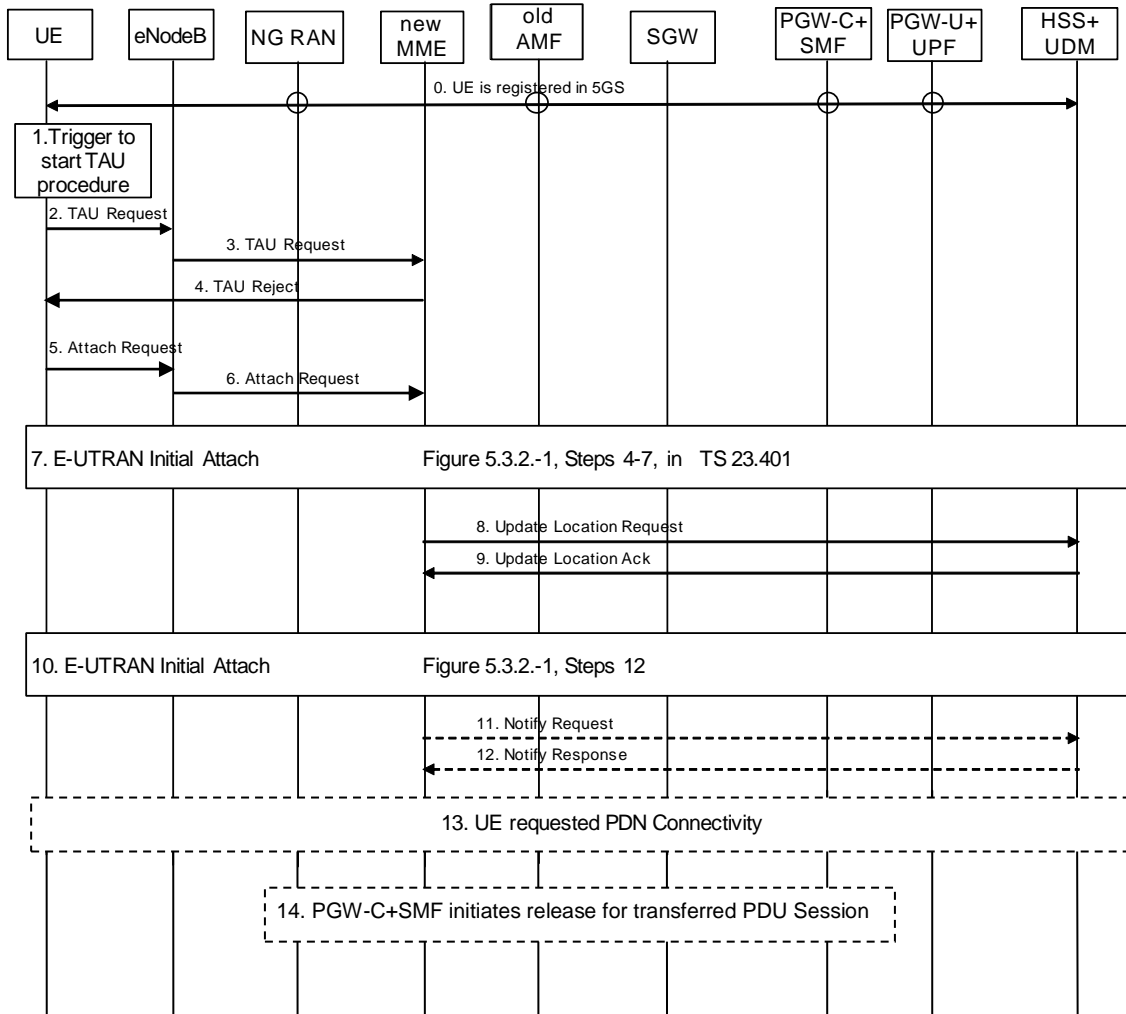

Figure 4.11.2.2-1: Mobility procedure from 5GS to EPS without N26 interface

The UE operating in single-registration mode can start the procedure from Step 1 or Step 5. The UE operating in dual-registration mode starts the procedure from Step 5.

NOTE 1: The network has indicated the "Interworking without N26" to the UE. To support IP address preservation, the UE in single-registration mode starts the procedure from Step 5. If the UE in single-registration mode starts the procedure from Step 1, the IP address preservation is not provided.

0. UE is registered in 5GS and established PDU sessions. The FQDN for the S5/S8 interface of the PGW-C+SMF is also stored in the UDM by the PGW-C+SMF during PDU Session setup in addition to what is specified in clause 4.3.2.2.1 and clause 4.3.2.2.2.

NOTE 2: At 5GS to EPS mobility, the MME use the FQDN for the S5/S8 interface of the PGW-C+SMF to find the PGW-C+SMF, and when UE moves back from EPS to 5GS, the AMF uses FQDN for the S5/S8 interface of the PGW-C+SMF to find the PGW-C+SMF.

1. Step 1 as in clause 5.3.3.1 (Tracking Area Update) in TS 23.401 [13].

2. Step 2 as in clause 5.3.3.1 (Tracking Area Update) in TS 23.401 [13] with the following modifications:

The UE shall provide a EPS-GUTI that is mapped from the 5G-GUTI following the mapping rules specified in TS 23.501 [2]. The UE indicates that it is moving from 5GC.

3. Step 3 as in clause 5.3.3.1 (Tracking Area Update) in TS 23.401 [13].

4. If the MME determined that the old node is an AMF based on UE's GUTI mapped from 5G-GUTI and the MME is configured to support 5GS-EPS interworking without N26 procedure, the MME sends a TAU Reject to the UE.
5. Step 1 as in clause 5.3.2.1 (E-UTRAN Initial Attach) in TS 23.401 [13] with the modifications captured in clause 4.11.2.4.1.
6. Step 2 as in clause 5.3.2.1 (E-UTRAN Initial Attach) in TS 23.401 [13].
7. Steps 4-7 as in clause 5.3.2.1 (E-UTRAN Initial Attach) in TS 23.401 [13], with the modifications captured in clause 4.11.2.4.1.
8. Step 8 as in clause 5.3.2.1 (E-UTRAN Initial Attach) in TS 23.401 [13], with the modifications captured in clause 4.11.2.4.1.
9. Step 11 as in clause 5.3.2.1 (E-UTRAN Initial Attach) in TS 23.401 [13], with the following modifications:

The subscription profile the MME receives from HSS+UDM includes per DNN/APN at most one PGW-C+SMF FQDN as described in in clause 5.17.2.1 in TS 23.501 [2].
10. Steps 12-24 as in clause 5.3.2.1 (E-UTRAN Initial Attach) in TS 23.401 [13], with the modifications as described in clause 4.11.2.4.1.
11. Step 25 as in clause 5.3.2.1 (E-UTRAN Initial Attach) in TS 23.401 [13].
12. Step 26 as in clause 5.3.2.1 (E-UTRAN Initial Attach) in TS 23.401 [13].
13. If the UE has remaining PDU Sessions in 5GS which it wants to transfer to EPS and maintain the same IP address/prefix, the UE performs the UE requested PDN Connectivity Procedure as specified in TS 23.401 [13] clause 5.10.2 and sets the Request Type to "handover" in Step 1 of the procedure with modification captured in clause 4.11.2.4.2. UE provides an APN and the PDU Session ID corresponding to the PDU Session it wants to transfer to EPS. The UE provides the PDU Session ID in PCO as described in clause 4.11.1.1.

UEs in single-registration mode performs this step for each PDU Session immediately after completing the E-UTRAN Initial Attach procedure. UEs in dual-registration mode may perform this step any time after the completing of E-UTRAN Initial Attach procedure. Also, UEs in dual-registration mode may perform this step only for a subset of PDU Sessions.

The MME determines the PGW-C+SMF address for the Create Session Request based on the APN received from the UE and the subscription profile received from the HSS+UDM in Step 9 or when the HSS+UDM notifies the MME for the new PGW-C+SMF ID in the updated subscription profile.

The PGW-C+SMF uses the PDU Session ID to correlate the transferred PDN connection with the PDU Session in 5GC.

As a result of the procedure the PGW-U+UPF starts routing DL data packets to the Serving GW for the default and any dedicated EPS bearers established for this PDN connection.

14. The PGW-C+SMF initiates release of the PDU Session(s) in 5GS transferred to EPS as specified in clause 4.3.4.2 with the following clarification:

In step 2, the PGW-C+SMF shall not release IP address/prefix(es) allocated for the PDU Session.

If UP connection of the PDU Session is not active, step 3b is not executed, thus the steps triggered by step 3b are not executed;

If UP connection of the PDU Session is active, the SMF invokes the Namf_Communication_N1N2MessageTransfer service operation without including N1 SM container (PDU Session Release Command).

[TS 23.502, clause 4.13.6.1]

Figure 4.13.6.1-1 describes the EPS fallback procedure for IMS voice.

When the UE is served by the 5G System, the UE has one or more ongoing PDU Sessions each including one or more QoS Flows. The serving PLMN AMF has sent an indication towards the UE during the Registration procedure that IMS

voice over PS session is supported, see clause 5.16.3.10 in TS 23.501 [2] and the UE has registered in the IMS. If N26 is not supported, the serving PLMN AMF sends an indication towards the UE during the Registration procedure that interworking without N26 is supported, see clause 5.17.2.3.1 in TS 23.501 [2].

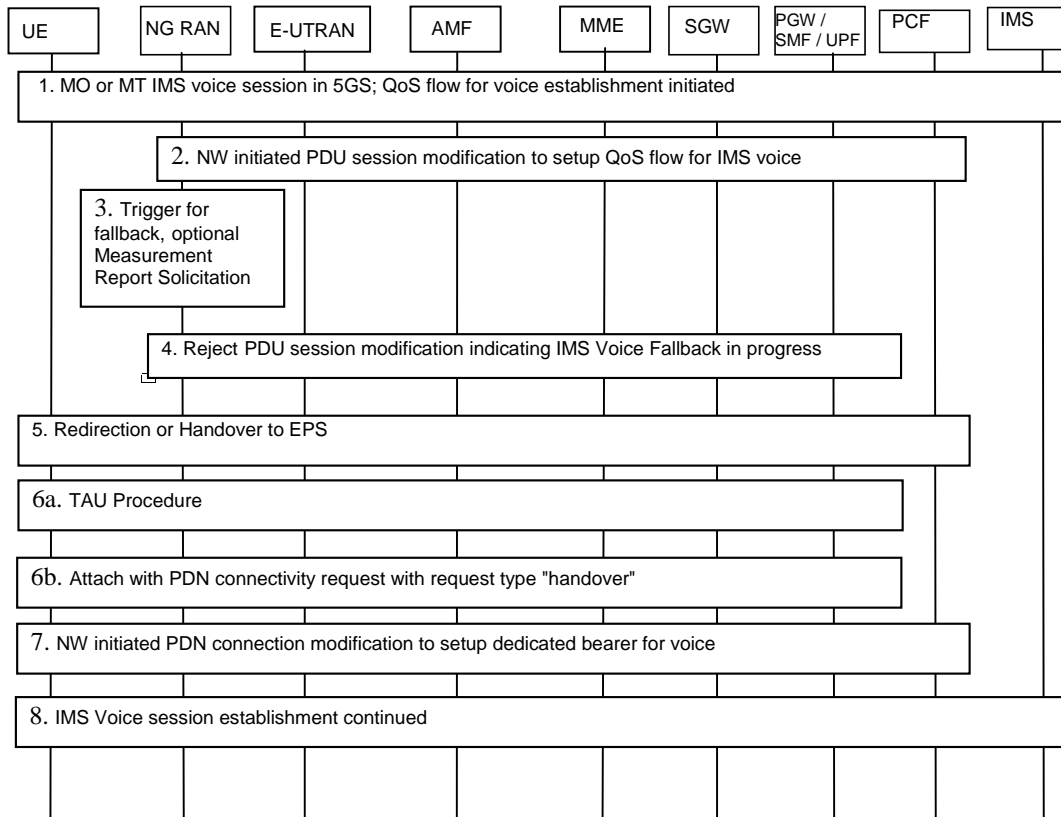

Figure 4.13.6.1-1: EPS Fallback for IMS voice

1. UE camps on NG-RAN in the 5GS and an MO or MT IMS voice session establishment has been initiated.
2. Network initiated PDU Session modification to setup QoS flow for voice reaches the NG-RAN (see N2 PDU Session Request in clause 4.3.3).
3. NG-RAN is configured to support EPS fallback for IMS voice and decides to trigger fallback to EPS, taking into account UE capabilities, indication from AMF that "Redirection for EPS fallback for voice is possible" (received as part of initial context setup as defined in TS 38.413 [10]), network configuration (e.g. N26 availability configuration) and radio conditions. If NG-RAN decides not to trigger fallback to EPS, then the procedure stops here and following steps are not executed.

NG-RAN may initiate measurement report solicitation from the UE including E-UTRAN as target.

NOTE 1: If AMF has indicated that "Redirection for EPS fallback for voice is not possible", then AN Release via inter-system redirection to EPS is not performed in step 5.

4. NG-RAN responds indicating rejection of the PDU Session modification to setup QoS flow for IMS voice received in step 2 by PDU Session Response message towards the PGW-C+SMF (or H-SMF+P-GW-C via V-SMF, in case of roaming scenario) via AMF with an indication that mobility due to fallback for IMS voice is ongoing. The PGW-C+SMF maintains the PCC rule(s) associated with the QoS Flow(s).
5. NG-RAN initiates either handover (see clause 4.11.1.2.1), or AN Release via inter-system redirection to EPS (see clause 4.2.6 and clause 4.11.1.3.2), taking into account UE capabilities. The PGW-C+SMF reports change of the RAT type if subscribed by PCF as specified in clause 4.11.1.2.1, or clause 4.11.1.3.2.6. When the UE is connected to EPS, either 6a or 6b is executed
- 6a. In the case of 5GS to EPS handover, see clause 4.11.1.2.1, and in the case of inter-system redirection to EPS with N26 interface, see clause 4.11.1.3.2. In either case the UE initiates TAU procedure; or

6b. In the case of inter-system redirection to EPS without N26 interface, see clause 4.11.2.2. If the UE supports Request Type flag "handover" for PDN connectivity request during the attach procedure as described in clause 5.3.2.1 of TS 23.401 [13] and has received the indication that interworking without N26 is supported, then the UE initiates Attach with PDN connectivity request with request type "handover".

In inter-system redirection, the UE uses the emergency indication in the RRC message as specified in clause 6.2.2 of TS 36.331 [16] and E-UTRAN provides the emergency indication to MME during Tracking Area Update or Attach procedure. For the handover procedure see clause 4.11.1.2.1, step 1.

7. After completion of the mobility procedure to EPS or as part of the 5GS to EPS handover procedure (see clause 4.11.1.2.1), the SMF/PGW re-initiates the setup of the dedicated bearer for IMS voice, mapping the 5G QoS to EPC QoS parameters. The PGW-C+SMF behaves as specified in clause 4.9.1.3.1. The PGW-C+SMF reports about Successful Resource Allocation and Access Network Information if subscribed by PCF.
8. The IMS voice session establishment is continued.

At least for the duration of the voice call in EPS the E-UTRAN is configured to not trigger any handover to 5GS.

[TS 24.501, clause 4.5.4.1]

When the UE is in 5GMM-IDLE mode, upon receiving a request from the upper layers for an access attempt, the NAS shall categorize the access attempt into access identities and an access category following subclause 4.5.2, table 4.5.2.1 and table 4.5.2.2, and subclause 4.5.3, and provide the applicable access identities and the access category to the lower layers for the purpose of access control checking. In this request to the lower layer the NAS can also provide to the lower layer the RRC establishment cause determined as specified in subclause 4.5.6 of this specification.

NOTE 1: The access barring check is performed by the lower layers.

NOTE 2: As an implementation option, the NAS can provide the RRC establishment cause to the lower layers after being informed by the lower layers that the access attempt is allowed.

If the UE has uplink user data pending for one or more PDU sessions when it builds a REGISTRATION REQUEST or SERVICE REQUEST message as initial NAS message, the UE shall indicate the respective PDU sessions in the Uplink data status IE as specified in subclause 5.5.1.3.2 and 5.6.1.2, regardless of the access category for which the access barring check is performed.

NOTE 3: The UE indicates pending user data for all the respective PDU sessions, even if barring timers are running for some of the corresponding access categories.

If the lower layers indicate that the access attempt is allowed, the NAS shall initiate the procedure to send the initial NAS message for the access attempt.

If the lower layers indicate that the access attempt is barred, the NAS shall not initiate the procedure to send the initial NAS message for the access attempt. Additionally:

- a) if the event which triggered the access attempt was an MO-MMTEL-voice-call-started indication or an MO-MMTEL-video-call-started indication:
 - 1) if the UE is operating in the single-registration mode and the UE's usage setting is "voice centric", the UE may attempt to select an E-UTRA cell connected to EPC. If the UE finds a suitable E-UTRA cell connected to EPC, it then proceeds with the appropriate EMM specific procedures and, if necessary, ESM procedures to make a PDN connection providing access to IMS available; see subclause 4.8.2 and 3GPP TS 24.301 [15];
 - 2) if the UE is operating in the dual-registration mode, the UE may proceed in S1 mode with the appropriate EMM specific procedures and ESM procedures to make a PDN connection providing access to IMS available; see subclause 4.8.3 and 3GPP TS 24.301 [15];
 - 3) otherwise, the NAS shall notify the upper layers that the access attempt is barred. In this case, upon receiving an indication from the lower layers that the barring is alleviated for the access category with which the access attempt was associated, the NAS shall notify the upper layers that the barring is alleviated for the access category and may initiate the procedure to send the initial NAS message, if still needed; and
- b) if the event which triggered the access attempt was an MO-SMSoIP-attempt-started indication:
 - 1) if the UE is operating in the single-registration mode, the UE may attempt to select an E-UTRA cell connected to EPC. If the UE finds a suitable E-UTRA cell connected to EPC, it then proceeds with the

appropriate EMM specific procedures and, if necessary, ESM procedures to make a PDN connection providing access to IMS available; see subclause 4.8.2 and 3GPP TS 24.301 [15];

- 2) if the UE is operating in the dual-registration mode, the UE may proceed in S1 mode with the appropriate EMM specific procedures and ESM procedures to make a PDN connection providing access to IMS available; see subclause 4.8.3 and 3GPP TS 24.301 [15];
- 3) otherwise, the NAS layer shall notify the upper layers that the access attempt is barred. In this case, upon receiving an indication from the lower layers that the barring is alleviated for the access category with which the access attempt was associated, the NAS shall notify the upper layers that the barring is alleviated for the access category and may initiate the procedure to send the initial NAS message, if still needed.

NOTE 4: Barring timers, on a per access category basis, are run by the lower layers. At expiry of barring timers, the indication of alleviation of access barring is indicated to the NAS on a per access category basis.

[TS 24.501, clause 4.8.2.3]

At inter-system change from N1 mode to S1 mode in EMM-IDLE mode when: (PDU SEESION ACTIVE)

- a) the UE supports non-IP PDN type and at least one PDU session is active; or
- b) the UE does not support non-IP PDN type and at least one PDU session of IPv4, IPv6 or IPv4v6 PDU session type is active,

the UE shall proceed as follows:

- a) if the UE supports sending an ATTACH REQUEST message containing a PDN CONNECTIVITY REQUEST message with request type set to "handover" to transfer a PDU session from N1 mode to S1 mode and the UE has received an "interworking without N26 interface supported" indication from the network, the UE shall:
 - 1) enter substates EMM-DEREGISTERED.NORMAL-SERVICE and 5GMM-REGISTERED.NO-CELL-AVAILABLE;
 - 2) map the PDU session(s) which the UE intends to transfer to EPS to the default EPS bearer context of the corresponding PDN connection(s) as specified in subclause 6.1.4.2; and
 - 3) initiate an EPS attach procedure and include a PDN CONNECTIVITY REQUEST message with request type set to "handover" in the ATTACH REQUEST message to activate a default EPS bearer context for one of the active PDU sessions which the UE intends to transfer to EPS.

After successful completion of the EPS attach procedure, the UE shall reset the registration attempt counter and the attach attempt counter (see 3GPP TS 24.301 [15]) and attempt to activate each of the other default EPS bearer contexts, if any, by initiating a stand-alone PDN connectivity procedure with request type set to "handover" in the PDN CONNECTIVITY REQUEST message; and

- b) otherwise, enter substates EMM-REGISTERED.NORMAL-SERVICE and 5GMM-REGISTERED.NO-CELL-AVAILABLE and initiate a tracking area update procedure (see 3GPP TS 24.301 [15]).

At inter-system change from N1 mode to S1 mode in EMM-IDLE mode when: (NO PDU SESSION)

- a) the UE supports non-IP PDN type and no PDU session is active; or
- b) the UE does not support non-IP PDN type and no PDU session of IPv4, IPv6 or IPv4v6 PDU session type is active,

the UE shall enter substates EMM-DEREGISTERED.NORMAL-SERVICE and 5GMM-DEREGISTERED.NO-CELL-AVAILABLE, and initiate an attach procedure.

At inter-system change from S1 mode to N1 mode in 5GMM-IDLE mode, the UE shall:

- a) enter substate 5GMM-REGISTERED.NORMAL-SERVICE and substate EMM-REGISTERED.NO-CELL-AVAILABLE;
- b) map the default EPS bearer context(s) of the PDN connection(s) which the UE intends to transfer to 5GS, if any, to the corresponding PDU session(s) as specified in subclause 6.1.4.2; and

- c) initiate the registration procedure for mobility and periodic registration update indicating "mobility registration updating" in the 5GS registration type IE of the REGISTRATION REQUEST message (see subclause 5.5.1.3).

After having successfully registered in N1 mode the UE shall reset the registration attempt counter and the attach attempt counter (see 3GPP TS 24.301 [15]) and:

- a) if the UE supports the PDU session establishment procedure with request type set to "existing PDU session" to transfer a PDN connection from S1 mode to N1 mode and the UE has received an "interworking without N26 interface supported" indication from the network, attempt to transfer the PDN connection(s) which the UE intends to transfer to 5GS, if any, from S1 mode to N1 mode by initiating the PDU session establishment procedure with request type set to "existing PDU session"; and
- b) otherwise, establish PDU session(s) corresponding to the PDN connection(s) which the UE intends to transfer to 5GS, if any, by initiating the PDU session establishment procedure with request type set to "initial request".

See subclause 5.1.4.3 for coordination between 5GMM and EMM and subclause 6.1.4.2 for coordination between 5GSM and ESM.

[TS 38.331, clause 5.3.11]

UE shall:

- 1> reset MAC;
- 1> if T302 is running:
 - 2> stop timer T302;
 - 2> perform the actions as specified in 5.3.14.4;
- 1> stop all timers that are running except T320 and T325;
- 1> discard the UE Inactive AS context;
- 1> set the variable *pendingRnaUpdate* to *false*, if that is set to *true*;
- 1> discard the K_{gNB} , the K_{RRcenc} key, the K_{RRcint} , the K_{UPint} key and the K_{UPenc} key, if any;
- 1> release all radio resources, including release of the RLC entity, the MAC configuration and the associated PDCP entity and SDAP for all established RBs;
- 1> indicate the release of the RRC connection to upper layers together with the release cause;
- 1> enter RRC_IDLE and perform cell selection as specified in TS 38.304 [20], except if going to RRC_IDLE was triggered by selecting an inter-RAT cell while T311 was running;
- 1> if going to RRC_IDLE was triggered by reception of the *RRCRelease* message including a *waitTime*:
 - 2> start timer T302 with the value set to the *waitTime*;
 - 2> inform the upper layer that access barring is applicable for all access categories except categories '0' and '2'.

11.1.2.3 Test description

11.1.2.3.1 Pre-test conditions

System Simulator:

- 2 cells
 - NR Cell 1 as defined in TS 38.508-1 [4] Table 4.4.2-3. System information combination NR-6 as defined in TS 38.508-1 [4], sub-clause 4.4.3.1.2.
 - E-UTRA Cell 1 as defined in TS 36.508 [7] Table 4.4.2-2. System information combination 31 as defined in TS 36.508 [7], sub-clause 4.4.3.1.1.

- Power levels are constant and as defined in Tables 11.1.2.3.1-1/2.

Table 11.1.2.3.1-1: Time instances of cell power level and parameter changes for conducted test environment

	Parameter name	Unit	NR Cell 1	E-UTRA Cell 1	Remark
T0	SS/PBCH SSS EPRE	dBm/SCS	-88	-	
	RS EPRE	dBm/15kHz	-	-91	

Table 11.1.2.3.1-2: Time instances of cell power level and parameter changes for OTA test environment

	Parameter name	Unit	NR Cell 1	E-UTRA Cell 1	Remark
T0	SS/PBCH SSS EPRE	dBm/SCS	-82	-	
	RS EPRE	dBm/15kHz	-	-91	

UE:

- None

Preamble:

- With E-UTRA Cell 1 "Serving cell" and NR Cell 1 "Non-suitable "Off" cell" in accordance with TS 38.508-1 [4], Table 6.2.2.1-3, the UE is brought to state RRC_IDLE using generic procedure parameters Connectivity (*E-UTRA/EPC*) and Unrestricted nr PDN (*On*) in accordance with the procedure described in TS 38.508-1 [4], clause 4.5.2. 4G GUTI and eKSI are assigned and security context established
- The UE is switched-off
- With E-UTRA Cell 1 "Non-suitable "Off" cell" and NR Cell 1 "Serving cell" in accordance with TS 38.508-1 [4], Table 6.2.2.1-3, the UE is brought to state 1N-A, RRC_IDLE Connectivity (NR), in accordance with the procedure described in TS 38.508-1 [4], with one IMS PDU session on NR Cell 1, Table 4.5.2.2-2. 5G-GUTI and ngKSI are assigned and security context established.

11.1.2.3.2 Test procedure sequence

Table 11.1.2.3.2-1: Main behaviour

St	Procedure	Message Sequence		TP	Verdict
		U – S	Message		
1	Void	-	-	-	-
-	EXCEPTION: Unless otherwise stated the following messages are exchanged on NR Cell 1.	-	-	-	-
2	User initiates a MMTEL call.	-	-	-	-
3	Check: Does the UE transmits an <i>RRCSetupRequest</i> message with <i>EstablishmentCause</i> set to 'mo-VoiceCall'?	-->	NR RRC: <i>RRCSetupRequest</i>	1	P
4	The SS transmits an <i>RRCSetup</i> message.	<--	NR RRC: <i>RRCSetup</i>	-	-
5	Check: Does the UE transmits an <i>RRCSetupComplete</i> message and a SERVICE REQUEST message with <i>Service Type</i> set to 'data'?	-->	NR RRC: <i>RRCSetupComplete</i> 5GMM: SERVICE REQUEST	1	P
5A A	Set the power levels according to "T0" as per Table 11.1.2.3.1-1/2.	-	-	-	-

5A	Void	-	-	-	-
5B	Void	-	-	-	-
5C-5F	Steps 5-8 of expected sequence from Table 4.5.4.2-3 as defined in TS 38.508-1 [4] are performed.	-	-	-	-
5G-5K	Steps 1-5 of expected sequence from A.9.1 as defined in TS 34.229-5 [41] are performed for initiating an MTSI MO speech call.	-	-	-	-
6	The SS transmits an <i>RRCRelease</i> message indicating redirection to E-UTRA Cell 1.	<--	NR RRC: <i>RRCRelease</i>	-	-
-	EXCEPTION: Unless otherwise stated the following messages are exchange on E-UTRA Cell 1.	-	-	-	-
7	The UE transmits an <i>RRCConnectionRequest</i> message on the cell specified in the test case.	-->	RRC: <i>RRCConnectionRequest</i>	-	-
8	SS transmits an <i>RRCConnectionSetup</i> message.	<--	RRC: <i>RRCConnectionSetup</i>	-	-
-	EXCEPTION: Steps 8a1 to 8b18 describe behaviour that depends on the UE implementation; the "lower case letter" identifies a step sequence that take place depending on the UE implementation.	-	-	-	-
8a1	If the UE tries to preserve the IP address of the PDN connection then check does the UE transmits an ATTACH REQUEST message?	-->	RRC: <i>RRCConnectionSetupComplete</i> NAS: ATTACH REQUEST	2	P
8b1	Else check: does the UE transmit a TRACKING AREA UPDATE REQUEST message?	-->	RRC: <i>RRCConnectionSetupComplete</i> NAS: TRACKING AREA UPDATE REQUEST	2	P
8b2	The SS transmits a TRACKING AREA UPDATE REJECT message to UE.	<--	RRC: <i>DLInformationTransfer</i> NAS: TRACKING AREA UPDATE REQUEST REJECT	-	-
8b3	The UE transmits an ATTACH REQUEST message.	-->	RRC: <i>ULInformationTransfer</i> NAS: ATTACH REQUEST	-	-
9-20	Steps 5 to 16 of the generic test procedure for UE registration (TS 36.508 [2] Table 4.5.2.3-1)	-	-	-	-
-	EXCEPTION: In parallel to the events described in steps 24A to 29 the steps specified in Table 11.1.2.3.2-2 may take place to transfer other PDU sessions to EPS.	-	-	-	-
-	EXCEPTION: In parallel to the events described in steps 10 to 16 the UE may perform IMS re-registration on EUTRAN as defined in TS 34.229-1 [35] subclause C.46	-	-	-	-
21a1 – 21a3	Void	-	-	-	-
21b1 – 21b3	Void	-	-	-	-
22-24	Void	-	-	-	-
24A	The SS configures a new RLC-UM data radio bearer with condition DRB (0,1), associated with the dedicated EPS bearer context. <i>RRCConnectionReconfiguration</i> message contains the ACTIVATE DEDICATED EPS BEARER CONTEXT REQUEST message. EPS bearer context #4 (QCI 1) according to table 6.6.2-1: Reference dedicated EPS bearer contexts.	<--	RRC: <i>RRCConnectionReconfiguration</i> NAS: ACTIVATE DEDICATED EPS BEARER CONTEXT REQUEST	-	-
-	EXCEPTION: In parallel to the events described in steps 24B-24C the steps specified in table 11.1.2.3.2-3 will take place.	-	-	-	-
24	The UE transmits an	-->	RRC:	-	-

B	<i>RRCConnectionReconfigurationComplete</i> message to confirm the establishment of the new data radio bearer, associated with the dedicated EPS bearer.		RRCConnectionReconfigurationComplete		
24 C	The UE transmits an ACTIVATE DEDICATED EPS BEARER CONTEXT ACCEPT message.	-->	RRC: ULInformationTransfer NAS:ACTIVATE DEDICATED EPS BEARER CONTEXT ACCEPT	-	-
25- 28	Void	-	-	-	-
29	The SS waits 1 second.	-	-	-	-
30	Release IMS Call as specified in the generic procedure in TS 34.229-1 [35] subclause C.32.	-	-	-	-

Table 11.1.2.3.2-2: Parallel behaviour

St	Procedure	Message Sequence		TP	Verdict
		U - S	Message		
1	Check: Does the UE transmit a PDN CONNECTIVITY REQUEST message to request an additional PDN.	-->	RRC: ULInformationTransfer NAS: PDN CONNECTIVITY REQUEST	1	P
2	The SS configures a new data radio bearer, associated with the additional default EPS bearer context. <i>RRCConnectionReconfiguration</i> message contains the ACTIVATE DEFAULT EPS BEARER CONTEXT REQUEST message.	<--	RRC: RRCConnectionReconfiguration NAS: ACTIVATE DEFAULT EPS BEARER CONTEXT REQUEST		
3	The UE transmits an <i>RRCConnectionReconfigurationComplete</i> message to confirm the establishment of additional default bearer.	-->	RRC: RRCConnectionReconfigurationC omplete		
-	EXCEPTION: In parallel to the event described in step 4 below, if initiated by the UE the generic procedure for IP address allocation in the U-plane specified in TS 36.508 subclause 4.5A.1 takes place performing IP address allocation in the U-plane.	-	-		
4	The UE transmits an ACTIVATE DEFAULT EPS BEARER CONTEXT ACCEPT message.	-->	RRC: ULInformationTransfer NAS: ACTIVATE DEFAULT EPS BEARER CONTEXT ACCEPT		

Table 11.1.2.3.2-3: Parallel behaviour

St	Procedure	Message Sequence		TP	Verdict
		U - S	Message		
1-5	Steps 1 to 5 of the Generic test procedure for setting up MTSI MO speech call - EPS fallback according TS 34.229-5 [41] subclause A.9.2 take place.	-	-	-	-
6	Step 6 of the Generic test procedure for setting up MTSI MO speech call - EPS fallback according TS 34.229-5 [41] subclause A.9.2 takes place.	-	-	2	P

11.1.2.3.3 Specific message contents

Table 11.1.2.3.3-0: REGISTRATION ACCEPT (preamble; step 14, TS 38.508-1 [4], Table 4.5.2.2-2)

Derivation path: TS 38.508-1 [4] Table 4.7.1-7			
Information Element	Value/remark	Comment	Condition
Extended protocol discriminator	'0111 1110'B	5GS mobility management	

Security header type	'0000'B	messages Plain 5GS NAS message, not security protected	
Spare half octet	'0000'B		
5GS network feature support	'0100 0001 0000 0000'B	Interworking without N26 interface supported	

Table 11.1.2.3.3-1: RRCSetupRequest (step 3, table 11.1.2.3.2-1)

Derivation Path: TS 38.508-1 [4] Table 4.6.1-23			
Information Element	Value/remark	Comment	Condition
RRCSetupRequest ::= SEQUENCE {			
rrcSetupRequest SEQUENCE {			
establishmentCause	Mo-Voicecall		
}			
}			

Table 11.1.2.3.3-2: SERVICE REQUEST (step 5, table 11.1.2.3.2-1)

Derivation path: TS 38.508-1 [4] Table 4.7.1-16			
Information Element	Value/Remark	Comment	Condition
Service type	'0001'B	data	
Uplink data status	Present	PSI bit corresponding to IMS PDN needs to be set	

Table 11.1.2.3.3-3: RRCRelease (step 6, table 11.1.2.3.2-1)

Derivation path: TS 38.508-1 [4] Table 4.6.1-16			
Information Element	Value/Remark	Comment	Condition
RRCRelease ::= SEQUENCE {			
criticalExtensions CHOICE {			
rrcRelease SEQUENCE {			
redirectedCarrierInfo CHOICE {			
eutra.SEQUENCE{			
eutraFrequency	Downlink EARFCN of E-UTRA cell 1		
cnType	epc		
}			
}			
}			
}			

Table 11.1.2.3.3-3A: ATTACH REQUEST (step 8a1, table 11.1.2.3.2-1)

Derivation Path: TS 36.508 [7], Table 4.7.2-4.			
Information Element	Value/Remark	Comment	Condition
NAS key set identifier	KSI _{ASME} that was created when the UE last registered to EPC E-UTRA		
EPS mobile identity	GUTI, assigned by E-UTRA Cell 1 at the initial registration when the UE entered S1		
Last visited registered TAI	The TAI the last visited E-UTRA Cell belonged		

	to, if any. Not included if the UE does not have last stored EPC TAI.		
Old GUTI type	"Native GUTI"		
ESM message container	PDN CONNECTIVITY REQUEST message to active PDU sessions which the UE intends to transfer to EPS.		

Table 11.1.2.3.3-3B: PDN CONNECTIVITY REQUEST (Table 11.1.2.3.3-3A)

Derivation Path: TS 36.508 [7], Table 4.7.3-20			
Information Element	Value/remark	Comment	Condition
EPS bearer identity	0	No EPS bearer identity assigned, for coding see Table 9.11.4.8.1 in TS 24.501 [22]	
Procedure transaction identity	Any value from 1 to 254		
PDN connectivity request message identity	'1101 0000'B	PDN connectivity request	
Request type	'010'B	Handover	
PDN type	Any value between '001'B, '010'B, '011'B and '100'B	The allowed values are respectively IPv4, IPv6, IPv4v6 and "unused but interpreted as IPv6 by the network"	
Protocol configuration options	PDU session ID of 5GS PDU session		

Table 11.1.2.3.3-4: TRACKING AREA UPDATE REQUEST (step 8b1, table 11.1.2.3.2-1)

Derivation Path: TS 36.508 [7], Table 4.7.2-27, condition NR.			
Information Element	Value/Remark	Comment	Condition
"Active" flag	0001	Bearer Establishment requested	
EPS bearer context status	Present	EBI corresponding to active PDU Sessions need to be set to 1	
NAS key set identifier	KSI _{ASME} that was created when the UE last registered to EPC E-UTRA		
Old GUTI	GUTI, mapped from the 5G-GUTI assigned at the initial registration when the UE entered N1		
Last visited registered TAI	The TAI the last visited E-UTRA Cell belonged to, if any. Not included if the UE does not have last stored EPC TAI.		
Old GUTI type	"Native GUTI"		
UE status	"UE is in 5GMM-REGISTERED state"		

Table 11.1.2.3.3-5: TRACKING AREA UPDATE REJECT (step 8b2, table 11.1.2.3.2-1)

Derivation Path: TS 36.508 [7], Table 4.7.2-26.			
Information Element	Value/Remark	Comment	Condition
EMM cause	'0000 1001'B	#9 "UE identity cannot be derived by the network"	

Table 11.1.2.3.3-6: ATTACH REQUEST (step 8b3, table 11.1.2.3.2-1)

Derivation Path: TS 36.508 [7], Table 4.7.2-4.			
Information Element	Value/Remark	Comment	Condition
IMSI	IMSI of the UE		

Table 11.1.2.3.3-7: PDN CONNECTIVITY REQUEST (step 1, table 11.1.2.3.2-2)

Derivation Path: TS 36.508 [7], Table 4.7.3-20			
Information Element	Value/remark	Comment	Condition
EPS bearer identity	0	No EPS bearer identity assigned, for coding see Table 9.11.4.8.1 in TS 24.501 [22]	
Procedure transaction identity	Any value from 1 to 254		
PDN connectivity request message identity	'1101 0000'B	PDN connectivity request	
Request type	'010'B	Handover	
PDN type	Any value between '001'B, '010'B, '011'B and '100'B	The allowed values are respectively IPv4, IPv6, IPv4v6 and "unused but interpreted as IPv6 by the network"	
Protocol configuration options	PDU session ID of internet PDU session		

Table 11.1.2.3.3-8: ATTACH ACCEPT (preamble, step 18; step 14, TS 36.508-1 [7], Table 4.5.2.3-1)

Derivation path: TS 36.508-1 [7] Table 4.7.2-1			
Information Element	Value/remark	Comment	Condition
EPS network feature support	'0000 0011 0100 1000'B	- IMS voice over PS session in S1 mode supported - emergency bearer services in S1 mode supported - ePCO supported - Interworking without N26 interface supported	

Table 11.1.2.3.3-9: ACTIVATE DEFAULT EPS BEARER CONTEXT REQUEST (preamble, step 18; step 14, TS 36.508-1 [7], Table 4.5.2.3-1)

Derivation Path: TS 36.508-1 [7] Table 4.7.3-6			
Information Element	Value/remark	Comment	Condition
Protocol configuration options			
Container ID n+2	Not present	Session-AMBR	

		are not present	
Container ID n+3	Not present	QoS rules are not present	
Container ID n+4	Not present	Qos flow descriptions are not present	

11.1.3 MO MMTEL voice call setup from NR RRC_CONNECTED / EPS Fallback with handover / Single registration mode with N26 interface / Success

11.1.3.1 Test Purpose (TP)

(1)

```

with { UE supporting both S1 mode and N1 mode and operating in single-registration mode, and, the
Network has indicated "interworking without N26 interface not supported", and, the UE is in NR
RRC_CONNECTED state }
ensure that {
  when { User initiates a MMTEL call, the MO IMS voice session establishment has been initiated and
the UE receives a MobilityFromNRCommand message which includes targetRAT-Type set to eutra }
  then { UE performs a handover to the E-UTRA including a TAU procedure, and, the UE successfully
completes the MO MMTEL call in EPS }
}

```

11.1.3.2 Conformance requirements

References: The conformance requirements covered in the present test case are specified in: TS 23.502, clauses 4.13.6.1, TS 24.501, clauses 4.8.2.2, 5.5.1.2.2, 5.5.1.2.4, 5.1.4.2 and 6.1.4.1, TS 38.331, clause 5.4.3.3 and 5.4.3.4. Unless otherwise stated these are Rel-15 requirements.

[TS 23.502, clause 4.13.6.1]

Figure 4.13.6.1-1 describes the EPS fallback procedure for IMS voice.

When the UE is served by the 5G System, the UE has one or more ongoing PDU Sessions each including one or more QoS Flows. The serving PLMN AMF has sent an indication towards the UE during the Registration procedure that IMS voice over PS session is supported, see clause 5.16.3.10 in TS 23.501 [2] and the UE has registered in the IMS. If N26 is not supported, the serving PLMN AMF sends an indication towards the UE during the Registration procedure that interworking without N26 is supported, see clause 5.17.2.3.1 in TS 23.501 [2].

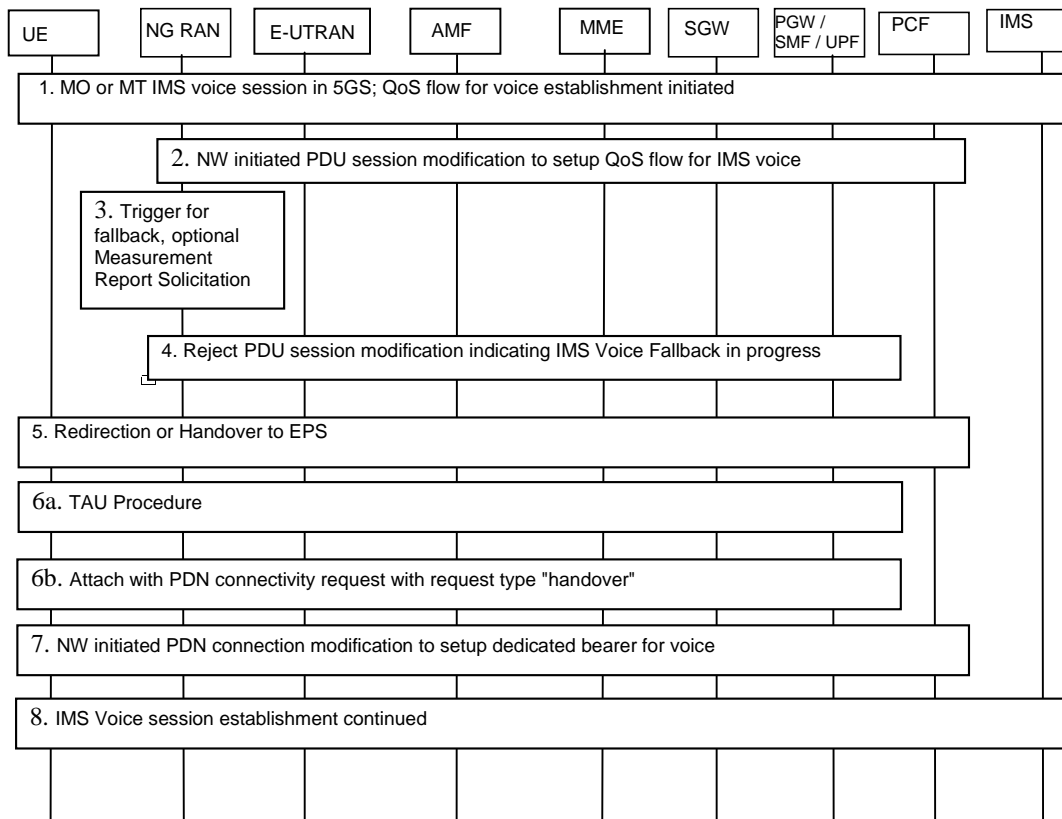

Figure 4.13.6.1-1: EPS Fallback for IMS voice

1. UE camps on NG-RAN in the 5GS and an MO or MT IMS voice session establishment has been initiated.
2. Network initiated PDU Session modification to setup QoS flow for voice reaches the NG-RAN (see N2 PDU Session Request in clause 4.3.3).
3. NG-RAN is configured to support EPS fallback for IMS voice and decides to trigger fallback to EPS, taking into account UE capabilities, indication from AMF that "Redirection for EPS fallback for voice is possible" (received as part of initial context setup as defined in TS 38.413 [10]), network configuration (e.g. N26 availability configuration) and radio conditions. If NG-RAN decides not to trigger fallback to EPS, then the procedure stops here and following steps are not executed.

NG-RAN may initiate measurement report solicitation from the UE including E-UTRAN as target.

NOTE 1: If AMF has indicated that "Redirection for EPS fallback for voice is not possible", then AN Release via inter-system redirection to EPS is not performed in step 5.

4. NG-RAN responds indicating rejection of the PDU Session modification to setup QoS flow for IMS voice received in step 2 by PDU Session Response message towards the PGW-C+SMF (or H-SMF+P-GW-C via V-SMF, in case of roaming scenario) via AMF with an indication that mobility due to fallback for IMS voice is ongoing. The PGW-C+SMF maintains the PCC rule(s) associated with the QoS Flow(s).
5. NG-RAN initiates either handover (see clause 4.11.1.2.1), or AN Release via inter-system redirection to EPS (see clause 4.2.6 and clause 4.11.1.3.2), taking into account UE capabilities. The PGW-C+SMF reports change of the RAT type if subscribed by PCF as specified in clause 4.11.1.2.1, or clause 4.11.1.3.2.6. When the UE is connected to EPS, either 6a or 6b is executed
 - 6a. In the case of 5GS to EPS handover, see clause 4.11.1.2.1, and in the case of inter-system redirection to EPS with N26 interface, see clause 4.11.1.3.2. In either case the UE initiates TAU procedure; or
 - 6b. In the case of inter-system redirection to EPS without N26 interface, see clause 4.11.2.2. If the UE supports Request Type flag "handover" for PDN connectivity request during the attach procedure as described in

clause 5.3.2.1 of TS 23.401 [13] and has received the indication that interworking without N26 is supported, then the UE initiates Attach with PDN connectivity request with request type "handover".

In inter-system redirection, the UE uses the emergency indication in the RRC message as specified in clause 6.2.2 of TS 36.331 [16] and E-UTRAN provides the emergency indication to MME during Tracking Area Update or Attach procedure. For the handover procedure see clause 4.11.1.2.1, step 1.

7. After completion of the mobility procedure to EPS or as part of the 5GS to EPS handover procedure (see clause 4.11.1.2.1), the SMF/PGW re-initiates the setup of the dedicated bearer for IMS voice, mapping the 5G QoS to EPC QoS parameters. The PGW-C+SMF behaves as specified in clause 4.9.1.3.1. The PGW-C+SMF reports about Successful Resource Allocation and Access Network Information if subscribed by PCF.
8. The IMS voice session establishment is continued.

At least for the duration of the voice call in EPS the E-UTRAN is configured to not trigger any handover to 5GS.

[TS 24.501, clause 4.8.2.2]

See subclause 5.1.4.2 for coordination between 5GMM and EMM and subclause 6.1.4.1 for coordination between 5GSM and ESM.

[TS 24.501, clause 5.5.1.2.2]

If the UE supports S1 mode, the UE shall:

- set the S1 mode bit to "S1 mode supported" in the 5GMM capability IE of the REGISTRATION REQUEST message;
- include the S1 UE network capability IE in the REGISTRATION REQUEST message; and
- if the UE supports sending an ATTACH REQUEST message containing a PDN CONNECTIVITY REQUEST message with request type set to "handover" to transfer a PDU session from N1 mode to S1 mode, set the HO attach bit to "attach request message containing PDN connectivity request with request type set to handover to transfer PDU session from N1 mode to S1 mode supported" in the 5GMM capability IE of the REGISTRATION REQUEST message.

[TS 24.501, clause 5.5.1.2.4]

If the UE included S1 mode supported indication in the REGISTRATION REQUEST message, the AMF supporting interworking with EPS shall set the IWK N26 bit to either:

- a) "interworking without N26 interface not supported" if the AMF supports N26 interface ; or
- b) "interworking without N26 interface supported" if the AMF does not support N26 interface

in the 5GS network feature support IE in the REGISTRATION ACCEPT message.

The UE supporting S1 mode shall operate in the mode for interworking with EPS as follows:

- a) if the IWK N26 bit in the 5GS network feature support IE is set to "interworking without N26 interface not supported", the UE shall operate in single-registration mode;
- b) if the IWK N26 bit in the 5GS network feature support IE is set to "interworking without N26 interface supported" and the UE supports dual-registration mode, the UE may operate in dual-registration mode; or

NOTE 3: The registration mode used by the UE is implementation dependent.

- c) if the IWK N26 bit in the 5GS network feature support IE is set to "interworking without N26 interface supported" and the UE only supports single-registration mode, the UE shall operate in single-registration mode.

The UE shall treat the received interworking without N26 interface indicator for interworking with EPS as valid in the entire PLMN and its equivalent PLMN(s).

The network informs the UE about the support of specific features, such as IMS voice over PS session, emergency services or emergency services fallback, in the 5GS network feature support information element. In a UE with IMS voice over PS session capability, the IMS voice over PS session indicator, the Emergency services support indicator,

and the Emergency services fallback indicator shall be provided to the upper layers. The upper layers take the IMS voice over PS session indicator into account when selecting the access domain for voice sessions or calls. When initiating an emergency call, the upper layers also take the IMS voice over PS session indicator, the Emergency services support indicator, and the Emergency services fallback indicator into account for the access domain selection.

[TS 24.501, clause 5.1.4.2]

At inter-system change from N1 mode to S1 mode when there is at least one active PDU session for which interworking with EPS is supported as specified in subclause 6.1.4.1, the UE shall enter substates EMM-REGISTERED.NORMAL-SERVICE and 5GMM-REGISTERED.NO-CELL-AVAILABLE and initiate a tracking area updating procedure (see 3GPP TS 24.301 [15]).

[TS 24.501, clause 6.1.4.1]

Upon inter-system change from N1 mode to S1 mode, the UE shall create the default EPS bearer context and the dedicated EPS bearer context(s) based on the parameters of the mapped EPS bearer contexts or the associations between QoS flow and mapped EPS bearer in the PDU session, if available. The EPS bearer identity assigned for the QoS flow of the default QoS rule becomes the EPS bearer identity of the default bearer in the corresponding PDN connection. If there is no EPS bearer identity assigned to the QoS flow of the default QoS rule, the UE shall release locally the PDU session. If there is no EPS bearer identity assigned to the QoS flow(s) which is not associated with the default QoS rule, the UE shall locally delete the QoS rules and the QoS flow level QoS parameters associated with the QoS flow(s). The UE uses the parameters from each PDU session for which interworking with EPS is supported to create corresponding default EPS bearer context and optionally dedicated EPS bearer context(s) as follows:

- a) the PDU session type of the PDU session shall be mapped to the PDN type of the default EPS bearer context as follows:
 - 1) the PDN type shall be set to "non-IP" if the PDU session type is "Ethernet" or "Unstructured";
 - 2) the PDN type shall be set to "IPv4" if the PDU session type is "IPv4";
 - 3) the PDN type shall be set to "IPv6" if the PDU session type is "IPv6"; and
 - 4) the PDN type shall be set to "IPv4v6" if the PDU session type is "IPv4v6";
- b) the PDU address of the PDU session shall be mapped to the PDN address of the default EPS bearer context as follows:
 - 1) the PDN address of the default EPS bearer context is set to the PDU address of the PDU session, if the PDU session type is "IPv4", "IPv6" or "IPv4v6"; and
 - 2) the PDN address of the default EPS bearer context is set to zero, if the PDU session type is "Ethernet" or "Unstructured";
- c) the DNN of the PDU session shall be mapped to the APN of the default EPS bearer context;
- d) the APN-AMBR and extended APN-AMBR received in the parameters of the default EPS bearer context of the mapped EPS bearer contexts shall be mapped to the APN-AMBR and extended APN-AMBR of the default EPS bearer context;
- e) for each PDU session in state PDU SESSION ACTIVE, PDU SESSION MODIFICATION PENDING or PDU SESSION INACTIVE PENDING the UE shall set the state of the mapped EPS bearer context(s) to BEARER CONTEXT ACTIVE; and
- f) for any other PDU session the UE shall set the state of the mapped EPS bearer context(s) to BEARER CONTEXT INACTIVE.

Additionally, for each mapped EPS bearer context or the association between QoS flow and mapped EPS bearer in the PDU session:

- a) the EPS bearer identity shall be set to the EPS bearer identity received in the mapped EPS bearer context, or the EPS bearer identity associated with the QoS flow;
- b) the EPS QoS parameters shall be set to the mapped EPS QoS parameters of the EPS bearer received in the mapped EPS bearer context, or the EPS QoS parameters associated with the QoS flow;

- c) the extended EPS QoS parameters shall be set to the mapped extended EPS QoS parameters of the EPS bearer received in the mapped EPS bearer context, or the extended EPS QoS parameters associated with the QoS flow; and
- d) the traffic flow template shall be set to the mapped traffic flow template of the EPS bearer received in the mapped EPS bearer context, or the stored traffic flow template associated with the QoS flow, if available.

After inter-system change from N1 mode to S1 mode, the UE shall associate the PDU session identity, the S-NSSAI, and the session-AMBR with the default EPS bearer context, and for each EPS bearer context mapped from one or more QoS flows, associate the QoS rule(s) for the QoS flow(s) and the QoS flow description(s) for the QoS flow(s) with the EPS bearer context.

After inter-system change from N1 mode to S1 mode, the UE and the SMF shall maintain the PDU session type of the PDU session until the PDN connection corresponding to the PDU session is released if the UE supports non-IP PDN type and the PDU session type is "Ethernet" or "Unstructured".

After inter-system change from N1 mode to S1 mode, the UE and the SMF shall maintain the always-on PDU session indication.

After inter-system change from N1 mode to S1 mode, the UE and the SMF shall maintain the maximum number of supported packet filters until the PDN connection corresponding to the PDU session is released.

[TS 38.331, clause 5.4.3.3]

The UE shall:

- 1> if T390 is running:
 - 2> stop timer T390 for all access categories;
 - 2> perform the actions as specified in 5.3.14.4;
- 1> if the *targetRAT-Type* is set to *eutra*:
 - 2> consider inter-RAT mobility as initiated towards E-UTRA;
 - 2> forward the *nas-SecurityParamFromNR* to the upper layers, if included;
- 1> access the target cell indicated in the inter-RAT message in accordance with the specifications of the target RAT.

[TS 38.331, clause 5.4.3.4]

Upon successfully completing the handover, at the source side the UE shall:

- 1> reset MAC;
- 1> stop all timers that are running;
- 1> release ran-NotificationAreaInfo, if stored;
- 1> release the AS security context including the K_{RRCEnc} key, the K_{RRCint} key, the K_{UPint} key and the K_{UPenc} key, if stored;
- 1> release all radio resources, including release of the RLC entity and the MAC configuration;
- 1> if the E-UTRA *RRCConnectionReconfiguration* message included in the received *MobilityFromNRCommand* does not include *fullConfig*:
 - 2> maintain source RAT configuration of PDCP and SDAP for applicable RBs which is used for target RAT RBs;
- 1> else:
 - 2> release the associated PDCP entity and SDAP entity for all established RBs;
- 1> indicate the release of the RRC connection to upper layers together with the release cause 'other'.

11.1.3.3 Test Description

11.1.3.3.1 Pre-test conditions

System Simulator:

- 2 cells
- NR Cell 1 as defined in TS 38.508-1 [4] Table 4.4.2-3. System information combination NR-6 as defined in TS 38.508-1 [4], sub-clause 4.4.3.1.2.
- E-UTRA Cell 1 as defined in TS 36.508 [7] Table 4.4.2-2. System information combination 31 as defined in TS 36.508 [7], sub-clause 4.4.3.1.1.
- N26 interface is configured.
- Power levels are constant and as defined in Tables 11.1.3.3.1-1/2.

Table 11.1.3.3.1-1: Time instances of cell power level and parameter changes for conducted test environment

	Parameter name	Unit	NR Cell 1	E-UTRA Cell 1	Remark
T0	SS/PBCH SSS EPRE	dBm/SCS	-88	-	
	RS EPRE	dBm/15kHz	-	-91	

Table 11.1.3.3.1-2: Time instances of cell power level and parameter changes for OTA test environment

	Parameter name	Unit	NR Cell 1	E-UTRA Cell 1	Remark
T0	SS/PBCH SSS EPRE	dBm/SCS	-82	-	
	RS EPRE	dBm/15kHz	-	-91	

UE:

- The UE is configured to not use IMS preconditions.

Preamble:

- With E-UTRA Cell 1 "Serving cell" and NR Cell 1 "Non-suitable "Off" cell" in accordance with TS 38.508-1 [4], Table 6.2.2.1-3, the UE is brought to state RRC_IDLE using generic procedure parameters Connectivity (*E-UTRA/EPC*) and Unrestricted nr PDN (*On*) in accordance with the procedure described in TS 38.508-1 [4], clause 4.5.2. 4G GUTI and eKSI are assigned and security context established.
- The UE is switched-off.
- With E-UTRA Cell 1 "Non-suitable "Off" cell" and NR Cell 1 "Serving cell" in accordance with TS 38.508-1 [4], Table 6.2.2.1-3, the UE is brought to state 1N-A, RRC_IDLE Connectivity (NR) with at least one IMS PDU session on NR Cell 1, in accordance with the procedure described in TS 38.508-1 [4], Table 4.5.2.2-2. 5G-GUTI and ngKSI are assigned.

11.1.3.3.2 Test procedure sequence

Table 11.1.3.3.2-1: Main behaviour

St	Procedure	Message Sequence	TP	Verdict
----	-----------	------------------	----	---------

		U - S	Message		
1	Void	-	-	-	-
-	The following messages are to be observed on NR Cell 1 unless explicitly stated otherwise.	-	-	-	-
2	The SS transmits a <i>Paging</i> message.	<--	NR RRC: <i>Paging</i>	-	-
3	The UE transmits an <i>RRCSetupRequest</i> message.	-->	NR RRC: <i>RRCSetupRequest</i>	-	-
4-9	Steps 3 to 8 of the NR RRC_CONNECTED procedure in TS 38.508-1 [4] Table 4.5.4.2-3 are executed to successfully complete the service request procedure.	-	-	-	-
9A	Set the power levels according to "T0" as per Table 11.1.3.3.1-1/2.	-	-	-	-
10a1	Void	-	-	-	-
11	Make the UE attempt an MTSI MO Speech Call.	-	-	-	-
12-16	Steps 1-5 of the MTSI MO speech call for 5GS procedure according to Annex A.9.1 of TS 34.229-5 [41] take place.	-	-	-	-
17	The SS transmits a <i>MobilityFromNRCommand</i> message which includes targetRAT-Type set to eutra according to 38.508-1 [4] Table 4.6.1-8.	<--	NR RRC: <i>MobilityFromNRCommand</i>	-	-
-	The following messages are to be observed on E-UTRA Cell 1 unless explicitly stated otherwise.	-	-	-	-
18	Check: Does the UE transmit an <i>RRCConnectionReconfigurationComplete</i> message to confirm the successful completion of handover?	-->	RRC: <i>RRCConnectionReconfigurationComplete</i>	1	P
19	The UE transmits an <i>ULInformationTransfer</i> message on the cell specified in the test case. This message includes a TRACKING AREA UPDATE REQUEST message.	-->	RRC: <i>ULInformationTransfer</i> NAS: TRACKING AREA UPDATE REQUEST	1	P
20-23	Steps 4a1-6 of the generic test procedure in TS 38.508-1 [4] Table 4.9.7.2.2-1 for N1 to S1 Inter mode change with condition 'connected without release' & 'mapped 5G security context' are performed to make sure successfully camped on E-UTRAN cell upon mobility from NR.	-	-	-	-
24	The SS configures a new RLC-UM data radio bearer with condition DRB (0,1), associated with the dedicated EPS bearer context. <i>RRCConnectionReconfiguration</i> message contains the ACTIVATE DEDICATED EPS BEARER CONTEXT REQUEST message. EPS bearer context #4 (QCI 1) according to TS 36.508 [7] Table 6.6.2-1: Reference dedicated EPS bearer contexts. Reference dedicated EPS bearer contexts is to establish the dedicated EPS bearer context on IMS PDN.	<--	RRC: <i>RRCConnectionReconfiguration</i> NAS: ACTIVATE DEDICATED EPS BEARER CONTEXT REQUEST	-	-
-	EXCEPTION: In parallel to the events described in steps 25-28 below, the steps specified in table 11.1.3.3.2-2 will take place.	-	-	-	-
25	The UE transmits an <i>RRCConnectionReconfigurationComplete</i> message.	-->	RRC: <i>RRCConnectionReconfigurationComplete</i>	-	-
26	The UE transmits an <i>ULInformationTransfer</i> message including the ACTIVATE DEDICATED EPS BEARER CONTEXT ACCEPT message.	-->	RRC: <i>ULInformationTransfer</i> NAS: ACTIVATE DEDICATED EPS BEARER CONTEXT ACCEPT	-	-
27	The SS waits 1 second for call duration.	-	-	-	-
28a1	Void	-	-	-	-

29	Release IMS Call as specified in the generic procedure in TS 34.229-1 [35] subclause C.32.	-	-	-	-
----	--	---	---	---	---

Table 11.1.3.3.2-2: Parallel behaviour

St	Procedure	Message Sequence		TP	Verdict
		U - S	Message		
-	EXCEPTION: Steps 1a1 to 1b7 describe behaviour that depends on the UE capability; the "lower case letter" identifies a step sequence that take place if a capability is supported	-	-	-	-
1a1-a2	The UE performs IMS re-registration on EUTRAN as per steps 1-2 as defined in TS 34.229-1 [35] C.46.	-	-	-	-
1a3-1a6A	Steps 1-5 clause A.9.2 "EPS Fallback for Voice Call / steps after fallback / 5GS" of TS 34.229-5 [41] take place.	-	-	-	-
1a7	Check: Does the UE perform step 6 of the generic procedure "EPS Fallback for Voice Call / steps after fallback / 5GS" as defined in Appendix A.9.2 of TS 34.229-5 [41]	-->	SIP: ACK	1	P

11.1.3.3.3 Specific message contents

Table 11.1.3.3.3-1: REGISTRATION REQUEST (preamble, Table 11.1.3.3.2-1)

Derivation path: TS 38.508-1 [4] Table 4.7.1-6			
Information Element	Value/remark	Comment	Condition
5GMM capability			
S1 mode	'1'B	S1 mode supported	
S1 UE network capability	Present but contents not checked		

Table 11.1.3.3.3-2: REGISTRATION ACCEPT (preamble, Table 11.1.3.3.2-1)

Derivation path: TS 38.508-1 [4] Table 4.7.1-7			
Information Element	Value/remark	Comment	Condition
5GS network feature support			
IMS- VoPS-3GPP	'1'B	IMS voice over PS session supported over 3GPP access	
IWK N26	'0'B	Interworking without N26 interface not supported	

Table 11.1.3.3.3-3: PDU SESSION ESTABLISHMENT ACCEPT (preamble for PDU Session for PS data, Table 11.1.3.3.2-1)

Derivation path: TS 38.508-1 [4] Table 4.7.2-2, condition Interworking_with_EPS

Table 11.1.3.3.3-4: PDU SESSION ESTABLISHMENT ACCEPT (preamble for IMS PDU Session, Table 11.1.3.3.2-1)

Derivation path: TS 38.508-1 [4] Table 4.7.2-2, condition Interworking_with_EPS, IMS_DNN_Requested
--

Table 11.1.3.3.3-5: Void

Table 11.1.3.3.3-6: MobilityFromNRCommand (step 17, Table 11.1.3.3.2-1)

Derivation path: TS 38.508-1 [4] Table 4.6.1-8			
Information Element	Value/remark	Comment	Condition
MobilityFromNRCommand ::= SEQUENCE {			
rrc-TransactionIdentifier	RRC-TransactionIdentifier		
criticalExtensions CHOICE {			
mobilityFromNRCommand SEQUENCE {			
targetRAT-Type	eutra		
targetRAT-MessageContainer	RRCConnectionReconfiguration		
nas-SecurityParamFromNR	8 LSB of the downlink NAS COUNT		
}			
}			
}			
}			

Table 11.1.3.3.3-7: RRCConnectionReconfiguration (Table 11.1.3.3.3-6)

Derivation path: TS 36.508-1 [4], Table 4.6.1-8 condition HO-TO-EUTRA(n,0)
--

Table 11.1.3.3.3-8: MobilityControllInfo (Table 11.1.3.3.3-7)

Derivation path: TS 36.508 [7], Table 4.6.5-1			
Information Element	Value/remark	Comment	Condition
MobilityControllInfo ::= SEQUENCE {			
targetPhysCellId	PhysicalCellIdentity of E-UTRA Cell 1		
carrierFreq SEQUENCE {			
dl-CarrierFreq	Same downlink EARFCN as used for E-UTRA Cell 1		
}			
carrierFreq	Not present		Band > 64
carrierBandwidth SEQUENCE {			
dl-Bandwidth	Downlink system bandwidth under test.		
ul-Bandwidth	Uplink Bandwidth under test.		FDD
ul-Bandwidth	Not present		TDD
}			
additionalSpectrumEmission	1		HO-to-EUTRA

carrierFreq-v9e0 SEQUENCE {			Band > 64
dl-CarrierFreq-v9e0	Same downlink EARFCN as used for E-UTRA Cell 1		
}			
}			

Condition	Explanation
FDD	FDD cell environment
TDD	TDD cell environment
Band > 64	If band > 64 is selected

Table 11.1.3.3.3-9: TRACKING AREA UPDATE REQUEST (step 19, Table 11.1.3.3.2-1)

Derivation Path: TS 38.508-1[4] Table 4.9.7.2.3-1.			
Information Element	Value/remark	Comment	Condition
EPS update type			
"Active" flag	AnyValue		
EPS bearer context status	Not checked	EBI corresponding to active PDU Sessions need to be set to 1	

11.1.3a MO MMTEL enhanced voice service call setup from NR RRC_CONNECTED / EPS Fallback with handover / Single registration mode with N26 interface / Success

11.1.3a.1 Test Purpose (TP)

(1)

```

with { UE supporting both S1 mode and N1 mode and configured to use preconditions and configured to use the EVS default configuration and the UE is in NR RRC_CONNECTED state }
ensure that {
  when { User initiates a MMTEL call, the MO IMS voice call has been initiated and the UE receives a MobilityFromNRCommand message which includes targetRAT-Type set to eutra an RRCRelease message which includes redirectedCarrierInfo indicating redirection to E-UTRA }
  then { UE performs a handover to the E-UTRA including a TAU procedure, and, successfully completes the voice call setup in EPS using EVS }
}
    
```

11.1.3a.2 Conformance requirements

References: The conformance requirements covered in the present TC are specified in: TS 38.331 clause 5.4.3.3, 5.4.3.4 and TS 26.114 clause 5.2.1.1.

[TS 38.331, clause 5.4.3.3]

The UE shall:

- 1> if T390 is running:
- 2> stop timer T390 for all access categories;

2> perform the actions as specified in 5.3.14.4;

1> if the *targetRAT-Type* is set to *eutra*:

2> consider inter-RAT mobility as initiated towards E-UTRA;

2> forward the *nas-SecurityParamFromNR* to the upper layers, if included;

1> access the target cell indicated in the inter-RAT message in accordance with the specifications of the target RAT.

[TS 38.331, clause 5.4.3.4]

Upon successfully completing the handover, at the source side the UE shall:

1> reset MAC;

1> stop all timers that are running;

1> release *ran-NotificationAreaInfo*, if stored;

1> release the AS security context including the K_{RRCEnc} key, the K_{RRCint} key, the K_{UPint} key and the K_{UPenc} key, if stored;

1> release all radio resources, including release of the RLC entity and the MAC configuration;

1> if the E-UTRA *RRCConnectionReconfiguration* message included in the received *MobilityFromNRCommand* does not include *fullConfig*:

2> maintain source RAT configuration of PDCP and SDAP for applicable RBs which is used for target RAT RBs;

1> else:

2> release the associated PDCP entity and SDAP entity for all established RBs;

1> indicate the release of the RRC connection to upper layers together with the release cause 'other'.

[TS 26.114, clause 5.2.1.1]

MTSI clients in terminals offering speech communication shall support narrowband, wideband and super-wideband communication.

...

MTSI clients in terminals offering super-wideband or fullband speech communication shall support:

- EVS codec ...

11.1.3a.3 Test Description

11.1.3a.3.1 Pre-test conditions

System Simulator:

- NR Cell 1, E-UTRA Cell 1.
- System information for the NR Cell 1 in accordance with combination NR-6 in TS 38.508-1 [4] sub-clause 4.4.3.1.2, and, for the E-UTRA Cell 1 in accordance with system information combination 31 as defined in TS 36.508 [7], subclause 4.4.3.1.1.
- Power levels are constant and as defined in Tables 11.1.3a.3.1-1/2.

Table 11.1.3a.3.1-1: Time instances of cell power level and parameter changes for FR1

	Parameter name	Unit	NR Cell 1	E-UTRA Cell 1	Remark
T0	SS/PBCH	dBm/SCS	-88		

	SSS EPRE				
	RS EPRE	dBm/15kHz		-85	

Table 11.1.3a.3.1-2: Time instances of cell power level and parameter changes for FR2

	Parameter name	Unit	NR Cell 1	E-UTRA Cell 1	Remark
T0	SS/PBCH SSS EPRE	dBm/SCS	-82	-	
	RS EPRE	dBm/15kHz	-	-85	

UE:

- The UE is configured to use preconditions.

Preamble:

- With E-UTRA Cell 1 "Serving cell" and NR Cell 1 "Non-suitable "Off" cell" in accordance with TS 38.508-1 [4], Table 6.2.2.1-3, the UE is brought to state RRC_IDLE using generic procedure parameters Connectivity (*E-UTRA/EPC*) and Unrestricted nr PDN (*On*) in accordance with the procedure described in TS 38.508-1 [4], clause 4.5.2. 4G GUTI and eKSI are assigned and security context established.
- the UE is switched-off.
- With E-UTRA Cell 1 "Non-suitable "Off" cell" and NR Cell 1 "Serving cell" in accordance with TS 38.508-1 [4], Table 6.2.2.1-3, the UE is brought to state 1N-A, RRC_IDLE Connectivity (*NR*), in accordance with the procedure described in TS 38.508-1 [4], Table 4.5.2.2-2. 5G-GUTI and ngKSI are assigned and security context established.

11.1.3a.3.2 Test procedure sequence

Table 11.1.3a.3.2-1: Main behaviour

St	Procedure	Message Sequence		TP	Verdict
		U - S	Message		
-	The following messages are to be observed on NR Cell 1 unless explicitly stated otherwise.	-	-	-	-
1	The SS transmits a <i>Paging</i> message.	<--	NR RRC: <i>Paging</i>	-	-
2	The UE transmits an <i>RRCSetupRequest</i> message.	-->	NR RRC: <i>RRCSetupRequest</i>	-	-
3-7	Steps 3 to 8 of the NR RRC_CONNECTED procedure in TS 38.508-1 [4] Table 4.5.4.2-3 are executed to successfully complete the service request procedure.	-	-	-	-
8	Set the power levels according to "T0" as per Table 11.1.3a.3.1-1/2.	-	-	-	-
9	Make the UE attempt an IMS voice call.	-	-	-	-
10-14	Steps 1-5 of expected sequence from A.4.1a as defined in TS 34.229-5 [41] are performed for initiating an MTSI MO speech call.	-	-	-	-
15	The SS transmits a <i>MobilityFromNRCommand</i> message which includes targetRAT-Type set to <i>eutra</i> according to 38.508-1 [4] Table 4.6.1-8.	<--	NR RRC: <i>MobilityFromNRCommand</i>	-	-
-	The following messages are to be observed on E-UTRA Cell 1 unless explicitly stated otherwise.	-	-	-	-
16	Check: Does the UE transmit an <i>RRCConnectionReconfigurationComplete</i> message to confirm the successful	-->	RRC: <i>RRCConnectionReconfigurationComplete</i>	1	P

	completion of handover?				
17	The UE transmits an <i>ULInformationTransfer</i> message on the cell specified in the test case. This message includes a TRACKING AREA UPDATE REQUEST message.	-->	RRC: <i>ULInformationTransfer</i> NAS: TRACKING AREA UPDATE REQUEST	1	P
18-21	Steps 4a1-6 of the generic test procedure in TS 38.508-1 [4] Table 4.9.7.2.2-1 for N1 to S1 Inter mode change with condition 'connected without release' & 'mapped 5G security context' are performed to make sure successfully camped on E-UTRAN cell upon mobility from NR.	-	-	-	-
22	The SS configures a new RLC-UM data radio bearer with condition DRB (0,1), associated with the dedicated EPS bearer context. <i>RRCConnectionReconfiguration</i> message contains the ACTIVATE DEDICATED EPS BEARER CONTEXT REQUEST message. EPS bearer context #4 (QCI 1) according to TS 36.508 [7] Table 6.6.2-1: Reference dedicated EPS bearer contexts. Reference dedicated EPS bearer contexts is to establish the dedicated EPS bearer context on IMS PDN.	<--	RRC: <i>RRCConnectionReconfiguration</i> NAS: ACTIVATE DEDICATED EPS BEARER CONTEXT REQUEST	-	-
-	EXCEPTION: In parallel to the events described in steps 23-24 the steps specified in table 11.1.3a.3.2-2 will take place.	-	-	-	-
23	The UE transmits an <i>RRCConnectionReconfigurationComplete</i> message.	-->	RRC: <i>RRCConnectionReconfigurationComplete</i>	-	-
24	The UE transmits an <i>ULInformationTransfer</i> message including the ACTIVATE DEDICATED EPS BEARER CONTEXT ACCEPT message.	-->	RRC: <i>ULInformationTransfer</i> NAS: ACTIVATE DEDICATED EPS BEARER CONTEXT ACCEPT	-	-
24A	The SS waits 1 second for call duration.	-	-	-	-
25	Release IMS Call as specified in the generic procedure in TS 34.229-1 [35] subclause C.32.	-	-	-	-

Table 11.1.3a.3.2-2: Parallel behaviour

St	Procedure	Message Sequence		TP	Verdict
		U - S	Message		
1-6	Steps 6-11 of expected sequence from A.4.1a as defined in TS 34.229-5 [41] are performed for initiating an MTSI MO speech call.	-	-	-	-
7	Step 12 of expected sequence from A.4.1a as defined in TS 34.229-5 [41] is performed for initiating an MTSI MO speech call.	-	-	1	P

11.1.3a.3.3 Specific message contents

Table 11.1.3a.3.3-1: REGISTRATION REQUEST (preamble, Table 11.1.3a.3.2-1)

Derivation path: TS 38.508-1 [4] Table 4.7.1-6			
Information Element	Value/remark	Comment	Condition
5GMM capability			
S1 mode	'1'B	S1 mode supported	
S1 UE network capability	Present but contents not checked		

Table 11.1.3a.3.3-2: REGISTRATION ACCEPT (preamble, Table 11.1.3a.3.2-1)

Derivation path: TS 38.508-1 [4] Table 4.7.1-7			
Information Element	Value/remark	Comment	Condition
5GS network feature support			
IMS- VoPS-3GPP	'1'B	IMS voice over PS session supported over 3GPP access	
IWK N26	'0'B	Interworking without N26 interface not supported	

Table 11.1.3a.3.3-3: PDU SESSION ESTABLISHMENT ACCEPT (preamble for PDU Session for PS data, Table 11.1.3a.3.2-1)

Derivation path: TS 38.508-1 [4] Table 4.7.2-2, condition Interworking_with_EPS

Table 11.1.3a.3.3-4: PDU SESSION ESTABLISHMENT ACCEPT (preamble for IMS PDU Session, Table 11.1.3a.3.2-1)

Derivation path: TS 38.508-1 [4] Table 4.7.2-2, condition Interworking_with_EPS, IMS_DNN_Requested
--

Table 11.1.3a.3.3-5: MobilityFromNRCommand (step 15, Table 11.1.3a.3.2-1)

Derivation path: TS 38.508-1 [4] Table 4.6.1-8			
Information Element	Value/remark	Comment	Condition
MobilityFromNRCommand ::= SEQUENCE {			
rrc-TransactionIdentifier	RRC-TransactionIdentifier		
criticalExtensions CHOICE {			
mobilityFromNRCommand SEQUENCE {			
targetRAT-Type	eutra		
targetRAT-MessageContainer	RRCConnectionReconfiguration		
nas-SecurityParamFromNR	8 LSB of the downlink NAS COUNT		
}			
}			
}			

Table 11.1.3a.3.3-6: RRCConnectionReconfiguration (Table 11.1.3a.3.3-5)

Derivation path: TS 36.508-1 [4], Table 4.6.1-8 condition HO-TO-EUTRA(n,0)
--

Table 11.1.3a.3.3-7: MobilityControllInfo (Table 11.1.3a.3.3-6)

Derivation path: TS 36.508 [7], Table 4.6.5-1			
Information Element	Value/remark	Comment	Condition
MobilityControllInfo ::= SEQUENCE {			
targetPhysCellId	PhysicalCellIdentity of E-UTRA Cell 1		
carrierFreq SEQUENCE {			

dl-CarrierFreq	Same downlink EARFCN as used for E-UTRA Cell 1		
}			
carrierFreq	Not present		Band > 64
carrierBandwidth SEQUENCE {			
dl-Bandwidth	Downlink system bandwidth under test.		
ul-Bandwidth	Uplink Bandwidth under test.		FDD
ul-Bandwidth	Not present		TDD
}			
additionalSpectrumEmission	1		HO-to-EUTRA
carrierFreq-v9e0 SEQUENCE {			Band > 64
dl-CarrierFreq-v9e0	Same downlink EARFCN as used for E-UTRA Cell 1		
}			
}			

Condition	Explanation
FDD	FDD cell environment
TDD	TDD cell environment
Band > 64	If band > 64 is selected

Table 11.1.3a.3.3-8: TRACKING AREA UPDATE REQUEST (step 17, Table 11.1.3a.3.2-1)

Derivation Path: TS 38.508-1 [4] Table 4.9.7.2.3-1.			
Information Element	Value/remark	Comment	Condition
EPS update type			
"Active" flag	AnyValue		
EPS bearer context status	Not checked	EBI corresponding to active PDU Sessions need to be set to 1	

11.1.4 MO MMTEL voice call setup from NR RRC_CONNECTED / EPS Fallback with redirection / Single registration mode with N26 interface / E-UTRAN cell selection using cell status barred / Success

11.1.4.1 Test Purpose (TP)

(1)

```
with { UE supporting both S1 mode and N1 mode and operating in single-registration mode, and, the Network has indicated "interworking without N26 interface not supported", and, the UE in NR RRC_CONNECTED state }  
ensure that {  
  when { User initiates a MMTEL call, the MO IMS voice session establishment has been initiated and the UE receives a RRCRelease message which includes redirectedCarrierInfo indicating redirection to eutra, and, an E-UTRA cell on the frequency indicated by redirectedCarrierInfo is found with cell status "barred" and another E-UTRA cell is found on another frequency with cell status "notBarred" }  
  then { UE selects the E-UTRA cell with cell status "notBarred", performs a TAU procedure, and, the UE successfully completes the MO MMTEL call in EPS }  
}
```

11.1.4.2 Conformance requirements

References: The conformance requirements covered in the present test case are specified in: TS 23.502, clauses 4.13.6.1 and 4.11.1.3.2, TS 24.501, clauses 4.8.2.2, 5.1.4.2 and 6.1.4.1, TS 38.331, clauses 5.3.3.2, 5.3.3.3, 5.3.8.3 and 5.3.11; TS 38.304, clause 5.2.6, TS 36.304 clause 5.3.1. Unless otherwise stated these are Rel-15 requirements.

[TS 23.502, clause 4.13.6.1]

Figure 4.13.6.1-1 describes the EPS fallback procedure for IMS voice.

When the UE is served by the 5G System, the UE has one or more ongoing PDU Sessions each including one or more QoS Flows. The serving PLMN AMF has sent an indication towards the UE during the Registration procedure that IMS voice over PS session is supported, see clause 5.16.3.10 in TS 23.501 [2] and the UE has registered in the IMS. If N26 is not supported, the serving PLMN AMF sends an indication towards the UE during the Registration procedure that interworking without N26 is supported, see clause 5.17.2.3.1 in TS 23.501 [2].

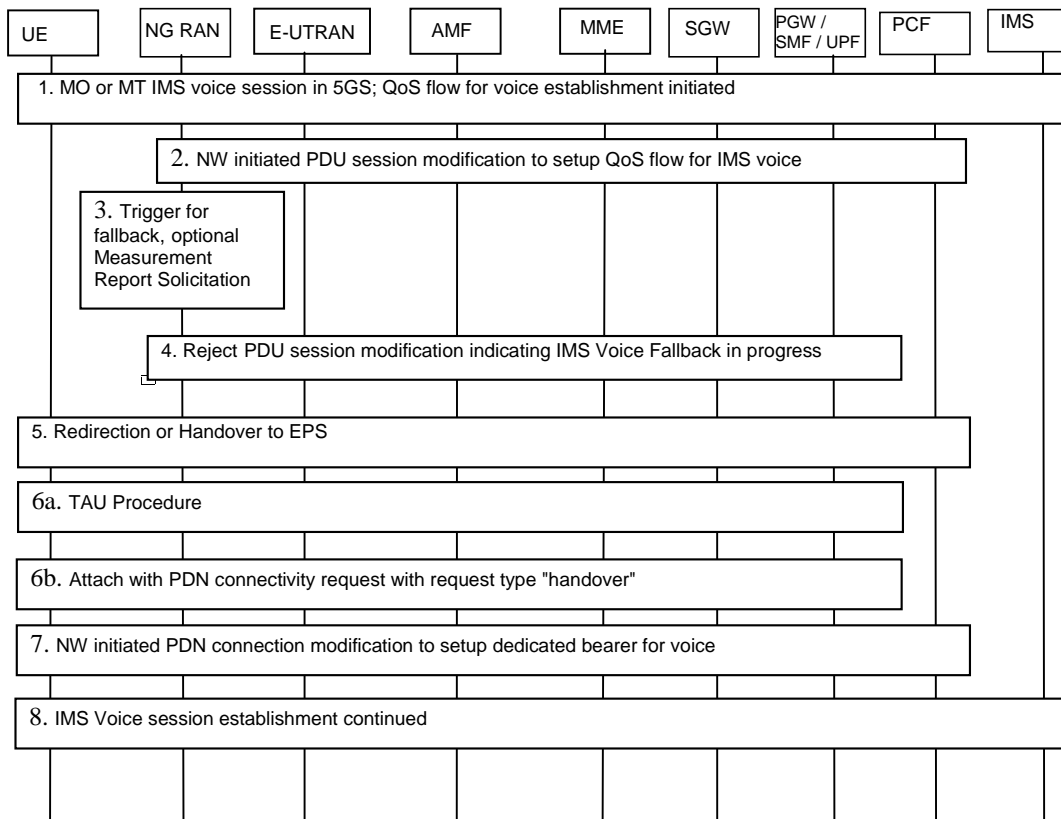

Figure 4.13.6.1-1: EPS Fallback for IMS voice

1. UE camps on NG-RAN in the 5GS and an MO or MT IMS voice session establishment has been initiated.
2. Network initiated PDU Session modification to setup QoS flow for voice reaches the NG-RAN (see N2 PDU Session Request in clause 4.3.3).
3. NG-RAN is configured to support EPS fallback for IMS voice and decides to trigger fallback to EPS, taking into account UE capabilities, indication from AMF that "Redirection for EPS fallback for voice is possible" (received as part of initial context setup as defined in TS 38.413 [10]), network configuration (e.g. N26 availability configuration) and radio conditions. If NG-RAN decides not to trigger fallback to EPS, then the procedure stops here and following steps are not executed.

NG-RAN may initiate measurement report solicitation from the UE including E-UTRAN as target.

NOTE 1: If AMF has indicated that "Redirection for EPS fallback for voice is not possible", then AN Release via inter-system redirection to EPS is not performed in step 5.

4. NG-RAN responds indicating rejection of the PDU Session modification to setup QoS flow for IMS voice received in step 2 by PDU Session Response message towards the PGW-C+SMF (or H-SMF+P-GW-C via V-SMF, in case of roaming scenario) via AMF with an indication that mobility due to fallback for IMS voice is ongoing. The PGW-C+SMF maintains the PCC rule(s) associated with the QoS Flow(s).
5. NG-RAN initiates either handover (see clause 4.11.1.2.1), or AN Release via inter-system redirection to EPS (see clause 4.2.6 and clause 4.11.1.3.2), taking into account UE capabilities. The PGW-C+SMF reports change of the RAT type if subscribed by PCF as specified in clause 4.11.1.2.1, or clause 4.11.1.3.2.6. When the UE is connected to EPS, either 6a or 6b is executed
 - 6a. In the case of 5GS to EPS handover, see clause 4.11.1.2.1, and in the case of inter-system redirection to EPS with N26 interface, see clause 4.11.1.3.2. In either case the UE initiates TAU procedure; or
 - 6b. In the case of inter-system redirection to EPS without N26 interface, see clause 4.11.2.2. If the UE supports Request Type flag "handover" for PDN connectivity request during the attach procedure as described in

clause 5.3.2.1 of TS 23.401 [13] and has received the indication that interworking without N26 is supported, then the UE initiates Attach with PDN connectivity request with request type "handover".

In inter-system redirection, the UE uses the emergency indication in the RRC message as specified in clause 6.2.2 of TS 36.331 [16] and E-UTRAN provides the emergency indication to MME during Tracking Area Update or Attach procedure. For the handover procedure see clause 4.11.1.2.1, step 1.

7. After completion of the mobility procedure to EPS or as part of the 5GS to EPS handover procedure (see clause 4.11.1.2.1), the SMF/PGW re-initiates the setup of the dedicated bearer for IMS voice, mapping the 5G QoS to EPC QoS parameters. The PGW-C+SMF behaves as specified in clause 4.9.1.3.1. The PGW-C+SMF reports about Successful Resource Allocation and Access Network Information if subscribed by PCF.
8. The IMS voice session establishment is continued.

At least for the duration of the voice call in EPS the E-UTRAN is configured to not trigger any handover to 5GS.

[TS 23.502, clause 4.11.1.3.2]

Clause 4.11.1.3.2 covers the case of idle mode mobility from 5GC to EPC. UE performs Tracking Area Update procedure in E-UTRA/EPS when it moves from NG-RAN/5GS to E-UTRA/EPS coverage area.

The procedure involves a Tracking Area Update to EPC and setup of default EPS bearer and dedicated bearers in EPC in steps 1-11 and re-activation, if required.

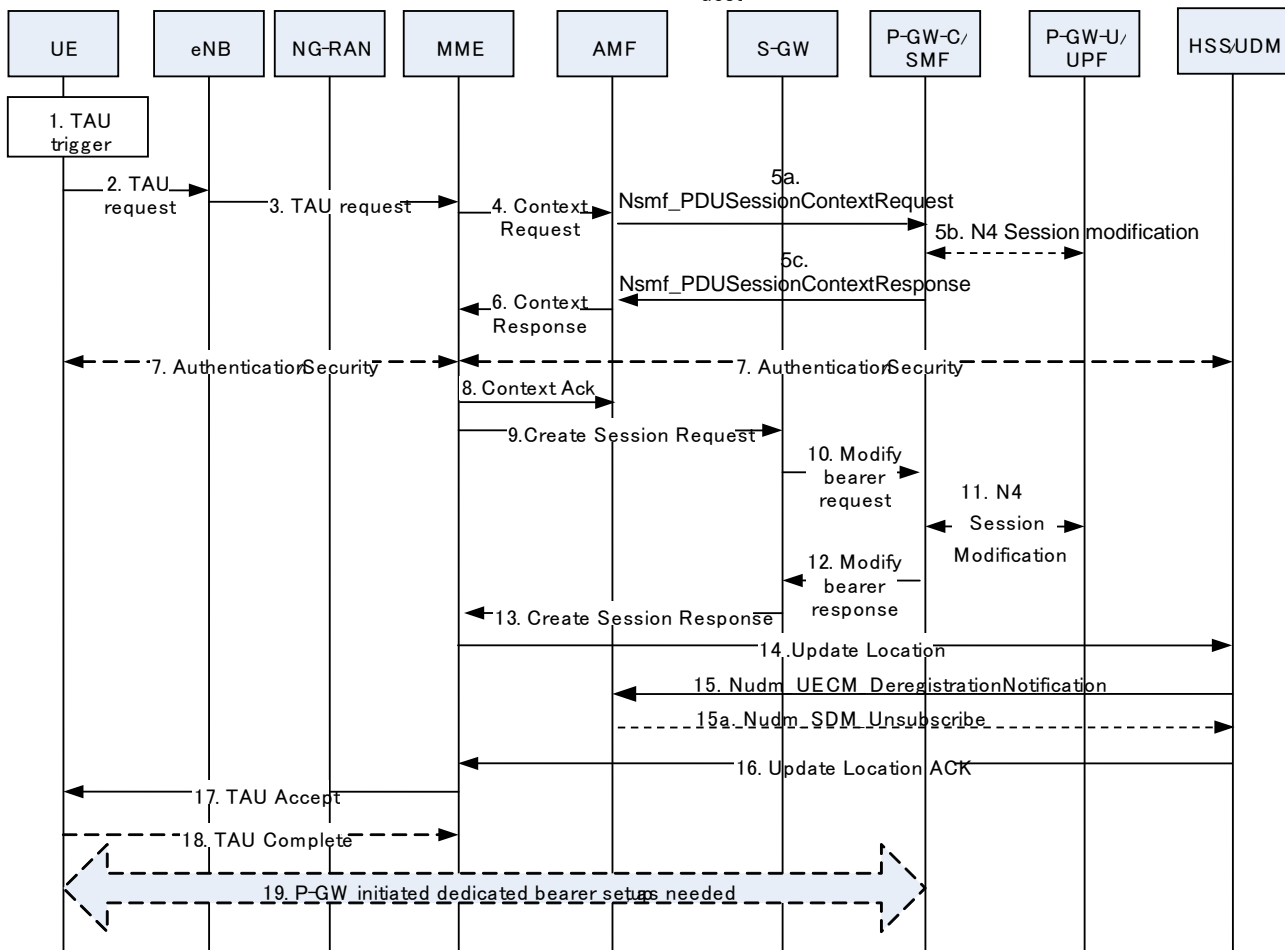

Figure 4.11.1.3.2-1: 5GS to EPS Idle mode mobility using N26 interface

The TAU procedure in TS 23.401 [13] is used with the following 5GS interaction:

1. Step 1 from clause 5.3.3.1 (Tracking Area Update procedure with Serving GW change) in TS 23.401 [13].

2. Step 2 from clause 5.3.3.1 (Tracking Area Update procedure with Serving GW change) in TS 23.401 [13] with the modification captured in clause 4.11.1.5.3.
- 3-4. Steps 3-4 from clause 5.3.3.1 (Tracking Area Update procedure with Serving GW change) in TS 23.401 [13].
- 5a. The AMF verifies the integrity of the TAU request message and requests the PGW-C+SMF to provide SM Context by using Nsmf_PDUSession_ContextRequest that also includes the mapped EPS Bearer Contexts. The AMF provides the target MME capability to SMF in the request to allow the SMF to determine whether to include EPS Bearer context for non-IP PDN Type or not. This step is performed with all the PGW-C+SMFs corresponding to PDU Sessions of the UE which are associated with 3GPP access and have EBI(s) allocated to them. In this step, if the AMF correctly validates the UE, then the AMF starts a timer.

NOTE 1: The AMF knows the MME capability to support non-IP PDN type or not through local configuration.

- 5b. For Non-roaming or roaming with local breakout scenario, if CN Tunnel Info is allocated by the PGW-U+UPF, the SMF sends N4 Session Modification Request to PGW-U+UPF to establish the tunnel for each EPS bearers, and PGW-U+UPF provides the PGW-U Tunnel Info for each EPS bearers to PGW-C+SMF.

NOTE2: In home routed roaming case, the CN Tunnel Info for each EPS bearer has been prepared by the PGW-C+SMF and provided to the V-SMF as specified in clause 4.11.1.4.1.

- 5c. SMF returns mapped EPS bearer contexts, which includes PGW-C control plane tunnel information of the PDN connection corresponding to the PDU session, EBI for each EPS bearer, PGW-U tunnel information for each EPS bearer, and EPS QoS parameters for each EPS bearer. For PDU Sessions with PDU Session Type Ethernet or Unstructured, the SMF provides SM Context for non-IP PDN Type.
6. The AMF responds with a Context Response message carrying mapped MM context (including mapped security context), Return preferred and SM EPS UE Context (default and dedicated GBR bearers) to the MME. If the verification of the integrity protection fails, the AMF returns an appropriate error cause. Return preferred is an optional indication by the AMF of a preferred return of the UE to the 5GS PLMN at a later access change to a 5GS shared network. The AMF may start an implementation specific (guard) timer for the UE context.
- 7 - 14. Steps 6-12 from clause 5.3.3.1 (Tracking Area Update procedure with Serving GW change) in TS 23.401 [13] are performed with following addition and modification:

In the step 10, If the QoS Flow associated with the default QoS rule has an EPS Bearer ID assigned, the PGW-C+SMF keeps the PDU Session (PDN connection) and for the remaining QoS Flows that do not have EPS bearer ID(s) assigned, the PGW-C+SMF deletes the PCC rule(s) associated with those QoS Flows and informs the PCF about the removed PCC rule(s).

In the step 11, the PGW-C+SMF requests the PGW-U+UPF to establish the tunnel for each EPS bearer by providing SGW-U Tunnel Info, and PGW-U Tunnel Info if the PGW-U Tunnel Info is allocated by the PGW-C+SMF.

In step 10, the PGW-C+SMF may need to report some subscribed event to the PCF by performing an SMF initiated SM Policy Association Modification procedure as defined in clause 4.16.5.

Step 9a from clause 5.3.3.1 (Tracking Area Update procedure with Serving GW change) in TS 23.401 [13] with the modification captured in clause 4.11.1.5.3

- 15a. The HSS+UDM invokes Nudm_UECM_DeregistrationNotification to notify the AMF associated with 3GPP access with reason as 5GS to EPS Mobility. If the timer started in step 6 is not running, the old AMF removes the UE context. Otherwise, the AMF may remove UE context when the timer expires. The AMF request the release of the PDU Session which is associated with 3GPP access, not expected to be transferred to EPC, i.e. no EBI(s) allocated to them, and corresponding to the PGW-C+SMF which is not contacted by AMF for SM context at step 5a. The AMF requests the release of the SM context in the V-SMF only, for Home Routed PDU Session with EBIs allocated. The 5GC may also keep UE context to allow the use of native security parameters when UE moves back from EPS to 5GS later.

Registration associated with the non-3GPP access in the AMF is not removed (i.e. an AMF that was serving the UE over both 3GPP and non-3GPP accesses does not consider the UE as deregistered over non 3GPP access and will remain registered and subscribed to subscription data updates in UDM).

When the UE decides to deregister over non-3GPP access or the old AMF decides not to maintain a UE registration for non-3GPP access anymore, the old AMF then deregisters from UDM by sending a

Nudm_UECM_Deregistration service operation, unsubscribes from Subscription Data updates by sending an Nudm_SDM_Unsubscribe service operation to UDM and releases all the AMF and AN resources related to the UE.

16 - 18. Steps 17-21 from clause 5.3.3.1 (Tracking Area Update procedure with Serving GW change) in TS 23.401 [13] with the following modification:

The MME may provide the eNodeB with a PLMN list in the Handover Restriction List taking into account the last used 5GS PLMN ID and the Return preferred indication. The Handover Restriction List contains a list of PLMN IDs as specified by TS 23.251 [35] clause 5.2a for eNodeB functions.

The MME may not release the signalling connection with the UE based on the indication received in the step 1 that the UE is moving from 5GC.

19. [conditional] Step 19 from clause 4.11.1.2.1 applies.

[TS 24.501, clause 4.8.2.2]

See subclause 5.1.4.2 for coordination between 5GMM and EMM and subclause 6.1.4.1 for coordination between 5GSM and ESM.

[TS 24.501, clause 5.1.4.2]

At inter-system change from N1 mode to S1 mode when there is at least one active PDU session for which interworking with EPS is supported as specified in subclause 6.1.4.1, the UE shall enter substates EMM-REGISTERED.NORMAL-SERVICE and 5GMM-REGISTERED.NO-CELL-AVAILABLE and initiate a tracking area updating procedure (see 3GPP TS 24.301 [15]).

[TS 24.501, clause 6.1.4.1]

Upon inter-system change from N1 mode to S1 mode, the UE shall create the default EPS bearer context and the dedicated EPS bearer context(s) based on the parameters of the mapped EPS bearer contexts or the associations between QoS flow and mapped EPS bearer in the PDU session, if available. The EPS bearer identity assigned for the QoS flow of the default QoS rule becomes the EPS bearer identity of the default bearer in the corresponding PDN connection. If there is no EPS bearer identity assigned to the QoS flow of the default QoS rule, the UE shall release locally the PDU session. If there is no EPS bearer identity assigned to the QoS flow(s) which is not associated with the default QoS rule, the UE shall locally delete the QoS rules and the QoS flow level QoS parameters associated with the QoS flow(s). The UE uses the parameters from each PDU session for which interworking with EPS is supported to create corresponding default EPS bearer context and optionally dedicated EPS bearer context(s) as follows:

- a) the PDU session type of the PDU session shall be mapped to the PDN type of the default EPS bearer context as follows:
 - 1) the PDN type shall be set to "non-IP" if the PDU session type is "Ethernet" or "Unstructured";
 - 2) the PDN type shall be set to "IPv4" if the PDU session type is "IPv4";
 - 3) the PDN type shall be set to "IPv6" if the PDU session type is "IPv6"; and
 - 4) the PDN type shall be set to "IPv4v6" if the PDU session type is "IPv4v6";
- b) the PDU address of the PDU session shall be mapped to the PDN address of the default EPS bearer context as follows:
 - 1) the PDN address of the default EPS bearer context is set to the PDU address of the PDU session, if the PDU session type is "IPv4", "IPv6" or "IPv4v6"; and
 - 2) the PDN address of the default EPS bearer context is set to zero, if the PDU session type is "Ethernet" or "Unstructured";
- c) the DNN of the PDU session shall be mapped to the APN of the default EPS bearer context;
- d) the APN-AMBR and extended APN-AMBR received in the parameters of the default EPS bearer context of the mapped EPS bearer contexts shall be mapped to the APN-AMBR and extended APN-AMBR of the default EPS bearer context;

- e) for each PDU session in state PDU SESSION ACTIVE, PDU SESSION MODIFICATION PENDING or PDU SESSION INACTIVE PENDING the UE shall set the state of the mapped EPS bearer context(s) to BEARER CONTEXT ACTIVE; and
- f) for any other PDU session the UE shall set the state of the mapped EPS bearer context(s) to BEARER CONTEXT INACTIVE.

Additionally, for each mapped EPS bearer context or the association between QoS flow and mapped EPS bearer in the PDU session:

- a) the EPS bearer identity shall be set to the EPS bearer identity received in the mapped EPS bearer context, or the EPS bearer identity associated with the QoS flow;
- b) the EPS QoS parameters shall be set to the mapped EPS QoS parameters of the EPS bearer received in the mapped EPS bearer context, or the EPS QoS parameters associated with the QoS flow;
- c) the extended EPS QoS parameters shall be set to the mapped extended EPS QoS parameters of the EPS bearer received in the mapped EPS bearer context, or the extended EPS QoS parameters associated with the QoS flow; and
- d) the traffic flow template shall be set to the mapped traffic flow template of the EPS bearer received in the mapped EPS bearer context, or the stored traffic flow template associated with the QoS flow, if available.

After inter-system change from N1 mode to S1 mode, the UE shall associate the PDU session identity, the S-NSSAI, and the session-AMBR with the default EPS bearer context, and for each EPS bearer context mapped from one or more QoS flows, associate the QoS rule(s) for the QoS flow(s) and the QoS flow description(s) for the QoS flow(s) with the EPS bearer context.

After inter-system change from N1 mode to S1 mode, the UE and the SMF shall maintain the PDU session type of the PDU session until the PDN connection corresponding to the PDU session is released if the UE supports non-IP PDN type and the PDU session type is "Ethernet" or "Unstructured".

After inter-system change from N1 mode to S1 mode, the UE and the SMF shall maintain the always-on PDU session indication.

After inter-system change from N1 mode to S1 mode, the UE and the SMF shall maintain the maximum number of supported packet filters until the PDN connection corresponding to the PDU session is released.

[TS 38.331, clause 5.3.3.2]

Upon initiation of the procedure, the UE shall:

- 1> if the upper layers provide an Access Category and one or more Access Identities upon requesting establishment of an RRC connection:
 - 2> perform the unified access control procedure as specified in 5.3.14 using the Access Category and Access Identities provided by upper layers;
 - 3> if the access attempt is barred, the procedure ends;
- 1> apply the default L1 parameter values as specified in corresponding physical layer specifications except for the parameters for which values are provided in *SIB1*;
- 1> apply the default MAC Cell Group configuration as specified in 9.2.2;
- 1> apply the CCCH configuration as specified in 9.1.1.2;
- 1> apply the timeAlignmentTimerCommon included in *SIB1*;
- 1> start timer T300;
- 1> initiate transmission of the *RRCSetupRequest* message in accordance with 5.3.3.3;

[TS 38.331, clause 5.3.3.3]

The UE shall set the contents of *RRCSetupRequest* message as follows:

1> set the *ue-Identity* as follows:

2> if upper layers provide a 5G-S-TMSI:

3> set the *ue-Identity* to *ng-5G-S-TMSI-Part1*;

2> else:

3> draw a 39-bit random value in the range $0..2^{39}-1$ and set the *ue-Identity* to this value;

NOTE 1: Upper layers provide the *5G-S-TMSI* if the UE is registered in the TA of the current cell.

1> set the *establishmentCause* in accordance with the information received from upper layers;

The UE shall submit the *RRCSetupRequest* message to lower layers for transmission.

The UE shall continue cell re-selection related measurements as well as cell re-selection evaluation. If the conditions for cell re-selection are fulfilled, the UE shall perform cell re-selection as specified in 5.3.3.6.

[TS 38.331, clause 5.3.8.3]

The UE shall:

...

1> if the *RRCRelease* message includes *redirectedCarrierInfo* indicating redirection to *eutra*:

2> if *cnType* is included:

3> after the cell selection, indicate the available CN Type(s) and the received *cnType* to upper layers;

NOTE 1: Handling the case if the E-UTRA cell selected after the redirection does not support the core network type specified by the *cnType*, is up to UE implementation.

2> if *voiceFallbackIndication* is included:

3> consider the RRC connection release was for EPS fallback for IMS voice (see TS 23.502 [43]);

[TS 38.331, clause 5.3.11]

The UE shall:

...

1> else:

2> if T302 is running:

3> stop timer T302;

3> perform the actions as specified in 5.3.14.4;

[TS 38.304, clause 5.2.6]

At reception of *RRCRelease* message to transition the UE to RRC_IDLE or RRC_INACTIVE, UE shall attempt to camp on a suitable cell according to *redirectedCarrierInfo* if included in the *RRCRelease* message. If the UE cannot find a suitable cell, the UE is allowed to camp on any suitable cell of the indicated RAT. If the *RRCRelease* message does not contain the *redirectedCarrierInfo*, UE shall attempt to select a suitable cell on an NR carrier. If no suitable cell is found according to the above, the UE shall perform cell selection using stored information in order to find a suitable cell to camp on.

When returning to RRC_IDLE state after UE moved to RRC_CONNECTED state from *camped on any cell* state, UE shall attempt to camp on an acceptable cell according to *redirectedCarrierInfo*, if included in the *RRCRelease* message. If the UE cannot find an acceptable cell, the UE is allowed to camp on any acceptable cell of the indicated RAT. If the *RRCRelease* message does not contain *redirectedCarrierInfo* UE shall attempt to select an acceptable cell on an NR frequency. If no acceptable cell is found according to the above, the UE not in SNPN Access Mode shall continue to search for an acceptable cell of any PLMN in state *any cell selection*.

[TS 36.304, clause 5.3.1]

Cell status and cell reservations are indicated in the *SystemInformationBlockType1* message (or *SystemInformationBlockType1-BR* message or *SystemInformationBlockType1-NB* message) TS 36.331 [3] by means of the following fields:

- *cellBarred* (IE type: "barred" or "not barred")
This field indicates if the cell is barred for connectivity to EPC.
This field is ignored by the UEs supporting *crs-IntfMitig* while *crs-IntfMitigEnabled* is included in SIB1.
This field is ignored by the BL UEs or UEs in CE supporting *ce-CRS-IntfMitig* while *crs-IntfMitigNumPRBs* is included in SIB1-BR.
In case of multiple EPC PLMNs indicated in SIB1/SIB1-BR, this field is common for all EPC PLMNs

NOTE: For IAB node, it ignores the *cellBarred*, *cellReservedForOperatorUse* and *cellReservedForOtherUse* as defined in TS 36.331 [3].

...

The following description for handling of barred and reserved cells is per CN type. If the UE supports more than one CN type, the UE shall only exclude a cell as candidate for selection/reselection if it is excluded for both CN types.

NOTE: Fields *cellBarred-CRS* and *cellReservedForOperatorUse-CRS* are not indicated in *SystemInformationBlockType1-NB*

When cell status is indicated as "not barred" and "not reserved" for operator use,

- All UEs shall treat this cell as candidate during the cell selection and cell reselection procedures.

When cell status is indicated as "not barred" and "reserved" for operator use for any PLMN,

- UEs assigned to Access Class 11 or 15 operating in their HPLMN/EHPLMN shall treat this cell as candidate during the cell selection and reselection procedures if the field *cellReservedForOperatorUse* for that PLMN set to "reserved".
- UEs assigned to an Access Class in the range of 0 to 9, 12 to 14 shall behave as if the cell status is "barred" in case the cell is "reserved for operator use" for the registered PLMN or the selected PLMN.

NOTE: ACs 11, 15 are only valid for use in the HPLMN/ EHPLMN; ACs 12, 13, 14 are only valid for use in the home country TS 22.011 [4].

When cell status "barred" is indicated or to be treated as if the cell status is "barred",

- The UE is not permitted to select/reselect this cell, not even for emergency calls.
- The UE shall consider other cells for cell selection/reselection according to the following rule:

11.1.4.3 Test Description

11.1.4.3.1 Pre-test conditions

System Simulator:

- NR Cell 1 is configured according to TS 38.508-1 [4] Table 4.4.2-3 and is connected to 5GC.
- E-UTRA Cell 1 and E-UTRA Cell 3 are configured to TS 36.508 [7] Table 4.4.2-2 and are connected to EPC.
- System information on the NR Cell 1 in accordance with combination NR-6 in TS 38.508-1 [4] sub-clause 4.4.3.1.2, and, for the E-UTRA Cell 1 and Cell 3 in accordance with combination 31 as defined in TS 36.508 [7], subclause 4.4.3.1.1.
- N26 interface is configured.
- Power levels are constant and as defined in Tables 11.1.4.3.1-1/2.

Table 11.1.4.3.1-1: Time instances of cell power level and parameter changes for conducted test environment

	Parameter name	Unit	NR Cell 1	E-UTRA Cell 1	E-UTRA Cell 3	Remark
T0	SS/PBCH SSS EPRE	dBm/SCS	-88	-	-	
	RS EPRE	dBm/15kHz	-	-97	-85	

Table 11.1.4.3.1-2: Time instances of cell power level and parameter changes for OTA test environment

	Parameter name	Unit	NR Cell 1	E-UTRA Cell 1	E-UTRA Cell 3	Remark
T0	SS/PBCH SSS EPRE	dBm/SCS	-82	-	-	
	RS EPRE	dBm/15kHz	-	-96	-96	

UE:

- The UE is configured to use IMS preconditions

Preamble:

- With E-UTRA Cell 1 "Serving cell" and NR Cell 1 "Non-suitable "Off" cell" in accordance with TS 38.508-1 [4], Table 6.2.2.1-3, the UE is brought to state RRC_IDLE using generic procedure parameters Connectivity (E-UTRA) and Unrestricted nr PDN (On) in accordance with the procedure described in TS 38.508-1 [4], clause 4.5.2. 4G GUTI and eKSI are assigned and security context established.
- The UE is switched-off.
- With E-UTRA Cell 1 "Non-suitable "Off" cell" and NR Cell 1 "Serving cell" in accordance with TS 38.508-1 [4], Table 6.2.2.1-3, the UE is brought to state 1N-A, RRC_IDLE Connectivity (NR) with at least one IMS PDU session on NR Cell 1, in accordance with the procedure described in TS 38.508-1 [4], Table 4.5.2.2-2. 5G-GUTI and ngKSI are assigned.

11.1.4.3.2 Test procedure sequence

Table 11.1.4.3.2-1: Main behaviour

St	Procedure	Message Sequence		TP	Verdict
		U - S	Message		
1	Void	-	-	-	-
-	The following messages are to be observed on NR Cell 1 unless explicitly stated otherwise.	-	-	-	-
2	The SS transmits a <i>Paging</i> message.	<--	NR RRC: <i>Paging</i>	-	-
3	The UE transmits an <i>RRCSetupRequest</i> message.	-->	NR RRC: <i>RRCSetupRequest</i>	-	-
4-9	Steps 3 to 8 of the NR RRC_CONNECTED procedure in TS 38.508-1 [4] Table 4.5.4.2-3 are executed to successfully complete the service request procedure.	-	-	-	-
9A	Set the power levels according to "T0" as per Table 11.1.4.3.1-1/2.	-	-	-	-
10a1	Void	-	-	-	-
11	Make the UE attempt an IMS speech call.	-	-	-	-
12-16	Steps 1-5 of generic procedure "EPS Fallback for Voice Call / steps before fallback / 5GS" as defined in Appendix A.9.1 of TS 34.229-5 [41] take place.	-	-	-	-

17	The SS transmits an <i>RRCRelease</i> message	<--	NR RRC:RRCRelease	-	-
-	The following messages are to be observed on E-UTRA Cell 1 unless explicitly stated otherwise.	-	-	-	-
18	Generic test procedure in TS 38.508-1 [4] Table 4.9.7.2.2-1 Steps 1-6 is performed without ' <i>connected without release</i> ' on E-UTRAN cell upon mobility from NR.	-	-	-	-
18A-18D	Generic Test Procedure as defined in Steps 5-8 of TS 36.508-1 [4] Table 4.5A.6.3-1 is performed to establish radio bearer corresponding to IMS PDN.	-	-	-	-
19	The SS configures a new RLC-UM data radio bearer with condition DRB (0,1), associated with the dedicated EPS bearer context. <i>RRCConnectionReconfiguration</i> message contains the ACTIVATE DEDICATED EPS BEARER CONTEXT REQUEST message. EPS bearer context #4 (QCI 1) according to TS 36.508 [7] Table 6.6.2-1: Reference dedicated EPS bearer contexts. Reference dedicated EPS bearer contexts is to establish the dedicated EPS bearer context on IMS PDN.	<--	RRC: RRCConnectionReconfiguration NAS: ACTIVATE DEDICATED EPS BEARER CONTEXT REQUEST	-	-
-	EXCEPTION: In parallel to the events described in steps 20-22 below, the steps specified in table 11.1.4.3.2-2 will take place.	-	-	-	-
20	The UE transmits an <i>RRCConnectionReconfigurationComplete</i> message.	-->	RRC: RRCConnectionReconfigurationC omplete	-	-
21	The UE transmits an <i>ULInformationTransfer</i> message including the ACTIVATE DEDICATED EPS BEARER CONTEXT ACCEPT message.	-->	RRC: ULInformationTransfer NAS: ACTIVATE DEDICATED EPS BEARER CONTEXT ACCEPT	-	-
22	The SS waits 1 second for call duration.	-	-	-	-
23a1	Void	-	-	-	-
24	Release IMS Call as specified in the generic procedure in TS 34.229-1 [35] subclause C.32.	-	-	-	-

Table 11.1.4.3.2-2: Parallel behaviour

St	Procedure	Message Sequence		TP	Verdict
		U - S	Message		
-	EXCEPTION: Steps 1a1 to 1b7 describe behaviour that depends on the UE capability; the "lower case letter" identifies a step sequence that take place if a capability is supported	-	-	-	-
1a1-1a2	The UE performs IMS re-registration on EUTRAN as per steps 1-2 as defined in TS 34.229-1 [35] C.46.	-	-	-	-
1a3-1a6A	Steps 1-5 of the generic procedure "EPS Fallback for Voice Call / steps after fallback / 5GS" as defined in Appendix A.9.2 of TS 34.229-5 [41] take place.	-	-	-	-
1a7	Check: Does the UE perform step 6 of the generic procedure "EPS Fallback for Voice Call / steps after fallback / 5GS" as defined in Appendix A.9.2 of TS 34.229-5 [41]	-->	SIP: ACK	1	P

11.1.4.3.3 Specific message contents

Table 11.1.4.3.3-1: REGISTRATION REQUEST (preamble, Table 11.1.4.3.2-1)

Derivation path: TS 38.508-1 [4] Table 4.7.1-6			
Information Element	Value/remark	Comment	Condition
5GMM capability			
S1 mode	'1'B	S1 mode supported	
S1 UE network capability	Present but contents not checked		

Table 11.1.4.3.3-2: REGISTRATION ACCEPT (preamble, Table 11.1.4.3.2-1)

Derivation path: TS 38.508-1 [4] Table 4.7.1-7			
Information Element	Value/remark	Comment	Condition
5GS network feature support			
IMS- VoPS-3GPP	'1'B	IMS voice over PS session supported over 3GPP access	
IWK N26	'0'B	Interworking without N26 interface not supported	

Table 11.1.4.3.3-3: PDU SESSION ESTABLISHMENT ACCEPT (preamble for PDU Session for PS data, Table 11.1.4.3.2-1)

Derivation path: TS 38.508-1 [4] Table 4.7.2-2, condition Interworking_with_EPS

Table 11.1.4.3.3-4: PDU SESSION ESTABLISHMENT ACCEPT (preamble for IMS PDU Session, Table 11.1.4.3.2-1)

Derivation path: TS 38.508-1 [4] Table 4.7.2-2, condition Interworking_with_EPS, IMS_DNN_Requested
--

Table 11.1.4.3.3-5: Void**Table 11.1.4.3.3-6: RRCRelease message (step 17, table 11.1.4.3.2-1)**

Derivation path: TS 38.508-1 [4] Table 4.6.1-16			
Information Element	Value/remark	Comment	Condition
RRCRelease ::= SEQUENCE {			
criticalExtensions CHOICE {			
rrcRelease SEQUENCE {			
redirectedCarrierInfo CHOICE {			
eutra SEQUENCE {			
eutraFrequency	Cell 3's EARFCN		
cnType	epc		
}			
}			
}			
}			
}			

Table 11.1.4.3.3-7: SystemInformationBlockType1 of E-UTRA Cell 3 (Preamble and all steps, Table 11.1.4.3.2-1)

Derivation Path: 36.508 [7] Table 4.4.3.2-3

Information Element	Value/remark	Comment	Condition
SystemInformationBlockType1 ::= SEQUENCE {			
cellAccessRelatedInfo SEQUENCE {			
cellBarred	barred		
}			
}			

11.1.5 MO MMTEL voice call setup from NR RRC_CONNECTED / EPS Fallback with redirection / Single registration mode without N26 interface / E-UTRAN cell selection using cell status reservation / Success

11.1.5.1 Test Purpose (TP)

(1)

```

with {UE supporting both S1 mode and N1 mode and operating in single-registration mode, and, the Network has indicated "interworking without N26 interface supported", and, the UE is in in NR RRC_CONNECTED state }
ensure that {
  when {User initiates a MMTEL call, the MO IMS voice session establishment has been initiated and the UE receives a RRCRelease message which includes redirectedCarrierInfo indicating redirection to eutra, and, an E-UTRA cell on the frequency indicated by redirectedCarrierInfo is found with cell status "reserved for operator use" and another E-UTRA cell is found on another frequency which is not "reserved for operator use" both cells belonging to the UE's HPLMN}
  then { UE selects the E-UTRA cell respecting the UE Access Class, performs an ATTACH or a TAU procedure, and the UE successfully completes the MO MMTEL call in EPS}
}

```

11.1.5.2 Conformance requirements

References: The conformance requirements covered in the current TC are specified in: TS23.502, clauses 4.11.2.2, 4.13.6.1; TS 24.501, clause 6.1.4.2; TS 38.331, clause 5.3.11, TS 38.304, clause 5.2.6. Unless otherwise stated these are Rel-15 requirements.

[TS 23.502, clause 4.11.2.2]

The following procedure is used by UEs in single-registration or dual registration mode on mobility from 5GS to EPS.

In the case of network sharing the UE selects the target PLMN ID according to clause 5.18.3 of TS 23.501 [2].

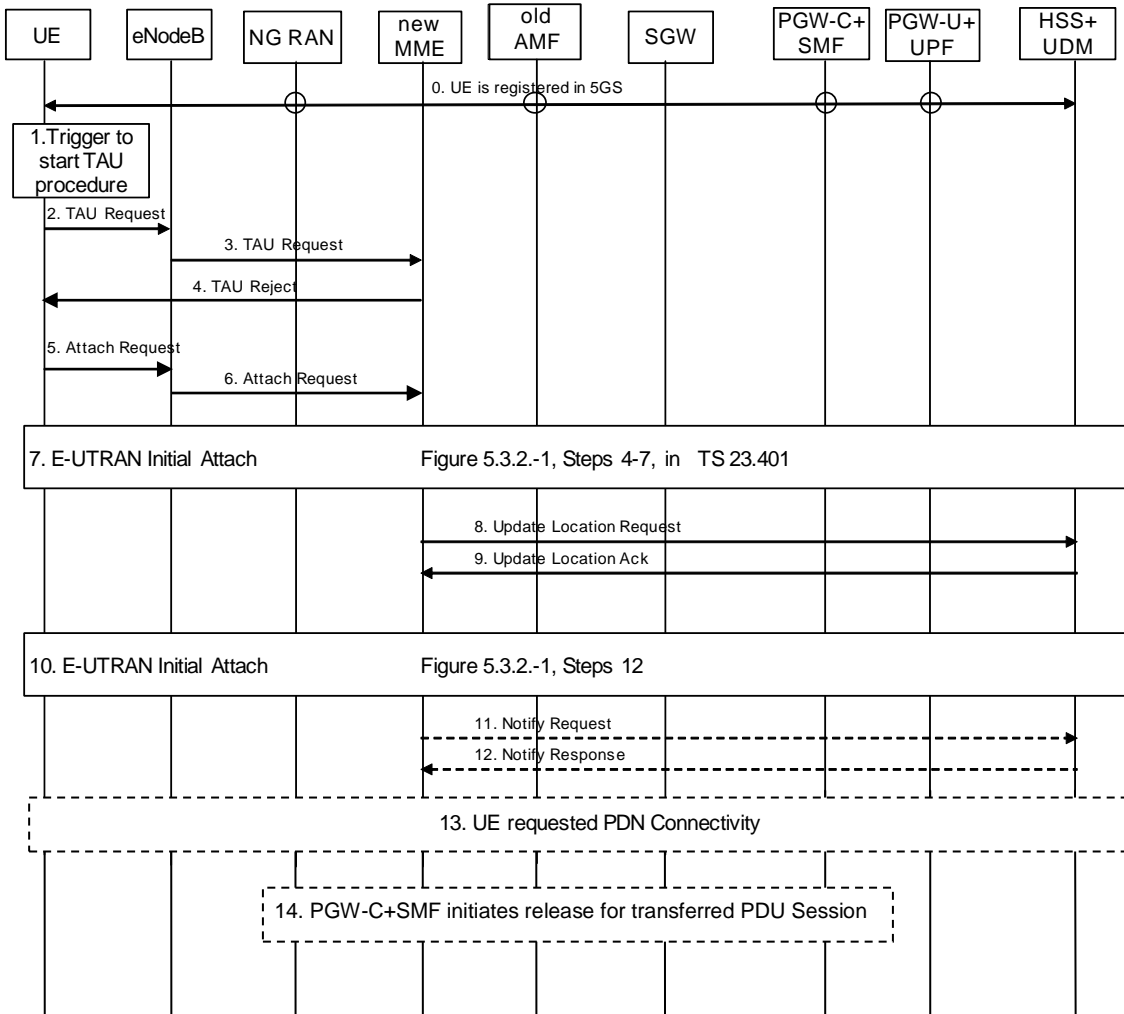

Figure 4.11.2.2-1: Mobility procedure from 5GS to EPS without N26 interface

The UE operating in single-registration mode can start the procedure from Step 1 or Step 5. The UE operating in dual-registration mode starts the procedure from Step 5.

NOTE 1: The network has indicated the "Interworking without N26" to the UE. To support IP address preservation, the UE in single-registration mode starts the procedure from Step 5. If the UE in single-registration mode starts the procedure from Step 1, the IP address preservation is not provided.

0. UE is registered in 5GS and established PDU sessions. The FQDN for the S5/S8 interface of the PGW-C+SMF is also stored in the UDM by the PGW-C+SMF during PDU Session setup in addition to what is specified in clause 4.3.2.2.1 and clause 4.3.2.2.2.

NOTE 2: At 5GS to EPS mobility, the MME use the FQDN for the S5/S8 interface of the PGW-C+SMF to find the PGW-C+SMF, and when UE moves back from EPS to 5GS, the AMF uses FQDN for the S5/S8 interface of the PGW-C+SMF to find the PGW-C+SMF.

1. Step 1 as in clause 5.3.3.1 (Tracking Area Update) in TS 23.401 [13].

2. Step 2 as in clause 5.3.3.1 (Tracking Area Update) in TS 23.401 [13] with the following modifications:

The UE shall provide a EPS-GUTI that is mapped from the 5G-GUTI following the mapping rules specified in TS 23.501 [2]. The UE indicates that it is moving from 5GC.

3. Step 3 as in clause 5.3.3.1 (Tracking Area Update) in TS 23.401 [13].

4. If the MME determined that the old node is an AMF based on UE's GUTI mapped from 5G-GUTI and the MME is configured to support 5GS-EPS interworking without N26 procedure, the MME sends a TAU Reject to the UE.
5. Step 1 as in clause 5.3.2.1 (E-UTRAN Initial Attach) in TS 23.401 [13] with the modifications captured in clause 4.11.2.4.1.
6. Step 2 as in clause 5.3.2.1 (E-UTRAN Initial Attach) in TS 23.401 [13].
7. Steps 4-7 as in clause 5.3.2.1 (E-UTRAN Initial Attach) in TS 23.401 [13], with the modifications captured in clause 4.11.2.4.1.
8. Step 8 as in clause 5.3.2.1 (E-UTRAN Initial Attach) in TS 23.401 [13], with the modifications captured in clause 4.11.2.4.1.
9. Step 11 as in clause 5.3.2.1 (E-UTRAN Initial Attach) in TS 23.401 [13], with the following modifications:

The subscription profile the MME receives from HSS+UDM includes per DNN/APN at most one PGW-C+SMF FQDN as described in in clause 5.17.2.1 in TS 23.501 [2].
10. Steps 12-24 as in clause 5.3.2.1 (E-UTRAN Initial Attach) in TS 23.401 [13], with the modifications as described in clause 4.11.2.4.1.
11. Step 25 as in clause 5.3.2.1 (E-UTRAN Initial Attach) in TS 23.401 [13].
12. Step 26 as in clause 5.3.2.1 (E-UTRAN Initial Attach) in TS 23.401 [13].
13. If the UE has remaining PDU Sessions in 5GS which it wants to transfer to EPS and maintain the same IP address/prefix, the UE performs the UE requested PDN Connectivity Procedure as specified in TS 23.401 [13] clause 5.10.2 and sets the Request Type to "handover" in Step 1 of the procedure with modification captured in clause 4.11.2.4.2. UE provides an APN and the PDU Session ID corresponding to the PDU Session it wants to transfer to EPS. The UE provides the PDU Session ID in PCO as described in clause 4.11.1.1.

UEs in single-registration mode performs this step for each PDU Session immediately after completing the E-UTRAN Initial Attach procedure. UEs in dual-registration mode may perform this step any time after the completing of E-UTRAN Initial Attach procedure. Also, UEs in dual-registration mode may perform this step only for a subset of PDU Sessions.

The MME determines the PGW-C+SMF address for the Create Session Request based on the APN received from the UE and the subscription profile received from the HSS+UDM in Step 9 or when the HSS+UDM notifies the MME for the new PGW-C+SMF ID in the updated subscription profile.

The PGW-C+SMF uses the PDU Session ID to correlate the transferred PDN connection with the PDU Session in 5GC.

As a result of the procedure the PGW-U+UPF starts routing DL data packets to the Serving GW for the default and any dedicated EPS bearers established for this PDN connection.

14. The PGW-C+SMF initiates release of the PDU Session(s) in 5GS transferred to EPS as specified in clause 4.3.4.2 with the following clarification:

In step 2, the PGW-C+SMF shall not release IP address/prefix(es) allocated for the PDU Session.

If UP connection of the PDU Session is not active, step 3b is not executed, thus the steps triggered by step 3b are not executed;

If UP connection of the PDU Session is active, the SMF invokes the Namf_Communication_N1N2MessageTransfer service operation without including N1 SM container (PDU Session Release Command).

[TS 23.502, clause 4.13.6.1]

Figure 4.13.6.1-1 describes the EPS fallback procedure for IMS voice.

When the UE is served by the 5G System, the UE has one or more ongoing PDU Sessions each including one or more QoS Flows. The serving PLMN AMF has sent an indication towards the UE during the Registration procedure that IMS

voice over PS session is supported, see clause 5.16.3.10 in TS 23.501 [2] and the UE has registered in the IMS. If N26 is not supported, the serving PLMN AMF sends an indication towards the UE during the Registration procedure that interworking without N26 is supported, see clause 5.17.2.3.1 in TS 23.501 [2].

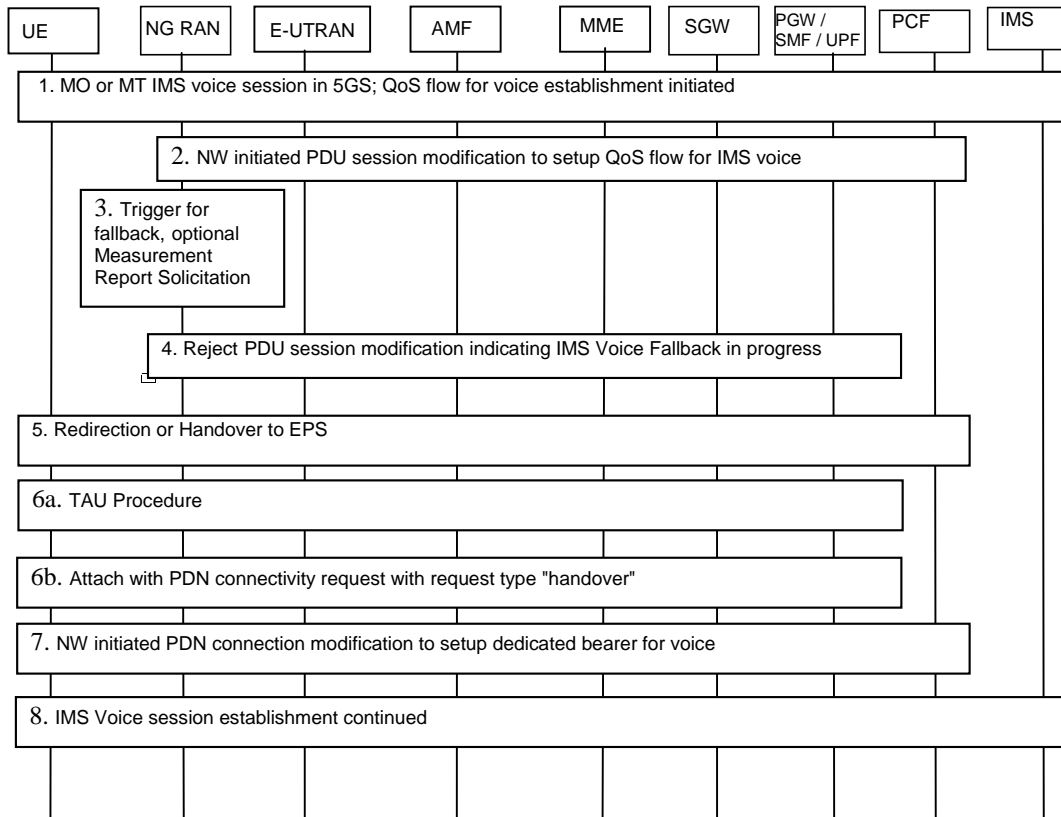

Figure 4.13.6.1-1: EPS Fallback for IMS voice

1. UE camps on NG-RAN in the 5GS and an MO or MT IMS voice session establishment has been initiated.
2. Network initiated PDU Session modification to setup QoS flow for voice reaches the NG-RAN (see N2 PDU Session Request in clause 4.3.3).
3. NG-RAN is configured to support EPS fallback for IMS voice and decides to trigger fallback to EPS, taking into account UE capabilities, indication from AMF that "Redirection for EPS fallback for voice is possible" (received as part of initial context setup as defined in TS 38.413 [10]), network configuration (e.g. N26 availability configuration) and radio conditions. If NG-RAN decides not to trigger fallback to EPS, then the procedure stops here and following steps are not executed.

NG-RAN may initiate measurement report solicitation from the UE including E-UTRAN as target.

NOTE 1: If AMF has indicated that "Redirection for EPS fallback for voice is not possible", then AN Release via inter-system redirection to EPS is not performed in step 5.

4. NG-RAN responds indicating rejection of the PDU Session modification to setup QoS flow for IMS voice received in step 2 by PDU Session Response message towards the PGW-C+SMF (or H-SMF+P-GW-C via V-SMF, in case of roaming scenario) via AMF with an indication that mobility due to fallback for IMS voice is ongoing. The PGW-C+SMF maintains the PCC rule(s) associated with the QoS Flow(s).
5. NG-RAN initiates either handover (see clause 4.11.1.2.1), or AN Release via inter-system redirection to EPS (see clause 4.2.6 and clause 4.11.1.3.2), taking into account UE capabilities. The PGW-C+SMF reports change of the RAT type if subscribed by PCF as specified in clause 4.11.1.2.1, or clause 4.11.1.3.2.6. When the UE is connected to EPS, either 6a or 6b is executed
- 6a. In the case of 5GS to EPS handover, see clause 4.11.1.2.1, and in the case of inter-system redirection to EPS with N26 interface, see clause 4.11.1.3.2. In either case the UE initiates TAU procedure; or

6b. In the case of inter-system redirection to EPS without N26 interface, see clause 4.11.2.2. If the UE supports Request Type flag "handover" for PDN connectivity request during the attach procedure as described in clause 5.3.2.1 of TS 23.401 [13] and has received the indication that interworking without N26 is supported, then the UE initiates Attach with PDN connectivity request with request type "handover".

In inter-system redirection, the UE uses the emergency indication in the RRC message as specified in clause 6.2.2 of TS 36.331 [16] and E-UTRAN provides the emergency indication to MME during Tracking Area Update or Attach procedure. For the handover procedure see clause 4.11.1.2.1, step 1.

7. After completion of the mobility procedure to EPS or as part of the 5GS to EPS handover procedure (see clause 4.11.1.2.1), the SMF/PGW re-initiates the setup of the dedicated bearer for IMS voice, mapping the 5G QoS to EPC QoS parameters. The PGW-C+SMF behaves as specified in clause 4.9.1.3.1. The PGW-C+SMF reports about Successful Resource Allocation and Access Network Information if subscribed by PCF.

8. The IMS voice session establishment is continued.

At least for the duration of the voice call in EPS the E-UTRAN is configured to not trigger any handover to 5GS.

[TS 24.501, clause 6.1.4.2]

When the network does not support N26 interface, the SMF does not provide the UE with the mapped EPS bearer context for a PDU session.

NOTE 1: Since the SMF does not provide the UE with the mapped EPS bearer context for a PDU session, the UE does not know whether interworking with EPS is supported for a PDU session before attempting to transfer the PDU session from N1 mode to S1 mode.

NOTE 2: It is up to UE implementation to decide which PDU session(s) to be attempted to transfer from N1 mode to S1 mode, e.g. based on UE policy or user preference.

Upon inter-system change from N1 mode to S1 mode in EMM-IDLE mode, the UE shall use the parameters from each PDU session which the UE intends to transfer to EPS to create the contents of a PDN CONNECTIVITY REQUEST message as follows:

- a) if the PDU session is an emergency PDU session, the request type shall be set to "handover of emergency bearer services". Otherwise the request type shall be set to "handover";
- b) the PDU session type of the PDU session shall be mapped to the PDN type of the default EPS bearer context as follows:
 - 1) the PDN type shall be set to "non-IP" if the PDU session type is "Ethernet" or "Unstructured";
 - 2) the PDN type shall be set to "IPv4" if the PDU session type is "IPv4";
 - 3) the PDN type shall be set to "IPv6" if the PDU session type is "IPv6"; and
 - 4) the PDN type shall be set to "IPv4v6" if the PDU session type is "IPv4v6";
- c) the DNN of the PDU session shall be mapped to the APN of the default EPS bearer context; and
- d) the PDU session ID parameter in the PCO IE shall be set to the PDU session identity of the PDU session.

After inter-system change from N1 mode to S1 mode, the UE shall associate the PDU session identity with the default EPS bearer context.

Upon successful completion of an EPS attach procedure after inter-system change from N1 mode to S1 mode (see 3GPP TS 24.301 [15]), the UE shall delete any UE derived QoS rules.

The UE shall locally release the PDU session(s) and QoS flow(s) associated with the 3GPP access which have not been transferred to EPS.

...

[TS 38.331, clause 5.3.11]

UE shall:

- 1> reset MAC;
- 1> if T302 is running:
 - 2> stop timer T302;
 - 2> perform the actions as specified in 5.3.14.4;
- 1> stop all timers that are running except T320 and T325;
- 1> discard the UE Inactive AS context;
- 1> set the variable *pendingRnaUpdate* to *false*, if that is set to *true*;
- 1> discard the K_{gNB} , the K_{RRcenc} key, the K_{RRcint} , the K_{UPint} key and the K_{UPenc} key, if any;
- 1> release all radio resources, including release of the RLC entity, the MAC configuration and the associated PDCP entity and SDAP for all established RBs;
- 1> indicate the release of the RRC connection to upper layers together with the release cause;
- 1> enter RRC_IDLE and perform cell selection as specified in TS 38.304 [20], except if going to RRC_IDLE was triggered by selecting an inter-RAT cell while T311 was running;
- 1> if going to RRC_IDLE was triggered by reception of the *RRCRelease* message including a *waitTime*:
 - 2> start timer T302 with the value set to the *waitTime*;
- 2> inform the upper layer that access barring is applicable for all access categories except categories '0' and '2'.

[TS 38.304, clause 5.2.6]

At reception of *RRCRelease* message to transition the UE to RRC_IDLE or RRC_INACTIVE, UE shall attempt to camp on a suitable cell according to *redirectedCarrierInfo* if included in the *RRCRelease* message. If the UE cannot find a suitable cell, the UE is allowed to camp on any suitable cell of the indicated RAT. If the *RRCRelease* message does not contain the *redirectedCarrierInfo*, UE shall attempt to select a suitable cell on an NR carrier. If no suitable cell is found according to the above, the UE shall perform cell selection using stored information in order to find a suitable cell to camp on.

When returning to RRC_IDLE state after UE moved to RRC_CONNECTED state from *camped on any cell* state, UE shall attempt to camp on an acceptable cell according to *redirectedCarrierInfo*, if included in the *RRCRelease* message. If the UE cannot find an acceptable cell, the UE is allowed to camp on any acceptable cell of the indicated RAT. If the *RRCRelease* message does not contain *redirectedCarrierInfo* UE shall attempt to select an acceptable cell on an NR frequency. If no acceptable cell is found according to the above, the UE not in SNPN Access Mode shall continue to search for an acceptable cell of any PLMN in state *any cell selection*.

11.1.5.3 Test description

11.1.5.3.1 Pre-test conditions

System Simulator:

- 3 cells
 - NR Cell 1 as defined in TS 38.508-1 [4] Table 4.4.2-3. System information combination NR-6 as defined in TS 38.508-1 [4], sub-clause 4.4.3.1.2.
 - E-UTRA Cell 1 as defined in TS 36.508 [7] Table 4.4.2-2. System information combination 31 as defined in TS 36.508 [7], sub-clause 4.4.3.1.1.
 - E-UTRA Cell 3 as defined in TS 36.508 [7] Table 4.4.2-2. System information combination 1 as defined in TS 36.508 [7], sub-clause 4.4.3.1.1. Cell 3 is set as "reserved for operator use" in SIB1.
 - Power levels are constant and as defined in Tables 11.1.5.3.1-1/2.

Table 11.1.5.3.1-1: Time instances of cell power level and parameter changes for conducted test environment

	Parameter name	Unit	NR Cell 1	E-UTRA Cell 1	E-UTRA Cell 3	Remark
T0	SS/PBCH SSS EPRE	dBm/SCS	-88	-	-	
	RS EPRE	dBm/15kHz	-	-85	-73	

Table 11.1.5.3.1-2: Time instances of cell power level and parameter changes for OTA test environment

	Parameter name	Unit	NR Cell 1	E-UTRA Cell 1	E-UTRA Cell 3	Remark
T0	SS/PBCH SSS EPRE	dBm/SCS	-82	-	-	
	RS EPRE	dBm/15kHz	-	-96	-96	

UE:

- The UE fitted with a USIM with access class 0..9

Preamble:

- With E-UTRA Cell 1 "Serving cell", E-UTRA Cell 3 "Non-suitable "Off" cell" and NR Cell 1 "Non-suitable "Off" cell" in accordance with TS 38.508-1 [4], Table 6.2.2.1-3, the UE is brought to state RRC_IDLE using generic procedure parameters Connectivity (*E-UTRA/EPC*) and Unrestricted nr PDN (*On*) in accordance with the procedure described in TS 38.508-1 [4], clause 4.5.2. 4G GUTI and eKSI are assigned and security context established.
- The UE is switched-off.
- With E-UTRA Cell 1 "Non-suitable "Off" cell", E-UTRA Cell 3 "Non-suitable "Off" cell" and NR Cell 1 "Serving cell" in accordance with TS 38.508-1 [4], Table 6.2.2.1-3, the UE is brought to state 1N-A, RRC_IDLE Connectivity (NR), with at least one IMS PDU session on NR Cell 1, in accordance with the procedure described in TS 38.508-1 [4], Table 4.5.2.2-2. 5G-GUTI and ngKSI are assigned.

11.1.5.3.2 Test procedure sequence

Table 11.1.5.3.2-1: Main behaviour

St	Procedure	Message Sequence		TP	Verdict
		U – S	Message		
0	Void	-	-	-	-
-	EXCEPTION: The following messages are to be observed on NR Cell 1 unless explicitly stated otherwise.	-	-	-	-
1	The SS transmits a <i>Paging</i> message.	<--	NR RRC: <i>Paging</i>	-	-
2	The UE transmits an <i>RRCSetupRequest</i> message.	-->	NR RRC: <i>RRCSetupRequest</i>	-	-
3-9a2	Steps 3 to 9a2 of the NR RRC_CONNECTED procedure in TS 38.508-1 [4] Table 4.5.4.2-3 are executed to successfully complete the service request procedure.	-	-	-	-
9A	Set the power levels according to "T0" as per Table 11.1.5.3.1-1/2.	-	-	-	-

10	Make the UE attempt an MTSI MO Speech Call.	-	-	-	-
11	The UE transmits an INVITE message.	-	-	-	-
12	Void	-	-	-	-
12a 1	Void	-	-	-	-
13	The SS transmits an <i>RRCRelease</i> message.	<--	NR RRC: <i>RRCRelease</i>	-	-
-	EXCEPTION: The following messages are to be observed on E-UTRA Cell 1 unless explicitly stated otherwise.	-	-	-	-
14	Check: Does the UE send an <i>RRCConnectionRequest</i> message on E-UTRA cell 1?	-->	RRC: <i>RRCConnectionRequest</i>	1	P
15	SS transmits an <i>RRCConnectionSetup</i> message.	<--	RRC: <i>RRCConnectionSetup</i>	-	-
-	EXCEPTION: Steps 15Aa1 to 15Ab3 describe behaviour that depends on the UE implementation; the "lower case letter" identifies a step sequence that take place depending on the UE implementation.	-	-	-	-
15a 1- 15b 3	Void	-	-	-	-
15 Aa 1	If the UE tries to preserve the IP address of the PDN connection then check does the UE transmits an ATTACH REQUEST message?	-->	RRC: <i>RRCConnectionSetupComplete</i> NAS: ATTACH REQUEST	1	P
15 Ab 1	Else check: does the UE transmit a TRACKING AREA UPDATE REQUEST message?	-->	RRC: <i>RRCConnectionSetupComplete</i> NAS: TRACKING AREA UPDATE REQUEST	1	P
15 Ab 2	The SS transmits a TRACKING AREA UPDATE REJECT message to UE.	<--	RRC: <i>DLInformationTransfer</i> NAS: TRACKING AREA UPDATE REQUEST REJECT	-	-
15 Ab 3	The UE transmits an ATTACH REQUEST message.	-->	RRC: <i>ULInformationTransfer</i> NAS: ATTACH REQUEST	-	-
16- 27	Steps 5 to 16 of the generic test procedure for UE registration (TS 36.508 [2] Table 4.5.2.3-1).	-	-	-	-
-	EXCEPTION: In parallel to the events described in steps 28 to 36 the steps specified in Table 11.1.5.3.2-2 may take place to transfer other PDU sessions to EPS.	-	-	-	-
-	EXCEPTION: In parallel to the events described in steps 28 to 37 the UE may perform IMS re-registration on EUTRAN as per steps 3-11 as defined in 34.229-1 [35] subclause C.46 using the message "REGISTER" with condition A31.	-	-	-	-
28- 32	Steps 9a1-13 from the Generic Test Procedure for MTSI MO speech call establishment (TS 36.508 [2] table 4.5A.6.3-1) are performed.	-	-	-	-
33- 34	Void	-	-	-	-
35	Check: Does the UE transmit an ACTIVATE DEDICATED EPS BEARER CONTEXT ACCEPT message?	-->	RRC: <i>ULInformationTransfer</i> NAS:ACTIVATE DEDICATED EPS BEARER CONTEXT ACCEPT	1	P
36	The SS waits 1 second.	-	-	-	-
36a 1	Void	-	-	-	-
37	Release IMS Call as specified in the generic procedure in TS 34.229-1 [35] subclause C.32.	-	-	-	-

Table 11.1.5.3.2-2: Parallel behaviour

St	Procedure	Message Sequence		TP	Verdict
		U - S	Message		
1	Check: Does the UE transmit a PDN CONNECTIVITY REQUEST message to request an additional PDN.	-->	RRC: ULInformationTransfer NAS: PDN CONNECTIVITY REQUEST	1	P
2	The SS configures a new data radio bearer, associated with the additional default EPS bearer context. <i>RRCConnectionReconfiguration</i> message contains the ACTIVATE DEFAULT EPS BEARER CONTEXT REQUEST message.	<--	RRC: RRCConnectionReconfiguration NAS: ACTIVATE DEFAULT EPS BEARER CONTEXT REQUEST		
3	The UE transmits an <i>RRCConnectionReconfigurationComplete</i> message to confirm the establishment of additional default bearer.	-->	RRC: RRCConnectionReconfigurationC omplete		
-	EXCEPTION: In parallel to the event described in step 4 below, if initiated by the UE the generic procedure for IP address allocation in the U-plane specified in TS 36.508 subclause 4.5A.1 takes place performing IP address allocation in the U-plane.	-	-		
4	The UE transmits an ACTIVATE DEFAULT EPS BEARER CONTEXT ACCEPT message.	-->	RRC: ULInformationTransfer NAS: ACTIVATE DEFAULT EPS BEARER CONTEXT ACCEPT		

11.1.5.3.3

Specific message contents

Table 11.1.5.3.3-0: REGISTRATION ACCEPT (preamble)

Derivation path: TS 38.508-1 [4] Table 4.7.1-7			
Information Element	Value/remark	Comment	Condition
Extended protocol discriminator	'0111 1110'B	5GS mobility management messages	
Security header type	'0000'B	Plain 5GS NAS message, not security protected	
Spare half octet	'0000'B		
5GS network feature support	'0100 0001 0000 0000'B	Interworking without N26 interface supported	

Table 11.1.5.3.3-1: RRCRelease (step 13, table 11.1.5.3.2-1)

Derivation path: TS 38.508-1 [4] Table Table 4.6.1-16			
Information Element	Value/Remark	Comment	Condition
RRCRelease ::= SEQUENCE {			
criticalExtensions CHOICE {			
rrcRelease SEQUENCE {			
redirectedCarrierInfo CHOICE {			
eutra SEQUENCE {			
eutraFrequency	Downlink EARFCN of E-UTRA cell 3		
cnType	epc		
}			
}			
}			
}			
}			
}			

Table 11.1.5.3.3-2: ATTACH REQUEST (step 15a1, table 11.1.5.3.2-1)

Derivation Path: TS 36.508 [7], Table 4.7.2-4			
Information Element	Value/Remark	Comment	Condition
NAS key set identifier	KSI _{ASME} that was created when the UE last registered to EPC E-UTRA		
EPS mobile identity	GUTI, assigned by E-UTRA Cell 1 at the initial registration when the UE entered S1		
Last visited registered TAI	The TAI the last visited E-UTRA Cell belonged to, if any. Not included if the UE does not have last stored EPC TAI.		
Old GUTI type	"Native GUTI"		
ESM message container	PDN CONNECTIVITY REQUEST message to active PDU sessions which the UE intends to transfer to EPS.		

Table 11.1.5.3.3-3: PDN CONNECTIVITY REQUEST (Table 11.1.5.3.3-2)

Derivation Path: TS 36.508 [7], Table 4.7.3-20			
Information Element	Value/remark	Comment	Condition
EPS bearer identity	0	No EPS bearer identity assigned, for coding see Table 9.11.4.8.1 in TS 24.501 [22]	
Procedure transaction identity	Any value from 1 to 254		
PDN connectivity request message identity	'1101 0000'B	PDN connectivity request	
Request type	'010'B	Handover	
PDN type	Any value between '001'B, '010'B, '011'B and '100'B	The allowed values are respectively IPv4, IPv6, IPv4v6 and "unused but interpreted as IPv6 by the network"	
Protocol configuration options	PDU session ID of IMS PDU session		

Table 11.1.5.3.3-4: TRACKING AREA UPDATE REQUEST (step 15b1, table 11.1.5.3.2-1)

Derivation Path: TS 36.508 [7], Table 4.7.2-27, condition NR.			
Information Element	Value/Remark	Comment	Condition
"Active" flag	0001	Bearer Establishment requested	
EPS bearer context status	Present	EBI corresponding to active PDU Sessions need to be set to 1	
NAS key set identifier	KSI _{ASME} that was created when the UE last registered to EPC E-UTRA		

Old GUTI	GUTI, mapped from the 5G-GUTI assigned at the initial registration when the UE entered N1		
Last visited registered TAI	The TAI the last visited E-UTRA Cell belonged to, if any. Not included if the UE does not have last stored EPC TAI.		
Old GUTI type	"Native GUTI"		
UE status	"UE is in 5GMM-REGISTERED state"		

Table 11.1.5.3.3-5: TRACKING AREA UPDATE REJECT (step 15b2, table 11.1.5.3.2-1)

Derivation Path: TS 36.508 [7], Table 4.7.2-26.			
Information Element	Value/Remark	Comment	Condition
EMM cause	'0000 1001'B	#9 "UE identity cannot be derived by the network"	

Table 11.1.5.3.3-6: ATTACH REQUEST (step 15b3, table 11.1.5.3.2-1)

Derivation Path: TS 36.508 [7], Table 4.7.2-4.			
Information Element	Value/Remark	Comment	Condition
IMSI	IMSI of the UE		

Table 11.1.5.3.3-7: PDN CONNECTIVITY REQUEST (step 1, table 11.1.5.3.2-2)

Derivation Path: TS 36.508 [7], Table 4.7.3-20			
Information Element	Value/remark	Comment	Condition
EPS bearer identity	0	No EPS bearer identity assigned, for coding see Table 9.11.4.8.1 in TS 24.501 [22]	
Procedure transaction identity	Any value from 1 to 254		
PDN connectivity request message identity	'1101 0000'B	PDN connectivity request	
Request type	'010'B	Handover	
PDN type	Any value between '001'B, '010'B, '011'B and '100'B	The allowed values are respectively IPv4, IPv6, IPv4v6 and "unused but interpreted as IPv6 by the network"	
Protocol configuration options	PDU session ID of internet PDU session		

Table 11.1.5.3.3-8: SystemInformationBlockType1 of E-UTRA Cell 3 (all steps, table 11.1.5.3.2-1)

Derivation Path: 36.508 [7] Table 4.4.3.2-3			
Information Element	Value/remark	Comment	Condition
SystemInformationBlockType1 ::= SEQUENCE {			
cellAccessRelatedInfo SEQUENCE {			
plmn-IdentityList SEQUENCE (SIZE (1..6))	1 entry		
OF SEQUENCE {			
cellReservedForOperatorUse[1]	reserved		
}			

}			
}			

Table 11.1.5.3.3-9: ATTACH ACCEPT (preamble, step 25; step 14, TS 36.508-1 [7], Table 4.5.2.3-1)

Derivation path: TS 36.508-1 [7] Table 4.7.2-1			
Information Element	Value/remark	Comment	Condition
EPS network feature support	'0000 0011 0100 1000'B	- IMS voice over PS session in S1 mode supported - emergency bearer services in S1 mode supported - ePCO supported - Interworking without N26 interface supported	

Table 11.1.5.3.3-10: ACTIVATE DEFAULT EPS BEARER CONTEXT REQUEST (preamble, step 25; step 14, TS 36.508-1 [7], Table 4.5.2.3-1)

Derivation Path: TS 36.508-1 [7] Table 4.7.3-6			
Information Element	Value/remark	Comment	Condition
Protocol configuration options			
Container ID n+2	Not present	Session-AMBR are not present	
Container ID n+3	Not present	QoS rules are not present	
Container ID n+4	Not present	Qos flow descriptions are not present	

11.1.6 MT MMTEL voice call setup from NR RRC_IDLE / EPS Fallback with redirection / Single registration mode without N26 interface / Success

11.1.6.1 Test Purpose (TP)

(1)

with {UE supporting both S1 mode and N1 mode and operating in single-registration mode, and, the Network has indicated "interworking without N26 interface supported", and, the UE is in NR RRC_IDLE state }

ensure that {

when { UE receives a *Paging* message with MT MMTEL voice call, the MT IMS voice session establishment has been initiated and the UE receives a RRCRelease message which includes *redirectedCarrierInfo* indicating redirection to *eutra* }

then { UE selects the E-UTRA cell, performs an ATTACH or a TAU procedure, **and**, successfully completes the MT MMTEL call setup in EPS }

11.1.6.2 Conformance requirements

References: The conformance requirements covered in the current TC are specified in: TS23.502, clauses 4.11.2.2, 4.13.6.1; TS 24.501, clauses 4.5.4.1, 4.8.2.3; TS 38.331, clause 5.3.11. Unless otherwise stated these are Rel-15 requirements.

[TS 23.502, clause 4.11.2.2]

The following procedure is used by UEs in single-registration or dual registration mode on mobility from 5GS to EPS.

In the case of network sharing the UE selects the target PLMN ID according to clause 5.18.3 of TS 23.501 [2].

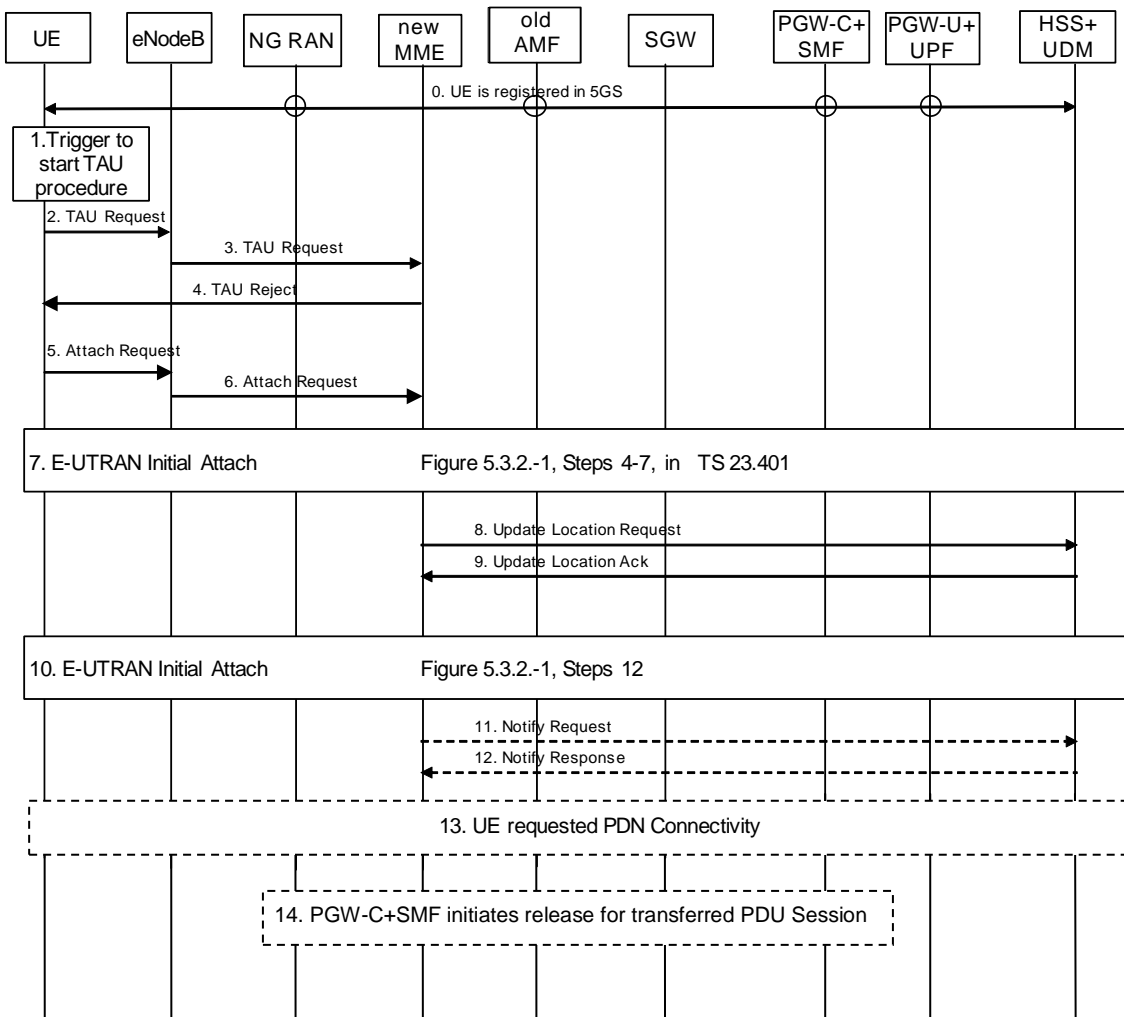

Figure 4.11.2.2-1: Mobility procedure from 5GS to EPS without N26 interface

The UE operating in single-registration mode can start the procedure from Step 1 or Step 5. The UE operating in dual-registration mode starts the procedure from Step 5.

NOTE 1: The network has indicated the "Interworking without N26" to the UE. To support IP address preservation, the UE in single-registration mode starts the procedure from Step 5. If the UE in single-registration mode starts the procedure from Step 1, the IP address preservation is not provided.

0. UE is registered in 5GS and established PDU sessions. The FQDN for the S5/S8 interface of the PGW-C+SMF is also stored in the UDM by the PGW-C+SMF during PDU Session setup in addition to what is specified in clause 4.3.2.2.1 and clause 4.3.2.2.2.

NOTE 2: At 5GS to EPS mobility, the MME use the FQDN for the S5/S8 interface of the PGW-C+SMF to find the PGW-C+SMF, and when UE moves back from EPS to 5GS, the AMF uses FQDN for the S5/S8 interface of the PGW-C+SMF to find the PGW-C+SMF.

1. Step 1 as in clause 5.3.3.1 (Tracking Area Update) in TS 23.401 [13].

2. Step 2 as in clause 5.3.3.1 (Tracking Area Update) in TS 23.401 [13] with the following modifications:

The UE shall provide a EPS-GUTI that is mapped from the 5G-GUTI following the mapping rules specified in TS 23.501 [2]. The UE indicates that it is moving from 5GC.

3. Step 3 as in clause 5.3.3.1 (Tracking Area Update) in TS 23.401 [13].
4. If the MME determined that the old node is an AMF based on UE's GUTI mapped from 5G-GUTI and the MME is configured to support 5GS-EPS interworking without N26 procedure, the MME sends a TAU Reject to the UE.
5. Step 1 as in clause 5.3.2.1 (E-UTRAN Initial Attach) in TS 23.401 [13] with the modifications captured in clause 4.11.2.4.1.
6. Step 2 as in clause 5.3.2.1 (E-UTRAN Initial Attach) in TS 23.401 [13].
7. Steps 4-7 as in clause 5.3.2.1 (E-UTRAN Initial Attach) in TS 23.401 [13], with the modifications captured in clause 4.11.2.4.1.
8. Step 8 as in clause 5.3.2.1 (E-UTRAN Initial Attach) in TS 23.401 [13], with the modifications captured in clause 4.11.2.4.1.
9. Step 11 as in clause 5.3.2.1 (E-UTRAN Initial Attach) in TS 23.401 [13], with the following modifications:
The subscription profile the MME receives from HSS+UDM includes per DNN/APN at most one PGW-C+SMF FQDN as described in in clause 5.17.2.1 in TS 23.501 [2].
10. Steps 12-24 as in clause 5.3.2.1 (E-UTRAN Initial Attach) in TS 23.401 [13], with the modifications as described in clause 4.11.2.4.1.
11. Step 25 as in clause 5.3.2.1 (E-UTRAN Initial Attach) in TS 23.401 [13].
12. Step 26 as in clause 5.3.2.1 (E-UTRAN Initial Attach) in TS 23.401 [13].
13. If the UE has remaining PDU Sessions in 5GS which it wants to transfer to EPS and maintain the same IP address/prefix, the UE performs the UE requested PDN Connectivity Procedure as specified in TS 23.401 [13] clause 5.10.2 and sets the Request Type to "handover" in Step 1 of the procedure with modification captured in clause 4.11.2.4.2. UE provides an APN and the PDU Session ID corresponding to the PDU Session it wants to transfer to EPS. The UE provides the PDU Session ID in PCO as described in clause 4.11.1.1.

UEs in single-registration mode performs this step for each PDU Session immediately after completing the E-UTRAN Initial Attach procedure. UEs in dual-registration mode may perform this step any time after the completing of E-UTRAN Initial Attach procedure. Also, UEs in dual-registration mode may perform this step only for a subset of PDU Sessions.

The MME determines the PGW-C+SMF address for the Create Session Request based on the APN received from the UE and the subscription profile received from the HSS+UDM in Step 9 or when the HSS+UDM notifies the MME for the new PGW-C+SMF ID in the updated subscription profile.

The PGW-C+SMF uses the PDU Session ID to correlate the transferred PDN connection with the PDU Session in 5GC.

As a result of the procedure the PGW-U+UPF starts routing DL data packets to the Serving GW for the default and any dedicated EPS bearers established for this PDN connection.

14. The PGW-C+SMF initiates release of the PDU Session(s) in 5GS transferred to EPS as specified in clause 4.3.4.2 with the following clarification:

In step 2, the PGW-C+SMF shall not release IP address/prefix(es) allocated for the PDU Session.

If UP connection of the PDU Session is not active, step 3b is not executed, thus the steps triggered by step 3b are not executed;

If UP connection of the PDU Session is active, the SMF invokes the Namf_Communication_N1N2MessageTransfer service operation without including N1 SM container (PDU Session Release Command).

[TS 23.502, clause 4.13.6.1]

Figure 4.13.6.1-1 describes the EPS fallback procedure for IMS voice.

When the UE is served by the 5G System, the UE has one or more ongoing PDU Sessions each including one or more QoS Flows. The serving PLMN AMF has sent an indication towards the UE during the Registration procedure that IMS voice over PS session is supported, see clause 5.16.3.10 in TS 23.501 [2] and the UE has registered in the IMS. If N26 is not supported, the serving PLMN AMF sends an indication towards the UE during the Registration procedure that interworking without N26 is supported, see clause 5.17.2.3.1 in TS 23.501 [2].

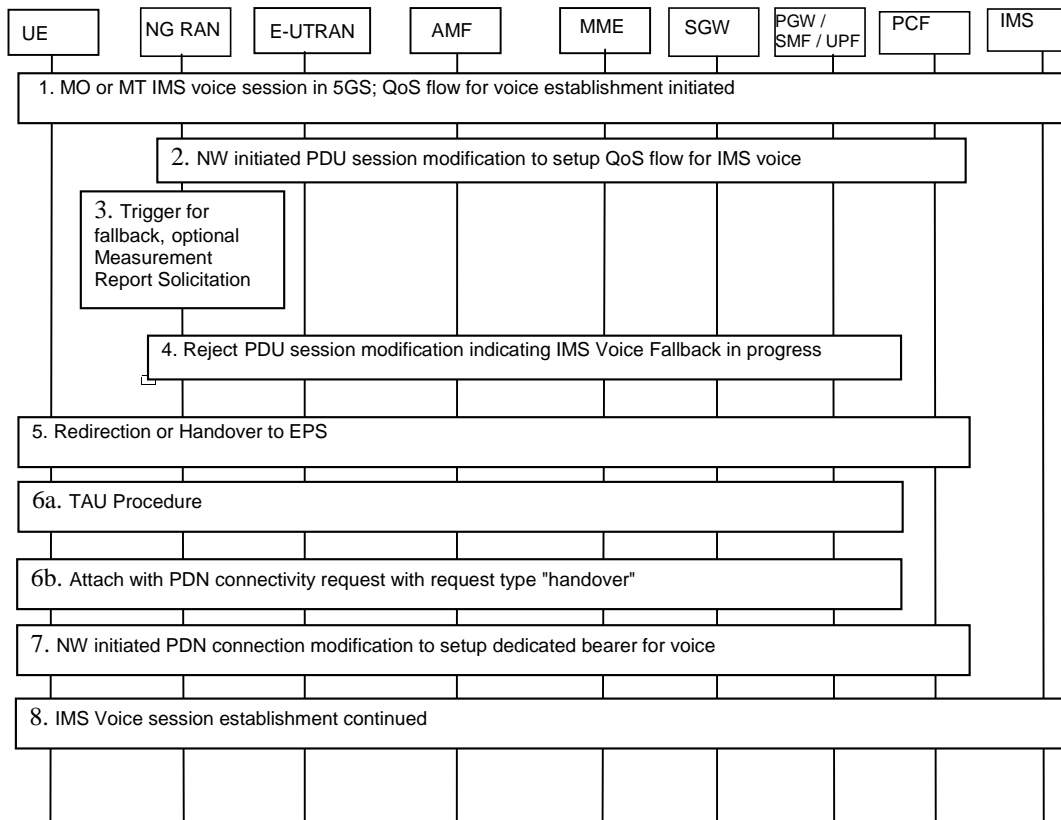

Figure 4.13.6.1-1: EPS Fallback for IMS voice

1. UE camps on NG-RAN in the 5GS and an MO or MT IMS voice session establishment has been initiated.
2. Network initiated PDU Session modification to setup QoS flow for voice reaches the NG-RAN (see N2 PDU Session Request in clause 4.3.3).
3. NG-RAN is configured to support EPS fallback for IMS voice and decides to trigger fallback to EPS, taking into account UE capabilities, indication from AMF that "Redirection for EPS fallback for voice is possible" (received as part of initial context setup as defined in TS 38.413 [10]), network configuration (e.g. N26 availability configuration) and radio conditions. If NG-RAN decides not to trigger fallback to EPS, then the procedure stops here and following steps are not executed.

NG-RAN may initiate measurement report solicitation from the UE including E-UTRAN as target.

NOTE 1: If AMF has indicated that "Redirection for EPS fallback for voice is not possible", then AN Release via inter-system redirection to EPS is not performed in step 5.

4. NG-RAN responds indicating rejection of the PDU Session modification to setup QoS flow for IMS voice received in step 2 by PDU Session Response message towards the PGW-C+SMF (or H-SMF+P-GW-C via V-SMF, in case of roaming scenario) via AMF with an indication that mobility due to fallback for IMS voice is ongoing. The PGW-C+SMF maintains the PCC rule(s) associated with the QoS Flow(s).
5. NG-RAN initiates either handover (see clause 4.11.1.6.1), or AN Release via inter-system redirection to EPS (see clause 4.2.6 and clause 4.11.1.3.2), taking into account UE capabilities. The PGW-C+SMF reports change of the RAT type if subscribed by PCF as specified in clause 4.11.1.6.1, or clause 4.11.1.3.2.6. When the UE is connected to EPS, either 6a or 6b is executed

- 6a. In the case of 5GS to EPS handover, see clause 4.11.1.6.1, and in the case of inter-system redirection to EPS with N26 interface, see clause 4.11.1.3.2. In either case the UE initiates TAU procedure; or
- 6b. In the case of inter-system redirection to EPS without N26 interface, see clause 4.11.2.2. If the UE supports Request Type flag "handover" for PDN connectivity request during the attach procedure as described in clause 5.3.2.1 of TS 23.401 [13] and has received the indication that interworking without N26 is supported, then the UE initiates Attach with PDN connectivity request with request type "handover".

In inter-system redirection, the UE uses the emergency indication in the RRC message as specified in clause 6.2.2 of TS 36.331 [16] and E-UTRAN provides the emergency indication to MME during Tracking Area Update or Attach procedure. For the handover procedure see clause 4.11.1.6.1, step 1.

7. After completion of the mobility procedure to EPS or as part of the 5GS to EPS handover procedure (see clause 4.11.1.6.1), the SMF/PGW re-initiates the setup of the dedicated bearer for IMS voice, mapping the 5G QoS to EPC QoS parameters. The PGW-C+SMF behaves as specified in clause 4.9.1.3.1. The PGW-C+SMF reports about Successful Resource Allocation and Access Network Information if subscribed by PCF.
8. The IMS voice session establishment is continued.

At least for the duration of the voice call in EPS the E-UTRAN is configured to not trigger any handover to 5GS.

[TS 24.501, clause 4.5.4.1]

When the UE is in 5GMM-IDLE mode, upon receiving a request from the upper layers for an access attempt, the NAS shall categorize the access attempt into access identities and an access category following subclause 4.5.2, table 4.5.2.1 and table 4.5.2.2, and subclause 4.5.3, and provide the applicable access identities and the access category to the lower layers for the purpose of access control checking. In this request to the lower layer the NAS can also provide to the lower layer the RRC establishment cause determined as specified in subclause 4.5.6 of this specification.

NOTE 1: The access barring check is performed by the lower layers.

NOTE 2: As an implementation option, the NAS can provide the RRC establishment cause to the lower layers after being informed by the lower layers that the access attempt is allowed.

If the UE has uplink user data pending for one or more PDU sessions when it builds a REGISTRATION REQUEST or SERVICE REQUEST message as initial NAS message, the UE shall indicate the respective PDU sessions in the Uplink data status IE as specified in subclause 5.5.1.3.2 and 5.6.1.2, regardless of the access category for which the access barring check is performed.

NOTE 3: The UE indicates pending user data for all the respective PDU sessions, even if barring timers are running for some of the corresponding access categories.

If the lower layers indicate that the access attempt is allowed, the NAS shall initiate the procedure to send the initial NAS message for the access attempt.

If the lower layers indicate that the access attempt is barred, the NAS shall not initiate the procedure to send the initial NAS message for the access attempt. Additionally:

- a) if the event which triggered the access attempt was an MO-MMTEL-voice-call-started indication or an MO-MMTEL-video-call-started indication:
 - 1) if the UE is operating in the single-registration mode and the UE's usage setting is "voice centric", the UE may attempt to select an E-UTRA cell connected to EPC. If the UE finds a suitable E-UTRA cell connected to EPC, it then proceeds with the appropriate EMM specific procedures and, if necessary, ESM procedures to make a PDN connection providing access to IMS available; see subclause 4.8.2 and 3GPP TS 24.301 [15];
 - 2) if the UE is operating in the dual-registration mode, the UE may proceed in S1 mode with the appropriate EMM specific procedures and ESM procedures to make a PDN connection providing access to IMS available; see subclause 4.8.3 and 3GPP TS 24.301 [15];
 - 3) otherwise, the NAS shall notify the upper layers that the access attempt is barred. In this case, upon receiving an indication from the lower layers that the barring is alleviated for the access category with which the access attempt was associated, the NAS shall notify the upper layers that the barring is alleviated for the access category and may initiate the procedure to send the initial NAS message, if still needed; and
- b) if the event which triggered the access attempt was an MO-SMSoIP-attempt-started indication:

- 1) if the UE is operating in the single-registration mode, the UE may attempt to select an E-UTRA cell connected to EPC. If the UE finds a suitable E-UTRA cell connected to EPC, it then proceeds with the appropriate EMM specific procedures and, if necessary, ESM procedures to make a PDN connection providing access to IMS available; see subclause 4.8.2 and 3GPP TS 24.301 [15];
- 2) if the UE is operating in the dual-registration mode, the UE may proceed in S1 mode with the appropriate EMM specific procedures and ESM procedures to make a PDN connection providing access to IMS available; see subclause 4.8.3 and 3GPP TS 24.301 [15];
- 3) otherwise, the NAS layer shall notify the upper layers that the access attempt is barred. In this case, upon receiving an indication from the lower layers that the barring is alleviated for the access category with which the access attempt was associated, the NAS shall notify the upper layers that the barring is alleviated for the access category and may initiate the procedure to send the initial NAS message, if still needed.

NOTE 4: Barring timers, on a per access category basis, are run by the lower layers. At expiry of barring timers, the indication of alleviation of access barring is indicated to the NAS on a per access category basis.

[TS 24.501, clause 4.8.2.3]

At inter-system change from N1 mode to S1 mode in EMM-IDLE mode when: (PDU SEESION ACTIVE)

- a) the UE supports non-IP PDN type and at least one PDU session is active; or
- b) the UE does not support non-IP PDN type and at least one PDU session of IPv4, IPv6 or IPv4v6 PDU session type is active,

the UE shall proceed as follows:

- a) if the UE supports sending an ATTACH REQUEST message containing a PDN CONNECTIVITY REQUEST message with request type set to "handover" to transfer a PDU session from N1 mode to S1 mode and the UE has received an "interworking without N26 interface supported" indication from the network, the UE shall:
 - 1) enter substates EMM-DEREGISTERED.NORMAL-SERVICE and 5GMM-REGISTERED.NO-CELL-AVAILABLE;
 - 2) map the PDU session(s) which the UE intends to transfer to EPS to the default EPS bearer context of the corresponding PDN connection(s) as specified in subclause 6.1.4.2; and
 - 3) initiate an EPS attach procedure and include a PDN CONNECTIVITY REQUEST message with request type set to "handover" in the ATTACH REQUEST message to activate a default EPS bearer context for one of the active PDU sessions which the UE intends to transfer to EPS.

After successful completion of the EPS attach procedure, the UE shall reset the registration attempt counter and the attach attempt counter (see 3GPP TS 24.301 [15]) and attempt to activate each of the other default EPS bearer contexts, if any, by initiating a stand-alone PDN connectivity procedure with request type set to "handover" in the PDN CONNECTIVITY REQUEST message; and

- b) otherwise, enter substates EMM-REGISTERED.NORMAL-SERVICE and 5GMM-REGISTERED.NO-CELL-AVAILABLE and initiate a tracking area update procedure (see 3GPP TS 24.301 [15]).

At inter-system change from N1 mode to S1 mode in EMM-IDLE mode when: (NO PDU SESSION)

- a) the UE supports non-IP PDN type and no PDU session is active; or
- b) the UE does not support non-IP PDN type and no PDU session of IPv4, IPv6 or IPv4v6 PDU session type is active,

the UE shall enter substates EMM-DEREGISTERED.NORMAL-SERVICE and 5GMM-DEREGISTERED.NO-CELL-AVAILABLE, and initiate an attach procedure.

At inter-system change from S1 mode to N1 mode in 5GMM-IDLE mode, the UE shall:

- a) enter substate 5GMM-REGISTERED.NORMAL-SERVICE and substate EMM-REGISTERED.NO-CELL-AVAILABLE;

- b) map the default EPS bearer context(s) of the PDN connection(s) which the UE intends to transfer to 5GS, if any, to the corresponding PDU session(s) as specified in subclause 6.1.4.2; and
- c) initiate the registration procedure for mobility and periodic registration update indicating "mobility registration updating" in the 5GS registration type IE of the REGISTRATION REQUEST message (see subclause 5.5.1.3).

After having successfully registered in N1 mode the UE shall reset the registration attempt counter and the attach attempt counter (see 3GPP TS 24.301 [15]) and:

- a) if the UE supports the PDU session establishment procedure with request type set to "existing PDU session" to transfer a PDN connection from S1 mode to N1 mode and the UE has received an "interworking without N26 interface supported" indication from the network, attempt to transfer the PDN connection(s) which the UE intends to transfer to 5GS, if any, from S1 mode to N1 mode by initiating the PDU session establishment procedure with request type set to "existing PDU session"; and
- b) otherwise, establish PDU session(s) corresponding to the PDN connection(s) which the UE intends to transfer to 5GS, if any, by initiating the PDU session establishment procedure with request type set to "initial request".

See subclause 5.1.4.3 for coordination between 5GMM and EMM and subclause 6.1.4.2 for coordination between 5GSM and ESM.

[TS 38.331, clause 5.3.11]

UE shall:

- 1> reset MAC;
- 1> if T302 is running:
 - 2> stop timer T302;
 - 2> perform the actions as specified in 5.3.14.4;
- 1> stop all timers that are running except T320 and T325;
- 1> discard the UE Inactive AS context;
- 1> set the variable *pendingRnaUpdate* to *false*, if that is set to *true*;
- 1> discard the K_{gNB} , the K_{RRCenc} key, the K_{RRCint} , the K_{UPint} key and the K_{UPenc} key, if any;
- 1> release all radio resources, including release of the RLC entity, the MAC configuration and the associated PDCP entity and SDAP for all established RBs;
- 1> indicate the release of the RRC connection to upper layers together with the release cause;
- 1> enter RRC_IDLE and perform cell selection as specified in TS 38.304 [20], except if going to RRC_IDLE was triggered by selecting an inter-RAT cell while T311 was running;
- 1> if going to RRC_IDLE was triggered by reception of the *RRCRelease* message including a *waitTime*:
 - 2> start timer T302 with the value set to the *waitTime*;
 - 2> inform the upper layer that access barring is applicable for all access categories except categories '0' and '2'.

11.1.6.3 Test description

11.1.6.3.1 Pre-test conditions

System Simulator:

- 2 cells
- NR Cell 1 as defined in TS 38.508-1 [4] Table 4.4.2-3. System information combination NR-6 as defined in TS 38.508-1 [4], sub-clause 4.4.3.1.2.

- E-UTRA Cell 1 as defined in TS 36.508 [7] Table 4.4.2-2. System information combination 31 as defined in TS 36.508 [7], sub-clause 4.4.3.1.1.
- Power levels are constant and as defined in Tables 11.1.6.3.1-1/2.

Table 11.1.6.3.1-1: Time instances of cell power level and parameter changes for conducted test environment

	Parameter name	Unit	NR Cell 1	E-UTRA Cell 1	Remark
T0	SS/PBCH SSS EPRE	dBm/SCS	-88	-	
	RS EPRE	dBm/15kHz	-	-91	

Table 11.1.6.3.1-2: Time instances of cell power level and parameter changes for OTA test environment

	Parameter name	Unit	NR Cell 1	E-UTRA Cell 1	Remark
T0	SS/PBCH SSS EPRE	dBm/SCS	-82	-	
	RS EPRE	dBm/15kHz	-	-91	

UE:

None.

Preamble:

- With E-UTRA Cell 1 "Serving cell" and NR Cell 1 "Non-suitable "Off" cell" in accordance with TS 38.508-1 [4], Table 6.2.2.1-3, the UE is brought to state RRC_IDLE using generic procedure parameters Connectivity (*E-UTRA/EPC*) and Unrestricted nr PDN (*On*) in accordance with the procedure described in TS 38.508-1 [4], clause 4.5.2. 4G GUTI and eKSI are assigned and security context established.
- The UE is switched-off.
- With E-UTRA Cell 1 "Non-suitable "Off" cell" and NR Cell 1 "Serving cell" in accordance with TS 38.508-1 [4], Table 6.2.2.1-3, the UE is brought to state 1N-A, RRC_IDLE Connectivity (NR), in accordance with the procedure described in TS 38.508-1 [4], with one IMS PDU session on NR Cell 1, Table 4.5.2.2-2. 5G-GUTI and ngKSI are assigned and security context established.

11.1.6.3.2 Test procedure sequence

Table 11.1.6.3.2-1: Main behaviour

St	Procedure	Message Sequence		TP	Verdict
		U – S	Message		
1	Void	-	-	-	-
-	EXCEPTION: Unless otherwise stated the following messages are exchange on NR Cell 1.	-	-	-	-
2	The SS transmits a <i>Paging</i> message.	<--	NR RRC: Paging	-	-
3	The UE transmits an <i>RRCSetupRequest</i> message.	-->	NR RRC: RRCSetupRequest	-	-
4	The SS transmits an <i>RRCSetup</i> message.	<--	NR RRC: RRCSetup	-	-
5	The UE transmits an <i>RRCSetupComplete</i> message and a SERVICE REQUEST message.	-->	NR RRC: RRCSetupComplete 5GMM: SERVICE REQUEST	-	-
5A	The SS transmits a <i>SecurityModeCommand</i> message.	<--	NR RRC: SecurityModeCommand	-	-

5B	The UE transmits a <i>SecurityModeComplete</i> message.	-->	NR RRC: <i>SecurityModeComplete</i>	-	-
5C	Set the power levels according to "T0" as per Table 11.1.6.3.1-1/2.	-	-	-	-
6	The SS transmits an <i>RRCRelease</i> message.	<--	NR RRC: <i>RRCRelease</i>	-	-
-	EXCEPTION: The following message was sent on E-UTRA Cell 1.	-	-	-	-
7	UE transmits an <i>RRCConnectionRequest</i> message.	-->	RRC: <i>RRCConnectionRequest</i>	-	-
8	SS transmits an <i>RRCConnectionSetup</i> message.	<--	RRC: <i>RRCConnectionSetup</i>	-	-
-	EXCEPTION: Steps 8a1 to 8b3 describe behaviour that depends on the UE implementation; the "lower case letter" identifies a step sequence that take place depending on the UE implementation.	-	-	-	-
8a1	If the UE tries to preserve the IP address of the PDN connection then check does the UE transmits an ATTACH REQUEST message?	-->	RRC: <i>RRCConnectionSetupComplete</i> NAS: ATTACH REQUEST	1	P
8b1	Else check: does the UE transmit a TRACKING AREA UPDATE REQUEST message?	-->	RRC: <i>RRCConnectionSetupComplete</i> NAS: TRACKING AREA UPDATE REQUEST	1	P
8b2	The SS transmits a TRACKING AREA UPDATE REJECT message to UE.	<--	RRC: <i>DLInformationTransfer</i> NAS: TRACKING AREA UPDATE REQUEST REJECT	-	-
8b3	The UE transmits an ATTACH REQUEST message.	-->	RRC: <i>ULInformationTransfer</i> NAS: ATTACH REQUEST	-	-
9-20	Steps 5 to 16 of the generic test procedure for UE registration (TS 36.508 [7] Table 4.5.2.3-1).	-	-	-	-
-	EXCEPTION: In parallel to the events described in steps 21 to 41 the steps specified in Table 11.1.6.3.2-2 may take place to transfer other PDU sessions to EPS.	-	-	-	-
-	EXCEPTION: In parallel to the events described in steps 21 to 29 the UE may perform IMS re-registration on EUTRAN as per steps as defined in defined in 34.229-1 [35] subclause C.46 using the message "REGISTER" with condition A31. 34.229-1 [35] subclause C.46.	-	-	-	-
21-28	Steps 7-14 from the Generic Test Procedure for MTSI MT speech call establishment (TS 36.508 [7] table 4.5A.7.3-1) are performed.	-	-	-	-
29	Check: Does the UE transmit an ACTIVATE DEDICATED EPS BEARER CONTEXT ACCEPT message?	-->	RRC: <i>ULInformationTransfer</i> NAS:ACTIVATE DEDICATED EPS BEARER CONTEXT ACCEPT	1	P
30-40	Steps 16-26 from the Generic Test Procedure for MTSI MT speech call establishment (TS 36.508 [7] table 4.5A.7.3-1) are performed.	-	-	-	-
41	The SS waits 1 second.	-	-	-	-
42	Release IMS Call as specified in the generic procedure in TS 34.229-1 [35] subclause C.33.	-	-	-	-

Table 11.1.6.3.2-2: Parallel behaviour

St	Procedure	Message Sequence		TP	Verdict
		U - S	Message		
1	Check: Does the UE transmit a PDN CONNECTIVITY REQUEST message to request an additional PDN.	-->	RRC: <i>ULInformationTransfer</i> NAS: PDN CONNECTIVITY REQUEST	1	P
2	The SS configures a new data radio bearer, associated with the additional default EPS bearer context. <i>RRCConnectionReconfiguration</i> message	<--	RRC: <i>RRCConnectionReconfiguration</i> NAS: ACTIVATE DEFAULT EPS		

	contains the ACTIVATE DEFAULT EPS BEARER CONTEXT REQUEST message.		BEARER CONTEXT REQUEST		
3	The UE transmits an <i>RRCConnectionReconfigurationComplete</i> message to confirm the establishment of additional default bearer.	-->	RRC: RRCConnectionReconfigurationComplete		
-	EXCEPTION: In parallel to the event described in step 4 below, if initiated by the UE the generic procedure for IP address allocation in the U-plane specified in TS 36.508 subclause 4.5A.1 takes place performing IP address allocation in the U-plane.	-	-		
4	The UE transmits an ACTIVATE DEFAULT EPS BEARER CONTEXT ACCEPT message.	-->	RRC: ULInformationTransfer NAS: ACTIVATE DEFAULT EPS BEARER CONTEXT ACCEPT		

11.1.6.3.3 Specific message contents

Table 11.1.6.3.3-0: REGISTRATION ACCEPT (preamble; step 14, TS 38.508-1 [4], Table 4.5.2.2-2)

Derivation path: TS 38.508-1 [4] Table 4.7.1-7			
Information Element	Value/remark	Comment	Condition
Extended protocol discriminator	'0111 1110'B	5GS mobility management messages	
Security header type	'0000'B	Plain 5GS NAS message, not security protected	
Spare half octet	'0000'B		
5GS network feature support	'0100 0001 0000 0000'B	Interworking without N26 interface supported	

Table 11.1.6.3.3-1: RRCRelease (step 6, table 11.1.6.3.2-1)

Derivation path: TS 38.508-1 [4] Table Table 4.6.1-16			
Information Element	Value/Remark	Comment	Condition
RRCRelease ::= SEQUENCE {			
criticalExtensions CHOICE {			
rrcRelease SEQUENCE {			
redirectedCarrierInfo CHOICE {			
eutra SEQUENCE {			
eutraFrequency	Downlink EARFCN of cell 1		
cnType	epc		
}			
}			
}			
}			
}			

Table 11.1.6.3.3-1A: ATTACH REQUEST (step 8a1, table 11.1.6.3.2-1)

Derivation Path: TS 36.508 [7], Table 4.7.2-4.			
Information Element	Value/Remark	Comment	Condition
NAS key set identifier	KSI _{ASME} that was created when the UE last registered to EPC E-UTRA		
EPS mobile identity	GUTI, assigned by E-		

	UTRA Cell 1 at the initial registration when the UE entered S1		
Last visited registered TAI	The TAI the last visited E-UTRA Cell belonged to, if any. Not included if the UE does not have last stored EPC TAI.		
Old GUTI type	"Native GUTI"		
ESM message container	PDN CONNECTIVITY REQUEST message to active PDU sessions which the UE intends to transfer to EPS.		

Table 11.1.6.3.3-1B: PDN CONNECTIVITY REQUEST (step 8a1, table 11.1.6.3.2-1)

Derivation Path: TS 36.508 [7], Table 4.7.3-20			
Information Element	Value/remark	Comment	Condition
EPS bearer identity	0	No EPS bearer identity assigned	
Procedure transaction identity	Any value from 1 to 254		
PDN connectivity request message identity	'1101 0000'B	PDN connectivity request	
Request type	'010'B	Handover	
PDN type	Any value between '001'B, '010'B, '011'B and '100'B	The allowed values are respectively IPv4, IPv6, IPv4v6 and "unused but interpreted as IPv6 by the network"	
Protocol configuration options	PDU session ID of 5GS PDU session		

Table 11.1.6.3.3-2: TRACKING AREA UPDATE REQUEST (step 8b1, table 11.1.6.3.2-1)

Derivation Path: TS 36.508 [7], Table 4.7.2-27, condition NR.			
Information Element	Value/Remark	Comment	Condition
"Active" flag	0001	Bearer Establishment requested	
EPS bearer context status	Present	EBI corresponding to active PDU Sessions need to be set to 1	
NAS key set identifier	KSI _{ASME} that was created when the UE last registered to EPC E-UTRA		
Old GUTI	GUTI, mapped from the 5G-GUTI assigned at the initial registration when the UE entered N1		
Last visited registered TAI	The TAI the last visited E-UTRA Cell belonged to, if any. Not included if the UE does not have last stored EPC TAI.		
Old GUTI type	"Native GUTI"		
UE status	"UE is in 5GMM-REGISTERED state"		

Table 11.1.6.3.3-3: TRACKING AREA UPDATE REJECT (step8b2, table 11.1.6.3.2-1)

Derivation Path: TS 36.508 [7], Table 4.7.2-26.			
Information Element	Value/Remark	Comment	Condition
EMM cause	'0000 1001'B	#9 "UE identity cannot be derived by the network"	

Table 11.1.6.3.3-4: ATTACH REQUEST (step 8b3, table 11.1.6.3.2-1)

Derivation Path: TS 36.508 [7], Table 4.7.2-4.			
Information Element	Value/Remark	Comment	Condition
IMSI	IMSI of the UE		

Table 11.1.6.3.3-5: ATTACH ACCEPT (preamble, step 18; step 14, TS 36.508-1 [7], Table 4.5.2.3-1)

Derivation path: TS 36.508-1 [7] Table 4.7.2-1			
Information Element	Value/remark	Comment	Condition
EPS network feature support	'0000 0011 0100 1000'B	- IMS voice over PS session in S1 mode supported - emergency bearer services in S1 mode supported - ePCO supported - Interworking without N26 interface supported	

Table 11.1.6.3.3-6: ACTIVATE DEFAULT EPS BEARER CONTEXT REQUEST (preamble, step 18; step 14, TS 36.508-1 [7], Table 4.5.2.3-1)

Derivation Path: TS 36.508-1 [7] Table 4.7.3-6			
Information Element	Value/remark	Comment	Condition
Protocol configuration options			
Container ID n+2	Not present	Session-AMBR are not present	
Container ID n+3	Not present	QoS rules are not present	
Container ID n+4	Not present	Qos flow descriptions are not present	

11.1.7 Emergency call setup from NR RRC_IDLE / Emergency Services Fallback to EPS with redirection / Single registration mode with N26 interface / Success

11.1.7.1 Test Purpose (TP)

(1)

```

with { UE supporting both S1 mode and N1 mode and operating in single-registration mode, and, the
Network has indicated "interworking without N26 interface not supported", and, the UE in NR RRC_IDLE
state }
ensure that {
  when { User initiates an Emergency call and the UE completes Access control checking in 5GMM-IDLE
mode }

```

```

    then { UE requests the establishment of an Emergency call by transmitting an RRCSetupRequest
message with establishmentCause set to 'emergency', and, a SERVICE REQUEST message with Service type
set to 'emergency services fallback' }
}

```

(2)

```

with { UE is NR RRC_CONNECTED state after having requested a MMTEL call establishment and the MO IMS
voice session establishment has been initiated }
ensure that {
  when { UE receives a RRCRelease message which includes redirectedCarrierInfo indicating
redirection with cnType=epc }
  then { UE selects the E-UTRA cell, performs a TAU procedure, and, successfully completes the
Emergency call setup in EPS }
}

```

11.1.7.2 Conformance requirements

References: The conformance requirements covered in the present TC are specified in: TS 24.501 [22], subclauses 5.6.1.1, 5.6.1.2, 5.6.1.4; TS 23.502 [31], subclause 4.13.4.2; TS 24.301 [21], subclauses 4.4.2.3, 5.5.3.2.2 and TS 24.229 subclause U.2.2.6.4. Unless otherwise stated these are Rel-15 requirements.

NOTE: Conformance requirements in regard to establishing an emergency call in EPS are not provided. This can be found in IMS Emergency tests specified in TS 36.523-1 [13].

[TS 24.501, subclause 5.6.1.1]

The UE shall invoke the service request procedure when:

...

- h) the UE, in 5GMM-IDLE, 5GMM-CONNECTED mode over 3GPP access, or 5GMM-CONNECTED mode with RRC inactive indication, receives a request for emergency services fallback from the upper layer and performs emergency services fallback as specified in subclause 4.13.4.2 of 3GPP TS 23.502 [9]; or

[TS 24.501, subclause 5.6.1.2]

For case h) in subclause 5.6.1.1, the UE shall send a SERVICE REQUEST message with service type set to "emergency services fallback".

[TS 24.501, subclause 5.6.1.4]

For case h) in subclause 5.6.1.1, the UE shall treat the indication from the lower layers when the UE has changed to S1 mode or E-UTRA connected to 5GCN (see 3GPP TS 23.502 [9]) as successful completion of the procedure and stop timer T3517.

[TS 23.502, subclause 4.13.4.2]

The call flow in Figure 4.13.4.2-1 describes the procedure for emergency services fallback.

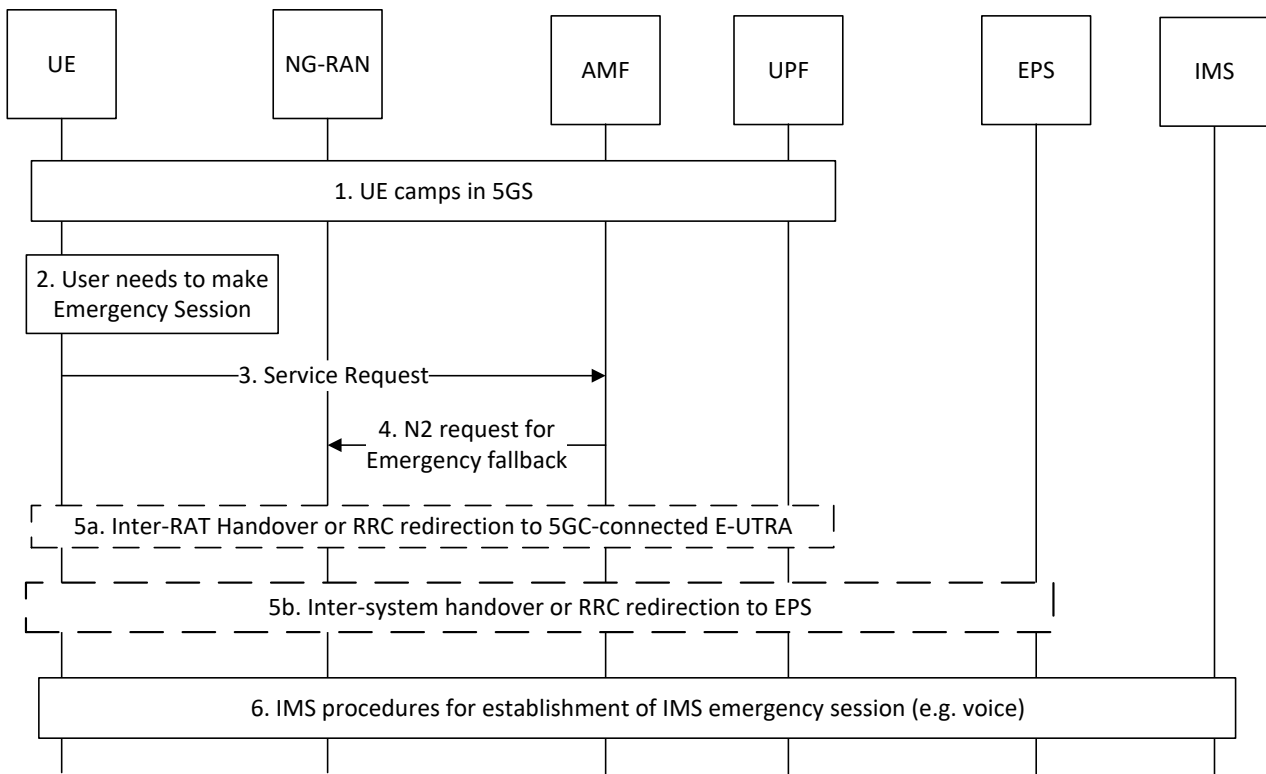

Figure 4.13.4.2-1: Emergency Services Fallback

1. UE camps on E-UTRA or NR cell in the 5GS (in either CM_IDLE or CM_CONNECTED state).
2. UE has a pending IMS emergency session request (e.g. voice) from the upper layers.
3. If the AMF has indicated support for emergency services using fallback via the Registration Accept message for the current RAT, the UE sends a Service Request message indicating that it requires emergency services fallback.
- ...
5. Based on the target CN indicated in message 4, one of the following procedures is executed by NG-RAN:

...

5b. NG-RAN initiates handover (see clause 4.11.1.2.1) or redirection to E-UTRAN connected to EPS. NG-RAN uses the security context provided by the AMF to secure the redirection procedure.

If the redirection procedure is used either in 5a or 5b the target CN is also conveyed to the UE in order to be able to perform the appropriate NAS procedures (S1 or N1 Mode).

[TS 24.301, subclause 4.4.2.3]

Secure exchange of NAS messages via a NAS signalling connection is usually established by the MME during the attach procedure by initiating a security mode control procedure. After successful completion of the security mode control procedure, all NAS messages exchanged between the UE and the MME are sent integrity protected using the current EPS security algorithms, and except for the messages specified in subclause 4.4.5, all NAS messages exchanged between the UE and the MME are sent ciphered using the current EPS security algorithms.

...

During inter-system change from N1 mode to S1 mode in 5GMM-IDLE mode, if the UE is operating in the single-registration mode and:

- 1) if the tracking area updating procedure is initiated as specified in 3GPP TS 24.501 [54], the UE shall transmit a TRACKING AREA UPDATE REQUEST message integrity protected with the current 5G NAS security context and the UE shall derive a mapped EPS security context (see subclause 8.6.1 of 3GPP TS 33.501 [56]). The UE shall include the eKSI indicating the 5G NAS security context value in the TRACKING AREA UPDATE REQUEST message.

After receiving the TRACKING AREA UPDATE REQUEST message including the eKSI, the MME forwards the TRACKING AREA UPDATE REQUEST message to the source AMF, if possible, to obtain the mapped EPS security context from the AMF as specified in 3GPP TS 33.501 [56]. The MME re-establishes the secure exchange of NAS messages by either:

- replying with a TRACKING AREA UPDATE ACCEPT message that is integrity protected and ciphered using the mapped EPS NAS security context. From this time onward, all NAS messages exchanged between the UE and the MME are sent integrity protected and except for the messages specified in subclause 4.4.5, all NAS messages exchanged between the UE and the MME are sent ciphered; or

[TS 24.301, subclause 5.5.3.2.2]

The UE in state EMM-REGISTERED shall initiate the tracking area updating procedure by sending a TRACKING AREA UPDATE REQUEST message to the MME,

...

- z) when the UE performs inter-system change from N1 mode to S1 mode in EMM-IDLE mode, the UE operates in single-registration mode, and conditions specified in 3GPP TS 24.501 [54] apply;

...

- zd) when the UE performs inter-system change from N1 mode to S1 mode in EMM-CONNECTED mode.

For all cases except case b, the UE shall set the EPS update type IE in the TRACKING AREA UPDATE REQUEST message to "TA updating". For case b, the UE shall set the EPS update type IE to "periodic updating".

...

When initiating a tracking area updating procedure while in S1 mode, the UE shall use the current EPS NAS integrity key to integrity protect the TRACKING AREA UPDATE REQUEST message, unless the UE is performing inter-system change from N1 mode to S1 mode.

...

If a UE has established PDN connection(s) and uplink user data pending to be sent via user plane when it initiates the tracking area updating procedure, or uplink signalling not related to the tracking area updating procedure when the UE does not support control plane CIoT EPS optimization, it may also set an "active" flag in the TRACKING AREA UPDATE REQUEST message to indicate the request to establish the user plane to the network and to keep the NAS signalling connection after the completion of the tracking area updating procedure.

...

If the UE has a current EPS security context, the UE shall include the eKSI (either KSI_{ASME} or KSI_{SGSN}) in the NAS Key Set Identifier IE in the TRACKING AREA UPDATE REQUEST message. Otherwise, the UE shall set the NAS Key Set Identifier IE to the value "no key is available". If the UE has a current EPS security context, the UE shall integrity protect the TRACKING AREA UPDATE REQUEST message with the current EPS security context. Otherwise the UE shall not integrity protect the TRACKING AREA UPDATE REQUEST message.

...

For the case z and zd, the TRACKING AREA UPDATE REQUEST message shall be integrity protected using the 5GS security context available in the UE. The UE shall include a GUTI, mapped from 5G-GUTI (see 3GPP TS 23.501 [54] and 3GPP TS 23.003 [2]), in the Old GUTI IE in the TRACKING AREA UPDATE REQUEST message. In addition, the UE shall include Old GUTI type IE with GUTI set to "Native GUTI", and the UE shall include a UE status IE with a 5GMM registration status set to "UE is in 5GMM-REGISTERED state".

When the tracking area updating procedure is initiated in EMM-IDLE mode, the UE may also include an EPS bearer context status IE in the TRACKING AREA UPDATE REQUEST message, indicating which EPS bearer contexts are

active in the UE. The UE shall include the EPS bearer context status IE in TRACKING AREA UPDATE REQUEST message:

- ...
- for the case z; and
- ...

If the UE initiates the first tracking area updating procedure following an initial registration in N1 mode and the UE is operating in the single-registration mode, the UE shall include a UE radio capability information update needed IE in the TRACKING AREA UPDATE REQUEST message.

...

If the UE supports NB-S1 mode, Non-IP PDN type, or N1 mode, then the UE shall support the extended protocol configuration options IE.

For all cases except case b, if the UE supports the extended protocol configuration options IE, then the UE shall set the ePCO bit to "extended protocol configuration options supported" in the UE network capability IE of the TRACKING AREA UPDATE REQUEST message.

...

For all cases except case b, if the UE supports dual connectivity with NR, then the UE shall set the DCNR bit to "dual connectivity with NR supported" in the UE network capability IE of the TRACKING AREA UPDATE REQUEST message and shall include the UE additional security capability IE in the TRACKING AREA UPDATE REQUEST message.

...

For all cases except case b, if the UE supports N1 mode, the UE shall set the N1mode bit to "N1 mode supported" in the UE network capability IE of the TRACKING AREA UPDATE REQUEST message and shall include the UE additional security capability IE in the TRACKING AREA UPDATE REQUEST message.

[TS 24.229, subclause U.2.2.6.4]

NOTE: This subclause covers only the case where the UE selects the IM CN subsystem in accordance with the conventions and rules specified in 3GPP TS 23.167 [4B] and describes the IP-CAN specific procedure. It does not preclude the use of CS domain. When a CS system based on 3GPP TS 24.008 [8] is to be used, clause B.5 applies.

When the UE operates in single-registration mode as described in 3GPP TS 24.501 [258] and the UE recognises that a call request is an emergency call, if:

- 1) the IM CN subsystem is selected in accordance with the conventions and rules specified in 3GPP TS 23.167 [4B]; and
- 2) the UE is currently registered to the 5GS services while the UE is in an NR cell connected to 5GCN;

then the following treatment is applied:

- 1) if the EMC indicates "Emergency services not supported":
 - a) if the UE supports emergency services fallback as specified in 3GPP TS 23.501 [257] and the emergency services fallback is available (i.e., "ESFB is Y" as described in 3GPP TS 23.167 [4B]), the UE shall attempt emergency services fallback as specified in 3GPP TS 24.501 [258]. If the UE receives from the lower layers an indication that the emergency services fallback attempt failed, the UE may behave as described in bullet b) below assuming that the emergency services fallback is not available;

...

11.1.7.3 Test description

11.1.7.3.1 Pre-test conditions

System Simulator:

- 2 cells
- NR Cell 1 as defined in TS 38.508-1 [4] Table 4.4.2-3. System information combination NR-6 as defined in TS 38.508-1 [4], subclause 4.4.3.1.2.
- E-UTRA Cell 1 as defined in TS 36.508 [7] Table 4.4.2-2. System information combination 31 as defined in TS 36.508 [7], subclause 4.4.3.1.1.
- Power levels are constant and as defined in Tables 11.1.7.3.1-1/2.

Table 11.1.7.3.1-1: Time instances of cell power level and parameter changes for conducted test environment

	Parameter name	Unit	NR Cell 1	E-UTRA Cell 1	Remark
T0	SS/PBCH SSS EPRE	dBm/SCS	-88	-	
	RS EPRE	dBm/15kHz	-	-91	

Table 11.1.7.3.1-2: Time instances of cell power level and parameter changes for OTA test environment

	Parameter name	Unit	NR Cell 1	E-UTRA Cell 1	Remark
T0	SS/PBCH SSS EPRE	dBm/SCS	-82	-	
	RS EPRE	dBm/15kHz	-	-91	

UE:

None.

Preamble:

- With E-UTRA Cell 1 "Serving cell" and NR Cell 1 "Non-suitable "Off" cell" in accordance with TS 38.508-1 [4], Table 6.2.2.1-3, the UE is brought to state RRC_IDLE using generic procedure parameters Connectivity (*E-UTRA/EPC*) and Unrestricted nr PDN (*On*) in accordance with the procedure described in TS 38.508-1 [4], clause 4.5.2. 4G GUTI and eKSI are assigned and security context established.
- the UE is switched-off.
- With E-UTRA Cell 1 "Non-suitable "Off" cell" and NR Cell 1 "Serving cell" in accordance with TS 38.508-1 [4], Table 6.2.2.1-3, the UE is brought to state 1N-A, RRC_IDLE Connectivity (NR), in accordance with the procedure described in TS 38.508-1 [4], Table 4.5.2.2-2. 5G-GUTI and ngKSI are assigned and security context established.

11.1.7.2 Test procedure sequence

Table 11.1.7.3.2-1: Main behaviour

St	Procedure	Message Sequence		TP	Verdict
		U - S	Message		
1	Void	-	-	-	-

-	EXCEPTION: Unless otherwise stated the following messages are exchange on NR Cell 1.	-	-	-	-
2	Make the UE initiate an Emergency call.	-	-	-	-
3	Check: Does the UE transmit an <i>RRCSetupRequest</i> message with <i>establishmentCause</i> set to 'emergency'?	-->	NR RRC: <i>RRCSetupRequest</i>	1	P
4	The SS transmits an <i>RRCSetup</i> message.	<--	NR RRC: <i>RRCSetup</i>	-	-
5	Check: Does the UE transmit a SERVICE REQUEST message with Service type set to 'emergency services fallback'? NOTE: The UE shall request 'emergency services fallback' when the AMF has indicated support for emergency services using fallback via the Registration Accept message for the current RAT as per TS 23.502 [31], subclause 4.13.4.2.	-->	NR RRC: <i>RRCSetupComplete</i> 5GMM: SERVICE REQUEST	1	P
5A	The SS transmits a <i>SecurityModeCommand</i> message.	<--	NR RRC: <i>SecurityModeCommand</i>	-	-
5B	The UE transmits a <i>SecurityModeComplete</i> message.	-->	NR RRC: <i>SecurityModeComplete</i>	-	-
5C	Set the power levels according to "T0" as per Table 11.1.7.3.1-1/2.	-	-	-	-
6	SS transmits <i>RRCRelease</i> message indicating redirection to E-UTRA Cell 1.	<--	NR RRC: <i>RRCRelease</i>	-	-
-	EXCEPTION: Unless otherwise stated the following messages are exchange on E-UTRA Cell 1.	-	-	-	-
7	The UE transmits an <i>RRCConnectionRequest</i> message with 'establishmentCause' set to 'emergency'.	-->	RRC: <i>RRCConnectionRequest</i>	2	P
8-10b 2	Steps 2-4b2 from the Tracking area updating procedure as specified in TS 38.508-1 [4], Table 4.9.7.2.2-1 are performed (UE performs inter-system change from N1 to S1, mapped EPS NAS security context from the 5GC).	-	-	-	-
10 A-10 D	Steps 5-8 from the Generic Test Procedure for IMS Emergency call establishment in EUTRA: Normal Service as specified in TS 36.508 [7], Table 4.5A.4.3-1 are performed.	-	-	-	-
10 E	SS responds with TRACKING AREA UPDATE ACCEPT message.	<--	RRC: <i>DLInformationTransfer</i> NAS: TRACKING AREA UPDATE ACCEPT	-	-
11	Check: Does the UE transmit a TRACKING AREA UPDATE COMPLETE message?	-->	RRC: <i>ULInformationTransfer</i> NAS: TRACKING AREA UPDATE COMPLETE	2	P
12-17	Steps 9-14 from the Generic Test Procedure for IMS Emergency call establishment in EUTRA: Normal Service as specified in TS 36.508 [7], Table 4.5A.4.3-1 are performed.	-	-	-	-
18-19	Void	-	-	-	-
20	Check: Does the UE transmit an ACTIVATE DEDICATED EPS BEARER CONTEXT ACCEPT message?	-->	RRC: <i>ULInformationTransfer</i> NAS: ACTIVATE DEDICATED EPS BEARER CONTEXT ACCEPT	2	P
21	The SS waits 1 second.	-	-	-	-
22	Release IMS Call as specified in the generic procedure in TS 34.229-1 [35] subclause C.32.	-	-	-	-

11.1.7.3.3 Specific message contents

Table 11.1.7.3.3-1: REGISTRATION REQUEST (Preamble; TS 38.508-1 [4], Table 4.5.2.2-2)

Derivation Path: TS 38.508-1 [4], Table 4.7.1-6			
Information Element	Value/remark	Comment	Condition

5GMM capability			
S1 mode (octet 3, bit 1)	'1'B	S1 mode supported	

Table 11.1.7.3.3-2: REGISTRATION ACCEPT (Preamble; TS 38.508-1 [4], Table 4.5.2.2-2)

Derivation path: TS 38.508-1 [4], Table 4.7.1-7			
Information Element	Value/remark	Comment	Condition
5GS network feature support			
Emergency service support indicator for 3GPP access (EMC) (octet 3, bit 3 and bit 4)	'00'B	Emergency services not supported	
Emergency service fallback indicator for 3GPP access (EMF) (octet 3, bit 5 and bit 6)	'01'B	Emergency services fallback supported in NR connected to 5GCN only	

Table 11.1.7.3.3-3: RRCSetupRequest (step 3, table 11.1.7.3.2-1)

Derivation Path: TS 38.508-1 [4], Table 4.6.1-23			
Information Element	Value/remark	Comment	Condition
RRCSetupRequest ::= SEQUENCE {			
rrcSetupRequest SEQUENCE {			
establishmentCause	emergency		
}			
}			

Table 11.1.7.3.3-4: SERVICE REQUEST (step 5, table 11.1.7.3.2-1)

Derivation path: TS 38.508-1 [4], Table 4.7.1-16			
Information Element	Value/Remark	Comment	Condition
Service type	'0100'B	emergency services fallback	

Table 11.1.7.3.3-5: RRCRelease (step 6, table 11.1.7.3.2-1)

Derivation path: TS 38.508-1 [4], Table 4.6.1-16			
Information Element	Value/Remark	Comment	Condition
RRCRelease ::= SEQUENCE {			
criticalExtensions CHOICE {			
rrcRelease SEQUENCE {			
redirectedCarrierInfo CHOICE {			
eutra SEQUENCE {			
eutraFrequency	Downlink EARFCN of E-UTRA Cell 1		
cnType	epc		
}			
}			
}			
}			
}			

Table 11.1.7.3.3-6: RRCConnectionRequest (step 7, Table 11.1.7.3.2-1)

Derivation Path: TS 36.508 [7], Table 4.6.1-16			
Information Element	Value/remark	Comment	Condition
RRCConnectionRequest ::= SEQUENCE {			
criticalExtensions CHOICE {			

rrcConnectionRequest-r8 SEQUENCE {			
establishmentCause	emergency		
}			
}			
}			

Table 11.1.7.3.3-7: Void

Table 11.1.7.3.3-8: Void

Table 11.1.7.3.3-8a: TRACKING AREA UPDATE ACCEPT (Step 10D, Table 11.1.7.3.2-1)

Derivation Path: TS 36.508 [2], Table 4.7.2-24, condition NR.

Table 11.1.7.3.3-9: Message PDN CONNECTIVITY REQUEST (step 14, Table 11.1.7.3.2-1)

Derivation Path: TS 36.508 [7], Table 4.7.2-1.			
Information Element	Value/Remark	Comment	Condition
Request type	'0100'B	emergency	
Access point name	Not present		

Table 11.1.7.3.3-10: Message ACTIVATE DEFAULT EPS BEARER CONTEXT REQUEST (step 15, Table 11.1.7.3.2-1)

Derivation path: TS 36.508 [7], Table 4.7.3-6 and table 4.6.1-8 with condition UM-DRB-ADD(2).			
Information Element	Value/Remark	Comment	Condition
EPS bearer identity	an additional EPS Bearer Id different from default EPS Bearer Id or/and any mapped EPS bearer		
Access point name	sos	APN value as recommended by IR.88 clause 6.4 [39]	

Table 11.1.7.3.3-11: TRACKING AREA UPDATE REQUEST (step 9, Table 11.1.7.3.2-1)

Derivation Path: TS 36.508 [7], Table 4.7.2-27, condition NR			
Information Element	Value/remark	Comment	Condition
UE network capability			NR
All octets with the exception of octet 8, bit 8 and octet 9, bit 6	Any allowed value		
Extended protocol configuration options (ePCO) (octet 8, bit 8)	Any allowed value	ePCO supported	
N1 mode supported (N1 mode) (octet 9, bit 6)	Any allowed value	N1 mode supported	

11.1.8 MO MMTEL voice call setup from NR RRC_CONNECTED / EPS Fallback with handover / Single registration mode with N26 interface / voiceFallbackIndication

11.1.8.1 Test Purpose (TP)

(1)

```
with { UE supporting both S1 mode and N1 mode and operating in single-registration mode, and, the Network has indicated "interworking without N26 interface not supported", and, the UE is in NR RRC_CONNECTED state, then, the User initiates a MMTEL call, the MO IMS voice session establishment has been initiated }  
ensure that {  
  when { UE receives a MobilityFromNRCommand message which includes targetRAT-Type set to eutra and with voiceFallbackIndication, and the UE does not succeed in establishing the connection to the target radio access technology }  
  then { UE selects another suitable E-UTRA cell with starting a TAU procedure by using "mo-VoiceCall" as the establishment cause value in RRCConnectionRequest, and, UE successfully completes the MO MMTEL call in EPS }  
}
```

11.1.8.2 Conformance requirements

References: The conformance requirements covered in the present test case are specified in: TS 23.502, clauses 4.13.6.1, TS 24.501, clauses 4.8.2.2, 5.5.1.2.2, 5.5.1.2.4, 5.1.4.2 and 6.1.4.1, TS 38.331, clause 5.4.3.5. Unless otherwise stated these are Rel-16 requirements.

[TS 23.502, clause 4.13.6.1]

Figure 4.13.6.1-1 describes the EPS fallback procedure for IMS voice.

When the UE is served by the 5G System, the UE has one or more ongoing PDU Sessions each including one or more QoS Flows. The serving PLMN AMF has sent an indication towards the UE during the Registration procedure that IMS voice over PS session is supported, see clause 5.16.3.10 in TS 23.501 [2] and the UE has registered in the IMS. If N26 is not supported, the serving PLMN AMF sends an indication towards the UE during the Registration procedure that interworking without N26 is supported, see clause 5.17.2.3.1 in TS 23.501 [2].

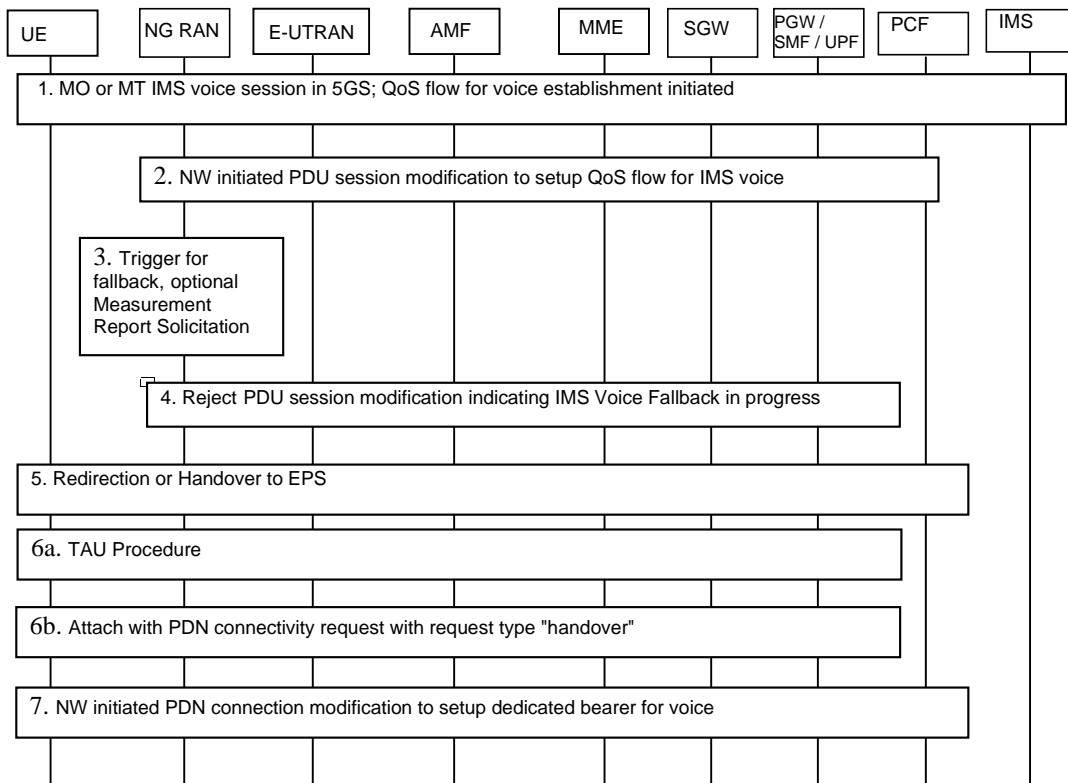

Figure 4.13.6.1-1: EPS Fallback for IMS voice

1. UE camps on NG-RAN in the 5GS and an MO or MT IMS voice session establishment has been initiated.
2. Network initiated PDU Session modification to setup QoS flow for voice reaches the NG-RAN (see N2 PDU Session Request in clause 4.3.3).
3. NG-RAN is configured to support EPS fallback for IMS voice and decides to trigger fallback to EPS, taking into account UE capabilities, indication from AMF that "Redirection for EPS fallback for voice is possible" (received as part of initial context setup as defined in TS 38.413 [10]), network configuration (e.g. N26 availability configuration) and radio conditions. If NG-RAN decides not to trigger fallback to EPS, then the procedure stops here and following steps are not executed.

NG-RAN may initiate measurement report solicitation from the UE including E-UTRAN as target.

NOTE 1: If AMF has indicated that "Redirection for EPS fallback for voice is not possible", then AN Release via inter-system redirection to EPS is not performed in step 5.

4. NG-RAN responds indicating rejection of the PDU Session modification to setup QoS flow for IMS voice received in step 2 by PDU Session Modification Response message towards the PGW-C+SMF (or H-SMF+P-GW-C via V-SMF, in the case of home routed roaming scenario) via AMF with an indication that mobility due to fallback for IMS voice is ongoing. The PGW-C+SMF maintains the PCC rule(s) associated with the QoS Flow(s) and reports the EPS Fallback event to the PCF if PCF has subscribed to this event.
5. NG-RAN initiates either handover (see clause 4.11.1.2.1), or AN Release via inter-system redirection to EPS (see clause 4.2.6 and clause 4.11.1.3.2), taking into account UE capabilities. The PGW-C+SMF reports change of the RAT type if subscribed by PCF as specified in clause 4.11.1.2.1, or clause 4.11.1.3.2.6. When the UE is connected to EPS, either 6a or 6b is executed
 - 6a. In the case of 5GS to EPS handover, see clause 4.11.1.2.1, and in the case of inter-system redirection to EPS with N26 interface, see clause 4.11.1.3.2. In either case the UE initiates TAU procedure; or
 - 6b. In the case of inter-system redirection to EPS without N26 interface, see clause 4.11.2.2. If the UE supports Request Type flag "handover" for PDN connectivity request during the attach procedure as described in clause 5.3.2.1 of TS 23.401 [13] and has received the indication that interworking without N26 is supported, then the UE initiates Attach with PDN connectivity request with request type "handover".

In inter-system redirection, the UE uses the emergency indication in the RRC message as specified in clause 6.2.2 of TS 36.331 [16] and E-UTRAN provides the emergency indication to MME during Tracking Area Update or Attach procedure. For the handover procedure see clause 4.11.1.2.1, step 1.

7. After completion of the mobility procedure to EPS or as part of the 5GS to EPS handover procedure (see clause 4.11.1.2.1), the SMF/PGW re-initiates the setup of the dedicated bearer(s) for the maintained PCC rule(s) in step 4 including of the dedicated bearer for IMS voice, mapping the 5G QoS to EPC QoS parameters. The PGW-C+SMF behaves as specified in clause 4.9.1.3.1. The PGW-C+SMF reports about Successful Resource Allocation and Access Network Information if subscribed by PCF.

The IMS signalling related to IMS voice call establishment continues after step 1 as specified in the TS 23.228 [55].

At least for the duration of the voice call in EPS the E-UTRAN is configured to not trigger any handover to 5GS.

[TS 24.501, clause 4.8.2.2]

See subclause 5.1.4.2 for coordination between 5GMM and EMM and subclause 6.1.4.1 for coordination between 5GSM and ESM.

[TS 24.501, clause 5.5.1.2.2]

If the UE supports S1 mode, the UE shall:

- set the S1 mode bit to "S1 mode supported" in the 5GMM capability IE of the REGISTRATION REQUEST message;
- include the S1 UE network capability IE in the REGISTRATION REQUEST message; and
- if the UE supports sending an ATTACH REQUEST message containing a PDN CONNECTIVITY REQUEST message with request type set to "handover" to transfer a PDU session from N1 mode to S1 mode, set the HO attach bit to "attach request message containing PDN connectivity request with request type set to handover to transfer PDU session from N1 mode to S1 mode supported" in the 5GMM capability IE of the REGISTRATION REQUEST message.

[TS 24.501, clause 5.5.1.2.4]

If the UE included S1 mode supported indication in the REGISTRATION REQUEST message, the AMF supporting interworking with EPS shall set the IWK N26 bit to either:

- a) "interworking without N26 interface not supported" if the AMF supports N26 interface ; or
- b) "interworking without N26 interface supported" if the AMF does not support N26 interface

in the 5GS network feature support IE in the REGISTRATION ACCEPT message.

The UE supporting S1 mode shall operate in the mode for interworking with EPS as follows:

- a) if the IWK N26 bit in the 5GS network feature support IE is set to "interworking without N26 interface not supported", the UE shall operate in single-registration mode;
- b) if the IWK N26 bit in the 5GS network feature support IE is set to "interworking without N26 interface supported" and the UE supports dual-registration mode, the UE may operate in dual-registration mode; or

NOTE 3: The registration mode used by the UE is implementation dependent.

- c) if the IWK N26 bit in the 5GS network feature support IE is set to "interworking without N26 interface supported" and the UE only supports single-registration mode, the UE shall operate in single-registration mode.

The UE shall treat the received interworking without N26 interface indicator for interworking with EPS as valid in the entire PLMN and its equivalent PLMN(s).

The network informs the UE about the support of specific features, such as IMS voice over PS session, emergency services or emergency services fallback, in the 5GS network feature support information element. In a UE with IMS voice over PS session capability, the IMS voice over PS session indicator, the Emergency services support indicator, and the Emergency services fallback indicator shall be provided to the upper layers. The upper layers take the IMS voice over PS session indicator into account when selecting the access domain for voice sessions or calls. When

initiating an emergency call, the upper layers also take the IMS voice over PS session indicator, the Emergency services support indicator, and the Emergency services fallback indicator into account for the access domain selection.

[TS 24.501, clause 5.1.4.2]

At inter-system change from N1 mode to S1 mode when there is at least one active PDU session for which interworking with EPS is supported as specified in subclause 6.1.4.1, the UE shall enter substates EMM-REGISTERED.NORMAL-SERVICE and 5GMM-REGISTERED.NO-CELL-AVAILABLE and initiate a tracking area updating procedure (see 3GPP TS 24.301 [15]).

[TS 24.501, clause 6.1.4.1]

Upon inter-system change from N1 mode to S1 mode, the UE shall create the default EPS bearer context and the dedicated EPS bearer context(s) based on the parameters of the mapped EPS bearer contexts or the associations between QoS flow and mapped EPS bearer in the PDU session, if available. The EPS bearer identity assigned for the QoS flow of the default QoS rule becomes the EPS bearer identity of the default bearer in the corresponding PDN connection. If there is no EPS bearer identity assigned to the QoS flow of the default QoS rule, the UE shall release locally the PDU session. If there is no EPS bearer identity assigned to the QoS flow(s) which is not associated with the default QoS rule, the UE shall locally delete the QoS rules and the QoS flow level QoS parameters associated with the QoS flow(s). The UE uses the parameters from each PDU session for which interworking with EPS is supported to create corresponding default EPS bearer context and optionally dedicated EPS bearer context(s) as follows:

- a) the PDU session type of the PDU session shall be mapped to the PDN type of the default EPS bearer context as follows:
 - 1) the PDN type shall be set to "non-IP" if the PDU session type is "Ethernet" or "Unstructured";
 - 2) the PDN type shall be set to "IPv4" if the PDU session type is "IPv4";
 - 3) the PDN type shall be set to "IPv6" if the PDU session type is "IPv6"; and
 - 4) the PDN type shall be set to "IPv4v6" if the PDU session type is "IPv4v6";
- b) the PDU address of the PDU session shall be mapped to the PDN address of the default EPS bearer context as follows:
 - 1) the PDN address of the default EPS bearer context is set to the PDU address of the PDU session, if the PDU session type is "IPv4", "IPv6" or "IPv4v6"; and
 - 2) the PDN address of the default EPS bearer context is set to zero, if the PDU session type is "Ethernet" or "Unstructured";
- c) the DNN of the PDU session shall be mapped to the APN of the default EPS bearer context;
- d) the APN-AMBR and extended APN-AMBR received in the parameters of the default EPS bearer context of the mapped EPS bearer contexts shall be mapped to the APN-AMBR and extended APN-AMBR of the default EPS bearer context;
- e) for each PDU session in state PDU SESSION ACTIVE, PDU SESSION MODIFICATION PENDING or PDU SESSION INACTIVE PENDING the UE shall set the state of the mapped EPS bearer context(s) to BEARER CONTEXT ACTIVE; and
- f) for any other PDU session the UE shall set the state of the mapped EPS bearer context(s) to BEARER CONTEXT INACTIVE.

Additionally, for each mapped EPS bearer context or the association between QoS flow and mapped EPS bearer in the PDU session:

- a) the EPS bearer identity shall be set to the EPS bearer identity received in the mapped EPS bearer context, or the EPS bearer identity associated with the QoS flow;
- b) the EPS QoS parameters shall be set to the mapped EPS QoS parameters of the EPS bearer received in the mapped EPS bearer context, or the EPS QoS parameters associated with the QoS flow;

- c) the extended EPS QoS parameters shall be set to the mapped extended EPS QoS parameters of the EPS bearer received in the mapped EPS bearer context, or the extended EPS QoS parameters associated with the QoS flow; and
- d) the traffic flow template shall be set to the mapped traffic flow template of the EPS bearer received in the mapped EPS bearer context, or the stored traffic flow template associated with the QoS flow, if available.

After inter-system change from N1 mode to S1 mode, the UE shall associate the PDU session identity, the S-NSSAI, and the session-AMBR with the default EPS bearer context, and for each EPS bearer context mapped from one or more QoS flows, associate the QoS rule(s) for the QoS flow(s) and the QoS flow description(s) for the QoS flow(s) with the EPS bearer context.

After inter-system change from N1 mode to S1 mode, the UE and the SMF shall maintain the PDU session type of the PDU session until the PDN connection corresponding to the PDU session is released if the UE supports non-IP PDN type and the PDU session type is "Ethernet" or "Unstructured".

After inter-system change from N1 mode to S1 mode, the UE and the SMF shall maintain the always-on PDU session indication.

After inter-system change from N1 mode to S1 mode, the UE and the SMF shall maintain the maximum number of supported packet filters until the PDN connection corresponding to the PDU session is released.

[TS 38.331, clause 5.4.3.5]

The UE shall:

- 1> if the UE does not succeed in establishing the connection to the target radio access technology:
 - 2> if the UE supports Radio Link Failure Report for Inter-RAT MRO:
 - 3> store handover failure information in *VarRLF-Report* according to 5.3.10.5;
 - 2> if voiceFallbackIndication is included in the MobilityFromNRCommand message:
 - 3> attempt to select an E-UTRA cell:
 - 4> if a suitable E-UTRA cell is selected:
 - 5> perform the actions upon going to RRC_IDLE as specified in 5.3.11, with release cause 'RRC connection failure';

11.1.8.3 Test Description

11.1.8.3.1 Pre-test conditions

System Simulator:

- 3 cells
 - NR Cell 1 as defined in TS 38.508-1 [4] Table 4.4.2-3. System information combination NR-6 as defined in TS 38.508-1 [4], sub-clause 4.4.3.1.2.
 - E-UTRA Cell 1 and Cell 2 as defined in TS 36.508 [7] Table 4.4.2-2. System information combination 31 as defined in TS 36.508 [7], sub-clause 4.4.3.1.1.
- N26 interface is configured.
- Power levels are constant and as defined in Tables 11.1.8.3.1-1/2.

Table 11.1.8.3.1-1: Time instances of cell power level and parameter changes for conducted test environment

	Parameter name	Unit	NR Cell 1	E-UTRA Cell 1	E-UTRA Cell 2	Remark
T0	SS/PBCH	dBm/SCS	-88	-	-	

	SSS EPRE					
	RS EPRE	dBm/15kHz	-	"Off"	-91	

Table 11.1.8.3.1-2: Time instances of cell power level and parameter changes for OTA test environment

	Parameter name	Unit	NR Cell 1	E-UTRA Cell 1	E-UTRA Cell 2	Remark
T0	SS/PBCH SSS EPRE	dBm/SCS	-82	-	-	
	RS EPRE	dBm/15kHz	-	"Off"	-91	

UE:

- The UE is configured to use IMS preconditions

Preamble:

- With E-UTRA Cell 1 "Serving cell", E-UTRA Cell 2 "Non-suitable "Off" cell" and NR Cell 1 "Non-suitable "Off" cell" in accordance with TS 38.508-1 [4], Table 6.2.2.1-3, the UE is brought to state RRC_IDLE using generic procedure parameters Connectivity (*E-UTRA/EPC*) and Unrestricted nr PDN (*On*) in accordance with the procedure described in TS 38.508-1 [4], clause 4.5.2. 4G GUTI and eKSI are assigned and security context established.
- The UE is switched-off.
- With E-UTRA Cell 1 "Non-suitable "Off" cell", E-UTRA Cell 2 "Non-suitable "Off" cell" and NR Cell 1 "Serving cell" in accordance with TS 38.508-1 [4], Table 6.2.2.1-3, the UE is brought to state 1N-A, RRC_IDLE Connectivity (NR) with at least one IMS PDU session on NR Cell 1, in accordance with the procedure described in TS 38.508-1 [4], Table 4.5.2.2-2. 5G-GUTI and ngKSI are assigned.

11.1.8.3.2 Test procedure sequence

Table 11.1.8.3.2-1: Main behaviour

St	Procedure	Message Sequence		TP	Verdict
		U – S	Message		
1	Void	-	-	-	-
-	The following messages are to be observed on NR Cell 1 unless explicitly stated otherwise.	-	-	-	-
2	The SS transmits a <i>Paging</i> message.	<--	NR RRC: <i>Paging</i>	-	-
3	The UE transmits an <i>RRCSetupRequest</i> message.	-->	NR RRC: <i>RRCSetupRequest</i>	-	-
4-9	Steps 3 to 8 of the NR RRC_CONNECTED procedure in TS 38.508-1 [4] Table 4.5.4.2-3 are executed to successfully complete the service request procedure.	-	-	-	-
10	Set the power levels according to "T0" as per Table 11.1.8.3.1-1/2.	-	-	-	-
11	Make the UE attempt an MTSI MO Speech Call.				
12-16	Steps 1-5 of the MTSI MO speech call for 5GS procedure according to TS 34.229-5 [41] subclause A.9.1 take place.	-	-	-	-
17	The SS transmits a <i>MobilityFromNRCommand</i> message which includes target extra cell set to E-UTRA Cell 1 according to 38.508-1 [4] Table 4.6.1-8.	<--	NR RRC: <i>MobilityFromNRCommand</i>	-	-
-	The following messages are to be observed	-	-	-	-

	on E-UTRA Cell 2 unless explicitly stated otherwise.				
18	Check: Does the UE transmit an <i>RRCConnectionRequest</i> message on E-UTRA cell 2?	-->	RRC: <i>RRCConnectionRequest</i>	1	P
19-23	UE performs generic procedure as defined in TS 38.508-1 [4], Table 4.9.7.2.2-1 Steps 2-6 for N1 to S1 Inter mode change with condition 'connected without release' & 'mapped 5G security context'.	-	-	-	-
24-27	Generic Test Procedure as defined in Steps 5-8 of TS 36.508-1 [4] Table 4.5A.6.3-1 is performed to establish radio bearer corresponding to IMS PDN.	-	-	-	-
28	The SS configures a new RLC-UM data radio bearer with condition DRB (0,1), associated with the dedicated EPS bearer context. <i>RRCConnectionReconfiguration</i> message contains the ACTIVATE DEDICATED EPS BEARER CONTEXT REQUEST message. EPS bearer context #4 (QCI 1) according to TS 36.508 [7] Table 6.6.2-1: Reference dedicated EPS bearer contexts. Reference dedicated EPS bearer contexts is to establish the dedicated EPS bearer context on IMS PDN.	<--	RRC: <i>RRCConnectionReconfiguration</i> NAS: ACTIVATE DEDICATED EPS BEARER CONTEXT REQUEST	-	-
-	EXCEPTION: In parallel to the events described in steps 291-3 below, the steps specified in table 11.1.8.3.2-2 will take place.	-	-	-	-
29	The UE transmits an <i>RRCConnectionReconfigurationComplete</i> message.	-->	RRC: <i>RRCConnectionReconfigurationComplete</i>	-	-
30	The UE transmits an <i>ULInformationTransfer</i> message including the ACTIVATE DEDICATED EPS BEARER CONTEXT ACCEPT message.	-->	RRC: <i>ULInformationTransfer</i> NAS: ACTIVATE DEDICATED EPS BEARER CONTEXT ACCEPT	-	-
31	The SS waits 1 second for call duration.	-	-	-	-
32	Release IMS Call as specified in the generic procedure in TS 34.229-1 [35] subclause C.32.	-	-	-	-

Table 11.1.8.3.2-2: Parallel behaviour

St	Procedure	Message Sequence		TP	Verdict
		U - S	Message		
	EXCEPTION: Steps 1a1 to 1a7 describe behaviour that depends on the UE capability; the "lower case letter" identifies a step sequence that take place if a capability is supported	-	-	-	-
1a1-1a2	The UE performs IMS re-registration on EUTRAN as per steps 1-2 as defined in TS 34.229-1 [35] C.46.	-	-	-	-
1a3-1a6A	Steps 1-5 clause A.9.2 "EPS Fallback for Voice Call / steps after fallback / 5GS" of TS 34.229-5 [41] take place.	-	-	-	-
1a7	Check: Does the UE send an ACK to acknowledge receipt of the 200 OK for INVITE?	-->	SIP: ACK	1	P

11.1.8.3.3 Specific message contents

Table 11.1.8.3.3-1: REGISTRATION REQUEST (preamble)

Derivation Path: 38.508-1 [4] Table 4.7.1-6			
Information Element	Value/remark	Comment	Condition
5GMM capability			
S1 mode	'1'B	S1 mode supported	
S1 UE network capability	Present but contents not checked		

Table 11.1.8.3.3-2: REGISTRATION ACCEPT (preamble)

Derivation Path: 38.508-1 [4] Table 4.7.1-7			
Information Element	Value/remark	Comment	Condition
5GS network feature support			
IMS- VoPS-3GPP	'1'B	IMS voice over PS session supported over 3GPP access	
IWK N26	'0'B	Interworking without N26 interface not supported	

Table 11.1.8.3.3-3: Void**Table 11.1.8.3.3-4: MobilityFromNRCommand (step 17, Table 11.1.8.3.2-1)**

Derivation Path: 38.508-1 [4] Table 4.6.1-8			
Information Element	Value/remark	Comment	Condition
MobilityFromNRCommand ::= SEQUENCE {			
rrc-TransactionIdentifier	RRC-TransactionIdentifier		
criticalExtensions CHOICE {			
mobilityFromNRCommand ::= SEQUENCE {			
targetRAT-Type	eutra		
targetRAT-MessageContainer	RRCConnectionReconfiguration		
nas-SecurityParamFromNR	8 LSB of the downlink NAS COUNT		
nonCriticalExtension {			
voiceFallbackIndication-r16	true		
}			
}			
}			
}			

Table 11.1.8.3.3-5: RRCConnectionReconfiguration (Table 11.1.8.3.3-4)

Derivation Path: 36.508-1 Table 4.6.1-8 condition HO-TO-EUTRA(n,0)
--

Table 11.1.8.3.3-6: RRCConnectionRequest (step 18, table 11.1.8.3.2-1)

Derivation path: 36.508-1 Table 4.6.1-16			
Information Element	Value/Remark	Comment	Condition
RRCConnectionRequest ::= SEQUENCE {			
criticalExtensions CHOICE {			
rrcConnectionRequest-r8 SEQUENCE {			

ue-Identity CHOICE {			
s-TMSI	Any allowed value		
}			
establishmentCause	mo-VoiceCall-v1280	mo-VoiceCall	
spare	Present but contents not checked		
}			
}			
}			

Table 11.1.8.3.3-7: SystemInformationBlockType2 for E-UTRA Cell 2 (preamble and all steps, Table 11.1.8.3.2-1)

Derivation Path: 36.508, Table 4.4.3.3-1			
Information Element	Value/remark	Comment	Condition
SystemInformationBlockType2 ::= SEQUENCE {			
voiceServiceCauseIndication-r12	true		
}			

11.1.9 MO MMTEL voice call setup from NR RRC_IDLE / EPS Fallback with redirection / Single registration mode with N26 interface / voiceFallbackIndication

11.1.9.1 Test Purpose (TP)

(1)

```

with { UE being in NR RRC_CONNECTED state after having requested an MMTEL call establishment and the
MO IMS voice session establishment has been initiated }
ensure that {
  when { UE receives an RRCRelease message which includes redirectedCarrierInfo indicating
redirection to E-UTRA and with voiceFallbackIndication }
  then {UE selects the E-UTRA cell, uses "mo-VoiceCall" as the establishment cause value in RRC
Connection Request, performs a TAU procedure, and, successfully completes the MMTEL call setup in
EPS }
}

```

11.1.9.2 Conformance requirements

References: The conformance requirements covered in the current TC are specified in: TS 24.501, clauses 4.5.4.1; TS 38.331, clause 5.3.8.3, 5.3.11. Unless otherwise stated these are Rel-16 requirements.

[TS 24.501, clause 4.5.4.1]

When the UE is in 5GMM-IDLE mode or 5GMM-IDLE mode with suspend indication, upon receiving a request from the upper layers for an access attempt, the NAS shall categorize the access attempt into access identities and an access category following:

- a) subclause 4.5.2, table 4.5.2.1 and table 4.5.2.2, and subclause 4.5.3, if the UE is not operating in SNPN access mode; or
- b) subclause 4.5.2A, table 4.5.2A.1 and table 4.5.2A.2, and subclause 4.5.3, if the UE is operating in SNPN access mode,

and provide the applicable access identities and the access category to the lower layers for the purpose of access control checking. In this request to the lower layer the NAS can also provide to the lower layer the RRC establishment cause determined as specified in subclause 4.5.6 of this specification.

NOTE 1: The access barring check is performed by the lower layers.

NOTE 2: As an implementation option, the NAS can provide the RRC establishment cause to the lower layers after being informed by the lower layers that the access attempt is allowed.

If the UE has uplink user data pending for one or more PDU sessions when it builds a REGISTRATION REQUEST or SERVICE REQUEST message as initial NAS message, the UE shall indicate the respective PDU sessions in the Uplink data status IE as specified in subclause 5.5.1.3.2 and 5.6.1.2.1, regardless of the access category for which the access barring check is performed.

If the UE is registered for 5GS services with control plane CIoT 5GS optimization has uplink user data pending for one or more PDU sessions when it builds a CONTROL PLANE SERVICE REQUEST message as initial NAS message, the UE shall indicate the respective PDU sessions as specified in subclause 5.6.1.2.2, regardless of the access category for which the access barring check is performed.

NOTE 3: The UE indicates pending user data for all the respective PDU sessions, even if barring timers are running for some of the corresponding access categories.

If the lower layers indicate that the access attempt is allowed, the NAS shall initiate the procedure to send the initial NAS message for the access attempt.

[TS 38.331, clause 5.3.8.3]

The UE shall:

- 1> delay the following actions defined in this sub-clause 60 ms from the moment the *RRCRelease* message was received or optionally when lower layers indicate that the receipt of the *RRCRelease* message has been successfully acknowledged, whichever is earlier;
- 1> stop timer T380, if running;
- 1> stop timer T320, if running;
- 1> if timer T316 is running:
 - 2> stop timer T316;
 - 2> clear the information included in *VarRLF-Report*, if any;
- 1> stop timer T350, if running;
- 1> if the AS security is not activated:
 - 2> ignore any field included in *RRCRelease* message except *waitTime*;
 - 2> perform the actions upon going to RRC_IDLE as specified in 5.3.11 with the release cause 'other' upon which the procedure ends;
- 1> if the *RRCRelease* message includes *redirectedCarrierInfo* indicating redirection to *eutra*:
 - 2> if *cnType* is included:
 - 3> after the cell selection, indicate the available CN Type(s) and the received *cnType* to upper layers;

NOTE 1: Handling the case if the E-UTRA cell selected after the redirection does not support the core network type specified by the *cnType*, is up to UE implementation.

- 2> if *voiceFallbackIndication* is included:
 - 3> consider the RRC connection release was for EPS fallback for IMS voice (see TS 23.502 [43]);

[TS 38.331, clause 5.3.11]

UE shall:

- 1> reset MAC;
- 1> if T302 is running:
 - 2> stop timer T302;
 - 2> perform the actions as specified in 5.3.14.4;

- 1> stop all timers that are running except T320 and T325;
- 1> discard the UE Inactive AS context;
- 1> set the variable *pendingRnaUpdate* to *false*, if that is set to *true*;
- 1> discard the K_{gNB} , the K_{RRCenc} key, the K_{RRCint} , the K_{UPint} key and the K_{UPenc} key, if any;
- 1> release all radio resources, including release of the RLC entity, the MAC configuration and the associated PDCP entity and SDAP for all established RBs;
- 1> indicate the release of the RRC connection to upper layers together with the release cause;
- 1> enter RRC_IDLE and perform cell selection as specified in TS 38.304 [20], except if going to RRC_IDLE was triggered by selecting an inter-RAT cell while T311 was running;
- 1> if going to RRC_IDLE was triggered by reception of the *RRCRelease* message including a *waitTime*:
 - 2> start timer T302 with the value set to the *waitTime*;
 - 2> inform the upper layer that access barring is applicable for all access categories except categories '0' and '2'.

11.1.9.3 Test description

11.1.9.3.1 Pre-test conditions

System Simulator:

- 2 cells
- NR Cell 1 is configured according to TS 38.508-1 [4] Table 4.4.2-3 and is connected to 5GC.
- E-UTRA Cell 1 is configured to TS 36.508 [7] Table 4.4.2-2 and is connected to EPC.
- System information for the NR Cell 1 in accordance with combination NR-6 in TS 38.508-1 [4] sub-clause 4.4.3.1.2, and, for the E-UTRA Cell 1 in accordance with system information combination 31 as defined in TS 36.508 [7], subclause 4.4.3.1.1.
- Power levels are constant and as defined in Tables 11.1.9.3.1-1/2.

Table 11.1.9.3.1-1: Time instances of cell power level and parameter changes for conducted test environment

	Parameter name	Unit	NR Cell 1	E-UTRA Cell 1	Remark
T0	SS/PBCH SSS EPRE	dBm/SCS	-88		
	RS EPRE	dBm/15kHz		-85	

Table 11.1.9.3.1-2: Time instances of cell power level and parameter changes for OTA test environment

	Parameter name	Unit	NR Cell 1	E-UTRA Cell 1	Remark
T0	SS/PBCH SSS EPRE	dBm/SCS	-82	-	
	RS EPRE	dBm/15kHz	-	-85	

UE:

- The UE is configured to use IMS preconditions

Preamble:

With E-UTRA Cell 1 "Serving cell" and NR Cell 1 "Non-suitable "Off" cell" in accordance with TS 38.508-1 [4], Table 6.2.2.1-3, the UE is brought to state RRC_IDLE using generic procedure parameters Connectivity (*E-UTRA/EPC*) and Unrestricted nr PDN (*On*) in accordance with the procedure described in TS 38.508-1 [4], clause 4.5.2. 4G GUTI and eKSI are assigned and security context established

The UE is switched-off

With E-UTRA Cell 1 "Non-suitable "Off" cell" and NR Cell 1 "Serving cell" in accordance with TS 38.508-1 [4], Table 6.2.2.1-3, the UE is brought to state 1N-A, RRC_IDLE Connectivity (NR), in accordance with the procedure described in TS 38.508-1 [4], Table 4.5.2.2-2. 5G-GUTI and ngKSI are assigned and security context established.

11.1.9.3.2 Test procedure sequence

Table 11.1.9.3.2-1: Main behaviour

St	Procedure	Message Sequence		TP	Verdict
		U - S	Message		
0	Void	-	-	-	-
1	Make the UE attempt an MTSI MO Speech Call (Note 1).	-	-	-	-
2	UE sends NR RRCSetupRequest with EstablishmentCause set to 'mo-VoiceCall'.	-->	NR RRC: RRCSetupRequest	-	-
3	SS transmits an NR <i>RRCSetup</i> message	<--	NR RRC: RRCSetup	-	-
4	UE transmits an NR <i>RRCSetupComplete</i> message to confirm the successful completion of the connection establishment including initiation of 5GSM procedure by including the SERVICE REQUEST message with <i>Service Type</i> set to 'data'.	-->	NR RRC: <i>RRCSetupComplete</i> 5GSM: SERVICE REQUEST	-	-
5	Set the power levels according to "T0" as per Table 11.1.9.3.1-1/2.	-	-	-	-
6-7	Void	-	-	-	-
8	Steps 5-8 of expected sequence from Table 4.5.4.2-3 as defined in TS 38.508-1 [4] are performed.	-	-	-	-
9-13	Steps 1-5 of expected sequence from A.9.1 as defined in TS 34.229-5 [41] are performed for setting up MTSI MO speech call - EPS fallback.	-	-	-	-
14	SS transmits <i>RRCRelease</i> message indicating redirection to E-UTRA Cell 1.	<--	NR RRC: RRCRelease	-	-
-	EXCEPTION: Unless otherwise stated all the messages below are transmitted on the cell specified in the test case.	-	-	-	-
15	The UE transmits an <i>RRCCONNECTIONREQUEST</i> message on the cell specified in the test case.	-->	RRC: RRCCONNECTIONREQUEST	1	P
16-20	UE performs generic procedure as defined in TS 38.508-1 [4], Table 4.9.7.2.2-1 Steps 2-6 for N1 to S1 Inter mode change with condition 'connected without release' & 'mapped 5G security context'.	-	-	-	-
21-24	Generic Test Procedure as defined in Steps 5-8 of TS 36.508-1 [4] Table 4.5A.6.3-1 is performed to establish radio bearer corresponding to IMS PDN.	-	-	-	-
-	EXCEPTION: Steps 25a1-25a2 describe a step sequence depending on UE implementation.	-	-	-	-

25a 1- 25a 2	The UE may perform steps 1-2 according to TS 34.229-1 subclause C.46 to perform IMS re-registration on EUTRAN.	-	-	-	-
26	The SS configures a new RLC-UM data radio bearer with condition DRB (0,1), associated with the dedicated EPS bearer context. <i>RRCConnectionReconfiguration</i> message contains the ACTIVATE DEDICATED EPS BEARER CONTEXT REQUEST message. EPS bearer context #4 (QCI 1) according to table 6.6.2-1: Reference dedicated EPS bearer contexts.	<--	RRC: RRCConnectionReconfiguration NAS: ACTIVATE DEDICATED EPS BEARER CONTEXT REQUEST	-	-
-	EXCEPTION: In parallel to the events described in steps 27-28 the steps specified in table 11.1.9.3.2-2 will take place.	-	-	-	-
27	The UE transmits an <i>RRCConnectionReconfigurationComplete</i> message to confirm the establishment of the new data radio bearer, associated with the dedicated EPS bearer.	-->	RRC: RRCConnectionReconfigurationComplete	-	-
28	The UE transmits an ACTIVATE DEDICATED EPS BEARER CONTEXT ACCEPT message.	-->	RRC: ULInformationTransfer NAS:ACTIVATE DEDICATED EPS BEARER CONTEXT ACCEPT	1	P
29	UE is triggered by MMI to release the call.	-	-	-	-
30- 33	Follow the Test Steps 2-5 as defined in TS 34.229-1 [35] subclause C.32 for Generic test procedure for MO release of IMS call followed by EPS Bearer Deactivation.	-	-	-	-

Table 11.1.9.3.2-2: Parallel behaviour

St	Procedure	Message Sequence		TP	Verdict
		U - S	Message		
1-4A	Steps 1 to 5 of the the generic procedure “EPS Fallback for Voice Call / steps after fallback / 5GS” as defined in Appendix A.9.2 of TS 34.229-5 [41] take place.	-	-	-	-
5	Check: Does the UE perform step 6 of the generic procedure “EPS Fallback for Voice Call / steps after fallback / 5GS” as defined in Appendix A.9.2 of TS 34.229-5 [41] take place?	-->	SIP: ACK	1	P

11.1.9.3.3 Specific message contents

Table 11.1.9.3.3-1: RRCRelease (step 6, table 11.1.9.3.2-1)

Derivation path: TS 38.508-1 [4] Table Table 4.6.1-16			
Information Element	Value/Remark	Comment	Condition
RRCRelease ::= SEQUENCE {			
criticalExtensions CHOICE {			
rrcRelease SEQUENCE {			
redirectedCarrierInfo CHOICE {			
eutra SEQUENCE {			
eutraFrequency	Downlink EARFCN of cell 1		
cnType	epc		
}			
}			
}			
nonCriticalExtension {			
nonCriticalExtension {			

voiceFallbackIndication-r16	true		
}			
}			
}			
}			

Table 11.1.9.3.3-2: RRCConnectionRequest (step 15, table 11.1.9.3.2-1)

Derivation path: TS 36.508-1 Table Table 4.6.1-16			
Information Element	Value/Remark	Comment	Condition
RRCConnectionRequest ::= SEQUENCE {			
criticalExtensions CHOICE {			
rrcConnectionRequest-r8 SEQUENCE {			
ue-Identity CHOICE {			
s-TMSI	Any allowed value		
}			
establishmentCause	mo-VoiceCall-v1280	mo-VoiceCall	
spare	Present but contents not checked		
}			
}			
}			

Table 11.1.9.3.3-3: SystemInformationBlockType2 for E-UTRA Cell 1 (preamble and all steps, Table 11.1.9.3.2-1)

Derivation Path: 36.508, Table 4.4.3.3-1			
Information Element	Value/remark	Comment	Condition
SystemInformationBlockType2 ::= SEQUENCE {			
voiceServiceCauseIndication-r12	true		
}			

11.2 5G-SRVCC

11.2.1 5G-SRVCC from NG-RAN to 3GPP UTRAN

11.2.1.1 Test Purpose (TP)

(1)

```
with { the UE is in NR RRC_CONNECTED state }
ensure that {
  when { UE receives a MobilityFromNRCommand message and an IMS voice call is ongoing and an UTRA
Speech RAB combination is configured for an UTRA cell }
  then { UE transmits a HANDOVER TO UTRAN COMPLETE message on the utra cell }
}
```

(2)

```
with { the UE has performed 5G-SRVCC from NG-RAN to UTRAN }
ensure that {
  when { UE in 5GMM-DEREGISTERED state moves from a UTRAN to NG-RAN coverage }
  then { UE starts the Initial registration procedure on the NR cell }
}
```

11.2.1.2 Conformance requirements

References: The conformance requirements covered in the present test case are specified in TS 23.216, clause 6.5.4, TS 38.331, clause 5.4.3.3 and TS 24.501, clause 5.5.1.2.2. Unless otherwise stated these are Rel-16 requirements.

[TS 23.216, clause 6.5.4]

Depicted in Figure 6.5.4-1 is a call flow for 5G-SRVCC from NG-RAN to 3GPP UTRAN.

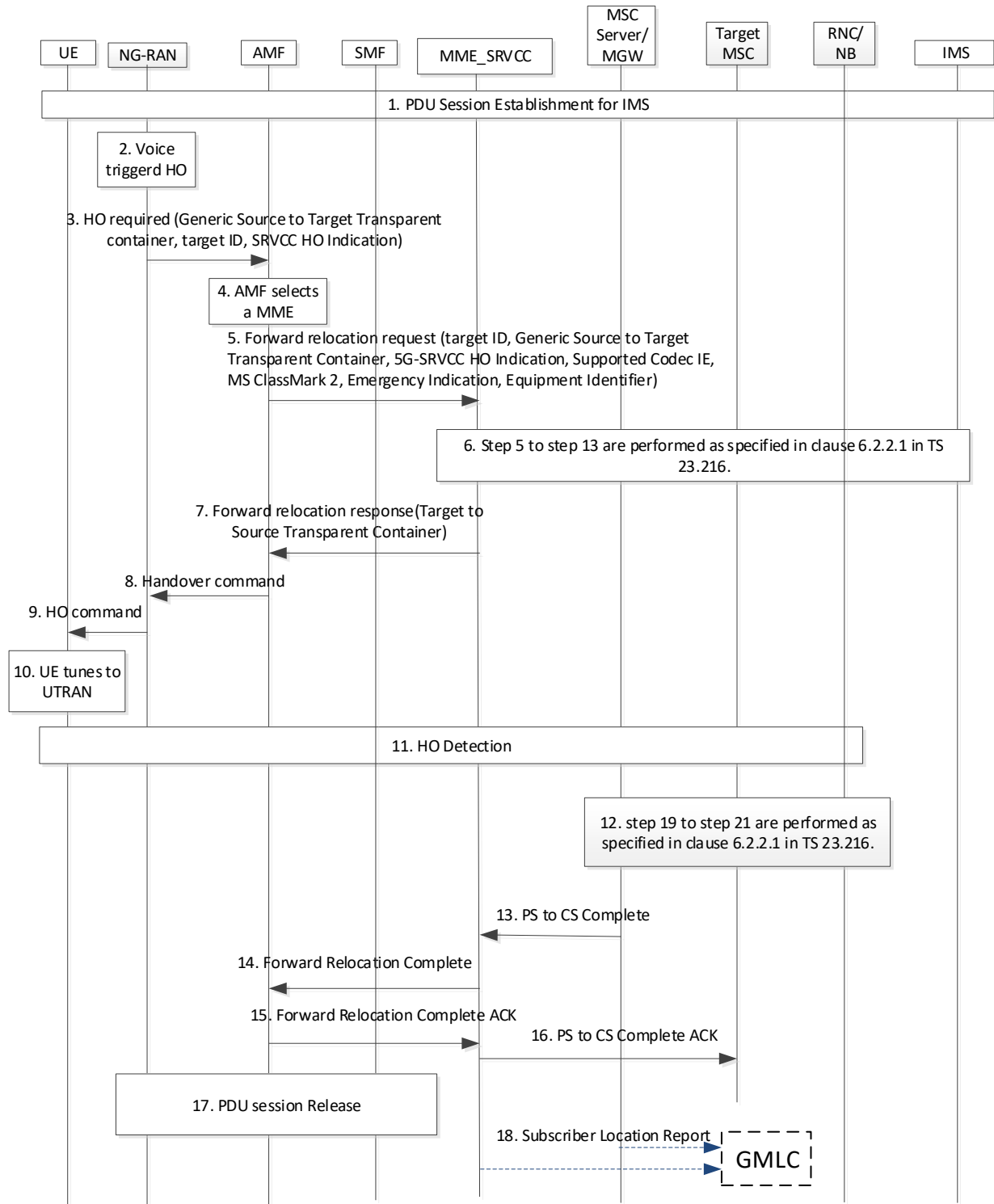

Figure 6.5.4-1: 5G-SRVCC from NG-RAN to 3GPP UTRAN call flow

1. UE establishes the PDU session for IMS.
2. 5G-SRVCC HO is triggered by NG-RAN.
3. NG-RAN sends a Handover Required (Target ID, generic Source to Target Transparent Container, 5G-SRVCC HO indication) message to the source AMF. The Target ID is the UTRAN RNC-ID. 5G-SRVCC HO Indication

indicates to AMF that this is for 5G-SRVCC. The Generic Source to Target Transparent Container is the Source RNC to Target RNC Transparent container.

4. AMF determines the HO is used for 5G-SRVCC by the 5G-SRVCC HO Indication. AMF selects an MME_SRVCC that can have Sv connection to the MSC SERVER/MSC according to the target RNC ID which is included in the Target ID.

NOTE: The MME_SRVCC selection can be realised through operator's configuration.

5. AMF sends the forward relocation request (IMSI, Target ID, STN-SR, C-MSISDN, MM Context, Generic Source to Target Transparent Container, 5G-SRVCC HO Indication, Supported Codec IE, MS ClassMark 2, Emergency Indication, Equipment Identifier) to MME_SRVCC. The Emergency Indication and the equipment identifier are included if the ongoing session is emergency session. Authenticated IMSI and C MSISDN are also included in this case, if available.
6. MME_SRVCC initiates the PS-CS handover procedure towards MSC Server. Steps 5 to 13 as specified in Figure 6.2.2.1-1 (referenced by clause 6.2.2.1A SRVCC from E-UTRAN to UTRAN without PS HO) are performed for the PS-CS handover procedure.
7. MME_SRVCC receives the response message from MSC server after HO preparation is completed. MME_SRVCC sends the Forward Relocation Response message (Target to Source Transparent Container) to AMF.
8. AMF sends the HO command to NG-RAN.
9. NG-RAN sends a HO command to the UE. UE detects the 5G-SRVCC HO.
10. UE tunes to the target UTRAN cell.
11. Handover Detection at the target RNS occurs, then the target RNS sends Handover Detection message to the target MSC SERVER/MSC.
12. The UE sends a Handover Complete message via the target RNS to the target MSC SERVER. Steps 19 to 21 as specified in Figure 6.2.2.1-1 (referenced by clause 6.2.2.1A SRVCC from E-UTRAN to UTRAN without PS HO) are performed for this handover complete procedure. At this stage, the target MSC SERVER/MSC can send/receive voice data.
13. MSC SERVER sends MME_SRVCC the SRVCC PS to CS completion.
14. MME_SRVCC forwards the Forward Relocation completion message which includes the information received in step 13 to AMF.
15. AMF forwards the Forward Relocation Complete ACK message to MME_SRVCC. AMF releases the UE context related to MME_SRVCC.
16. MME_SRVCC forwards the PS to CS Complete ACK message to MSC server. MME_SRVCC removes stored UE context. After receives the message, MSC server removes the UE context related to the MME_SRVCC.
17. AMF performs the PDU session release procedure for all the PDU session(s) which is described in TS 23.502 [45] indicating that the release is due to PS to CS handover for 5G SRVCC.
18. For an emergency services session after handover is complete, the source AMF or the MSC Server may respectively invoke the Namf_Location_EventNotify service operation or send a Subscriber Location Report, towards a GMLC associated with the source or target side, respectively, carrying the identity of the MSC Server, as defined respectively in TS 23.273 [50] or TS 23.271 [29], to support location continuity.

The IMS service control is described in TS 23.292 [13] when UE accesses in UTRAN cell due to 5G-SRVCC.

[TS 38.331, clause 5.4.3.3]

Reception of the MobilityFromNRCommand by the UE

The UE shall:

- 1> stop timer T310, if running;

- 1> stop timer T312, if running;
- 1> if T316 is running:
 - 2> stop timer T316;
 - 2> clear the information included in *VarRLF-Report*, if any;
- 1> if T390 is running:
 - 2> stop timer T390 for all access categories;
 - 2> perform the actions as specified in 5.3.14.4;
- 1> if the *targetRAT-Type* is set to *eutra*:
 - 2> consider inter-RAT mobility as initiated towards E-UTRA;
 - 2> forward the *nas-SecurityParamFromNR* to the upper layers, if included;
- 1> else if the *targetRAT-Type* is set to *utra-fdd*:
 - 2> consider inter-RAT mobility as initiated towards UTRA-FDD;
 - 2> forward the *nas-SecurityParamFromNR* to the upper layers, if included;
- 1> access the target cell indicated in the inter-RAT message in accordance with the specifications of the target RAT.

[TS 24.501, clause 5.5.1.2.2]

The UE in state 5GMM-DEREGISTERED shall initiate the registration procedure for initial registration by sending a REGISTRATION REQUEST message to the AMF,

- a) when the UE performs initial registration for 5GS services;
- b) when the UE performs initial registration for emergency services;
- c) when the UE performs initial registration for SMS over NAS; and
- d) when the UE moves from GERAN to NG-RAN coverage or the UE moves from a UTRAN to NG-RAN coverage and the following applies:
 - 1) the UE initiated a GPRS attach or routing area updating procedure while in A/Gb mode or Iu mode; or
 - 2) the UE has performed 5G-SRVCC from NG-RAN to UTRAN as specified in 3GPP TS 23.216 [6A],
 and since then the UE did not perform a successful EPS attach or tracking area updating procedure in S1 mode or registration procedure in N1 mode,

...

11.2.1.3 Test Description

11.2.1.3.1 Pre-test conditions

System Simulator:

- NR Cell 1 with system information combination NR-1 as defined in TS 38.508-1 [4].
- UTRA Cell 5 as defined in TS 36.508 [7].

UE:

None.

Preamble:

- The UE is in test state 0N-B according to TS 38.508-1.

11.2.1.3.2 Test procedure sequence

Table 11.2.1.3.2-1/2 illustrate the downlink power levels and other changing parameters to be applied for the cell at various time instants of the test execution. The exact instants on which these values shall be applied are described in the texts in this clause. The configuration T0 indicates the initial conditions for preamble. Configurations marked "T1" and "T2" are applied at the points indicated in the Main behaviour description in Table 11.2.1.3.2-3.

Table 11.2.1.3.2-1: Time instances of cell power level and parameter changes for FR1

	Parameter	Unit	NR Cell 1	UTRA Cell 5	Remark
T0	SS/PBCH	dBm/	-88	-	
	SSS EPRE	SCS			
	CPICH_Ec (UTRA FDD)	dBm/3. 84 MHz	-	Off	
T1	SS/PBCH	dBm/	-88	-	
	SSS EPRE	SCS			
	CPICH_Ec (UTRA FDD)	dBm/3. 84 MHz	-	-60	
T2	SS/PBCH	dBm/	-88	-	
	SSS EPRE	SCS			
	CPICH_Ec (UTRA FDD)	dBm/3. 84 MHz	-	Off	

Table 11.2.1.3.2-2: Time instances of cell power level and parameter changes for FR2

	Parameter	Unit	NR Cell 1	UTRA Cell 5	Remark
T0	SS/PBCH	dBm/	-82	-	
	SSS EPRE	SCS			
	CPICH_Ec (UTRA FDD)	dBm/3. 84 MHz	-	Off	
T1	SS/PBCH	dBm/	-82	-	
	SSS EPRE	SCS			
	CPICH_Ec (UTRA FDD)	dBm/3. 84 MHz	-	-60	
T2	SS/PBCH	dBm/	-82	-	
	SSS EPRE	SCS			

	CPICH_Ec (UTRA FDD)	dBm/3. 84 MHz	-	Off	
--	---------------------------	---------------------	---	-----	--

Table 11.2.1.3.2-3: Main behaviour

St	Procedure	Message Sequence		TP	Verdict
		U – S	Message		
1	The UE is switched on.	-	-	-	-
-	The following messages are to be observed on NR Cell 1 unless explicitly stated otherwise.	-	-	-	-
2-3	The UE establishes RRC connection by executing steps 2-3 of Table 4.5.2.2-2 in TS 38.508-1 [4].	-	-	-	-
4	The UE transmits an <i>RRCSetupComplete</i> message and a REGISTRATION REQUEST message indicating 5G-SRVCC from NG-RAN to UTRAN supported.	-->	NR RRC: RRCSetupComplete 5GMM: REGISTRATION REQUEST	-	-
5-19	Steps 5-19a1 of Table 4.5.2.2-2 of the generic procedure in TS 38.508-1 [4] are performed.	-	-	-	-
20	The SS transmits a <i>UECapabilityEnquiry</i> message to request UE radio access capability information for NR and UTRA.	<--	NR RRC: UECapabilityEnquiry	-	-
21	The UE transmits a <i>UECapabilityInformation</i> message. NOTE: The start-CS values received, should be used to configure ciphering on cell 5.	-->	NR RRC: UECapabilityInformation	-	-
22	The SS releases the RRC Connection.	<--	NR RRC: RRCRelease	-	-
23	Perform Generic Test Procedure for IMS MO speech call establishment as specified in TS 38.508-1 [4], subclause 4.9.15.	-	-	-	-
24	Set the power levels according to "T1" as per Table 11.2.1.3.2-1/2.	-	-	-	-
25	The SS transmits a <i>MobilityFromNRCommand</i> message.	<--	NR RRC: MobilityFromNRCommand	-	-
-	The following messages are to be observed on UTRA Cell 5 unless explicitly stated otherwise.	-	-	-	-
26	Check: Does the UE transmit a HANOVER TO UTRAN COMPLETE message on cell 5?	-->	HANOVER TO UTRAN COMPLETE	1	P
-	EXCEPTION: In parallel to the events described in step 27 to 32 the steps specified in table 11.2.1.3.2-4 takes place.	-	-	-	-
27	The SS transmits a SECURITY MODE COMMAND message for the CS domain.	<--	SECURITY MODE COMMAND	-	-
28	The UE transmits a SECURITY MODE COMPLETE message.	-->	SECURITY MODE COMPLETE	-	-
29	The SS transmits an UTRAN MOBILITY INFORMATION message to notify CN information.	<--	UTRAN MOBILITY INFORMATION	-	-
30	The UE transmits an UTRAN MOBILITY INFORMATION CONFIRM message.	-->	UTRAN MOBILITY INFORMATION CONFIRM	-	-
31	The SS transmits a TMSI REALLOCATION COMMAND message.	<--	TMSI REALLOCATION COMMAND	-	-
32	The UE transmits a TMSI REALLOCATION COMPLETE message.	-->	TMSI REALLOCATION COMPLETE	-	-
33	Make the UE release the CS call.	-	-	-	-
33A	The UE transmits a DISCONNECT message.	-->	DISCONNECT		
33B	The SS transmits a RELEASE message.	<--	RELEASE	-	-
33C	The UE transmits a RELEASE COMPLETE message.	-->	RELEASE COMPLETE	-	-
33D	The SS releases the RRC connection.	-	-	-	-

34	Set the power levels according to "T2" as per Table 11.2.1.3.2-1/2.	-	-	-	-
35-52	Check: Does the UE perform initial registration procedure on NR Cell 1 as steps 2-19a1 of Table 4.5.2.2-2 NR RRC_IDLE in TS 38.508-1 [4]?	-	-	2	P

Table 11.2.1.3.2-4: Parallel behaviour

St	Procedure	Message Sequence		TP	Verdict
		U - S	Message		
1	Check: Does the UE transmit an ATTACH REQUEST message?	-->	ATTACH REQUEST	-	-
1AA	The SS transmits an AUTHENTICATION AND CIPHERING REQUEST message.	<--	AUTHENTICATION AND CIPHERING REQUEST	-	-
1AB	The UE transmits an AUTHENTICATION AND CIPHERING RESPONSE message.	-->	AUTHENTICATION AND CIPHERING RESPONSE	-	-
1A	The SS transmits a SECURITY MODE COMMAND message for the PS domain.	<--	SECURITY MODE COMMAND	-	-
1B	The UE transmits a SECURITY MODE COMPLETE message.	-->	SECURITY MODE COMPLETE	-	-
2	The SS transmits an ATTACH ACCEPT message.	<--	ATTACH ACCEPT	-	-
3	The UE transmits an ATTACH COMPLETE message.	-->	ATTACH COMPLETE	-	-

11.2.1.3.3 Specific message contents

Table 11.2.1.3.3-1: Message REGISTRATION REQUEST (step 4, Table 11.2.1.3.2-3)

Derivation path: TS 38.508-1 [4], table 4.7.1-6			
Information Element	Value/Remark	Comment	Condition
5GMM capability			
5GSRVCC (octet 4, bit 1)	'1'B	5G-SRVCC from NG-RAN to UTRAN supported	

Table 11.2.1.3.3-2: UECapabilityEnquiry (step 20, Table 11.2.1.3.2-3)

Derivation Path: TS 38.508-1 [4], Table 4.6.1-31			
Information Element	Value/remark	Comment	Condition
UECapabilityEnquiry ::= SEQUENCE {			
rrc-TransactionIdentifier	RRC-TransactionIdentifier		
criticalExtensions CHOICE {			
ueCapabilityEnquiry SEQUENCE {			
ue-CapabilityRAT-RequestList SEQUENCE (SIZE (1.. maxRAT-CapabilityContainers)) OF CapabilityRAT-Request {	2 entries		
UE-CapabilityRAT-Request[1] SEQUENCE {		entry 1	
rat-Type	nr		
}			
UE-CapabilityRAT-Request[2] SEQUENCE {		entry 2	
rat-Type	ultra-fdd-v1610		
}			
}			
lateNonCriticalExtension	Not present		
nonCriticalExtension	Not present		
}			
criticalExtensionsFuture			
}			
}			

Table 11.2.1.3.3-3: UECapabilityInformation (step 21, Table 11.2.1.3.2-3)

Derivation Path: TS 38.508-1 [4], Table 4.6.1-32			
Information Element	Value/remark	Comment	Condition
UECapabilityInformation ::= SEQUENCE {			
rrc-TransactionIdentifier	RRC-TransactionIdentifier		
criticalExtensions CHOICE {			
ueCapabilityInformation SEQUENCE {			
ue-CapabilityRAT-ContainerList SEQUENCE (SIZE (0..maxRAT-CapabilityContainers)) OF CapabilityRAT-Container{	2 entries		
UE-CapabilityRAT-Container[1] SEQUENCE {		entry 1	
rat-Type	nr		
ueCapabilityRAT-Container	Not checked		
}			
UE-CapabilityRAT-Container[2] SEQUENCE {		entry 2	
rat-Type	ultra-fdd-v1610		
ueCapabilityRAT-Container	Octet string	INTER RAT HANDOVER INFO	
}			
}			
lateNonCriticalExtension	Not checked		
nonCriticalExtension	Not checked		
}			
criticalExtensionsFuture	Not checked		
}			
}			

Table 11.2.1.3.3-4: MobilityFromNRCommand (step 25, Table 11.2.1.3.2-3)

Derivation Path: TS 38.508-1 [4] Table 4.6.1-8			
Information Element	Value/remark	Comment	Condition
MobilityFromNRCommand ::= SEQUENCE {			
rrc-TransactionIdentifier	RRC-TransactionIdentifier		
criticalExtensions CHOICE {			
mobilityFromNRCommand ::= SEQUENCE {			
targetRAT-Type	ultra-fdd-v1610		
targetRAT-MessageContainer	HANDOVER TO UTRAN COMMAND(UTRA RRC message)		
nas-SecurityParamFromNR	4 LSB of the downlink NAS COUNT		
}			
}			
}			

Table 11.2.1.3.3-5: HANDOVER TO UTRAN COMMAND (Table 11.2.1.3.3-4)

Derivation Path: TS 36.508 [7], Table 4.7B.1-1, condition UTRA Speech

Table 11.2.1.3.3-6: SECURITY MODE COMMAND (step 27, Table 11.2.1.3.2-3)

Derivation Path: TS 36.508 [7], Table 4.7B.1-n		
Information Element	Condition	Value/remark
Ciphering mode info		Not Present

Table 11.2.1.3.3-7: Void

Table 11.2.1.3.3-8: SECURITY MODE COMMAND (step 1A, 11.2.1.3.2-4)

Derivation Path: TS 36.508 [7], Table 4.7B.1-n		
Information Element	Condition	Value/remark
Ciphering mode info		StartRestart
Integrity protection mode info		modify
CN Domain Identity		ps-domain

11.3 Unified Access Control (UAC)

11.3.1 UAC / Access Identity 0 / 0% access probability / MTSI MO speech call / SMSoIP

11.3.1.1 Test Purpose (TP)

(1)

```
with { UE not configured for special AIs (1,2,11-15) having received a SIB1 message indicating UAC
Info set to 0% accessibility for Access category 4 and in NR RRC_IDLE }
ensure that {
  when { User initiates MMTEL Voice call }
    then { UE does not initiate connection over NR Cell }
}
```

(2)

```
with { UE not configured for special AIs (1,2,11-15) , previously barred for MO MTSI MMTEL Voice in
NR RRC_IDLE & current SIB1 indicates no access barred as part of UAC Info }
ensure that {
  when { user tries another MO MTSI MMTEL Voice session after T390 expires }
    then { UE is able to successfully establish MMTEL Voice session }
}
```

(3)

```
with { UE not configured for special AIs (1,2,11-15) with SIB1 indicating UAC info set to 0%
accessibility for Access category 6 in NR RRC_CONNECTED state }
ensure that {
  when { user tries to send SMS over IP }
    then { UE does not initiate SMS access attempt }
}
```

(4)

Void

11.3.1.2 Conformance requirements

References: The conformance requirements covered in the present TC are specified in TS 24.501: clause 4.5.2, 4.5.4.2 and 4.5.6 and TS 38.331: clause 5.3.14.1, 5.3.14.2, 5.3.14.4 and 5.3.14.5. Unless otherwise stated these are Rel-15 requirements.

[TS 24.501, clause 4.5.2]

When the UE needs to initiate an access attempt in one of the events listed in subclause 4.5.1, the UE shall determine one or more access identities from the set of standardized access identities, and one access category from the set of standardized access categories and operator-defined access categories, to be associated with that access attempt.

The set of the access identities applicable for the request is determined by the UE in the following way:

- a) for each of the access identities 1, 2, 11, 12, 13, 14 and 15 in table 4.5.2.1, the UE shall check whether the access identity is applicable in the selected PLMN, if a new PLMN is selected, or otherwise if it is applicable in the RPLMN or equivalent PLMN; and
- b) if none of the above access identities is applicable, then access identity 0 is applicable.

Table 4.5.2.1: Access identities

Access Identity number	UE configuration
0	UE is not configured with any parameters from this table
1 (NOTE 1)	UE is configured for multimedia priority service (MPS).
2 (NOTE 2)	UE is configured for mission critical service (MCS).
3-10	Reserved for future use
11 (NOTE 3)	Access Class 11 is configured in the UE.
12 (NOTE 3)	Access Class 12 is configured in the UE.
13 (NOTE 3)	Access Class 13 is configured in the UE.
14 (NOTE 3)	Access Class 14 is configured in the UE.
15 (NOTE 3)	Access Class 15 is configured in the UE.
<p>NOTE 1: Access identity 1 is valid when:</p> <ul style="list-style-type: none"> - the USIM file EF_{UAC_AIC} indicates the UE is configured for access identity 1 and the RPLMN is the HPLMN (if the EHPLMN list is not present or is empty) or EHPLMN (if the EHPLMN list is present), or a visited PLMN of the home country (see the definition of home country in 3GPP TS 24.301 [15]); or - the UE receives the 5GS network feature support IE with the MPS indicator bit set to "Access identity 1 valid in RPLMN or equivalent PLMN" from the RPLMN as described in subclause 5.5.1.2.4 and subclause 5.5.1.3.4. <p>NOTE 2: Access identity 2 is used by UEs configured for MCS and is valid when:</p> <ul style="list-style-type: none"> - the USIM file EF_{UAC_AIC} indicates the UE is configured for access identity 2 and the RPLMN is the HPLMN (if the EHPLMN list is not present or is empty) or EHPLMN (if the EHPLMN list is present), or a visited PLMN of the home country (see 3GPP TS 23.122 [5]); or - the UE receives the 5GS network feature support IE with the MCS indicator bit set to "Access identity 2 valid in RPLMN or equivalent PLMN" from the RPLMN as described in subclause 5.5.1.2.4 and subclause 5.5.1.3.4. <p>NOTE 3: Access identities 11 and 15 are valid in HPLMN (if the EHPLMN list is not present or is empty) or EHPLMN (if the EHPLMN list is present). Access Identities 12, 13 and 14 are valid in HPLMN and visited PLMNs of home country only (see the definition of home country in 3GPP TS 24.301 [15]).</p>	

The UE uses the MPS indicator bit of the 5GS network feature support IE to determine if access identity 1 is valid. Processing of the MPS indicator bit of the 5GS network feature support IE in the REGISTRATION ACCEPT message is described in subclause 5.5.1.2.4 and subclause 5.5.1.3.4. The UE shall not consider access identity 1 to be valid when the UE is not in the country of its HPLMN prior to receiving the MPS indicator bit of the 5GS network feature support IE in the REGISTRATION ACCEPT message being set to "Access identity 1 valid in RPLMN or equivalent PLMN".

When the UE is in the country of its HPLMN, the contents of the USIM files EF_{UAC_AIC} and EF_{ACC} as specified in 3GPP TS 31.102 [22] and the rules specified in table 4.5.2.1 are used to determine the applicability of access identity 1 and access classes 11 - 15. When the UE is in the country of its HPLMN, and the USIM file EF_{UAC_AIC} does not indicate the UE is configured for access identity 1, the UE uses the MPS indicator bit of the 5GS network feature support IE in the REGISTRATION ACCEPT message to determine if access identity 1 is valid. When the UE is in the country of its HPLMN, and the USIM file EF_{UAC_AIC} indicates the UE is configured for access identity 1, the MPS indicator bit of the 5GS network feature support IE is not applicable. When the UE is not in the country of its HPLMN, the contents of the USIM files EF_{UAC_AIC} and EF_{ACC} are not applicable.

The UE uses the MCS indicator bit of the 5GS network feature support IE to determine if access identity 2 is valid. Processing of the MCS indicator bit of the 5GS network feature support IE in the REGISTRATION ACCEPT message is described in subclause 5.5.1.2.4 and subclause 5.5.1.3.4. The UE shall not consider access identity 2 to be valid when the UE is not in the country of its HPLMN prior to receiving the MCS indicator bit of the 5GS network feature support IE in the REGISTRATION ACCEPT message being set to "Access identity 2 valid in RPLMN or equivalent PLMN".

When the UE is in the country of its HPLMN, the contents of the USIM files EF_{UAC_AIC} and EF_{ACC} as specified in 3GPP TS 31.102 [22] and the rules specified in table 4.5.2.1 are used to determine the applicability of access identity 2 and access classes 11 - 15. When the UE is in the country of its HPLMN, and the USIM file EF_{UAC_AIC} does not indicate

the UE is configured for access identity 2, the UE uses the MCS indicator bit of the 5GS network feature support IE in the REGISTRATION ACCEPT message to determine if access identity 2 is valid. When the UE is in the country of its HPLMN, and the USIM file EF_{UAC_AIC} indicates the UE is configured for access identity 2, the MCS indicator bit of the 5GS network feature support IE is not applicable. When the UE is not in the country of its HPLMN, the contents of the USIM files EF_{UAC_AIC} and EF_{ACC} are not applicable.

In order to determine the access category applicable for the access attempt, the NAS shall check the rules in table 4.5.2.2, and use the access category for which there is a match for barring check. If the access attempt matches more than one rule, the access category of the lowest rule number shall be selected. If the access attempt matches more than one operator-defined access category definition, the UE shall select the access category from the operator-defined access category definition with the lowest precedence value (see subclause 4.5.3).

NOTE: The case when an access attempt matches more than one rule includes the case when multiple events trigger an access attempt at the same time.

Table 4.5.2.2: Mapping table for access categories

Rule #	Type of access attempt	Requirements to be met	Access Category
1	Response to paging or NOTIFICATION over non-3GPP access; 5GMM connection management procedure initiated for the purpose of transporting an LPP message	Access attempt is for MT access	0 (= MT_acc)
2	Emergency	UE is attempting access for an emergency session (NOTE 1, NOTE 2)	2 (= emergency)
3	Access attempt for operator-defined access category	UE stores operator-defined access category definitions valid in the current PLMN as specified in subclause 4.5.3, and access attempt is matching criteria of an operator-defined access category definition	32-63 (= based on operator classification)
4	Access attempt for delay tolerant service	(a) UE is configured for NAS signalling low priority or UE supporting S1 mode is configured for EAB (see the "ExtendedAccessBarring" leaf of NAS configuration MO in 3GPP TS 24.368 [17] or 3GPP TS 31.102 [22]) where "EAB override" does not apply, and (b) the UE received one of the categories a, b or c as part of the parameters for unified access control in the broadcast system information, and the UE is a member of the broadcasted category in the selected PLMN or RPLMN/equivalent PLMN (NOTE 3, NOTE 5, NOTE 6, NOTE 7, NOTE 8)	1 (= delay tolerant)
5	MO MMTel voice call	Access attempt is for MO MMTel voice call or for NAS signalling connection recovery during ongoing MO MMTel voice call (NOTE 2)	4 (= MO MMTel voice)
6	MO MMTel video call	Access attempt is for MO MMTel video call or for NAS signalling connection recovery during ongoing MO MMTel video call (NOTE 2)	5 (= MO MMTel video)
7	MO SMS over NAS or MO SMSoIP	Access attempt is for MO SMS over NAS (NOTE 4) or MO SMS over SMSoIP transfer or for NAS signalling connection recovery during ongoing MO SMS or SMSoIP transfer (NOTE 2)	6 (= MO SMS and SMSoIP)
8	UE NAS initiated 5GMM specific procedures	Access attempt is for MO signalling	3 (= MO_sig)
9	UE NAS initiated 5GMM connection management procedure or 5GMM NAS	Access attempt is for MO data	7 (= MO_data)

	transport procedure		
10	An uplink user data packet is to be sent for a PDU session with suspended user-plane resources	No further requirement is to be met	7 (= MO_data)
<p>NOTE 1: This includes 5GMM specific procedures while the service is ongoing and 5GMM connection management procedures required to establish a PDU session with request type = "initial emergency request" or "existing emergency PDU session", or to re-establish user-plane resources for such a PDU session. This further includes the service request procedure initiated with a SERVICE REQUEST message with the Service type IE set to "emergency services fallback".<</p> <p>NOTE 2: Access for the purpose of NAS signalling connection recovery during an ongoing service, or for the purpose of NAS signalling connection establishment following fallback indication from lower layers during an ongoing service, is mapped to the access category of the ongoing service in order to derive an RRC establishment cause, but barring checks will be skipped for this access attempt.</p> <p>NOTE 3: If the UE selects a new PLMN, then the selected PLMN is used to check the membership; otherwise the UE uses the RPLMN or a PLMN equivalent to the RPLMN.</p> <p>NOTE 4: This includes the 5GMM connection management procedures triggered by the UE-initiated NAS transport procedure for transporting the MO SMS.</p> <p>NOTE 5: The UE configured for NAS signalling low priority is not supported in this release of specification. If a UE supporting both S1 mode and N1 mode is configured for NAS signalling low priority in S1 mode as specified in 3GPP TS 24.368 [17] or 3GPP TS 31.102 [22], the UE shall ignore the configuration for NAS signalling low priority when in N1 mode.</p> <p>NOTE 6: If the access category applicable for the access attempt is 1, then the UE shall additionally determine a second access category from the range 3 to 7. If more than one access category matches, the access category of the lowest rule number shall be chosen. The UE shall use the second access category only to derive an RRC establishment cause for the access attempt.</p> <p>NOTE 7: "EAB override" does not apply, if the UE is not configured to allow overriding EAB (see the "Override_ExtendedAccessBarring" leaf of NAS configuration MO in 3GPP TS 24.368 [17] or 3GPP TS 31.102 [22]), or if NAS has not received an indication from the upper layers to override EAB and the UE does not have a PDU session that was established with EAB override.</p> <p>NOTE 8: For the definition of categories a, b and c associated with access category 1, see 3GPP TS 22.261 [3]. The categories associated with access category 1 are distinct from the categories a, b and c associated with EAB (see 3GPP TS 22.011 [1A]).</p>			

[TS 24.501, clause 4.5.4.1]

When the UE is in 5GMM-IDLE mode, upon receiving a request from the upper layers for an access attempt, the NAS shall categorize the access attempt into access identities and an access category following subclause 4.5.2, table 4.5.2.1 and table 4.5.2.2, and subclause 4.5.3, and provide the applicable access identities and the access category to the lower layers for the purpose of access control checking. In this request to the lower layer the NAS can also provide to the lower layer the RRC establishment cause determined as specified in subclause 4.5.6 of this specification.

NOTE 1: The access barring check is performed by the lower layers.

NOTE 2: As an implementation option, the NAS can provide the RRC establishment cause to the lower layers after being informed by the lower layers that the access attempt is allowed.

If the UE has uplink user data pending for one or more PDU sessions when it builds a REGISTRATION REQUEST or SERVICE REQUEST message as initial NAS message, the UE shall indicate the respective PDU sessions in the Uplink data status IE as specified in subclause 5.5.1.3.2 and 5.6.1.2, regardless of the access category for which the access barring check is performed.

NOTE 3: The UE indicates pending user data for all the respective PDU sessions, even if barring timers are running for some of the corresponding access categories.

If the lower layers indicate that the access attempt is allowed, the NAS shall initiate the procedure to send the initial NAS message for the access attempt.

If the lower layers indicate that the access attempt is barred, the NAS shall not initiate the procedure to send the initial NAS message for the access attempt. Additionally:

- a) if the event which triggered the access attempt was an MO-MMTEL-voice-call-started indication or an MO-MMTEL-video-call-started indication:

- 1) if the UE is operating in the single-registration mode and the UE's usage setting is "voice centric", the UE may attempt to select an E-UTRA cell connected to EPC. If the UE finds a suitable E-UTRA cell connected to EPC, it then proceeds with the appropriate EMM specific procedures and, if necessary, ESM procedures to make a PDN connection providing access to IMS available; see subclause 4.8.2 and 3GPP TS 24.301 [15];
 - 2) if the UE is operating in the dual-registration mode, the UE may proceed in S1 mode with the appropriate EMM specific procedures and ESM procedures to make a PDN connection providing access to IMS available; see subclause 4.8.3 and 3GPP TS 24.301 [15];
 - 3) otherwise, the NAS shall notify the upper layers that the access attempt is barred. In this case, upon receiving an indication from the lower layers that the barring is alleviated for the access category with which the access attempt was associated, the NAS shall notify the upper layers that the barring is alleviated for the access category and may initiate the procedure to send the initial NAS message, if still needed; and
- b) if the event which triggered the access attempt was an MO-SMSoIP-attempt-started indication:
- 1) if the UE is operating in the single-registration mode, the UE may attempt to select an E-UTRA cell connected to EPC. If the UE finds a suitable E-UTRA cell connected to EPC, it then proceeds with the appropriate EMM specific procedures and, if necessary, ESM procedures to make a PDN connection providing access to IMS available; see subclause 4.8.2 and 3GPP TS 24.301 [15];
 - 2) if the UE is operating in the dual-registration mode, the UE may proceed in S1 mode with the appropriate EMM specific procedures and ESM procedures to make a PDN connection providing access to IMS available; see subclause 4.8.3 and 3GPP TS 24.301 [15];
 - 3) otherwise, the NAS layer shall notify the upper layers that the access attempt is barred. In this case, upon receiving an indication from the lower layers that the barring is alleviated for the access category with which the access attempt was associated, the NAS shall notify the upper layers that the barring is alleviated for the access category and may initiate the procedure to send the initial NAS message, if still needed.

NOTE 4: Barring timers, on a per access category basis, are run by the lower layers. At expiry of barring timers, the indication of alleviation of access barring is indicated to the NAS on a per access category basis.

[TS 24.501, clause 4.5.6]

When 5GMM requests the establishment of a NAS-signalling connection, the RRC establishment cause used by the UE shall be selected according to one or more access identities (see subclause 4.5.2) and the determined access category as specified in table 4.5.6.1 and table 4.5.6.2. If the determined access category is an operator-defined access category, then the RRC establishment cause used by the UE shall be selected according to table 4.5.6.1 and table 4.5.6.2 based on one or more access identities (see subclause 4.5.2) and the standardized access category determined for the operator-defined access category as described in subclause 4.5.3.

Table 4.5.6.1: Mapping table for access identities/access categories and RRC establishment cause when establishing N1 NAS signalling connection via NR connected to 5GCN

Access identities	Access categories	RRC establishment cause is set to
0	0 (= MT_acc)	mt-Access
	1 (= delay tolerant)	Not applicable (NOTE 1)
	2 (= emergency)	emergency
	3 (= MO_sig)	mo-Signalling
	4 (= MO MMTel voice)	mo-VoiceCall
	5 (= MO MMTel video)	mo-VideoCall
	6 (= MO SMS and SMSoIP)	mo-SMS
	7 (= MO_data)	mo-Data
1	Any category	mps-PriorityAccess
2	Any category	mcs-PriorityAccess
11, 15	Any category	highPriorityAccess
12,13,14,	Any category	highPriorityAccess
NOTE 1: A UE using access category 1 for the access barring check will determine a second access category in the range 3 to 7 that is to be used for determination of the RRC establishment cause. See subclause 4.5.2, table 4.5.2.2, NOTE 6.		
NOTE 2: See subclause 4.5.2, table 4.5.2.1 for use of the access identities of 0, 1, 2, and 11-15.		

Table 4.5.6.2: Mapping table for access identities/access categories and RRC establishment cause when establishing N1 NAS signalling connection via E-UTRA connected to 5GCN

Access identities	Access categories	RRC establishment cause is set to
0	0 (= MT_acc)	mt-Access
	1 (= delay tolerant)	Not applicable (NOTE 1)
	2 (= emergency)	emergency
	3 (= MO_sig)	mo-Signalling
	4 (= MO MMTel voice)	mo-VoiceCall
	5 (= MO MMTel video)	mo-VoiceCall
	6 (= MO SMS and SMSoIP)	mo-Data
	7 (= MO_data)	mo-Data
1	Any category	highPriorityAccess
2	Any category	highPriorityAccess
11, 15	Any category	highPriorityAccess
12,13,14,	Any category	highPriorityAccess
NOTE 1: A UE using access category 1 for the access barring check will determine a second access category in the range 3 to 7 that is to be used for determination of the RRC establishment cause. See subclause 4.5.2, table 4.5.2.2, NOTE 6.		
NOTE 2: See subclause 4.5.2, table 4.5.2.1 for use of the access identities of 0, 1, 2, and 11-15.		

[TS 38.331, clause 5.3.14.1]

The purpose of this procedure is to perform access barring check for an access attempt associated with a given Access Category and one or more Access Identities upon request from upper layers according to TS 24.501 [23] or the RRC layer.

After a handover resulting in change of PCell in RRC_CONNECTED the UE shall defer access barring checks until it has obtained valid UAC information (from *SIB1*) from the target cell.

[TS 38.331, clause 5.3.14.2]

Upon initiation of the procedure, the UE shall:

- 1> if timer T390 is running for the Access Category:
 - 2> consider the access attempt as barred;
- 1> else if timer T302 is running and the Access Category is neither '2' nor '0':
 - 2> consider the access attempt as barred;
- 1> else:
 - 2> if the Access Category is '0':
 - 3> consider the access attempt as allowed;
 - 2> else:
 - 3> if *SIB1* includes *uac-BarringPerPLMN-List* and the *uac-BarringPerPLMN-List* contains an *UAC-BarringPerPLMN* entry with the *plmn-IdentityIndex* corresponding to the PLMN selected by upper layers (see TS 24.501 [23]):
 - 4> select the *UAC-BarringPerPLMN* entry with the *plmn-IdentityIndex* corresponding to the PLMN selected by upper layers;
 - 4> in the remainder of this procedure, use the selected *UAC-BarringPerPLMN* entry (i.e. presence or absence of access barring parameters in this entry) irrespective of the *uac-BarringForCommon* included in *SIB1*;
 - 3> else if *SIB1* includes *uac-BarringForCommon*:
 - 4> in the remainder of this procedure use the *uac-BarringForCommon* (i.e. presence or absence of these parameters) included in *SIB1*;

- 3> else:
 - 4> consider the access attempt as allowed;
 - 3> if *uac-BarringForCommon* is applicable or the *uac-ACBarringListType* indicates that *uac-ExplicitACBarringList* is used:
 - 4> if the corresponding *UAC-BarringPerCatList* contains a *UAC-BarringPerCat* entry corresponding to the Access Category:
 - 5> select the *UAC-BarringPerCat* entry;
 - 5> if the *uac-BarringInfoSetList* contains a *UAC-BarringInfoSet* entry corresponding to the selected *uac-barringInfoSetIndex* in the *UAC-BarringPerCat*:
 - 6> select the *UAC-BarringInfoSet* entry;
 - 6> perform access barring check for the Access Category as specified in 5.3.14.5, using the selected *UAC-BarringInfoSet* as "UAC barring parameter";
 - 5> else:
 - 6> consider the access attempt as allowed;
 - 4> else:
 - 5> consider the access attempt as allowed;
 - 3> else if the *uac-ACBarringListType* indicates that *uac-ImplicitACBarringList* is used:
 - 4> select the *uac-BarringInfoSetIndex* corresponding to the Access Category in the *uac-ImplicitACBarringList*;
 - 4> if the *uac-BarringInfoSetList* contains the *UAC-BarringInfoSet* entry corresponding to the selected *uac-BarringInfoSetIndex*:
 - 5> select the *UAC-BarringInfoSet* entry;
 - 5> perform access barring check for the Access Category as specified in 5.3.14.5, using the selected *UAC-BarringInfoSet* as "UAC barring parameter";
 - 4> else:
 - 5> consider the access attempt as allowed;
 - 3> else:
 - 4> consider the access attempt as allowed;
- 1> if the access barring check was requested by upper layers:
- 2> if the access attempt is considered as barred:
 - 3> if timer T302 is running:
 - 4> inform the upper layer that access barring is applicable for all access categories except categories '0' and '2', upon which the procedure ends;
 - 3> else:
 - 4> inform upper layers that the access attempt for the Access Category is barred, upon which the procedure ends;
 - 2> else:
 - 3> inform upper layers that the access attempt for the Access Category is allowed, upon which the procedure ends;

1> else:

2> the procedure ends.

[TS 38.331, clause 5.3.14.4]

The UE shall:

1> if timer T302 expires or is stopped, and if timer T390 corresponding to an Access Category is not running; or

1> if timer T390 corresponding to an Access Category other than '2' expires or is stopped, and if timer T302 is not running; or

1> if timer T390 corresponding to the Access Category '2' expires or is stopped:

2> consider the barring for this Access Category to be alleviated;

1> when barring for an Access Category is considered being alleviated:

2> if the Access Category was informed to upper layers as barred:

3> inform upper layers about barring alleviation for the Access Category.

2> if barring is alleviated for Access Category '8':

3> perform actions specified in 5.3.13.8;

[TS 38.331, clause 5.3.14.5]

The UE shall:

1> if one or more Access Identities are indicated according to TS 24.501 [23], and

1> if for at least one of these Access Identities the corresponding bit in the *uac-BarringForAccessIdentity* contained in "UAC barring parameter" is set to *zero*:

2> consider the access attempt as allowed;

1> else:

2> draw a random number '*rand*' uniformly distributed in the range: $0 \leq rand < 1$;

2> if '*rand*' is lower than the value indicated by *uac-BarringFactor* included in "UAC barring parameter":

3> consider the access attempt as allowed;

2> else:

3> consider the access attempt as barred;

1> if the access attempt is considered as barred:

2> draw a random number '*rand*' that is uniformly distributed in the range $0 \leq rand < 1$;

2> start timer T390 for the Access Category with the timer value calculated as follows, using the *uac-BarringTime* included in "AC barring parameter":

$$T390 = (0.7 + 0.6 * rand) * uac-BarringTime.$$

11.3.1.3 Test description

11.3.1.3.1 Pre-test conditions

System Simulator:

- NR Cell 1.

- Cell power level is selected according to 38.508-1 [4] Table 6.2.2.1-3.
- System information combination NR-1 as defined in TS 38.508-1 [4] Table 4.4.3.1.2-1 is used in NR cell 1.

UE:

- None.

Preamble:

- The UE is switched on and brought to state 1N-A, RRC_IDLE Connectivity (NR), in accordance with the procedure described in TS 38.508-1 [4], clause 4.5.2 and IMS PDU session establishment and IMS registration procedure need to be performed on NR Cell 1.

11.3.1.3.2 Test procedure sequence

Table 11.3.1.3.2-1: Main behaviour

St	Procedure	Message Sequence		TP	Verdict
		U - S	Message		
1-12 B	Void	-	-	-	-
12 C	SS changes <i>SIB1</i> according to Table 11.3.1.3.3-1 and sends Short Message on PDCCH using P-RNTI. Wait for 2.1* modification period to allow the new system information to take effect.	<--	PDCCH (DCI 1_0): Short Message	-	-
13	Make the UE attempt a MMTel voice call.	-	-	-	-
14	Check: Does the UE transmit <i>RRCSetupRequest</i> message including <i>mo-VoiceCall</i> with within 21s? (Note 1)	-->	NR RRC: <i>RRCSetupRequest</i>	1	F
15	SS changes <i>SIB1</i> according to Table 11.3.1.3.3-1 and sends Short Message on PDCCH using P-RNTI.	<--	PDCCH (DCI 1_0): Short Message	-	-
15 A	Start Timer=20 sec	-	-	-	-
-	EXCEPTION: Steps 15Aa1-15Ab3 describes optional behaviour that depends on the UE implementation.	-	-	-	-
15 Aa 1	Check: Does the UE send NR <i>RRCSetupRequest</i> with EstablishmentCause set to 'mo-VoiceCall'?	-->	NR RRC: <i>RRCSetupRequest</i>	2	P
15 Aa 2	Stop Timer=20 sec	-	-	-	-
15 Ab 1	Timer=20 sec expires	-	-	-	-
15 Ab 2	Make the UE attempt another MO MTSI MMTEL Voice session.	-	-	-	-
15 Ab 3	Check: Does the UE send NR <i>RRCSetupRequest</i> with EstablishmentCause set to 'mo-VoiceCall'?	-->	NR RRC: <i>RRCSetupRequest</i>	2	P
16-17	Void	-	-	-	-
18-28	Step 3 to step 13 from test procedure for IMS MO speech call establishment as described in TS 38.508-1 [4] Table 4.9.15.2.2-1 take place.	-	-	-	-
28 A	Make the UE release the MO speech call. (Note 2)	-	-	-	-
29-31	Step 1 to step 5 from test procedure for test procedure for IMS MO speech call release as described in TS 38.508-1 [4] Table 4.9.17.2.2-1 take place.	-	-	-	-

31 A	The SS transmits an <i>RRCRelease</i> message to release RRC connection and move the UE to RRC_IDLE.	<--	NR RRC: RRCRelease	-	-
32	AT command to make the UE attempt to send SMS over IP	-	-	-	-
33	Check: Does the UE transmit an <i>RRCSetupRequest</i> message with 'establishmentCause' set to 'mo-SMS' within 21s? (Note 1)	-->	NR RRC: RRCSetupRequest	3	F
34	SS changes <i>SIB1</i> according to Table 11.3.1.3.3-1 and sends Short Message on PDCCH using P-RNTI.	<--	PDCCH (DCI 1_0): Short Message	-	-
34 A	Start Timer=20 sec	-	-	-	-
-	EXCEPTION: Steps 34Aa1-34Ab3 describes optional behaviour that depends on the UE implementation.	-	-	-	-
34 Aa 1	Check: Does the UE send NR <i>RRCSetupRequest</i> with <i>EstablishmentCause</i> set to 'mo-SMS'?	-->	NR RRC: RRCSetupRequest	3	P
34 Aa 2	Stop Timer=20 sec	-	-	-	-
34 Ab 1	Timer=20 sec expires	-	-	-	-
34 Ab 2	AT command to make the UE attempt to send another SMS over IP	-	-	-	-
34 Ab 3	Check: Does the UE send NR <i>RRCSetupRequest</i> with <i>EstablishmentCause</i> set to 'mo-SMS'?	-->	NR RRC: RRCSetupRequest	3	P
35	Void	-	-	-	-
36- 49	Steps 3-16 from generic procedure IMS MO SMS in 5GS as described in TS 38.508-1 [4] Table 4.9.19.2.2-1 take place.	-	-	-	-
Note 1: T390 is a random value between $(0.7 + 0.6 * 0) * \text{uac-BarringTime}(16\text{s}) = 11.2\text{s}$ and $(0.7 + 0.6 * 1) * \text{uac-BarringTime}(16\text{s}) = 20.8\text{s}$.					
Note 2: This could be done by e.g. MMI or AT command.					

11.3.1.3.3 Specific message contents

Table 11.3.1.3.3-1: *SIB1* of NR Cell 1 (All steps, Table 11.3.1.3.2-1)

Derivation Path: TS 38.508-1 [4], Table 4.6.1-28			
Information Element	Value/remark	Comment	Condition
SIB1 ::= SEQUENCE {			
uac-BarringInfo SEQUENCE {			
uac-BarringForCommon SEQUENCE (SIZE (1..maxAccessCat-1)) OF UAC-BarringPerCat {	1 entry		
UAC-BarringPerCat[1] SEQUENCE {		entry 1	
accessCategory	4	(= MO MMTel voice)	Step12C
	6	(= MO SMS and SMSoIP)	Step 15
uac-barringInfoSetIndex	1	Value 1 corresponds to the first entry in uac-BarringInfoSetList	
}			
}			
uac-BarringPerPLMN-List	Not present		
uac-BarringInfoSetList SEQUENCE (SIZE(1..maxBarringInfoSet)) OF UAC-BarringInfoSet {	1 entry		

UAC-BarringInfoSet[1] SEQUENCE {		entry 1	
uac-BarringFactor	p00	0% access probability	
uac-BarringTime	s16	16 s	
uac-BarringForAccessIdentity	'0000000'B		
}			
uac-AccessCategory1-SelectionAssistanceInfo	Not Present		
}			
uac-BarringInfo	Not present		Step 34
}			

Table 11.3.1.3.3-2: RRCSetupRequest (step 15A and step 34A, Table 11.3.1.3.2-1)

Derivation Path: TS 38.508-1 [4] Table 4.6.1-23			
Information Element	Value/remark	Comment	Condition
RRCSetupRequest ::= SEQUENCE {			
rrcSetupRequest SEQUENCE {			
establishmentCause	mo-Voicecall		Step 15Aa1 and 15Ab3
	mo-SMS		Step 34Aa1 and 34Ab3
}			
}			

11.3.1a UAC / Access Identity 0 / 0% access probability / Uplink user data transfer / RRC_INACTIVE

11.3.1a.1 Test Purpose (TP)

(1)

```

with { UE not configured for special AIs (1,2,11-15) , with at least one PDU Session in 5GSM PDU
SESSION ACTIVE state (with user plane suspended) in NR RRC_INACTIVE state & SIB1 indicating 0%
accessibility for Access Category 7 in NR RRC_INACTIVE state }
ensure that {
  when { User initiates uplink user data packet to be sent for a PDU session with suspended user-
plane resources }
    then { UE does not send the data packet }
}

```

11.3.1a.2 Conformance requirements

References: The conformance requirements covered in the present TC are specified in TS 24.501: clause 4.5.2, 4.5.4.2 and 4.5.6 and TS 38.331: clause 5.3.14.1, 5.3.14.2, 5.3.14.4 and 5.3.14.5. Unless otherwise stated these are Rel-15 requirements.

[TS 24.501, clause 4.5.2]

When the UE needs to initiate an access attempt in one of the events listed in subclause 4.5.1, the UE shall determine one or more access identities from the set of standardized access identities, and one access category from the set of standardized access categories and operator-defined access categories, to be associated with that access attempt.

The set of the access identities applicable for the request is determined by the UE in the following way:

- a) for each of the access identities 1, 2, 11, 12, 13, 14 and 15 in table 4.5.2.1, the UE shall check whether the access identity is applicable in the selected PLMN, if a new PLMN is selected, or otherwise if it is applicable in the RPLMN or equivalent PLMN; and
- b) if none of the above access identities is applicable, then access identity 0 is applicable.

Table 4.5.2.1: Access identities

Access Identity number	UE configuration
0	UE is not configured with any parameters from this table
1 (NOTE 1)	UE is configured for multimedia priority service (MPS).
2 (NOTE 2)	UE is configured for mission critical service (MCS).
3-10	Reserved for future use
11 (NOTE 3)	Access Class 11 is configured in the UE.
12 (NOTE 3)	Access Class 12 is configured in the UE.
13 (NOTE 3)	Access Class 13 is configured in the UE.
14 (NOTE 3)	Access Class 14 is configured in the UE.
15 (NOTE 3)	Access Class 15 is configured in the UE.
<p>NOTE 1: Access identity 1 is valid when:</p> <ul style="list-style-type: none"> - the USIM file EF_{UAC_AIC} indicates the UE is configured for access identity 1 and the RPLMN is the HPLMN (if the EHPLMN list is not present or is empty) or EHPLMN (if the EHPLMN list is present), or a visited PLMN of the home country (see the definition of home country in 3GPP TS 24.301 [15]); or - the UE receives the 5GS network feature support IE with the MPS indicator bit set to "Access identity 1 valid in RPLMN or equivalent PLMN" from the RPLMN as described in subclause 5.5.1.2.4 and subclause 5.5.1.3.4. <p>NOTE 2: Access identity 2 is used by UEs configured for MCS and is valid when:</p> <ul style="list-style-type: none"> - the USIM file EF_{UAC_AIC} indicates the UE is configured for access identity 2 and the RPLMN is the HPLMN (if the EHPLMN list is not present or is empty) or EHPLMN (if the EHPLMN list is present), or a visited PLMN of the home country (see 3GPP TS 23.122 [5]); or - the UE receives the 5GS network feature support IE with the MCS indicator bit set to "Access identity 2 valid in RPLMN or equivalent PLMN" from the RPLMN as described in subclause 5.5.1.2.4 and subclause 5.5.1.3.4. <p>NOTE 3: Access identities 11 and 15 are valid in HPLMN (if the EHPLMN list is not present or is empty) or EHPLMN (if the EHPLMN list is present). Access Identities 12, 13 and 14 are valid in HPLMN and visited PLMNs of home country only (see the definition of home country in 3GPP TS 24.301 [15]).</p>	

The UE uses the MPS indicator bit of the 5GS network feature support IE to determine if access identity 1 is valid. Processing of the MPS indicator bit of the 5GS network feature support IE in the REGISTRATION ACCEPT message is described in subclause 5.5.1.2.4 and subclause 5.5.1.3.4. The UE shall not consider access identity 1 to be valid when the UE is not in the country of its HPLMN prior to receiving the MPS indicator bit of the 5GS network feature support IE in the REGISTRATION ACCEPT message being set to "Access identity 1 valid in RPLMN or equivalent PLMN".

When the UE is in the country of its HPLMN, the contents of the USIM files EF_{UAC_AIC} and EF_{ACC} as specified in 3GPP TS 31.102 [22] and the rules specified in table 4.5.2.1 are used to determine the applicability of access identity 1 and access classes 11 - 15. When the UE is in the country of its HPLMN, and the USIM file EF_{UAC_AIC} does not indicate the UE is configured for access identity 1, the UE uses the MPS indicator bit of the 5GS network feature support IE in the REGISTRATION ACCEPT message to determine if access identity 1 is valid. When the UE is in the country of its HPLMN, and the USIM file EF_{UAC_AIC} indicates the UE is configured for access identity 1, the MPS indicator bit of the 5GS network feature support IE is not applicable. When the UE is not in the country of its HPLMN, the contents of the USIM files EF_{UAC_AIC} and EF_{ACC} are not applicable.

The UE uses the MCS indicator bit of the 5GS network feature support IE to determine if access identity 2 is valid. Processing of the MCS indicator bit of the 5GS network feature support IE in the REGISTRATION ACCEPT message is described in subclause 5.5.1.2.4 and subclause 5.5.1.3.4. The UE shall not consider access identity 2 to be valid when the UE is not in the country of its HPLMN prior to receiving the MCS indicator bit of the 5GS network feature support IE in the REGISTRATION ACCEPT message being set to "Access identity 2 valid in RPLMN or equivalent PLMN".

When the UE is in the country of its HPLMN, the contents of the USIM files EF_{UAC_AIC} and EF_{ACC} as specified in 3GPP TS 31.102 [22] and the rules specified in table 4.5.2.1 are used to determine the applicability of access identity 2 and access classes 11 - 15. When the UE is in the country of its HPLMN, and the USIM file EF_{UAC_AIC} does not indicate the UE is configured for access identity 2, the UE uses the MCS indicator bit of the 5GS network feature support IE in the REGISTRATION ACCEPT message to determine if access identity 2 is valid. When the UE is in the country of its HPLMN, and the USIM file EF_{UAC_AIC} indicates the UE is configured for access identity 2, the MCS indicator bit of the 5GS network feature support IE is not applicable. When the UE is not in the country of its HPLMN, the contents of the USIM files EF_{UAC_AIC} and EF_{ACC} are not applicable.

In order to determine the access category applicable for the access attempt, the NAS shall check the rules in table 4.5.2.2, and use the access category for which there is a match for barring check. If the access attempt matches

more than one rule, the access category of the lowest rule number shall be selected. If the access attempt matches more than one operator-defined access category definition, the UE shall select the access category from the operator-defined access category definition with the lowest precedence value (see subclause 4.5.3).

NOTE: The case when an access attempt matches more than one rule includes the case when multiple events trigger an access attempt at the same time.

Table 4.5.2.2: Mapping table for access categories

Rule #	Type of access attempt	Requirements to be met	Access Category
1	Response to paging or NOTIFICATION over non-3GPP access; 5GMM connection management procedure initiated for the purpose of transporting an LPP message	Access attempt is for MT access	0 (= MT_acc)
2	Emergency	UE is attempting access for an emergency session (NOTE 1, NOTE 2)	2 (= emergency)
3	Access attempt for operator-defined access category	UE stores operator-defined access category definitions valid in the current PLMN as specified in subclause 4.5.3, and access attempt is matching criteria of an operator-defined access category definition	32-63 (= based on operator classification)
4	Access attempt for delay tolerant service	(a) UE is configured for NAS signalling low priority or UE supporting S1 mode is configured for EAB (see the "ExtendedAccessBarring" leaf of NAS configuration MO in 3GPP TS 24.368 [17] or 3GPP TS 31.102 [22]) where "EAB override" does not apply, and (b). the UE received one of the categories a, b or c as part of the parameters for unified access control in the broadcast system information, and the UE is a member of the broadcasted category in the selected PLMN or RPLMN/equivalent PLMN (NOTE 3, NOTE 5, NOTE 6, NOTE 7, NOTE 8)	1 (= delay tolerant)
5	MO MMTel voice call	Access attempt is for MO MMTel voice call or for NAS signalling connection recovery during ongoing MO MMTel voice call (NOTE 2)	4 (= MO MMTel voice)
6	MO MMTel video call	Access attempt is for MO MMTel video call or for NAS signalling connection recovery during ongoing MO MMTel video call (NOTE 2)	5 (= MO MMTel video)
7	MO SMS over NAS or MO SMSoIP	Access attempt is for MO SMS over NAS (NOTE 4) or MO SMS over SMSoIP transfer or for NAS signalling connection recovery during ongoing MO SMS or SMSoIP transfer (NOTE 2)	6 (= MO SMS and SMSoIP)
8	UE NAS initiated 5GMM specific procedures	Access attempt is for MO signalling	3 (= MO_sig)
9	UE NAS initiated 5GMM connection management procedure or 5GMM NAS transport procedure	Access attempt is for MO data	7 (= MO_data)
10	An uplink user data packet is to be sent for a PDU session with suspended user-plane resources	No further requirement is to be met	7 (= MO_data)
NOTE 1: This includes 5GMM specific procedures while the service is ongoing and 5GMM connection management procedures required to establish a PDU session with request type = "initial emergency request" or "existing emergency PDU session", or to re-establish user-plane			

	resources for such a PDU session. This further includes the service request procedure initiated with a SERVICE REQUEST message with the Service type IE set to "emergency services fallback".<
NOTE 2:	Access for the purpose of NAS signalling connection recovery during an ongoing service, or for the purpose of NAS signalling connection establishment following fallback indication from lower layers during an ongoing service, is mapped to the access category of the ongoing service in order to derive an RRC establishment cause, but barring checks will be skipped for this access attempt.
NOTE 3:	If the UE selects a new PLMN, then the selected PLMN is used to check the membership; otherwise the UE uses the RLPMN or a PLMN equivalent to the RPLMN.
NOTE 4:	This includes the 5GMM connection management procedures triggered by the UE-initiated NAS transport procedure for transporting the MO SMS.
NOTE 5:	The UE configured for NAS signalling low priority is not supported in this release of specification. If a UE supporting both S1 mode and N1 mode is configured for NAS signalling low priority in S1 mode as specified in 3GPP TS 24.368 [17] or 3GPP TS 31.102 [22], the UE shall ignore the configuration for NAS signalling low priority when in N1 mode.
NOTE 6:	If the access category applicable for the access attempt is 1, then the UE shall additionally determine a second access category from the range 3 to 7. If more than one access category matches, the access category of the lowest rule number shall be chosen. The UE shall use the second access category only to derive an RRC establishment cause for the access attempt.
NOTE 7:	"EAB override" does not apply, if the UE is not configured to allow overriding EAB (see the "Override_ExtendedAccessBarring" leaf of NAS configuration MO in 3GPP TS 24.368 [17] or 3GPP TS 31.102 [22]), or if NAS has not received an indication from the upper layers to override EAB and the UE does not have a PDU session that was established with EAB override.
NOTE 8:	For the definition of categories a, b and c associated with access category 1, see 3GPP TS 22.261 [3]. The categories associated with access category 1 are distinct from the categories a, b and c associated with EAB (see 3GPP TS 22.011 [1A]).

[TS 24.501, clause 4.5.4.2]

When the UE is in 5GMM-CONNECTED mode or 5GMM-CONNECTED mode with RRC inactive indication, upon detecting one of events 1) through 6) listed in subclause 4.5.1, the NAS shall categorize the corresponding access attempt into access identities and an access category following subclause 4.5.2, table 4.5.2.1 and table 4.5.2.2, and subclause 4.5.2.3, and provide the access identities and the access category to the lower layers for the purpose of access control checking. In this request to the lower layer the NAS can also provide to the lower layer the RRC establishment cause determined as specified in subclause 4.5.6 of this specification.

NOTE 1: As an implementation option, the NAS can provide the RRC establishment cause to the lower layers after being informed by the lower layers that the access attempt is allowed.

If the UE has uplink user data pending for one or more PDU sessions when it builds a REGISTRATION REQUEST or SERVICE REQUEST message for the access attempt, the UE shall indicate the respective PDU sessions in the Uplink data status IE as specified in subclause 5.5.1.3.2 and 5.6.1.2, regardless of the access category for which the access barring check is performed.

NOTE 2: The UE indicates pending user data for all the respective PDU sessions, even if barring timers are running for some of the corresponding access categories.

If the lower layers indicate that the access attempt is allowed, the NAS shall take the following action depending on the event which triggered the access attempt:

- a) if the event which triggered the access attempt was an MO-MMTEL-voice-call-started indication, an MO-MMTEL-video-call-started indication or an MO-SMSoIP-attempt-started indication, the NAS shall notify the upper layers that the access attempt is allowed;
- b) if the event which triggered the access attempt was a request from upper layers to send a mobile originated SMS over NAS, 5GMM shall initiate the NAS transport procedure as specified in subclause 5.4.5 to send the SMS in an UL NAS TRANSPORT message;
- c) if the event which triggered the access attempt was a request from upper layers to establish a new PDU session, 5GMM shall initiate the NAS transport procedure as specified in subclause 5.4.5 to send the PDU SESSION ESTABLISHMENT REQUEST message;

- d) if the event which triggered the access attempt was a request from upper layers to modify an existing PDU session, 5GMM shall initiate the NAS transport procedure as specified in subclause 5.4.5 to send the PDU SESSION MODIFICATION REQUEST message;
- e) if the event which triggered the access attempt was a request to re-establish the user-plane resources for an existing PDU session, 5GMM shall initiate the service request procedure as specified in subclause 5.6.1; and
- f) if the event which triggered the access attempt was an uplink user data packet to be sent for a PDU session with suspended user-plane resources, 5GMM shall consider that the uplink user data packet is allowed to be sent.

If the lower layers indicate that the access attempt is barred, the NAS shall take the following action depending on the event which triggered the access attempt:

- a) if the event which triggered the access attempt was an MO-MMTEL-voice-call-started indication, an MO-MMTEL-video-call-started indication or an MO-SMSoIP-attempt-started indication:
 - 1) if the UE is operating in the dual-registration mode, the UE may proceed in S1 mode with the appropriate EMM specific procedures and ESM procedures to make a PDN connection providing access to IMS available; see subclause 4.8.3 and 3GPP TS 24.301 [15];
 - 2) otherwise, the NAS shall notify the upper layers that the access attempt is barred. In this case, upon receiving an indication from the lower layers that the barring is alleviated for the access category with which the access attempt was associated, the NAS shall notify the upper layers that the barring is alleviated for the access category;

NOTE 3: In this case prohibiting the initiation of the MMTEL voice session, MMTEL video session or prohibiting sending of the SMS over IP is performed by the upper layers.

- b) if the event which triggered the access attempt was a request from upper layers to send a mobile originated SMS over NAS, 5GMM shall not initiate the NAS transport procedure as specified in subclause 5.4.5 to send the SMS in an UL NAS TRANSPORT message. Upon receiving an indication from the lower layers that the barring is alleviated for the access category with which the access attempt was associated, 5GMM may initiate the NAS transport procedure as specified in subclause 5.4.5 to send the SMS in an UL NAS TRANSPORT message, if still needed;
- c) if the event which triggered the access attempt was a request from upper layers to establish a new PDU session, 5GMM shall not initiate the NAS transport procedure to send the PDU SESSION ESTABLISHMENT REQUEST message. Upon receiving an indication from the lower layers that the barring is alleviated for the access category with which the access attempt was associated, the NAS may initiate the NAS transport procedure as specified in subclause 5.4.5, if still needed;
- d) if the event which triggered the access attempt was a request from upper layers to modify an existing PDU session modification, 5GMM shall not initiate the NAS transport procedure to send the PDU SESSION MODIFICATION REQUEST message. Upon receiving an indication from the lower layers that the barring is alleviated for the access category with which the access attempt was associated, the NAS may initiate the NAS transport procedure as specified in subclause 5.4.5, if still needed;
- e) if the event which triggered the access attempt was a request to re-establish the user-plane resources for an existing PDU session, the NAS shall not initiate the service request procedure as specified in subclause 5.6.1. Upon receiving an indication from the lower layers that the barring is alleviated for the access category with which the access attempt was associated, the NAS may initiate the service request procedure as specified in subclause 5.6.1, if still needed; and
- f) if the event which triggered the access attempt was an uplink user data packet to be sent for a PDU session with suspended user-plane resources, 5GMM shall consider that the uplink user data packet is not allowed to be sent. Upon receiving an indication from the lower layers that the barring is alleviated for the access category with which the access attempt was associated, the NAS shall consider that the barring is alleviated for the access category.

[TS 24.501, clause 4.5.6]

When 5GMM requests the establishment of a NAS-signalling connection, the RRC establishment cause used by the UE shall be selected according to one or more access identities (see subclause 4.5.2) and the determined access category as specified in table 4.5.6.1 and table 4.5.6.2. If the determined access category is an operator-defined access category, then the RRC establishment cause used by the UE shall be selected according to table 4.5.6.1 and table 4.5.6.2 based on

one or more access identities (see subclause 4.5.2) and the standardized access category determined for the operator-defined access category as described in subclause 4.5.3.

Table 4.5.6.1: Mapping table for access identities/access categories and RRC establishment cause when establishing N1 NAS signalling connection via NR connected to 5GCN

Access identities	Access categories	RRC establishment cause is set to
0	0 (= MT_acc)	mt-Access
	1 (= delay tolerant)	Not applicable (NOTE 1)
	2 (= emergency)	emergency
	3 (= MO_sig)	mo-Signalling
	4 (= MO MMTel voice)	mo-VoiceCall
	5 (= MO MMTel video)	mo-VideoCall
	6 (= MO SMS and SMSoIP)	mo-SMS
	7 (= MO_data)	mo-Data
1	Any category	mps-PriorityAccess
2	Any category	mcs-PriorityAccess
11, 15	Any category	highPriorityAccess
12,13,14,	Any category	highPriorityAccess
NOTE 1: A UE using access category 1 for the access barring check will determine a second access category in the range 3 to 7 that is to be used for determination of the RRC establishment cause. See subclause 4.5.2, table 4.5.2.2, NOTE 6.		
NOTE 2: See subclause 4.5.2, table 4.5.2.1 for use of the access identities of 0, 1, 2, and 11-15.		

Table 4.5.6.2: Mapping table for access identities/access categories and RRC establishment cause when establishing N1 NAS signalling connection via E-UTRA connected to 5GCN

Access identities	Access categories	RRC establishment cause is set to
0	0 (= MT_acc)	mt-Access
	1 (= delay tolerant)	Not applicable (NOTE 1)
	2 (= emergency)	emergency
	3 (= MO_sig)	mo-Signalling
	4 (= MO MMTel voice)	mo-VoiceCall
	5 (= MO MMTel video)	mo-VoiceCall
	6 (= MO SMS and SMSoIP)	mo-Data
	7 (= MO_data)	mo-Data
1	Any category	highPriorityAccess
2	Any category	highPriorityAccess
11, 15	Any category	highPriorityAccess
12,13,14,	Any category	highPriorityAccess
NOTE 1: A UE using access category 1 for the access barring check will determine a second access category in the range 3 to 7 that is to be used for determination of the RRC establishment cause. See subclause 4.5.2, table 4.5.2.2, NOTE 6.		
NOTE 2: See subclause 4.5.2, table 4.5.2.1 for use of the access identities of 0, 1, 2, and 11-15.		

[TS 38.331, clause 5.3.14.1]

The purpose of this procedure is to perform access barring check for an access attempt associated with a given Access Category and one or more Access Identities upon request from upper layers according to TS 24.501 [23] or the RRC layer.

After a handover resulting in change of PCell in RRC_CONNECTED the UE shall defer access barring checks until it has obtained valid UAC information (from *SIB1*) from the target cell.

[TS 38.331, clause 5.3.14.2]

Upon initiation of the procedure, the UE shall:

- 1> if timer T390 is running for the Access Category:
- 2> consider the access attempt as barred;

- 1> else if timer T302 is running and the Access Category is neither '2' nor '0':
 - 2> consider the access attempt as barred;
- 1> else:
 - 2> if the Access Category is '0':
 - 3> consider the access attempt as allowed;
 - 2> else:
 - 3> if *SIB1* includes *uac-BarringPerPLMN-List* and the *uac-BarringPerPLMN-List* contains an *UAC-BarringPerPLMN* entry with the *plmn-IdentityIndex* corresponding to the PLMN selected by upper layers (see TS 24.501 [23]):
 - 4> select the *UAC-BarringPerPLMN* entry with the *plmn-IdentityIndex* corresponding to the PLMN selected by upper layers;
 - 4> in the remainder of this procedure, use the selected *UAC-BarringPerPLMN* entry (i.e. presence or absence of access barring parameters in this entry) irrespective of the *uac-BarringForCommon* included in *SIB1*;
 - 3> else if *SIB1* includes *uac-BarringForCommon*:
 - 4> in the remainder of this procedure use the *uac-BarringForCommon* (i.e. presence or absence of these parameters) included in *SIB1*;
 - 3> else:
 - 4> consider the access attempt as allowed;
 - 3> if *uac-BarringForCommon* is applicable or the *uac-ACBarringListType* indicates that *uac-ExplicitACBarringList* is used:
 - 4> if the corresponding *UAC-BarringPerCatList* contains a *UAC-BarringPerCat* entry corresponding to the Access Category:
 - 5> select the *UAC-BarringPerCat* entry;
 - 5> if the *uac-BarringInfoSetList* contains a *UAC-BarringInfoSet* entry corresponding to the selected *uac-barringInfoSetIndex* in the *UAC-BarringPerCat*:
 - 6> select the *UAC-BarringInfoSet* entry;
 - 6> perform access barring check for the Access Category as specified in 5.3.14.5, using the selected *UAC-BarringInfoSet* as "UAC barring parameter";
 - 5> else:
 - 6> consider the access attempt as allowed;
 - 4> else:
 - 5> consider the access attempt as allowed;
 - 3> else if the *uac-ACBarringListType* indicates that *uac-ImplicitACBarringList* is used:
 - 4> select the *uac-BarringInfoSetIndex* corresponding to the Access Category in the *uac-ImplicitACBarringList*;
 - 4> if the *uac-BarringInfoSetList* contains the *UAC-BarringInfoSet* entry corresponding to the selected *uac-BarringInfoSetIndex*:
 - 5> select the *UAC-BarringInfoSet* entry;

- 5> perform access barring check for the Access Category as specified in 5.3.14.5, using the selected *UAC-BarringInfoSet* as "UAC barring parameter";
- 4> else:
 - 5> consider the access attempt as allowed;
- 3> else:
 - 4> consider the access attempt as allowed;
- 1> if the access barring check was requested by upper layers:
 - 2> if the access attempt is considered as barred:
 - 3> if timer T302 is running:
 - 4> inform the upper layer that access barring is applicable for all access categories except categories '0' and '2', upon which the procedure ends;
 - 3> else:
 - 4> inform upper layers that the access attempt for the Access Category is barred, upon which the procedure ends;
 - 2> else:
 - 3> inform upper layers that the access attempt for the Access Category is allowed, upon which the procedure ends;
- 1> else:
 - 2> the procedure ends.

[TS 38.331, clause 5.3.14.4]

The UE shall:

- 1> if timer T302 expires or is stopped, and if timer T390 corresponding to an Access Category is not running; or
- 1> if timer T390 corresponding to an Access Category other than '2' expires or is stopped, and if timer T302 is not running; or
- 1> if timer T390 corresponding to the Access Category '2' expires or is stopped:
 - 2> consider the barring for this Access Category to be alleviated;
- 1> when barring for an Access Category is considered being alleviated:
 - 2> if the Access Category was informed to upper layers as barred:
 - 3> inform upper layers about barring alleviation for the Access Category.
 - 2> if barring is alleviated for Access Category '8':
 - 3> perform actions specified in 5.3.13.8;

[TS 38.331, clause 5.3.14.5]

The UE shall:

- 1> if one or more Access Identities are indicated according to TS 24.501 [23], and
- 1> if for at least one of these Access Identities the corresponding bit in the *uac-BarringForAccessIdentity* contained in "UAC barring parameter" is set to *zero*:
 - 2> consider the access attempt as allowed;

1> else:

2> draw a random number '*rand*' uniformly distributed in the range: $0 \leq rand < 1$;

2> if '*rand*' is lower than the value indicated by *uac-BarringFactor* included in "UAC barring parameter":

3> consider the access attempt as allowed;

2> else:

3> consider the access attempt as barred;

1> if the access attempt is considered as barred:

2> draw a random number '*rand*' that is uniformly distributed in the range $0 \leq rand < 1$;

2> start timer T390 for the Access Category with the timer value calculated as follows, using the *uac-BarringTime* included in "AC barring parameter":

$$T390 = (0.7 + 0.6 * rand) * uac-BarringTime.$$

11.3.1a.3 Test description

11.3.1a.3.1 Pre-test conditions

System Simulator:

- NR Cell 1.
- Cell power level is selected according to 38.508-1 [4] Table 6.2.2.1-3.
- System information combination NR-1 as defined in TS 38.508-1 [4] Table 4.4.3.1.2-1 is used in NR Cell 1.

UE:

- None.

Preamble:

- The UE is in state 3N-A on NR Cell 1(serving cell) with at least one PDU session active according to TS 38.508-1 [4] Table 4.4A.2-1 and using the message condition UE TEST LOOP MODE B active with IP PDU delay = 2 second according to TS 38.508-1 [4]. DRB 1 is defined as default DRB for the PDU session.
- The IMS-VoPS-3GPP bit in the 5GS network feature support IE is set to "IMS voice over PS session not supported over 3GPP access" in REGISTRATION ACCEPT message.

11.3.1a.3.2 Test procedure sequence

Table 11.3.1a.3.2-1: Main behaviour

St	Procedure	Message Sequence		TP	Verdict
		U - S	Message		
1	The SS changes SIB1 according to Table 11.3.1a.3.3-1 and sends Short Message on PDCCH using P-RNTI. Wait for 2.1* modification period to allow the new system information to take effect.	<--	PDCCH (DCI 1_0): Short Message	-	-
2	The SS transmits one IP PDU.	-	-	-	-
3	The SS transmits an <i>RRCRelease</i> message with <i>suspendConfig</i> IE and move the UE to <i>RRC_Inactive</i> state.	<--	NR RRC: <i>RRCRelease</i>	-	-
4	Check: Does the UE transmit <i>RRCResumeRequest</i> message including <i>mo-Data</i> as resume cause within 6s?	-->	NR RRC: <i>RRCResumeRequest</i>	1	F

5	SS changes <i>SIB1</i> according to Table 11.3.1a.3.3-1 and sends Short Message on PDCCH using P-RNTI. Wait for the new system information to take effect and T390 to expire. (Note 1)	<--	PDCCH (DCI 1_0): Short Message	-	-
5A	Start Timer=30 sec. (Note 2)	-	-	-	-
	EXCEPTION: Steps 5Aa1-5Ab8 describe optional behaviour that depends on the UE implementation.	-	-		
5A a1	The UE transmits an <i>RRCResumeRequest</i> message including resumeCause as <i>mo-Data</i> . (Note 2)	-->	NR RRC: <i>RRCResumeRequest</i>	-	-
5A a2	Stop Timer=30	-	-	-	-
5A b1	Timer=30 sec expires	-	-	-	-
5A b2	The SS transmits a <i>Paging</i> message including a matched identity (correct <i>fullI-RNTI</i>).	<--	NR RRC: <i>Paging</i>	-	-
5A b3	The UE transmits an <i>RRCResumeRequest</i> message including resumeCause as <i>mt-Access</i> .	-->	NR RRC: <i>RRCResumeRequest</i>		
5A b4	The SS transmits an <i>RRCResume</i> message.	<--	NR RRC: <i>RRCResume</i>	-	-
5A b5	The UE transmits an <i>RRCResumeComplete</i> message.	-->	NR RRC: <i>RRCResumeComplete</i>	-	-
5A b6	The SS transmits one IP PDU.	-	-	-	-
5A b7	The SS transmits an <i>RRCRelease</i> message with <i>suspendConfig</i> IE and move the UE to <i>RRC_Inactive</i> state.	<--	NR RRC: <i>RRCRelease</i>	-	-
5A b8	The UE transmits <i>RRCResumeRequest</i> message including <i>mo-Data</i> as resume cause.	-->	NR RRC: <i>RRCResumeRequest</i>	-	-
6-12	Void	-	-	-	-
13	SS transmits an NR <i>RRCResume</i> message	<--	NR RRC: <i>RRCResume</i>	-	-
-	EXCEPTION: Steps 14 and 15 can happen in any order	-	-	-	-
14	The UE transmits an NR <i>RRCResumeComplete</i> message to confirm the successful completion of the connection resumption.	-->	NR RRC: <i>RRCResumeComplete</i>	-	-
15	The UE loops back the IP PDU	-	-	-	-
16	The SS transmits DEACTIVATE TEST MODE message.	<--	DEACTIVATE TEST MODE	-	-
17	The UE transmits DEACTIVATE TEST MODE COMPLETE message.	-->	DEACTIVATE TEST MODE COMPLETE	-	-
18	The SS transmits an <i>RRCRelease</i> message to release RRC connection and move the UE to <i>RRC_IDLE</i> .	<--	NR RRC: <i>RRCRelease</i>	-	-
<p>Note 1: $T390$ is a random value between $(0.7 + 0.6 * 0) * uac\text{-}BarringTime(16s) = 11.2s$ and $(0.7 + 0.6 * 1) * uac\text{-}BarringTime(16s) = 20.8s$.</p> <p>Note 2: The wait time 30s is selected to cover $(0.7 + 0.6 * rand) * uac\text{-}BarringTime(16s) = 20.8s + 2s$ (IP PDU delay timer) + 5.12s (modification period) = 27.92s rounded up to 28s when '<i>rand</i>' takes the maximum value of 1.</p>					

11.3.1a.3.3 Specific message contents

Table 11.3.1a.3.3-1: *SIB1* of NR Cell 1 (All steps, Table 11.3.1a.3.2-1)

Derivation Path: TS 38.508-1 [4], Table 4.6.1-28			
Information Element	Value/remark	Comment	Condition
<i>SIB1</i> ::= SEQUENCE {			
<i>uac-BarringInfo</i> SEQUENCE {			
<i>uac-BarringForCommon</i> SEQUENCE (SIZE (1.. <i>maxAccessCat</i> -1)) OF UAC-BarringPerCat {	1 entry		
UAC-BarringPerCat[1] SEQUENCE {		entry 1	

accessCategory	7	(= MO_data)	Step 1
	4	(= MO MMTel voice)	Step 5
uac-barringInfoSetIndex	1	Value 1 corresponds to the first entry in uac-BarringInfoSetList	
}			
}			
uac-BarringPerPLMN-List	Not present		
uac-BarringInfoSetList SEQUENCE (SIZE(1..maxBarringInfoSet)) OF UAC-BarringInfoSet {	1 entry		
UAC-BarringInfoSet[1] SEQUENCE {		entry 1	
uac-BarringFactor	p00	0% access probability	
uac-BarringTime	s16	16 s	
uac-BarringForAccessIdentity	'0000000'B		
}			
}			
uac-AccessCategory1-SelectionAssistanceInfo	Not Present		
}			
}			

Table 11.3.1a.3.3-2: RRCResumeRequest (All steps, Table 11.3.1a.3.2-1)

Derivation Path: TS 38.508-1 [4], Table 4.6.1-19			
Information Element	Value/remark	Comment	Condition
RRCResumeRequest ::= SEQUENCE {			
rrcResumeRequest SEQUENCE {			
resumeCause	mo-Data		Step 4, 5Aa1 and 5Ab8
	mt-Access		Step 5Ab3
}			
}			

Table 11.3.1a.3.3-3: REGISTRATION ACCEPT (preamble, Table 11.3.1a.3.2-1)

Derivation path: TS 38.508-1 [4] Table 4.7.1-7			
Information Element	Value/remark	Comment	Condition
5GS network feature support			
IMS-VoPS-3GPP	'0'B	IMS voice over PS session not supported over 3GPP access	

11.3.2 UAC / Access Identity 0 / 0% access probability / Paging for MT access/Emergency call

11.3.2.1 Test Purpose (TP)

(1)

```

with { UE not configured for special AIs (1,2,11-15) having received a SIB1 message indicating 0%
accessibility for all Access Categories in NR RRC_Idle state }
ensure that {
  when { UE is paged for MT access }
  then { UE does not consider the access as barred and initiates RRC Connection }
}
    
```

(2)

```

with { UE not configured for special AIs (1,2,11-15) having received a SIB1 message including UAC
Info set to 0% accessibility for Access Category 2 in NR RRC_Idle state }
ensure that {
  when { UE attempts emergency call }
  then { UE does not initiate emergency call }
}

```

(3)

```

with { UE not configured for special AIs (1,2,11-15) with T302 running but T390 expired for Access
Category 2 and with SIB1 including UAC Info indicating 100% accessibility for Access Category 2 in
NR RRC_IDLE state }
ensure that {
  when { UE attempts emergency call }
  then { UE does not consider the access attempt as barred and initiates the emergency call }
}

```

11.3.2.2 Conformance requirements

References: The conformance requirements covered in the present TC are specified in TS 24.501: clause 4.5.2, 4.5.4.1 and 4.5.6 and TS 38.331: clause 5.3.14.1, 5.3.14.2, 5.3.14.4 and 5.3.14.5. Unless otherwise stated these are Rel-15 requirements.

[TS 24.501, clause 4.5.2]

When the UE needs to initiate an access attempt in one of the events listed in subclause 4.5.1, the UE shall determine one or more access identities from the set of standardized access identities, and one access category from the set of standardized access categories and operator-defined access categories, to be associated with that access attempt.

The set of the access identities applicable for the request is determined by the UE in the following way:

- a) for each of the access identities 1, 2, 11, 12, 13, 14 and 15 in table 4.5.2.1, the UE shall check whether the access identity is applicable in the selected PLMN, if a new PLMN is selected, or otherwise if it is applicable in the RPLMN or equivalent PLMN; and
- b) if none of the above access identities is applicable, then access identity 0 is applicable.

Table 4.5.2.1: Access identities

Access Identity number	UE configuration
0	UE is not configured with any parameters from this table
1 (NOTE 1)	UE is configured for multimedia priority service (MPS).
2 (NOTE 2)	UE is configured for mission critical service (MCS).
3-10	Reserved for future use
11 (NOTE 3)	Access Class 11 is configured in the UE.
12 (NOTE 3)	Access Class 12 is configured in the UE.
13 (NOTE 3)	Access Class 13 is configured in the UE.
14 (NOTE 3)	Access Class 14 is configured in the UE.
15 (NOTE 3)	Access Class 15 is configured in the UE.
NOTE 1: Access identity 1 is valid when: <ul style="list-style-type: none"> - the USIM file EFUAC_AIC indicates the UE is configured for access identity 1 and the RPLMN is the HPLMN (if the EHPLMN list is not present or is empty) or EHPLMN (if the EHPLMN list is present), or a visited PLMN of the home country (see the definition of home country in 3GPP TS 24.301 [15]); or - the UE receives the 5GS network feature support IE with the MPS indicator bit set to "Access identity 1 valid in RPLMN or equivalent PLMN" from the RPLMN as described in subclause 5.5.1.2.4 and subclause 5.5.1.3.4. 	
NOTE 2: Access identity 2 is used by UEs configured for MCS and is valid when: <ul style="list-style-type: none"> - the USIM file EFUAC_AIC indicates the UE is configured for access identity 2 and the RPLMN is the HPLMN (if the EHPLMN list is not present or is empty) or EHPLMN (if the EHPLMN list is present), or a visited PLMN of the home country (see 3GPP TS 23.122 [5]); or - the UE receives the 5GS network feature support IE with the MCS indicator bit set to "Access identity 2 valid in RPLMN or equivalent PLMN" from the RPLMN as described in subclause 5.5.1.2.4 and subclause 5.5.1.3.4. 	
NOTE 3: Access identities 11 and 15 are valid in HPLMN (if the EHPLMN list is not present or is empty) or	

EHPLMN (if the EHPLMN list is present). Access Identities 12, 13 and 14 are valid in HPLMN and visited PLMNs of home country only (see the definition of home country in 3GPP TS 24.301 [15]).

The UE uses the MPS indicator bit of the 5GS network feature support IE to determine if access identity 1 is valid. Processing of the MPS indicator bit of the 5GS network feature support IE in the REGISTRATION ACCEPT message is described in subclause 5.5.1.2.4 and subclause 5.5.1.3.4. The UE shall not consider access identity 1 to be valid when the UE is not in the country of its HPLMN prior to receiving the MPS indicator bit of the 5GS network feature support IE in the REGISTRATION ACCEPT message being set to "Access identity 1 valid in RPLMN or equivalent PLMN".

When the UE is in the country of its HPLMN, the contents of the USIM files EF_{UAC_AIC} and EF_{ACC} as specified in 3GPP TS 31.102 [22] and the rules specified in table 4.5.2.1 are used to determine the applicability of access identity 1 and access classes 11 - 15. When the UE is in the country of its HPLMN, and the USIM file EF_{UAC_AIC} does not indicate the UE is configured for access identity 1, the UE uses the MPS indicator bit of the 5GS network feature support IE in the REGISTRATION ACCEPT message to determine if access identity 1 is valid. When the UE is in the country of its HPLMN, and the USIM file EF_{UAC_AIC} indicates the UE is configured for access identity 1, the MPS indicator bit of the 5GS network feature support IE is not applicable. When the UE is not in the country of its HPLMN, the contents of the USIM files EF_{UAC_AIC} and EF_{ACC} are not applicable.

The UE uses the MCS indicator bit of the 5GS network feature support IE to determine if access identity 2 is valid. Processing of the MCS indicator bit of the 5GS network feature support IE in the REGISTRATION ACCEPT message is described in subclause 5.5.1.2.4 and subclause 5.5.1.3.4. The UE shall not consider access identity 2 to be valid when the UE is not in the country of its HPLMN prior to receiving the MCS indicator bit of the 5GS network feature support IE in the REGISTRATION ACCEPT message being set to "Access identity 2 valid in RPLMN or equivalent PLMN".

When the UE is in the country of its HPLMN, the contents of the USIM files EF_{UAC_AIC} and EF_{ACC} as specified in 3GPP TS 31.102 [22] and the rules specified in table 4.5.2.1 are used to determine the applicability of access identity 2 and access classes 11 - 15. When the UE is in the country of its HPLMN, and the USIM file EF_{UAC_AIC} does not indicate the UE is configured for access identity 2, the UE uses the MCS indicator bit of the 5GS network feature support IE in the REGISTRATION ACCEPT message to determine if access identity 2 is valid. When the UE is in the country of its HPLMN, and the USIM file EF_{UAC_AIC} indicates the UE is configured for access identity 2, the MCS indicator bit of the 5GS network feature support IE is not applicable. When the UE is not in the country of its HPLMN, the contents of the USIM files EF_{UAC_AIC} and EF_{ACC} are not applicable.

In order to determine the access category applicable for the access attempt, the NAS shall check the rules in table 4.5.2.2, and use the access category for which there is a match for barring check. If the access attempt matches more than one rule, the access category of the lowest rule number shall be selected. If the access attempt matches more than one operator-defined access category definition, the UE shall select the access category from the operator-defined access category definition with the lowest precedence value (see subclause 4.5.3).

NOTE: The case when an access attempt matches more than one rule includes the case when multiple events trigger an access attempt at the same time.

Table 4.5.2.2: Mapping table for access categories

Rule #	Type of access attempt	Requirements to be met	Access Category
1	Response to paging or NOTIFICATION over non-3GPP access; 5GMM connection management procedure initiated for the purpose of transporting an LPP message	Access attempt is for MT access	0 (= MT_acc)
2	Emergency	UE is attempting access for an emergency session (NOTE 1, NOTE 2)	2 (= emergency)
3	Access attempt for operator-defined access category	UE stores operator-defined access category definitions valid in the current PLMN as specified in subclause 4.5.3, and access attempt is matching criteria of an operator-defined access category definition	32-63 (= based on operator classification)
4	Access attempt for delay tolerant service	(a) UE is configured for NAS signalling low priority or UE supporting S1 mode is configured for EAB (see the	1 (= delay tolerant)

		"ExtendedAccessBarring" leaf of NAS configuration MO in 3GPP TS 24.368 [17] or 3GPP TS 31.102 [22]) where "EAB override" does not apply, and (b).the UE received one of the categories a, b or c as part of the parameters for unified access control in the broadcast system information, and the UE is a member of the broadcasted category in the selected PLMN or RPLMN/equivalent PLMN (NOTE 3, NOTE 5, NOTE 6, NOTE 7, NOTE 8)	
5	MO MMTel voice call	Access attempt is for MO MMTel voice call or for NAS signalling connection recovery during ongoing MO MMTel voice call (NOTE 2)	4 (= MO MMTel voice)
6	MO MMTel video call	Access attempt is for MO MMTel video call or for NAS signalling connection recovery during ongoing MO MMTel video call (NOTE 2)	5 (= MO MMTel video)
7	MO SMS over NAS or MO SMSoIP	Access attempt is for MO SMS over NAS (NOTE 4) or MO SMS over SMSoIP transfer or for NAS signalling connection recovery during ongoing MO SMS or SMSoIP transfer (NOTE 2)	6 (= MO SMS and SMSoIP)
8	UE NAS initiated 5GMM specific procedures	Access attempt is for MO signalling	3 (= MO_sig)
9	UE NAS initiated 5GMM connection management procedure or 5GMM NAS transport procedure	Access attempt is for MO data	7 (= MO_data)
10	An uplink user data packet is to be sent for a PDU session with suspended user-plane resources	No further requirement is to be met	7 (= MO_data)
<p>NOTE 1: This includes 5GMM specific procedures while the service is ongoing and 5GMM connection management procedures required to establish a PDU session with request type = "initial emergency request" or "existing emergency PDU session", or to re-establish user-plane resources for such a PDU session. This further includes the service request procedure initiated with a SERVICE REQUEST message with the Service type IE set to "emergency services fallback".<</p> <p>NOTE 2: Access for the purpose of NAS signalling connection recovery during an ongoing service, or for the purpose of NAS signalling connection establishment following fallback indication from lower layers during an ongoing service, is mapped to the access category of the ongoing service in order to derive an RRC establishment cause, but barring checks will be skipped for this access attempt.</p> <p>NOTE 3: If the UE selects a new PLMN, then the selected PLMN is used to check the membership; otherwise the UE uses the RLPMN or a PLMN equivalent to the RPLMN.</p> <p>NOTE 4: This includes the 5GMM connection management procedures triggered by the UE-initiated NAS transport procedure for transporting the MO SMS.</p> <p>NOTE 5: The UE configured for NAS signalling low priority is not supported in this release of specification. If a UE supporting both S1 mode and N1 mode is configured for NAS signalling low priority in S1 mode as specified in 3GPP TS 24.368 [17] or 3GPP TS 31.102 [22], the UE shall ignore the configuration for NAS signalling low priority when in N1 mode.</p> <p>NOTE 6: If the access category applicable for the access attempt is 1, then the UE shall additionally determine a second access category from the range 3 to 7. If more than one access category matches, the access category of the lowest rule number shall be chosen. The UE shall use the second access category only to derive an RRC establishment cause for the access attempt.</p> <p>NOTE 7: "EAB override" does not apply, if the UE is not configured to allow overriding EAB (see the "Override_ExtendedAccessBarring" leaf of NAS configuration MO in 3GPP TS 24.368 [17] or 3GPP TS 31.102 [22]), or if NAS has not received an indication from the upper layers to override EAB and the UE does not have a PDU session that was established with EAB override.</p> <p>NOTE 8: For the definition of categories a, b and c associated with access category 1, see 3GPP TS 22.261 [3]. The categories associated with access category 1 are distinct from the categories a, b and c associated with EAB (see 3GPP TS 22.011 [1A]).</p>			

[TS 24.501, clause 4.5.4.1]

When the UE is in 5GMM-IDLE mode, upon receiving a request from the upper layers for an access attempt, the NAS shall categorize the access attempt into access identities and an access category following subclause 4.5.2, table 4.5.2.1 and table 4.5.2.2, and subclause 4.5.3, and provide the applicable access identities and the access category to the lower layers for the purpose of access control checking. In this request to the lower layer the NAS can also provide to the lower layer the RRC establishment cause determined as specified in subclause 4.5.6 of this specification.

NOTE 1: The access barring check is performed by the lower layers.

NOTE 2: As an implementation option, the NAS can provide the RRC establishment cause to the lower layers after being informed by the lower layers that the access attempt is allowed.

If the UE has uplink user data pending for one or more PDU sessions when it builds a REGISTRATION REQUEST or SERVICE REQUEST message as initial NAS message, the UE shall indicate the respective PDU sessions in the Uplink data status IE as specified in subclause 5.5.1.3.2 and 5.6.1.2, regardless of the access category for which the access barring check is performed.

NOTE 3: The UE indicates pending user data for all the respective PDU sessions, even if barring timers are running for some of the corresponding access categories.

If the lower layers indicate that the access attempt is allowed, the NAS shall initiate the procedure to send the initial NAS message for the access attempt.

If the lower layers indicate that the access attempt is barred, the NAS shall not initiate the procedure to send the initial NAS message for the access attempt. Additionally:

- a) if the event which triggered the access attempt was an MO-MMTEL-voice-call-started indication or an MO-MMTEL-video-call-started indication:
 - 1) if the UE is operating in the single-registration mode and the UE's usage setting is "voice centric", the UE may attempt to select an E-UTRA cell connected to EPC. If the UE finds a suitable E-UTRA cell connected to EPC, it then proceeds with the appropriate EMM specific procedures and, if necessary, ESM procedures to make a PDN connection providing access to IMS available; see subclause 4.8.2 and 3GPP TS 24.301 [15];
 - 2) if the UE is operating in the dual-registration mode, the UE may proceed in S1 mode with the appropriate EMM specific procedures and ESM procedures to make a PDN connection providing access to IMS available; see subclause 4.8.3 and 3GPP TS 24.301 [15];
 - 3) otherwise, the NAS shall notify the upper layers that the access attempt is barred. In this case, upon receiving an indication from the lower layers that the barring is alleviated for the access category with which the access attempt was associated, the NAS shall notify the upper layers that the barring is alleviated for the access category and may initiate the procedure to send the initial NAS message, if still needed; and
- b) if the event which triggered the access attempt was an MO-SMSoIP-attempt-started indication:
 - 1) if the UE is operating in the single-registration mode, the UE may attempt to select an E-UTRA cell connected to EPC. If the UE finds a suitable E-UTRA cell connected to EPC, it then proceeds with the appropriate EMM specific procedures and, if necessary, ESM procedures to make a PDN connection providing access to IMS available; see subclause 4.8.2 and 3GPP TS 24.301 [15];
 - 2) if the UE is operating in the dual-registration mode, the UE may proceed in S1 mode with the appropriate EMM specific procedures and ESM procedures to make a PDN connection providing access to IMS available; see subclause 4.8.3 and 3GPP TS 24.301 [15];
 - 3) otherwise, the NAS layer shall notify the upper layers that the access attempt is barred. In this case, upon receiving an indication from the lower layers that the barring is alleviated for the access category with which the access attempt was associated, the NAS shall notify the upper layers that the barring is alleviated for the access category and may initiate the procedure to send the initial NAS message, if still needed.

NOTE 4: Barring timers, on a per access category basis, are run by the lower layers. At expiry of barring timers, the indication of alleviation of access barring is indicated to the NAS on a per access category basis.

[TS 24.501, clause 4.5.6]

When 5GMM requests the establishment of a NAS-signalling connection, the RRC establishment cause used by the UE shall be selected according to one or more access identities (see subclause 4.5.2) and the determined access category as

specified in table 4.5.6.1 and table 4.5.6.2. If the determined access category is an operator-defined access category, then the RRC establishment cause used by the UE shall be selected according to table 4.5.6.1 and table 4.5.6.2 based on one or more access identities (see subclause 4.5.2) and the standardized access category determined for the operator-defined access category as described in subclause 4.5.3.

Table 4.5.6.1: Mapping table for access identities/access categories and RRC establishment cause when establishing N1 NAS signalling connection via NR connected to 5GCN

Access identities	Access categories	RRC establishment cause is set to
0	0 (= MT_acc)	mt-Access
	1 (= delay tolerant)	Not applicable (NOTE 1)
	2 (= emergency)	emergency
	3 (= MO_sig)	mo-Signalling
	4 (= MO MMTel voice)	mo-VoiceCall
	5 (= MO MMTel video)	mo-VideoCall
	6 (= MO SMS and SMSoIP)	mo-SMS
	7 (= MO_data)	mo-Data
1	Any category	mps-PriorityAccess
2	Any category	mcs-PriorityAccess
11, 15	Any category	highPriorityAccess
12,13,14,	Any category	highPriorityAccess
NOTE 1: A UE using access category 1 for the access barring check will determine a second access category in the range 3 to 7 that is to be used for determination of the RRC establishment cause. See subclause 4.5.2, table 4.5.2.2, NOTE 6.		
NOTE 2: See subclause 4.5.2, table 4.5.2.1 for use of the access identities of 0, 1, 2, and 11-15.		

Table 4.5.6.2: Mapping table for access identities/access categories and RRC establishment cause when establishing N1 NAS signalling connection via E-UTRA connected to 5GCN

Access identities	Access categories	RRC establishment cause is set to
0	0 (= MT_acc)	mt-Access
	1 (= delay tolerant)	Not applicable (NOTE 1)
	2 (= emergency)	emergency
	3 (= MO_sig)	mo-Signalling
	4 (= MO MMTel voice)	mo-VoiceCall
	5 (= MO MMTel video)	mo-VoiceCall
	6 (= MO SMS and SMSoIP)	mo-Data
	7 (= MO_data)	mo-Data
1	Any category	highPriorityAccess
2	Any category	highPriorityAccess
11, 15	Any category	highPriorityAccess
12,13,14,	Any category	highPriorityAccess
NOTE 1: A UE using access category 1 for the access barring check will determine a second access category in the range 3 to 7 that is to be used for determination of the RRC establishment cause. See subclause 4.5.2, table 4.5.2.2, NOTE 6.		
NOTE 2: See subclause 4.5.2, table 4.5.2.1 for use of the access identities of 0, 1, 2, and 11-15.		

[TS 38.331, clause 5.3.14.1]

The purpose of this procedure is to perform access barring check for an access attempt associated with a given Access Category and one or more Access Identities upon request from upper layers according to TS 24.501 [23] or the RRC layer.

After a handover resulting in change of PCell in RRC_CONNECTED the UE shall defer access barring checks until it has obtained valid UAC information (from *SIB1*) from the target cell.

[TS 38.331, clause 5.3.14.2]

Upon initiation of the procedure, the UE shall:

- 1> if timer T390 is running for the Access Category:

- 2> consider the access attempt as barred;
- 1> else if timer T302 is running and the Access Category is neither '2' nor '0':
 - 2> consider the access attempt as barred;
- 1> else:
 - 2> if the Access Category is '0':
 - 3> consider the access attempt as allowed;
 - 2> else:
 - 3> if *SIB1* includes *uac-BarringPerPLMN-List* and the *uac-BarringPerPLMN-List* contains an *UAC-BarringPerPLMN* entry with the *plmn-IdentityIndex* corresponding to the PLMN selected by upper layers (see TS 24.501 [23]):
 - 4> select the *UAC-BarringPerPLMN* entry with the *plmn-IdentityIndex* corresponding to the PLMN selected by upper layers;
 - 4> in the remainder of this procedure, use the selected *UAC-BarringPerPLMN* entry (i.e. presence or absence of access barring parameters in this entry) irrespective of the *uac-BarringForCommon* included in *SIB1*;
 - 3> else if *SIB1* includes *uac-BarringForCommon*:
 - 4> in the remainder of this procedure use the *uac-BarringForCommon* (i.e. presence or absence of these parameters) included in *SIB1*;
 - 3> else:
 - 4> consider the access attempt as allowed;
 - ...
 - 1> if the access barring check was requested by upper layers:
 - 2> if the access attempt is considered as barred:
 - 3> if timer T302 is running:
 - 4> inform the upper layer that access barring is applicable for all access categories except categories '0' and '2', upon which the procedure ends;
 - 3> else:
 - 4> inform upper layers that the access attempt for the Access Category is barred, upon which the procedure ends;
 - 2> else:
 - 3> inform upper layers that the access attempt for the Access Category is allowed, upon which the procedure ends;
 - 1> else:
 - 2> the procedure ends.

[TS 38.331, clause 5.3.14.4]

The UE shall:

- 1> if timer T302 expires or is stopped, and if timer T390 corresponding to an Access Category is not running; or
- 1> if timer T390 corresponding to an Access Category other than '2' expires or is stopped, and if timer T302 is not running; or

- 1> if timer T390 corresponding to the Access Category '2' expires or is stopped:
 - 2> consider the barring for this Access Category to be alleviated;
- 1> when barring for an Access Category is considered being alleviated:
 - 2> if the Access Category was informed to upper layers as barred:
 - 3> inform upper layers about barring alleviation for the Access Category.
 - 2> if barring is alleviated for Access Category '8':
 - 3> perform actions specified in 5.3.13.8;

[TS 38.331, clause 5.3.14.5]

The UE shall:

- 1> if one or more Access Identities are indicated according to TS 24.501 [23], and
- 1> if for at least one of these Access Identities the corresponding bit in the *uac-BarringForAccessIdentity* contained in "UAC barring parameter" is set to *zero*:
 - 2> consider the access attempt as allowed;
- 1> else:
 - 2> draw a random number '*rand*' uniformly distributed in the range: $0 \leq rand < 1$;
 - 2> if '*rand*' is lower than the value indicated by *uac-BarringFactor* included in "UAC barring parameter":
 - 3> consider the access attempt as allowed;
 - 2> else:
 - 3> consider the access attempt as barred;
- 1> if the access attempt is considered as barred:
 - 2> draw a random number '*rand*' that is uniformly distributed in the range $0 \leq rand < 1$;
 - 2> start timer T390 for the Access Category with the timer value calculated as follows, using the *uac-BarringTime* included in "AC barring parameter":

$$T390 = (0.7 + 0.6 * rand) * uac-BarringTime.$$

11.3.2.3 Test description

11.3.2.3.1 Pre-test conditions

System Simulator:

- NR Cell 1.
- System information combination NR-1 as defined in TS 38.508-1 [4] Table 4.4.3.1.2-1 is used in NR cell 1 with SIB 1 modified as per Table 11.3.2.3.3-1.

UE:

- None.

Preamble:

- The UE is brought to state 1N-A, RRC_IDLE Connectivity (NR), in accordance with the procedure described in TS 38.508-1 [4], Table 4.5.2.2-2.

11.3.2.3.2 Test procedure sequence

Table 11.3.2.3.2-1: Main behaviour

St	Procedure	Message Sequence		TP	Verdict
		U - S	Message		
1	Make the UE attempt an emergency call dialling a number which is stored on the ME (e.g. 112 or 911). (Note 1)	-	-	-	-
2	Check: Does the UE transmit an <i>RRCSetupRequest</i> message with <i>establishmentCause</i> set to 'emergency' within 30 s'?	-->	NR RRC: <i>RRCSetupRequest</i>	2	F
2A 1	IF <i>pc_SwitchOnOff</i> THEN switch off UE, ELSE IF <i>pc_USIM_Removal</i> THEN remove the USIM, ELSE power off UE in which case steps 2A2 to 2A4 are not performed.	-	-	-	-
2A 2	SS starts timer <i>T_Delay</i> =15 sec.	-	-	-	-
-	EXCEPTION: Steps 2A3a1-2A3b1 describes optional behaviour that depends on the UE implementation; the "lower case letter" identifies a step sequence that take place if a particular implementation is under test.	-	-	-	-
2A 3a1	Steps 1a2-1a4 of the Switch off procedure in <i>RRC_IDLE</i> in table 4.9.6.1-1 in TS 38.508-1 [4] are performed.	-	-	-	-
2A 3a2	Stop timer <i>T_Delay</i> .	-	-	-	-
2A 3a3	The SS transmits an <i>RRCRelease</i> message.	<--	NR RRC: <i>RRCRelease</i>	-	-
2A 3b1	Timer <i>T_Delay</i> expires.	-	-	-	-
2A 4	Void	-	-	-	-
2A 5	Switch on the UE.	-	-	-	-
2A 6	The UE performs Registration procedure as specified in TS 38.508-1 [4] subclause 4.5.2.	-	-	-	-
3	SS changes <i>SIB1</i> according to Table 11.3.2.3.3-2 and sends Short Message on PDCCH using P-RNTI. Wait for 2.1* modification period to allow the new system information to take effect and T390 expire. (Note 1)	<--	PDCCH (DCI 1_0): Short Message	-	-
4	The SS transmits a <i>Paging</i> message including a matched ng-5G-S-TMSI.	<--	NR RRC: <i>Paging</i>	-	-
5	Check: Does the UE transmit an <i>RRCSetupRequest</i> message with <i>establishmentCause</i> set to 'mt-access'?	-->	NR RRC: <i>RRCSetupRequest</i>	1	P
6- 12	Steps 3 to 9a1 of the generic test procedure in TS 38.508-1 [4] Table 4.9.4.2.2-1 are performed on NR Cell 1.	-	-	-	-
13	SS changes <i>SIB1</i> according to 38.508-1 [4] Table 4.6.1-28 and sends Short Message on PDCCH using P-RNTI. Wait for 2.1* modification period to allow the new system information to take effect.	<--	PDCCH (DCI 1_0): Short Message	-	-
14- 15	Steps 1-2 of the NR <i>RRC_CONNECTED</i> procedure in table 4.5.4.2-3 in TS 38.508-1 [4] are performed.	-	-	-	-
16	The SS responds with <i>RRCReject</i> message with <i>IE_waitTime</i> set to 16s(T302).	<--	NR RRC: <i>RRCReject</i>	-	-
17	Make the UE attempt an emergency call dialling a number which is stored on the ME (e.g. 112 or 911), before the T302 timer expires.	-	-	-	-
18	Check: Does the UE transmit an <i>RRCSetupRequest</i> message with	-->	NR RRC: <i>RRCSetupRequest</i>	3	P

	<i>establishmentCause</i> set to 'emergency' (Note 2)?				
19	Void	-	-	-	-
20	Void	-	-	-	-
-	EXCEPTION: Steps 21a1 – 21b6 describe the UE behaviour that depends on UE capability; the "lower case letter" identifies a step sequence that takes place if a capability is supported	-	-	-	-
21a 1-21a 12	IF <i>pc_Nr_5GC_EmergencyServices</i> THEN Step 2-13 for IMS Emergency call establishment are performed as specified in TS 38.508-1 [4], subclause 4.9.11 on NR Cell 1.	-	-	-	-
21a 13	Make the UE release the emergency call. (NOTE 3)	-	-	-	-
21a 14	Test procedure for IMS MO Emergency call release is performed as specified in TS 38.508-1 [4], subclause 4.9.12A on NR Cell 1.	-	-	-	-
21b 1 – 21b 4	ELSE Step 2- 5 for IMS Emergency call establishment are performed as specified in TS 38.508-1 [4], subclause 4.9.11 on NR Cell 1.	-	-	-	-
21b 5	IF <i>pc_SwitchOnOff</i> THEN switch off UE, IF <i>pc_USIM_Removal</i> THEN remove the USIM.	-	-	-	-
21b 6	SS starts timer1 = 15 sec to see if UE performs optional Step 21b6a1	-	-	-	-
-	EXCEPTION: Steps 21b6a1-21b6b1 describes optional behaviour that depends on the UE implementation; the "lower case letter" identifies a step sequence that take place if a particular implementation is under test.	-	-	-	-
21b 6a1	The UE transmits a DEREGISTRATION REQUEST message.	-->	NR RRC: ULInformationTransfer 5GMM: DEREGISTRATION REQUEST	-	-
21b 6a2	The SS transmits an <i>RRCRelease</i> message.	<--	NR RRC: RRCRelease		
21b 6b1	ELSE power off UE.	-	-	-	-
<p>Note 1: T390 is a random value between $(0.7 + 0.6 * 0) * uac\text{-}BarringTime(4s) = 2.8s$ and $(0.7 + 0.6 * 1) * uac\text{-}BarringTime(4s) = 5.2s$, which will start after UE attempts an emergency call.</p> <p>Note2: The emergency call dialling and UE <i>RRCSetupRequest</i> message should be initiated before T302 timer expires.</p> <p>Note 3: This could be done by e.g. MMI or AT command.</p>					

11.3.2.3.3 Specific message contents

Table 11.3.2.3.3-1: SIB1 for NR Cell 1 (Preamble, table 11.3.2.3.2-1)

Derivation Path: TS 38.508-1 [4], Table 4.6.1-28			
Information Element	Value/remark	Comment	Condition
SIB1 ::= SEQUENCE {			
uac-BarringInfo SEQUENCE {			
uac-BarringForCommon SEQUENCE (SIZE (1..maxAccessCat-1)) OF UAC-BarringPerCat {	1 entry		
UAC-BarringPerCat[1] SEQUENCE {		entry 1	
accessCategory	2		
uac-barringInfoSetIndex	1		
}			
}			
uac-BarringPerPLMN-List	Not present		
uac-BarringInfoSetList SEQUENCE (SIZE(1..maxBarringInfoSet)) OF UAC-BarringInfoSet {	1 entry		
UAC-BarringInfoSet[1] SEQUENCE {		entry 1	
uac-BarringFactor	p00		
uac-BarringTime	s4		

uac-BarringForAccessIdentity	'0000000'B		
}			
}			
uac-AccessCategory1-SelectionAssistanceInfo	Not Present		
}			
}			

Table 11.3.2.3.3-2: SIB1 for NR Cell 1 (Step3, Table 11.3.2.3.2-1)

Derivation Path: TS 38.508-1 [4], Table 4.6.1-28			
Information Element	Value/remark	Comment	Condition
SIB1 ::= SEQUENCE {			
uac-BarringInfo SEQUENCE {			
uac-BarringForCommon SEQUENCE (SIZE (1..maxAccessCat-1)) OF UAC-BarringPerCat {	8 entries		
UAC-BarringPerCat[1] SEQUENCE {		entry 1	
UAC-BarringPerCat[2] SEQUENCE {		entry 2	
accessCategory	1		
uac-barringInfoSetIndex	1		
}			
UAC-BarringPerCat[3] SEQUENCE {		entry 3	
accessCategory	2		
uac-barringInfoSetIndex	1		
}			
UAC-BarringPerCat[4] SEQUENCE {		entry 4	
accessCategory	3		
uac-barringInfoSetIndex	1		
}			
UAC-BarringPerCat[5] SEQUENCE {		entry 5	
accessCategory	4		
uac-barringInfoSetIndex	1		
}			
UAC-BarringPerCat[6] SEQUENCE {		entry 6	
accessCategory	5		
uac-barringInfoSetIndex	1		
}			
UAC-BarringPerCat[7] SEQUENCE {		entry 7	
accessCategory	6		
uac-barringInfoSetIndex	1		
}			
UAC-BarringPerCat[8] SEQUENCE {		entry 8	
accessCategory	7		
uac-barringInfoSetIndex	1		
}			
}			
uac-BarringPerPLMN-List	Not present		
uac-BarringInfoSetList ::= SEQUENCE (SIZE(1..maxBarringInfoSet)) OF UAC-BarringInfoSet {	1 entry		
UAC-BarringInfoSet[1] SEQUENCE {		entry 1	
uac-BarringFactor	p00		
uac-BarringTime	s4		
uac-BarringForAccessIdentity	'0000000'B		
}			
}			
uac-AccessCategory1-SelectionAssistanceInfo	Not Present		
}			
}			

Table 11.3.2.3.3-3: RRCReject (step 16, table 11.3.2.3.2-1)

Derivation path: TS 38.508-1 [4] Table 4.6.1-15			
Information Element	Value/remark	Comment	Condition

RRCReject ::= SEQUENCE {			
criticalExtensions CHOICE {			
rrcReject SEQUENCE {			
waitTime	16	16 seconds	
}			
}			
}			

Table 11.3.2.3.3-4: SERVICE REQUEST (step 21b2, Table 11.3.2.3.2-1)

Derivation Path: Table 4.7.1-16.			
Information Element	Value/remark	Comment	Condition
Service type	'0100'B	emergency services fallback	

11.3.3 UAC / Access Identity 0 / AC8 / RRC_INACTIVE / RNA update / RRC resume

11.3.3.1 Test Purpose (TP)

(1)

```
with { UE not configured for special AIs (1,2,11-15) having received SIB1 indicating UAC info
containing 0% accessibility for Access category 8 in NR RRC_INACTIVE state }
ensure that {
  when { RRC connection is to be resumed due to an RNA update with no emergency services ongoing }
  then { UE resume attempt is barred and UE does not attempt the connection }
}
```

(2)

```
with { SIB1 indicating UAC info containing 100% accessibility for Access category 8 in NR
RRC_INACTIVE state }
ensure that {
  when { Access Barring is alleviated for Access Category 8 & upper layers do not request resumption
of an RRC connection & variable pendingRnaUpdate is set to true }
  then { UE initiates RRC connection resume procedure with resumeCause value set to rna-Update }
}
```

11.3.3.2 Conformance requirements

References: The conformance requirements covered in the present TC are specified in: TS 38.331, clause 5.3.13.2, 5.3.13.8, 5.3.14.2, 5.3.14.4 and 5.3.14.5. Unless otherwise stated these are Rel-15 requirements.

[TS 38.331, clause 5.3.13.2]

The UE initiates the procedure when upper layers or AS (when responding to RAN paging or upon triggering RNA updates while the UE is in RRC_INACTIVE) requests the resume of a suspended RRC connection.

The UE shall ensure having valid and up to date essential system information as specified in clause 5.2.2.2 before initiating this procedure.

Upon initiation of the procedure, the UE shall:

...

1> else if the resumption of the RRC connection is triggered due to an RNA update as specified in 5.3.13.8:

2> if an emergency service is ongoing:

NOTE: How the RRC layer in the UE is aware of an ongoing emergency service is up to UE implementation.

3> select '2' as the Access Category;

- 3> set the resumeCause to emergency;
- 2> else:
 - 3> select '8' as the Access Category;
- 2> perform the unified access control procedure as specified in 5.3.14 using the selected Access Category and one or more Access Identities to be applied as specified in TS 24.501 [23];
- 3> if the access attempt is barred:
 - 4> set the variable *pendingRnaUpdate* to true;
 - 4> the procedure ends;

[TS 38.331, clause 5.3.13.8]

In RRC_INACTIVE state, the UE shall:

- 1> if T380 expires; or
- 1> if RNA Update is triggered at reception of SIB1, as specified in 5.2.2.4.2:
 - 2> initiate RRC connection resume procedure in 5.3.13.2 with *resumeCause* set to *rna-Update*;
- 1> if barring is alleviated for Access Category '8', as specified in 5.3.14.4:
 - 2> if upper layers do not request RRC the resumption of an RRC connection, and
 - 2> if the variable *pendingRnaUpdate* is set to true:
 - 3> initiate RRC connection resume procedure in 5.3.13.2 with *resumeCause* value set to *rna-Update*.

[TS 38.331, clause 5.3.14.2]

Upon initiation of the procedure, the UE shall:

- 1> if timer T390 is running for the Access Category:
 - 2> consider the access attempt as barred;
- 1> else if timer T302 is running and the Access Category is neither '2' nor '0':
 - 2> consider the access attempt as barred;
- 1> else:
 - 2> if the Access Category is '0':
 - 3> consider the access attempt as allowed;
 - 2> else:

...

- 3> else if SIB1 includes *uac-BarringForCommon*:
 - 4> in the remainder of this procedure use the *uac-BarringForCommon* (i.e. presence or absence of these parameters) included in *SIB1*;
- 3> else:
 - 4> consider the access attempt as allowed;
- 3> if *uac-BarringForCommon* is applicable or the *uac-ACBarringListType* indicates that *uac-ExplicitACBarringList* is used:
 - 4> if the corresponding *UAC-BarringPerCatList* contains a *UAC-BarringPerCat* entry corresponding to the Access Category:

- 5> select the *UAC-BarringPerCat* entry;
- 5> if the *uac-BarringInfoSetList* contains a *UAC-BarringInfoSet* entry corresponding to the selected *uac-barringInfoSetIndex* in the *UAC-BarringPerCat*:
 - 6> select the *UAC-BarringInfoSet* entry;
 - 6> perform access barring check for the Access Category as specified in 5.3.14.5, using the selected *UAC-BarringInfoSet* as "UAC barring parameter";
- 5> else:
 - 6> consider the access attempt as allowed;
- 4> else:
 - 5> consider the access attempt as allowed;

[TS 38.331, clause 5.3.14.4]

The UE shall:

...

- 1> else if timer T390 corresponding to an Access Category other than '2' expires or is stopped, and if timer T302 is not running:
 - 2> consider the barring for this Access Category to be alleviated;

...

- 1> when barring for an Access Category is considered being alleviated:
 - 2> if the Access Category was informed to upper layers as barred:
 - 3> inform upper layers about barring alleviation for the Access Category.
 - 2> if barring is alleviated for Access Category '8':
 - 3> perform actions specified in 5.3.13.8;

[TS 38.331, clause 5.3.14.5]

The UE shall:

- 1> if one or more Access Identities are indicated according to TS 24.501 [23], and
 - 1> if for at least one of these Access Identities the corresponding bit in the *uac-BarringForAccessIdentity* contained in "UAC barring parameter" is set to *zero*:
 - 2> consider the access attempt as allowed;
 - 1> else:
 - 2> draw a random number '*rand*' uniformly distributed in the range: $0 \leq rand < 1$;
 - 2> if '*rand*' is lower than the value indicated by *uac-BarringFactor* included in "UAC barring parameter":
 - 3> consider the access attempt as allowed;
 - 2> else:
 - 3> consider the access attempt as barred;
- 1> if the access attempt is considered as barred:
 - 2> draw a random number '*rand*' that is uniformly distributed in the range $0 \leq rand < 1$;

2> start timer T390 for the Access Category with the timer value calculated as follows, using the *uac-BarringTime* included in "AC barring parameter":

$$T390 = (0.7 + 0.6 * rand) * uac-BarringTime.$$

11.3.3.3 Test description

11.3.3.3.1 Pre-test conditions

System Simulator:

- NR Cell 1
- System information combination NR-1 as defined in TS 38.508-1 [4] clause 4.4.3.1.2 is used in NR cells.

UE:

- None.

Preamble:

- The UE is in state 2N-A on NR cell 1 according to TS 38.508-1 [4] Table 4.4A.2-2.

11.3.3.3.2 Test procedure sequence

Table 11.3.3.3.2-1: Main behaviour

St	Procedure	Message Sequence		TP	Verdict
		U - S	Message		
1	Wait for 5 minute to make the timer T380 expire and trigger the RNA update procedure in UE.				
2	Check: Does the UE transmit an <i>RRCResumeRequest</i> message with resumeCause value set to rna-Update on NR Cell 1 within 60s?	-->	NR RRC: RRCResumeRequest	1	F
3	The SS changes the SIB1 according to 38.508-1 [4] Table 4.6.1-28 and transmits a Short message on PDCCH using P-RNTI indicating a systemInfoModification.	<--	PDCCH (DCI 1_0): Short Message	-	-
4	Check: Does the UE transmit an <i>RRCResumeRequest</i> message with resumeCause value set to rna-Update on NR Cell 1?	-->	NR RRC: RRCResumeRequest	2	P
5	The SS transmits an <i>RRCResume</i> message.	<--	NR RRC: RRCResume	-	-
6	The UE transmits an <i>RRCResumeComplete</i> message.	-->	NR RRC: RRCResumeComplete	-	-

11.3.3.3.3 Specific message contents

Table 11.3.3.3.3-1: SIB1 for NR Cell 1 (preamble, Table 11.3.3.3.2-1)

Derivation Path: TS 38.508-1 [4], Table 4.6.1-28			
Information Element	Value/remark	Comment	Condition
SIB1 ::= SEQUENCE {			
uac-BarringInfo SEQUENCE {			
uac-BarringForCommon SEQUENCE (SIZE (1..maxAccessCat-1)) OF UAC-BarringPerCat {	1 entry		
UAC-BarringPerCat[1] SEQUENCE {		entry 1	
accessCategory	8		
uac-barringInfoSetIndex	1		
}			

}			
uac-BarringPerPLMN-List	Not present		
uac-BarringInfoSetList SEQUENCE (SIZE(1..maxBarringInfoSet)) OF UAC-BarringInfoSet	1 entry		
{			
UAC-BarringInfoSet[1] SEQUENCE {		entry 1	
uac-BarringFactor	p00		
uac-BarringTime	s64		
uac-BarringForAccessIdentity	'0000000'B		
}			
}			
uac-AccessCategory1-SelectionAssistanceInfo	Not Present		
}			
}			

Table 11.3.3.3.3-2: *RRCRelease* (preamble, Table 11.3.3.3.2-1)

Derivation Path: TS 38.508-1 [4], Table 4.6.1-16			
Information Element	Value/remark	Comment	Condition
RRCRelease ::= SEQUENCE {			
criticalExtensions CHOICE {			
rrcRelease SEQUENCE {			
suspendConfig SEQUENCE {			NR_RRC_I NACTIVE
t380	min5	5 minutes	
}			
}			
}			
}			

Table 11.3.3.3.3-3: *RRCResumeRequest* (step 2 and step 5, Table 11.3.3.3.2-1)

Derivation Path: TS 38.508-1 [4], Table 4.6.1-19			
Information Element	Value/remark	Comment	Condition
RRCResumeRequest ::= SEQUENCE {			
rrcResumeRequest SEQUENCE {			
resumeCause	rna-Update		
}			
}			

11.3.4 UAC / Access Identity 0 / Registration procedure for mobility and periodic registration update / Barring per PLMN / Implicit AC barring list

11.3.4.1 Test Purpose (TP)

(1)

```
with { UE in NR RRC_IDLE not configured for special AIs (1,2,11-15) having received a SIB1 message
including UAC set to 0% accessibility for Access Category 3 }
ensure that {
  when { UE finds a new cell (AC 3) with SIB1 containing UAC Barring Info Per PLMN with Implicit AC
Barring List }
  then { UE does not access the new cell until access barring is alleviated }
}
```

11.3.4.2 Conformance requirements

References: The conformance requirements covered in the present TC are specified in: TS 24.501 clause 4.5.2, 4.5.4.1 and 5.5.1.3.7, TS 38.331 clause 5.3.14.2, 5.3.14.4 and 5.3.14.5. Unless otherwise stated these are Rel-15 requirements.

[TS 24.501, clause 4.5.2]

When the UE needs to initiate an access attempt in one of the events listed in subclause 4.5.1, the UE shall determine one or more access identities from the set of standardized access identities, and one access category from the set of standardized access categories and operator-defined access categories, to be associated with that access attempt.

The set of the access identities applicable for the request is determined by the UE in the following way:

- a) for each of the access identities 1, 2, 11, 12, 13, 14 and 15 in table 4.5.2.1, the UE shall check whether the access identity is applicable in the selected PLMN, if a new PLMN is selected, or otherwise if it is applicable in the RPLMN or equivalent PLMN; and
- b) if none of the above access identities is applicable, then access identity 0 is applicable.

Table 4.5.2.1: Access identities

Access Identity number	UE configuration
0	UE is not configured with any parameters from this table
1 (NOTE 1)	UE is configured for multimedia priority service (MPS).
2 (NOTE 2)	UE is configured for mission critical service (MCS).
3-10	Reserved for future use
11 (NOTE 3)	Access Class 11 is configured in the UE.
12 (NOTE 3)	Access Class 12 is configured in the UE.
13 (NOTE 3)	Access Class 13 is configured in the UE.
14 (NOTE 3)	Access Class 14 is configured in the UE.
15 (NOTE 3)	Access Class 15 is configured in the UE.
<p>NOTE 1: Access identity 1 is valid when:</p> <ul style="list-style-type: none"> - the USIM file EFUAC_AIC indicates the UE is configured for access identity 1 and the RPLMN is the HPLMN (if the EHPLMN list is not present or is empty) or EHPLMN (if the EHPLMN list is present), or a visited PLMN of the home country (see the definition of home country in 3GPP TS 24.301 [15]); or - the UE receives the 5GS network feature support IE with the MPS indicator bit set to "Access identity 1 valid in RPLMN or equivalent PLMN" from the RPLMN as described in subclause 5.5.1.2.4 and subclause 5.5.1.3.4. <p>NOTE 2: Access identity 2 is used by UEs configured for MCS and is valid when:</p> <ul style="list-style-type: none"> - the USIM file EFUAC_AIC indicates the UE is configured for access identity 2 and the RPLMN is the HPLMN (if the EHPLMN list is not present or is empty) or EHPLMN (if the EHPLMN list is present), or a visited PLMN of the home country (see 3GPP TS 23.122 [5]); or - the UE receives the 5GS network feature support IE with the MCS indicator bit set to "Access identity 2 valid in RPLMN or equivalent PLMN" from the RPLMN as described in subclause 5.5.1.2.4 and subclause 5.5.1.3.4. <p>NOTE 3: Access identities 11 and 15 are valid in HPLMN (if the EHPLMN list is not present or is empty) or EHPLMN (if the EHPLMN list is present). Access Identities 12, 13 and 14 are valid in HPLMN and visited PLMNs of home country only (see the definition of home country in 3GPP TS 24.301 [15]).</p>	

...

In order to determine the access category applicable for the access attempt, the NAS shall check the rules in table 4.5.2.2, and use the access category for which there is a match for barring check. If the access attempt matches more than one rule, the access category of the lowest rule number shall be selected. If the access attempt matches more than one operator-defined access category definition, the UE shall select the access category from the operator-defined access category definition with the lowest precedence value (see subclause 4.5.3).

NOTE: The case when an access attempt matches more than one rule includes the case when multiple events trigger an access attempt at the same time.

Table 4.5.2.2: Mapping table for access categories

Rule #	Type of access attempt	Requirements to be met	Access Category
1	Response to paging or NOTIFICATION over non-3GPP access; 5GMM connection management procedure initiated for the purpose of	Access attempt is for MT access	0 (= MT_acc)

	transporting an LPP message		
2	Emergency	UE is attempting access for an emergency session (NOTE 1, NOTE 2)	2 (= emergency)
3	Access attempt for operator-defined access category	UE stores operator-defined access category definitions valid in the current PLMN as specified in subclause 4.5.3, and access attempt is matching criteria of an operator-defined access category definition	32-63 (= based on operator classification)
4	Access attempt for delay tolerant service	(a) UE is configured for NAS signalling low priority or UE supporting S1 mode is configured for EAB (see the "ExtendedAccessBarring" leaf of NAS configuration MO in 3GPP TS 24.368 [17] or 3GPP TS 31.102 [22]) where "EAB override" does not apply, and (b) the UE received one of the categories a, b or c as part of the parameters for unified access control in the broadcast system information, and the UE is a member of the broadcasted category in the selected PLMN or RPLMN/equivalent PLMN (NOTE 3, NOTE 5, NOTE 6, NOTE 7, NOTE 8)	1 (= delay tolerant)
5	MO MMTel voice call	Access attempt is for MO MMTel voice call or for NAS signalling connection recovery during ongoing MO MMTel voice call (NOTE 2)	4 (= MO MMTel voice)
6	MO MMTel video call	Access attempt is for MO MMTel video call or for NAS signalling connection recovery during ongoing MO MMTel video call (NOTE 2)	5 (= MO MMTel video)
7	MO SMS over NAS or MO SMSoIP	Access attempt is for MO SMS over NAS (NOTE 4) or MO SMS over SMSoIP transfer or for NAS signalling connection recovery during ongoing MO SMS or SMSoIP transfer (NOTE 2)	6 (= MO SMS and SMSoIP)
8	UE NAS initiated 5GMM specific procedures	Access attempt is for MO signalling	3 (= MO_sig)
9	UE NAS initiated 5GMM connection management procedure or 5GMM NAS transport procedure	Access attempt is for MO data	7 (= MO_data)
10	An uplink user data packet is to be sent for a PDU session with suspended user-plane resources	No further requirement is to be met	7 (= MO_data)
<p>NOTE 1: This includes 5GMM specific procedures while the service is ongoing and 5GMM connection management procedures required to establish a PDU session with request type = "initial emergency request" or "existing emergency PDU session", or to re-establish user-plane resources for such a PDU session. This further includes the service request procedure initiated with a SERVICE REQUEST message with the Service type IE set to "emergency services fallback".<</p> <p>NOTE 2: Access for the purpose of NAS signalling connection recovery during an ongoing service, or for the purpose of NAS signalling connection establishment following fallback indication from lower layers during an ongoing service, is mapped to the access category of the ongoing service in order to derive an RRC establishment cause, but barring checks will be skipped for this access attempt.</p> <p>NOTE 3: If the UE selects a new PLMN, then the selected PLMN is used to check the membership; otherwise the UE uses the RPLMN or a PLMN equivalent to the RPLMN.</p> <p>NOTE 4: This includes the 5GMM connection management procedures triggered by the UE-initiated NAS transport procedure for transporting the MO SMS.</p> <p>NOTE 5: The UE configured for NAS signalling low priority is not supported in this release of specification. If a UE supporting both S1 mode and N1 mode is configured for NAS signalling low priority in S1 mode as specified in 3GPP TS 24.368 [17] or 3GPP TS 31.102 [22], the UE shall ignore the configuration for NAS signalling low priority when in N1 mode.</p> <p>NOTE 6: If the access category applicable for the access attempt is 1, then the UE shall additionally determine a second access category from the range 3 to 7. If more than one access category</p>			

<p>NOTE 7: "EAB override" does not apply, if the UE is not configured to allow overriding EAB (see the "Override_ExtendedAccessBarring" leaf of NAS configuration MO in 3GPP TS 24.368 [17] or 3GPP TS 31.102 [22]), or if NAS has not received an indication from the upper layers to override EAB and the UE does not have a PDU session that was established with EAB override.</p> <p>NOTE 8: For the definition of categories a, b and c associated with access category 1, see 3GPP TS 22.261 [3]. The categories associated with access category 1 are distinct from the categories a, b and c associated with EAB (see 3GPP TS 22.011 [1A]).</p>	<p>matches, the access category of the lowest rule number shall be chosen. The UE shall use the second access category only to derive an RRC establishment cause for the access attempt.</p>
--	--

[TS 24.501, clause 4.5.4.1]

When the UE is in 5GMM-IDLE mode, upon receiving a request from the upper layers for an access attempt, the NAS shall categorize the access attempt into access identities and an access category following subclause 4.5.2, table 4.5.2.1 and table 4.5.2.2, and subclause 4.5.3, and provide the applicable access identities and the access category to the lower layers for the purpose of access control checking. In this request to the lower layer the NAS can also provide to the lower layer the RRC establishment cause determined as specified in subclause 4.5.6 of this specification.

NOTE 1: The access barring check is performed by the lower layers.

NOTE 2: As an implementation option, the NAS can provide the RRC establishment cause to the lower layers after being informed by the lower layers that the access attempt is allowed.

...

If the lower layers indicate that the access attempt is allowed, the NAS shall initiate the procedure to send the initial NAS message for the access attempt.

If the lower layers indicate that the access attempt is barred, the NAS shall not initiate the procedure to send the initial NAS message for the access attempt. Additionally:

- a) if the event which triggered the access attempt was an MO-MMTEL-voice-call-started indication or an MO-MMTEL-video-call-started indication:
 - 1) if the UE is operating in the single-registration mode and the UE's usage setting is "voice centric", the UE may attempt to select an E-UTRA cell connected to EPC. If the UE finds a suitable E-UTRA cell connected to EPC, it then proceeds with the appropriate EMM specific procedures and, if necessary, ESM procedures to make a PDN connection providing access to IMS available; see subclause 4.8.2 and 3GPP TS 24.301 [15];
 - 2) if the UE is operating in the dual-registration mode, the UE may proceed in S1 mode with the appropriate EMM specific procedures and ESM procedures to make a PDN connection providing access to IMS available; see subclause 4.8.3 and 3GPP TS 24.301 [15];
 - 3) otherwise, the NAS shall notify the upper layers that the access attempt is barred. In this case, upon receiving an indication from the lower layers that the barring is alleviated for the access category with which the access attempt was associated, the NAS shall notify the upper layers that the barring is alleviated for the access category and may initiate the procedure to send the initial NAS message, if still needed; and
- b) if the event which triggered the access attempt was an MO-SMSoIP-attempt-started indication:
 - 1) if the UE is operating in the single-registration mode, the UE may attempt to select an E-UTRA cell connected to EPC. If the UE finds a suitable E-UTRA cell connected to EPC, it then proceeds with the appropriate EMM specific procedures and, if necessary, ESM procedures to make a PDN connection providing access to IMS available; see subclause 4.8.2 and 3GPP TS 24.301 [15];
 - 2) if the UE is operating in the dual-registration mode, the UE may proceed in S1 mode with the appropriate EMM specific procedures and ESM procedures to make a PDN connection providing access to IMS available; see subclause 4.8.3 and 3GPP TS 24.301 [15];
 - 3) otherwise, the NAS layer shall notify the upper layers that the access attempt is barred. In this case, upon receiving an indication from the lower layers that the barring is alleviated for the access category with which the access attempt was associated, the NAS shall notify the upper layers that the barring is alleviated for the access category and may initiate the procedure to send the initial NAS message, if still needed.

NOTE 4: Barring timers, on a per access category basis, are run by the lower layers. At expiry of barring timers, the indication of alleviation of access barring is indicated to the NAS on a per access category basis.

[TS 24.501, clause 5.5.1.3.7]

b) The lower layers indicate that the access attempt is barred.

The UE shall not start the registration procedure for mobility and periodic registration update. The UE stays in the current serving cell and applies the normal cell reselection process.

The registration procedure for mobility and periodic registration update is started, if still needed, when the lower layers indicate that the barring is alleviated for the access category with which the access attempt was associated.

ba) The lower layers indicate that access barring is applicable for all access categories except categories 0 and 2 and the access category with which the access attempt was associated is other than 0 and 2.

If the REGISTRATION REQUEST message has not been sent, the UE shall proceed as specified for case b. If the REGISTRATION REQUEST message has been sent, the UE shall proceed as specified for case e and, additionally, the registration procedure for mobility and periodic registration update is started, if still needed, when the lower layers indicate that the barring is alleviated for the access category with which the access attempt was associated. For additional UE requirements for both cases see subclause 4.5.5.

[TS 38.331, clause 5.3.14.2]

Upon initiation of the procedure, the UE shall:

1> if timer T390 is running for the Access Category:

2> consider the access attempt as barred;

...

1> else:

2> if the Access Category is '0':

3> consider the access attempt as allowed;

2> else:

3> if *SIB1* includes *uac-BarringPerPLMN-List* and the *uac-BarringPerPLMN-List* contains an *UAC-BarringPerPLMN* entry with the *plmn-IdentityIndex* corresponding to the PLMN selected by upper layers (see TS 24.501 [23]):

4> select the *UAC-BarringPerPLMN* entry with the *plmn-IdentityIndex* corresponding to the PLMN selected by upper layers;

4> in the remainder of this procedure, use the selected *UAC-BarringPerPLMN* entry (i.e. presence or absence of access barring parameters in this entry) irrespective of the *uac-BarringForCommon* included in *SIB1*;

...

3> else if the *uac-ACBarringListType* indicates that *uac-ImplicitACBarringList* is used:

4> select the *uac-BarringInfoSetIndex* corresponding to the Access Category in the *uac-ImplicitACBarringList*;

4> if the *uac-BarringInfoSetList* contains the *UAC-BarringInfoSet* entry corresponding to the selected *uac-BarringInfoSetIndex*:

5> select the *UAC-BarringInfoSet* entry;

5> perform access barring check for the Access Category as specified in 5.3.14.5, using the selected *UAC-BarringInfoSet* as "UAC barring parameter";

4> else:

- 5> consider the access attempt as allowed;
- 3> else:
 - 4> consider the access attempt as allowed;
- 1> if the access barring check was requested by upper layers:
 - 2> if the access attempt is considered as barred:
 - 3> if timer T302 is running:
 - 4> if timer T390 is running for Access Category '2':
 - 5> inform the upper layer that access barring is applicable for all access categories except categories '0', upon which the procedure ends;
 - 4> else
 - 5> inform the upper layer that access barring is applicable for all access categories except categories '0' and '2', upon which the procedure ends;
 - 3> else:
 - 4> inform upper layers that the access attempt for the Access Category is barred, upon which the procedure ends;
 - 2> else:
 - 3> inform upper layers that the access attempt for the Access Category is allowed, upon which the procedure ends;
- 1> else:
 - 2> the procedure ends.

[TS 38.331, clause 5.3.14.4]

The UE shall:

...

- 1> else if timer T390 corresponding to an Access Category other than '2' expires or is stopped, and if timer T302 is not running:
 - 2> consider the barring for this Access Category to be alleviated;

...

- 1> when barring for an Access Category is considered being alleviated:
 - 2> if the Access Category was informed to upper layers as barred:
 - 3> inform upper layers about barring alleviation for the Access Category.

[TS 38.331, clause 5.3.14.5]

The UE shall:

- 1> if one or more Access Identities are indicated according to TS 24.501 [23], and
 - 1> if for at least one of these Access Identities the corresponding bit in the *uac-BarringForAccessIdentity* contained in "UAC barring parameter" is set to *zero*:
 - 2> consider the access attempt as allowed;
 - 1> else:

- 2> draw a random number '*rand*' uniformly distributed in the range: $0 \leq rand < 1$;
- 2> if '*rand*' is lower than the value indicated by *uac-BarringFactor* included in "UAC barring parameter":
- 3> consider the access attempt as allowed;
- 2> else:
- 3> consider the access attempt as barred;
- 1> if the access attempt is considered as barred:
- 2> draw a random number '*rand*' that is uniformly distributed in the range $0 \leq rand < 1$;
- 2> start timer T390 for the Access Category with the timer value calculated as follows, using the *uac-BarringTime* included in "AC barring parameter":
- $$T390 = (0.7 + 0.6 * rand) * uac-BarringTime.$$

11.3.4.3 Test description

11.3.4.3.1 Pre-test conditions

System Simulator:

- NR Cell 1 and NR Cell 11 have different tracking areas according to TS 38.508-1 [4] Table 4.4.2-3.
- System information combination NR-2 as defined in TS 38.508-1 [4] clause 4.4.3.1.2 is used in NR Cells.

UE:

- None.

Preamble:

- The UE is in state 1N-A on NR cell 1 according to TS 38.508-1 [4] Table 4.4A.2-1.

11.3.4.3.2 Test procedure sequence

Table 11.3.4.3.2-1/2 illustrate the downlink power levels and other changing parameters to be applied for the cell at various time instants of the test execution. The exact instants on which these values shall be applied are described in the texts in this clause. The configuration T0 indicates the initial conditions for preamble. Configurations marked "T1" is applied at the points indicated in the Main behaviour description in Table 11.3.4.3.2-3.

Table 11.3.4.3.2-1: Time instances of cell power level and parameter changes for FR1

	Parameter	Unit	NR Cell 1	NR Cell 11	Remark
T0	SS/PBCH SSS EPRE	dBm/ SCS	-88	Off	
T1	SS/PBCH SSS EPRE	dBm/ SCS	-88	-80	The power level values are assigned to satisfy $R_{NRCell\ 1} < R_{NRCell\ 11}$

Table 11.3.4.3.2-2: Time instances of cell power level and parameter changes for FR2

	Parameter	Unit	NR Cell 1	NR Cell 11	Remark
T0	SS/PBCH SSS EPRE	dBm/ SCS	-91	Off	
T1	SS/PBCH SSS EPRE	dBm/ SCS	-91	-82	The power level values are assigned to satisfy $R_{NRCell\ 1} < R_{NRCell\ 11}$

Table 11.3.4.3.2-3: Main behaviour

St	Procedure	Message Sequence		TP	Verdict
		U - S	Message		
1	Void				
2	The SS adjusts the SS/PBCH EPRE levels and according to row "T1" in table 11.3.4.3.2-1/2.	-	-	-	-
3	Wait for 34s for FR1 or 130s for FR2 to allow UE to recognise the change.(Note 1)				
3A	Wait for 84s for T390 to expire (Note 2)	-	-	-	-
4	Check: Does the UE transmit an RRCSetupRequest message on NR cell 11?	-->	NR RRC: RRCSetupRequest	1	F
5	The SS changes the SIB1 according to 38.508-1 [4] Table 4.6.1-28 and transmits a Short message on PDCCH using P-RNTI indicating a systemInfoModification.	<--	PDCCH (DCI 1_0): Short Message	-	-
6	Wait for one paging cycle.				
7	Void				
8	Check: Does UE transmit RRCSetupRequest message on NR cell 11?	-->	NR RRC: RRCSetupRequest	1	P
9-12	Steps 2 to 5 of the generic test procedure in TS 38.508-1 Table 4.9.5.2.2-1 with condition MOBILITY are performed on NR cell 11. NOTE: The UE performs a "REGISTRATION REQUEST" procedure with type "mobility registration updating".	-	-	-	-
<p>Note 1: The wait time for reselection to a newly detected intra frequency cell is selected to cover $T_{detect,NR_Intra} (25 \cdot 1280ms = 32s \text{ for FR1 and } 25 \cdot 4 \cdot 1280ms = 128s \text{ for FR2}) + T_{SI-NR} (1.28s \text{ for FR1 and FR2}) = 33.28s$ rounded up to 34s for FR1 and 129.28s rounded up to 130s for FR2.</p> <p>Note 2: T390 timer value is derived from 38.331 [12] $T390 = (0.7 + 0.6 \cdot rand) \cdot uac\text{-BarringTime}$ where the $uac\text{-BarringTime}$ value of 64s is provided in 38.523 Table 11.3.4.3.3-1 and where the value of $rand$ is chosen to be 1 as to arrive at the maximum value for T390 of 83.2s rounded up to 84s</p>					

11.3.4.3.3 Specific message contents

Table 11.3.4.3.3-1: SIB1 for NR Cell 11 (Preamble, Table 11.3.4.3.3-1)

Derivation Path: TS 38.508-1 [4], Table 4.6.1-28			
Information Element	Value/remark	Comment	Condition
SIB1 ::= SEQUENCE {			
cellAccessRelatedInfo SEQUENCE {			
PLMN-IdentityInfoList SEQUENCE (SIZE (1..maxPLMN)) OF PLMN-IdentityInfo {	1 entry		
PLMN-IdentityInfo[1] SEQUENCE {		entry 1	
plmn-IdentityList SEQUENCE (SIZE (1..maxPLMN)) OF PLMN-Identity {	1 entry		
plmn-Identity[1]		entry 1 PLMN ID of NR Cell 11	
}			
}			
}			
uac-BarringInfo SEQUENCE {			
uac-BarringForCommon	Not present		
uac-BarringPerPLMN-List SEQUENCE (SIZE (1..maxPLMN)) OF UAC-BarringPerPLMN {			
UAC-BarringPerPLMN SEQUENCE {			
plmn-IdentityIndex	1		
uac-ACBarringListType CHOICE {			

uac-ImplicitACBarringList SEQUENCE (SIZE(maxAccessCat-1)) OF UAC- BarringInfoSetIndex {	63 entries		
UAC-BarringInfoSetIndex[1]	2	entry 1	
UAC-BarringInfoSetIndex[2]	2	entry 2	
UAC-BarringInfoSetIndex[3]	1	entry 3	
UAC-BarringInfoSetIndex[4]	2	entry 4	
UAC-BarringInfoSetIndex[5]	2	entry 5	
UAC-BarringInfoSetIndex[6]	2	entry 6	
UAC-BarringInfoSetIndex[7]	2	entry 7	
UAC-BarringInfoSetIndex[8]	2	entry 8	
UAC-BarringInfoSetIndex[9]	2	entry 9	
UAC-BarringInfoSetIndex[10]	2	entry 10	
UAC-BarringInfoSetIndex[11]	2	entry 11	
UAC-BarringInfoSetIndex[12]	2	entry 12	
UAC-BarringInfoSetIndex[13]	2	entry 13	
UAC-BarringInfoSetIndex[14]	2	entry 14	
UAC-BarringInfoSetIndex[15]	2	entry 15	
UAC-BarringInfoSetIndex[16]	2	entry 16	
UAC-BarringInfoSetIndex[17]	2	entry 17	
UAC-BarringInfoSetIndex[18]	2	entry 18	
UAC-BarringInfoSetIndex[19]	2	entry 19	
UAC-BarringInfoSetIndex[20]	2	entry 20	
UAC-BarringInfoSetIndex[21]	2	entry 21	
UAC-BarringInfoSetIndex[22]	2	entry 22	
UAC-BarringInfoSetIndex[23]	2	entry 23	
UAC-BarringInfoSetIndex[24]	2	entry 24	
UAC-BarringInfoSetIndex[25]	2	entry 25	
UAC-BarringInfoSetIndex[26]	2	entry 26	
UAC-BarringInfoSetIndex[27]	2	entry 27	
UAC-BarringInfoSetIndex[28]	2	entry 28	
UAC-BarringInfoSetIndex[29]	2	entry 29	
UAC-BarringInfoSetIndex[30]	2	entry 30	
UAC-BarringInfoSetIndex[31]	2	entry 31	
UAC-BarringInfoSetIndex[32]	2	entry 32	
UAC-BarringInfoSetIndex[33]	2	entry 33	
UAC-BarringInfoSetIndex[34]	2	entry 34	
UAC-BarringInfoSetIndex[35]	2	entry 35	
UAC-BarringInfoSetIndex[36]	2	entry 36	
UAC-BarringInfoSetIndex[37]	2	entry 37	
UAC-BarringInfoSetIndex[38]	2	entry 38	
UAC-BarringInfoSetIndex[39]	2	entry 39	
UAC-BarringInfoSetIndex[40]	2	entry 40	
UAC-BarringInfoSetIndex[41]	2	entry 41	
UAC-BarringInfoSetIndex[42]	2	entry 42	
UAC-BarringInfoSetIndex[43]	2	entry 43	
UAC-BarringInfoSetIndex[44]	2	entry 44	
UAC-BarringInfoSetIndex[45]	2	entry 45	
UAC-BarringInfoSetIndex[46]	2	entry 46	
UAC-BarringInfoSetIndex[47]	2	entry 47	
UAC-BarringInfoSetIndex[48]	2	entry 48	
UAC-BarringInfoSetIndex[49]	2	entry 49	
UAC-BarringInfoSetIndex[50]	2	entry 50	
UAC-BarringInfoSetIndex[51]	2	entry 51	
UAC-BarringInfoSetIndex[52]	2	entry 52	
UAC-BarringInfoSetIndex[53]	2	entry 53	
UAC-BarringInfoSetIndex[54]	2	entry 54	
UAC-BarringInfoSetIndex[55]	2	entry 55	
UAC-BarringInfoSetIndex[56]	2	entry 56	
UAC-BarringInfoSetIndex[57]	2	entry 57	
UAC-BarringInfoSetIndex[58]	2	entry 58	
UAC-BarringInfoSetIndex[59]	2	entry 59	
UAC-BarringInfoSetIndex[60]	2	entry 60	
UAC-BarringInfoSetIndex[61]	2	entry 61	
UAC-BarringInfoSetIndex[62]	2	entry 62	

UAC-BarringInfoSetIndex[63]	2	entry 63	
}			
}			
}			
uac-BarringInfoSetList SEQUENCE (SIZE(1..maxBarringInfoSet)) OF UAC-BarringInfoSet {	1 entry		
UAC-BarringInfoSet[1] SEQUENCE {		entry 1	
uac-BarringFactor	p00		
uac-BarringTime	s64		
uac-BarringForAccessIdentity	'0000000'B		
}			
uac-AccessCategory1-SelectionAssistanceInfo	Not Present		
}			
}			
Note : UAC-BarringInfoSetIndex value 2 referring to an entry not included in uac-BarringInfoSetList indicates no barring for the Access Category.			

11.3.5 UAC / Access Identity 1 / New cell not in the country of its HPLMN/EHPLMN 0% access probability / MPS indicator / HPLMN/0%/100% accessibility AC5 / MMTEL-Video call

11.3.5.1 Test Purpose (TP)

(1)

```
with { UE configured for Access Identity 1 }
ensure that {
  when { UE moves to a new cell which is not in the country of its HPLMN or in an EHPLMN (if the
EHPLMN list is present) having received SIB1 message including UAC set to 0% accessibility for
Access Category 7 and Access Identity 1 is exempted from the access barring check }
  then { UE does not consider Access Identity 1 as valid and does not initiate RRC connection
since Access Identity 0 is not exempted from the access barring check until barring for Access
Category 7 is removed }
}
```

(2)

```
with { UE configured for Access Identity 1 }
ensure that {
  when { UE moves to a new cell which is not in the country of its HPLMN or in an EHPLMN (if the
EHPLMN list is present) but receives the MPS indicator bit of the 5GS network feature support IE in
the REGISTRATION ACCEPT message being set to "Access identity 1 valid" }
  then { UE does consider Access Identity 1 as valid }
}
```

(3)

```
with { UE configured for Access Identity 1 having received SIB1 containing UAC Barring Info
indicating 0% accessibility for Access Category 5 in NR RRC_IDLE state on HPLMN }
ensure that {
  when { User initiates MMTEL-Video call }
  then { UE does not attempt to initiate connection on the NR Cell }
}
```

(4)

```
with { UE configured for Access Identity 1 having received SIB1 containing UAC Info indicating 100%
accessibility for Access Category 5 while camped on HPLMN in NR RRC_IDLE state }
ensure that {
  when { User initiates MMTEL-Video call and Access Barring check indicates Barring is alleviated }
  then { UE initiates RRC Connection Setup procedure with establishmentCause set to mps-
PriorityAccess }
}
```

11.3.5.2 Conformance requirements

References: The conformance requirements covered in the present TC are specified in TS 24.501: clause 4.5.2, 4.5.4.1 and 4.5.6 and TS 38.331: clause 5.3.14.1, 5.3.14.2, 5.3.14.4 and 5.3.14.5. Unless otherwise stated these are Rel-15 requirements.

[TS 24.501, clause 4.5.2]

When the UE needs to initiate an access attempt in one of the events listed in subclause 4.5.1, the UE shall determine one or more access identities from the set of standardized access identities, and one access category from the set of standardized access categories and operator-defined access categories, to be associated with that access attempt.

The set of the access identities applicable for the request is determined by the UE in the following way:

- a) for each of the access identities 1, 2, 11, 12, 13, 14 and 15 in table 4.5.2.1, the UE shall check whether the access identity is applicable in the selected PLMN, if a new PLMN is selected, or otherwise if it is applicable in the RPLMN or equivalent PLMN; and
- b) if none of the above access identities is applicable, then access identity 0 is applicable.

Table 4.5.2.1: Access identities

Access Identity number	UE configuration
0	UE is not configured with any parameters from this table
1 (NOTE 1)	UE is configured for multimedia priority service (MPS).
2 (NOTE 2)	UE is configured for mission critical service (MCS).
3-10	Reserved for future use
11 (NOTE 3)	Access Class 11 is configured in the UE.
12 (NOTE 3)	Access Class 12 is configured in the UE.
13 (NOTE 3)	Access Class 13 is configured in the UE.
14 (NOTE 3)	Access Class 14 is configured in the UE.
15 (NOTE 3)	Access Class 15 is configured in the UE.
NOTE 1: Access identity 1 is valid when: <ul style="list-style-type: none"> - the USIM file EFUAC_AIC indicates the UE is configured for access identity 1 and the RPLMN is the HPLMN (if the EHPLMN list is not present or is empty) or EHPLMN (if the EHPLMN list is present), or a visited PLMN of the home country (see the definition of home country in 3GPP TS 24.301 [15]); or - the UE receives the 5GS network feature support IE with the MPS indicator bit set to "Access identity 1 valid in RPLMN or equivalent PLMN" from the RPLMN as described in subclause 5.5.1.2.4 and subclause 5.5.1.3.4. 	
NOTE 2: Access identity 2 is used by UEs configured for MCS and is valid when: <ul style="list-style-type: none"> - the USIM file EFUAC_AIC indicates the UE is configured for access identity 2 and the RPLMN is the HPLMN (if the EHPLMN list is not present or is empty) or EHPLMN (if the EHPLMN list is present), or a visited PLMN of the home country (see 3GPP TS 23.122 [5]); or - the UE receives the 5GS network feature support IE with the MCS indicator bit set to "Access identity 2 valid in RPLMN or equivalent PLMN" from the RPLMN as described in subclause 5.5.1.2.4 and subclause 5.5.1.3.4. 	
NOTE 3: Access identities 11 and 15 are valid in HPLMN (if the EHPLMN list is not present or is empty) or EHPLMN (if the EHPLMN list is present). Access Identities 12, 13 and 14 are valid in HPLMN and visited PLMNs of home country only (see the definition of home country in 3GPP TS 24.301 [15]).	

The UE uses the MPS indicator bit of the 5GS network feature support IE to determine if access identity 1 is valid. Processing of the MPS indicator bit of the 5GS network feature support IE in the REGISTRATION ACCEPT message is described in subclause 5.5.1.2.4 and subclause 5.5.1.3.4. The UE shall not consider access identity 1 to be valid when the UE is not in the country of its HPLMN prior to receiving the MPS indicator bit of the 5GS network feature support IE in the REGISTRATION ACCEPT message being set to "Access identity 1 valid in RPLMN or equivalent PLMN".

When the UE is in the country of its HPLMN, the contents of the USIM files EF_{UAC_AIC} and EF_{ACC} as specified in 3GPP TS 31.102 [22] and the rules specified in table 4.5.2.1 are used to determine the applicability of access identity 1 and access classes 11 - 15. When the UE is in the country of its HPLMN, and the USIM file EF_{UAC_AIC} does not indicate the UE is configured for access identity 1, the UE uses the MPS indicator bit of the 5GS network feature support IE in the REGISTRATION ACCEPT message to determine if access identity 1 is valid. When the UE is in the country of its

HPLMN, and the USIM file EF_{UAC_AIC} indicates the UE is configured for access identity 1, the MPS indicator bit of the 5GS network feature support IE is not applicable. When the UE is not in the country of its HPLMN, the contents of the USIM files EF_{UAC_AIC} and EF_{ACC} are not applicable.

The UE uses the MCS indicator bit of the 5GS network feature support IE to determine if access identity 2 is valid. Processing of the MCS indicator bit of the 5GS network feature support IE in the REGISTRATION ACCEPT message is described in subclause 5.5.1.2.4 and subclause 5.5.1.3.4. The UE shall not consider access identity 2 to be valid when the UE is not in the country of its HPLMN prior to receiving the MCS indicator bit of the 5GS network feature support IE in the REGISTRATION ACCEPT message being set to "Access identity 2 valid in RPLMN or equivalent PLMN".

When the UE is in the country of its HPLMN, the contents of the USIM files EF_{UAC_AIC} and EF_{ACC} as specified in 3GPP TS 31.102 [22] and the rules specified in table 4.5.2.1 are used to determine the applicability of access identity 2 and access classes 11 - 15. When the UE is in the country of its HPLMN, and the USIM file EF_{UAC_AIC} does not indicate the UE is configured for access identity 2, the UE uses the MCS indicator bit of the 5GS network feature support IE in the REGISTRATION ACCEPT message to determine if access identity 2 is valid. When the UE is in the country of its HPLMN, and the USIM file EF_{UAC_AIC} indicates the UE is configured for access identity 2, the MCS indicator bit of the 5GS network feature support IE is not applicable. When the UE is not in the country of its HPLMN, the contents of the USIM files EF_{UAC_AIC} and EF_{ACC} are not applicable.

In order to determine the access category applicable for the access attempt, the NAS shall check the rules in table 4.5.2.2, and use the access category for which there is a match for barring check. If the access attempt matches more than one rule, the access category of the lowest rule number shall be selected. If the access attempt matches more than one operator-defined access category definition, the UE shall select the access category from the operator-defined access category definition with the lowest precedence value (see subclause 4.5.3).

NOTE: The case when an access attempt matches more than one rule includes the case when multiple events trigger an access attempt at the same time.

Table 4.5.2.2: Mapping table for access categories

Rule #	Type of access attempt	Requirements to be met	Access Category
1	Response to paging or NOTIFICATION over non-3GPP access; 5GMM connection management procedure initiated for the purpose of transporting an LPP message	Access attempt is for MT access	0 (= MT_acc)
2	Emergency	UE is attempting access for an emergency session (NOTE 1, NOTE 2)	2 (= emergency)
3	Access attempt for operator-defined access category	UE stores operator-defined access category definitions valid in the current PLMN as specified in subclause 4.5.3, and access attempt is matching criteria of an operator-defined access category definition	32-63 (= based on operator classification)
4	Access attempt for delay tolerant service	(a) UE is configured for NAS signalling low priority or UE supporting S1 mode is configured for EAB (see the "ExtendedAccessBarring" leaf of NAS configuration MO in 3GPP TS 24.368 [17] or 3GPP TS 31.102 [22]) where "EAB override" does not apply, and (b) the UE received one of the categories a, b or c as part of the parameters for unified access control in the broadcast system information, and the UE is a member of the broadcasted category in the selected PLMN or RPLMN/equivalent PLMN (NOTE 3, NOTE 5, NOTE 6, NOTE 7, NOTE 8)	1 (= delay tolerant)
5	MO MMTel voice call	Access attempt is for MO MMTel voice call or for NAS signalling connection recovery during ongoing MO MMTel voice call (NOTE 2)	4 (= MO MMTel voice)

6	MO MMTel video call	Access attempt is for MO MMTel video call or for NAS signalling connection recovery during ongoing MO MMTel video call (NOTE 2)	5 (= MO MMTel video)
7	MO SMS over NAS or MO SMSoIP	Access attempt is for MO SMS over NAS (NOTE 4) or MO SMS over SMSoIP transfer or for NAS signalling connection recovery during ongoing MO SMS or SMSoIP transfer (NOTE 2)	6 (= MO SMS and SMSoIP)
8	UE NAS initiated 5GMM specific procedures	Access attempt is for MO signalling	3 (= MO_sig)
9	UE NAS initiated 5GMM connection management procedure or 5GMM NAS transport procedure	Access attempt is for MO data	7 (= MO_data)
10	An uplink user data packet is to be sent for a PDU session with suspended user-plane resources	No further requirement is to be met	7 (= MO_data)
<p>NOTE 1: This includes 5GMM specific procedures while the service is ongoing and 5GMM connection management procedures required to establish a PDU session with request type = "initial emergency request" or "existing emergency PDU session", or to re-establish user-plane resources for such a PDU session. This further includes the service request procedure initiated with a SERVICE REQUEST message with the Service type IE set to "emergency services fallback".<</p> <p>NOTE 2: Access for the purpose of NAS signalling connection recovery during an ongoing service, or for the purpose of NAS signalling connection establishment following fallback indication from lower layers during an ongoing service, is mapped to the access category of the ongoing service in order to derive an RRC establishment cause, but barring checks will be skipped for this access attempt.</p> <p>NOTE 3: If the UE selects a new PLMN, then the selected PLMN is used to check the membership; otherwise the UE uses the RPLMN or a PLMN equivalent to the RPLMN.</p> <p>NOTE 4: This includes the 5GMM connection management procedures triggered by the UE-initiated NAS transport procedure for transporting the MO SMS.</p> <p>NOTE 5: The UE configured for NAS signalling low priority is not supported in this release of specification. If a UE supporting both S1 mode and N1 mode is configured for NAS signalling low priority in S1 mode as specified in 3GPP TS 24.368 [17] or 3GPP TS 31.102 [22], the UE shall ignore the configuration for NAS signalling low priority when in N1 mode.</p> <p>NOTE 6: If the access category applicable for the access attempt is 1, then the UE shall additionally determine a second access category from the range 3 to 7. If more than one access category matches, the access category of the lowest rule number shall be chosen. The UE shall use the second access category only to derive an RRC establishment cause for the access attempt.</p> <p>NOTE 7: "EAB override" does not apply, if the UE is not configured to allow overriding EAB (see the "Override_ExtendedAccessBarring" leaf of NAS configuration MO in 3GPP TS 24.368 [17] or 3GPP TS 31.102 [22]), or if NAS has not received an indication from the upper layers to override EAB and the UE does not have a PDU session that was established with EAB override.</p> <p>NOTE 8: For the definition of categories a, b and c associated with access category 1, see 3GPP TS 22.261 [3]. The categories associated with access category 1 are distinct from the categories a, b and c associated with EAB (see 3GPP TS 22.011 [1A]).</p>			

[TS 24.501, clause 4.5.4.1]

When the UE is in 5GMM-IDLE mode, upon receiving a request from the upper layers for an access attempt, the NAS shall categorize the access attempt into access identities and an access category following subclause 4.5.2, table 4.5.2.1 and table 4.5.2.2, and subclause 4.5.3, and provide the applicable access identities and the access category to the lower layers for the purpose of access control checking. In this request to the lower layer the NAS can also provide to the lower layer the RRC establishment cause determined as specified in subclause 4.5.6 of this specification.

NOTE 1: The access barring check is performed by the lower layers.

NOTE 2: As an implementation option, the NAS can provide the RRC establishment cause to the lower layers after being informed by the lower layers that the access attempt is allowed.

If the UE has uplink user data pending for one or more PDU sessions when it builds a REGISTRATION REQUEST or SERVICE REQUEST message as initial NAS message, the UE shall indicate the respective PDU sessions in the Uplink

data status IE as specified in subclause 5.5.1.3.2 and 5.6.1.2, regardless of the access category for which the access barring check is performed.

NOTE 3: The UE indicates pending user data for all the respective PDU sessions, even if barring timers are running for some of the corresponding access categories.

If the lower layers indicate that the access attempt is allowed, the NAS shall initiate the procedure to send the initial NAS message for the access attempt.

If the lower layers indicate that the access attempt is barred, the NAS shall not initiate the procedure to send the initial NAS message for the access attempt. Additionally:

- a) if the event which triggered the access attempt was an MO-MMTEL-voice-call-started indication or an MO-MMTEL-video-call-started indication:
 - 1) if the UE is operating in the single-registration mode and the UE's usage setting is "voice centric", the UE may attempt to select an E-UTRA cell connected to EPC. If the UE finds a suitable E-UTRA cell connected to EPC, it then proceeds with the appropriate EMM specific procedures and, if necessary, ESM procedures to make a PDN connection providing access to IMS available; see subclause 4.8.2 and 3GPP TS 24.301 [15];
 - 2) if the UE is operating in the dual-registration mode, the UE may proceed in S1 mode with the appropriate EMM specific procedures and ESM procedures to make a PDN connection providing access to IMS available; see subclause 4.8.3 and 3GPP TS 24.301 [15];
 - 3) otherwise, the NAS shall notify the upper layers that the access attempt is barred. In this case, upon receiving an indication from the lower layers that the barring is alleviated for the access category with which the access attempt was associated, the NAS shall notify the upper layers that the barring is alleviated for the access category and may initiate the procedure to send the initial NAS message, if still needed; and
- b) if the event which triggered the access attempt was an MO-SMSoIP-attempt-started indication:
 - 1) if the UE is operating in the single-registration mode, the UE may attempt to select an E-UTRA cell connected to EPC. If the UE finds a suitable E-UTRA cell connected to EPC, it then proceeds with the appropriate EMM specific procedures and, if necessary, ESM procedures to make a PDN connection providing access to IMS available; see subclause 4.8.2 and 3GPP TS 24.301 [15];
 - 2) if the UE is operating in the dual-registration mode, the UE may proceed in S1 mode with the appropriate EMM specific procedures and ESM procedures to make a PDN connection providing access to IMS available; see subclause 4.8.3 and 3GPP TS 24.301 [15];
 - 3) otherwise, the NAS layer shall notify the upper layers that the access attempt is barred. In this case, upon receiving an indication from the lower layers that the barring is alleviated for the access category with which the access attempt was associated, the NAS shall notify the upper layers that the barring is alleviated for the access category and may initiate the procedure to send the initial NAS message, if still needed.

NOTE 4: Barring timers, on a per access category basis, are run by the lower layers. At expiry of barring timers, the indication of alleviation of access barring is indicated to the NAS on a per access category basis.

[TS 24.501, clause 4.5.6]

When 5GMM requests the establishment of a NAS-signalling connection, the RRC establishment cause used by the UE shall be selected according to one or more access identities (see subclause 4.5.2) and the determined access category as specified in table 4.5.6.1 and table 4.5.6.2. If the determined access category is an operator-defined access category, then the RRC establishment cause used by the UE shall be selected according to table 4.5.6.1 and table 4.5.6.2 based on one or more access identities (see subclause 4.5.2) and the standardized access category determined for the operator-defined access category as described in subclause 4.5.3.

Table 4.5.6.1: Mapping table for access identities/access categories and RRC establishment cause when establishing N1 NAS signalling connection via NR connected to 5GCN

Access identities	Access categories	RRC establishment cause is set to
0	0 (= MT_acc)	mt-Access
	1 (= delay tolerant)	Not applicable (NOTE 1)
	2 (= emergency)	emergency

	3 (= MO_sig)	mo-Signalling
	4 (= MO MMTel voice)	mo-VoiceCall
	5 (= MO MMTel video)	mo-VideoCall
	6 (= MO SMS and SMSoIP)	mo-SMS
	7 (= MO_data)	mo-Data
1	Any category	mps-PriorityAccess
2	Any category	mcs-PriorityAccess
11, 15	Any category	highPriorityAccess
12,13,14,	Any category	highPriorityAccess
NOTE 1: A UE using access category 1 for the access barring check will determine a second access category in the range 3 to 7 that is to be used for determination of the RRC establishment cause. See subclause 4.5.2, table 4.5.2.2, NOTE 6.		
NOTE 2: See subclause 4.5.2, table 4.5.2.1 for use of the access identities of 0, 1, 2, and 11-15.		

Table 4.5.6.2: Mapping table for access identities/access categories and RRC establishment cause when establishing N1 NAS signalling connection via E-UTRA connected to 5GCN

Access identities	Access categories	RRC establishment cause is set to
0	0 (= MT_acc)	mt-Access
	1 (= delay tolerant)	Not applicable (NOTE 1)
	2 (= emergency)	emergency
	3 (= MO_sig)	mo-Signalling
	4 (= MO MMTel voice)	mo-VoiceCall
	5 (= MO MMTel video)	mo-VoiceCall
	6 (= MO SMS and SMSoIP)	mo-Data
	7 (= MO_data)	mo-Data
1	Any category	highPriorityAccess
2	Any category	highPriorityAccess
11, 15	Any category	highPriorityAccess
12,13,14,	Any category	highPriorityAccess
NOTE 1: A UE using access category 1 for the access barring check will determine a second access category in the range 3 to 7 that is to be used for determination of the RRC establishment cause. See subclause 4.5.2, table 4.5.2.2, NOTE 6.		
NOTE 2: See subclause 4.5.2, table 4.5.2.1 for use of the access identities of 0, 1, 2, and 11-15.		

[TS 38.331, clause 5.3.14.1]

The purpose of this procedure is to perform access barring check for an access attempt associated with a given Access Category and one or more Access Identities upon request from upper layers according to TS 24.501 [23] or the RRC layer.

After a handover resulting in change of PCell in RRC_CONNECTED the UE shall defer access barring checks until it has obtained valid UAC information (from *SIB1*) from the target cell.

[TS 38.331, clause 5.3.14.2]

Upon initiation of the procedure, the UE shall:

- 1> if timer T390 is running for the Access Category:
 - 2> consider the access attempt as barred;
- 1> else if timer T302 is running and the Access Category is neither '2' nor '0':
 - 2> consider the access attempt as barred;
- 1> else:
 - 2> if the Access Category is '0':
 - 3> consider the access attempt as allowed;
 - 2> else:

- 3> if *SIB1* includes *uac-BarringPerPLMN-List* and the *uac-BarringPerPLMN-List* contains an *UAC-BarringPerPLMN* entry with the *plmn-IdentityIndex* corresponding to the PLMN selected by upper layers (see TS 24.501 [23]):
 - 4> select the *UAC-BarringPerPLMN* entry with the *plmn-IdentityIndex* corresponding to the PLMN selected by upper layers;
 - 4> in the remainder of this procedure, use the selected *UAC-BarringPerPLMN* entry (i.e. presence or absence of access barring parameters in this entry) irrespective of the *uac-BarringForCommon* included in *SIB1*;
 - 3> else if *SIB1* includes *uac-BarringForCommon*:
 - 4> in the remainder of this procedure use the *uac-BarringForCommon* (i.e. presence or absence of these parameters) included in *SIB1*;
 - 3> else:
 - 4> consider the access attempt as allowed;
 - 3> if *uac-BarringForCommon* is applicable or the *uac-ACBarringListType* indicates that *uac-ExplicitACBarringList* is used:
 - 4> if the corresponding *UAC-BarringPerCatList* contains a *UAC-BarringPerCat* entry corresponding to the Access Category:
 - 5> select the *UAC-BarringPerCat* entry;
 - 5> if the *uac-BarringInfoSetList* contains a *UAC-BarringInfoSet* entry corresponding to the selected *uac-barringInfoSetIndex* in the *UAC-BarringPerCat*:
 - 6> select the *UAC-BarringInfoSet* entry;
 - 6> perform access barring check for the Access Category as specified in 5.3.14.5, using the selected *UAC-BarringInfoSet* as "UAC barring parameter";
 - 5> else:
 - 6> consider the access attempt as allowed;
 - 4> else:
 - 5> consider the access attempt as allowed;
 - 3> else if the *uac-ACBarringListType* indicates that *uac-ImplicitACBarringList* is used:
 - 4> select the *uac-BarringInfoSetIndex* corresponding to the Access Category in the *uac-ImplicitACBarringList*;
 - 4> if the *uac-BarringInfoSetList* contains the *UAC-BarringInfoSet* entry corresponding to the selected *uac-BarringInfoSetIndex*:
 - 5> select the *UAC-BarringInfoSet* entry;
 - 5> perform access barring check for the Access Category as specified in 5.3.14.5, using the selected *UAC-BarringInfoSet* as "UAC barring parameter";
 - 4> else:
 - 5> consider the access attempt as allowed;
 - 3> else:
 - 4> consider the access attempt as allowed;
- 1> if the access barring check was requested by upper layers:

- 2> if the access attempt is considered as barred:
 - 3> if timer T302 is running:
 - 4> inform the upper layer that access barring is applicable for all access categories except categories '0' and '2', upon which the procedure ends;
 - 3> else:
 - 4> inform upper layers that the access attempt for the Access Category is barred, upon which the procedure ends;
- 2> else:
 - 3> inform upper layers that the access attempt for the Access Category is allowed, upon which the procedure ends;
- 1> else:
 - 2> the procedure ends.

[TS 38.331, clause 5.3.14.4]

The UE shall:

- 1> if timer T302 expires or is stopped, and if timer T390 corresponding to an Access Category is not running; or
- 1> if timer T390 corresponding to an Access Category other than '2' expires or is stopped, and if timer T302 is not running; or
- 1> if timer T390 corresponding to the Access Category '2' expires or is stopped:
 - 2> consider the barring for this Access Category to be alleviated;
- 1> when barring for an Access Category is considered being alleviated:
 - 2> if the Access Category was informed to upper layers as barred:
 - 3> inform upper layers about barring alleviation for the Access Category.
 - 2> if barring is alleviated for Access Category '8':
 - 3> perform actions specified in 5.3.13.8;

[TS 38.331, clause 5.3.14.5]

The UE shall:

- 1> if one or more Access Identities are indicated according to TS 24.501 [23], and
- 1> if for at least one of these Access Identities the corresponding bit in the *uac-BarringForAccessIdentity* contained in "UAC barring parameter" is set to *zero*:
 - 2> consider the access attempt as allowed;
- 1> else:
 - 2> draw a random number '*rand*' uniformly distributed in the range: $0 \leq rand < 1$;
 - 2> if '*rand*' is lower than the value indicated by *uac-BarringFactor* included in "UAC barring parameter":
 - 3> consider the access attempt as allowed;
 - 2> else:
 - 3> consider the access attempt as barred;
- 1> if the access attempt is considered as barred:

- 2> draw a random number '*rand*' that is uniformly distributed in the range $0 \leq rand < 1$;
- 2> start timer T390 for the Access Category with the timer value calculated as follows, using the *uac-BarringTime* included in "AC barring parameter":

$$T390 = (0.7 + 0.6 * rand) * uac-BarringTime.$$

11.3.5.3 Test description

11.3.5.3.1 Pre-test conditions

System Simulator:

- 2 NR cells: NR Cell 1 and 12 as specified in TS 38.508-1 [4] table 4.4.2-3 are configured as shown in Table 11.3.5.3.1–1. PLMN settings are defined in TS 36.523-1 [13] table 6.0.1-1.

Table 11.3.5.3.1–1: PLMN identifiers

NR Cell	PLMN names
NR Cell 1	PLMN1
NR Cell 12	PLMN2

- System information combination NR-1 as defined in TS 38.508-1 [4] Table 4.4.3.1.2-1 is used in NR cells.

UE:

- The UE is equipped with USIM configuration 18 as defined in TS 38.508-1 [4] Table 6.4.1-18.

Preamble:

- The UE is in state 1N-A, RRC_IDLE Connectivity (NR), in accordance with the procedure described in TS 38.508-1 [4], clause 4.5.2.

11.3.5.3.2 Test procedure sequence

Table 11.3.5.3.2-1 for FR1 and Table 11.3.5.3.2-2 for FR2 illustrates the downlink power levels and other changing parameters to be applied for the cells at various time instants of the test execution. Row marked "T0" denotes the initial conditions in preamble, while columns marked "T1", "T2" and "T3" are to be applied subsequently in the Main behaviour. The exact instants on which these values shall be applied are described in the texts in this clause.

Table 11.3.5.3.2-1: Time instances of cell power level and parameter changes for FR1

	Parameter	Unit	NR Cell 1	NR Cell 12	Remarks
T0	SS/PBCH SSS EPRE	dBm/SCS	-88	Off	The power level values are assigned to ensure UE registered on NR Cell 1.
T1	SS/PBCH SSS EPRE	dBm/SCS	Off	-80	The power level values are assigned to ensure UE registered on NR Cell 12.
T2	SS/PBCH SSS EPRE	dBm/SCS	-80	Off	The power level values are assigned to ensure UE registered on NR Cell 1.
Note 1: Power level "Off" is defined in TS 38.508-1 [4] Table 6.2.2.1-3.					

Table 11.3.5.3.2-2: Time instances of cell power level and parameter changes for FR2

	Parameter	Unit	NR Cell 1	NR Cell 12	Remarks
T0	SS/PBCH SSS EPRE	dBm/SCS	FFS	Off	The power level values are assigned to ensure UE registered on NR Cell 1.
T1	SS/PBCH SSS EPRE	dBm/SCS	Off	FFS	The power level values are assigned to ensure UE registered on NR Cell 12.
T2	SS/PBCH SSS EPRE	dBm/SCS	FFS	Off	The power level values are assigned to ensure UE registered on NR Cell 1.
Note 1: Power level "Off" is defined in TS 38.508-1 [4] Table 6.2.2.2-2.					

Table 11.3.5.3.2-3: Main behaviour

St	Procedure	Message Sequence		TP	Verdict
		U - S	Message		
1	The SS adjusts the NR Cells power levels according to row "T1" in table 11.3.5.3.2-1/2.	-	-	-	-
1A	Void	-	-	-	-
1B	Void	-	-	-	-
2	The UE transmits <i>RRCSetupRequest</i> message on NR cell 12. Check: Does the <i>RRCSetupRequest</i> message includes the <i>establishmentCause</i> which is any value except <i>mps-PriorityAccess</i> ?	-->	NR RRC: <i>RRCSetupRequest</i>	1	P
2A-2B	Steps 3-4 of Table 4.5.2.2-2 of the generic procedure in TS 38.508-1 [4] are performed on NR Cell 12. (Note 2)	-	-	-	-
-	EXCEPTION: Steps 2Ca1 to 2Cb3a1 describe behaviour that depends on events happening prior to their execution; the "lower case letter" identifies a step sequence that take place if a specific prior event takes place.	-	-	-	-
2C a1-2C a15	IF 5GS registration type is set as Initial Registration in step 2B, THEN Steps 5 to 19 of the generic test procedure in TS 38.508-1 Table 4.5.2.2-2 are performed without RRC release on NR Cell 12.	-	-	-	-
2C b1-2C b2	IF 5GS registration type is set as Mobility Registration in step 2B, THEN Steps 4 to 5 of the generic test procedure in TS 38.508-1 Table 4.9.5.2.2-1 are performed without RRC release on NR Cell 12.	-	-	-	-
3-10	Void	-	-	-	-
10 A	The SS transmits an <i>RRCRelease</i> message and move the UE to <i>RRC_IDLE</i> .	<--	NR RRC: <i>RRCRelease</i>	-	-
10 B	Make the UE attempt to establish a PDU session. This can be done by an AT/MMI command.	-	-	-	-
10 C	Check: Does the UE transmit an <i>RRCSetupRequest</i> message within 21s on NR Cell 12? (Note3)	-->	NR RRC: <i>RRCSetupRequest</i>	1	F
10 D	SS changes SIB1 of NR Cell 12 according to Table 11.3.5.3.3-2 and sends Short Message on PDCCH using P-RNTI.	-	-	-	-
10 E	Start Timer=28 sec. (Note4)	-	-	-	-
-	EXCEPTION: Steps 10Ea1-10Eb3 describes optional behaviour that depends on the UE implementation.	-	-	-	-
10 Ea 1	Check: Does the UE transmit an <i>RRCSetupRequest</i> message and <i>establishmentCause</i> is set to <i>mo-Data</i> ?	-->	NR RRC: <i>RRCSetupRequest</i>	1	P
10 Ea 2	Stop Timer=28 sec.	-	-	-	-
10e b1	Timer=28 sec expires	-	-	-	-
10 Eb 2	Make the UE attempt to establish a PDU session. This can be done by an AT/MMI command.	-	-	-	-
10 Eb 3	Check: Does the UE transmit an <i>RRCSetupRequest</i> message and <i>establishmentCause</i> is set to <i>mo-Data</i> ?	-->	NR RRC: <i>RRCSetupRequest</i>	1	P
10F a1-	Steps 3-8 of the generic procedure for	-	-	-	-

10F a8	NR RRC_Connected specified in TS 38.508-1 Table 4.5.2.2-4 are performed without RRC release.				
10 H	The UE is switched off by executing generic procedure in Table 4.9.6.3-1 in TS 38.508-1 [4]	-	-	-	-
11	Void	-	-	-	-
11 A	The SS adjusts the NR Cells power levels according to row "T2" in table 11.3.5.3.2-1/2.	-	-	-	-
11 B	The UE is Switched ON. The generic test procedure in TS 38.508-1 [4] Table 4.5.2.2-2 indicate that the UE performs registration on NR Cell 1.	-	-	-	-
11 C	The SS adjusts the NR Cells power levels according to row "T1" in table 11.3.5.3.2-1/2.	-	-	-	-
11 D- 11F	Steps 2-4 of Table 4.5.2.2-2 of the generic procedure in TS 38.508-1 [4] are performed on NR Cell 12. (Note 2)	-	-	-	-
-	EXCEPTION: Steps 11Fa1 to 11Fb3a1 describe behaviour that depends on events happening prior to their execution; the "lower case letter" identifies a step sequence that take place if a specific prior event takes place.	-	-	-	-
11F a1- 11F a16 a1	IF 5GS registration type is set as Initial Registration in step 11F, THEN Steps 5 to 20a1 of the generic test procedure in TS 38.508- 1 Table 4.5.2.2-2 are performed on NR Cell 12.	-	-	-	-
11F b1- 11F b3a 1	IF 5GS registration type is set as Mobility Registration in step 211F, THEN Steps 4 to 6a1 of the generic test procedure in TS 38.508-1 Table 4.9.5.2.2-1 are performed on NR Cell 12.	-	-	-	-
12	The SS transmits a <i>Paging</i> message.	<--	NR RRC: <i>Paging</i>	-	-
13	Void	-	-	-	-
14	Check: Does the UE transmit a <i>RRCSetupRequest</i> message including establishmentCause equal to <i>mps- PriorityAccess</i> within 10 s?	-->	NR RRC: <i>RRCSetupRequest</i>	2	P
15- 20	Steps 3 to 8 of the NR RRC_CONNECTED procedure in TS 38.508-1 [4] Table 4.5.4.2-3 are performed.	-	-	-	-
21- 23	Void	-	-	-	-
24	The SS transmits an <i>RRCRelease</i> message to release RRC connection and moves the UE to <i>RRC_IDLE</i> .	<--	NR RRC: <i>RRCRelease</i>	-	-
25	SS changes SIB1 of NR cell 1 according to Table 11.3.5.3.3-1.	-	-	-	-
26	The SS adjusts the NR Cells power levels according to row "T2" in table 11.3.5.3.2-1/2.	-	-	-	-
26 A- 26 C	Steps 2-4 of Table 4.5.2.2-2 of the generic procedure in TS 38.508-1 [4] are performed. (Note 2)	-	-	-	-
-	EXCEPTION: Steps 26Da1 to 26Db3a1 describe behaviour that depends on events happening prior to their execution; the "lower case letter" identifies a step sequence that take place if a specific prior event takes place.	-	-	-	-
26 Da 1- 26 Da 16a 1	IF 5GS registration type is set as Initial Registration in step 26C, THEN Steps 5 to 20a1 of the generic test procedure in TS 38.508- 1 Table 4.5.2.2-2 are performed on NR Cell 1.	-	-	-	-

26 Db 1- 26 Db 3a1	IF 5GS registration type is set as Mobility Registration in step 26C, THEN Steps 4 to 6a1 of the generic test procedure in TS 38.508-1 Table 4.9.5.2.2-1 are performed on NR Cell 1.	-	-	-	-
27- 32a 1	Void	-	-	-	-
33	AT command to make the UE attempt MMTEL-Video call.	-	-	-	-
34	Check: Does the UE transmit an <i>RRCSetupRequest</i> message including establishmentCause equal to <i>mps-PriorityAccess</i> within 6 s?	-->	NR RRC: <i>RRCSetupRequest</i>	3	F
35	SS changes <i>SIB1</i> of NR cell 1 according to Table 11.3.5.3.3-1 and notifies the UE of change of System Information on NR Cell 1 by send Short Message on PDCCH using P-RNTI.	<--	PDCCH (DCI 1_0): Short Message	-	-
35 A	SS starts timer T_Delay=26 sec.	-	-	-	-
-	EXCEPTION: Steps 35Aa1 to 35Ab3 describe behaviour that depends on the UE implementation; the "lower case letter" identifies a step sequence that take place depending on the UE implementation.	-	-	-	-
35 Aa 1	Check: Does the UE transmit an <i>RRCSetupRequest</i> message including establishmentCause equal to <i>mps-PriorityAccess</i> ?	-->	NR RRC: <i>RRCSetupRequest</i>	4	P
35 Aa 2	SS stops timer T_Delay=26 sec.	-	-	-	-
35 Ab 1	timer T_Delay=26 sec expires.	-	-	-	-
35 Ab 2	Make the UE attempt another MMTEL-Video call.	-	-	-	-
35 Ab 3	Check: Does the UE transmit an <i>RRCSetupRequest</i> message including establishmentCause equal to <i>mps-PriorityAccess</i> within 10 s?	-->	NR RRC: <i>RRCSetupRequest</i>	4	P
36- 38	Void	-	-	-	-
39- 49b 3	Steps 3-13b3 of generic test procedure for IMS MO Video call establishment in 5GC as specified in 38.508-1 [4] Table 4.9.24.2.2-1 are performed.	-	-	-	-
50	The generic test procedure for IMS MT call release in 5GC as specified in TS 38.508-1 [4] Table 4.9.18.2.2-1 takes place.	-	-	-	-
<p>Note 1: The SS includes a 5GS network feature support IE in the REGISTRATION ACCEPT message configured as Table 11.3.5.3.3-3.</p> <p>Note 2: The 5GS registration type shall be only set as Mobility Registration for R16 UEs according to TS 24.501 subclause 5.2.3.2.5 specified in Release 16. The EXCEPTION description applies only to R15 UEs.</p> <p>Note 3: The wait time 21s is selected to be more than T390 maximum = $(0.7 + 0.6 * \text{rand}) * \text{uac-BarringTime}(16\text{s}) = 20.7\text{s}$ when 'rand' takes the maximum value of 0.99.</p> <p>Note 4: The wait time 28s is selected to cover $20.7\text{s} ((0.7 + 0.6 * \text{rand}) * \text{uac-BarringTime}(16\text{s})) + 5.12\text{s}$ (modification period) + 2s (extra wait timer for UE to trigger <i>RRCSetupRequest</i>) = 27.82s rounded up to 28s when 'rand' takes the maximum value of 0.99.</p>					

11.3.5.3.3 Specific message contents

Table 11.3.5.3.3-1: *SIB1* of NR Cell 1 (step 25 and step 35, Table 11.3.5.3.2-3)

Derivation Path: TS 38.508-1 [4], Table 4.6.1-28

Information Element	Value/remark	Comment	Condition
SIB1 ::= SEQUENCE {			
uac-BarringInfo SEQUENCE {			step 25
uac-BarringForCommon SEQUENCE (SIZE (1..maxAccessCat-1)) OF UAC-BarringPerCat {	1 entry		
UAC-BarringPerCat[1] SEQUENCE {		entry 1	
accessCategory	5	(= MO MMTel video)	
uac-barringInfoSetIndex	1	Value 1 corresponds to the first entry in uac-BarringInfoSetList	
}			
}			
uac-BarringPerPLMN-List	Not present		
uac-BarringInfoSetList SEQUENCE (SIZE(1..maxBarringInfoSet)) OF UAC-BarringInfoSet {	1 entry		
UAC-BarringInfoSet[1] SEQUENCE {		entry 1	
uac-BarringFactor	p00	0% access probability	
uac-BarringTime	s16	16 s	
uac-BarringForAccessIdentity	'1111111'B	Value 1 means that access attempt is not allowed for the corresponding access identity. The leftmost bit, bit 0 in the bit string corresponds to Access Identity 1.	
}			
}			
uac-AccessCategory1-SelectionAssistanceInfo	Not Present		
}			
uac-BarringInfo	Not present		Step 35
}			

Table 11.3.5.3.3-2: SIB1 of NR Cell 12 (Step 1 and step 10D, Table 11.3.5.3.2-3)

Derivation Path: TS 38.508-1 [4], Table 4.6.1-28			
Information Element	Value/remark	Comment	Condition
SIB1 ::= SEQUENCE {			
uac-BarringInfo SEQUENCE {			Step 1
uac-BarringForCommon SEQUENCE (SIZE (1..maxAccessCat-1)) OF UAC-BarringPerCat {	1 entry		
UAC-BarringPerCat[1] SEQUENCE {		entry 1	
accessCategory	7	(= MO_data)	
uac-barringInfoSetIndex	1	Value 1 corresponds to the first entry in uac-BarringInfoSetList	
}			
}			
uac-BarringPerPLMN-List	Not present		
uac-BarringInfoSetList SEQUENCE (SIZE(1..maxBarringInfoSet)) OF UAC-BarringInfoSet {	1 entry		
UAC-BarringInfoSet[1] SEQUENCE {		entry 1	
uac-BarringFactor	p00	0% access probability	
uac-BarringTime	s16	16 s	
uac-BarringForAccessIdentity	0111111'B	Value 1 means that access attempt is not allowed for the corresponding access identity.	
}			
}			

		The leftmost bit, bit 0 in the bit string corresponds to Access Identity 1.	
}			
uac-AccessCategory1-SelectionAssistanceInfo	Not Present		
}			
uac-BarringInfo	Not present		Step 10D
}			

Table 11.3.5.3.3-3: REGISTRATION ACCEPT (step 11Fa10 and step 11Fb2, Table 11.3.5.3.2-3)

Derivation path: TS 38.508 [4], Table 4.7.1-7			
Information Element	Value/remark	Comment	Condition
5GS network feature support	'1000 0001 0000 0000 0000 0000'B	Access identity 1 valid in RPLMN or equivalent PLMN. IMS voice over PS session supported over 3GPP access. All other features set to "not supported" including the 'Interworking without N26 interface not supported'.	

11.3.6 UAC / Access Identity 2 / New cell not in the country of its HPLMN/EHPLMN 0% access probability / MCS indicator / HPLMN/0%/100% accessibility AC7 / RRC_INACTIVE

11.3.6.1 Test Purpose (TP)

(1)

```
with { UE configured for Access Identity 2 }
ensure that {
  when { UE moves to a new cell which is not in the country of its HPLMN or in an EHPLMN (if the EHPLMN list is present) having received SIB1 message including UAC set to 0% accessibility for Access Category 7 and Access Identity 2 is exempted from the access barring check }
  then { UE does not consider Access Identity 2 as valid and does not initiate RRC connection since Access Identity 0 is not exempted from the access barring check until barring for Access Category 7 is removed }
}
```

(2)

```
with { UE configured for Access Identity 2 }
ensure that {
  when { UE moves to a new cell which is not in the country of its HPLMN or in an EHPLMN (if the EHPLMN list is present) but receives the MCS indicator bit of the 5GS network feature support IE in the REGISTRATION ACCEPT message being set to ""Access identity 2 valid"" }
  then { UE does consider Access Identity 2 as valid }
}
```

(3)

```

with { UE configured for Access Identity 2 having received SIB1 containing UAC Info indicating 0%
accessibility for Access Category 7 camped in NR RRC_INACTIVE state on HPLMN }
ensure that {
  when { UE attempts to send uplink user data packet for a PDU session with suspended user-plane
resources }
  then { UE does not attempt to initiate connection on the NR Cell until barring is alleviated }

```

(4)

```

with { UE configured for Access Identity 2 having received SIB1 containing UAC Info indicating 100%
accessibility for Access Category 7 while camped on HPLMN in NR RRC_INACTIVE state }
ensure that {
  when { UE attempts to send uplink user data packet for a PDU session with suspended user-plane
resources }
  then { UE initiates RRC Resume procedure with establishmentCause set to mcs-PriorityAccess }
}

```

11.3.6.2 Conformance requirements

References: The conformance requirements covered in the present TC are specified in TS 24.501: clause 4.5.2, 4.5.4.1 and 4.5.6 and TS 38.331: clause 5.3.14.1, 5.3.14.2, 5.3.14.4 and 5.3.14.5. Unless otherwise stated these are Rel-15 requirements.

[TS 24.501, clause 4.5.2]

When the UE needs to initiate an access attempt in one of the events listed in subclause 4.5.1, the UE shall determine one or more access identities from the set of standardized access identities, and one access category from the set of standardized access categories and operator-defined access categories, to be associated with that access attempt.

The set of the access identities applicable for the request is determined by the UE in the following way:

- a) for each of the access identities 1, 2, 11, 12, 13, 14 and 15 in table 4.5.2.1, the UE shall check whether the access identity is applicable in the selected PLMN, if a new PLMN is selected, or otherwise if it is applicable in the RPLMN or equivalent PLMN; and
- b) if none of the above access identities is applicable, then access identity 0 is applicable.

Table 4.5.2.1: Access identities

Access Identity number	UE configuration
0	UE is not configured with any parameters from this table
1 (NOTE 1)	UE is configured for multimedia priority service (MPS).
2 (NOTE 2)	UE is configured for mission critical service (MCS).
3-10	Reserved for future use
11 (NOTE 3)	Access Class 11 is configured in the UE.
12 (NOTE 3)	Access Class 12 is configured in the UE.
13 (NOTE 3)	Access Class 13 is configured in the UE.
14 (NOTE 3)	Access Class 14 is configured in the UE.
15 (NOTE 3)	Access Class 15 is configured in the UE.
NOTE 1: Access identity 1 is valid when: <ul style="list-style-type: none"> - the USIM file EFUAC_AIC indicates the UE is configured for access identity 1 and the RPLMN is the HPLMN (if the EHPLMN list is not present or is empty) or EHPLMN (if the EHPLMN list is present), or a visited PLMN of the home country (see the definition of home country in 3GPP TS 24.301 [15]); or - the UE receives the 5GS network feature support IE with the MPS indicator bit set to "Access identity 1 valid in RPLMN or equivalent PLMN" from the RPLMN as described in subclause 5.5.1.2.4 and subclause 5.5.1.3.4. 	
NOTE 2: Access identity 2 is used by UEs configured for MCS and is valid when: <ul style="list-style-type: none"> - the USIM file EFUAC_AIC indicates the UE is configured for access identity 2 and the RPLMN is the HPLMN (if the EHPLMN list is not present or is empty) or EHPLMN (if the EHPLMN list is present), or a visited PLMN of the home country (see 3GPP TS 23.122 [5]); or - the UE receives the 5GS network feature support IE with the MCS indicator bit set to "Access identity 2 valid in RPLMN or equivalent PLMN" from the RPLMN as described in subclause 5.5.1.2.4 and subclause 5.5.1.3.4. 	
NOTE 3: Access identities 11 and 15 are valid in HPLMN (if the EHPLMN list is not present or is empty) or	

EHPLMN (if the EHPLMN list is present). Access Identities 12, 13 and 14 are valid in HPLMN and visited PLMNs of home country only (see the definition of home country in 3GPP TS 24.301 [15]).

The UE uses the MPS indicator bit of the 5GS network feature support IE to determine if access identity 1 is valid. Processing of the MPS indicator bit of the 5GS network feature support IE in the REGISTRATION ACCEPT message is described in subclause 5.5.1.2.4 and subclause 5.5.1.3.4. The UE shall not consider access identity 1 to be valid when the UE is not in the country of its HPLMN prior to receiving the MPS indicator bit of the 5GS network feature support IE in the REGISTRATION ACCEPT message being set to "Access identity 1 valid in RPLMN or equivalent PLMN".

When the UE is in the country of its HPLMN, the contents of the USIM files EF_{UAC_AIC} and EF_{ACC} as specified in 3GPP TS 31.102 [22] and the rules specified in table 4.5.2.1 are used to determine the applicability of access identity 1 and access classes 11 - 15. When the UE is in the country of its HPLMN, and the USIM file EF_{UAC_AIC} does not indicate the UE is configured for access identity 1, the UE uses the MPS indicator bit of the 5GS network feature support IE in the REGISTRATION ACCEPT message to determine if access identity 1 is valid. When the UE is in the country of its HPLMN, and the USIM file EF_{UAC_AIC} indicates the UE is configured for access identity 1, the MPS indicator bit of the 5GS network feature support IE is not applicable. When the UE is not in the country of its HPLMN, the contents of the USIM files EF_{UAC_AIC} and EF_{ACC} are not applicable.

The UE uses the MCS indicator bit of the 5GS network feature support IE to determine if access identity 2 is valid. Processing of the MCS indicator bit of the 5GS network feature support IE in the REGISTRATION ACCEPT message is described in subclause 5.5.1.2.4 and subclause 5.5.1.3.4. The UE shall not consider access identity 2 to be valid when the UE is not in the country of its HPLMN prior to receiving the MCS indicator bit of the 5GS network feature support IE in the REGISTRATION ACCEPT message being set to "Access identity 2 valid in RPLMN or equivalent PLMN".

When the UE is in the country of its HPLMN, the contents of the USIM files EF_{UAC_AIC} and EF_{ACC} as specified in 3GPP TS 31.102 [22] and the rules specified in table 4.5.2.1 are used to determine the applicability of access identity 2 and access classes 11 - 15. When the UE is in the country of its HPLMN, and the USIM file EF_{UAC_AIC} does not indicate the UE is configured for access identity 2, the UE uses the MCS indicator bit of the 5GS network feature support IE in the REGISTRATION ACCEPT message to determine if access identity 2 is valid. When the UE is in the country of its HPLMN, and the USIM file EF_{UAC_AIC} indicates the UE is configured for access identity 2, the MCS indicator bit of the 5GS network feature support IE is not applicable. When the UE is not in the country of its HPLMN, the contents of the USIM files EF_{UAC_AIC} and EF_{ACC} are not applicable.

In order to determine the access category applicable for the access attempt, the NAS shall check the rules in table 4.5.2.2, and use the access category for which there is a match for barring check. If the access attempt matches more than one rule, the access category of the lowest rule number shall be selected. If the access attempt matches more than one operator-defined access category definition, the UE shall select the access category from the operator-defined access category definition with the lowest precedence value (see subclause 4.5.3).

NOTE: The case when an access attempt matches more than one rule includes the case when multiple events trigger an access attempt at the same time.

Table 4.5.2.2: Mapping table for access categories

Rule #	Type of access attempt	Requirements to be met	Access Category
1	Response to paging or NOTIFICATION over non-3GPP access; 5GMM connection management procedure initiated for the purpose of transporting an LPP message	Access attempt is for MT access	0 (= MT_acc)
2	Emergency	UE is attempting access for an emergency session (NOTE 1, NOTE 2)	2 (= emergency)
3	Access attempt for operator-defined access category	UE stores operator-defined access category definitions valid in the current PLMN as specified in subclause 4.5.3, and access attempt is matching criteria of an operator-defined access category definition	32-63 (= based on operator classification)
4	Access attempt for delay tolerant service	(a) UE is configured for NAS signalling low priority or UE supporting S1 mode is configured for EAB (see the	1 (= delay tolerant)

		"ExtendedAccessBarring" leaf of NAS configuration MO in 3GPP TS 24.368 [17] or 3GPP TS 31.102 [22]) where "EAB override" does not apply, and (b).the UE received one of the categories a, b or c as part of the parameters for unified access control in the broadcast system information, and the UE is a member of the broadcasted category in the selected PLMN or RPLMN/equivalent PLMN (NOTE 3, NOTE 5, NOTE 6, NOTE 7, NOTE 8)	
5	MO MMTel voice call	Access attempt is for MO MMTel voice call or for NAS signalling connection recovery during ongoing MO MMTel voice call (NOTE 2)	4 (= MO MMTel voice)
6	MO MMTel video call	Access attempt is for MO MMTel video call or for NAS signalling connection recovery during ongoing MO MMTel video call (NOTE 2)	5 (= MO MMTel video)
7	MO SMS over NAS or MO SMSoIP	Access attempt is for MO SMS over NAS (NOTE 4) or MO SMS over SMSoIP transfer or for NAS signalling connection recovery during ongoing MO SMS or SMSoIP transfer (NOTE 2)	6 (= MO SMS and SMSoIP)
8	UE NAS initiated 5GMM specific procedures	Access attempt is for MO signalling	3 (= MO_sig)
9	UE NAS initiated 5GMM connection management procedure or 5GMM NAS transport procedure	Access attempt is for MO data	7 (= MO_data)
10	An uplink user data packet is to be sent for a PDU session with suspended user-plane resources	No further requirement is to be met	7 (= MO_data)
<p>NOTE 1: This includes 5GMM specific procedures while the service is ongoing and 5GMM connection management procedures required to establish a PDU session with request type = "initial emergency request" or "existing emergency PDU session", or to re-establish user-plane resources for such a PDU session. This further includes the service request procedure initiated with a SERVICE REQUEST message with the Service type IE set to "emergency services fallback".<</p> <p>NOTE 2: Access for the purpose of NAS signalling connection recovery during an ongoing service, or for the purpose of NAS signalling connection establishment following fallback indication from lower layers during an ongoing service, is mapped to the access category of the ongoing service in order to derive an RRC establishment cause, but barring checks will be skipped for this access attempt.</p> <p>NOTE 3: If the UE selects a new PLMN, then the selected PLMN is used to check the membership; otherwise the UE uses the RLPMN or a PLMN equivalent to the RPLMN.</p> <p>NOTE 4: This includes the 5GMM connection management procedures triggered by the UE-initiated NAS transport procedure for transporting the MO SMS.</p> <p>NOTE 5: The UE configured for NAS signalling low priority is not supported in this release of specification. If a UE supporting both S1 mode and N1 mode is configured for NAS signalling low priority in S1 mode as specified in 3GPP TS 24.368 [17] or 3GPP TS 31.102 [22], the UE shall ignore the configuration for NAS signalling low priority when in N1 mode.</p> <p>NOTE 6: If the access category applicable for the access attempt is 1, then the UE shall additionally determine a second access category from the range 3 to 7. If more than one access category matches, the access category of the lowest rule number shall be chosen. The UE shall use the second access category only to derive an RRC establishment cause for the access attempt.</p> <p>NOTE 7: "EAB override" does not apply, if the UE is not configured to allow overriding EAB (see the "Override_ExtendedAccessBarring" leaf of NAS configuration MO in 3GPP TS 24.368 [17] or 3GPP TS 31.102 [22]), or if NAS has not received an indication from the upper layers to override EAB and the UE does not have a PDU session that was established with EAB override.</p> <p>NOTE 8: For the definition of categories a, b and c associated with access category 1, see 3GPP TS 22.261 [3]. The categories associated with access category 1 are distinct from the categories a, b and c associated with EAB (see 3GPP TS 22.011 [1A]).</p>			

[TS 24.501, clause 4.5.4.1]

When the UE is in 5GMM-IDLE mode, upon receiving a request from the upper layers for an access attempt, the NAS shall categorize the access attempt into access identities and an access category following subclause 4.5.2, table 4.5.2.1 and table 4.5.2.2, and subclause 4.5.3, and provide the applicable access identities and the access category to the lower layers for the purpose of access control checking. In this request to the lower layer the NAS can also provide to the lower layer the RRC establishment cause determined as specified in subclause 4.5.6 of this specification.

NOTE 1: The access barring check is performed by the lower layers.

NOTE 2: As an implementation option, the NAS can provide the RRC establishment cause to the lower layers after being informed by the lower layers that the access attempt is allowed.

If the UE has uplink user data pending for one or more PDU sessions when it builds a REGISTRATION REQUEST or SERVICE REQUEST message as initial NAS message, the UE shall indicate the respective PDU sessions in the Uplink data status IE as specified in subclause 5.5.1.3.2 and 5.6.1.2, regardless of the access category for which the access barring check is performed.

NOTE 3: The UE indicates pending user data for all the respective PDU sessions, even if barring timers are running for some of the corresponding access categories.

If the lower layers indicate that the access attempt is allowed, the NAS shall initiate the procedure to send the initial NAS message for the access attempt.

If the lower layers indicate that the access attempt is barred, the NAS shall not initiate the procedure to send the initial NAS message for the access attempt. Additionally:

- a) if the event which triggered the access attempt was an MO-MMTEL-voice-call-started indication or an MO-MMTEL-video-call-started indication:
 - 1) if the UE is operating in the single-registration mode and the UE's usage setting is "voice centric", the UE may attempt to select an E-UTRA cell connected to EPC. If the UE finds a suitable E-UTRA cell connected to EPC, it then proceeds with the appropriate EMM specific procedures and, if necessary, ESM procedures to make a PDN connection providing access to IMS available; see subclause 4.8.2 and 3GPP TS 24.301 [15];
 - 2) if the UE is operating in the dual-registration mode, the UE may proceed in S1 mode with the appropriate EMM specific procedures and ESM procedures to make a PDN connection providing access to IMS available; see subclause 4.8.3 and 3GPP TS 24.301 [15];
 - 3) otherwise, the NAS shall notify the upper layers that the access attempt is barred. In this case, upon receiving an indication from the lower layers that the barring is alleviated for the access category with which the access attempt was associated, the NAS shall notify the upper layers that the barring is alleviated for the access category and may initiate the procedure to send the initial NAS message, if still needed; and
- b) if the event which triggered the access attempt was an MO-SMSoIP-attempt-started indication:
 - 1) if the UE is operating in the single-registration mode, the UE may attempt to select an E-UTRA cell connected to EPC. If the UE finds a suitable E-UTRA cell connected to EPC, it then proceeds with the appropriate EMM specific procedures and, if necessary, ESM procedures to make a PDN connection providing access to IMS available; see subclause 4.8.2 and 3GPP TS 24.301 [15];
 - 2) if the UE is operating in the dual-registration mode, the UE may proceed in S1 mode with the appropriate EMM specific procedures and ESM procedures to make a PDN connection providing access to IMS available; see subclause 4.8.3 and 3GPP TS 24.301 [15];
 - 3) otherwise, the NAS layer shall notify the upper layers that the access attempt is barred. In this case, upon receiving an indication from the lower layers that the barring is alleviated for the access category with which the access attempt was associated, the NAS shall notify the upper layers that the barring is alleviated for the access category and may initiate the procedure to send the initial NAS message, if still needed.

NOTE 4: Barring timers, on a per access category basis, are run by the lower layers. At expiry of barring timers, the indication of alleviation of access barring is indicated to the NAS on a per access category basis.

[TS 24.501, clause 4.5.6]

When 5GMM requests the establishment of a NAS-signalling connection, the RRC establishment cause used by the UE shall be selected according to one or more access identities (see subclause 4.5.2) and the determined access category as

specified in table 4.5.6.1 and table 4.5.6.2. If the determined access category is an operator-defined access category, then the RRC establishment cause used by the UE shall be selected according to table 4.5.6.1 and table 4.5.6.2 based on one or more access identities (see subclause 4.5.2) and the standardized access category determined for the operator-defined access category as described in subclause 4.5.3.

Table 4.5.6.1: Mapping table for access identities/access categories and RRC establishment cause when establishing N1 NAS signalling connection via NR connected to 5GCN

Access identities	Access categories	RRC establishment cause is set to
0	0 (= MT_acc)	mt-Access
	1 (= delay tolerant)	Not applicable (NOTE 1)
	2 (= emergency)	emergency
	3 (= MO_sig)	mo-Signalling
	4 (= MO MMTel voice)	mo-VoiceCall
	5 (= MO MMTel video)	mo-VideoCall
	6 (= MO SMS and SMSoIP)	mo-SMS
	7 (= MO_data)	mo-Data
1	Any category	mps-PriorityAccess
2	Any category	mcs-PriorityAccess
11, 15	Any category	highPriorityAccess
12,13,14,	Any category	highPriorityAccess
NOTE 1: A UE using access category 1 for the access barring check will determine a second access category in the range 3 to 7 that is to be used for determination of the RRC establishment cause. See subclause 4.5.2, table 4.5.2.2, NOTE 6.		
NOTE 2: See subclause 4.5.2, table 4.5.2.1 for use of the access identities of 0, 1, 2, and 11-15.		

Table 4.5.6.2: Mapping table for access identities/access categories and RRC establishment cause when establishing N1 NAS signalling connection via E-UTRA connected to 5GCN

Access identities	Access categories	RRC establishment cause is set to
0	0 (= MT_acc)	mt-Access
	1 (= delay tolerant)	Not applicable (NOTE 1)
	2 (= emergency)	emergency
	3 (= MO_sig)	mo-Signalling
	4 (= MO MMTel voice)	mo-VoiceCall
	5 (= MO MMTel video)	mo-VoiceCall
	6 (= MO SMS and SMSoIP)	mo-Data
	7 (= MO_data)	mo-Data
1	Any category	highPriorityAccess
2	Any category	highPriorityAccess
11, 15	Any category	highPriorityAccess
12,13,14,	Any category	highPriorityAccess
NOTE 1: A UE using access category 1 for the access barring check will determine a second access category in the range 3 to 7 that is to be used for determination of the RRC establishment cause. See subclause 4.5.2, table 4.5.2.2, NOTE 6.		
NOTE 2: See subclause 4.5.2, table 4.5.2.1 for use of the access identities of 0, 1, 2, and 11-15.		

[TS 38.331, clause 5.3.14.1]

The purpose of this procedure is to perform access barring check for an access attempt associated with a given Access Category and one or more Access Identities upon request from upper layers according to TS 24.501 [23] or the RRC layer.

After a handover resulting in change of PCell in RRC_CONNECTED the UE shall defer access barring checks until it has obtained valid UAC information (from *SIB1*) from the target cell.

[TS 38.331, clause 5.3.14.2]

Upon initiation of the procedure, the UE shall:

- 1> if timer T390 is running for the Access Category:

- 2> consider the access attempt as barred;
- 1> else if timer T302 is running and the Access Category is neither '2' nor '0':
 - 2> consider the access attempt as barred;
- 1> else:
 - 2> if the Access Category is '0':
 - 3> consider the access attempt as allowed;
 - 2> else:
 - 3> if *SIB1* includes *uac-BarringPerPLMN-List* and the *uac-BarringPerPLMN-List* contains an *UAC-BarringPerPLMN* entry with the *plmn-IdentityIndex* corresponding to the PLMN selected by upper layers (see TS 24.501 [23]):
 - 4> select the *UAC-BarringPerPLMN* entry with the *plmn-IdentityIndex* corresponding to the PLMN selected by upper layers;
 - 4> in the remainder of this procedure, use the selected *UAC-BarringPerPLMN* entry (i.e. presence or absence of access barring parameters in this entry) irrespective of the *uac-BarringForCommon* included in *SIB1*;
 - 3> else if *SIB1* includes *uac-BarringForCommon*:
 - 4> in the remainder of this procedure use the *uac-BarringForCommon* (i.e. presence or absence of these parameters) included in *SIB1*;
 - 3> else:
 - 4> consider the access attempt as allowed;
 - 3> if *uac-BarringForCommon* is applicable or the *uac-ACBarringListType* indicates that *uac-ExplicitACBarringList* is used:
 - 4> if the corresponding *UAC-BarringPerCatList* contains a *UAC-BarringPerCat* entry corresponding to the Access Category:
 - 5> select the *UAC-BarringPerCat* entry;
 - 5> if the *uac-BarringInfoSetList* contains a *UAC-BarringInfoSet* entry corresponding to the selected *uac-barringInfoSetIndex* in the *UAC-BarringPerCat*:
 - 6> select the *UAC-BarringInfoSet* entry;
 - 6> perform access barring check for the Access Category as specified in 5.3.14.5, using the selected *UAC-BarringInfoSet* as "UAC barring parameter";
 - 5> else:
 - 6> consider the access attempt as allowed;
 - 4> else:
 - 5> consider the access attempt as allowed;
 - 3> else if the *uac-ACBarringListType* indicates that *uac-ImplicitACBarringList* is used:
 - 4> select the *uac-BarringInfoSetIndex* corresponding to the Access Category in the *uac-ImplicitACBarringList*;
 - 4> if the *uac-BarringInfoSetList* contains the *UAC-BarringInfoSet* entry corresponding to the selected *uac-BarringInfoSetIndex*:
 - 5> select the *UAC-BarringInfoSet* entry;

- 5> perform access barring check for the Access Category as specified in 5.3.14.5, using the selected *UAC-BarringInfoSet* as "UAC barring parameter";
- 4> else:
 - 5> consider the access attempt as allowed;
- 3> else:
 - 4> consider the access attempt as allowed;
- 1> if the access barring check was requested by upper layers:
 - 2> if the access attempt is considered as barred:
 - 3> if timer T302 is running:
 - 4> inform the upper layer that access barring is applicable for all access categories except categories '0' and '2', upon which the procedure ends;
 - 3> else:
 - 4> inform upper layers that the access attempt for the Access Category is barred, upon which the procedure ends;
 - 2> else:
 - 3> inform upper layers that the access attempt for the Access Category is allowed, upon which the procedure ends;
- 1> else:
 - 2> the procedure ends.

[TS 38.331, clause 5.3.14.4]

The UE shall:

- 1> if timer T302 expires or is stopped, and if timer T390 corresponding to an Access Category is not running; or
- 1> if timer T390 corresponding to an Access Category other than '2' expires or is stopped, and if timer T302 is not running; or
- 1> if timer T390 corresponding to the Access Category '2' expires or is stopped:
 - 2> consider the barring for this Access Category to be alleviated;
- 1> when barring for an Access Category is considered being alleviated:
 - 2> if the Access Category was informed to upper layers as barred:
 - 3> inform upper layers about barring alleviation for the Access Category.
 - 2> if barring is alleviated for Access Category '8':
 - 3> perform actions specified in 5.3.13.8;

[TS 38.331, clause 5.3.14.5]

The UE shall:

- 1> if one or more Access Identities are indicated according to TS 24.501 [23], and
- 1> if for at least one of these Access Identities the corresponding bit in the *uac-BarringForAccessIdentity* contained in "UAC barring parameter" is set to *zero*:
 - 2> consider the access attempt as allowed;

1> else:

2> draw a random number '*rand*' uniformly distributed in the range: $0 \leq rand < 1$;

2> if '*rand*' is lower than the value indicated by *uac-BarringFactor* included in "UAC barring parameter":

3> consider the access attempt as allowed;

2> else:

3> consider the access attempt as barred;

1> if the access attempt is considered as barred:

2> draw a random number '*rand*' that is uniformly distributed in the range $0 \leq rand < 1$;

2> start timer T390 for the Access Category with the timer value calculated as follows, using the *uac-BarringTime* included in "AC barring parameter":

$$T390 = (0.7 + 0.6 * rand) * uac-BarringTime.$$

11.3.6.3 Test description

11.3.6.3.1 Pre-test conditions

System Simulator:

- 2 NR cells: NR Cell 1 and 12 as specified in TS 38.508-1 [4] table 4.4.2-3 are configured as shown in Table 11.3.6.3.1-1.

Table 11.3.6.3.1-1: PLMN identifiers

NR Cell	PLMN names	MCC	MNC
NR Cell 1	PLMN1	001	01
NR Cell 12	PLMN2	002	11

- System information combination NR-1 as defined in TS 38.508-1 [4] Table 4.4.3.1.2-1 is used in NR cells.

UE:

- The UE is equipped with a USIM configuration as defined in TS 38.508-1 [4] Table 6.4.1-19.

Preamble:

- The UE is in state 1N-A on NR Cell 1 (serving cell) according to TS 38.508-1 [4] Table 4.4A.2-1 and using the message condition UE TEST LOOP MODE B prepared according to TS 38.508-1 [4].

11.3.6.3.2 Test procedure sequence

Table 11.3.6.3.2-1 for FR1 and Table 11.3.6.3.2-2 for FR2 illustrates the downlink power levels and other changing parameters to be applied for the cells at various time instants of the test execution. Row marked "T0" denotes the initial conditions in preamble, while columns marked "T1", "T2" and "T3" are to be applied subsequently in the Main behaviour. The exact instants on which these values shall be applied are described in the texts in this clause.

Table 11.3.6.3.2-1: Cell configuration changes over time for FR1

	Parameter	Unit	NR Cell 1	NR Cell 12	Remarks
T0	SS/PBCH SSS EPRE	dBm/SCS	-88	Off	The power level values are assigned to ensure UE registered on NR Cell 1.

T1	SS/PBCH SSS EPRE	dBm/SCS	Off	-80	The power level values are assigned to ensure UE registered on NR Cell 12.
T2	SS/PBCH SSS EPRE	dBm/SCS	-80	Off	The power level values are assigned to ensure UE registered on NR Cell 1.
Note 1: Power level "Off" is defined in TS 38.508-1 [4] Table 6.2.2.1-3.					

Table 11.3.6.3.2-2: Cell configuration changes over time for FR2

	Parameter	Unit	NR Cell 1	NR Cell 12	Remarks
T0	SS/PBCH SSS EPRE	dBm/SCS	FFS	Off	The power level values are assigned to ensure UE registered on NR Cell 1.
T1	SS/PBCH SSS EPRE	dBm/SCS	Off	FFS	The power level values are assigned to ensure UE registered on NR Cell 12.
T2	SS/PBCH SSS EPRE	dBm/SCS	FFS	Off	The power level values are assigned to ensure UE registered on NR Cell 1.
Note 1: Power level "Off" is defined in TS 38.508-1 [4] Table 6.2.2.2-2.					

Table 11.3.6.3.2-3: Main behaviour

St	Procedure	Message Sequence		TP	Verdict
		U - S	Message		
1	The SS adjusts the NR Cells power levels according to row "T1" in table 11.3.6.3.2-1/2.	-	-	-	-
1A	Void	-	-	-	-
1A A	Check: Does the UE transmit a <i>RRCSetupRequest</i> message on NR cell 12 including the <i>establishmentCause</i> which is any value except <i>mcs-PriorityAccess</i> ?	-->	NR RRC: RRCSetupRequest	1	P
1A B- 1A E	Steps 2 to 5 of the mobility registration updating procedure described in TS 38.508-1 [4] Table 4.9.5.2.2-1 are performed on NR Cell 12.	-	-	-	-
1A F- 1A	Steps 5 to 8 of the NR RRC_CONNECTED procedure in TS 38.508-1 Table 4.5.4.2-3 are performed.	-	-	-	-
1AJ	The SS transmits a CLOSE UE TEST LOOP message.	<--	NR RRC: DLInformationTransfer TC: CLOSE UE TEST LOOP	-	-
1A K	The UE transmits a CLOSE UE TEST LOOP COMPLETE message.	-->	NR RRC: ULInformationTransfer TC: CLOSE UE TEST LOOP COMPLETE	-	-
1A L	The SS transmits one IP PDU.	-	-	-	-
1A M	The SS transmits an RRCRelease message and move the UE to RRC_IDLE.	<--	NR RRC: RRCRelease	-	-
1A N	Check: Does the UE transmit an RRCSetupRequest message within 21s on NR Cell 12? (Note 4)	-->	NR RRC: RRCSetupRequest	1	F
1B	SS changes SIB1 of NR Cell 12 according to 38.508-1 [4] Table 4.6.1-28 and sends Short Message on PDCCH using P-RNTI.	-	-	-	-
1C	Start Timer=30 sec. (Note 3)	-	-	-	-

-	EXCEPTION: Steps 1Da1-1Db16 describe optional behaviour that depends on the UE implementation.	-	-	-	-
1D a1	Check: Does the UE transmit an RRCSetupRequest message and establishmentCause is set to mo-Data?	-->	NR RRC: RRCSetupRequest	1	P
1D a2	Stop Timer=30 sec	-	-	-	-
1D b1	Timer=30 sec expires	-	-	-	-
1D b2- 1D b9	Steps 1-8 of the generic procedure for NR RRC Connected specified in TS 38.508-1 Table 4.5.4.2-3 are performed.	-	-	-	-
1D b10	The SS transmits an OPEN UE TEST LOOP message.	<--	NR RRC: DLInformationTransfer TC: OPEN UE TEST LOOP	-	-
1D b11	The UE transmits an OPEN UE TEST LOOP COMPLETE message.	-->	NR RRC: ULInformationTransfer TC: OPEN UE TEST LOOP COMPLETE	-	-
1D b12	The SS transmits a CLOSE UE TEST LOOP message.	<--	NR RRC: DLInformationTransfer TC: CLOSE UE TEST LOOP	-	-
1D b13	The UE transmits a CLOSE UE TEST LOOP COMPLETE message.	-->	NR RRC: ULInformationTransfer TC: CLOSE UE TEST LOOP COMPLETE	-	-
1D b14	The SS transmits one IP PDU.	-	-	-	-
1D b15	The SS transmits an RRCRelease message and move the UE to RRC_IDLE.	<--	NR RRC: RRCRelease	-	-
1D b16	Check: Does the UE transmit an RRCSetupRequest message and establishmentCause is set to mo-Data?	-->	NR RRC: RRCSetupRequest	1	P
1E- 1I	Steps 3-7 of the generic procedure for NR RRC Connected specified in TS 38.508-1 Table 4.5.4.2-3 are performed.	-	-	-	-
-	EXCEPTION: Steps 1J and 1K can occur in any order.	-	-	-	-
1J	The UE transmits an RRCReconfigurationComplete message.	-->	NR RRC: RRCReconfigurationComplete	-	-
1K	The UE loops back the IP PDU	-	-	-	-
1L	The UE is switched off by executing generic procedure in Table 4.9.6.3-1 in TS 38.508-1 [4]	-	-	-	-
1M	The SS adjusts the NR Cells power levels according to row "T2" in table 11.3.6.3.2-1/2.	-	-	-	-
1N	The UE is Switched ON. The generic test procedure in TS 38.508-1 [4] Table 4.5.2.2-2 indicate that the UE performs registration on NR Cell 1 with condition Test Mode = On.	-	-	-	-
-	EXCEPTION: Step 1O is performed in p_pc_noOf_PDUsNewConnection > 0.	-	-	-	-
1O	The generic procedure in TS 38.508-1 [4] Table 4.5.2.2-4 for UE-requested PDU session establishment performs registration on NR Cell 1 and then release the RRC Connection.	-	-	-	-
1P	The SS adjusts the NR Cells power levels according to row "T1" in table 11.3.6.3.2-1/2.	-	-	-	-
2	Check: Does the UE transmit an RRCSetupRequest message on NR cell 12 including the establishmentCause which is any value except mcs-PriorityAccess.	-->	NR RRC: RRCSetupRequest	1	P
3-6	Steps 2 to 5 of the mobility registration updating procedure described in TS 38.508-1 [4] Table 4.9.5.2.2-1 are performed on NR Cell 12. (Note	-	-	-	-

	1)				
6A-6D	Steps 5 to 8 of the NR RRC_CONNECTED procedure in TS 38.508-1 Table 4.5.4.2-3 are performed.	-	-	-	-
6E	The SS transmits a CLOSE UE TEST LOOP message.	<--	NR RRC: DLInformationTransfer TC: CLOSE UE TEST LOOP	-	-
6F	The UE transmits a CLOSE UE TEST LOOP COMPLETE message.	-->	NR RRC: ULInformationTransfer TC: CLOSE UE TEST LOOP COMPLETE	-	-
7	The SS transmits one IP PDU.	-	-	-	-
8	The SS transmits an <i>RRCRelease</i> message and move the UE to RRC_IDLE.	<--	NR RRC: RRCRelease	-	-
9	Check: Does the UE transmit an <i>RRCSetupRequest</i> message including <i>establishmentCause</i> of <i>mcs-PriorityAccess</i> within 10 s?	-->	NR RRC: RRCSetupRequest	2	P
10	SS transmit an <i>RRCSetup</i> message.	<--	NR RRC: <i>RRCSetup</i>	-	-
11	The UE transmits an <i>RRCSetupComplete</i> message to confirm the successful completion of the connection establishment.	-->	NR RRC: RRCSetupComplete 5GMM: SERVICE REQUEST	-	-
11A-11C	Steps 5 to 7 of the NR RRC_CONNECTED procedure in TS 38.508-1 Table 4.5.4.2-3 are performed.	-	-	-	-
-	EXCEPTION: Steps 11D and 12 can occur in any order.	-	-	-	-
11D	The UE transmits an <i>RRCReconfigurationComplete</i> message.	-->	NR RRC: <i>RRCReconfigurationComplete</i>	-	-
12	The UE loops back the IP PDU.	-	-	-	-
13	Void	-	-	-	-
-	EXCEPTION: Steps 14a1A1-14a19 describe behaviour that depends on UE configuration; the "lower case letter" identifies a step sequence that takes place if <i>inactiveState</i> is configured	-	-	-	-
14a1A1	IF <i>pc_inactiveState</i> THEN the SS transmits an <i>RRCRelease</i> message to release RRC connection and move the UE to RRC_IDLE.	<--	NR RRC: RRCRelease	-	-
14a1A2	The SS changes the SIB1 of NR Cell 1 according to Table 11.3.6.3.3-4 to set the <i>uac-BarringInfo</i> and adjusts the NR Cells power levels according to row "T2" in table 11.3.6.3.2-1/2.	-	-	-	-
14a2-14a6	Steps 1 to 5 of the mobility registration updating procedure described in TS 38.508-1 [4] Table 4.9.5.2.2-1 are performed on NR Cell 1. (Note 2)	-	-	-	-
14a7-14a10	Steps 5 to 8 of the NR RRC_CONNECTED procedure in TS 38.508-1 Table 4.5.4.2-3 are performed.	-	-	-	-
14a10A	The SS transmits an OPEN UE TEST LOOP message.	<--	NR RRC: DLInformationTransfer TC: OPEN UE TEST LOOP	-	-
14a10B	The UE transmits an OPEN UE TEST LOOP COMPLETE message.	-->	NR RRC: ULInformationTransfer TC: OPEN UE TEST LOOP COMPLETE	-	-
14a10C	The SS transmits a CLOSE UE TEST LOOP message.	<--	NR RRC: DLInformationTransfer TC: CLOSE UE TEST LOOP	-	-
14a10D	The UE transmits a CLOSE UE TEST LOOP COMPLETE message.	-->	NR RRC: ULInformationTransfer TC: CLOSE UE TEST LOOP COMPLETE	-	-
14a11	The SS transmits one IP PDU.	-	-	-	-
14a12	The SS transmits an <i>RRCRelease</i> message with suspend configuration and move the UE to RRC_INACTIVE.	<--	NR RRC: RRCRelease	-	-

14a 13	Check: Does the UE transmit an <i>RRCResumeRequest</i> message including <i>resumeCause</i> of <i>mcs-PriorityAccess</i> within 21 s? (Note 4)	-->	NR RRC: <i>RRCResumeRequest</i>	3	F
14a 14	SS changes SIB1 according to Table 11.3.6.3.3-6 and the SS notifies the UE of change of System Information on NR Cell 1 by send Short Message on PDCCH using P-RNTI.	<--	NR RRC: <i>Paging</i>	-	-
14a 15	Start Timer=30 sec. (Note 3) NOTE: This is an arbitrary value to wait for UE initiated RRC resume procedure.	-	-	-	-
-	EXCEPTION: Steps 14a15a1-14a15b8 describes optional behaviour that depends on the UE implementation.	-	-	-	-
14a 15a 1	Check: Does the UE transmit an <i>RRCResumeRequest</i> message including <i>resumeCause</i> of <i>mcs-PriorityAccess</i> ?	-->	NR RRC: <i>RRCResumeRequest</i>	4	P
14a 15a 2	Stop Timer=30.	-	-	-	-
14a 15b 1	Timer=30 sec expires	-	-	-	-
14a 15b 2	The SS transmits a Paging message including a matched identity (correct full-I-RNTI).	<--	NR RRC: <i>Paging</i>	-	-
14a 15b 3	The UE transmit an <i>RRCResumeRequest</i> message.	-->	NR RRC: <i>RRCResumeRequest</i>		
14a 15b 4	The SS transmits an <i>RRCResume</i> message.	<--	NR RRC: <i>RRCResume</i>	-	-
14a 15b 5	The UE transmits an <i>RRCResumeComplete</i> message.	-->	NR RRC: <i>RRCResumeComplete</i>	-	-
14a 15b 5A	The SS transmits an OPEN UE TEST LOOP message.	<--	NR RRC: <i>DLInformationTransfer</i> TC: OPEN UE TEST LOOP	-	-
14a 15b 5B	The UE transmits an OPEN UE TEST LOOP COMPLETE message.	-->	NR RRC: <i>ULInformationTransfer</i> TC: OPEN UE TEST LOOP COMPLETE	-	-
14a 15b 5C	The SS transmits a CLOSE UE TEST LOOP message.	<--	NR RRC: <i>DLInformationTransfer</i> TC: CLOSE UE TEST LOOP	-	-
14a 15b 5D	The UE transmits a CLOSE UE TEST LOOP COMPLETE message.	-->	NR RRC: <i>ULInformationTransfer</i> TC: CLOSE UE TEST LOOP COMPLETE	-	-
14a 15b 6	The SS transmits one IP PDU.	-	-	-	-
14a 15b 7	The SS transmits an <i>RRCRelease</i> message with <i>suspendConfig</i> IE and move the UE to <i>RRC_Inactive</i> state.	<--	NR RRC: <i>RRCRelease</i>	-	-
14a 15b 8	Check: Does the UE transmit an <i>RRCResumeRequest</i> message including <i>resumeCause</i> of <i>mcs-PriorityAccess</i> ?	-->	NR RRC: <i>RRCResumeRequest</i>	4	P
14a 16	SS transmit an <i>RRCResume</i> message.	<--	NR RRC: <i>RRCResume</i>	-	-
-	EXCEPTION: Steps 14a17 and 14a18 can occur in any order.	-	-	-	-
14a 17	The UE transmits an <i>RRCResumeComplete</i> message to confirm the successful completion of the connection establishment.	-->	NR RRC: <i>RRCResumeComplete</i>	-	-
14a 18	The UE loops back the IP PDU.	-	-	-	-

14a 19	Void	-	-	-	-
15- 28	Void	-	-	-	-
<p>Note 1: The SS includes a 5GS network feature support IE in the REGISTRATION ACCEPT message configured as Table 11.3.6.3.3-3.</p> <p>Note 2: The UE performs registration and the RRC connection is released.</p> <p>Note 3: The wait time 30s is selected to cover $(0.7 + 0.6 * rand) * uac\text{-}BarringTime(16s) = 20.7s + 2s$ (IP PDU delay timer) + 5.12s (modification period) = 27.92s rounded up to 28s when 'rand' takes the maximum value of 0.99.</p> <p>Note 4: The wait time 21s is selected to be more than T390 maximum = $(0.7 + 0.6 * rand) * uac\text{-}BarringTime(16s) = 20.7s$ when 'rand' takes the maximum value of 0.99.</p>					

11.3.6.3.3 Specific message contents

Table 11.3.6.3.3-1: SIB1 of NR Cell 12 (preamble)

Derivation Path: TS 38.508-1 [4], Table 4.6.1-28			
Information Element	Value/remark	Comment	Condition
SIB1 ::= SEQUENCE {			
uac-BarringInfo SEQUENCE {			
uac-BarringForCommon SEQUENCE (SIZE (1..maxAccessCat-1)) OF UAC-BarringPerCat {	1 entry		
UAC-BarringPerCat[1] SEQUENCE {		entry 1	
accessCategory	7	(= MO_data)	
uac-barringInfoSetIndex	1	Value 1 corresponds to the first entry in uac-BarringInfoSetList	
}			
}			
uac-BarringPerPLMN-List	Not present		
uac-BarringInfoSetList SEQUENCE (SIZE(1..maxBarringInfoSet)) OF UAC-BarringInfoSet {	1 entry		
UAC-BarringInfoSet[1] SEQUENCE {		entry 1	
uac-BarringFactor	p00	0% access probability	
uac-BarringTime	s16	16 s	
uac-BarringForAccessIdentity	'1011111'B	Value 1 means that access attempt is not allowed for the corresponding access identity. The leftmost bit, bit 0 in the bit string corresponds to Access Identity 1.	
}			
}			
uac-AccessCategory1-SelectionAssistanceInfo	Not present		
}			
}			

Table 11.3.6.3.3-2: RRCSetupRequest (step1AA, step 2 and step 9, Table 11.3.6.3.2-3)

Derivation Path: TS 38.508-1 [4], Table 4.6.1-23:			
Information Element	Value/remark	Comment	Condition
RRCSetupRequest ::= SEQUENCE {			
rrcSetupRequest SEQUENCE {			
establishmentCause	Any allowed value other than mcs-PriorityAccess		Step 2, Step 1AA

	mcs-PriorityAccess		Step 9
}			
}			

Table 11.3.6.3.3-3: REGISTRATION ACCEPT(step 5, Table 11.3.6.3.2-3)

Derivation path: TS 38.508 [4] Table 4.7.1-7			
Information Element	Value/remark	Comment	Condition
5GS network feature support	'0000 0001 0000 0010'B	Access identity 2 valid in RPLMN or equivalent PLMN. IMS voice over PS session supported over 3GPP access. All other features set to "not supported" including the 'Interworking without N26 interface not supported'.	

Table 11.3.6.3.3-3A: RRCReconfiguration (step 6C and step 14a9 in Table 11.3.6.3.2-3)

Derivation path: TS 38.508-1 [4], Table 4.6.1-13 condition NR and SRB2 and DRB1			
Information Element	Value/remark	Comment	Condition
RRCReconfiguration ::= SEQUENCE {			
dedicatedNAS-MessageList	Not present		
}			

Table 11. 3.6.3.3-3B: SERVICE REQUEST (preamble and step 11 in Table 11.3.6.3.2-3)

Derivation path: TS 38.508-1 [4] Table 4.7.1-16			
Information Element	Value/Remark	Comment	Condition
Service type	'0101'B	high priority access	

Table 11. 3.6.3.3-3C: CLOSE UE TEST LOOP (step1AJ, step 1Db12, step 6E, step 14a10C and step 14a15b15C Table 11.3.6.3.2-3)

Derivation Path: TS 36.508 [7], Table 4.7A-3, condition UE TEST LOOP MODE B			
Information Element	Value/remark	Comment	Condition
UE test loop mode B LB setup			
IP PDU delay	'0000 0010'B	2 seconds	

Table 11.3.6.3.3-4: SIB1 of NR Cell 1 (step 14a1A2, Table 11.3.6.3.2-3)

Derivation Path: TS 38.508-1 [4], Table 4.6.1-28			
Information Element	Value/remark	Comment	Condition
SIB1 ::= SEQUENCE {			
uac-BarringInfo SEQUENCE {			
uac-BarringForCommon SEQUENCE (SIZE (1..maxAccessCat-1)) OF UAC-BarringPerCat {	1 entry		
UAC-BarringPerCat[1] SEQUENCE {		entry 1	
accessCategory	7	(= MO_data)	
uac-barringInfoSetIndex	1	Value 1 corresponds to the first entry in uac-BarringInfoSetList	
}			
}			

}			
uac-BarringPerPLMN-List	Not present		
uac-BarringInfoSetList SEQUENCE (SIZE(1..maxBarringInfoSet)) OF SEQUENCE {	1 entry		
UAC-BarringInfoSet[1] SEQUENCE {		entry 1	
uac-BarringFactor	P00	0% access probability	
uac-BarringTime	s16	16 s	
uac-BarringForAccessIdentity	1111111	Value 1 means that access attempt is not allowed for the corresponding access identity. The leftmost bit, bit 0 in the bit string corresponds to Access Identity 1.	
}			
}			
uac-AccessCategory1-SelectionAssistanceInfo	Not present		
}			
}			

Table 11.3.6.3.3-5: RRCResumeRequest (step 14a13, 14a15a1, 14a15b3 and step 14a15b8, Table 11.3.6.3.2-3)

Derivation Path: TS 38.508-1 [4], Table 4.6.1-19:			
Information Element	Value/remark	Comment	Condition
RRCResumeRequest ::= SEQUENCE {			
rrcResumeRequest SEQUENCE {			
resumeCause	mcs-PriorityAccess		
}			
}			

Table 11.3.6.3.3-6: SIB1 of NR Cell 1 (step 14a14, Table 11.3.6.3.2-3)

Derivation Path: TS 38.508-1 [4], Table 4.6.1-28			
Information Element	Value/remark	Comment	Condition
SIB1 ::= SEQUENCE {			
uac-BarringInfo	Not present		
}			

11.3.7 UAC / Access Identity 11..15 / High priority access / HPLMN/0% accessibility AC2 / Emergency call

11.3.7.1 Test Purpose (TP)

(1)

```

with { UE configured for Access Identity 11..15 having received SIB1 containing UAC Info indicating
0% accessibility for Access Category 2 camped in NR RRC_IDLE state on HPLMN }
ensure that {
  when { User initiates MO emergency call }
  then { UE does not initiate emergency call on NR Cell }
}

```

11.3.7.2 Conformance requirements

References: The conformance requirements covered in the present TC are specified in: TS 24.501 clause 4.5.2, 4.5.4.1 and 4.5.6, TS 38.331 clause 5.3.14.2, 5.3.14.4 and 5.3.14.5, TS 22.101 clause 10.1.1. Unless otherwise stated these are Rel-15 requirements.

[TS 24.501, clause 4.5.2]

When the UE needs to initiate an access attempt in one of the events listed in subclause 4.5.1, the UE shall determine one or more access identities from the set of standardized access identities, and one access category from the set of standardized access categories and operator-defined access categories, to be associated with that access attempt.

The set of the access identities applicable for the request is determined by the UE in the following way:

- a) for each of the access identities 1, 2, 11, 12, 13, 14 and 15 in table 4.5.2.1, the UE shall check whether the access identity is applicable in the selected PLMN, if a new PLMN is selected, or otherwise if it is applicable in the RPLMN or equivalent PLMN; and
- b) if none of the above access identities is applicable, then access identity 0 is applicable.

Table 4.5.2.1: Access identities

Access Identity number	UE configuration
0	UE is not configured with any parameters from this table
1 (NOTE 1)	UE is configured for multimedia priority service (MPS).
2 (NOTE 2)	UE is configured for mission critical service (MCS).
3-10	Reserved for future use
11 (NOTE 3)	Access Class 11 is configured in the UE.
12 (NOTE 3)	Access Class 12 is configured in the UE.
13 (NOTE 3)	Access Class 13 is configured in the UE.
14 (NOTE 3)	Access Class 14 is configured in the UE.
15 (NOTE 3)	Access Class 15 is configured in the UE.
NOTE 1: Access identity 1 is valid when: - the USIM file EF _{UAC_AIC} indicates the UE is configured for access identity 1 and the selected PLMN, if a new PLMN is selected, or RPLMN is the HPLMN (if the EHPLMN list is not present or is empty) or EHPLMN (if the EHPLMN list is present), or a visited PLMN of the home country (see the definition of home country in 3GPP TS 24.301 [15]); or - the UE receives the 5GS network feature support IE with the MPS indicator bit set to "Access identity 1 valid" from the RPLMN as described in subclause 5.5.1.2.4 and subclause 5.5.1.3.4. NOTE 2: Access identity 2 is used by UEs configured for MCS and is valid when: - the USIM file EF _{UAC_AIC} indicates the UE is configured for access identity 2 and the selected PLMN, if a new PLMN is selected, or RPLMN is the HPLMN (if the EHPLMN list is not present or is empty) or EHPLMN (if the EHPLMN list is present), or a visited PLMN of the home country (see 3GPP TS 23.122 [5]); or - the UE receives the 5GS network feature support IE with the MCS indicator bit set to "Access identity 2 valid" from the RPLMN as described in subclause 5.5.1.2.4 and subclause 5.5.1.3.4. NOTE 3: Access identities 11 and 15 are valid in HPLMN (if the EHPLMN list is not present or is empty) or EHPLMN (if the EHPLMN list is present). Access Identities 12, 13 and 14 are valid in HPLMN and visited PLMNs of home country only (see the definition of home country in 3GPP TS 24.301 [15]).	

...

In order to determine the access category applicable for the access attempt, the NAS shall check the rules in table 4.5.2.2, and use the access category for which there is a match for barring check. If the access attempt matches more than one rule, the access category of the lowest rule number shall be selected. If the access attempt matches more than one operator-defined access category definition, the UE shall select the access category from the operator-defined access category definition with the lowest precedence value (see subclause 4.5.3).

NOTE: The case when an access attempt matches more than one rule includes the case when multiple events trigger an access attempt at the same time.

Table 4.5.2.2: Mapping table for access categories

Rule #	Type of access attempt	Requirements to be met	Access
--------	------------------------	------------------------	--------

			Category
1	Response to paging or NOTIFICATION over non-3GPP access; 5GMM connection management procedure initiated for the purpose of transporting an LPP message without an ongoing 5GC-MO-LR procedure; Access attempt to handover of ongoing MMTEL voice call, MMTEL video call or SMSoIP from non-3GPP access	Access attempt is for MT access, or handover of ongoing MMTEL voice call, MMTEL video call or SMSoIP from non-3GPP access	0 (= MT_acc)
2	Emergency	UE is attempting access for an emergency session (NOTE 1, NOTE 2)	2 (= emergency)
3	Access attempt for operator-defined access category	UE stores operator-defined access category definitions valid in the current PLMN as specified in subclause 4.5.3, and access attempt is matching criteria of an operator-defined access category definition	32-63 (= based on operator classification)
4	Access attempt for delay tolerant service	(a) UE is configured for NAS signalling low priority or UE supporting S1 mode is configured for EAB (see the "ExtendedAccessBarring" leaf of NAS configuration MO in 3GPP TS 24.368 [17] or 3GPP TS 31.102 [22]) where "EAB override" does not apply, and (b): the UE received one of the categories a, b or c as part of the parameters for unified access control in the broadcast system information, and the UE is a member of the broadcasted category in the selected PLMN or RPLMN/equivalent PLMN (NOTE 3, NOTE 5, NOTE 6, NOTE 7, NOTE 8)	1 (= delay tolerant)
4.1	MO IMS registration related signalling	Access attempt is for MO IMS registration related signalling (e.g. IMS initial registration, re-registration, subscription refresh) or for NAS signalling connection recovery during ongoing procedure for MO IMS registration related signalling (NOTE 2a)	9 (= MO IMS registration related signalling)
5	MO MMTel voice call	Access attempt is for MO MMTel voice call or for NAS signalling connection recovery during ongoing MO MMTel voice call (NOTE 2)	4 (= MO MMTel voice)
6	MO MMTel video call	Access attempt is for MO MMTel video call or for NAS signalling connection recovery during ongoing MO MMTel video call (NOTE 2)	5 (= MO MMTel video)
7	MO SMS over NAS or MO SMSoIP	Access attempt is for MO SMS over NAS (NOTE 4) or MO SMS over SMSoIP transfer or for NAS signalling connection recovery during ongoing MO SMS or SMSoIP transfer (NOTE 2)	6 (= MO SMS and SMSoIP)
8	UE NAS initiated 5GMM specific procedures	Access attempt is for MO signalling	3 (= MO_sig)
8.1	Mobile originated location request	Access attempt is for mobile originated location request (NOTE 9)	3 (= MO_sig)
8.2	Mobile originated signalling transaction towards the PCF	Access attempt is for mobile originated signalling transaction towards the PCF (NOTE 10)	3 (= MO_sig)
9	UE NAS initiated 5GMM connection management	Access attempt is for MO data	7 (= MO_data)

	procedure or 5GMM NAS transport procedure		
10	An uplink user data packet is to be sent for a PDU session with suspended user-plane resources	No further requirement is to be met	7 (= MO_data)
<p>NOTE 1: This includes 5GMM specific procedures while the service is ongoing and 5GMM connection management procedures required to establish a PDU session with request type = "initial emergency request" or "existing emergency PDU session", or to re-establish user-plane resources for such a PDU session. This further includes the service request procedure initiated with a SERVICE REQUEST message with the Service type IE set to "emergency services fallback".</p> <p>NOTE 2: Access for the purpose of NAS signalling connection recovery during an ongoing service as defined in subclause 4.5.5, or for the purpose of NAS signalling connection establishment following fallback indication from lower layers during an ongoing service as defined in subclause 4.5.5, is mapped to the access category of the ongoing service in order to derive an RRC establishment cause, but barring checks will be skipped for this access attempt.</p> <p>NOTE 2a: Access for the purpose of NAS signalling connection recovery during an ongoing procedure for MO IMS registration related signalling as defined in subclause 4.5.5, or for the purpose of NAS signalling connection establishment following fallback indication from lower layers during an ongoing procedure for MO IMS registration related signalling as defined in subclause 4.5.5, is mapped to the access category of the MO IMS registration related signalling in order to derive an RRC establishment cause, but barring checks will be skipped for this access attempt.</p> <p>NOTE 3: If the UE selects a new PLMN, then the selected PLMN is used to check the membership; otherwise the UE uses the RPLMN or a PLMN equivalent to the RPLMN.</p> <p>NOTE 4: This includes the 5GMM connection management procedures triggered by the UE-initiated NAS transport procedure for transporting the MO SMS.</p> <p>NOTE 5: The UE configured for NAS signalling low priority is not supported in this release of specification. If a UE supporting both S1 mode and N1 mode is configured for NAS signalling low priority in S1 mode as specified in 3GPP TS 24.368 [17] or 3GPP TS 31.102 [22], the UE shall ignore the configuration for NAS signalling low priority when in N1 mode.</p> <p>NOTE 6: If the access category applicable for the access attempt is 1, then the UE shall additionally determine a second access category from the range 3 to 7. If more than one access category matches, the access category of the lowest rule number shall be chosen. The UE shall use the second access category only to derive an RRC establishment cause for the access attempt.</p> <p>NOTE 7: "EAB override" does not apply, if the UE is not configured to allow overriding EAB (see the "Override_ExtendedAccessBarring" leaf of NAS configuration MO in 3GPP TS 24.368 [17] or 3GPP TS 31.102 [22]), or if NAS has not received an indication from the upper layers to override EAB and the UE does not have a PDU session that was established with EAB override.</p> <p>NOTE 8: For the definition of categories a, b and c associated with access category 1, see 3GPP TS 22.261 [3]. The categories associated with access category 1 are distinct from the categories a, b and c associated with EAB (see 3GPP TS 22.011 [1A]).</p> <p>NOTE 9: This includes:</p> <ul style="list-style-type: none"> a) the UE-initiated NAS transport procedure for transporting a mobile originated location request; b) the 5GMM connection management procedure triggered by a) above; and c) NAS signalling connection recovery during an ongoing 5GC-MO-LR procedure. <p>NOTE 10: This includes:</p> <ul style="list-style-type: none"> a) the UE-initiated NAS transport procedure for transporting a mobile originated signalling transaction towards the PCF; b) the 5GMM connection management procedure triggered by a) above; and c) NAS signalling connection recovery during an ongoing UE triggered V2X policy provisioning procedure. 			

[TS 24.501, clause 4.5.4.1]

When the UE is in 5GMM-IDLE mode or 5GMM-IDLE mode with suspend indication, upon receiving a request from the upper layers for an access attempt, the NAS shall categorize the access attempt into access identities and an access category following:

- a) subclause 4.5.2, table 4.5.2.1 and table 4.5.2.2, and subclause 4.5.3, if the UE is not operating in SNPN access mode; or
- b) subclause 4.5.2A, table 4.5.2A.1 and table 4.5.2A.2, and subclause 4.5.3, if the UE is operating in SNPN access mode,

and provide the applicable access identities and the access category to the lower layers for the purpose of access control checking. In this request to the lower layer the NAS can also provide to the lower layer the RRC establishment cause determined as specified in subclause 4.5.6 of this specification.

NOTE 1: The access barring check is performed by the lower layers.

NOTE 2: As an implementation option, the NAS can provide the RRC establishment cause to the lower layers after being informed by the lower layers that the access attempt is allowed.

...

If the lower layers indicate that the access attempt is barred, the NAS shall not initiate the procedure to send the initial NAS message for the access attempt. Additionally:

...

[TS 38.331, clause 5.3.14.2]

Upon initiation of the procedure, the UE shall:

...

1> else:

2> if the Access Category is '0':

3> consider the access attempt as allowed;

2> else:

3> if *SIB1* includes *uac-BarringPerPLMN-List* and the *uac-BarringPerPLMN-List* contains an *UAC-BarringPerPLMN* entry with the *plmn-IdentityIndex* corresponding to the PLMN or SNPN selected by upper layers (see TS 24.501 [23]):

4> select the *UAC-BarringPerPLMN* entry with the *plmn-IdentityIndex* corresponding to the PLMN or to the SNPN selected by upper layers;

4> in the remainder of this procedure, use the selected *UAC-BarringPerPLMN* entry (i.e. presence or absence of access barring parameters in this entry) irrespective of the *uac-BarringForCommon* included in *SIB1*;

3> else if *SIB1* includes *uac-BarringForCommon*:

4> in the remainder of this procedure use the *uac-BarringForCommon* (i.e. presence or absence of these parameters) included in *SIB1*;

3> else:

4> consider the access attempt as allowed;

3> if *uac-BarringForCommon* is applicable or the *uac-ACBarringListType* indicates that *uac-ExplicitACBarringList* is used:

4> if the corresponding *UAC-BarringPerCatList* contains a *UAC-BarringPerCat* entry corresponding to the Access Category:

5> select the *UAC-BarringPerCat* entry;

5> if the *uac-BarringInfoSetList* contains a *UAC-BarringInfoSet* entry corresponding to the selected *uac-barringInfoSetIndex* in the *UAC-BarringPerCat*:

6> select the *UAC-BarringInfoSet* entry;

6> perform access barring check for the Access Category as specified in 5.3.14.5, using the selected *UAC-BarringInfoSet* as "UAC barring parameter";

5> else:

- 6> consider the access attempt as allowed;
- 4> else:
 - 5> consider the access attempt as allowed;
- 3> else if the *uac-ACBarringListType* indicates that *uac-ImplicitACBarringList* is used:
 - 4> select the *uac-BarringInfoSetIndex* corresponding to the Access Category in the *uac-ImplicitACBarringList*;
 - 4> if the *uac-BarringInfoSetList* contains the *UAC-BarringInfoSet* entry corresponding to the selected *uac-BarringInfoSetIndex*:
 - 5> select the *UAC-BarringInfoSet* entry;
 - 5> perform access barring check for the Access Category as specified in 5.3.14.5, using the selected *UAC-BarringInfoSet* as "UAC barring parameter";
 - 4> else:
 - 5> consider the access attempt as allowed;
- 3> else:
 - 4> consider the access attempt as allowed;
- 1> if the access barring check was requested by upper layers:
 - 2> if the access attempt is considered as barred:
 - ...
 - 3> else:
 - 4> inform upper layers that the access attempt for the Access Category is barred, upon which the procedure ends;
 - 2> else:
 - 3> inform upper layers that the access attempt for the Access Category is allowed, upon which the procedure ends;
 - 1> else:
 - 2> the procedure ends.

[TS 38.331, clause 5.3.14.5]

The UE shall:

- 1> if one or more Access Identities are indicated according to TS 24.501 [23], and
 - 1> if for at least one of these Access Identities the corresponding bit in the *uac-BarringForAccessIdentity* contained in "UAC barring parameter" is set to *zero*:
 - 2> consider the access attempt as allowed;
 - 1> else:
 - 2> draw a random number '*rand*' uniformly distributed in the range: $0 \leq rand < 1$;
 - 2> if '*rand*' is lower than the value indicated by *uac-BarringFactor* included in "UAC barring parameter":
 - 3> consider the access attempt as allowed;
 - 2> else:

- 3> consider the access attempt as barred;
- 1> if the access attempt is considered as barred:
- 2> draw a random number '*rand*' that is uniformly distributed in the range $0 \leq rand < 1$;
- 2> start timer T390 for the Access Category with the timer value calculated as follows, using the *uac-BarringTime* included in "AC barring parameter":

$$T390 = (0.7 + 0.6 * rand) * uac-BarringTime.$$

[TS 22.101, subclause 10.1.1]

The ME shall identify an emergency number dialled by the end user as a valid emergency number and initiate emergency call establishment if it occurs under one or more of the following conditions. If it occurs outside of the following conditions, the ME should not initiate emergency call establishment but normal call establishment. Emergency number identification takes place before and takes precedence over any other (e.g. supplementary service related) number analysis.

- a) 112 and 911 shall always be available. These numbers shall be stored on the ME.

11.3.7.3 Test description

11.3.7.3.1 Pre-test conditions

System Simulator:

- NR Cell 1
- NR Cell 1 as defined in TS 38.508-1 [4] Table 4.4.2-3 is configured as per table 11.3.7.3.1-1 (PLMN1 is the HPLMN). System information combination NR-1 as defined in TS 38.508-1 [4], subclause 4.4.3.1.2.

Table 11.3.7.3.1-1: PLMN identifiers

NR Cell	PLMN names	MCC	MNC
NR Cell 1	PLMN1	001	01

UE:

- The UE is equipped with a USIM configuration as defined in TS 38.508-1 [4] Table 6.4.1-17.

Preamble:

- The UE is brought to state 1N-A, RRC_IDLE Connectivity (NR), in accordance with the procedure described in TS 38.508-1 [4], Table 4.5.2.2-2.

11.3.7.3.2 Test procedure sequence

Table 11.3.7.3.2-1: Main behaviour

St	Procedure	Message Sequence		TP	Verdict
		U - S	Message		
1	Make the UE attempt an emergency call dialling a number which is stored on the ME (e.g. 112 or 911). (NOTE 1)	-	-	-	-
2	Check: Does the UE transmit an <i>RRCSetupRequest</i> message with <i>establishmentCause</i> set to 'emergency' within 30 s'?	-->	NR RRC: <i>RRCSetupRequest</i>	1	F
3	SS modifies NR Cell 1 SIB1 to remove Access barring for AC2 and sends short message. (NOTE 2, NOTE 3)	<--	Short Message	-	-
4	Wait for 2.1* modification period to allow the new system information to take effect	-	-	-	-
5	Start Timer = 84s (NOTE 2, NOTE 4)	-	-	-	-

5A a2	Stop Timer = 84s	-	-	-	-
5A b1	Timer = 84s expires	-	-	-	-
5A b2	Make the UE attempt an emergency call dialling a number which is stored on the ME (e.g. 112 or 911). (NOTE 1)	-	-	-	-
5A b3	UE transmits an <i>RRCSetupRequest</i> message with <i>establishmentCause</i> set to ' <i>highPriorityAccess</i> ' to establish an emergency call.	-->	NR RRC: <i>RRCSetupRequest</i>	-	-
6	Void	-	-	-	-
7	The SS transmits an <i>RRCSetup</i> message.	<--	NR RRC: <i>RRCSetup</i>	-	-
-	EXCEPTION: Steps 8a1 to 8b2 describe behaviour that depends on the UE implementation; the "lower case letter" identifies a step sequence that take place if a particular implementation is under test.	-	-	-	-
8a1	The UE transmits an <i>RRCSetupComplete</i> message AND a SERVICE REQUEST message with 'Service type' set to 'high priority access'.	-->	NR RRC: <i>RRCSetupComplete</i> 5GMM: SERVICE REQUEST	-	-
8a2	Steps 4-8 are performed from the generic test procedure as specified in TS 38.508-1 [4] subclause 4.9.11.	-	-	-	-
8b1	The UE transmits an <i>RRCSetupComplete</i> message AND a REGISTRATION REQUEST message with 'registration type' set to 'emergency'. (Note 6)	-->	NR RRC: <i>RRCSetupComplete</i> 5GMM: REGISTRATION REQUEST	-	-
8b2	Steps 5-15 are performed from the generic test procedure as specified in TS 38.508-1 [4] subclause 4.5.2.2-2fv	-	-	-	-
9	Void	-	-	-	-
-	EXCEPTION: Steps 10a1 to 10b1 describe behaviour that depends on the UE implementation; the "lower case letter" identifies a step sequence that take place if a particular implementation is under test.	-	-	-	-
10a 1	IF <i>pc_SwitchOnOff</i> THEN switch off UE, IF <i>pc_USIM_Removal</i> THEN remove the USIM.	-	-	-	-
10a 2	SS starts timer1 = 5 sec to see if UE performs optional Step 10a3a1 (Note 5)	-	-	-	-
10a 3a1	The UE transmits a DEREGISTRATION REQUEST message.	-->	NR RRC: <i>ULInformationTransfer</i> 5GMM: DEREGISTRATION REQUEST	-	-
10a 3a2	The SS transmits an <i>RRCRelease</i> message IF step 10a3a1 was performed ELSE SS implicitly releases the RRC connection.	<--	NR RRC: <i>RRCRelease</i>	-	-
10b 1	ELSE power off UE	-	-	-	-
<p>NOTE 1: This could be done by e.g. MMI or AT command.</p> <p>NOTE 2: Since barring is alleviated, UE may re-attempt an emergency call, triggered at step 1, automatically after T390 stop/expiry without manual intervention.</p> <p>NOTE 3: Steps 3 to 9 are there to ensure that UE under test supports emergency call and is not initiating it at Step 2 due to access barring for AC2.</p> <p>NOTE 4: T390 timer value is derived from 38.331[12] $T390 = (0.7 + 0.6 \cdot \text{rand}) \cdot \text{uac-BarringTime}$ where the <i>uac-BarringTime</i> value of 64s is provided in 38.523-1 Table 11.3.7.3.3-1 and where the value of <i>rand</i> is chosen to be 1 as to arrive at the maximum value for T390 of 83.2s rounded up to 84s.</p> <p>Note 5: The UE may implicitly de-register upon disabling N1 mode capability due to 'IMS voice not available'</p> <p>Note 6: UE may try to find service to place the emergency call (step 1) on other RATs since emergency access is barred on NR Cell 1. In this case UE will send a REGISTRATION REQUEST instead of a SERVICE REQUEST.</p> <p>NOTE 7: UE may perform domain selection and stop T390. If UE move back to the NR Cell 1 during 84s timer running, UE may initiate emergency call before 84s timer expire.</p>					

11.3.7.3.3 Specific message contents

Table 11.3.7.3.3-1: SIB1 for NR Cell 1 (preamble, Table 11.3.7.3.2-1)

Derivation Path: TS 38.508-1 [4], Table 4.6.1-28			
Information Element	Value/remark	Comment	Condition
SIB1 ::= SEQUENCE {			
uac-BarringForCommon SEQUENCE {			
UAC-BarringPerCatList ::= SEQUENCE (SIZE (1..maxAccessCat-1)) OF UAC-BarringPerCat {	1 entry		
UAC-BarringPerCat[1] SEQUENCE {		entry 1	
accessCategory	2		
uac-barringInfoSetIndex	1		
}			
}			
uac-BarringPerPLMN-List	Not present		
uac-BarringInfoSetList ::= SEQUENCE (SIZE(1..maxBarringInfoSet)) OF UAC-BarringInfoSet {	1 entry		
UAC-BarringInfoSet[1] SEQUENCE {		entry 1	
uac-BarringFactor	p00		
uac-BarringTime	s64		
uac-BarringForAccessIdentity	'0011111'B		
}			
uac-AccessCategory1-SelectionAssistanceInfo	Not Present		
}			
}			

Table 11.3.7.3.3-2: SERVICE REQUEST (preamble and Step 8, Table 11.3.7.3.2-2)

Derivation path: TS 38.508-1 [4] Table 4.7.1-16			
Information Element	Value/Remark	Comment	Condition
Service type	'0101'B	High priority access	pc_noOf_PDUsNewConnections > 0

Table 11.3.7.3.3-3: RRCSetupRequest (step 6, Table 11.3.7.3.2-1)

Derivation Path: TS 38.508-1 [4], Table 4.6.1-23			
Information Element	Value/remark	Comment	Condition
RRCSetupRequest ::= SEQUENCE {			
rrcSetupRequest SEQUENCE {			
establishmentCause	highPriorityAccess		
}			
}			

11.3.8 UAC / Access Identity 0 / NR RRC_IDLE / Cell re-selection while T390 is running

11.3.8.1 Test Purpose (TP)

(1)

```

with { UE not configured for special AIs (1,2,11-15) ,having access barred for MO signalling and
T390 running in NR RRC_IDLE state}
ensure that {
  when { UE performs Cell Reselection to a new NR Cell }
  then { UE stops T390 for MO signalling and informs upper layers about barring alleviation for
this Access Category }
}

```

11.3.8.2 Conformance requirements

References: The conformance requirements covered in the present TC are specified in TS 24.501: clause 4.5.2, 4.5.4.1 and 4.5.6 and TS 38.331: clause 5.3.14.1, 5.3.14.2, 5.3.14.4 and 5.3.14.5. Unless otherwise stated these are Rel-15 requirements.

[TS 24.501, clause 4.5.2]

When the UE needs to initiate an access attempt in one of the events listed in subclause 4.5.1, the UE shall determine one or more access identities from the set of standardized access identities, and one access category from the set of standardized access categories and operator-defined access categories, to be associated with that access attempt.

The set of the access identities applicable for the request is determined by the UE in the following way:

- a) for each of the access identities 1, 2, 11, 12, 13, 14 and 15 in table 4.5.2.1, the UE shall check whether the access identity is applicable in the selected PLMN, if a new PLMN is selected, or otherwise if it is applicable in the RPLMN or equivalent PLMN; and
- b) if none of the above access identities is applicable, then access identity 0 is applicable.

Table 4.5.2.1: Access identities

Access Identity number	UE configuration
0	UE is not configured with any parameters from this table
1 (NOTE 1)	UE is configured for multimedia priority service (MPS).
2 (NOTE 2)	UE is configured for mission critical service (MCS).
3-10	Reserved for future use
11 (NOTE 3)	Access Class 11 is configured in the UE.
12 (NOTE 3)	Access Class 12 is configured in the UE.
13 (NOTE 3)	Access Class 13 is configured in the UE.
14 (NOTE 3)	Access Class 14 is configured in the UE.
15 (NOTE 3)	Access Class 15 is configured in the UE.
<p>NOTE 1: Access identity 1 is valid when:</p> <ul style="list-style-type: none"> - the USIM file EFUAC_AIC indicates the UE is configured for access identity 1 and the RPLMN is the HPLMN (if the EHPLMN list is not present or is empty) or EHPLMN (if the EHPLMN list is present), or a visited PLMN of the home country (see the definition of home country in 3GPP TS 24.301 [15]); or - the UE receives the 5GS network feature support IE with the MPS indicator bit set to "Access identity 1 valid in RPLMN or equivalent PLMN" from the RPLMN as described in subclause 5.5.1.2.4 and subclause 5.5.1.3.4. <p>NOTE 2: Access identity 2 is used by UEs configured for MCS and is valid when:</p> <ul style="list-style-type: none"> - the USIM file EFUAC_AIC indicates the UE is configured for access identity 2 and the RPLMN is the HPLMN (if the EHPLMN list is not present or is empty) or EHPLMN (if the EHPLMN list is present), or a visited PLMN of the home country (see 3GPP TS 23.122 [5]); or - the UE receives the 5GS network feature support IE with the MCS indicator bit set to "Access identity 2 valid in RPLMN or equivalent PLMN" from the RPLMN as described in subclause 5.5.1.2.4 and subclause 5.5.1.3.4. <p>NOTE 3: Access identities 11 and 15 are valid in HPLMN (if the EHPLMN list is not present or is empty) or EHPLMN (if the EHPLMN list is present). Access Identities 12, 13 and 14 are valid in HPLMN and visited PLMNs of home country only (see the definition of home country in 3GPP TS 24.301 [15]).</p>	

The UE uses the MPS indicator bit of the 5GS network feature support IE to determine if access identity 1 is valid. Processing of the MPS indicator bit of the 5GS network feature support IE in the REGISTRATION ACCEPT message is described in subclause 5.5.1.2.4 and subclause 5.5.1.3.4. The UE shall not consider access identity 1 to be valid when the UE is not in the country of its HPLMN prior to receiving the MPS indicator bit of the 5GS network feature support IE in the REGISTRATION ACCEPT message being set to "Access identity 1 valid in RPLMN or equivalent PLMN".

When the UE is in the country of its HPLMN, the contents of the USIM files EF_{UAC_AIC} and EF_{ACC} as specified in 3GPP TS 31.102 [22] and the rules specified in table 4.5.2.1 are used to determine the applicability of access identity 1 and access classes 11 - 15. When the UE is in the country of its HPLMN, and the USIM file EF_{UAC_AIC} does not indicate the UE is configured for access identity 1, the UE uses the MPS indicator bit of the 5GS network feature support IE in the REGISTRATION ACCEPT message to determine if access identity 1 is valid. When the UE is in the country of its HPLMN, and the USIM file EF_{UAC_AIC} indicates the UE is configured for access identity 1, the MPS indicator bit of the

5GS network feature support IE is not applicable. When the UE is not in the country of its HPLMN, the contents of the USIM files EF_{UAC_AIC} and EF_{ACC} are not applicable.

The UE uses the MCS indicator bit of the 5GS network feature support IE to determine if access identity 2 is valid. Processing of the MCS indicator bit of the 5GS network feature support IE in the REGISTRATION ACCEPT message is described in subclause 5.5.1.2.4 and subclause 5.5.1.3.4. The UE shall not consider access identity 2 to be valid when the UE is not in the country of its HPLMN prior to receiving the MCS indicator bit of the 5GS network feature support IE in the REGISTRATION ACCEPT message being set to "Access identity 2 valid in RPLMN or equivalent PLMN".

When the UE is in the country of its HPLMN, the contents of the USIM files EF_{UAC_AIC} and EF_{ACC} as specified in 3GPP TS 31.102 [22] and the rules specified in table 4.5.2.1 are used to determine the applicability of access identity 2 and access classes 11 - 15. When the UE is in the country of its HPLMN, and the USIM file EF_{UAC_AIC} does not indicate the UE is configured for access identity 2, the UE uses the MCS indicator bit of the 5GS network feature support IE in the REGISTRATION ACCEPT message to determine if access identity 2 is valid. When the UE is in the country of its HPLMN, and the USIM file EF_{UAC_AIC} indicates the UE is configured for access identity 2, the MCS indicator bit of the 5GS network feature support IE is not applicable. When the UE is not in the country of its HPLMN, the contents of the USIM files EF_{UAC_AIC} and EF_{ACC} are not applicable.

In order to determine the access category applicable for the access attempt, the NAS shall check the rules in table 4.5.2.2, and use the access category for which there is a match for barring check. If the access attempt matches more than one rule, the access category of the lowest rule number shall be selected. If the access attempt matches more than one operator-defined access category definition, the UE shall select the access category from the operator-defined access category definition with the lowest precedence value (see subclause 4.5.3).

NOTE: The case when an access attempt matches more than one rule includes the case when multiple events trigger an access attempt at the same time.

Table 4.5.2.2: Mapping table for access categories

Rule #	Type of access attempt	Requirements to be met	Access Category
1	Response to paging or NOTIFICATION over non-3GPP access; 5GMM connection management procedure initiated for the purpose of transporting an LPP message	Access attempt is for MT access	0 (= MT_acc)
2	Emergency	UE is attempting access for an emergency session (NOTE 1, NOTE 2)	2 (= emergency)
3	Access attempt for operator-defined access category	UE stores operator-defined access category definitions valid in the current PLMN as specified in subclause 4.5.3, and access attempt is matching criteria of an operator-defined access category definition	32-63 (= based on operator classification)
4	Access attempt for delay tolerant service	(a) UE is configured for NAS signalling low priority or UE supporting S1 mode is configured for EAB (see the "ExtendedAccessBarring" leaf of NAS configuration MO in 3GPP TS 24.368 [17] or 3GPP TS 31.102 [22]) where "EAB override" does not apply, and (b) the UE received one of the categories a, b or c as part of the parameters for unified access control in the broadcast system information, and the UE is a member of the broadcasted category in the selected PLMN or RPLMN/equivalent PLMN (NOTE 3, NOTE 5, NOTE 6, NOTE 7, NOTE 8)	1 (= delay tolerant)
5	MO MMTel voice call	Access attempt is for MO MMTel voice call or for NAS signalling connection recovery during ongoing MO MMTel voice call (NOTE 2)	4 (= MO MMTel voice)
6	MO MMTel video call	Access attempt is for MO MMTel video call	5 (= MO MMTel

		or for NAS signalling connection recovery during ongoing MO MMTel video call (NOTE 2)	video)
7	MO SMS over NAS or MO SMSoIP	Access attempt is for MO SMS over NAS (NOTE 4) or MO SMS over SMSoIP transfer or for NAS signalling connection recovery during ongoing MO SMS or SMSoIP transfer (NOTE 2)	6 (= MO SMS and SMSoIP)
8	UE NAS initiated 5GMM specific procedures	Access attempt is for MO signalling	3 (= MO_sig)
9	UE NAS initiated 5GMM connection management procedure or 5GMM NAS transport procedure	Access attempt is for MO data	7 (= MO_data)
10	An uplink user data packet is to be sent for a PDU session with suspended user-plane resources	No further requirement is to be met	7 (= MO_data)
<p>NOTE 1: This includes 5GMM specific procedures while the service is ongoing and 5GMM connection management procedures required to establish a PDU session with request type = "initial emergency request" or "existing emergency PDU session", or to re-establish user-plane resources for such a PDU session. This further includes the service request procedure initiated with a SERVICE REQUEST message with the Service type IE set to "emergency services fallback".<</p> <p>NOTE 2: Access for the purpose of NAS signalling connection recovery during an ongoing service, or for the purpose of NAS signalling connection establishment following fallback indication from lower layers during an ongoing service, is mapped to the access category of the ongoing service in order to derive an RRC establishment cause, but barring checks will be skipped for this access attempt.</p> <p>NOTE 3: If the UE selects a new PLMN, then the selected PLMN is used to check the membership; otherwise the UE uses the RPLMN or a PLMN equivalent to the RPLMN.</p> <p>NOTE 4: This includes the 5GMM connection management procedures triggered by the UE-initiated NAS transport procedure for transporting the MO SMS.</p> <p>NOTE 5: The UE configured for NAS signalling low priority is not supported in this release of specification. If a UE supporting both S1 mode and N1 mode is configured for NAS signalling low priority in S1 mode as specified in 3GPP TS 24.368 [17] or 3GPP TS 31.102 [22], the UE shall ignore the configuration for NAS signalling low priority when in N1 mode.</p> <p>NOTE 6: If the access category applicable for the access attempt is 1, then the UE shall additionally determine a second access category from the range 3 to 7. If more than one access category matches, the access category of the lowest rule number shall be chosen. The UE shall use the second access category only to derive an RRC establishment cause for the access attempt.</p> <p>NOTE 7: "EAB override" does not apply, if the UE is not configured to allow overriding EAB (see the "Override_ExtendedAccessBarring" leaf of NAS configuration MO in 3GPP TS 24.368 [17] or 3GPP TS 31.102 [22]), or if NAS has not received an indication from the upper layers to override EAB and the UE does not have a PDU session that was established with EAB override.</p> <p>NOTE 8: For the definition of categories a, b and c associated with access category 1, see 3GPP TS 22.261 [3]. The categories associated with access category 1 are distinct from the categories a, b and c associated with EAB (see 3GPP TS 22.011 [1A]).</p>			

[TS 24.501, clause 4.5.4.1]

When the UE is in 5GMM-IDLE mode, upon receiving a request from the upper layers for an access attempt, the NAS shall categorize the access attempt into access identities and an access category following subclause 4.5.2, table 4.5.2.1 and table 4.5.2.2, and subclause 4.5.3, and provide the applicable access identities and the access category to the lower layers for the purpose of access control checking. In this request to the lower layer the NAS can also provide to the lower layer the RRC establishment cause determined as specified in subclause 4.5.6 of this specification.

NOTE 1: The access barring check is performed by the lower layers.

NOTE 2: As an implementation option, the NAS can provide the RRC establishment cause to the lower layers after being informed by the lower layers that the access attempt is allowed.

If the UE has uplink user data pending for one or more PDU sessions when it builds a REGISTRATION REQUEST or SERVICE REQUEST message as initial NAS message, the UE shall indicate the respective PDU sessions in the Uplink data status IE as specified in subclause 5.5.1.3.2 and 5.6.1.2, regardless of the access category for which the access barring check is performed.

NOTE 3: The UE indicates pending user data for all the respective PDU sessions, even if barring timers are running for some of the corresponding access categories.

If the lower layers indicate that the access attempt is allowed, the NAS shall initiate the procedure to send the initial NAS message for the access attempt.

If the lower layers indicate that the access attempt is barred, the NAS shall not initiate the procedure to send the initial NAS message for the access attempt. Additionally:

- a) if the event which triggered the access attempt was an MO-MMTel-voice-call-started indication or an MO-MMTel-video-call-started indication:
 - 1) if the UE is operating in the single-registration mode and the UE's usage setting is "voice centric", the UE may attempt to select an E-UTRA cell connected to EPC. If the UE finds a suitable E-UTRA cell connected to EPC, it then proceeds with the appropriate EMM specific procedures and, if necessary, ESM procedures to make a PDN connection providing access to IMS available; see subclause 4.8.2 and 3GPP TS 24.301 [15];
 - 2) if the UE is operating in the dual-registration mode, the UE may proceed in S1 mode with the appropriate EMM specific procedures and ESM procedures to make a PDN connection providing access to IMS available; see subclause 4.8.3 and 3GPP TS 24.301 [15];
 - 3) otherwise, the NAS shall notify the upper layers that the access attempt is barred. In this case, upon receiving an indication from the lower layers that the barring is alleviated for the access category with which the access attempt was associated, the NAS shall notify the upper layers that the barring is alleviated for the access category and may initiate the procedure to send the initial NAS message, if still needed; and
- b) if the event which triggered the access attempt was an MO-SMS over IP-attempt-started indication:
 - 1) if the UE is operating in the single-registration mode, the UE may attempt to select an E-UTRA cell connected to EPC. If the UE finds a suitable E-UTRA cell connected to EPC, it then proceeds with the appropriate EMM specific procedures and, if necessary, ESM procedures to make a PDN connection providing access to IMS available; see subclause 4.8.2 and 3GPP TS 24.301 [15];
 - 2) if the UE is operating in the dual-registration mode, the UE may proceed in S1 mode with the appropriate EMM specific procedures and ESM procedures to make a PDN connection providing access to IMS available; see subclause 4.8.3 and 3GPP TS 24.301 [15];
 - 3) otherwise, the NAS layer shall notify the upper layers that the access attempt is barred. In this case, upon receiving an indication from the lower layers that the barring is alleviated for the access category with which the access attempt was associated, the NAS shall notify the upper layers that the barring is alleviated for the access category and may initiate the procedure to send the initial NAS message, if still needed.

NOTE 4: Barring timers, on a per access category basis, are run by the lower layers. At expiry of barring timers, the indication of alleviation of access barring is indicated to the NAS on a per access category basis.

[TS 24.501, clause 4.5.6]

When 5GMM requests the establishment of a NAS-signalling connection, the RRC establishment cause used by the UE shall be selected according to one or more access identities (see subclause 4.5.2) and the determined access category as specified in table 4.5.6.1 and table 4.5.6.2. If the determined access category is an operator-defined access category, then the RRC establishment cause used by the UE shall be selected according to table 4.5.6.1 and table 4.5.6.2 based on one or more access identities (see subclause 4.5.2) and the standardized access category determined for the operator-defined access category as described in subclause 4.5.3.

Table 4.5.6.1: Mapping table for access identities/access categories and RRC establishment cause when establishing N1 NAS signalling connection via NR connected to 5GCN

Access identities	Access categories	RRC establishment cause is set to
0	0 (= MT_acc)	mt-Access
	1 (= delay tolerant)	Not applicable (NOTE 1)
	2 (= emergency)	emergency
	3 (= MO_sig)	mo-Signalling
	4 (= MO MMTel voice)	mo-VoiceCall
	5 (= MO MMTel video)	mo-VideoCall

	6 (= MO SMS and SMSoIP)	mo-SMS
	7 (= MO_data)	mo-Data
1	Any category	mps-PriorityAccess
2	Any category	mcs-PriorityAccess
11, 15	Any category	highPriorityAccess
12,13,14,	Any category	highPriorityAccess
NOTE 1: A UE using access category 1 for the access barring check will determine a second access category in the range 3 to 7 that is to be used for determination of the RRC establishment cause. See subclause 4.5.2, table 4.5.2.2, NOTE 6.		
NOTE 2: See subclause 4.5.2, table 4.5.2.1 for use of the access identities of 0, 1, 2, and 11-15.		

Table 4.5.6.2: Mapping table for access identities/access categories and RRC establishment cause when establishing N1 NAS signalling connection via E-UTRA connected to 5GCN

Access identities	Access categories	RRC establishment cause is set to
0	0 (= MT_acc)	mt-Access
	1 (= delay tolerant)	Not applicable (NOTE 1)
	2 (= emergency)	emergency
	3 (= MO_sig)	mo-Signalling
	4 (= MO MMTel voice)	mo-VoiceCall
	5 (= MO MMTel video)	mo-VoiceCall
	6 (= MO SMS and SMSoIP)	mo-Data
	7 (= MO_data)	mo-Data
1	Any category	highPriorityAccess
2	Any category	highPriorityAccess
11, 15	Any category	highPriorityAccess
12,13,14,	Any category	highPriorityAccess
NOTE 1: A UE using access category 1 for the access barring check will determine a second access category in the range 3 to 7 that is to be used for determination of the RRC establishment cause. See subclause 4.5.2, table 4.5.2.2, NOTE 6.		
NOTE 2: See subclause 4.5.2, table 4.5.2.1 for use of the access identities of 0, 1, 2, and 11-15.		

[TS 38.331, clause 5.3.14.1]

The purpose of this procedure is to perform access barring check for an access attempt associated with a given Access Category and one or more Access Identities upon request from upper layers according to TS 24.501 [23] or the RRC layer.

After a handover resulting in change of PCell in RRC_CONNECTED the UE shall defer access barring checks until it has obtained valid UAC information (from *SIB1*) from the target cell.

[TS 38.331, clause 5.3.14.2]

Upon initiation of the procedure, the UE shall:

- 1> if timer T390 is running for the Access Category:
 - 2> consider the access attempt as barred;
- 1> else if timer T302 is running and the Access Category is neither '2' nor '0':
 - 2> consider the access attempt as barred;
- 1> else:
 - 2> if the Access Category is '0':
 - 3> consider the access attempt as allowed;
 - 2> else:

- 3> if *SIB1* includes *uac-BarringPerPLMN-List* and the *uac-BarringPerPLMN-List* contains an *UAC-BarringPerPLMN* entry with the *plmn-IdentityIndex* corresponding to the PLMN selected by upper layers (see TS 24.501 [23]):
 - 4> select the *UAC-BarringPerPLMN* entry with the *plmn-IdentityIndex* corresponding to the PLMN selected by upper layers;
 - 4> in the remainder of this procedure, use the selected *UAC-BarringPerPLMN* entry (i.e. presence or absence of access barring parameters in this entry) irrespective of the *uac-BarringForCommon* included in *SIB1*;
 - 3> else if *SIB1* includes *uac-BarringForCommon*:
 - 4> in the remainder of this procedure use the *uac-BarringForCommon* (i.e. presence or absence of these parameters) included in *SIB1*;
 - 3> else:
 - 4> consider the access attempt as allowed;
 - 3> if *uac-BarringForCommon* is applicable or the *uac-ACBarringListType* indicates that *uac-ExplicitACBarringList* is used:
 - 4> if the corresponding *UAC-BarringPerCatList* contains a *UAC-BarringPerCat* entry corresponding to the Access Category:
 - 5> select the *UAC-BarringPerCat* entry;
 - 5> if the *uac-BarringInfoSetList* contains a *UAC-BarringInfoSet* entry corresponding to the selected *uac-barringInfoSetIndex* in the *UAC-BarringPerCat*:
 - 6> select the *UAC-BarringInfoSet* entry;
 - 6> perform access barring check for the Access Category as specified in 5.3.14.5, using the selected *UAC-BarringInfoSet* as "UAC barring parameter";
 - 5> else:
 - 6> consider the access attempt as allowed;
 - 4> else:
 - 5> consider the access attempt as allowed;
 - 3> else if the *uac-ACBarringListType* indicates that *uac-ImplicitACBarringList* is used:
 - 4> select the *uac-BarringInfoSetIndex* corresponding to the Access Category in the *uac-ImplicitACBarringList*;
 - 4> if the *uac-BarringInfoSetList* contains the *UAC-BarringInfoSet* entry corresponding to the selected *uac-BarringInfoSetIndex*:
 - 5> select the *UAC-BarringInfoSet* entry;
 - 5> perform access barring check for the Access Category as specified in 5.3.14.5, using the selected *UAC-BarringInfoSet* as "UAC barring parameter";
 - 4> else:
 - 5> consider the access attempt as allowed;
 - 3> else:
 - 4> consider the access attempt as allowed;
- 1> if the access barring check was requested by upper layers:

- 2> if the access attempt is considered as barred:
 - 3> if timer T302 is running:
 - 4> inform the upper layer that access barring is applicable for all access categories except categories '0' and '2', upon which the procedure ends;
 - 3> else:
 - 4> inform upper layers that the access attempt for the Access Category is barred, upon which the procedure ends;
- 2> else:
 - 3> inform upper layers that the access attempt for the Access Category is allowed, upon which the procedure ends;
- 1> else:
 - 2> the procedure ends.

[TS 38.331, clause 5.3.14.4]

The UE shall:

- 1> if timer T302 expires or is stopped, and if timer T390 corresponding to an Access Category is not running; or
- 1> if timer T390 corresponding to an Access Category other than '2' expires or is stopped, and if timer T302 is not running; or
- 1> if timer T390 corresponding to the Access Category '2' expires or is stopped:
 - 2> consider the barring for this Access Category to be alleviated;
- 1> when barring for an Access Category is considered being alleviated:
 - 2> if the Access Category was informed to upper layers as barred:
 - 3> inform upper layers about barring alleviation for the Access Category.
 - 2> if barring is alleviated for Access Category '8':
 - 3> perform actions specified in 5.3.13.8;

[TS 38.331, clause 5.3.14.5]

The UE shall:

- 1> if one or more Access Identities are indicated according to TS 24.501 [23], and
- 1> if for at least one of these Access Identities the corresponding bit in the *uac-BarringForAccessIdentity* contained in "UAC barring parameter" is set to *zero*:
 - 2> consider the access attempt as allowed;
- 1> else:
 - 2> draw a random number '*rand*' uniformly distributed in the range: $0 \leq rand < 1$;
 - 2> if '*rand*' is lower than the value indicated by *uac-BarringFactor* included in "UAC barring parameter":
 - 3> consider the access attempt as allowed;
 - 2> else:
 - 3> consider the access attempt as barred;
- 1> if the access attempt is considered as barred:

- 2> draw a random number '*rand*' that is uniformly distributed in the range $0 \leq rand < 1$;
- 2> start timer T390 for the Access Category with the timer value calculated as follows, using the *uac-BarringTime* included in "AC barring parameter":

$$T390 = (0.7 + 0.6 * rand) * uac-BarringTime.$$

11.3.8.3 Test description

11.3.8.3.1 Pre-test conditions

System Simulator:

- NR Cell 1 and NR Cell 3 belong to the same tracking areas according to TS 38.508-1 [4] Table 4.4.2-3.
- System information combination NR-4 in TS 38.508-1 [4] sub-clause 4.4.3.1.2 is used in NR cells

UE:

None.

Preamble:

The UE is in state ON-B on NR cell 1 according to TS 38.508-1 [4].

11.3.8.3.2 Test procedure sequence

Table 11.3.8.3.2-1/2 illustrate the downlink power levels and other changing parameters to be applied for the cell at various time instants of the test execution. The exact instants on which these values shall be applied are described in the texts in this clause. The configuration "T1" indicates the initial conditions for preamble. Configurations marked "T2" is applied at the points indicated in the Main behaviour description in Table 11.3.8.3.2-3.

Table 11.3.8.3.2-1: Time instances of cell power level and parameter changes for FR1

	Parameter	Unit	NR Cell 1	NR Cell 3	Remark
T1	SS/PBCH SSS EPRE	dBm/ SCS	-88	Off	The power level is such that $Sr_{xlevNRCell1} > 0$
	Qrxlevmin	dBm	-110	-	
T2	SS/PBCH SSS EPRE	dBm/ SCS	-99	-88	The power level values are assigned to satisfy $R_{NRCell1} < R_{NRCell3}$
	Qrxlevmin	dBm	-110	-110	

Table 11.3.8.3.2-2: Time instances of cell power level and parameter changes for FR2

	Parameter	Unit	NR Cell 1	NR Cell 3	Remark
T1	SS/PBCH SSS EPRE	dBm/ SCS	-82	Off	The power level is such that $Sr_{xlevNRCell1} > 0$
	Qrxlevmin	dBm	- 110+Delta(NRf1)	-	
T2	SS/PBCH SSS EPRE	dBm/ SCS	-91	-82	The power level values are assigned to satisfy $R_{NRCell1} < R_{NRCell3}$
	Qrxlevmin	dBm	- 110+Delta(NRf1)	- 110+Delta(NRf1)	

Table 11.3.8.3.2-3: Main behaviour

St	Procedure	Message Sequence		TP	Verdict
		U - S	Message		

1	The UE is switched on.	-	-	-	-
1A-1L	Steps 2-13 of the generic procedure for UE registration specified in TS 38.508-1 [4] table 4.5.2.2-2 are performed.	-	-	-	-
1M	SS transmits a REGISTRATION REJECT message with cause #22 (Congestion) and T3346 set to 1 minute	<--	REGISTRATION REJECT	-	-
1N	The SS releases the RRC connection	-	-	-	-
1O	The SS changes the SIB1 of NR Cell 1 to set Cell 1 barred for 'mo_Signalling'.	-	-	-	-
1P	The SS transmits a Short message on PDCCH using P-RNTI indicating a <i>systemInfoModification</i> .	<--	PDCCH (DCI 1_0): Short Message	-	-
2	Check: Does the UE send NR <i>RRCSetupRequest</i> with <i>EstablishmentCause</i> set to 'mo-Sigalling' within 70s (Note 1)?	-->	NR RRC: RRCSetupRequest	1	F
2A	Void	-	-	-	-
3	Set the power levels according to "T2" as per Table 11.3.8.3.2-1/2 for UE to reselect to NR Cell 3.	-	-	-	-
4	Void	-	-	-	-
5	Check: Does the UE send NR <i>RRCSetupRequest</i> with <i>EstablishmentCause</i> set to 'mo-Sigalling' on NR Cell 3 within 130s? (Note 2)	-->	NR RRC: RRCSetupRequest	1	P
5A-5C	Void	-	-	-	-
6-23	Steps 3-20a1 of the generic procedure for UE registration specified in TS 38.508-1 [4] table 4.5.2.2-2 are performed.	-	-	-	-
<p>Note 1: Expire of T3346 (60s) + 10s tolerance = 70s make sure UE request to send REGISTRATION REQUEST message.</p> <p>Note 2: T390 timer value is calculated by "T390 = (0.7 + 0.6 * rand) * uac-BarringTime". With uac-BarringTime as s256 the worst-case timer value is 180 seconds which covers both FR1 and FR2 cell reselection scenario. The wait time for reselection to a newly detected inter frequency cell is selected to cover T_{detect,NR_Inter} ($25 \times 1280ms = 32s$ for FR1 and $25 \times 4 \times 1280ms = 128s$ for FR2) + T_{SI-NR} (1.28s for FR1 and FR2) = 33.28s rounded up to 34s for FR1 and 129.28s rounded up to 130s for FR2.</p>					

11.3.8.3.3 Specific message contents

Table 11.3.8.3.3-1: SIB1 for NR Cell 1 (Step10, Table 11.3.8.3.2-3)

Derivation Path: TS 38.508-1 [4], Table 4.6.1-28			
Information Element	Value/remark	Comment	Condition
SIB1 ::= SEQUENCE {			
uac-BarringForCommon SEQUENCE {			
UAC-BarringPerCatList SEQUENCE (SIZE (1..maxAccessCat-1)) OF UAC-BarringPerCat {	1 entry		
UAC-BarringPerCat[1] SEQUENCE {		entry 1	
accessCategory	3		
uac-barringInfoSetIndex	1		
}			
}			
uac-BarringPerPLMN-List	Not present		
uac-BarringInfoSetList ::= SEQUENCE (SIZE(1..maxBarringInfoSet)) OF UAC-BarringInfoSet {	1 entry		
UAC-BarringInfoSet[1] SEQUENCE {		entry 1	
uac-BarringFactor	p00		
uac-BarringTime	s256		
uac-BarringForAccessIdentity	'0000000'B		
}			
}			

uac-AccessCategory1-SelectionAssistanceInfo	Not Present		
}			
}			

Table 11.3.8.3.3-2: REGISTRATION REJECT (Step 1M, Table 11.3.8.3.2-3)

Derivation path: TS 38.508-1 [4], table 4.7.1-9			
Information Element	Value/Remark	Comment	Condition
5GMM cause	'00010110'B	Cause #22 (Congestion)	
T3346 Value	'00100001'B	1 minute	

11.3.9 UAC / Access Identity 0 / ODAC / PLMN / RPLMN / not EPLMN

11.3.9.1 Test Purpose (TP)

(1)

```
with { UE not configured for special AIs (1,2,11-15) having received Operator Defined Access
Category "x" in the range 32..63 with access category criteria type set to "DNN" valid in the
selected PLMN or RPLMN as part of Registration Procedure }
ensure that {
  when { SIB1 message indicates no barring for Access category 7 but 0% accessibility for Access
Category "x" }
  then { UE does not initiate PDU Session Establishment for the "DNN" }
}
```

(2)

```
with { UE not configured for special AIs (1,2,11-15) having received Operator Defined Access
Category "x" in the range 32..63 with access category criteria type set to "DNN" valid in the
selected PLMN or RPLMN as part of Registration Procedure , SIB1 message indicates no barring for
Access category 7 but 0% accessibility for Access Category "x" }
ensure that {
  when { UE moves to another cell belonging to a different PLMN not equivalent to the previous
PLMN }
  then { UE is able to initiate PDU Session Establishment for "DNN" in the new PLMN }
}
```

11.3.9.2 Conformance requirements

References: The conformance requirements covered in the present TC are specified in TS 24.501: clause 4.5.3 and TS 38.331: clause 5.3.14.1, 5.3.14.2, 5.3.14.4 and 5.3.14.5. Unless otherwise stated these are Rel-15 requirements.

[TS 24.501, clause 4.5.3]

Operator-defined access category definitions can be signalled to the UE using NAS signalling. Each operator-defined access category definition consists of the following parameters:

- a) a precedence value which indicates in which order the UE shall evaluate the operator-defined category definition for a match;
- b) an operator-defined access category number, i.e. access category number in the 32-63 range that uniquely identifies the access category in the PLMN in which the access categories are being sent to the UE;
- c) criteria consisting of one or more access category criteria type and associated access category criteria type values. The access category criteria type can be set to one of the following:
 - 1) DNN;
 - 2) OS Id + OS App Id of application triggering the access attempt; or
 - 3) S-NSSAI; and

NOTE 1: An access category criteria type can be associated with more than one access category criteria values.

- d) optionally, a standardized access category. This standardized access category is used in combination with the access identities of the UE to determine the RRC establishment cause as specified in subclause 4.5.6.

An access attempt matches the criteria of an operator-defined access category definition, if the access attempt matches all access category criteria types included in the criteria with any of the associated access criteria type values.

Each operator-defined access category definition has a different precedence value.

Several operator-defined access category definitions can have the same operator-defined access category number.

If:

- an access category in bullet d) is not provided;
- an access category in bullet d) is provided and is not a standardized access category; or
- an access category in bullet d) is provided, is a standardized access category and is not recognized by the UE;

the UE shall use instead:

- access category 3 (MO_sig) if the access attempt is triggered by uplink signalling; or
- access category 7 (MO_data) if the access attempt is triggered by uplink data

in combination with the access identities of the UE to determine the RRC establishment cause as specified in subclause 4.5.6.

The operator-defined access category definitions are valid in the PLMN which provided them and in a PLMN equivalent to the PLMN which provided them, as specified in annex C.

If the UE stores operator-defined access category definitions valid in the selected PLMN or the RPLMN, then access control in 5GMM-IDLE mode will only be performed for the event a) defined in subclause 4.5.1. If the transition from 5GMM-IDLE mode over 3GPP access to 5GMM-CONNECTED mode is due to a UE NAS initiated 5GMM specific procedure, then this access attempt shall be mapped to one of the standardized access categories in the range < 32, see subclause 4.5.2. I.e. for this case the UE shall skip the checking of operator-defined access category definitions.

If the UE stores operator-defined access category definitions valid in the selected PLMN or the RPLMN, then access control in 5GMM-CONNECTED mode and in 5GMM-CONNECTED mode with RRC inactive indication will only be performed for the events 1) to 6) defined in subclause 4.5.1.

The UE shall handle the operator-defined access category definitions stored for the RPLMN as specified in subclause 5.4.4.3, subclause 5.5.1.2.4, and subclause 5.5.1.3.4.

When the UE is switched off, the UE shall keep the operator-defined access category definitions so that the operator-defined access category definitions can be used after switch on.

When the UE selects a new PLMN which is not equivalent to the previously selected PLMN, the UE shall stop using the operator-defined access category definitions stored for the previously selected PLMN and should keep the operator-defined access category definitions stored for the previously selected PLMN.

NOTE 2: When the UE selects a new PLMN which is not equivalent to the previously selected PLMN, the UE can delete the operator-defined access category definitions stored for the previously selected PLMN e.g. if there is no storage space in the UE.

[TS 38.331, clause 5.3.14.1]

The purpose of this procedure is to perform access barring check for an access attempt associated with a given Access Category and one or more Access Identities upon request from upper layers according to TS 24.501 [23] or the RRC layer.

After a PCell change in RRC_CONNECTED the UE shall defer access barring checks until it has obtained *SIB1* (as specified in 5.2.2.2) from the target cell.

[TS 38.331, clause 5.3.14.2]

Upon initiation of the procedure, the UE shall:

- 1> if timer T390 is running for the Access Category:
 - 2> consider the access attempt as barred;
- 1> else if timer T302 is running and the Access Category is neither '2' nor '0':
 - 2> consider the access attempt as barred;
- 1> else:
 - 2> if the Access Category is '0':
 - 3> consider the access attempt as allowed;
 - 2> else:
 - 3> if *SIB1* includes *uac-BarringPerPLMN-List* and the *uac-BarringPerPLMN-List* contains an *UAC-BarringPerPLMN* entry with the *plmn-IdentityIndex* corresponding to the PLMN selected by upper layers (see TS 24.501 [23]):
 - 4> select the *UAC-BarringPerPLMN* entry with the *plmn-IdentityIndex* corresponding to the PLMN selected by upper layers;
 - 4> in the remainder of this procedure, use the selected *UAC-BarringPerPLMN* entry (i.e. presence or absence of access barring parameters in this entry) irrespective of the *uac-BarringForCommon* included in *SIB1*;
 - 3> else if *SIB1* includes *uac-BarringForCommon*:
 - 4> in the remainder of this procedure use the *uac-BarringForCommon* (i.e. presence or absence of these parameters) included in *SIB1*;
 - 3> else:
 - 4> consider the access attempt as allowed;
 - 3> if *uac-BarringForCommon* is applicable or the *uac-ACBarringListType* indicates that *uac-ExplicitACBarringList* is used:
 - 4> if the corresponding *UAC-BarringPerCatList* contains a *UAC-BarringPerCat* entry corresponding to the Access Category:
 - 5> select the *UAC-BarringPerCat* entry;
 - 5> if the *uac-BarringInfoSetList* contains a *UAC-BarringInfoSet* entry corresponding to the selected *uac-barringInfoSetIndex* in the *UAC-BarringPerCat*:
 - 6> select the *UAC-BarringInfoSet* entry;
 - 6> perform access barring check for the Access Category as specified in 5.3.14.5, using the selected *UAC-BarringInfoSet* as "UAC barring parameter";
 - 5> else:
 - 6> consider the access attempt as allowed;
 - 4> else:
 - 5> consider the access attempt as allowed;
 - 3> else if the *uac-ACBarringListType* indicates that *uac-ImplicitACBarringList* is used:
 - 4> select the *uac-BarringInfoSetIndex* corresponding to the Access Category in the *uac-ImplicitACBarringList*;

- 4> if the *uac-BarringInfoSetList* contains the *UAC-BarringInfoSet* entry corresponding to the selected *uac-BarringInfoSetIndex*:
 - 5> select the *UAC-BarringInfoSet* entry;
 - 5> perform access barring check for the Access Category as specified in 5.3.14.5, using the selected *UAC-BarringInfoSet* as "UAC barring parameter";
- 4> else:
 - 5> consider the access attempt as allowed;
- 3> else:
 - 4> consider the access attempt as allowed;
- 1> if the access barring check was requested by upper layers:
 - 2> if the access attempt is considered as barred:
 - 3> if timer T302 is running:
 - 4> if timer T390 is running for Access Category '2':
 - 5> inform the upper layer that access barring is applicable for all access categories except categories '0', upon which the procedure ends;
 - 4> else
 - 5> inform the upper layer that access barring is applicable for all access categories except categories '0' and '2', upon which the procedure ends;
 - 3> else:
 - 4> inform upper layers that the access attempt for the Access Category is barred, upon which the procedure ends;
 - 2> else:
 - 3> inform upper layers that the access attempt for the Access Category is allowed, upon which the procedure ends;
 - 1> else:
 - 2> the procedure ends.

[TS 38.331, clause 5.3.14.4]

The UE shall:

- 1> if timer T302 expires or is stopped:
 - 2> for each Access Category for which T390 is not running:
 - 3> consider the barring for this Access Category to be alleviated;
- 1> else if timer T390 corresponding to an Access Category other than '2' expires or is stopped, and if timer T302 is not running:
 - 2> consider the barring for this Access Category to be alleviated;
- 1> else if timer T390 corresponding to the Access Category '2' expires or is stopped:
 - 2> consider the barring for this Access Category to be alleviated;
- 1> when barring for an Access Category is considered being alleviated:
 - 2> if the Access Category was informed to upper layers as barred:

3> inform upper layers about barring alleviation for the Access Category.

2> if barring is alleviated for Access Category '8':

3> perform actions specified in 5.3.13.8;

[TS 38.331, clause 5.3.14.5]

The UE shall:

1> if one or more Access Identities are indicated according to TS 24.501 [23], and

1> if for at least one of these Access Identities the corresponding bit in the *uac-BarringForAccessIdentity* contained in "UAC barring parameter" is set to *zero*:

2> consider the access attempt as allowed;

1> else:

2> draw a random number 'rand' uniformly distributed in the range: $0 \leq \text{rand} < 1$;

2> if 'rand' is lower than the value indicated by *uac-BarringFactor* included in "UAC barring parameter":

3> consider the access attempt as allowed;

2> else:

3> consider the access attempt as barred;

1> if the access attempt is considered as barred:

2> draw a random number 'rand' that is uniformly distributed in the range $0 \leq \text{rand} < 1$;

2> start timer T390 for the Access Category with the timer value calculated as follows, using the *uac-BarringTime* included in "AC barring parameter":

$T390 = (0.7 + 0.6 * \text{rand}) * \text{uac-BarringTime}$.

11.3.9.3 Test description

11.3.9.3.1 Pre-test conditions

System Simulator:

- 2 NR cells: NR Cell 1 and 12 as specified in TS 38.508-1 [4] table 4.4.2-3.
- System information combination NR-1 as defined in TS 38.508-1 [4] Table 4.4.3.1.2-1 is used in NR cells.

UE:

- None.

Preamble:

- The UE is registered on PLMN1 (NR Cell 1) and in state 3N-A on NR Cell 1 (serving cell) by using the procedure described in TS 38.508-1 [4] clause 4.5.2.2 with "connected without release" except that the REGISTRATION ACCEPT message indicates Operator Defined Access Category "'33'" as described in Table 11.3.9.3.3-1.

11.3.9.3.2 Test procedure sequence

Table 11.3.9.3.2-1 for FR1 and Table 11.3.9.3.2-2 for FR2 illustrates the downlink power levels and other changing parameters to be applied for the cells at various time instants of the test execution. Row marked "T0" denotes the initial conditions in preamble, while the column marked "T1" is to be applied subsequently in the Main behaviour. The exact instants on which these values shall be applied are described in the texts in this clause.

Table 11.3.9.3.2-1: Time instances of cell power level and parameter changes for FR1

	Parameter	Unit	NR Cell 1	NR Cell 12	Remarks
T0	SS/PBCH SSS EPRE	dBm/SCS	-88	Off	The power level values are assigned to ensure UE registered on NR Cell 1.
T1	SS/PBCH SSS EPRE	dBm/SCS	Off	-88	The power level values are assigned to ensure UE registered on NR Cell 12.
Note 1: Power level "Off" is defined in TS 38.508-1 [4] Table 6.2.2.1-3.					

Table 11.3.9.3.2-2: Time instances of cell power level and parameter changes for FR2

	Parameter	Unit	NR Cell 1	NR Cell 12	Remarks
T0	SS/PBCH SSS EPRE	dBm/SCS	-82	Off	The power level values are assigned to ensure UE registered on NR Cell 1.
T1	SS/PBCH SSS EPRE	dBm/SCS	Off	-82	The power level values are assigned to ensure UE registered on NR Cell 12.
Note 1: Power level "Off" is defined in TS 38.508-1 [4] Table 6.2.2.2-2.					

Table 11.3.9.3.2-3: Main behaviour

St	Procedure	Message Sequence		TP	Verdict
		U - S	Message		
1-2	Void	-	-	-	-
3	Make the UE attempt to establish a PDU session for the DNN defined in Table 11.3.9.3.3-1. This can be done by an AT/MMI command.	-	-	-	-
4	Check: Does the UE transmit a PDU SESSION ESTABLISHMENT REQUEST and the DNN in UL NAS TRANSPORT message is the same value in UL NAS TRANSPORT message in preamble within 11.2s?	-->	5GMM: UL NAS TRANSPORT 5GSM: PDU SESSION ESTABLISHMENT REQUEST	1	F
5	The SS adjusts the NR Cells power levels according to row "T1" in table 11.3.9.3.2-1/2.	-	-	-	-
6	The mobility registration updating procedure described in TS 38.508-1 [4] Table 4.9.5.2.2-1 is performed on NR Cell 12 and release RRC connection. (Note 1)	-	-	-	-
6A	Start Timer=5 sec.	-	-	-	-
	EXCEPTION: Steps 6Ba1-6Bb3 describes optional behaviour that depends on the UE implementation.				
6B a1	Check: Does the UE transmit an <i>RRCSetupRequest</i> message and <i>establishmentCause</i> is set to <i>mo-Data</i> ?	-->	NR RRC: RRCSetupRequest	2	P
6B a2	Stop Timer=5 sec.	-	-	-	-
6B b1	Timer=5 sec expires	-	-	-	-
6B b2	Make the UE attempt to establish a PDU session for the DNN defined in Table 11.3.9.3.3-1. This can be done by an AT/MMI command.	-	-	-	-
6B b3	Check: Does the UE transmit an <i>RRCSetupRequest</i> message and <i>establishmentCause</i> is set to <i>mo-Data</i> ?	-->	NR RRC: RRCSetupRequest	2	P
9- 14	Steps 3-8 of the generic procedure for NR RRC_Connected specified in TS 38.508-1 Table 4.5.4.2-3 are performed.	-	-	-	-
15	Check: Does the UE transmit a PDU SESSION ESTABLISHMENT REQUEST and the DNN value in UL NAS TRANSPORT message is the same as the DNN value of Operator-defined	-->	5GMM: UL NAS TRANSPORT 5GSM: PDU SESSION ESTABLISHMENT REQUEST	2	P

	access category definitions defined in Table 11.3.9.3.3-1				
16	The SS transmits <i>RRCReconfiguration</i> message containing PDU SESSION ESTABLISHMENT ACCEPT message.	<--	NR RRC: <i>RRCReconfiguration</i> 5GMM: DL NAS TRANSPORT 5GSM: PDU SESSION ESTABLISHMENT ACCEPT	-	-
17	The UE transmits <i>RRCReconfigurationComplete</i> message to confirm the establishment of DRB.	-->	NR RRC: <i>RRCReconfigurationComplete</i>	-	-
18	Void	-	-	-	-
Note 1: SS ignore the PDU SESSION ESTABLISHMENT REQUEST sent before SS release RRC connection.					

11.3.9.3.3 Specific message contents

Table 11.3.9.3.3-1: REGISTRATION ACCEPT (preamble)

Derivation path: TS 38.508 [4] Table 4.7.1-7			
Information Element	Value/remark	Comment	Condition
Operator-defined access category definitions			
Precedence value	'0000 0000'B		
PSAC	'1'B	Value 1 means that standardized access category is present.	
Operator-defined access category number	'00001'B	33	
Criteria			
Criteria type	'0000 0000'B	DNN type	
Criteria value			
DNN length-value pair count	'0000 0001'B		
DNN length-value pair			
DNN value length		Set to the length in octets of the DNN value field.	
DNN value	'ABCD'		
Standardized access category	'00111'B	Access category number 7	

Table 11.3.9.3.3-2: SIB1 of NR Cell 1 and NR Cell 12 (preamble and all steps, Table 11.3.9.3.2-3)

Derivation Path: TS 38.508-1 [4], Table 4.6.1-28			
Information Element	Value/remark	Comment	Condition
SIB1 ::= SEQUENCE {			
uac-BarringInfo SEQUENCE {			NR cell 1 NR cell 12
uac-BarringForCommon SEQUENCE (SIZE (1..maxAccessCat-1)) OF UAC-BarringPerCat {	1 entry		
UAC-BarringPerCat[1] SEQUENCE {		entry 1	
accessCategory	33		
uac-barringInfoSetIndex	1	Value 1 corresponds to the first entry in uac-BarringInfoSetList	
}			
}			
uac-BarringPerPLMN-List	Not present		
uac-BarringInfoSetList SEQUENCE (SIZE(1..maxBarringInfoSet)) OF UAC-BarringInfoSet {	1 entry		
UAC-BarringInfoSet[1] SEQUENCE {		entry 1	
uac-BarringFactor	p00	0% access probability	
uac-BarringTime	s16	16 s	
uac-BarringForAccessIdentity	'1111111'B	Value 1 means that access attempt is not allowed for the corresponding access	

		identity. The leftmost bit, bit 0 in the bit string corresponds to Access Identity 1.	
}			
}			
uac-AccessCategory1- SelectionAssistanceInfo	Not Present		
}			
}			

Table 11.3.9.3.3-3: PDU SESSION ESTABLISHMENT ACCEPT (step 16, Table 11.3.9.3.2-3)

Derivation path: TS 38.508-1 [4], Table 4.7.2-2			
Information Element	Value/remark	Comment	Condition
Authorized QoS rules	5GC QoS rule of the Config#1 in Table 4.8.4-1		
Mapped EPS bearer contexts			
Mapped EPS bearer context			
Mapped EPS QoS parameters	EPC default bearer context of the Config#1 in Table 4.8.4-1		
DNN	The same DNN value as sent in the UL NAS TRANSPORT message at step 15		

11.3.10 UAC / Access Identity 0 / AC9 / 0% access probability / SIP Re-registration

11.3.10.1 Test Purpose (TP)

(1)

```
with { the UE is NR RRC_CONNECTED }
ensure that {
  when { the UE receives SIB1 message not configured for special AIs (1,2,11-15) indicating UAC Info
set to 0% accessibility for Access category 9}
  then { UE is not able to send SIP REGISTER message successfully }
}
```

(2)

```
with { the UE is NR RRC_CONNECTED }
ensure that {
  when { the UE receives SIB1 default message }
  then { UE is able to perform reregistration successfully }
}
```

11.3.10.2 Conformance requirements

References: The conformance requirements covered in the present TC are specified in TS 24.501: clause 4.5.2, 4.5.4.2 and 4.5.6 and TS 38.331: clause 5.3.14.1, 5.3.14.2, 5.3.14.4 and 5.3.14.5. Unless otherwise stated these are Rel-16 requirements.

[TS 24.501, clause 4.5.2]

When the UE needs to initiate an access attempt in one of the events listed in subclause 4.5.1, the UE shall determine one or more access identities from the set of standardized access identities, and one access category from the set of standardized access categories and operator-defined access categories, to be associated with that access attempt.

The set of the access identities applicable for the request is determined by the UE in the following way:

- a) for each of the access identities 1, 2, 11, 12, 13, 14 and 15 in table 4.5.2.1, the UE shall check whether the access identity is applicable in the selected PLMN, if a new PLMN is selected, or otherwise if it is applicable in the RPLMN or equivalent PLMN; and
- b) if none of the above access identities is applicable, then access identity 0 is applicable.

Table 4.5.2.1: Access identities

Access Identity number	UE configuration
0	UE is not configured with any parameters from this table
1 (NOTE 1)	UE is configured for multimedia priority service (MPS).
2 (NOTE 2)	UE is configured for mission critical service (MCS).
3-10	Reserved for future use
11 (NOTE 3)	Access Class 11 is configured in the UE.
12 (NOTE 3)	Access Class 12 is configured in the UE.
13 (NOTE 3)	Access Class 13 is configured in the UE.
14 (NOTE 3)	Access Class 14 is configured in the UE.
15 (NOTE 3)	Access Class 15 is configured in the UE.
<p>NOTE 1: Access identity 1 is valid when:</p> <ul style="list-style-type: none"> - the USIM file EF_{UAC_AIC} indicates the UE is configured for access identity 1 and the selected PLMN, if a new PLMN is selected, or RPLMN is the HPLMN (if the EHPLMN list is not present or is empty) or EHPLMN (if the EHPLMN list is present), or a visited PLMN of the home country (see the definition of home country in 3GPP TS 24.301 [15]); or - the UE receives the 5GS network feature support IE with the MPS indicator bit set to "Access identity 1 valid" from the RPLMN as described in subclause 5.5.1.2.4 and subclause 5.5.1.3.4. <p>NOTE 2: Access identity 2 is used by UEs configured for MCS and is valid when:</p> <ul style="list-style-type: none"> - the USIM file EF_{UAC_AIC} indicates the UE is configured for access identity 2 and the selected PLMN, if a new PLMN is selected, or RPLMN is the HPLMN (if the EHPLMN list is not present or is empty) or EHPLMN (if the EHPLMN list is present), or a visited PLMN of the home country (see 3GPP TS 23.122 [5]); or - the UE receives the 5GS network feature support IE with the MCS indicator bit set to "Access identity 2 valid" from the RPLMN as described in subclause 5.5.1.2.4 and subclause 5.5.1.3.4. <p>NOTE 3: Access identities 11 and 15 are valid in HPLMN (if the EHPLMN list is not present or is empty) or EHPLMN (if the EHPLMN list is present). Access Identities 12, 13 and 14 are valid in HPLMN and visited PLMNs of home country only (see the definition of home country in 3GPP TS 24.301 [15]).</p>	

The UE uses the MPS indicator bit of the 5GS network feature support IE to determine if access identity 1 is valid. Processing of the MPS indicator bit of the 5GS network feature support IE in the REGISTRATION ACCEPT message is described in subclause 5.5.1.2.4 and subclause 5.5.1.3.4. The UE shall not consider access identity 1 to be valid when the UE is not in the country of its HPLMN or in an EHPLMN (if the EHPLMN list is present) prior to receiving the MPS indicator bit of the 5GS network feature support IE in the REGISTRATION ACCEPT message being set to "Access identity 1 valid".

When the UE is in the country of its HPLMN or in an EHPLMN (if the EHPLMN list is present), the contents of the USIM file EF_{UAC_AIC} as specified in 3GPP TS 31.102 [22] and the rules specified in table 4.5.2.1 are used to determine the applicability of access identity 1. When the UE is in the country of its HPLMN or in an EHPLMN (if the EHPLMN list is present), and the USIM file EF_{UAC_AIC} does not indicate the UE is configured for access identity 1, the UE uses the MPS indicator bit of the 5GS network feature support IE in the REGISTRATION ACCEPT message to determine if access identity 1 is valid. When the UE is in the country of its HPLMN or in an EHPLMN (if the EHPLMN list is present), and the USIM file EF_{UAC_AIC} indicates the UE is configured for access identity 1, the MPS indicator bit of the 5GS network feature support IE is not applicable. When the UE is not in the country of its HPLMN or in an EHPLMN (if the EHPLMN list is present), the contents of the USIM file EF_{UAC_AIC} are not applicable.

The UE uses the MCS indicator bit of the 5GS network feature support IE to determine if access identity 2 is valid. Processing of the MCS indicator bit of the 5GS network feature support IE in the REGISTRATION ACCEPT message is described in subclause 5.5.1.2.4 and subclause 5.5.1.3.4. The UE shall not consider access identity 2 to be valid when the UE is not in the country of its HPLMN or in an EHPLMN (if the EHPLMN list is present) prior to receiving the MCS indicator bit of the 5GS network feature support IE in the REGISTRATION ACCEPT message being set to "Access identity 2 valid".

When the UE is in the country of its HPLMN or in an EHPLMN (if the EHPLMN list is present), the contents of the USIM file EF_{UAC_AIC} as specified in 3GPP TS 31.102 [22] and the rules specified in table 4.5.2.1 are used to determine the applicability of access identity 2. When the UE is in the country of its HPLMN or in an EHPLMN (if the EHPLMN

list is present), and the USIM file EF_{UAC_AIC} does not indicate the UE is configured for access identity 2, the UE uses the MCS indicator bit of the 5GS network feature support IE in the REGISTRATION ACCEPT message to determine if access identity 2 is valid. When the UE is in the country of its HPLMN or in an EHPLMN (if the EHPLMN list is present), and the USIM file EF_{UAC_AIC} indicates the UE is configured for access identity 2, the MCS indicator bit of the 5GS network feature support IE is not applicable. When the UE is not in the country of its HPLMN or in an EHPLMN (if the EHPLMN list is present), the contents of the USIM file EF_{UAC_AIC} are not applicable.

When the UE is in its HPLMN (if the EHPLMN list is not present or is empty) or in an EHPLMN (if the EHPLMN list is present), the contents of the USIM file EF_{ACC} as specified in 3GPP TS 31.102 [22] and the rules specified in table 4.5.2.1 are used to determine the applicability of access classes 11 and 15. When the UE is not in its HPLMN (if the EHPLMN list is not present or is empty) or in an EHPLMN (if the EHPLMN list is present), access classes 11 and 15 are not applicable.

When the UE is in the country of its HPLMN, the contents of the USIM file EF_{ACC} as specified in 3GPP TS 31.102 [22] and the rules specified in table 4.5.2.1 are used to determine the applicability of access classes 12 - 14. When the UE is not in the country of its HPLMN, access classes 12-14 are not applicable.

In order to determine the access category applicable for the access attempt, the NAS shall check the rules in table 4.5.2.2, and use the access category for which there is a match for barring check. If the access attempt matches more than one rule, the access category of the lowest rule number shall be selected. If the access attempt matches more than one operator-defined access category definition, the UE shall select the access category from the operator-defined access category definition with the lowest precedence value (see subclause 4.5.3).

NOTE: The case when an access attempt matches more than one rule includes the case when multiple events trigger an access attempt at the same time.

Table 4.5.2.2: Mapping table for access categories

Rule #	Type of access attempt	Requirements to be met	Access Category
1	Response to paging or NOTIFICATION over non-3GPP access; 5GMM connection management procedure initiated for the purpose of transporting an LPP message without an ongoing 5GC-MO-LR procedure; Access attempt to handover of ongoing MMTEL voice call, MMTEL video call or SMSoIP from non-3GPP access	Access attempt is for MT access, or handover of ongoing MMTEL voice call, MMTEL video call or SMSoIP from non-3GPP access	0 (= MT_acc)
2	Emergency	UE is attempting access for an emergency session (NOTE 1, NOTE 2)	2 (= emergency)
3	Access attempt for operator-defined access category	UE stores operator-defined access category definitions valid in the current PLMN as specified in subclause 4.5.3, and access attempt is matching criteria of an operator-defined access category definition	32-63 (= based on operator classification)
3.1	Access attempt for MO exception data	UE is in NB-N1 mode and allowed to use exception data reporting (see the ExceptionDataReportingAllowed leaf of the NAS configuration MO in 3GPP TS 24.368 [17] or the USIM file EF _{NASCONFIG} in 3GPP TS 31.102 [22]), and access attempt is for MO data or for MO signalling initiated upon receiving a request from upper layers to transmit user data related to an exceptional event.	10 (= MO exception data)
4	Access attempt for delay tolerant service	(a) UE is configured for NAS signalling low priority or UE supporting S1 mode is configured for EAB (see the	1 (= delay tolerant)

		"ExtendedAccessBarring" leaf of NAS configuration MO in 3GPP TS 24.368 [17] or 3GPP TS 31.102 [22]) where "EAB override" does not apply, and (b): the UE received one of the categories a, b or c as part of the parameters for unified access control in the broadcast system information, and the UE is a member of the broadcasted category in the selected PLMN or RPLMN/equivalent PLMN (NOTE 3, NOTE 5, NOTE 6, NOTE 7, NOTE 8)	
4.1	MO IMS registration related signalling	Access attempt is for MO IMS registration related signalling (e.g. IMS initial registration, re-registration, subscription refresh) or for NAS signalling connection recovery during ongoing procedure for MO IMS registration related signalling (NOTE 2a)	9 (= MO IMS registration related signalling)
5	MO MMTel voice call	Access attempt is for MO MMTel voice call or for NAS signalling connection recovery during ongoing MO MMTel voice call (NOTE 2)	4 (= MO MMTel voice)
6	MO MMTel video call	Access attempt is for MO MMTel video call or for NAS signalling connection recovery during ongoing MO MMTel video call (NOTE 2)	5 (= MO MMTel video)
7	MO SMS over NAS or MO SMSoIP	Access attempt is for MO SMS over NAS (NOTE 4) or MO SMS over SMSoIP transfer or for NAS signalling connection recovery during ongoing MO SMS or SMSoIP transfer (NOTE 2)	6 (= MO SMS and SMSoIP)
8	UE NAS initiated 5GMM specific procedures	Access attempt is for MO signalling	3 (= MO_sig)
8.1	Mobile originated location request	Access attempt is for mobile originated location request (NOTE 9)	3 (= MO_sig)
8.2	Mobile originated signalling transaction towards the PCF	Access attempt is for mobile originated signalling transaction towards the PCF (NOTE 10)	3 (= MO_sig)
9	UE NAS initiated 5GMM connection management procedure or 5GMM NAS transport procedure	Access attempt is for MO data	7 (= MO_data)
10	An uplink user data packet is to be sent for a PDU session with suspended user-plane resources	No further requirement is to be met	7 (= MO_data)
<p>NOTE 1: This includes 5GMM specific procedures while the service is ongoing and 5GMM connection management procedures required to establish a PDU session with request type = "initial emergency request" or "existing emergency PDU session", or to re-establish user-plane resources for such a PDU session. This further includes the service request procedure initiated with a SERVICE REQUEST message with the Service type IE set to "emergency services fallback".</p> <p>NOTE 2: Access for the purpose of NAS signalling connection recovery during an ongoing service as defined in subclause 4.5.5, or for the purpose of NAS signalling connection establishment following fallback indication from lower layers during an ongoing service as defined in subclause 4.5.5, is mapped to the access category of the ongoing service in order to derive an RRC establishment cause, but barring checks will be skipped for this access attempt.</p> <p>NOTE 2a: Access for the purpose of NAS signalling connection recovery during an ongoing procedure for MO IMS registration related signalling as defined in subclause 4.5.5, or for the purpose of NAS signalling connection establishment following fallback indication from lower layers during an ongoing procedure for MO IMS registration related signalling as defined in subclause 4.5.5, is mapped to the access category of the MO IMS registration related signalling in order to derive an RRC establishment cause, but barring checks will be skipped for this access attempt.</p> <p>NOTE 3: If the UE selects a new PLMN, then the selected PLMN is used to check the membership; otherwise the UE uses the RPLMN or a PLMN equivalent to the RPLMN.</p> <p>NOTE 4: This includes the 5GMM connection management procedures triggered by the UE-initiated NAS transport procedure for transporting the MO SMS.</p>			

NOTE 5:	The UE configured for NAS signalling low priority is not supported in this release of specification. If a UE supporting both S1 mode and N1 mode is configured for NAS signalling low priority in S1 mode as specified in 3GPP TS 24.368 [17] or 3GPP TS 31.102 [22], the UE shall ignore the configuration for NAS signalling low priority when in N1 mode.
NOTE 6:	If the access category applicable for the access attempt is 1, then the UE shall additionally determine a second access category from the range 3 to 7. If more than one access category matches, the access category of the lowest rule number shall be chosen. The UE shall use the second access category only to derive an RRC establishment cause for the access attempt.
NOTE 7:	"EAB override" does not apply, if the UE is not configured to allow overriding EAB (see the "Override_ExtendedAccessBarring" leaf of NAS configuration MO in 3GPP TS 24.368 [17] or 3GPP TS 31.102 [22]), or if NAS has not received an indication from the upper layers to override EAB and the UE does not have a PDU session that was established with EAB override.
NOTE 8:	For the definition of categories a, b and c associated with access category 1, see 3GPP TS 22.261 [3]. The categories associated with access category 1 are distinct from the categories a, b and c associated with EAB (see 3GPP TS 22.011 [1A]).
NOTE 9:	This includes: <ul style="list-style-type: none"> a) the UE-initiated NAS transport procedure for transporting a mobile originated location request; b) the 5GMM connection management procedure triggered by a) above; and c) NAS signalling connection recovery during an ongoing 5GC-MO-LR procedure.
NOTE 10:	This includes: <ul style="list-style-type: none"> a) the UE-initiated NAS transport procedure for transporting a mobile originated signalling transaction towards the PCF; b) the 5GMM connection management procedure triggered by a) above; and c) NAS signalling connection recovery during an ongoing UE triggered V2X policy provisioning procedure.

[TS 24.501, clause 4.5.4.2]

When the UE is in 5GMM-CONNECTED mode or 5GMM-CONNECTED mode with RRC inactive indication, upon detecting one of events 1) through 8) listed in subclause 4.5.1, the NAS shall categorize the corresponding access attempt into access identities and an access category following:

- a) subclause 4.5.2, table 4.5.2.1 and table 4.5.2.2, and subclause 4.5.2.3, if the UE is not operating in SNPN access mode; or
- b) subclause 4.5.2A, table 4.5.2A.1 and table 4.5.2A.2, and subclause 4.5.3, if the UE is operating in SNPN access mode,

and provide the access identities and the access category to the lower layers for the purpose of access control checking. In this request to the lower layer the NAS can also provide to the lower layer the RRC establishment cause determined as specified in subclause 4.5.6 of this specification.

NOTE 1: As an implementation option, the NAS can provide the RRC establishment cause to the lower layers after being informed by the lower layers that the access attempt is allowed.

If the UE has uplink user data pending for one or more PDU sessions when it builds a REGISTRATION REQUEST or SERVICE REQUEST message for the access attempt, the UE shall indicate the respective PDU sessions in the Uplink data status IE as specified in subclause 5.5.1.3.2 and 5.6.1.2, regardless of the access category for which the access barring check is performed.

NOTE 2: The UE indicates pending user data for all the respective PDU sessions, even if barring timers are running for some of the corresponding access categories.

If the lower layers indicate that the access attempt is allowed, the NAS shall take the following action depending on the event which triggered the access attempt:

- a) if the event which triggered the access attempt was an MO-MMTEL-voice-call-started indication, an MO-MMTEL-video-call-started indication, an MO-SMSoIP-attempt-started indication, or an MO-IMS-registration-related-signalling-started indication, the NAS shall notify the upper layers that the access attempt is allowed;
- b) if the event which triggered the access attempt was a request from upper layers to send a mobile originated SMS over NAS, 5GMM shall initiate the NAS transport procedure as specified in subclause 5.4.5 to send the SMS in an UL NAS TRANSPORT message;

- c) if the event which triggered the access attempt was a request from upper layers to establish a new PDU session, 5GMM shall initiate the NAS transport procedure as specified in subclause 5.4.5 to send the PDU SESSION ESTABLISHMENT REQUEST message;
- d) if the event which triggered the access attempt was a request from upper layers to modify an existing PDU session, 5GMM shall initiate the NAS transport procedure as specified in subclause 5.4.5 to send the PDU SESSION MODIFICATION REQUEST message;
- e) if the event which triggered the access attempt was a request to re-establish the user-plane resources for an existing PDU session, 5GMM shall initiate the service request procedure as specified in subclause 5.6.1;
- f) if the event which triggered the access attempt was an uplink user data packet to be sent for a PDU session with suspended user-plane resources, 5GMM shall consider that the uplink user data packet is allowed to be sent;
- g) if the event which triggered the access attempt was a request from upper layers to send a mobile originated location request, 5GMM shall initiate the NAS transport procedure as specified in clause 5.4.5 to send an LCS message in an UL NAS TRANSPORT message; and
- h) if the event which triggered the access attempt was a request from upper layers to send a mobile originated signalling transaction towards the PCF by sending an UL NAS TRANSPORT message including a UE policy container (see 3GPP TS 24.587 [19B]), 5GMM shall initiate the NAS transport procedure as specified in subclause 5.4.5 to send the signalling transaction via an UL NAS TRANSPORT message.

If the lower layers indicate that the access attempt is barred, the NAS shall take the following action depending on the event which triggered the access attempt:

- a) if the event which triggered the access attempt was an MO-MMTEL-voice-call-started indication, an MO-MMTEL-video-call-started indication or an MO-SMSoIP-attempt-started indication, or an MO-IMS-registration-related-signalling-started indication:
 - 1) if the UE is operating in the dual-registration mode, the UE may proceed in S1 mode with the appropriate EMM specific procedures and ESM procedures to make a PDN connection providing access to IMS available; see subclause 4.8.3 and 3GPP TS 24.301 [15];
 - 2) otherwise, the NAS shall notify the upper layers that the access attempt is barred. In this case, upon receiving an indication from the lower layers that the barring is alleviated for the access category with which the access attempt was associated, the NAS shall notify the upper layers that the barring is alleviated for the access category;

NOTE 3: In this case prohibiting the initiation of the MMTEL voice session, MMTEL video session or prohibiting sending of the SMS over IP or the IMS registration related signalling is performed by the upper layers.

- b) if the event which triggered the access attempt was a request from upper layers to send a mobile originated SMS over NAS, 5GMM shall not initiate the NAS transport procedure as specified in subclause 5.4.5 to send the SMS in an UL NAS TRANSPORT message. Upon receiving an indication from the lower layers that the barring is alleviated for the access category with which the access attempt was associated, 5GMM may initiate the NAS transport procedure as specified in subclause 5.4.5 to send the SMS in an UL NAS TRANSPORT message, if still needed;
- c) if the event which triggered the access attempt was a request from upper layers to establish a new PDU session, 5GMM shall not initiate the NAS transport procedure to send the PDU SESSION ESTABLISHMENT REQUEST message. Upon receiving an indication from the lower layers that the barring is alleviated for the access category with which the access attempt was associated, the NAS may initiate the NAS transport procedure as specified in subclause 5.4.5, if still needed;
- d) if the event which triggered the access attempt was a request from upper layers to modify an existing PDU session modification, 5GMM shall not initiate the NAS transport procedure to send the PDU SESSION MODIFICATION REQUEST message. Upon receiving an indication from the lower layers that the barring is alleviated for the access category with which the access attempt was associated, the NAS may initiate the NAS transport procedure as specified in subclause 5.4.5, if still needed;
- e) if the event which triggered the access attempt was a request to re-establish the user-plane resources for an existing PDU session, the NAS shall not initiate the service request procedure as specified in subclause 5.6.1. Upon receiving an indication from the lower layers that the barring is alleviated for the access category with

which the access attempt was associated, the NAS may initiate the service request procedure as specified in subclause 5.6.1, if still needed;

- f) if the event which triggered the access attempt was an uplink user data packet to be sent for a PDU session with suspended user-plane resources, 5GMM shall consider that the uplink user data packet is not allowed to be sent. Upon receiving an indication from the lower layers that the barring is alleviated for the access category with which the access attempt was associated, the NAS shall consider that the barring is alleviated for the access category;
- g) if the event which triggered the access attempt was a request from upper layers to send a mobile originated location request, 5GMM shall not initiate the NAS transport procedure as specified in clause 5.4.5 to send an LCS message in an UL NAS TRANSPORT message. Upon receiving an indication from the lower layers that the barring is alleviated for the access category with which the access attempt was associated, 5GMM may initiate the NAS transport procedure as specified in clause 5.4.5 to send the LCS message in an UL NAS TRANSPORT message, if still needed; and
- h) if the event which triggered the access attempt was a request from upper layers to send a mobile originated signalling transaction towards the PCF by sending an UL NAS TRANSPORT message including a UE policy container (see 3GPP TS 24.587 [19B]), 5GMM shall not initiate the NAS transport procedure as specified in subclause 5.4.5 to send the mobile originated signalling transaction via an UL NAS TRANSPORT message. Upon receiving an indication from the lower layers that the barring is alleviated for the access category with which the access attempt was associated, 5GMM may initiate the NAS transport procedure as specified in subclause 5.4.5 to send the mobile originated signalling transaction via an UL NAS TRANSPORT message, if still needed.

[TS 24.501, clause 4.5.6]

When 5GMM requests the establishment of a NAS-signalling connection, the RRC establishment cause used by the UE shall be selected according to one or more access identities (see subclauses 4.5.2 and 4.5.2A) and the determined access category by checking the rules specified in table 4.5.6.1 and table 4.5.6.2. If the access attempt matches more than one rule, the RRC establishment cause of the lowest rule number shall be used. If the determined access category is an operator-defined access category, then the RRC establishment cause used by the UE shall be selected according to table 4.5.6.1 and table 4.5.6.2 based on one or more access identities (see subclauses 4.5.2 and 4.5.2A) and the standardized access category determined for the operator-defined access category as described in subclause 4.5.3.

Table 4.5.6.1: Mapping table for access identities/access categories and RRC establishment cause when establishing N1 NAS signalling connection via NR connected to 5GCN

Rule #	Access identities	Access categories	RRC establishment cause is set to
1	1	Any category	mps-PriorityAccess
2	2	Any category	mcs-PriorityAccess
3	11, 15	Any category	highPriorityAccess
4	12,13,14,	Any category	highPriorityAccess
5	0	0 (= MT_acc)	mt-Access
		1 (= delay tolerant)	Not applicable (NOTE 1)
		2 (= emergency)	emergency
		3 (= MO_sig)	mo-Signalling
		4 (= MO MMTel voice)	mo-VoiceCall
		5 (= MO MMTel video)	mo-VideoCall
		6 (= MO SMS and SMSoIP)	mo-SMS
		7 (= MO_data)	mo-Data
		9 (= MO IMS registration related signalling)	mo-Data
NOTE 1: A UE using access category 1 for the access barring check will determine a second access category in the range 3 to 7 that is to be used for determination of the RRC establishment cause. See subclause 4.5.2, table 4.5.2.2, NOTE 6.			
NOTE 2: See subclause 4.5.2, table 4.5.2.1 for use of the access identities of 0, 1, 2, and 11-15.			

Table 4.5.6.2: Mapping table for access identities/access categories and RRC establishment cause when establishing N1 NAS signalling connection via E-UTRA connected to 5GCN

Rule #	Access identities	Access categories	RRC establishment cause is set to
--------	-------------------	-------------------	-----------------------------------

1	1	Any category	highPriorityAccess
2	2	Any category	highPriorityAccess
3	11, 15	Any category	highPriorityAccess
4	12,13,14,	Any category	highPriorityAccess
5	0	0 (= MT_acc)	mt-Access
		1 (= delay tolerant)	Not applicable (NOTE 1)
		2 (= emergency)	emergency
		3 (= MO_sig)	mo-Signalling
		4 (= MO MMTel voice)	mo-VoiceCall
		5 (= MO MMTel video)	mo-VoiceCall
		6 (= MO SMS and SMSoIP)	mo-Data
		7 (= MO_data)	mo-Data
		9 (= MO IMS registration related signalling)	mo-Data
		10 (= MO exception data)	mo-ExceptionData (NOTE 3)
NOTE 1: A UE using access category 1 for the access barring check will determine a second access category in the range 3 to 7 that is to be used for determination of the RRC establishment cause. See subclause 4.5.2, table 4.5.2.2, NOTE 6.			
NOTE 2: See subclause 4.5.2, table 4.5.2.1 for use of the access identities of 0, 1, 2, and 11-15.			
NOTE 3: This applies to the UE in NB-N1 mode.			

[TS 38.331, clause 5.3.14.1]

The purpose of this procedure is to perform access barring check for an access attempt associated with a given Access Category and one or more Access Identities upon request from upper layers according to TS 24.501 [23] or the RRC layer. This procedure does not apply to IAB-MT.

After a PCell change in RRC_CONNECTED the UE shall defer access barring checks until it has obtained *SIB1* (as specified in 5.2.2.2) from the target cell.

[TS 38.331, clause 5.3.14.2]

Upon initiation of the procedure, the UE shall:

- 1> if timer T390 is running for the Access Category:
 - 2> consider the access attempt as barred;
- 1> else if timer T302 is running and the Access Category is neither '2' nor '0':
 - 2> consider the access attempt as barred;
- 1> else:
 - 2> if the Access Category is '0':
 - 3> consider the access attempt as allowed;
 - 2> else:
 - 3> if *SIB1* includes *uac-BarringPerPLMN-List* that contains a *UAC-BarringPerPLMN* for the selected PLMN or SNPN:
 - 4> if the procedure in 5.2.2.4.2 for a selected PLMN resulted in use of information in *nnp-IdentityInfoList* and *UAC-BarringPerPLMN* has an entry with the *plmn-IdentityIndex* corresponding to used information in this list:
 - 5> select the *UAC-BarringPerPLMN* entry with the *plmn-IdentityIndex* corresponding to used information in the *nnp-IdentityInfoList*;
 - 4> else:
 - 5> select the *UAC-BarringPerPLMN* entry with the *plmn-IdentityIndex* corresponding to the selected PLMN and the *PLMN-IdentityInfo*, if any, or the selected SNPN and the *nnp-IdentityInfoList*;

- 3> if any *UAC-BarringPerPLMN* entry is selected:
 - 4> in the remainder of this procedure, use the selected *UAC-BarringPerPLMN* entry (i.e. presence or absence of access barring parameters in this entry) irrespective of the *uac-BarringForCommon* included in *SIB1*;
 - 3> else if *SIB1* includes *uac-BarringForCommon*:
 - 4> in the remainder of this procedure use the *uac-BarringForCommon* (i.e. presence or absence of these parameters) included in *SIB1*;
 - 3> else:
 - 4> consider the access attempt as allowed;
 - 3> if *uac-BarringForCommon* is applicable or the *uac-ACBarringListType* indicates that *uac-ExplicitACBarringList* is used:
 - 4> if the corresponding *UAC-BarringPerCatList* contains a *UAC-BarringPerCat* entry corresponding to the Access Category:
 - 5> select the *UAC-BarringPerCat* entry;
 - 5> if the *uac-BarringInfoSetList* contains a *UAC-BarringInfoSet* entry corresponding to the selected *uac-barringInfoSetIndex* in the *UAC-BarringPerCat*:
 - 6> select the *UAC-BarringInfoSet* entry;
 - 6> perform access barring check for the Access Category as specified in 5.3.14.5, using the selected *UAC-BarringInfoSet* as "UAC barring parameter";
 - 5> else:
 - 6> consider the access attempt as allowed;
 - 4> else:
 - 5> consider the access attempt as allowed;
 - 3> else if the *uac-ACBarringListType* indicates that *uac-ImplicitACBarringList* is used:
 - 4> select the *uac-BarringInfoSetIndex* corresponding to the Access Category in the *uac-ImplicitACBarringList*;
 - 4> if the *uac-BarringInfoSetList* contains the *UAC-BarringInfoSet* entry corresponding to the selected *uac-BarringInfoSetIndex*:
 - 5> select the *UAC-BarringInfoSet* entry;
 - 5> perform access barring check for the Access Category as specified in 5.3.14.5, using the selected *UAC-BarringInfoSet* as "UAC barring parameter";
 - 4> else:
 - 5> consider the access attempt as allowed;
 - 3> else:
 - 4> consider the access attempt as allowed;
- 1> if the access barring check was requested by upper layers:
 - 2> if the access attempt is considered as barred:
 - 3> if timer T302 is running:
 - 4> if timer T390 is running for Access Category '2':

- 5> inform the upper layer that access barring is applicable for all access categories except categories '0', upon which the procedure ends;
- 4> else
 - 5> inform the upper layer that access barring is applicable for all access categories except categories '0' and '2', upon which the procedure ends;
- 3> else:
 - 4> inform upper layers that the access attempt for the Access Category is barred, upon which the procedure ends;
- 2> else:
 - 3> inform upper layers that the access attempt for the Access Category is allowed, upon which the procedure ends;
- 1> else:
 - 2> the procedure ends.

[TS 38.331, clause 5.3.14.4]

The UE shall:

- 1> if timer T302 expires or is stopped:
 - 2> for each Access Category for which T390 is not running:
 - 3> consider the barring for this Access Category to be alleviated;
- 1> else if timer T390 corresponding to an Access Category other than '2' expires or is stopped, and if timer T302 is not running:
 - 2> consider the barring for this Access Category to be alleviated;
- 1> else if timer T390 corresponding to the Access Category '2' expires or is stopped:
 - 2> consider the barring for this Access Category to be alleviated;
- 1> when barring for an Access Category is considered being alleviated:
 - 2> if the Access Category was informed to upper layers as barred:
 - 3> inform upper layers about barring alleviation for the Access Category.
 - 2> if barring is alleviated for Access Category '8'; or
 - 2> if barring is alleviated for Access Category '2':
 - 3> perform actions specified in 5.3.13.8;

[TS 38.331, clause 5.3.14.5]

The UE shall:

- 1> if one or more Access Identities are indicated according to TS 24.501 [23], and
- 1> if for at least one of these Access Identities the corresponding bit in the *uac-BarringForAccessIdentity* contained in "UAC barring parameter" is set to *zero*:
 - 2> consider the access attempt as allowed;
- 1> else:
 - 2> if the establishment of the RRC connection is the result of release with redirect with *mpsPriorityIndication* (either in NR or E-UTRAN); and

- 2> if the bit corresponding to Access Identity 1 in the *uac-BarringForAccessIdentity* contained in the "UAC barring parameter" is set to *zero*:
- 3> consider the access attempt as allowed;
- 2> else:
- 3> draw a random number '*rand*' uniformly distributed in the range: $0 \leq rand < 1$;
- 3> if '*rand*' is lower than the value indicated by *uac-BarringFactor* included in "UAC barring parameter":
- 4> consider the access attempt as allowed;
- 3> else:
- 4> consider the access attempt as barred;
- 1> if the access attempt is considered as barred:
- 2> draw a random number '*rand*' that is uniformly distributed in the range $0 \leq rand < 1$;
- 2> start timer T390 for the Access Category with the timer value calculated as follows, using the *uac-BarringTime* included in "UAC barring parameter":
- $$T390 = (0.7 + 0.6 * rand) * uac-BarringTime.$$

11.3.10.3 Test description

11.3.10.3.1 Pre-test conditions

System Simulator:

- NR Cell 1.
- Cell power level is selected according to 38.508-1 [4] Table 6.2.2.1-3.
- System information combination NR-1 as defined in TS 38.508-1 [4] Table 4.4.3.1.2-1 is used in NR cell 1.

UE:

- None.

Preamble:

- The UE is switched on and brought to state 3N-A in accordance with the procedure described in TS 38.508-1 [4] and IMS PDU session establishment is completed on NR Cell 1.

11.3.10.3.2 Test procedure sequence

Table 11.3.10.3.2-1: Main behaviour

St	Procedure	Message Sequence		TP	Verdict
		U - S	Message		
1-8	Steps 1-8 of initial IMS registration procedure as defined in Annex A.2 of TS 34.229-5 [41] take place, with SS giving 120 seconds expiration interval.				
9	The SS changes the SIB1 according to 38.508-1[4] Table 11.3.10.3.3-2 and send Short Message on PDCCH using P-RNTI.	<--	PDCCH (DCI 1_0): Short Message	-	-
9A	Wait for 2.1* modification period to allow the new system information to take effect				
10	Check: Does the UE performs SIP <i>re-registration</i> message in a time span between	-->	REGISTER: Re-Registration	1	F

	half of the expiration time and the full expiration time? (Note: in this test case, the re-registration time is set to an untypically short value of 120 seconds. As there are no requirements on the duration of a re-registration procedure it is only checked that the re-registration procedure starts between half of the expiration time and the full expiration time.)				
11	The SS changes the SIB1 according to 38.508-1 [4] Table 4.6.1-28 and transmits a Short message on PDCCH using P-RNTI indicating a systemInfoModification	<--	PDCCH (DCI 1_0): Short Message		
11A	Wait for 2.1* modification period to allow the new system information to take effect				
12	Check: Does the UE performs SIP REGISTER message?	-->	REGISTER: Re-Registration	2	P
13	SS responds with 200 OK	<--	200 OK		
Note 1: T390 is a random value between $(0.7 + 0.6 * 0) * uac-BarringTime(4s) = 2.8s$ and $(0.7 + 0.6 * 1) * uac-BarringTime(4s) = 5.2s$,					

11.3.10.3.3 Specific message contents

Table 11.3.10.3-1: 200 OK for REGISTER (step 4, Table 11.3.10.3.2-1)

Derivation path: TS 34.229-1 [2], Table in subclause A.1.3				
Header/param	Cond	Value/remark	Rel	Reference
Contact expires		120		

Table 11.3.10.3.3-2: SIB1 of NR Cell 1 (step9, Table 11.3.10.3.2-1)

Derivation Path: TS 38.508-1 [4], Table 4.6.1-28			
Information Element	Value/remark	Comment	Condition
SIB1 ::= SEQUENCE {			
uac-BarringInfo SEQUENCE {			
uac-BarringForCommon SEQUENCE (SIZE (1..maxAccessCat-1)) OF UAC-BarringPerCat {	1 entries		
UAC-BarringPerCat[1] SEQUENCE {		entry 1	
accessCategory	9	(= MO IMS registration related signalling)	
uac-barringInfoSetIndex	1		
}			
}			
uac-BarringPerPLMN-List	Not present		
uac-BarringInfoSetList SEQUENCE (SIZE(1..maxBarringInfoSet)) OF UAC-BarringInfoSet {	1 entry		
UAC-BarringInfoSet[1] SEQUENCE {		entry 1	
uac-BarringFactor	p00	0 % access probability	
uac-BarringTime	s4	4 s	
uac-BarringForAccessIdentity	'0000000'B		
}			
}			
uac-AccessCategory1-SelectionAssistanceInfo	Not Present		
}			
}			

11.4 Emergency Services

11.4.1 5GMM-REGISTERED.NORMAL-SERVICE / 5GMM-IDLE / Emergency call / Utilising emergency number stored on the USIM / New emergency PDU session / Network failing the authentication check (5G AKA)

11.4.1.1 Test Purpose (TP)

(1)

```
with { UE in 5GMM-REGISTERED.NORMAL-SERVICE state and 5GMM-IDLE mode }
ensure that {
  when { UE is requested to make an outgoing call using an emergency number stored on the USIM }
  then { UE establishes an RRC connection with the RRC establishmentCause set to "emergency", and,
  sends a SERVICE REQUEST message with Service type IE set to "emergency services", and, establishes a
  New emergency PDU session by sending an UL NAS TRANSPORT message with Request type set to "initial
  emergency request" and a PDU SESSION ESTABLISHMENT REQUEST }
}
```

(2)

```
with { UE in 5GMM-REGISTERED.NORMAL-SERVICE state and 5GMM-CONNECTED mode having established an
Emergency call }
ensure that {
  when { UE establishes that the network has failed the authentication check during a 5G AKA based
  primary authentication and key agreement procedure }
  then { UE continues using the current security context, and, releases all non-emergency PDU
  sessions by initiating UE-requested PDU session release procedure and does not treat the active cell
  as barred for non-emergency services }
}
```

11.4.1.2 Conformance requirements

References: The conformance requirements covered in the present TC are specified in: TS 38.331 [12], subclause 5.3.3.3, TS 24.501 [22], subclauses 5.6.1.2, 6.4.1.2, 5.4.1.3.7, TS 22.101 [42], subclause 10.1.1. Unless otherwise stated these are Rel-15 requirements.

[TS 38.331, subclause 5.3.3.3]

The UE shall set the contents of *RRCSetupRequest* message as follows:

...

1> set the *establishmentCause* in accordance with the information received from upper layers;

The UE shall submit the *RRCSetupRequest* message to lower layers for transmission.

[TS 24.501, subclause 5.6.1.2]

The UE initiates the service request procedure by sending a SERVICE REQUEST message to the AMF and starts timer T3517.

If the UE is sending the SERVICE REQUEST message from 5GMM-IDLE mode and the UE needs to send non-clear-text IEs, the UE shall send the SERVICE REQUEST message including the NAS message container IE as described in subclause 4.4.6.

...

For case c) in subclause 5.6.1.1, the Uplink data status IE shall not be included in the SERVICE REQUEST message except if the UE has one or more active always-on PDU sessions associated with the access type over which the SERVICE REQUEST message is sent. If the UE is not a UE configured for high priority access in selected PLMN and:

- a) if the SERVICE REQUEST message is triggered by a request for emergency services from the upper layer, the UE shall set the service type IE in the SERVICE REQUEST message to "emergency services"; or

[TS 24.501, subclause 6.4.1.2]

In order to initiate the UE-requested PDU session establishment procedure, the UE shall create a PDU SESSION ESTABLISHMENT REQUEST message.

NOTE 0: When IMS voice is available over either 3GPP access or non-3GPP access, the "voice centric" UE in 5GMM-REGISTERED state will receive a request from upper layers to establish the PDU session for IMS signalling, if the conditions for performing an initial registration with IMS indicated in 3GPP TS 24.229 [14] subclause U.3.1.2 are satisfied.

If the UE requests to establish a new PDU session, the UE shall allocate a PDU session ID which is not currently being used by another PDU session over either 3GPP access or non-3GPP access.

The UE shall allocate a PTI value currently not used and shall set the PTI IE of the PDU SESSION ESTABLISHMENT REQUEST message to the allocated PTI value.

...

If the UE requests to establish a new emergency PDU session, the UE shall set the SSC mode IE of the PDU SESSION ESTABLISHMENT REQUEST message to "SSC mode 1".

...

The UE shall transport:

- a) the PDU SESSION ESTABLISHMENT REQUEST message;
- b) the PDU session ID of the PDU session being established, or being handed over or being transferred;

..

- e) the request type which is set to:

...

- 3) "initial emergency request", if the UE requests to establish a new emergency PDU session; and

...

If the request type is set to "initial emergency request" or "existing emergency PDU session", neither DNN nor S-NSSAI is transported by the UE using the NAS transport procedure as specified in subclause 5.4.5.

[TS 22.101, subclause 10.1.1]

The ME shall identify an emergency number dialled by the end user as a valid emergency number and initiate emergency call establishment if it occurs under one or more of the following conditions. If it occurs outside of the following conditions, the ME should not initiate emergency call establishment but normal call establishment. Emergency number identification takes place before and takes precedence over any other (e.g. supplementary service related) number analysis.

...

- b) Any emergency call number stored on a SIM/USIM when the SIM/USIM is present.

[TS 24.501, subclause 5.4.1.3.7]

- g) Network failing the authentication check.

If the UE deems that the network has failed the authentication check, then it shall request RRC to locally release the RRC connection and treat the active cell as barred (see 3GPP TS 38.304 [28]). The UE shall start any retransmission timers (e.g. T3510, T3517 or T3521), if they were running and stopped when the UE received the first AUTHENTICATION REQUEST message containing an incorrect authentication challenge data causing authentication failure.

...

For items c, d, e, and f whether or not the UE is registered for emergency services:

...

The UE shall deem that the network has failed the authentication check or assume that the authentication is not genuine and proceed as described in item g above if any of the following occurs:

- the timer T3520 expires;

...

For items c, d, e, and f:

...

If a UE has an emergency PDU session established or is establishing an emergency PDU session when timer T3520 expires, the UE shall not deem that the network has failed the authentication check and not behave as described in item g. Instead the UE shall continue using the current security context, if any, release all non-emergency PDU sessions, if any, by initiating UE-requested PDU session release procedure. If there is an ongoing PDU session establishment procedure, the UE shall release all non-emergency PDU sessions upon completion of the PDU session establishment procedure. The UE shall start any retransmission timers (e.g. T3510, T3517 or T3521) if:

- they were running and stopped when the UE received the AUTHENTICATION REQUEST message and detected an authentication failure;
- the procedures associated with these timers have not yet been completed.

The UE shall behave as if the UE is registered for emergency services.

11.4.1.3 Test description

11.4.1.3.1 Pre-test conditions

System Simulator:

- 1 NR Cell
- NR Cell 1 as defined in TS 38.508-1 [4] Table 4.4.2-3. System information combination NR-1 as defined in TS 38.508-1 [4], subclause 4.4.3.1.2. SIB1 indicates *ims-EmergencySupport*.

UE:

- The UE is equipped with a test USIM with USIM Configuration 20 as defined in TS 38.508-1 [4] Table 6.4.1-20 (USIM contains two Emergency Numbers: 144, 117).

Preamble:

- Cells power level configuration in accordance with TS 38.508-1 [4], Table 6.2.2.1-3:
- NR Cell 1 "Serving cell"
- The UE is in test state 1N-A as defined in TS 38.508-1 [4], subclause 4.4A.2 on NR Cell 1.

NOTE: $pc_noOf_PDUsSameConnection + pc_noOf_PDUsNewConnection > 0$.

11.4.1.3.2 Test procedure sequence

Table 11.4.1.3.2-1: Main behaviour

St	Procedure	Message Sequence		TP	Verdict
		U - S	Message		
-	The following messages are to be observed on NR Cell 1 unless explicitly stated otherwise.	-	-	-	-
1	Make the UE attempt an IMS emergency call dialling the number 144 which is stored on the	-	-	-	-

	USIM. (NOTE 1)				
2	Check: Does the UE performs Generic Test Procedure for IMS Emergency call establishment with IMS emergency registration as specified in TS 38.508-1 [4], subclause 4.9.11?	-	-	1	-
2A	The SS initiates the 5G AKA based primary authentication and key agreement procedure by sending an AUTHENTICATION REQUEST message; the included ngKSI value is the same as the one used in the initial message SERVICE REQUEST sent in step 2.	<--	AUTHENTICATION REQUEST	-	-
2B	The UE sends an AUTHENTICATION FAILURE message with 5GMM cause #71 "ngKSI already in use"	-->	AUTHENTICATION FAILURE	-	-
2B A	Wait for T3520 expires.	-	-	-	-
-	EXCEPTION: Depending on the number of non-IMS Emergency relevant PDUs active at this moment of time step 2C is repeated 1 or more times.	-	-	-	-
2C	FOR i=1 TO i= pc_noOf_PDUsSameConnection + pc_noOf_PDUsNewConnection Repeat the PDU session release procedure specified in Table 11.4.1.3.2-2: Parallel behaviour. Depending on UE implementation the PDU session release procedures can run in parallel or in sequence.	-	-	-	-
3	Make the UE release the emergency call. (NOTE 1)	-	-	-	-
4	The Generic test procedure for IMS MO Emergency call release as specified in TS 38.508-1 [4], subclause 4.9.12A takes place.	-	-	-	-
4A	Start Timer T1=5 seconds. NOTE: This is an arbitrary value to wait for UE to initiate deregistration.	-	-	-	-
-	EXCEPTION: Steps 4Ba1-4Bb1 describes optional behaviour that depends on the UE implementation.	-	-	-	-
4B a1	The UE transmits a DEREGISTRATION REQUEST message with De-registration type IE set to "Normal de-registration".	-->	NR RRC: ULInformationTransfer 5GMM: DEREGISTRATION REQUEST	-	-
4B a2	The SS transmits a DEREGISTRATION ACCEPT message.	<--	NR RRC: DLInformationTransfer 5GMM: DEREGISTRATION ACCEPT	-	-
4B a3	Stop Timer T1=5 seconds	-	-	-	-
4B b1	Timer T1=5 seconds expires	-	-	-	-
5	SS releases the RRC connection	<--	NR RRC: RRCRelease	-	-
5A	Start Timer T1=5 seconds.	-	-	-	-
	EXCEPTION: Steps 5Aa1-5Ab3 describes optional behaviour that depends on the UE implementation.	-	-	-	-
5A a1	Check: Does the UE transmit RRCSetupRequest on NR Cell 1?	-->	NR RRC: RRCSetupRequest	2	P
5A a2	Stop Timer T1=5 seconds	-	-	-	-
5A a3	Step 2-20a1 of Table 4.5.2.2- 2: Registration procedure for initial registration as specified in TS 38.508-1 [4] are performed on NR Cell 1.	-	-	-	-
5A	Make the UE attempt an IMS [non-emergency]	-	-	-	-

a4	call. (NOTE 1)				
5A b1	Timer T1=5 seconds expires	-	-	-	-
5A b2	Make the UE attempt an IMS [non-emergency] call. (NOTE 1)				
5A b3	Check: Does the UE perform on NR Cell 1 the Registration procedure for initial registration as specified in TS 38.508-1 [4] subclause 4.5.2.2-2?	-->	NR RRC: RRCSetupRequest	2	P
6-9	Void	-	-	-	-
10- 21b 3	Step 2-13b3 of Table 4.9.15.2.2-1: IMS MO speech call establishment in 5GC as defined in TS 38.508-1 [4] are performed.	-	-	-	-
22	Table 4.9.18.2.2-1: IMS MT call release in 5GC as defined in TS 38.508-1 [4] is performed.	-	-	-	-
23	The SS transmits an RRCRelease message.	<--	NR RRC: RRCRelease	-	-
NOTE 1: This could be done by e.g. MMI or AT command.					

Table 11.4.1.3.2-2: Parallel behaviour

St	Procedure	Message Sequence		TP	Verdict
		U - S	Message		
1	Check: Does the UE transmit a PDU SESSION RELEASE REQUEST message with PDU session ID equal to one of the IDs of an existing PDU session BUT different to the PDU session ID assigned to the Emergency PDU session in step 2, Table 11.4.1.3.2-1?	-	PDU SESSION RELEASE REQUEST	2	P
2	Check: Does the UE perform PDU session release procedure defined in clause 4.9.21 of TS 38.508-1 [4]?	-		2	P

11.4.1.3.3 Specific message contents

Table 11.4.1.3.3-1: Message AUTHENTICATION REQUEST (step 2A, Table 11.4.1.3.2-1)

Derivation path: TS 38.508-1 [4], Table 4.7.1-1			
Information Element	Value/Remark	Comment	Condition
ngKSI	The same ng-KSI assigned in the Preamble and indicated in the initial message SERVICE REQUEST sent in step 2		

Table 11.4.1.3.3-2: Message AUTHENTICATION FAILURE (step 2B, Table 11.4.1.3.2-1)

Derivation path: TS 38.508-1 [4], Table 4.7.1-4			
Information Element	Value/Remark	Comment	Condition
5GMM cause	'0100 0111'B	ngKSI already in use	

11.4.2 5GMM-DEREGISTERED.LIMITED-SERVICE / Emergency call / Utilisation of emergency numbers stored on the ME / Initial registration for emergency services / Handling of forbidden PLMNs

11.4.2.1 Test Purpose (TP)

(1)

```
with { UE in 5GMM-DEREGISTERED.LIMITED-SERVICE state }
ensure that {
  when { UE is requested to make an outgoing call using an emergency number stored on the ME }
  then { UE establishes an RRC connection with the RRC establishmentCause set to "emergency", and,
attempts an Initial registration for emergency services by sending a REGISTRATION REQUEST message
with IE Service type set to "emergency services", and, accepts and applies security with NULL
security and integrity algorithms, and, after successful completion of the registration for
emergency services establishes an emergency PDU session by sending an UL NAS TRANSPORT message with
Request type set to "initial emergency request" and a PDU SESSION ESTABLISHMENT REQUEST }
}
```

(2)

```
with { UE in 5GMM-DEREGISTERED.LIMITED-SERVICE state }
ensure that {
  when { UE has performed an IMS Emergency call on a forbidden PLMN }
  then { UE does not remove the PLMN code of the accessed PLMN from the list of forbidden PLMNs }
}
```

11.4.2.2 Conformance requirements

References: The conformance requirements covered in the present TC are specified in: TS 38.331 [12], subclause 5.3.3.3, TS 23.501 [37], subclause 5.16.4.1, TS 23.122 [38], subclauses 2, 3.1, 3.5, TS 24.501 [22], subclauses 4.4.4.1, 5.1.3.2.1.3.3, 5.3.2, 5.4.2.3, 5.5.1.2.2, 5.5.1.2.4, 6.4.1.2, TS 22.101 [42], subclause 10.1.1. Unless otherwise stated these are Rel-15 requirements.

[TS 36.331, subclause 5.3.3.3]

The UE shall set the contents of *RRCSetupRequest* message as follows:

...

1> set the *establishmentCause* in accordance with the information received from upper layers;

The UE shall submit the *RRCSetupRequest* message to lower layers for transmission.

[TS 23.501, subclause 5.16.4.1]

UEs that are in limited service state, as specified in TS 23.122 [17], or that camp normally on a cell but failed to register successfully to the network under conditions specified in TS 24.501 [47], initiate the Registration procedure by indicating that the registration is to receive Emergency Services, referred to as Emergency Registration, and a Follow-on request is included in the Registration Request to initiate PDU Session Establishment procedure with a Request Type indicating "Emergency Request". UEs that had registered for normal services and do not have emergency PDU Sessions established and that are subject to Mobility Restriction in the present area or RAT (e.g. because of restricted tracking area) shall initiate the UE Requested PDU Session Establishment procedure to receive Emergency Services, i.e. with a Request Type indicating "Emergency Request". Based on local regulation, the network supporting Emergency Services for UEs in limited service state provides Emergency Services to these UE, regardless whether the UE can be authenticated, has roaming or Mobility Restrictions or a valid subscription.

[TS 23.122, clause 2]

If the MS is unable to find a suitable cell to camp on, or the SIM is not inserted, or if it receives certain responses to an LR request (e.g., "illegal MS"), it attempts to camp on a cell irrespective of the PLMN identity, and enters a "limited service" state in which it can only attempt to make emergency calls. An MS operating in NB-S1 mode, never attempts to make emergency calls.

[TS 23.122, subclause 3.1]

An MS that is attaching for emergency bearer services or is attached for emergency bearer services may access PLMNs in the list of "forbidden PLMNs" or the list of "forbidden PLMNs for GPRS service". The MS shall not remove any entry from the list of "forbidden PLMNs" or the list of "forbidden PLMNs for GPRS service" as a result of such accesses.

[TS 23.122, subclause 3.5]

There are a number of situations in which the MS is unable to obtain normal service from a PLMN. These include:

- a) Failure to find a suitable cell of the selected PLMN;

...

(In automatic PLMN selection mode, items a, c and f would normally cause a new PLMN selection, but even in this case, the situation may arise when no PLMNs are available and allowable for use).

For the items a to f, the MS attempts to camp on an acceptable cell, irrespective of its PLMN identity, so that emergency calls can be made if necessary, with the exception that an MS operating in NB-S1 mode, shall never attempt to make emergency calls. When in the limited service state with a valid SIM, the MS shall search for available and allowable PLMNs in the manner described in subclause 4.4.3.1 and when indicated in the SIM also as described in subclause 4.4.3.4. For an MS that is not in eCall only mode, with the exception of performing GPRS attach or EPS attach for emergency bearer services, or performing registration for emergency services, no LR requests are made until a valid SIM is present and either a suitable cell is found or a manual network reselection is performed. For an MS in eCall only mode, no LR requests are made except for performing EPS attach for emergency bearer services or registration for emergency services. When performing GPRS attach or EPS attach for emergency bearer services, or registration for emergency services, the PLMN of the current serving cell is considered as the selected PLMN for the duration the MS is attached for emergency bearer services or registered for emergency services. In the limited service state the presence of the MS need not be known to the PLMN on whose cell it has camped.

There are also other conditions under which only emergency calls may be made. These are shown in table 2 in clause 5. ProSe direct communication and ProSe direct discovery for public safety use can be initiated if necessary (see 3GPP TS 24.334 [51]) when in the limited service state due to items a) or c) or f). V2X communication over PC5 can be initiated if necessary (see 3GPP TS 24.386 [59]) when in the limited service state due to items a) or c) or f).

[TS 24.501, subclause 4.4.4.1]

The use of "null integrity protection algorithm" 5G-IA0 (see subclause 9.11.3.32) in the current 5G NAS security context is only allowed for an unauthenticated UE for which establishment of emergency services is allowed. For setting the security header type in outbound NAS messages, the UE and the AMF shall apply the same rules irrespective of whether the "null integrity protection algorithm" or any other integrity protection algorithm is indicated in the 5G NAS security context.

If the "null integrity protection algorithm" 5G-IA0 has been selected as an integrity protection algorithm, the receiver shall regard the NAS messages with the security header indicating integrity protection as integrity protected.

[TS 24.501, subclause 5.1.3.2.1.3.3]

The substate 5GMM-DEREGISTERED.LIMITED-SERVICE is chosen in the UE, when it is known that a selected cell for 3GPP access or TA for non-3GPP access is unable to provide normal service (e.g. the selected cell over 3GPP access is in a forbidden PLMN or is in a forbidden tracking area or TA for non-3GPP access is forbidden).

[TS 24.501, subclause 5.3.2]

The UE provides the SUPI to the network in concealed form. The SUCI is a privacy preserving identifier containing the concealed SUPI. When the SUPI contains a network specific identifier, the SUCI shall take the form of an NAI as specified in 3GPP TS 23.003 [4].

A UE supporting N1 mode includes a SUCI:

- a) in the REGISTRATION REQUEST message when the UE is attempting initial registration procedure and a valid 5G-GUTI is not available; or

...

The UE shall use the "null-scheme" as specified in 3GPP TS 33.501 [24] to generate the SUCI, if the following applies:

- a) the UE performs a registration procedure for emergency services or initiates a de-registration procedure before the registration procedure for emergency services was completed successfully; and

[TS 24.501, subclause 5.4.2.3]

If the UE is registered for emergency services, performing initial registration for emergency services or establishing an emergency PDU session and the SECURITY MODE COMMAND message is received with ngKSI value "000" and 5G-IA0 and 5G-EA0 as selected 5G NAS security algorithms, the UE shall locally derive and take in use 5G NAS security context. The UE shall delete existing current 5G NAS security context.

The UE shall accept a SECURITY MODE COMMAND message indicating the "null integrity protection algorithm" 5G-EA0 as the selected 5G NAS integrity algorithm only if the message is received when the UE is registered for emergency services, performing initial registration for emergency services or establishing an emergency PDU session.

[TS 24.501, subclause 5.5.1.2.2]

The UE in state 5GMM-DEREGISTERED shall initiate the registration procedure for initial registration by sending a REGISTRATION REQUEST message to the AMF,

...

- b) when the UE performs initial registration for emergency services;

...

If the UE initiates an initial registration for emergency services or needs to prolong the established NAS signalling connection after the completion of the initial registration procedure (e.g. due to uplink signalling pending), the UE shall set the Follow-on request indicator to 1.

[TS 24.501, subclause 5.5.1.2.4]

If the initial registration procedure is not for emergency services, and if the PLMN identity of the registered PLMN is a member of the list of "forbidden PLMNs", any such PLMN identity shall be deleted from the corresponding list(s).

[TS 24.501, subclause 6.4.1.2]

In order to initiate the UE-requested PDU session establishment procedure, the UE shall create a PDU SESSION ESTABLISHMENT REQUEST message.

NOTE 0: When IMS voice is available over either 3GPP access or non-3GPP access, the "voice centric" UE in 5GMM-REGISTERED state will receive a request from upper layers to establish the PDU session for IMS signalling, if the conditions for performing an initial registration with IMS indicated in 3GPP TS 24.229 [14] subclause U.3.1.2 are satisfied.

If the UE requests to establish a new PDU session, the UE shall allocate a PDU session ID which is not currently being used by another PDU session over either 3GPP access or non-3GPP access.

The UE shall allocate a PTI value currently not used and shall set the PTI IE of the PDU SESSION ESTABLISHMENT REQUEST message to the allocated PTI value.

...

If the UE requests to establish a new emergency PDU session, the UE shall set the SSC mode IE of the PDU SESSION ESTABLISHMENT REQUEST message to "SSC mode 1".

...

The UE shall transport:

- a) the PDU SESSION ESTABLISHMENT REQUEST message;
- b) the PDU session ID of the PDU session being established, or being handed over or being transferred;

..

- e) the request type which is set to:

...

- 3) "initial emergency request", if the UE requests to establish a new emergency PDU session; and

...

If the request type is set to "initial emergency request" or "existing emergency PDU session", neither DNN nor S-NSSAI is transported by the UE using the NAS transport procedure as specified in subclause 5.4.5.

[TS 22.101, subclause 10.1.1]

The ME shall identify an emergency number dialled by the end user as a valid emergency number and initiate emergency call establishment if it occurs under one or more of the following conditions. If it occurs outside of the following conditions, the ME should not initiate emergency call establishment but normal call establishment. Emergency number identification takes place before and takes precedence over any other (e.g. supplementary service related) number analysis.

- a) 112 and 911 shall always be available. These numbers shall be stored on the ME.

11.4.2.3 Test description

11.4.2.3.1 Pre-test conditions

System Simulator:

- 1 NR Cell
- NR Cell 1, as defined in TS 38.508-1 [4], Table 4.4.2-3, with the exception that cells' PLMN is defined in Table 11.4.2.3.1-1 below.

Table 11.4.2.3.1-1: PLMN identifiers

NR Cell	PLMN name
1	PLMN2

- System information combination NR-1 as defined in TS 38.508-1 [4], subclause 4.4.3.1.2. SIB1 indicates *ims-EmergencySupport*.

UE:

- The UE is equipped with a test USIM with USIM Configuration 15 as defined in TS 38.508-1 [4], Table 6.4.1-15 (PLMN2 is set in it as 'forbidden PLMN', PLMN1 is the HPLMN).

Preamble:

- The UE is in test state 0N-B (Switched Off) as defined in TS 38.508-1 [4], subclause 4.4A.2. Prior to being switched off the UE is registered on PLMN1.

11.4.2.3.2 Test procedure sequence

Table 11.4.2.3.2-1: Main behaviour

St	Procedure	Message Sequence		TP	Verdict
		U - S	Message		
1	Void	-	-	-	-
-	The SS configures: - NR Cell 1 as "Serving cell"	-	-	-	-
2	Switch the UE on.	-	-	-	-
3	Make the UE attempt an IMS emergency call dialling a number which is stored on the ME	-	-	-	-

	(e.g. 112 or 911). (NOTE 1)				
4	Check: Does the UE performs Generic Test Procedure for IMS Emergency call establishment without IMS emergency registration as specified in TS 38.508-1 [4], subclause 4.9.12?	-	-	1	-
5	Make the UE release the emergency call. (NOTE 1)	-	-	-	-
6	Void	-	-	-	-
6A-6C	Steps 1-3 of the Generic test procedure for IMS MO Emergency call release as specified in TS 38.508-1 [4], subclause 4.9.12A take place.	-	-	-	-
7	Start Timer T1=6 seconds. NOTE: This is an arbitrary value to wait for UE initiated detach.	-	-	-	-
-	EXCEPTION: In parallel to step 8 below, the steps specified in Tables 11.4.2.3.2-2 and 11.4.2.3.2-3 may take place	-	-	-	-
8	Timer T1=5 seconds expires	-	-	-	-
8a1-8b3	Void	-	-	-	-
9	SS releases the RRC connection	<--	NR RRC: RRCRelease	-	-
9A	Make the UE attempt an IMS none-emergency call. (NOTE 2).	-	-	-	-
10	Check: Does the UE transmit an <i>RRCSetupRequest</i> message in the next 10seconds? NOTE: This is an arbitrary value to wait for catching not allowed UE behaviour.	-->	NR RRC: RRCSetupRequest	2	F
NOTE 1: This could be done by e.g. MMI or AT command.					
NOTE 2: This could be done by e.g. MMI or AT command.					

Table 11.4.2.3.2-2: Parallel Behaviour

St	Procedure	Message Sequence		TP	Verdict
		U - S	Message		
1	The UE transmits a Deregistration REQUEST message with De-registration type IE set to "Normal de-registration".	-->	NR RRC: ULInformationTransfer 5GMM: Deregistration REQUEST	-	-
2	The SS transmits a Deregistration ACCEPT message.	<--	NR RRC: DLInformationTransfer 5GMM: Deregistration ACCEPT	-	-

Table 11.4.2.3.2-3: Parallel Behaviour

St	Procedure	Message Sequence		TP	Verdict
		U - S	Message		
1	The UE transmits a PDU SESSION RELEASE REQUEST message.	-->	NR RRC: ULInformationTransfer PDU SESSION RELEASE REQUEST	-	-
2	The SS transmits a PDU SESSION RELEASE COMMAND message.	<--	NR RRC: <i>DLInformationTransfer</i> NR NAS: PDU SESSION RELEASE COMMAND	-	-
3	Check: Does the UE transmit a PDU SESSION RELEASE COMPLETE message?	-->	NR RRC: ULInformationTransfer 5GMM: UL NAS TRANSPORT 5GSM: PDU SESSION RELEASE COMPLETE	-	-

11.4.2.3.3 Specific message contents

Table 11.4.2.3.3-1: REGISTRATION REQUEST (step 4, Table 11.4.2.3.2-1; step 3, TS 38.508-1 [4], Table 4.9.12.2.2-1)

Derivation Path: TS 38.508-1 [4], Table 4.7.1-6, condition EMERGENCY.			
Information Element	Value/remark	Comment	Condition
5GS mobile identity	SUCI	The UE shall use the "null-scheme" as specified in 3GPP TS 33.501 [20] to generate the SUCI	

Table 11.4.2.3.3-2: DEREGISTRATION REQUEST (Step 8a1, Table 11.4.2.3.2-1)

Derivation Path: TS 38.508-1 [4], Table 4.7.1-12, Condition NORMAL.

Table 11.4.2.3.3-3: Void

11.4.3 5GMM-DEREGISTERED.NO-SUPI / Emergency call / Utilisation of emergency numbers stored on the ME / Initial registration for emergency services

11.4.3.1 Test Purpose (TP)

(1)

```

with { UE in 5GMM-DEREGISTERED.NO-SUPI state (no USIM) }
ensure that {
  when { UE is requested to make an outgoing call using an emergency number stored on the ME }
  then { UE establishes an RRC connection with the RRC establishmentCause set to "emergency", and,
attempts an Initial registration for emergency services by sending a REGISTRATION REQUEST message
with IE Service type set to "emergency services", and, accepts and applies security with NULL
security and integrity algorithms, and, after successful completion of the registration for
emergency services establishes an emergency PDU session by sending an UL NAS TRANSPORT message with
Request type set to "initial emergency request" and a PDU SESSION ESTABLISHMENT REQUEST }
}

```

11.4.3.2 Conformance requirements

References: The conformance requirements covered in the present TC are specified in: TS 38.331 [12], subclause 5.3.3.3, TS 23.501 [37], subclause 5.16.4.1, TS 23.122 [38], subclauses 2, 3.5, TS 24.501 [22], subclauses 4.4.4.1, 5.1.3.2.1.3.6, 5.3.2, 5.4.2.3, 5.5.1.2.2, 6.4.1.2, TS 22.101 [42], subclause 10.1.1. Unless otherwise stated these are Rel-15 requirements.

[TS 36.331, subclause 5.3.3.3]

The UE shall set the contents of *RRCSetupRequest* message as follows:

...

1> set the *establishmentCause* in accordance with the information received from upper layers;

The UE shall submit the *RRCSetupRequest* message to lower layers for transmission.

[TS 23.501, subclause 5.16.4.1]

UEs that are in limited service state, as specified in TS 23.122 [17], or that camp normally on a cell but failed to register successfully to the network under conditions specified in TS 24.501 [47], initiate the Registration procedure by indicating that the registration is to receive Emergency Services, referred to as Emergency Registration, and a Follow-

on request is included in the Registration Request to initiate PDU Session Establishment procedure with a Request Type indicating "Emergency Request". UEs that had registered for normal services and do not have emergency PDU Sessions established and that are subject to Mobility Restriction in the present area or RAT (e.g. because of restricted tracking area) shall initiate the UE Requested PDU Session Establishment procedure to receive Emergency Services, i.e. with a Request Type indicating "Emergency Request". Based on local regulation, the network supporting Emergency Services for UEs in limited service state provides Emergency Services to these UE, regardless whether the UE can be authenticated, has roaming or Mobility Restrictions or a valid subscription.

[TS 23.122, clause 2]

If the MS is unable to find a suitable cell to camp on, or the SIM is not inserted, or if it receives certain responses to an LR request (e.g., "illegal MS"), it attempts to camp on a cell irrespective of the PLMN identity, and enters a "limited service" state in which it can only attempt to make emergency calls. An MS operating in NB-S1 mode, never attempts to make emergency calls.

[TS 23.122, subclause 3.5]

There are a number of situations in which the MS is unable to obtain normal service from a PLMN. These include:

...

b) No SIM in the MS;

...

For the items a to f, the MS attempts to camp on an acceptable cell, irrespective of its PLMN identity, so that emergency calls can be made if necessary, with the exception that an MS operating in NB-S1 mode, shall never attempt to make emergency calls. When in the limited service state with a valid SIM, the MS shall search for available and allowable PLMNs in the manner described in subclause 4.4.3.1 and when indicated in the SIM also as described in subclause 4.4.3.4. For an MS that is not in eCall only mode, with the exception of performing GPRS attach or EPS attach for emergency bearer services, or performing registration for emergency services, no LR requests are made until a valid SIM is present and either a suitable cell is found or a manual network reselection is performed. For an MS in eCall only mode, no LR requests are made except for performing EPS attach for emergency bearer services or registration for emergency services. When performing GPRS attach or EPS attach for emergency bearer services, or registration for emergency services, the PLMN of the current serving cell is considered as the selected PLMN for the duration the MS is attached for emergency bearer services or registered for emergency services. In the limited service state the presence of the MS need not be known to the PLMN on whose cell it has camped.

There are also other conditions under which only emergency calls may be made. These are shown in table 2 in clause 5. ProSe direct communication and ProSe direct discovery for public safety use can be initiated if necessary (see 3GPP TS 24.334 [51]) when in the limited service state due to items a) or c) or f). V2X communication over PC5 can be initiated if necessary (see 3GPP TS 24.386 [59]) when in the limited service state due to items a) or c) or f).

[TS 24.501, subclause 4.4.4.1]

The use of "null integrity protection algorithm" 5G-IA0 (see subclause 9.11.3.32) in the current 5G NAS security context is only allowed for an unauthenticated UE for which establishment of emergency services is allowed. For setting the security header type in outbound NAS messages, the UE and the AMF shall apply the same rules irrespective of whether the "null integrity protection algorithm" or any other integrity protection algorithm is indicated in the 5G NAS security context.

If the "null integrity protection algorithm" 5G-IA0 has been selected as an integrity protection algorithm, the receiver shall regard the NAS messages with the security header indicating integrity protection as integrity protected.

[TS 24.501, subclause 5.1.3.2.1.3.6]

The substate 5GMM-DEREGISTERED.NO-SUPI is chosen in the UE, if the N1 mode is enabled and the UE has no valid subscriber data available (SIM/USIM not available, the SIM/USIM is considered invalid by the UE).

[TS 24.501, subclause 5.3.2]

A UE supporting NG-RAN includes a PEI:

- a) when neither SUPI nor valid 5G-GUTI is available to use for emergency services in the REGISTRATION REQUEST message with 5GS registration type IE set to "emergency registration"; and

[TS 24.501, subclause 5.4.2.3]

If the UE is registered for emergency services, performing initial registration for emergency services or establishing an emergency PDU session and the SECURITY MODE COMMAND message is received with ngKSI value "000" and 5G-IA0 and 5G-EA0 as selected 5G NAS security algorithms, the UE shall locally derive and take in use 5G NAS security context. The UE shall delete existing current 5G NAS security context.

The UE shall accept a SECURITY MODE COMMAND message indicating the "null integrity protection algorithm" 5G-EA0 as the selected 5G NAS integrity algorithm only if the message is received when the UE is registered for emergency services, performing initial registration for emergency services or establishing an emergency PDU session.

[TS 24.501, subclause 5.5.1.2.2]

The UE in state 5GMM-DEREGISTERED shall initiate the registration procedure for initial registration by sending a REGISTRATION REQUEST message to the AMF,

...

b) when the UE performs initial registration for emergency services;

...

If the UE initiates an initial registration for emergency services or needs to prolong the established NAS signalling connection after the completion of the initial registration procedure (e.g. due to uplink signalling pending), the UE shall set the Follow-on request indicator to 1.

[TS 24.501, subclause 6.4.1.2]

In order to initiate the UE-requested PDU session establishment procedure, the UE shall create a PDU SESSION ESTABLISHMENT REQUEST message.

NOTE 0: When IMS voice is available over either 3GPP access or non-3GPP access, the "voice centric" UE in 5GMM-REGISTERED state will receive a request from upper layers to establish the PDU session for IMS signalling, if the conditions for performing an initial registration with IMS indicated in 3GPP TS 24.229 [14] subclause U.3.1.2 are satisfied.

If the UE requests to establish a new PDU session, the UE shall allocate a PDU session ID which is not currently being used by another PDU session over either 3GPP access or non-3GPP access.

The UE shall allocate a PTI value currently not used and shall set the PTI IE of the PDU SESSION ESTABLISHMENT REQUEST message to the allocated PTI value.

...

If the UE requests to establish a new emergency PDU session, the UE shall set the SSC mode IE of the PDU SESSION ESTABLISHMENT REQUEST message to "SSC mode 1".

...

The UE shall transport:

a) the PDU SESSION ESTABLISHMENT REQUEST message;

b) the PDU session ID of the PDU session being established, or being handed over or being transferred;

..

e) the request type which is set to:

...

3) "initial emergency request", if the UE requests to establish a new emergency PDU session; and

...

If the request type is set to "initial emergency request" or "existing emergency PDU session", neither DNN nor S-NSSAI is transported by the UE using the NAS transport procedure as specified in subclause 5.4.5.

[TS 22.101, subclause 10.1.1]

The ME shall identify an emergency number dialled by the end user as a valid emergency number and initiate emergency call establishment if it occurs under one or more of the following conditions. If it occurs outside of the following conditions, the ME should not initiate emergency call establishment but normal call establishment. Emergency number identification takes place before and takes precedence over any other (e.g. supplementary service related) number analysis.

- a) 112 and 911 shall always be available. These numbers shall be stored on the ME.

11.4.3.3 Test description

11.4.3.3.1 Pre-test conditions

System Simulator:

- 1 NR Cells
- NR Cell 1, as defined in TS 38.508-1 [4] Table 4.4.2-3. System information combination NR-1 as defined in TS 38.508-1 [4], subclause 4.4.3.1.2. SIB1 indicates ims-EmergencySupport.

UE:

- The UE is NOT equipped with USIM.

Preamble:

- The UE is in test state 0-A (Switched Off) as defined in TS 38.508-1 [4], subclause 4.4A.2.

11.4.3.3.2 Test procedure sequence

Table 11.4.3.3.2-1: Main behaviour

St	Procedure	Message Sequence		TP	Verdict
		U - S	Message		
1	Switch the UE on.	-	-	-	-
2	Make the UE attempt an IMS emergency call dialling a number which is stored on the ME (e.g. 112 or 911). (NOTE 1)	-	-	-	-
3	Check: Does the UE performs Generic Test Procedure for IMS Emergency call establishment without IMS emergency registration as specified in TS 38.508-1 [4], subclause 4.9.12?	-	-	1	P
4	Make the UE release the emergency call. (NOTE 1)	-	-	-	-
5	Void	-	-	-	-
6A-6C	Steps 1-3 of the Generic test procedure for IMS MO Emergency call release as specified in TS 38.508-1 [4], subclause 4.9.12A take place.	-	-	-	-
6	Start Timer=5 sec. NOTE: This is an arbitrary value to wait for UE initiated detach.	-	-	-	-
-	EXCEPTION: In parallel to step 7 below, the steps specified in Tables 11.4.3.3.2-2, and 11.4.3.3.2-3 may take place	-	-	-	-
7	Timer T1=5 seconds expires	-	-	-	-
8	The Generic test procedure Switch/Power off procedure after EMERGENCY CALL RELEASED in RRC_CONNECTED of Table 10.3.7-1 in TS 38.523-3 [3] takes place.	-	-	-	-

NOTE 1: This could be done by e.g. MMI or AT command.

Table 11.4.3.3.2-2: Parallel Behaviour

St	Procedure	Message Sequence		TP	Verdict
		U - S	Message		
1	The UE transmits a DEREGISTRATION REQUEST message with De-registration type IE set to "Normal de-registration".	-->	NR RRC: ULInformationTransfer 5GMM: DEREGISTRATION REQUEST	-	-
2	The SS transmits a DEREGISTRATION ACCEPT message.	<--	NR RRC: DLInformationTransfer 5GMM: DEREGISTRATION ACCEPT	-	-

Table 11.4.3.3.2-3: Parallel Behaviour

St	Procedure	Message Sequence		TP	Verdict
		U - S	Message		
1	The UE transmits a PDU SESSION RELEASE REQUEST message.	-->	NR RRC: ULInformationTransfer PDU SESSION RELEASE REQUEST	-	-
2	The SS transmits a PDU SESSION RELEASE COMMAND message.	<--	NR RRC: <i>DLInformationTransfer</i> NR NAS: PDU SESSION RELEASE COMMAND	-	-
3	Check: Does the UE transmit a PDU SESSION RELEASE COMPLETE message?	-->	NR RRC: ULInformationTransfer 5GMM: UL NAS TRANSPORT 5GSM: PDU SESSION RELEASE COMPLETE	-	-

11.4.3.3.3 Specific message contents

Table 11.4.3.3.3-1: REGISTRATION REQUEST (step 3, Table 11.4.3.3.2-1; step 3, TS 38.508-1 [4], Table 4.9.12.2.2-1)

Derivation Path: TS 38.508-1 [4], Table 4.7.1-6, condition EMERGENCY.			
Information Element	Value/remark	Comment	Condition
5GS mobile identity	PEI		

Table 11.4.3.3.3-2: DEREGISTRATION REQUEST (Step 7a1, Table 11.4.3.3.2-1)

Derivation Path: TS 38.508-1 [4], Table 4.7.1-12, Condition NORMAL.

11.4.4 5GMM-REGISTERED.ATTEMPTING-REGISTRATION-UPDATE T3346 running / Emergency call establishment / 5GMM-REGISTERED.NORMAL-SERVICE / Emergency call establishment before T3396 expiry

11.4.4.1 Test Purpose (TP)

(1)

```

with { UE in 5GMM-REGISTERED.ATTEMPTING-REGISTRATION-UPDATE state, timer T3346 is running and 5GMM-IDLE mode }
ensure that {
  when { UE is requested to make an Emergency call }
  then { UE initiates the registration procedure for mobility and periodic registration update, and, establishes the Emergency call }
}

```

(2)

```

with { UE in 5GMM-REGISTERED.NORMAL-SERVICE state, timer T3396 is running and 5GMM-IDLE mode }

```

```
ensure that {  
  when { UE is requested to make an Emergency call }  
  then { UE establishes the Emergency call }  
}
```

11.4.4.2 Conformance requirements

References: The conformance requirements covered in the present TC are specified in: TS 24.501 [22], subclause 5.5.1.3.5, 5.3.9, 5.5.1.3.2, 6.3.3.3, TS 22.101 [42], subclause 10.1.1. Unless otherwise stated these are Rel-15 requirements.

[TS 24.501, subclause 5.5.1.3.5]

If the mobility and periodic registration update request cannot be accepted by the network, the AMF shall send a REGISTRATION REJECT message to the UE including an appropriate 5GMM cause value.

...

The UE shall take the following actions depending on the 5GMM cause value received in the REGISTRATION REJECT message.

...

#22 (Congestion).

If the T3346 value IE is present in the REGISTRATION REJECT message and the value indicates that this timer is neither zero nor deactivated, the UE shall proceed as described below, otherwise it shall be considered as an abnormal case and the behaviour of the UE for this case is specified in subclause 5.5.1.3.7.

The UE shall abort the registration procedure for mobility and periodic registration update. If the rejected request was not for initiating an emergency PDU session, the UE shall set the 5GS update status to 5U2 NOT UPDATED and change to state 5GMM-REGISTERED.ATTEMPTING-REGISTRATION-UPDATE.

The UE shall stop timer T3346 if it is running.

If the REGISTRATION REJECT message is integrity protected, the UE shall start timer T3346 with the value provided in the T3346 value IE.

...

The UE stays in the current serving cell and applies the normal cell reselection process. The registration procedure for mobility and periodic registration update is started, if still necessary, when timer T3346 expires or is stopped.

[TS 24.501, subclause 5.3.9]

If timer T3346 is running or is deactivated, and the UE is a UE configured for high priority access in selected PLMN, or the UE needs to initiate signalling for emergency services or emergency services fallback, then the UE is allowed to initiate 5GMM procedures.

[TS 24.501, subclause 5.5.1.3.2]

The UE in state 5GMM-REGISTERED shall initiate the registration procedure for mobility and periodic registration update by sending a REGISTRATION REQUEST message to the AMF,

...

- k) when the UE in state 5GMM-REGISTERED.ATTEMPTING-REGISTRATION-UPDATE receives a request from the upper layers to establish an emergency PDU session or perform emergency services fallback;

[TS 24.501, subclause 6.3.3.3]

Upon receipt of a PDU SESSION RELEASE COMMAND message and a PDU session ID, using the NAS transport procedure as specified in subclause 5.4.5, the UE considers the PDU session as released and the UE shall create a PDU SESSION RELEASE COMPLETE message.

...

If the PDU SESSION RELEASE COMMAND message includes 5GSM cause #26 "insufficient resources" and the Back-off timer value IE, the UE shall ignore the 5GSM congestion re-attempt indicator IE provided by the network, if any, and the UE shall take different actions depending on the timer value received for timer T3396 in the Back-off timer value:

...

When the timer T3396 is running or the timer is deactivated, the UE is allowed to initiate a PDU session establishment procedure for emergency services.

...

The UE shall set the Follow-on request indicator to 1, if the UE:

- a) initiates the mobility and periodic registration updating procedure upon request of the upper layers to establish an emergency PDU session;

[TS 22.101, subclause 10.1.1]

The ME shall identify an emergency number dialled by the end user as a valid emergency number and initiate emergency call establishment if it occurs under one or more of the following conditions. If it occurs outside of the following conditions, the ME should not initiate emergency call establishment but normal call establishment. Emergency number identification takes place before and takes precedence over any other (e.g. supplementary service related) number analysis.

- a) 112 and 911 shall always be available. These numbers shall be stored on the ME.
- b) Any emergency call number stored on a SIM/USIM when the SIM/USIM is present.
- c) 000, 08, 110, 999, 118 and 119 when a SIM/USIM is not present. These numbers shall be stored on the ME.
- d) Additional emergency call numbers that may have been downloaded by the serving network when the SIM/USIM is present.

11.4.4.3 Test description

11.4.4.3.1 Pre-test conditions

System Simulator:

- 2 NR Cells
 - NR Cell 1 and NR Cell 11 as defined in TS 38.508-1 [4] Table 4.4.2-3.
 - On all cells when active: System information combination NR-1 as defined in TS 38.508-1 [4], subclause 4.4.3.1.2. SIB1 indicates ims-EmergencySupport.

UE:

None.

Preamble:

- Cells power level configuration in accordance with TS 38.508-1 [4], Table 6.2.2.1-3:
 - NR Cell 1 "Serving cell"
 - NR Cell 11 "Non-Suitable "Off" cell"
- The UE is in test state 1N-A as defined in TS 38.508-1 [4], subclause 4.4A.2 on NR Cell 1
 - During the initial registration:
 - The list of tracking areas provided by the AMF (IE 'TAI list') contains only the TAI of NR Cell 1.

11.4.4.3.2 Test procedure sequence

Table 11.4.4.3.2-1: Main behaviour

St	Procedure	Message Sequence		TP	Verdict
		U - S	Message		
1	The SS configures: - NR Cell 11 as "Serving cell" - NR Cell 1 as "Non-Suitable "Off" cell".	-	-	-	-
-	The following messages are to be observed on NR Cell 11 unless explicitly stated otherwise.	-	-	-	-
2	The UE transmits an <i>RRCSetupRequest</i> message.	-->	NR RRC: <i>RRCSetupRequest</i>	-	-
3	SS transmit an <i>RRCSetup</i> message.	<--	NR RRC: <i>RRCSetup</i>	-	-
4	The UE transmits an <i>RRCSetupComplete</i> message to confirm the successful completion of the connection establishment and a REGISTRATION REQUEST message indicating "mobility registration updating" is sent to update the registration of the actual tracking area.	-->	NR RRC: <i>RRCSetupComplete</i> 5GMM: REGISTRATION REQUEST	-	-
5	SS sends a REGISTRATION REJECT message containing 5GMM cause value = #22 (Congestion).	<--	NR RRC: <i>DLInformationTransfer</i> 5GMM: REGISTRATION REJECT	-	-
6	The SS transmits an <i>RRCRelease</i> message.	<--	NR RRC: <i>RRCRelease</i>	-	-
7	Make the UE attempt an IMS emergency call dialling an emergency number e.g. 112 or 911). (NOTE 1)	-	-	-	-
8	Check: Does the UE perform steps 1-3 from the Registration procedure for mobility registration update as specified in TS 38.508-1 [4] subclause 4.9.5	-	-	1	P
8AA	The SS transmits a <i>SecurityModeCommand</i> message.	<--	NR RRC: <i>SecurityModeCommand</i>	-	-
8AB	The UE transmits a <i>SecurityModeComplete</i> message.	-->	NR RRC: <i>SecurityModeComplete</i>	-	-
8AC	The UE performs steps 4-5 from the Registration procedure for mobility registration update as specified in TS 38.508-1 [4] subclause 4.9.5?	-	-	-	-
8A	Check: Does the UE transmit an UL NAS TRANSPORT message with 'Request type' set to 'initial emergency request', and, a PDU SESSION ESTABLISHMENT REQUEST for establishing an emergency PDU?	-->	NR RRC: <i>ULInformationTransfer</i> 5GMM: UL NAS TRANSPORT 5GSM: PDU SESSION ESTABLISHMENT REQUEST	1	P
9-9D	Steps 9-13 from Generic Test Procedure for IMS Emergency call establishment with IMS Emergency registration as specified in TS 38.508-1 [4], subclause 4.9.11, including the parallel behaviour specified in table 4.9.11.2.2-2 are performed.	-	-	-	-
10	Make the UE release the emergency call. (NOTE 1)	-	-	-	-
11	The Generic test procedure for IMS MO Emergency call release as specified in TS 38.508-1 [4], subclause 4.9.12A takes place.	-	-	-	-
-	EXCEPTION: Steps 12-13 below are repeated <i>pc_noOf_PDUs</i> times. The SS releases all active PDUs due to insufficient resources.	-	-	-	-
12	The SS sends a PDU SESSION RELEASE COMMAND including 5GSM cause #26 "insufficient resources", and, Back-off timer value <i>IE</i> , which provides the value of the	<--	NR RRC: <i>DLInformationTransfer</i> 5GMM: DL NAS TRANSPORT 5GSM: PDU SESSION RELEASE COMMAND	-	-

	T3396, set to a value which is neither zero nor a value which indicates that the timer is deactivated.				
13	The UE transmits a PDU SESSION RELEASE COMPLETE.	-->	NR RRC: ULInformationTransfer 5GMM: UL NAS TRANSPORT 5GSM: PDU SESSION RELEASE COMPLETE	-	-
14	The SS releases the RRC connection.	-	NR RRC: RRCRelease	-	-
15	Make the UE attempt an IMS emergency call dialling an emergency number e.g. 112 or 911). (NOTE 1)	-	-	-	-
16A - 16E	Check: Does the UE perform steps 1-5 of Generic Test Procedure for IMS Emergency call establishment with IMS Emergency registration as specified in TS 38.508-1 [4], subclause 4.9.11?	-	-	2	P
16F	The SS transmits a SERVICE ACCEPT message.	<--	NR RRC: DLInformationTransfer 5GMM: SERVICE ACCEPT	-	-
16G - 16L	Check: Does the UE perform steps 8-13 of Generic Test Procedure for IMS Emergency call establishment with IMS Emergency registration as specified in TS 38.508-1 [4], subclause 4.9.11?	-	-	2	P
17	Make the UE release the emergency call. (NOTE 1)	-	-	-	-
18	The Generic test procedure for IMS MO Emergency call release as specified in TS 38.508-1 [4], subclause 4.9.12A takes place.	-	-	-	-
NOTE 1: This could be done by e.g. MMI or AT command.					

11.4.4.3.3 Specific message contents

Table 11.4.4.3.3-0: REGISTRATION REQUEST (step 4, Table 11.4.4.3.2-1)

Derivation Path: TS 38.508-1 [4], Table 4.7.1-6, Condition MOBILITY MOBILITY.

Table 11.4.4.3.3-1: REGISTRATION REJECT (step 5, Table 11.4.4.3.2-1)

Derivation Path: TS 38.508-1 [4], Table 4.7.1-9			
Information Element	Value/remark	Comment	Condition
5GMM cause	'00010110'B	#22 (Congestion)	
T3346 value	'00100011'B	3 minutes	

Table 11.4.4.3.3-2: REGISTRATION REQUEST (step 8, Table 11.4.4.3.2-1; step 3, TS 38.508-1 [4] Table 4.9.5.2.2-1)

Derivation Path: TS 38.508-1 [4], Table 4.7.1-6, Condition.

Table 11.4.4.3.3-3: UL NAS TRANSPORT (step 8A, Table 11.4.4.3.2-1)

Derivation Path: Table 4.7.1-10, condition INITIAL_PDU_REQUEST.			
Information Element	Value/remark	Comment	Condition
Request type	'011'B	initial emergency request	
S-NSSAI	Not Present		
DNN	Not Present		

Table 11.4.4.3.3-4: PDU SESSION ESTABLISHMENT REQUEST (step 8A, Table 11.4.4.3.2-1)

Derivation Path: Table 4.7.2-1.			
Information Element	Value/remark	Comment	Condition
PDU session ID	A value that is not currently being used by another PDU session		
PTI	A value currently not used		
SSC mode	'001'B	SSC mode 1	

Table 11.4.4.3.3-5: PDU SESSION RELEASE COMMAND (step 12)

Derivation Path: TS 38.508-1 [4] Table 4.7.2-14			
Information Element	Value/remark	Comment	Condition
PDU session ID	An ID of an existing PDU session		
5GSM cause	'0001 1010'B	insufficient resources	
Back-off timer value	'1010 0101'B	5 minutes	

Table 11.4.4.3.3-6: RRCReconfiguration (step 16H, Table 11.4.4.3.2-1; step 9, TS 38.508-1 [4] Table 4.9.11.2.2-1)

Derivation Path: TS 38.508-1 [4] Table 4.8.1-1B: RRCReconfiguration-SRB2-DRB(1,0)			
---	--	--	--

11.4.5 5GMM-REGISTERED.LIMITED-SERVICE / 5GMM-IDLE / Emergency call establishment and release / Handling of 5GS forbidden tracking areas for roaming

11.4.5.1 Test Purpose (TP)

(1)

```
with { UE in 5GMM-REGISTERED.LIMITED-SERVICE state and 5GMM-IDLE mode }
ensure that {
  when { UE is requested to make an Emergency call }
  then { UE establishes the Emergency call }
}
```

(2)

```
with { UE in 5GMM-REGISTERED.LIMITED-SERVICE state and 5GMM-IDLE mode having established an
Emergency call }
ensure that {
  when { UE is requested to release the Emergency call }
  then { UE releases the Emergency call, and, the UE considers the current cell as belonging to
5GS forbidden tracking areas for roaming }
}
```

11.4.5.2 Conformance requirement

References: The conformance requirements covered in the present TC are specified in: TS 24.501 [22], subclause 5.5.1.3.5, TS 23.122 [38], subclause 3.4.2. Unless otherwise stated these are Rel-15 requirements.

[TS 24.501, subclause 5.5.1.3.5]

#15 (No suitable cells in tracking area).

The UE shall set the 5GS update status to 5U3 ROAMING NOT ALLOWED (and shall store it according to subclause 5.1.3.2.2). The UE shall reset the registration attempt counter and shall enter the state 5GMM-REGISTERED.LIMITED-SERVICE. The UE shall search for a suitable cell in another tracking area according to 3GPP TS 38.304 [28].

The UE shall store the current TAI in the list of "5GS forbidden tracking areas for roaming" and shall remove the current TAI from the stored TAI list, if present.

If the UE is operating in single-registration mode, the UE shall handle the EMM parameters EMM state, EPS update status and tracking area updating attempt counter as specified in 3GPP TS 24.301 [15] for the case when the normal tracking area updating procedure is rejected with the EMM cause with the same value.

[TS 23.122, subclause 3.4.2]

The MS is not allowed to request 5GS services except emergency services when camped on a cell of a TA of which belongs to the list of "5GS forbidden tracking areas for regional provision of service".

11.4.5.3 Test description

11.4.5.3.1 Pre-test conditions

System Simulator:

- 2 NR Cells
 - NR Cell 1 and NR Cell 11 as defined in TS 38.508-1 [4], Table 4.4.2-3.
 - On all cells when active: System information combination NR-1 as defined in TS 38.508-1 [4], subclause 4.4.3.1.2. SIB1 indicates ims-EmergencySupport.

UE:

None.

Preamble:

- Cell configuration " in accordance with TS 38.508-1 [4], Table 4.4.2-3:
 - NR Cell 1 "Serving cell"
 - NR Cell 11 "Non-Suitable "Off" cell"
- The UE is in test state 1N-A as defined in TS 38.508-1 [4], subclause 4.4A.2 on NR Cell 1
 - During the initial registration:
 - In the list of tracking areas provided by the AMF (IE 'TAI list') contains only the TAI of NR Cell 1.

11.4.5.3.2 Test procedure sequence

Table 11.4.5.3.2-1: Main behaviour

St	Procedure	Message Sequence		TP	Verdict
		U - S	Message		

1	The SS configures: - NR Cell 11 as "Serving cell" - NR Cell 1 as "Non-Suitable "Off" cell".	-	-	-	-
-	EXCEPTION: The following messages are to be observed on NR Cell 11 unless explicitly stated otherwise.	-	-	-	-
2	The UE transmits an <i>RRCSetupRequest</i> message.	-->	NR RRC: <i>RRCSetupRequest</i>	-	-
3	SS transmit an <i>RRCSetup</i> message.	<--	NR RRC: <i>RRCSetup</i>	-	-
4	The UE transmits an <i>RRCSetupComplete</i> message to confirm the successful completion of the connection establishment and a REGISTRATION REQUEST message indicating "mobility registration updating" is sent to update the registration of the actual tracking area.	-->	NR RRC: <i>RRCSetupComplete</i> 5GMM: REGISTRATION REQUEST	-	-
5	SS sends a REGISTRATION REJECT message containing 5GMM cause value = #15 (No suitable cells in tracking area).	<--	NR RRC: <i>DLInformationTransfer</i> 5GMM: REGISTRATION REJECT	-	-
6	The SS transmits an <i>RRCRelease</i> message.	<--	NR RRC: <i>RRCRelease</i>	-	-
7	Make the UE attempt an IMS emergency call dialling an emergency number e.g. 112 or 911). (NOTE 1)	-	-	-	-
8	Check: Does the UE performs Generic Test Procedure for IMS Emergency call establishment without IMS Emergency registration as specified in TS 38.508-1 [4], subclause 4.9.12?	-	-	1	P
9	Make the UE release the emergency call. (NOTE 1)	-	-	-	-
10	Void	-	-	-	-
10A	the Generic test procedure for IMS MO Emergency call release with ' <i>release emergency PDU session</i> ' as specified in TS 38.508-1 [4], subclause 4.9.12A take place.	-	-	-	-
10B	Void	-	-	-	-
-					
12b					
1					
12A	The SS transmits an <i>RRCRelease</i> message.	<--	NR RRC: <i>RRCRelease</i>	-	-
12B	Make the UE attempt an IMS non-emergency call. (NOTE 2)	-	-	-	-
12C	Check: Does the UE transmit an <i>RRCSetupRequest</i> message for initial registration procedure on NR Cell 11 within the next 10 seconds?	-->	NR RRC: <i>RRCSetupRequest</i>	2	F
13	The SS configures: - NR Cell 1 as "Suitable neighbour intra-frequency cell" - NR Cell 11 as "Non-suitable cell".	-	-	-	-
14	Check: Does the UE transmit an <i>RRCSetupRequest</i> message on NR Cell 1	-	-	2	P
15-16	Steps 3-4 of Table 4.5.2.2-2 of the generic procedure in TS 38.508-1 [4] are performed.	-	-	-	-
-	EXCEPTION: Steps 17a1 to 17b3a1 describe behaviour that depends on events happening prior to their execution; the "lower case letter" identifies a step sequence that take place if a specific prior event takes place.	-	-	-	-
17a	IF 5GS registration type is set as Initial Registration in step 16, THEN Steps 5 to 20a1 of the generic test procedure in TS 38.508-1 Table 4.5.2.2-2 are performed on NR Cell 1.	-	-	-	-
1-17a					
16a					
1					
17b	IF 5GS registration type is set as Mobility Registration in step 16, THEN Steps 4 to 6a1 of the generic test procedure in TS 38.508-1	-	-	-	-
1-17b					

3a1	Table 4.9.5.2.2-1 are performed on NR Cell 1.			
NOTE 1: This could be done by e.g. MMI or AT command.				
NOTE 2: This could be done by e.g. MMI or AT command.				

Table 11.4.5.3.2-2: Void

Table 11.4.5.3.2-3: Void

11.4.5.3.3 Specific message contents

Table 11.4.5.3.3-1: REGISTRATION REJECT (step 5, Table 11.4.5.3.2-1)

Derivation path: TS 38.508-1 [4] table 4.7.1-9			
Information Element	Value/remark	Comment	Condition
5GMM cause	'00001111'B	#15 (No suitable cells in tracking area).	

11.4.6 5GMM-REGISTERED.NON-ALLOWED-SERVICE / Emergency call establishment and release / Handling of non-allowed tracking areas

11.4.6.1 Test Purpose (TP)

(1)

```
with { UE in 5GMM-REGISTERED.NON-ALLOWED-SERVICE state and 5GMM-IDLE mode }
ensure that {
  when { UE is requested to make an Emergency call }
  then { UE establishes the Emergency call }
}
```

(2)

```
with { UE in 5GMM-REGISTERED.NON-ALLOWED-SERVICE state and 5GMM-CONNECTED mode having established an
Emergency call }
ensure that {
  when { UE is requested to release the Emergency call }
  then { UE releases the Emergency call, and, the UE considers the current cell as belonging to
non-allowed tracking areas }
}
```

11.4.6.2 Conformance requirements

References: The conformance requirements covered in the present TC are specified in: TS 24.501 [22], subclause 5.3.5, TS 22.101 [42], subclause 10.1.1. Unless otherwise stated these are Rel-15 requirements.

[TS 24.501, subclause 5.3.5]

When the UE receives a Service area list IE with a non-allowed area indication during a registration procedure or a generic UE configuration update procedure, the UE shall delete the old list of "non-allowed tracking areas" and store the tracking areas in the non-allowed area as the list of "non-allowed tracking areas". If the UE has a stored list of "allowed tracking areas", the UE shall delete that list.

...

If the UE is successfully registered to a PLMN and has a stored list of "non-allowed tracking areas":

...

b) while camped on a cell whose TAI is in the list of "non-allowed tracking areas", the UE shall enter the state 5GMM-REGISTERED.NON-ALLOWED-SERVICE, and:

1) if the UE is in 5GMM-IDLE mode over 3GPP access, the UE:

...

ii) shall not initiate a service request procedure except for emergency services, high priority access, responding to paging or notification or indicating a change of 3GPP PS data off UE status; and

[TS 22.101, subclause 10.1.1]

The ME shall identify an emergency number dialled by the end user as a valid emergency number and initiate emergency call establishment if it occurs under one or more of the following conditions. If it occurs outside of the following conditions, the ME should not initiate emergency call establishment but normal call establishment. Emergency number identification takes place before and takes precedence over any other (e.g. supplementary service related) number analysis.

- a) 112 and 911 shall always be available. These numbers shall be stored on the ME.
- b) Any emergency call number stored on a SIM/USIM when the SIM/USIM is present.
- c) 000, 08, 110, 999, 118 and 119 when a SIM/USIM is not present. These numbers shall be stored on the ME.
- d) Additional emergency call numbers that may have been downloaded by the serving network when the SIM/USIM is present.

11.4.6.3 Test description

11.4.6.3.1 Pre-test conditions

System Simulator:

- 2 NR Cells
 - NR Cell 1 and NR Cell 11 as defined in TS 38.508-1 [4] Table 4.4.2-3.
 - Maximum of 1 cell is active at any point of time.
 - On all cells when active: System information combination NR-2 as defined in TS 38.508-1 [4], subclause 4.4.3.1.2. SIB1 indicates ims-EmergencySupport.

UE:

None.

Preamble:

- Cells power level configuration in accordance with TS 38.508-1 [4], Table 6.2.2.1-3:
 - NR Cell 1 "Serving cell"
 - NR Cell 11 "Non-Suitable "Off" cell"
- The UE is in test state 1N-A as defined in TS 38.508-1 [4], subclause 4.4A.2 on NR Cell 1
 - During the initial registration:
 - The list of tracking areas provided by the AMF (IE 'TAI list') contains only the TAI of NR Cell 1 whereas the TAI of NR Cell 11 is indicated in the Service area list IE with non-allowed areas as specified in Table 11.4.6.3.3-1.

11.4.6.3.2 Test procedure sequence

Table 11.4.6.3.2-1: Main behaviour

St	Procedure	Message Sequence		TP	Verdict
		U - S	Message		
1	The SS configures: - NR Cell 11 as "Serving cell" - NR Cell 1 as "Non-Suitable "Off" cell"	-	-	-	-
-	The following messages are to be observed on NR Cell 11 unless explicitly stated otherwise.	-	-	-	-
2	The UE performs a registration for mobility procedure and the RRC connection is released according to generic test procedure in TS 38.508-1 [4] Table 4.9.5.2.2-1, which indicates that the UE is camped on NR Cell 11.	-	-	-	-
3	Make the UE attempt an IMS emergency call dialling an emergency number e.g. 112 or 911. (NOTE 1)	-	-	-	-
4	Check: Does the UE performs Generic Test Procedure for IMS Emergency call establishment with IMS Emergency registration as specified in TS 38.508-1 [4], subclause 4.9.11?	-	-	1	P
5	Make the UE release the emergency call. (NOTE 1)	-	-	-	-
6	The Generic test procedure for IMS MO Emergency call release as specified in TS 38.508-1 [4], subclause 4.9.12A takes place.	-	-	-	-
7	SS releases the RRC connection	<--	NR RRC: RRCRelease	-	-
8	Make the UE attempt an IMS none-emergency call. (NOTE 1)				
9	Check: Does the UE transmit in the next 10 sec an <i>RRCSetupRequest</i> message?	-->	NR RRC: RRCSetupRequest	2	F

NOTE 1: This could be done by e.g. MMI or AT command.

11.4.6.3.3 Specific message contents

Table 11.4.6.3.3-1: REGISTRATION ACCEPT (Preamble, step 2)

Derivation Path: TS 38.508-1 [4], Table 4.7.1-7.			
Information Element	Value/remark	Comment	Condition
Service area list			
Allowed type (octet 1)	'1'B	TAls in the list are in the non-allowed area	
Type of list (octet 1)	'00'B	list of TACs belonging to one PLMN, with non-consecutive TAC values	
Number of elements (octet 1)	'00000'B	1 element	
MCC	As defined for NR Cell 11 in TS 38.508-1 [4], Table 4.4.2-3.		
MNC	As defined for NR Cell 11 in TS 38.508-1 [4], Table 4.4.2-3.		
TAC 1	As defined for NR Cell 11 in TS 38.508-1 [4], Table 4.4.2-3.		

11.4.7 Handling of Local and Extended emergency numbers / Mobility

11.4.7.1 Test Purpose (TP)

(1)

```
with { UE in 5GMM-REGISTERED.NORMAL-SERVICE state and 5GMM-IDLE mode, UE receives a Local emergency numbers list in the REGISTRATION ACCEPT message, provided in the Emergency number list IE }
ensure that {
  when { UE is requested to make an outgoing call using any of the emergency numbers received in the Local emergency numbers list }
  then { UE establishes an IMS Emergency call }
}
```

(2)

```
with { UE in 5GMM-REGISTERED.NORMAL-SERVICE state and 5GMM-IDLE mode, UE receives an Extended local emergency numbers list in the REGISTRATION ACCEPT message, provided in the Extended emergency number list IE }
ensure that {
  when { UE is requested to make an outgoing call using any of the emergency numbers received in the Extended local emergency numbers list }
  then { UE establishes an IMS Emergency call }
}
```

(3)

```
with { UE in 5GMM-REGISTERED.NORMAL-SERVICE state and 5GMM-IDLE mode, having stored a Local emergency numbers list and an Extended local emergency numbers list }
ensure that {
  when { UE receives a new Local emergency numbers list in the REGISTRATION ACCEPT message, provided in the Emergency number list IE }
  then { UE replaces the previously stored Local emergency numbers list }
}
```

(4)

```
with { UE in 5GMM-REGISTERED.NORMAL-SERVICE state and 5GMM-IDLE mode, having stored a Local emergency numbers list and an Extended local emergency numbers list }
ensure that {
  when { UE receives a new Extended local emergency numbers list, in the REGISTRATION ACCEPT message, provided in the Extended emergency number list IE }
  then { UE replaces the previously stored Extended local emergency numbers list }
}
```

(5)

```
with { UE in 5GMM-REGISTERED.NORMAL-SERVICE state and 5GMM-IDLE mode, having stored a Local emergency numbers list }
ensure that {
  when { UE moves within the same PLMN from which the currently stored Local emergency numbers list provided in an Emergency number list IE were received, and, no Emergency number list IE is contained in the REGISTRATION ACCEPT message received during a Mobility and periodic update procedure }
  then { UE keeps the stored Local emergency numbers list in the user equipment }
}
```

(6)

```
with { UE in 5GMM-REGISTERED.NORMAL-SERVICE state and 5GMM-IDLE mode, having stored an Extended local emergency numbers list }
ensure that {
  when { UE moves within the same PLMN from which the currently stored Extended local Emergency Numbers List provided in an Extended emergency number list IE were received, and, no Extended emergency number list IE is contained in the REGISTRATION ACCEPT message received during a Mobility and periodic update procedure }
  then { UE keeps the stored Extended local Emergency Numbers List in the user equipment }
}
```

(7)

```

with { UE in 5GMM-REGISTERED.NORMAL-SERVICE state and 5GMM-IDLE mode, having stored a Local
emergency numbers list}
ensure that {
  when { UE moves to a new PLMN in the same country as the PLMN from which the currently stored
Local emergency numbers list provided in an Emergency number list IE were received, and, no
Emergency number list IE is contained in the REGISTRATION ACCEPT message received in the new PLMN }
  then { UE keeps the stored Local emergency numbers list in the user equipment }
}

```

(8)

```

with { UE in 5GMM-REGISTERED.NORMAL-SERVICE state and 5GMM-IDLE mode, having stored an Extended
local emergency numbers list }
ensure that {
  when { UE moves to a new PLMN in the same country as the PLMN from which the currently stored
Extended Emergency Numbers List provided in an Extended emergency number list IE were received, and
the Extended Emergency Number List Validity (EENLV) field within the Extended emergency number list
IE indicated "Extended local Emergency Numbers List is valid in the country of the PLMN from which
this IE is received", and, no Extended emergency number list IE is contained in the REGISTRATION
ACCEPT message received in the new PLMN }
  then { UE keeps the stored Extended local Emergency Numbers List in the user equipment }
}

```

(9)

```

with { UE in 5GMM-REGISTERED.NORMAL-SERVICE state and 5GMM-IDLE mode, having stored a Local
emergency numbers list and an Extended local emergency numbers list }
ensure that {
  when { UE moves to a new PLMN in the same country as the PLMN from which the currently stored
Extended Emergency Numbers List provided in an Extended emergency number list IE were received, and
the Extended Emergency Number List Validity (EENLV) field within the Extended emergency number list
IE indicated "Extended local Emergency Numbers List is valid only in the PLMN from which this IE is
received", and, no Extended emergency number list IE is contained in the REGISTRATION ACCEPT message
received in the new PLMN }
  then { UE deletes the stored Extended local Emergency Numbers List, and, keeps the stored Local
emergency numbers list in the user equipment }
}

```

(10)

```

with { UE in 5GMM-REGISTERED.NORMAL-SERVICE state and 5GMM-IDLE mode, having stored a Local
emergency numbers list }
ensure that {
  when { UE moves to a new PLMN in a different country as the PLMN from which the currently stored
Local emergency numbers list provided in an Emergency number list IE was received, and, no Emergency
number list IE is contained in the REGISTRATION ACCEPT message received in the new PLMN }
  then { UE deletes the stored Local emergency numbers list in the user equipment }
}

```

(11)

```

with { UE in 5GMM-REGISTERED.NORMAL-SERVICE state and 5GMM-IDLE mode, having stored an Extended
local emergency numbers list }
ensure that {
  when { UE moves to a new PLMN in a different country as the PLMN from which the currently stored
Extended Emergency Numbers List provided in an Extended emergency number list IE were, and, no
Extended emergency number list IE is contained in the REGISTRATION ACCEPT message received in the
new PLMN }
  then { UE deletes the stored Extended emergency numbers list in the user equipment }
}

```

11.4.7.2 Conformance requirements

References: The conformance requirements covered in the present TC are specified in: TS 38.331 [12], subclause 5.3.3.3, TS 24.501 [22], subclause 5.3.12, TS 24.301 [21], subclause 5.3.7, TS 22.101 [42], subclause 10.1.1. Unless otherwise stated these are Rel-15 requirements.

[TS 38.331, subclause 5.3.3.3]

The UE shall set the contents of *RRCSetupRequest* message as follows:

...

1> set the *establishmentCause* in accordance with the information received from upper layers;

The UE shall submit the *RRCSetupRequest* message to lower layers for transmission.

[TS 24.501, subclause 5.3.12]

The network may send a Local emergency numbers list or an Extended local emergency numbers list or both, in the REGISTRATION ACCEPT message, by including the Emergency number list IE and the Extended emergency number list IE, respectively. The Local emergency numbers list can be updated as described in 3GPP TS 24.301 [15], subclause 5.3.7.

The user equipment shall store the Local emergency numbers list and the Extended local emergency numbers list, as provided by the network. The Local emergency numbers list stored in the user equipment shall be replaced on each receipt of the Emergency number list IE. The Extended local emergency numbers list stored in the user equipment shall be replaced on each receipt of the Extended emergency number list IE. The received Local emergency numbers list or the received Extended local emergency numbers list or both shall be provided to the upper layers.

...

The emergency number(s) received in the Emergency number list IE are valid only in networks in the same country as the PLMN from which this IE is received. If no Emergency number list IE is contained in the REGISTRATION ACCEPT message, then the stored Local emergency numbers list in the user equipment shall be kept, except if the user equipment has successfully registered to a PLMN in a country different from that of the PLMN that sent the list.

The emergency number(s) received in the Extended emergency number list IE are valid only in:

- networks in the same country as the PLMN from which this IE is received, if the Extended Emergency Number List Validity (EENLV) field within the Extended emergency number list IE indicates "Extended local Emergency Numbers List is valid in the country of the PLMN from which this IE is received"; and
- the PLMN from which this IE is received, if the EENLV field within the Extended emergency number list IE indicates "Extended local Emergency Numbers List is valid only in the PLMN from which this IE is received".

If no Extended local Emergency Numbers List is contained in the REGISTRATION ACCEPT message, and the registered PLMN has not changed, then the stored Extended local Emergency Numbers List in the user equipment shall be kept. If no Extended local Emergency Numbers List is contained in the REGISTRATION ACCEPT message, but the registered PLMN has changed, then:

- if the last received indication in the EENLV field within the Extended emergency number list IE indicates "Extended local Emergency Numbers List is valid only in the PLMN from which this IE is received", the stored Extended local Emergency Numbers List in the user equipment shall be deleted; and
- if the last received indication in the EENLV field within the Extended emergency number list IE indicates "Extended local Emergency Numbers List is valid in the country of the PLMN from which this IE is received" the list shall be kept except if the user equipment has successfully registered to a PLMN in a country different from that of the PLMN that sent the stored list.

NOTE: To prevent the misrouting of emergency calls, all operators within a country need to follow the regulation or agree on the setting of the Extended emergency number list IE in accordance to national agreement – either to indicate validity within a country or to indicate validity only within the PLMN.

The Local emergency numbers list and the Extended local emergency numbers list shall be deleted at switch off or removal of the USIM. The user equipment shall be able to store up to ten entries in the Local emergency numbers list and up to twenty entries in the Extended local emergency numbers list, received from the network.

For the use of the Local emergency numbers list and the Extended local emergency numbers list by the UE see 3GPP TS 24.301 [15], subclause 5.3.7.

[TS 24.301, subclause 5.3.7]

The Local Emergency Numbers List and the Extended local Emergency Numbers list contain additional Local emergency numbers used by the serving network. These lists can be downloaded by the network to the UE at successful registration and subsequent registration updates. There is only one Local Emergency Numbers List and only one Extended local Emergency Numbers list in the UE. The Local Emergency Numbers List can be updated with EMM

procedures if the UE is in S1 mode, with GMM and MM procedures if the UE is in A/Gb or Iu mode, and with 5GMM procedures, as specified in 3GPP TS 24.501 [54], if UE is in N1 mode. The Extended local Emergency Numbers List can be updated with EMM procedures if the UE is in S1 mode and with 5GMM procedures, as specified in 3GPP TS 24.501 [54], if UE is in N1 mode.

The UE shall use the stored Local Emergency Numbers List and the stored Extended local Emergency Numbers List received from the network in addition to the emergency numbers stored on the USIM or user equipment to detect that the number dialled is an emergency number.

If the UE determines that the number dialled is an emergency number, the procedures specified in 3GPP TS 23.167 [45] and 3GPP TS 24.229 [13D] are utilised to select a domain for the emergency session attempt.

If the domain selected for the emergency session attempt is the PS domain, then the UE shall perform the session establishment procedures specified in 3GPP TS 24.229 [13D] to initiate an emergency session.

[TS 22.101, subclause 10.1.1]

The ME shall identify an emergency number dialled by the end user as a valid emergency number and initiate emergency call establishment if it occurs under one or more of the following conditions. If it occurs outside of the following conditions, the ME should not initiate emergency call establishment but normal call establishment. Emergency number identification takes place before and takes precedence over any other (e.g. supplementary service related) number analysis.

- a) 112 and 911 shall always be available. These numbers shall be stored on the ME.
- b) Any emergency call number stored on a SIM/USIM when the SIM/USIM is present.
- c) 000, 08, 110, 999, 118 and 119 when a SIM/USIM is not present. These numbers shall be stored on the ME.
- d) Additional emergency call numbers that may have been downloaded by the serving network when the SIM/USIM is present.

11.4.7.3 Test description

11.4.7.3.1 Pre-test conditions

System Simulator:

- 4 NR Cells
- NR Cell 1, NR Cell 3, NR Cell 11, NR Cell 12 as defined in TS 38.508-1 [4], Table 4.4.2-3, with the exception that cells' PLMNs are defined in Table 11.4.7.3.1-1 below.

Table 11.4.7.3.1-1: PLMN identifiers

NR Cell	PLMN name
1	PLMN1
3	PLMN15
11	PLMN1
12	PLMN2
NOTE 1: PLMN1 is stored in EF _{IMSI} on the test USIM card. NOTE 2: PLMN1 and PLMN15 are in the same country; PLMN2 is in a different country.	

- System information combination NR-1 as defined in TS 38.508-1 [4], subclause 4.4.3.1.2. SIB1 indicates *ims-EmergencySupport*.

NOTE: No more than 1 cell is active at any time throughout the test.

UE:

- The UE is equipped with a test USIM with USIM Configuration 20 as defined in TS 38.508-1 [4] Table 6.4.1-20 (USIM contains two Emergency Numbers: 144, 117).

Preamble:

- Cells signal level in accordance with TS 38.508-1 [4], Table 6.2.2.1-3:
 - NR Cell 12 "Serving cell"
 - NR Cell 1 "Non-Suitable "Off" cell"
 - NR Cell 11 "Non-Suitable "Off" cell"
 - NR Cell 3 "Non-Suitable "Off" cell"
- The UE is in test state 1N-A as defined in TS 38.508-1 [4], subclause 4.4A.2 on NR Cell 12.
- During the initial registration:
 - Local emergency number(s) and Extended local emergency number(s) are provided by the Network as specified in Table 11.4.7.3.3-1.

11.4.7.3.2 Test procedure sequence

Table 11.4.7.3.2-1: Main behaviour

St	Procedure	Message Sequence		TP	Verdict
		U - S	Message		
-	The following messages are to be observed on NR Cell 12 unless explicitly stated otherwise.	-	-	-	-
1	Make the UE attempt an IMS call dialling number 120. (NOTE 1) The number is expected to be stored in the Local emergency number list being received in the REGISTRATION ACCEPT message in the Preamble.	-	-	-	-
2	Check: Does the UE performs Generic Test Procedure for IMS Emergency call establishment with IMS emergency registration as specified in TS 38.508-1 [4], subclause 4.9.11?	-	-	1	-
3	Make the UE release the emergency call. (NOTE 1)	-	-	-	-
4	The Generic test procedure for IMS MO Emergency call release as specified in TS 38.508-1 [4], subclause 4.9.12A takes place.	-	-	-	-
5	SS releases the RRC connection	<--	NR RRC: RRCRelease	-	-
6	Make the UE attempt an IMS call dialling number 10. (NOTE 1) The number is expected to be stored in the Extended local emergency number list being received in the REGISTRATION ACCEPT message in the Preamble.	-	-	-	-
7	Check: Does the UE performs Generic Test Procedure for IMS Emergency call establishment with IMS emergency registration as specified in TS 38.508-1 [4], subclause 4.9.11?	-	-	2	-
8	Make the UE release the emergency call. (NOTE 1)	-	-	-	-
9	The Generic test procedure for IMS MO Emergency call release as specified in TS 38.508-1 [4], subclause 4.9.12A takes place.	-	-	-	-
10	SS releases the RRC connection	<--	NR RRC: RRCRelease	-	-

-	The SS configures: - NR Cell 1 as "Serving cell" - NR Cell 12 as "Non-Suitable "Off" cell" - NR Cell 11 as "Non-Suitable "Off" cell" - NR Cell 3 as "Non-Suitable "Off" cell"	-	-	-	-
-	The following messages are to be observed on NR Cell 1 unless explicitly stated otherwise.	-	-	-	-
11	The UE performs the Registration procedure for mobility registration update as specified in TS 38.508-1 [4] subclause 4.9.5. During the procedure the Network provides new Local emergency number list and Extended local emergency number list (EENLV=Extended Local Emergency Numbers List is valid in the country of the PLMN from which this IE is received) in the REGISTRATION ACCEPT message.	-	-	-	-
12	Make the UE attempt an IMS call dialling number 1001. (NOTE 1) The number is expected to be stored in the Local emergency number list being received in the REGISTRATION ACCEPT message in step 11.	-	-	-	-
13	Check: Does the UE performs Generic Test Procedure for IMS Emergency call establishment with IMS emergency registration as specified in TS 38.508-1 [4], subclause 4.9.11?	-	-	3	-
14	Make the UE release the emergency call. (NOTE 1)	-	-	-	-
15	The Generic test procedure for IMS MO Emergency call release as specified in TS 38.508-1 [4], subclause 4.9.12A takes place.	-	-	-	-
16	SS releases the RRC connection	<--	NR RRC: RRCRelease	-	-
17	Make the UE attempt an IMS call dialling number 120. (NOTE 1) The number was initially stored in the Local emergency number list being received in the REGISTRATION ACCEPT message in the Preamble but is expected to have been removed from the list when a new list was received in the REGISTRATION ACCEPT message in step 11.	-	-	-	-
18	Check: Does the UE performs Generic Test Procedure for IMS MO speech call establishment as specified in TS 38.508-1 [4], subclause 4.9.15?	-	-	3	-
19	Make the UE release the call. (NOTE 1)	-	-	-	-
20	The Generic test procedure for IMS MO call release as specified in TS 38.508-1 [4], subclause 4.9.17 takes place.	-	-	-	-
21	SS releases the RRC connection	<--	NR RRC: RRCRelease	-	-
22	Make the UE attempt an IMS call dialling number 12345. (NOTE 1) The number is expected to be stored in the Extended local emergency number list being received in the REGISTRATION ACCEPT message in step 11.	-	-	-	-
23	Check: Does the UE performs Generic Test Procedure for IMS Emergency call establishment with IMS emergency registration as specified in TS 38.508-1 [4], subclause 4.9.11?	-	-	4	-
24	Make the UE release the emergency call. (NOTE 1)	-	-	-	-
25	The Generic test procedure for IMS MO Emergency call release as specified in TS 38.508-1 [4], subclause 4.9.12A takes place.	-	-	-	-

26	SS releases the RRC connection	<--	NR RRC: RRCRelease	-	-
27	Make the UE attempt an IMS call dialling number 10. (NOTE 1) The number was initially stored in the Extended local emergency number list being received in the REGISTRATION ACCEPT message in the Preamble but is expected to have been removed from the list when a new list was received in the REGISTRATION ACCEPT message in step 11.	-	-	-	-
28	Check: Does the UE performs Generic Test Procedure for IMS MO speech call establishment as specified in TS 38.508-1 [4], subclause 4.9.15?	-	-	4	-
29	Make the UE release the call. (NOTE 1)	-	-	-	-
30	The Generic test procedure for IMS MO call release as specified in TS 38.508-1 [4], subclause 4.9.17 takes place.	-	-	-	-
31	SS releases the RRC connection	<--	NR RRC: RRCRelease	-	-
-	The SS configures: - NR Cell 11 as "Serving cell" - NR Cell 1 as "Non-Suitable "Off" cell" - NR Cell 12 as "Non-Suitable "Off" cell" - NR Cell 3 as "Non-Suitable "Off" cell"	-	-	-	-
-	The following messages are to be observed on NR Cell 11 unless explicitly stated otherwise.	-	-	-	-
32	The UE performs the Registration procedure for mobility registration update as specified in TS 38.508-1 [4] subclause 4.9.5. During the procedure the Network does not send new Local emergency number list and Extended local emergency number list in the REGISTRATION ACCEPT message.	-	-	-	-
33	Make the UE attempt an IMS call dialling number 1001. (NOTE 1) The number is expected to be stored in the Local emergency number list being received in the REGISTRATION ACCEPT message in step 11.	-	-	-	-
34	Check: Does the UE performs Generic Test Procedure for IMS Emergency call establishment with IMS emergency registration as specified in TS 38.508-1 [4], subclause 4.9.11?	-	-	5	-
35	Make the UE release the emergency call. (NOTE 1)	-	-	-	-
36	The Generic test procedure for IMS MO Emergency call release as specified in TS 38.508-1 [4], subclause 4.9.12A takes place.	-	-	-	-
37	SS releases the RRC connection	<--	NR RRC: RRCRelease	-	-
38	Make the UE attempt an IMS call dialling number 12345. (NOTE 1) The number is expected to be stored in the Extended local emergency number list being received in the REGISTRATION ACCEPT message in step 11.	-	-	-	-
39	Check: Does the UE performs Generic Test Procedure for IMS Emergency call establishment with IMS emergency registration as specified in TS 38.508-1 [4], subclause 4.9.11?	-	-	6	-
40	Make the UE release the emergency call. (NOTE 1)	-	-	-	-
41	The Generic test procedure for IMS MO Emergency call release as specified in TS 38.508-1 [4], subclause 4.9.12A takes place.	-	-	-	-
42	SS releases the RRC connection	<--	NR RRC: RRCRelease	-	-
-	The SS configures:	-	-	-	-

	- NR Cell 3 as "Serving cell" - NR Cell 1 as "Non-Suitable "Off" cell" - NR Cell 11 as "Non-Suitable "Off" cell" - NR Cell 12 as "Non-Suitable "Off" cell"				
-	The following messages are to be observed on NR Cell 3 unless explicitly stated otherwise.	-	-	-	-
43	The UE performs the Registration procedure for mobility registration update as specified in TS 38.508-1 [4] subclause 4.9.5. During the procedure the Network does not send new Local emergency number list and Extended local emergency number list in the REGISTRATION ACCEPT message.	-	-	-	-
44	Make the UE attempt an IMS call dialling number 1001. (NOTE 1) The number is expected to be stored in the Local emergency number list being received in the REGISTRATION ACCEPT message in step 11.	-	-	-	-
45	Check: Does the UE performs Generic Test Procedure for IMS Emergency call establishment with IMS emergency registration as specified in TS 38.508-1 [4], subclause 4.9.11?	-	-	7	-
46	Make the UE release the emergency call. (NOTE 1)	-	-	-	-
47	The Generic test procedure for IMS MO Emergency call release as specified in TS 38.508-1 [4], subclause 4.9.12A takes place.	-	-	-	-
48	SS releases the RRC connection	<--	NR RRC: RRCRelease	-	-
49	Make the UE attempt an IMS call dialling number 12345. (NOTE 1) The number is expected to be stored in the Extended local emergency number list being received in the REGISTRATION ACCEPT message in step 11.	-	-	-	-
50	Check: Does the UE performs Generic Test Procedure for IMS Emergency call establishment with IMS emergency registration as specified in TS 38.508-1 [4], subclause 4.9.11?	-	-	8	-
51	Make the UE release the emergency call. (NOTE 1)	-	-	-	-
52	The Generic test procedure for IMS MO Emergency call release as specified in TS 38.508-1 [4], subclause 4.9.12A takes place.	-	-	-	-
53	SS releases the RRC connection	<--	NR RRC: RRCRelease	-	-
-	The SS configures: - NR Cell 12 as "Serving cell" - NR Cell 1 as "Non-Suitable "Off" cell" - NR Cell 11 as "Non-Suitable "Off" cell" - NR Cell 3 as "Non-Suitable "Off" cell"	-	-	-	-
-	The following messages are to be observed on NR Cell 12 unless explicitly stated otherwise.	-	-	-	-
54	The UE performs the Registration procedure for mobility registration update as specified in TS 38.508-1 [4] subclause 4.9.5. During the procedure the Network does not send new Local emergency number list and Extended local emergency number list in the REGISTRATION ACCEPT message.	-	-	-	-
55	Make the UE attempt an IMS call dialling number 1001. (NOTE 1) The number was initially stored in the Local emergency number list being received in the REGISTRATION ACCEPT message in step 11 but is expected to have been removed from the list when no new list was received in the	-	-	-	-

	REGISTRATION ACCEPT message in step 54.				
56	Check: Does the UE performs Generic Test Procedure for IMS MO speech call establishment as specified in TS 38.508-1 [4], subclause 4.9.15?	-	-	10	-
57	Make the UE release the call. (NOTE 1)	-	-	-	-
58	The Generic test procedure for IMS MO call release as specified in TS 38.508-1 [4], subclause 4.9.17 takes place.	-	-	-	-
59	SS releases the RRC connection	<--	NR RRC: RRCRelease	-	-
60	Make the UE attempt an IMS call dialling number 12345. (NOTE 1) The number was initially stored in the Extended local emergency number list being received in the REGISTRATION ACCEPT message in step 11 but is expected to have been removed from the list when no new list was received in the REGISTRATION ACCEPT message in step 54.	-	-	-	-
61	Check: Does the UE performs Generic Test Procedure for IMS MO speech call establishment as specified in TS 38.508-1 [4], subclause 4.9.15?	-	-	11	-
62	Make the UE release the call. (NOTE 1)	-	-	-	-
63	The Generic test procedure for IMS MO call release as specified in TS 38.508-1 [4], subclause 4.9.17 takes place.	-	-	-	-
64	SS releases the RRC connection	<--	NR RRC: RRCRelease	-	-
-	The SS configures: - NR Cell 1 as "Serving cell" - NR Cell 12 as "Non-Suitable "Off" cell" - NR Cell 11 as "Non-Suitable "Off" cell" - NR Cell 3 as "Non-Suitable "Off" cell"	-	-	-	-
-	The following messages are to be observed on NR Cell 1 unless explicitly stated otherwise.	-	-	-	-
65	The UE performs the Registration procedure for mobility registration update as specified in TS 38.508-1 [4] subclause 4.9.5. During the procedure the Network provides new Local emergency number list and Extended local emergency number list (EENLV=Extended Local Emergency Numbers List is valid in the PLMN from which this IE is received) in the REGISTRATION ACCEPT message.	-	-	-	-
-	The SS configures: - NR Cell 3 as "Serving cell" - NR Cell 1 as "Non-Suitable "Off" cell" - NR Cell 11 as "Non-Suitable "Off" cell" - NR Cell 12 as "Non-Suitable "Off" cell"	-	-	-	-
-	The following messages are to be observed on NR Cell 3 unless explicitly stated otherwise.	-	-	-	-
66	The UE performs the Registration procedure for mobility registration update as specified in TS 38.508-1 [4] subclause 4.9.5. During the procedure the Network does not send new Local emergency number list and Extended local emergency number list in the REGISTRATION ACCEPT message.	-	-	-	-
67	Make the UE attempt an IMS call dialling number 12345. (NOTE 1) The number was initially stored in the Extended local emergency number list being received in the REGISTRATION ACCEPT message in step 65 but is expected to have been removed from the list when no new list was received in the REGISTRATION ACCEPT	-	-	-	-

	message in step 66.				
68	Check: Does the UE performs Generic Test Procedure for IMS MO speech call establishment as specified in TS 38.508-1 [4], subclause 4.9.15?	-	-	9	-
69	Make the UE release the call. (NOTE 1)	-	-	-	-
70	The Generic test procedure for IMS MO call release as specified in TS 38.508-1 [4], subclause 4.9.17 takes place.	-	-	-	-
71	SS releases the RRC connection	<--	NR RRC: RRCRelease	-	-
72	Make the UE attempt an IMS call dialling number 1001. (NOTE 1) The number was initially stored in the Local emergency number list being received in the REGISTRATION ACCEPT message in step 65 and is not expected to have been removed from the list when no new list was received in the REGISTRATION ACCEPT message in step 66.	-	-	-	-
73	Check: Does the UE performs Generic Test Procedure for IMS Emergency call establishment with IMS emergency registration as specified in TS 38.508-1 [4], subclause 4.9.11?	-	-	9	-
74	Make the UE release the emergency call. (NOTE 1)	-	-	-	-
75	The Generic test procedure for IMS MO Emergency call release as specified in TS 38.508-1 [4], subclause 4.9.12A takes place.	-	-	-	-
76	SS releases the RRC connection	<--	NR RRC: RRCRelease	-	-
NOTE 1: This could be done by e.g. MMI or AT command.					

11.4.7.3.3 Specific message contents

Table 11.4.7.3.3-1: REGISTRATION ACCEPT (Preamble)

Derivation Path: TS 38.508-1 [4], Table 4.7.1-7.			
Information Element	Value/remark	Comment	Condition
Emergency number list			
Emergency Number information	120 TS 24.008 [43], 10.5.3.13.	Number is different to any emergency number stored permanently in the ME AND the numbers stored in the USIM, as indicated in TS 22.101 [42] clause 10.1.1 a)-c).	
Extended emergency number list			
EENLV	'0'	Extended Local Emergency Numbers List is valid in the country of the PLMN from which this IE is received	
Emergency Number information	10 TS 24.301 [21], 9.9.3.37A.	Number is different to any emergency number stored permanently in the ME AND the numbers stored in	

		the USIM, as indicated in TS 22.101 [42] clause 10.1.1 a)-c).	
--	--	---	--

Table 11.4.7.3.3-2: REGISTRATION ACCEPT (step 11, Table 11.4.7.3.2-1; step 4, TS 38.508-1 [4], Table 4.9.5.2.2-1)

Derivation Path: TS 38.508-1 [4], Table 4.7.1-7.			
Information Element	Value/remark	Comment	Condition
Emergency number list			
Emergency Number information	1 number: 1001 TS 24.008 [43], 10.5.3.13.	Number is different to any emergency number stored permanently in the ME AND the numbers stored in the USIM, as indicated in TS 22.101 [42] clause 10.1.1 a)-c).	
Extended emergency number list			
EENLV	'0'	Extended Local Emergency Numbers List is valid in the country of the PLMN from which this IE is received	
Emergency Number information	1 number: 12345 TS 24.301 [21], 9.9.3.37A.	Number is different to any emergency number stored permanently in the ME AND the numbers stored in the USIM, as indicated in TS 22.101 [42] clause 10.1.1 a)-c).	

Table 11.4.7.3.3-3: REGISTRATION ACCEPT (step 65, Table 11.4.7.3.2-1; step 4, TS 38.508-1 [4], Table 4.9.5.2.2-1)

Derivation Path: TS 38.508-1 [4], Table 4.7.1-7.			
Information Element	Value/remark	Comment	Condition
Emergency number list			
Emergency Number information	1 number: 1001 TS 24.008 [43], 10.5.3.13.	Number is different to any emergency number stored permanently in the ME AND the numbers stored in the USIM, as indicated in TS 22.101 [42] clause 10.1.1 a)-c).	
Extended emergency number list			
EENLV	'1'	Extended Local	

		Emergency Numbers List is valid in the PLMN from which this IE is received	
Emergency Number information	1 number: 12345 TS 24.301 [21], 9.9.3.37A.	Number is different to any emergency number stored permanently in the ME AND the numbers stored in the USIM, as indicated in TS 22.101 [42] clause 10.1.1 a)-c).	

11.4.8 Handling of Local and extended emergency numbers / Switch-off and maximum local numbers storage

11.4.8.1 Test Purpose (TP)

(1)

with { UE in 5GMM-REGISTERED.NORMAL-SERVICE state and 5GMM-IDLE mode, having stored a Local emergency numbers list }

ensure that {
 when { UE is switched off or the USIM is removed }
 then { UE deletes the stored Local emergency numbers list in the user equipment }
}

(2)

with { UE in 5GMM-REGISTERED.NORMAL-SERVICE state and 5GMM-IDLE mode, having stored an Extended local emergency numbers list }

ensure that {
 when { UE is switched off or the USIM is removed }
 then { UE deletes the stored Extended local Emergency Numbers List in the user equipment }
}

(3)

with { UE in 5GMM-REGISTERED.NORMAL-SERVICE state and 5GMM-IDLE mode, UE receives a Local emergency numbers list with 10 entries in the REGISTRATION ACCEPT message, provided in the Emergency number list IE and the UE has stored them in local emergency numbers list }

ensure that {
 when { UE is requested to make an outgoing call using any of the emergency numbers received in the Local emergency numbers list }
 then { UE establishes an IMS Emergency call }
}

(4)

with { UE in 5GMM-REGISTERED.NORMAL-SERVICE state and 5GMM-IDLE mode, UE receives an Extended local emergency numbers list with 20 entries, in the REGISTRATION ACCEPT message, provided in the Extended emergency number list IE and the UE has stored them in Extended local emergency numbers lists }

ensure that {
 when { UE is requested to make an outgoing call using any of the emergency numbers received in the Extended local emergency numbers list }
 then { UE establishes an IMS Emergency call }
}

11.4.8.2 Conformance requirements

References: The conformance requirements covered in the present TC are specified in: TS 38.331 [12], subclause 5.3.3.3, TS 24.501 [22], subclause 5.3.12, TS 24.301 [21], subclause 5.3.7, TS 22.101 [42], subclause 10.1.1. [The following represents a copy/paste extraction of the requirements relevant to the test purpose; any references within the copy/paste text should be understood within the scope of the core spec they have been copied from.](#) Unless otherwise stated these are Rel-15 requirements.

[TS 38.331 [12], subclause 5.3.3.3]

The UE shall set the contents of *RRCSetupRequest* message as follows:

...

1> set the *establishmentCause* in accordance with the information received from upper layers;

The UE shall submit the *RRCSetupRequest* message to lower layers for transmission.

[TS 24.501 [22], subclause 5.3.12]

The network may send a Local emergency numbers list or an Extended local emergency numbers list or both, in the REGISTRATION ACCEPT message, by including the Emergency number list IE and the Extended emergency number list IE, respectively. The Local emergency numbers list can be updated as described in 3GPP TS 24.301 [15], subclause 5.3.7.

The user equipment shall store the Local emergency numbers list and the Extended local emergency numbers list, as provided by the network. The Local emergency numbers list stored in the user equipment shall be replaced on each receipt of the Emergency number list IE. The Extended local emergency numbers list stored in the user equipment shall be replaced on each receipt of the Extended emergency number list IE. The received Local emergency numbers list or the received Extended local emergency numbers list or both shall be provided to the upper layers.

...

The Local emergency numbers list and the Extended local emergency numbers list shall be deleted at switch off or removal of the USIM. The user equipment shall be able to store up to ten entries in the Local emergency numbers list and up to twenty entries in the Extended local emergency numbers list, received from the network.

For the use of the Local emergency numbers list and the Extended local emergency numbers list by the UE see 3GPP TS 24.301 [15], subclause 5.3.7.

[TS 24.301 [21], subclause 5.3.7]

The Local Emergency Numbers List and the Extended local Emergency Numbers list contain additional Local emergency numbers used by the serving network. These lists can be downloaded by the network to the UE at successful registration and subsequent registration updates. There is only one Local Emergency Numbers List and only one Extended local Emergency Numbers list in the UE. The Local Emergency Numbers List can be updated with EMM procedures if the UE is in S1 mode, with GMM and MM procedures if the UE is in A/Gb or Iu mode, and with 5GMM procedures, as specified in 3GPP TS 24.501 [54], if UE is in N1 mode. The Extended local Emergency Numbers List can be updated with EMM procedures if the UE is in S1 mode and with 5GMM procedures, as specified in 3GPP TS 24.501 [54], if UE is in N1 mode.

The UE shall use the stored Local Emergency Numbers List and the stored Extended local Emergency Numbers List received from the network in addition to the emergency numbers stored on the USIM or user equipment to detect that the number dialled is an emergency number.

If the UE determines that the number dialled is an emergency number, the procedures specified in 3GPP TS 23.167 [45] and 3GPP TS 24.229 [13D] are utilised to select a domain for the emergency session attempt.

If the domain selected for the emergency session attempt is the PS domain, then the UE shall perform the session establishment procedures specified in 3GPP TS 24.229 [13D] to initiate an emergency session.

[TS 22.101 [42], subclause 10.1.1]

The ME shall identify an emergency number dialled by the end user as a valid emergency number and initiate emergency call establishment if it occurs under one or more of the following conditions. If it occurs outside of the following conditions, the ME should not initiate emergency call establishment but normal call establishment.

Emergency number identification takes place before and takes precedence over any other (e.g. supplementary service related) number analysis.

- a) 112 and 911 shall always be available. These numbers shall be stored on the ME.
- b) Any emergency call number stored on a SIM/USIM when the SIM/USIM is present.
- c) 000, 08, 110, 999, 118 and 119 when a SIM/USIM is not present. These numbers shall be stored on the ME.
- d) Additional emergency call numbers that may have been downloaded by the serving network when the SIM/USIM is present.

11.4.8.3 Test description

11.4.8.3.1 Pre-test conditions

System Simulator:

- 2 NR Cells
 - NR Cell 1 and NR Cell 12 as defined in TS 38.508-1 [4], Table 4.4.2-3. System information combination NR-1 as defined in TS 38.508-1 [4], subclause 4.4.3.1.2. SIB1 indicates *ims-EmergencySupport*.
 - No more than 1 cell is active at any time throughout the test.

UE:

- The UE is equipped with a test USIM with USIM Configuration 20 as defined in TS 38.508-1 [4], Table 6.4.1-20 (USIM contains two Emergency Numbers: 144, 117).

Preamble:

- Cells signal level in accordance with TS 38.508-1 [4], Table 6.2.2.1-3:
 - NR Cell 1 "Serving cell"
 - NR Cell 12 "Non-Suitable "Off" cell"
- The UE is in state SWITCHED_OFF as defined in TS 38.508-1 [4], subclause 4.5.5.
 - During the initial registration on NR Cell 1:
 - Local emergency number(s) and Extended local emergency number(s) are provided by the Network as specified in Table 11.4.8.3.3-1.

11.4.8.3.2 Test procedure sequence

Table 11.4.8.3.2-1: Main behaviour

St	Procedure	Message Sequence		TP	Verdict
		U - S	Message		
-	The following messages are to be observed on NR Cell 1 unless explicitly stated otherwise.	-	-	-	-
1	Power on the UE.	-	-	-	-
2	The Generic test procedure for NR RRC_IDLE described in TS 38.508-1 [4], Table 4.5.2.2-2 is performed. The UE performs registration and the RRC connection is released. During the procedure the SS does not send new Local emergency number list and Extended local emergency number list in the REGISTRATION ACCEPT message.	-	-	-	-
3	Make the UE attempt an IMS call dialling	-	-	-	-

	number 120. (NOTE 1) The number was initially stored in the Local emergency number list being received in the REGISTRATION ACCEPT message in the Preamble but is expected to have been removed from the list upon switch-off.				
4	Check: Does the UE performs Generic Test Procedure for IMS MO speech call establishment as specified in TS 38.508-1 [4], subclause 4.9.15?	-	-	1	-
5	Make the UE release the call. (NOTE 1)	-	-	-	-
6	The Generic test procedure for IMS MO call release as specified in TS 38.508-1 [4], subclause 4.9.17 takes place.	-	-	-	-
7	SS releases the RRC connection.	<--	NR RRC: RRCRelease	-	-
8	Make the UE attempt an IMS call dialling number 10. (NOTE 1) The number was initially stored in the Extended local emergency number list being received in the REGISTRATION ACCEPT message in the Preamble but is expected to have been removed from the list upon switch-off.	-	-	-	-
9	Check: Does the UE performs Generic Test Procedure for IMS MO speech call establishment as specified in TS 38.508-1 [4], subclause 4.9.15?	-	-	2	-
10	Make the UE release the call. (NOTE 1)	-	-	-	-
11	The Generic test procedure for IMS MO call release as specified in TS 38.508-1 [4], subclause 4.9.17 takes place.	-	-	-	-
12	SS releases the RRC connection.	<--	NR RRC: RRCRelease	-	-
-	The SS configures: - NR Cell 12 as "Serving cell" - NR Cell 1 as "Non-Suitable "Off" cell"	-	-	-	-
-	The following messages are to be observed on NR Cell 12 unless explicitly stated otherwise.	-	-	-	-
13	The UE performs the Registration procedure for mobility registration update as specified in TS 38.508-1 [4] subclause 4.9.5. During the procedure the UE receives new Local emergency number list with 10 entries and Extended local emergency number list with 20 entries in the REGISTRATION ACCEPT message.	-	-	-	-
-	EXCEPTION: Steps 14-18 are repeated 10 times. Each iteration shall be started with different number being dialled. The following Local emergency numbers received in the REGISTRATION ACCEPT message in step 13 shall be used: 120 ... 129.	-	-	-	-
14	Make the UE attempt an IMS call dialling one of the numbers specified in the EXCEPTION step above. (NOTE 1)	-	-	-	-
15	Check: Does the UE performs Generic Test Procedure for IMS Emergency call establishment with IMS emergency registration as specified in TS 38.508-1 [4], subclause 4.9.11?	-	-	3	-
16	Make the UE release the emergency call. (NOTE 1)	-	-	-	-
17	The Generic test procedure for IMS MO Emergency call release as specified in TS 38.508-1 [4], subclause 4.9.12A takes place.	-	-	-	-
18	SS releases the RRC connection.	<--	NR RRC: RRCRelease	-	-
-	EXCEPTION: Steps 19-23 are repeated 20 times. Each iteration shall be started with different number being dialled. The following	-	-	-	-

	Extended local emergency numbers received in the REGISTRATION ACCEPT message in step 13 shall be used: 130 ... 149.				
19	Make the UE attempt an IMS call dialling one of the numbers specified in the EXCEPTION step above. (NOTE 1)	-	-	-	-
20	Check: Does the UE performs Generic Test Procedure for IMS Emergency call establishment with IMS emergency registration as specified in TS 38.508-1 [4], subclause 4.9.11?	-	-	4	-
21	Make the UE release the emergency call. (NOTE 1)	-	-	-	-
22	The Generic test procedure for IMS MO Emergency call release as specified in TS 38.508-1 [4], subclause 4.9.12A takes place.	-	-	-	-
23	SS releases the RRC connection.	<--	NR RRC: RRCRelease	-	-
NOTE 1: This could be done by e.g. MMI or AT command.					

11.4.8.3.3 Specific message contents

Table 11.4.8.3.3-1: REGISTRATION ACCEPT (Preamble)

Derivation Path: TS 38.508-1 [4], Table 4.7.1-7.			
Information Element	Value/remark	Comment	Condition
Emergency number list			
Emergency Number information	120 TS 24.008 [43], 10.5.3.13.	Number is different to any emergency number stored permanently in the ME AND the numbers stored in the USIM, as indicated in TS 22.101 [42] clause 10.1.1 a)-c).	
Extended emergency number list			
EENLV	'0'	Extended Local Emergency Numbers List is valid in the country of the PLMN from which this IE is received	
Emergency Number information	10 TS 24.301 [21], 9.9.3.37A.	Number is different to any emergency number stored permanently in the ME AND the numbers stored in the USIM, as indicated in TS 22.101 [42] clause 10.1.1 a)-c).	

Table 11.4.8.3.3-2: REGISTRATION ACCEPT (step 13, Table 11.4.8.3.2-1; step 4, TS 38.508-1 [4], Table 4.9.5.2.2-1)

Derivation Path: TS 38.508-1 [4], Table 4.7.1-7.			
Information Element	Value/remark	Comment	Condition

Emergency number list			
Emergency Number information	10 numbers: 120 ... 129 TS 24.008 [43], 10.5.3.13.	Numbers different to any emergency number stored permanently in the ME AND the numbers stored in the USIM, as indicated in TS 22.101 [42] clause 10.1.1 a)-c).	
Extended emergency number list			
EENLV	'0'	Extended Local Emergency Numbers List is valid in the country of the PLMN from which this IE is received	
Emergency Number information	20 numbers: 130 ... 149 TS 24.301 [21], 9.9.3.37A.	Numbers different to any emergency number stored permanently in the ME AND the numbers stored in the USIM, as indicated in TS 22.101 [42] clause 10.1.1 a)-c).	

11.4.9 5GMM-DEREGISTERED.LIMITED-SERVICE No suitable cells in tracking area / Emergency call establishment and release

11.4.9.1 Test Purpose (TP)

(1)

```
with { UE in 5GMM-DEREGISTERED.LIMITED-SERVICE state after receiving REGISTRATION REJECT message
with 5GMM cause value #15 'No suitable cells in tracking area' }
ensure that {
  when { UE is requested to make an Emergency call }
  then { UE establishes an RRC connection with the RRC establishmentCause set to "emergency", and,
attempts an Initial registration for emergency services by sending a REGISTRATION REQUEST message
with IE Service type set to "emergency services", and, accepts and applies security with NULL
security and integrity algorithms, and, after successful completion of the registration for
emergency services establishes an emergency PDU session by sending an UL NAS TRANSPORT message with
Request type set to "initial emergency request" and a PDU SESSION ESTABLISHMENT REQUEST }
}
```

(2)

```
with { UE in 5GMM-DEREGISTERED.LIMITED-SERVICE state after receiving REGISTRATION REJECT message
with 5GMM cause value #15 'No suitable cells in tracking area' and having established an Emergency
call }
ensure that {
  when { UE is requested to release the Emergency call }
  then { UE releases the Emergency call, and, the UE considers the current cell as belonging to
5GS forbidden tracking areas for roaming }
}
```

11.4.9.2 Conformance requirements

References: The conformance requirements covered in the present TC are specified in: TS 38.331 [12], subclause 5.3.3.3, TS 23.501 [37], subclause 5.16.4.1, TS 23.122 [38], subclause 3.4.2, TS 24.501 [22], subclauses 5.5.1.2.5,

4.4.4.1, 5.1.3.2.1.3.3, 5.3.2, 5.4.2.3, 5.5.1.2.2, 6.4.1.2, TS 22.101 [42], subclause 10.1.1. Unless otherwise stated these are Rel-15 requirements.

[TS 24.501, subclause 5.5.1.2.5]

If the initial registration request cannot be accepted by the network, the AMF shall send a REGISTRATION REJECT message to the UE including an appropriate 5GMM cause value.

...

The UE shall take the following actions depending on the 5GMM cause value received in the REGISTRATION REJECT message.

...

#15 (No suitable cells in tracking area).

The UE shall set the 5GS update status to 5U3 ROAMING NOT ALLOWED (and shall store it according to subclause 5.1.3.2.2). The UE shall reset the registration attempt counter and shall enter the state 5GMM-REGISTERED.LIMITED-SERVICE. The UE shall search for a suitable cell in another tracking area according to 3GPP TS 38.304 [28].

The UE shall store the current TAI in the list of "5GS forbidden tracking areas for roaming" and shall remove the current TAI from the stored TAI list, if present.

If the UE is operating in single-registration mode, the UE shall handle the EMM parameters EMM state, EPS update status and tracking area updating attempt counter as specified in 3GPP TS 24.301 [15] for the case when the normal tracking area updating procedure is rejected with the EMM cause with the same value.

[TS 23.122, subclause 3.4.2]

The MS is not allowed to request 5GS services except emergency services when camped on a cell of a TA of which belongs to the list of "5GS forbidden tracking areas for regional provision of service".

[TS 36.331, subclause 5.3.3.3]

The UE shall set the contents of *RRCSetupRequest* message as follows:

...

1> set the *establishmentCause* in accordance with the information received from upper layers;

The UE shall submit the *RRCSetupRequest* message to lower layers for transmission.

[TS 23.501, subclause 5.16.4.1]

UEs that are in limited service state, as specified in TS 23.122 [17], or that camp normally on a cell but failed to register successfully to the network under conditions specified in TS 24.501 [47], initiate the Registration procedure by indicating that the registration is to receive Emergency Services, referred to as Emergency Registration, and a Follow-on request is included in the Registration Request to initiate PDU Session Establishment procedure with a Request Type indicating "Emergency Request". UEs that had registered for normal services and do not have emergency PDU Sessions established and that are subject to Mobility Restriction in the present area or RAT (e.g. because of restricted tracking area) shall initiate the UE Requested PDU Session Establishment procedure to receive Emergency Services, i.e. with a Request Type indicating "Emergency Request". Based on local regulation, the network supporting Emergency Services for UEs in limited service state provides Emergency Services to these UE, regardless whether the UE can be authenticated, has roaming or Mobility Restrictions or a valid subscription.

[TS 24.501, subclause 4.4.4.1]

The use of "null integrity protection algorithm" 5G-IA0 (see subclause 9.11.3.32) in the current 5G NAS security context is only allowed for an unauthenticated UE for which establishment of emergency services is allowed. For setting the security header type in outbound NAS messages, the UE and the AMF shall apply the same rules irrespective of whether the "null integrity protection algorithm" or any other integrity protection algorithm is indicated in the 5G NAS security context.

If the "null integrity protection algorithm" 5G-IA0 has been selected as an integrity protection algorithm, the receiver shall regard the NAS messages with the security header indicating integrity protection as integrity protected.

[TS 24.501, subclause 5.1.3.2.1.3.3]

The substate 5GMM-DEREGISTERED.LIMITED-SERVICE is chosen in the UE, when it is known that a selected cell for 3GPP access or TA for non-3GPP access is unable to provide normal service (e.g. the selected cell over 3GPP access is in a forbidden PLMN or is in a forbidden tracking area or TA for non-3GPP access is forbidden).

[TS 24.501, subclause 5.3.2]

The UE provides the SUPI to the network in concealed form. The SUCI is a privacy preserving identifier containing the concealed SUPI. When the SUPI contains a network specific identifier, the SUCI shall take the form of an NAI as specified in 3GPP TS 23.003 [4].

A UE supporting N1 mode includes a SUCI:

- a) in the REGISTRATION REQUEST message when the UE is attempting initial registration procedure and a valid 5G-GUTI is not available; or

...

The UE shall use the "null-scheme" as specified in 3GPP TS 33.501 [24] to generate the SUCI, if the following applies:

- a) the UE performs a registration procedure for emergency services or initiates a de-registration procedure before the registration procedure for emergency services was completed successfully; and

[TS 24.501, subclause 5.4.2.3]

If the UE is registered for emergency services, performing initial registration for emergency services or establishing an emergency PDU session and the SECURITY MODE COMMAND message is received with ngKSI value "000" and 5G-IA0 and 5G-EA0 as selected 5G NAS security algorithms, the UE shall locally derive and take in use 5G NAS security context. The UE shall delete existing current 5G NAS security context.

The UE shall accept a SECURITY MODE COMMAND message indicating the "null integrity protection algorithm" 5G-EA0 as the selected 5G NAS integrity algorithm only if the message is received when the UE is registered for emergency services, performing initial registration for emergency services or establishing an emergency PDU session.

[TS 24.501, subclause 5.5.1.2.2]

The UE in state 5GMM-DEREGISTERED shall initiate the registration procedure for initial registration by sending a REGISTRATION REQUEST message to the AMF,

...

- b) when the UE performs initial registration for emergency services;

...

If the UE initiates an initial registration for emergency services or needs to prolong the established NAS signalling connection after the completion of the initial registration procedure (e.g. due to uplink signalling pending), the UE shall set the Follow-on request indicator to 1.

[TS 24.501, subclause 6.4.1.2]

In order to initiate the UE-requested PDU session establishment procedure, the UE shall create a PDU SESSION ESTABLISHMENT REQUEST message.

NOTE 0: When IMS voice is available over either 3GPP access or non-3GPP access, the "voice centric" UE in 5GMM-REGISTERED state will receive a request from upper layers to establish the PDU session for IMS signalling, if the conditions for performing an initial registration with IMS indicated in 3GPP TS 24.229 [14] subclause U.3.1.2 are satisfied.

If the UE requests to establish a new PDU session, the UE shall allocate a PDU session ID which is not currently being used by another PDU session over either 3GPP access or non-3GPP access.

The UE shall allocate a PTI value currently not used and shall set the PTI IE of the PDU SESSION ESTABLISHMENT REQUEST message to the allocated PTI value.

...

If the UE requests to establish a new emergency PDU session, the UE shall set the SSC mode IE of the PDU SESSION ESTABLISHMENT REQUEST message to "SSC mode 1".

...

The UE shall transport:

- a) the PDU SESSION ESTABLISHMENT REQUEST message;
- b) the PDU session ID of the PDU session being established, or being handed over or being transferred;

..

- e) the request type which is set to:

...

- 3) "initial emergency request", if the UE requests to establish a new emergency PDU session; and

...

If the request type is set to "initial emergency request" or "existing emergency PDU session", neither DNN nor S-NSSAI is transported by the UE using the NAS transport procedure as specified in subclause 5.4.5.

[TS 22.101, subclause 10.1.1]

The ME shall identify an emergency number dialled by the end user as a valid emergency number and initiate emergency call establishment if it occurs under one or more of the following conditions. If it occurs outside of the following conditions, the ME should not initiate emergency call establishment but normal call establishment. Emergency number identification takes place before and takes precedence over any other (e.g. supplementary service related) number analysis.

- a) 112 and 911 shall always be available. These numbers shall be stored on the ME.

11.4.9.3 Test description

11.4.9.3.1 Pre-test conditions

System Simulator:

- 1 NR Cell
- NR Cell 1, as defined in TS 38.508-1 [4], Table 4.4.2-3.
- System information combination NR-1 as defined in TS 38.508-1 [4], subclause 4.4.3.1.2. SIB1 indicates *ims-EmergencySupport*.

UE:

None.

Preamble:

- The UE is in test state 0N-B (Switched Off) as defined in TS 38.508-1 [4], subclause 4.4A.2.

11.4.9.3.2 Test procedure sequence

Table 11.4.9.3.2-1: Main behaviour

St	Procedure	Message Sequence		TP	Verdict
		U - S	Message		
1	Switch the UE on.	-	-	-	-
2-4	Steps 2-4 of Table 4.5.2.2-2 NR RRC_IDLE in TS38.508-1 [4] take place (the UE initiates an initial registration procedure).	-	-	-	-
5	SS sends a REGISTRATION REJECT message containing 5GMM cause value = #15 (No suitable cells in tracking area).	<--	NR RRC: DLInformationTransfer 5GMM: REGISTRATION REJECT	-	-
6	The SS transmits an <i>RRCRelease</i> message.	<--	NR RRC: RRCRelease	-	-
7	Make the UE attempt an IMS emergency call dialling a number which is stored on the ME (e.g. 112 or 911). (NOTE 1)	-	-	-	-
8	Check: Does the UE performs Generic Test Procedure for IMS Emergency call establishment without IMS emergency registration as specified in TS 38.508-1 [4], subclause 4.9.12?	-	-	1	P
9	Make the UE release the emergency call. (NOTE 1)	-	-	-	-
10	Void	-	-	-	-
10 A- 10 C	Steps 1-3 of the Generic test procedure for IMS MO Emergency call release as specified in TS 38.508-1 [4], subclause 4.9.12A take place.	-	-	-	-
11	Start Timer T1=5 seconds. NOTE: This is an arbitrary value to wait for UE initiated detach.	-	-	-	-
-	EXCEPTION: In parallel to step 12 below, the steps specified in Tables 11.4.9.3.2-2, and 11.4.9.3.2-3 may take place	-	-	-	-
12	Timer T1=5 seconds expires	-	-	-	-
12a 1- 12b 3	Void	-	-	-	-
13	SS releases the RRC connection	<--	NR RRC: RRCRelease	-	-
13 A	Make the UE attempt an IMS none-emergency call. (NOTE 2)	-	-	-	-
14	Check: Does the UE transmit an <i>RRCSetupRequest</i> message in the next 10 seconds? NOTE: This is an arbitrary value to wait for catching not allowed UE behaviour.	-->	NR RRC: RRCSetupRequest	2	F
NOTE 1: This could be done by e.g. MMI or AT command.					
NOTE 2: This could be done by e.g. MMI or AT command.					

Table 11.4.9.3.2-2: Parallel Behaviour

St	Procedure	Message Sequence		TP	Verdict
		U - S	Message		
1	The UE transmits a DEREGISTRATION REQUEST message with De-registration type IE set to "Normal de-registration".	-->	NR RRC: ULInformationTransfer 5GMM: DEREGISTRATION REQUEST	-	-
2	The SS transmits a DEREGISTRATION ACCEPT message.	<--	NR RRC: DLInformationTransfer 5GMM: DEREGISTRATION ACCEPT	-	-

Table 11.4.9.3.2-3: Parallel Behaviour

St	Procedure	Message Sequence		TP	Verdict
		U - S	Message		
1	The UE transmits a PDU SESSION RELEASE REQUEST message.	-->	NR RRC: ULInformationTransfer PDU SESSION RELEASE REQUEST	-	-
2	The SS transmits a PDU SESSION RELEASE COMMAND message.	<--	NR RRC: DLInformationTransfer NR NAS: PDU SESSION RELEASE COMMAND	-	-
3	Check: Does the UE transmit a PDU SESSION RELEASE COMPLETE message?	-->	NR RRC: ULInformationTransfer 5GMM: UL NAS TRANSPORT 5GSM: PDU SESSION RELEASE COMPLETE	-	-

11.4.9.3.3 Specific message contents

Table 11.4.9.3.3-1: REGISTRATION REJECT (step 5, Table 11.4.9.3.2-1)

Derivation path: TS 38.508-1 [4] table 4.7.1-9.			
Information Element	Value/remark	Comment	Condition
5GMM cause	'00001111'B	#15 (No suitable cells in tracking area).	

Table 11.4.9.3.3-2: REGISTRATION REQUEST (step 8, Table 11.4.9.3.2-1; step 3, TS 38.508-1 [4], Table 4.9.12.2.2-1)

Derivation Path: TS 38.508-1 [4], Table 4.7.1-6, condition EMERGENCY.			
Information Element	Value/remark	Comment	Condition
5GS mobile identity	SUCI	The UE shall use the "null-scheme" as specified in 3GPP TS 33.501 [20] to generate the SUCI	

Table 11.4.9.3.3-3: DEREGISTRATION REQUEST (Step 12a1, Table 11.4.9.3.2-1)

Derivation Path: TS 38.508-1 [4], Table 4.7.1-12, Condition NORMAL.

Table 11.4.9.3.3-4: Void

11.4.10 Void

11.4.10a 5GMM-REGISTERED.NORMAL-SERVICE / N26 interface not supported / N1 mode to S1 mode transfer of an existing emergency PDU session

11.4.10a.1 Test Purpose (TP)

(1)

with { UE in 5GMM-REGISTERED.NORMAL-SERVICE state and 5GMM-IDLE mode with Interworking without N26 interface supported, **and**, the UE has an emergency PDU session established }

```

ensure that {
  when { UE performs a inter-system change from the N1 to S1 mode }
  then { UE correctly transfers the existing emergency PDU session into an emergency PDN
connection }
}

```

11.4.10a.2 Conformance requirements

References: The conformance requirements covered in the present TC are specified in: TS 24.501 [22], subclause 6.1.4.2, TS 22.101 [42], subclause 10.1.1. Unless otherwise stated these are Rel-15 requirements.

[TS 24.501, subclause 6.1.4.2]

When the network does not support N26 interface, the SMF does not provide the UE with the mapped EPS bearer context for a PDU session.

NOTE 1: Since the SMF does not provide the UE with the mapped EPS bearer context for a PDU session, the UE does not know whether interworking with EPS is supported for a PDU session before attempting to transfer the PDU session from N1 mode to S1 mode.

NOTE 2: It is up to UE implementation to decide which PDU session(s) to be attempted to transfer from N1 mode to S1 mode, e.g. based on UE policy or UE local configuration.

...

Upon inter-system change from N1 mode to S1 mode in EMM-IDLE mode, the UE shall use the parameters from each PDU session which the UE intends to transfer to EPS to create the contents of a PDN CONNECTIVITY REQUEST message as follows:

- a) if the PDU session is an emergency PDU session, the request type shall be set to "handover of emergency bearer services". Otherwise the request type shall be set to "handover";
- b) the PDU session type of the PDU session shall be mapped to the PDN type of the default EPS bearer context as follows:
 - 1) the PDN type shall be set to "non-IP" if the PDU session type is "Ethernet" or "Unstructured";
 - 2) the PDN type shall be set to "IPv4" if the PDU session type is "IPv4";
 - 3) the PDN type shall be set to "IPv6" if the PDU session type is "IPv6"; and
 - 4) the PDN type shall be set to "IPv4v6" if the PDU session type is "IPv4v6";
- c) the DNN of the PDU session shall be mapped to the APN of the default EPS bearer context; and
- d) the PDU session ID parameter in the PCO IE shall be set to the PDU session identity of the PDU session.

...

After inter-system change from N1 mode to S1 mode, the UE shall associate the PDU session identity with the default EPS bearer context.

[TS 22.101, subclause 10.1.1]

The ME shall identify an emergency number dialled by the end user as a valid emergency number and initiate emergency call establishment if it occurs under one or more of the following conditions. If it occurs outside of the following conditions, the ME should not initiate emergency call establishment but normal call establishment. Emergency number identification takes place before and takes precedence over any other (e.g. supplementary service related) number analysis.

- a) 112 and 911 shall always be available. These numbers shall be stored on the ME.

11.4.10a.3 Test description

11.4.10a.3.1 Pre-test conditions

System Simulator:

- 2 cells
- NR Cell 1 as defined in TS 38.508-1 [4] Table 4.4.2-3. System information combination NR-6 as defined in TS 38.508-1 [4], subclause 4.4.3.1.2.
- E-UTRA Cell 1 as defined in TS 36.508 [7] Table 4.4.2-2. System information combination 31 as defined in TS 36.508 [7], subclause 4.4.3.1.1.

UE:

None.

Preamble:

With E-UTRA Cell 1 "Non-suitable "Off" cell" and NR Cell 1 "Serving cell" in accordance with TS 38.508-1 [4], Table 6.2.2.1-3, the UE is brought to state 1N-A, RRC_IDLE Connectivity (NR), in accordance with the procedure described in TS 38.508-1 [4], subclause 4.5.2 (Table 4.5.2.2-2 and depending on UE implementation Table 4.5.2.2-4). Interworking without N26 interface supported in accordance with the definition specified in TS 38.508-1 [4], subclause 4.5.1.

11.4.10a.3.2 Test procedure sequence

Table 11.4.10a.3.2-1: Main behaviour

St	Procedure	Message Sequence		TP	Verdict
		U - S	Message		
1	Make the UE attempt an IMS emergency call dialling an emergency number. (NOTE 1)	-	-	-	-
-	The following messages are to be observed on NR Cell 1 unless explicitly stated otherwise.	-	-	-	-
2	The UE performs Generic Test Procedure for IMS Emergency call establishment with IMS emergency registration as specified in TS 38.508-1 [4], subclause 4.9.11.	-	-	-	-
2A	Make the UE release the IMS emergency call. (NOTE 1)	-	-	-	-
2B	Generic Test Procedure for IMS MO call release in 5GC as defined in TS 38.508-1 [4], Table 4.9.17.2.2-1 takes place. The dedicated voice bearer is released but the Emergency session is not.	-	-	-	-
3	SS releases the RRC connection	<--	NR RRC: RRCRelease	-	-
4	The SS configures: - E-UTRA Cell 1 as "Serving cell" - NR Cell 1 as "Non-suitable "off" cell".	-	-	-	-
-	The following messages are to be observed on E-UTRA Cell 1 unless explicitly stated otherwise.	-	-	-	-
5-10	Void	-	-	-	-
-	EXCEPTION: Steps 10AAa1 to 10AAb3 describe behaviour that depends on the UE implementation; the "lower case letter" identifies a step sequence that take place depending on the UE implementation.	-	-	-	-
10AAa1	If the UE tries to preserve the IP address of the PDN connection then check does the UE transmits an ATTACH REQUEST message?	-->	RRC: RRCConnectionSetupComplete NAS: ATTACH REQUEST	-	-
10	Else check: does the UE transmit a TRACKING	-->	RRC:	-	-

AA b1	AREA UPDATE REQUEST message?		<i>RRCConnectionSetupComplete</i> NAS: TRACKING AREA UPDATE REQUEST		
10 AA b2	The SS transmits a TRACKING AREA UPDATE REJECT message to UE.	<--	RRC: DLInformationTransfer NAS: TRACKING AREA UPDATE REQUEST REJECT	-	-
10 AA b3	The UE transmits an ATTACH REQUEST message.	-->	RRC: ULInformationTransfer NAS: ATTACH REQUEST	-	-
10 AB- 10 AM	Steps 5 to 16 of the generic test procedure for UE registration (TS 36.508 [7] Table 4.5.2.3-1)	-	-	-	-
-	EXCEPTION: In parallel to step 10Aa1 below the steps described in table 11.4.10a.3.2-2 take place.	-	-	-	-
10 Aa 1	Step 8a1 from the test procedure for UE for Tracking area updating / Inter-system change from N1 mode to S1 mode in 5GMM/EMM-IDLE mode as specified in TS 38.508-1 [4], Table 4.9.7.2.2-1, takes place performing establishment of UE-requested PDN connection(s) with ExpectedNumberOfNewPDNConnections = pc_noOf_PDNsSameConnection. NOTE: The pc_noOf_PDNsSameConnection covers the "normal" PDNs the UE will establish when it attaches to EPC. This does not include the PDN connection for Emergency services - this is handled separately and in parallel in Table 11.4.10a.3.2-2.	-	-	-	-
10 Ab 2a1 - 10 Ab 2a8	Void	-	-	-	-
11	Wait 3 sec.	-	-	-	-
12	The SS transmits a DEACTIVATE EPS BEARER CONTEXT REQUEST including the EPS bearer identity of the default EPS bearer of the Emergency PDN.	<--	DEACTIVATE EPS BEARER CONTEXT REQUEST	-	-
13	The UE transmit a DEACTIVATE EPS BEARER CONTEXT ACCEPT.	-->	DEACTIVATE EPS BEARER CONTEXT ACCEPT	-	-
14	SS releases the RRC connection.	<--	RRC: RRCConnectionRelease	-	-
NOTE 1: This could be done by e.g. MMI or AT command.					

Table 11.4.10a.3.2-2: Parallel behaviour

St	Procedure	Message Sequence		TP	Verdict
		U - S	Message		
1	Check: Does the UE transmit a PDN CONNECTIVITY REQUEST message to request an additional PDN, with 'Request type' set to 'handover of emergency bearer services'?	-->	PDN CONNECTIVITY REQUEST	1	P
24-	Steps 10-12 from the Generic Test Procedure for IMS Emergency call establishment in EUTRA: Normal Service as specified in TS 36.508 [7], Table 4.5A.4.3-1 take place with the exception that the parallel to Table 4.5A.4.3-1 step 11 behaviour does not take place. The default bearer for the Emergency connection is established	-	-	-	-
-	EXCEPTION: Step 5a1 describes a step	-	-	-	-

	sequence depending on UE implementation.				
5a1	IMS re-registration on E-UTRAN as specified in TS 34.229-1 [35] subclause C.46, takes place.	-	-	-	-

11.4.10a.3.3 Specific message contents

Table 11.4.10a.3.3-1: REGISTRATION ACCEPT (Preamble)

Derivation path: TS 38.508-1 [4], Table 4.7.1-7, condition EMERGENCY			
Information Element	Value/remark	Comment	Condition
5GS network feature support	'0100 1101 0000 0000'B	IMS voice over PS session supported over 3GPP access, Emergency services supported in NR connected to 5GCN and E-UTRA connected to 5GCN. Interworking without N26 interface supported (octet 3, bit 7) All other features set to "not supported".	Interworking without N26 interface supported

Table 11.4.10a.3.3-2: PDN CONNECTIVITY REQUEST (step 1, Table 11.4.10a.3.2-2)

Derivation Path: TS 36.508 [7], Table 4.7.2-1.			
Information Element	Value/remark	Comment	Condition
Request type	'110'B	'handover of emergency bearer services'	
PDN type	The PDU session type of the emergency PDU session established prior to the N1 to S1 move	The PDU session established in step 2, Table 11.4.10a.3.2-1	
Access point name	sos		
Protocol configuration options	Only the values indicated below are checked		
protocol identifier			
length of the protocol identifier contents of the unit			
protocol identifier contents			
Additional parameters list			
container identifier	001AH	(PDU session ID)	
container identifier contents	The PDU session ID of the emergency PDU session established prior to the N1 to S1 move.		

Table 11.4.10a.3.3-3: ATTACH ACCEPT (preamble, step 10AK; step 14, TS 36.508-1 [7], Table 4.5.2.3-1)

Derivation path: TS 36.508-1 [7] Table 4.7.2-1			
Information Element	Value/remark	Comment	Condition
EPS network feature support	'0000 0011 0100 1000'B	- IMS voice over PS session in S1 mode supported - emergency	

		bearer services in S1 mode supported - ePCO supported - Interworking without N26 interface supported	
--	--	--	--

Table 11.4.10a.3.3-4: ACTIVATE DEFAULT EPS BEARER CONTEXT REQUEST (preamble, step 10AK; step 14, TS 36.508-1 [7], Table 4.5.2.3-1)

Derivation Path: TS 36.508-1 [7] Table 4.7.3-6			
Information Element	Value/remark	Comment	Condition
Protocol configuration options			
Container ID n+2	Not present	Session-AMBR are not present	
Container ID n+3	Not present	QoS rules are not present	
Container ID n+4	Not present	Qos flow descriptions are not present	

11.4.11 5GMM-REGISTERED.NORMAL-SERVICE / N26 interface not supported / S1 mode to N1 mode transfer of an existing emergency PDN connection

11.4.11.1 Test Purpose (TP)

(1)

```

with { UE in EMM-REGISTERED and EMM-IDLE on an E-UTRA cell, and, the UE has an emergency PDN
connection established }
ensure that {
  when { UE performs a inter-system change from the S1 to N1 mode, to an NR Cell belonging to a NWK
supporting Interworking without N26 interface }
  then { UE correctly transfers the existing emergency PDN connection into an emergency PDU
session }
}

```

11.4.11.2 Conformance requirements

References: The conformance requirements covered in the present TC are specified in: TS 24.501 [22], subclause 6.1.4.2, TS 22.101 [42], subclause 10.1.1. Unless otherwise stated these are Rel-15 requirements.

[TS 24.501, subclause 6.1.4.2]

When the network does not support N26 interface, the SMF does not provide the UE with the mapped EPS bearer context for a PDU session.

NOTE 1: Since the SMF does not provide the UE with the mapped EPS bearer context for a PDU session, the UE does not know whether interworking with EPS is supported for a PDU session before attempting to transfer the PDU session from N1 mode to S1 mode.

NOTE 2: It is up to UE implementation to decide which PDU session(s) to be attempted to transfer from N1 mode to S1 mode, e.g. based on UE policy or UE local configuration.

...

Upon inter-system change from S1 mode to N1 mode in 5GMM-IDLE mode, the UE uses the parameters from the default EPS bearer context of each PDN connection which the UE intends to transfer to 5GS and for which the UE has allocated a PDU session identity to create a PDU SESSION ESTABLISHMENT REQUEST message as follows:

- a) if the PDN connection is for emergency bearer services, the request type shall be set to "existing emergency PDU session". Otherwise the request type shall be set to "existing PDU session";
- b) the PDN type of the default EPS bearer context shall be mapped to the PDU session type of the PDU session as follows:
 - ...
 - 2) if the PDN type is "IPv4" the PDU session type is set to "IPv4";
 - 3) if the PDN type is "IPv6", the PDU session type is set to "IPv6"; and
 - 4) the PDN type shall be set to "IPv4v6" if the PDU session type is "IPv4v6";
- c) the APN of the default EPS bearer context shall be mapped to the DNN of the PDU session;
- d) the PDU session ID shall be set to the PDU session identity included by the UE in the Protocol configuration options IE or Extended protocol configuration options IE in the PDN CONNECTIVITY REQUEST message, or to the PDU session ID associated with the default EPS bearer context; and
- e) the S-NSSAI of the PDU session shall be set to the S-NSSAI included by the network in the Protocol configuration options IE or Extended protocol configuration options IE in the ACTIVATE DEFAULT EPS BEARER REQUEST message, if provided by the network, or the S-NSSAI associated with the default EPS bearer context, if available.

NOTE 5: If T3584 is running or deactivated for the S-NSSAI and optionally the DNN combination, the UE is allowed to initiate ESM procedures in EPS with or without APN corresponding to that DNN, and if the APN is congested in EPS, the MME can send a back-off timer for the APN to the UE as specified in 3GPP TS 24.301 [15].

The UE shall locally release the PDN connection(s) and EPS bearer(s) associated with the 3GPP access which have not been transferred to 5GS.

[TS 22.101, subclause 10.1.1]

The ME shall identify an emergency number dialled by the end user as a valid emergency number and initiate emergency call establishment if it occurs under one or more of the following conditions. If it occurs outside of the following conditions, the ME should not initiate emergency call establishment but normal call establishment. Emergency number identification takes place before and takes precedence over any other (e.g. supplementary service related) number analysis.

- a) 112 and 911 shall always be available. These numbers shall be stored on the ME.

11.4.11.3 Test description

11.4.11.3.1 Pre-test conditions

System Simulator:

- 2 cells
 - E-UTRA Cell 1 as defined in TS 36.508 [7] Table 4.4.2-2. System information combination 31 as defined in TS 36.508 [7], subclause 4.4.3.1.1.
 - NR Cell 1 as defined in TS 38.508-1 [4] Table 4.4.2-3. System information combination NR-6 as defined in TS 38.508-1 [4], subclause 4.4.3.1.2.

UE:

None.

Preamble:

- With NR Cell 1 "Serving cell" and E-UTRA Cell 1 "Non-suitable "Off" cell", the UE is brought to state 1N-A, RRC_IDLE Connectivity (NR), in accordance with the procedure described in TS 38.508-1 [4], subclause 4.5.2 (Table 4.5.2.2-2 and depending on UE implementation Table 4.5.2.2-4). 5G-GUTI and ngKSI are assigned and security context established. During the registration the NWK indicates Interworking without N26 interface supported in accordance with the definition specified in TS 38.508-1 [4], subclause 4.5.1.
- the UE is switched-off
- With E-UTRA Cell 1 "Serving cell" and NR Cell 1 "Non-suitable "Off" cell", the UE is brought to state RRC_IDLE Connectivity (*E-UTRA/EPC*) in accordance with the procedure described in TS 38.508-1 [4], Table 4.5.2.2-1. 4G GUTI and eKSI are assigned and security context established

11.4.11.3.2 Test procedure sequence

Table 11.4.11.3.2-1: Main behaviour

St	Procedure	Message Sequence		TP	Verdict
		U - S	Message		
1	Make the UE attempt an IMS emergency call dialling an emergency number. (NOTE 1)	-	-	-	-
-	The following messages are to be observed on E-UTRA Cell 1 unless explicitly stated otherwise.	-	-	-	-
2-15	Steps 2-15, from the Generic Test Procedure for IMS Emergency call establishment in EUTRA: Normal Service as specified in TS 36.508-1 [7], subclause 4.5A.4 take place.	-	-	-	-
15 A	Make the UE release the IMS emergency call. (NOTE 1)	-	-	-	-
15 B	The Generic test procedure for MO release of IMS call - EPS as defined in TS 34.229-1 [35], subclause C.32, takes place.	-	-	-	-
15 C	The Generic Test Procedure for EPS Bearer Deactivation TS 36.508-1 [7], subclause 4.5A.15, take place. The SS deactivates the dedicated for IMS voice EPS bearer context of the Emergency PDN connection. The default bearer is kept i.e. the Emergency session is not released.	-	-	-	-
16	SS releases the RRC connection on E-UTRA.	<--	RRC: RRCConnectionRelease	-	-
17	The SS configures: - NR Cell 1 as "Serving cell" - E-UTRA Cell 1 as "Non-suitable "off" cell".	-	-	-	-
-	The following messages are to be observed on NR Cell 1 unless explicitly stated otherwise.	-	-	-	-
18-28	Steps 1-11 from the test procedure for UE for Tracking area updating / Inter-system change from S1 mode to N1 mode in 5GMM/EMM-IDLE mode as specified in TS 38.508-1 [4], Table 4.9.9, take place.	-	-	-	-
-	EXCEPTION: In parallel to step 29Aa1 below the steps described in table 11.4.11.3.2-2 take place.	-	-	-	-
29a 1	Step 14a1 from the test procedure for UE for Tracking area updating / Inter-system change from S1 mode to N1 mode in 5GMM/EMM-IDLE mode as specified in TS 38.508-1 [4], Table 4.9.9.2.2-1, takes place performing establishment of UE-requested PDU session(s) with ExpectedNumberOfNewPDUSessions = pc_noOf_PDUsSameConnection NOTE: The pc_noOf_PDUsSameConnection covers the "normal" PDUs the UE will establish when it attaches to 5GC. This does not include	-	-	-	-

	the PDU connection for Emergency services - this is handled separately and in parallel in Table 11.4.11.3.2-2..				
29a 2a1 - 29b 3a9	Void	-	-	-	-
30	Wait 3 sec.	-	-	-	-
31	The SS transmits a <i>RRCReconfiguration</i> message and a PDU SESSION RELEASE COMMAND message to release the Emergency session.	<--	NR RRC: RRCReconfiguration NR NAS: PDU SESSION RELEASE COMMAND	-	-
32	The UE transmits a <i>RRCReconfigurationComplete</i>	-	NR RRC: RRCReconfigurationComplete	-	-
33	The UE transmits a PDU SESSION RELEASE COMPLETE message?	-->	NR RRC: ULInformationTransfer 5GMM: UL NAS TRANSPORT 5GSM: PDU SESSION RELEASE COMPLETE	-	-
34	SS releases the RRC connection.	<--	NR RRC: RRCRelease	-	-
NOTE 1: This could be done by e.g. MMI or AT command.					

Table 11.4.11.3.2-2: Parallel behaviour

St	Procedure	Message Sequence		TP	Verdict
		U - S	Message		
1	Check: Does the UE transmit an UL NAS TRANSPORT message with 'Request type' set to "existing emergency PDU session", and, a PDU SESSION ESTABLISHMENT REQUEST?	-->	NR RRC: ULInformationTransfer 5GMM: UL NAS TRANSPORT 5GSM: PDU SESSION ESTABLISHMENT REQUEST	1	P
2	The SS transmits an <i>RRCReconfiguration</i> message and an PDU SESSION ESTABLISHMENT ACCEPT.	<--	NR RRC: RRCReconfiguration 5GMM: DL NAS TRANSPORT 5GSM: PDU SESSION ESTABLISHMENT ACCEPT	-	-
-	EXCEPTION: Step 3a1 describes a step sequence depending on UE implementation.	-	-	-	-
3a1	IMS re-registration on NR as specified in TS 34.229-5 [41], annex A.12, takes place.	-	-	-	-

11.4.11.3.3 Specific message contents

Table 11.4.11.3.3-1: REGISTRATION ACCEPT (Preamble)

Derivation path: TS 38.508-1 [4], Table 4.7.1-7, condition EMERGENCY			
Information Element	Value/remark	Comment	Condition
5GS network feature support	'0100 1101 0000 0000'B	IMS voice over PS session supported over 3GPP access, Emergency services supported in NR connected to 5GCN and E-UTRA connected to 5GCN. Interworking without N26 interface supported (octet 3, bit 7) All other features set to "not supported".	Interworking without N26 interface supported

Table 11.4.11.3.3-2: PDU SESSION ESTABLISHMENT REQUEST (step 1, Table 11.4.11.3.2-2)

Derivation Path: TS 38.508-1 [4], Table 4.7.2-1.			
Information Element	Value/remark	Comment	Condition
PDU session ID	Shall be set to the PDU session identity included by the UE in the Protocol configuration options IE or Extended protocol configuration options IE in the PDN CONNECTIVITY REQUEST message, or to the PDU session ID associated with the default EPS bearer context		
PTI	A value currently not used		
SSC mode	'001'B	SSC mode 1	

Table 11.4.11.3.3-3: UL NAS TRANSPORT (step 1, Table 11.4.11.3.2-2)

Derivation Path: TS 38.508-1 [4], Table 4.7.1-10, condition INITIAL_PDU_REQUEST.			
Information Element	Value/remark	Comment	Condition
Request type	'100'B	existing emergency PDU session	
S-NSSAI	Not Present		
DNN	Not Present		

Table 11.4.11.3.3-4: ATTACH ACCEPT (preamble)

Derivation path: TS 36.508-1 [7] Table 4.7.2-1			
Information Element	Value/remark	Comment	Condition
EPS network feature support	'0000 0011 0100 1000'B	- IMS voice over PS session in S1 mode supported - emergency bearer services in S1 mode supported - ePCO supported - Interworking without N26 interface supported	

Table 11.4.11.3.3-5: ACTIVATE DEFAULT EPS BEARER CONTEXT REQUEST (step 10; TS 36.508-1 [7], Table 4.5.2.3-1)

Derivation Path: TS 36.508-1 [7] Table 4.7.3-6			
Information Element	Value/remark	Comment	Condition
Protocol configuration options			
Container ID n+2	Not present	Session-AMBR are not present	
Container ID n+3	Not present	QoS rules are not present	
Container ID n+4	Not present	Qos flow descriptions are not present	

Container ID n+5	Not present	S-NSSAI are not present	
------------------	-------------	-------------------------	--

11.4.12 5GMM-REGISTERED.NORMAL-SERVICE / 5GMM-IDLE / Emergency call / Disabling N1 mode / Emergency call establishment over EPS / Success

11.4.12.1 Test Purpose (TP)

(1)

```

with { UE supporting both S1 mode and N1 mode and operating in single-registration mode, and, the
Network has indicated "interworking without N26 interface not supported", and, the Network has
indicated "Emergency service Fallback not supported" regardless whether the UE supports emergency
service fallback or not, and, the UE is in NR RRC_IDLE state }
ensure that {
  when { User initiates an Emergency call and the UE completes Access control checking in 5GMM-IDLE
mode }
  then { UE selects the E-UTRA cell, and, requests the establishment of an Emergency call by
transmitting an RRCConnectionRequest message with establishmentCause set to 'emergency' }
}

```

(2)

```

with { UE establishes RRC connection in E-UTRA }
ensure that {
  when { UE performs a TAU procedure caused by RAT change }
  then { UE transmits TRACKING AREA UPDATE REQUEST with N1 mode capability set to 'N1 mode not
supported' }
}

```

11.4.12.2 Conformance requirements

References: The conformance requirements covered in the present TC are specified in: TS 24.501 [22], subclauses 4.9.2, 5.6.1.4; TS 24.301 [21], subclauses 4.4.2.3, 5.5.3.2.2 and TS 24.229 subclause U.2.2.6.4. Unless otherwise stated these are Rel-15 requirements.

NOTE: Conformance requirements in regard to establishing an emergency call in EPS are not provided. This can be found in IMS Emergency tests specified in TS 36.523-1 [13].

[TS 24.501, subclause 4.9.2]

The UE shall only disable the N1 mode capability for 3GPP access when in 5GMM-IDLE mode.

[TS 24.501, subclause 5.6.1.4]

For case h) in subclause 5.6.1.1, the UE shall treat the indication from the lower layers when the UE has changed to S1 mode or E-UTRA connected to 5GCN (see 3GPP TS 23.502 [9]) as successful completion of the procedure and stop timer T3517.

[TS 24.301, subclause 4.4.2.3]

Secure exchange of NAS messages via a NAS signalling connection is usually established by the MME during the attach procedure by initiating a security mode control procedure. After successful completion of the security mode control procedure, all NAS messages exchanged between the UE and the MME are sent integrity protected using the current EPS security algorithms, and except for the messages specified in subclause 4.4.5, all NAS messages exchanged between the UE and the MME are sent ciphered using the current EPS security algorithms.

...

During inter-system change from N1 mode to S1 mode in 5GMM-IDLE mode, if the UE is operating in the single-registration mode and:

- 1) if the tracking area updating procedure is initiated as specified in 3GPP TS 24.501 [54], the UE shall transmit a TRACKING AREA UPDATE REQUEST message integrity protected with the current 5G NAS security context and the UE shall derive a mapped EPS security context (see subclause 8.6.1 of 3GPP TS 33.501 [56]). The UE shall include the eKSI indicating the 5G NAS security context value in the TRACKING AREA UPDATE REQUEST message.

After receiving the TRACKING AREA UPDATE REQUEST message including the eKSI, the MME forwards the TRACKING AREA UPDATE REQUEST message to the source AMF, if possible, to obtain the mapped EPS security context from the AMF as specified in 3GPP TS 33.501 [56]. The MME re-establishes the secure exchange of NAS messages by either:

- replying with a TRACKING AREA UPDATE ACCEPT message that is integrity protected and ciphered using the mapped EPS NAS security context. From this time onward, all NAS messages exchanged between the UE and the MME are sent integrity protected and except for the messages specified in subclause 4.4.5, all NAS messages exchanged between the UE and the MME are sent ciphered; or

[TS 24.301, subclause 5.5.3.2.2]

The UE in state EMM-REGISTERED shall initiate the tracking area updating procedure by sending a TRACKING AREA UPDATE REQUEST message to the MME,

...

- z) when the UE performs inter-system change from N1 mode to S1 mode in EMM-IDLE mode, the UE operates in single-registration mode, and conditions specified in 3GPP TS 24.501 [54] apply;

...

- zd) when the UE performs inter-system change from N1 mode to S1 mode in EMM-CONNECTED mode.

For all cases except case b, the UE shall set the EPS update type IE in the TRACKING AREA UPDATE REQUEST message to "TA updating". For case b, the UE shall set the EPS update type IE to "periodic updating".

...

When initiating a tracking area updating procedure while in S1 mode, the UE shall use the current EPS NAS integrity key to integrity protect the TRACKING AREA UPDATE REQUEST message, unless the UE is performing inter-system change from N1 mode to S1 mode.

...

If a UE has established PDN connection(s) and uplink user data pending to be sent via user plane when it initiates the tracking area updating procedure, or uplink signalling not related to the tracking area updating procedure when the UE does not support control plane CIoT EPS optimization, it may also set an "active" flag in the TRACKING AREA UPDATE REQUEST message to indicate the request to establish the user plane to the network and to keep the NAS signalling connection after the completion of the tracking area updating procedure.

...

If the UE has a current EPS security context, the UE shall include the eKSI (either KSI_{ASME} or KSI_{SGSN}) in the NAS Key Set Identifier IE in the TRACKING AREA UPDATE REQUEST message. Otherwise, the UE shall set the NAS Key Set Identifier IE to the value "no key is available". If the UE has a current EPS security context, the UE shall integrity protect the TRACKING AREA UPDATE REQUEST message with the current EPS security context. Otherwise the UE shall not integrity protect the TRACKING AREA UPDATE REQUEST message.

...

For the case z and zd, the TRACKING AREA UPDATE REQUEST message shall be integrity protected using the 5GS security context available in the UE. The UE shall include a GUTI, mapped from 5G-GUTI (see 3GPP TS 23.501 [54] and 3GPP TS 23.003 [2]), in the Old GUTI IE in the TRACKING AREA UPDATE REQUEST message. In addition, the UE shall include Old GUTI type IE with GUTI set to "Native GUTI", and the UE shall include a UE status IE with a 5GMM registration status set to "UE is in 5GMM-REGISTERED state".

When the tracking area updating procedure is initiated in EMM-IDLE mode, the UE may also include an EPS bearer context status IE in the TRACKING AREA UPDATE REQUEST message, indicating which EPS bearer contexts are

active in the UE. The UE shall include the EPS bearer context status IE in TRACKING AREA UPDATE REQUEST message:

- ...
- for the case z; and
- ...

If the UE initiates the first tracking area updating procedure following an initial registration in N1 mode and the UE is operating in the single-registration mode, the UE shall include a UE radio capability information update needed IE in the TRACKING AREA UPDATE REQUEST message.

...

If the UE supports NB-S1 mode, Non-IP PDN type, or N1 mode, then the UE shall support the extended protocol configuration options IE.

For all cases except case b, if the UE supports the extended protocol configuration options IE, then the UE shall set the ePCO bit to "extended protocol configuration options supported" in the UE network capability IE of the TRACKING AREA UPDATE REQUEST message.

...

For all cases except case b, if the UE supports dual connectivity with NR, then the UE shall set the DCNR bit to "dual connectivity with NR supported" in the UE network capability IE of the TRACKING AREA UPDATE REQUEST message and shall include the UE additional security capability IE in the TRACKING AREA UPDATE REQUEST message.

...

For all cases except case b, if the UE supports N1 mode, the UE shall set the N1mode bit to "N1 mode supported" in the UE network capability IE of the TRACKING AREA UPDATE REQUEST message and shall include the UE additional security capability IE in the TRACKING AREA UPDATE REQUEST message.

[TS 24.229, subclause U.2.2.6.4]

NOTE: This subclause covers only the case where the UE selects the IM CN subsystem in accordance with the conventions and rules specified in 3GPP TS 23.167 [4B] and describes the IP-CAN specific procedure. It does not preclude the use of CS domain. When a CS system based on 3GPP TS 24.008 [8] is to be used, clause B.5 applies.

When the UE operates in single-registration mode as described in 3GPP TS 24.501 [258] and the UE recognises that a call request is an emergency call, if:

- 1) the IM CN subsystem is selected in accordance with the conventions and rules specified in 3GPP TS 23.167 [4B]; and
- 2) the UE is currently registered to the 5GS services while the UE is in an NR cell connected to 5GCN;

then the following treatment is applied:

- 1) if the EMC indicates "Emergency services not supported":

...

b) if the UE supports emergency services fallback as specified in 3GPP TS 23.501 [257] and the emergency services fallback is not available (i.e., "ESFB is N" as described in 3GPP TS 23.167 [4B]) and if:

...

- ii) the EMF is set to "Emergency services fallback not supported" or the UE is not capable of accessing 5GCN via E-UTRA, the UE shall disable the N1 mode capability for 3GPP access as specified in 3GPP TS 24.501 [257] and attempt to select an E-UTRA cell connected to EPC. If the UE finds a suitable E-UTRA cell connected to EPC and the network provides the UE with the EMC BS set to "emergency bearer services in S1 mode

supported" as described in 3GPP TS 24.301 [8J], the UE shall perform the procedures as described in subclause L.2.2.6 to establish a PDN connection for emergency bearer services; and

c) if the UE does not support emergency services fallback as specified in 3GPP TS 23.501 [257], the UE shall disable the N1 mode capability for 3GPP access as specified in 3GPP TS 24.501 [257] and attempt to select an E-UTRA cell connected to EPC. If the UE finds a suitable E-UTRA cell connected to EPC and the network provides the UE with the EMC BS set to "emergency bearer services in S1 mode supported" as described in 3GPP TS 24.301 [8J], the UE shall perform the procedures as described in subclause L.2.2.6 to establish a PDN connection for emergency bearer services;

11.4.12.3 Test description

11.4.12.3.1 Pre-test conditions

System Simulator:

- 2 cells
- NR Cell 1 as defined in TS 38.508-1 [4] Table 4.4.2-3. System information combination NR-6 as defined in TS 38.508-1 [4], subclause 4.4.3.1.2.
- E-UTRA Cell 1 as defined in TS 36.508 [7] Table 4.4.2-2. System information combination 31 as defined in TS 36.508 [7], subclause 4.4.3.1.1.
- Power levels are constant and as defined in Tables 11.1.10.3.1-1/2.

Table 11.4.12.3.1-1: Time instances of cell power level and parameter changes for FR1

	Parameter name	Unit	NR Cell 1	E-UTRA Cell 1	Remark
T0	SS/PBCH SSS EPRE	dBm/SCS	-88	-	
	RS EPRE	dBm/15kHz	-	-91	

Table 11.4.12.3.1-2: Time instances of cell power level and parameter changes for FR2

	Parameter name	Unit	NR Cell 1	E-UTRA Cell 1	Remark
T0	SS/PBCH SSS EPRE	dBm/SCS	-82	-	
	RS EPRE	dBm/15kHz	-	-91	

UE:

None.

Preamble:

- With E-UTRA Cell 1 "Serving cell" and NR Cell 1 "Non-suitable "Off" cell" in accordance with TS 38.508-1 [4], Table 6.2.2.1-3, the UE is brought to state RRC_IDLE using generic procedure parameters Connectivity (*E-UTRA/EPC*) and Unrestricted nr PDN (*On*) in accordance with the procedure described in TS 38.508-1 [4], clause 4.5.2. 4G GUTI and eKSI are assigned and security context established.
- the UE is switched-off.
- With E-UTRA Cell 1 "Non-suitable "Off" cell" and NR Cell 1 "Serving cell" in accordance with TS 38.508-1 [4], Table 6.2.2.1-3, the UE is brought to state 1N-A, NR RRC_IDLE Connectivity (NR) in accordance with the procedure described in TS 38.508-1 [4], Table 4.5.4.2-2. 5G-GUTI and ngKSI are assigned and security context established.

11.4.12.3.2 Test procedure sequence

Table 11.4.12.3.2-1: Main behaviour

St	Procedure	Message Sequence		TP	Verdict
		U - S	Message		
0	Set the power levels according to "T0" as per Table 11.4.12.3.1-1/2	-	-	-	-
1	Make the UE initiate an Emergency call.	-	-	-	-
2	Check: Does the UE transmit an <i>RRCCoNNECTIONRequest</i> message with 'establishmentCause' set to 'emergency' on E-UTRA cell 1?	-->	RRC: <i>RRCCoNNECTIONRequest</i>	1	P
3	SS transmits an <i>RRCCoNNECTIONSetup</i> message.	<--	RRC: <i>RRCCoNNECTIONSetup</i>	-	-
4	Check: Does the UE transmit an <i>RRCCoNNECTIONSetupComplete</i> message to confirm the successful completion of the connection establishment and a TRACKING AREA UPDATE REQUEST message is sent to update the registration of the actual tracking area. For some consequences related to the content of the TRACKING AREA UPDATE REQUEST message see the Notes in TS.36.508 [7], Table 4.5A.2.1-1.	-->	RRC: <i>RRCCoNNECTIONSetupComplete</i> NAS: TRACKING AREA UPDATE REQUEST	2	P
5-8	Steps 5-8 from the Generic Test Procedure for IMS Emergency call establishment in EUTRA: Normal Service as specified in TS 36.508 [7], Table 4.5A.4.3-1 are performed.	-	-	-	-
9	SS responds with TRACKING AREA UPDATE ACCEPT message.	<--	RRC: <i>DLInformationTransfer</i> NAS: TRACKING AREA UPDATE ACCEPT	-	-
10	The UE transmits a TRACKING AREA UPDATE COMPLETE message.	-->	RRC: <i>ULInformationTransfer</i> NAS: TRACKING AREA UPDATE COMPLETE	-	-
11-17	Steps 9-15 from the Generic Test Procedure for IMS Emergency call establishment in EUTRA: Normal Service as specified in TS 36.508 [7], Table 4.5A.4.3-1 are performed.	-	-	-	-
18	The SS waits 1 second.	-	-	-	-
19	Release IMS Call as specified in the generic procedure in TS 34.229-1 [35] subclause C.32.	-	-	-	-

11.4.12.3.3 Specific message contents

Table 11.4.12.3.3-1: REGISTRATION REQUEST (Preamble; TS 38.508-1 [4], Table 4.5.2.2-2)

Derivation Path: TS 38.508-1 [4], Table 4.7.1-6			
Information Element	Value/remark	Comment	Condition
5GMM capability			
S1 mode (octet 3, bit 1)	'1'B	S1 mode supported	

Table 11.4.12.3.3-2: REGISTRATION ACCEPT (Preamble; TS 38.508-1 [4], Table 4.5.2.2-2)

Derivation path: TS 38.508-1 [4], Table 4.7.1-7			
Information Element	Value/remark	Comment	Condition
5GS network feature support			
Emergency service support indicator for 3GPP access (EMC) (octet 3, bit 3 and bit 4)	'00'B	Emergency services not supported	
Emergency service fallback indicator for 3GPP access (EMF) (octet 3, bit 5 and bit 6)	'00'B	Emergency services fallback	

		not supported	
--	--	---------------	--

Table 11.4.12.3.3-3: RRCConnectionRequest (step 2, table 11.4.12.3.2-1)

Derivation Path: TS 36.508 [7], Table 4.6.1-16			
Information Element	Value/remark	Comment	Condition
RRCConnectionRequest ::= SEQUENCE {			
criticalExtensions CHOICE {			
rrcConnectionRequest-r8 SEQUENCE {			
establishmentCause	emergency		
}			
}			
}			

Table 11.4.12.3.3-4: TRACKING AREA UPDATE REQUEST (step 4, Table 11.4.12.3.2-1)

Derivation Path: TS 36.508 [7], Table 4.7.2-27			
Information Element	Value/remark	Comment	Condition
UE network capability			NR
All octets with the exception of octet 8, bit 8 and octet 9, bit 6	Any allowed value		
Extended protocol configuration options (ePCO) (octet 8, bit 8)	1	ePCO supported	
N1 mode supported (N1mode) (octet 9, bit 6)	0	N1 mode not supported	

Table 11.4.12.3.3-5: Message PDN CONNECTIVITY REQUEST (step 11, Table 11.4.12.3.2-1)

Derivation Path: TS 36.508 [7], Table 4.7.2-1.			
Information Element	Value/Remark	Comment	Condition
Request type	'0100'B	emergency	
Access point name	Not present		

Table 11.4.12.3.3-6: Message ACTIVATE DEFAULT EPS BEARER CONTEXT REQUEST (step 12, Table 11.4.12.3.2-1)

Derivation path: TS 36.508 [7], Table 4.7.3-6 and table 4.6.1-8 with condition UM-DRB-ADD(2).			
Information Element	Value/Remark	Comment	Condition
EPS bearer identity	an additional EPS Bearer Id different from default EPS Bearer Id or/and any mapped EPS bearer		
Access point name	sos	APN value as recommended by IR.88 clause 6.4 [39]	

11.5 eCall over IMS

11.5.1 eCall Only mode / T3444 / eCall inactivity procedure / Removal of eCall only restriction after an eCall over IMS / 5GS to EPS

11.5.1.1 Test Purpose (TP)

(1)

```
with { UE is switched ON with eCall only enabled USIM }
ensure that {
  when { UE reads ims-EmergencySupport and eCallOverIMS-Support from SIB1 }
```

```
    then { UE enters substate 5GMM-DEREGISTERED.eCALL-INACTIVE and shall not start registration
procedure }
    }
```

(2)

```
with { The UE is in the state 5GMM-DEREGISTERED.eCALL-INACTIVE }
ensure that {
    when { UE is requested to make a manual eCall }
        then { UE sends REGISTRATION REQUEST message with 5GS registration type set to 'initial
registration' }
    }
```

(3)

```
with { UE receives REGISTRATION ACCEPT message and IMS voice over PS session is supported over 3GPP
access }
ensure that {
    when { UE is in 5GMM-REGISTERED.NORMAL-SERVICE state and an initial IMS registration is performed
}
    then { the UE establishes a New emergency PDU session by sending an UL NAS TRANSPORT message
with Request type set to "initial emergency request" and a PDU SESSION ESTABLISHMENT REQUEST }
}
```

(4)

```
with { UE receives an RRCRelease message and enters RRC_IDLE state }
ensure that {
    when { UE receives a Paging message with MT MMTEL voice call }
        then { the UE answers the paging request for MT MMTEL voice call }
    }
```

(5)

```
with { UE receives an RRCRelease message and enters RRC_IDLE state }
ensure that {
    when { UE starts T3444 for 12Hours and the periodic registration update timer T3512 expires }
        then { the UE initiates the registration procedure for mobility and periodic registration update
and indicates "periodic registration updating" in the 5GS registration type IE }
    }
```

(6)

```
with { UE in state 5GMM-REGISTERED and 5GMM-IDLE on a 5GC NR cell }
ensure that {
    when { UE detects a suitable EPC E-UTRA cell after the serving NGC cell becomes not suitable when
eCall Inactivity timer T3444 is running }
        then { UE performs a Inter-system change from N1 mode to S1 mode by initiating and successfully
completing a TAU procedure }
    }
```

(7)

```
with { UE in state EMM-REGISTERED and EMM-IDLE on an E-UTRA cell }
ensure that {
    when { UE detects a suitable NGC cell after the serving E-UTRA cell becomes not suitable when
eCall Inactivity timer T3444 is running }
        then { UE performs a Inter-system change from S1 mode to N1 mode by initiating and successfully
completing a mobility and periodic registration update procedure }
    }
```

(8)

```
with { UE is in RRC_IDLE state }
ensure that {
    when { eCall Inactivity timer T3444 expires }
        then { The UE performs Deregistration procedure }
    }
```

11.5.1.2 Conformance requirements

References: The conformance requirements covered in the present TC are specified in TS 24.501, clauses 5.1.3.2.1.3.8, 5.3.1.3, 5.5.3, TS 24.301, clauses 10.2 and TS 38.331, clauses 5.2.2.4.2, 6.2.2. Unless otherwise stated these are Rel-16 requirements.

[TS 24.501, clause 5.1.3.2.1.3.8]

The substate 5GMM-DEREGISTERED.eCALL-INACTIVE is chosen in the UE when:

- a) the UE is configured for eCall only mode as specified in 3GPP TS 31.102 [22];
- b) timer T3444 and timer T3445 have expired or are not running;
- c) a PLMN has been selected as specified in 3GPP TS 23.122 [5];
- d) the UE does not need to perform an eCall over IMS; and
- e) the UE does not need to perform a call to a non-emergency MSISDN or URI for test or terminal reconfiguration service.

In this substate, the UE shall not initiate any signalling towards the network, except to originate an eCall over IMS, or a call to a non-emergency MSISDN or URI for test or terminal reconfiguration service.

[TS 24.501, clause 5.3.1.3]

The signalling procedure for the release of the N1 NAS signalling connection is initiated by the network.

In N1 mode, upon indication from lower layers that the access stratum connection has been released, the UE shall enter 5GMM-IDLE mode and consider the N1 NAS signalling connection released.

If the UE in 3GPP access is configured for eCall only mode as specified in 3GPP TS 31.102 [22] then:

- if the N1 NAS signalling connection that was released had been established for eCall over IMS, the UE shall start timer T3444; and
- if the N1 NAS signalling connection that was released had been established for a call to an HPLMN designated non-emergency MSISDN or URI for test or terminal reconfiguration service, the UE shall start timer T3445.

[TS 24.501, clause 5.5.3]

The eCall inactivity procedure is performed only in 3GPP access and applicable only to a UE configured for eCall only mode as specified in 3GPP TS 31.102 [22]. The procedure shall be started when:

- a) the UE is in any 5GMM-REGISTERED substate except substates 5GMM-REGISTERED.PLMN-SEARCH or 5GMM-REGISTERED.NO-CELL-AVAILABLE;
- b) the UE is in 5GMM-IDLE mode; and
- c) one of the following conditions applies:
 - 1) timer T3444 expires or is found to have already expired and timer T3445 is not running;
 - 2) timer T3445 expires or is found to have already expired and timer T3444 is not running; or
 - 3) timers T3444 and T3445 expire or are found to have already expired.

The UE shall then perform the following actions:

- a) stop other running timers (e.g. T3511, T3512);
- b) if the UE is currently registered to the network for 5GS services, perform a de-registration procedure;
- c) delete any 5G-GUTI, TAI list, last visited registered TAI, list of equivalent PLMNs, and ngKSI; and
- d) enter 5GMM-DEREGISTERED.eCALL-INACTIVE state.

[TS 24.301, clause 10.2]

T3444	NOTE 11	All except EMM-NULL and 5GMM-NULL (defined in 3GPP TS 24.501 [54])	- UE configured for eCall only mode enters EMM-IDLE mode after an eCall over IMS - UE configured for eCall only mode moves from GERAN/UTRAN to E-UTRAN with timer T3242 (see 3GPP TS 24.008 [13]) running - UE configured for eCall only mode enters 5GMM-IDLE mode (defined in 3GPP TS 24.501 [54]) after an eCall over IMS	- Removal of eCall only restriction - Intersystem change from S1 mode to A/Gb or lu mode	Perform eCall inactivity procedure in EPS as described in clause 5.5.4. Perform eCall inactivity procedure in 5GS as described in 3GPP TS 24.501 [54].
T3445	NOTE 12	All except EMM-NULL and 5GMM-NULL (defined in 3GPP TS 24.501 [54])	- UE configured for eCall only mode enters EMM-IDLE mode after a call to a non-emergency MSISDN or URI for test or terminal reconfiguration service - UE configured for eCall only mode moves from GERAN/UTRAN to E-UTRAN with timer T3243 (see 3GPP TS 24.008 [13]) running - UE configured for eCall only mode enters 5GMM-IDLE mode (defined in 3GPP TS 24.501 [54]) after a call to a non-emergency MSISDN or URI for test or terminal reconfiguration service	Removal of eCall only restriction - Intersystem change from S1 mode to A/Gb or lu mode	Perform eCall inactivity procedure in EPS as described in clause 5.5.4. Perform eCall inactivity procedure in 5GS as described in 3GPP TS 24.501 [54].

[TS 38.331, clause 5.2.2.4.2]

Upon receiving the *SIB1* the UE shall:

1> store the acquired *SIB1*;

...

4> forward the *eCallOverIMS-Support* to upper layers, if present;

[TS 38.331, clause 6.2.2]

eCallOverIMS-Support

Indicates whether the cell supports eCall over IMS services as defined in TS 23.501 [32]. If absent, eCall over IMS is not supported by the network in the cell.

11.5.1.3 Test description

11.5.1.3.1 Pre-test conditions

System Simulator:

- 2 cells
- NR Cell 1 as defined in TS 38.508-1 [4] Table 4.4.2-3. System information combination NR-6 as defined in TS 38.508-1 [4], sub-clause 4.4.3.1.2.
- E-UTRA Cell 1 as defined in TS 36.508 [7] Table 4.4.2-2. System information combination 31 as defined in TS 36.508 [7], sub-clause 4.4.3.1.1.

UE:

- the eCall capable UE is equipped with 'eCall only' enabled USIM configured as per TS 38.508-1 [4] Table 6.4.1-24.

Preamble:

- The UE is in test state 0-A (Switched Off) as defined in TS 38.508-1 [4], subclause 4.4A.2.

11.5.1.3.2 Test procedure sequence

Table 11.5.1.3.2-1: Main behaviour

St	Procedure	Message Sequence		TP	Verdict
		U - S	Message		
1	The SS configures: - NR Cell 1 as "Serving cell" - E-UTRA Cell 1 as "Non-suitable "off" cell".	-	-	-	-
2	The UE is switched on.	-	-	-	-
3	Check: Does the UE send an <i>RRCSetupRequest</i> on NR Cell 1 within 120 seconds?	-->	NR RRC: RRCSetupRequest	1	F
4	A manual eCall is initiated. (Note 1)	-	-	-	-
5	Check: Does the UE send REGISTRATION REQUEST message with 5GS registration type set to 'initial registration'?	-->	5GMM: REGISTRATION REQUEST	2	P
6-14	Steps 5-13 of Table 4.5.2.2-2 of the generic procedure in TS 38.508-1 [4] are performed.	-	-	-	-
15	The SS transmits a REGISTRATION ACCEPT message and assigns value of 7 hours for the timer T3512.	<--	5GMM: REGISTRATION ACCEPT	-	-
16-20a1	Steps 15-19a1 of Table 4.5.2.2-2 of the generic procedure in TS 38.508-1 [4] are performed.	-	-	-	-
21	Check: The UE transmits an <i>ULInformationTransfer</i> message with Request type set to "initial emergency request" and a PDU SESSION ESTABLISHMENT REQUEST message?	-->	NR RRC: ULInformationTransfer 5GMM: UL NAS TRANSPORT 5GSM: PDU SESSION ESTABLISHMENT REQUEST	3	P
22-26	Steps 22-26 of Table 4.9.29.2.2-1 of the test procedure in TS 38.508-1 [4] are performed.	-	-	-	-
27-28	Release eCall over IMS using the generic procedure described in TS 34.229-5 [41] subclause A.8.				
29	The SS releases the RRC connection. (Note 2)	<--	NR RRC: RRCRelease	-	-
30	The SS waits 1 minute.	-	-	-	-
31-43	Steps 1 to 13 of the generic test procedure for IMS MT speech call establishment in 5GC specified in TS 38.508-1 [4] subclause 4.9.16 are performed.	-	-	4	P
44-45	Generic test procedure for MT release of Voice call in 5GS described in TS 34.229-5 [41] subclause A.8 takes place.	-	-	-	-
46	The SS releases the RRC connection. (Note 3)	<--	NR RRC: RRCRelease	-	-
47	Check: Does the UE transmit a REGISTRATION REQUEST message at the expiry of T3512?	-->	5GMM: REGISTRATION REQUEST	5	P
48	The SS transmits a REGISTRATION ACCEPT message including T3512 value IE.	<--	5GMM: REGISTRATION ACCEPT	-	-
49	The UE transmits a REGISTRATION COMPLETE message	-->	5GMM: REGISTRATION COMPLETE		
50	The SS releases the RRC connection.	<--	NR RRC: RRCRelease	-	-
51	The SS configures: - NR Cell 1 as " Non-suitable "off" cell"	-	-	-	-

	- E-UTRA Cell 1 as "Serving cell".				
52	Check: Does the UE perform on the E-UTRA Cell 1 the TAU procedure for Inter-system change from N1 mode to S1 mode as described in TS 38.508-1 [4], Table 4.9.7.2.2-1?	-	-	6	P
53	The SS configures: - NR Cell 1 as "Serving cell" - E-UTRA Cell 1 as "Non-suitable "off" cell".	-	-	-	-
54	Check: Does the UE perform on the NR Cell 1 the Test procedure for UE Tracking area updating for Inter-system change from S1 mode to N1 mode as described in TS 38.508-1 [4], Table 4.9.9.2.2-1?	-	-	7	P
55	Check: Does the UE transmit a DEREGISTRATION REQUEST message at expiry of T3444?	-->	5GMM: DEREGISTRATION REQUEST	8	P
<p>Note 1: The request to originate a manual eCall may be performed by MMI or AT command. Note 2: Timer T3444 of 12hours starts. Note 3: Timer T3512 of 7hours starts.</p>					

11.5.1.3.3 Specific message contents

Table 11.5.1.3.3-1: SIB1 for NR Cell 1 (All steps, Table 11.5.1.3.2-1)

Derivation path: TS 38.508-1 [4] table 4.6.1-28 Condition eCalloverIMSforNR

Table 11.5.1.3.3-2: REGISTRATION ACCEPT (step 15, 48, 54 Table 11.5.1.3.2-1)

Derivation path: TS 38.508-1 [4], table 4.7.1-7			
Information Element	Value/Remark	Comment	Condition
T3512 value			
Unit	'001'B	value is incremented in multiples of 1 hour	
Timer value	'0 0111'B	7 hours	

Table 11.5.1.3.3-3: UL NAS TRANSPORT (step 21, Table 11.5.1.3.2-1)

Derivation Path: TS 38.508-1 [4] table 4.7.1-10, condition INITIAL_PDU_REQUEST.			
Information Element	Value/remark	Comment	Condition
Request type	'011'B	initial emergency request	
S-NSSAI	Not Present		
DNN	Not Present		

Table 11.5.1.3.3-4: REGISTRATION REQUEST (step 47, Table 11.5.1.3.2-1)

Derivation path: TS 38.508-1 [4] table 4.7.1-6			
Information Element	Value/remark	Comment	Condition
5GS registration type			
5GS registration type value	'011'B		PERIODIC

Table 11.5.1.3.3-5: TRACKING AREA UPDATE REQUEST (Step 52, Table 11.5.1.3.2-1; step 3, TS 38.508-1 [4] Table 4.9.7.2.2-1)

Derivation Path: TS 38.508-1 [4] table 4.9.7.2.3-1 with condition First-N1-to-S1 = TRUE

Table 11.5.1.3.3-6: DEREGISTRATION REQUEST (step 55, Table 11.5.1.3.2-1)

Derivation path: TS 38.508-1 [4], Table 4.7.1-12			
Information Element	Value/remark	Comment	Condition
De-registration type			
Switch off	'0'B	Normal de-registration	

11.5.2 eCall Only mode / T3445 / eCall inactivity procedure / Removal of eCall only restriction after a call to URI for test service / 5GS to EPS

11.5.2.1 Test Purpose (TP)

(1)

```
with { The UE is in the state 5GMM-DEREGISTERED.eCALL-INACTIVE }
ensure that {
  when { UE is requested to make an eCall to URI for test service }
  then { UE sends REGISTRATION REQUEST message with 5GS registration type set to 'initial
registration' }
}
```

(2)

```
with { UE receives REGISTRATION ACCEPT message and IMS voice over PS session is supported over 3GPP
access }
ensure that {
  when { UE is in 5GMM-REGISTERED.NORMAL-SERVICE state and an initial registration is performed }
  then { the UE establishes a new PDU session by sending an UL NAS TRANSPORT message with Request
type set to "initial request" and a PDU SESSION ESTABLISHMENT REQUEST }
}
```

(3)

```
with { UE receives an RRCRelease message and enters RRC_IDLE state }
ensure that {
  when { UE receives a Paging message with MT MMTEL voice call }
  then {the UE answers the paging request for MT MMTEL voice call }
}
```

(4)

```
with { UE receives an RRCRelease message and enters RRC_IDLE state }
ensure that {
  when { UE starts T3445 for 12Hours and the periodic registration update timer T3512 expires }
  then { the UE initiates the registration procedure for mobility and periodic registration update
and indicates "periodic registration updating" in the 5GS registration type IE }
}
```

(5)

```
with { UE in state 5GMM-REGISTERED and 5GMM-IDLE on a 5GC NR cell }
ensure that {
  when { UE detects a suitable EPC E-UTRA cell after the serving NGC cell becomes not suitable when
eCall Inactivity timer T3445 is running }
  then { UE performs a Inter-system change from N1 mode to S1 mode by initiating and successfully
completing a TAU procedure }
}
```

(6)

```
with { UE in state EMM-REGISTERED and EMM-IDLE on an E-UTRA cell }
ensure that {
  when { UE detects a suitable NGC cell after the serving E-UTRA cell becomes not suitable when
eCall Inactivity timer T3445 is running }
  then { UE performs a Inter-system change from S1 mode to N1 mode by initiating and successfully
completing a mobility and periodic registration update procedure }
}
```

```
    }
```

(7)

```
with { UE is in RRC_IDLE state }
ensure that {
  when { eCall Inactivity timer T3445 expires }
  then { The UE performs Deregistration procedure }
}
```

11.5.2.2 Conformance requirements

References: The conformance requirements covered in the present TC are specified in TS 24.501, clauses 5.1.3.2.1.3.8, 5.3.1.3, 5.5.3, TS 24.301, clauses 10.2 and TS 38.331, clauses 5.2.2.4.2, 6.2.2. Unless otherwise stated these are Rel-16 requirements.

[TS 24.501, clause 5.1.3.2.1.3.8]

The substate 5GMM-DEREGISTERED.eCALL-INACTIVE is chosen in the UE when:

- a) the UE is configured for eCall only mode as specified in 3GPP TS 31.102 [22];
- b) timer T3444 and timer T3445 have expired or are not running;
- c) a PLMN has been selected as specified in 3GPP TS 23.122 [5];
- d) the UE does not need to perform an eCall over IMS; and
- e) the UE does not need to perform a call to a non-emergency MSISDN or URI for test or terminal reconfiguration service.

In this substate, the UE shall not initiate any signalling towards the network, except to originate an eCall over IMS, or a call to a non-emergency MSISDN or URI for test or terminal reconfiguration service.

[TS 24.501, clause 5.3.1.3]

The signalling procedure for the release of the N1 NAS signalling connection is initiated by the network.

In N1 mode, upon indication from lower layers that the access stratum connection has been released, the UE shall enter 5GMM-IDLE mode and consider the N1 NAS signalling connection released.

If the UE in 3GPP access is configured for eCall only mode as specified in 3GPP TS 31.102 [22] then:

- if the N1 NAS signalling connection that was released had been established for eCall over IMS, the UE shall start timer T3444; and
- if the N1 NAS signalling connection that was released had been established for a call to an HPLMN designated non-emergency MSISDN or URI for test or terminal reconfiguration service, the UE shall start timer T3445.

[TS 24.501, clause 5.5.3]

The eCall inactivity procedure is performed only in 3GPP access and applicable only to a UE configured for eCall only mode as specified in 3GPP TS 31.102 [22]. The procedure shall be started when:

- a) the UE is in any 5GMM-REGISTERED substate except substates 5GMM-REGISTERED.PLMN-SEARCH or 5GMM-REGISTERED.NO-CELL-AVAILABLE;
- b) the UE is in 5GMM-IDLE mode; and
- c) one of the following conditions applies:
 - 1) timer T3444 expires or is found to have already expired and timer T3445 is not running;
 - 2) timer T3445 expires or is found to have already expired and timer T3444 is not running; or
 - 3) timers T3444 and T3445 expire or are found to have already expired.

The UE shall then perform the following actions:

- a) stop other running timers (e.g. T3511, T3512);
- b) if the UE is currently registered to the network for 5GS services, perform a de-registration procedure;
- c) delete any 5G-GUTI, TAI list, last visited registered TAI, list of equivalent PLMNs, and ngKSI; and
- d) enter 5GMM-DEREGISTERED.eCALL-INACTIVE state.

[TS 24.301, clause 10.2]

T3444	NOTE 11	All except EMM-NULL and 5GMM-NULL (defined in 3GPP TS 24.501 [54])	- UE configured for eCall only mode enters EMM-IDLE mode after an eCall over IMS - UE configured for eCall only mode moves from GERAN/UTRAN to E-UTRAN with timer T3242 (see 3GPP TS 24.008 [13]) running - UE configured for eCall only mode enters 5GMM-IDLE mode (defined in 3GPP TS 24.501 [54]) after an eCall over IMS	- Removal of eCall only restriction - Intersystem change from S1 mode to A/Gb or lu mode	Perform eCall inactivity procedure in EPS as described in clause 5.5.4. Perform eCall inactivity procedure in 5GS as described in 3GPP TS 24.501 [54].
T3445	NOTE 12	All except EMM-NULL and 5GMM-NULL (defined in 3GPP TS 24.501 [54])	- UE configured for eCall only mode enters EMM-IDLE mode after a call to a non-emergency MSISDN or URI for test or terminal reconfiguration service - UE configured for eCall only mode moves from GERAN/UTRAN to E-UTRAN with timer T3243 (see 3GPP TS 24.008 [13]) running - UE configured for eCall only mode enters 5GMM-IDLE mode (defined in 3GPP TS 24.501 [54]) after a call to a non-emergency MSISDN or URI for test or terminal reconfiguration service	Removal of eCall only restriction - Intersystem change from S1 mode to A/Gb or lu mode	Perform eCall inactivity procedure in EPS as described in clause 5.5.4. Perform eCall inactivity procedure in 5GS as described in 3GPP TS 24.501 [54].

[TS 38.331, clause 5.2.2.4.2]

Upon receiving the *SIB1* the UE shall:

- 1> store the acquired *SIB1*;

...

- 4> forward the *eCallOverIMS-Support* to upper layers, if present;

[TS 38.331, clause 6.2.2]

eCallOverIMS-Support

Indicates whether the cell supports eCall over IMS services as defined in TS 23.501 [32]. If absent, eCall over IMS is not supported by the network in the cell.

11.5.2.3 Test description

11.5.2.3.1 Pre-test conditions

System Simulator:

- 2 cells

- NR Cell 1 as defined in TS 38.508-1 [4] Table 4.4.2-3. System information combination NR-6 as defined in TS 38.508-1 [4], sub-clause 4.4.3.1.2.
- E-UTRA Cell 1 as defined in TS 36.508 [7] Table 4.4.2-2. System information combination 31 as defined in TS 36.508 [7], sub-clause 4.4.3.1.1.

UE:

- the eCall capable UE is equipped with 'eCall only' enabled USIM configured as per TS 38.508-1 [4] Table 6.4.1-24.

Preamble:

- The UE is in test state 0-A (Switched Off) as defined in TS 38.508-1 [4], subclause 4.4A.2.

11.5.2.3.2 Test procedure sequence

Table 11.5.2.3.2-1: Main behaviour

St	Procedure	Message Sequence		TP	Verdict
		U - S	Message		
1	The SS configures: - NR Cell 1 as "Serving cell" - E-UTRA Cell 1 as "Non-suitable "off" cell".	-	-	-	-
2	The UE is switched on.	-	-	-	-
3	Wait for 60s for the UE to enter 5GMM- DEREGISTERED.eCALL-INACTIVE state	-	-	-	-
4	An eCall to URI for test service is initiated. (Note 1)	-	-	-	-
5	Check: Does the UE send REGISTRATION REQUEST message with 5GS registration type set to 'initial registration'?	-->	5GMM: REGISTRATION REQUEST	1	P
6- 14	Steps 5-13 of Table 4.5.2.2-2 of the generic procedure in TS 38.508-1 [4] are performed.	-	-	-	-
15	The SS transmits a REGISTRATION ACCEPT message and assigns value of 7 hours for the timer T3512.	<--	5GMM: REGISTRATION ACCEPT	-	-
16	The UE transmits an <i>ULInformationTransfer</i> message and a REGISTRATION COMPLETE message.	-->	5GMM: REGISTRATION COMPLETE	-	-
17	Step 19a1 of Table 4.5.2.2-2 of the generic procedure in TS 38.508-1 [4] is performed with 'connected without release'. Check: The UE transmits an <i>ULInformationTransfer</i> message with Request type set to "initial request" and a PDU SESSION ESTABLISHMENT REQUEST message?	-->	NR RRC: <i>ULInformationTransfer</i> 5GMM: UL NAS TRANSPORT 5GSM: PDU SESSION ESTABLISHMENT REQUEST	2	P
18- 28	Void				
29	Step 1 of expected sequence from A.4.1 as defined in TS 34.229-5 [41] is performed.	-	-	-	-
30- 34	Steps 9a1 to 13b3 of Table 4.9.15.2.2-1 of the test procedure in TS 38.508-1 [4] are performed.	-	-	-	-
35- 36	Release eCall over IMS using the generic procedure described in TS 34.229-5 [41] subclause A.8.				
37	The SS releases the RRC connection. (Note 2)	<--	NR RRC: RRCRelease	-	-
38	The SS waits 1 minute.	-	-	-	-
39- 51	Steps 1 to 13 of the generic test procedure for IMS MT speech call establishment in 5GC specified in TS 38.508-1 [4] subclause 4.9.16	-	-	3	P

	are performed.				
52-53	Generic test procedure for MT release of Voice call in 5GS described in TS 34.229-5 [41] subclause A.8 takes place.	-	-	-	-
54	The SS releases the RRC connection. (Note 3)	<--	NR RRC: RRCRelease	-	-
55	Check: Does the UE transmit a REGISTRATION REQUEST message at the expiry of T3512?	-->	5GMM: REGISTRATION REQUEST	4	P
56	The SS transmits a REGISTRATION ACCEPT message including T3512 value IE.	<--	5GMM: REGISTRATION ACCEPT	-	-
57	The UE transmits a REGISTRATION COMPLETE message	-->	5GMM: REGISTRATION COMPLETE		
58	The SS releases the RRC connection.	<--	NR RRC: RRCRelease	-	-
59	The SS configures: - NR Cell 1 as "Non-suitable "off" cell" - E-UTRA Cell 1 as "Serving cell".	-	-	-	-
60	Check: Does the UE perform on the E-UTRA Cell 1 the TAU procedure for Inter-system change from N1 mode to S1 mode as described in TS 38.508-1 [4], Table 4.9.7.2.2-1?	-	-	5	P
61	The SS configures: - NR Cell 1 as "Serving cell" - E-UTRA Cell 1 as "Non-suitable "off" cell".	-	-	-	-
62	Check: Does the UE perform on the NR Cell 1 the Test procedure for UE Tracking area updating for Inter-system change from S1 mode to N1 mode as described in TS 38.508-1 [4], Table 4.9.9.2.2-1?	-	-	6	P
63	Check: Does the UE transmit a DEREGISTRATION REQUEST message at expiry of T3445?	-->	5GMM: DEREGISTRATION REQUEST	7	P
Note 1: The request to originate a manual eCall may be performed by MMI or AT command. Note 2: Timer T3445 of 12hours starts. Note 3: Timer T3512 of 7hours starts.					

11.5.2.3.3 Specific message contents

Table 11.5.2.3.3-1: SIB1 for NR Cell 1 (All steps, Table 11.5.2.3.2-1)

Derivation path: TS 38.508-1 [4] table 4.6.1-28 Condition eCalloverIMSforNR

Table 11.5.2.3.3-2: REGISTRATION ACCEPT (step 15, 56, 62 Table 11.5.2.3.2-1)

Derivation path: TS 38.508-1 [4], table 4.7.1-7			
Information Element	Value/Remark	Comment	Condition
T3512 value			
Unit	'001'B	value is incremented in multiples of 1 hour	
Timer value	'0 0111'B	7 hours	

Table 11.5.2.3.3-3: UL NAS TRANSPORT (step 17, Table 11.5.2.3.2-1)

Derivation Path: TS 38.508-1 [4] table 4.7.1-10, condition INITIAL_PDU_REQUEST.			
Information Element	Value/remark	Comment	Condition
Request type	'001'B	initial request	
S-NSSAI	Not Present		

Table 11.5.2.3.3-4: REGISTRATION REQUEST (step 55, Table 11.5.2.3.2-1)

Derivation path: TS 38.508-1 [4] table 4.7.1-6			
Information Element	Value/remark	Comment	Condition

5GS registration type			
5GS registration type value	'011'B		PERIODIC

Table 11.5.2.3.3-5: TRACKING AREA UPDATE REQUEST (Step 60, Table 11.5.2.3.2-1; step 3, TS 38.508-1 [4] Table 4.9.7.2.2-1)

Derivation Path: TS 38.508-1 [4] table 4.9.7.2.3-1 with condition First-N1-to-S1 = TRUE

Table 11.5.2.3.3-6: DEREGISTRATION REQUEST (step 63, Table 11.5.2.3.2-1)

Derivation path: TS 38.508-1 [4], Table 4.7.1-12			
Information Element	Value/remark	Comment	Condition
De-registration type			
Switch off	'0'B	Normal de-registration	

11.5.3

11.5.4 eCall Only mode / 5GS supports IMS voice over PS session / 5GS supports emergency service / eCall over IMS is supported on 5GS / RACH failure in NR cell / eCall over EPS

11.5.4.1 Test Purpose (TP)

(1)

```
with { UE is in the state 5GMM-DEREGISTERED.eCALL-INACTIVE }
ensure that {
  when { UE is requested to make an automatic eCall and RACH failure is observed in NR cell }
  then { UE establishes eCall over EPS }
}
```

11.5.4.2 Conformance requirements

References: The conformance requirements covered in the present TC are specified in: TS 36.331, clauses 5.2.2.7, 6.2.2, TS 38.331, clause 6.2.2 and TS 23.167, Annex H.6.

[TS 36.331 clause 5.2.2.7]

Upon receiving the *SystemInformationBlockType1* or *SystemInformationBlockType1-BR* either via broadcast or via dedicated signalling, the UE shall:

...

1> else:

2> if the frequency band indicated in the *freqBandIndicator* is part of the frequency bands supported by the UE and it is not a downlink only band; or

...

3> forward the *ims-EmergencySupport* to upper layers, if present;

[TS 23.167 clause H.6]

Table H.2: Domain Selection Rules for eCall over IMS session attempts for E-UTRAN or NG-RAN radio access networks

	PS Available	VoIMS	EMS	ECL	First eCall Attempt	Second eCall Attempt
A	Y	Y	Y	Y	PS	PS on another PS RAT

						if available with EMS=Y and ECL=Y or CS if available
B	Y	Y	Y	N	CS if available	PS (UE establishes IMS emergency session)
C	Y	Y or N	N	N	CS if available	PS on another PS RAT if available with EMS=Y or EMS unknown
D	Y	N	Y	Y	PS or CS if available	CS if first attempt in PS PS if first attempt in CS
E	Y	N	Y	N	CS if available	PS (UE establishes IMS emergency session)
F	N		-	-	CS if available	
<p>VoIMS = Voice over IMS over PS sessions support as indicated by IMS Voice over PS session supported indication as defined in TS 23.401 [28] and TS 23.502 [49].</p> <p>EMS = IMS Emergency Services supported as indicated by Emergency Service Support indicator as defined in TS 23.401 [28] and TS 23.501 [48] and TS 23.502 [49].</p> <p>ECL = eCall Over IMS support as indicated by the eCall support indicator defined in TS 23.401 [28] and TS 23.501 [48].</p> <p>NOTE 1: As an implementation option, when the first attempt uses PS and fails for reasons other than related to IMS, the second attempt may use PS with a different 3GPP RAT. In this case the UE, can make a third attempt using CS.</p>						

NOTE: If the E-UTRAN and NG-RAN cells available to the UE have different settings, the UE assumes "PS Available" and "ECL" apply to whichever cell is indicated (as defined in TS 23.401 [28] and TS 23.501 [48]) as providing eCall over IMS support. When support by more than one cell is indicated, a UE may select any cell to attempt eCall over IMS according to the UE implementation.

[TS 38.331, clause 6.2.2]

eCallOverIMS-Support

Indicates whether the cell supports eCall over IMS services as defined in TS 23.501 [32]. If absent, eCall over IMS is not supported by the network in the cell.

[TS 36.331, clause 6.2.2]

eCallOverIMS-Support

Indicates whether the cell supports eCall over IMS services via EPC for UEs as defined in TS 23.401 [41]. If absent, eCall over IMS via EPC is not supported by the network in the cell. NOTE 2.

11.5.4.3 Test description

11.5.4.3.1 Pre-test conditions

System Simulator:

- 2 cells
- NR Cell 1 as defined in TS 38.508-1 [4] Table 4.4.2-3. System information combination NR-6 as defined in TS 38.508-1 [4], sub-clause 4.4.3.1.2.
- E-UTRA Cell 1 as defined in TS 36.508 [7] Table 4.4.2-2. System information combination 31 as defined in TS 36.508 [7], sub-clause 4.4.3.1.1.

UE:

- the eCall capable UE is equipped with 'eCall only' enabled USIM configured as per TS 38.508-1 [4] Table 6.4.1-24.

Preamble:

- The UE is in test state 0-A (Switched Off) as defined in TS 38.508-1 [4], subclause 4.4A.2.

11.5.4.3.2 Test procedure sequence

Table 11.5.4.3.2-1: Main behaviour

St	Procedure	Message Sequence		TP	Verdict
		U - S	Message		
1	The SS configures: - NR Cell 1 as "Serving cell" - E-UTRA Cell 1 as "Non-suitable "off" cell".	-	-	-	-
2	The UE is switched on.	-	-	-	-
3	Wait for 60s for the UE to enter 5GMM- DEREGISTERED.eCALL-INACTIVE state.	-	-	-	-
4	An automatic eCall is initiated. (Note 1)	-	-	-	-
-	EXCEPTION: In parallel to the events described in step 4 the steps specified in Table 11.5.4.3.2-2 should take place.	-	-	-	-
5	The UE transmits preamble on PRACH.	-->	PRACH Preamble	-	-
6	The SS configures: - E-UTRA Cell 1 as "Suitable cell".	-	-	-	-
-	The following messages are to be observed on E-UTRA Cell 1 unless explicitly stated otherwise	-	-	-	-
7	Check: Does the UE sends an ATTACH REQUEST message with a PDN CONNECTIVITY REQUEST message to request PDN connectivity to the default PDN. EPS attach type = "combined EPS/IMSI attach"?	-->	ATTACH REQUEST	1	P
8-26	Steps 7 to 25 of Generic Test Procedure for eCall over IMS establishment in EUTRA: eCall Only Support specified in TS 36.508 subclause 4.5A.27 take place.	-	-	-	-
27	Release eCall over IMS using the generic procedure described in TS 34.229-1 [35] subclause C.33.	-	-	-	-
28	The SS releases the RRC connection.	<--	RRCConnectionRelease	-	-
Note 1: The request to originate an automatic eCall may be performed by MMI or AT command.					

Table 11.5.4.3.2-2: Parallel behaviour

St	Procedure	Message Sequence		TP	Verdict
		U - S	Message		
-	EXCEPTION: The steps 1 and 2 below are repeated for the duration of T300.	-	-	-	-
1	The UE attempts to perform RACH procedure on NR Cell 1.	-->	PRACH Preamble	-	-
2	The SS does not respond.	-	-	-	-

11.5.4.3.3 Specific message contents

Table 11.5.4.3.3-1: Message *SystemInformationBlockType1* for NR Cell (All steps, Table 11.5.4.3.2-1)

Derivation path: TS 38.508-1 [4] table 4.6.1-28 Condition eCalloverIMSforNR

Table 11.5.4.3.3-2: Message *SystemInformationBlockType1* for E-UTRA Cell 1(All Steps, Table 11.5.4.3.2-1)

Derivation path: TS 36.508 [7] table 4.4.3.2-3 Condition eCalloverIMS

Table 11.5.4.3.3-3: Message ATTACH ACCEPT (step 17, Table 11.5.4.3.2-1)

Derivation path: TS 36.508 [7] table 4.7.2-1			
Information Element	Value/Remark	Comment	Condition
EPS attach result	'010'B	"Combined EPS/IMSI attach"	
EPS network feature support	'0000 0011'B	emergency bearer services in S1 mode and IMS voice over PS session in S1 mode are supported	

11.5.5 eCall Only mode / Limited service state / Call to URI for test service should not be attempted / eCall over IMS should be attempted / 5GS

11.5.5.1 Test Purpose (TP)

(1)

```
with { UE in eCALL-INACTIVE.LIMITED-SERVICE state }
ensure that {
  when { UE is requested to make an eCall to URI for test service }
  then { UE does not transmit any RRCSetupRequest message }
}
```

(2)

```
with { UE in eCALL-INACTIVE.LIMITED-SERVICE state }
ensure that {
  when { UE is requested to make a manual eCall }
  then { UE transmits a REGISTRATION REQUEST message with registration type set to "emergency" }
}
```

11.5.5.2 Conformance requirements

References: The conformance requirements covered in the present TC are specified in: TS 23.122 [38], subclause 2

[TS 23.122 clause 2]

If the MS is in eCall only mode, it attempts to camp on a suitable cell and enters an "eCall inactive" state in which it can only attempt an eCall over IMS, or a call to a non-emergency MSISDN or URI for test or terminal reconfiguration services as specified in 3GPP TS 31.102 [40].

If the MS is in eCall only mode and is unable to find a suitable cell to camp on, it attempts to camp on an acceptable cell in limited service state, and enters an "eCall inactive" state in which it can only attempt an eCall over IMS.

11.5.5.3 Test description

11.5.5.3.1 Pre-test conditions

System Simulator:

- NGC Cell A
- The PLMN is defined in Table 11.5.5.3.1-1.

Table 11.5.5.3.1–1: PLMN identifier

NGC Cell	PLMN name	MCC / MNC
A	PLMN4	004 / 31

UE:

- the eCall capable UE is equipped with ‘eCall only’ enabled USIM configured as per TS 38.508-1 [4] Table 6.4.1-26.

Preamble:

- The UE is in test state 0-A (Switched Off) as defined in TS 38.508-1 [4], subclause 4.4A.2.

11.5.5.3.2 Test procedure sequence

Table 11.5.5.3.2-1: Main behaviour

St	Procedure	Message Sequence		TP	Verdict
		U - S	Message		
1	The UE is switched on.	-	-	-	-
2	Wait 60s for the UE to camp on NGC Cell A as an acceptable cell.	-	-	-	-
3	A manual eCall is initiated. (Note 1)	-	-	-	-
4A-4B	Steps 1-2 of test procedure 4.9.12 in TS 38.508-1 [4] are performed.	-	-	-	-
4C	Check: Does the UE transmits an <i>RRCSetupComplete</i> message and a REGISTRATION REQUEST message with 'Registration type' set to 'emergency'?	-->	NR RRC: <i>RRCSetupComplete</i> 5GMM: REGISTRATION REQUEST	2	P
4D-4O	Steps 4-15 of test procedure 4.9.12 in TS 38.508-1 [4] are performed.	-	-	-	-
-	EXCEPTION: In parallel to the events described in steps 4P-4R below the events specified Table 11.5.5.3.2-2 take place.	-	-	-	-
4P-4R	Steps 16-18 of test procedure 4.9.12 in TS 38.508-1 [4] are performed.	-	-	-	-
5	Test procedure for IMS MT Emergency call release is performed as specified in TS 38.508-1 [4], subclause 4.9.12B on NGC Cell A.	-	-	-	-
6	Void	-	-	-	-
7	The SS releases the RRC connection.	<--	RRC: <i>RRCRelease</i>	-	-
8	Wait for 5 seconds	-	-	-	-
9	An eCall to URI for test service is initiated. (Note 2)	-	-	-	-
10	Check: Does UE send an <i>RRCConnectionRequest</i> on NGC Cell A within 120 seconds?	-->	RRC: <i>RRCSetupRequest</i>	1	F

Note 1: The request to originate a manual eCall may be performed by MMI or AT command.

Note 2: The request to originate an eCall to URI for test service may be performed by MMI or AT command.

Table 11.5.5.3.2-2: Parallel behaviour

St	Procedure	Message Sequence		TP	Verdict
		U - S	Message/PDU/SDU		
1-3	Steps 1-3 of generic test procedure for setting up eCall as defined in TS 34.229-5 [47] annex A.23 are performed.	-	-	-	-

11.5.5.3.3 Specific message contents

Table 11.5.5.3.3-1: SIB1 for NGC Cell A (All steps, Table 11.5.5.3.2-1)

Derivation path: TS 38.508-1 [4] table 4.6.1-28 Condition eCallOverIMSforNR

Table 11.5.5.3.3-2: REGISTRATION REQUEST (step 4C, Table 11.5.5.3.2-1)

Derivation Path: Table 4.7.1-6, condition EMERGENCY.
--

11.5.6 eCall capable / 5GS supports IMS voice over PS session / 5GS supports emergency service / eCall over IMS is not supported / eCall using the CS domain / emergency call over IMS if eCall using the CS domain is not available / UTRA

11.5.6.1 Test Purpose (TP)

(1)

```
with { UE in 5GMM-REGISTERED.NORMAL-SERVICE state and 5GMM-IDLE mode }
ensure that {
  when { eCallOverIMS-Support is not indicated in SIB1 and UE is requested to make an automatic
eCall and UTRA Cell is available }
    then { UE establishes the eCall using the CS domain (UTRA) }
}
```

(2)

```
with { UE in 5GMM-REGISTERED.NORMAL-SERVICE state and 5GMM-IDLE mode }
ensure that {
  when { eCallOverIMS-Support is not indicated in SIB1 and UE is requested to make an automatic
eCall }
    then { UE establishes an RRC connection for normal emergency call with the RRC
establishmentCause set to "emergency", and, sends a SERVICE REQUEST message with Service type IE set
to "emergency services" }
}
```

11.5.6.2 Conformance requirements

References: The conformance requirements covered in the present TC are specified in: TS 38.331, clauses 5.2.2.4.2, 6.2.2 and TS 23.167, Annex H.6.

[TS 38.331, clause 5.2.2.4.2]

Upon receiving the *SIB1* the UE shall:

1> store the acquired *SIB1*;

...

4> forward the *eCallOverIMS-Support* to upper layers, if present;

[TS 38.331, clause 6.2.2]

eCallOverIMS-Support

Indicates whether the cell supports eCall over IMS services as defined in TS 23.501 [32]. If absent, eCall over IMS is not supported by the network in the cell.

[TS 23.167, clause H.6]

This clause details the domain priority and selection (see clause 7.3) for a UE that attempts to make an eCall over IMS session using E-UTRAN or NG-RAN radio access networks based on the availability of the CS or PS domains and the network support for IMS emergency, eCall over IMS and IMS voice over PS.

The following table (Table H.2) defines these rules based on the UE (last 2 columns) for different initial conditions (first 4 columns) when an eCall over IMS session is initiated and when the UE is not in limited service state.

Table H.2: Domain Selection Rules for eCall over IMS session attempts for E-UTRAN or NG-RAN radio access networks

	PS Available	VoIMS	EMS	ECL	First eCall Attempt	Second eCall Attempt
A	Y	Y	Y	Y	PS	PS on another PS RAT if available with EMS=Y and ECL=Y or CS if available
B	Y	Y	Y	N	CS if available	PS (UE establishes IMS emergency session)
C	Y	Y or N	N	N	CS if available	PS on another PS RAT if available with EMS=Y or EMS unknown
D	Y	N	Y	Y	PS or CS if available	CS if first attempt in PS PS if first attempt in CS
E	Y	N	Y	N	CS if available	PS (UE establishes IMS emergency session)
F	N		-	-	CS if available	

VoIMS = Voice over IMS over PS sessions support as indicated by IMS Voice over PS session supported indication as defined in TS 23.401 [28] and TS 23.502 [49].

EMS = IMS Emergency Services supported as indicated by Emergency Service Support indicator as defined in TS 23.401 [28] and TS 23.501 [48] and TS 23.502 [49].

ECL = eCall Over IMS support as indicated by the eCall support indicator defined in TS 23.401 [28] and TS 23.501 [48].

NOTE 1: As an implementation option, when the first attempt uses PS and fails for reasons other than related to IMS, the second attempt may use PS with a different 3GPP RAT. In this case the UE, can make a third attempt using CS.

NOTE: If the E-UTRAN and NG-RAN cells available to the UE have different settings, the UE assumes "PS Available" and "ECL" apply to whichever cell is indicated (as defined in TS 23.401 [28] and TS 23.501 [48]) as providing eCall over IMS support. When support by more than one cell is indicated, a UE may select any cell to attempt eCall over IMS according to the UE implementation.

11.5.6.3 Test description

11.5.6.3.1 Pre-test conditions

System Simulator:

- NR Cell 1 as defined in TS 38.508-1 [4] Table 4.4.2-3. System information combination NR-1 as defined in TS 38.508-1 [4], subclause 4.4.3.1.2.
- UTRA Cell 5 is configured as Non-suitable "Off" cell as defined in TS 36.508 [7].

UE:

- the eCall capable UE is equipped with USIM configured as per TS 38.508-1 [4] Table 6.4.1-23.

Preamble:

- The UE is in test state 1N-A as defined in TS 38.508-1 [4], subclause 4.4A.2 on NR Cell 1.

11.5.6.3.2 Test procedure sequence

Table 11.5.6.3.2-1: Main behaviour

St	Procedure	Message Sequence		TP	Verdict
		U - S	Message		
-	EXCEPTION: Steps 1a1 to 1a27 describes behaviour that depends on the UE capability pc_UTRA = TRUE; the "lower case letter" identifies a step sequence that takes place if a capability is supported.	-	-	-	-
1a1	The SS configures UTRA Cell 5 as "Suitable Neighbour cell".	-	-	-	-
1a2	Cause the UE to originate an automatic eCall. (Note 1)	-	-	-	-
1a3	Check: Does the UE transmit an RRC CONNECTION REQUEST message on Cell 5 with establishment cause set to Emergency Call?	-->	RRC CONNECTION REQUEST	1	P
1a4	The SS transmits an RRC CONNECTION SETUP message.	<--	RRC CONNECTION SETUP	-	-
1a5	The UE transmits an RRC CONNECTION SETUP COMPLETE message.	-->	RRC CONNECTION SETUP COMPLETE	-	-
-	EXCEPTION: In parallel to the event described in steps 1a6 to 1a17, if initiated by the UE the steps 5 to 13 of the generic procedure for Registration on PS specified in TS 34.108 subclause 7.2.2.2.3 take place.	-	-	-	-
1a6	Check: Does the UE transmit a CM SERVICE REQUEST with CM service type IE indicating "Emergency call establishment"?	-->	CM SERVICE REQUEST	1	P
1a7	The SS transmits an AUTHENTICATION REQUEST.	<--	AUTHENTICATION REQUEST	-	-
1a8	The UE transmits AUTHENTICATION RESPONSE.	-->	AUTHENTICATION RESPONSE	-	-
1a9	The SS transmits a SECURITY MODE COMMAND message for the CS domain.	<--	SECURITY MODE COMMAND	-	-
1a10	The UE transmits a SECURITY MODE COMPLETE message.	-->	SECURITY MODE COMPLETE	-	-
1a11	Check: Does the UE transmit an EMERGENCY SETUP message with Emergency Service Category IE bit 7 set to 1 and all other bits are set to 0?	-->	EMERGENCY SETUP	1	P
1a12 - 1a17	Steps 11 to 16 of the generic test procedure in TS 34.108 subclause 7.2.3.2.3 are performed on Cell 5. NOTE: the CS call setup is completed.	-	-	-	-
1a18	Traffic channel is kept active for at least 5 seconds.	-	-	-	-
1a19	The SS transmits DISCONNECT.	<--	DISCONNECT	-	-
1a20	The UE transmits RELEASE.	-->	RELEASE	-	-
1a21	The SS transmits RELEASE COMPLETE.	<--	RELEASE COMPLETE	-	-
1a22	The SS transmits an RRC CONNECTION RELEASE message.	<--	RRC CONNECTION RELEASE	-	-
1a23	The UE transmits RRC CONNECTION RELEASE COMPLETE.	-	RRC CONNECTION RELEASE COMPLETE	-	-
1a24	if possible (see ICS) switch off is performed or the USIM is removed. Otherwise the power is removed.	-	-	-	-
-	EXCEPTION: Step1a24Aa1 describes behaviour that depends on the UE capability.	-	-	-	-
1a24 Aa1	If pc_SwitchOnOff or pc_USIM_Removal then UE sends DETACH REQUEST message	-->	DETACH REQUEST	-	-
1a25	Set the power level of Cell 5 to Non-suitable"	-	-	-	-

	Off" level.				
1a26	The UE is brought back to operation or the USIM configured as per TS 38.508-1 [4] Table 6.4.1-23 is inserted.	-	-	-	-
1a27	The Generic test procedure for NR RRC_IDLE described in TS 38.508-1 [4], Table 4.5.2.2-2 is performed. The UE performs registration and the RRC connection is released.	-	-	-	-
2-17a1	Void	-	-	-	-
18	Cause the UE to originate Automatic eCall. (see Note 1)	-	-	-	-
19	Check: Does the UE perform Generic Test Procedure for IMS Emergency call establishment with IMS Emergency registration as specified in TS 38.508-1 [4], subclause 4.9.11? (see Note 2)	-	-	2	-
20	Test procedure for IMS MT Emergency call release is performed as specified in TS 38.508-1 [4], subclause 4.9.12B.	-	-	-	-
21	The SS releases the RRC connection.	-	-	-	-
Note 1: The request to originate an automatic eCall may be performed by MMI or AT command.					
Note 2: The UE shall set the "Request URI and To header" to "urn:service:sos.ecall.automatic" and shall not include the initial MSD in the SIP INVITE message.					

11.5.6.3.3 Specific message contents

able 11.5.6.3.3-0: SIB1 of NR Cell 1 (All steps, Table 11.5.6.3.2-1)

Derivation Path: TS 38.508-1 [4], Table 4.6.1-28			
Information Element	Value/remark	Comment	Condition
SIB1 ::= SEQUENCE {			
eCallOverIMS-Support	Not present		
}			

Table 11.5.6.3.3-1: RRC CONNECTION REQUEST (Step 1a3, Table 11.5.6.3.2-1)

Derivation Path: TS 34.108 clause 9.1.1			
Information Element	Value/remark	Comment	Condition
Establishment cause	Emergency Call		

Table 11.5.6.3.3-2: CM SERVICE REQUEST (Step 1a6, Table 11.5.6.3.2-1)

Derivation Path: TS 24.008 Table 9.2.11			
Information Element	Value/remark	Comment	Condition
CM service type	0010	Emergency call establishment	

11.5.7 eCall Only mode / SRVCC Handover to CS domain / UTRAN / MSD Update / Success / 5GS

11.5.7.1 Test Purpose (TP)

(1)

```
with { UE in eCall Only Mode and an IMS eCall is ongoing }
ensure that {
  when { UE receives a MobilityFromNRCommand message and an UTRA Speech RAB combination is
  configured for an UTRA cell }
  then { UE transmits a HANDOVER TO UTRAN COMPLETE message on the utra cell }
```

}

11.5.7.2 Conformance requirements

References: The conformance requirements covered in the present testcase are specified in TS 38.331, clause 5.4.3.3, TS 23.237, clauses 5.3.3, 6c.2.1, TS 26.267, clause 4.3, and TS 24.008, clause 5.2.4.2.

[TS 38.331, clause 5.4.3.3]

Reception of the *MobilityFromNRCommand* by the UE

The UE shall:

- 1> stop timer T310, if running;
- 1> stop timer T312, if running;
- 1> if T316 is running:
 - 2> stop timer T316;
 - 2> clear the information included in *VarRLF-Report*, if any;
- 1> if T390 is running:
 - 2> stop timer T390 for all access categories;
 - 2> perform the actions as specified in 5.3.14.4;
- 1> if the *targetRAT-Type* is set to *eutra*:
 - 2> consider inter-RAT mobility as initiated towards E-UTRA;
 - 2> forward the *nas-SecurityParamFromNR* to the upper layers, if included;
- 1> else if the *targetRAT-Type* is set to *utra-fdd*:
 - 2> consider inter-RAT mobility as initiated towards UTRA-FDD;
 - 2> forward the *nas-SecurityParamFromNR* to the upper layers, if included;
- 1> access the target cell indicated in the inter-RAT message in accordance with the specifications of the target RAT.

[TS 23.237, clause 5.3.3]

The Emergency Access Transfer Function (EATF) provides IMS-based mechanisms for enabling service continuity of IMS emergency sessions and eCall over IMS. It is a function in the serving (visited if roaming) IMS network, providing the procedures for IMS emergency session anchoring and PS to CS Access Transfer. The EATF acts as a routing B2BUA which invokes third party call control (3pcc) for enablement of Access Transfer.

When supporting PS to CS DRVCC for IMS emergency, the EATF provides the following functions:

- Generates and sends an E-STN-DR to UE for session continuity procedure toward the CS domain. The E-STN-DR is used by the EATF to correlate two access legs, and is unique for each access transfer function within an EATF.

The EATF performs the session continuity when the Access Transfer request indicated by the E-STN-SR is received.

[TS 23.237, clause 6c.2.1]

Figure 6c.2.1-1 provides flow for SRVCC for IMS emergency session, when the IMS emergency session is active session. This applies when a single EATF instance is deployed (see clause 6c.2.3 for multiple EATF instances).

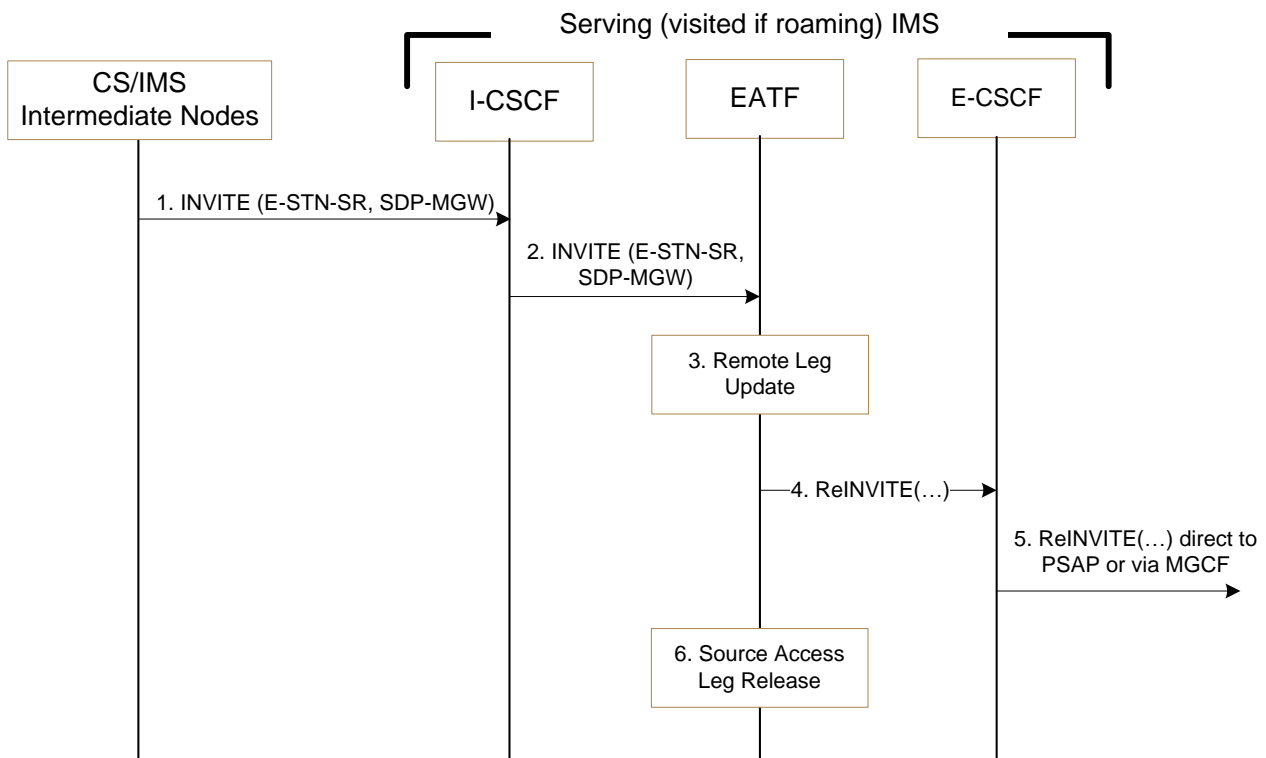

Figure 6c.2.1-1: IMS level Call flow for SRVCC for IMS emergency session with E-STN-SR with a single EATF instance

1. MSC Server initiates the session transfer with the E-STN-SR and it includes the equipment identifier.
2. The I-CSCF routes the INVITE directly to the EATF via I5 by using similar procedures to that defined in TS 23.228 [4] for PSI based Application Server termination.

NOTE 1: The use of indirect routing for PSI based Application Server Termination as described in TS 23.228 [4] in clause 5.7.6 cannot be used for routing the INVITE to the EATF.

- 3 - 4. The EATF uses the E-STN-SR to determine that Access Transfer is requested. The EATF proceeds with the Access Transfer of the active session with bi-directional speech for the UE by updating the Remote Leg with the media description and other information using the Remote Leg Update procedure as specified in clause 6.3.1.5. For SRVCC session transfer of an eCall over IMS, the EATF indicates in the reINVITE that the EATF shall exclude INFO requests for any Info Packages related to eCall over IMS as defined in RFC 6086 [34] clause 5.2.2.

NOTE: Indicating an unwillingness to receive INFO requests will prevent an emergency centre/PSAP from sending an INFO message to request an updated MSD from the UE.

5. The E-CSCF forwards the Re-INVITE to the MGCF associated with the PSAP if the PSAP is located in the PSTN or CS Domain (the u-plane path is switched between the UE and the MGW) or the Re-INVITE is sent directly to an IP-capable PSAP (the u-plane path between the UE and the PSAP is switched end-to-end).
6. When session modification procedures complete, the source access leg (i.e. the access leg previously established over IMS) is released as specified in clause 6.3.1.6.

NOTE 2: If non-voice media was part of the original Multimedia emergency call session, the non-voice media will be released.

[TS 26.267, clause 4.3]

After an emergency voice call has been (automatically or manually) established, the IVS modem receiver constantly monitors the incoming signal from the speech decoder output. When prompted by a request from the PSAP operator for MSD, the IVS connects the IVS data modem transmitter to the input of the speech coder and mutes any speech from the motorist for the duration of MSD transmission to prevent it from interfering with the eCall data transmission.

Alternatively, it can be the IVS that may trigger the MSD transmission. In this case, the IVS asks the PSAP to request an MSD transmission.

The first operation mode shall be referred to as the *pull* mode whereas the latter one is the *push* mode. Essentially, push mode is realized by a request from the IVS to the PSAP to *pull* the MSD.

The requirement about the modem to be configured in either *push* or *pull* mode is beyond the scope of this specification. Refer to clause 4.2 for a reproduction of eCall service requirements.

[TS 24.008, clause 5.2.4.2]

If the MS supports single radio PS to CS access transfer for calls in alerting state as specified in 3GPP TS 24.237 [136] subclause 12.2.3B, and the MS has a single voice media stream over the PS domain that is handed over to the CS domain via SRVCC, and the call control entity of the MS in the "null" state receives an indication "MM connection establishment due to SRVCC handover" then:

- the call control entity shall indicate to the upper layers that call establishment is due to SRVCC handover;
- if the upper layers indicate that the media stream(s) is/are associated with a mobile originated session in the "early" state (defined in IETF RFC 3261 [137]) according to the conditions specified in 3GPP TS 24.237 [136] subclause 12.2.3B.3.2, the call control entity of the MS shall enter the "call delivered" state for this transaction. The MS and the network shall locally set the TI value of the call to "000" and the TI flag value as in mobile terminated call; and

...

If the MS has additional voice media streams carried over the PS domain that are handed over to the CS domain via SRVCC, the call states for the transactions and the setting of the TI value and TI flag for these additional media streams are described in 3GPP TS 24.237 [136].

11.5.7.3 Test Description

11.5.7.3.1 Pre-test conditions

System Simulator:

- NR Cell 1 with system information combination NR-1 as defined in TS 38.508-1 [4].
- UTRA Cell 5 as defined in TS 36.508 [7].

UE:

- the eCall capable UE is equipped with 'eCall only' enabled USIM configured as per TS 38.508-1 [4] Table 6.4.1-24.

Preamble:

- The UE is in test state 0-A (Switched Off) as defined in TS 38.508-1 [4], subclause 4.4A.2.

11.5.7.3.2 Test procedure sequence

Table 11.5.7.3.2-1/2 illustrate the downlink power levels and other changing parameters to be applied for the cell at various time instants of the test execution. The exact instants on which these values shall be applied are described in the texts in this clause. The configuration T0 indicates the initial conditions for preamble. Configurations marked "T1" and "T2" are applied at the points indicated in the Main behaviour description in Table 11.5.7.3.2-3.

Table 11.5.7.3.2-1: Time instances of cell power level and parameter changes for FR1

	Parameter	Unit	NR Cell 1	UTRA Cell 5	Remark
T0	SS/PBCH	dBm/	-88	-	

	SSS EPRE	SCS			
	CPICH_Ec (UTRA FDD)	dBm/3. 84 MHz	-	Off	
T1	SS/PBCH	dBm/	-88	-	
	SSS EPRE	SCS			
	CPICH_Ec (UTRA FDD)	dBm/3. 84 MHz		-60	
T2	SS/PBCH	dBm/	Off	-	
	SSS EPRE	SCS			
	CPICH_Ec (UTRA FDD)	dBm/3. 84 MHz		-60	

Table 11.5.7.3.2-2: Time instances of cell power level and parameter changes for FR2

	Parameter	Unit	NR Cell 1	UTRA Cell 5	Remark
T0	SS/PBCH	dBm/	-82	-	
	SSS EPRE	SCS			
	CPICH_Ec (UTRA FDD)	dBm/3. 84 MHz			
T1	SS/PBCH	dBm/	-82	-	
	SSS EPRE	SCS			
	CPICH_Ec (UTRA FDD)	dBm/3. 84 MHz		-60	
T2	SS/PBCH	dBm/	Off	-	
	SSS EPRE	SCS			
	CPICH_Ec (UTRA FDD)	dBm/3. 84 MHz		-60	

Table 11.5.7.3.2-3: Main behaviour

St	Procedure	Message Sequence		TP	Verdict
		U – S	Message		
1-12	A manual eCall is established by following the test procedure as defined in steps 1 to 12 of TS 38.508-1 [4], subclause 4.9.29.	-	-	-	-
13	The SS transmits a <i>UECapabilityEnquiry</i> message to request UE radio access capability information for NR and UTRA.	<--	NR RRC: <i>UECapabilityEnquiry</i>	-	-
14	The UE transmits a <i>UECapabilityInformation</i> message.	-->	NR RRC: <i>UECapabilityInformation</i>	-	-

	NOTE: The start-CS values received, should be used to configure ciphering on cell 5.				
15-26	Steps 15-26 of generic procedure specified in Table 4.9.29.2.2-1 of TS 38.508-1 [4] are performed.	-	-	-	-
27	Set the power levels according to "T1" as per Table 11.5.7.3.2-1/2.	-	-	-	-
28	The SS transmits a <i>MobilityFromNRCommand</i> message.	<--	NR RRC: <i>MobilityFromNRCommand</i>	-	-
-	The following messages are to be observed on UTRA Cell 5 unless explicitly stated otherwise.	-	-	-	-
29	Check: Does the UE transmit a HANDOVER TO UTRAN COMPLETE message on cell 5?	-	HANDOVER TO UTRAN COMPLETE	1	P
30	The SS transmits a SECURITY MODE COMMAND message for the CS domain.	<--	SECURITY MODE COMMAND	-	-
31	The UE transmits a SECURITY MODE COMPLETE message.	-->	SECURITY MODE COMPLETE	-	-
32	The SS transmits an UTRAN MOBILITY INFORMATION message to notify CN information.	<--	UTRAN MOBILITY INFORMATION	-	-
33	The UE transmits an UTRAN MOBILITY INFORMATION CONFIRM message.	-->	UTRAN MOBILITY INFORMATION CONFIRM	-	-
34	The SS transmits a TMSI REALLOCATION COMMAND message.	<--	TMSI REALLOCATION COMMAND	-	-
35	The UE transmits a TMSI REALLOCATION COMPLETE message.	-->	TMSI REALLOCATION COMPLETE	-	-
36	The CS traffic channel is kept alive by UE for at-least 5 seconds for in-band MSD transfer.	-	-	-	-
37	Set the power levels according to "T2" as per Table 11.5.7.3.2-1/2.	-	-	-	-
38	The SS transmits DISCONNECT.	<--	DISCONNECT	-	-
39	The UE transmits RELEASE.	-->	RELEASE	-	-
40	The SS transmits RELEASE COMPLETE.	<--	RELEASE COMPLETE	-	-
41	The SS transmits an RRC CONNECTION RELEASE message.	<--	RRC CONNECTION RELEASE	-	-
42	The UE transmits RRC CONNECTION RELEASE COMPLETE.	-->	RRC CONNECTION RELEASE COMPLETE	-	-
Note 1: The request to originate a manual eCall may be performed by MMI or AT command.					

11.5.7.3.3 Specific message contents

Table 11.5.7.3.3-1: SIB1 for NR Cell 1 (All steps, Table 11.5.7.3.2-3)

Derivation path: TS 38.508-1 [4] table 4.6.1-28 Condition eCalloverIMSforNR

Table 11.5.7.3.3-2: Message REGISTRATION REQUEST (step 5, Table 11.5.7.3.2-3)

Derivation path: TS 38.508-1 [4], table 4.7.1-6			
Information Element	Value/Remark	Comment	Condition
5GMM capability	'???? ???? ???? ???? ???? ???? ???? ???? *B	5G-SRVCC from NG-RAN to UTRAN supported	

Table 11.5.7.3.3-3: UECapabilityEnquiry (step 13, Table 11.5.7.3.2-3)

Derivation Path: 38.508-1 [4], Table 4.6.1-31			
Information Element	Value/remark	Comment	Condition
UECapabilityEnquiry ::= SEQUENCE {			
rrc-TransactionIdentifier	RRC-TransactionIdentifier		
criticalExtensions CHOICE {			
ueCapabilityEnquiry SEQUENCE {			

ue-CapabilityRAT-RequestList SEQUENCE (SIZE (1.. maxRAT-CapabilityContainers)) OF CapabilityRAT-Request {	2 entries		
UE-CapabilityRAT-Request[1] SEQUENCE {		entry 1	
rat-Type	nr		
}			
UE-CapabilityRAT-Request[2] SEQUENCE {		entry 2	
rat-Type	ultra-fdd-v1610		
}			
}			
lateNonCriticalExtension	Not present		
nonCriticalExtension	Not present		
}			
criticalExtensionsFuture			
}			
}			

Table 11.5.7.3.3-4: UECapabilityInformation (step 14, Table 11.5.7.3.2-3)

Derivation Path: 38.508-1 [4], Table 4.6.1-32			
Information Element	Value/remark	Comment	Condition
UECapabilityInformation ::= SEQUENCE {			
rrc-TransactionIdentifier	RRC-TransactionIdentifier		
criticalExtensions CHOICE {			
ueCapabilityInformation SEQUENCE {			
ue-CapabilityRAT-ContainerList SEQUENCE (SIZE (0..maxRAT-CapabilityContainers)) OF CapabilityRAT-Request {	2 entries		
UE-CapabilityRAT-Request[1] SEQUENCE {		entry 1	
rat-Type	nr		
ueCapabilityRAT-Container	Not checked		
}			
UE-CapabilityRAT-Request[2] SEQUENCE {		entry 2	
rat-Type	ultra-fdd-v1610		
ueCapabilityRAT-Container	Octet string	INTER RAT HANDOVER INFO	
}			
}			
lateNonCriticalExtension	Not checked		
nonCriticalExtension	Not checked		
}			
criticalExtensionsFuture	Not checked		
}			
}			

Table 11.5.7.3.3-5: MobilityFromNRCommand (step 28, Table 11.5.7.3.2-3)

Derivation Path: 38.508-1 [4] Table 4.6.1-8			
Information Element	Value/remark	Comment	Condition
MobilityFromNRCommand ::= SEQUENCE {			
rrc-TransactionIdentifier	RRC-TransactionIdentifier		
criticalExtensions CHOICE {			
mobilityFromNRCommand ::= SEQUENCE {			
targetRAT-Type	ultra-fdd-v1610		
targetRAT-MessageContainer	HANDOVER TO UTRAN COMMAND(UTRA RRC message)		
nas-SecurityParamFromNR	4 LSB of the downlink NAS COUNT		
}			
}			

}		
---	--	--

Table 11.5.7.3.3-6: HANDOVER TO UTRAN COMMAND (Table 11.5.7.3.3-5)

Derivation Path: 36.508 [7], Table 4.7B.1-1, condition UTRA Speech
--

Table 11.5.7.3.3-7: SECURITY MODE COMMAND (step 30, Table 11.5.7.3.2-3)

Derivation Path: 36.508 [7], Table 4.7B.1-n		
Information Element	Condition	Value/remark
Ciphering mode info		Not Present

11.5.8 eCall Only mode / 5GS supports IMS voice over PS session / 5GS supports emergency service / eCall over IMS is supported / RACH failure in NR cell / eCall using the CS domain

11.5.8.1 Test Purpose (TP)

(1)

```
with { UE is in state 5GMM-DEREGISTERED.eCALL-INACTIVE }
ensure that {
  when { UE is requested to make an automatic eCall over IMS and RACH failure is observed in NR cell }
  then { UE establishes the eCall using CS domain (UTRA or GERAN) }
}
```

11.5.8.2 Conformance requirements

References: The conformance requirements covered in the present TC are specified in: TS 23.167, Annex H.6.

[TS 23.167 Annex H.6]

This clause details the domain priority and selection (see clause 7.3) for a UE that attempts to make an eCall over IMS session using E-UTRAN or NG-RAN radio access networks based on the availability of the CS or PS domains and the network support for IMS emergency, eCall over IMS and IMS voice over PS.

The following table (Table H.2) defines these rules based on the UE (last 2 columns) for different initial conditions (first 4 columns) when an eCall over IMS session is initiated and when the UE is not in limited service state.

Table H.2: Domain Selection Rules for eCall over IMS session attempts for E-UTRAN or NG-RAN radio access networks

	PS Available	VoIMS	EMS	ECL	First eCall Attempt	Second eCall Attempt
A	Y	Y	Y	Y	PS	PS on another PS RAT if available with EMS=Y and ECL=Y or CS if available
B	Y	Y	Y	N	CS if available	PS (UE establishes IMS emergency session)
C	Y	Y or N	N	N	CS if available	PS on another PS RAT if available with EMS=Y or EMS unknown
D	Y	N	Y	Y	PS or CS if available	CS if first attempt in PS PS if first attempt in CS
E	Y	N	Y	N	CS if available	PS (UE establishes IMS emergency session)
F	N		-	-	CS if available	

VoIMS =	Voice over IMS over PS sessions support as indicated by IMS Voice over PS session supported indication as defined in TS 23.401 [28] and TS 23.502 [49].
EMS =	IMS Emergency Services supported as indicated by Emergency Service Support indicator as defined in TS 23.401 [28] and TS 23.501 [48] and TS 23.502 [49].
ECL =	eCall Over IMS support as indicated by the eCall support indicator defined in TS 23.401 [28] and TS 23.501 [48].
NOTE 1:	As an implementation option, when the first attempt uses PS and fails for reasons other than related to IMS, the second attempt may use PS with a different 3GPP RAT. In this case the UE, can make a third attempt using CS.

11.5.8.3 Test description

11.5.8.3.1 Pre-test conditions

System Simulator:

- 2 cells
- NR Cell 1 as defined in TS 38.508-1 [4] Table 4.4.2-3. System information combination NR-1 as defined in TS 38.508-1 [4], subclause 4.4.3.1.2. SIB1 indicates ims-EmergencySupport and eCallOverIMS-Support.
- if px_NR_RATComb_Tested = NR_UTRA, UTRA Cell 5 as defined in TS 36.508 [7].
 - cell 5 is configured as "Suitable Neighbour cell".
- if px_NR_RATComb_Tested = NR_GERAN, GERAN cell 24 as defined in TS 36.508 [7].
 - cell 24 is configured as "Suitable Neighbour cell".

UE:

- the eCall capable UE is equipped with 'eCall only' enabled USIM configured as per TS 38.508-1 [4] Table 6.4.1-24.

Preamble:

- The UE is in state 0-A(Switched Off) as defined in TS 38.508-1 [4], subclause 4.4A.2.

11.5.8.3.2 Test procedure sequence

Table 11.5.8.3.2-1: Main behaviour

St	Procedure	Message Sequence		TP	Verdict
		U - S	Message		
1	The UE is switched on.	-	-	-	-
2	Wait 60s for the UE to enter 5GMM-DEREGISTERED.eCALL-INACTIVE state	-	-	-	-
3	An automatic eCall is initiated. (NOTE 1)	-	-	-	-
4	UE transmits preamble on PRACH	-->	PRACH Preamble	-	-
-	EXCEPTION: In parallel to the events described in step 4, the steps specified in Table 11.5.8.3.2-2 should take place.	-	-	-	-
-	EXCEPTION: Steps 5a1 to 5b20 describe behaviour that depends on the UE capability; the "lower case letter" identifies a step sequence that takes place if a capability is supported.	-	-	-	-
5a1	IF (px_NR_RATComb_Tested = NR_UTRA), Check: Does the UE transmit an RRC CONNECTION REQUEST message on Cell 5 with establishment cause set to Emergency Call?	-->	RRC CONNECTION REQUEST	1	P

5a2	The SS transmits an RRC CONNECTION SETUP message.	<--	RRC CONNECTION SETUP	-	-
5a3	The UE transmits an RRC CONNECTION SETUP COMPLETE message.	-->	RRC CONNECTION SETUP COMPLETE	-	-
5a4	Check: Does the UE transmit a CM SERVICE REQUEST with CM service type IE indicating "Emergency call establishment"?	-->	CM SERVICE REQUEST	1	P
5a5	The SS transmits an AUTHENTICATION REQUEST.	<--	AUTHENTICATION REQUEST	-	-
5a6	The UE transmits AUTHENTICATION RESPONSE.	-->	AUTHENTICATION RESPONSE	-	-
5a7	The SS transmits a SECURITY MODE COMMAND message for the CS domain.	<--	SECURITY MODE COMMAND	-	-
5a8	The UE transmits a SECURITY MODE COMPLETE message.	-->	SECURITY MODE COMPLETE	-	-
5a9	Check: Does the UE transmit an EMERGENCY SETUP message with Emergency Service Category IE bit 7 set to 1 and all other bits are set to 0?	-->	EMERGENCY SETUP	1	P
5a10 - 5a15	Steps 11 to 16 of the generic test procedure in TS 34.108 subclause 7.2.3.2.3 are performed on Cell 5. NOTE: the CS call setup is completed.	-	-	-	-
5a16	Traffic channel is kept active for at least 5 seconds.	-	-	-	-
5a17	The SS transmits DISCONNECT.	<--	DISCONNECT	-	-
5a18	The UE transmits RELEASE.	-->	RELEASE	-	-
5a19	The SS transmits RELEASE COMPLETE.	<--	RELEASE COMPLETE	-	-
5a20	The SS transmits an RRC CONNECTION RELEASE message.	<--	RRC CONNECTION RELEASE	-	-
5a21	The UE transmits RRC CONNECTION RELEASE COMPLETE.	-->	RRC CONNECTION RELEASE COMPLETE	-	-
5b1	IF (px_Nr_RATComb_Tested = NR_GERAN), Check: Does the UE transmit a CHANNEL REQUEST message on Cell 24 with Establishment cause: Emergency call?	-->	CHANNEL REQUEST	1	P
5b2	The SS transmits an IMMEDIATE ASSIGNMENT message.	<--	IMMEDIATE ASSIGNMENT	-	-
5b3	Check: Does the UE transmit a CM SERVICE REQUEST with CM service type IE indicating "Emergency call establishment"?	-->	CM SERVICE REQUEST	1	P
5b4	The SS transmits an AUTHENTICATION REQUEST message.	<--	AUTHENTICATION REQUEST	-	-
5b5	The UE transmits an AUTHENTICATION RESPONSE message.	-->	AUTHENTICATION RESPONSE	-	-
5b6	The SS transmits a CIPHERING MODE COMMAND.	<--	CIPHERING MODE COMMAND	-	-
5b7	The UE transmits a CIPHERING MODE COMPLETE.	-->	CIPHERING MODE COMPLETE	-	-
5b8	Check: Does the UE transmit an EMERGENCY SETUP message with Emergency Service Category IE bit 7 set to 1 and all other bits are set to 0?	-->	EMERGENCY SETUP	1	P
5b9- 5b15	Steps 11 to 17 of the generic test procedure in TS 51.010-1 subclause 10.2.3 are performed on Cell 24. NOTE: the CS call setup is completed.	-	-	-	-
5b16	Traffic channel is kept active for at least 5 seconds.	-	-	-	-
5b17	The SS transmits DISCONNECT.	<--	DISCONNECT	-	-
5b18	The UE transmits RELEASE.	-->	RELEASE	-	-
5b19	The SS transmits RELEASE COMPLETE.	<--	RELEASE COMPLETE	-	-
5b20	The SS transmits CHANNEL RELEASE	<--	CHANNEL RELEASE	-	-
NOTE 1: The request to originate an automatic eCall may be performed by MMI or AT command.					

Table 11.5.8.3.2-2: Parallel behaviour

St	Procedure	Message Sequence		TP	Verdict
		U - S	Message		
-	EXCEPTION: Steps 1 and 2 are repeated for the duration of T300.	-	-	-	-
1	The UE attempts to perform RACH procedure on NR Cell 1.	-	-	-	-
2	The SS does not respond	-	-	-	-

11.5.8.3.3 Specific message contents

Table 11.5.8.3.3-1: SIB1 for NR Cell 1 (All steps, Table 11.5.8.3.2-1)

Derivation path: TS 38.508-1 [4] table 4.6.1-28 Condition eCalloverIMSforNR

Table 11.5.8.3.3-2: RRC CONNECTION REQUEST (Step 5a1, Table 11.5.8.3.2-1)

Derivation Path: TS 34.108 clause 9.1.1			
Information Element	Value/remark	Comment	Condition
Establishment cause	Emergency Call		

Table 11.5.8.3.3-3: CM SERVICE REQUEST (Steps 5a4 and 5b3, Table 11.5.8.3.2-1)

Derivation Path: TS 24.008[43] Table 9.2.11			
Information Element	Value/remark	Comment	Condition
CM service type	0010	Emergency call establishment	

Table 11.5.8.3-4: CHANNEL REQUEST (Step 5b1, Table 11.5.8.3.2-1)

Derivation Path: TS 44.018 Table 9.1.8.1			
Information Element	Value/remark	Comment	Condition
Establishment cause	101	Emergency call	

11.5.9 eCall Only mode / Manual initiation / Emergency registration / Abnormal case / IMS CN sends 486 (Busy Here) / UE performs eCall in CS domain / UTRAN or GERAN / 5GS

11.5.9.1 Test Purpose (TP)

(1)

```

with { UE is in state 5GMM-DEREGISTERED.eCALL-INACTIVE and requested to make a manual eCall over IMS
}
ensure that {
  when { UE receives 486 Busy Here in response to INVITE }
  then { UE establishes the eCall using CS domain (UTRA or GERAN) }
}

```

11.5.9.2 Conformance requirements

References: The conformance requirements covered in the present TC are specified in: TS 24.229, clauses 5.1.6.11.1, 5.1.6.11.2 and TS 23.167, Annex H.6.

[TS 24.229 clause 5.1.6.11.1]

If the upper layers request establishment of an IMS emergency call of the manually initiated eCall type of emergency service, the service URN shall be "urn:service:sos.ecall.manual" as specified in RFC 8147 [244].

If the upper layers request establishment of an IMS emergency call of the automatically initiated eCall type of emergency service, the service URN shall be "urn:service:sos.ecall.automatic" as specified in RFC 8147 [244].

NOTE 1: The manually initiated eCall type of emergency service is used when the eCall IMS emergency session is invoked with user input. The automatically initiated eCall type of emergency service is used if the eCall IMS emergency session is invoked without user input.

[TS 24.229 clause 5.1.6.11.2]

If the upper layers request establishment of an IMS emergency call of the automatically initiated eCall type of emergency service or of the manually initiated eCall type of emergency service and if allowed by IP-CAN specific annex, the UE shall send an INVITE request as specified in the procedures in subclause 5.1.6.8 with the following additions:

- 1) the UE shall set the Request-URI to "urn:service:sos.ecall.automatic" or "urn:service:sos.ecall.manual"; and
- 2) if the IP-CAN indicates the eCall support indication, the UE shall:
 - a) insert a multipart/mixed body containing an "application/EmergencyCallData.eCall.MSD" MIME body part as defined in RFC 8147 [244], containing the MSD not exceeding 140 bytes and encoded in binary ASN.1 PER as specified in CEN EN 15722:2015 [245] and include a Content-Disposition header field with a "handling" header field parameter with an "optional" value, as described in RFC 3261 [26];
 - b) insert an Accept header field indicating the UE is willing to accept an "application/EmergencyCallData.Control+xml" MIME type as defined in RFC 8147 [244]; and
 - c) insert a Recv-Info header field set to "EmergencyCallData.eCall.MSD" as defined in RFC 8147 [244].

NOTE: Further content for the INVITE is as defined in RFC 8147 [244].

Then the UE shall proceed as follows:

...

- 3) if the UE receives a 486 (Busy Here), 600 (Busy Everywhere) or 603 (Decline) response to the INVITE request containing:
 - a) a multipart/mixed body containing an "application/EmergencyCallData.Control+xml" MIME body part as defined in RFC 8147 [244] with an "ack" element containing:
 - i) a "received" attribute set to "true"; and
 - ii) a "ref" attribute set to the Content-ID of the MIME body part containing the MSD sent by the UE;

then the UE shall consider the initial MSD transmission as successful and shall perform domain selection to re-attempt the eCall as specified in 3GPP TS 23.167 [4B]; and
- 4) in all other cases, the UE shall perform domain selection to re-attempt the eCall as specified in 3GPP TS 23.167 [4B].

[TS 23.167 clause H.6]

Table H.2: Domain Selection Rules for eCall over IMS session attempts for E-UTRAN or NG-RAN radio access networks

	PS Available	VoIMS	EMS	ECL	First eCall Attempt	Second eCall Attempt
A	Y	Y	Y	Y	PS	PS on another PS RAT if available with EMS=Y and ECL=Y or CS if available
B	Y	Y	Y	N	CS if available	PS (UE establishes IMS emergency session)
C	Y	Y or N	N	N	CS if available	PS on another PS RAT

						if available with EMS=Y or EMS unknown
D	Y	N	Y	Y	PS or CS if available	CS if first attempt in PS PS if first attempt in CS
E	Y	N	Y	N	CS if available	PS (UE establishes IMS emergency session)
F	N		-	-	CS if available	
<p>VoIMS = Voice over IMS over PS sessions support as indicated by IMS Voice over PS session supported indication as defined in TS 23.401 [28] and TS 23.502 [49].</p> <p>EMS = IMS Emergency Services supported as indicated by Emergency Service Support indicator as defined in TS 23.401 [28] and TS 23.501 [48] and TS 23.502 [49].</p> <p>ECL = eCall Over IMS support as indicated by the eCall support indicator defined in TS 23.401 [28] and TS 23.501 [48].</p> <p>NOTE 1: As an implementation option, when the first attempt uses PS and fails for reasons other than related to IMS, the second attempt may use PS with a different 3GPP RAT. In this case the UE, can make a third attempt using CS.</p>						

11.5.9.3 Test description

11.5.9.3.1 Pre-test conditions

System Simulator:

- 2 cells
 - NR Cell 1 as defined in TS 38.508-1 [4] Table 4.4.2-3.
- if px_NR_RATComb_Tested = NR_UTRA, UTRA Cell 5 as defined in TS 36.508 [7].
 - cell 5 is configured as "Suitable Neighbour cell".
- if px_NR_RATComb_Tested = NR_GERAN, GERAN cell 24 as defined in TS 36.508 [7].
 - cell 24 is configured as "Suitable Neighbour cell".

UE:

- the eCall capable UE is equipped with 'eCall only' enabled USIM configured as per TS 38.508-1 [4] Table 6.4.1-24.

Preamble:

- The UE is in test state 0-A (Switched Off) as defined in TS 38.508-1 [4], subclause 4.4A.2.

11.5.9.3.2 Test procedure sequence

Table 11.5.9.3.2-1: Main behaviour

St	Procedure	Message Sequence		TP	Verdict
		U - S	Message		
1	The UE is switched on.	-	-	-	-
2	Wait 60s for the UE to enter 5GMM-DEREGISTERED.eCALL-INACTIVE state.	-	-	-	-
3	A manual eCall is initiated. (Note 1)	-	-	-	-
4-21	Steps 2 to 19 of generic procedure specified in Table 4.5.2.2-2 of 38.508-1 [4] takes place.	-	-	-	-

22-24	Steps 8-10 of generic procedure specified in Table 4.9.11.2.2-1 of TS 38.508-1 [4] with condition 'eCall' are performed.	-	-	-	-
25	Step 1 of Annex A.23 of TS 34.229-5 [41] happens	-->	INVITE	-	-
26	SS sends 486 Busy Here response	<--	486 Busy Here	-	-
-	EXCEPTION: Steps 27a1 to 27b20 describe behaviour that depends on the UE capability; the "lower case letter" identifies a step sequence that takes place if a capability is supported.	-	-	-	-
27a1	IF (px_NR_RATComb_Tested = NR_UTRA), Check: Does the UE transmit an RRC CONNECTION REQUEST message on Cell 5 with establishment cause set to Emergency Call?	-->	RRC CONNECTION REQUEST	1	P
27a2	The SS transmits an RRC CONNECTION SETUP message.	<--	RRC CONNECTION SETUP	-	-
27a3	The UE transmits an RRC CONNECTION SETUP COMPLETE message.	-->	RRC CONNECTION SETUP COMPLETE	-	-
27a4	Check: Does the UE transmit a CM SERVICE REQUEST with CM service type IE indicating "Emergency call establishment"?	-->	CM SERVICE REQUEST	1	P
27a5	The SS transmits an AUTHENTICATION REQUEST.	<--	AUTHENTICATION REQUEST	-	-
27a6	The UE transmits AUTHENTICATION RESPONSE.	-->	AUTHENTICATION RESPONSE	-	-
27a7	The SS transmits a SECURITY MODE COMMAND message for the CS domain.	<--	SECURITY MODE COMMAND	-	-
27a8	The UE transmits a SECURITY MODE COMPLETE message.	-->	SECURITY MODE COMPLETE	-	-
27a9	Check: Does the UE transmit an EMERGENCY SETUP message with Emergency Service Category IE bit 6 set to 1 and all other bits are set to 0?	-->	EMERGENCY SETUP	1	P
27a10-27a15	Steps 11 to 16 of the generic test procedure in TS 34.108 subclause 7.2.3.2.3 are performed on Cell 5. NOTE: the CS call setup is completed.	-	-	-	-
27a16	Traffic channel is kept active for at least 5 seconds.	-	-	-	-
27a17	The SS transmits DISCONNECT.	<--	DISCONNECT	-	-
27a18	The UE transmits RELEASE.	-->	RELEASE	-	-
27a19	The SS transmits RELEASE COMPLETE.	<--	RELEASE COMPLETE	-	-
27a20	The SS transmits an RRC CONNECTION RELEASE message.	<--	RRC CONNECTION RELEASE	-	-
27a21	The UE transmits RRC CONNECTION RELEASE COMPLETE.	-->	RRC CONNECTION RELEASE COMPLETE	-	-
27b1	IF (px_NR_RATComb_Tested = NR_GERAN), Check: Does the UE transmit a CHANNEL REQUEST message on Cell 24 with Establishment cause: Emergency call?	-->	CHANNEL REQUEST	1	P
27b2	The SS transmits an IMMEDIATE ASSIGNMENT message.	<--	IMMEDIATE ASSIGNMENT	-	-
27b3	Check: Does the UE transmit a CM SERVICE REQUEST with CM service type IE indicating "Emergency call establishment"?	-->	CM SERVICE REQUEST	1	P
27b4	The SS transmits an AUTHENTICATION REQUEST message.	<--	AUTHENTICATION REQUEST	-	-
27b5	The UE transmits an AUTHENTICATION RESPONSE message.	-->	AUTHENTICATION RESPONSE	-	-

27b6	The SS transmits a CIPHERING MODE COMMAND.	<--	CIPHERING MODE COMMAND	-	-
27b7	The UE transmits a CIPHERING MODE COMPLETE.	-->	CIPHERING MODE COMPLETE	-	-
27b8	Check: Does the UE transmit an EMERGENCY SETUP message with Emergency Service Category IE bit 6 set to 1 and all other bits are set to 0?	-->	EMERGENCY SETUP	1	P
27b9 - 27b1 5	Steps 11 to 17 of the generic test procedure in TS 51.010-1 subclause 10.2.3 are performed on Cell 24. NOTE: the CS call setup is completed.	-	-	-	-
27b1 6	Traffic channel is kept active for at least 5 seconds.	-	-	-	-
27b1 7	The SS transmits DISCONNECT.	<--	DISCONNECT	-	-
27b1 8	The UE transmits RELEASE.	-->	RELEASE	-	-
27b1 9	The SS transmits RELEASE COMPLETE.	<--	RELEASE COMPLETE	-	-
26b2 0	The SS transmits CHANNEL RELEASE	<--	CHANNEL RELEASE	-	-
Note 1: The request to originate a manual eCall may be performed by MMI or AT command.					

11.5.9.3.3 Specific message contents

Table 11.5.9.3.3-1: SIB1 for NR Cell 1 (All steps, Table 11.5.9.3.2-1)

Derivation path: TS 38.508-1 [4] table 4.6.1-28 Condition eCalloverIMSforNR

Table 11.5.9.3.3-2: INVITE (step 25, Table 11.5.9.3.2-1)

Derivation path: TS 34.299-5 [41] Step 1 in Annex A.23 Condition A20

Table 11.5.9.3.3-3: 486 Busy Here (step 26, Table 11.5.9.3.2-1)

Derivation path: TS 34.229-1 [35] Annex A.2.21 Condition A1

Table 11.5.9.3.3-4: RRC CONNECTION REQUEST (Step 27a1, Table 11.5.9.3.2-1)

Derivation Path: TS 34.108 clause 9.1.1			
Information Element	Value/remark	Comment	Condition
Establishment cause	Emergency Call		

Table 11.5.9.3.3-5: CM SERVICE REQUEST (Steps 27a4 and 27b3, Table 11.5.9.3.2-1)

Derivation Path: TS 24.008[43] Table 9.2.11			
Information Element	Value/remark	Comment	Condition
CM service type	0010	Emergency call establishment	

Table 11.5.9.3.3-6: CHANNEL REQUEST (Step 27b1, Table 11.5.9.3.2-1)

Derivation Path: TS 44.018 Table 9.1.8.1			
Information Element	Value/remark	Comment	Condition
Establishment cause	101	Emergency call	

11.5.10 eCall Only mode / Automatic initiation / Emergency registration / Abnormal case / IMS CN sends 600 (Busy Everywhere) / UE performs eCall in CS domain / UTRAN or GERAN / 5GS

11.5.10.1 Test Purpose (TP)

(1)

```
with { UE is in state 5GMM-DEREGISTERED.eCALL-INACTIVE and requested to make an automatic eCall over IMS }
ensure that {
  when { UE receives 600 Busy Everywhere in response to INVITE }
  then { UE establishes the eCall using CS domain (UTRA or GERAN) }
}
```

11.5.10.2 Conformance requirements

References: The conformance requirements covered in the present TC are specified in: TS 24.229, clauses 5.1.6.11.1, 5.1.6.11.2 and TS 23.167, Annex H.6.

[TS 24.229 clause 5.1.6.11.1]

If the upper layers request establishment of an IMS emergency call of the manually initiated eCall type of emergency service, the service URN shall be "urn:service:sos.ecall.manual" as specified in RFC 8147 [244].

If the upper layers request establishment of an IMS emergency call of the automatically initiated eCall type of emergency service, the service URN shall be "urn:service:sos.ecall.automatic" as specified in RFC 8147 [244].

NOTE 1: The manually initiated eCall type of emergency service is used when the eCall IMS emergency session is invoked with user input. The automatically initiated eCall type of emergency service is used if the eCall IMS emergency session is invoked without user input.

[TS 24.229 clause 5.1.6.11.2]

If the upper layers request establishment of an IMS emergency call of the automatically initiated eCall type of emergency service or of the manually initiated eCall type of emergency service and if allowed by IP-CAN specific annex, the UE shall send an INVITE request as specified in the procedures in subclause 5.1.6.8 with the following additions:

- 1) the UE shall set the Request-URI to "urn:service:sos.ecall.automatic" or "urn:service:sos.ecall.manual"; and
- 2) if the IP-CAN indicates the eCall support indication, the UE shall:
 - a) insert a multipart/mixed body containing an "application/EmergencyCallData.eCall.MSD" MIME body part as defined in RFC 8147 [244], containing the MSD not exceeding 140 bytes and encoded in binary ASN.1 PER as specified in CEN EN 15722:2015 [245] and include a Content-Disposition header field with a "handling" header field parameter with an "optional" value, as described in RFC 3261 [26];
 - b) insert an Accept header field indicating the UE is willing to accept an "application/EmergencyCallData.Control+xml" MIME type as defined in RFC 8147 [244]; and
 - c) insert a Recv-Info header field set to "EmergencyCallData.eCall.MSD" as defined in RFC 8147 [244].

NOTE: Further content for the INVITE is as defined in RFC 8147 [244].

Then the UE shall proceed as follows:

...

- 3) if the UE receives a 486 (Busy Here), 600 (Busy Everywhere) or 603 (Decline) response to the INVITE request containing:
 - a) a multipart/mixed body containing an "application/EmergencyCallData.Control+xml" MIME body part as defined in RFC 8147 [244] with an "ack" element containing:

- i) a "received" attribute set to "true"; and
- ii) a "ref" attribute set to the Content-ID of the MIME body part containing the MSD sent by the UE;

then the UE shall consider the initial MSD transmission as successful and shall perform domain selection to re-attempt the eCall as specified in 3GPP TS 23.167 [4B]; and

- 4) in all other cases, the UE shall perform domain selection to re-attempt the eCall as specified in 3GPP TS 23.167 [4B].

[TS 23.167 clause H.6]

Table H.2: Domain Selection Rules for eCall over IMS session attempts for E-UTRAN or NG-RAN radio access networks

	PS Available	VoIMS	EMS	ECL	First eCall Attempt	Second eCall Attempt
A	Y	Y	Y	Y	PS	PS on another PS RAT if available with EMS=Y and ECL=Y or CS if available
B	Y	Y	Y	N	CS if available	PS (UE establishes IMS emergency session)
C	Y	Y or N	N	N	CS if available	PS on another PS RAT if available with EMS=Y or EMS unknown
D	Y	N	Y	Y	PS or CS if available	CS if first attempt in PS PS if first attempt in CS
E	Y	N	Y	N	CS if available	PS (UE establishes IMS emergency session)
F	N		-	-	CS if available	
VoIMS = Voice over IMS over PS sessions support as indicated by IMS Voice over PS session supported indication as defined in TS 23.401 [28] and TS 23.502 [49]. EMS = IMS Emergency Services supported as indicated by Emergency Service Support indicator as defined in TS 23.401 [28] and TS 23.501 [48] and TS 23.502 [49]. ECL = eCall Over IMS support as indicated by the eCall support indicator defined in TS 23.401 [28] and TS 23.501 [48]. NOTE 1: As an implementation option, when the first attempt uses PS and fails for reasons other than related to IMS, the second attempt may use PS with a different 3GPP RAT. In this case the UE, can make a third attempt using CS.						

11.5.10.3 Test description

11.5.10.3.1 Pre-test conditions

System Simulator:

- 2 cells
 - NR Cell 1 as defined in TS 38.508-1 [4] Table 4.4.2-3.
- if px_NR_RATComb_Tested = NR_UTRA, UTRA Cell 5 as defined in TS 36.508 [7].
 - cell 5 is configured as "Suitable Neighbour cell".
- if px_NR_RATComb_Tested = NR_GERAN, GERAN cell 24 as defined in TS 36.508 [7].
 - cell 24 is configured as "Suitable Neighbour cell".

UE:

- the eCall capable UE is equipped with ‘eCall only’ enabled USIM configured as per TS 38.508-1 [4] Table 6.4.1-24.

Preamble:

- The UE is in test state 0-A (Switched Off) as defined in TS 38.508-1 [4], subclause 4.4A.2.

11.5.10.3.2 Test procedure sequence

Table 11.5.10.3.2-1: Main behaviour

St	Procedure	Message Sequence		TP	Verdict
		U - S	Message		
1	The UE is switched on.	-	-	-	-
2	Wait 60s for the UE to enter 5GMM-DEREGISTERED.eCALL-INACTIVE state.	-	-	-	-
3	An automatic eCall is initiated. (Note 1)	-	-	-	-
4-21	Steps 2 to 19 of generic procedure specified in Table 4.5.2.2-2 of 38.508-1 [4] takes place.	-	-	-	-
22-24	Steps 8-10 of generic procedure specified in Table 4.9.11.2.2-1 of TS 38.508-1 [4] with condition ‘eCall’ are performed.	-	-	-	-
25	Step 1 of Annex A.23 of TS 34.229-5 [41] happens	-->	INVITE	-	-
26	SS sends 600 Busy Everywhere response	<--	600 Busy Everywhere	-	-
-	EXCEPTION: Steps 27a1 to 27b20 describe behaviour that depends on the UE capability; the "lower case letter" identifies a step sequence that takes place if a capability is supported.	-	-	-	-
27a1	IF (px_NR_RATComb_Tested = NR_UTRA), Check: Does the UE transmit an RRC CONNECTION REQUEST message on Cell 5 with establishment cause set to Emergency Call?	-->	RRC CONNECTION REQUEST	1	P
27a2	The SS transmits an RRC CONNECTION SETUP message.	<--	RRC CONNECTION SETUP	-	-
27a3	The UE transmits an RRC CONNECTION SETUP COMPLETE message.	-->	RRC CONNECTION SETUP COMPLETE	-	-
27a4	Check: Does the UE transmit a CM SERVICE REQUEST with CM service type IE indicating “Emergency call establishment”?	-->	CM SERVICE REQUEST	1	P
27a5	The SS transmits an AUTHENTICATION REQUEST.	<--	AUTHENTICATION REQUEST	-	-
27a6	The UE transmits AUTHENTICATION RESPONSE.	-->	AUTHENTICATION RESPONSE	-	-
27a7	The SS transmits a SECURITY MODE COMMAND message for the CS domain.	<--	SECURITY MODE COMMAND	-	-
27a8	The UE transmits a SECURITY MODE COMPLETE message.	-->	SECURITY MODE COMPLETE	-	-
27a9	Check: Does the UE transmit an EMERGENCY SETUP message with Emergency Service Category IE bit 7 set to 1 and all other bits are set to 0?	-->	EMERGENCY SETUP	1	P
27a10-27a11	Steps 11 to 16 of the generic test procedure in TS 34.108 subclause 7.2.3.2.3 are performed on Cell 5.	-	-	-	-

5	NOTE: the CS call setup is completed.				
27a1 6	Traffic channel is kept active for at least 5 seconds.	-	-	-	-
27a1 7	The SS transmits DISCONNECT.	<--	DISCONNECT	-	-
27a1 8	The UE transmits RELEASE.	-->	RELEASE	-	-
27a1 9	The SS transmits RELEASE COMPLETE.	<--	RELEASE COMPLETE	-	-
27a2 0	The SS transmits an RRC CONNECTION RELEASE message.	<--	RRC CONNECTION RELEASE	-	-
27a2 1	The UE transmits RRC CONNECTION RELEASE COMPLETE.	-->	RRC CONNECTION RELEASE COMPLETE	-	-
27b1	IF (px_NR_RATComb_Tested = NR_GERAN), Check: Does the UE transmit a CHANNEL REQUEST message on Cell 24 with Establishment cause: Emergency call?	-->	CHANNEL REQUEST	1	P
27b2	The SS transmits an IMMEDIATE ASSIGNMENT message.	<--	IMMEDIATE ASSIGNMENT	-	-
27b3	Check: Does the UE transmit a CM SERVICE REQUEST with CM service type IE indicating "Emergency call establishment"?	-->	CM SERVICE REQUEST	1	P
27b4	The SS transmits an AUTHENTICATION REQUEST message.	<--	AUTHENTICATION REQUEST	-	-
27b5	The UE transmits an AUTHENTICATION RESPONSE message.	-->	AUTHENTICATION RESPONSE	-	-
27b6	The SS transmits a CIPHERING MODE COMMAND.	<--	CIPHERING MODE COMMAND	-	-
27b7	The UE transmits a CIPHERING MODE COMPLETE.	-->	CIPHERING MODE COMPLETE	-	-
27b8	Check: Does the UE transmit an EMERGENCY SETUP message with Emergency Service Category IE bit 7 set to 1 and all other bits are set to 0?	-->	EMERGENCY SETUP	1	P
27b9 - 27b1 5	Steps 11 to 17 of the generic test procedure in TS 51.010-1 subclause 10.2.3 are performed on Cell 24. NOTE: the CS call setup is completed.				
27b1 6	Traffic channel is kept active for at least 5 seconds.	-	-	-	-
27b1 7	The SS transmits DISCONNECT.	<--	DISCONNECT	-	-
27b1 8	The UE transmits RELEASE.	-->	RELEASE	-	-
27b1 9	The SS transmits RELEASE COMPLETE.	<--	RELEASE COMPLETE	-	-
26b2 0	The SS transmits CHANNEL RELEASE	<--	CHANNEL RELEASE	-	-
Note 1: The request to originate an automatic eCall may be performed by MMI or AT command.					

11.5.10.3.3 Specific message contents

Table 11.5.10.3.3-1: SIB1 for NR Cell 1 (All steps, Table 11.5.10.3.2-1)

Derivation path: TS 38.508-1 [4] table 4.6.1-28 Condition eCalloverIMSforNR

Table 11.5.10.3.3-2: INVITE (step 25, Table 11.5.10.3.2-1)

Derivation path: TS 34.299-5 [41] Step 1 in Annex A.23 Condition A21

Table 11.5.10.3.3-3: 600 Busy Everywhere (step 26, Table 11.5.10.3.2-1)

Derivation path: TS 34.229-1 [35] Annex A.2.22 Condition A1

Table 11.5.10.3.3-4: RRC CONNECTION REQUEST (Step 27a1, Table 11.5.10.3.2-1)

Derivation Path: TS 34.108 clause 9.1.1			
Information Element	Value/remark	Comment	Condition
Establishment cause	Emergency Call		

Table 11.5.10.3.3-5: CM SERVICE REQUEST (Steps 27a4 and 27b3, Table 11.5.10.3.2-1)

Derivation Path: TS 24.008[43] Table 9.2.11			
Information Element	Value/remark	Comment	Condition
CM service type	0010	Emergency call establishment	

Table 11.5.10.3.3-6: CHANNEL REQUEST (Step 27b1, Table 11.5.10.3.2-1)

Derivation Path: TS 44.018 Table 9.1.8.1			
Information Element	Value/remark	Comment	Condition
Establishment cause	101	Emergency call	

11.5.11 eCall Only mode / Automatic initiation / Emergency registration / Abnormal case / IMS CN sends 603 (Decline) / UE performs eCall in CS domain / UTRAN or GERAN / 5GS

11.5.11.1 Test Purpose (TP)

(1)

```

with { UE is in state 5GMM-DEREGISTERED.eCALL-INACTIVE and requested to make an automatic eCall over IMS }
ensure that {
  when { UE receives 603 Decline in response to INVITE }
  then { UE establishes the eCall using CS domain (UTRA or GERAN) }
}

```

11.5.11.2 Conformance requirements

References: The conformance requirements covered in the present TC are specified in: TS 24.229, clauses 5.1.6.11.1, 5.1.6.11.2 and TS 23.167, Annex H.6.

[TS 24.229 clause 5.1.6.11.1]

If the upper layers request establishment of an IMS emergency call of the manually initiated eCall type of emergency service, the service URN shall be "urn:service:sos.ecall.manual" as specified in RFC 8147 [244].

If the upper layers request establishment of an IMS emergency call of the automatically initiated eCall type of emergency service, the service URN shall be "urn:service:sos.ecall.automatic" as specified in RFC 8147 [244].

NOTE 1: The manually initiated eCall type of emergency service is used when the eCall IMS emergency session is invoked with user input. The automatically initiated eCall type of emergency service is used if the eCall IMS emergency session is invoked without user input.

[TS 24.229 clause 5.1.6.11.2]

If the upper layers request establishment of an IMS emergency call of the automatically initiated eCall type of emergency service or of the manually initiated eCall type of emergency service and if allowed by IP-CAN specific

annex, the UE shall send an INVITE request as specified in the procedures in subclause 5.1.6.8 with the following additions:

- 1) the UE shall set the Request-URI to "urn:service:sos.ecall.automatic" or "urn:service:sos.ecall.manual"; and
- 2) if the IP-CAN indicates the eCall support indication, the UE shall:
 - a) insert a multipart/mixed body containing an "application/EmergencyCallData.eCall.MSD" MIME body part as defined in RFC 8147 [244], containing the MSD not exceeding 140 bytes and encoded in binary ASN.1 PER as specified in CEN EN 15722:2015 [245] and include a Content-Disposition header field with a "handling" header field parameter with an "optional" value, as described in RFC 3261 [26];
 - b) insert an Accept header field indicating the UE is willing to accept an "application/EmergencyCallData.Control+xml" MIME type as defined in RFC 8147 [244]; and
 - c) insert a Recv-Info header field set to "EmergencyCallData.eCall.MSD" as defined in RFC 8147 [244].

NOTE: Further content for the INVITE is as defined in RFC 8147 [244].

Then the UE shall proceed as follows:

...

- 3) if the UE receives a 486 (Busy Here), 600 (Busy Everywhere) or 603 (Decline) response to the INVITE request containing:
 - a) a multipart/mixed body containing an "application/EmergencyCallData.Control+xml" MIME body part as defined in RFC 8147 [244] with an "ack" element containing:
 - i) a "received" attribute set to "true"; and
 - ii) a "ref" attribute set to the Content-ID of the MIME body part containing the MSD sent by the UE;

then the UE shall consider the initial MSD transmission as successful and shall perform domain selection to re-attempt the eCall as specified in 3GPP TS 23.167 [4B]; and
- 4) in all other cases, the UE shall perform domain selection to re-attempt the eCall as specified in 3GPP TS 23.167 [4B].

[TS 23.167 clause H.6]

Table H.2: Domain Selection Rules for eCall over IMS session attempts for E-UTRAN or NG-RAN radio access networks

	PS Available	VoIMS	EMS	ECL	First eCall Attempt	Second eCall Attempt
A	Y	Y	Y	Y	PS	PS on another PS RAT if available with EMS=Y and ECL=Y or CS if available
B	Y	Y	Y	N	CS if available	PS (UE establishes IMS emergency session)
C	Y	Y or N	N	N	CS if available	PS on another PS RAT if available with EMS=Y or EMS unknown
D	Y	N	Y	Y	PS or CS if available	CS if first attempt in PS PS if first attempt in CS
E	Y	N	Y	N	CS if available	PS (UE establishes IMS emergency session)
F	N		-	-	CS if available	
VoIMS	= Voice over IMS over PS sessions support as indicated by IMS Voice over PS session supported indication as defined in TS 23.401 [28] and TS 23.502 [49].					
EMS	= IMS Emergency Services supported as indicated by Emergency Service Support indicator as defined in TS 23.401 [28] and TS 23.501 [48] and TS 23.502 [49].					
ECL	= eCall Over IMS support as indicated by the eCall support indicator defined in TS 23.401 [28] and					

TS 23.501 [48].

NOTE 1: As an implementation option, when the first attempt uses PS and fails for reasons other than related to IMS, the second attempt may use PS with a different 3GPP RAT. In this case the UE, can make a third attempt using CS.

11.5.11.3 Test description

11.5.11.3.1 Pre-test conditions

System Simulator:

- 2 cells
 - NR Cell 1 as defined in TS 38.508-1 [4] Table 4.4.2-3.
- if px_NR_RATComb_Testcd = NR_UTRA, UTRA Cell 5 as defined in TS 36.508 [7].
 - cell 5 is configured as "Suitable Neighbour cell".
- if px_NR_RATComb_Testcd = NR_GERAN, GERAN cell 24 as defined in TS 36.508 [7].
 - cell 24 is configured as "Suitable Neighbour cell".

UE:

- the eCall capable UE is equipped with 'eCall only' enabled USIM configured as per TS 38.508-1 [4] Table 6.4.1-24.

Preamble:

- The UE is in test state 0-A (Switched Off) as defined in TS 38.508-1 [4], subclause 4.4A.2.

11.5.11.3.2 Test procedure sequence

Table 11.5.11.3.2-1: Main behaviour

St	Procedure	Message Sequence		TP	Verdict
		U - S	Message		
1	The UE is switched on.	-	-	-	-
2	Wait 60s for the UE to enter 5GMM-DEREGISTERED.eCALL-INACTIVE state.	-	-	-	-
3	An automatic eCall is initiated. (Note 1)	-	-	-	-
4-21	Steps 2 to 19 of generic procedure specified in Table 4.5.2.2-2 of 38.508-1 [4] takes place.	-	-	-	-
22-24	Steps 8-10 of generic procedure specified in Table 4.9.11.2.2-1 of TS 38.508-1 [4] with condition 'eCall' are performed.	-	-	-	-
25	Step 1 of Annex A.23 of TS 34.229-5 [41] happens	-->	INVITE	-	-
26	SS sends 603 Decline response	<--	603 Decline	-	-
-	EXCEPTION: Steps 27a1 to 27b20 describe behaviour that depends on the UE capability; the "lower case letter" identifies a step sequence that takes place if a capability is supported.	-	-	-	-
27a1	IF (px_NR_RATComb_Testcd = NR_UTRA), Check: Does the UE transmit an RRC	-->	RRC CONNECTION REQUEST	1	P

	CONNECTION REQUEST message on Cell 5 with establishment cause set to Emergency Call?				
27a2	The SS transmits an RRC CONNECTION SETUP message.	<--	RRC CONNECTION SETUP	-	-
27a3	The UE transmits an RRC CONNECTION SETUP COMPLETE message.	-->	RRC CONNECTION SETUP COMPLETE	-	-
27a4	Check: Does the UE transmit a CM SERVICE REQUEST with CM service type IE indicating "Emergency call establishment"?	-->	CM SERVICE REQUEST	1	P
27a5	The SS transmits an AUTHENTICATION REQUEST.	<--	AUTHENTICATION REQUEST	-	-
27a6	The UE transmits AUTHENTICATION RESPONSE.	-->	AUTHENTICATION RESPONSE	-	-
27a7	The SS transmits a SECURITY MODE COMMAND message for the CS domain.	<--	SECURITY MODE COMMAND	-	-
27a8	The UE transmits a SECURITY MODE COMPLETE message.	-->	SECURITY MODE COMPLETE	-	-
27a9	Check: Does the UE transmit an EMERGENCY SETUP message with Emergency Service Category IE bit 7 set to 1 and all other bits are set to 0?	-->	EMERGENCY SETUP	1	P
27a10-27a15	Steps 11 to 16 of the generic test procedure in TS 34.108 subclause 7.2.3.2.3 are performed on Cell 5. NOTE: the CS call setup is completed.	-	-	-	-
27a16	Traffic channel is kept active for at least 5 seconds.	-	-	-	-
27a17	The SS transmits DISCONNECT.	<--	DISCONNECT	-	-
27a18	The UE transmits RELEASE.	-->	RELEASE	-	-
27a19	The SS transmits RELEASE COMPLETE.	<--	RELEASE COMPLETE	-	-
27a20	The SS transmits an RRC CONNECTION RELEASE message.	<--	RRC CONNECTION RELEASE	-	-
27a21	The UE transmits RRC CONNECTION RELEASE COMPLETE.	-->	RRC CONNECTION RELEASE COMPLETE	-	-
27b1	IF (px_NR_RATComb_Tested = NR_GERAN), Check: Does the UE transmit a CHANNEL REQUEST message on Cell 24 with Establishment cause: Emergency call?	-->	CHANNEL REQUEST	1	P
27b2	The SS transmits an IMMEDIATE ASSIGNMENT message.	<--	IMMEDIATE ASSIGNMENT	-	-
27b3	Check: Does the UE transmit a CM SERVICE REQUEST with CM service type IE indicating "Emergency call establishment"?	-->	CM SERVICE REQUEST	1	P
27b4	The SS transmits an AUTHENTICATION REQUEST message.	<--	AUTHENTICATION REQUEST	-	-
27b5	The UE transmits an AUTHENTICATION RESPONSE message.	-->	AUTHENTICATION RESPONSE	-	-
27b6	The SS transmits a CIPHERING MODE COMMAND.	<--	CIPHERING MODE COMMAND	-	-
27b7	The UE transmits a CIPHERING MODE COMPLETE.	-->	CIPHERING MODE COMPLETE	-	-
27b8	Check: Does the UE transmit an EMERGENCY SETUP message with Emergency Service Category IE bit 7 set to 1 and all other bits are set to 0?	-->	EMERGENCY SETUP	1	P
27b9-27b15	Steps 11 to 17 of the generic test procedure in TS 51.010-1 subclause 10.2.3 are performed on Cell 24. NOTE: the CS call setup is completed.	-	-	-	-
27b16	Traffic channel is kept active for at least 5 seconds.	-	-	-	-

27b1 7	The SS transmits DISCONNECT.	<--	DISCONNECT	-	-
27b1 8	The UE transmits RELEASE.	-->	RELEASE	-	-
27b1 9	The SS transmits RELEASE COMPLETE.	<--	RELEASE COMPLETE	-	-
26b2 0	The SS transmits CHANNEL RELEASE	<--	CHANNEL RELEASE	-	-
Note 1: The request to originate an automatic eCall may be performed by MMI or AT command.					

11.5.11.3.3 Specific message contents

Table 11.5.11.3.3-1: SIB1 for NR Cell 1 (All steps, Table 11.5.11.3.2-1)

Derivation path: TS 38.508-1 [4] table 4.6.1-28 Condition eCallOverIMSforNR

Table 11.5.11.3.3-2: INVITE (step 25, Table 11.5.11.3.2-1)

Derivation path: TS 34.299-5 [41] Step 1 in Annex A.23 Condition A21
--

Table 11.5.11.3.3-3: 603 Decline (step 26, Table 11.5.11.3.2-1)

Derivation path: TS 34.229-1 [35] Annex A.2.23 Condition A1

Table 11.5.11.3.3-4: RRC CONNECTION REQUEST (Step 27a1, Table 11.5.11.3.2-1)

Derivation Path: TS 34.108 clause 9.1.1			
Information Element	Value/remark	Comment	Condition
Establishment cause	Emergency Call		

Table 11.5.11.3.3-5: CM SERVICE REQUEST (Steps 27a4 and 27b3, Table 11.5.11.3.2-1)

Derivation Path: TS 24.008[43] Table 9.2.11			
Information Element	Value/remark	Comment	Condition
CM service type	0010	Emergency call establishment	

Table 11.5.11.3.3-6: CHANNEL REQUEST (Step 27b1, Table 11.5.11.3.2-1)

Derivation Path: TS 44.018 Table 9.1.8.1			
Information Element	Value/remark	Comment	Condition
Establishment cause	101	Emergency call	

11.5.12 eCall Only mode / 5GS supports IMS voice over PS session / 5GS supports emergency service / eCall over IMS is not supported on 5GS / eCall over EPS

11.5.12.1 Test Purpose (TP)

(1)

```
with { UE is switched ON with eCall only enabled USIM }
ensure that {
  when { eCallOverIMS-Support on 5GS is not indicated, eCallOverIMS-Support-r14 on EPS is indicated
and UE is requested to make an automatic eCall }
```

```

then { UE establishes eCall over EPS }
}
    
```

11.5.12.2 Conformance requirements

References: The conformance requirements covered in the present TC are specified in: TS 36.331, clauses 5.2.2.7, 6.2.2, TS 38.331, clause 6.2.2 and TS 23.167, Annex H.6.

[TS 36.331 clause 5.2.2.7]

Upon receiving the *SystemInformationBlockType1* or *SystemInformationBlockType1-BR* either via broadcast or via dedicated signalling, the UE shall:

...

1> else:

2> if the frequency band indicated in the *freqBandIndicator* is part of the frequency bands supported by the UE and it is not a downlink only band; or

...

3> forward the *ims-EmergencySupport* to upper layers, if present;

[TS 23.167 clause H.6]

Table H.2: Domain Selection Rules for eCall over IMS session attempts for E-UTRAN or NG-RAN radio access networks

	PS Available	VoIMS	EMS	ECL	First eCall Attempt	Second eCall Attempt
A	Y	Y	Y	Y	PS	PS on another PS RAT if available with EMS=Y and ECL=Y or CS if available
B	Y	Y	Y	N	CS if available	PS (UE establishes IMS emergency session)
C	Y	Y or N	N	N	CS if available	PS on another PS RAT if available with EMS=Y or EMS unknown
D	Y	N	Y	Y	PS or CS if available	CS if first attempt in PS PS if first attempt in CS
E	Y	N	Y	N	CS if available	PS (UE establishes IMS emergency session)
F	N		-	-	CS if available	

VoIMS = Voice over IMS over PS sessions support as indicated by IMS Voice over PS session supported indication as defined in TS 23.401 [28] and TS 23.502 [49].
 EMS = IMS Emergency Services supported as indicated by Emergency Service Support indicator as defined in TS 23.401 [28] and TS 23.501 [48] and TS 23.502 [49].
 ECL = eCall Over IMS support as indicated by the eCall support indicator defined in TS 23.401 [28] and TS 23.501 [48].
 NOTE 1: As an implementation option, when the first attempt uses PS and fails for reasons other than related to IMS, the second attempt may use PS with a different 3GPP RAT. In this case the UE, can make a third attempt using CS.

NOTE: If the E-UTRAN and NG-RAN cells available to the UE have different settings, the UE assumes "PS Available" and "ECL" apply to whichever cell is indicated (as defined in TS 23.401 [28] and TS 23.501 [48]) as providing eCall over IMS support. When support by more than one cell is indicated, a UE may select any cell to attempt eCall over IMS according to the UE implementation.

[TS 38.331, clause 6.2.2]

eCallOverIMS-Support

Indicates whether the cell supports eCall over IMS services as defined in TS 23.501 [32]. If absent, eCall over IMS is not supported by the network in the cell.

[TS 36.331, clause 6.2.2]

eCallOverIMS-Support

Indicates whether the cell supports eCall over IMS services via EPC for UEs as defined in TS 23.401 [41]. If absent, eCall over IMS via EPC is not supported by the network in the cell. NOTE 2.

11.5.12.3 Test description

11.5.12.3.1 Pre-test conditions

System Simulator:

- 2 cells
 - NR Cell 1 as defined in TS 38.508-1 [4] Table 4.4.2-3. System information combination NR-6 as defined in TS 38.508-1 [4], sub-clause 4.4.3.1.2.
 - E-UTRA Cell 1 as defined in TS 36.508 [7] Table 4.4.2-2. System information combination 31 as defined in TS 36.508 [7], sub-clause 4.4.3.1.1.

UE:

- the eCall capable UE is equipped with 'eCall only' enabled USIM configured as per TS 38.508-1 [4] Table 6.4.1-24.

Preamble:

- The UE is in test state 0-A (Switched Off) as defined in TS 38.508-1 [4], subclause 4.4A.2.

11.5.12.3.2 Test procedure sequence

Table 11.5.12.3.2-1 illustrate the downlink power levels to be applied for NR Cell 1, and E-UTRA Cell 1 at various time instants of the test execution. Row marked "T0" denotes the conditions after the preamble.

Table 11.5.12.3.2-1: Power levels in FR1

	Parameter	Unit	NR Cell 1	E-UTRA Cell 1	Remark
T0	SS/PBCH SSS EPRE	dBm/SCS	-85	-	
	Cell-specific RS EPRE	dBm/15 kHz		-93	

Editor's Note: FR2 power levels are FFS

11.5.12.3.3 Test procedure sequence

Table 11.5.12.3.3-1: Main behaviour

St	Procedure	Message Sequence		TP	Verdict
		U - S	Message		
1	The UE is switched on.	-	-	-	-
2	Wait 60s for the UE to enter eCALL-INACTIVE state.	-	-	-	-
3	An automatic eCall is initiated. (Note 1)	-	-	-	-

-	The following messages are to be observed on E-UTRA Cell 1 unless explicitly stated otherwise	-	-	-	-
4	Check: Does the UE sends an ATTACH REQUEST message with a PDN CONNECTIVITY REQUEST message to request PDN connectivity to the default PDN. EPS attach type = "combined EPS/IMSI attach"?	-->	ATTACH REQUEST	1	P
5-23	Steps 7 to 25 of Generic Test Procedure for eCall over IMS establishment in EUTRA: eCall Only Support specified in clause 4.5A.27 of TS 36.508 [7] take place.	-	-	-	-
24	Release eCall over IMS using the generic procedure described in TS 34.229-1 [35] subclause C.33	-	-	-	-
25	The SS releases the RRC connection.	<--	RRCConnectionRelease	-	-
Note 1: The request to originate an automatic eCall may be performed by MMI or AT command.					

11.5.12.3.4 Specific message contents

Table 11.5.12.3.4-1: Message SystemInformationBlockType1 for E-UTRA Cell 1 (All Steps)

Derivation path: TS 36.508 [7] table 4.4.3.2-3 Condition eCallOverIMS

Table 11.5.12.3.4-2: SIB1 of NR Cell 1 (All steps)

Derivation Path: TS 38.508-1 [4], Table 4.6.1-28			
Information Element	Value/remark	Comment	Condition
SIB1 ::= SEQUENCE {			
eCallOverIMS-Support	Not present		
}			

Table 11.5.12.3.4-3: Message ATTACH ACCEPT (step 14, Table 11.5.12.3.3-1)

Derivation path: TS 36.508 [7] table 4.7.2-1			
Information Element	Value/Remark	Comment	Condition
EPS attach result	'010'B	"Combined EPS/IMSI attach"	
EPS network feature support	'0000 0011'B	emergency bearer services in S1 mode and IMS voice over PS session in S1 mode are supported	

11.5.13 eCall capable / Manual initiation / MSD Transfer failure / UE performs eCall in CS domain after Timer expiry / UTRAN or GERAN / 5GS

11.5.13.1 Test Purpose (TP)

(1)

```
with { UE in state 5GMM-REGISTERED.NORMAL-SERVICE state and 5GMM-IDLE mode and requested to make a manual eCall over IMS }
ensure that {
  when { UE does not receive any response to INVITE }
```

```

    then { UE establishes the eCall using CS domain (UTRA or GERAN) after emerg-request timer expiry
  }
}

```

11.5.13.2 Conformance requirements

References: The conformance requirements covered in the present TC are specified in: TS 24.229, clauses 5.1.6.11.2, 5.1.6.8.1, Table 7.8.1 and TS 23.167, Annex H.6.

[TS 24.229 clause 5.1.6.11.2]

If the upper layers request establishment of an IMS emergency call of the automatically initiated eCall type of emergency service or of the manually initiated eCall type of emergency service and if allowed by IP-CAN specific annex, the UE shall send an INVITE request as specified in the procedures in subclause 5.1.6.8 with the following additions:

- 1) the UE shall set the Request-URI to "urn:service:sos.ecall.automatic" or "urn:service:sos.ecall.manual"; and
- 2) if the IP-CAN indicates the eCall support indication, the UE shall:
 - a) insert a multipart/mixed body containing an "application/EmergencyCallData.eCall.MSD" MIME body part as defined in RFC 8147 [244], containing the MSD not exceeding 140 bytes and encoded in binary ASN.1 PER as specified in CEN EN 15722:2015 [245] and include a Content-Disposition header field with a "handling" header field parameter with an "optional" value, as described in RFC 3261 [26];
 - b) insert an Accept header field indicating the UE is willing to accept an "application/EmergencyCallData.Control+xml" MIME type as defined in RFC 8147 [244]; and
 - c) insert a Recv-Info header field set to "EmergencyCallData.eCall.MSD" as defined in RFC 8147 [244].

NOTE: Further content for the INVITE is as defined in RFC 8147 [244].

Then the UE shall proceed as follows:

- 1) if the UE receives a 200 (OK) response to the INVITE request not containing:
 - a) a multipart/mixed body containing an "application/EmergencyCallData.Control+xml" MIME body part as defined in RFC 8147 [244] with an "ack" element containing:
 - i) a "received" attribute set to "true"; and
 - ii) a "ref" attribute set to the Content-ID of the MIME body part containing the MSD sent by the UE;
 then the UE shall send the MSD using audio media stream encoded as described in 3GPP TS 26.267 [9C];
- 2) if the UE receives a 200 (OK) response to the INVITE request containing:
 - a) a multipart/mixed body containing an "application/EmergencyCallData.Control+xml" MIME body part as defined in RFC 8147 [244] with an "ack" element containing:
 - i) a "received" attribute set to "true"; and
 - ii) a "ref" attribute set to the Content-ID of the MIME body part containing the MSD sent by the UE;
 then the UE shall consider the initial MSD transmission as successful;
- 3) if the UE receives a 486 (Busy Here), 600 (Busy Everywhere) or 603 (Decline) response to the INVITE request containing:
 - a) a multipart/mixed body containing an "application/EmergencyCallData.Control+xml" MIME body part as defined in RFC 8147 [244] with an "ack" element containing:
 - i) a "received" attribute set to "true"; and
 - ii) a "ref" attribute set to the Content-ID of the MIME body part containing the MSD sent by the UE;

then the UE shall consider the initial MSD transmission as successful and shall perform domain selection to re-attempt the eCall as specified in 3GPP TS 23.167 [4B]; and

- 4) in all other cases, the UE shall perform domain selection to re-attempt the eCall as specified in 3GPP TS 23.167 [4B].

[TS 24.229 Table 7.8.1]

Table 7.8.1: IM CN subsystem

Timer	Value to be applied at the UE	Value to be applied at the P-CSCF	Value to be applied at the S-CSCF	Meaning
emerg-request	Configurable value between 5 seconds and 15 seconds	not applicable	not applicable	The timer is used by the UE during initial request for emergency service. For detailed usage of the timer see subclause 5.1.6.8.1.

[TS 24.229 clause 5.1.6.8.1]

If the UE supports the emerg-request timer defined in Table 7.8.1, the UE shall start the emerg-request timer when sending the initial INVITE request for emergency service. The UE shall stop the timer upon receipt of any 18x provisional SIP response. When the emerg-request timer expires, the UE shall consider that the emergency service request has failed and apply the procedures related to emergency service request failure that are defined in 3GPP TS 23.167 [4B] subclause 7.3 with clarifications in clause H.5. The UE may support being configured for the emerg-request timer using one or more of the following methods:

- the Timer_Emerg-request leaf of the EF_{IMSCConfigData} file described in 3GPP TS 31.102 [15C];
- the Timer_Emerg-request leaf of the EF_{IMSCConfigData} file described in 3GPP TS 31.103 [15B]; and
- the Timer_Emerg-request leaf of 3GPP TS 24.167 [8G].

If the UE is configured with both the Timer_Emerg-request leaf of 3GPP TS 24.167 [8G] and the Timer_Emerg-request leaf of the EF_{IMSCConfigData} file described in 3GPP TS 31.102 [15C] or 3GPP TS 31.103 [15B], then the Timer_Emerg-request leaf of the EF_{IMSCConfigData} file shall take precedence.

[TS 23.167 clause H.6]

Table H.2: Domain Selection Rules for eCall over IMS session attempts for E-UTRAN or NG-RAN radio access networks

	PS Available	VoIMS	EMS	ECL	First eCall Attempt	Second eCall Attempt
A	Y	Y	Y	Y	PS	PS on another PS RAT if available with EMS=Y and ECL=Y or CS if available
B	Y	Y	Y	N	CS if available	PS (UE establishes IMS emergency session)
C	Y	Y or N	N	N	CS if available	PS on another PS RAT if available with EMS=Y or EMS unknown
D	Y	N	Y	Y	PS or CS if available	CS if first attempt in PS PS if first attempt in CS
E	Y	N	Y	N	CS if available	PS (UE establishes IMS emergency session)
F	N		-	-	CS if available	
VoIMS	= Voice over IMS over PS sessions support as indicated by IMS Voice over PS session supported indication as defined in TS 23.401 [28] and TS 23.502 [49].					
EMS	= IMS Emergency Services supported as indicated by Emergency Service Support indicator as defined in TS 23.401 [28] and TS 23.501 [48] and TS 23.502 [49].					
ECL	= eCall Over IMS support as indicated by the eCall support indicator defined in TS 23.401 [28] and					

TS 23.501 [48].

NOTE 1: As an implementation option, when the first attempt uses PS and fails for reasons other than related to IMS, the second attempt may use PS with a different 3GPP RAT. In this case the UE, can make a third attempt using CS.

11.5.13.3 Test description

11.5.13.3.1 Pre-test conditions

System Simulator:

- 2 cells
 - NR Cell 1 as defined in TS 38.508-1 [4] Table 4.4.2-3.
- if px_NR_RATComb_Testcd = NR_UTRA, UTRA Cell 5 as defined in TS 36.508 [7].
 - cell 5 is configured as "Suitable Neighbour cell".
- if px_NR_RATComb_Testcd = NR_GERAN, GERAN cell 24 as defined in TS 36.508 [7].
 - cell 24 is configured as "Suitable Neighbour cell".

UE:

- the eCall capable UE is equipped with ecall enabled USIM configured as per TS 38.508-1 [4] Table 6.4.1-23.

Preamble:

- The UE is in test state 1N-A as defined in TS 38.508-1 [4], subclause 4.4A.2 on NR Cell 1.

11.5.13.3.2 Test procedure sequence

Table 11.5.13.3.2-1: Main behaviour

St	Procedure	Message Sequence		TP	Verdict
		U - S	Message		
1	A manual eCall is initiated. (Note 1)	-	-	-	-
2-11	Steps 1-10 of generic procedure specified in Table 4.9.11.2.2-1 of TS 38.508-1 [4] with condition 'eCall' are performed.	-	-	-	-
12	Step 1 of Annex A.23 of TS 34.229-5 [41] happens	-->	INVITE	-	-
13	SS waits 15s for emerg-request timer to expire so that MSD transfer fails.	-	-	-	-
-	EXCEPTION: Steps 14a1 to 14b20 describe behaviour that depends on the UE capability; the "lower case letter" identifies a step sequence that takes place if a capability is supported.	-	-	-	-
14a1	IF (px_NR_RATComb_Testcd = NR_UTRA), Check: Does the UE transmit an RRC CONNECTION REQUEST message on Cell 5 with establishment cause set to Emergency Call?	-->	RRC CONNECTION REQUEST	1	P
14a2	The SS transmits an RRC CONNECTION SETUP message.	<--	RRC CONNECTION SETUP	-	-
14a3	The UE transmits an RRC CONNECTION SETUP COMPLETE message.	-->	RRC CONNECTION SETUP COMPLETE	-	-
-	EXCEPTION: In parallel to the event described in steps 1a6 to 1a17, if initiated by the UE the steps 5 to 13 of the generic procedure for Registration on PS specified in	-	-	-	-

	TS 34.108 subclause 7.2.2.2.3 take place.				
14a4	Check: Does the UE transmit a CM SERVICE REQUEST with CM service type IE indicating "Emergency call establishment"?	-->	CM SERVICE REQUEST	1	P
14a5	The SS transmits an AUTHENTICATION REQUEST.	<--	AUTHENTICATION REQUEST	-	-
14a6	The UE transmits AUTHENTICATION RESPONSE.	-->	AUTHENTICATION RESPONSE	-	-
14a7	The SS transmits a SECURITY MODE COMMAND message for the CS domain.	<--	SECURITY MODE COMMAND	-	-
14a8	The UE transmits a SECURITY MODE COMPLETE message.	-->	SECURITY MODE COMPLETE	-	-
14a9	Check: Does the UE transmit an EMERGENCY SETUP message with Emergency Service Category IE bit 6 set to 1 and all other bits are set to 0?	-->	EMERGENCY SETUP	1	P
14a10-14a15	Steps 11 to 16 of the generic test procedure in TS 34.108 subclause 7.2.3.2.3 are performed on Cell 5. NOTE: the CS call setup is completed.	-	-	-	-
14a16	Traffic channel is kept active for at least 5 seconds.	-	-	-	-
14a17	The SS transmits DISCONNECT.	<--	DISCONNECT	-	-
14a18	The UE transmits RELEASE.	-->	RELEASE	-	-
14a19	The SS transmits RELEASE COMPLETE.	<--	RELEASE COMPLETE	-	-
14a20	The SS transmits an RRC CONNECTION RELEASE message.	<--	RRC CONNECTION RELEASE	-	-
14a21	The UE transmits RRC CONNECTION RELEASE COMPLETE.	-->	RRC CONNECTION RELEASE COMPLETE	-	-
14b1	IF (px_Nr_RATComb_Tested = NR_GERAN), Check: Does the UE transmit a CHANNEL REQUEST message on Cell 24 with Establishment cause: Emergency call?	-->	CHANNEL REQUEST	1	P
14b2	The SS transmits an IMMEDIATE ASSIGNMENT message.	<--	IMMEDIATE ASSIGNMENT	-	-
14b3	Check: Does the UE transmit a CM SERVICE REQUEST with CM service type IE indicating "Emergency call establishment"?	-->	CM SERVICE REQUEST	1	P
14b4	The SS transmits an AUTHENTICATION REQUEST message.	<--	AUTHENTICATION REQUEST	-	-
14b5	The UE transmits an AUTHENTICATION RESPONSE message.	-->	AUTHENTICATION RESPONSE	-	-
14b6	The SS transmits a CIPHERING MODE COMMAND.	<--	CIPHERING MODE COMMAND	-	-
14b7	The UE transmits a CIPHERING MODE COMPLETE.	-->	CIPHERING MODE COMPLETE	-	-
14b8	Check: Does the UE transmit an EMERGENCY SETUP message with Emergency Service Category IE bit 6 set to 1 and all other bits are set to 0?	-->	EMERGENCY SETUP	1	P
14b9-14b15	Steps 11 to 17 of the generic test procedure in TS 51.010-1 subclause 10.2.3 are performed on Cell 24. NOTE: the CS call setup is completed.	-	-	-	-
14b16	Traffic channel is kept active for at least 5 seconds.	-	-	-	-
14b17	The SS transmits DISCONNECT.	<--	DISCONNECT	-	-
14b18	The UE transmits RELEASE.	-->	RELEASE	-	-
14b19	The SS transmits RELEASE COMPLETE.	<--	RELEASE COMPLETE	-	-

14b2 0	The SS transmits CHANNEL RELEASE	<--	CHANNEL RELEASE	-	-
Note 1: The request to originate a manual eCall may be performed by MMI or AT command.					

11.5.13.3.3 Specific message contents

Table 11.5.13.3.3-1: SIB1 for NR Cell 1 (All steps, Table 11.5.13.3.2-1)

Derivation path: TS 38.508-1 [4] table 4.6.1-28 Condition eCalloverIMSforNR

Table 11.5.13.3.3-2: INVITE (step 12, Table 11.5.13.3.2-1)

Derivation path: TS 34.229-5 [41] Step 1 in Annex A.23 Condition A20
--

Table 11.5.13.3.3-3: RRC CONNECTION REQUEST (Step 14a1, Table 11.5.13.3.2-1)

Derivation Path: TS 34.108 clause 9.1.1			
Information Element	Value/remark	Comment	Condition
Establishment cause	Emergency Call		

Table 11.5.13.3.3-4: CM SERVICE REQUEST (Steps 14a4 and 14b3, Table 11.5.13.3.2-1)

Derivation Path: TS 24.008[43] Table 9.2.11			
Information Element	Value/remark	Comment	Condition
CM service type	0010	Emergency call establishment	

Table 11.5.13.3.3-5: CHANNEL REQUEST (Step 14b1, Table 11.5.13.3.2-1)

Derivation Path: TS 44.018 Table 9.1.8.1			
Information Element	Value/remark	Comment	Condition
Establishment cause	101	Emergency call	

11.6 3GPP PS Data Off

11.6.1 Data Off / MO Voice Call

11.6.1.1 Test Purpose (TP)

(1)

```
with { UE in PDU SESSION ACTIVE state and in 5GMM-CONNECTED mode and PS Data Off configured to "inactive" }
ensure that {
  when { UE PS Data Off status is changed to "active" }
  then { UE performs a PDU session modification procedure providing the PS Data Off status set to "active" }
}
```

(2)

```
with { UE being registered to IMS and with PS Data Off configured to "inactive" }
ensure that {
  when { UE PS Data Off status is changed to "active" }
  then { UE sends REGISTER with PS Data Off configured to "active" }
}
```

(3)

```

with { UE being registered to IMS and with PS Data Off configured to "active" }
ensure that {
  when { UE is being made to initiate a voice call }
  then { UE sends INVITE for voice call }
}

```

11.6.1.2 Conformance Requirements

References: The conformance requirements covered in the present TC are specified in: TS 24.501, clause 6.2.10. TS 24.229 clause 4.17, Rel-15. Unless otherwise stated these are Rel-16 requirements.

[TS 24.501, clause 6.2.10]

In case of PLMN, a UE, which supports 3GPP PS data off (see 3GPP TS 23.501 [8]), can be configured with up to two lists of 3GPP PS data off exempt services as specified in 3GPP TS 24.368 [17] or in the EF_{3GPPPSDATAOFF} USIM file as specified in 3GPP TS 31.102 [22]:

- a) a list of 3GPP PS data off exempt services to be used in the HPLMN or EHPLMN; and
- b) a list of 3GPP PS data off exempt services to be used in the VPLMN.

If only the list of 3GPP PS data off exempt services to be used in the HPLMN or EHPLMN is configured at the UE, this list shall be also used in the VPLMN.

In case of SNPN, a UE, which supports 3GPP PS data off (see 3GPP TS 23.501 [8]), can be configured with a list of 3GPP PS data off exempt services as specified in 3GPP TS 24.368 [17] for each SNPN whose entry exists in the "list of subscriber data":

- a) a list of 3GPP PS data off exempt services to be used in the SNPN.

If the UE supports 3GPP PS data off, the UE shall provide the 3GPP PS data off UE status in the Extended protocol configuration options IE during UE-requested PDU session establishment procedure except for the transfer of a PDU session from non-3GPP access to 3GPP access and except for the establishment of user plane resources on the other access for the MA PDU session (see subclause 6.4.1), and during UE-requested PDU session modification procedure (see subclause 6.4.2), regardless of associated access type of the PDU session. If the UE requests a PDU session establishment procedure in order to transfer a PDU session from non-3GPP access to 3GPP access, or in order to establish user plane resources on the other access for the MA PDU session over 3GPP access or non-3GPP access, and:

- a) if the 3GPP PS data off UE status has changed since the last providing to the network, the UE shall provide the 3GPP PS data off UE status in the Extended protocol configuration options IE; or
- b) if the 3GPP PS data off UE status has not changed since the last providing to the network, the UE need not provide the 3GPP PS data off UE status.

The network shall support of 3GPP PS data off.

The UE shall indicate change of the 3GPP PS data off UE status for the PDU session by using the UE-requested PDU session modification procedure as specified in subclause 6.4.2.

When the 3GPP PS data off UE status is "activated":

- a) the UE does not send uplink IP packets via 3GPP access except:
 - 1) for those services indicated in the list of 3GPP PS data off exempt services to be used in the HPLMN or EHPLMN as specified in 3GPP TS 24.368 [17] when the UE is in its HPLMN or EHPLMN or for those services indicated in the list of 3GPP PS data off exempt services to be used in the SNPN as specified in 3GPP TS 24.368 [17] when the UE is in an SNPN;
 - 2) for those services indicated in the list of 3GPP PS data off exempt services to be used in the HPLMN or EHPLMN when the UE is in the VPLMN, if only the list of 3GPP PS data off exempt services to be used in the HPLMN or EHPLMN is configured to the UE as specified in 3GPP TS 24.368 [17];
 - 3) for those services indicated in the list of 3GPP PS data off exempt services to be used in the VPLMN when the UE is in the VPLMN, if the list of 3GPP PS data off exempt services to be used in the VPLMN is configured to the UE as specified in 3GPP TS 24.368 [17];

- 4) for those services indicated in the $EF_{3GPPPSDATAOFF}$ USIM file as specified in 3GPP TS 31.102 [22];
 - 5) any uplink traffic due to procedures specified in 3GPP TS 24.229 [14]; and
 - 6) any uplink traffic due to procedures specified in 3GPP TS 24.623 [20];
- b) the UE does not send uplink Ethernet user data packets via 3GPP access; and
- c) the UE does not send uplink Unstructured user data packets via 3GPP access.

Otherwise the UE sends uplink user data packets without restriction.

NOTE: If the UE supports 3GPP PS data off, uplink IP packets are filtered as specified in 3GPP TS 24.229 [14] in U.3.1.5.

3GPP PS data off does not restrict sending of uplink user data packets via non-3GPP access of a single access PDU session or an MA PDU session.

[TS 24.229, Rel-15, clause 4.17]

The UE and the network can support the 3GPP PS data off.

When 3GPP PS data off is supported and active, IP packets that are associated with services that are not a 3GPP PS data off exempt service are prevented from transport over EPS IP-CAN, GPRS IP-CAN and 5GS IP-CAN as specified in 3GPP TS 23.228 [7]. The UE may be configured by the HPLMN or the EHPLMN with up to two indications whether a 3GPP IMS service is a 3GPP PS Data Off exempt service, one indication is valid for the UE is in the HPLMN or the EHPLMN and the other indication is valid for the UE is in the VPLMN. When the UE is only configured with the indication valid for the UE camping in the HPLMN or the EHPLMN, the UE shall use this indication also when the UE is in the VPLMN.

When 3GPP PS data off is supported and active and the UE is configured, either as specified in 3GPP TS 24.167 [8G] or in 3GPP TS 31.102 [15C], with services that are 3GPP PS data off exempt, then the UE will not send uplink IP packets related to any services that are not 3GPP PS data off exempt over EPS IP-CAN, GPRS IP-CAN and 5GS IP-CAN. The UE informs the network about its 3GPP PS data off status by including a `g.3gpp.ps-data-off` media feature tag specified in subclause 7.9.8 in all REGISTER requests sent over GPRS IP-CAN, EPS IP-CAN or 5GS IP-CAN. The UE reregisters over EPS IP-CAN, GPRS IP-CAN and 5GS IP-CAN every time the 3GPP PS data off status is changed or the UE is provided by the network with a new list of 3GPP PS data off exempt services while the 3GPP PS data off status is "active".

An AS handling a service is configured with information whether the service is a 3GPP PS data off exempt service. If the 3GPP PS data off status is active and the service is not a 3GPP PS data off exempt service, the AS prevents downlink IP packets of the service from reaching the UE over EPS IP-CAN, GPRS IP-CAN and 5GS IP-CAN. The AS shall be configured with up to two indications whether a 3GPP IMS service is a 3GPP PS Data Off exempt service, one indication is valid for non-roaming users, and the other indication is valid for users roaming in the various VPLMNs with whom roaming agreements exist. When the AS is only configured with the indication valid for the UE camping in the HPLMN or the EHPLMN, the AS shall use this indication also when the UE is in the VPLMN.

[TS 24.229, Rel-15, clause U.3.1.0]

If the UE supports the 3GPP PS data off, then the UE shall in all REGISTER requests include the `+g.3gpp.ps-data-off` header field parameter defined in subclause 7.9.8 set to a value indicating the 3GPP PS data off status.

When the UE sends a REGISTER request, if the 3GPP PS data off status is "active", then the UE shall only include media feature tags associated with services that are 3GPP PS data off exempt services in the `g.3gpp.icsi-ref` media feature tag, as defined in subclause 7.9.2 and RFC 3840 [62], for the IMS communication services it intends to use.

If the UE is registered, and the 3GPP PS data off status is changed, then the UE shall perform a reregistration of the previously registered public user identity.

11.6.1.3 Test description

11.6.1.3.1 Pre-test conditions

System Simulator:

- 1 NR Cell connected to 5GC, default parameters.

UE:

- None.

Preamble:

- UE is in state 3N-A with IMS registered on NR cell 1 according to TS 38.508-1 [4] Table 4.4A.2-3.

11.6.1.3.2 Test procedure sequence

Table 11.6.1.3.2-1: Main Behaviour

St	Procedure	Message Sequence		TP	Verdict
		U - S	Message		
1	UE is made to activate Data Off, see NOTE 1	-	-	-	-
2	Check: Does the UE transmit a PDU SESSION MODIFICATION REQUEST message with Data Off status set to activated?	-->	5GSM: PDU SESSION MODIFICATION REQUEST	1	P
3	The SS transmits an PDU SESSION MODIFICATION COMMAND message.	<--	5GSM: PDU SESSION MODIFICATION COMMAND	-	-
-	EXCEPTION: Steps 4 and 5 can occur in any order	-	-	-	-
4	the UE transmit an PDU SESSION MODIFICATION COMPLETE message.	-->	5GSM: PDU SESSION MODIFICATION COMPLETE	-	-
5	Check: does the UE re-register with "+g.3gpp.ps-data-off" header field parameter set to "active"?	-->	IMS: REGISTER	2	P
6	SS responds with 200 OK	<--	IMS: 200 OK		
7	UE is made to attempt an IMS voice call.	-	-		
8-12	Check: is the MTSI MO Voice call / 5GS procedure, steps 1-5, of Annex A.4.1a in TS 34.229-5 [41] performed?			3	P
13-15	Steps 10-12 of generic procedure specified in Table 4.9.15.2.2-1 of TS 38.508-1 [21] are performed.	-	-	-	-
16-22	Check: is the MTSI MO Voice call / 5GS procedure, steps 6-12, of Annex A.4.1a in TS 34.229-5 [41] performed?	-	-	3	P
23-24	SS releases the call. (Steps 1-2 of Annex A.8 in TS 34.229-5 [41])	-	-	-	-
NOTE 1: This could be done by e.g. MMI or AT command.					

11.6.1.3.3 Specific message contents

Table 11.6.1.3.3-1: PDU SESSION MODIFICATION REQUEST (step 2, Table 11.6.1.3.2-1)

Derivation path: TS 38.508-1 [4], Table 4.7.2-7			
Information Element	Value/remark	Comment	Condition
Extended protocol configuration options			
Container ID n	'0017'H	n assigned to next available number	
Length of container ID n contents		1 octet	
Container ID n contents	'02'H	3GPP PS data off UE status activated	

Table 11.6.1.3.3-2: PDU SESSION MODIFICATION COMMAND (step 3, Table 11.6.1.3.2-1)

Derivation path: TS 38.508-1 [4], Table 4.7.2-7			
Information Element	Value/remark	Comment	Condition
Extended protocol configuration options			
Container ID n	'0017'H	n assigned to next available number	
Length of container ID n contents		0 octets	
Container ID n contents	empty	3GPP PS data off support indication	

Table 11.6.1.3.3-3: REGISTER (step 5, Table 11.6.1.3.2-1)

Derivation Path: TS 34.229-1 [2], Annex A.1.1, Conditions A2, A4, A17, A32				
Header/param	Cond	Value/remark	Rel	Reference
Contact feature-param		+g.3gpp.ps-data-off="active"		TS 24.229 [7]

11.6.2 Data Off / MO Video Call

11.6.2.1 Test Purpose (TP)

(1)

```
with { UE in PDU SESSION ACTIVE state and in 5GMM-CONNECTED mode and PS Data Off configured to "inactive" }
ensure that {
  when { UE PS Data Off status is changed to "active" }
  then { UE performs a PDU session modification procedure providing the PS Data Off status set to "active" }
}
```

(2)

```
with { UE being registered to IMS and with PS Data Off configured to "inactive" }
ensure that {
  when { UE PS Data Off status is changed to "active" }
  then { UE sends REGISTER with PS Data Off configured to "active" }
}
```

(3)

```
with { UE being registered to IMS and with PS Data Off configured to "active" }
ensure that {
  when { UE is being made to initiate a video call }
  then { UE does not send INVITE for video call }
}
```

11.6.2.2 Conformance Requirements

References: The conformance requirements covered in the present TC are specified in: TS 24.501, clause 6.2.10. TS 24.229 clause 4.17, Rel-15. Unless otherwise stated these are Rel-16 requirements.

[TS 24.501, clause 6.2.10]

In case of PLMN, a UE, which supports 3GPP PS data off (see 3GPP TS 23.501 [8]), can be configured with up to two lists of 3GPP PS data off exempt services as specified in 3GPP TS 24.368 [17] or in the EF_{3GPPPSDATAOFF} USIM file as specified in 3GPP TS 31.102 [22]:

- a) a list of 3GPP PS data off exempt services to be used in the HPLMN or EHPLMN; and
- b) a list of 3GPP PS data off exempt services to be used in the VPLMN.

If only the list of 3GPP PS data off exempt services to be used in the HPLMN or EHPLMN is configured at the UE, this list shall be also used in the VPLMN.

In case of SNPN, a UE, which supports 3GPP PS data off (see 3GPP TS 23.501 [8]), can be configured with a list of 3GPP PS data off exempt services as specified in 3GPP TS 24.368 [17] for each SNPN whose entry exists in the "list of subscriber data":

- a) a list of 3GPP PS data off exempt services to be used in the SNPN.

If the UE supports 3GPP PS data off, the UE shall provide the 3GPP PS data off UE status in the Extended protocol configuration options IE during UE-requested PDU session establishment procedure except for the transfer of a PDU session from non-3GPP access to 3GPP access and except for the establishment of user plane resources on the other access for the MA PDU session (see subclause 6.4.1), and during UE-requested PDU session modification procedure (see subclause 6.4.2), regardless of associated access type of the PDU session. If the UE requests a PDU session establishment procedure in order to transfer a PDU session from non-3GPP access to 3GPP access, or in order to establish user plane resources on the other access for the MA PDU session over 3GPP access or non-3GPP access, and:

- a) if the 3GPP PS data off UE status has changed since the last providing to the network, the UE shall provide the 3GPP PS data off UE status in the Extended protocol configuration options IE; or
- b) if the 3GPP PS data off UE status has not changed since the last providing to the network, the UE need not provide the 3GPP PS data off UE status.

The network shall support of 3GPP PS data off.

The UE shall indicate change of the 3GPP PS data off UE status for the PDU session by using the UE-requested PDU session modification procedure as specified in subclause 6.4.2.

When the 3GPP PS data off UE status is "activated":

- a) the UE does not send uplink IP packets via 3GPP access except:
 - 1) for those services indicated in the list of 3GPP PS data off exempt services to be used in the HPLMN or EHPLMN as specified in 3GPP TS 24.368 [17] when the UE is in its HPLMN or EHPLMN or for those services indicated in the list of 3GPP PS data off exempt services to be used in the SNPN as specified in 3GPP TS 24.368 [17] when the UE is in an SNPN;
 - 2) for those services indicated in the list of 3GPP PS data off exempt services to be used in the HPLMN or EHPLMN when the UE is in the VPLMN, if only the list of 3GPP PS data off exempt services to be used in the HPLMN or EHPLMN is configured to the UE as specified in 3GPP TS 24.368 [17];
 - 3) for those services indicated in the list of 3GPP PS data off exempt services to be used in the VPLMN when the UE is in the VPLMN, if the list of 3GPP PS data off exempt services to be used in the VPLMN is configured to the UE as specified in 3GPP TS 24.368 [17];
 - 4) for those services indicated in the EF_{3GPPPSDATAOFF} USIM file as specified in 3GPP TS 31.102 [22];
 - 5) any uplink traffic due to procedures specified in 3GPP TS 24.229 [14]; and
 - 6) any uplink traffic due to procedures specified in 3GPP TS 24.623 [20];
- b) the UE does not send uplink Ethernet user data packets via 3GPP access; and
- c) the UE does not send uplink Unstructured user data packets via 3GPP access.

Otherwise the UE sends uplink user data packets without restriction.

NOTE: If the UE supports 3GPP PS data off, uplink IP packets are filtered as specified in 3GPP TS 24.229 [14] in U.3.1.5.

3GPP PS data off does not restrict sending of uplink user data packets via non-3GPP access of a single access PDU session or an MA PDU session.

[TS 24.229, Rel-15, clause 4.17]

The UE and the network can support the 3GPP PS data off.

When 3GPP PS data off is supported and active, IP packets that are associated with services that are not a 3GPP PS data off exempt service are prevented from transport over EPS IP-CAN, GPRS IP-CAN and 5GS IP-CAN as specified in 3GPP TS 23.228 [7]. The UE may be configured by the HPLMN or the EHPLMN with up to two indications whether a 3GPP IMS service is a 3GPP PS Data Off exempt service, one indication is valid for the UE is in the HPLMN or the EHPLMN and the other indication is valid for the UE is in the VPLMN. When the UE is only configured with the indication valid for the UE camping in the HPLMN or the EHPLMN, the UE shall use this indication also when the UE is in the VPLMN.

When 3GPP PS data off is supported and active and the UE is configured, either as specified in 3GPP TS 24.167 [8G] or in 3GPP TS 31.102 [15C], with services that are 3GPP PS data off exempt, then the UE will not send uplink IP packets related to any services that are not 3GPP PS data off exempt over EPS IP-CAN, GPRS IP-CAN and 5GS IP-CAN. The UE informs the network about its 3GPP PS data off status by including a g.3gpp.ps-data-off media feature tag specified in subclause 7.9.8 in all REGISTER requests sent over GPRS IP-CAN, EPS IP-CAN or 5GS IP-CAN. The UE reregisters over EPS IP-CAN, GPRS IP-CAN and 5GS IP-CAN every time the 3GPP PS data off status is changed or the UE is provided by the network with a new list of 3GPP PS data off exempt services while the 3GPP PS data off status is "active".

An AS handling a service is configured with information whether the service is a 3GPP PS data off exempt service. If the 3GPP PS data off status is active and the service is not a 3GPP PS data off exempt service, the AS prevents downlink IP packets of the service from reaching the UE over EPS IP-CAN, GPRS IP-CAN and 5GS IP-CAN. The AS shall be configured with up to two indications whether a 3GPP IMS service is a 3GPP PS Data Off exempt service, one indication is valid for non-roaming users, and the other indication is valid for users roaming in the various VPLMNs with whom roaming agreements exist. When the AS is only configured with the indication valid for the UE camping in the HPLMN or the EHPLMN, the AS shall use this indication also when the UE is in the VPLMN.

[TS 24.229, Rel-15, clause U.3.1.0]

If the UE supports the 3GPP PS data off, then the UE shall in all REGISTER requests include the "+g.3gpp.ps-data-off" header field parameter defined in subclause 7.9.8 set to a value indicating the 3GPP PS data off status.

When the UE sends a REGISTER request, if the 3GPP PS data off status is "active", then the UE shall only include media feature tags associated with services that are 3GPP PS data off exempt services in the g.3gpp.icsi-ref media feature tag, as defined in subclause 7.9.2 and RFC 3840 [62], for the IMS communication services it intends to use.

If the UE is registered, and the 3GPP PS data off status is changed, then the UE shall perform a reregistration of the previously registered public user identity.

11.6.2.3 Test description

11.6.2.3.1 Pre-test conditions

System Simulator:

- 1 NR Cell connected to 5GC, default parameters.

UE:

- None.

Preamble:

- UE is in state 3N-A with IMS registered on NR cell 1 according to TS 38.508-1 [4] Table 4.4A.2-3.

11.6.2.3.2 Test procedure sequence

Table 11.6.2.3.2-1: Main Behaviour

St	Procedure	Message Sequence		TP	Verdict
		U - S	Message		
1	UE is made to activate Data Off, see NOTE 1.	-	-	-	-
2	Check: Does the UE transmit a PDU SESSION MODIFICATION REQUEST message with	-->	5GSM: PDU SESSION MODIFICATION REQUEST	1	P

	Data Off status set to activated?				
3	The SS transmits an PDU SESSION MODIFICATION COMMAND message.	<--	5GSM: PDU SESSION MODIFICATION COMMAND	-	-
-	EXCEPTION: Steps 4 and 5 can occur in any order	-	-	-	-
4	the UE transmit an PDU SESSION MODIFICATION COMPLETE message.	-->	5GSM: PDU SESSION MODIFICATION COMPLETE	-	-
5	Check: does the UE re-register with "+g.3gpp.ps-data-off" header field parameter set to "active"?	-->	IMS: REGISTER	2	P
6	SS responds with 200 OK	<--	IMS: 200 OK		
7	UE is made to attempt an IMS video call.	-	-		
8	Check: Does the UE send a SIP INVITE within 30 seconds?	-	-	3	F
NOTE 1: This could be done by e.g. MMI or AT command.					

11.6.2.3.3 Specific message contents

Table 11.6.2.3.3-1: PDU SESSION MODIFICATION REQUEST (step 2, Table 11.6.2.3.2-1)

Derivation path: TS 38.508-1 [4], Table 4.7.2-7			
Information Element	Value/remark	Comment	Condition
Extended protocol configuration options			
Container ID n	'0017'H	n assigned to next available number	
Length of container ID n contents			
Container ID n contents	'02'H	3GPP PS data off UE status activated	

Table 11.6.2.3.3-2: PDU SESSION MODIFICATION COMMAND (step 3, Table 11.6.2.3.2-1)

Derivation path: TS 38.508-1 [4], Table 4.7.2-9			
Information Element	Value/remark	Comment	Condition
Extended protocol configuration options			
Container ID n	'0017'H	n assigned to next available number	
Length of container ID n contents			
Container ID n contents	empty	3GPP PS data off support indication	

Table 11.6.2.3.3-3: REGISTER (step 5, Table 11.6.2.3.2-1)

Derivation Path: TS 34.229-1 [2], Annex A.1.1, Conditions A2, A4, A17, A32				
Header/param	Cond	Value/remark	Rel	Reference
Contact feature-param		+g.3gpp.ps-data-off="active"		TS 24.229 [7]

11.6.3 Data Off / SMSoIP

11.6.3.1 Test Purpose (TP)

(1)

```

with { UE in PDU SESSION ACTIVE state and in 5GMM-CONNECTED mode and PS Data Off configured to
"inactive" }
ensure that {
  when { UE PS Data Off status is changed to "active" }
  then { UE performs a PDU session modification procedure providing the PS Data Off status set to
"active" }
}

```

(2)

```

with { UE being registered to IMS and with PS Data Off configured to "inactive" }
ensure that {
  when { UE PS Data Off status is changed to "active" }
  then { UE sends REGISTER with PS Data Off configured to "active" }
}

```

(3)

```

with { UE being registered to IMS and with PS Data Off configured to "active" }
ensure that {
  when { UE is being made to send an SMS over IP }
  then { UE sends a SIP MESSAGE request containing a short message }
}

```

11.6.3.2 Conformance Requirements

References: The conformance requirements covered in the present TC are specified in: TS 24.501, clause 6.2.10. TS 24.341, clause 5.3.1.2, 5.3.1.3 and TS 24.229 clause 4.17, Rel-15. Unless otherwise stated these are Rel-16 requirements.

[TS 24.341, clause 5.3.1.2]:

When an SM-over-IP sender wants to submit an SM over IP, the SM-over-IP sender shall send a SIP MESSAGE request with the following information:

- a) the Request-URI, which shall contain the PSI of the SC of the SM-over-IP sender;

NOTE 1: The PSI of the SC can be SIP URI or tel URI based on operator policy. The PSI of the SC can be obtained using one of the following methods in the priority order listed below:

- 1) provided by the user;
- 2) if UICC is used, then:
 - if present in the ISIM, then the PSI of the SC is obtained from the EF_{PSISMSC} in DF_TELECOM of the ISIM as per 3GPP TS 31.103 [18];
 - if not present on the ISIM, then the PSI of the SC is obtained from the EF_{PSISMSC} in DF_TELECOM of the USIM as per 3GPP TS 31.102 [19]; or
 - if neither present on the ISIM nor on the USIM, then the PSI of the SC contains the TS-Service-Centre-Address stored in the EF_{SMSP} in DF_TELECOM as per 3GPP TS 31.102 [19]. If the PSI of the SC is based on the E.164 number from the TS-Service-Centre-Address stored in the EF_{SMSP} in DF_TELECOM then the URI constructed can be either a tel URI or a SIP URI (using the "user=phone" SIP URI parameter format).
- 3) if SIM is used instead of UICC, then the PSI of the SC contains the TS-Service Centre Address stored in the EF_{SMSP} in DF_TELECOM as per 3GPP TS 51.011 [20]. If the PSI of the SC is based on the E.164 number from the TS-Service-Centre-Address stored in the EF_{SMSP} in DF_TELECOM then the URI constructed can be either a tel URI or a SIP URI (using the "user=phone" SIP URI parameter format); or
- 4) if neither the UICC nor SIM is used, then how the PSI of the SC is configured and obtained is through means outside the scope of this specification.

- b) the From header, which shall contain a public user identity of the SM-over-IP sender;

NOTE 2: The IP-SM-GW will have to use an address of the SM-over-IP sender that the SC can process (i.e. an E.164 number). This address will come from a tel URI in a P-Asserted-Identity header (as defined in RFC 3325 [13]) placed in the SIP MESSAGE request by the P-CSCF or S-CSCF.

NOTE 3: The SM-over-IP sender has to store the Call-ID of the SIP MESSAGE request, so it can associate the appropriate SIP MESSAGE request including a submit report with it.

- c) the To header, which shall contain the SC of the SM-over-IP sender;
- d) the Content-Type header, which shall contain "application/vnd.3gpp.sms"; and
- e) the body of the request shall contain an RP-DATA message as defined in 3GPP TS 24.011 [8], including the SMS headers and the SMS user information encoded as specified in 3GPP TS 23.040 [3].

NOTE 4: The address of the SC is included in the RP-DATA message content. The address of the SC included in the RP-DATA message content is stored in the EF_{SMSP} in DF_TELECOM of the (U)SIM of the SM-over-IP sender.

NOTE 5: The SM-over-IP sender will use content transfer encoding of type "binary" for the encoding of the SM in the body of the SIP MESSAGE request.

NOTE 6: Both the address of the SC and the PSI of the SC can be configured in the EF_{PSISMSC} in DF_TELECOM of the USIM and ISIM respectively using the USAT as per 3GPP TS 31.111 [21].

The SM-over-IP sender may request the SC to return the status of the submitted message. The support of status report capabilities is optional for the SC.

When a SIP MESSAGE request including a submit report in the "vnd.3gpp.sms" payload is received, the SM-over-IP sender shall:

- if SM-over-IP sender supports In-Reply-To header usage and the In-Reply-To header indicates that the request corresponds to a short message submitted by the SM-over-IP sender, generate a 200 (OK) SIP response according to RFC 3428 [14].

if SM-over-IP sender supports In-Reply-To header usage and the In-Reply-To header indicates that the request does not correspond to a short message submitted by the SM-over-IP sender, a 488 (Not Acceptable here) SIP response according to RFC 3428 [14].

- if SM-over-IP sender does not support In-Reply-To header usage, generate a 200 (OK) SIP response according to RFC 3428 [14]; and extract the payload encoded according to 3GPP TS 24.011 [8] for RP-ACK or RP-ERROR.

[TS 24.341 clause 5.3.1.3]:

When a SIP MESSAGE request including a status report in the "vnd.3gpp.sms" payload is delivered, the SM-over-IP sender shall:

- generate a SIP response according to RFC 3428 [14];
- extract the payload encoded according to 3GPP TS 24.011 [8] for RP-DATA; and
- create a delivery report for the status report as described in subclause 5.3.2.4. The content of the delivery report is defined in 3GPP TS 24.011 [8].

[TS 24.341 clause 5.3.2.4]:

When an SM-over-IP receiver wants to send an SM delivery report over IP, the SM-over-IP receiver shall send a SIP MESSAGE request with the following information:

- a) the Request-URI, which shall contain the IP-SM-GW;

NOTE 1: The address of the IP-SM-GW is received in the P-Asserted-Identity header in the SIP MESSAGE request including the delivered short message.

- b) the From header, which shall contain a public user identity of the SM-over-IP receiver.
- c) the To header, which shall contain the IP-SM-GW;
- b) the Content-Type header shall contain "application/vnd.3gpp.sms"; and
- c) the body of the request shall contain the RP-ACK or RP-ERROR message for the SM delivery report, as defined in 3GPP TS 24.011 [8].

NOTE 2: The SM-over-IP sender will use content transfer encoding of type "binary" for the encoding of the SM in the body of the SIP MESSAGE request.

[TS 24.501, clause 6.2.10]

In case of PLMN, a UE, which supports 3GPP PS data off (see 3GPP TS 23.501 [8]), can be configured with up to two lists of 3GPP PS data off exempt services as specified in 3GPP TS 24.368 [17] or in the EF_{3GPPPSDATAOFF} USIM file as specified in 3GPP TS 31.102 [22]:

- a) a list of 3GPP PS data off exempt services to be used in the HPLMN or EHPLMN; and
- b) a list of 3GPP PS data off exempt services to be used in the VPLMN.

If only the list of 3GPP PS data off exempt services to be used in the HPLMN or EHPLMN is configured at the UE, this list shall be also used in the VPLMN.

In case of SNPN, a UE, which supports 3GPP PS data off (see 3GPP TS 23.501 [8]), can be configured with a list of 3GPP PS data off exempt services as specified in 3GPP TS 24.368 [17] for each SNPN whose entry exists in the "list of subscriber data":

- a) a list of 3GPP PS data off exempt services to be used in the SNPN.

If the UE supports 3GPP PS data off, the UE shall provide the 3GPP PS data off UE status in the Extended protocol configuration options IE during UE-requested PDU session establishment procedure except for the transfer of a PDU session from non-3GPP access to 3GPP access and except for the establishment of user plane resources on the other access for the MA PDU session(see subclause 6.4.1), and during UE-requested PDU session modification procedure (see subclause 6.4.2), regardless of associated access type of the PDU session. If the UE requests a PDU session establishment procedure in order to transfer a PDU session from non-3GPP access to 3GPP access, or in order to establish user plane resources on the other access for the MA PDU session over 3GPP access or non-3GPP access, and:

- a) if the 3GPP PS data off UE status has changed since the last providing to the network, the UE shall provide the 3GPP PS data off UE status in the Extended protocol configuration options IE; or
- b) if the 3GPP PS data off UE status has not changed since the last providing to the network, the UE need not provide the 3GPP PS data off UE status.

The network shall support of 3GPP PS data off.

The UE shall indicate change of the 3GPP PS data off UE status for the PDU session by using the UE-requested PDU session modification procedure as specified in subclause 6.4.2.

When the 3GPP PS data off UE status is "activated":

- a) the UE does not send uplink IP packets via 3GPP access except:
 - 1) for those services indicated in the list of 3GPP PS data off exempt services to be used in the HPLMN or EHPLMN as specified in 3GPP TS 24.368 [17] when the UE is in its HPLMN or EHPLMN or for those services indicated in the list of 3GPP PS data off exempt services to be used in the SNPN as specified in 3GPP TS 24.368 [17] when the UE is in an SNPN;
 - 2) for those services indicated in the list of 3GPP PS data off exempt services to be used in the HPLMN or EHPLMN when the UE is in the VPLMN, if only the list of 3GPP PS data off exempt services to be used in the HPLMN or EHPLMN is configured to the UE as specified in 3GPP TS 24.368 [17];
 - 3) for those services indicated in the list of 3GPP PS data off exempt services to be used in the VPLMN when the UE is in the VPLMN, if the list of 3GPP PS data off exempt services to be used in the VPLMN is configured to the UE as specified in 3GPP TS 24.368 [17];
 - 4) for those services indicated in the EF_{3GPPPSDATAOFF} USIM file as specified in 3GPP TS 31.102 [22];
 - 5) any uplink traffic due to procedures specified in 3GPP TS 24.229 [14]; and
 - 6) any uplink traffic due to procedures specified in 3GPP TS 24.623 [20];
- b) the UE does not send uplink Ethernet user data packets via 3GPP access; and

c) the UE does not send uplink Unstructured user data packets via 3GPP access.

Otherwise the UE sends uplink user data packets without restriction.

NOTE: If the UE supports 3GPP PS data off, uplink IP packets are filtered as specified in 3GPP TS 24.229 [14] in U.3.1.5.

3GPP PS data off does not restrict sending of uplink user data packets via non-3GPP access of a single access PDU session or an MA PDU session.

[TS 24.229, Rel-15, clause 4.17]

The UE and the network can support the 3GPP PS data off.

When 3GPP PS data off is supported and active, IP packets that are associated with services that are not a 3GPP PS data off exempt service are prevented from transport over EPS IP-CAN, GPRS IP-CAN and 5GS IP-CAN as specified in 3GPP TS 23.228 [7]. The UE may be configured by the HPLMN or the EHPLMN with up to two indications whether a 3GPP IMS service is a 3GPP PS Data Off exempt service, one indication is valid for the UE is in the HPLMN or the EHPLMN and the other indication is valid for the UE is in the VPLMN. When the UE is only configured with the indication valid for the UE camping in the HPLMN or the EHPLMN, the UE shall use this indication also when the UE is in the VPLMN.

When 3GPP PS data off is supported and active and the UE is configured, either as specified in 3GPP TS 24.167 [8G] or in 3GPP TS 31.102 [15C], with services that are 3GPP PS data off exempt, then the UE will not send uplink IP packets related to any services that are not 3GPP PS data off exempt over EPS IP-CAN, GPRS IP-CAN and 5GS IP-CAN. The UE informs the network about its 3GPP PS data off status by including a g.3gpp.ps-data-off media feature tag specified in subclause 7.9.8 in all REGISTER requests sent over GPRS IP-CAN, EPS IP-CAN or 5GS IP-CAN. The UE reregisters over EPS IP-CAN, GPRS IP-CAN and 5GS IP-CAN every time the 3GPP PS data off status is changed or the UE is provided by the network with a new list of 3GPP PS data off exempt services while the 3GPP PS data off status is "active".

An AS handling a service is configured with information whether the service is a 3GPP PS data off exempt service. If the 3GPP PS data off status is active and the service is not a 3GPP PS data off exempt service, the AS prevents downlink IP packets of the service from reaching the UE over EPS IP-CAN, GPRS IP-CAN and 5GS IP-CAN. The AS shall be configured with up to two indications whether a 3GPP IMS service is a 3GPP PS Data Off exempt service, one indication is valid for non-roaming users, and the other indication is valid for users roaming in the various VPLMNs with whom roaming agreements exist. When the AS is only configured with the indication valid for the UE camping in the HPLMN or the EHPLMN, the AS shall use this indication also when the UE is in the VPLMN.

[TS 24.229, Rel-15, clause U.3.1.0]

If the UE supports the 3GPP PS data off, then the UE shall in all REGISTER requests include the "+g.3gpp.ps-data-off" header field parameter defined in subclause 7.9.8 set to a value indicating the 3GPP PS data off status.

When the UE sends a REGISTER request, if the 3GPP PS data off status is "active", then the UE shall only include media feature tags associated with services that are 3GPP PS data off exempt services in the g.3gpp.icsi-ref media feature tag, as defined in subclause 7.9.2 and RFC 3840 [62], for the IMS communication services it intends to use.

If the UE is registered, and the 3GPP PS data off status is changed, then the UE shall perform a reregistration of the previously registered public user identity.

11.6.3.3 Test description

11.6.3.3.1 Pre-test conditions

System Simulator:

- 1 NR Cell connected to 5GC, default parameters.

UE:

- None.

Preamble:

- UE is in state 3N-A with IMS registered on NR cell 1 according to TS 38.508-1 [4] Table 4.4A.2-3.

11.6.3.3.2 Test procedure sequence

Table 11.6.3.3.2-1: Main Behaviour

St	Procedure	Message Sequence		TP	Verdict
		U - S	Message		
1	UE is made to activate Data Off, see NOTE 1.	-	-	-	-
2	Check: Does the UE transmit a PDU SESSION MODIFICATION REQUEST message with Data Off status set to activated?	-->	5GSM: PDU SESSION MODIFICATION REQUEST	1	P
3	The SS transmits an PDU SESSION MODIFICATION COMMAND message.	<--	5GSM: PDU SESSION MODIFICATION COMMAND	-	-
-	EXCEPTION: Steps 4 and 5 can occur in any order	-	-	-	-
4	the UE transmit an PDU SESSION MODIFICATION COMPLETE message.	-->	5GSM: PDU SESSION MODIFICATION COMPLETE	-	-
5	Check: does the UE re-register with "+g.3gpp.ps-data-off" header field parameter set to "active"?	-->	IMS: REGISTER	2	P
6	SS responds with 200 OK	<--	IMS: 200 OK	-	-
7	UE is made to attempt to send an SMSolP message.	-	-		
8	Check: Is the IMS MO SMS / 5GS procedure performed according to steps 1-8 of annex A.13 in TS 34.229-5?	-	-	3	P

NOTE 1: This could be done by e.g. MMI or AT command.

11.6.3.3.3 Specific message contents

Table 11.6.3.3.3-1: PDU SESSION MODIFICATION REQUEST (step 2, Table 11.6.3.3.2-1)

Derivation path: TS 38.508-1 [4], Table 4.7.2-7			
Information Element	Value/remark	Comment	Condition
Extended protocol configuration options			
Container ID n	'0017'H	n assigned to next available number	
Length of container ID n contents		1 octet	
Container ID n contents	'02'H	3GPP PS data off UE status activated	

Table 11.6.3.3.3-2: PDU SESSION MODIFICATION COMMAND (step 3, Table 11.6.3.3.2-1)

Derivation path: TS 38.508-1 [4], Table 4.7.2-9			
Information Element	Value/remark	Comment	Condition
Extended protocol configuration options			
Container ID n	'0017'H	n assigned to next available number	
Length of container ID n contents		0 octets	
Container ID n contents	empty	3GPP PS data off support indication	

Table 11.6.3.3.3-3: REGISTER (step 5, Table 11.6.3.3.2-1)

Derivation Path: TS 34.229-1 [2], Annex A.1.1, Conditions A2, A4, A17, A32				
Header/param	Cond	Value/remark	Rel	Reference
Contact feature-param		+g.3gpp.ps-data-off="active"		TS 24.229 [7]

11.7 eDRX /Redcap

11.7.2 eDRX / Inactive

11.7.2.1 Test Purpose (TP)

(1)

```
with { UE supporting Redcap and in NR RRC_Inactive state and configured eDRX (eDRX cycle < 10.24s) }
ensure that {
  when { the network sends Paging message within a paging occasion }
  then { the UE resumes RRC connection }
}
```

11.7.2.2 Conformance Requirements

References: The conformance requirements covered in the present TC are specified in: TS 24.501, clause 5.3.16.

[TS 24.501, clause 5.3.16]

Extended DRX (eDRX) cycle is supported for a UE in N1 mode. When eDRX is requested by the UE and accepted by the network:

- if the UE is not in NB-N1 mode, eDRX is used when the UE is in 5GMM-IDLE mode or in 5GMM-CONNECTED mode with RRC inactive indication; or
- if the UE is in NB-N1 mode, eDRX is used when the UE is in 5GMM-IDLE mode.

The UE may request the use of eDRX cycle during a registration procedure by including the Requested extended DRX parameters IE (see 3GPP TS 23.501 [8] and 3GPP TS 23.502 [9]). The UE shall not request the use of eDRX during a registration procedure for emergency services. The UE may use the extended idle mode DRX cycle length stored in the USIM (see 3GPP TS 31.102 [22]) when requesting the use of eDRX.

The UE and the network may negotiate eDRX parameters during a registration procedure when the UE has an emergency PDU session.

The network accepts the request to use the eDRX by providing the Negotiated extended DRX parameters IE when accepting the registration procedure. The UE shall use eDRX only if it received the Negotiated extended DRX parameters IE during the last registration procedure and the UE does not have an emergency PDU session.

NOTE: If the UE wants to keep using eDRX, the UE includes the Extended DRX parameters IE in each registration procedure.

If the UE received the Negotiated extended DRX parameters IE during the last registration procedure, upon successful completion of the PDU session release procedure of the emergency PDU session, the UE shall resume eDRX.

If the network has provided the Negotiated extended DRX parameters IE during the last registration procedure, upon successful completion of the PDU session release procedure of the emergency PDU session, the network shall resume eDRX.

If the UE or the network locally releases an emergency PDU session, the UE or the network shall not use eDRX until the UE receives eDRX parameters during a registration procedure with PDU session context synchronization or upon successful completion of a service request procedure with PDU session context synchronization.

If the UE did not receive the Negotiated extended DRX parameters IE, or if the UE has an emergency PDU session, the UE shall use the stored UE specific DRX parameter, if available.

If the network did not accept the request to use eDRX, or if the UE has an emergency PDU session, the network shall use the stored UE specific DRX parameter, if available.

If the network provided the Negotiated extended DRX parameters IE and also assigned a new 5G-GUTI for the UE as described in subclause 5.5.1.3.4 during the last registration procedure, the network shall use the stored UE specific DRX parameter, if available, with the old 5G-GUTI and use the eDRX provided by the network with the new 5G-GUTI until the old 5G-GUTI can be considered as invalid by the network (see subclauses 5.4.4.4 and 5.5.1.3.4).

11.7.2.3 Test description

11.7.2.3.1 Pre-test conditions

System Simulator:

- 1 NR Cell connected to 5GC, default parameters.

UE:

- UE supporting RedCap and extended DRX and eDRX configured to 5,12 seconds and Paging Time Window configured to 2,56 seconds.

Preamble:

- UE is in state 2N-A according to TS 38.508-1 [4] Table 4.4A.2-2.

11.7.2.3.2 Test procedure sequence

Table 11.7.2.3.2-1: Main Behaviour

St	Procedure	Message Sequence		TP	Verdict
		U - S	Message		
1	The SS transmits a <i>Paging</i> message within a paging occasion	<--	NR RRC: <i>Paging</i>	-	-
2	Check: Does the UE transmit an <i>RRCResumeRequest</i> message?	-->	NR RRC: <i>RRCResumeRequest</i>	1	P
3	The SS transmits an <i>RRCResume</i> message.	<--	NR RRC: <i>RRCResume</i>	-	-
4	The UE transmits an <i>RRCResumeComplete</i> message.	-->	NR RRC: <i>RRCResumeComplete</i>	-	-
5	Check: Does the test result of generic test procedure in TS 38.508-1 subclause 4.9.1 indicate that the UE is capable of exchanging IP data on DRB#n associated with default Internet PDU session?	-	-	1	P

11.7.2.3.3 Specific message contents

Table 11.7.2.3.3-1: REGISTRATION REQUEST (preamble)

Derivation path: TS 38.508-1 [4], table 4.7.1-6			
Information Element	Value/Remark	Comment	Condition
Requested extended DRX parameters			
Paging Time Window	'0001'B	2,56 seconds	
eDRX value	'0001'B	5,12 seconds	

Table 11.7.2.3.3-2: REGISTRATION ACCEPT (preamble) Derivation path: TS 38.508-1 [4], table 4.7.1-7			
Information Element	Value/Remark	Comment	Condition
Negotiated extended DRX parameters			
Paging Time Window	'0001'B	2,56 seconds	
eDRX value	'0001'B	5,12 seconds	

11.8

11.8.1 to 11.8.4

11.8.5 Inter-system mobility between untrusted Non-3GPP and 3GPP system/Handover from 5GS to EPC/ePDG

11.8.5.1 Test Purpose (TP)

(1)

```

With { the UE supports N1 mode and S1 mode and IP address preservation between EPC/ePDG and 5GS, at
least one PDU Sessions have been established between the UE and the SMF/UPF via NG-RAN }
ensure that {
  when { When UE detect cellular not available and performs a handover of existing PDU session to
ePDG/EPC }
  then { the UE shall include the CFG_REQUEST Configuration payload containing the type of IP
address, the "IDr" payload containing the APN in the Identification Data, the "IDi" payload
containing the NAI, the N1_MODE_CAPABILITY Notify payload. }
}

```

11.8.5.2 Conformance requirements

[Rel-15, TS 24.302, clause 7.2.2.1]

Once the ePDG has been selected, the UE shall initiate the IPsec tunnel establishment procedure using the IKEv2 protocol as defined in IETF RFC 7296 [28] and 3GPP TS 33.402 [15].

The UE shall send an IKE_SA_INIT request message to the selected ePDG in order to setup an IKEv2 security association. Upon receipt of an IKE_SA_INIT response, the UE shall send an IKE_AUTH request message to the ePDG, including:

- The type of IP address (IPv4 address or IPv6 prefix or both) that needs to be configured in an IKEv2 CFG_REQUEST Configuration Payload. If the UE requests for both IPv4 address and IPv6 prefix, the UE shall send two configuration attributes in the CFG_REQUEST Configuration Payload: one for the IPv4 address and the other for the IPv6 prefix;
- The "IDr" payload, containing the APN in the Identification Data, for non-emergency session establishment. For emergency session establishment, the UE shall format the "IDr" payload according to clause 7.2.5. The UE shall set the ID Type field of the "IDr" payload to ID_FQDN as defined in IETF RFC 7296 [28]. The UE indicates a request for the default APN by omitting the "IDr" payload, which is in accordance with IKEv2 protocol as defined in IETF RFC 7296 [28]; and
- The "IDi" payload containing the NAI.

If the UE supports N1 mode, the UE shall indicate the PDU session ID in the IKE_AUTH request message. If N1 mode capability is disabled, the UE may indicate the PDU session ID in the IKE_AUTH request message.

In order to indicate the PDU session ID in the IKE_AUTH request message, the UE shall include the N1_MODE_CAPABILITY Notify payload as defined in clause 8.2.9.15 in the IKE_AUTH request message and shall:

- if the UE is establishing a PDN connection not related to any existing PDU session or any existing PDN connection, allocate a PDU session ID which is not currently being used by another PDU session over either 3GPP access or non-3GPP access, set the PDU Session ID field of the N1_MODE_CAPABILITY Notify payload to the allocated PDU session ID, and associate the allocated PDU session ID with the PDN connection that is being established;

if the UE is transferring an existing PDU session from 5GS, set the PDU Session ID field of the N1_MODE_CAPABILITY Notify payload to the PDU session ID of the existing PDU session that is being transferred, and associate the PDU session ID with the PDN connection that is being established. If the existing PDU session is a non-emergency PDU session, the UE shall in addition associate the S-NSSAI of the existing PDU session that is being transferred and the related PLMN ID with the PDN connection that is being established; or

- if the UE is transferring an existing PDN connection from EPS and a PDU session ID is associated with the PDN connection that is being transferred, set the PDU Session ID field of the N1_MODE_CAPABILITY Notify payload to the PDU session ID associated with the existing PDN connection. If the existing PDN connection is a non-emergency PDN connection and an S-NSSAI and a related PLMN ID are associated with the existing PDN connection, the UE shall in addition associate the S-NSSAI and the related PLMN ID with the PDN connection that is being established.

...

During the IKEv2 authentication and security association establishment for handover, the UE supporting IP address preservation for NBM, shall provide an indication about Attach Type, which indicates Handover Attach. During the IKEv2 authentication and security association establishment for transfer of an existing PDU session from 5GS, the UE shall provide an indication about Attach Type, which indicates Handover Attach. To indicate attach due to handover, the UE shall include the previously allocated home address information during the IPsec tunnel establishment. Depending on the IP version, the UE shall include either the INTERNAL_IP4_ADDRESS or the INTERNAL_IP6_ADDRESS attribute or both in the CFG_REQUEST Configuration Payload within the IKE_AUTH request message to indicate the home address information which is in accordance with IKEv2 protocol as defined in IETF RFC 7296 [28]. If the previously allocated home address information consists of both an IPv4 address and an IPv6 prefix, then the UE shall include the INTERNAL_IP4_ADDRESS attribute and the INTERNAL_IP6_ADDRESS attribute in the CFG_REQUEST configuration payload within the IKE_AUTH request message. If the previously allocated home address information consists of an IPv4 address only, then the UE shall include the INTERNAL_IP4_ADDRESS attribute and shall not include the INTERNAL_IP6_ADDRESS attribute in the CFG_REQUEST configuration payload within the IKE_AUTH request message. If the previously allocated home address information consists of an IPv6 prefix only, then the UE shall include the INTERNAL_IP6_ADDRESS attribute and shall not include the INTERNAL_IP4_ADDRESS attribute in the CFG_REQUEST configuration payload within the IKE_AUTH request message. The UE shall support IPsec ESP (see IETF RFC 4303 [32]) in order to provide secure tunnels between the UE and the ePDG as specified in 3GPP TS 33.402 [15].

...

After the successful authentication with the 3GPP AAA server, the UE receives from the ePDG an IKE_AUTH response message containing a single CFG_REPLY Configuration Payload including the assigned remote IP address information (IPv4 address or IPv6 prefix) as described in clause 7.4.1. Depending on the used IP mobility management mechanism the following cases can be differentiated:

- If DSMIPv6 is used for IP mobility management, the UE configures a remote IP address based on the IP address information contained in the INTERNAL_IP4_ADDRESS or INTERNAL_IP6_SUBNET attribute of the CFG_REPLY Configuration Payload. The UE uses the remote IP address as Care-of-Address to contact the HA.
- If NBM is used for IP mobility management and the UE performs an initial attach, the UE configures a home address based on the address information from the CFG_REPLY Configuration Payload. Otherwise, if NBM is used and the UE performs a handover attach, the UE continues to use its IP address configured before the handover, if the address information provided in the CFG_REPLY Configuration Payload does match with the UE's IP address configured before the handover. If the UE's IP address (IPv4 address or IPv6 prefix) does not match with the address information of the CFG_REPLY Configuration Payload, the UE shall configure a new home address based on the IP address information contained in the INTERNAL_IP4_ADDRESS, INTERNAL_IP6_SUBNET or INTERNAL_IP6_ADDRESS attribute of the CFG_REPLY Configuration Payload. In the latter case, the IP address preservation is not possible.

NOTE 3: In case of IPv6 address, the UE performs the match only on the IPv6 prefix provided within the CFG_REPLY Configuration Payload contained in the INTERNAL_IP6_SUBNET or INTERNAL_IP6_ADDRESS.

...

During the IKEv2 authentication and security association establishment, following the UE's initial IKE_AUTH request message to the ePDG, if the UE subsequently receives an IKE_AUTH response message from the ePDG containing the EAP-Request/AKA-Challenge, after verifying the received authentication parameters and successfully authenticating the ePDG as specified in 3GPP TS 33.402 [15], the UE shall send a new IKE_AUTH request message to the ePDG including the EAP-Response/AKA-Challenge. In addition, the UE shall provide the requested mobile device identity if available, as specified in clause 7.2.6.

If the UE supports P-CSCF restoration extension for untrusted WLAN as specified in 3GPP TS 23.380 [66], the UE shall send its capability indication of the support of P-CSCF restoration to the ePDG by including the P-

CSCF_RESELECTION_SUPPORT Notify payload within an IKE_AUTH request message. The content of the P-CSCF_RESELECTION_SUPPORT Notify payload is described in clause 8.2.9.4.

If the UE supports N1 mode and the UE receives the N1_MODE_INFORMATION Notify payload as defined in clause 8.2.9.16 in the IKE_AUTH response message, the UE shall delete the associated S-NSSAI, if any, and (re-)associate the S-NSSAI in the S-NSSAI Value field of the N1_MODE_INFORMATION Notify payload with the PDU session associated with the IKEv2 security association that was established, and if the UE receives the N1_MODE_S_NSSAI_PLMN_ID Notify payload as defined in clause 8.2.9.17 in the IKE_AUTH response message, the UE shall delete the associated PLMN ID, if any, and (re-)associate the PLMN ID that the S-NSSAI relates to in the S-NSSAI PLMN ID field of the N1_MODE_S_NSSAI_PLMN_ID Notify payload with the PDU session associated with the IKEv2 security association that was established.

11.8.5.3 Test description

11.8.5.3.1 Pre-test conditions

System Simulator:

- WLAN Cell 27 is configured according to TS 36.508[18], Table 4.4.8-1 with condition IMSoWLAN.
- NR Cell 1 is configured according to TS 38.508-1 [4], Table 4.4.2-3.
- NR Cell 1 is set to "Serving cell".

UE:

- The UE is configured to use IMS preconditions.

Preamble:

- The UE is brought to state 1N-A according to TS 38.508-1 [4], Table 4.4A.2-1. The UE is initially attached to the 3GPP Access network and establish at least an IMS PDU session with 5GC network.

11.8.5.3.2 Test procedure sequence

Table 11.8.5.3.2-1: Main behaviour

St	Procedure	Message Sequence		TP	Verdict
		U - S	Message		
1	NR Cell is set "Off" cell", WLAN Cell is set to "Serving cell "	-		-	-
2	UE associates with the WLAN AP and obtains the local IP address.	-	-	-	-
3	UE transmit a DNS Query message with QNAME set to FQDN of the ePDG	-->	DNS Query	-	-
4	The SS transmits a DNS Response message with the IP address of the ePDG.	<--	DNS Response	-	-
5	UE transmit an IKE_SA_INIT request message to the ePDG	-->	IKE_SA_INIT Request	-	-
6	SS transmits an IKE_SA_INIT response message to UE	<--	IKE_SA_INIT Response	-	-
7	Check: Does UE transmit an IKE_AUTH request including the CFG_REQUEST Configuration payload containing the type of IP address, the "IDr" payload containing the APN in the Identification Data, the "IDi" payload containing the NAI, N1_MODE_CAPABILITY Notify payload?	-->	IKE_AUTH Request	1	P
8	The SS transmits an IKE_AUTH Response message including an EAP-Request/AKA-Challenge.	<--	IKE_AUTH Response	-	-
9	UE transmit an IKE_AUTH Request message including the EAP-Response/AKA-Challenge	-->	IKE_AUTH Request	-	-

10	The SS transmits an IKE_AUTH Response message including EAP-Success.	<--	IKE_AUTH Response	-	-
11	UE transmit an IKE_AUTH Request message with Authentication payload.	-->	IKE_AUTH Request	-	-
12	The SS transmits an IKE_AUTH Response message with Authentication and Configuration payloads.	<--	IKE_AUTH Response	-	-

11.8.5.3.3 Specific message contents

Table 11.8.5.3.3-1: Message DNS Query (step 3, Table 11.8.5.3.2-1)

Derivation path: IETF RFC 1035 [56]			
Information Element	Value/remark	Comment	Condition
QR=	'0'	Query	
OPCODE=	'0000'	QUERY	
QNAME=	Operator provisioned FQDN of the ePDG.		pc_ePDG_FQDN_Provisioned
	Operator Identifier FQDN format shall be "epdg.epc.mnc<MNC>.mcc<MCC>.pub.3gppnetwork.org"		pc_ePDG_FQDN_constructed
QTYPE=	A	query for the IPv4 address	IPv4
	AAAA	query for the IPv6 address	IPv6
QCLASS=	IN		

Condition	Explanation
IPv4	DNS query for IPv4 address
IPv6	DNS query for IPv6 address

Table 11.8.5.3.3-2: Message DNS Response (step 4, Table 11.8.5.3.2-1)

Derivation path: IETF RFC 1035 [56]			
Information Element	Value/remark	Comment	Condition
QR=	'1'	Response	
OPCODE=	'0000'	QUERY	
QNAME=	Same as received in DNS Query		
QTYPE=	A		
QCLASS=	IN		
RR {			
NAME	Same as received in DNS Query		
TYPE	Same as received in DNS Query	A for IPv4 AAAA for IPv6	
CLASS	IN		
RDATA	IP address of ePDG		
}			

Table 11.8.5.3.3-2A: IKE_AUTH request (step 7, Table 11.8.5.3.2-1)

Derivation path: 36.508 table 4.7G-3			
Information Element	Value/remark	Comment	Condition
IKE Header			
Next Payload	'00101111'B	CP	
Exchange Type	'00100011'B	IKE_AUTH	

Configuration Payload			
Next Payload	'00000000'B	Notify payload	
CFG Type	'00000001'B	CFG_REQUEST	
Attribute Type	'00000001'B	INTERNAL_IP4_ADDRESS	IPv4
IPv4 Address	Previously allocated IPv4 address in cellular network		IPv4
Attribute Type	'00001000'B	INTERNAL_IP6_ADDRESS	IPv6
IPv6 Address	Previously allocated IPv6 address in cellular network		IPv6
Attribute Type	'00010100'B	P_CSCF_IP4_ADDRESS	IPv4
IPv4 Address	Not checked		IPv4
Attribute Type	'00010101'B	P_CSCF_IP6_ADDRESS	IPv6
IPv6 Address	Not checked		IPv6
Notify payload	'000101001'B		
Next Payload	'00100100'B	IDr payload	
Notify Message Type	'1100011101000111'B	N1_MODE_CAPABILITY Notify payload	
PDU Session ID	PDU Session ID of the transferred PDU session from 5GC		
IDr payload	'00100100'B		
Next Payload	'00100011'B	IDi payload	
ID Type	'00000010'B	ID_FQDN	
Identification Data	APN		
IDi payload	'00100011'B		
Next Payload	'00000000'B	No Next Payload if Notify payload is the last payload	
ID Type	'00000011'B	NAI	
Identification Data	Not checked		
NOTE 1: The order of Payloads/fields is not checked, unless explicitly specified. Additional Payloads/fields are ignored.			

Condition	Explanation
IPv4	If the UE requests an IPv4 address
IPv6	If the UE requests an IPv6 address
NOTE: At least one of IPv4 and IPv6 shall be true.	

Table 11.8.5.3.3-2B: IKE_AUTH request (step 9, Table 11.8.5.3.2-1)

Derivation path: 36.508 table 4.7G-3			
Information Element	Value/remark	Comment	Condition
IKE Header			
Next Payload	'00110000'B	EAP	
Exchange Type	'00100011'B	IKE_AUTH	
Extensible Authentication Payload			
Next Payload	'00000000'B	No Next Payload if EAP is the last payload	
Code	'00000010'B	Response	
Identifier	Not checked		
Type	Not checked		
Type_Data	Not checked		
NOTE 1: The order of Payloads/fields is not checked, unless explicitly specified. Additional Payloads/fields are ignored.			

Table 11.8.5.3.3-3: IKE_AUTH request (step 11, Table 11.8.5.3.2-1)

Derivation path: 36.508 table 4.7G-3			
Information Element	Value/remark	Comment	Condition
IKE Header			
Next Payload	'00101111'B	AUTH	
Exchange Type	'00100011'B	IKE_AUTH	
Authentication Payload			
Next Payload	'00000000'B	No Next Payload if AUTH is the last payload	
Authentication Method	Not checked		
Authentication Data	Not checked		
NOTE 1: The order of Payloads/fields is not checked, unless explicitly specified. Additional Payloads/fields are ignored.			

Table 11.8.5.3.3-4: IKE_AUTH response (step 12, Table 11.8.5.3.2-1)

Derivation path: 36.508 table 4.7G-4			
Information Element	Value/remark	Comment	Condition
IKE Header			
Next Payload	'00101111'B	CP	
Exchange Type	'00100011'B	IKE_AUTH	
Configuration Payload			
Next Payload	Set by the SS		
CFG Type	'00000010'B	CFG_REPLY	
Attribute Type	'00000001'B	INTERNAL_IP4_ADDRESS	IPv4
IPv4 Address	Previously allocated IPv4 address in cellular network		IPv4
Attribute Type	'00001000'B	INTERNAL_IP6_ADDRESS	IPv6
IPv6 Address	Previously allocated IPv6 address in cellular network		IPv6
Attribute Type	'00010100'B	P_CSCF_IP4_ADDRESS	
IPv4 Address	Set by the SS		
Attribute Type	'00010101'B	P_CSCF_IP6_ADDRESS	
IPv6 Address	Set by the SS		

Condition	Explanation
IPv4	If the UE requested an IPv4 address
IPv6	If the UE requested an IPv6 address

12 NR sidelink

12.1 PC5-only operation

12.1.1 PC5-only operation / Sidelink communication

12.1.1.1

12.1.1.2 PC5-only operation / Sidelink communication / Reception

12.1.1.2.1 Test Purpose (TP)

(1)

```
with { UE being authorized for performing NR sidelink Communication }
ensure that {
  when { UE is configured by upper layer to perform NR sidelink reception }
  then { UE is able to monitor NR sidelink transmission using sl-RxPool included in pre-
configuration }
}
```

12.1.1.2.2 Conformance requirements

References: The conformance requirements covered in the present TC are specified in: TS 38.331 [22], subclause 5.8.7. Unless otherwise stated these are Rel-16 requirements.

[TS 38.331, subclause 5.8.7]

A UE capable of NR sidelink communication that is configured by upper layers to receive NR sidelink communication shall:

- 1> if the conditions for NR sidelink communication operation as defined in 5.8.2 are met:
 - 2> if the frequency used for NR sidelink communication is included in *sl-FreqInfoToAddModList* in *RRCReconfiguration* message or *sl-FreqInfoList* included in *SIB12*:
 - 3> if the UE is configured with *sl-RxPool* included in *RRCReconfiguration* message with *reconfigurationWithSync* (i.e. handover):
 - 4> configure lower layers to monitor sidelink control information and the corresponding data using the pool of resources indicated by *sl-RxPool*;
 - 3> else if the cell chosen for NR sidelink communication provides *SIB12*:
 - 4> configure lower layers to monitor sidelink control information and the corresponding data using the pool of resources indicated by *sl-RxPool* in *SIB12*;
- 2> else:
 - 3> configure lower layers to monitor sidelink control information and the corresponding data using the pool of resources that were preconfigured by *sl-RxPool* in *SL-PreconfigurationNR*, as defined in sub-clause 9.3;

12.1.1.2.3 Test description

12.1.1.2.3.1 Pre-test conditions

System Simulator:

- NR-SS-UE

- NR-SS-UE1 operating as NR sidelink communication device on the resources (i.e. the frequency included in pre-configuration) that UE is expected to use for transmission and reception via PC5 interface.
- GNSS simulator
 - The GNSS simulator is started and configured for Scenario #1.

UE:

- UE is authorised to perform NR sidelink communication.
- The UE is equipped with below information in UE or in a USIM containing default values (as per TS 38.508-1 [4] clause 4.8.3.3.3).

Table 12.1.1.2.3.1-1: UE/ USIM configuration

USIM field	Priority	Value	Access Technology Identifier
EF _{UST}		Service n°119 (V2X) supported	
EF _{VST}		As per TS 38.508-1 [4] clause 4.8.3.3.3	
EF _{V2XP_PC5}		<i>SL-PreconfigurationNR</i> field as defined in TS 38.508-1 [4], table 4.10.1-1, except <i>SL-BWP-PoolConfigCommon</i> field as defined in table 12.1.1.2.3.3-1	

Preamble:

- The UE is in state 0-A as defined in TS 38.508-1 [4], Sidelink (*On*), Cast Type (*Unicast*), GNSS Sync (*On*).

12.1.1.2.3.2 Test procedure sequence

Table 12.1.1.2.3.2-1: Main behaviour

St	Procedure	Message Sequence		TP	Verdict
		U - S	Message		
1	Power on the UE.	-	-	-	-
2	Trigger UE to reset or clear the current UTC time that has been calculated from GNSS. NOTE: The UTC time can be reset or clear on the UE using AT command (+CUTCRCR).	-	-	-	-
3	The NR-SS-UE1 transmits a DIRECT LINK ESTABLISHMENT REQUEST message using the pool of resources that were preconfigured by <i>sl-RxPool</i> in <i>SL-PreconfigurationNR</i> .	<--	PC5-S: DIRECT LINK ESTABLISHMENT REQUEST	-	-
4	Check: Does the UE transmit a DIRECT LINK SECURITY MODE COMMAND message.	-->	PC5-S: DIRECT LINK SECURITY MODE COMMAND	1	P
5	The NR-SS-UE1 transmits a DIRECT LINK SECURITY MODE COMPLETE message.	<--	PC5-S: DIRECT LINK SECURITY MODE COMPLETE	-	-
6	The UE transmits a DIRECT LINK ESTABLISHMENT ACCEPT message.	-->	PC5-S: DIRECT LINK ESTABLISHMENT ACCEPT	-	-
7	The NR-SS-UE1 transmits an <i>RRCReconfigurationSidelink</i> message.	<--	PC5-RRC: <i>RRCReconfigurationSidelink</i>	-	-
8	Check: Does the UE transmit an <i>RRCReconfigurationSidelinkComplete</i> message?	-->	PC5-RRC: <i>RRCReconfigurationSidelinkComplete</i>	1	P

12.1.1.2.3.3 Specific message contents

Table 12.1.1.2.3.3-1: SL-BWP-PoolConfigCommon (Preamble)

Derivation Path: TS 38.508-1 [4], Table 4.6.6-4 with condition RXPOOL

12.1.2 PC5-only operation / Sidelink synchronization related procedure

12.1.2.1 PC5-only operation / Sidelink synchronization related procedure / Synchronization reference source (re-)selection

12.1.2.1.1 Test Purpose (TP)

(1)

```
with { UE is configured by upper layer to perform sidelink transmission and is configured with sl-SyncPriority = gnss in pre-configuration. }
ensure that {
  when { GNSS signal is reliable and a SyncRef UE which directly synchronized to GNSS is detected. }
  then { UE selects GNSS as synchronization reference source. }
}
```

(2)

```
with { UE is configured by upper layer to perform sidelink transmission and is configured with sl-SyncPriority = gnss in pre-configuration. }
ensure that {
  when { Two SyncRef UEs, one directly synchronized to GNSS and the other indirectly synchronized to GNSS, are detected. }
  then { UE selects the SyncRef UE directly synchronized to GNSS as synchronization reference source. }
}
```

(3)

```
with { UE is configured by upper layer to perform sidelink transmission and is configured with sl-SyncPriority = gnss in pre-configuration. }
ensure that {
  when { Two SyncRef UEs, one indirectly synchronized to GNSS and the other neither directly nor indirectly synchronized to GNSS, are detected. }
  then { UE selects the SyncRef UE indirectly synchronized to GNSS as synchronization reference source. }
}
```

(4)

```
with { UE is configured by upper layer to perform sidelink transmission and is configured with sl-SyncPriority = gnss in pre-configuration. }
ensure that {
  when { A SyncRef UE which neither directly nor indirectly synchronized to GNSS is detected. }
  then { UE selects the SyncRef UE which neither directly nor indirectly synchronized to GNSS as synchronization reference source. }
}
```

(5)

```
with { UE is configured by upper layer to perform sidelink transmission, and is configured with sl-SyncPriority = gnss in pre-configuration. }
ensure that {
  when { No SyncRef UE is detectable. }
  then { UE uses its internal clock as synchronization reference source. }
}
```

12.1.2.1.2 Conformance requirements

References: The conformance requirements covered in the present TC are specified in: TS 38.331 [22], subclause 5.8.2. Unless otherwise stated these are Rel-16 requirements.

[TS 38.331, clause 5.8.2]

The UE shall perform NR sidelink communication operation only if the conditions defined in this clause are met:

...

1> if the UE has no serving cell (RRC_IDLE);

[TS 38.331, clause 5.8.5.1]

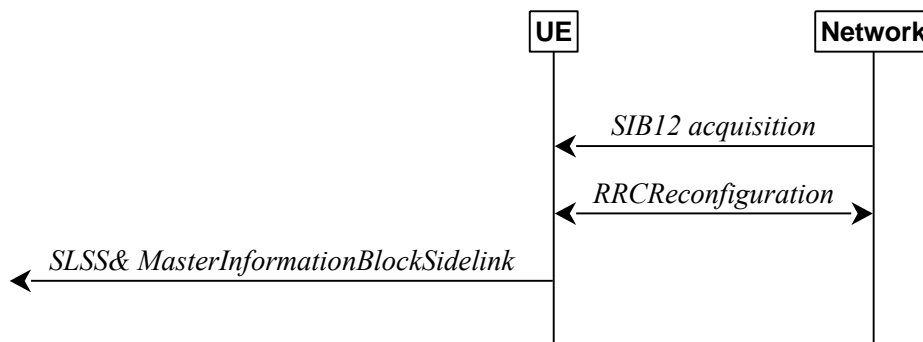

Figure 5.8.5.1-1: Synchronisation information transmission for NR sidelink communication, in (partial) coverage

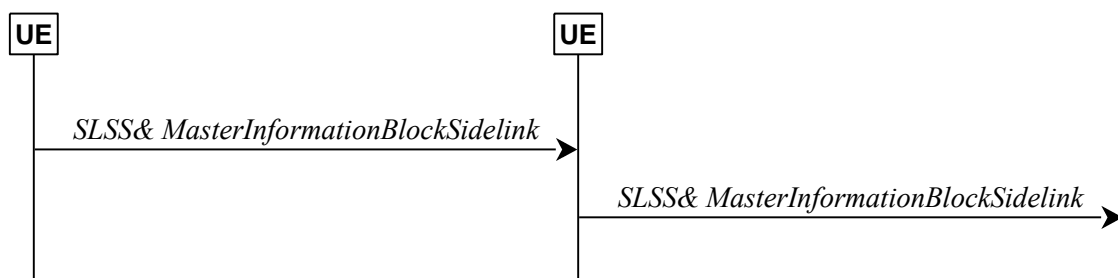

Figure 5.8.5.1-2: Synchronisation information transmission for NR sidelink communication, out of coverage

The purpose of this procedure is to provide synchronisation information to a UE.

[TS 38.331, clause 5.8.5.2]

A UE capable of NR sidelink communication and SLSS/PSBCH transmission shall, when transmitting NR sidelink communication, and if the conditions for NR sidelink communication operation are met and when the following conditions are met:

...

1> else:

- 2> for the frequency used for NR sidelink communication, if *syncTxThreshOoC* is included in *SidelinkPreconfigNR*; and the UE is not directly synchronized to GNSS, and the UE has no selected SyncRef UE or the PSBCH-RSRP measurement result of the selected SyncRef UE is below the value of *syncTxThreshOoC*; or
- 2> for the frequency used for NR sidelink communication, if the UE selects GNSS as the synchronization reference source:

- 3> transmit sidelink SSB on the frequency used for NR sidelink communication in accordance with TS 38.211 [16], including the transmission of SLSS as specified in 5.8.5.3 and transmission of *MasterInformationBlockSidelink* as specified in 5.8.9.4.3;

[TS 38.331, clause 5.8.5.3]

The UE shall select the SLSSID and the slot in which to transmit SLSS as follows:

...

- 1> else if triggered by NR sidelink communication and the UE has GNSS as the synchronization reference:

- 2> select SLSSID 0;

...

- 2> else:

- 3> select the slot(s) indicated by *sl-SSB-TimeAllocation1*;

- 1> else:

- 2> select the synchronisation reference UE (i.e. SyncRef UE) as defined in 5.8.6;

- 2> if the UE has a selected SyncRef UE and *inCoverage* in the *MasterInformationBlockSidelink* message received from this UE is set to *true*; or

- 2> if the UE has a selected SyncRef UE and *inCoverage* in the *MasterInformationBlockSidelink* message received from this UE is set to *false* while the SLSS from this UE is part of the set defined for out of coverage, see TS 38.211 [16]:

- 3> select the same SLSSID as the SLSSID of the selected SyncRef UE;

- 3> select the slot in which to transmit the SLSS according to the *sl-SSB-TimeAllocation1* or *sl-SSB-TimeAllocation2* included in the preconfigured sidelink parameters corresponding to the concerned frequency, such that the timing is different from the SLSS of the selected SyncRef UE;

...

- 2> else if the UE has a selected SyncRef UE:

- 3> select the SLSSID from the set defined for out of coverage having an index that is 336 more than the index of the SLSSID of the selected SyncRef UE, see TS 38.211 [16];

- 3> select the slot in which to transmit the SLSS according to *sl-SSB-TimeAllocation1* or *sl-SSB-TimeAllocation2* included in the preconfigured sidelink parameters corresponding to the concerned frequency, such that the timing is different from the SLSS of the selected SyncRef UE;

- 2> else (i.e. no SyncRef UE selected):

- 3> if the UE has not randomly selected an SLSSID:

- 4> randomly select, using a uniform distribution, an SLSSID from the set of sequences defined for out of coverage except SLSSID 336 and 337, see TS 38.211 [16];

- 4> select the slot in which to transmit the SLSS according to the *sl-SSB-TimeAllocation1* or *sl-SSB-TimeAllocation2* (arbitrary selection between these) included in the preconfigured sidelink parameters in *SidelinkPreconfigNR* corresponding to the concerned frequency;

[TS 38.331, clause 5.8.6.2]

The UE shall:

...

- 1> else if the frequency used for NR sidelink communication is included in *SL-PreconfigurationNR*, and *sl-SyncPriority* in *SidelinkPreconfigNR* is set to *gnss* and GNSS is reliable in accordance with TS 38.101-1 [15] and TS 38.133 [14]:
- 2> select GNSS as the synchronization reference source;
- 1> else:
- 2> perform a full search (i.e. covering all subframes and all possible SLSSIDs) to detect candidate SLSS, in accordance with TS 38.133 [14]
- 2> when evaluating the one or more detected SLSSIDs, apply layer 3 filtering as specified in 5.5.3.2 using the preconfigured *sl-filterCoefficient*, before using the PSBCH-RSRP measurement results;
- 2> if the UE has selected a SyncRef UE:
- ...
- 3> if the PSBCH-RSRP of the current SyncRef UE is less than the minimum requirement defined in TS 38.133 [14]:
- 4> consider no SyncRef UE to be selected;
- 2> if the UE has selected GNSS as the synchronization reference for NR sidelink communication:
- ...
- 3> if GNSS becomes not reliable in accordance with TS 38.101-1 [15] and TS 38.133 [14]:
- 4> consider GNSS not to be selected;
- ...
- 2> if the UE has not selected any synchronization reference:
- 3> if the UE detects one or more SLSSIDs for which the PSBCH-RSRP exceeds the minimum requirement defined in TS 38.133 [14] by *sl-SyncRefMinHyst* and for which the UE received the corresponding *MasterInformationBlockSidelink* message (candidate SyncRef UEs), or if the UE detects GNSS that is reliable in accordance with TS 38.101-1 [15] and TS 38.133 [14], or if the UE detects a cell, select a synchronization reference according to the following priority group order:
- ...
- 4> if *sl-SyncPriority* corresponding to the concerned frequency is set to *gnss*, and *sl-NbAsSync* is set to *false*:
- 5> UEs of which SLSSID is 0, and *inCoverage*, included in the *MasterInformationBlockSidelink* message received from this UE, is set to *true*, or of which SLSSID is 0 and SLSS is transmitted on slot(s) indicated by *sl-SSB-TimeAllocation3*, starting with the UE with the highest PSBCH-RSRP result (priority group 1);
- 5> UEs of which SLSSID is 0 and SLSS is not transmitted on slot(s) indicated by *sl-SSB-TimeAllocation3*, and *inCoverage*, included in the *MasterInformationBlockSidelink* message received from this UE, is set to *false*, starting with the UE with the highest PSBCH-RSRP result (priority group 2);
- ...
- 5> Other UEs, starting with the UE with the highest PSBCH-RSRP result (priority group 3);

[TS 38.331, clause 5.8.9.4.3]

The UE shall set the contents of the *MasterInformationBlockSidelink* message as follows:

...

- 1> else if out of coverage on the frequency used for NR sidelink communication as defined in TS 38.304 [20]; and the UE selects GNSS as the synchronization reference and *sl-SSB-TimeAllocation3* is not configured for the frequency used in *SidelinkPreconfigNR*:
- 2> set *inCoverage* to *true*;
- 2> set *reservedBits* to the value of the corresponding field included in the preconfigured sidelink parameters (i.e. *sl-PreconfigGeneral* in *SidelinkPreconfigNR* defined in 9.3);
- 2> set *sl-TDD-Config* to the value representing the same meaning as that is included in the corresponding field included in the preconfigured sidelink parameters (i.e. *sl-PreconfigGeneral* in *SL-PreconfigurationNR* defined in 9.3) as described in TS 38.213, clause 16.1 [13];
- 1> else if the UE has a selected SyncRef UE (as defined in 5.8.6):
- 2> set *inCoverage* to *false*;
- 2> set *sl-TDD-Config* and *reservedBits* to the value of the corresponding field included in the received *MasterInformationBlockSidelink*;
- 1> else:
- 2> set *inCoverage* to *false*;
- 2> set *reservedBits* to the value of the corresponding field included in the preconfigured sidelink parameters (i.e. *sl-PreconfigGeneral* in *SidelinkPreconfigNR* defined in 9.3);
- 2> set *sl-TDD-Config* to the value representing the same meaning as that is included in the corresponding field included in the preconfigured sidelink parameters (i.e. *sl-PreconfigGeneral* in *SL-PreconfigurationNR* defined in 9.3) as described in TS 38.213, clause 16.1 [13];
- 1> set *directFrameNumber* and *slotIndex* according to the slot used to transmit the SLSS, as specified in 5.8.5.3;
- 1> submit the *MasterInformationBlockSidelink* to lower layers for transmission upon which the procedure ends;

[TS 38.331, clause 5.8.12]

When the UE selects GNSS as the synchronization reference source, the DFN, the subframe number within a frame and slot number within a frame used for NR sidelink communication are derived from the current UTC time, by the following formulae:

$$DFN = \text{Floor}(0.1 * (T_{\text{current}} - T_{\text{ref}} - \text{OffsetDFN})) \bmod 1024$$

$$\text{SubframeNumber} = \text{Floor}(T_{\text{current}} - T_{\text{ref}} - \text{OffsetDFN}) \bmod 10$$

$$\text{SlotNumber} = \text{Floor}((T_{\text{current}} - T_{\text{ref}} - \text{OffsetDFN}) * 2^{\mu}) \bmod (10 * 2^{\mu})$$

Where:

T_{current} is the current UTC time obtained from GNSS. This value is expressed in milliseconds;

T_{ref} is the reference UTC time 00:00:00 on Gregorian calendar date 1 January, 1900 (midnight between Thursday, December 31, 1899 and Friday, January 1, 1900). This value is expressed in milliseconds;

OffsetDFN is the value *sl-OffsetDFN* if configured, otherwise it is zero. This value is expressed in milliseconds.

$\mu=0/1/2/3$ corresponding to the 15/30/60/120 kHz of SCS for SL, respectively.

NOTE 1: In case of leap second change event, how UE obtains the scheduled time of leap second change to adjust *T_{current}* correspondingly is left to UE implementation. How UE handles to avoid the sudden discontinuity of DFN is left to UE implementation.

NOTE 2: Void.

12.1.2.1.3 Test description

12.1.2.1.3.1 Pre-test conditions

System Simulator:

- NR-SS-UE
 - NR-SS-UE 1, 2 and 3 operating as NR sidelink communication device on the resources (i.e. the frequency included in pre-configuration) that UE is expected to use for transmission and reception via PC5 interface.
 - NR-SS-UE 1 transmits S-SSB with SLSSID = 0, *inCoverage* = true in slots determined by *sl-SSB-TimeAllocation1* and GNSS timing.
 - NR-SS-UE 2 transmits S-SSB with SLSSID = 0, *inCoverage* = false in slots determined by *sl-SSB-TimeAllocation2* and GNSS timing.
 - NR-SS-UE 3 transmits S-SSB with SLSSID = 336, *inCoverage* = false in slots determined by *sl-SSB-TimeAllocation1* and GNSS timing.
- GNSS simulator
- The GNSS simulator is started and configured for Scenario #1.

UE:

- UE is authorised to perform NR sidelink communication.
- The UE is equipped with below information in UE or in a USIM containing default values (as per TS 38.508-1 [4]) except for those listed in Table 12.1.2.1.3.1-1.

Table 12.1.2.1.3.1-1: UE/ USIM configuration

USIM field	Priority	Value	Access Technology Identifier
EF _{UST}		As per TS 36.508 [18] clause 4.9.3.4	
EF _{VST}		Service n°119 is "available"	
EF _{V2XP_PC5}		As per TS 38.508-1[4] clause 4.8.3.3.3 SL-PreconfigurationNR included in V2X data policy over PC5 is defined in Table 12.1.2.1.3.3-1	

Preamble:

- The UE is in state 4-A as defined in TS 38.508-1 [4], subclause 4.4A, using generic procedure parameter Sidelink (On), GNSS Sync (On) as defined in TS 38.508-1 [4], subclause 4.5.1.

12.1.2.1.3.2 Test procedure sequence

Table 12.1.2.1.3.2-1 illustrates the sidelink power levels to be applied for NR-SS-UE 1, 2 and 3 at various time instants of the test execution. Row marked "T0" denotes the conditions after the preamble, while the configuration marked "T1", "T2" and "T3", are applied at the point indicated in the Main behaviour description in Table 12.1.2.1.3.2-2.

Table 12.1.2.1.3.2-1: Time instances of NR-SS-UE power level and parameter changes in conducted test environment

	Parameter	Unit	NR-SS-UE 1	NR-SS-UE 2	NR-SS-UE 3	Remark
T0	NR-SS-UE power	dBm/SCS	-85	OFF	OFF	Priority of NR-SS-UE 1 is lower than GNSS
	EPRE ratio of S-SSS	dB	0	-	-	

	to NR-SS-UE power					
T1	NR-SS-UE power	dBm/SCS	-85	-85	OFF	Priority of NR-SS-UE 2 is lower than Priority of NR-SS-UE 1
	EPRE ratio of S-SSS to NR-SS-UE power	dB	0	0	-	
T2	NR-SS-UE power	dBm/SCS	OFF	-85	-85	Priority of NR-SS-UE 3 is lower than Priority of NR-SS-UE 2
	EPRE ratio of S-SSS to NR-SS-UE power	dB	-	0	0	
T3	NR-SS-UE power	dBm/SCS	OFF	OFF	-85	Priority of UE internal clock is lower than NR-SS-UE 3
	EPRE ratio of S-SSS to NR-SS-UE power	dB	-	-	0	

Table 12.1.2.1.3.2-2: Main behaviour

St	Procedure	Message Sequence		TP	Verdict
		U - S	Message		
1	The SS triggers UE to close UE test loop mode E (Transmit Mode). NOTE: Closing of UE test loop mode E may be performed by MMI or AT command (+CCUTLE).	-	-	-	-
2	The SS waits 10 seconds	-	-	-	-
3	Check: Does the UE transmit S-SSBs which satisfy all following conditions? - SLSSID = 0; - incoverage = true in SL-MIB; - slotIndex and directFrameNumber in SL-MIB are consistent with the slot index and DFN calculated based on the UTC time obtained from GNSS as specified in TS 38.331 [22] clause 5.8.12; - transmitted in slots determined by sl-SSB-TimeAllocation1 and GNSS timing; - reserveBits in SL-MIB is consistent with reserveBits in pre-configuration.	-	-	1	P
4	The SS powers off GNSS simulator.	-	-	-	-
5	The SS re-adjusts the NR-SS-UE power level according to row "T1" in table 12.1.2.1.3.2-1.	-	-	-	-
6	The SS waits 10 seconds	-	-	-	-
7	Check: Does the UE transmit S-SSBs which satisfy all following conditions? - SLSSID = 0; - incoverage = false in SL-MIB; - slotIndex and directFrameNumber in SL-MIB are consistent with the slot index and DFN of SyncRef UE 1; - transmitted in slots determined by sl-SSB-TimeAllocation2 and NR-SS-UE 1 timing; - reserveBits in SL-MIB is consistent with reserveBits in SL-MIB of NR-SS-UE 1.	-	-	2	P
8	The SS re-adjusts the NR-SS-UE power level according to row "T2" in table 12.1.2.1.3.2-1.	-	-	-	-
9	The SS waits 10 seconds	-	-	-	-
10	Check: Does the UE transmit S-SSBs which satisfy all following conditions? - SLSSID = 336; - incoverage = false in SL-MIB; - slotIndex and directFrameNumber in SL-MIB are consistent with the slot index and DFN of SyncRef UE 2.	-	-	3	P

	<ul style="list-style-type: none"> - transmitted in slots determined by sl-SSB-TimeAllocation1 and the NR-SS-UE 2 timing? - reserveBits in SL-MIB is consistent with reserveBits in SL-MIB of NR-SS-UE 2. 				
11	The SS re-adjusts the NR-SS-UE power level according to row "T3" in table 12.1.2.1.3.2-1.	-	-	-	-
12	The SS waits 10 seconds	-	-	-	-
13	Check: Does the UE transmit S-SSBs which satisfy all following conditions? <ul style="list-style-type: none"> - SLSSID is consistent with SLSSID of NR-SS-UE 3; - incoverage = false in SL-MIB; - slotIndex and directFrameNumber in SL-MIB are consistent with the slot index and DFN of SyncRef UE 3; - transmitted in slots determined by sl-SSB-TimeAllocation2 and SyncRef UE 3 timing; - reserveBits in SL-MIB is consistent with reserveBits in SL-MIB of SyncRef UE 3. 	-	-	4	P
14	The SS re-adjusts the NR-SS-UE power level according to row "T0" in table 12.1.2.1.3.2-1.	-	-	-	-
15	The SS waits 10 seconds	-	-	-	-
16	Check: Does the UE transmit S-SSBs which satisfy all following conditions? <ul style="list-style-type: none"> - SLSSID is larger than 335; - incoverage = false in SL-MIB; - reserveBits in SL-MIB is consistent with reserveBits in pre-configuration. 	-	-	5	P
17	The SS triggers UE to open UE test loop mode E. NOTE: Closing of UE test loop mode E may be performed by MMI or AT command (+CCUTLE).	-	-	-	-

12.1.2.1.3.3 Specific message contents

Table 12.1.2.1.3.3-1: V2X service identifier to default mode of communication mapping rule (Pre-configuration, UE under test)

Derivation Path: TS 38.508-1 [4] Table 4.7.5.5-53			
Information Element	Value/remark	Comment	Condition
DMC	'10'B	Default mode of communication is set to broadcast	

Table 12.1.2.1.3.3-2: SL-SyncConfig (Pre-configuration, UE under test)

Derivation Path: TS 38.508-1 [4], Table 4.6.6-31			
Information Element	Value/remark	Comment	Condition
SL-SyncConfig-r16 ::= SEQUENCE (SIZE (1..maxSL-SyncConfig-r16)) OF SL-SyncConfig-r16 {	1 entry		
SL-SyncConfig-r16[1] SEQUENCE {			
txParameters-r16 SEQUENCE {			
syncTxThreshOoC-r16	13	actual threshold is +infinity	
}			
}			

Table 12.1.2.1.3.3-3: +CCUTLE (Table 12.1.2.1.3.2-2, step 1)

Derivation Path: TS 38.508-1 [4] Table 4.7B-1 with condition Close and Transmit

Table 12.1.2.1.3.3-4: MasterInformationBlockSidelink (Table 12.1.2.1.3.2-2, SyncRef UE 1, 2 and 3)

Derivation Path: TS 38.508-1 [4], Table 4.6.1A-1			
Information Element	Value/remark	Comment	Condition
MasterInformationBlockSidelink ::= SEQUENCE {			
inCoverage-r16	true		SyncRef UE 1
	false		SyncRef UE 2 SyncRef UE 3
directFrameNumber-r16	DFN determined based on the formula given in 38.331 [22] clause 5.8.12.		
slotIndex-r16	slot index determined based on the formula given in 38.331 [22] clause 5.8.12.		
reservedBits-r16	01		SyncRef UE 1
	10		SyncRef UE 2
	11		SyncRef UE 3
}			

Table 12.1.2.1.3.3-5: MasterInformationBlockSidelink (Table 12.1.2.1.3.2-2, step 3, 7, 10, 13 and 16, UE under test)

Derivation Path: TS 38.508-1 [4], Table 4.6.1A-1 with condition TX			
Information Element	Value/remark	Comment	Condition
MasterInformationBlockSidelink ::= SEQUENCE {			
inCoverage-r16	true		Step 3
	false		Step 7, 10, 13, 16
directFrameNumber-r16	DFN determined based on the formula given in 38.331 [22] clause 5.8.12		Step 3, 7, 10, 13
	Not checked		Step 6
slotIndex-r16	slot index determined based on the formula given in 38.331 [22] clause 5.8.12		Step 3, 7, 10, 13
	Not checked		Step 6
reservedBits-r16	00	Same as preconfiguration	Step 3, 16
	01	Same as SyncRef UE 1	Step 7
	10	Same as SyncRef UE 2	Step 10
	11	Same as SyncRef UE 3	Step 13
}			

Table 12.1.2.1.3.3-6: +CCUTLE (Table 12.1.2.1.3.2-2, step 17)

Derivation Path: TS 38.508-1 [4] Table 4.7B-1 with condition Open

12.1.2.2 PC5-only operation / Sidelink synchronization related procedure / SL-SSB transmission Initiation and Cease

12.1.2.2.1 Test Purpose (TP)

(1)

```
with { UE is configured by upper layer to perform sidelink transmission. }
ensure that {
  when { UE selects GNSS as synchronization reference source. }
  then { UE keeps transmitting S-SSB. }
}
```

(2)

```
with { UE is configured by upper layer to perform sidelink transmission and is configured with
syncTxThreshOoC in pre-configuration. }
ensure that {
  when { UE selects SyncRef UE as synchronization reference source. PSBCH-RSRP of the SyncRef UE is
lower than syncTxThreshOoC. }
  then { UE starts transmitting S-SSB. }
}
```

(3)

```
with { UE is configured by upper layer to perform sidelink transmission and is configured with
syncTxThreshOoC in pre-configuration. }
ensure that {
  when { UE selects SyncRef UE as synchronization reference source. PSBCH-RSRP of the SyncRef UE is
above than syncTxThreshOoC. }
  then { UE stops transmitting S-SSB. }
}
```

(4)

```
with { UE is configured by upper layer to perform sidelink transmission and is configured with
syncTxThreshOoC in pre-configuration. }
ensure that {
  when { UE selects SyncRef UE as synchronization reference source. PSBCH-RSRP of the SyncRef UE is
above than syncTxThreshOoC. }
  then { UE stops transmitting S-SSB. }
}
```

12.1.2.2.2 Conformance requirements

References: The conformance requirements covered in the present TC are specified in: TS 38.331 [22], subclause 5.8.2. Unless otherwise stated these are Rel-16 requirements.

[TS 38.331, clause 5.8.2]

The UE shall perform NR sidelink communication operation only if the conditions defined in this clause are met:

...

1> if the UE has no serving cell (RRC_IDLE);

[TS 38.331, clause 5.8.5.1]

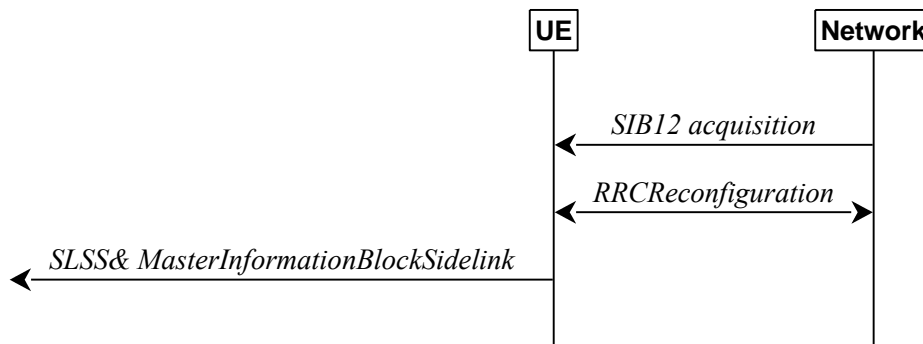

Figure 5.8.5.1-1: Synchronisation information transmission for NR sidelink communication, in (partial) coverage

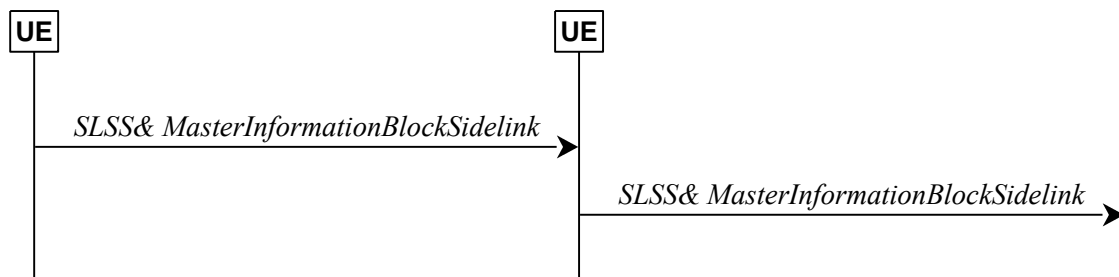

Figure 5.8.5.1-2: Synchronisation information transmission for NR sidelink communication, out of coverage

The purpose of this procedure is to provide synchronisation information to a UE.

[TS 38.331, clause 5.8.5.2]

A UE capable of NR sidelink communication and SLSS/PSBCH transmission shall, when transmitting NR sidelink communication, and if the conditions for NR sidelink communication operation are met and when the following conditions are met:

...

1> else:

- 2> for the frequency used for NR sidelink communication, if *syncTxThreshOoC* is included in *SidelinkPreconfigNR*; and the UE is not directly synchronized to GNSS, and the UE has no selected SyncRef UE or the PSBCH-RSRP measurement result of the selected SyncRef UE is below the value of *syncTxThreshOoC*; or
- 2> for the frequency used for NR sidelink communication, if the UE selects GNSS as the synchronization reference source:
- 3> transmit sidelink SSB on the frequency used for NR sidelink communication in accordance with TS 38.211 [16], including the transmission of SLSS as specified in 5.8.5.3 and transmission of *MasterInformationBlockSidelink* as specified in 5.8.9.4.3;

12.1.2.2.3 Test description

12.1.2.2.3.1 Pre-test conditions

System Simulator:

- NR-SS-UE
- NR-SS-UE 1 operating as NR sidelink communication device on the resources (i.e. the frequency included in pre-configuration) that UE is expected to use for transmission and reception via PC5 interface.

- NR-SS-UE 1 transmits S-SSB with SLSSID = 0, *inCoverage* = true in slots determined by *sl-SSB-TimeAllocation1* and GNSS timing.
- GNSS simulator
- The GNSS simulator is started and configured for Scenario #1.

UE:

- UE is authorised to perform NR sidelink communication.
- The UE is equipped with below information in UE or in a USIM containing default values (as per TS 38.508-1 [4]) except for those listed in Table 12.1.2.2.3.1-1.

Table 12.1.2.2.3.1-1: UE/ USIM configuration

USIM field	Priority	Value	Access Technology Identifier
EF _{UST}		As per TS 36.508 [18] clause 4.9.3.4	
EF _{VST}		Service n°119 is "available"	
EF _{V2XP_PC5}		As per TS 38.508-1[4] clause 4.8.3.3.3 SL-PreconfigurationNR included in V2X data policy over PC5 is defined in Table 12.1.2.2.3.3-1	

Preamble:

- The UE is in state 4-A as defined in TS 38.508-1 [4], subclause 4.4A, using generic procedure parameter Sidelink (On), GNSS Sync (On) as defined in TS 38.508-1 [4], subclause 4.5.1.

12.1.2.2.3.2 Test procedure sequence

Table 12.1.2.2.3.2-1 illustrates the sidelink power levels to be applied for NR-SS-UE 1, 2 and 3 at various time instants of the test execution. Row marked "T0" denotes the conditions after the preamble, while the configuration marked "T1" and "T2", are applied at the point indicated in the Main behaviour description in Table 12.1.2.2.3.2-2.

Table 12.1.2.2.3.2-1: Time instances of NR-SS-UE power level and parameter changes in conducted test environment

	Parameter	Unit	NR-SS-UE 1	Remark
T0	NR-SS-UE power	dBm/SCS	OFF	NR-SS-UE 1 is powered off.
	EPRE ratio of S-SSS to NR-SS-UE power	dB	-	
T1	NR-SS-UE power	dBm/SCS	-106	The power level to ensure that PSBCH-RSRP of NR-SS-UE 1 is lower than syncTxThreshOoC
	EPRE ratio of S-SSS to NR-SS-UE power	dB	0	
T2	NR-SS-UE power	dBm/SCS	-94	The power level to ensure that PSBCH-RSRP of NR-SS-UE 1 is higher than syncTxThreshOoC
	EPRE ratio of S-SSS to NR-SS-UE power	dB	0	

Table 12.1.2.2.3.2-2: Main behaviour

St	Procedure	Message Sequence		TP	Verdict
		U - S	Message		
1	The SS triggers UE to close UE test loop mode E (Transmit Mode).	-	-	-	-

	NOTE: Closing of UE test loop mode E may be performed by MMI or AT command (+CCUTLE).				
2	The SS waits 10 seconds	-	-	-	-
3	Check: Does the UE transmit S-SSBs in slots determined by sl-SSB-TimeAllocation1 and GNSS timing?	-	-	1	P
4	The SS powers off GNSS simulator.	-	-	-	-
5	The SS re-adjusts the NR-SS-UE power level according to row "T1" in table 12.1.2.2.3.2-1.	-	-	-	-
6	The SS waits 10 seconds	-	-	-	-
7	Check: Does the UE transmit S-SSBs in slots determined by sl-SSB-TimeAllocation2 and NR-SS-UE 1 timing?	-	-	2	P
8	The SS re-adjusts the NR-SS-UE power level according to row "T2" in table 12.1.2.2.3.2-1.	-	-	-	-
9	The SS waits 10 seconds	-	-	-	-
10	Check: Does the UE transmit S-SSBs in slots determined by sl-SSB-TimeAllocation2 and NR-SS-UE 1 timing?	-	-	3	F
11	The SS re-adjusts the NR-SS-UE power level according to row "T0" in table 12.1.2.2.3.2-1.	-	-	-	-
12	The SS waits 10 seconds	-	-	-	-
13	Check: Does the UE transmit S-SSBs?	-	-	4	P
14	The SS triggers UE to open UE test loop mode E. NOTE: Closing of UE test loop mode E may be performed by MMI or AT command (+CCUTLE).	-	-	-	-

12.1.2.2.3.3 Specific message contents

Table 12.1.2.2.3.3-1: V2X service identifier to default mode of communication mapping rule (Pre-configuration, UE under test)

Derivation Path: TS 38.508-1 [4] Table 4.7.5.5-53			
Information Element	Value/remark	Comment	Condition
DMC	'10'B	Default mode of communication is set to broadcast	

Table 12.1.2.2.3.3-2: +CCUTLE (Table 12.1.2.2.3.2-2, step 1)

Derivation Path: TS 38.508-1 [4] Table 4.7B-1 with condition Close and Transmit

Table 12.1.2.2.3.3-3: MasterInformationBlockSidelink (Table 12.1.2.2.3.2-2, SyncRef UE 1)

Derivation Path: TS 38.508-1 [4], Table 4.6.1A-1			
Information Element	Value/remark	Comment	Condition
MasterInformationBlockSidelink ::= SEQUENCE {			
inCoverage-r16	true		
directFrameNumber-r16	DFN determined based on the formula given in 38.331 [22] clause 5.8.12.		
slotIndex-r16	slot index determined based on the formula given in 38.331 [22] clause 5.8.12.		

}		
---	--	--

Table 12.1.2.2.3.3-5: MasterInformationBlockSidelink (Table 12.1.2.2.3.2-2, step 3, 7, 13, UE under test)

Derivation Path: TS 38.508-1 [4], Table 4.6.1A-1 with condition TX			
Information Element	Value/remark	Comment	Condition
MasterInformationBlockSidelink ::= SEQUENCE {			
inCoverage-r16	true		Step 3
	false		Step 7, 13
directFrameNumber-r16	DFN determined based on the formula given in 38.331 [22] clause 5.8.12		Step 3, 7
	Not checked		Step 13
slotIndex-r16	slot index determined based on the formula given in 38.331 [22] clause 5.8.12		Step 3, 7
	Not checked		Step 13
}			

Table 12.1.2.2.3.3-6: +CCUTLE (Table 12.1.2.2.3.2-2, step 17)

Derivation Path: TS 38.508-1 [4] Table 4.7B-1 with condition Open

12.1.3 PC5-only operation / Measurement configuration and reporting via PC5 RRC

12.1.3.1 PC5-only operation / Measurement configuration and reporting via PC5 RRC / PSBCH-RSRP measurement configuration

12.1.3.1.1 Test Purpose (TP)

(1)

```
with { UE having established PC5 RRC connection with peer UE on unicast sidelink }
ensure that {
  when { UE is configured by upper layer to configure periodical PSBCH-RSRP measurement }
  then { UE sends a RRCReconfigurationSidelink message to peer UE }
}
```

12.1.3.1.2 Conformance requirements

References: The conformance requirements covered in the present TC are specified in: TS 38.331 [22], subclause 5.8.1, 5.8.9.1.3, 5.8.9.1.9. Unless otherwise stated these are Rel-16 requirements.

[TS 38.331, clause 5.8.1]

The PC5-RRC signalling, as specified in sub-clause 5.8.9, can be initiated after its corresponding PC5 unicast link establishment (TS 23.287 [55]).

[TS 38.331, clause 5.8.9.1.2]

The UE shall set the contents of *RRCReconfigurationSidelink* message as follows:

- 1> for each sidelink DRB that is to be released, according to sub-clause 5.8.9.1a.1.1, due to configuration by *sl-ConfigDedicatedNR*, *SIB12*, *SidelinkPreconfigNR* or by upper layers:
- 2> set the *SLRB-PC5-ConfigIndex* included in the *slrb-ConfigToReleaseList* corresponding to the sidelink DRB;
- 1> for each sidelink DRB that is to be established or modified, according to sub-clause 5.8.9.1a.2.1, due to receiving *sl-ConfigDedicatedNR*, *SIB12* or *SidelinkPreconfigNR*:
- 2> set the *SLRB-Config* included in the *slrb-ConfigToAddModList*, according to the received *sl-RadioBearerConfig* and *sl-RLC-BearerConfig* corresponding to the sidelink DRB;
- 1> set the *sl-MeasConfig* as follows:
 - 2> If the frequency used for NR sidelink communication is included in *sl-FreqInfoToAddModList* in *sl-ConfigDedicatedNR* within *RRCReconfiguration* message or included in *sl-ConfigCommonNR* within *SIB12*:
 - 3> if UE is in *RRC_CONNECTED*:
 - 4> set the *sl-MeasConfig* according to stored NR sidelink measurement configuration information for this destination;
 - 3> if UE is in *RRC_IDLE* or *RRC_INACTIVE*:
 - 4> set the *sl-MeasConfig* according to stored NR sidelink measurement configuration received from *SIB12*;
 - 2> else:
 - 3> set the *sl-MeasConfig* according to the *sl-MeasPreconfig* in *SidelinkPreconfigNR*;
 - 1> start timer T400 for the destination associated with the sidelink DRB;
 - 1> set the *sl-CSI-RS-Config*;
 - 1> set the *sl-LatencyBoundCSI-Report*,

NOTE 1: How to set the parameters included in *sl-CSI-RS-Config* and *sl-LatencyBoundCSI-Report* is up to UE implementation.

The UE shall submit the *RRCReconfigurationSidelink* message to lower layers for transmission.

[TS 38.331, clause 5.8.9.1.3]

The UE shall perform the following actions upon reception of the *RRCReconfigurationSidelink*:

- 1> if the *RRCReconfigurationSidelink* includes the *sl-ResetConfig*:
- 2> perform the sidelink reset configuration procedure as specified in 5.8.9.1.10;
- 1> if the *RRCReconfigurationSidelink* includes the *slrb-ConfigToReleaseList*:
- 2> for each *SLRB-PC5-ConfigIndex* value included in the *slrb-ConfigToReleaseList* that is part of the current UE sidelink configuration;
- 3> perform the sidelink DRB release procedure, according to sub-clause 5.8.9.1a.1;
- 1> if the *RRCReconfigurationSidelink* includes the *slrb-ConfigToAddModList*:
- 2> for each *slrb-PC5-ConfigIndex* value included in the *slrb-ConfigToAddModList* that is not part of the current UE sidelink configuration:
- 3> if *sl-MappedQoS-FlowsToAddList* is included:
- 4> apply the *SL-PQFI* included in *sl-MappedQoS-FlowsToAddList*;
- 3> perform the sidelink DRB addition procedure, according to sub-clause 5.8.9.1a.2;
- 2> for each *slrb-PC5-ConfigIndex* value included in the *slrb-ConfigToAddModList* that is part of the current UE sidelink configuration:

- 3> if *sl-MappedQoS-FlowsToAddList* is included:
 - 4> add the *SL-PQFI* included in *sl-MappedQoS-FlowsToAddList* to the corresponding sidelink DRB;
- 3> if *sl-MappedQoS-FlowsToReleaseList* is included:
 - 4> remove the *SL-PQFI* included in *sl-MappedQoS-FlowsToReleaseList* from the corresponding sidelink DRB;
- 3> if the sidelink DRB release conditions as described in sub-clause 5.8.9.1a.1.1 are met:
 - 4> perform the sidelink DRB release procedure according to sub-clause 5.8.9.1a.1.2;
- 3> else if the sidelink DRB modification conditions as described in sub-clause 5.8.9.1a.2.1 are met:
 - 4> perform the sidelink DRB modification procedure according to sub-clause 5.8.9.1a.2.2;
- 1> if the *RRCReconfigurationSidelink* message includes the *sl-MeasConfig*:
 - 2> perform the sidelink measurement configuration procedure as specified in 5.8.10;
- 1> if the *RRCReconfigurationSidelink* message includes the *sl-CSI-RS-Config*:
 - 2> apply the sidelink CSI-RS configuration;
- 1> if the *RRCReconfigurationSidelink* message includes the *sl-LatencyBoundCSI-Report*:
 - 2> apply the configured sidelink CSI report latency bound;
- 1> if the UE is unable to comply with (part of) the configuration included in the *RRCReconfigurationSidelink* (i.e. sidelink RRC reconfiguration failure):
 - 2> continue using the configuration used prior to the reception of the *RRCReconfigurationSidelink* message;
 - 2> set the content of the *RRCReconfigurationFailureSidelink* message;
 - 3> submit the *RRCReconfigurationFailureSidelink* message to lower layers for transmission;
- 1> else:
 - 2> set the content of the *RRCReconfigurationCompleteSidelink* message;
 - 3> submit the *RRCReconfigurationCompleteSidelink* message to lower layers for transmission;

NOTE 1: When the same logical channel is configured with different RLC mode by another UE, the UE handles the case as sidelink RRC reconfiguration failure.

[TS 38.331, clause 5.8.9.1.9]

The UE shall perform the following actions upon reception of the *RRCReconfigurationCompleteSidelink*:

- 1> stop timer T400 for the destination, if running;
- 1> consider the configurations in the corresponding *RRCReconfigurationSidelink* message to be applied.

12.1.3.1.3 Test description

12.1.3.1.3.1 Pre-test conditions

System Simulator:

- NR-SS-UE
- NR-SS-UE1 operating as NR sidelink communication device on the resources (i.e. the frequency included in pre-configuration) that UE is expected to use for transmission and reception via PC5 interface.
- NR-SS-UE1 uses GNSS as the synchronization reference source.

- GNSS simulator
 - The GNSS simulator is started and configured for Scenario #1.

UE:

- UE is authorised to perform NR sidelink communication.
 - The UE uses GNSS as the synchronization reference source.
 - The UE is equipped with below information in UE or in a USIM containing default values (as per TS 38.508-1 [4] clause 4.8.3.3.3) except for those listed in Table 12.1.3.1.3.1-1.

Table 12.1.3.1.3.1-1: UE/ USIM configuration

USIM field	Priority	Value	Access Technology Identifier
EF _{UST}		service no. 119 is available	
EF _{VST}		Service no.2 V2X policy configuration data over PC5 is supported, i.e. value is '01 02' HEX	
EF _{V2XP_PC5}		As per TS 38.508-1[4] clause 4.8.3.3.3 SL-PreconfigurationNR included in V2X data policy over PC5 is defined in Table 12.1.3.1.3.3-1	

Preamble:

- The UE is in state 4-A as defined in TS 38.508-1 [4], subclause 4.4A, using generic procedure parameter Sidelink (On), Cast Type (Unicast), GNSS Sync (On) using UE initiated unicast mode NR sidelink communication procedure in subclause 4.9.22.

12.1.3.1.3.2 Test procedure sequence

Table 12.1.3.1.3.2-1: Main behaviour

St	Procedure	Message Sequence		TP	Verdict
		U - S	Message		
1	UE is configured by upper layer to initiate the sidelink RRC reconfiguration procedure to configure periodical PSBCH-RSRP measurement Note: This step is triggered by MMI or AT command.	--			
2	Check: Does UE send a <i>RRCReconfigurationSidelink</i> message to NR-SS-UE1?	-->	PC5 RRC: <i>RRCReconfigurationSidelink</i>	1	P
3	NR-SS-UE1 sends a <i>RRCReconfigurationCompleteSidelink</i> message	<--	PC5 RRC: <i>RRCReconfigurationCompleteSidelink</i>		

12.1.3.1.3.3 Specific message contents

Table 12.1.3.1.3.3-1: SL-PreconfigurationNR

Derivation path: TS 38.508-1 [4], Table 4.10.1-1			
Information Element	Value/Remark	Comment	Condition
SL-PreconfigurationNR-r16 ::= SEQUENCE {			
sidelinkPreconfigNR-r16 SEQUENCE {			
sl-MeasPreConfig-r16	SL-MeasConfigCommon		
}			
}			

Table 12.1.3.1.3.3-2: SL-MeasConfigCommon (Table 12.1.3.1.3.3-1)

Derivation path: TS 38.508-1 [4], Table 4.6.6-13			
Information Element	Value/Remark	Comment	Condition
SL-MeasConfigCommon-r16 ::= SEQUENCE {			
sl-MeasObjectListCommon-r16 ::= SEQUENCE (SIZE (1..maxNrofSL-ObjectId-r16)) OF SL-MeasObjectInfo-r16{	1 entry		
SL-MeasObjectInfo-r16[1] SEQUENCE {		entry 1	
sl-MeasObjectId-r16	1		
sl-MeasObject-r16 SEQUENCE {			
frequencyInfoSL-r16	ARFCN-ValueNR as defined in TS 38.508-1 [4], Table 4.6.3-5 with condition SL_SSB of NRf1		
}			
}			
}			
}			

Table 12.1.3.1.3.3-3: RRCReconfigurationSidelink (step 2, Table 12.1.3.1.3.2-1)

Derivation path: TS 38.508-1 [4], Table 4.6.1A-3 with condition SL_MEASand TX			
Information Element	Value/Remark	Comment	Condition
RRCReconfigurationSidelink ::= SEQUENCE {			
criticalExtensions CHOICE {			
rrcReconfigurationSidelink-r16 SEQUENCE {			
sl-MeasConfig-r16 CHOICE {			
setup SEQUENCE {			
sl-ReportConfigToAddModList-r16	SL-ReportConfigList-r16 as defined in TS 38.508-1 [4], Table 4.6.6-24 with condition PERIODICAL		

}			
}			
}			
}			
}			

Table 12.1.3.1.3.3-4: RRCReconfigurationCompleteSidelink (step 3, Table 12.1.3.1.3.2-1)

Derivation path: TS 38.508-1 [4], Table 4.6.1A-4 with condition RX

12.1.3.2 PC5-only operation / Measurement configuration and reporting via PC5 RRC / PSBCH-RSRP measurement reporting / Event S1 and S2

12.1.3.2.1 Test Purpose (TP)

(1)

```
with { UE configured to perfv
form event S1 PSBCH-RSRP measurement on SL-SSB via PC5 RRC }
ensure that {
  when { PSBCH-RSRP measurement results of SL SSB are below threshold }
  then { UE does not trigger PSBCH-RSRP measurement reporting }
}
```

(2)

```
with { UE configured to perform event S1 PSBCH-RSRP measurement on SL-SSB via PC5 RRC }
ensure that {
  when { PSBCH-RSRP measurement results of SL SSB are above threshold }
  then { UE triggers PSBCH-RSRP measurement reporting }
}
```

(3)

```
with { UE configured to perform event S2 PSBCH-RSRP measurement on SL-SSB via PC5 RRC }
ensure that {
  when { PSBCH-RSRP measurement results of SL SSB are above threshold }
  then { UE does not trigger PSBCH-RSRP measurement reporting }
}
```

(4)

```
with { UE configured to perform event S2 PSBCH-RSRP measurement on SL-SSB via PC5 RRC }
ensure that {
  when { PSBCH-RSRP measurement results of SL SSB are below threshold }
  then { UE triggers PSBCH-RSRP measurement reporting }
}
```

12.1.3.2.2 Conformance requirements

References: The conformance requirements covered in the present TC are specified in: TS 38.331 [22], subclause 5.8.9.1.3, 5.8.10.2.1, 5.8.10.2.5, 5.8.10.2.7, 5.8.10.3.1, 5.8.10.4.2, 5.8.10.4.3 and 5.8.10.5.1. Unless otherwise stated these are Rel-16 requirements.

[TS 38.331, subclause 5.8.9.1.3]

The UE shall perform the following actions upon reception of the *RRCReconfigurationSidelink*:

...

- 1> if the *RRCReconfigurationSidelink* message includes the *sl-MeasConfig*:
- 2> perform the sidelink measurement configuration procedure as specified in 5.8.10;
- ...

1> else:

- 2> set the content of the *RRCReconfigurationCompleteSidelink* message;
- 3> submit the *RRCReconfigurationCompleteSidelink* message to lower layers for transmission;

NOTE 1: When the same logical channel is configured with different RLC mode by another UE, the UE handles the case as sidelink RRC reconfiguration failure.

[TS 38.331, subclause 5.8.10.2.1]

The UE shall:

...

1> if the received *sl-MeasConfig* includes the *sl-MeasObjectToAddModList* in the *RRCReconfigurationSidelink*:

2> perform the sidelink measurement object addition/modification procedure as specified in 5.8.10.2.5;

...

1> if the received *sl-MeasConfig* includes the *sl-ReportConfigToAddModList* in the *RRCReconfigurationSidelink*:

2> perform the sidelink reporting configuration addition/modification procedure as specified in 5.8.10.2.7;

1> if the received *sl-MeasConfig* includes the *sl-QuantityConfig* in the *RRCReconfigurationSidelink*:

2> perform the sidelink quantity configuration procedure as specified in 5.8.10.2.8;

...

1> if the received *sl-MeasConfig* includes the *sl-MeasIdToAddModList* in the *RRCReconfigurationSidelink*:

2> perform the sidelink measurement identity addition/modification procedure as specified in 5.8.10.2.3;

[TS 38.331, subclause 5.8.10.2.5]

The UE shall:

1> for each *sl-MeasObjectId* included in the received *sl-MeasObjectToAddModList*:

2> if an entry with the matching *sl-MeasObjectId* exists in the *sl-MeasObjectList* within the *VarMeasConfigSL*, for this entry:

3> for each *sl-MeasId* associated with this *sl-MeasObjectId* included in the *sl-MeasIdList* within the *VarMeasConfigSL*, if any:

4> remove the measurement reporting entry for this *sl-MeasId* from the *VarMeasReportListSL*, if included;

4> stop the periodical reporting timer and reset the associated information (e.g. *sl-TimeToTrigger*) for this *sl-MeasId*;

3> reconfigure the entry with the value received for this *sl-MeasObject*;

2> else:

3> add a new entry for the received *sl-MeasObject* to the *sl-MeasObjectList* within *VarMeasConfigSL*.

[TS 38.331, subclause 5.8.10.2.7]

The UE shall:

1> for each *sl-ReportConfigId* included in the received *sl-ReportConfigToAddModList*:

2> if an entry with the matching *sl-ReportConfigId* exists in the *sl-ReportConfigList* within the *VarMeasConfigSL*, for this entry:

3> reconfigure the entry with the value received for this *sl-ReportConfig*;

3> for each *sl-MeasId* associated with this *sl-ReportConfigId* included in the *sl-MeasIdList* within the *VarMeasConfigSL*, if any:

4> remove the measurement reporting entry for this *sl-MeasId* from the *VarMeasReportListSL*, if included;

4> stop the periodical reporting timer and reset the associated information (e.g. *sl-TimeToTrigger*) for this *sl-MeasId*;

2> else:

3> add a new entry for the received *sl-ReportConfig* to the *sl-ReportConfigList* within the *VarMeasConfigSL*.

[TS 38.331, subclause 5.8.10.3.1]

A UE shall derive NR sidelink measurement results by measuring one or multiple DMRS associated per PC5-RRC connection as configured by the peer UE associated, as described in 5.8.10.3.2. For all NR sidelink measurement results the UE applies the layer 3 filtering as specified in sub-clause 5.5.3.2, before using the measured results for evaluation of reporting criteria and measurement reporting. In this release, only NR sidelink RSRP can be configured as trigger quantity and reporting quantity.

The UE shall:

1> for each *sl-MeasId* included in the *sl-MeasIdList* within *VarMeasConfigSL*:

2> if the *sl-MeasObject* is associated to NR sidelink and the *sl-RS-Type* is set to *dmrs*:

3> derive the layer 3 filtered NR sidelink measurement result based on DMRS for the trigger quantity and each measurement quantity indicated in *sl-ReportQuantity* using parameters from the associated *sl-MeasObject*, as described in 5.8.10.3.2.

2> perform the evaluation of reporting criteria as specified in 5.8.10.4.

[TS 38.331, subclause 5.8.10.4.2]

The UE shall:

1> consider the entering condition for this event to be satisfied when condition S1-1, as specified below, is fulfilled;

1> consider the leaving condition for this event to be satisfied when condition S1-2, as specified below, is fulfilled;

1> for this NR sidelink measurement, consider the NR sidelink frequency corresponding to the associated *sl-MeasObject* associated with this event.

Inequality S1-1 (Entering condition)

$$M_s - H_{ys} > Thresh$$

Inequality S1-2 (Leaving condition)

$$M_s + H_{ys} < Thresh$$

The variables in the formula are defined as follows:

M_s is the NR sidelink measurement result of the NR sidelink frequency, not taking into account any offsets.

H_{ys} is the hysteresis parameter for this event (i.e. *sl-Hysteresis* as defined within *sl-ReportConfig* for this event).

Thresh is the threshold parameter for this event (i.e. *sl-Threshold* as defined within *sl-ReportConfig* for this event).

M_s is expressed in dBm in case of RSRP.

H_{ys} is expressed in dB.

Thresh is expressed in the same unit as ***M_s***.

[TS 38.331, subclause 5.8.10.4.3]

The UE shall:

- 1> consider the entering condition for this event to be satisfied when condition S2-1, as specified below, is fulfilled;
- 1> consider the leaving condition for this event to be satisfied when condition S2-2, as specified below, is fulfilled;
- 1> for this NR sidelink measurement, consider the NR sidelink frequency indicated by the *sl-MeasObject* associated to this event.

Inequality S2-1 (Entering condition)

$$Ms + Hys < Thresh$$

Inequality S2-2 (Leaving condition)

$$Ms - Hys > Thresh$$

The variables in the formula are defined as follows:

Ms is the NR sidelink measurement result of the NR sidelink frequency, not taking into account any offsets.

Hys is the hysteresis parameter for this event (i.e. *sl-Hysteresis* as defined within *sl-ReportConfig* for this event).

Thresh is the threshold parameter for this event (i.e. *s2-Threshold* as defined within *sl-ReportConfig* for this event).

Ms is expressed in dBm in case of RSRP.

Hys is expressed in dB.

Thresh is expressed in the same unit as ***Ms***.

[TS 38.331, subclause 5.8.10.5.1]



Figure 5.8.10.5.1-1: NR sidelink measurement reporting

The purpose of this procedure is to transfer measurement results from the UE to the peer UE associated.

For the *sl-MeasId* for which the NR sidelink measurement reporting procedure was triggered, the UE shall set the *sl-MeasResults* within the *MeasurementReportSidelink* message as follows:

- 1> set the *sl-MeasId* to the measurement identity that triggered the NR sidelink measurement reporting;
- 1> if the *sl-ReportConfig* associated with the *sl-MeasId* that triggered the NR sidelink measurement reporting is set to *sl-EventTriggered* or *sl-Periodical*:
 - 2> set *sl-ResultDMRS* within *sl-MeasResult* to include the NR sidelink DMRS based quantity indicated in the *sl-ReportQuantity* within the concerned *sl-ReportConfig*;
- 1> increment the *sl-NumberOfReportsSent* as defined within the *VarMeasReportListSSL* for this *sl-MeasId* by 1;
- 1> stop the periodical reporting timer, if running;
- 1> if the *sl-NumberOfReportsSent* as defined within the *VarMeasReportListSL* for this *sl-MeasId* is less than the *sl-ReportAmount* as defined within the corresponding *sl-ReportConfig* for this *sl-MeasId*:
 - 2> start the periodical reporting timer with the value of *sl-ReportInterval* as defined within the corresponding *sl-ReportConfig* for this *sl-MeasId*;

1> else:

2> if the *sl-ReportType* is set to *sl-Periodical*:

3> remove the entry within the *VarMeasReportListSL* for this *sl-MeasId*;

3> remove this *sl-MeasId* from the *sl-MeasIdList* within *VarMeasConfigSL*;

1> submit the *MeasurementReportSidelink* message to lower layers for transmission, upon which the procedure ends.

12.1.3.2.3 Test description

12.1.3.2.3.1 Pre-test conditions

System Simulator:

- NR-SS-UE
 - NR-SS-UE1 operating as NR sidelink communication device on the resources (i.e. the frequency included in pre-configuration) that UE is expected to use for transmission and reception via PC5 interface.
 - NR-SS-UE1 uses GNSS as the synchronization reference source.
- GNSS simulator
- The GNSS simulator is started and configured for Scenario #1.

UE:

- UE is authorised to perform NR sidelink communication.
- The UE uses GNSS as the synchronization reference source.
- The UE is equipped with a USIM containing default values as per TS 38.508-1 [4] clause 4.8.3.3.3.

Preamble:

- The UE is in state 4-A as defined in TS 38.508-1 [4], subclause 4.4A using generic procedure parameter *Sidelink (On)*, *Cast Type (Unicast)*, *GNSS Sync (On)* using NR-SS-UE initiated unicast mode NR sidelink communication procedure in subclause 4.9.23.

12.1.3.2.3.2 Test procedure sequence

Table 12.1.3.2.3.2-1 illustrates the downlink power levels and other, if any, changing parameters to be applied for the NR-SS-UE at various time instants of the test execution. Row marked "T0" denotes the initial conditions after preamble, while columns marked "T1" is to be applied subsequently. The exact instants on which these values shall be applied are described elsewhere in the present clause.

Table 12.1.3.2.3.2-1: Time instances of simulated NR-SS-UE power level and parameter changes

	Parameter	Unit	NR-SS-UE1	Comment
T0	S-RSRP	dBm/SCS	-98	Power level is such that entering condition for event $S1 Ms - Hys > Thresh$ is not satisfied and entering condition for event $S2 Ms + Hys < Thresh$ is satisfied.
T1	S-RSRP	dBm/SCS	-76	Power level is such that entering condition for event $S1 Ms - Hys > Thresh$ is satisfied and entering condition for event $S2 Ms + Hys < Thresh$ is not satisfied.

Table 12.1.3.2.3.2-2: Main behaviour

St	Procedure	Message Sequence		TP	Verdict
		U - S	Message		
1	The NR-SS-UE1 transmits an <i>RRCReconfigurationSidelink</i> message including <i>sl-MeasConfig</i> to setup event S1 triggered PSBCH-RSRP measurement and reporting.	<--	PC5 RRC: <i>RRCReconfigurationSidelink</i>	-	-
2	The UE transmits an <i>RRCReconfigurationCompleteSidelink</i> message.	-->	PC5 RRC: <i>RRCReconfigurationCompleteSidelink</i>	-	-
3	Check: Does the UE transmit a <i>MeasurementReportSidelink</i> message to report event S1 within the next 10s?	-	-	1	F
4	The NR-SS-UE1 re-adjusts the power level according to row "T1" in Table 12.1.3.2.3.2-1.	-	-	-	-
-	EXCEPTION: Step 5 below is repeated until 2 <i>MeasurementReportSidelink</i> messages are received from the UE.	-	-	-	-
5	Check: Does the UE transmit a <i>MeasurementReportSidelink</i> message to report event S1?	-->	PC5 RRC: <i>MeasurementReportSidelink</i>	2	P
6	The NR-SS-UE1 transmits an <i>RRCReconfigurationSidelink</i> message including <i>sl-MeasConfig</i> to setup event S2 triggered PSBCH-RSRP measurement and reporting.	<--	PC5 RRC: <i>RRCReconfigurationSidelink</i>	-	-
7	The UE transmits an Table 12.1.3.2.3.2-2 message.	-->	PC5 RRC: Table 12.1.3.2.3.2-2	-	-
8	Check: Does the UE transmit a <i>MeasurementReportSidelink</i> message to report event S2 within the next 10s?	-	-	3	F
9	The NR-SS-UE1 re-adjusts the power level according to row "T0" in Table 12.1.3.2.3.2-1.	-	-	-	-
-	EXCEPTION: Step 10 below is repeated until 2 <i>MeasurementReportSidelink</i> messages are received from the UE.	-	-	-	-
10	Check: Does the UE transmit a <i>MeasurementReportSidelink</i> message to report event S2?	-->	PC5 RRC: <i>MeasurementReportSidelink</i>	4	P

12.1.3.2.3.3 Specific message contents

Table 12.1.3.2.3.3-1: *RRCReconfigurationSidelink* (step 1, Table 12.1.3.2.3.2-2)

Derivation Path: TS 38.508-1 [4], Table 4.6.1A-3 with condition RX and SL_MEAS

Table 12.1.3.2.3.3-2: *SL-ReportConfigList* (69) (Table 12.1.3.2.3.3-1)

Derivation Path: TS 38.508-1 [4], Table 4.6.6-24 with condition EVENT_S1

Table 12.1.3.2.3.3-3: *MeasurementReportSidelink* (step 5, 10, Table 12.1.3.2.3.2-2)

Derivation Path: TS 38.508-1 [4], Table 4.6.1A-2 with condition TX

Table 12.1.3.2.3.3-4: *RRCReconfigurationSidelink* (step 6, Table 12.1.3.2.3.2-2)

Derivation Path: TS 38.508-1 [4], Table 4.6.1A-3 with condition RX and SL_MEAS

Table 12.1.3.2.3.3-5: SL-ReportConfigList (69) (Table 12.1.3.2.3.3-4)

Derivation Path: TS 38.508-1 [4], Table 4.6.6-24 with condition EVENT_S2
--

12.1.3.3 PC5-only operation / Measurement configuration and reporting via PC5 RRC / PSBCH-RSRP measurement reporting / Periodical reporting

12.1.3.3.1 Test Purpose (TP)

(1)

```

with { UE being configured to perform periodical PSBCH-RSRP measurement reporting on SL SSB via PC5 RRC }
ensure that {
  when { The first measurement result is available and thereafter every time periodical timer expires until sl-NumberOfReportsSent is equal to sl-ReportAmount }
  then { UE triggers PSBCH-RSRP measurement reporting }
}

```

12.1.3.3.2 Conformance requirements

References: The conformance requirements covered in the present TC are specified in: TS 38.331 [22], subclause 5.8.10.2.1, 5.8.10.2.3, 5.8.10.2.5, 5.8.10.2.7, 5.8.10.3.1, 5.8.10.3.2, 5.8.10.4.1 and 5.8.10.5.1. Unless otherwise stated these are Rel-16 requirements.

[TS 38.331, subclause 5.8.10.2.1]

The UE shall:

....

- 1> if the received *sl-MeasConfig* includes the *sl-MeasObjectToAddModList* in the *RRCReconfigurationSidelink*:
 - 2> perform the sidelink measurement object addition/modification procedure as specified in 5.8.10.2.5;

...

- 1> if the received *sl-MeasConfig* includes the *sl-ReportConfigToAddModList* in the *RRCReconfigurationSidelink*:
 - 2> perform the sidelink reporting configuration addition/modification procedure as specified in 5.8.10.2.7;

- 1> if the received *sl-MeasConfig* includes the *sl-QuantityConfig* in the *RRCReconfigurationSidelink*:
 - 2> perform the sidelink quantity configuration procedure as specified in 5.8.10.2.8;

...

- 1> if the received *sl-MeasConfig* includes the *sl-MeasIdToAddModList* in the *RRCReconfigurationSidelink*:
 - 2> perform the sidelink measurement identity addition/modification procedure as specified in 5.8.10.2.3;

[TS 38.331, subclause 5.8.10.2.3]

The UE shall:

- 1> for each *sl-MeasId* included in the received *sl-MeasIdToAddModList*:
 - 2> if an entry with the matching *sl-MeasId* exists in the *sl-MeasIdList* within the *VarMeasConfigSL*:
 - 3> replace the entry with the value received for this *sl-MeasId*;
 - 2> else:
 - 3> add a new entry for this *sl-MeasId* within the *VarMeasConfigSL*;
 - 2> remove the measurement reporting entry for this *sl-MeasId* from the *VarMeasReportListSL*, if included;

- 2> stop the periodical reporting timer and reset the associated information (e.g. *sl-TimeToTrigger*) for this *sl-MeasId*;

[TS 38.331, subclause 5.8.10.2.5]

The UE shall:

- 1> for each *sl-MeasObjectId* included in the received *sl-MeasObjectToAddModList*:
 - 2> if an entry with the matching *sl-MeasObjectId* exists in the *sl-MeasObjectList* within the *VarMeasConfigSL*, for this entry:
 - 3> for each *sl-MeasId* associated with this *sl-MeasObjectId* included in the *sl-MeasIdList* within the *VarMeasConfigSL*, if any:
 - 4> remove the measurement reporting entry for this *sl-MeasId* from the *VarMeasReportListSL*, if included;
 - 4> stop the periodical reporting timer and reset the associated information (e.g. *sl-TimeToTrigger*) for this *sl-MeasId*;
 - 3> reconfigure the entry with the value received for this *sl-MeasObject*;
 - 2> else:
 - 3> add a new entry for the received *sl-MeasObject* to the *sl-MeasObjectList* within *VarMeasConfigSL*.

[TS 38.331, subclause 5.8.10.2.7]

The UE shall:

- 1> for each *sl-ReportConfigId* included in the received *sl-ReportConfigToAddModList*:
 - 2> if an entry with the matching *sl-ReportConfigId* exists in the *sl-ReportConfigList* within the *VarMeasConfigSL*, for this entry:
 - 3> reconfigure the entry with the value received for this *sl-ReportConfig*;
 - 3> for each *sl-MeasId* associated with this *sl-ReportConfigId* included in the *sl-MeasIdList* within the *VarMeasConfigSL*, if any:
 - 4> remove the measurement reporting entry for this *sl-MeasId* from the *VarMeasReportListSL*, if included;
 - 4> stop the periodical reporting timer and reset the associated information (e.g. *sl-TimeToTrigger*) for this *sl-MeasId*;
 - 2> else:
 - 3> add a new entry for the received *sl-ReportConfig* to the *sl-ReportConfigList* within the *VarMeasConfigSL*.

[TS 38.331, subclause 5.8.10.3.1]

A UE shall derive NR sidelink measurement results by measuring one or multiple DMRS associated per PC5-RRC connection as configured by the peer UE associated, as described in 5.8.10.3.2. For all NR sidelink measurement results the UE applies the layer 3 filtering as specified in sub-clause 5.5.3.2, before using the measured results for evaluation of reporting criteria and measurement reporting. In this release, only NR sidelink RSRP can be configured as trigger quantity and reporting quantity.

The UE shall:

- 1> for each *sl-MeasId* included in the *sl-MeasIdList* within *VarMeasConfigSL*:
 - 2> if the *sl-MeasObject* is associated to NR sidelink and the *sl-RS-Type* is set to *dmrs*:

3> derive the layer 3 filtered NR sidelink measurement result based on DMRS for the trigger quantity and each measurement quantity indicated in *sl-ReportQuantity* using parameters from the associated *sl-MeasObject*, as described in 5.8.10.3.2.

2> perform the evaluation of reporting criteria as specified in 5.8.10.4.

[TS 38.331, subclause 5.8.10.3.2]

The UE may be configured by the peer UE associated to derive NR sidelink RSRP measurement results per PC5-RRC connection associated to the NR sidelink measurement objects based on parameters configured in the *sl-MeasObject* and in the *sl-ReportConfig*.

The UE shall:

1> for each NR sidelink measurement quantity to be derived based on NR sidelink DMRS:

2> derive the corresponding measurement of NR sidelink frequency indicated quantity based on DMRS as described in TS 38.215 [9] in the concerned *sl-MeasObject*;

2> apply layer 3 filtering as described in 5.5.3.2;

[TS 38.331, subclause 5.8.10.4.1]

The UE shall:

1> for each *sl-MeasId* included in the *sl-MeasIdList* within *VarMeasConfigSL*:

...

2> if *sl-ReportType* is set to *sl-Periodical* and if a (first) NR sidelink measurement result is available:

3> include a NR sidelink measurement reporting entry within the *VarMeasReportListSL* for this *sl-MeasId*;

3> set the *sl-NumberOfReportsSent* defined within the *VarMeasReportListSL* for this *sl-MeasId* to 0;

3> initiate the NR sidelink measurement reporting procedure, as specified in 5.8.10.5, immediately after the quantity to be reported becomes available for the NR sidelink frequency:

2> upon expiry of the periodical reporting timer for this *sl-MeasId*:

3> initiate the NR sidelink measurement reporting procedure, as specified in 5.8.10.5.

[TS 38.331, subclause 5.8.10.5.1]



Figure 5.8.10.5.1-1: NR sidelink measurement reporting

The purpose of this procedure is to transfer measurement results from the UE to the peer UE associated.

For the *sl-MeasId* for which the NR sidelink measurement reporting procedure was triggered, the UE shall set the *sl-MeasResults* within the *MeasurementReportSidelink* message as follows:

1> set the *sl-MeasId* to the measurement identity that triggered the NR sidelink measurement reporting;

1> if the *sl-ReportConfig* associated with the *sl-MeasId* that triggered the NR sidelink measurement reporting is set to *sl-EventTriggered* or *sl-Periodical*:

2> set *sl-ResultDMRS* within *sl-MeasResult* to include the NR sidelink DMRS based quantity indicated in the *sl-ReportQuantity* within the concerned *sl-ReportConfig*;

- 1> increment the *sl-NumberOfReportsSent* as defined within the *VarMeasReportListSSL* for this *sl-MeasId* by 1;
- 1> stop the periodical reporting timer, if running;
- 1> if the *sl-NumberOfReportsSent* as defined within the *VarMeasReportListSL* for this *sl-MeasId* is less than the *sl-ReportAmount* as defined within the corresponding *sl-ReportConfig* for this *sl-MeasId*:
 - 2> start the periodical reporting timer with the value of *sl-ReportInterval* as defined within the corresponding *sl-ReportConfig* for this *sl-MeasId*;
- 1> else:
 - 2> if the *sl-ReportType* is set to *sl-Periodical*:
 - 3> remove the entry within the *VarMeasReportListSL* for this *sl-MeasId*;
 - 3> remove this *sl-MeasId* from the *sl-MeasIdList* within *VarMeasConfigSL*;
- 1> submit the *MeasurementReportSidelink* message to lower layers for transmission, upon which the procedure ends.

12.1.3.3.3 Test description

12.1.3.3.3.1 Pre-test conditions

System Simulator:

- NR-SS-UE
 - NR-SS-UE1: operating as NR sidelink communication device on the resources (i.e. the frequency included in pre-configuration) that UE is expected to use for transmission and reception via PC5 interface.
 - NR-SS-UE1 uses GNSS as the synchronization reference source.
- GNSS simulator
- The GNSS simulator is started and configured for Scenario #1.

UE:

- UE is authorised to perform NR sidelink communication.
- The UE is equipped with a USIM containing default values as per TS 38.508-1 [4] clause 4.8.3.3.3.
- The UE uses GNSS as the synchronization reference source.

Preamble:

- The UE is in state 4-A as defined in TS 38.508-1 [4] subclause 4.4A using generic procedure defined in TS 38.508-1[4] clause 4.5.7 with parameters Sidelink (*On*), Cast Type (*Unicast*), GNSS Sync (*On*) using UE initiated unicast mode NR sidelink communication procedure in subclause 4.9.22.

12.1.3.3.3.2 Test procedure sequence

Table 12.1.3.3.3.2-1: Main behaviour

St	Procedure	Message Sequence		TP	Verdict
		U - S	Message		
0	The NR-SS-UE1 transmits SLSS & <i>MasterInformationBlockSidelink</i> (Note 1).	<--	PC5 RRC: SLSS & <i>MasterInformationBlockSidelink</i>	-	-
1	The NR-SS-UE1 transmits a <i>RRCReconfigurationSidelink</i> message on SL-SRB3.	<--	PC5 RRC: <i>RRCReconfigurationSidelink</i>	-	-
2	The UE transmits a	-->	PC5 RRC:	-	-

	<i>RRCReconfigurationCompleteSidelink</i> message on SL-SRB3.		RRCReconfigurationCompleteSidelink		
3	Check: Does the UE transmit a <i>MeasurementReportSidelink</i> message to perform periodical reporting?	-->	PC5 RRC: <i>MeasurementReportSidelink</i>	1	P
-	EXCEPTION: After the 1st <i>MeasurementReportSidelink</i> message at step 3 is received, step 4 below is repeated until 15 <i>MeasurementReport</i> messages are received from the UE. The interval between two <i>MeasurementReportSidelink</i> shall be as specified by the IE <i>sl-ReportInterval</i>	-	-	-	-
4	Check: Does the UE transmit a <i>MeasurementReportSidelink</i> message to perform periodical reporting?	-->	PC5 RRC: <i>MeasurementReportSidelink</i>	1	P
Note 1: UE is using TS 38.508-1 [4] Table 4.6.6-31: <i>SL-SyncConfig</i> parameters to transmit SLSS.					

12.1.3.3.3.3 Specific message contents

Table 12.1.3.3.3.3-0: *SL-SyncConfig* (step 0, Table 12.1.3.3.3.2-1)

Derivation Path: TS 38.508-1 [4], Table 4.6.6-31			
Information Element	Value/remark	Comment	Condition
SL-SyncConfig-r16 ::= SEQUENCE {			
gnss-Sync-r16	true		
}			

Table 12.1.3.3.3.3-0A: *MasterInformationBlockSidelink* (step 0, Table 12.1.3.3.3.2-1)

Derivation Path: TS 38.508-1 [4], Table 4.6.1A-1 with condition RX AND GNSS_SYNC
--

Table 12.1.3.3.3.3-1: *RRCReconfigurationSidelink* (step 1, Table 12.1.3.3.3.2-1)

Derivation Path: TS 38.508-1 [4], Table 4.6.1A-3 with condition SL_MEAS and RX			
Information Element	Value/remark	Comment	Condition
RRCReconfigurationSidelink ::= SEQUENCE {			
criticalExtensions CHOICE {			
rrcReconfigurationSidelink-r16 SEQUENCE {			
sl-MeasConfig-r16 CHOICE {			
setup SEQUENCE {			
sl-ReportConfigToAddModList-r16	SL-ReportConfigList-r16	Table 12.1.3.3.3.3-2	
}			
}			
}			
}			
}			

Table 12.1.3.3.3.3-2: *SL-ReportConfigList-r16* (Table 12.1.3.3.3.3-1)

Derivation Path: TS 38.508-1 [4], Table 4.6.6-24 with condition PERIODICAL			
Information Element	Value/remark	Comment	Condition
SL-ReportConfigList-r16 ::= SEQUENCE (SIZE (1..maxNrofSL-ReportConfigId-r16)) OF SL-ReportConfigInfo-r16 {	1 entry		
SL-ReportConfigInfo-r16[1] SEQUENCE {		entry 1	
sl-ReportConfig-r16 SEQUENCE {			
sl-ReportType-r16 CHOICE {			
sl-Periodical-r16 SEQUENCE {			
sl-ReportAmount-r16	r16		
}			

}			
}			
}			
}			

Table 12.1.3.3.3-3: RRCReconfigurationCompleteSidelink (step 2, Table 12.1.3.3.2-1)

Derivation path: TS 38.508-1 [4], Table 4.6.1A-4 with condition TX
--

Table 12.1.3.3.3-4: MeasurementReportSidelink (step 3, step 4, Table 12.2.5.3.2-1)

Derivation path: TS 38.508-1 [4], Table 4.6.1A-2 with condition TX
--

12.1.4 PC5-only operation / Sidelink Reconfiguration via PC5 RRC

12.1.4.1 PC5-only operation / Sidelink Reconfiguration via PC5 RRC / SL-DRB management / initiating UE side

12.1.4.1.1 Test Purpose (TP)

(1)

```
with { UE having established PC5 RRC connection with peer UE }
ensure that {
  when { UE is configured by higher layer to transmit a PC5 RRCReconfiguration message to establish
a unicast SL-DRB }
  then { UE sends a RRCReconfigurationSidelink message to peer UE }
}
```

(2)

```
with { UE having established PC5 RRC connection with peer UE }
ensure that {
  when { UE is configured by higher layer to transmit a PC5 RRCReconfiguration message to modify a
unicast SL-DRB }
  then { UE sends a RRCReconfigurationSidelink message to peer UE }
}
```

(3)

```
with { UE having established PC5 RRC connection with peer UE }
ensure that {
  when { UE is configured by higher layer to transmit a PC5 RRCReconfiguration message to release a
unicast SL-DRB }
  then { UE sends a RRCReconfigurationSidelink message to peer UE }
}
```

12.1.4.1.2 Conformance requirements

References: The conformance requirements covered in the present TC are specified in: TS 38.331 , subclause 5.8.9.1a.1.2, 5.8.9.1a.2.1, 5.8.9.1a.2.2. Unless otherwise stated these are Rel-16 requirements.

[TS 38.331, subclause 5.8.9.1a.1.2]

For each sidelink DRB, whose sidelink DRB release conditions are met as in sub-clause 5.8.9.1a.1.1, the UE capable of NR sidelink communication that is configured by upper layers to perform NR sidelink communication shall:

1> for groupcast and broadcast; or

1> for unicast, if the sidelink DRB release was triggered after the reception of the *RRCReconfigurationSidelink* message; or

- 1> for unicast, after receiving the *RRCReconfigurationCompleteSidelink* message, if the sidelink DRB release was triggered due to the configuration received within the *sl-ConfigDedicatedNR*, *SIB12*, *SidelinkPreconfigNR* or indicated by upper layers:
 - 2> release the PDCP entity for NR sidelink communication associated with the sidelink DRB;
 - 2> if SDAP entity for NR sidelink communication associated with this sidelink DRB is configured:
 - 3> indicate the release of the sidelink DRB to the SDAP entity associated with this sidelink DRB (TS 37.324 [24], clause 5.3.3);
 - 2> release SDAP entities for NR sidelink communication, if any, that have no associated sidelink DRB as specified in TS 37.324 [24] clause 5.1.2;
- 1> for groupcast and broadcast; or
- 1> for unicast, after receiving the *RRCReconfigurationCompleteSidelink* message, if the sidelink DRB release was triggered due to the configuration received within the *sl-ConfigDedicatedNR*:
 - 2> for each *sl-RLC-BearerConfigIndex* included in the received *sl-RLC-BearerToReleaseList* that is part of the current UE sidelink configuration:
 - 3> release the RLC entity and the corresponding logical channel for NR sidelink communication, associated with the *sl-RLC-BearerConfigIndex*.
- 1> for unicast, if the sidelink DRB release was triggered due to the reception of the *RRCReconfigurationSidelink* message; or
- 1> for unicast, after receiving the *RRCReconfigurationCompleteSidelink* message, if the sidelink DRB release was triggered due to the configuration received within the *SIB12*, *SidelinkPreconfigNR* or indicated by upper layers:
 - 2> release the RLC entity and the corresponding logical channel for NR sidelink communication associated with the sidelink DRB;
 - 2> perform the sidelink UE information procedure in sub-clause 5.8.3 for unicast if needed.
- 1> if the sidelink radio link failure is detected for a specific destination:
 - 2> release the PDCP entity, RLC entity and the logical channel of the sidelink DRB for the specific destination.

[TS 38.331, subclause 5.8.9.1a.2.1]

For NR sidelink communication, a sidelink DRB addition is initiated only in the following cases:

- 1> if any sidelink QoS flow is (re)configured by *sl-ConfigDedicatedNR*, *SIB12*, *SidelinkPreconfigNR* and is to be mapped to one sidelink DRB, which is not established; or
- 1> if any sidelink QoS flow is (re)configured by *RRCReconfigurationSidelink* and is to be mapped to a sidelink DRB, which is not established;

For NR sidelink communication, a sidelink DRB modification is initiated only in the following cases:

- 1> if any of the sidelink DRB related parameters is changed by *sl-ConfigDedicatedNR*, *SIB12*, *SidelinkPreconfigNR* or *RRCReconfigurationSidelink* for one sidelink DRB, which is established;

[TS 38.331, subclause 5.8.9.1a.2.2]

For the sidelink DRB, whose sidelink DRB addition conditions are met as in sub-clause 5.8.9.1a.2.1, the UE capable of NR sidelink communication that is configured by upper layers to perform NR sidelink communication shall:

- 1> for groupcast and broadcast; or
- 1> for unicast, if the sidelink DRB addition was triggered due to the reception of the *RRCReconfigurationSidelink* message; or

- 1> for unicast, after receiving the *RRCReconfigurationCompleteSidelink* message, if the sidelink DRB addition was triggered due to the configuration received within the *sl-ConfigDedicatedNR*, *SIB12*, *SidelinkPreconfigNR* or indicated by upper layers:
 - 2> if an SDAP entity for NR sidelink communication associated with the destination and the cast type of the sidelink DRB does not exist:
 - 3> establish an SDAP entity for NR sidelink communication as specified in TS 37.324 [24] clause 5.1.1;
 - 2> (re)configure the SDAP entity in accordance with the *sl-SDAP-ConfigPC5* received in the *RRCReconfigurationSidelink* or *sl-SDAP-Config* received in *sl-ConfigDedicatedNR*, *SIB12*, *SidelinkPreconfigNR*, associated with the sidelink DRB;
 - 2> establish a PDCP entity for NR sidelink communication and configure it in accordance with the *sl-PDCP-ConfigPC5* received in the *RRCReconfigurationSidelink* or *sl-PDCP-Config* received in *sl-ConfigDedicatedNR*, *SIB12*, *SidelinkPreconfigNR*, associated with the sidelink DRB;
 - 2> establish a RLC entity for NR sidelink communication and configure it in accordance with the *sl-RLC-ConfigPC5* received in the *RRCReconfigurationSidelink* or *sl-RLC-Config* received in *sl-ConfigDedicatedNR*, *SIB12*, *SidelinkPreconfigNR*, associated with sidelink DRB;
 - 2> if this procedure was due to the reception of a *RRCReconfigurationSidelink* message:
 - 3> configure the MAC entity with a logical channel in accordance with the *sl-MAC-LogicalChannelConfigPC5* received in the *RRCReconfigurationSidelink* associated with the sidelink DRB, and perform the sidelink UE information procedure in sub-clause 5.8.3 for unicast if need;
 - 2> else:
 - 3> configure the MAC entity with a logical channel associated with the sidelink DRB, by assigning a new logical channel identity, in accordance with the *sl-MAC-LogicalChannelConfig* received in the *sl-ConfigDedicatedNR*, *SIB12*, *SidelinkPreconfigNR*.

NOTE 1: When a sidelink DRB addition is due to the configuration by *RRCReconfigurationSidelink*, it is up to UE implementation to select the sidelink DRB configuration as necessary transmitting parameters for the sidelink DRB, from the received *sl-ConfigDedicatedNR* (if in RRC_CONNECTED), *SIB12* (if in RRC_IDLE/INACTIVE), *SidelinkPreconfigNR* (if out of coverage) with the same RLC mode as the one configured in *RRCReconfigurationSidelink*.

For the sidelink DRB, whose sidelink DRB modification conditions are met as in sub-clause 5.8.9.1a.2.1, the UE capable of NR sidelink communication that is configured by upper layers to perform NR sidelink communication shall:

- 1> for groupcast and broadcast; or
- 1> for unicast, if the sidelink DRB modification was triggered due to the reception of the *RRCReconfigurationSidelink* message; or
- 1> for unicast, after receiving the *RRCReconfigurationCompleteSidelink* message, if the sidelink DRB modification was triggered due to the configuration received within the *sl-ConfigDedicatedNR*, *SIB12* or *SidelinkPreconfigNR*:
 - 2> reconfigure the SDAP entity of the sidelink DRB, in accordance with the *sl-SDAP-ConfigPC5* received in the *RRCReconfigurationSidelink* or *sl-SDAP-Config* received in *sl-ConfigDedicatedNR*, *SIB12*, *SidelinkPreconfigNR*, if included;
 - 2> reconfigure the PDCP entity of the sidelink DRB, in accordance with the *sl-PDCP-ConfigPC5* received in the *RRCReconfigurationSidelink* or *sl-PDCP-Config* received in *sl-ConfigDedicatedNR*, *SIB12*, *SidelinkPreconfigNR*, if included;
 - 2> reconfigure the RLC entity of the sidelink DRB, in accordance with the *sl-RLC-ConfigPC5* received in the *RRCReconfigurationSidelink* or *sl-RLC-Config* received in *sl-ConfigDedicatedNR*, *SIB12*, *SidelinkPreconfigNR*, if included;
 - 2> reconfigure the logical channel of the sidelink DRB, in accordance with the *sl-MAC-LogicalChannelConfigPC5* received in the *RRCReconfigurationSidelink* or *sl-MAC-LogicalChannelConfig* received in *sl-ConfigDedicatedNR*, *SIB12*, *SidelinkPreconfigNR*, if included.

12.1.4.1.3 Test description

12.1.4.1.3.1 Pre-test conditions

System Simulator:

- NR-SS-UE
 - NR-SS-UE1 operating as NR sidelink communication device on the resources (i.e. the frequency included in pre-configuration) that UE is expected to use for transmission and reception via PC5 interface.
- GNSS simulator
 - The GNSS simulator is started and configured for Scenario #1.
- NR-SS-UE 1 is synchronised on GNSS.

UE:

- UE is authorised to perform NR sidelink communication.
- The UE is equipped with a USIM containing default values as per TS 38.508-1 [4] clause 4.8.3.3.3.
- UE is synchronised on GNSS.

Preamble:

- The UE is in state 0-A as defined in TS 38.508-1 [4].

12.1.4.1.3.2 Test procedure sequence

Table 12.1.4.1.3.2-1: Main behaviour

	Procedure	Message Sequence		TP	Verdict
		U - S	Message		
1	Power on the UE.	-	-	-	-
2	Trigger UE to reset or clear the current UTC time that has been calculated from GNSS. NOTE: The UTC time can be reset or clear on the UE using AT command (+CUTCR).	-	-	-	-
3	The UE is configured by upper layer to establish unicast mode link. NOTE: This can be done by sending AT COMMAND +CCUTLE to close test loop function.	-	-	-	-
4	The UE sends a DIRECT LINK ESTABLISHMENT REQUEST message.	-->	PC5-S: DIRECT LINK ESTABLISHMENT REQUEST	-	-
5	The NR-SS-UE sends a DIRECT LINK SECURITY MODE COMMAND message.	<<--	PC5-S: DIRECT LINK SECURITY MODE COMMAND	-	-
6	The UE sends a DIRECT LINK SECURITY MODE COMPLETE message.	-->	PC5-S: DIRECT LINK SECURITY MODE COMPLETE	-	-
7	The NR-SS-UE sends a DIRECT LINK ESTABLISHMENT ACCEPT message.	<<--	PC5-S: DIRECT LINK ESTABLISHMENT ACCEPT	-	-
8	Check: Does the UE send an RRCReconfigurationSidelink message to establish a unicast mode SL-DRB?	-->	PC5-RRC: RRCReconfigurationSidelink	1	P
9	The NR-SS-UE sends an RRCReconfigurationCompleteSidelink message.	<<--	PC5-RRC: RRCReconfigurationCompleteSidelink	-	-
10	The SS sends AT COMMAND +CCUTLE to open test loop function	-	-	-	-
11	UE is configured by upper layer to modify SL-DRB to NR-SS-UE1. NOTE: This step is triggered by MMI or AT command.	-	-	-	-

12	Check: Does the UE send an RRCReconfigurationSidelink message to modify the unicast mode SL-DRB?	-->	PC5-RRC: RRCReconfigurationSidelink	2	P
13	The NR-SS-UE sends an RRCReconfigurationCompleteSidelink message.	<--	PC5-RRC: RRCReconfigurationCompleteSidelink	-	-
14	UE is configured by upper layer to release SL-DRB to NR-SS-UE1. Note: This step is triggered by MMI or AT command.	--	-	-	-
15	Check: Does the UE send an RRCReconfigurationSidelink message to NR-SS-UE1 to indicate SL-DRB release?	-->	PC5 RRC: RRCReconfigurationSidelink	3	P
16	The NR-SS-UE sends an RRCReconfigurationCompleteSidelink message to confirm SL-DRB release.	<--	PC5-RRC: RRCReconfigurationCompleteSidelink	-	-

12.1.4.1.3.3 Specific message contents

Table 12.1.4.1.3.3-1: DIRECT LINK ESTABLISHMENT REQUEST (step 4, Table 12.1.4.1.3.2-1)

Derivation path: TS 38.508-1 [4], Table 4.7.4-7 with condition Tx

Table 12.1.4.1.3.3-2: Message DIRECT LINK SECURITY MODE COMMAND (step 5, Table 12.1.4.1.3.2-1)

Derivation path: TS 38.508-1 [4], Table 4.7.4-18 with condition Rx

Table 12.1.4.1.3.3-3: Message DIRECT LINK SECURITY MODE COMPLETE (step 6, Table 12.1.4.1.3.2-1)

Derivation path: TS 38.508-1 [4], Table 4.7.4-19 with condition Tx

Table 12.1.4.1.3.3-4: Message DIRECT LINK ESTABLISHMENT ACCEPT (step 7, Table 12.1.4.1.3.2-1)

Derivation path: TS 38.508-1 [4], Table 4.7.4-8 with condition Rx

Table 12.1.4.1.3.3-5: RRCReconfigurationSidelink (step 8, Table 12.1.4.1.3.2-1)

Derivation path: TS 38.508-1 [4], Table 4.6.1A-3, conditions TX and SL_DRB

Table 12.1.4.1.3.3-6: RRCReconfigurationCompleteSidelink (steps 9, 13 & 16, Table 12.1.4.1.3.2-1)

Derivation path: TS 38.508-1 [4], Table 4.6.1A-4, conditions RX

Table 12.1.4.1.3.3-7: RRCReconfigurationSidelink (step 12, Table 12.1.4.1.3.2-1)

Derivation path: TS 38.508-1 [4], Table 4.6.1A-3, conditions TX and SL_DRB

Table 12.1.4.1.3.3-8: RRCReconfigurationSidelink (step 15, Table 12.1.4.1.3.2-1)

Derivation path: TS 38.508-1 [4], Table 4.6.1A-3, condition TX			
Information Element	Value/Remark	Comment	Condition
RRCReconfigurationSidelink ::= SEQUENCE {			
criticalExtensions CHOICE {			
rrcReconfigurationSidelink-r16 SEQUENCE {			
slrb-ConfigToReleaseList-r16 SEQUENCE (SIZE (1..maxNrofSLRB-r16)) OF SLRB-PC5-ConfigIndex-	1 entry		

r16 {			
SLRB-PC5-ConfigIndex-r16 [1]	1	entry 1	
}			
}			
}			
}			
}			

12.1.4.2 PC5-only operation / Sidelink Reconfiguration via PC5 RRC / SL DRB management / Peer UE side

12.1.4.2.1 Test Purpose (TP)

(1)

```
with { UE having established PC5 RRC connection with peer UE}
ensure that {
  when { UE receives an RRCReconfigurationSidelink that can comply to add an unicast SL-DRB}
  then { UE applies the parameters in RRCReconfigurationSidelink and sends a
RRCReconfigurationCompleteSidelink message to peer UE}
}
```

(2)

```
with { UE having established PC5 RRC connection with peer UE }
ensure that {
  when { UE receives an RRCReconfigurationSidelink that can comply to modify an unicast SL-DRB}
  then {UE applies the parameters in RRCReconfigurationSidelink and sends a
RRCReconfigurationCompleteSidelink message to peer UE }
}
```

(3)

```
with { UE having established PC5 RRC connection with peer UE }
ensure that {
  when { UE receives an RRCReconfigurationSidelink that can comply to release an unicast SL-DRB}
  then { UE applies the parameters in RRCReconfigurationSidelink and sends a
RRCReconfigurationCompleteSidelink message to peer UE}
}
```

12.1.4.2.2 Conformance requirements

References: The conformance requirements covered in the present TC are specified in: TS 38.331 , subclause 5.8.9.1a.1.2, 5.8.9.1a.2.1, 5.8.9.1a.2.2. Unless otherwise stated these are Rel-16 requirements.

[TS 38.331, subclause 5.8.9.1a.1.2]

For each sidelink DRB, whose sidelink DRB release conditions are met as in sub-clause 5.8.9.1a.1.1, the UE capable of NR sidelink communication that is configured by upper layers to perform NR sidelink communication shall:

1> for groupcast and broadcast; or

1> for unicast, if the sidelink DRB release was triggered after the reception of the *RRCReconfigurationSidelink* message; or

1> for unicast, after receiving the *RRCReconfigurationCompleteSidelink* message, if the sidelink DRB release was triggered due to the configuration received within the *sl-ConfigDedicatedNR*, *SIB12*, *SidelinkPreconfigNR* or indicated by upper layers:

2> release the PDCP entity for NR sidelink communication associated with the sidelink DRB;

2> if SDAP entity for NR sidelink communication associated with this sidelink DRB is configured:

3> indicate the release of the sidelink DRB to the SDAP entity associated with this sidelink DRB (TS 37.324 [24], clause 5.3.3);

- 2> release SDAP entities for NR sidelink communication, if any, that have no associated sidelink DRB as specified in TS 37.324 [24] clause 5.1.2;
- 1> for groupcast and broadcast; or
- 1> for unicast, after receiving the *RRCReconfigurationCompleteSidelink* message, if the sidelink DRB release was triggered due to the configuration received within the *sl-ConfigDedicatedNR*:
 - 2> for each *sl-RLC-BearerConfigIndex* included in the received *sl-RLC-BearerToReleaseList* that is part of the current UE sidelink configuration:
 - 3> release the RLC entity and the corresponding logical channel for NR sidelink communication, associated with the *sl-RLC-BearerConfigIndex*.
- 1> for unicast, if the sidelink DRB release was triggered due to the reception of the *RRCReconfigurationSidelink* message; or
- 1> for unicast, after receiving the *RRCReconfigurationCompleteSidelink* message, if the sidelink DRB release was triggered due to the configuration received within the *SIB12*, *SidelinkPreconfigNR* or indicated by upper layers:
 - 2> release the RLC entity and the corresponding logical channel for NR sidelink communication associated with the sidelink DRB;
 - 2> perform the sidelink UE information procedure in sub-clause 5.8.3 for unicast if needed.
- 1> if the sidelink radio link failure is detected for a specific destination:
 - 2> release the PDCP entity, RLC entity and the logical channel of the sidelink DRB for the specific destination.

[TS 38.331, subclause 5.8.9.1a.2.1]

For NR sidelink communication, a sidelink DRB addition is initiated only in the following cases:

- 1> if any sidelink QoS flow is (re)configured by *sl-ConfigDedicatedNR*, *SIB12*, *SidelinkPreconfigNR* and is to be mapped to one sidelink DRB, which is not established; or
- 1> if any sidelink QoS flow is (re)configured by *RRCReconfigurationSidelink* and is to be mapped to a sidelink DRB, which is not established;

For NR sidelink communication, a sidelink DRB modification is initiated only in the following cases:

- 1> if any of the sidelink DRB related parameters is changed by *sl-ConfigDedicatedNR*, *SIB12*, *SidelinkPreconfigNR* or *RRCReconfigurationSidelink* for one sidelink DRB, which is established;

[TS 38.331, subclause 5.8.9.1a.2.2]

For the sidelink DRB, whose sidelink DRB addition conditions are met as in sub-clause 5.8.9.1a.2.1, the UE capable of NR sidelink communication that is configured by upper layers to perform NR sidelink communication shall:

- 1> for groupcast and broadcast; or
- 1> for unicast, if the sidelink DRB addition was triggered due to the reception of the *RRCReconfigurationSidelink* message; or
- 1> for unicast, after receiving the *RRCReconfigurationCompleteSidelink* message, if the sidelink DRB addition was triggered due to the configuration received within the *sl-ConfigDedicatedNR*, *SIB12*, *SidelinkPreconfigNR* or indicated by upper layers:
 - 2> if an SDAP entity for NR sidelink communication associated with the destination and the cast type of the sidelink DRB does not exist:
 - 3> establish an SDAP entity for NR sidelink communication as specified in TS 37.324 [24] clause 5.1.1;
 - 2> (re)configure the SDAP entity in accordance with the *sl-SDAP-ConfigPC5* received in the *RRCReconfigurationSidelink* or *sl-SDAP-Config* received in *sl-ConfigDedicatedNR*, *SIB12*, *SidelinkPreconfigNR*, associated with the sidelink DRB;

- 2> establish a PDCP entity for NR sidelink communication and configure it in accordance with the *sl-PDCP-ConfigPC5* received in the *RRCReconfigurationSidelink* or *sl-PDCP-Config* received in *sl-ConfigDedicatedNR*, *SIB12*, *SidelinkPreconfigNR*, associated with the sidelink DRB;
- 2> establish a RLC entity for NR sidelink communication and configure it in accordance with the *sl-RLC-ConfigPC5* received in the *RRCReconfigurationSidelink* or *sl-RLC-Config* received in *sl-ConfigDedicatedNR*, *SIB12*, *SidelinkPreconfigNR*, associated with sidelink DRB;
- 2> if this procedure was due to the reception of a *RRCReconfigurationSidelink* message:
 - 3> configure the MAC entity with a logical channel in accordance with the *sl-MAC-LogicalChannelConfigPC5* received in the *RRCReconfigurationSidelink* associated with the sidelink DRB, and perform the sidelink UE information procedure in sub-clause 5.8.3 for unicast if need;
- 2> else:
 - 3> configure the MAC entity with a logical channel associated with the sidelink DRB, by assigning a new logical channel identity, in accordance with the *sl-MAC-LogicalChannelConfig* received in the *sl-ConfigDedicatedNR*, *SIB12*, *SidelinkPreconfigNR*.

NOTE 1: When a sidelink DRB addition is due to the configuration by *RRCReconfigurationSidelink*, it is up to UE implementation to select the sidelink DRB configuration as necessary transmitting parameters for the sidelink DRB, from the received *sl-ConfigDedicatedNR* (if in *RRC_CONNECTED*), *SIB12* (if in *RRC_IDLE/INACTIVE*), *SidelinkPreconfigNR* (if out of coverage) with the same RLC mode as the one configured in *RRCReconfigurationSidelink*.

For the sidelink DRB, whose sidelink DRB modification conditions are met as in sub-clause 5.8.9.1a.2.1, the UE capable of NR sidelink communication that is configured by upper layers to perform NR sidelink communication shall:

- 1> for groupcast and broadcast; or
- 1> for unicast, if the sidelink DRB modification was triggered due to the reception of the *RRCReconfigurationSidelink* message; or
- 1> for unicast, after receiving the *RRCReconfigurationCompleteSidelink* message, if the sidelink DRB modification was triggered due to the configuration received within the *sl-ConfigDedicatedNR*, *SIB12* or *SidelinkPreconfigNR*:
 - 2> reconfigure the SDAP entity of the sidelink DRB, in accordance with the *sl-SDAP-ConfigPC5* received in the *RRCReconfigurationSidelink* or *sl-SDAP-Config* received in *sl-ConfigDedicatedNR*, *SIB12*, *SidelinkPreconfigNR*, if included;
 - 2> reconfigure the PDCP entity of the sidelink DRB, in accordance with the *sl-PDCP-ConfigPC5* received in the *RRCReconfigurationSidelink* or *sl-PDCP-Config* received in *sl-ConfigDedicatedNR*, *SIB12*, *SidelinkPreconfigNR*, if included;
 - 2> reconfigure the RLC entity of the sidelink DRB, in accordance with the *sl-RLC-ConfigPC5* received in the *RRCReconfigurationSidelink* or *sl-RLC-Config* received in *sl-ConfigDedicatedNR*, *SIB12*, *SidelinkPreconfigNR*, if included;
 - 2> reconfigure the logical channel of the sidelink DRB, in accordance with the *sl-MAC-LogicalChannelConfigPC5* received in the *RRCReconfigurationSidelink* or *sl-MAC-LogicalChannelConfig* received in *sl-ConfigDedicatedNR*, *SIB12*, *SidelinkPreconfigNR*, if included.

12.1.4.2.3 Test description

12.1.4.2.3.1 Pre-test conditions

System Simulator:

- NR-SS-UE
- NR-SS-UE1 operating as NR sidelink communication device on the resources (i.e. the frequency included in pre-configuration) that UE is expected to use for transmission and reception via PC5 interface.

- GNSS simulator
 - The GNSS simulator is started and configured for Scenario #1.
- NR-SS-UE 1 is synchronised on GNSS.

UE:

- UE is authorised to perform NR sidelink communication.
- The UE is equipped with a USIM containing default values as per TS 38.508-1 [4] clause 4.8.3.3.3.
- UE is synchronised on GNSS.

Preamble:

- The UE is in state 0-A as defined in TS 38.508-1 [4].

12.1.4.2.3.2 Test procedure sequence

Table 12.1.4.2.3.2-1: Main behaviour

	Procedure	Message Sequence		TP	Verdict
		U - S	Message		
1	Power on the UE.	-	-	-	-
2	Trigger UE to reset or clear the current UTC time that has been calculated from GNSS. NOTE: The UTC time can be reset or clear on the UE using AT command (+CUTCR).	-	-	-	-
3	The NR-SS-UE sends a DIRECT LINK ESTABLISHMENT REQUEST message.	<--	PC5-S: DIRECT LINK ESTABLISHMENT REQUEST		
4	The UE sends a DIRECT LINK SECURITY MODE COMMAND message.	-->	PC5-S: DIRECT LINK SECURITY MODE COMMAND	-	-
5	The NR-SS-UE sends a DIRECT LINK SECURITY MODE COMPLETE message.	<--	PC5-S: DIRECT LINK SECURITY MODE COMPLETE	-	-
6	The UE sends a DIRECT LINK ESTABLISHMENT ACCEPT message.	-->	PC5-S: DIRECT LINK ESTABLISHMENT ACCEPT	-	-
7	The NR-SS-UE sends a RRCReconfigurationSidelink message to establish a unicast mode SL-DRB.	<--	PC5-RRC: RRCReconfigurationSidelink	-	-
8	Check: Does the UE send a RRCReconfigurationCompleteSidelink message?	-->	PC5-RRC: RRCReconfigurationCompleteSidelink	1	P
9	The NR-SS-UE sends a RRCReconfigurationSidelink message to indicate modification of unicast mode SL-DRB.	<--	PC5-RRC: RRCReconfigurationSidelink	-	-
10	Check: Does the UE send a RRCReconfigurationCompleteSidelink message?	-->	PC5-RRC: RRCReconfigurationCompleteSidelink	2	P
11	The NR-SS-UE sends a RRCReconfigurationSidelink message to indicate release of unicast mode SL DRB.	<--	PC5-RRC: RRCReconfigurationSidelink	-	-
12	Check: The UE sends a RRCReconfigurationSidelinkComplete message?	-->	PC5-RRC: RRCReconfigurationSidelinkComplete	3	P

12.1.4.2.3.3 Specific message contents

Editor's note: content missing for some of the changes.

Table 12.1.4.2.3.3-1: RRCReconfigurationSidelink (step 7, Table 12.1.4.2.3.2-1)

Derivation path: TS 38.508-1 [4], Table 4.6.1A-3 Conditions RX and SL_DRB

Table 12.1.4.2.3.3-2: RRCReconfigurationSidelink (step 11, Table 12.1.4.2.3.2-1)

Derivation path: TS 38.508-1 [4], Table 4.6.1A-3 Conditions RX and SL_DRB			
Information Element	Value/remark	Comment	Condition
RRCReconfigurationSidelink ::= SEQUENCE {			
criticalExtensions CHOICE {			
rrcReconfigurationSidelink-r16 SEQUENCE {			
slrb-ConfigToAddModList-r16 SEQUENCE (SIZE (1..maxNrofSLRB-r16)) OF SLRB-Config-r16 {	1 entry		
SLRB-Config-r16[1] SEQUENCE {		entry 1	
sl-PDCP-ConfigPC5-r16 SEQUENCE {			
sl-PDCP-SN-Size-r16	len12bits		
sl-OutOfOrderDelivery-r16	true		
}			
}			
}			
}			
}			

Table 12.1.4.2.3.3-3: RRCReconfigurationSidelink (step 14, Table 12.1.4.2.3.2-1)

Derivation path: TS 38.508-1 [4], Table 4.6.1A-3			
Information Element	Value/Remark	Comment	Condition
RRCReconfigurationSidelink ::= SEQUENCE {			
criticalExtensions CHOICE {			
rrcReconfigurationSidelink-r16 SEQUENCE {			
slrb-ConfigToReleaseList-r16 SEQUENCE (SIZE (1..maxNrofSLRB-r16)) OF SLRB-PC5-ConfigIndex-r16 {	1 entry		
SLRB-PC5-ConfigIndex-r16 [1]	1	entry 1	
}			
}			
}			
}			

12.1.5 PC5-only operation / Sidelink CSI reporting

12.1.5.1 PC5-only operation / Sidelink CSI reporting / Configuration

12.1.5.1.1 Test Purpose (TP)

(1)

```
with { UE having established PC5 RRC connection with peer UE }
ensure that {
  when { UE is configured by upper layer to configure SL CSI-RS resource to peer UE }
  then { UE sends an RRCReconfigurationSidelink message including sl-CSI-RS-Config to peer UE and
starts transmitting SL CSI-RS }
}
```

(2)

```
with { UE having established PC5 RRC connection with peer UE }
ensure that {
  when { UE is configured by upper layer to trigger SL CSI report }
  then { UE sends an SCI format 2-A to trigger SL CSI report }
}
```

12.1.5.1.2 Conformance requirements

References: The conformance requirements covered in the present TC are specified in: TS 38.331 [22], subclause 5.8.9.1.1, 5.8.9.1.2, 5.8.9.1.3. Unless otherwise stated these are Rel-16 requirements.

[TS 38.331, clause 5.8.9.1.1]

General

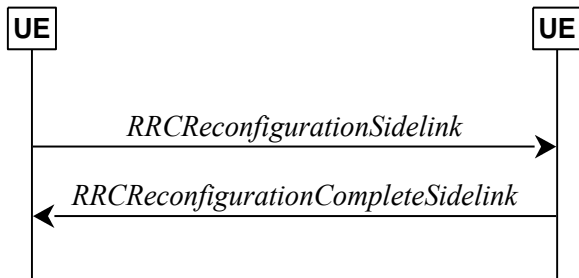

Figure 5.8.9.1.1-1: Sidelink RRC reconfiguration, successful

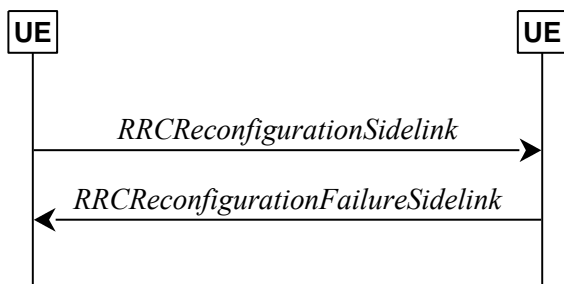

Figure 5.8.9.1.1-2: Sidelink RRC reconfiguration, failure

The purpose of this procedure is to modify a PC5-RRC connection, e.g. to establish/modify/release sidelink DRBs, to (re-)configure NR sidelink measurement and reporting, to (re-)configure sidelink CSI reference signal resources and CSI reporting latency bound.

The UE may initiate the sidelink RRC reconfiguration procedure and perform the operation in sub-clause 5.8.9.1.2 on the corresponding PC5-RRC connection in following cases:

- the release of sidelink DRBs associated with the peer UE, as specified in sub-clause 5.8.9.1a.1;
- the establishment of sidelink DRBs associated with the peer UE, as specified in sub-clause 5.8.9.1a.2;
- the modification for the parameters included in *SLRB-Config* of sidelink DRBs associated with the peer UE, as specified in sub-clause 5.8.9.1a.2;
- the (re-)configuration of the peer UE to perform NR sidelink measurement and report.
- the (re-)configuration of the sidelink CSI reference signal resources and CSI reporting latency bound.

In *RRC_CONNECTED*, the UE applies the NR sidelink communications parameters provided in *RRCReconfiguration* (if any). In *RRC_IDLE* or *RRC_INACTIVE*, the UE applies the NR sidelink communications parameters provided in system information (if any). For other cases, UEs apply the NR sidelink communications parameters provided in *SidelinkPreconfigNR* (if any). When UE performs state transition between above three cases, the UE applies the NR sidelink communications parameters provided in the new state, after acquisition of the new configurations. Before acquisition of the new configurations, UE continues applying the NR sidelink communications parameters provided in the old state.

[TS 38.331, clause 5.8.9.1.2]

The UE shall set the contents of *RRCReconfigurationSidelink* message as follows:

- 1> for each sidelink DRB that is to be released, according to sub-clause 5.8.9.1a.1.1, due to configuration by *sl-ConfigDedicatedNR*, *SIB12*, *SidelinkPreconfigNR* or by upper layers:
 - 2> set the *SLRB-PC5-ConfigIndex* included in the *slrb-ConfigToReleaseList* corresponding to the sidelink DRB;
- 1> for each sidelink DRB that is to be established or modified, according to sub-clause 5.8.9.1a.2.1, due to receiving *sl-ConfigDedicatedNR*, *SIB12* or *SidelinkPreconfigNR*:
 - 2> set the *SLRB-Config* included in the *slrb-ConfigToAddModList*, according to the received *sl-RadioBearerConfig* and *sl-RLC-BearerConfig* corresponding to the sidelink DRB;
- 1> set the *sl-MeasConfig* as follows:
 - 2> If the frequency used for NR sidelink communication is included in *sl-FreqInfoToAddModList* in *sl-ConfigDedicatedNR* within *RRCReconfiguration* message or included in *sl-ConfigCommonNR* within *SIB12*:
 - 3> if UE is in *RRC_CONNECTED*:
 - 4> set the *sl-MeasConfig* according to stored NR sidelink measurement configuration information for this destination;
 - 3> if UE is in *RRC_IDLE* or *RRC_INACTIVE*:
 - 4> set the *sl-MeasConfig* according to stored NR sidelink measurement configuration received from *SIB12*;
 - 2> else:
 - 3> set the *sl-MeasConfig* according to the *sl-MeasPreconfig* in *SidelinkPreconfigNR*;
- 1> start timer T400 for the destination associated with the sidelink DRB;
- 1> set the *sl-CSI-RS-Config*;
- 1> set the *sl-LatencyBoundCSI-Report*,

NOTE 1: How to set the parameters included in *sl-CSI-RS-Config* and *sl-LatencyBoundCSI-Report* is up to UE implementation.

The UE shall submit the *RRCReconfigurationSidelink* message to lower layers for transmission.

[TS 38.331, clause 5.8.9.1.3]

The UE shall perform the following actions upon reception of the *RRCReconfigurationSidelink*:

- 1> if the *RRCReconfigurationSidelink* includes the *sl-ResetConfig*:
- 2> perform the sidelink reset configuration procedure as specified in 5.8.9.1.10;
- 1> if the *RRCReconfigurationSidelink* includes the *slrb-ConfigToReleaseList*:
 - 2> for each *SLRB-PC5-ConfigIndex* value included in the *slrb-ConfigToReleaseList* that is part of the current UE sidelink configuration;
 - 3> perform the sidelink DRB release procedure, according to sub-clause 5.8.9.1a.1;
- 1> if the *RRCReconfigurationSidelink* includes the *slrb-ConfigToAddModList*:
 - 2> for each *slrb-PC5-ConfigIndex* value included in the *slrb-ConfigToAddModList* that is not part of the current UE sidelink configuration:
 - 3> if *sl-MappedQoS-FlowsToAddList* is included:
 - 4> apply the *SL-PQFI* included in *sl-MappedQoS-FlowsToAddList*;
 - 3> perform the sidelink DRB addition procedure, according to sub-clause 5.8.9.1a.2;

2> for each *slrb-PC5-ConfigIndex* value included in the *slrb-ConfigToAddModList* that is part of the current UE sidelink configuration:

3> if *sl-MappedQoS-FlowsToAddList* is included:

4> add the *SL-PQFI* included in *sl-MappedQoS-FlowsToAddList* to the corresponding sidelink DRB;

3> if *sl-MappedQoS-FlowsToReleaseList* is included:

4> remove the *SL-PQFI* included in *sl-MappedQoS-FlowsToReleaseList* from the corresponding sidelink DRB;

3> if the sidelink DRB release conditions as described in sub-clause 5.8.9.1a.1.1 are met:

4> perform the sidelink DRB release procedure according to sub-clause 5.8.9.1a.1.2;

3> else if the sidelink DRB modification conditions as described in sub-clause 5.8.9.1a.2.1 are met:

4> perform the sidelink DRB modification procedure according to sub-clause 5.8.9.1a.2.2;

1> if the *RRCReconfigurationSidelink* message includes the *sl-MeasConfig*:

2> perform the sidelink measurement configuration procedure as specified in 5.8.10;

1> if the *RRCReconfigurationSidelink* message includes the *sl-CSI-RS-Config*:

2> apply the sidelink CSI-RS configuration;

1> if the *RRCReconfigurationSidelink* message includes the *sl-LatencyBoundCSI-Report*:

2> apply the configured sidelink CSI report latency bound;

1> if the UE is unable to comply with (part of) the configuration included in the *RRCReconfigurationSidelink* (i.e. sidelink RRC reconfiguration failure):

2> continue using the configuration used prior to the reception of the *RRCReconfigurationSidelink* message;

2> set the content of the *RRCReconfigurationFailureSidelink* message;

3> submit the *RRCReconfigurationFailureSidelink* message to lower layers for transmission;

1> else:

2> set the content of the *RRCReconfigurationCompleteSidelink* message;

3> submit the *RRCReconfigurationCompleteSidelink* message to lower layers for transmission;

NOTE 1: When the same logical channel is configured with different RLC mode by another UE, the UE handles the case as sidelink RRC reconfiguration failure.

12.1.5.1.3 Test description

12.1.5.1.3.1 Pre-test conditions

System Simulator:

- NR-SS-UE
- NR-SS-UE1 operating as NR sidelink communication device on the resources (i.e. the frequency included in pre-configuration) that UE is expected to use for transmission and reception via PC5 interface.
 - NR-SS-UE1 uses GNSS as the synchronization reference source.
 - GNSS simulator
 - The GNSS simulator is started and configured for Scenario #1.

UE:

- UE is authorised to perform NR sidelink communication.
- The UE uses GNSS as the synchronization reference source.
- The UE is equipped with below information in UE or in a USIM containing default values (as per TS 38.508-1 [4] clause 4.8.3.3.3) except for those listed in Table 12.1.5.1.3.1-1.

Table 12.1.5.1.3.1-1: UE/ USIM configuration

USIM field	Priority	Value	Access Technology Identifier
EF _{UST}		service no. 119 is available	
EF _{VST}		Service no.2 V2X policy configuration data over PC5 is supported, i.e. value is '01 02' HEX	
EF _{V2XP_PC5}		As per TS 38.508-1[4] clause 4.8.3.3.3 SL-PreconfigurationNR included in V2X data policy over PC5 is defined in Table 12.1.5.1.3.3-1	

Preamble:

- The UE is in state 4-A as defined in TS 38.508-1 [4], subclause 4.4A, using generic procedure parameter Sidelink (On), Cast Type (Unicast), GNSS Sync (On) using UE initiated unicast mode NR sidelink communication procedure in subclause 4.9.22.

12.1.5.1.3.2 Test procedure sequence

Table 12.1.5.1.3.2-1: Main behaviour

St	Procedure	Message Sequence		TP	Verdict
		U - S	Message		
1	UE is configured by upper layer to configure SL CSI-RS resource to NR-SS-UE1. Note: This step is triggered by MMI or AT command.	-	-	-	-
2	Check: Does UE send a <i>RRCReconfigurationSidelink</i> message including <i>sl-CSI-RS-Config</i> ?	-->	PC5 RRC: <i>RRCReconfigurationSidelink</i>	1	P
3	Check: Does UE start transmitting SL CSI-RS?	-->	-	1	P
4	NR-SS-UE1 sends a <i>RRCReconfigurationCompleteSidelink</i> message	<--	PC5 RRC: <i>RRCReconfigurationCompleteSidelink</i>		
5	UE is configured by upper layer to trigger SL CSI report. Note: This step is triggered by MMI or AT command.	-	-	-	-
6	Check: Does the UE transmit an SCI format 2-A with CSI request = "1" to trigger SL CSI report?	-->	PSSCH (SCI 2-A)	2	P

12.1.5.1.3.3 Specific message contents

Table 12.1.5.1.3.3-1: SL-PreconfigurationNR

Derivation path: TS 38.508-1 [4], Table 4.10.1-1			
Information Element	Value/Remark	Comment	Condition
SL-PreconfigurationNR-r16 ::= SEQUENCE {			
sidelinkPreconfigNR-r16 SEQUENCE {			

sl-CSI-Acquisition-r16	enabled		
}			
}			

Table 12.1.5.1.3.3-2: RRCReconfigurationSidelink (step 2, Table 12.1.5.1.3.2-1)

Derivation path: TS 38.508-1 [4], Table 4.6.1A-3 with condition SL_CSI and TX

Table 12.1.5.1.3.3-3: RRCReconfigurationCompleteSidelink (step 4, Table 12.1.5.1.3.2-1)

Derivation path: TS 38.508-1 [4], Table 4.6.1A-4 with condition RX

12.1.5.2 PC5-only operation / Sidelink CSI reporting / Reporting

12.1.5.2.1 Test Purpose (TP)

(1)

```

with { UE having established PC5 RRC connection with peer UE and configured by peer UE to perform
CSI measurement}
ensure that {
  when { UE receives a SCI format 2-A to trigger SL CSI report}
  then { UE sends an CSI reporting MAC-CE to peer UE }
}
    
```

12.1.5.2.2 Conformance requirements

References: The conformance requirements covered in the present TC are specified in: TS 38.331 [22], subclause 5.8.9.1.1,5.8.9.1.2,5.8.9.1.3, TS 38.321, clause 6.1.3.35. Unless otherwise stated these are Rel-16 requirements.

[TS 38.331, clause 5.8.9.1.1]

General

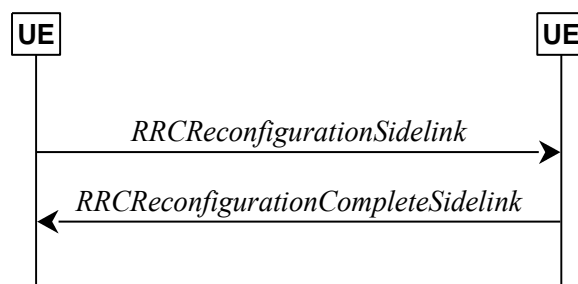

Figure 5.8.9.1.1-1: Sidelink RRC reconfiguration, successful

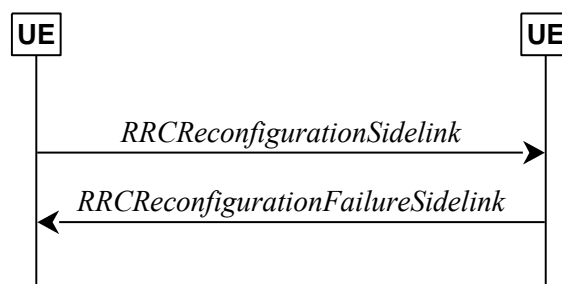

Figure 5.8.9.1.1-2: Sidelink RRC reconfiguration, failure

The purpose of this procedure is to modify a PC5-RRC connection, e.g. to establish/modify/release sidelink DRBs, to (re-)configure NR sidelink measurement and reporting, to (re-)configure sidelink CSI reference signal resources and CSI reporting latency bound.

The UE may initiate the sidelink RRC reconfiguration procedure and perform the operation in sub-clause 5.8.9.1.2 on the corresponding PC5-RRC connection in following cases:

- the release of sidelink DRBs associated with the peer UE, as specified in sub-clause 5.8.9.1a.1;
- the establishment of sidelink DRBs associated with the peer UE, as specified in sub-clause 5.8.9.1a.2;
- the modification for the parameters included in *SLRB-Config* of sidelink DRBs associated with the peer UE, as specified in sub-clause 5.8.9.1a.2;
- the (re-)configuration of the peer UE to perform NR sidelink measurement and report.
- the (re-)configuration of the sidelink CSI reference signal resources and CSI reporting latency bound.

In *RRC_CONNECTED*, the UE applies the NR sidelink communications parameters provided in *RRCReconfiguration* (if any). In *RRC_IDLE* or *RRC_INACTIVE*, the UE applies the NR sidelink communications parameters provided in system information (if any). For other cases, UEs apply the NR sidelink communications parameters provided in *SidelinkPreconfigNR* (if any). When UE performs state transition between above three cases, the UE applies the NR sidelink communications parameters provided in the new state, after acquisition of the new configurations. Before acquisition of the new configurations, UE continues applying the NR sidelink communications parameters provided in the old state.

[TS 38.331, clause 5.8.9.1.2]

The UE shall set the contents of *RRCReconfigurationSidelink* message as follows:

- 1> for each sidelink DRB that is to be released, according to sub-clause 5.8.9.1a.1.1, due to configuration by *sl-ConfigDedicatedNR*, *SIB12*, *SidelinkPreconfigNR* or by upper layers:
 - 2> set the *SLRB-PC5-ConfigIndex* included in the *slrb-ConfigToReleaseList* corresponding to the sidelink DRB;
- 1> for each sidelink DRB that is to be established or modified, according to sub-clause 5.8.9.1a.2.1, due to receiving *sl-ConfigDedicatedNR*, *SIB12* or *SidelinkPreconfigNR*:
 - 2> set the *SLRB-Config* included in the *slrb-ConfigToAddModList*, according to the received *sl-RadioBearerConfig* and *sl-RLC-BearerConfig* corresponding to the sidelink DRB;
- 1> set the *sl-MeasConfig* as follows:
 - 2> If the frequency used for NR sidelink communication is included in *sl-FreqInfoToAddModList* in *sl-ConfigDedicatedNR* within *RRCReconfiguration* message or included in *sl-ConfigCommonNR* within *SIB12*:
 - 3> if UE is in *RRC_CONNECTED*:
 - 4> set the *sl-MeasConfig* according to stored NR sidelink measurement configuration information for this destination;
 - 3> if UE is in *RRC_IDLE* or *RRC_INACTIVE*:
 - 4> set the *sl-MeasConfig* according to stored NR sidelink measurement configuration received from *SIB12*;
 - 2> else:
 - 3> set the *sl-MeasConfig* according to the *sl-MeasPreconfig* in *SidelinkPreconfigNR*;
- 1> start timer T400 for the destination associated with the sidelink DRB;
- 1> set the *sl-CSI-RS-Config*;
- 1> set the *sl-LatencyBoundCSI-Report*,

NOTE 1: How to set the parameters included in *sl-CSI-RS-Config* and *sl-LatencyBoundCSI-Report* is up to UE implementation.

The UE shall submit the *RRCReconfigurationSidelink* message to lower layers for transmission.

[TS 38.331, clause 5.8.9.1.3]

The UE shall perform the following actions upon reception of the *RRCReconfigurationSidelink*:

- 1> if the *RRCReconfigurationSidelink* includes the *sl-ResetConfig*:
 - 2> perform the sidelink reset configuration procedure as specified in 5.8.9.1.10;
- 1> if the *RRCReconfigurationSidelink* includes the *slrb-ConfigToReleaseList*:
 - 2> for each *SLRB-PC5-ConfigIndex* value included in the *slrb-ConfigToReleaseList* that is part of the current UE sidelink configuration;
 - 3> perform the sidelink DRB release procedure, according to sub-clause 5.8.9.1a.1;
- 1> if the *RRCReconfigurationSidelink* includes the *slrb-ConfigToAddModList*:
 - 2> for each *slrb-PC5-ConfigIndex* value included in the *slrb-ConfigToAddModList* that is not part of the current UE sidelink configuration:
 - 3> if *sl-MappedQoS-FlowsToAddList* is included:
 - 4> apply the *SL-PQFI* included in *sl-MappedQoS-FlowsToAddList*;
 - 3> perform the sidelink DRB addition procedure, according to sub-clause 5.8.9.1a.2;
 - 2> for each *slrb-PC5-ConfigIndex* value included in the *slrb-ConfigToAddModList* that is part of the current UE sidelink configuration:
 - 3> if *sl-MappedQoS-FlowsToAddList* is included:
 - 4> add the *SL-PQFI* included in *sl-MappedQoS-FlowsToAddList* to the corresponding sidelink DRB;
 - 3> if *sl-MappedQoS-FlowsToReleaseList* is included:
 - 4> remove the *SL-PQFI* included in *sl-MappedQoS-FlowsToReleaseList* from the corresponding sidelink DRB;
 - 3> if the sidelink DRB release conditions as described in sub-clause 5.8.9.1a.1.1 are met:
 - 4> perform the sidelink DRB release procedure according to sub-clause 5.8.9.1a.1.2;
 - 3> else if the sidelink DRB modification conditions as described in sub-clause 5.8.9.1a.2.1 are met:
 - 4> perform the sidelink DRB modification procedure according to sub-clause 5.8.9.1a.2.2;
- 1> if the *RRCReconfigurationSidelink* message includes the *sl-MeasConfig*:
 - 2> perform the sidelink measurement configuration procedure as specified in 5.8.10;
- 1> if the *RRCReconfigurationSidelink* message includes the *sl-CSI-RS-Config*:
 - 2> apply the sidelink CSI-RS configuration;
- 1> if the *RRCReconfigurationSidelink* message includes the *sl-LatencyBoundCSI-Report*:
 - 2> apply the configured sidelink CSI report latency bound;
- 1> if the UE is unable to comply with (part of) the configuration included in the *RRCReconfigurationSidelink* (i.e. sidelink RRC reconfiguration failure):
 - 2> continue using the configuration used prior to the reception of the *RRCReconfigurationSidelink* message;
 - 2> set the content of the *RRCReconfigurationFailureSidelink* message;

- 3> submit the *RRCReconfigurationFailureSidelink* message to lower layers for transmission;
- 1> else:
- 2> set the content of the *RRCReconfigurationCompleteSidelink* message;
- 3> submit the *RRCReconfigurationCompleteSidelink* message to lower layers for transmission;

NOTE 1: When the same logical channel is configured with different RLC mode by another UE, the UE handles the case as sidelink RRC reconfiguration failure.

[TS 38.321, clause 6.1.3.35]

The Sidelink CSI Reporting MAC CE is identified by a MAC subheader with LCID as specified in Table 6.2.4-1. The priority of the Sidelink CSI Reporting MAC CE is fixed to '1'. The Sidelink CSI Reporting MAC CE is defined as follows (Figure 6.1.3.35-1):

- RI: This field indicates the derived value of the Rank Indicator for sidelink CSI reporting as specified in clause 8.5 of TS 38.214 [7]. The length of the field is 1 bit;
- CQI: This field indicates the derived value of the Channel Quality Indicator for sidelink CSI reporting as specified in clause 8.5 of TS 38.214 [7]. The length of the field is 4 bit;
- R: Reserved bit, set to 0.

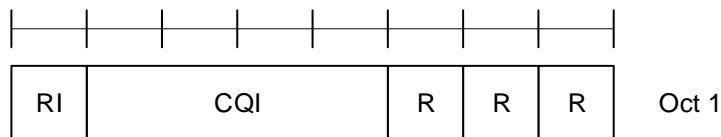

Figure 6.1.3.35-1: Sidelink CSI Reporting MAC CE

12.1.5.2.3 Test description

12.1.5.2.3.1 Pre-test conditions

System Simulator:

- SS-UE
- NR-SS-UE1 operating as NR sidelink communication device on the resources (i.e. the frequency included in pre-configuration) that UE is expected to use for transmission and reception via PC5 interface.
- NR-SS-UE1 uses GNSS as the synchronization reference source.
- GNSS simulator
- The GNSS simulator is started and configured for Scenario #1.

UE:

- UE is authorised to perform NR sidelink communication.
- The UE uses GNSS as the synchronization reference source.
- The UE is equipped with below information in UE or in a USIM containing default values (as per TS 38.508-1 [4] clause 4.8.3.3.3) except for those listed in Table 12.1.5.2.3.1-1.

Table 12.1.5.2.3.1-1: UE/ USIM configuration

USIM field	Priority	Value	Access Technology Identifier
------------	----------	-------	------------------------------

EF _{UST}		service no. 119 is available	
EF _{VST}		Service no.2 V2X policy configuration data over PC5 is supported, i.e. value is '01 02' HEX	
EF _{V2XP_PC5}		As per TS 38.508-1[4] clause 4.8.3.3.3 SL-PreconfigurationNR included in V2X data policy over PC5 is defined in Table 12.1.5.2.3.3-1	

Preamble:

- The UE is in state 4-A as defined in TS 38.508-1 [4], subclause 4.4A, using generic procedure parameter Sidelink (On), Cast Type (Unicast), GNSS Sync (On) using UE initiated unicast mode NR sidelink communication procedure in subclause 4.9.22.

12.1.5.2.3.2 Test procedure sequence

Table 12.1.5.2.3.2-1: Main behaviour

St	Procedure	Message Sequence		TP	Verdict
		U - S	Message		
1	NR-SS-UE1 sends an <i>RRCReconfigurationSidelink</i> message including <i>sl-CSI-RS-Config</i> and starts to transmit SL CSI-RS.	<--	PC5 RRC: <i>RRCReconfigurationSidelink</i>	-	-
2	UE sends a <i>RRCReconfigurationCompleteSidelink</i> message	-->	PC5 RRC: <i>RRCReconfigurationCompleteSidelink</i>	-	-
3	NR-SS-UE1 sends a SCI format 2-A with CSI request = "1" to trigger SL CSI report.	<--	PSSCH (SCI 2-A)	-	-
4	Check: Does UE send a CSI reporting MAC-CE to NR-SS-UE1?	-->	MAC CE (sidelink CSI)	1	P

12.1.5.2.3.3 Specific message contents

Table 12.1.5.2.3.3-1: SL-PreconfigurationNR

Derivation path: TS 38.508-1 [4], Table 4.10.1-1			
Information Element	Value/Remark	Comment	Condition
SL-PreconfigurationNR-r16 ::= SEQUENCE {			
sidelinkPreconfigNR-r16 SEQUENCE {			
sl-CSI-Acquisition-r16	enabled		
}			
}			

Table 12.1.5.2.3.3-2: RRCReconfigurationSidelink (step 1, Table 12.1.5.2.3.2-1)

Derivation path: TS 38.508-1 [4], Table 4.6.1A-3 with condition RX
--

Table 12.1.5.2.3.3-3: RRCReconfigurationCompleteSidelink (step 2, Table 12.1.5.2.3.2-1)

Derivation path: TS 38.508-1 [4], Table 4.6.1A-4 with condition TX
--

12.1.6 PC5-only operation / Sidelink failure

12.1.6.1 PC5-only operation / Sidelink failure / PC5 RRC reconfiguration failure / Initiating UE side

12.1.6.1.1 Test Purpose (TP)

(1)

```
with { UE having established PC5 RRC connection with peer UE on unicast sidelink }
ensure that {
  when { UE receives a RRCReconfigurationFailureSidelink from peer UE }
  then { UE continues using the configuration used prior to corresponding
RRCReconfigurationSidelink message }
}
```

12.1.6.1.2 Conformance requirements

References: The conformance requirements covered in the present TC are specified in: TS 38.331 [22], subclause 5.8.9.1.1, 5.8.9.1.8. Unless otherwise stated these are Rel-16 requirements.

[TS 38.331, subclause 5.8.9.1.1]

...

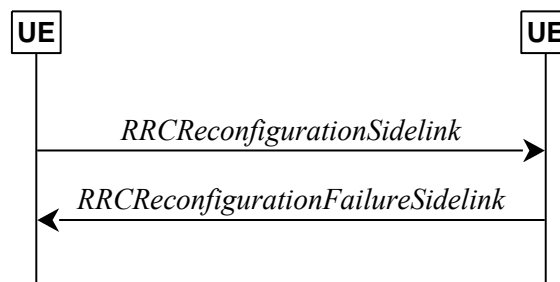

Figure 5.8.9.1.1-2: Sidelink RRC reconfiguration, failure

[TS 38.331, subclause 5.8.9.1.8]

The UE shall perform the following actions upon reception of the *RRCReconfigurationFailureSidelink*:

- 1> stop timer T400 for the destination, if running;
- 1> continue using the configuration used prior to corresponding *RRCReconfigurationSidelink* message;
- 1> if UE is in RRC_CONNECTED:
 - 2> perform the sidelink UE information for NR sidelink communication procedure, as specified in 5.8.3.3 or sub-clause 5.10.15 in TS 36.331 [10];

12.1.6.1.3 Test description

12.1.6.1.3.1 Pre-test conditions

System Simulator:

- NR-SS-UE

- NR-SS-UE 1 is as defined in TS 38.508-1 [4], configured for and operating as NR sidelink communication device on the resources (i.e. the frequency included in pre-configuration) that UE is expected to use for transmission and reception via PC5 interface.
- NR-SS-UE 1 is synchronised on GNSS.
- GNSS simulator
- The GNSS simulator is started and configured for Scenario #1.

UE:

- UE is authorised to perform NR sidelink communication.
- The UE is equipped with a USIM containing default values as per TS 38.508-1 [4] clause 4.8.3.3.3.
- UE is synchronised on GNSS.

Preamble:

- The UE is in state 4-A as defined in TS 38.508-1 [4], subclause 4.4A using generic procedure parameter Sidelink (On), Cast Type (Unicast), GNSS Sync (On) using UE initiated unicast mode NR sidelink communication procedure in subclause 4.9.22.

12.1.6.1.3.2 Test procedure sequence

Table 12.1.6.1.3.2-1: Main behaviour

St	Procedure	Message Sequence		TP	Verdict
		U - S	Message		
1	UE is configured by upper layer to release SL-DRB to NR-SS-UE1. Note: This step is triggered by MMI or AT command.	-	-	-	-
2	UE sends an <i>RRCReconfigurationSidelink</i> message to NR-SS-UE1 to indicate SL-DRB release?	-->	PC5 RRC: <i>RRCReconfigurationSidelink</i>	-	-
3	The NR-SS-UE1 sends a <i>RRCReconfigurationFailureSidelink</i> message.	<--	PC5 RRC: <i>RRCReconfigurationFailureSidelink</i>	-	-
4	Check: Does the test result of generic test procedure in TS 38.508-1 subclause 4.9.31 indicate the UE still has SL-DRB configured in preamble?	-	-	1	-

12.1.6.1.3.3 Specific message contents

Table 12.1.6.1.3.3-1: RRCReconfigurationSidelink (step 2, Table 12.1.6.1.3.2-1)

Derivation path: TS 38.508-1 [4], Table 4.6.1A-3 with condition TX			
Information Element	Value/Remark	Comment	Condition
<i>RRCReconfigurationSidelink</i> ::= SEQUENCE { criticalExtensions CHOICE { rrcReconfigurationSidelink-r16 SEQUENCE { slrb-ConfigToReleaseList-r16 SEQUENCE (SIZE (1..maxNrofSLRB-r16)) OF SLRB-PC5-ConfigIndex-r16 { SLRB-PC5-ConfigIndex-r16 [1]}}}	1 entry		
SLRB-PC5-ConfigIndex-r16 [1]	1	Index value to refer to a different value than TS 38.508-1[4] Table 4.6.6-37	

}			
}			
}			
}			

Table 12.1.6.1.3.3-2: RRCReconfigurationFailureSidelink (step 3, Table 12.1.6.1.3.2-1)

Derivation path: TS 38.508-1 [4], Table 4.6.1A-5 with condition RX

12.1.6.2 PC5-only operation / Sidelink failure / PC5 RRC reconfiguration failure / Peer UE side

12.1.6.2.1 Test Purpose (TP)

(1)

```
with { UE having established PC5 RRC connection with peer UE on unicast sidelink}
ensure that {
  when { UE receives an RRCReconfigurationSidelink that UE cannot comply from peer UE }
  then { UE continues using the configuration used prior to corresponding
RRCReconfigurationSidelink message and sends a RRCReconfigurationFailureSidelink message }
}
```

12.1.6.2.2 Conformance requirements

References: The conformance requirements covered in the present TC are specified in: TS 38.331 [22], subclause 5.8.9.1.1, 5.8.9.1.3. Unless otherwise stated these are Rel-16 requirements.

[TS 38.331, subclause 5.8.9.1.1]

...

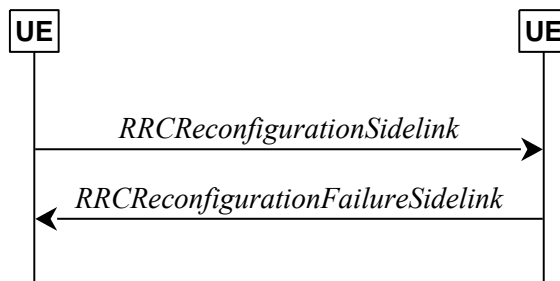

Figure 5.8.9.1.1-2: Sidelink RRC reconfiguration, failure

[TS 38.331, subclause 5.8.9.1.3]

The UE shall perform the following actions upon reception of the *RRCReconfigurationSidelink*:

- 1> if the *RRCReconfigurationSidelink* includes the *sl-ResetConfig*:
 - 2> perform the sidelink reset configuration procedure as specified in 5.8.9.1.10;
- 1> if the *RRCReconfigurationSidelink* includes the *slrb-ConfigToReleaseList*:
 - 2> for each *SLRB-PC5-ConfigIndex* value included in the *slrb-ConfigToReleaseList* that is part of the current UE sidelink configuration;
 - 3> perform the sidelink DRB release procedure, according to sub-clause 5.8.9.1.a.1;
- 1> if the *RRCReconfigurationSidelink* includes the *slrb-ConfigToAddModList*:

- 2> for each *slrb-PC5-ConfigIndex* value included in the *slrb-ConfigToAddModList* that is not part of the current UE sidelink configuration:
 - 3> if *sl-MappedQoS-FlowsToAddList* is included:
 - 4> apply the *SL-PQFI* included in *sl-MappedQoS-FlowsToAddList*;
 - 3> perform the sidelink DRB addition procedure, according to sub-clause 5.8.9.1a.2;
- 2> for each *slrb-PC5-ConfigIndex* value included in the *slrb-ConfigToAddModList* that is part of the current UE sidelink configuration:
 - 3> if *sl-MappedQoS-FlowsToAddList* is included:
 - 4> add the *SL-PQFI* included in *sl-MappedQoS-FlowsToAddList* to the corresponding sidelink DRB;
 - 3> if *sl-MappedQoS-FlowsToReleaseList* is included:
 - 4> remove the *SL-PQFI* included in *sl-MappedQoS-FlowsToReleaseList* from the corresponding sidelink DRB;
 - 3> if the sidelink DRB release conditions as described in sub-clause 5.8.9.1a.1.1 are met:
 - 4> perform the sidelink DRB release procedure according to sub-clause 5.8.9.1a.1.2;
 - 3> else if the sidelink DRB modification conditions as described in sub-clause 5.8.9.1a.2.1 are met:
 - 4> perform the sidelink DRB modification procedure according to sub-clause 5.8.9.1a.2.2;
- 1> if the *RRCReconfigurationSidelink* message includes the *sl-MeasConfig*:
 - 2> perform the sidelink measurement configuration procedure as specified in 5.8.10;
- 1> if the *RRCReconfigurationSidelink* message includes the *sl-CSI-RS-Config*:
 - 2> apply the sidelink CSI-RS configuration;
- 1> if the *RRCReconfigurationSidelink* message includes the *sl-LatencyBoundCSI-Report*:
 - 2> apply the configured sidelink CSI report latency bound;
- 1> if the UE is unable to comply with (part of) the configuration included in the *RRCReconfigurationSidelink* (i.e. sidelink RRC reconfiguration failure):
 - 2> continue using the configuration used prior to the reception of the *RRCReconfigurationSidelink* message;
 - 2> set the content of the *RRCReconfigurationFailureSidelink* message;
 - 3> submit the *RRCReconfigurationFailureSidelink* message to lower layers for transmission;
- 1> else:
 - 2> set the content of the *RRCReconfigurationCompleteSidelink* message;
 - 3> submit the *RRCReconfigurationCompleteSidelink* message to lower layers for transmission;

NOTE 1: When the same logical channel is configured with different RLC mode by another UE, the UE handles the case as sidelink RRC reconfiguration failure.

12.1.6.2.3 Test description

12.1.6.2.3.1 Pre-test conditions

System Simulator:

- NR-SS-UE

- NR-SS-UE 1 is as defined in TS 38.508-1 [4], configured for and operating as NR sidelink communication device on the resources (i.e. the frequency included in pre-configuration) that UE is expected to use for transmission and reception via PC5 interface.
- NR-SS-UE 1 is synchronised on GNSS.
- GNSS simulator
- The GNSS simulator is started and configured for Scenario #1.

UE:

- UE is authorised to perform NR sidelink communication.
- UE is synchronised on GNSS.
- The UE is equipped with a USIM containing default values as per TS 38.508-1 [4] clause 4.8.3.3.3.

Preamble:

- The UE is in state 4-A as defined in TS 38.508-1 [4], subclause 4.4A using generic procedure parameter Sidelink (On), Cast Type (Unicast), GNSS Sync (On) using NR-SS-UE1 initiated unicast mode NR sidelink communication procedure in subclause 4.9.23.

12.1.6.2.3.2 Test procedure sequence

Table 12.1.6.2.3.2-1: Main behaviour

St	Procedure	Message Sequence		TP	Verdict
		U - S	Message		
1	The NR-SS-UE1 sends a <i>RRCReconfigurationSidelink</i> message to UE to indicate SL-DRB release with SLRB-PC5-ConfigIndex-r16 pointing to SL-DRB which has not been configured yet?	<--	PC5 RRC: RRCReconfigurationSidelink	-	-
2	Check: Does the UE sends an <i>RRCReconfigurationFailureSidelink</i> message.	-->	PC5 RRC: RRCReconfigurationFailureSidelink	1	P
3	Check: Does the test result of generic test procedure in TS 38.508-1 subclause 4.9.31 indicate the UE still has SL-DRB configured in preamble?	-	-	1	-

12.1.6.2.3.3 Specific message contents

Table 12.1.6.2.3.3-1: RRCReconfigurationSidelink (step 1, Table 12.1.6.2.3.2-1)

Derivation path: TS 38.508-1 [4], Table 4.6.1A-3 with condition RX			
Information Element	Value/Remark	Comment	Condition
RRCReconfigurationSidelink ::= SEQUENCE {			
criticalExtensions CHOICE {			
rrcReconfigurationSidelink-r16 SEQUENCE {			
slrb-ConfigToReleaseList-r16 SEQUENCE (SIZE (1..maxNrofSLRB-r16)) OF SLRB-PC5-ConfigIndex-r16 {	1 entry		
SLRB-PC5-ConfigIndex-r16 [1]	2	Index value to refer to a different value than TS 38.508-1[4] Table 4.6.6-37	
}			
}			

}			
}			

Table 12.1.6.2.3.3-2: RRCReconfigurationFailureSidelink (step 2, Table 12.1.6.2.3.2-1)

Derivation path: TS 38.508-1 [4], Table 4.6.1A-5 with condition TX

12.1.6.3 PC5-only operation / Sidelink failure / Sidelink radio link failure / Transmission side

12.1.6.3.1 Test Purpose (TP)

(1)

```
with { UE having established PC5 RRC connection with peer UE on unicast sidelink and has sent an
RRCReconfigurationSidelink message to peer UE }
ensure that {
  when { UE does not receive RRCReconfigurationCompleteSidelink or RRCReconfigurationFailure before
T400 expires}
    then { UE releases PC5-RRC connection and indicates the release to upper layer}
}
```

(2)

```
with { UE having established PC5 RRC connection with peer UE on unicast sidelink and has established
a AM SL-DRB}
ensure that {
  when { Retransmission number of the AM SL-DRB reaches the maximum number of retransmissions}
    then { UE releases PC5-RRC connection and indicates the release to upper layer.}
}
```

(3)

```
with { UE having established PC5 RRC connection with peer UE on unicast sidelink }
ensure that {
  when { MAC detects that maximum number of consecutive HARQ DTX has been reached }
    then { UE releases PC5-RRC connection and indicates the release to upper layer }
}
```

12.1.6.3.2 Conformance requirements

References: The conformance requirements covered in the present TC are specified in: TS 38.331 [22], subclause 5.8.9.3. Unless otherwise stated these are Rel-16 requirements.

[TS 38.331, subclause 5.8.9.3]

The UE shall:

- 1> upon indication from sidelink RLC entity that the maximum number of retransmissions for a specific destination has been reached; or
- 1> upon T400 expiry for a specific destination; or
- 1> upon indication from MAC entity that the maximum number of consecutive HARQ DTX for a specific destination has been reached; or
- 1> upon integrity check failure indication from sidelink PDCP entity concerning SL-SRB2 or SL-SRB3 for a specific destination:
 - 2> consider sidelink radio link failure to be detected for this destination;
 - 2> release the DRBs of this destination, in according to sub-clause 5.8.9.1a.1;
 - 2> release the SRBs of this destination, in according to sub-clause 5.8.9.1a.3;

- 2> discard the NR sidelink communication related configuration of this destination;
- 2> reset the sidelink specific MAC of this destination;
- 2> consider the PC5-RRC connection is released for the destination;
- 2> indicate the release of the PC5-RRC connection to the upper layers for this destination (i.e. PC5 is unavailable);
- 2> if UE is in RRC_CONNECTED:
 - 3> perform the sidelink UE information for NR sidelink communication procedure, as specified in 5.8.3.3;

NOTE: It is up to UE implementation on whether and how to indicate to upper layers to maintain the keep-alive procedure [55].

12.1.6.3.3 Test description

12.1.6.3.3.1 Pre-test conditions

System Simulator:

- NR-SS-UE
 - NR-SS-UE 1 is as defined in TS 38.508-1 [4], configured for and operating as NR sidelink communication device on the resources (i.e. the frequency included in pre-configuration) that UE is expected to use for transmission and reception via PC5 interface.
 - NR-SS-UE 1 is synchronised on GNSS.
- GNSS simulator
 - The GNSS simulator is started and configured for Scenario #1.

UE:

- UE is authorised to perform NR sidelink communication.
- The UE is equipped with a USIM containing default values as per TS 38.508-1 [4] clause 4.8.3.3.3.
- UE is synchronised on GNSS.

Preamble:

- The UE is in state 4-A as defined in TS 38.508-1 [4], subclause 4.4A using generic procedure parameter Sidelink (*On*), Cast Type (*Unicast*), GNSS Sync (*On*) using UE initiated unicast mode NR sidelink communication procedure in subclause 4.9.23.

12.1.6.3.3.2 Test procedure sequence

Table 12.1.6.3.3.2-1: Specific Parameters

Parameter	Value	Comment
sl-MaxRetxThreshold-r16	1	
sl-MaxNumConsecutiveDTX-r16	1	

Table 12.1.6.3.3.2-2: Main behaviour

St	Procedure	Message Sequence		TP	Verdict
		U - S	Message		
1	UE is configured by upper layer to release SL-DRB to NR-SS-UE1.	-	-	-	-

	Note: This step is triggered by MMI or AT command.				
2	UE sends an <i>RRCReconfigurationSidelink</i> message to NR-SS-UE1 to indicate SL-DRB release	-->	PC5 RRC: <i>RRCReconfigurationSidelink</i>	-	-
3	NR-SS-UE1 does not respond and waits for the expiration of <i>t_400</i> (1 second).	-	-	-	-
3A	1 second after step 3, the NR-SS-UE1 sends a DIRECT LINK RELEASE REQUEST message.	<--	PC5-S: DIRECT LINK RELEASE REQUEST	-	-
4	Check: Does the UE send a DIRECT LINK RELEASE ACCEPT message within the next 5 seconds.	-->	PC5-S: DIRECT LINK RELEASE ACCEPT	1	F
5	The UE is brought to state 4-A as defined in TS 38.508-1 [4], subclause 4.4A using generic procedure parameter Sidelink (<i>On</i>), Cast Type (<i>Unicast</i>), GNSS Sync (<i>On</i>), Test Mode = <i>On</i> using procedure in subclause 4.9.23.	-	-	-	-
6	The SS triggers UE to close UE test loop mode E (Transmission Mode). NOTE: Closing of UE test loop mode E may be performed by MMI or AT command (+CCUTLE).	-	-	-	-
7	The UE transmits one AMD PDU#1 to NR-SS-UE1 on SL-DRB	-->	AMD PDU#1 (SN=0)	-	-
-	EXCEPTION: Steps 9-10 are repeated sl-maxRetxThreshold times	-	-	-	-
-	EXCEPTION: In parallel to steps 9-10 any additional AMD PDU's received are ignored by the SS	-	-	-	-
8	The NR-SS-UE1 transmits an RLC STATUS PDU. ACK_SN =1 and NACK_SN =0.	<--	STATUS PDU	-	-
9	The UE transmits one AMD PDU#1 to NR-SS-UE1	-->	AMD PDU#1 (SN=0)	-	-
10	The NR-SS-UE1 transmits an RLC STATUS PDU. ACK_SN =1 and NACK_SN =0.	<--	STATUS PDU	-	-
11	1 second after step 10, the NR-SS-UE1 sends a DIRECT LINK RELEASE REQUEST message.	<--	PC5-S: DIRECT LINK RELEASE REQUEST	-	-
11 A	Check: Does the UE send a DIRECT LINK RELEASE ACCEPT message within the next 5 seconds?	-->	PC5-S: DIRECT LINK RELEASE ACCEPT	2	F
12	The UE is brought to state 4-A as defined in TS 38.508-1 [4], subclause 4.4A using generic procedure parameter Sidelink (<i>On</i>), Cast Type (<i>Unicast</i>), GNSS Sync (<i>On</i>), Test Mode = <i>On</i> using procedure in subclause 4.9.23.	-	-	-	-
13	The SS triggers UE to close UE test loop mode E (Transmission Mode). NOTE: Closing of UE test loop mode E may be performed by MMI or AT command (+CCUTLE).	-	-	-	-
14	The NR-SS-UE1 MAC is configured to not send HARQ feedback	-	-	-	-
-	EXCEPTION: Step 14 is repeated sl-NumConsecutiveDTX-r16 times	-	-	-	-
-	EXCEPTION: In parallel to step 14 any additional MAC PDU's received are ignored by the SS.	-	-	-	-
15	The UE transmits one MAC PDU to NR-SS-UE1	-->	MAC PDU	-	-
15 A	1 second after step 15, the NR-SS-UE1 sends a DIRECT LINK RELEASE REQUEST message.	<--	PC5-S: DIRECT LINK RELEASE REQUEST		
16	Check: Does the UE send a DIRECT LINK RELEASE ACCEPT message within the next 5 seconds?	-->	PC5-S: DIRECT LINK RELEASE ACCEPT	3	F

12.1.6.3.3.3 Specific message contents

Table 12.1.6.3.3.3-1: RRCReconfigurationSidelink (step 2, Table 12.1.6.3.3.2-2)

Derivation path: TS 38.508-1 [4], Table 4.6.1A-3 with condition TX			
Information Element	Value/Remark	Comment	Condition
RRCReconfigurationSidelink ::= SEQUENCE {			
criticalExtensions CHOICE {			
rrcReconfigurationSidelink-r16 SEQUENCE {			
slrb-ConfigToReleaseList-r16 SEQUENCE (SIZE (1..maxNrofSLRB-r16)) OF SLRB-PC5-ConfigIndex-r16 {	1 entry		
SLRB-PC5-ConfigIndex-r16 [1]	1	entry 1	
}			
}			
}			
}			

Table 12.1.6.3.3.3-2: DIRECT LINK RELEASE REQUEST (Steps 3A, 11 and 15A, Table 12.1.6.3.3.2-2)

Derivation Path: Table 4.7.4-11 with condition Rx

12.1.7 PC5-only operation / Sidelink UE capability transfer via PC5 RRC

12.1.7.1 PC5-only operation / Sidelink UE capability transfer via PC5 RRC / One-way and two-way transfer

12.1.7.1.1 Test Purpose (TP)

(1)

```
with { UE has established PC5 RRC connection with peer UE on unicast sidelink }
ensure that {
  when { UE receives a UECapabilityEnquirySidelink message from peer UE }
  then { UE sends a UECapabilityInformationSidelink message to peer UE }
}
```

(2)

```
with { UE has established PC5 RRC connection with peer UE on unicast sidelink }
ensure that {
  when { UE is configured by upper layer to initiate capability transfer procedure }
  then { UE sends a UECapabilityEnquirySidelink message to peer UE }
}
```

(3)

```
with { UE has established PC5 RRC connection with peer UE on unicast sidelink }
ensure that {
  when { UE is configured by upper layer to initiate capability transfer procedure and to provide UE
radio access capabilities }
  then { UE sends a UECapabilityEnquirySidelink message with ue-CapabilityInformationSidelink to
peer UE }
}
```

12.1.7.1.2 Conformance requirements

References: The conformance requirements covered in the present TC are specified in: TS 38.331 [22], subclause 5.8.9.2.1, 5.8.9.2.2, 5.8.9.2.3 and 5.8.9.2.4. Unless otherwise stated these are Rel-16 requirements.

[TS 38.331, subclause 5.8.9.2.1]

This clause describes how the UE compiles and transfers its sidelink UE capability information for unicast to the initiating UE.

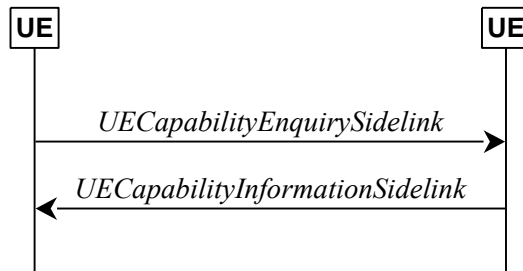

Figure 5.8.9.2.1-1: Sidelink UE capability transfer

[TS 38.331, subclause 5.8.9.2.2]

The UE may initiate the sidelink UE capability transfer procedure upon indication from upper layer when it needs (additional) UE radio access capability information.

[TS 38.331, subclause 5.8.9.2.3]

The initiating UE shall set the contents of *UECapabilityEnquirySidelink* message as follows:

- 1> include in UE radio access capabilities for sidelink within *ue-CapabilityInformationSidelink*, if needed;

NOTE 1: It is up to initiating UE to decide whether *ue-CapabilityInformationSidelink* should be included.

- 1> set *frequencyBandListFilterSidelink* to include frequency bands for which the peer UE is requested to provide supported bands and band combinations;

NOTE 2: The initiating UE is not allowed to send the *UECapabilityEnquirySidelink* message without including the field *frequencyBandListFilterSidelink*.

- 1> submit the *UECapabilityEnquirySidelink* message to lower layers for transmission.

[TS 38.331, subclause 5.8.9.2.4]

The peer UE shall set the contents of *UECapabilityInformationSidelink* message as follows:

- 1> include UE radio access capabilities for sidelink within *ue-CapabilityInformationSidelink*;

- 1> compile a list of "candidate band combinations" only consisting of bands included in *frequencyBandListFilterSidelink*, and prioritized in the order of *frequencyBandListFilterSidelink* (i.e. first include band combinations containing the first-listed band, then include remaining band combinations containing the second-listed band, and so on).

- 1> include into *supportedBandCombinationListSidelinkNR* as many band combinations as possible from the list of "candidate band combinations", starting from the first entry;

- 1> include the received *frequencyBandListFilterSidelink* in the field *appliedFreqBandListFilter* of the requested UE capability;

- 1> submit the *UECapabilityInformationSidelink* message to lower layers for transmission.

NOTE: If the UE cannot include all band combinations due to message size or list size constraints, it is up to UE implementation which band combinations it prioritizes.

12.1.7.1.3 Test description

12.1.7.1.3.1 Pre-test conditions

System Simulator:

- SS-UE
 - Operating as NR sidelink communication device on the resources (i.e. the frequency included in pre-configuration) that UE is expected to use for transmission and reception via PC5 interface.
- GNSS simulator

UE:

- UE is authorised to perform NR sidelink communication.

Preamble:

- The UE is in state 4-A as defined in TS 38.508-1 [4], subclause 4.4A using generic procedure parameter Sidelink (*On*), Cast Type (*Unicast*), GNSS Sync (*On*).

12.1.7.1.3.2 Test procedure sequence

[Editor's Note: For the below test procedure sequence it is assumed that the initiating UE side (= UE under test) as well as the peer UE (= SS-UE) are both out-of-coverage.]

Table 12.1.7.1.3.2-1: Main behaviour

St	Procedure	Message Sequence		TP	Verdict
		U - S	Message		
1	The UE receives a UECapabilityEnquirySidelink message from SS-UE on SL-SRB3.	<--	PC5 RRC: UECapabilityEnquirySidelink	-	-
2	Check: Does the UE send a UECapabilityInformationSidelink message?		PC5 RRC: UECapabilityInformationSidelink	1	P
3	The UE is configured by upper layers to initiate capability transfer procedure and to include only the single frequency band and band combination which is currently used in this TC for communication over PC5 interface. Note: This step is triggered by MMI or AT command.	-	-	-	-
4	Check: Does the UE send on SL-SRB3 a UECapabilityEnquirySidelink message?	-->	PC5 RRC: UECapabilityEnquirySidelink	2	P
5	The SS-UE sends a UECapabilityInformationSidelink message.	<--	PC5 RRC: UECapabilityInformationSidelink	-	-
6	The UE is configured by upper layers to initiate capability transfer procedure, to include only the single frequency band and band combination which is currently used in this TC for communication over PC5 interface and to provide UE radio access capabilities. Note: This step is triggered by MMI or AT command.	-			
7	Check: Does the UE send on SL-SRB3 a UECapabilityInformationSidelink message with <i>ue-CapabilityInformationSidelink-r16</i> IE?	-->	PC5 RRC: UECapabilityEnquirySidelink	3	P
8	The SS-UE sends a UECapabilityInformationSidelink message.	<--	PC5 RRC: UECapabilityInformationSidelink	-	-

12.1.7.1.3.3 Specific message contents

Table 12.1.7.1.3.3-1: UECapabilityEnquirySidelink (step 1, Table 12.1.7.1.3.2-1)

Derivation Path: TS 38.508-1 [4], Table 4.6.1A-6			
Information Element	Value/remark	Comment	Condition
UECapabilityEnquirySidelink ::= SEQUENCE {			
criticalExtensions CHOICE {			
ueCapabilityEnquirySidelink-r16 SEQUENCE {			
frequencyBandListFilterSidelink-r16	FreqBandList with condition NR_SL_PC5	Includes only the single frequency band and band combination which is currently used in this TC for communication over the PC5 interface	NR_SL_PC5
}			
}			
}			

Table 12.1.7.2.3.3-2: UECapabilityInformationSidelink (step 2, Table 12.1.7.1.3.2-1)

Derivation Path: TS 38.508-1 [4], Table 4.6.1A-7			
Information Element	Value/remark	Comment	Condition
UECapabilityEnquirySidelink ::= SEQUENCE {			
criticalExtensions CHOICE {			
ueCapabilityInformationSidelink-r16 SEQUENCE {			
pdcp-ParametersSidelink-r16 SEQUENCE {			
outOfOrderDeliverySidelink-r16	Checked		pc_outOfOrderDeliverySidelink_r16
}			
rlc-ParametersSidelink-r16 SEQUENCE {			
am-WithLongSN-Sidelink-r16	Checked		pc_amWithLongSN_Sidelink_r16
um-WithLongSN-Sidelink-r16	Checked		pc_umWithLongSN_Sidelink_r16
}			
supportedBandCombinationListSidelinkNR-r16	Checked	Includes all band combinations which the UE (= UE Under Test) supports for NR Sidelink acc. to the declared UE capabilities	
supportedBandListSidelink-r16	Checked	Includes all frequency bands which the UE (= UE Under Test) supports for NR Sidelink acc. to the declared UE capabilities	
appliedFreqBandListFilter-r16	Checked	Includes only the single frequency band and band combination which the SS-UE requested to include in the IE frequencyBandList	

		tFilterSidelink-r16 of UECapabilityEnquirySidelink message acc. to Table 12.1.7.2.3.3-1.	
}			
}			
}			

Table 12.1.7.1.3.3-3: UECapabilityEnquirySidelink (step 4, Table 12.1.7.1.3.2-1)

Derivation Path: TS 38.508-1 [4], Table 4.6.1A-6			
Information Element	Value/remark	Comment	Condition
UECapabilityEnquirySidelink ::= SEQUENCE {			
criticalExtensions CHOICE {			
ueCapabilityEnquirySidelink-r16 SEQUENCE {			
frequencyBandListFilterSidelink-r16	FreqBandList with condition NR_SL_PC5	Includes only the single frequency band and band combination which is currently used in this TC for communication over the PC5 interface	NR_SL_PC5
}			
}			
}			

Table 12.1.7.1.3.3-4: UECapabilityInformationSidelink (steps 5 and 8, Table 12.1.7.1.3.2-1)

Derivation Path: TS 38.331 [6], clause 6.6.2			
Information Element	Value/remark	Comment	Condition
UECapabilityInformationSidelink ::= SEQUENCE {			
rrc-TransactionIdentifier-r16	RRC-TransactionIdentifier		
criticalExtensions CHOICE {			
ueCapabilityInformationSidelink-r16 SEQUENCE {			
accessStratumReleaseSidelink-r16	rel16		
supportedBandCombinationListSidelinkNR-r16		Includes only the single band combination which is currently used in this TC for communication over the PC5 interface.	
supportedBandListSidelink-r16		Includes only the single frequency band which is currently used in this TC for communication over the PC5 interface	
appliedFreqBandListFilter-r16		Includes only the single frequency band and band combination which the UE requested to include in the IE frequencyBandListFilterSidelink-r16	

		of UECapabilityEnquirySidelink message acc. to Table 12.1.7.1.3.3-1.	
}			
}			
}			

Table 12.1.7.1.3.3-5: UECapabilityEnquirySidelink (step 7, Table 12.1.7.1.3.2-1)

Derivation Path: TS 38.508-1 [4], Table 4.6.1A-6 with condition TWO_WAY_ENQUIRY			
Information Element	Value/remark	Comment	Condition
UECapabilityEnquirySidelink ::= SEQUENCE {			
criticalExtensions CHOICE {			
ueCapabilityEnquirySidelink-r16 SEQUENCE {			
frequencyBandListFilterSidelink-r16	FreqBandList with condition NR_SL_PC5	Includes only the single frequency band and band combination which is currently used in this TC for communication over the PC5 interface	NR_SL_PC 5
ue-CapabilityInformationSidelink-r16	Checked		
}			
}			
}			

12.2 Inter-carrier concurrent operation

12.2.1 Inter-carrier concurrent operation / Sidelink communication

12.2.1.1

12.2.1.2 Inter-carrier concurrent operation / Sidelink communication / RRC_IDLE / Reception

12.2.1.2.1 Test Purpose (TP)

(1)

```
with { UE being in RRC_IDLE state and the cell on which UE camps broadcasting SIB12 including no sl-FreqInfoList but anchor carrier configuration }
ensure that {
  when { A neighbour cell on anchor carrier starts broadcasting SIB12 which includes sl-RxPool and UE is configured by upper layer to perform NR sidelink reception }
  then { UE considers the anchor carrier to be the highest priority, reselects to neighbour cell on anchor carrier and is able to monitor NR sidelink transmission using the resource pool indicated by sl-RxPool in SIB12 }
}
```

(2)

```
with { UE being in RRC_IDLE state and the cell on which UE camps not broadcasting SIB12 }
ensure that {
  when { UE is configured by upper layer to perform NR sidelink reception }
  then { UE is able to monitor NR sidelink transmission using the resource pool indicated by sl-RxPool in pre-configuration }
}
```

12.2.1.2.2 Conformance requirements

References: The conformance requirements covered in the present TC are specified in: TS 38.304, subclause 5.2.4.1 and 5.8.2, TS 38.331 [22], subclause 5.8.7. Unless otherwise stated these are Rel-16 requirements.

[TS 38.304, clause 5.2.4.1]

Absolute priorities of different NR frequencies or inter-RAT frequencies may be provided to the UE in the system information, in the *RRCRelease* message, or by inheriting from another RAT at inter-RAT cell (re)selection. In the case of system information, an NR frequency or inter-RAT frequency may be listed without providing a priority (i.e. the field *cellReselectionPriority* is absent for that frequency). If priorities are provided in dedicated signalling, the UE shall ignore all the priorities provided in system information. If UE is in *camped on any cell* state, UE shall only apply the priorities provided by system information from current cell, and the UE preserves priorities provided by dedicated signalling and *deprioritisationReq* received in *RRCRelease* unless specified otherwise. When the UE in camped normally state, has only dedicated priorities other than for the current frequency, the UE shall consider the current frequency to be the lowest priority frequency (i.e. lower than any of the network configured values). If the UE is configured to perform both NR sidelink communication and V2X sidelink communication, the UE may consider the frequency providing both NR sidelink communication configuration and V2X sidelink communication configuration to be the highest priority. If the UE is configured to perform NR sidelink communication and not perform V2X communication, the UE may consider the frequency providing NR sidelink communication configuration to be the highest priority. If the UE is configured to perform V2X sidelink communication and not perform NR sidelink communication, the UE may consider the frequency providing V2X sidelink communication configuration to be the highest priority.

NOTE 1: The frequency only providing the anchor frequency configuration should not be prioritized for V2X service during cell reselection, as specified in TS 38.331[3].

NOTE 2: When UE is configured to perform NR sidelink communication or V2X sidelink communication performs cell reselection, it may consider the frequencies providing the intra-carrier and inter-carrier configuration have equal priority in cell reselection.

NOTE 3: The prioritization among the frequencies which UE considers to be the highest priority frequency is left to UE implementation.

NOTE 4: The UE is configured to perform V2X sidelink communication or NR sidelink communication, if it has the capability and is authorized for the corresponding sidelink operation.

NOTE 5: When UE is configured to perform both NR sidelink communication and V2X sidelink communication, but cannot find a frequency which can provide both NR sidelink communication configuration and V2X sidelink communication configuration, UE may consider the frequency providing either NR sidelink communication configuration or V2X sidelink communication configuration to be the highest priority.

The UE shall only perform cell reselection evaluation for NR frequencies and inter-RAT frequencies that are given in system information and for which the UE has a priority provided.

...

[TS 38.304, clause 8.2]

The requirements defined in this clause for sidelink operation apply for UEs in *RRC_IDLE*, *RRC_INACTIVE* and in *RRC_CONNECTED*.

When UE is interested to perform NR sidelink communication on non-serving frequency, it may perform measurements on that frequency or the frequencies which can provide inter carrier NR sidelink configuration for that frequency for cell selection and reselection purpose in accordance with TS 38.133[8]. When UE is interested to perform V2X sidelink communication on non-serving frequency, it may perform measurements on that frequency or the frequencies which can provide inter carrier V2X sidelink configuration for that frequency for cell selection and intra-frequency reselection purpose in accordance with TS 38.133[8].

If the UE detects at least one cell on the frequency which UE is configured to perform NR sidelink communication on fulfilling the S criterion in accordance with clause 8.2.1, it shall consider itself to be in-coverage for NR sidelink communication on that frequency. If the UE cannot detect any cell on that frequency meeting the S criterion, it shall consider itself to be out-of-coverage for NR sidelink communication on that frequency.

If the UE detects at least one cell on the frequency which UE is configured to perform V2X sidelink communication on fulfilling the S criterion in accordance with clause 8.2.1, it shall consider itself to be in-coverage for V2X sidelink communication on that frequency. If the UE cannot detect any cell on that frequency meeting the S criterion, it shall consider itself to be out-of-coverage for V2X sidelink communication on that frequency.

If the UE has selected a cell on a non-serving frequency for V2X sidelink communication, it shall perform additional intra-frequency reselection process to select a better cell for sidelink operation on that frequency in accordance with clause 8.2.1.

If the UE has selected a cell on a non-serving frequency for NR sidelink communication, it shall perform additional reselection process to select a better cell for sidelink operation in accordance with clause 8.2.1.

[TS 38.331, clause 5.8.7]

A UE capable of NR sidelink communication that is configured by upper layers to receive NR sidelink communication shall:

- 1> if the conditions for NR sidelink communication operation as defined in 5.8.2 are met:
 - 2> if the frequency used for NR sidelink communication is included in *sl-FreqInfoToAddModList* in *RRCReconfiguration* message or *sl-FreqInfoList* included in *SIB12*:
 - 3> if the UE is configured with *sl-RxPool* included in *RRCReconfiguration* message with *reconfigurationWithSync* (i.e. handover):
 - 4> configure lower layers to monitor sidelink control information and the corresponding data using the pool of resources indicated by *sl-RxPool*;
 - 3> else if the cell chosen for NR sidelink communication provides *SIB12*:
 - 4> configure lower layers to monitor sidelink control information and the corresponding data using the pool of resources indicated by *sl-RxPool* in *SIB12*;
 - 2> else:
 - 3> configure lower layers to monitor sidelink control information and the corresponding data using the pool of resources that were preconfigured by *sl-RxPool* in *SL-PreconfigurationNR*, as defined in sub-clause 9.3;

12.2.1.2.3 Test description

12.2.1.2.3.1 Pre-test conditions

System Simulator:

- SS-NW
 - NR Cell 1, NR Cell 12.
 - System information combination NR-4 as defined in TS 38.508-1 [4] clause 4.4.3.1 is used in NR Cell 1 and NR Cell 12.
- NR-SS-UE
 - NR-SS-UE1 operating as NR sidelink communication transmitting device on the resources that UE is expected to use for transmission.
 - NR-SS-UE1 is synchronised on NR Cell 1.

UE:

- UE is authorised to perform NR sidelink communication.
- The UE is equipped with a USIM containing default values as per TS 38.508-1 [4] clause 4.8.3.3.3 except for those listed in Table 12.2.1.2.3.1-1.

- UE is synchronised on NR Cell 1.

Table 12.2.1.2.3.1-1: UE/ USIM configuration

USIM field	Priority	Value	Access Technology Identifier
EF _{UST}		service no. 119 is available	
EF _{VST}		Service no.2 V2X policy configuration data over PC5 is supported, i.e. value is '01 02' HEX	
EF _{V2XP_PC5}		SL-PreconfigurationNR field as defined in TS 38.508-1 [4], table 4.10.1-1, except SL-BWP-PoolConfigCommon field as defined in Table 12.2.1.2.3.3-1	

Preamble:

- The UE is in state 1N-A as defined in TS 38.508-1 [4], subclause 4.4A on NR Cell 1.

12.2.1.2.3.2 Test procedure sequence

Table 12.2.1.2.3.2-1 and 12.2.1.2.3.2-2 illustrate the downlink power levels to be applied for NR Cell 1 and NR Cell 12 at various time instants of the test execution for FR1 and FR2 respectively. Row marked "T0" denotes the conditions after the preamble, while rows marked "T1" is to be applied subsequently. The exact instants on which these values shall be applied are described in the texts in this clause.

Table 12.2.1.2.3.2-1: Time instances of cell power level and parameter changes in FR1

	Parameter	Unit	NR Cell 1	NR Cell 12	Remark
T0	SS/PBCH SSS EPRE	dBm/SCS	-88	Off	
T1	SS/PBCH SSS EPRE	dBm/SCS	-88	-80	

Table 12.2.1.2.3.2-2: Time instances of cell power level and parameter changes in FR2

	Parameter	Unit	NR Cell 1	NR Cell 12	Remark
T0	SS/PBCH SSS EPRE	dBm/SCS	-82	Off	
T1	SS/PBCH SSS EPRE	dBm/SCS	-82	-72	

Table 12.2.1.2.3.2-3: Main behaviour

St	Procedure	Message Sequence		TP	Verdict
		U	S		
1	Check: Does the test result of generic test procedure in TS 38.508-1 [4] Table 4.9.23.2.2-1 indicate that the UE has established sidelink communication using the pool of resources indicated by sl-RxPool in pre-configuration?	-	-	2	P
2	The UE is switched off by executing generic procedure in Table 4.9.6.1-1 in TS 38.508-1 [4].	-	-	-	-
3	The SS-NW adds SIB12 on NR Cell 1 and NR Cell 12, system information combination NR-14 as defined in TS 38.508-1 [4] clause 4.4.3.1 is used.	-	-	-	-
4	The UE is Switched ON.	-	-	-	-
5-	Steps 1 to 20a1 of the generic test procedure	-	-	-	-

24a 1	described in TS 38.508-1 [4] table 4.5.2.2-2 are performed on NR Cell 1.				
25	The SS adjusts cell levels according to row T1 of table 12.2.1.2.3.2-1/2.	-	-	-	-
26	Upper layers of the UE configure the UE to perform sidelink transmission. Note: This step is triggered by MMI or AT command	-	-	-	-
-	EXCEPTION: In parallel with step 27, parallel behaviour defined in table 12.2.1.2.3.2-4 is executed.	-	-	-	-
27	Check: Does the test result of generic test procedure in TS 38.508-1 [4] Table 4.9.5.2.2-1 indicate that the UE is camped on NR Cell 12. NOTE: The UE performs a registration for mobility procedure and the RRC connection is not released.	-	-	1	P
28	The NR-SS-UE1 transmits a DIRECT LINK ESTABLISHMENT REQUEST message using the pool of resources indicated by <i>sl-RxPool</i> in <i>SIB12</i> of NR Cell 12.	<--	PC5-S: DIRECT LINK ESTABLISHMENT REQUEST	-	-
29	Check: Does the UE transmit a DIRECT LINK SECURITY MODE COMMAND message.	-->	PC5-S: DIRECT LINK SECURITY MODE COMMAND	1	P
30	The NR-SS-UE1 transmits a DIRECT LINK SECURITY MODE COMPLETE message.	<--	PC5-S: DIRECT LINK SECURITY MODE COMPLETE	-	-
31	The UE transmits a DIRECT LINK ESTABLISHMENT ACCEPT message.	-->	PC5-S: DIRECT LINK ESTABLISHMENT ACCEPT	-	-
32	The NR-SS-UE1 transmits an <i>RRCReconfigurationSidelink</i> message.	<--	PC5-RRC: <i>RRCReconfigurationSidelink</i>	-	-
33	Check: Does the UE transmit an <i>RRCReconfigurationCompleteSidelink</i> message?	-->	PC5-RRC: <i>RRCReconfigurationCompleteSidelink</i>	1	P

Table 12.2.1.2.3.2-4: Parallel behaviour

St	Procedure	Message Sequence		TP	Verdict
		U - S	Message		
1	The UE sends a <i>SidelinkUEInformationNR</i> message.	-->	NR RRC: <i>SidelinkUEInformationNR</i>	-	-

12.2.1.2.3.3 Specific message contents

Table 12.2.1.2.3.3-1: SL-BWP-PoolConfigCommon (Preamble)

Derivation Path: TS 38.508-1 [4], Table 4.6.6-4 with condition RXPOOL and SELECTED

Table 12.2.1.2.3.3-2: SIB12 for NR Cell 12 (Step 3, Table 12.2.1.2.3.2-3)

Derivation Path: TS 38.508-1 [4], Table 4.6.2-14			
Information Element	Value/remark	Comment	Condition
SIB12-r16 ::= SEQUENCE { segmentContainer-r16	OCTET STRING (CONTAINING SIB12-IEs-r16 or segment of SIB12-IEs-r16)		
}			

Table 12.2.1.2.3.3-3: SIB12-IEs-r16 (Table 12.2.1.2.3.3-2)

Derivation Path: TS 38.508-1 [4], Table 4.6.2-14A			
Information Element	Value/remark	Comment	Condition
SIB12-IEs-r16 ::= SEQUENCE {			

sl-ConfigCommonNR-r16 SEQUENCE {			
sl-FreqInfoList-r16 SEQUENCE (SIZE (1..maxNrofFreqSL-r16)) OF SL-FreqConfigCommon-r16{	1 entry		
SL-FreqConfigCommon-r16[1]	SL-FreqConfigCommon		
}			
}			
}			

Table 12.2.1.2.3.3-4: SL-FreqConfigCommon (Table 12.2.1.2.3.3-3)

Derivation Path: TS 38.508-1 [4], Table 4.6.6-11			
Information Element	Value/remark	Comment	Condition
SL-FreqConfigCommon-r16 ::= SEQUENCE {			
sl-ConfigCommonNR-r16 SEQUENCE {			
sl-BWP-List-r16 SEQUENCE (SIZE (1..maxNrofSL-BWPs-r16)) OF SL-BWP-ConfigCommon-r16 {	1 entry		
SL-BWP-ConfigCommon-r16[1]	SL-BWP-ConfigCommon		
}			
}			
}			

Table 12.2.1.2.3.3-5: SL-BWP-ConfigCommon (Table 12.2.1.2.3.3-4)

Derivation Path: TS 38.508-1 [4], Table 4.6.6-2			
Information Element	Value/remark	Comment	Condition
SL-BWP-ConfigCommon-r16 ::= SEQUENCE {			
sl-BWP-PoolConfigCommon-r16	SL-BWP-PoolConfigCommon		
}			

Table 12.2.1.2.3.3-6: SL-BWP-PoolConfigCommon (Table 12.2.1.2.3.3-5)

Derivation Path: TS 38.508-1 [4], Table 4.6.6-4 with condition RXPOOL and SELECTED
--

Table 12.2.1.2.3.3-7: SL-ResourcePool (Table 12.2.1.2.3.3-6)

Derivation Path: TS 38.508-1 [4], Table 4.6.6-25			
Information Element	Value/remark	Comment	Condition
SL-ResourcePool-r16 ::= SEQUENCE {			
sl-TimeResource-r16	0000000011		
}			

Table 12.2.1.2.3.3-8: SIB12 for NR Cell 1 (Step 3, Table 12.2.1.2.3.2-3)

Derivation Path: TS 38.508-1 [4], Table 4.6.2-14
--

Table 12.2.1.2.3.3-9: SIB12-IEs-r16 (Table 12.2.1.2.3.3-8)

Derivation Path: TS 38.508-1 [4], Table 4.6.2-14A			
Information Element	Value/remark	Comment	Condition
SIB12-IEs-r16 ::= SEQUENCE {			
sl-ConfigCommonNR-r16 SEQUENCE {			
sl-FreqInfoList-r16	Not present		
sl-NR-AnchorCarrierFreqList-r16 SEQUENCE (SIZE (1.. maxFreqSL-NR-r16)) OF ARFCN-ValueNR {	1 entry		
ARFCN-ValueNR[1]	ARFCN-ValueNR of NR Cell 12		

}			
}			
}			

Table 12.2.1.2.3.3-10: SidelinkUEInformationNR (Step 1, Table 12.2.1.2.3.2-4)

Derivation Path: TS 38.508-1 [4], Table 4.6.1-28A with condition SIDELINK_TX

12.2.1.3 Inter-carrier concurrent operation / Sidelink communication / RRC_CONNECTED / Transmission / Network scheduling

12.2.1.3.1 Test Purpose (TP)

(1)

```
with { UE is in RRC_CONNECTED state and its serving cell broadcasts SIB12 including sl-
ConfigCommonNR }
ensure that {
  when { UE is configured by upper layers to perform sidelink transmission on the frequency included
in sl-FreqInfoList }
  then { UE sends a SidelinkUEInformationNR message to indicate it requires sidelink transmission
resources }
}
```

(2)

```
with { UE is in RRC_CONNECTED state and is configured by upper layers to perform sidelink
transmission }
ensure that {
  when { UE receives an RRCReconfiguration message which includes sl-ScheduledConfig and no sl-
ConfiguredGrantConfigList }
  then { UE performs sidelink transmission based on dynamic scheduling }
}
```

(3)

```
with { UE is in RRC_CONNECTED state }
ensure that {
  when { UE is configured by upper layers to provide configured grant assistance information for NR
sidelink communication }
  then { UE sends a UEAssistanceInformation message including sl-UE-AssistanceInformationNR }
}
```

(4)

```
with { UE is in RRC_CONNECTED state and is configured by upper layers to perform sidelink
transmission }
ensure that {
  when { UE receives an RRCReconfiguration message which includes sl-ConfiguredGrantConfigList }
  then { UE performs sidelink transmission using the configured grant included in sl-
ConfiguredGrantConfigList }
}
```

(5)

```
with { UE is in RRC_CONNECTED state and is configured by upper layer to perform sidelink
transmission }
ensure that {
  when { UE is no longer configured by upper layers to perform sidelink transmission }
  then { UE sends a SidelinkUEInformationNR message to indicate it no longer requires sidelink
transmission resources }
}
```

12.2.1.3.2 Conformance requirements

References: The conformance requirements covered in the current TC are specified in: TS 38.331, clause 5.3.5.3, 5.5.2, 5.5.4.1, 5.5.4.2, 5.5.4.3 and 5.5.5. Unless otherwise stated these are Rel-16 requirements.

[TS 38.331, clause 5.3.5.3]

The UE shall perform the following actions upon reception of the *RRCReconfiguration*, or upon execution of the conditional reconfiguration (CHO or CPC):

...

1> if the *RRCReconfiguration* message includes the *otherConfig*:

2> perform the other configuration procedure as specified in 5.3.5.9;

...

1> if the *RRCReconfiguration* message includes the *sl-ConfigDedicatedNR*:

2> perform the sidelink dedicated configuration procedure as specified in 5.3.5.14;

...

1> else (*RRCReconfiguration* was received via SRB1):

2> submit the *RRCReconfigurationComplete* message via SRB1 to lower layers for transmission using the new configuration;

...

[TS 38.331, clause 5.3.5.14]

Upon initiating the procedure, the UE shall:

...

1> if *sl-FreqInfoToAddModList* is included in *sl-ConfigDedicatedNR* within *RRCReconfiguration*:

...

2> if configured to transmit NR sidelink communication:

3> use the resource pool(s) indicated by *sl-TxPoolSelectedNormal*, *sl-TxPoolScheduling* or *sl-TxPoolExceptional* for NR sidelink communication transmission, as specified in 5.8.8;

2> perform CBR measurement on the transmission resource pools indicated by *sl-TxPoolSelectedNormal*, *sl-TxPoolScheduling* or *sl-TxPoolExceptional* for NR sidelink communication transmission, as specified in 5.5.3;

2> use the synchronization configuration parameters for NR sidelink communication on frequencies included in *sl-FreqInfoToAddModList*, as specified in 5.8.5;

...

1> if *sl-RadioBearerToAddModList* or *sl-RLC-BearerToAddModList* is included in *sl-ConfigDedicatedNR* within *RRCReconfiguration*:

2> perform sidelink DRB addition/modification as specified in 5.8.9.1a.2;

1> if *sl-ScheduledConfig* is included in *sl-ConfigDedicatedNR* within *RRCReconfiguration*:

2> configure the MAC entity parameters, which are to be used for NR sidelink communication, in accordance with the received *sl-ScheduledConfig*;

...

[TS 38.331, clause 5.7.4.2]

...

A UE capable of providing configured grant assistance information for NR sidelink communication in RRC_CONNECTED may initiate the procedure in several cases, including upon being configured to provide traffic pattern information and upon change of traffic patterns.

...

Upon initiating the procedure, the UE shall:

...

- 1> if configured to provide configured grant assistance information for NR sidelink communication:
 - 2> initiate transmission of the *UEAssistanceInformation* message in accordance with 5.7.4.3 to provide configured grant assistance information for NR sidelink communication;

...

[TS 38.331, clause 5.7.4.3]

...

The UE shall set the contents of the *UEAssistanceInformation* message for configured grant assistance information for NR sidelink communication:

- 1> if configured to provide configured grant assistance information for NR sidelink communication:
 - 2> include the *sl-UE-AssistanceInformationNR*;
- ...
- 1> else:
 - 2> submit the *UEAssistanceInformation* message to lower layers for transmission.

[TS 38.331, clause 5.8.3.2]

Upon initiating this procedure, the UE shall:

- 1> if *SIB12* including *sl-ConfigCommonNR* is provided by the PCell:
 - 2> ensure having a valid version of *SIB12* for the PCell;
 - ...
 - 2> if configured by upper layers to transmit NR sidelink communication on the frequency included in *sl-FreqInfoList* in *SIB12* of the PCell:
 - 3> if the UE did not transmit a *SidelinkUEInformationNR* message since last entering RRC_CONNECTED state; or
 - 3> if since the last time the UE transmitted a *SidelinkUEInformationNR* message the UE connected to a PCell not providing *SIB12* including *sl-ConfigCommonNR*; or
 - 3> if the last transmission of the *SidelinkUEInformationNR* message did not include *sl-TxResourceReqList*; or if the information carried by the *sl-TxResourceReqList* has changed since the last transmission of the *SidelinkUEInformationNR* message:
 - 4> initiate transmission of the *SidelinkUEInformationNR* message to indicate the NR sidelink communication transmission resources required by the UE in accordance with 5.8.3.3;
 - 2> else:
 - 3> if the last transmission of the *SidelinkUEInformationNR* message included *sl-TxResourceReqList*:

- 4> initiate transmission of the *SidelinkUEInformationNR* message to indicate it no longer requires NR sidelink communication transmission resources in accordance with 5.8.3.3.

[TS 38.331, clause 5.8.3.3]

The UE shall set the contents of the *SidelinkUEInformationNR* message as follows:

- 1> if the UE initiates the procedure to indicate it is (no more) interested to receive NR sidelink communication or to request (configuration/ release) of NR sidelink communication transmission resources or to report to the network that a sidelink radio link failure or sidelink RRC reconfiguration failure has been declared (i.e. UE includes all concerned information, irrespective of what triggered the procedure):

- 2> if *SIB12* including *sl-ConfigCommonNR* is provided by the PCell:

...

- 3> if configured by upper layers to transmit NR sidelink communication:

- 4> include *sl-TxResourceReqList* and set its fields (if needed) as follows for each destination for which it requests network to assign NR sidelink communication resource:

- 5> set *sl-DestinationIdentity* to the destination identity configured by upper layer for NR sidelink communication transmission;

- 5> set *sl-CastType* to the cast type of the associated destination identity configured by the upper layer for the NR sidelink communication transmission;

...

- 5> set *sl-QoS-InfoList* to include QoS profile(s) of the sidelink QoS flow(s) of the associated destination configured by the upper layer for the NR sidelink communication transmission;

- 5> set *sl-InterestedFreqList* to indicate the frequency of the associated destination for NR sidelink communication transmission;

- 5> set *sl-TypeTxSyncList* to the current synchronization reference type used on the associated *sl-InterestedFreqList* for NR sidelink communication transmission.

...

...

- 1> else:

- 2> submit the *SidelinkUEInformationNR* message to lower layers for transmission;

[TS 38.331, clause 5.8.8]

A UE capable of NR sidelink communication that is configured by upper layers to transmit NR sidelink communication and has related data to be transmitted shall:

- 1> if the conditions for NR sidelink communication operation as defined in 5.8.2 are met:

- 2> if the frequency used for NR sidelink communication is included in *sl-FreqInfoToAddModList* in *sl-ConfigDedicatedNR* within *RRCReconfiguration* message or included in *sl-ConfigCommonNR* within *SIB12*:

- 3> if the UE is in *RRC_CONNECTED* and uses the frequency included in *sl-ConfigDedicatedNR* within *RRCReconfiguration* message:

- 4> if the UE is configured with *sl-ScheduledConfig*:

...

- 5> else:

- 6> configure lower layers to perform the sidelink resource allocation mode 1 for NR sidelink communication;

...

[TS 38.321, clause 5.22.1.1]

...

If the MAC entity has been configured with Sidelink resource allocation mode 1 as indicated in TS 38.331 [5], the MAC entity shall for each PDCCH occasion and for each grant received for this PDCCH occasion:

1> if a sidelink grant has been received on the PDCCH for the MAC entity's SL-RNTI:

...

2> else:

3> use the received sidelink grant to determine PSCCH duration(s) and PSSCH duration(s) for initial transmission and, if available, retransmission(s) of a single MAC PDU according to clause 8.1.2 of TS 38.214 [7].

...

1> else if a sidelink grant has been received on the PDCCH for the MAC entity's SLCS-RNTI:

2> if PDCCH contents indicate retransmission(s) for the identified HARQ process ID that has been set for an activated configured sidelink grant identified by *sl-ConfigIndexCG*:

3> use the received sidelink grant to determine PSCCH duration(s) and PSSCH duration(s) for one or more retransmissions of a single MAC PDU according to clause 8.1.2 of TS 38.214 [7].

...

The MAC entity shall for each PSSCH duration:

1> for each sidelink grant occurring in this PSSCH duration:

2> if the MAC entity has been configured with Sidelink resource allocation mode 1:

3> select a MCS which is, if configured, within the range that is configured by RRC between *sl-MinMCS-PSSCH* and *sl-MaxMCS-PSSCH* included in *sl-ConfigDedicatedNR*;

3> set the resource reservation interval to 0ms.

...

2> if the configured sidelink grant has been activated and this PSSCH duration corresponds to the first PSSCH transmission opportunity within this *sl-PeriodCG* of the configured sidelink grant:

3> set the HARQ Process ID to the HARQ Process ID associated with this PSSCH duration and, if available, all subsequent PSSCH duration(s) occurring in this *sl-PeriodCG* for the configured sidelink grant;

3> determine that this PSSCH duration is used for initial transmission;

3> if a dynamic sidelink grant associated to the HARQ Process ID has been received on the PDCCH for the MAC entity's SLCS-RNTI:

4> clear the dynamic sidelink grant.

2> deliver the sidelink grant, the selected MCS, and the associated HARQ information to the Sidelink HARQ Entity for this PSSCH duration.

...

[TS 38.321, clause 5.22.1.1]

...

A SL-BSR shall be triggered if any of the following events occur:

- 1> if the MAC entity has been configured with Sidelink resource allocation mode 1:
 - 2> SL data, for a logical channel of a Destination, becomes available to the MAC entity; and either
 - 3> this SL data belongs to a logical channel with higher priority than the priorities of the logical channels containing available SL data which belong to any LCG belonging to the same Destination; or
 - 3> none of the logical channels which belong to an LCG belonging to the same Destination contains any available SL data.

in which case the SL-BSR is referred below to as 'Regular SL-BSR';

...

1> else:

- 2> Sidelink resource allocation mode 1 is configured by RRC and SL data is available for transmission in the RLC entity or in the PDCP entity, in which case the Sidelink BSR is referred below to as "Regular SL-BSR".

For Regular SL-BSR, the MAC entity shall:

- 1> if the SL-BSR is triggered for a logical channel for which *sl-logicalChannelSR-DelayTimerApplied* with value *true* is configured by RRC:

- 2> start or restart the *sl-logicalChannelSR-DelayTimer*.

1> else:

- 2> if running, stop the *sl-logicalChannelSR-DelayTimer*.

For Regular and Periodic SL-BSR, the MAC entity shall:

- 1> if *sl-PrioritizationThres* is configured and the value of the highest priority of the logical channels that belong to any LCG and contain SL data for any Destination is lower than *sl-PrioritizationThres*; and

- 1> if either *ul-PrioritizationThres* is not configured or *ul-PrioritizationThres* is configured and the value of the highest priority of the logical channels that belong to any LCG and contain UL data is equal to or higher than *ul-PrioritizationThres* according to clause 5.4.5:

- 2> prioritize the LCG(s) for the Destination(s).

- 1> if the Buffer Status reporting procedure determines that at least one BSR has been triggered and not cancelled according to clause 5.4.5 and the UL grant cannot accommodate a SL-BSR MAC CE containing buffer status only for all prioritized LCGs having data available for transmission plus the subheader of the SL-BSR according to clause 5.4.3.1.3, in case the SL-BSR is considered as not prioritized:

- 2> prioritize the SL-BSR for logical channel prioritization specified in clause 5.4.3.1;

- 2> report Truncated SL-BSR containing buffer status for as many prioritized LCGs having data available for transmission as possible, taking the number of bits in the UL grant into consideration.

- 1> else if the number of bits in the UL grant is expected to be equal to or larger than the size of a SL-BSR containing buffer status for all LCGs having data available for transmission plus the subheader of the SL-BSR according to clause 5.4.3.1.3:

- 2> report SL-BSR containing buffer status for all LCGs having data available for transmission.

1> else:

- 2> report Truncated SL-BSR containing buffer status for as many LCGs having data available for transmission as possible, taking the number of bits in the UL grant into consideration.

...

The MAC entity shall:

- 1> if the sidelink Buffer Status reporting procedure determines that at least one SL-BSR has been triggered and not cancelled:
- 2> if UL-SCH resources are available for a new transmission and the UL-SCH resources can accommodate the SL-BSR MAC CE plus its subheader as a result of logical channel prioritization according to clause 5.4.3.1:
- 3> instruct the Multiplexing and Assembly procedure in clause 5.4.3 to generate the SL-BSR MAC CE(s);
- 3> start or restart *sl-periodicBSR-Timer* except when all the generated SL-BSRs are Truncated SL-BSRs;
- 3> start or restart *sl-retxBSR-Timer*.

...

12.2.1.3.3 Test description

12.2.1.3.3.1 Pre-test conditions

System Simulator:

- SS-NW
 - NR Cell 1
 - System information combination FFS as defined in TS 38.508-1 [4] clause 4.4.3.1 is used in NR Cell 1.
- SS-UE
 - Operating as NR sidelink communication receiving device on the resources that UE is expected to use for transmission.

UE:

- UE is authorised to perform NR sidelink communication.

Preamble:

- The UE is in state 3N-A as defined in TS 38.508-1 [4], subclause 4.4A on NR Cell 1 and Test Loop Function (*On*) with UE test loop mode FFS defined in 38.509 [6], subclause FFS.

12.2.1.3.3.2 Test procedure sequence

FFS

Table 12.2.1.3.3.2-1: Main behaviour

St	Procedure	Message Sequence		TP	Verdict
		U - S	Message		
1	Upper layers of the UE configures the UE to perform sidelink transmission. Note: This step is triggered by MMI or AT command	-	-	-	-
2	Check: Does the UE send a SidelinkUEInformationNR message to request sidelink transmission resource?	-->	NR RRC: SidelinkUEInformationNR	1	P
3	SS-NW transmits an RRCReconfiguration message with sl-ConfigDedicatedNR to configure transmission resources and to configure the UE to perform network scheduling-based sidelink transmission	<--	NR RRC: RRCReconfiguration	-	-
4	The UE transmits an RRCReconfigurationComplete message.	-->	NR RRC: RRCReconfigurationComplete		
5	Check: Does the UE send a Sidelink BSR MAC-CE?	-->	MAC CE (sidelink BSR)	2	P

5	SS-NW sends a DCI format 3_0 to configure sidelink grant for the UE	<--	DCI format 3_0	-	-
6	Check: Does the UE transmit one STCH PDCP SDU over the PC5 interface using the resources scheduled by SS-NW?	-->	STCH PDCP SDU	2	P
7	Upper layers of the UE configures the UE to send a UEAssistanceInformation message. Note: This step is triggered by MMI or AT command	-	-	-	-
8	Check: Does the UE send a UEAssistanceInformation message to provide configured grant assistance information?	-->	NR RRC: UEAssistanceInformation	3	P
9	SS-NW transmits an RRCReconfiguration message with sl-ConfiguredGrantConfigList to provide a Type 2 configure grant for the UE.	<--	NR RRC: RRCReconfiguration	-	-
10	The UE transmits an RRCReconfigurationComplete message.	-->	NR RRC: RRCReconfigurationComplete	-	-
11	SS-NW transmits an DCI format 3_0 to activate the configured grant.	<--	DCI format 3_0	-	-
12	The UE sends a Sidelink Configured Grant Confirmation MAC CE	-->	MAC CE (Sidelink Configured Grant Confirmation)	-	-
13	Check: Does the UE transmit one STCH PDCP SDU over the PC5 interface using the resources indicated by the configured grant?	-->	STCH PDCP SDU	4	P
14	Upper layer of the UE configures the UE to stop sidelink transmission.	-	-	-	-
15	Check: Does the UE send a SidelinkUEInformationNR message to indicate that sidelink transmission resource is not needed?	-->	NR RRC: SidelinkUEInformationNR	1	P

12.2.1.3.3.3 Specific message contents

FFS

12.2.1.4

12.2.1.5

12.2.1.6 Inter-carrier concurrent operation / Sidelink communication / RRC_CONNECTED / Reception

12.2.1.6.1 Test Purpose (TP)

(1)

```
with { UE being in RRC_CONNECTED state and its serving cell not broadcasting SIB12 }
ensure that {
  when { UE is configured by upper layer to perform NR sidelink reception}
  then { UE is able to monitor NR sidelink reception using sl-RxPool included in pre-configuration}
}
```

(2)

```
with { UE being in RRC_CONNECTED state and its serving cell broadcasting SIB12 }
ensure that {
  when { UE is configured by upper layer to perform NR sidelink reception}
  then { UE is able to monitor NR sidelink reception using sl-RxPool included in SIB12}
}
```

(3)

```

with { UE being in RRC_CONNECTED state and having received a RRCReconfiguration including sl-RxPool
}
ensure that {
  when { UE is configured by upper layer to perform NR sidelink reception}
  then { UE is able to monitor NR sidelink reception using sl-RxPool included in sl-
ConfigDedicatedNR}
}

```

(4)

```

with { UE being in RRC_CONNECTED state and being configured by upper layer to perform NR sidelink
reception }
ensure that {
  when { UE receives a RRCReconfiguration including reconfigurationWithSync and sl-RxPool}
  then { UE is able to monitor NR sidelink reception using sl-RxPool included in the received
RRCReconfiguration message during handover procedure}
}

```

12.2.1.6.2 Conformance requirements

References: The conformance requirements covered in the present TC are specified in: TS 38.331, clause 5.8.1, clause 5.8.7. Unless otherwise stated these are Rel-16 requirements.

[TS 38.331, clause 5.8.1]

The PC5-RRC signalling, as specified in sub-clause 5.8.9, can be initiated after its corresponding PC5 unicast link establishment (TS 23.287 [55]).

[TS 38.331, clause 5.8.7]

A UE capable of NR sidelink communication that is configured by upper layers to receive NR sidelink communication shall:

- 1> if the conditions for NR sidelink communication operation as defined in 5.8.2 are met:
 - 2> if the frequency used for NR sidelink communication is included in *sl-FreqInfoToAddModList* in *RRCReconfiguration* message or *sl-FreqInfoList* included in *SIB12*:
 - 3> if the UE is configured with *sl-RxPool* included in *RRCReconfiguration* message with *reconfigurationWithSync* (i.e. handover):
 - 4> configure lower layers to monitor sidelink control information and the corresponding data using the pool of resources indicated by *sl-RxPool*;
 - 3> else if the cell chosen for NR sidelink communication provides *SIB12*:
 - 4> configure lower layers to monitor sidelink control information and the corresponding data using the pool of resources indicated by *sl-RxPool* in *SIB12*;
 - 2> else:
 - 3> configure lower layers to monitor sidelink control information and the corresponding data using the pool of resources that were preconfigured by *sl-RxPool* in *SL-PreconfigurationNR*, as defined in sub-clause 9.3;

12.2.1.6.3 Test description

12.2.1.6.3.1 Pre-test conditions

System Simulator:

- SS-NW
- NR Cell 1 is the serving cell and NR Cell 3 is the inter-frequency neighbour cell of NR Cell 1.

- System information combination NR-4 as defined in TS 38.508-1 [4] clause 4.4.3.1.
- NR-SS-UE
- NR-SS-UE1 operating as NR sidelink communication receiving and transmitting device on the resources that UE is expected to use for transmission and reception via PC5 interface.
- NR-SS-UE1 is synchronised on NR Cell 1.

UE:

- UE is authorised to perform NR sidelink communication.
- The UE is equipped with below information in UE or in a USIM containing default values (as per TS 38.508-1 [4] clause 4.8.3.3.3) except for those listed in Table 12.2.1.6.3.1-1.
- UE is synchronised on NR Cell 1.

Table 12.2.1.6.3.1-1: UE/ USIM configuration

USIM field	Priority	Value	Access Technology Identifier
EF _{UST}		service no. 119 is available	
EF _{VST}		Service no.2 V2X policy configuration data over PC5 is supported, i.e. value is '01 02' HEX	
EF _{V2XP_PC5}		SL-PreconfigurationNR field as defined in TS 38.508-1 [4], table 4.10.1-1, except SL-BWP-PoolConfigCommon field as defined in Table 12.2.1.6.3.3-1 with condition SL-PRECONFIG	

Preamble:

- The UE is in state 3N-B RRC_CONNECTED_with_SL and Test Loop Function (On) with UE test loop mode E as defined in TS 38.508-1 [4] subclause 4.4A on NR Cell 1, using generic parameters Sidelink (On), Cast Type (Unicast) using UE initiated unicast mode NR sidelink communication procedure in subclause 4.9.22.
- NR-SS-UE1 initiated unicast mode NR sidelink communication.

12.2.1.6.3.2 Test procedure sequence

Tables 12.2.1.6.3.2-1 and 12.2.1.6.3.2-2 illustrate the downlink power levels to be applied for NR Cell 1 and NR Cell 3 at various time instants of the test execution. Row marked "T0" denotes the conditions after the preamble, while the configuration marked "T1" is applied at the point indicated in the Main behaviour description in Table 12.2.1.6.3.2-3.

Table 12.2.1.6.3.2-1: Power levels in FR1

	Parameter	Unit	NR Cell 1	NR Cell 3	Remark
T0	SS/PBCH SSS EPRE	dBm/SCS	-85	-91	Power levels are such that entry condition for event A3 is not satisfied for NR Cell 3
T1	SS/PBCH SSS EPRE	dBm/SCS	-85	-79	Power levels are such that entry condition for event A3 is satisfied for NR Cell 3

Table 12.2.1.6.3.2-2: Power levels in FR2

	Parameter	Unit	NR Cell 1	NR Cell 3	Remark
--	-----------	------	-----------	-----------	--------

T0	SS/PBCH SSS EPRE	dBm/ SCS	FFS	FFS	Power levels are such that entry condition for event A3 is not satisfied for NR Cell 3
T1	SS/PBCH SSS EPRE	dBm/ SCS	FFS	FFS	Power levels are such that entry condition for event A3 is satisfied for NR Cell 3

Table 12.2.1.6.3.2-3: Main behaviour

St	Procedure	Message Sequence		TP	Verdict
		U - S	Message		
1	Check: Does the test result of generic test procedure in TS 38.508-1[4] subclause 4.9.31 indicate that the UE monitors NR sidelink reception using sl-RxPool included in pre-configuration?	-->		1	-
2	SS starts broadcasting SIB12 in NR-Cell 1 using system information combination NR-14	-		-	-
3	NR Cell 1 transmits a Short message on PDCCH using P-RNTI indicating a systemInfoModification.	-	PDCCH (DCI 1_0): Short Message		-
4	Wait for 2.1* modification period to allow the new system information to take effect.	-	-	-	-
5	The UE transmits a <i>SidelinkUEInformationNR</i> message to indicate it is (interested in) receiving NR sidelink communication.	-->	NR RRC: SidelinkUEInformationNR	-	-
6	Check: Does the test result of generic test procedure in TS 38.508-1[4] subclause 4.9.31 indicate that the UE monitors NR sidelink reception using sl-RxPool included in SIB12?	-	-	2	-
7	SS-NW sends an <i>RRCReconfiguration</i> message including sl-RxPool.	<--	NR RRC: RRCReconfiguration	-	-
8	UE sends an <i>RRCReconfigurationComplete</i> message	-->	NR RRC: RRCReconfigurationComplete	-	-
9	Check: Does the test result of generic test procedure in TS 38.508-1[4] subclause 4.9.31 indicate that the UE monitors NR sidelink reception using sl-RxPool included in sl-ConfigDedicatedNR?	-	-	3	-
10	The SS changes NR Cell 3 parameters according to the row "T1" in Table 12.2.1.6.3.2-1/2.	-	-	-	-
11	SS-NW sends an <i>RRCReconfiguration</i> message including <i>reconfigurationWithSync</i> and sl-RxPool on NR Cell 1 to order the UE to perform intra handover to NR Cell 3.	<--	NR RRC: RRCReconfiguration	-	-
12	UE sends an <i>RRCReconfigurationComplete</i> message on NR Cell 3 to confirm the successful handover.	-->	NR RRC: RRCReconfigurationComplete	-	-
13	Check: Does the test result of generic test procedure in TS 38.508-1[4] subclause 4.9.31 indicate that the UE monitors NR sidelink reception using sl-RxPool included in the received <i>RRCReconfiguration</i> ?	-	-	4	-

12.2.1.6.3.3 Specific message contents

Table 12.2.1.6.3.3-1: SL-BWP-PoolConfigCommon (Preamble, Table 12.2.1.6.3.1-1 and Table 12.2.1.6.3.3-5)

Derivation Path: TS 38.508-1 [4], Table 4.6.6-4			
Information Element	Value/remark	Comment	Condition
SL-BWP-PoolConfigCommon-r16 ::= SEQUENCE {			
sl-RxPool-r16 SEQUENCE (SIZE (1..maxNrofRXPool-r16)) OF SL-ResourcePool-r16 {	1 entry		
SL-ResourcePool-r16[1]	SL-ResourcePool with condition RX_TX1 as defined in Table 12.2.1.6.3.3-13	entry 1	SL-PRECONFIG
SL-ResourcePool-r16[1]	SL-ResourcePool with condition RX_TX2 as defined in Table 12.2.1.6.3.3-13		SIB-12
}			
sl-TxPoolSelectedNormal-r16 SEQUENCE (SIZE (1..maxNrofTXPool-r16)) OF SL-ResourcePoolConfig-r16 {	1 entry		
SL-ResourcePoolConfig-r16[1] SEQUENCE {		entry 1	
sl-ResourcePoolID-r16	1	Index of the resource pool for normal case	
sl-ResourcePool-r16	SL-ResourcePool with condition RX_TX1 as defined in Table 12.2.1.6.3.3-13		SL-PRECONFIG
sl-ResourcePool-r16	SL-ResourcePool with condition RX_TX2 as defined in Table 12.2.1.6.3.3-13		SIB-12
}			
}			
}			

Table 12.2.1.6.3.3-2: SIB12 (step 2, Table 12.2.1.6.3.2-3)

Derivation path: TS 38.508-1 [4], Table 4.6.2-14 with condition LAST_SEG			
Information Element	Value/Remark	Comment	Condition
SIB12-r16 ::= SEQUENCE {			
segmentContainer-r16	OCTET STRING (CONTAINING SIB12-RESOURCEPOOL)		
}			

Table 12.2.1.6.3.3-3: SIB12-RESOURCEPOOL (Table 12.2.1.6.3.3-2)

Derivation path: TS 38.508-1 [4], Table 4.6.2-14A			
Information Element	Value/Remark	Comment	Condition
SIB12-IEs-r16 ::= SEQUENCE {			
sl-ConfigCommonNR-r16 SEQUENCE {			
sl-FreqInfoList-r16 SEQUENCE (SIZE (1..maxNrofFreqSL-r16)) OF SL-FreqConfigCommon-r16{			
SL-FreqConfigCommon-r16[1]	SL-FreqConfigCommon		
}			
}			
}			

Table 12.2.1.6.3.3-4: SL-FreqConfigCommon (Table 12.2.1.6.3.3-3)

Derivation path: TS 38.508-1 [4], Table 4.6.6-11			
Information Element	Value/Remark	Comment	Condition
SL-FreqConfigCommon-r16 ::= SEQUENCE {			
sl-BWP-List-r16 SEQUENCE (SIZE (1..maxNrofSL-BWPs-r16)) OF SL-BWP-ConfigCommon-r16 {			
SL-BWP-ConfigCommon-r16[1]	SL-BWP-ConfigCommon		
}			
}			

Table 12.2.1.6.3.3-5: SL-BWP-ConfigCommon (Table 12.2.1.6.3.3-4)

Derivation path: TS 38.508-1 [4], Table 4.6.6-2			
Information Element	Value/Remark	Comment	Condition
SL-BWP-ConfigCommon-r16 ::= SEQUENCE {			
sl-BWP-PoolConfigCommon-r16	SL-BWP-PoolConfigCommon with condition SIB-12 as defined in Table 12.2.1.6.3.3-1		
}			

Table 12.2.1.6.3.3-6: RRCReconfiguration (step 7, Table 12.2.1.6.3.2-3)

Derivation path: TS 38.508-1 [4], Table 4.6.1-13			
Information Element	Value/Remark	Comment	Condition
RRCReconfiguration ::= SEQUENCE {			
criticalExtensions CHOICE {			
rrcReconfiguration SEQUENCE {			
nonCriticalExtension SEQUENCE {			
nonCriticalExtension SEQUENCE {			
nonCriticalExtension SEQUENCE {			
nonCriticalExtension SEQUENCE {			
sl-ConfigDedicatedNR-r16	SL-ConfigDedicatedNR with condition SCHEDULING as defined in Table 12.2.1.6.3.3-7		
}			
}			
}			
}			
}			
}			
}			

Table 12.2.1.6.3.3-7: SL-ConfigDedicatedNR (Table 12.2.1.6.3.3-6 and Table 12.2.1.6.3.3-11)

Derivation path: TS 38.508-1 [4], Table 4.6.6-7 with condition SCHEDULING			
Information Element	Value/Remark	Comment	Condition
SL-ConfigDedicatedNR-r16 ::= SEQUENCE {			
sl-FreqInfoToAddModList-r16 SEQUENCE (SIZE (1..maxNrofFreqSL-r16)) OF SL-FreqConfig-r16 {	one entry		
SL-FreqConfig-r16[1]	SL-FreqConfig with condition SCHEDULING as defined in Table 12.2.1.6.3.3-8		SCHEDULING
SL-FreqConfig-r16[1]	SL-FreqConfig with condition EXCEPTIONAL as defined in Table 12.2.1.6.3.3-8		EXCEPTIONAL
}			
}			

Table 12.2.1.6.3.3-8: SL-FreqConfig (Table 12.2.1.6.3.3-7)

Derivation path: TS 38.508-1 [4], Table 4.6.6-10			
Information Element	Value/Remark	Comment	Condition
SL-FreqConfig-r16 ::= SEQUENCE {			
sl-BWP-ToAddModList-r16 SEQUENCE (SIZE (1..maxNrofSL-BWPs-r16)) OF SL-BWP-Config-r16 {	one entry		
SL-BWP-Config-r16[1]	SL-BWP-Config with condition RX_SCHEDULINGTX as defined in Table 12.2.1.6.3.3-9		SCHEDULING
SL-BWP-Config-r16[1]	SL-BWP-Config with condition RX_EXCEPTIONALTX as defined in Table 12.2.1.6.3.3-9		EXCEPTIONAL
}			
}			

Table 12.2.1.6.3.3-9: SL-BWP-Config (Table 12.2.1.6.3.3-8)

Derivation path: TS 38.508-1 [4], Table 4.6.6-1			
Information Element	Value/Remark	Comment	Condition
SL-BWP-Config-r16 ::= SEQUENCE {			
sl-BWP-PoolConfig-r16 SEQUENCE {			
sl-RxPool-r16 SEQUENCE (SIZE (1..maxNrofRXPool-r16)) OF SL-ResourcePool-r16 {	1 entry		RX_SCHEDULINGTX, RX_EXCEPTIONALTX
SL-ResourcePool-r16[1]	SL-ResourcePool with condition RX_TX2 as defined in Table 12.2.1.6.3.3-13	entry 1	
SL-ResourcePool-r16[1]	SL-ResourcePool with condition RX as defined in Table 12.2.1.6.3.3-13		RX_EXCEPTIONALTX
}			
sl-TxPoolScheduling-r16	Not Present		
sl-TxPoolScheduling-r16 SEQUENCE {			RX_SCHEDULINGTX
sl-PoolToAddModList-r16 SEQUENCE (SIZE (1..maxNrofTXPool-r16)) OF SL-ResourcePoolConfig-r16 {	1 entry		
SL-ResourcePoolConfig-r16[1] SEQUENCE {		entry 1	
sl-ResourcePoolID-r16	1		
sl-ResourcePool-r16	SL-ResourcePool with condition RX_TX2 as defined in Table 12.2.1.6.3.3-13		
}			
}			
}			
sl-TxPoolExceptional-r16	Not Present		
sl-TxPoolExceptional-r16 SEQUENCE {			RX_EXCEPTIONALTX
sl-ResourcePoolID-r16	2		
sl-ResourcePool-r16	SL-ResourcePool with condition EXCEPTIONAL as defined in Table 12.2.1.6.3.3-13		
}			
}			
}			

Table 12.2.1.6.3.3-10: RRCReconfigurationComplete (step 8 and step 12, Table 12.2.1.6.3.2-3)

Derivation path: TS 38.508-1 [4], Table 4.6.1-14

Table 12.2.1.6.3.3-11: RRCReconfiguration-HO (step 11, Table 12.2.1.6.3.2-3)

Derivation path: TS 38.508-1 [4], Table 4.8.1-1A with condition RBConfig_KeyChange			
Information Element	Value/Remark	Comment	Condition
RRCReconfiguration ::= SEQUENCE {			
criticalExtensions CHOICE {			
rrcReconfiguration SEQUENCE {			
nonCriticalExtension SEQUENCE {			
nonCriticalExtension SEQUENCE {			
nonCriticalExtension SEQUENCE {			
nonCriticalExtension SEQUENCE {			
sl-ConfigDedicatedNR-r16	SL-ConfigDedicatedNR with condition EXCEPTIONAL as defined in Table 12.2.1.6.3.3-7		
}			
}			
}			
}			
}			
}			
}			
}			

Table 12.2.1.6.3.3-12: SidelinkUEInformationNR (step 5, Table 12.2.1.6.3.2-3)

Derivation path: TS 38.508-1 [4], Table 4.6.1-28A with condition SIDELINK_RX

Table 12.2.1.6.3.3-13: sl-ResourcePool (Table 12.2.1.6.3.3-7)

Derivation path: TS 38.508-1 [4], Table 4.6.6-25			
Information Element	Value/Remark	Comment	Condition
SL-ResourcePool-r16 ::= SEQUENCE {			
sl-TimeResource-r16	1100000000		RX_TX1
sl-TimeResource-r16	0011000000		RX_TX2
sl-TimeResource-r16	0000110000		RX
sl-TimeResource-r16	0000000011		EXCEPTIO NAL
}			

12.2.2 Inter-carrier concurrent operation / Sidelink synchronization related procedure

12.2.2.1 Inter-carrier concurrent operation / Sidelink synchronization related procedure / Synchronization reference source (re-)selection

12.2.2.1.1 Test Purpose (TP)

(1)

```

with { UE is on connected state. UE is configured by upper layer to perform sidelink transmission and is configured with sl-SyncPriority = gnss. }
ensure that {
  when { GNSS signal is reliable and a SyncRef UE directly synchronized to GNSS is detected. }
  then { UE selects GNSS as synchronization reference source. }
}
    
```

(2)

```

with { UE is on connected state. UE is configured by upper layer to perform sidelink transmission
and is configured with sl-SyncPriority = gnss. }
ensure that {
  when { Two SyncRef UEs, one directly synchronized to GNSS and the other indirectly synchronized to
GNSS, are detected. }
  then { UE selects the SyncRef UE directly synchronized to GNSS as synchronization reference
source. }
}

```

(3)

```

with { UE is on connected state. UE is configured by upper layer to perform sidelink transmission
and is configured with sl-SyncPriority = gnss. }
ensure that {
  when { One SyncRef UE indirectly synchronized to GNSS is detected. }
  then { UE selects the SyncRef UE indirectly synchronized to GNSS as synchronization reference
source. }
}

```

(4)

```

with { UE is on connected state. UE is configured by upper layer to perform sidelink transmission
and is configured with sl-SyncPriority = gnbEnb. }
ensure that {
  when { A SyncRef UE directly synchronized to gNB is detected. }
  then { UE selects serving cell as synchronization reference source. }
}

```

(5)

```

with { UE is configured by upper layer to perform sidelink transmission and is configured with sl-
SyncPriority = gnbEnb in pre-configuration. }
ensure that {
  when { Two SyncRef UEs, one directly synchronized to gNB and the other indirectly synchronized to
gNB, are detected. }
  then { UE selects the SyncRef UE directly synchronizd to gNB as synchronization reference source
}
}

```

(6)

```

with { UE is configured by upper layer to perform sidelink transmission and is configured with sl-
SyncPriority = gnbEnb in pre-configuration. }
ensure that {
  when { GNSS is reliable and one SyncRef UE indirectly synchronized to gNB is detected. }
  then { UE selects the SyncRef UE indirectly synchronizd to gNB as synchronization reference
source. }
}

```

(7)

```

with { UE is configured by upper layer to perform sidelink transmission and is configured with sl-
SyncPriority = gnbEnb in pre-configuration. }
ensure that {
  when { GNSS is reliable and one SyncRef UE directly synchronized to GNSS is detected. }
  then { UE selects GNSS as synchronization reference source. }
}

```

(8)

```

with { UE is configured by upper layer to perform sidelink transmission and is configured with sl-
SyncPriority = gnbEnb in pre-configuration. }
ensure that {
  when { Two SyncRef UEs, one directly synchronized to GNSS and the other indirectly synchronized to
GNSS, are detected. }
  then { UE selects the SyncRef UE directly synchronized to GNSS as synchronization reference
source. }
}

```

(9)

```

with { UE is configured by upper layer to perform sidelink transmission and is configured with sl-SyncPriority = gnbEnb in pre-configuration. }
ensure that {
  when { Two SyncRef UEs, one indirectly synchronized to GNSS and the other one neither directly nor indirectly synchronized to GNSS or gNB, are detected. }
  then { UE selects the SyncRef UE indirectly synchronized to GNSS as synchronization reference source }
}
    
```

(10)

```

with { UE is configured by upper layer to perform sidelink transmission and is configured with sl-SyncPriority = gnbEnb in pre-configuration. }
ensure that {
  when { A SyncRef UE which neither directly nor indirectly synchronized to GNSS or gNB is detected. }
  then { UE selects the SyncRef UE which neither directly nor indirectly synchronized to GNSS or gNB as synchronization reference source. }
}
    
```

12.2.2.1.2 Conformance requirements

References: The conformance requirements covered in the present TC are specified in: TS 38.331 [22], subclause 5.8.2. Unless otherwise stated these are Rel-16 requirements.

[TS 38.331, clause 5.8.2]

The UE shall perform NR sidelink communication operation only if the conditions defined in this clause are met:

- 1> if the UE's serving cell is suitable (RRC_IDLE or RRC_INACTIVE or RRC_CONNECTED); and if either the selected cell on the frequency used for NR sidelink communication operation belongs to the registered or equivalent PLMN as specified in TS 24.587 [57] or the UE is out of coverage on the frequency used for NR sidelink communication operation as defined in TS 38.304 [20] and TS 36.304 [27]; or

...

- 1> if the UE has no serving cell (RRC_IDLE);

[TS 38.331, clause 5.8.5.1]

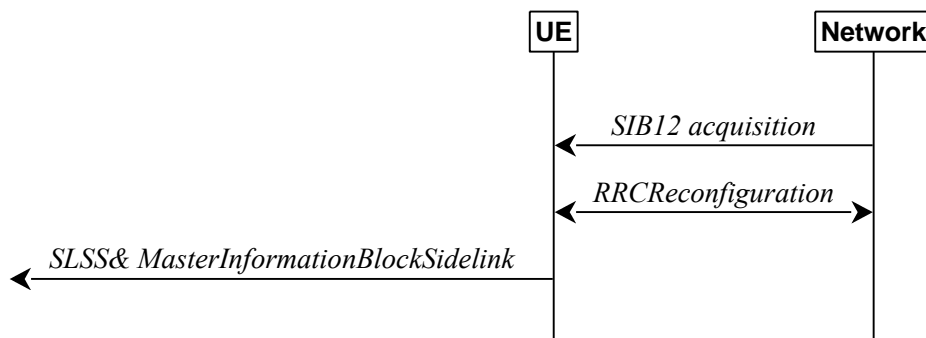

Figure 5.8.5.1-1: Synchronisation information transmission for NR sidelink communication, in (partial) coverage

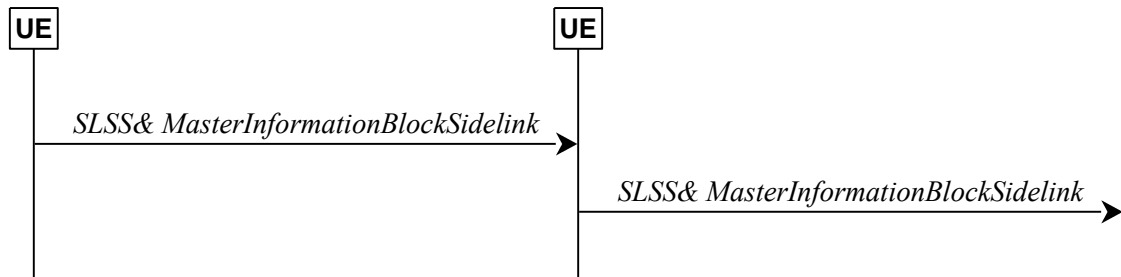

Figure 5.8.5.1-2: Synchronisation information transmission for NR sidelink communication, out of coverage

The purpose of this procedure is to provide synchronisation information to a UE.

[TS 38.331, clause 5.8.5.2]

A UE capable of NR sidelink communication and SLSS/PSBCH transmission shall, when transmitting NR sidelink communication, and if the conditions for NR sidelink communication operation are met and when the following conditions are met:

...

1> if out of coverage on the frequency used for NR sidelink communication, and the frequency used to transmit NR sidelink communication is included in *sl-FreqInfoToAddModList* in *sl-ConfigDedicatedNR* within *RRCReconfiguration* message or included in *sl-FreqInfoList* within *SIB12*; and has selected GNSS or the cell as synchronization reference as defined in 5.8.6.3:

2> if in *RRC_CONNECTED*; and if *networkControlledSyncTx* is configured and set to *on*; or

...

3> transmit sidelink SSB on the frequency used for NR sidelink communication in accordance with 5.8.5.3 and TS 38.211 [16], including the transmission of SLSS as specified in 5.8.5.3 and transmission of *MasterInformationBlockSidelink* as specified in 5.8.9.4.3;

1> else:

2> for the frequency used for NR sidelink communication, if *syncTxThreshOoC* is included in *SidelinkPreconfigNR*; and the UE is not directly synchronized to GNSS, and the UE has no selected SyncRef UE or the PSBCH-RSRP measurement result of the selected SyncRef UE is below the value of *syncTxThreshOoC*; or

2> for the frequency used for NR sidelink communication, if the UE selects GNSS as the synchronization reference source:

3> transmit sidelink SSB on the frequency used for NR sidelink communication in accordance with TS 38.211 [16], including the transmission of SLSS as specified in 5.8.5.3 and transmission of *MasterInformationBlockSidelink* as specified in 5.8.9.4.3;

[TS 38.331, clause 5.8.5.3]

The UE shall select the SLSSID and the slot in which to transmit SLSS as follows:

...

1> if triggered by NR sidelink communication, and out of coverage on the frequency used for NR sidelink communication, and the concerned frequency is included in *sl-FreqInfoToAddModList* in *sl-ConfigDedicatedNR* within *RRCReconfiguration* message or included in *sl-FreqInfoList* within *SIB12*:

2> if the UE has selected GNSS as synchronization reference in accordance with 5.8.6.2:

3> select SLSSID 0;

- 3> use *sl-SSB-TimeAllocation1* included in the entry of configured *sl-SyncConfigList* corresponding to the concerned frequency, that includes *txParameters* and *gnss-Sync*;
- 3> select the slot(s) indicated by *sl-SSB-TimeAllocation1*;
- 2> if the UE has selected a cell as synchronization reference in accordance with 5.8.6.2:
 - 3> select the SLSSID included in the entry of configured *sl-SyncConfigList* corresponding to the concerned frequency, that includes *txParameters* and does not include *gnss-Sync*;
 - 3> select the slot(s) indicated by *sl-SSB-TimeAllocation1*;
- 1> else if triggered by NR sidelink communication and the UE has GNSS as the synchronization reference:
 - 2> select SLSSID 0;
 - ...
 - 2> else:
 - 3> select the slot(s) indicated by *sl-SSB-TimeAllocation1*;
- 1> else:
 - 2> select the synchronisation reference UE (i.e. SyncRef UE) as defined in 5.8.6;
 - 2> if the UE has a selected SyncRef UE and *inCoverage* in the *MasterInformationBlockSidelink* message received from this UE is set to *true*; or
 - 2> if the UE has a selected SyncRef UE and *inCoverage* in the *MasterInformationBlockSidelink* message received from this UE is set to *false* while the SLSS from this UE is part of the set defined for out of coverage, see TS 38.211 [16]:
 - 3> select the same SLSSID as the SLSSID of the selected SyncRef UE;
 - 3> select the slot in which to transmit the SLSS according to the *sl-SSB-TimeAllocation1* or *sl-SSB-TimeAllocation2* included in the preconfigured sidelink parameters corresponding to the concerned frequency, such that the timing is different from the SLSS of the selected SyncRef UE;
 - ...
 - 2> else if the UE has a selected SyncRef UE:
 - 3> select the SLSSID from the set defined for out of coverage having an index that is 336 more than the index of the SLSSID of the selected SyncRef UE, see TS 38.211 [16];
 - 3> select the slot in which to transmit the SLSS according to *sl-SSB-TimeAllocation1* or *sl-SSB-TimeAllocation2* included in the preconfigured sidelink parameters corresponding to the concerned frequency, such that the timing is different from the SLSS of the selected SyncRef UE;
 - ...

[TS 38.331, clause 5.8.6.2]

The UE shall:

- 1> if the frequency used for NR sidelink communication is included in *sl-FreqInfoToAddModList* in *sl-ConfigDedicatedNR* within *RRCReconfiguration* message or included in *sl-ConfigCommonNR* within *SIB12*, and *sl-SyncPriority* is configured for the concerned frequency and set to *gnbEnb*:
 - 2> select a cell as the synchronization reference source as defined in 5.8.6.3:
- 1> else if the frequency used for NR sidelink communication is included in *sl-FreqInfoToAddModList* in *sl-ConfigDedicatedNR* within *RRCReconfiguration* message or included in *sl-ConfigCommonNR* within *SIB12*, and *sl-SyncPriority* for the concerned frequency is not configured or is set to *gnss*, and GNSS is reliable in accordance with TS 38.101-1 [15] and TS 38.133 [14]:

2> select GNSS as the synchronization reference source;

...

1> else:

2> perform a full search (i.e. covering all subframes and all possible SLSSIDs) to detect candidate SLSS, in accordance with TS 38.133 [14]

2> when evaluating the one or more detected SLSSIDs, apply layer 3 filtering as specified in 5.5.3.2 using the preconfigured *sl-filterCoefficient*, before using the PSBCH-RSRP measurement results;

2> if the UE has selected a SyncRef UE:

...

3> if the PSBCH-RSRP of the current SyncRef UE is less than the minimum requirement defined in TS 38.133 [14]:

4> consider no SyncRef UE to be selected;

...

2> if the UE has selected cell as the synchronization reference for NR sidelink communication:

3> if the PSBCH-RSRP of the candidate SyncRef UE exceeds the minimum requirement defined in TS 38.133 [14] by *sl-SyncRefMinHyst* and the candidate SyncRef UE belongs to a higher priority group than gNB/eNB; or

3> if the selected cell is not detected:

4> consider the cell not to be selected;

2> if the UE has not selected any synchronization reference:

3> if the UE detects one or more SLSSIDs for which the PSBCH-RSRP exceeds the minimum requirement defined in TS 38.133 [14] by *sl-SyncRefMinHyst* and for which the UE received the corresponding *MasterInformationBlockSidelink* message (candidate SyncRef UEs), or if the UE detects GNSS that is reliable in accordance with TS 38.101-1 [15] and TS 38.133 [14], or if the UE detects a cell, select a synchronization reference according to the following priority group order:

4> if *sl-SyncPriority* corresponding to the concerned frequency is set to *gnbEnb*:

5> UEs of which SLSSID is part of the set defined for in coverage, and *inCoverage*, included in the *MasterInformationBlockSidelink* message received from this UE, is set to *true*, starting with the UE with the highest PSBCH-RSRP result (priority group 1);

5> UE of which SLSSID is part of the set defined for in coverage, and *inCoverage*, included in the *MasterInformationBlockSidelink* message received from this UE, is set to *false*, starting with the UE with the highest PSBCH-RSRP result (priority group 2);

5> GNSS that is reliable in accordance with TS 38.101-1 [15] and TS 38.133 [14] (priority group 3);

5> UEs of which SLSSID is 0, and *inCoverage*, included in the *MasterInformationBlockSidelink* message received from this UE, is set to *true*, or of which SLSSID is 0 and SLSS is transmitted on slot(s) indicated by *sl-SSB-TimeAllocation3*, starting with the UE with the highest PSBCH-RSRP result (priority group 4);

5> UEs of which SLSSID is 0 and SLSS is not transmitted on slot(s) indicated by *sl-SSB-TimeAllocation3*, and *inCoverage*, included in the *MasterInformationBlockSidelink* message received from this UE, is set to *false*, starting with the UE with the highest PSBCH-RSRP result (priority group 5);

5> UEs of which SLSSID is 337 and *inCoverage*, included in the *MasterInformationBlockSidelink* message received from this UE, is set to *false*, starting with the UE with the highest PSBCH-RSRP result (priority group 5);

- 5> Other UEs, starting with the UE with the highest PSBCH-RSRP result (priority group 6);
- 4> if *sl-SyncPriority* corresponding to the concerned frequency is set to *gnss*, and *sl-NbAsSync* is set to *true*:
 - 5> UEs of which SLSSID is 0, and *inCoverage*, included in the *MasterInformationBlockSidelink* message received from this UE, is set to *true*, or of which SLSSID is 0 and SLSS is transmitted on slot(s) indicated by *sl-SSB-TimeAllocation3*, starting with the UE with the highest PSBCH-RSRP result (priority group 1);
 - 5> UEs of which SLSSID is 0 and SLSS is not transmitted on slot(s) indicated by *sl-SSB-TimeAllocation3*, and *inCoverage*, included in the *MasterInformationBlockSidelink* message received from this UE, is set to *false*, starting with the UE with the highest PSBCH-RSRP result (priority group 2);
 - 5> UEs of which SLSSID is 337 and *inCoverage*, included in the *MasterInformationBlockSidelink* message received from this UE, is set to *false*, starting with the UE with the highest PSBCH-RSRP result (priority group 2);
 - 5> the cell detected by the UE as defined in 5.8.6.3 (priority group 3);
 - 5> UEs of which SLSSID is part of the set defined for in coverage, and *inCoverage*, included in the *MasterInformationBlockSidelink* message received from this UE, is set to *true*, starting with the UE with the highest PSBCH-RSRP result (priority group 4);
 - 5> UE of which SLSSID is part of the set defined for in coverage, and *inCoverage*, included in the *MasterInformationBlockSidelink* message received from this UE, is set to *false*, starting with the UE with the highest PSBCH-RSRP result (priority group 5);
 - 5> Other UEs, starting with the UE with the highest S-RSRP result (priority group 6);

...

[TS 38.331, clause 5.8.9.4.3]

The UE shall set the contents of the *MasterInformationBlockSidelink* message as follows:

...

- 1> else if out of coverage on the frequency used for NR sidelink communication as defined in TS 38.304 [20]; and the concerned frequency is included in *sl-FreqInfoToAddModList* in *RRCReconfiguration* or in *sl-FreqInfoList* within *SIB12*:
 - 2> set *inCoverage* to *true*;
 - 2> set *reservedBits* to the value of the corresponding field included in the preconfigured sidelink parameters (i.e. *sl-PreconfigGeneral* in *SidelinkPreconfigNR* defined in 9.3);
 - 2> set *sl-TDD-Config* to the value representing the same meaning as that is included in the corresponding field included in the preconfigured sidelink parameters (i.e. *sl-PreconfigGeneral* in *SL-PreconfigurationNR* defined in 9.3) as described in TS 38.213, clause 16.1 [13];
- 1> else if out of coverage on the frequency used for NR sidelink communication as defined in TS 38.304 [20]; and the UE selects GNSS as the synchronization reference and *sl-SSB-TimeAllocation3* is not configured for the frequency used in *SidelinkPreconfigNR*:
 - 2> set *inCoverage* to *true*;
 - 2> set *reservedBits* to the value of the corresponding field included in the preconfigured sidelink parameters (i.e. *sl-PreconfigGeneral* in *SidelinkPreconfigNR* defined in 9.3);
 - 2> set *sl-TDD-Config* to the value representing the same meaning as that is included in the corresponding field included in the preconfigured sidelink parameters (i.e. *sl-PreconfigGeneral* in *SL-PreconfigurationNR* defined in 9.3) as described in TS 38.213, clause 16.1 [13];
- 1> else if the UE has a selected SyncRef UE (as defined in 5.8.6):

2> set *inCoverage* to *false*;

2> set *sl-TDD-Config* and *reservedBits* to the value of the corresponding field included in the received *MasterInformationBlockSidelink*;

1> else:

2> set *inCoverage* to *false*;

2> set *reservedBits* to the value of the corresponding field included in the preconfigured sidelink parameters (i.e. *sl-PreconfigGeneral* in *SidelinkPreconfigNR* defined in 9.3);

2> set *sl-TDD-Config* to the value representing the same meaning as that is included in the corresponding field included in the preconfigured sidelink parameters (i.e. *sl-PreconfigGeneral* in *SL-PreconfigurationNR* defined in 9.3) as described in TS 38.213, clause 16.1 [13];

1> set *directFrameNumber* and *slotIndex* according to the slot used to transmit the SLSS, as specified in 5.8.5.3;

1> submit the *MasterInformationBlockSidelink* to lower layers for transmission upon which the procedure ends;

[TS 38.331, clause 5.8.12]

When the UE selects GNSS as the synchronization reference source, the DFN, the subframe number within a frame and slot number within a frame used for NR sidelink communication are derived from the current UTC time, by the following formulae:

$$DFN = \text{Floor}(0.1 * (T_{current} - T_{ref} - \text{OffsetDFN})) \bmod 1024$$

$$\text{SubframeNumber} = \text{Floor}(T_{current} - T_{ref} - \text{OffsetDFN}) \bmod 10$$

$$\text{SlotNumber} = \text{Floor}((T_{current} - T_{ref} - \text{OffsetDFN}) * 2^\mu) \bmod (10 * 2^\mu)$$

Where:

T_{current} is the current UTC time obtained from GNSS. This value is expressed in milliseconds;

T_{ref} is the reference UTC time 00:00:00 on Gregorian calendar date 1 January, 1900 (midnight between Thursday, December 31, 1899 and Friday, January 1, 1900). This value is expressed in milliseconds;

OffsetDFN is the value *sl-OffsetDFN* if configured, otherwise it is zero. This value is expressed in milliseconds.

$\mu=0/1/2/3$ corresponding to the 15/30/60/120 kHz of SCS for SL, respectively.

NOTE 1: In case of leap second change event, how UE obtains the scheduled time of leap second change to adjust *T_{current}* correspondingly is left to UE implementation. How UE handles to avoid the sudden discontinuity of DFN is left to UE implementation.

NOTE 2: Void.

12.2.2.1.3 Test description

12.2.2.1.3.1 Pre-test conditions

System Simulator:

- NR Cell
 - NR Cell 1 is the serving cell.
 - System information combination NR-14 as defined in TS 38.508-1 [4] clause 4.4.3.1.2 is used in NR cell 1.
- NR-SS-UE
 - NR-SS-UE 1, 2, 3, 4 and 5 operating as NR sidelink communication device on the resources (i.e. the frequency included in pre-configuration) that UE is expected to use for transmission and reception via PC5 interface.

- NR-SS-UE 1 transmits S-SSB with SLSSID = 3, *inCoverage* = true in slots determined by *sl-SSB-TimeAllocation1* and NR Cell 1 timing.
- NR-SS-UE 2 transmits S-SSB with SLSSID = 4, *inCoverage* = false in slots determined by *sl-SSB-TimeAllocation2* and NR Cell 1 timing.
- NR-SS-UE 3 transmits S-SSB with SLSSID = 0, *inCoverage* = true in slots determined by *sl-SSB-TimeAllocation1* and GNSS timing.
- NR-SS-UE 4 transmits S-SSB with SLSSID = 0, *inCoverage* = false in slots determined by *sl-SSB-TimeAllocation2* and GNSS timing.
- NR-SS-UE 5 transmits S-SSB with SLSSID = 338, *inCoverage* = false in slots determined by *sl-SSB-TimeAllocation1* and NR Cell 1 timing.
- GNSS simulator
 - The GNSS simulator is started and configured for Scenario #1.

UE:

- UE is authorised to perform NR sidelink communication.
- The UE is equipped with below information in UE or in a USIM containing default values (as per TS 38.508-1 [4]) except for those listed in Table 12.2.2.1.3.1-1.

Table 12.2.2.1.3.1-1: UE/ USIM configuration

USIM field	Priority	Value	Access Technology Identifier
EF _{UST}		As per TS 36.508 [18] clause 4.9.3.4	
EF _{VST}		Service n°119 is "available"	
EF _{V2XP_PC5}		As per TS 38.508-1[4] clause 4.8.3.3.3 SL-PreconfigurationNR included in V2X data policy over PC5 is defined in Table 12.2.2.1.3.3-1	

Preamble:

- The UE is in state 3N-B as defined in TS 38.508-1 [4], subclause 4.4A, using generic procedure parameter Sidelink (On), GNSS Sync (On) and Test Mode (On) as defined in TS 38.508-1 [4], subclause 4.5.1.

12.2.2.1.3.2 Test procedure sequence

Table 12.2.2.1.3.2-1 illustrates the sidelink power levels to be applied for NR-SS-UE 1, 2, 3, 4 and 5 at various time instants of the test execution. Row marked "T0" denotes the conditions after the preamble, while the configuration marked "T1" to "T7", are applied at the point indicated in the Main behaviour description in Table 12.2.2.1.3.2-2.

Table 12.2.2.1.3.2-1: Time instances of NR-SS-UE power level and parameter changes in conducted test environment

	Parameter	Unit	NR-SS-UE 1	NR-SS-UE 2	NR-SS-UE 3	NR-SS-UE 4	NR-SS-UE 5	Remark
T0	NR-SS-UE power	dBm/SCS	OFF	OFF	-85	OFF	OFF	Priority of NR-SS-UE 3 is lower than GNSS
	EPRE ratio of S-SSS to NR-SS-UE power	dB	-	-	0	-	-	
T1	NR-SS-UE power	dBm/SCS	OFF	OFF	-85	-85	OFF	Priority of NR-SS-UE 4 is lower than priority of NR-SS-UE
	EPRE ratio	dB	-	-	0	0	-	

	of S-SSS to NR-SS-UE power							3
T2	NR-SS-UE power	dBm/SCS	OFF	OFF	OFF	-85	OFF	Priority of NR Cell is lower than priority of NR-SS-UE 3 when GNSS has the highest priority
	EPRE ratio of S-SSS to NR-SS-UE power	dB	-	-	-	0	-	
T3	NR-SS-UE power	dBm/SCS	-85	OFF	OFF	OFF	OFF	Priority of NR-SS-UE 1 is lower than NR Cell.
	EPRE ratio of S-SSS to NR-SS-UE power	dB	0	-	-	-	-	
T4	NR-SS-UE power	dBm/SCS	-85	-85	OFF	OFF	OFF	Priority of NR-SS-UE 2 is lower than priority of NR-SS-UE 1
	EPRE ratio of S-SSS to NR-SS-UE power	dB	0	0	-	-	-	
T5	NR-SS-UE power	dBm/SCS	OFF	-85	OFF	OFF	OFF	Priority of GNSS is lower than priority of NR-SS-UE 2 when gNB has the highest priority
	EPRE ratio of S-SSS to NR-SS-UE power	dB	-	0	-	-	-	
T6	NR-SS-UE power	dBm/SCS	OFF	OFF	OFF	-85	-85	Priority of NR-SS-UE 5 is lower than priority of NR-SS-UE 4
	EPRE ratio of S-SSS to NR-SS-UE power	dB	-	-	-	0	0	
T7	NR-SS-UE power	dBm/SCS	OFF	OFF	OFF	OFF	-85	Priority of UE internal clock is lower than NR-SS-UE 5
	EPRE ratio of S-SSS to NR-SS-UE power	dB	-	-	-	-	0	

Table 12.2.2.1.3.2-2: Main behaviour

St	Procedure	Message Sequence		TP	Verdict
		U - S	Message		
1	The SS transmits an RRCReconfiguration message to configure sl-SyncPriority = gnss	<--	NR RRC: <i>RRCReconfiguration</i>	-	-
2	The UE transmits an RRCReconfigurationComplete message	-->	NR RRC: <i>RRCReconfigurationComplete</i>	-	-
3	The SS transmits a CLOSE UE TEST LOOP message to close UE test loop mode E (Transmit Mode).	<--	NR RRC: <i>DLInformationTransfer</i> TC: CLOSE UE TEST LOOP	-	-
4	The UE transmits a CLOSE UE TEST LOOP COMPLETE message	-->	NR RRC: <i>ULInformationTransfer</i> TC: CLOSE UE TEST LOOP COMPLETE	-	-
5	The SS waits 10 seconds	-	-	-	-
6	Check: Does the UE transmit S-SSBs which satisfy all following conditions? - SLSSID = 0; - incoverage = true in SL-MIB; - slotIndex and directFrameNumber in SL-MIB are consistent with the slot index and DFN calculated based on the UTC time obtained from GNSS as specified in TS 38.331 [22] clause 5.8.12; - transmitted in slots determined by sl-SSB-	-	-	1	P

	TimeAllocation1 and GNSS timing; - reserveBits in SL-MIB is consistent with reserveBits in pre-configuration.				
7	The SS powers off GNSS simulator.	-	-	-	-
8	The SS re-adjusts the NR-SS-UE power level according to row "T1" in table 12.2.2.1.3.2-1.	-	-	-	-
9	The SS waits 10 seconds	-	-	-	-
10	Check: Does the UE transmit S-SSBs which satisfy all following conditions? - SLSSID = 0; - incoverage = false in SL-MIB; - slotIndex and directFrameNumber in SL-MIB are consistent with the slot index and DFN of NR-SS-UE 3; - transmitted in slots determined by sl-SSB-TimeAllocation2 and the NR-SS-UE 3 timing; - reserveBits in SL-MIB is consistent with reserveBits in SL-MIB of NR-SS-UE 3.	-	-	2	P
11	The SS re-adjusts the NR-SS-UE power level according to row "T2" in table 12.2.2.1.3.2-1.	-	-	-	-
12	The SS waits 10 seconds	-	-	-	-
13	Check: Does the UE transmit S-SSBs which satisfy all following conditions? - SLSSID = 336; - incoverage = false in SL-MIB; - slotIndex and directFrameNumber in SL-MIB are consistent with the slot index and DFN of NR-SS-UE 4. - transmitted in slots determined by sl-SSB-TimeAllocation1 and the NR-SS-UE 4 timing? - reserveBits in SL-MIB is consistent with reserveBits in SL-MIB of NR-SS-UE 4.	-	-	3	P
14	The SS transmits an RRCReconfiguration message to configure sl-SyncPriority = gnbEnb	<--	NR RRC: <i>RRCReconfiguration</i>	-	-
15	The UE transmits an RRCReconfigurationComplete message.	-->	NR RRC: <i>RRCReconfigurationComplete</i>	-	-
16	The SS re-adjusts the NR-SS-UE power level according to row "T3" in table 12.2.2.1.3.2-1.	-	-	-	-
17	The SS waits 10 seconds	-	-	-	-
18	Check: Does the UE transmit S-SSBs which satisfy all following conditions? - SLSSID is consistent with SLSSID in sl-ConfigDedicatedNR; - incoverage = true in SL-MIB; - slotIndex and directFrameNumber in SL-MIB are consistent with the slot index and SFN of NR Cell 1. - transmitted in slots determined by sl-SSB-TimeAllocation1 and the NR Cell 1 timing? - reserveBits in SL-MIB is consistent with reserveBits in pre-configuration.	-	-	4	P
19	The SS powers off NR Cell 1.	-	-	-	-
20	The SS re-adjusts the NR-SS-UE power level according to row "T4" in table 12.2.2.1.3.2-1.	-	-	-	-
21	The SS waits 10 seconds	-	-	-	-
22	Check: Does the UE transmit S-SSBs which satisfy all following conditions? - SLSSID is consistent with SLSSID of NR-SS-UE 1;	-	-	5	P

	<ul style="list-style-type: none"> - incoverage = false in SL-MIB; - slotIndex and directFrameNumber in SL-MIB are consistent with the slot index and DFN of SyncRef UE 1; - transmitted in slots determined by sl-SSB-TimeAllocation2 and SyncRef UE 1 timing; - reserveBits in SL-MIB is consistent with reserveBits in SL-MIB of SyncRef UE 1. 				
23	The SS powers on GNSS simulator.	-	-	-	-
24	The SS re-adjusts the NR-SS-UE power level according to row "T5" in table 12.2.2.1.3.2-1.	-	-	-	-
25	The SS waits 10 seconds	-	-	-	-
26	<p>Check: Does the UE transmit S-SSBs which satisfy all following conditions?</p> <ul style="list-style-type: none"> - SLSSID equals to SLSSID of NR-SS-UE 2 plus 336; - incoverage = false in SL-MIB; - slotIndex and directFrameNumber in SL-MIB are consistent with the slot index and DFN of SyncRef UE 2; - transmitted in slots determined by sl-SSB-TimeAllocation1 and SyncRef UE 2 timing; - reserveBits in SL-MIB is consistent with reserveBits in SL-MIB of SyncRef UE 2. 	-	-	6	P
27	The SS re-adjusts the NR-SS-UE power level according to row "T0" in table 12.2.2.1.3.2-1.	-	-	-	-
28	The SS waits 10 seconds	-	-	-	-
29	<p>Check: Does the UE transmit S-SSBs which satisfy all following conditions?</p> <ul style="list-style-type: none"> - SLSSID = 0; - incoverage = true in SL-MIB; - slotIndex and directFrameNumber in SL-MIB are consistent with the slot index and DFN calculated based on the UTC time obtained from GNSS as specified in TS 38.331 [22] clause 5.8.12; - transmitted in slots determined by sl-SSB-TimeAllocation1 and GNSS timing; - reserveBits in SL-MIB is consistent with reserveBits in pre-configuration. 	-	-	7	P
30	The SS powers off GNSS simulator.	-	-	-	-
31	The SS re-adjusts the NR-SS-UE power level according to row "T1" in table 12.2.2.1.3.2-1.	-	-	-	-
32	The SS waits 10 seconds	-	-	-	-
33	<p>Check: Does the UE transmit S-SSBs which satisfy all following conditions?</p> <ul style="list-style-type: none"> - SLSSID = 0; - incoverage = false in SL-MIB; - slotIndex and directFrameNumber in SL-MIB are consistent with the slot index and DFN of SyncRef UE 3; - transmitted in slots determined by sl-SSB-TimeAllocation2 and SyncRef UE 3 timing; - reserveBits in SL-MIB is consistent with reserveBits in SL-MIB of SyncRef UE 3. 	-	-	8	P
34	The SS re-adjusts the NR-SS-UE power level according to row "T6" in table 12.2.2.1.3.2-1.	-	-	-	-
35	The SS waits 10 seconds	-	-	-	-
36	Check: Does the UE transmit S-SSBs which	-	-	9	P

	satisfy all following conditions? - SLSSID = 336; - incoverage = false in SL-MIB; - slotIndex and directFrameNumber in SL-MIB are consistent with the slot index and DFN of SyncRef UE 4; - transmitted in slots determined by sl-SSB-TimeAllocation1 and SyncRef UE 4 timing; - reserveBits in SL-MIB is consistent with reserveBits in SL-MIB of SyncRef UE 4.				
37	The SS re-adjusts the NR-SS-UE power level according to row "T7" in table 12.2.2.1.3.2-1.	-	-	-	-
38	The SS waits 10 seconds	-	-	-	-
39	Check: Does the UE transmit S-SSBs which satisfy all following conditions? - SLSSID is consistent with SLSSID of NR-SS-UE 5; - incoverage = false in SL-MIB; - slotIndex and directFrameNumber in SL-MIB are consistent with the slot index and DFN of SyncRef UE 5; - transmitted in slots determined by sl-SSB-TimeAllocation2 and SyncRef UE 5 timing; - reserveBits in SL-MIB is consistent with reserveBits in SL-MIB of SyncRef UE 5.	-	-	10	P
40	The SS transmits an OPEN UE TEST LOOP message to open UE test loop mode E.	<--	NR RRC: <i>DLInformationTransfer</i> TC: OPEN UE TEST LOOP	-	-
41	The UE transmits an OPEN UE TEST LOOP COMPLETE message	-->	NR RRC: <i>ULInformationTransfer</i> TC: OPEN UE TEST LOOP COMPLETE	-	-

12.2.2.1.3.3 Specific message contents

Table 12.2.2.1.3.3-1: V2X service identifier to default mode of communication mapping rule (Pre-configuration, UE under test)

Derivation Path: TS 38.508-1 [4] Table 4.7.5.5-53			
Information Element	Value/remark	Comment	Condition
DMC	'10'B	Default mode of communication is set to broadcast	

Table 12.2.2.1.3.3-2: SL-SyncConfig (Pre-configuration, UE under test)

Derivation Path: TS 38.508-1 [4], Table 4.6.6-31			
Information Element	Value/remark	Comment	Condition
SL-SyncConfig-r16 ::= SEQUENCE {			
sl-SSID-r16	Not present		
txParameters-r16 SEQUENCE {			
syncTxThreshOoC-r16	13	actual threshold is +infinity	
}			
}			

Table 12.2.2.1.3.3-3: RRCReconfiguration (Table 12.2.2.1.3.2-2, Step 1 and 14)

Derivation Path: TS 38.508-1 [4], Table 4.6.1-13 with condition SIDELINK			
Information Element	Value/remark	Comment	Condition

RRCReconfiguration ::= SEQUENCE {			
criticalExtensions CHOICE {			
rrcReconfiguration SEQUENCE {			
nonCriticalExtension SEQUENCE {			
nonCriticalExtension SEQUENCE {			
nonCriticalExtension SEQUENCE {			
nonCriticalExtension SEQUENCE {			
sl-ConfigDedicatedNR-r16 CHOICE {			
setup	SL-ConfigDedicatedNR-r16	Table 12.2.2.1.3.3-4	
}			
}			
}			
}			
}			
}			
}			
}			
}			

Table 12.2.2.1.3.3-4: SL-ConfigDedicatedNR (Table 12.2.2.1.3.3-3)

Derivation Path: TS 38.508-1 [4], Table 4.6.6-7 with condition SELECTED			
Information Element	Value/remark	Comment	Condition
SL-ConfigDedicatedNR-r16 ::= SEQUENCE {			
sl-PHY-MAC-RLC-Config-r16 SEQUENCE {			
sl-FreqInfoToAddModList-r16 SEQUENCE (SIZE (1..maxNrofFreqSL-r16)) OF SL-FreqConfig-r16 {	1 entry		
SL-FreqConfig-r16[1] SEQUENCE {	SL-FreqConfig-r16	entry 1	
sl-SyncConfigList-r16 SEQUENCE (SIZE (1..maxSL-SyncConfig-r16)) OF SL-SyncConfig-r16 {	1 entry		
SL-SyncConfig-r16[1] SEQUENCE {		entry 1	
sl-SSID-r16	2		
}			
sl-SyncPriority-r16	gnss gnbEnb		Step 1 Step 14
}			
networkControlledSyncTx-r16	on		
}			
}			

Table 12.2.2.1.3.3-5: CLOSE UE TEST LOOP (Table 12.2.2.1.3.2-2, Step 3)

Derivation Path: 36.508 [7] Table 4.7A-3 with condition UE TEST LOOP MODE E(V2X Transmission)			
Information Element	Value/remark	Comment	Condition
UE test loop mode E LB setup			
Communication Transmit or Receive	0 0 0 0 0 0 1	'01' indicates V2X UE triggered to transmit NR sidelink communication with single spatial layer.	

Table 12.2.2.1.3.3-6: MasterInformationBlockSidelink (SyncRef UE 1, 2, 3, 4 and 5)

Derivation Path: TS 38.508-1 [4], Table 4.6.1A-1			
Information Element	Value/remark	Comment	Condition
MasterInformationBlockSidelink ::= SEQUENCE {			
inCoverage-r16	true false		SyncRef UE 1, 3 SyncRef UE 2, 4, 5
directFrameNumber-r16	DFN determined based on the		SyncRef UE 3, 4

	formula given in 38.331 [22] clause 5.8.12.		
	SFN of NR Cell 1		SyncRef UE 1, 2, 5
slotIndex-r16	slot index determined based on the formula given in 38.331 [22] clause 5.8.12.		SyncRef UE 3, 4
	slot index of NR Cell 1		SyncRef UE 1, 2, 5
reservedBits-r16	01		SyncRef UE 1, 3
	10		SyncRef UE 2, 4
	11		SyncRef UE 5
}			

Table 12.2.2.1.3.3-7: MasterInformationBlockSidelink (Table 12.2.2.1.3.2-2, step 6, 10, 13, 18, 22, 26, 29, 33, 36 and 39 UE under test)

Derivation Path: TS 38.508-1 [4], Table 4.6.1A-1 with condition TX			
Information Element	Value/remark	Comment	Condition
MasterInformationBlockSidelink ::= SEQUENCE {			
inCoverage-r16	true		Step 6, 18, 29
	false		Step 10, 13, 22, 26, 33, 36, 39
directFrameNumber-r16	DFN determined based on the formula given in 38.331 [22] clause 5.8.12		Step 6, 10, 13, 29, 33, 36,
	SFN of NR Cell 1		Step 18, 22, 26, 39
slotIndex-r16	slot index determined based on the formula given in 38.331 [22] clause 5.8.12		Step 6, 10, 13, 29, 33, 36,
	Slot index of NR Cell 1		Step 18, 22, 26, 39
reservedBits-r16	00	Same as pre-configuration	Step 6, 18, 29
	01	Same as SyncRef UE 1	Step 10, 22, 33
	10	Same as SyncRef UE 2	Step 13, 26, 36
	11	Same as SyncRef UE 3	Step 39
}			

12.2.2.2 Inter-carrier concurrent operation / Sidelink synchronization related procedure / SL-SSB transmission Initiation and Cease

12.2.2.2.1 Test Purpose (TP)

(1)

```

with { UE is on connected state. UE is configured by upper layer to perform sidelink transmission and is configured with sl-SyncPriority = gnbEnb, syncTxThreshIC but no networkControlledSyncTx. }
ensure that {
  when { SS-RSRP of serving cell is higher than syncTxThreshIC. }
  then { UE doesn't transmit S-SSB. }
}
    
```

(2)

```

with { UE is on connected state. UE is configured by upper layer to perform sidelink transmission
and is configured with sl-SyncPriority = gnbEnb, syncTxThreshIC but no networkControlledSyncTx. }
ensure that {
  when { SS-RSRP of serving cell is lower than syncTxThreshIC. }
  then { UE starts transmitting S-SSB. }
}

```

(3)

```

with { UE is on connected state. UE is configured by upper layer to perform sidelink transmission
and is configured with sl-SyncPriority = gnbEnb. }
ensure that {
  when { UE receives an RRCReconfiguration message with networkControlledSyncTx = off. }
  then { UE doesn't transmit S-SSB. }
}

```

(4)

```

with { UE is on connected state. UE is configured by upper layer to perform sidelink transmission
and is configured with sl-SyncPriority = gnbEnb. }
ensure that {
  when { UE receives an RRCReconfiguration message with networkControlledSyncTx = on. }
  then { UE starts transmitting S-SSB. }
}

```

(5)

```

with { UE is on connected state. UE is configured by upper layer to perform sidelink transmission
and is configured with sl-SyncPriority = gnss. syncTxThreshOoC is configured in pre-configuration. }
ensure that {
  when { UE selects a SyncRef UE as synchronization reference source. PSBCH-RSRP of the SyncRef UE
is higher than syncTxThreshOoC. }
  then { UE doesn't transmit S-SSB. }
}

```

(6)

```

with { UE is on connected state. UE is configured by upper layer to perform sidelink transmission
and is configured with sl-SyncPriority = gnss. syncTxThreshOoC is configured in pre-configuration. }
ensure that {
  when { UE selects a SyncRef UE as synchronization reference source. PSBCH-RSRP of the SyncRef UE
is lower than syncTxThreshOoC. }
  then { UE starts transmitting S-SSB. }
}

```

12.2.2.2.2 Conformance requirements

References: The conformance requirements covered in the present TC are specified in: TS 38.331 [22], subclause 5.8.2. Unless otherwise stated these are Rel-16 requirements.

[TS 38.331, clause 5.8.2]

The UE shall perform NR sidelink communication operation only if the conditions defined in this clause are met:

- 1> if the UE's serving cell is suitable (RRC_IDLE or RRC_INACTIVE or RRC_CONNECTED); and if either the selected cell on the frequency used for NR sidelink communication operation belongs to the registered or equivalent PLMN as specified in TS 24.587 [57] or the UE is out of coverage on the frequency used for NR sidelink communication operation as defined in TS 38.304 [20] and TS 36.304 [27]; or

...

- 1> if the UE has no serving cell (RRC_IDLE);

[TS 38.331, clause 5.8.5.1]

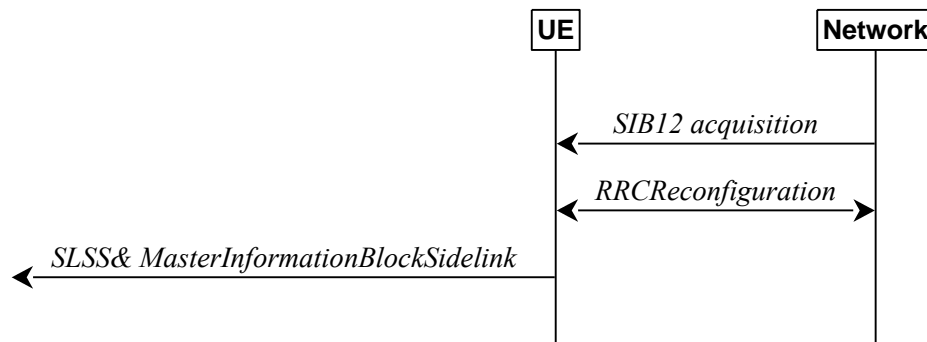

Figure 5.8.5.1-1: Synchronisation information transmission for NR sidelink communication, in (partial) coverage

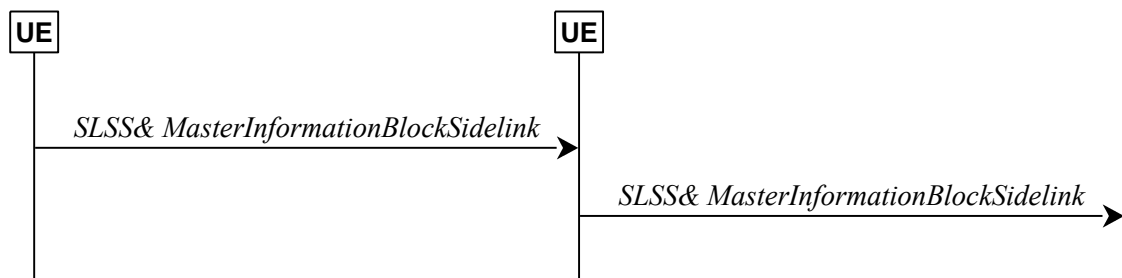

Figure 5.8.5.1-2: Synchronisation information transmission for NR sidelink communication, out of coverage

The purpose of this procedure is to provide synchronisation information to a UE.

[TS 38.331, clause 5.8.5.2]

A UE capable of NR sidelink communication and SLSS/PSBCH transmission shall, when transmitting NR sidelink communication, and if the conditions for NR sidelink communication operation are met and when the following conditions are met:

...

- 1> if out of coverage on the frequency used for NR sidelink communication, and the frequency used to transmit NR sidelink communication is included in *sl-FreqInfoToAddModList* in *sl-ConfigDedicatedNR* within *RRCReconfiguration* message or included in *sl-FreqInfoList* within *SIB12*; and has selected GNSS or the cell as synchronization reference as defined in 5.8.6.3:
 - 2> if in *RRC_CONNECTED*; and if *networkControlledSyncTx* is configured and set to *on*; or
 - 2> if *networkControlledSyncTx* is not configured; and for the concerned frequency *syncTxThreshIC* is configured; and the RSRP measurement of the reference cell, selected as defined in 5.8.6.3, for NR sidelink communication transmission is below the value of *syncTxThreshIC*:
 - 3> transmit sidelink SSB on the frequency used for NR sidelink communication in accordance with 5.8.5.3 and TS 38.211 [16], including the transmission of SLSS as specified in 5.8.5.3 and transmission of *MasterInformationBlockSidelink* as specified in 5.8.9.4.3;
- 1> else:
 - 2> for the frequency used for NR sidelink communication, if *syncTxThreshOoC* is included in *SidelinkPreconfigNR*; and the UE is not directly synchronized to GNSS, and the UE has no selected SyncRef UE or the PSBCH-RSRP measurement result of the selected SyncRef UE is below the value of *syncTxThreshOoC*; or

...

3> transmit sidelink SSB on the frequency used for NR sidelink communication in accordance with TS 38.211 [16] , including the transmission of SLSS as specified in 5.8.5.3 and transmission of *MasterInformationBlockSidelink* as specified in 5.8.9.4.3;

12.2.2.2.3 Test description

12.2.2.2.3.1 Pre-test conditions

System Simulator:

- NR Cell
- NR Cell 1 is the serving cell.
- System information combination NR-14 as defined in TS 38.508-1 [4] clause 4.4.3.1.2 is used in NR cell 1.
- NR-SS-UE
- NR-SS-UE 1 operating as NR sidelink communication device on the resources (i.e. the frequency included in pre-configuration) that UE is expected to use for transmission and reception via PC5 interface.
- NR-SS-UE 1 transmits S-SSB with SLSSID = 0, *inCoverage* = true in slots determined by *sl-SSB-TimeAllocation1* and NR Cell 1 timing.

UE:

- UE is authorised to perform NR sidelink communication.
- The UE is equipped with below information in UE or in a USIM containing default values (as per TS 38.508-1 [4]) except for those listed in Table 12.2.2.2.3.1-1.

Table 12.2.2.2.3.1-1: UE/ USIM configuration

USIM field	Priority	Value	Access Technology Identifier
EF _{UST}		As per TS 36.508 [18] clause 4.9.3.4	
EF _{VST}		Service n°119 is "available"	
EF _{V2XP_PC5}		As per TS 38.508-1[4] clause 4.8.3.3.3 SL-PreconfigurationNR included in V2X data policy over PC5 is defined in Table 12.2.2.2.3.3-1	

Preamble:

- The UE is in state 3N-B as defined in TS 38.508-1 [4], subclause 4.4A, using generic procedure parameter Sidelink (On) and Test Mode (On) as defined in TS 38.508-1 [4], subclause 4.5.1.

12.2.2.2.3.2 Test procedure sequence

Table 12.2.2.2.3.2-1 illustrates the sidelink power levels to be applied for NR-SS-UE 1, 2, 3, 4 and 5 at various time instants of the test execution. Row marked "T0" denotes the conditions after the preamble, while the configuration marked "T1" to "T7", are applied at the point indicated in the Main behaviour description in Table 12.2.2.2.3.2-2.

Table 12.2.2.2.3.2-1: Time instances of NR-SS-UE and NR Cell power level and parameter changes in conducted test environment

	Parameter	Unit	NR Cell 1	NR-SS-UE 1	Remark
T0	SS/PBCH SSS EPRE	dBm/ SCS	-84	-	The power level to ensure SS-RSRP of NR Cell 1 is higher than syncTxThreshIC
	NR-SS-UE power	dBm/	-	-94	

		SCS			and PSBCH-RSRP of NR-SS-UE 1 is higher than syncTxThreshOoC
	EPRE ratio of S-SSS to NR-SS-UE power	dB	-	0	
T1	SS/PBCH SSS EPRE	dBm/SCS	-96	-	The power level to ensure SS-RSRP of NR Cell 1 is lower than syncTxThreshIC and PSBCH-RSRP of NR-SS-UE 1 is lower than syncTxThreshOoC
	NR-SS-UE power	dBm/SCS	-	-106	
	EPRE ratio of S-SSS to NR-SS-UE power	dB	-	0	

Table 12.2.2.3.2-2: Main behaviour

St	Procedure	Message Sequence		TP	Verdict
		U - S	Message		
1	The SS transmits an RRCReconfiguration message to configure sl-SyncPriority = gnbEnb and syncTxThreshIC	<--	NR RRC: <i>RRCReconfiguration</i>	-	-
2	The UE transmits an RRCReconfigurationComplete message	-->	NR RRC: <i>RRCReconfigurationComplete</i>	-	-
3	The SS transmits a CLOSE UE TEST LOOP message to close UE test loop mode E (Transmit Mode).	<--	NR RRC: <i>DLInformationTransfer</i> TC: CLOSE UE TEST LOOP	-	-
4	The UE transmits a CLOSE UE TEST LOOP COMPLETE message	-->	NR RRC: <i>ULInformationTransfer</i> TC: CLOSE UE TEST LOOP COMPLETE	-	-
5	The SS waits 1 seconds.	-	-	-	-
6	Check: Does the UE transmit any S-SSBs?	-	-	1	F
7	The SS re-adjusts the NR-SS-UE power level according to row "T1" in table 12.2.2.3.2-1.	-	-	-	-
8	The SS waits 1 seconds	-	-	-	-
9	Check: Does the UE transmit S-SSBs in slots determined by sl-SSB-TimeAllocation1 and NR Cell 1 timing?	-	-	2	P
10	The SS transmits an RRCReconfiguration message to configure networkControlledSyncTx = off	<--	NR RRC: <i>RRCReconfiguration</i>	-	-
11	The UE transmits an RRCReconfigurationComplete message	-->	NR RRC: <i>RRCReconfigurationComplete</i>	-	-
12	The SS waits 1 seconds.	-	-	-	-
13	Check: Does the UE transmit any S-SSBs?	-	-	3	F
14	The SS transmits an RRCReconfiguration message to configure networkControlledSyncTx = on	<--	NR RRC: <i>RRCReconfiguration</i>	-	-
15	The UE transmits an RRCReconfigurationComplete message	-->	NR RRC: <i>RRCReconfigurationComplete</i>	-	-
16	The SS waits 1 seconds.	-	-	-	-
17	Check: Does the UE transmit S-SSBs in slots determined by sl-SSB-TimeAllocation1 and NR Cell 1 timing?	-	-	4	P
18	The SS re-adjusts the NR Cell 1 and NR-SS-UE 1 power level according to row "T0" in table 12.2.2.3.2-1.	-	-	-	-
19	The SS transmits an RRCReconfiguration message to configure sl-SyncPriority = gnss	<--	NR RRC: <i>RRCReconfiguration</i>	-	-
20	The UE transmits an RRCReconfigurationComplete message	-->	NR RRC: <i>RRCReconfigurationComplete</i>	-	-
21	The SS waits 10 seconds	-	-	-	-
22	Check: Does the UE transmit any S-SSBs?	-	-	5	F
23	The SS re-adjusts the NR Cell 1 and NR-SS-UE 1 power level according to row "T1" in table 12.2.2.3.2-1.	-	-	-	-
24	The SS waits 2 seconds	-	-	-	-
25	Check: Does the UE transmit S-SSBs in slots determined by sl-SSB-TimeAllocation2 and NR-SS-UE 1 timing?	-	-	6	P
26	The SS transmits an OPEN UE TEST LOOP	<--	NR RRC: <i>DLInformationTransfer</i>	-	-

	message to open UE test loop mode E.		TC: OPEN UE TEST LOOP		
27	The UE transmits an OPEN UE TEST LOOP COMPLETE message	-->	NR RRC: <i>ULInformationTransfer</i> TC: OPEN UE TEST LOOP COMPLETE	-	-

12.2.2.2.3.3 Specific message contents

Table 12.2.2.2.3.3-1: V2X service identifier to default mode of communication mapping rule (Pre-configuration, UE under test)

Derivation Path: TS 38.508-1 [4] Table 4.7.5.5-53			
Information Element	Value/remark	Comment	Condition
DMC	'10'B	Default mode of communication is set to broadcast	

Table 12.2.2.2.3.3-2: RRCReconfiguraion (Table 12.2.2.2.3.2-2, Step 1, 10, 14 and 19)

Derivation Path: TS 38.508-1 [4], Table 4.6.1-13 with condition SIDELINK			
Information Element	Value/remark	Comment	Condition
RRCReconfiguration ::= SEQUENCE {			
criticalExtensions CHOICE {			
rrcReconfiguration SEQUENCE {			
nonCriticalExtension SEQUENCE {			
nonCriticalExtension SEQUENCE {			
nonCriticalExtension SEQUENCE {			
nonCriticalExtension SEQUENCE {			
sl-ConfigDedicatedNR-r16 CHOICE {			
setup	SL-ConfigDedicatedNR-r16	Table 12.2.2.2.3.3-3	
}			
}			
}			
}			
}			
}			
}			
}			
}			

Table 12.2.2.2.3.3-3: SL-ConfigDedicatedNR (Table 12.2.2.2.3.3-3)

Derivation Path: TS 38.508-1 [4], Table 4.6.6-7 with condition SELECTED			
Information Element	Value/remark	Comment	Condition
SL-ConfigDedicatedNR-r16 ::= SEQUENCE {			
sl-PHY-MAC-RLC-Config-r16 SEQUENCE {			
sl-FreqInfoToAddModList-r16 SEQUENCE (SIZE (1..maxNrofFreqSL-r16)) OF SL-FreqConfig-r16 {	1 entry		
SL-FreqConfig-r16[1] SEQUENCE {		entry 1	
sl-SyncConfigList-r16 SEQUENCE (SIZE (1..maxSL-SyncConfig-r16)) OF SL-SyncConfig-r16 {	1 entry		
SL-SyncConfig-r16[1] SEQUENCE {		entry 1	
txParameters-r16 SEQUENCE {			
syncTxThreshIC-r16	6	Actual value is -120+6*5 = -90 dBm	Step 1
	Not present		Step 10, 14, 19
}			
}			
}			
sl-SyncPriority-r16	gnbEnb gnss		Step 1, 10, 14 Step 19
}			
}			

networkControlledSyncTx-r16	Not present		Step 1, 19
	off		Step 10
	on		Step 14
}			
}			

Table 12.2.2.2.3.3-4: CLOSE UE TEST LOOP (Table 12.2.2.2.3.2-2, Step 3)

Derivation Path: 36.508 [7] Table 4.7A-3 with condition UE TEST LOOP MODE E(V2X Transmission)			
Information Element	Value/remark	Comment	Condition
UE test loop mode E LB setup			
Communication Transmit or Receive	0 0 0 0 0 0 1	'01' indicates V2X UE triggered to transmit NR sidelink communication with single spatial layer.	

Table 12.2.2.2.3.3-5: MasterInformationBlockSidelink (SyncRef UE 1)

Derivation Path: TS 38.508-1 [4], Table 4.6.1A-1			
Information Element	Value/remark	Comment	Condition
MasterInformationBlockSidelink ::= SEQUENCE {			
inCoverage-r16	true		
directFrameNumber-r16	SFN of NR Cell 1		
slotIndex-r16	slot index of NR Cell 1		
}			

Table 12.2.2.2.3.3-6: MasterInformationBlockSidelink (Table 12.2.2.2.3.2-2, step 9, 17 and 25, UE under test)

Derivation Path: TS 38.508-1 [4], Table 4.6.1A-1 with condition TX			
Information Element	Value/remark	Comment	Condition
MasterInformationBlockSidelink ::= SEQUENCE {			
inCoverage-r16	true		Step 9, 17
	false		Step 25
directFrameNumber-r16	SFN of NR Cell 1		
slotIndex-r16	slot index of NR Cell 1		
}			

12.2.3 Inter-carrier concurrent operation / Measurement configuration and reporting via Uu RRC

12.2.3.1 Inter-carrier concurrent operation / Measurement configuration and reporting via Uu RRC / CBR measurement reporting / Event C1 and C2

12.2.3.1.1 Test Purpose (TP)

(1)

```

with { UE is in NR RRC_CONNECTED state and is configured to perform event C1 triggered CBR
measurement reporting on resource pool }
ensure that {
  when { CBR measurement result of indicated resource pool satisfies entering condition for event C1
}
  then { UE sends MeasurementReport message to report CBR measurement results of indicated
resource pool }
}

```

(2)

```

with { UE is in NR RRC_CONNECTED state and the periodical measurement reporting triggered by event
C1 is ongoing }
ensure that {
  when { CBR measurement result of indicated resource pool satisfies leaving condition for event C1
}
  then { UE stops sending MeasurementReport message }
}

```

(3)

```

with { UE is in NR RRC_CONNECTED state and is configured to perform event C2 triggered CBR
measurement reporting on resource pool }
ensure that {
  when { CBR measurement result of indicated resource pool satisfies entering condition for event C1
}
  then { UE sends MeasurementReport message to report CBR measurement results of indicated
resource pool }
}

```

(4)

```

with { UE is in NR RRC_CONNECTED state and the periodical measurement reporting triggered by event
C2 is ongoing }
ensure that {
  when { CBR measurement result of indicated resource pool satisfies leaving condition for event C2
}
  then { UE stops sending MeasurementReport message }
}

```

12.2.3.1.2 Conformance requirements

References: The conformance requirements covered in the current TC are specified in: TS 38.331, clause 5.3.5.3, 5.5.2, 5.5.4.1, 5.5.4.2, 5.5.4.3 and 5.5.5. Unless otherwise stated these are Rel-16 requirements.

[TS 38.331, clause 5.3.5.3]

The UE shall perform the following actions upon reception of the *RRCReconfiguration*, or upon execution of the conditional reconfiguration (CHO or CPC):

...

1> if the *RRCReconfiguration* message includes the *measConfig*:

2> perform the measurement configuration procedure as specified in 5.5.2;

...

1> else (*RRCReconfiguration* was received via SRB1):

2> submit the *RRCReconfigurationComplete* message via SRB1 to lower layers for transmission using the new configuration;

...

[TS 38.331, clause 5.5.2.1]

...

The UE shall:

...

1> if the received *measConfig* includes the *measObjectToAddModList*:

2> perform the measurement object addition/modification procedure as specified in 5.5.2.5;

...

- 1> if the received *measConfig* includes the *reportConfigToAddModList*:
 - 2> perform the reporting configuration addition/modification procedure as specified in 5.5.2.7;
- 1> if the received *measConfig* includes the *quantityConfig*:
 - 2> perform the quantity configuration procedure as specified in 5.5.2.8;
- ...
- 1> if the received *measConfig* includes the *measIdToAddModList*:
 - 2> perform the measurement identity addition/modification procedure as specified in 5.5.2.3;
- ...

[TS 38.331, clause 5.5.3.1]

The UE shall:

- 1> whenever the UE has a *measConfig*, perform RSRP and RSRQ measurements for each serving cell for which *servingCellMO* is configured as follows:
 - 2> if the *reportConfig* associated with at least one *measId* included in the *measIdList* within *VarMeasConfig* contains an *rsType* set to *ssb* and *ssb-ConfigMobility* is configured in the *measObject* indicated by the *servingCellMO*:
 - 3> if the *reportConfig* associated with at least one *measId* included in the *measIdList* within *VarMeasConfig* contains a *reportQuantityRS-Indexes* and *maxNrofRS-IndexesToReport* and contains an *rsType* set to *ssb*:
 - 4> derive layer 3 filtered RSRP and RSRQ per beam for the serving cell based on SS/PBCH block, as described in 5.5.3.3a;
 - 3> derive serving cell measurement results based on SS/PBCH block, as described in 5.5.3.3;
 - ...

The UE capable of CBR measurement when configured to transmit NR sidelink communication shall:

- 1> If the frequency used for NR sidelink communication is included in *sl-FreqInfoToAddModList* in *sl-ConfigDedicatedNR* within *RRCReconfiguration* message or included in *sl-ConfigCommonNR* within *SIB12*:
 - ...
 - 2> if the UE is in RRC_CONNECTED:
 - 3> if *tx-PoolMeasToAddModList* is included in *VarMeasConfig*:
 - 4> perform CBR measurements on each transmission resource pool indicated in the *tx-PoolMeasToAddModList*;
 - 3> if *sl-TxPoolSelectedNormal*, *sl-TxPoolScheduling* or *sl-TxPoolExceptional* is included in *sl-ConfigDedicatedNR* for the concerned frequency within RRCReconfiguration:
 - 4> perform CBR measurement on pools in *sl-TxPoolSelectedNormal*, *sl-TxPoolScheduling* or *sl-TxPoolExceptional* if included in *sl-ConfigDedicatedNR* for the concerned frequency within RRCReconfiguration;
 - 3> else if the cell chosen for NR sidelink communication provides *SIB12* which includes *sl-TxPoolSelectedNormal* or *sl-TxPoolExceptional* for the concerned frequency:
 - 4> perform CBR measurement on pools in *sl-TxPoolSelectedNormal* and *sl-TxPoolExceptional* for the concerned frequency in *SIB12*;

1> else:

- 2> perform CBR measurement on pools in *sl-TxPoolSelectedNormal* and *sl-TxPoolExceptional* in *SidelinkPreconfigNR* for the concerned frequency.

...

[TS 38.331, clause 5.5.4.1]

If AS security has been activated successfully, the UE shall:

- 1> for each *measId* included in the *measIdList* within *VarMeasConfig*:

...

- 2> if the corresponding *reportConfig* concerns the reporting for NR sidelink communication (i.e. *reportConfigNR-SL*):
 - 3> consider the transmission resource pools indicated by the *tx-PoolMeasToAddModList* defined within the *VarMeasConfig* for this *measId* to be applicable;
- ...
- 2> else if the *reportType* is set to *eventTriggered* and if the entry condition applicable for this event, i.e. the event corresponding with the *eventId* of the corresponding *reportConfig* within *VarMeasConfig*, is fulfilled for one or more applicable transmission resource pools for all measurements taken during *timeToTrigger* defined for this event within the *VarMeasConfig*, while the *VarMeasReportList* does not include an measurement reporting entry for this *measId* (a first transmission resource pool triggers the event):
 - 3> include a measurement reporting entry within the *VarMeasReportList* for this *measId*;
 - 3> set the *numberOfReportsSent* defined within the *VarMeasReportList* for this *measId* to 0;
 - 3> include the concerned transmission resource pool(s) in the *poolsTriggeredList* defined within the *VarMeasReportList* for this *measId*;
 - 3> initiate the measurement reporting procedure, as specified in 5.5.5;
- 2> else if the *reportType* is set to *eventTriggered* and if the entry condition applicable for this event, i.e. the event corresponding with the *eventId* of the corresponding *reportConfig* within *VarMeasConfig*, is fulfilled for one or more applicable transmission resource pools not included in the *poolsTriggeredList* for all measurements taken during *timeToTrigger* defined for this event within the *VarMeasConfig* (a subsequent transmission resource pool triggers the event):
 - 3> set the *numberOfReportsSent* defined within the *VarMeasReportList* for this *measId* to 0;
 - 3> include the concerned transmission resource pool(s) in the *poolsTriggeredList* defined within the *VarMeasReportList* for this *measId*;
 - 3> initiate the measurement reporting procedure, as specified in 5.5.5;
- 2> else if the *reportType* is set to *eventTriggered* and if the leaving condition applicable for this event is fulfilled for one or more applicable transmission resource pools included in the *poolsTriggeredList* defined within the *VarMeasReportList* for this *measId* for all measurements taken during *timeToTrigger* defined within the *VarMeasConfig* for this event:
 - 3> remove the concerned transmission resource pool(s) in the *poolsTriggeredList* defined within the *VarMeasReportList* for this *measId*;
 - 3> if the *poolsTriggeredList* defined within the *VarMeasReportList* for this *measId* is empty:
 - 4> remove the measurement reporting entry within the *VarMeasReportList* for this *measId*;
 - 4> stop the periodical reporting timer for this *measId*, if running
- ...
- 2> upon expiry of the periodical reporting timer for this *measId*:

3> initiate the measurement reporting procedure, as specified in 5.5.5.

...

[TS 38.331, clause 5.5.4.11]

The UE shall:

1> consider the entering condition for this event to be satisfied when condition C1-1, as specified below, is fulfilled;

1> consider the leaving condition for this event to be satisfied when condition C1-2, as specified below, is fulfilled;

Inequality C1-1 (Entering condition)

$$Ms - Hys > Thresh$$

Inequality C1-2 (Leaving condition)

$$Ms + Hys < Thresh$$

The variables in the formula are defined as follows:

Ms is the measurement result of channel busy ratio of the transmission resource pool, not taking into account any offsets.

Hys is the hysteresis parameter for this event (i.e. *hysteresis* as defined within *reportConfigNR-SL* for this event).

Thresh is the threshold parameter for this event (i.e. *c1-Threshold* as defined within *reportConfigNR-SL* for this event).

Ms is expressed in decimal from 0 to 1 in steps of 0.01.

Hys is expressed in the same unit as ***Ms***.

Thresh is expressed in the same unit as ***Ms***.

[TS 38.331, clause 5.5.4.12]

The UE shall:

1> consider the entering condition for this event to be satisfied when condition C2-1, as specified below, is fulfilled;

1> consider the leaving condition for this event to be satisfied when condition C2-2, as specified below, is fulfilled;

Inequality C2-1 (Entering condition)

$$Ms + Hys < Thresh$$

Inequality C2-2 (Leaving condition)

$$Ms - Hys > Thresh$$

The variables in the formula are defined as follows:

Ms is the measurement result of channel busy ratio of the transmission resource pool, not taking into account any offsets.

Hys is the hysteresis parameter for this event (i.e. *hysteresis* as defined within *reportConfigNR-SL* for this event).

Thresh is the threshold parameter for this event (i.e. *c2-Threshold* as defined within *reportConfigNR-SL* for this event).

Ms is expressed in decimal from 0 to 1 in steps of 0.01.

Hys is expressed in the same unit as ***Ms***.

Thresh is expressed in the same unit as ***Ms***.

[TS 38.331, clause 5.5.5.1]



Figure 5.5.5.1-1: Measurement reporting

The purpose of this procedure is to transfer measurement results from the UE to the network. The UE shall initiate this procedure only after successful AS security activation.

For the *measId* for which the measurement reporting procedure was triggered, the UE shall set the *measResults* within the *MeasurementReport* message as follows:

- 1> set the *measId* to the measurement identity that triggered the measurement reporting;
- 1> for each serving cell configured with *servingCellMO*:
 - ...
 - 2> else:
 - 3> if SSB based serving cell measurements are available:
 - 4> set the *measResultServingCell* within *measResultServingMOList* to include RSRP, RSRQ and the available SINR of the serving cell, derived based on SSB;
 - ...
 - 1> set the *servCellId* within *measResultServingMOList* to include each NR serving cell that is configured with *servingCellMO*, if any;
 - ...
 - 1> if there is at least one applicable transmission resource pool for NR sidelink communication (for *measResultsSL*):
 - 2> set the *measResultsListSL* to include the CBR measurement results in accordance with the following:
 - 3> if the *reportType* is set to *eventTriggered*:
 - 4> include the transmission resource pools included in the *poolsTriggeredList* as defined within the *VarMeasReportList* for this *measId*;
 - 3> else:
 - 4> include the applicable transmission resource pools for which the new measurement results became available since the last periodical reporting or since the measurement was initiated or reset;
 - 3> if the corresponding *measObject* concerns NR sidelink communication, then for each transmission resource pool to be reported:
 - 4> set the *sl-poolReportIdentity* to the identity of this transmission resource pool;
 - 4> set the *sl-CBR-ResultsNR* to the CBR measurement results on PSSCH and PSCCH of this transmission resource pool provided by lower layers, if available;
 - ...
 - 1> increment the *numberOfReportsSent* as defined within the *VarMeasReportList* for this *measId* by 1;
 - 1> stop the periodical reporting timer, if running;

- 1> if the *numberOfReportsSent* as defined within the *VarMeasReportList* for this *measId* is less than the *reportAmount* as defined within the corresponding *reportConfig* for this *measId*:
- 2> start the periodical reporting timer with the value of *reportInterval* as defined within the corresponding *reportConfig* for this *measId*;
- ...
- 1> else:
- 2> submit the *MeasurementReport* message to lower layers for transmission, upon which the procedure ends.

12.2.3.1.3 Test description

12.2.3.1.3.1 Pre-test conditions

System Simulator:

- NR Cell
 - NR Cell 1 is the serving cell.
 - System information combination NR-14 as defined in TS 38.508-1 [4] clause 4.4.3.1 is used in NR Cell 1.
- NR-SS-UE
 - NR-SS-UE 1 and 2 operating as NR sidelink communication device on the resources (i.e. the frequency included in pre-configuration) that UE is expected to use for transmission and reception via PC5 interface.
 - NR-SS-UE 1 and 2 transmit PSCCH/PSSCH continuously according to NR Cell 1 timing and the transmission pattern shown in figure 12.2.3.1.3.2-1.

UE:

- UE is authorised to perform NR sidelink communication.
- The UE is equipped with below information in UE or in a USIM containing default values (as per TS 38.508-1 [4]) except for those listed in Table 12.2.3.1.3.2-1.

Table 12.2.3.1.3.2-1: UE/ USIM configuration

USIM field	Priority	Value	Access Technology Identifier
EF _{UST}		As per TS 36.508 [18] clause 4.9.3.4	
EF _{VST}		Service n°119 is "available"	
EF _{V2XP_PC5}		As per TS 38.508-1[4] clause 4.8.3.3.3 SL-PreconfigurationNR included in V2X data policy over PC5 is defined in Table 12.2.5.2.3.3-1	

Preamble:

- The UE is in state 3N-B as defined in TS 38.508-1 [4], subclause 4.4A, using generic procedure parameter Sidelink (On) and Test Mode (On) as defined in TS 38.508-1 [4], subclause 4.5.1.

12.2.3.1.3.2 Test procedure sequence

During the test, NR-SS-UE 1 uses all subchannels in every slot with even slot index to transmit PSCCH/PSSCH and NR-SS-UE 2 uses all subchannels in every slot with odd slot index to transmit PSCCH/PSSCH. The PSCCH/PSSCH transmission pattern for NR-SS-UE 1 and 2 are illustrated in Figure 12.2.3.1.3.2-1.

Table 12.2.3.1.3.2-2 illustrates the sidelink power levels to be applied for NR-SS-UE 1 and 2 at various time instants of the test execution. Row marked "T0" denotes the conditions after the preamble, while the configuration marked "T1" is applied at the point indicated in the Main behaviour description in Table 12.2.3.1.3.2-3.

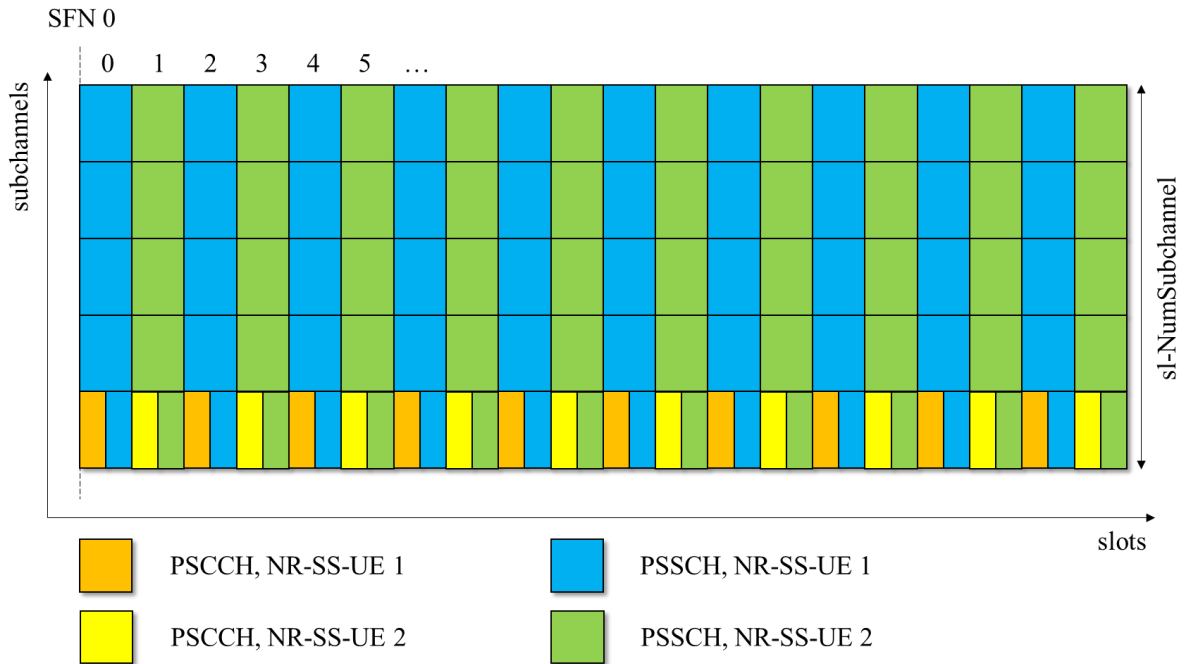

Figure 12.2.3.1.3.2-1: PSCCH/PSSCH transmission pattern for NR-SS-UE 1 and 2

Table 12.2.3.1.3.2-2: Time instances of NR-SS-UE power level and parameter changes in conducted test environment

	Parameter	Unit	NR-SS-UE 1	NR-SS-UE 2	Remark
T0	NR-SS-UE power	dBm/SCS	-85	-85	The power level that both SL-RSSI of NR-SS-UE 1 and NR-SS-UE 2 are above sl-ThresholdS-RSSI-CBR (SL CBR = 100%)
	SL-RSSI	dBm/subchannel	-74.2	-74.2	
T1	NR-SS-UE power	dBm/SCS	-85	-101	The power level that SL-RSSI of NR-SS-UE 1 is above sl-ThresholdS-RSSI-CBR and SL-RSSI of NR-SS-UE 2 is below sl-ThresholdS-RSSI-CBR (SL CBR = 50%)
	SL-RSSI	dBm/subchannel	-74.2	-90.2	

Table 12.2.3.1.3.2-3: Main behaviour

St	Procedure	Message Sequence		TP	Verdict
		U - S	Message		
1	The UE transmits a SidelinkUEInformationNR message to request resources for transmission of NR sidelink communication.	-->	NR RRC: SidelinkUEInformationNR	-	-
2	The SS re-adjusts the NR-SS-UE power level according to row "T1" in Table 12.2.3.1.3.2-2 to achieve 50% congestion.	-	-	-	-
3	SS-NW transmits an RRCReconfiguration message with sl-ConfigDedicatedNR to configure transmission resources.	<--	NR RRC: RRCReconfiguration	-	-
4	UE transmits an RRCReconfigurationComplete message.	-->	NR RRC: RRCReconfigurationComplete		

5	SS-NW transmits an RRCReconfiguration message with measConfig to setup event C1 triggered CBR measurement and reporting.	<--	NR RRC: RRCReconfiguration	-	-
6	UE transmits an RRCReconfigurationComplete message.	-->	NR RRC: RRCReconfigurationComplete		
7	Check: Does the UE transmit a MeasurementReport message in the following 5s?	-->	NR RRC: MeasurementReport	1	F
8	The SS re-adjusts the NR-SS-UE power level according to row "T0" in Table 12.2.3.1.3.2-2 to achieve 100% congestion.	-	-	-	-
9	Check: Does the UE transmit a MeasurementReport message with the measured CBR value for indicated resource pool?	-->	NR RRC: MeasurementReport	1	P
10	The SS re-adjusts the NR-SS-UE power level according to row "T1" in Table 12.2.3.1.3.2-2 to achieve 50% congestion.	-	-	-	-
11	SS-NW waits for 2s	-	-	-	-
12	Check: Does the UE transmit a MeasurementReport message in the following 5s?	-->	NR RRC: MeasurementReport	2	F
13	SS-NW transmits an RRCReconfiguration message with measConfig to release event C1 and setup event C2 triggered CBR measurement and reporting.	<--	NR RRC: RRCReconfiguration	-	-
14	UE transmits an RRCReconfigurationComplete message.	-->	NR RRC: RRCReconfigurationComplete		
15	Check: Does the UE transmit a MeasurementReport message with the measured CBR value for indicated resource pool?	-->	NR RRC: MeasurementReport	3	P
16	The SS re-adjusts the NR-SS-UE power level according to row "T0" in Table 12.2.3.1.3.2-2 to achieve 100% congestion.	-	-	-	-
17	SS-NW waits for 2s	-	-	-	-
18	Check: Does the UE transmit a MeasurementReport message in the following 5s?	-->	NR RRC: MeasurementReport	4	F

12.2.3.1.3.3 Specific message contents

Table 12.2.3.1.3.3-1: V2X service identifier to default mode of communication mapping rule (Pre-configuration, UE under test)

Derivation Path: TS 38.508-1 [4] Table 4.7.5.5-53			
Information Element	Value/remark	Comment	Condition
DMC	'10'B	Default mode of communication is set to broadcast	

Table 12.2.3.1.3.3-2: Physical layer parameters for SCI format 1-A (NR-SS-UE 1 and 2)

Derivation Path: TS 38.508-1 [4] Table 4.3.6.2.1.1-1			
Parameter	Value	Value in binary	Condition
Frequency resource assignment	$(N-1)*(N+2)/2$ where N is the number of subchannels in resource pool indicated by sl-NumSubchannel. FRIV is calculated according to the formula given in 38.214 clause 8.1.5	-	

Table 12.2.3.1.3.3-3: SidelinkUEInformationNR (Table 12.2.3.1.3.2-3, Step 1)

Derivation Path: TS 38.508-1 [4], Table 4.6.1-28A with condition SIDELINK_TX			
Information Element	Value/remark	Comment	Condition
SidelinkUEInformationNR-r16 ::= SEQUENCE {			
criticalExtensions CHOICE {			
sidelinkUEInformationNR-r16 SEQUENCE {			
sl-TxResourceReqList-r16 SEQUENCE (SIZE (1..maxNrofSL-Dest-r16)) OF SL-TxResourceReq-r16	1 entry		
SL-TxResourceReq-r16[1] SEQUENCE {		entry 1	
sl-DestinationIdentity-r16	Not checked		
sl-CastType-r16	broadcast		
sl-QoS-InfoList-r16	Not checked		
sl-TypeTxSyncList-r16	Not checked		
}			
}			
}			
}			
}			

Table 12.2.3.1.3.3-4: RRCReconfiguraion (Table 12.2.3.1.3.2-3, Step 3)

Derivation Path: TS 38.508-1 [4], Table 4.6.1-13 with condition SIDELINK			
Information Element	Value/remark	Comment	Condition
RRCReconfiguration ::= SEQUENCE {			
criticalExtensions CHOICE {			
rrcReconfiguration SEQUENCE {			
nonCriticalExtension SEQUENCE {			
nonCriticalExtension SEQUENCE {			
nonCriticalExtension SEQUENCE {			
nonCriticalExtension SEQUENCE {			
sl-ConfigDedicatedNR-r16 CHOICE {			
setup	SL-ConfigDedicatedNR specified in 38.508-1 Table 4.6.6-7 with condition SELECTED		
}			
}			
}			
}			
}			
}			
}			
}			

Table 12.2.3.1.3.3-5: SL-ResourcePool (Table 12.2.3.1.3.3-4)

Derivation Path: TS 38.508-1 [4], Table 4.6.6-25			
Information Element	Value/remark	Comment	Condition
SL-ResourcePool-r16 ::= SEQUENCE {			
sl-ThreshS-RSSI-CBR-r16	15	actual threshold = -112+15*2 = -82 dBm	
}			

Table 12.2.3.1.3.3-6: RRCReconfiguraion (Table 12.2.3.1.3.2-3, Step 5 and 13)

Derivation Path: TS 38.508-1 [4], Table 4.6.1-13 with condition NR_MEAS			
Information Element	Value/remark	Comment	Condition

RRCReconfiguration ::= SEQUENCE {			
criticalExtensions CHOICE {			
rrcReconfiguration SEQUENCE {			
measConfig	MeasConfig-1	Table 12.2.3.1.3.3-7	Step 5
	MeasConfig-2	Table 12.2.3.1.3.3-9	Step 13
}			
}			
}			

Table 12.2.3.1.3.3-7: MeasConfig-1 (Table 12.2.3.1.3.3-6)

Derivation Path: TS 38.508-1 [4], Table 4.6.3-69			
Information Element	Value/remark	Comment	Condition
MeasConfig ::= SEQUENCE {			
measObjectToAddModList SEQUENCE (SIZE (1..maxNrofObjectId)) OF MeasObjectToAddMod {	2 entries		
MeasObjectToAddMod[1] SEQUENCE {		Entry 1	
measObjectId	1		
measObject CHOICE {			
measObjectNR	MeasObjectNR	Table 12.2.3.1.3.3-8	
}			
}			
MeasObjectToAddMod[2] SEQUENCE {		Entry 2	
measObjectId	2		
measObject CHOICE {			
measObjectNR-SL-r16	MeasObjectNR-SL		
}			
}			
}			
reportConfigToAddModList SEQUENCE (SIZE (1..maxReportConfigId)) OF ReportConfigToAddMod {	2 entries		
ReportConfigToAddMod[1] SEQUENCE {		Entry 1	
reportConfigId	1		
reportConfig CHOICE {			
reportConfigNR-SL-r16	ReportConfigNR-SL(0.75) with condition EVENT_C1		
}			
}			
ReportConfigToAddMod[2] SEQUENCE {		Entry 2	
reportConfigId	2		
reportConfig CHOICE {			
reportConfigNR-SL-r16	ReportConfigNR-SL(0.75) with condition EVENT_C2		
}			
}			
}			
measIdToAddModList SEQUENCE (SIZE (1..maxNrofMeasId)) OF MeasIdToAddMod {	1 entry		
MeasIdToAddMod[1] SEQUENCE {			
measId	1		
measObjectId	2		
reportConfigId	1		
}			
}			
}			

Table 12.2.3.1.3.3-8: MeasObjectNR (Table 12.2.3.1.3.3-7)

Derivation Path: TS 38.508-1 [4], Table 4.6.3-76			
Information Element	Value/remark	Comment	Condition
MeasObjectNR ::= SEQUENCE {			
ssbFrequency	ARFCN-ValueNR of NR Cell 1		
absThreshSS-BlocksConsolidation	Not present		
}			

Table 12.2.3.1.3.3-9: MeasConfig-2 (Table 12.2.3.1.3.3-6)

Derivation Path: TS 38.508-1 [4], Table 4.6.3-69			
Information Element	Value/remark	Comment	Condition
MeasConfig ::= SEQUENCE {			
measObjectToAddModList	Not present		
reportConfigToAddModList	Not present		
measIdToAddModList SEQUENCE (SIZE (1..maxNrofMeasId)) OF MeasIdToAddMod {	1 entry		
MeasIdToAddMod[1] SEQUENCE {			
measId	1		
measObjectId	2		
reportConfigId	2		
}			
}			
}			

Table 12.2.3.1.3.3-10: MeasurementReport (Table 12.2.3.1.3.2-3, Step 9 and 15)

e			
Information Element	Value/remark	Comment	Condition
MeasurementReport ::= SEQUENCE {			
criticalExtensions CHOICE {			
measurementReport SEQUENCE {			
measResults SEQUENCE {			
measId	1		
measResultServingMOList	Not checked		
measResultNeighCells	Not present		
measResultsSL-r16 SEQUENCE {			
measResultsListSL-r16 CHOICE {			
measResultNR-SL-r16 SEQUENCE {			
measResultListCBR-NR-r16 SEQUENCE (SIZE (1.. maxNrofSL-PoolToMeasureNR-r16)) OF MeasResultCBR-NR-r16 {	1 entry		
MeasResultCBR-NR[1] SEQUENCE {		Entry 1	
sl-poolReportIdentity-r16	1		
sl-CBR-ResultsNR-r16	(0..100)		
}			
}			
}			
}			
}			
}			
}			
}			
}			

12.2.3.2 Inter-carrier concurrent operation / Measurement configuration and reporting via Uu RRC / CBR measurement reporting / Periodical reporting

12.2.3.2.1 Test Purpose (TP)

(1)

```
with { UE is configured to perform periodical CBR measurement reporting on resource pools }
ensure that {
  when { The first measurement result is available and thereafter every time periodical timer expires }
  then { UE triggers CBR measurement reporting }
}
```

12.2.3.2.2 Conformance requirements

References: The conformance requirements covered in the present TC are specified in: TS 38.331 [22], subclause 5.5.2.1, 5.5.3.1, 5.5.4.11 and 5.5.5.1. Unless otherwise stated these are Rel-16 requirements.

[TS 38.331, clause 5.5.2.1]

...

The UE shall:

...

- 1> if the received *measConfig* includes the *measObjectToAddModList*:
 - 2> perform the measurement object addition/modification procedure as specified in 5.5.2.5;
- ...
- 1> if the received *measConfig* includes the *reportConfigToAddModList*:
 - 2> perform the reporting configuration addition/modification procedure as specified in 5.5.2.7;
- 1> if the received *measConfig* includes the *quantityConfig*:
 - 2> perform the quantity configuration procedure as specified in 5.5.2.8;
- ...
- 1> if the received *measConfig* includes the *measIdToAddModList*:
 - 2> perform the measurement identity addition/modification procedure as specified in 5.5.2.3;
- ...

[TS 38.331, clause 5.5.3.1]

...

The UE capable of CBR measurement when configured to transmit NR sidelink communication shall:

- 1> If the frequency used for NR sidelink communication is included in *sl-FreqInfoToAddModList* in *sl-ConfigDedicatedNR* within *RRCReconfiguration* message or included in *sl-ConfigCommonNR* within *SIB12*:
 - ...
- 2> if the UE is in *RRC_CONNECTED*:
 - 3> if *tx-PoolMeasToAddModList* is included in *VarMeasConfig*:
 - 4> perform CBR measurements on each transmission resource pool indicated in the *tx-PoolMeasToAddModList*;

- 3> if *sl-TxPoolSelectedNormal*, *sl-TxPoolScheduling* or *sl-TxPoolExceptional* is included in *sl-ConfigDedicatedNR* for the concerned frequency within RRCReconfiguration:
- 4> perform CBR measurement on pools in *sl-TxPoolSelectedNormal*, *sl-TxPoolScheduling* or *sl-TxPoolExceptional* if included in *sl-ConfigDedicatedNR* for the concerned frequency within RRCReconfiguration;
- 3> else if the cell chosen for NR sidelink communication provides *SIB12* which includes *sl-TxPoolSelectedNormal* or *sl-TxPoolExceptional* for the concerned frequency:
- 4> perform CBR measurement on pools in *sl-TxPoolSelectedNormal* and *sl-TxPoolExceptional* for the concerned frequency in *SIB12*;
- 1> else:
- 2> perform CBR measurement on pools in *sl-TxPoolSelectedNormal* and *sl-TxPoolExceptional* in *SidelinkPreconfigNR* for the concerned frequency.

...

[TS 38.331, clause 5.5.4.11]

The UE shall:

- 1> consider the entering condition for this event to be satisfied when condition C1-1, as specified below, is fulfilled;
- 1> consider the leaving condition for this event to be satisfied when condition C1-2, as specified below, is fulfilled;

Inequality C1-1 (Entering condition)

$$Ms - Hys > Thresh$$

Inequality C1-2 (Leaving condition)

$$Ms + Hys < Thresh$$

The variables in the formula are defined as follows:

Ms is the measurement result of channel busy ratio of the transmission resource pool, not taking into account any offsets.

Hys is the hysteresis parameter for this event (i.e. *hysteresis* as defined within *reportConfigNR-SL* for this event).

Thresh is the threshold parameter for this event (i.e. *c1-Threshold* as defined within *reportConfigNR-SL* for this event).

Ms is expressed in decimal from 0 to 1 in steps of 0.01.

Hys is expressed in the same unit as ***Ms***.

Thresh is expressed in the same unit as ***Ms***.

[TS 38.331, clause 5.5.5.1]



Figure 5.5.5.1-1: Measurement reporting

The purpose of this procedure is to transfer measurement results from the UE to the network. The UE shall initiate this procedure only after successful AS security activation.

For the *measId* for which the measurement reporting procedure was triggered, the UE shall set the *measResults* within the *MeasurementReport* message as follows:

- 1> set the *measId* to the measurement identity that triggered the measurement reporting;
- 1> for each serving cell configured with *servingCellMO*:
 - ...
 - 2> else:
 - 3> if SSB based serving cell measurements are available:
 - 4> set the *measResultServingCell* within *measResultServingMOList* to include RSRP, RSRQ and the available SINR of the serving cell, derived based on SSB;
 - ...
 - 1> set the *servCellId* within *measResultServingMOList* to include each NR serving cell that is configured with *servingCellMO*, if any;
 - ...
 - 1> if there is at least one applicable transmission resource pool for NR sidelink communication (for *measResultsSL*):
 - 2> set the *measResultsListSL* to include the CBR measurement results in accordance with the following:
 - 3> if the *reportType* is set to *eventTriggered*:
 - 4> include the transmission resource pools included in the *poolsTriggeredList* as defined within the *VarMeasReportList* for this *measId*;
 - 3> else:
 - 4> include the applicable transmission resource pools for which the new measurement results became available since the last periodical reporting or since the measurement was initiated or reset;
 - 3> if the corresponding *measObject* concerns NR sidelink communication, then for each transmission resource pool to be reported:
 - 4> set the *sl-poolReportIdentity* to the identity of this transmission resource pool;
 - 4> set the *sl-CBR-ResultsNR* to the CBR measurement results on PSSCH and PSCCH of this transmission resource pool provided by lower layers, if available;
 - ...
 - 1> increment the *numberOfReportsSent* as defined within the *VarMeasReportList* for this *measId* by 1;
 - 1> stop the periodical reporting timer, if running;
 - 1> if the *numberOfReportsSent* as defined within the *VarMeasReportList* for this *measId* is less than the *reportAmount* as defined within the corresponding *reportConfig* for this *measId*:
 - 2> start the periodical reporting timer with the value of *reportInterval* as defined within the corresponding *reportConfig* for this *measId*;
 - ...
 - 1> else:
 - 2> submit the *MeasurementReport* message to lower layers for transmission, upon which the procedure ends.

12.2.3.2.3 Test description

12.2.3.2.3.1 Pre-test conditions

System Simulator:

- SS-NW
 - NR Cell 1
 - System information combination NR-14 as defined in TS 38.508-1 [4] clause 4.4.3.1 is used in NR Cell 1.
- NR-SS-UE
 - NR-SS-UE1 operating as NR sidelink communication receiving device on the resources that UE is expected to use for transmission
 - NR-SS-UE1 is synchronised on NR Cell 1.

UE:

- UE is authorised to perform NR sidelink communication.
- The UE is equipped with a USIM containing default values as per TS 38.508-1 [4] clause 4.8.3.3.3.
- UE is synchronised on NR Cell 1.

Preamble:

- The UE is in state 3N-B as defined in TS 38.508-1 [4], subclause 4.4A on NR Cell 1, using generic procedure parameters Sidelink (On), Cast Type (Unicast) using NR-SS-UE initiated unicast mode NR sidelink communication procedure in subclause 4.9.23.

12.2.3.2.3.2 Test procedure sequence

Table 12.2.3.2.3.2-1: Main behaviour

St	Procedure	Message Sequence		TP	Verdict
		U - S	Message		
1	Configure the UE to perform sidelink transmission. Note: This step is triggered by MMI or AT command.	-	-	-	-
2	The UE transmits a <i>SidelinkUEInformationNR</i> message to request resources for transmission of NR sidelink communication.	-->	NR RRC: <i>SidelinkUEInformationNR</i>	-	-
3	The SS-NW transmits an <i>RRCReconfiguration</i> message with <i>sl-ConfigDedicatedNR</i> and <i>MeasConfig</i> to configure resource pool configuration and periodical CBR measurement.	<--	NR RRC: <i>RRCReconfiguration</i>		
4	The UE transmits an <i>RRCReconfigurationComplete</i> message.	-->	NR RRC: <i>RRCReconfigurationComplete</i>	-	-
5	Check: Does the UE transmit a <i>MeasurementReport</i> message with the measured CBR value for indicated resource pool?	-->	NR RRC: <i>MeasurementReport</i>	1	P
-	EXCEPTION: Step 5 below is repeated until 3 <i>MeasurementReport</i> messages are received from the UE and Interval between two <i>MeasurementReport</i> is same as the IE <i>reportInterval</i> configured in <i>measConfig</i> .	-	-	-	-
6	Check: Does the UE transmit a <i>MeasurementReport</i> message with the measured CBR value for indicated resource	-->	NR RRC: <i>MeasurementReport</i>	1	P

pool?				
-------	--	--	--	--

12.2.3.2.3.3 Specific message contents

Table 12.2.3.2.3.3-1: RRCReconfiguration (step 2, Table 12.2.3.2.3.2-1)

Derivation Path: TS 38.508-1 [4], Table 4.6.1-13 with condition SIDELINK and NR_MEAS.			
Information Element	Value/remark	Comment	Condition
RRCReconfiguration ::= SEQUENCE {			
criticalExtensions CHOICE {			
rrcReconfiguration SEQUENCE {			
measConfig	MeasConfig		
}			
}			
}			

Table 12.2.3.2.3.3-2: SL-ConfigDedicatedNR (Table 12.2.3.2.3.3-1)

Derivation Path: TS 38.508-1 [4], Table 4.6.6-7 with condition SCHEDULING			
Information Element	Value/remark	Comment	Condition
SL-ConfigDedicatedNR-r16 ::= SEQUENCE {			
sl-FreqInfoToAddModList-r16 SEQUENCE (SIZE (1..maxNrofFreqSL-r16)) OF SL-FreqConfig-r16 {	1 entry		
SL-FreqConfig-r16[1]	SL-FreqConfig-		
}			
}			

Table 12.2.3.2.3.3-3: SL-FreqConfig (Table 12.2.3.2.3.3-2)

Derivation Path: TS 38.508-1 [4], Table 4.6.6-10			
Information Element	Value/remark	Comment	Condition
SL-FreqConfig-r16 ::= SEQUENCE {			
sl-BWP-ToAddModList-r16 SEQUENCE (SIZE (1..maxNrofSL-BWPs-r16)) OF SL-BWP-Config-r16 {	1 entry		
SL-BWP-Config-r16[1]	SL-BWP-Config		
}			
}			

Table 12.2.3.2.3.3-4: SL-BWP-Config (Table 12.2.3.2.3.3-3)

Derivation Path: TS 38.508-1 [4], Table 4.6.6-1			
Information Element	Value/remark	Comment	Condition
SL-BWP-Config-r16 ::= SEQUENCE {			
sl-BWP-PoolConfig-r16	SL-BWP-PoolConfig		
}			

Table 12.2.3.2.3.3-5: SL-BWP-PoolConfig (Table 12.2.3.2.3.3-4)

Derivation Path: TS 38.508-1 [4], Table 4.6.6-3 with condition SCHEDULING			
---	--	--	--

Table 12.2.3.2.3.3-6: MeasConfig (Table 12.2.3.2.3.3-1)

Derivation Path: TS 38.508-1 [4] Table 4.6.3-69			
Information Element	Value/Remark	Comment	Condition
measConfig ::= SEQUENCE {			
measObjectToAddModList SEQUENCE (SIZE (1..maxNrofObjectld)) OF MeasObjectToAddMod {	2 entries		
MeasObjectToAddMod[1] SEQUENCE {		entry 1	

measObjectId	1		
measObject CHOICE {			
measObjectNR	MeasObjectNR		
}			
MeasObjectToAddMod[2] SEQUENCE {		entry 2	
measObjectId	2		
measObject CHOICE {			
measObjectNR-SL-r16	MeasObjectNR-SL		
}			
}			
reportConfigToAddModList SEQUENCE (SIZE (1..maxReportConfigId)) OF ReportConfigToAddMod {	1 entry		
ReportConfigToAddMod[1] SEQUENCE {		entry 1	
reportConfigId	1		
reportConfigNR-SL-r16	ReportConfigNR-SL-PERIODICAL		
}			
}			
measIdToAddModList SEQUENCE (SIZE (1..maxNrofMeasId)) OF MeasIdToAddMod {	1 entry		
MeasIdToAddMod[1] SEQUENCE {		entry 1	
measId	1		
measObjectId	2		
reportConfigId	1		
}			
}			
}			
}			

Table 12.2.3.2.3.3-7: MeasObjectNR (Table 12.2.3.2.3.3-6)

Derivation Path: TS 38.508-1 [4], Table 4.6.3-76			
Information Element	Value/remark	Comment	Condition
MeasObjectNR ::= SEQUENCE {			
ssbFrequency	ARFCN-ValueNR of NR Cell 1		
absThreshSS-BlocksConsolidation	Not present		
}			

Table 12.2.3.2.3.3-8: MeasObjectNR-SL (Table 12.2.3.2.3.3-6)

Derivation Path: TS 38.508-1 [4] Table 4.6.3-76A			
MeasObjectNR-SL-r16 ::= SEQUENCE {			
tx-PoolMeasToRemoveList-r16	Not present		
tx-PoolMeasToAddModList-r16 SEQUENCE (SIZE (1..maxNrofSL-PoolToMeasureNR-r16)) OF SL-ResourcePoolID-r16 {	1 entry		
SL-ResourcePoolID-r16[1]	1		
}			
}			

Table 12.2.3.2.3.3-9: ReportConfigNR-SL-PERIODICAL (Table 12.2.3.2.3.3-6)

Derivation Path: TS 38.508-1 [4] Table 4.6.3-142A with condition PERIODICAL			
Information Element	Value/remark	Comment	Condition
ReportConfigNR-SL-r16 ::= SEQUENCE {			
reportType-r16 CHOICE {			
periodical-r16 SEQUENCE {			
reportInterval-r16	ms480		

reportAmount-r16	r4		
}			
}			
}			

Table 12.2.3.2.3.3-10: MeasurementReport (step 4, 5, Table 12.2.3.2.3.2-1)

Derivation Path: TS 38.508-1 [4], Table 4.6.1-5A			
Information Element	Value/remark	Comment	Condition
MeasurementReport ::= SEQUENCE {			
criticalExtensions CHOICE {			
measurementReport SEQUENCE {			
measResults SEQUENCE {			
measId	1		
measResultServingMOList	Not checked		
measResultNeighCells	Not present		
measResultsSL-r16 SEQUENCE {			
measResultsListSL-r16 CHOICE {			
measResultNR-SL-r16 SEQUENCE {			
measResultListCBR-NR-r16 SEQUENCE (SIZE (1.. maxNrofSL-PoolToMeasureNR-r16)) OF MeasResultCBR-NR-r16 {	1 entry		
MeasResultCBR-NR-r16[1] SEQUENCE {		entry 1	
sl-poolReportIdentity-r16	1		
sl-CBR-ResultsNR-r16	(0..100)		
}			
}			
}			
}			
}			
}			
}			
}			
}			
}			
}			

12.2.4 Inter-carrier concurrent operation / Sidelink Reconfiguration via Uu RRC

12.2.4.1 Inter-carrier concurrent operation / Sidelink Reconfiguration via Uu RRC / SL DRB management / transmission side

12.2.4.1.1 Test Purpose (TP)

(1)

```
with { UE in NR RRC_CONNECTED state and UE having established PC5-RRC connection with peer UE }
ensure that {
  when { UE receives an RRCReconfiguration message to establish a groupcast SL DRB }
  then { UE establishes a SL DRB and sends an RRCReconfigurationComplete message }
}
```

(2)

```
with { UE in NR RRC_CONNECTED state and UE having established PC5-RRC connection with peer UE }
ensure that {
  when { UE receives an RRCReconfiguration message to establish a unicast SL DRB }
  then { UE sends a RRCReconfigurationSidelink message to peer UE to indicate SL DRB addition.
  After receiving RRCReconfigurationCompleteSidelink message from peer UE, UE establishes the SL DRB }
}
```

(3)

```

with { UE in NR RRC_CONNECTED state and UE having established PC5-RRC connection with peer UE }
ensure that {
  when { UE receives an RRCReconfiguration message to establish a unicast SL DRB }
  then { UE sends a RRCReconfigurationSidelink message to peer UE to indicate SL DRB addition.
After receiving RRCReconfigurationFailureSidelink message from peer UE, UE does not establish the SL
DRB and sends a SidelinkUEInformationNR message to inform about sidelink reconfiguration failure}
}

```

(4)

```

with { UE in NR RRC_CONNECTED state, UE having established PC5-RRC connection with peer UE and
having established a unicast SL DRB }
ensure that {
  when { UE receives an RRCReconfiguration message to modify the unicast SL DRB }
  then { UE sends a RRCReconfigurationSidelink message to peer UE to indicate SL DRB modification.
After receiving RRCReconfigurationCompleteSidelink message from peer UE, UE modifies the SL DRB }
}

```

(5)

```

with { UE in NR RRC_CONNECTED state, UE having established PC5-RRC connection with peer UE and
having established a unicast SL DRB }
ensure that {
  when { UE receives an RRCReconfiguration message to reconfigure QoS-flow to SL DRB mapping and
after reconfiguration no QoS flow is mapped to the unicast SL DRB }
  then { UE sends a RRCReconfigurationSidelink message to peer UE to indicate the release of the
QoS flows mapped to the SL-DRB. After receiving RRCReconfigurationCompleteSidelink message from peer
UE, UE releases the SL DRB }
}

```

(6)

```

with { UE in NR RRC_CONNECTED state, UE having established PC5-RRC connection with peer UE and
having established a unicast SL DRB }
ensure that {
  when { UE receives an RRCReconfiguration message to release the unicast SL DRB }
  then { UE sends a RRCReconfigurationSidelink message to peer UE to indicate SL DRB release.
After receiving RRCReconfigurationCompleteSidelink message from peer UE, UE releases the SL DRB }
}

```

12.2.4.1.2 Conformance requirements

References: The conformance requirements covered in the present TC are specified in: TS 38.331, clause 5.8.9.1.2, 5.8.9.1.3, 5.8.9.1.8, 5.8.9.1.9, 5.8.9.1a1, 5.8.9.1a2. Unless otherwise stated these are Rel-16 requirements.

[TS 38.331, clause 5.8.9.1.2]

The UE shall set the contents of *RRCReconfigurationSidelink* message as follows:

- 1> for each sidelink DRB that is to be released, according to sub-clause 5.8.9.1a.1.1, due to configuration by *sl-ConfigDedicatedNR*, *SIB12*, *SidelinkPreconfigNR* or by upper layers:
 - 2> set the *SLRB-PC5-ConfigIndex* included in the *slrb-ConfigToReleaseList* corresponding to the sidelink DRB;
- 1> for each sidelink DRB that is to be established or modified, according to sub-clause 5.8.9.1a.2.1, due to receiving *sl-ConfigDedicatedNR*, *SIB12* or *SidelinkPreconfigNR*:
 - 2> set the *SLRB-Config* included in the *slrb-ConfigToAddModList*, according to the received *sl-RadioBearerConfig* and *sl-RLC-BearerConfig* corresponding to the sidelink DRB;

...

[TS 38.331, clause 5.8.9.1.3]

The UE shall perform the following actions upon reception of the *RRCReconfigurationSidelink*:

- 1> if the *RRCReconfigurationSidelink* includes the *sl-ResetConfig*:

- 2> perform the sidelink reset configuration procedure as specified in 5.8.9.1.10;
- 1> if the *RRCReconfigurationSidelink* includes the *slrb-ConfigToReleaseList*:
 - 2> for each *SLRB-PC5-ConfigIndex* value included in the *slrb-ConfigToReleaseList* that is part of the current UE sidelink configuration;
 - 3> perform the sidelink DRB release procedure, according to sub-clause 5.8.9.1a.1;
- 1> if the *RRCReconfigurationSidelink* includes the *slrb-ConfigToAddModList*:
 - 2> for each *slrb-PC5-ConfigIndex* value included in the *slrb-ConfigToAddModList* that is not part of the current UE sidelink configuration:
 - 3> if *sl-MappedQoS-FlowsToAddList* is included:
 - 4> apply the *SL-PQFI* included in *sl-MappedQoS-FlowsToAddList*;
 - 3> perform the sidelink DRB addition procedure, according to sub-clause 5.8.9.1a.2;
 - 2> for each *slrb-PC5-ConfigIndex* value included in the *slrb-ConfigToAddModList* that is part of the current UE sidelink configuration:
 - 3> if *sl-MappedQoS-FlowsToAddList* is included:
 - 4> add the *SL-PQFI* included in *sl-MappedQoS-FlowsToAddList* to the corresponding sidelink DRB;
 - 3> if *sl-MappedQoS-FlowsToReleaseList* is included:
 - 4> remove the *SL-PQFI* included in *sl-MappedQoS-FlowsToReleaseList* from the corresponding sidelink DRB;
 - 3> if the sidelink DRB release conditions as described in sub-clause 5.8.9.1a.1.1 are met:
 - 4> perform the sidelink DRB release procedure according to sub-clause 5.8.9.1a.1.2;
 - 3> else if the sidelink DRB modification conditions as described in sub-clause 5.8.9.1a.2.1 are met:
 - 4> perform the sidelink DRB modification procedure according to sub-clause 5.8.9.1a.2.2;

...

[TS 38.331, clause 5.8.9.1.8]

The UE shall perform the following actions upon reception of the *RRCReconfigurationFailureSidelink*:

- 1> stop timer T400 for the destination, if running;
- 1> continue using the configuration used prior to corresponding *RRCReconfigurationSidelink* message;
- 1> if UE is in *RRC_CONNECTED*:
 - 2> perform the sidelink UE information for NR sidelink communication procedure, as specified in 5.8.3.3 or sub-clause 5.10.15 in TS 36.331 [10];

[TS 38.331, clause 5.8.9.1.9]

The UE shall perform the following actions upon reception of the *RRCReconfigurationCompleteSidelink*:

- 1> stop timer T400 for the destination, if running;
- 1> consider the configurations in the corresponding *RRCReconfigurationSidelink* message to be applied.

[TS 38.331, clause 5.8.9.1a.1]

For NR sidelink communication, a sidelink DRB release is initiated in the following cases:

1> for groupcast, broadcast and unicast, if *slrb-Uu-ConfigIndex* (if any) of the sidelink DRB is included in *sl-RadioBearerToReleaseList* in *sl-ConfigDedicatedNR*; or

1> for groupcast and broadcast, if no sidelink QoS flow with data indicated by upper layers is mapped to the sidelink DRB for transmission, which is (re)configured by receiving *SIB12* or *SidelinkPreconfigNR*; or

1> for groupcast, broadcast and unicast, if *SL-RLC-BearerConfigIndex* (if any) of the sidelink DRB is included in *sl-RLC-BearerToReleaseList* in *sl-ConfigDedicatedNR*; or

1> for unicast, if no sidelink QoS flow with data indicated by upper layers is mapped to the sidelink DRB for transmission, which is (re)configured by receiving *SIB12* or *SidelinkPreconfigNR*, and if no sidelink QoS flow mapped to the sidelink DRB, which is (re)configured by receiving *RRCReconfigurationSidelink*, has data; or

1> for unicast, if *SLRB-PC5-ConfigIndex* (if any) of the sidelink DRB is included in *slrb-ConfigToReleaseList* in *RRCReconfigurationSidelink* or if *sl-ResetConfig* is included in *RRCReconfigurationSidelink*; or

1> for unicast, when the corresponding PC5-RRC connection is released due to sidelink RLF being detected, according to clause 5.8.9.3; or

1> for unicast, when the corresponding PC5-RRC connection is released due to upper layer request according to clause 5.8.9.5.

For each sidelink DRB, whose sidelink DRB release conditions are met as in sub-clause 5.8.9.1a.1.1, the UE capable of NR sidelink communication that is configured by upper layers to perform NR sidelink communication shall:

1> for groupcast and broadcast; or

1> for unicast, if the sidelink DRB release was triggered after the reception of the *RRCReconfigurationSidelink* message; or

1> for unicast, after receiving the *RRCReconfigurationCompleteSidelink* message, if the sidelink DRB release was triggered due to the configuration received within the *sl-ConfigDedicatedNR*, *SIB12*, *SidelinkPreconfigNR* or indicated by upper layers:

2> release the PDCP entity for NR sidelink communication associated with the sidelink DRB;

2> if SDAP entity for NR sidelink communication associated with this sidelink DRB is configured:

3> indicate the release of the sidelink DRB to the SDAP entity associated with this sidelink DRB (TS 37.324 [24], clause 5.3.3);

2> release SDAP entities for NR sidelink communication, if any, that have no associated sidelink DRB as specified in TS 37.324 [24] clause 5.1.2;

1> for groupcast and broadcast; or

1> for unicast, after receiving the *RRCReconfigurationCompleteSidelink* message, if the sidelink DRB release was triggered due to the configuration received within the *sl-ConfigDedicatedNR*:

2> for each *sl-RLC-BearerConfigIndex* included in the received *sl-RLC-BearerToReleaseList* that is part of the current UE sidelink configuration:

3> release the RLC entity and the corresponding logical channel for NR sidelink communication, associated with the *sl-RLC-BearerConfigIndex*.

1> for unicast, if the sidelink DRB release was triggered due to the reception of the *RRCReconfigurationSidelink* message; or

1> for unicast, after receiving the *RRCReconfigurationCompleteSidelink* message, if the sidelink DRB release was triggered due to the configuration received within the *SIB12*, *SidelinkPreconfigNR* or indicated by upper layers:

2> release the RLC entity and the corresponding logical channel for NR sidelink communication associated with the sidelink DRB;

2> perform the sidelink UE information procedure in sub-clause 5.8.3 for unicast if needed.

1> if the sidelink radio link failure is detected for a specific destination:

2> release the PDCP entity, RLC entity and the logical channel of the sidelink DRB for the specific destination.

[TS 38.331, clause 5.8.9.1a.2]

For NR sidelink communication, a sidelink DRB addition is initiated only in the following cases:

1> if any sidelink QoS flow is (re)configured by *sl-ConfigDedicatedNR*, *SIB12*, *SidelinkPreconfigNR* and is to be mapped to one sidelink DRB, which is not established; or

1> if any sidelink QoS flow is (re)configured by *RRCReconfigurationSidelink* and is to be mapped to a sidelink DRB, which is not established;

For NR sidelink communication, a sidelink DRB modification is initiated only in the following cases:

1> if any of the sidelink DRB related parameters is changed by *sl-ConfigDedicatedNR*, *SIB12*, *SidelinkPreconfigNR* or *RRCReconfigurationSidelink* for one sidelink DRB, which is established;

For the sidelink DRB, whose sidelink DRB addition conditions are met as in sub-clause 5.8.9.1a.2.1, the UE capable of NR sidelink communication that is configured by upper layers to perform NR sidelink communication shall:

1> for groupcast and broadcast; or

1> for unicast, if the sidelink DRB addition was triggered due to the reception of the *RRCReconfigurationSidelink* message; or

1> for unicast, after receiving the *RRCReconfigurationCompleteSidelink* message, if the sidelink DRB addition was triggered due to the configuration received within the *sl-ConfigDedicatedNR*, *SIB12*, *SidelinkPreconfigNR* or indicated by upper layers:

2> if an SDAP entity for NR sidelink communication associated with the destination and the cast type of the sidelink DRB does not exist:

3> establish an SDAP entity for NR sidelink communication as specified in TS 37.324 [24] clause 5.1.1;

2> (re)configure the SDAP entity in accordance with the *sl-SDAP-ConfigPC5* received in the *RRCReconfigurationSidelink* or *sl-SDAP-Config* received in *sl-ConfigDedicatedNR*, *SIB12*, *SidelinkPreconfigNR*, associated with the sidelink DRB;

2> establish a PDCP entity for NR sidelink communication and configure it in accordance with the *sl-PDCP-ConfigPC5* received in the *RRCReconfigurationSidelink* or *sl-PDCP-Config* received in *sl-ConfigDedicatedNR*, *SIB12*, *SidelinkPreconfigNR*, associated with the sidelink DRB;

2> establish a RLC entity for NR sidelink communication and configure it in accordance with the *sl-RLC-ConfigPC5* received in the *RRCReconfigurationSidelink* or *sl-RLC-Config* received in *sl-ConfigDedicatedNR*, *SIB12*, *SidelinkPreconfigNR*, associated with sidelink DRB;

2> if this procedure was due to the reception of a *RRCReconfigurationSidelink* message:

3> configure the MAC entity with a logical channel in accordance with the *sl-MAC-LogicalChannelConfigPC5* received in the *RRCReconfigurationSidelink* associated with the sidelink DRB, and perform the sidelink UE information procedure in sub-clause 5.8.3 for unicast if need;

2> else:

3> configure the MAC entity with a logical channel associated with the sidelink DRB, by assigning a new logical channel identity, in accordance with the *sl-MAC-LogicalChannelConfig* received in the *sl-ConfigDedicatedNR*, *SIB12*, *SidelinkPreconfigNR*.

NOTE 1: When a sidelink DRB addition is due to the configuration by *RRCReconfigurationSidelink*, it is up to UE implementation to select the sidelink DRB configuration as necessary transmitting parameters for the sidelink DRB, from the received *sl-ConfigDedicatedNR* (if in RRC_CONNECTED), *SIB12* (if in RRC_IDLE/INACTIVE), *SidelinkPreconfigNR* (if out of coverage) with the same RLC mode as the one configured in *RRCReconfigurationSidelink*.

For the sidelink DRB, whose sidelink DRB modification conditions are met as in sub-clause 5.8.9.1a.2.1, the UE capable of NR sidelink communication that is configured by upper layers to perform NR sidelink communication shall:

1> for groupcast and broadcast; or

1> for unicast, if the sidelink DRB modification was triggered due to the reception of the *RRCReconfigurationSidelink* message; or

1> for unicast, after receiving the *RRCReconfigurationCompleteSidelink* message, if the sidelink DRB modification was triggered due to the configuration received within the *sl-ConfigDedicatedNR*, *SIB12* or *SidelinkPreconfigNR*:

2> reconfigure the SDAP entity of the sidelink DRB, in accordance with the *sl-SDAP-ConfigPC5* received in the *RRCReconfigurationSidelink* or *sl-SDAP-Config* received in *sl-ConfigDedicatedNR*, *SIB12*, *SidelinkPreconfigNR*, if included;

2> reconfigure the PDCP entity of the sidelink DRB, in accordance with the *sl-PDCP-ConfigPC5* received in the *RRCReconfigurationSidelink* or *sl-PDCP-Config* received in *sl-ConfigDedicatedNR*, *SIB12*, *SidelinkPreconfigNR*, if included;

2> reconfigure the RLC entity of the sidelink DRB, in accordance with the *sl-RLC-ConfigPC5* received in the *RRCReconfigurationSidelink* or *sl-RLC-Config* received in *sl-ConfigDedicatedNR*, *SIB12*, *SidelinkPreconfigNR*, if included;

2> reconfigure the logical channel of the sidelink DRB, in accordance with the *sl-MAC-LogicalChannelConfigPC5* received in the *RRCReconfigurationSidelink* or *sl-MAC-LogicalChannelConfig* received in *sl-ConfigDedicatedNR*, *SIB12*, *SidelinkPreconfigNR*, if included.

The UE shall:

1> if a PC5-RRC connection release for a specific destination is requested by upper layers; or

1> if the sidelink radio link failure is detected for a specific destination:

2> release the PDCP entity, RLC entity and the logical channel of the sidelink SRB for PC5-RRC message of the specific destination;

2> consider the PC5-RRC connection is released for the destination.

1> if PC5-S transmission for a specific destination is terminated in upper layers:

2> release the PDCP entity, RLC entity and the logical channel of the sidelink SRB(s) for PC5-S message of the specific destination;

The UE shall:

1> if transmission of PC5-S message for a specific destination is requested by upper layers for sidelink SRB:

2> establish PDCP entity, RLC entity and the logical channel of a sidelink SRB for PC5-S message, as specified in sub-clause 9.1.1.4;

1> if a PC5-RRC connection establishment for a specific destination is indicated by upper layers:

2> establish PDCP entity, RLC entity and the logical channel of a sidelink SRB for PC5-RRC message of the specific destination, as specified in sub-clause 9.1.1.4;

2> consider the PC5-RRC connection is established for the destination.

12.2.4.1.3 Test description

12.2.4.1.3.1 Pre-test conditions

System Simulator:

- SS-NW

- NR Cell 1

- System information combination NR-14 as defined in TS 38.508-1 [4] clause 4.4.3.1 is used in NR Cell 1.

- NR-SS-UE
- NR-SS-UE1: Operating as NR sidelink communication receiving and transmitting device on the resources that UE is expected to use for transmission and reception via PC5 interface.
- NR-SS-UE1 is synchronised on NR Cell 1.

UE:

- UE is authorised to perform NR sidelink communication.
- The UE is equipped with a USIM containing default values as per TS 38.508-1 [4] clause 4.8.3.3.3.
- UE is synchronised on NR Cell 1.

Preamble:

- The UE is in state 3N-B and Test Loop Function (On) with UE test loop mode E as defined in TS 38.508-1 [4], subclause 4.4A on NR Cell 1 using generic procedure parameter Sidelink (On), Cast Type (Unicast) using UE initiated unicast mode NR sidelink communication procedure in subclause 4.9.22.

12.2.4.1.3.2 Test procedure sequence

Table 12.2.4.1.3.2-1: Main behaviour

St	Procedure	Message Sequence		TP	Verdict
		U - S	Message		
1	SS-NW sends an <i>RRCReconfiguration</i> message to establish a groupcast SL DRB.	<--	NR RRC: <i>RRCReconfiguration</i>		
2	Check: Does UE send an <i>RRCReconfigurationComplete</i> message to confirm the establishment of the groupcast SL DRB?	-->	NR RRC: <i>RRCReconfigurationComplete</i>	1	P
3	SS-NW sends an <i>RRCReconfiguration</i> message to establish a unicast SL DRB	<--	NR RRC: <i>RRCReconfiguration</i>		
4	Check: Does UE send an <i>RRCReconfigurationSidelink</i> message to NR-SS-UE1 to indicate SL DRB addition?	-->	PC5 RRC: <i>RRCReconfigurationSidelink</i>	3	P
5	NR-SS-UE1 sends an <i>RRCReconfigurationFailureSidelink</i> message.	<--	PC5 RRC: <i>RRCReconfigurationFailureSidelink</i>		
6	Check: Does UE send a <i>SidelinkUEInformationNR</i> message to inform about sidelink reconfiguration failure?	-->	NR RRC: <i>SidelinkUEInformationNR</i>	3	P
7	SS-NW sends an <i>RRCReconfiguration</i> message to establish a unicast SL DRB	<--	NR RRC: <i>RRCReconfiguration</i>		
8	Check: Does UE send an <i>RRCReconfigurationSidelink</i> message to NR-SS-UE1 to indicate SL DRB addition?	-->	PC5 RRC: <i>RRCReconfigurationSidelink</i>	2	P
9	NR-SS-UE1 sends an <i>RRCReconfigurationCompleteSidelink</i> message.	<--	PC5 RRC: <i>RRCReconfigurationCompleteSidelink</i>		
10	Check: Does UE send an <i>RRCReconfigurationComplete</i> message to confirm the establishment of the unicast SL DRB?	-->	NR RRC: <i>RRCReconfigurationComplete</i>	2	P
10 A	Check: Does the test result of generic test procedure in TS 38.508-1 [4] subclause 4.9.31 indicate that the UE is capable of exchanging IP data on SL DRB established in Step 10?	-		2	
11	SS-NW sends an <i>RRCReconfiguration</i> message to modify the unicast SL DRB	<--	NR RRC: <i>RRCReconfiguration</i>		
12	Check: Does UE send an	-->	PC5 RRC:	4	P

	<i>RRCReconfigurationSidelink</i> message to NR-SS-UE1 to indicate SL DRB modification?		RRCReconfigurationSidelink		
13	NR-SS-UE1 sends an <i>RRCReconfigurationCompleteSidelink</i> message.	<--	PC5 RRC: RRCReconfigurationCompleteSidelink		
14	Check: Does UE send an <i>RRCReconfigurationComplete</i> message to confirm the modification of the unicast SL DRB?	-->	NR RRC: RRCReconfigurationComplete	4	P
14 A	Check: Does the test result of generic test procedure in TS 38.508-1 [4] subclause 4.9.31 indicate that the UE is capable of exchanging IP data on SL DRB modified in Step 14?	-		4	
15	SS-NW sends an <i>RRCReconfiguration</i> message to reconfigure QoS-flow to SL DRB mapping.	<--	NR RRC: RRCReconfiguration		
16	Check: Does UE send an <i>RRCReconfigurationSidelink</i> message to NR-SS-UE1 to indicate the release of the QoS flows mapped to the SL-DRB?	-->	PC5 RRC: RRCReconfigurationSidelink	5	P
17	NR-SS-UE1 sends an <i>RRCReconfigurationCompleteSidelink</i> message.	<--	PC5 RRC: RRCReconfigurationCompleteSidelink		
18	Check: Does UE send an <i>RRCReconfigurationComplete</i> message to confirm the release of the unicast SL DRB?	-->	NR RRC: RRCReconfigurationComplete	5	P
19	SS-NW sends an <i>RRCReconfiguration</i> message to establish a unicast SL DRB	<--	NR RRC: RRCReconfiguration		
20	UE sends an <i>RRCReconfigurationSidelink</i> message to NR-SS-UE1 to indicate SL DRB addition.	-->	PC5 RRC: RRCReconfigurationSidelink		
21	NR-SS-UE1 sends an <i>RRCReconfigurationCompleteSidelink</i> message.	<--	PC5 RRC: RRCReconfigurationCompleteSidelink		
22	UE sends an <i>RRCReconfigurationComplete</i> message	-->	NR RRC: RRCReconfigurationComplete		
23	SS-NW sends an <i>RRCReconfiguration</i> message to release the unicast SL DRB.	<--	NR RRC: RRCReconfiguration		
24	Check: Does UE send an <i>RRCReconfigurationSidelink</i> message to NR-SS-UE1 to indicate SL DRB release?	-->	PC5 RRC: RRCReconfigurationSidelink	6	P
25	NR-SS-UE1 sends an <i>RRCReconfigurationCompleteSidelink</i> message.	<--	PC5 RRC: RRCReconfigurationCompleteSidelink		
26	Check: Does UE send an <i>RRCReconfigurationComplete</i> message to confirm the release of the unicast SL DRB?	-->	NR RRC: RRCReconfigurationComplete	6	P

12.2.4.1.3.3 Specific message contents

Table 12.2.4.1.3.3-1: RRCReconfiguration (step 1, step 3, step 7, step 11, step 15, step 19, step 23, Table 12.2.4.1.3.2-1)

Derivation path: TS 38.508-1 [4], Table 4.6.1-13			
Information Element	Value/Remark	Comment	Condition
RRCReconfiguration ::= SEQUENCE {			
criticalExtensions CHOICE {			
rrcReconfiguration SEQUENCE {			
nonCriticalExtension SEQUENCE {			
nonCriticalExtension SEQUENCE {			
nonCriticalExtension SEQUENCE {			
nonCriticalExtension SEQUENCE {			
sl-ConfigDedicatedNR-r16 CHOICE {			

setup	sl-ConfigDedicatedNR		step 1
	sl-ConfigDedicatedNR-Add		step 3, step 7, step 19
	sl-ConfigDedicatedNR-Mod		step11
	sl-ConfigDedicatedNR-QOS_Rel		step 15
	sl-ConfigDedicatedNR-Rel		step 23
}			
}			
}			
}			
}			
}			
}			
}			
}			

Table 12.2.4.1.3.3-2: sl-ConfigDedicatedNR (Table 12.2.4.1.3.3-1)

Derivation path: TS 38.508-1 [4], Table 4.6.6-7 with condition SL-DRB			
Information Element	Value/Remark	Comment	Condition
SL-ConfigDedicatedNR-r16 ::= SEQUENCE {			
sl-PHY-MAC-RLC-Config-r16 SEQUENCE {			
sl-RLC-BearerToAddModList-r16 SEQUENCE (SIZE (1..maxSL-LCID-r16)) OF SL-RLC-BearerConfig-r16 {	1 entry		
SL-RLC-BearerConfig-r16 [1] SEQUENCE {		entry 1	
sl-RLC-BearerConfigIndex-r16	2		
sl-ServedRadioBearer-r16	2		
}			
}			
sl-RadioBearerToAddModList-r16 SEQUENCE (SIZE (1..maxNrofSLRB-r16)) OF SL-RadioBearerConfig-r16 {	1 entry		
SL-RadioBearerConfig-r16 [1] SEQUENCE {		entry 1	
slrb-Uu-ConfigIndex-r16	2		
sl-SDAP-Config-r16 SEQUENCE {			
sl-DefaultRB-r16	false		
sl-MappedQoS-Flows-r16 CHOICE {			
sl-MappedQoS-FlowsListDedicated-r16 SEQUENCE {			
sl-MappedQoS-FlowsToAddList-r16 SEQUENCE (SIZE (1..maxNrofSL-QFIs-r16)) OF SL-QoS-FlowIdentity-r16{	1 entry		
SL-QoS-FlowIdentity-r16 [1]	2	entry 1	
}			
}			
}			
sl-CastType-r16	groupcast		
}			
}			
}			

Table 12.2.4.1.3.3-3: RRCReconfigurationComplete (step 2, step 10, step 14, step 18, step 22, step 26, Table 12.2.4.1.3.2-1)

Derivation path: TS 38.508-1 [4], Table 4.6.1-14
--

Table 12.2.4.1.3.3-4: sl-ConfigDedicatedNR-Add (Table 12.2.4.1.3.3-1)

Derivation path: TS 38.508-1 [4], Table 4.6.6-7 with condition SL-DRB			
Information Element	Value/Remark	Comment	Condition
SL-ConfigDedicatedNR-r16 ::= SEQUENCE {			
sl-PHY-MAC-RLC-Config-r16 SEQUENCE {			
sl-RLC-BearerToAddModList-r16 SEQUENCE (SIZE (1..maxSL-LCID-r16)) OF SL-RLC-BearerConfig-r16 {	1 entry		
SL-RLC-BearerConfig-r16 [1] SEQUENCE {		entry 1	
sl-RLC-BearerConfigIndex-r16	3		
sl-ServedRadioBearer-r16	3		
}			
}			
}			
sl-RadioBearerToAddModList-r16 SEQUENCE (SIZE (1..maxNrofSLRB-r16)) OF SL-RadioBearerConfig-r16 {	1 entry		
SL-RadioBearerConfig-r16[1] SEQUENCE {		entry 1	
slrb-Uu-ConfigIndex-r16	3		
sl-SDAP-Config-r16 SEQUENCE {			
sl-DefaultRB-r16	false		
sl-MappedQoS-Flows-r16 CHOICE {			
sl-MappedQoS-FlowsListDedicated-r16 SEQUENCE {			
sl-MappedQoS-FlowsToAddList-r16 SEQUENCE (SIZE (1..maxNrofSL-QFIs-r16)) OF SL-QoS-FlowIdentity-r16{	1 entry		
SL-QoS-FlowIdentity-r16 [1]	3	entry 1	
}			
}			
}			
}			
}			
}			
}			

Table 12.2.4.1.3.3-5: RRCReconfigurationSidelink (step 4, step 8, step 20, Table 12.2.4.1.3.2-1)

Derivation path: TS 38.508-1 [4], Table 4.6.1A-3 with condition SL_DRB and TX			
Information Element	Value/Remark	Comment	Condition
RRCReconfigurationSidelink ::= SEQUENCE {			
criticalExtensions CHOICE {			
rrcReconfigurationSidelink-r16 SEQUENCE {			
slrb-ConfigToAddModList-r16 SEQUENCE (SIZE (1..maxNrofSLRB-r16)) OF SLRB-Config-r16 {	1 entry		
SLRB-Config-r16[1] SEQUENCE {		entry 1	
slrb-PC5-ConfigIndex-r16	3		
}			
}			
}			
}			
}			

Table 12.2.4.1.3.3-6: RRCReconfigurationFailureSidelink (step 5, Table 12.2.4.1.3.2-1)

Derivation path: TS 38.508-1 [4], Table 4.6.1A-5 with condition RX

Table 12.2.5.3.3.3-7: SidelinkUEInformationNR (step 6, Table 12.2.4.1.3.2-1)

Derivation path: TS 38.508-1 [4], Table 4.6.1-28A			
Information Element	Value/Remark	Comment	Condition
SidelinkUEInformationNR-r16 ::= SEQUENCE {			

criticalExtensions CHOICE {			
sidelinkUEInformationNR-r16 SEQUENCE {			
sl-FailureList-r16 SEQUENCE (SIZE (1..maxNrofSL-Dest-r16)) OF SL-Failure-r16{	1 entry		
SL-Failure-r16 [1] SEQUENCE {		entry 1	
sl-DestinationIdentity-r16	Not checked		
sl-Failure-r16	configFailure		
}			
}			
}			
}			
}			

Table 12.2.5.3.3.3-8: RRCReconfigurationCompleteSidelink (step 9, step 13, step 17, step 21, step 25, 12.2.4.1.3.2-1)

Derivation path: TS 38.508-1 [4], Table 4.6.1A-4 with condition RX

Table 12.2.4.1.3.3-9: sl-ConfigDedicatedNR-Mod (Table 12.2.4.1.3.3-1)

Derivation path: TS 38.508-1 [4], Table 4.6.6-7			
Information Element	Value/Remark	Comment	Condition
SL-ConfigDedicatedNR-r16 ::= SEQUENCE {			
sl-PHY-MAC-RLC-Config-r16 SEQUENCE {			
sl-RLC-BearerToAddModList-r16 SEQUENCE (SIZE (1..maxSL-LCID-r16)) OF SL-RLC-BearerConfig-r16 {	1 entry		
SL-RLC-BearerConfig-r16 [1] SEQUENCE {		entry 1	
sl-RLC-BearerConfigIndex-r16	3		
sl-ServedRadioBearer-r16	3		
}			
}			
sl-RadioBearerToAddModList-r16 SEQUENCE (SIZE (1..maxNrofSLRB-r16)) OF SL-RadioBearerConfig-r16 {	1 entry		
SL-RadioBearerConfig-r16 [1] SEQUENCE {		entry 1	
slrb-Uu-ConfigIndex-r16	3		
sl-SDAP-Config-r16 SEQUENCE {			
sl-DefaultRB-r16	false		
sl-MappedQoS-Flows-r16 CHOICE {			
sl-MappedQoS-FlowsListDedicated-r16 SEQUENCE {			
sl-MappedQoS-FlowsToAddList-r16 SEQUENCE (SIZE (1..maxNrofSL-QFIs-r16)) OF SL-QoS-FlowIdentity-r16{	1 entry		
SL-QoS-FlowIdentity-r16 [1]	4	entry 1	
}			
}			
}			
}			
}			
}			

Table 12.2.4.1.3.3-10: RRCReconfigurationSidelink (step 12, Table 12.2.4.1.3.2-1)

Derivation path: TS 38.508-1 [4], Table 4.6.1A-3 with condition SL_DRB and TX			
Information Element	Value/Remark	Comment	Condition
RRCReconfigurationSidelink ::= SEQUENCE {			
criticalExtensions CHOICE {			
rrcReconfigurationSidelink-r16 SEQUENCE {			

slrb-ConfigToAddModList-r16 SEQUENCE (SIZE (1..maxNrofSLRB-r16)) OF SLRB-Config-r16 {	1 entry		
SLRB-Config-r16[1] SEQUENCE {		entry 1	
slrb-PC5-ConfigIndex-r16	3		
sl-SDAP-ConfigPC5-r16 SEQUENCE {			
sl-MappedQoS-FlowsToAddList-r16 SEQUENCE (SIZE (1.. maxNrofSL-QFIsPerDest-r16)) OF SL-PQFI-r16 {	1 entry		
SL-PQFI-r16 [1]	4	entry 1	
}			
}			
}			
}			
}			
}			
}			

Table 12.2.4.1.3.3-11: sl-ConfigDedicatedNR-QOS_Rel (Table 12.2.4.1.3.3-1)

Derivation path: TS 38.508-1 [4], Table 4.6.6-7 with condition SL_DRB			
Information Element	Value/Remark	Comment	Condition
SL-ConfigDedicatedNR-r16 ::= SEQUENCE {			
sl-PHY-MAC-RLC-Config-r16 SEQUENCE {			
sl-RLC-BearerToAddModList-r16	Not present		
}			
sl-RadioBearerToAddModList-r16 SEQUENCE (SIZE (1..maxNrofSLRB-r16)) OF SL-RadioBearerConfig-r16 {	1 entry		
SL-RadioBearerConfig-r16[1] SEQUENCE {		entry 1	
slrb-Uu-ConfigIndex-r16	3		
sl-SDAP-Config-r16 SEQUENCE {			
sl-DefaultRB-r16	false		
sl-MappedQoS-Flows-r16 CHOICE {			
sl-MappedQoS-FlowsListDedicated-r16 SEQUENCE {			
sl-MappedQoS-FlowsToAddList-r16	Not present		
sl-MappedQoS-FlowsToReleaseList-r16 SEQUENCE (SIZE (1..maxNrofSL-QFIs-r16)) OF SL-QoS-FlowIdentity-r16{	1 entry		
SL-QoS-FlowIdentity-r16 [1]	4	entry 1	
}			
}			
}			
}			
}			
}			
}			

Table 12.2.4.1.3.3-12: RRCReconfigurationSidelink (step 16, Table 12.2.4.1.3.2-1)

Derivation path: TS 38.508-1 [4], Table 4.6.1A-3 with condition SL_DRB and TX			
Information Element	Value/Remark	Comment	Condition
RRCReconfigurationSidelink ::= SEQUENCE {			
criticalExtensions CHOICE {			
rrcReconfigurationSidelink-r16 SEQUENCE {			
slrb-ConfigToAddModList-r16 SEQUENCE (SIZE (1..maxNrofSLRB-r16)) OF SLRB-Config-r16 {	1 entry		
SLRB-Config-r16[1] SEQUENCE {		entry 1	
slrb-PC5-ConfigIndex-r16	3		
sl-SDAP-ConfigPC5-r16 SEQUENCE {			
sl-MappedQoS-FlowsToReleaseList-r16 SEQUENCE (SIZE (1.. maxNrofSL-QFIsPerDest-r16)) OF SL-PQFI-r16 {	1 entry		
SL-PQFI-r16 [1]	4	entry 1	

}			
}			
}			
}			
}			
}			
}			
}			

Table 12.2.4.1.3.3-13: sl-ConfigDedicatedNR-Rel (Table 12.2.4.1.3.3-1)

Derivation path: TS 38.508-1 [4], Table 4.6.6-7			
Information Element	Value/Remark	Comment	Condition
SL-ConfigDedicatedNR-r16 ::= SEQUENCE {			
sl-PHY-MAC-RLC-Config-r16 SEQUENCE {			
sl-RLC-BearerToReleaseList-r16 SEQUENCE (SIZE (1..maxSL-LCID-r16)) OF SL-RLC-BearerConfigIndex-r16 {	1 entry		
sl-RLC-BearerConfigIndex-r16 [1]	3	entry 1	
}			
}			
sl-RadioBearerToReleaseList-r16 SEQUENCE (SIZE (1..maxNrofSLRB-r16)) OF SLRB-Uu-ConfigIndex-r16 {	1 entry		
SLRB-Uu-ConfigIndex-r16 [1]	3	entry 1	
}			
}			

Table 12.2.4.1.3.3-14: RRCReconfigurationSidelink (step 24, Table 12.2.4.1.3.2-1)

Derivation path: TS 38.508-1 [4], Table 4.6.1A-3 with condition TX			
Information Element	Value/Remark	Comment	Condition
RRCReconfigurationSidelink ::= SEQUENCE {			
criticalExtensions CHOICE {			
rrcReconfigurationSidelink-r16 SEQUENCE {			
slrb-ConfigToReleaseList-r16 SEQUENCE (SIZE (1..maxNrofSLRB-r16)) OF SLRB-PC5-ConfigIndex-r16 {	1 entry		
SLRB-PC5-ConfigIndex-r16 [1]	3	entry 1	
}			
}			
}			
}			

12.2.5 Inter-carrier concurrent operation / Measurement configuration and reporting via PC5 RRC

12.2.5.1 Inter-carrier concurrent operation / Measurement configuration and reporting via PC5 RRC / SL-RSRP measurement configuration

12.2.5.1.1 Test Purpose (TP)

(1)

```

with { UE is on connected state. UE has established PC5 RRC connection with peer UE on unicast
sidelink }
ensure that {
  when { UE receives an RRCReconfiguration message which provides SL-RSRP measurement configuration.
}
  then { UE sends a RRCReconfigurationSidelink message to peer UE. }
}

```

12.2.5.1.2 Conformance requirements

References: The conformance requirements covered in the present TC are specified in: TS 38.331 [22], subclause 5.8.2. Unless otherwise stated these are Rel-16 requirements.

[TS 38.331, clause 5.3.5.3]

The UE shall perform the following actions upon reception of the *RRCReconfiguration*, or upon execution of the conditional reconfiguration (CHO or CPC):

...

1> if the *RRCReconfiguration* message includes the *sl-ConfigDedicatedNR*:

2> perform the sidelink dedicated configuration procedure as specified in 5.3.5.14;

...

1> else (*RRCReconfiguration* was received via SRB1):

2> submit the *RRCReconfigurationComplete* message via SRB1 to lower layers for transmission using the new configuration;

...

[TS 38.331, clause 5.3.5.14]

Upon initiating the procedure, the UE shall:

...

1> if *sl-MeasConfigInfoToAddModList* is included in *sl-ConfigDedicatedNR* within *RRCReconfiguration*:

2> for each *sl-DestinationIndex* included in the received *sl-MeasConfigInfoToAddModList* that is part of the current stored NR sidelink measurement configuration:

3> reconfigure the entry according to the value received for this *sl-DestinationIndex* from the stored NR sidelink measurement configuration information;

2> for each *sl-DestinationIndex* included in the received *sl-MeasConfigInfoToAddModList* that is not part of the current stored NR sidelink measurement configuration:

3> add a new entry for this *sl-DestinationIndex* to the stored NR sidelink measurement configuration.

[TS 38.331, clause 5.8.9.1.1]

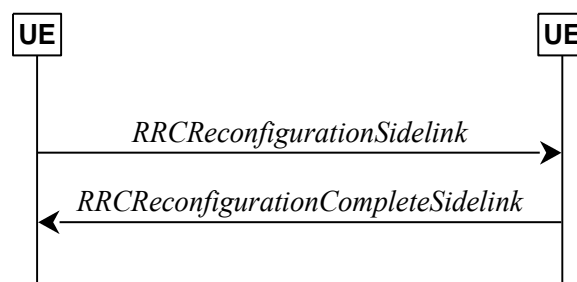

Figure 5.8.9.1.1-1: Sidelink RRC reconfiguration, successful

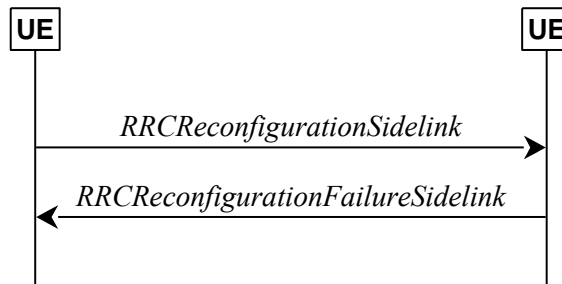

Figure 5.8.9.1.1-2: Sidelink RRC reconfiguration, failure

The purpose of this procedure is to modify a PC5-RRC connection, e.g. to establish/modify/release sidelink DRBs, to (re-)configure NR sidelink measurement and reporting, to (re-)configure sidelink CSI reference signal resources and CSI reporting latency bound.

The UE may initiate the sidelink RRC reconfiguration procedure and perform the operation in sub-clause 5.8.9.1.2 on the corresponding PC5-RRC connection in following cases:

...

- the (re-)configuration of the peer UE to perform NR sidelink measurement and report.

...

In RRC_CONNECTED, the UE applies the NR sidelink communications parameters provided in *RRCReconfiguration* (if any). In RRC_IDLE or RRC_INACTIVE, the UE applies the NR sidelink communications parameters provided in system information (if any). For other cases, UEs apply the NR sidelink communications parameters provided in *SidelinkPreconfigNR* (if any). When UE performs state transition between above three cases, the UE applies the NR sidelink communications parameters provided in the new state, after acquisition of the new configurations. Before acquisition of the new configurations, UE continues applying the NR sidelink communications parameters provided in the old state.

[TS 38.331, clause 5.8.9.1.2]

The UE shall set the contents of *RRCReconfigurationSidelink* message as follows:

...

1> set the *sl-MeasConfig* as follows:

2> If the frequency used for NR sidelink communication is included in *sl-FreqInfoToAddModList* in *sl-ConfigDedicatedNR* within *RRCReconfiguration* message or included in *sl-ConfigCommonNR* within SIB12:

3> if UE is in RRC_CONNECTED:

4> set the *sl-MeasConfig* according to stored NR sidelink measurement configuration information for this destination;

...

The UE shall submit the *RRCReconfigurationSidelink* message to lower layers for transmission.

[TS 38.331, clause 5.8.9.1.3]

The UE shall perform the following actions upon reception of the *RRCReconfigurationSidelink*:

...

1> if the *RRCReconfigurationSidelink* message includes the *sl-MeasConfig*:

2> perform the sidelink measurement configuration procedure as specified in 5.8.10;

...

1> else:

2> set the content of the *RRCReconfigurationCompleteSidelink* message;

3> submit the *RRCReconfigurationCompleteSidelink* message to lower layers for transmission;

12.2.5.1.3 Test description

12.2.5.1.3.1 Pre-test conditions

System Simulator:

- NR Cell
 - NR Cell 1 is the serving cell.
 - System information combination NR-14 as defined in TS 38.508-1 [4] clause 4.4.3.1.2 is used in NR cell 1.
- NR-SS-UE
 - NR-SS-UE 1 operating as NR sidelink communication device on the resources (i.e. the frequency included in pre-configuration) that UE is expected to use for transmission and reception via PC5 interface.

UE:

- UE is authorised to perform NR sidelink communication.
- The UE is equipped with below information in UE or in a USIM containing default values (as per TS 38.508-1 [4]) except for those listed in Table 12.2.5.1.3.1-1.

Table 12.2.5.1.3.1-1: UE/ USIM configuration

USIM field	Priority	Value	Access Technology Identifier
EF _{UST}		As per TS 36.508 [18] clause 4.9.3.4	
EF _{VST}		Service n°119 is "available"	
EF _{V2XP_PC5}		As per TS 38.508-1[4] clause 4.8.3.3.3 SL-PreconfigurationNR included in V2X data policy over PC5 is defined in Table 12.2.5.1.3.3-1	

Preamble:

- The UE is in state 3N-B as defined in TS 38.508-1 [4], subclause 4.4A, using generic procedure parameter Sidelink (On), Unicast (On), and Test Mode (On) as defined in TS 38.508-1 [4], subclause 4.5.1.

12.2.5.1.3.2 Test procedure sequence

Table 12.2.5.1.3.2-1: Main behaviour

St	Procedure	Message Sequence		TP	Verdict
		U - S	Message		
1	The SS transmits an <i>RRCReconfiguration</i> message to provide sidelink measurement configuration.	<--	NR RRC: <i>RRCReconfiguration</i>	-	-
2	The UE transmits an <i>RRCReconfigurationComplete</i> message	-->	NR RRC: <i>RRCReconfigurationComplete</i>	-	-
3	Check: Does the UE transmits an <i>RRCReconfigurationSidelink</i> message to NR-	-->	NR PC5 RRC: <i>RRCReconfigurationSidelink</i>	1	P

	SS-UE 1 to provide sidelink measurement configuration?				
4	The NR-SS-UE 1 transmits an RRCReconfigurationCompleteSidelink message to UE.	<--	NR PC5 RRC: RRCReconfigurationCompleteSidelink	-	-

12.2.5.1.3.3 Specific message contents

Table 12.2.5.1.3.3-1: RRCReconfiguraion (Table 12.2.5.1.3.2-1, Step 1)

Derivation Path: TS 38.508-1 [4], Table 4.6.1-13 with condition SIDELINK			
Information Element	Value/remark	Comment	Condition
RRCReconfiguration ::= SEQUENCE {			
criticalExtensions CHOICE {			
rrcReconfiguration SEQUENCE {			
nonCriticalExtension SEQUENCE {			
nonCriticalExtension SEQUENCE {			
nonCriticalExtension SEQUENCE {			
nonCriticalExtension SEQUENCE {			
sl-ConfigDedicatedNR-r16 CHOICE {			
setup	SL-ConfigDedicatedNR specified in TS 38.508-1 [4] Table 4.6.6-7 with condition SL_MEAS		
}			
}			
}			
}			
}			
}			
}			
}			

Table 12.2.5.1.3.3-2: RRCReconfigurationSidelink (Table 12.2.5.1.3.2-1, Step 3)

Derivation Path: TS 38.508-1 [4], Table 4.6.1A-3 with condition TX and SL_MEAS			
Information Element	Value/remark	Comment	Condition
RRCReconfigurationSidelink ::= SEQUENCE {			
criticalExtensions CHOICE {			
rrcReconfigurationSidelink-r16 SEQUENCE {			
sl-MeasConfig-r16 CHOICE {			
setup SEQUENCE {			
sl-MeasObjectToRemoveList-r16	Not present		
sl-MeasObjectToAddModList-r16	SL-MeasObjectList		
sl-ReportConfigToRemoveList-r16	Not present		
sl-ReportConfigToAddModList-r16	SL-ReportConfigList with condition PERIODICAL		
sl-MeasIdToRemoveList-r16	Not present		
sl-MeasIdToAddModList-r16	SL-MeasIdList		
sl-QuantityConfig-r16	SL-QuantityConfig		
}			
}			
}			
}			
}			

Table 12.2.5.1.3.3-3: RRCReconfigurationCompleteSidelink (Table 12.2.5.1.3.2-1, Step 4)

Derivation Path: TS 38.508-1 [4], Table 4.6.1A-4 with condition RX			
--	--	--	--

12.2.5.2 Inter-carrier concurrent operation / Measurement configuration and reporting via PC5 RRC / SL-RSRP measurement reporting / Event S1 and S2

12.2.5.2.1 Test Purpose (TP)

(1)

```
with { UE is on connected state. UE received an RRCReconfigurationSidelink message from peer UE to
configure event S1 triggered SL-RSRP measurement reporting. }
ensure that {
  when { SL-RSRP measurement on peer UE is below event S1 threshold. }
  then { UE doesn't transmit MeasurementReportSidelink message. }
}
```

(2)

```
with { UE is on connected state. UE received an RRCReconfigurationSidelink message from peer UE to
configure event S1 triggered SL-RSRP measurement reporting. }
ensure that {
  when { SL-RSRP measurement on peer UE is above event S1 threshold. }
  then { UE transmits an MeasurementReportSidelink message to peer UE. }
}
```

(3)

```
with { UE is on connected state. UE received an RRCReconfigurationSidelink message from peer UE to
configure event S2 triggered SL-RSRP measurement reporting. }
ensure that {
  when { SL-RSRP measurement on peer UE is above event S2 threshold. }
  then { UE doesn't transmit MeasurementReportSidelink message. }
}
```

(4)

```
with { UE is on connected state. UE received an RRCReconfigurationSidelink message from peer UE to
configure event S2 triggered SL-RSRP measurement reporting. }
ensure that {
  when { SL-RSRP measurement on peer UE is below event S2 threshold. }
  then { UE transmits an MeasurementReportSidelink message to peer UE. }
}
```

12.2.5.2.2 Conformance requirements

References: The conformance requirements covered in the present TC are specified in: TS 38.331 [22], subclause 5.8.9.1, 5.8.10.2, 5.8.10.3, 5.8.10.4 and 5.8.10.5. Unless otherwise stated these are Rel-16 requirements.

[TS 38.331, clause 5.8.9.1.1]

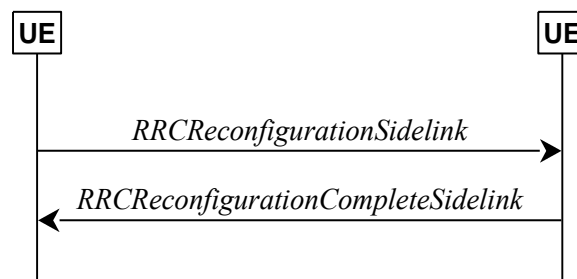

Figure 5.8.9.1.1-1: Sidelink RRC reconfiguration, successful

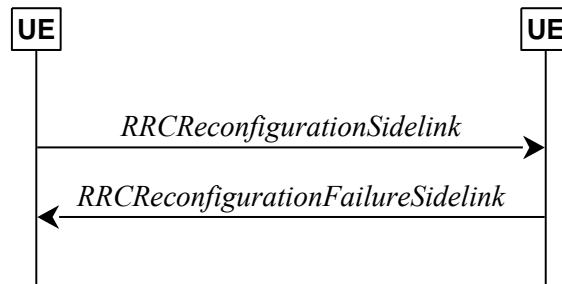

Figure 5.8.9.1.1-2: Sidelink RRC reconfiguration, failure

The purpose of this procedure is to modify a PC5-RRC connection, e.g. to establish/modify/release sidelink DRBs, to (re-)configure NR sidelink measurement and reporting, to (re-)configure sidelink CSI reference signal resources and CSI reporting latency bound.

The UE may initiate the sidelink RRC reconfiguration procedure and perform the operation in sub-clause 5.8.9.1.2 on the corresponding PC5-RRC connection in following cases:

...

- the (re-)configuration of the peer UE to perform NR sidelink measurement and report.

...

In RRC_CONNECTED, the UE applies the NR sidelink communications parameters provided in *RRCReconfiguration* (if any). In RRC_IDLE or RRC_INACTIVE, the UE applies the NR sidelink communications parameters provided in system information (if any). For other cases, UEs apply the NR sidelink communications parameters provided in *SidelinkPreconfigNR* (if any). When UE performs state transition between above three cases, the UE applies the NR sidelink communications parameters provided in the new state, after acquisition of the new configurations. Before acquisition of the new configurations, UE continues applying the NR sidelink communications parameters provided in the old state.

[TS 38.331, clause 5.8.9.1.3]

The UE shall perform the following actions upon reception of the *RRCReconfigurationSidelink*:

...

- 1> if the *RRCReconfigurationSidelink* message includes the *sl-MeasConfig*:
 - 2> perform the sidelink measurement configuration procedure as specified in 5.8.10;

...

- 1> else:
 - 2> set the content of the *RRCReconfigurationCompleteSidelink* message;
 - 3> submit the *RRCReconfigurationCompleteSidelink* message to lower layers for transmission;

NOTE 1: When the same logical channel is configured with different RLC mode by another UE, the UE handles the case as sidelink RRC reconfiguration failure.

[TS 38.331, clause 5.8.9.1.3]

The UE shall perform the following actions upon reception of the *RRCReconfigurationSidelink*:

...

- 1> if the *RRCReconfigurationSidelink* message includes the *sl-MeasConfig*:
 - 2> perform the sidelink measurement configuration procedure as specified in 5.8.10;

...

1> else:

2> set the content of the *RRCReconfigurationCompleteSidelink* message;

3> submit the *RRCReconfigurationCompleteSidelink* message to lower layers for transmission;

[TS 38.331, clause 5.8.10.2.1]

The UE shall:

...

1> if the received *sl-MeasConfig* includes the *sl-MeasObjectToAddModList* in the *RRCReconfigurationSidelink*:

2> perform the sidelink measurement object addition/modification procedure as specified in 5.8.10.2.5;

...

1> if the received *sl-MeasConfig* includes the *sl-ReportConfigToAddModList* in the *RRCReconfigurationSidelink*:

2> perform the sidelink reporting configuration addition/modification procedure as specified in 5.8.10.2.7;

1> if the received *sl-MeasConfig* includes the *sl-QuantityConfig* in the *RRCReconfigurationSidelink*:

2> perform the sidelink quantity configuration procedure as specified in 5.8.10.2.8;

...

1> if the received *sl-MeasConfig* includes the *sl-MeasIdToAddModList* in the *RRCReconfigurationSidelink*:

2> perform the sidelink measurement identity addition/modification procedure as specified in 5.8.10.2.3;

[TS 38.331, clause 5.8.10.2.3]

The UE shall:

1> for each *sl-MeasId* included in the received *sl-MeasIdToAddModList*:

2> if an entry with the matching *sl-MeasId* exists in the *sl-MeasIdList* within the *VarMeasConfigSL*:

3> replace the entry with the value received for this *sl-MeasId*;

2> else:

3> add a new entry for this *sl-MeasId* within the *VarMeasConfigSL*;

2> remove the measurement reporting entry for this *sl-MeasId* from the *VarMeasReportListSL*, if included;

2> stop the periodical reporting timer and reset the associated information (e.g. *sl-TimeToTrigger*) for this *sl-MeasId*;

[TS 38.331, clause 5.8.10.2.5]

The UE shall:

1> for each *sl-MeasObjectId* included in the received *sl-MeasObjectToAddModList*:

2> if an entry with the matching *sl-MeasObjectId* exists in the *sl-MeasObjectList* within the *VarMeasConfigSL*, for this entry:

3> for each *sl-MeasId* associated with this *sl-MeasObjectId* included in the *sl-MeasIdList* within the *VarMeasConfigSL*, if any:

4> remove the measurement reporting entry for this *sl-MeasId* from the *VarMeasReportListSL*, if included;

- 4> stop the periodical reporting timer and reset the associated information (e.g. *sl-TimeToTrigger*) for this *sl-MeasId*;
- 3> reconfigure the entry with the value received for this *sl-MeasObject*;
- 2> else:
 - 3> add a new entry for the received *sl-MeasObject* to the *sl-MeasObjectList* within *VarMeasConfigSL*.

[TS 38.331, clause 5.8.10.2.7]

The UE shall:

- 1> for each *sl-ReportConfigId* included in the received *sl-ReportConfigToAddModList*:
 - 2> if an entry with the matching *sl-ReportConfigId* exists in the *sl-ReportConfigList* within the *VarMeasConfigSL*, for this entry:
 - 3> reconfigure the entry with the value received for this *sl-ReportConfig*;
 - 3> for each *sl-MeasId* associated with this *sl-ReportConfigId* included in the *sl-MeasIdList* within the *VarMeasConfigSL*, if any:
 - 4> remove the measurement reporting entry for this *sl-MeasId* from the *VarMeasReportListSL*, if included;
 - 4> stop the periodical reporting timer and reset the associated information (e.g. *sl-TimeToTrigger*) for this *sl-MeasId*;
 - 2> else:
 - 3> add a new entry for the received *sl-ReportConfig* to the *sl-ReportConfigList* within the *VarMeasConfigSL*.

[TS 38.331, clause 5.8.10.2.8]

The UE shall:

- 1> for each received *sl-QuantityConfig*:
 - 2> set the corresponding parameter(s) in *sl-QuantityConfig* within *VarMeasConfigSL* to the value of the received *sl-QuantityConfig* parameter(s);
- 1> for each *sl-MeasId* included in the *sl-MeasIdList* within *VarMeasConfigSL*:
 - 2> remove the measurement reporting entry for this *sl-MeasId* from the *VarMeasReportListSL*, if included;
 - 2> stop the periodical reporting timer and reset the associated information (e.g. *sl-TimeToTrigger*) for this *sl-MeasId*.

[TS 38.331, clause 5.8.10.3.1]

The UE shall:

- 1> for each *sl-MeasId* included in the *sl-MeasIdList* within *VarMeasConfigSL*:
 - 2> if the *sl-MeasObject* is associated to NR sidelink and the *sl-RS-Type* is set to *dmrs*:
 - 3> derive the layer 3 filtered NR sidelink measurement result based on DMRS for the trigger quantity and each measurement quantity indicated in *sl-ReportQuantity* using parameters from the associated *sl-MeasObject*, as described in 5.8.10.3.2.
 - 2> perform the evaluation of reporting criteria as specified in 5.8.10.4.

[TS 38.331, clause 5.8.10.3.3]

The UE shall:

- 1> for each NR sidelink measurement quantity to be derived based on NR sidelink DMRS:

- 2> derive the corresponding measurement of NR sidelink frequency indicated quantity based on DMRS as described in TS 38.215 [9] in the concerned *sl-MeasObject*;
- 2> apply layer 3 filtering as described in 5.5.3.2;

[TS 38.331, clause 5.8.10.4.1]

The UE shall:

- 1> for each *sl-MeasId* included in the *sl-MeasIdList* within *VarMeasConfigSL*:
 - 2> if the *sl-ReportType* is set to *sl-EventTriggered* and if the entry condition applicable for this event, i.e. the event corresponding with the *sl-EventId* of the corresponding *sl-ReportConfig* within *VarMeasConfigSL*, is fulfilled for NR sidelink frequency for all NR sidelink measurements after layer 3 filtering taken during *sl-TimeToTrigger* defined for this event within the *VarMeasConfigSL*, while the *VarMeasReportListSL* does not include a NR sidelink measurement reporting entry for this *sl-MeasId* (a first NR sidelink frequency triggers the event):
 - 3> include a NR sidelink measurement reporting entry within the *VarMeasReportListSL* for this *sl-MeasId*;
 - 3> set the *sl-NumberOfReportsSent* defined within the *VarMeasReportListSL* for this *sl-MeasId* to 0;
 - 3> include the concerned NR sidelink frequency in the *sl-FrequencyTriggeredList* defined within the *VarMeasReportListSL* for this *sl-MeasId*;
 - 3> initiate the NR sidelink measurement reporting procedure, as specified in 5.8.10.5;
 - ...
 - 2> upon expiry of the periodical reporting timer for this *sl-MeasId*:
 - 3> initiate the NR sidelink measurement reporting procedure, as specified in 5.8.10.5.

[TS 38.331, clause 5.8.10.4.2]

The UE shall:

- 1> consider the entering condition for this event to be satisfied when condition S1-1, as specified below, is fulfilled;
- 1> consider the leaving condition for this event to be satisfied when condition S1-2, as specified below, is fulfilled;
- 1> for this NR sidelink measurement, consider the NR sidelink frequency corresponding to the associated *sl-MeasObject* associated with this event.

Inequality S1-1 (Entering condition)

$$Ms - Hys > Thresh$$

Inequality S1-2 (Leaving condition)

$$Ms + Hys < Thresh$$

The variables in the formula are defined as follows:

Ms is the NR sidelink measurement result of the NR sidelink frequency, not taking into account any offsets.

Hys is the hysteresis parameter for this event (i.e. *sl-Hysteresis* as defined within *sl-ReportConfig* for this event).

Thresh is the threshold parameter for this event (i.e. *sl-Threshold* as defined within *sl-ReportConfig* for this event).

Ms is expressed in dBm in case of RSRP.

Hys is expressed in dB.

Thresh is expressed in the same unit as ***Ms***.

[TS 38.331, clause 5.8.10.4.3]

The UE shall:

- 1> consider the entering condition for this event to be satisfied when condition S2-1, as specified below, is fulfilled;
- 1> consider the leaving condition for this event to be satisfied when condition S2-2, as specified below, is fulfilled;
- 1> for this NR sidelink measurement, consider the NR sidelink frequency indicated by the *sl-MeasObject* associated to this event.

Inequality S2-1 (Entering condition)

$$Ms + Hys < Thresh$$

Inequality S2-2 (Leaving condition)

$$Ms - Hys > Thresh$$

The variables in the formula are defined as follows:

Ms is the NR sidelink measurement result of the NR sidelink frequency, not taking into account any offsets.

Hys is the hysteresis parameter for this event (i.e. *sl-Hysteresis* as defined within *sl-ReportConfig* for this event).

Thresh is the threshold parameter for this event (i.e. *s2-Threshold* as defined within *sl-ReportConfig* for this event).

Ms is expressed in dBm in case of RSRP.

Hys is expressed in dB.

Thresh is expressed in the same unit as ***Ms***.

[TS 38.331, clause 5.8.10.5.1]



Figure 5.8.10.5.1-1: NR sidelink measurement reporting

The purpose of this procedure is to transfer measurement results from the UE to the peer UE associated.

For the *sl-MeasId* for which the NR sidelink measurement reporting procedure was triggered, the UE shall set the *sl-MeasResults* within the *MeasurementReportSidelink* message as follows:

- 1> set the *sl-MeasId* to the measurement identity that triggered the NR sidelink measurement reporting;
- 1> if the *sl-ReportConfig* associated with the *sl-MeasId* that triggered the NR sidelink measurement reporting is set to *sl-EventTriggered* or *sl-Periodical*:
 - 2> set *sl-ResultDMRS* within *sl-MeasResult* to include the NR sidelink DMRS based quantity indicated in the *sl-ReportQuantity* within the concerned *sl-ReportConfig*;
- 1> increment the *sl-NumberOfReportsSent* as defined within the *VarMeasReportListSSL* for this *sl-MeasId* by 1;
- 1> stop the periodical reporting timer, if running;
- 1> if the *sl-NumberOfReportsSent* as defined within the *VarMeasReportListSL* for this *sl-MeasId* is less than the *sl-ReportAmount* as defined within the corresponding *sl-ReportConfig* for this *sl-MeasId*:
 - 2> start the periodical reporting timer with the value of *sl-ReportInterval* as defined within the corresponding *sl-ReportConfig* for this *sl-MeasId*;

1> else:

2> if the *sl-ReportType* is set to *sl-Periodical*:

3> remove the entry within the *VarMeasReportListSL* for this *sl-MeasId*;

3> remove this *sl-MeasId* from the *sl-MeasIdList* within *VarMeasConfigSL*;

1> submit the *MeasurementReportSidelink* message to lower layers for transmission, upon which the procedure ends.

12.2.5.2.3 Test description

12.2.5.2.3.1 Pre-test conditions

System Simulator:

- NR Cell
 - NR Cell 1 is the serving cell.
 - System information combination NR-14 as defined in TS 38.508-1 [4] clause 4.4.3.1.2 is used in NR cell 1.
- NR-SS-UE
 - NR-SS-UE 1 operating as NR sidelink communication device on the resources (i.e. the frequency included in pre-configuration) that UE is expected to use for transmission and reception via PC5 interface.
 - NR-SS-UE 1 keeps transmitting PSCCH/PSSCH in resource pool during the test.

UE:

- UE is authorised to perform NR sidelink communication.
- The UE is equipped with below information in UE or in a USIM containing default values (as per TS 38.508-1 [4]) except for those listed in Table 12.2.5.2.3.1-1.

Table 12.2.5.2.3.1-1: UE/ USIM configuration

USIM field	Priority	Value	Access Technology Identifier
EF _{UST}		As per TS 36.508 [18] clause 4.9.3.4	
EF _{VST}		Service n°119 is "available"	
EF _{V2XP_PC5}		As per TS 38.508-1[4] clause 4.8.3.3.3 SL-PreconfigurationNR included in V2X data policy over PC5 is defined in Table 12.2.5.2.3.3-1	

Preamble:

- The UE is in state 3N-B as defined in TS 38.508-1 [4], subclause 4.4A, using generic procedure parameter Sidelink (On), Unicast (On), and Test Mode (On) as defined in TS 38.508-1 [4], subclause 4.5.1.

12.2.5.2.3.2 Test procedure sequence

Table 12.2.5.2.3.2-1 illustrates the sidelink power levels to be applied for NR-SS-UE 1 at various time instants of the test execution. Row marked "T0" denotes the conditions after the preamble, while the configuration marked "T1" is applied at the point indicated in the Main behaviour description in Table Table 12.2.5.2.3.2-2.

Table 12.2.5.2.3.2-1: Time instances of NR-SS-UE power level and parameter changes in conducted test environment

	Parameter	Unit	NR-SS-UE 1	Remark
T0	NR-SS-UE power	dBm/ SCS	-85	The power level that entering condition of event S1 and leaving condition of event S2 are satisfied:
	EPRE ratio of S-SSS to NR-SS-UE power	dB	0	Inequality S1-1 (Entering condition) Ms – Hys > Thresh Inequality S2-2 (Leaving condition) Ms – Hys > Thresh
T1	NR-SS-UE power	dBm/ SCS	-101	The power level that entering condition of event S2 and leaving condition of event S1 are satisfied:
	EPRE ratio of S-SSS to NR-SS-UE power	dB	0	Inequality S2-1 (Entering condition) Ms + Hys < Thresh Inequality S1-2 (Leaving condition) Ms + Hys < Thresh

Table 12.2.5.2.3.2-2: Main behaviour

St	Procedure	Message Sequence		TP	Verdict
		U - S	Message		
1	The NR-SS-UE 1 transmits an RRCReconfigurationSidelink message to configure event S1 triggered measurement reporting.	<--	NR PC5 RRC: <i>RRCReconfigurationSidelink</i>	-	-
2	The UE transmits an RRCReconfigurationCompleteSidelink message	-->	NR RRC: <i>RRCReconfigurationComplete</i>	-	-
3	The SS waits for 1 seconds	-	-	-	-
4	Check: Does the UE transmits a MeasurementReportSidelink message to NR-SS-UE 1 in the following 5 seconds?	-	-	1	F
5	The SS re-adjusts the NR-SS-UE power level according to row "T1" in Table 12.2.5.2.3.2-1.	-	-	-	-
6	The SS waits for 1 seconds				
7	Check: Does the UE transmits a MeasurementReportSidelink message to NR-SS-UE 1?	-->	NR PC5 RRC: <i>MeasurementReportSidelink</i>	2	P
8	The NR-SS-UE 1 transmits an RRCReconfigurationSidelink message to configure event S2 triggered measurement reporting.	<--	NR PC5 RRC: <i>RRCReconfigurationSidelink</i>	-	-
9	The UE transmits an RRCReconfigurationCompleteSidelink message	-->	NR RRC: <i>RRCReconfigurationComplete</i>	-	-
10	The SS waits for 1 seconds	-	-	-	-
11	Check: Does the UE transmits a MeasurementReportSidelink message to NR-SS-UE 1 in the following 5 seconds?	-	-	3	F
12	The SS re-adjusts the NR-SS-UE power level according to row "T0" in Table 12.2.5.2.3.2-1.	-	-	-	-
13	The SS waits for 1 seconds				
14	Check: Does the UE transmits a MeasurementReportSidelink message to NR-SS-UE 1?	-->	NR PC5 RRC: <i>MeasurementReportSidelink</i>	4	P

12.2.5.2.3.3 Specific message contents

Table 12.2.5.2.3.3-1: RRCReconfigurationSidelink (Table 12.2.5.2.3.2-2, Step 1 and 8)

Derivation Path: TS 38.508-1 [4], Table 4.6.1A-3 with condition RX and SL_MEAS			
Information Element	Value/remark	Comment	Condition
RRCReconfigurationSidelink ::= SEQUENCE {			
criticalExtensions CHOICE {			
rrcReconfigurationSidelink-r16 SEQUENCE {			
sl-MeasConfig-r16 CHOICE {			
setup SEQUENCE {			
sl-MeasObjectToAddModList-r16	SL-MeasObjectList specified in TS 38.508-1 [4] Table 4.6.6-16		Step 1
	Not present		Step 8
sl-ReportConfigToAddModList-r16	SL-ReportConfigList (-93) specified in TS 38.508-1 [4] Table 4.6.6-24 with condition EVENT_S1		Step 1
	SL-ReportConfigList (-93) specified in TS 38.508-1 [4] Table 4.6.6-24 with condition EVENT_S2		Step 8
sl-MeasIdToAddModList-r16	SL-MeasIdList specified in TS 38.508-1 [4] Table 4.6.6-15		Step 1
	Not present		Step 8
sl-QuantityConfig-r16	SL-QuantityConfig		Step 1
	Not present		Step 8
}			
}			
}			
}			
}			

Table 12.2.5.2.3.3-2: RRCReconfigurationCompleteSidelink (Table 12.2.5.2.3.2-2, Step 2 and 9)

Derivation Path: TS 38.508-1 [4], Table 4.6.1A-4 with condition TX
--

Table 12.2.5.2.3.3-3: MeasurementReportSidelink (Table 12.2.5.2.3.2-2, Step 7 and 14)

Derivation Path: TS 38.508-1 [4], Table 4.6.1A-2 with condition TX
--

12.2.5.3 Inter-carrier concurrent operation / Measurement configuration and reporting via PC5 RRC / PSBCH-RSRP measurement reporting / Periodical reporting

12.2.5.3.1 Test Purpose (TP)

(1)

```

with { UE configured to perform periodical PSBCH-RSRP measurement reporting on SL SSB via PC5 RRC }
ensure that {
  when { The first measurement result is available and thereafter every time periodical timer expires}
  then { UE triggers PSBCH-RSRP measurement reporting until the total number of measurement reports is 16}
}
    
```

12.2.5.3.2 Conformance requirements

References: The conformance requirements covered in the present TC are specified in: TS 38.331, clauses 5.8.1, 5.8.9.1.2, 5.8.9.1.3, 5.8.9.1.9, 5.8.10.2. 1, 5.8.10.3.1, 5.8.10.3.2 and 5.8.10.5.1. Unless otherwise stated these are Rel-16 requirements.

[TS 38.331, clause 5.8.1]

The PC5-RRC signalling, as specified in sub-clause 5.8.9, can be initiated after its corresponding PC5 unicast link establishment (TS 23.287 [55]).

[TS 38.331, clause 5.8.9.1.2]

The UE shall set the contents of *RRCReconfigurationSidelink* message as follows:

- 1> for each sidelink DRB that is to be released, according to sub-clause 5.8.9.1a.1.1, due to configuration by *sl-ConfigDedicatedNR*, *SIB12*, *SidelinkPreconfigNR* or by upper layers:
 - 2> set the *SLRB-PC5-ConfigIndex* included in the *slrb-ConfigToReleaseList* corresponding to the sidelink DRB;
- 1> for each sidelink DRB that is to be established or modified, according to sub-clause 5.8.9.1a.2.1, due to receiving *sl-ConfigDedicatedNR*, *SIB12* or *SidelinkPreconfigNR*:
 - 2> set the *SLRB-Config* included in the *slrb-ConfigToAddModList*, according to the received *sl-RadioBearerConfig* and *sl-RLC-BearerConfig* corresponding to the sidelink DRB;
 - 1> set the *sl-MeasConfig* as follows:
 - 2> If the frequency used for NR sidelink communication is included in *sl-FreqInfoToAddModList* in *sl-ConfigDedicatedNR* within *RRCReconfiguration* message or included in *sl-ConfigCommonNR* within *SIB12*:
 - 3> if UE is in *RRC_CONNECTED*:
 - 4> set the *sl-MeasConfig* according to stored NR sidelink measurement configuration information for this destination;
 - 3> if UE is in *RRC_IDLE* or *RRC_INACTIVE*:
 - 4> set the *sl-MeasConfig* according to stored NR sidelink measurement configuration received from *SIB12*;
 - 2> else:
 - 3> set the *sl-MeasConfig* according to the *sl-MeasPreconfig* in *SidelinkPreconfigNR*;
 - 1> start timer T400 for the destination associated with the sidelink DRB;
 - 1> set the *sl-CSI-RS-Config*;
 - 1> set the *sl-LatencyBoundCSI-Report*,

NOTE 1: How to set the parameters included in *sl-CSI-RS-Config* and *sl-LatencyBoundCSI-Report* is up to UE implementation.

The UE shall submit the *RRCReconfigurationSidelink* message to lower layers for transmission.

[TS 38.331, clause 5.8.9.1.3]

The UE shall perform the following actions upon reception of the *RRCReconfigurationSidelink*:

- 1> if the *RRCReconfigurationSidelink* includes the *sl-ResetConfig*:
 - 2> perform the sidelink reset configuration procedure as specified in 5.8.9.1.10;
- 1> if the *RRCReconfigurationSidelink* includes the *slrb-ConfigToReleaseList*:
 - 2> for each *SLRB-PC5-ConfigIndex* value included in the *slrb-ConfigToReleaseList* that is part of the current UE sidelink configuration;
 - 3> perform the sidelink DRB release procedure, according to sub-clause 5.8.9.1a.1;

- 1> if the *RRCReconfigurationSidelink* includes the *slrb-ConfigToAddModList*:
- 2> for each *slrb-PC5-ConfigIndex* value included in the *slrb-ConfigToAddModList* that is not part of the current UE sidelink configuration:
 - 3> if *sl-MappedQoS-FlowsToAddList* is included:
 - 4> apply the *SL-PQFI* included in *sl-MappedQoS-FlowsToAddList*;
 - 3> perform the sidelink DRB addition procedure, according to sub-clause 5.8.9.1a.2;
 - 2> for each *slrb-PC5-ConfigIndex* value included in the *slrb-ConfigToAddModList* that is part of the current UE sidelink configuration:
 - 3> if *sl-MappedQoS-FlowsToAddList* is included:
 - 4> add the *SL-PQFI* included in *sl-MappedQoS-FlowsToAddList* to the corresponding sidelink DRB;
 - 3> if *sl-MappedQoS-FlowsToReleaseList* is included:
 - 4> remove the *SL-PQFI* included in *sl-MappedQoS-FlowsToReleaseList* from the corresponding sidelink DRB;
 - 3> if the sidelink DRB release conditions as described in sub-clause 5.8.9.1a.1.1 are met:
 - 4> perform the sidelink DRB release procedure according to sub-clause 5.8.9.1a.1.2;
 - 3> else if the sidelink DRB modification conditions as described in sub-clause 5.8.9.1a.2.1 are met:
 - 4> perform the sidelink DRB modification procedure according to sub-clause 5.8.9.1a.2.2;
- 1> if the *RRCReconfigurationSidelink* message includes the *sl-MeasConfig*:
 - 2> perform the sidelink measurement configuration procedure as specified in 5.8.10;
- 1> if the *RRCReconfigurationSidelink* message includes the *sl-CSI-RS-Config*:
 - 2> apply the sidelink CSI-RS configuration;
- 1> if the *RRCReconfigurationSidelink* message includes the *sl-LatencyBoundCSI-Report*:
 - 2> apply the configured sidelink CSI report latency bound;
- 1> if the UE is unable to comply with (part of) the configuration included in the *RRCReconfigurationSidelink* (i.e. sidelink RRC reconfiguration failure):
 - 2> continue using the configuration used prior to the reception of the *RRCReconfigurationSidelink* message;
 - 2> set the content of the *RRCReconfigurationFailureSidelink* message;
 - 3> submit the *RRCReconfigurationFailureSidelink* message to lower layers for transmission;
- 1> else:
 - 2> set the content of the *RRCReconfigurationCompleteSidelink* message;
 - 3> submit the *RRCReconfigurationCompleteSidelink* message to lower layers for transmission;

NOTE 1: When the same logical channel is configured with different RLC mode by another UE, the UE handles the case as sidelink RRC reconfiguration failure.

[TS 38.331, clause 5.8.9.1.9]

The UE shall perform the following actions upon reception of the *RRCReconfigurationCompleteSidelink*:

- 1> stop timer T400 for the destination, if running;
- 1> consider the configurations in the corresponding *RRCReconfigurationSidelink* message to be applied.

[TS 38.331, clause 5.8.10.2]

The UE shall:

- 1> if the received *sl-MeasConfig* includes the *sl-MeasObjectToRemoveList* in the *RRCReconfigurationSidelink*:
- 2> perform the sidelink measurement object removal procedure as specified in 5.8.10.2.4;
- 1> if the received *sl-MeasConfig* includes the *sl-MeasObjectToAddModList* in the *RRCReconfigurationSidelink*:
- 2> perform the sidelink measurement object addition/modification procedure as specified in 5.8.10.2.5;
- 1> if the received *sl-MeasConfig* includes the *sl-ReportConfigToRemoveList* in the *RRCReconfigurationSidelink*:
- 2> perform the sidelink reporting configuration removal procedure as specified in 5.8.10.2.6;
- 1> if the received *sl-MeasConfig* includes the *sl-ReportConfigToAddModList* in the *RRCReconfigurationSidelink*:
- 2> perform the sidelink reporting configuration addition/modification procedure as specified in 5.8.10.2.7;
- 1> if the received *sl-MeasConfig* includes the *sl-QuantityConfig* in the *RRCReconfigurationSidelink*:
- 2> perform the sidelink quantity configuration procedure as specified in 5.8.10.2.8;
- 1> if the received *sl-MeasConfig* includes the *sl-MeasIdToRemoveList* in the *RRCReconfigurationSidelink*:
- 2> perform the sidelink measurement identity removal procedure as specified in 5.8.10.2.2;
- 1> if the received *sl-MeasConfig* includes the *sl-MeasIdToAddModList* in the *RRCReconfigurationSidelink*:
- 2> perform the sidelink measurement identity addition/modification procedure as specified in 5.8.10.2.3;

[TS 38.331, clause 5.8.10.3.1]

A UE shall derive NR sidelink measurement results by measuring one or multiple DMRS associated per PC5-RRC connection as configured by the peer UE associated, as described in 5.8.10.3.2. For all NR sidelink measurement results the UE applies the layer 3 filtering as specified in sub-clause 5.5.3.2, before using the measured results for evaluation of reporting criteria and measurement reporting. In this release, only NR sidelink RSRP can be configured as trigger quantity and reporting quantity.

The UE shall:

- 1> for each *sl-MeasId* included in the *sl-MeasIdList* within *VarMeasConfigSL*:
- 2> if the *sl-MeasObject* is associated to NR sidelink and the *sl-RS-Type* is set to *dmrs*:
- 3> derive the layer 3 filtered NR sidelink measurement result based on DMRS for the trigger quantity and each measurement quantity indicated in *sl-ReportQuantity* using parameters from the associated *sl-MeasObject*, as described in 5.8.10.3.2.
- 2> perform the evaluation of reporting criteria as specified in 5.8.10.4.

[TS 38.331, clause 5.8.10.3.2]

The UE may be configured by the peer UE associated to derive NR sidelink RSRP measurement results per PC5-RRC connection associated to the NR sidelink measurement objects based on parameters configured in the *sl-MeasObject* and in the *sl-ReportConfig*.

The UE shall:

- 1> for each NR sidelink measurement quantity to be derived based on NR sidelink DMRS:
- 2> derive the corresponding measurement of NR sidelink frequency indicated quantity based on DMRS as described in TS 38.215 [9] in the concerned *sl-MeasObject*;
- 2> apply layer 3 filtering as described in 5.5.3.2;

[TS 38.331, clause 5.8.10.5.1]



Figure 5.8.10.5.1-1: NR sidelink measurement reporting

The purpose of this procedure is to transfer measurement results from the UE to the peer UE associated.

For the *sl-MeasId* for which the NR sidelink measurement reporting procedure was triggered, the UE shall set the *sl-MeasResults* within the *MeasurementReportSidelink* message as follows:

- 1> set the *sl-MeasId* to the measurement identity that triggered the NR sidelink measurement reporting;
- 1> if the *sl-ReportConfig* associated with the *sl-MeasId* that triggered the NR sidelink measurement reporting is set to *sl-EventTriggered* or *sl-Periodical*:
 - 2> set *sl-ResultDMRS* within *sl-MeasResult* to include the NR sidelink DMRS based quantity indicated in the *sl-ReportQuantity* within the concerned *sl-ReportConfig*;
- 1> increment the *sl-NumberOfReportsSent* as defined within the *VarMeasReportListSSL* for this *sl-MeasId* by 1;
- 1> stop the periodical reporting timer, if running;
- 1> if the *sl-NumberOfReportsSent* as defined within the *VarMeasReportListSL* for this *sl-MeasId* is less than the *sl-ReportAmount* as defined within the corresponding *sl-ReportConfig* for this *sl-MeasId*:
 - 2> start the periodical reporting timer with the value of *sl-ReportInterval* as defined within the corresponding *sl-ReportConfig* for this *sl-MeasId*;
- 1> else:
 - 2> if the *sl-ReportType* is set to *sl-Periodical*:
 - 3> remove the entry within the *VarMeasReportListSL* for this *sl-MeasId*;
 - 3> remove this *sl-MeasId* from the *sl-MeasIdList* within *VarMeasConfigSL*;
- 1> submit the *MeasurementReportSidelink* message to lower layers for transmission, upon which the procedure ends.

12.2.5.3.3 Test description

12.2.5.3.3.1 Pre-test conditions

System Simulator:

- SS-NW
 - NR Cell 1
 - System information combination NR-14 as defined in TS 38.508-1 [4] clause 4.4.3.1 is used in NR Cell 1.
- NR-SS-UE
 - NR-SS-UE1: Operating as NR sidelink communication transmitting and receiving device on the resources that UE is expected to use for reception and transmission via PC5 interface.
 - NR-SS-UE1 is synchronised on NR Cell 1.

UE:

- UE is authorised to perform NR sidelink communication.

- The UE is equipped with a USIM containing default values as per TS 38.508-1 [4] clause 4.8.3.3.3.
- UE is synchronised on NR Cell 1.

Preamble:

- The UE is in state 3N-A as defined in TS 38.508-1 [4], subclause 4.4A on NR Cell 1, using generic procedure parameters Sidelink (On), Cast Type (Unicast) using UE initiated unicast mode NR sidelink communication procedure in subclause 4.9.22.

12.2.5.3.3.2 Test procedure sequence

Table 12.2.5.3.3.2-1: Main behaviour

St	Procedure	Message Sequence		TP	Verdict
		U - S	Message		
0	NR-SS-UE1 transmits SLSS and <i>MasterInformationBlockSidelink</i> (Note 1).	<--	PC5 RRC: SLSS & <i>MasterInformationBlockSidelink</i>	-	-
1	NR-SS-UE1 sends an <i>RRCReconfigurationSidelink</i> message to configure the UE to perform periodical PSBCH-RSRP measurement reporting	<--	PC5 RRC: <i>RRCReconfigurationSidelink</i>		
2	UE sends an <i>RRCReconfigurationCompleteSidelink</i> message	-->	PC5 RRC: <i>RRCReconfigurationCompleteSidelink</i>		
3	Check: Does the UE transmit a <i>MeasurementReportSidelink</i> message to perform periodical reporting?	-->	PC5 RRC: <i>MeasurementReportSidelink</i>	1	P
-	EXCEPTION: After the 1st <i>MeasurementReportSidelink</i> message at step 3 is received, step 4 below is repeated until 15 <i>MeasurementReport</i> messages are received from the UE. The interval between two <i>MeasurementReportSidelink</i> shall be as specified by the IE <i>sl-ReportInterval</i>				
4	Check: Does the UE transmit a <i>MeasurementReportSidelink</i> message to perform periodical reporting?	-->	PC5 RRC: <i>MeasurementReportSidelink</i>	1	P

Note 1: UE is using TS 38.508-1 [4] Table 4.6.6-31: SL-SyncConfig parameters to transmit SLSS.

12.2.5.3.3.3 Specific message contents

Table 12.2.5.3.3.3-0: MasterInformationBlockSidelink (step 0, Table 12.2.5.3.3.2-1)

Derivation path: TS 38.508-1 [4], Table 4.6.1A-1 with condition RX AND NB_SYNC
--

Table 12.2.5.3.3.3-1: RRCReconfigurationSidelink (step 1, Table 12.2.5.3.3.2-1)

Derivation Path: TS 38.508-1 [4], Table 4.6.1A-3 with condition SL_MEAS and RX			
Information Element	Value/remark	Comment	Condition
<i>RRCReconfigurationSidelink</i> ::= SEQUENCE {			
<i>criticalExtensions</i> CHOICE {			
<i>rrcReconfigurationSidelink-r16</i> SEQUENCE {			
<i>sl-MeasConfig-r16</i> CHOICE {			
<i>setup</i> SEQUENCE {			
<i>sl-ReportConfigToAddModList-r16</i>	SL-ReportConfigList	Table 12.2.5.3.3.3-2	
}			
}			
}			
}			
}			

Table 12.2.5.3.3.3-2: SL-ReportConfigList (Table 12.2.5.3.3.3-1)

Derivation path: TS 38.508-1 [4], Table 4.6.6-24 with condition PERIODICAL			
Information Element	Value/Remark	Comment	Condition
SL-ReportConfigList-r16 ::= SEQUENCE (SIZE (1..maxNrofSL-ReportConfigId-r16)) OF SL-ReportConfigInfo-r16 {	1 entry		
SL-ReportConfigInfo-r16[1] SEQUENCE {		entry 1	
sl-ReportConfig-r16 SEQUENCE {			
sl-ReportType-r16 CHOICE {			
sl-Periodical-r16 SEQUENCE {			
sl-ReportAmount-r16	16		
}			
}			
}			
}			
}			

Table 12.2.5.3.3.3-3: RRCReconfigurationCompleteSidelink (step 2, Table 12.2.5.3.3.2-1)

Derivation path: TS 38.508-1 [4], Table 4.6.1A-4 with condition TX
--

Table 12.2.5.3.3.3-4: MeasurementReportSidelink (step 3, step 4, Table 12.2.5.3.3.2-1)

Derivation path: TS 38.508-1 [4], Table 4.6.1A-2 with condition TX
--

12.2.6 Inter-carrier concurrent operation / Sidelink Reconfiguration via PC5 RRC

12.2.6.1 Inter-carrier concurrent operation / Sidelink Reconfiguration via PC5 RRC / SL DRB management / Initiating UE side

12.2.6.1.1 Test Purpose (TP)

(1)

```
with { UE in NR RRC_CONNECTED state and having established PC5-RRC connection with peer UE }
ensure that {
  when { UE is indicated by upper layer to establish a unicast SL DRB }
  then { UE sends a RRCReconfigurationSidelink message to peer UE to indicate SL DRB addition.
After receiving RRCReconfigurationCompleteSidelink message from peer UE, UE establishes the SL DRB }
}
```

(2)

```
with { UE in NR RRC_CONNECTED state and having established PC5-RRC connection with peer UE and
having established a unicast SL DRB }
ensure that {
  when { UE is indicated by upper layer to release the unicast SL DRB }
  then { UE sends a RRCReconfigurationSidelink message to peer UE to indicate SL DRB release.
After receiving RRCReconfigurationCompleteSidelink message from peer UE, UE releases the SL DRB }
}
```

12.2.6.1.2 Conformance requirements

References: The conformance requirements covered in the current TC are specified in: TS 38.331, clause 5.8.9.1.1, 5.8.9.1.2, 5.8.9.1a.2.1 and 5.8.9.1a.1.1. Unless otherwise stated these are Rel-16 requirements.

[TS 38.331, clause 5.8.9.1.1]

...

The UE may initiate the sidelink RRC reconfiguration procedure and perform the operation in sub-clause 5.8.9.1.2 on the corresponding PC5-RRC connection in following cases:

- the release of sidelink DRBs associated with the peer UE, as specified in sub-clause 5.8.9.1a.1;
- the establishment of sidelink DRBs associated with the peer UE, as specified in sub-clause 5.8.9.1a.2;
- the modification for the parameters included in *SLRB-Config* of sidelink DRBs associated with the peer UE, as specified in sub-clause 5.8.9.1a.2;
- the (re-)configuration of the peer UE to perform NR sidelink measurement and report.
- the (re-)configuration of the sidelink CSI reference signal resources and CSI reporting latency bound.

In *RRC_CONNECTED*, the UE applies the NR sidelink communications parameters provided in *RRCReconfiguration* (if any). In *RRC_IDLE* or *RRC_INACTIVE*, the UE applies the NR sidelink communications parameters provided in system information (if any). For other cases, UEs apply the NR sidelink communications parameters provided in *SidelinkPreconfigNR* (if any). When UE performs state transition between above three cases, the UE applies the NR sidelink communications parameters provided in the new state, after acquisition of the new configurations. Before acquisition of the new configurations, UE continues applying the NR sidelink communications parameters provided in the old state.

[TS 38.331, clause 5.8.9.1.2]

The UE shall set the contents of *RRCReconfigurationSidelink* message as follows:

- 1> for each sidelink DRB that is to be released, according to sub-clause 5.8.9.1a.1.1, due to configuration by *sl-ConfigDedicatedNR*, *SIB12*, *SidelinkPreconfigNR* or by upper layers:
 - 2> set the *SLRB-PC5-ConfigIndex* included in the *slrb-ConfigToReleaseList* corresponding to the sidelink DRB;
- 1> for each sidelink DRB that is to be established or modified, according to sub-clause 5.8.9.1a.2.1, due to receiving *sl-ConfigDedicatedNR*, *SIB12* or *SidelinkPreconfigNR*:
 - 2> set the *SLRB-Config* included in the *slrb-ConfigToAddModList*, according to the received *sl-RadioBearerConfig* and *sl-RLC-BearerConfig* corresponding to the sidelink DRB;

...

- 1> start timer T400 for the destination associated with the sidelink DRB;

...

The UE shall submit the *RRCReconfigurationSidelink* message to lower layers for transmission.

[TS 38.331, clause 5.8.9.1a.2.1]

For NR sidelink communication, a sidelink DRB addition is initiated only in the following cases:

- 1> if any sidelink QoS flow is (re)configured by *sl-ConfigDedicatedNR*, *SIB12*, *SidelinkPreconfigNR* and is to be mapped to one sidelink DRB, which is not established; or
- 1> if any sidelink QoS flow is (re)configured by *RRCReconfigurationSidelink* and is to be mapped to a sidelink DRB, which is not established;

...

[TS 38.331, clause 5.8.9.1a.1.1]

For NR sidelink communication, a sidelink DRB release is initiated in the following cases:

- 1> for groupcast, broadcast and unicast, if *slrb-Uu-ConfigIndex* (if any) of the sidelink DRB is included in *sl-RadioBearerToReleaseList* in *sl-ConfigDedicatedNR*; or

...

- 1> for groupcast, broadcast and unicast, if *SL-RLC-BearerConfigIndex* (if any) of the sidelink DRB is included in *sl-RLC-BearerToReleaseList* in *sl-ConfigDedicatedNR*; or
- 1> for unicast, if no sidelink QoS flow with data indicated by upper layers is mapped to the sidelink DRB for transmission, which is (re)configured by receiving *SIB12* or *SidelinkPreconfigNR*, and if no sidelink QoS flow mapped to the sidelink DRB, which is (re)configured by receiving *RRCReconfigurationSidelink*, has data; or
- 1> for unicast, if *SLRB-PC5-ConfigIndex* (if any) of the sidelink DRB is included in *slrb-ConfigToReleaseList* in *RRCReconfigurationSidelink* or if *sl-ResetConfig* is included in *RRCReconfigurationSidelink*; or
- 1> for unicast, when the corresponding PC5-RRC connection is released due to sidelink RLF being detected, according to clause 5.8.9.3; or
- 1> for unicast, when the corresponding PC5-RRC connection is released due to upper layer request according to clause 5.8.9.5.

12.2.6.1.3 Test description

12.2.6.1.3.1 Pre-test conditions

System Simulator:

- SS-NW
 - NR Cell 1
 - System information combination 14 as defined in TS 38.508-1 [4] clause 4.4.3.1 is used in NR Cell 1.
- NR-SS-UE
 - NR-SS-UE1: Operating as NR sidelink communication transmitting and receiving device and uses GNSS as the synchronization reference source.
- GNSS simulator
- The GNSS simulator is started and configured for Scenario #1.

UE:

- UE is authorised to perform NR sidelink communication.
- The UE is equipped with a USIM Configuration FFS as defined in TS 38.508 [4] Table FFS.
- The UE uses GNSS as the synchronization reference source.

Preamble:

- The UE is in state 3N-B RRC_CONNECTED_with_SL and Test Loop Function (*On*) with UE test loop mode E as defined in TS 38.508-1 [4] subclause 4.4A on NR Cell 1, using generic parameters Sidelink (*On*), Cast Type (Unicast), GNSS Sync (*On*).

12.2.6.1.3.2 Test procedure sequence

Table 12.2.6.1.3.2-1: Main behaviour

St	Procedure	Message Sequence		TP	Verdict
		U - S	Message		
1	The UE is configured by upper layer to establish a unicast SL DRB. Note: This step is triggered by MMI or AT command	-	-	-	-
2	The UE sends a <i>RRCReconfigurationSidelink</i> message to establish a unicast mode SL DRB.	-->	PC5-RRC: <i>RRCReconfigurationSidelink</i>	1	P
3	The NR-SS-UE1 sends a	<--	PC5-RRC:	-	-

	RRCReconfigurationSidelinkComplete message.		RRCReconfigurationSidelinkComplete		
4	The NR-SS-UE1 transmits the data on SL DRB to the UE. NOTE: it is expected that the UE shall receive the data - if they were received is checked in step 6.	-	-	-	-
5	The NR-SS-UE1 transmits an UE TEST LOOP NR SIDELINK PACKET COUNTER REQUEST message.	<--	UE TEST LOOP NR SIDELINK PACKET COUNTER REQUEST	-	-
6	Check: Does the UE respond with UE TEST LOOP NR SIDELINK PACKET COUNTER RESPONSE?	-->	UE TEST LOOP NR SIDELINK PACKET COUNTER RESPONSE	-	-
7	The UE is configured by upper layer to release the unicast SL DRB added by step 2. Note: This step is triggered by MMI or AT command	-	-	-	-
8	The UE sends a RRCReconfigurationSidelink message to release the unicast mode SL DRB added by step 2.	-->	PC5-RRC: RRCReconfigurationSidelink	2	P
9	The NR-SS-UE1 sends a RRCReconfigurationSidelinkComplete message.	<--	PC5-RRC: RRCReconfigurationSidelinkComplete	-	-

12.2.6.1.3.3 Specific message contents

FFS

12.2.7 Inter-carrier concurrent operation / Sidelink CSI reporting

12.2.7.1 Inter-carrier concurrent operation / Sidelink CSI reporting / Configuration

12.2.7.1.1 Test Purpose (TP)

(1)

```
with { UE in NR RRC_CONNECTED state and having established PC5 RRC connection with peer UE }
ensure that {
  when { UE is configured by upper layer to configure SL CSI-RS resource to peer UE }
  then { UE sends an RRCReconfigurationSidelink message including sl-CSI-RS-Config and sl-LatencyBoundCSI-Report to peer UE and starts to transmit SL CSI-RS }
}
```

(2)

```
with { UE in NR RRC_CONNECTED and having established PC5 RRC connection with peer UE }
ensure that {
  when { UE is configured by upper layer to trigger SL CSI report }
  then { UE sends an SCI format 2-A to trigger SL CSI report and the 'CSI request' field in the corresponding SCI format 2-A is set to 1 }
}
```

12.2.7.1.2 Conformance requirements

References: The conformance requirements covered in the current TC are specified in: TS 38.331 clause 5.8.9.1.1, 5.8.9.1.2, TS 38.214 clause 8.5.2.2, 8.2.1, TS 38.212 clause 8.3.1.1 and 8.4.1.1. Unless otherwise stated these are Rel-16 requirements.

[TS 38.331, clause 5.8.9.1.1]

The purpose of this procedure is to modify a PC5-RRC connection, e.g. to establish/modify/release sidelink DRBs, to (re-)configure NR sidelink measurement and reporting, to (re-)configure sidelink CSI reference signal resources and CSI reporting latency bound.

The UE may initiate the sidelink RRC reconfiguration procedure and perform the operation in sub-clause 5.8.9.1.2 on the corresponding PC5-RRC connection in following cases:

...

- the (re-)configuration of the sidelink CSI reference signal resources and CSI reporting latency bound.

In RRC_CONNECTED, the UE applies the NR sidelink communications parameters provided in *RRCReconfiguration* (if any). In RRC_IDLE or RRC_INACTIVE, the UE applies the NR sidelink communications parameters provided in system information (if any). For other cases, UEs apply the NR sidelink communications parameters provided in *SidelinkPreconfigNR* (if any). When UE performs state transition between above three cases, the UE applies the NR sidelink communications parameters provided in the new state, after acquisition of the new configurations. Before acquisition of the new configurations, UE continues applying the NR sidelink communications parameters provided in the old state.

[TS 38.331, clause 5.8.9.1.2]

The UE shall set the contents of *RRCReconfigurationSidelink* message as follows:

...

- 1> set the *sl-CSI-RS-Config*;
- 1> set the *sl-LatencyBoundCSI-Report*,

NOTE 1: How to set the parameters included in *sl-CSI-RS-Config* and *sl-LatencyBoundCSI-Report* is up to UE implementation.

The UE shall submit the *RRCReconfigurationSidelink* message to lower layers for transmission.

[TS 38.214, clause 8.5.2.2]

The UE can be configured with one CSI-RS pattern as indicated by the higher layer parameters *sl-CSI-RS-FreqAllocation*, *sl-OneAntennaPort*, *sl-CSI-RS-FirstSymbol* in *SL-CSI-RS-Config*.

Parameters for which the UE shall assume non-zero transmission power for CSI-RS are configured according to clause 8.2.1.

A UE is not expected to be configured such that a CSI-RS and the corresponding PSSCH can be mapped to the same resource element. A UE is not expected to receive sidelink CSI-RS and PSSCH DM-RS, nor CSI-RS and 2nd-stage SCI, on the same symbol.

Sidelink CSI-RS shall be transmitted according to [4, TS 38.211] in the resource blocks used for the PSSCH associated with the SCI format 2-A triggering a report.

[TS 38.214, clause 8.2.1]

A UE transmits sidelink CSI-RS within a unicast PSSCH transmission if the following conditions hold:

- CSI reporting is enabled by higher layer parameter *sl-CSI-Acquisition*; and
- the 'CSI request' field in the corresponding SCI format 2-A is set to 1.

The following parameters for CSI-RS transmission are configured for each CSI-RS configuration:

- *sl-CSI-RS-FirstSymbol* indicates the first OFDM symbol in a PRB used for SL CSI-RS
- *sl-CSI-RS-FreqAllocation* indicates the number of antenna ports and the frequency domain allocation for SL CSI-RS.

When the UE is configured with $Q_p=\{1,2\}$ CSI-RS port(s) in sidelink and the number of scheduled layers is n_{layer}^{PSSCH} ,

- The CSI-RS scaling factor β_{CSIRS} specified in clause 8.4.1.5.3 of [4, TS 38.211] is given by

$$\beta_{CSIRS} = \beta_{DMRS}^{PSSCH} \cdot \sqrt{\frac{n_{layer}^{PSSCH}}{Q_p}} \text{ where } \beta_{DMRS}^{PSSCH} \text{ is the scaling factor for the corresponding PSSCH specified in clause 8.3.1.5 of [4, TS 38.211].}$$

[TS 38.212, clause 8.3.1.1]

SCI format 1-A is used for the scheduling of PSSCH and 2nd-stage-SCI on PSSCH

The following information is transmitted by means of the SCI format 1-A:

- Priority – 3 bits as specified in clause 5.4.3.3 of [12, TS 23.287] and clause 5.22.1.3.1 of [8, TS 38.321].
- Frequency resource assignment – $\left\lceil \log_2 \left(\frac{N_{\text{subChannel}}^{\text{SL}} (N_{\text{subChannel}}^{\text{SL}} + 1)}{2} \right) \right\rceil$ bits when the value of the higher layer parameter *sl-MaxNumPerReserve* is configured to 2; otherwise $\left\lceil \log_2 \left(\frac{N_{\text{subChannel}}^{\text{SL}} (N_{\text{subChannel}}^{\text{SL}} + 1) (2N_{\text{subChannel}}^{\text{SL}} + 1)}{6} \right) \right\rceil$ bits when the value of the higher layer parameter *sl-MaxNumPerReserve* is configured to 3, as defined in clause 8.1.5 of [6, TS 38.214].
- Time resource assignment – 5 bits when the value of the higher layer parameter *sl-MaxNumPerReserve* is configured to 2; otherwise 9 bits when the value of the higher layer parameter *sl-MaxNumPerReserve* is configured to 3, as defined in clause 8.1.5 of [6, TS 38.214].
- Resource reservation period – $\left\lceil \log_2 N_{\text{rsv_period}} \right\rceil$ bits as defined in clause 16.4 of [5, TS 38.213], where *N_{rsv_period}* is the number of entries in the higher layer parameter *sl-ResourceReservePeriodList*, if higher layer parameter *sl-MultiReserveResource* is configured; 0 bit otherwise.
- DMRS pattern – $\left\lceil \log_2 N_{\text{pattern}} \right\rceil$ bits as defined in clause 8.4.1.1.2 of [4, TS 38.211], where *N_{pattern}* is the number of DMRS patterns configured by higher layer parameter *sl-PSSCH-DMRS-TimePatternList*.
- 2nd-stage SCI format – 2 bits as defined in Table 8.3.1.1-1.
- Beta_offset indicator – 2 bits as provided by higher layer parameter *sl-BetaOffsets2ndSCI* and Table 8.3.1.1-2.
- Number of DMRS port – 1 bit as defined in Table 8.3.1.1-3.
- Modulation and coding scheme – 5 bits as defined in clause 8.1.3 of [6, TS 38.214].
- Additional MCS table indicator – as defined in clause 8.1.3.1 of [6, TS 38.214]: 1 bit if one MCS table is configured by higher layer parameter *sl-Additional-MCS-Table*; 2 bits if two MCS tables are configured by higher layer parameter *sl-Additional-MCS-Table*; 0 bit otherwise.
- PSFCH overhead indication – 1 bit as defined clause 8.1.3.2 of [6, TS 38.214] if higher layer parameter *sl-PSFCH-Period* = 2 or 4; 0 bit otherwise.
- Reserved – a number of bits as determined by higher layer parameter *sl-NumReservedBits*, with value set to zero.

Table 8.3.1.1-1: 2nd-stage SCI formats

Value of 2nd-stage SCI format field	2nd-stage SCI format
00	SCI format 2-A
01	SCI format 2-B
10	Reserved
11	Reserved

Table 8.3.1.1-2: Mapping of Beta_offset indicator values to indexes in Table 9.3-2 of [5, TS38.213]

Value of Beta_offset indicator	Beta_offset index in Table 9.3-2 of [5, TS38.213]
00	1st index provided by higher layer parameter <i>sl-BetaOffsets2ndSCI</i>
01	2nd index provided by higher layer parameter <i>sl-BetaOffsets2ndSCI</i>
10	3rd index provided by higher layer parameter <i>sl-BetaOffsets2ndSCI</i>

11	4th index provided by higher layer parameter <i>s/BetaOffsets2ndSCI</i>
----	---

Table 8.3.1.1-3: Number of DMRS port(s)

Value of the Number of DMRS port field	Antenna ports
0	1000
1	1000 and 1001

[TS 38.212, clause 8.4.1.1]

SCI format 2-A is used for the decoding of PSSCH, with HARQ operation when HARQ-ACK information includes ACK or NACK, when HARQ-ACK information includes only NACK, or when there is no feedback of HARQ-ACK information.

The following information is transmitted by means of the SCI format 2-A:

- HARQ process number – 4 bits.
- New data indicator – 1 bit.
- Redundancy version – 2 bits as defined in Table 7.3.1.1.1-2.
- Source ID – 8 bits as defined in clause 8.1 of [6, TS 38.214].
- Destination ID – 16 bits as defined in clause 8.1 of [6, TS 38.214].
- HARQ feedback enabled/disabled indicator – 1 bit as defined in clause 16.3 of [5, TS 38.213].
- Cast type indicator – 2 bits as defined in Table 8.4.1.1-1 and in clause 8.1 of [6, TS 38.214].
- CSI request – 1 bit as defined in clause 8.2.1 of [6, TS 38.214] and in clause 8.1 of [6, TS 38.214].

Table 8.4.1.1-1: Cast type indicator

Value of Cast type indicator	Cast type
00	Broadcast
01	Groupcast when HARQ-ACK information includes ACK or NACK
10	Unicast
11	Groupcast when HARQ-ACK information includes only NACK

12.2.7.1.3 Test description

12.2.7.1.3.1 Pre-test conditions

System Simulator:

- SS-NW
 - NR Cell 1
 - System information combination 14 as defined in TS 38.508-1 [4] clause 4.4.3.1 is used in NR Cell 1.
- NR-SS-UE
 - NR-SS-UE1: Operating as NR sidelink communication transmitting and receiving device and uses GNSS as the synchronization reference source.

- GNSS simulator
- The GNSS simulator is started and configured for Scenario #1.

UE:

- UE is authorised to perform NR sidelink communication.
- The UE is equipped with a USIM Configuration FFS as defined in TS 38.508 [4] Table FFS.
- The UE uses GNSS as the synchronization reference source.

Preamble:

- The UE is in state 3N-B RRC_CONNECTED_with_SL as defined in TS 38.508-1 [4] subclause 4.4A on NR Cell 1 with parameters Sidelink (On), Cast Type (Unicast), GNSS Sync (On).

12.2.7.1.3.2 Test procedure sequence

Table 12.2.7.1.3.2-1: Main behaviour

St	Procedure	Message Sequence		TP	Verdict
		U - S	Message		
1	Cause the UE to request a Sidelink CSI Report. Note: This step is triggered by MMI or AT command	-	-	-	-
2	Check: Does the UE transmit a RRCReconfigurationSidelink message including IEs sl-CSI-RS-Config and sl-LatencyBoundCSI-Report on SL-SRB3?	-->	PC5 RRC: RRCReconfigurationSidelink	1	P
3	The NR-SS-UE1 transmits a RRCReconfigurationCompleteSidelink message on SL-SRB3.	<--	PC5 RRC: RRCReconfigurationCompleteSidelink	-	-
4	Check: Does the UE transmit an SCI format 2-A to trigger SL CSI report and the 'CSI request' field in the corresponding SCI format 2-A is set to 1.	-->	PSSCH (SCI format 2-A)	2	P
5	The NR-SS-UE1 sends a Sidelink CSI Reporting MAC CE.	<--	MAC CE (Sidelink CSI Reporting)	-	-

12.2.7.1.3.3 Specific message contents

Table 12.2.7.1.3.3-1: SIB12-IEs-r16 (preamble)

Derivation Path: TS 38.508-1 [4], Table 4.6.2-14A			
Information Element	Value/remark	Comment	Condition
SIB12-IEs-r16 ::= SEQUENCE {			
sl-ConfigCommonNR-r16 SEQUENCE {			
sl-CSI-Acquisition-r16	enabled		
}			
}			

Table 12.2.7.1.3.3-2: RRCReconfigurationSidelink (step 2, Table 12.2.7.1.3.2-1)

Derivation Path: TS 38.508-1 [4], Table 4.6.1A-3 with condition SL_CSI			
Information Element	Value/remark	Comment	Condition
RRCReconfigurationSidelink ::= SEQUENCE {			
criticalExtensions CHOICE {			
rrcReconfigurationSidelink-r16 SEQUENCE {			
sl-CSI-RS-Config-r16 CHOICE {			
setup SEQUENCE {			

sl-CSI-RS-FreqAllocation-r16	Any value		
sl-CSI-RS-FirstSymbol-r16	(3..12)		
}			
}			
sl-LatencyBoundCSI-Report-r16	(3..160)		
}			
}			
}			

Table 12.2.7.1.3.3-3: RRCReconfigurationCompleteSidelink (step 3, Table 12.2.7.1.3.2-1)

FFS

12.2.7.2 Inter-carrier concurrent operation / Sidelink CSI reporting / Reporting

12.2.7.2.1 Test Purpose (TP)

(1)

```

with { UE has established PC5 RRC connection with peer UE and is configured by peer UE to perform CSI measurement. }
ensure that {
  when { UE receives a SCI format 2-A to trigger SL CSI report. }
  then { UE sends an CSI reporting MAC-CE to peer UE within SL CSI report latency requirement. }
}
    
```

12.2.7.2.2 Conformance requirements

References: The conformance requirements covered in the present TC are specified in: TS 38.331 [22], subclause 5.8.9.1, 5.8.10.2, 5.8.10.3, 5.8.10.4 and 5.8.10.5. Unless otherwise stated these are Rel-16 requirements.

[TS 38.331, clause 5.8.9.1.1]

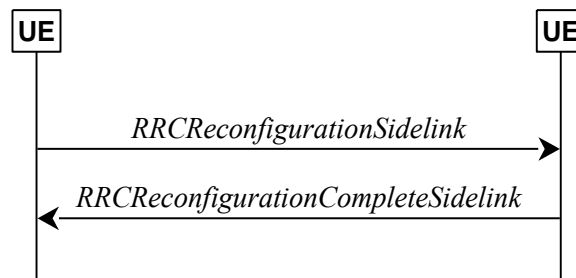

Figure 5.8.9.1.1-1: Sidelink RRC reconfiguration, successful

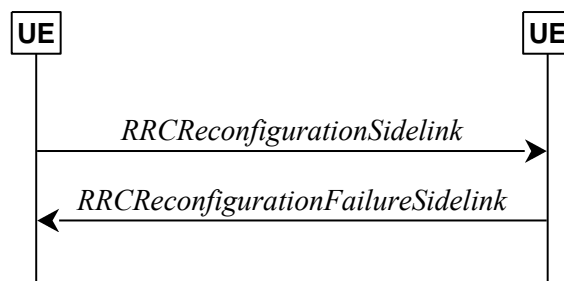

Figure 5.8.9.1.1-2: Sidelink RRC reconfiguration, failure

The purpose of this procedure is to modify a PC5-RRC connection, e.g. to establish/modify/release sidelink DRBs, to (re-)configure NR sidelink measurement and reporting, to (re-)configure sidelink CSI reference signal resources and CSI reporting latency bound.

The UE may initiate the sidelink RRC reconfiguration procedure and perform the operation in sub-clause 5.8.9.1.2 on the corresponding PC5-RRC connection in following cases:

...

- the (re-)configuration of the sidelink CSI reference signal resources and CSI reporting latency bound.

In RRC_CONNECTED, the UE applies the NR sidelink communications parameters provided in *RRCReconfiguration* (if any). In RRC_IDLE or RRC_INACTIVE, the UE applies the NR sidelink communications parameters provided in system information (if any). For other cases, UEs apply the NR sidelink communications parameters provided in *SidelinkPreconfigNR* (if any). When UE performs state transition between above three cases, the UE applies the NR sidelink communications parameters provided in the new state, after acquisition of the new configurations. Before acquisition of the new configurations, UE continues applying the NR sidelink communications parameters provided in the old state.

[TS 38.331, clause 5.8.9.1.3]

The UE shall perform the following actions upon reception of the *RRCReconfigurationSidelink*:

...

- 1> if the *RRCReconfigurationSidelink* message includes the *sl-CSI-RS-Config*:

- 2> apply the sidelink CSI-RS configuration;

- 1> if the *RRCReconfigurationSidelink* message includes the *sl-LatencyBoundCSI-Report*:

- 2> apply the configured sidelink CSI report latency bound;

...

- 1> else:

- 2> set the content of the *RRCReconfigurationCompleteSidelink* message;

- 3> submit the *RRCReconfigurationCompleteSidelink* message to lower layers for transmission;

[TS 38.214, clause 8.2.1]

A UE transmits sidelink CSI-RS within a unicast PSSCH transmission if the following conditions hold:

- CSI reporting is enabled by higher layer parameter *sl-CSI-Acquisition*; and
- the '*CSI request*' field in the corresponding SCI format 2-A is set to 1.

...

[TS 38.214, clause 8.5.1.1]

The UE shall calculate CSI parameters (if reported) assuming the following dependencies between CSI parameters (if reported)

- CQI shall be calculated conditioned on the reported RI

The CSI reporting can be aperiodic (using [10, TS 38.321]). Table 8.5.1.1-1 shows the supported combinations of CSI reporting configurations and CSI-RS configurations and how the CSI reporting is triggered for CSI-RS configuration. Aperiodic CSI-RS is configured and triggered/activated as described in Clause 8.5.1.2.

Table 8.5.1.1-1: Triggering/Activation of CSI reporting for the possible CSI-RS Configurations

CSI-RS Configuration	Aperiodic CSI Reporting
Aperiodic CSI-RS	Triggered by SCI.

For CSI reporting, wideband CQI reporting is supported. A wideband CQI is reported for a single codeword for the entire CSI reporting band.

[TS 38.214, clause 8.5.1.2]

The CSI-triggering UE is not allowed to trigger another aperiodic CSI report for the same UE before the last slot of the expected reception or completion of the ongoing aperiodic CSI report associated with the SCI format 2-A with the '*CSI request*' field set to 1, where the last slot of the expected reception of the ongoing aperiodic CSI report is given by [10, TS38.321].

An aperiodic CSI report is triggered by an SCI format 2-A with the '*CSI request*' field set to 1.

A UE is not expected to transmit a sidelink CSI-RS and a sidelink PT-RS which overlap.

[TS 38.321, clause 5.22.1.7]

The Sidelink Channel State Information (SL-CSI) reporting procedure is used to provide a peer UE with sidelink channel state information as specified in clause 8.5 of TS 38.214 [7].

RRC configures the following parameters to control the SL-CSI reporting procedure:

- *sl-LatencyBoundCSI-Report*, which is maintained for each PC5-RRC connection.

The MAC entity maintains an *sl-CSI-ReportTimer* for each pair of the Source Layer-2 ID and the Destination Layer-2 ID corresponding to a PC5-RRC connection. *sl-CSI-ReportTimer* is used for an SL-CSI reporting UE to follow the latency requirement signalled from a CSI triggering UE. The value of *sl-CSI-ReportTimer* is the same as the latency requirement of the SL-CSI reporting in *sl-LatencyBoundCSI-Report* configured by RRC.

The MAC entity shall for each pair of the Source Layer-2 ID and the Destination Layer-2 ID corresponding to a PC5-RRC connection which has been established by upper layers:

- 1> if the SL-CSI reporting has been triggered by an SCI and not cancelled:
 - 2> if the *sl-CSI-ReportTimer* for the triggered SL-CSI reporting is not running:
 - 3> start the *sl-CSI-ReportTimer*.
 - 2> if the *sl-CSI-ReportTimer* for the triggered SL-CSI reporting expires:
 - 3> cancel the triggered SL-CSI reporting.
 - 2> else if the MAC entity has SL resources allocated for new transmission and the SL-SCH resources can accommodate the SL-CSI reporting MAC CE and its subheader as a result of logical channel prioritization:
 - 3> instruct the Multiplexing and Assembly procedure to generate a Sidelink CSI Reporting MAC CE as defined in clause 6.1.3.35;
 - 3> stop the *sl-CSI-ReportTimer* for the triggered SL-CSI reporting;
 - 3> cancel the triggered SL-CSI reporting.
 - 2> else if the MAC entity has been configured with Sidelink resource allocation mode 1:
 - 3> trigger a Scheduling Request.

NOTE: The MAC entity configured with Sidelink resource allocation mode 1 may trigger a Scheduling Request if transmission of a pending SL-CSI reporting with the sidelink grant(s) cannot fulfil the latency requirement associated to the SL-CSI reporting.

12.2.7.2.3 Test description

12.2.7.2.3.1 Pre-test conditions

System Simulator:

- NR Cell

- NR Cell 1 is the serving cell.
- System information combination NR-14 as defined in TS 38.508-1 [4] clause 4.4.3.1.2 is used in NR cell 1.
- NR-SS-UE
 - NR-SS-UE 1 operating as NR sidelink communication device on the resources (i.e. the frequency included in pre-configuration) that UE is expected to use for transmission and reception via PC5 interface.
 - NR-SS-UE 1 uses NR Cell 1 as its synchronization reference source.

UE:

- UE is authorised to perform NR sidelink communication.
- UE uses NR Cell 1 as its synchronization reference source.
- The UE is equipped with below information in UE or in a USIM containing default values (as per TS 38.508-1 [4]) except for those listed in Table 12.2.7.2.3.1-1.

Table 12.2.7.2.3.1-1: UE/ USIM configuration

USIM field	Priority	Value	Access Technology Identifier
EF _{UST}		As per TS 36.508 [18] clause 4.9.3.4	
EF _{VST}		Service n°119 is "available"	
EF _{V2XP_PC5}		As per TS 38.508-1[4] clause 4.8.3.3.3 SL-PreconfigurationNR included in V2X data policy over PC5 is defined in 38.508-1[4] Table 4.10.1-1	

Preamble:

- The UE is in state 3N-B as defined in TS 38.508-1 [4], subclause 4.4A, using generic procedure parameter Sidelink (On), Unicast (On), and Test Mode (On) as defined in TS 38.508-1 [4], subclause 4.5.1 and using UE initiated unicast mode NR sidelink communication procedure as defined in TS 38.508-1 [4] subclause 4.9.22.

12.2.7.2.3.2 Test procedure sequence

Table 12.2.7.2.3.2-1: Main behaviour

St	Procedure	Message Sequence		TP	Verdict
		U - S	Message		
1	The SS transmits an RRCReconfiguration message to enable SL CSI reporting	<--	NR RRC: <i>RRCReconfiguration</i>	-	-
2	The UE transmits an RRCReconfigurationComplete message	-->	NR RRC: <i>RRCReconfigurationComplete</i>	-	-
3	The NR-SS-UE 1 transmits an <i>RRCReconfigurationSidelink</i> message to provide sidelink CSI-RS resource and reporting configuration.	<--	NR PC5 RRC: <i>RRCReconfigurationSidelink</i>	-	-
4	The UE transmits an RRCReconfigurationCompleteSidelink message	-->	NR PC5 RRC: <i>RRCReconfigurationCompleteSidelink</i>	-	-
5	The NR-SS-UE 1 transmits a SCI format 2-A with CSI request = 1 and starts transmitting SL CSI-RS according to the SL CSI-RS resource configuration included in <i>RRCReconfigurationSidelink</i> message.	<--	SCI format 2-A	-	-
6	Check: Does the UE transmit a SL CSI reporting MAC-CE before slot n+k?	-->	MAC CE (Sidelink CSI Reporting)	1	P

	NOTE: Slot n is the slot that UE receives SCI format 2-A with CSI request = 1. k is the SL CSI report latency requirement (in slots) indicated by sl-LatencyBoundCSI-Report.				
--	--	--	--	--	--

12.2.7.2.3.3 Specific message contents

Table 12.2.7.2.3.3-1: RRCReconfiguration (Table 12.2.7.2.3.2-1, Step 1)

Derivation Path: TS 38.508-1 [4], Table 4.6.1-13 with condition SIDELINK			
Information Element	Value/remark	Comment	Condition
RRCReconfiguration ::= SEQUENCE {			
criticalExtensions CHOICE {			
rrcReconfiguration SEQUENCE {			
nonCriticalExtension SEQUENCE {			
nonCriticalExtension SEQUENCE {			
nonCriticalExtension SEQUENCE {			
nonCriticalExtension SEQUENCE {			
sl-ConfigDedicatedNR-r16 CHOICE {			
setup	SL-ConfigDedicatedNR specified in 38.508-1 Table 4.6.6-7 with condition SELECTED and SL_CSI_REPORT		
}			
}			
}			
}			
}			
}			
}			

Table 12.2.7.2.3.3-2: RRCReconfigurationSidelink (Table 12.2.7.2.3.2-1, Step 3)

Derivation Path: TS 38.508-1 [4], Table 4.6.1A-3 with condition RX and SL_CSI

Table 12.2.7.2.3.3-3: RRCReconfigurationCompleteSidelink (Table 12.2.7.2.3.2-1, Step 4)

Derivation Path: TS 38.508-1 [4], Table 4.6.1A-4 with condition TX
--

12.2.8 Inter-carrier concurrent operation / Sidelink failure

12.2.8.1 Inter-carrier concurrent operation / Sidelink CSI reporting / Reporting

12.2.8.1.1 Test Purpose (TP)

(1)

```

with { UE is in connected state. UE has established PC5 RRC connection with peer UE on unicast
sidelink and has sent an RRCReconfigurationSidelink message to peer UE. }
ensure that {
  when { UE receives an RRCReconfigurationFailureSidelink from peer UE. }
  then { UE continues to use the configuration used prior to corresponding
RRCReconfigurationSidelink message and sends a SidelinkUEInformation message to indicate sidelink
reconfiguration failure. }
}
    
```

12.2.8.1.2 Conformance requirements

References: The conformance requirements covered in the present TC are specified in: TS 38.331 [22], subclause 5.8.9.1, 5.8.10.2, 5.8.10.3, 5.8.10.4 and 5.8.10.5. Unless otherwise stated these are Rel-16 requirements.

[TS 38.331, clause 5.8.9.1.1]

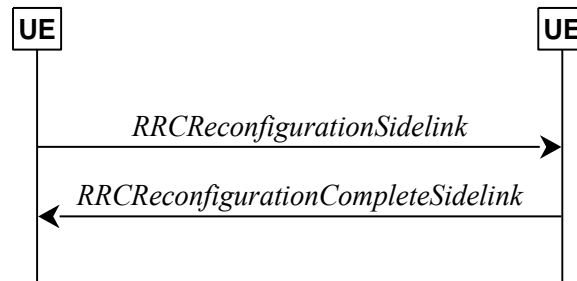

Figure 5.8.9.1.1-1: Sidelink RRC reconfiguration, successful

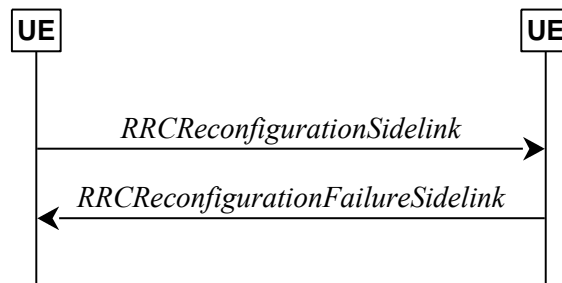

Figure 5.8.9.1.1-2: Sidelink RRC reconfiguration, failure

The purpose of this procedure is to modify a PC5-RRC connection, e.g. to establish/modify/release sidelink DRBs, to (re-)configure NR sidelink measurement and reporting, to (re-)configure sidelink CSI reference signal resources and CSI reporting latency bound.

The UE may initiate the sidelink RRC reconfiguration procedure and perform the operation in sub-clause 5.8.9.1.2 on the corresponding PC5-RRC connection in following cases:

- the release of sidelink DRBs associated with the peer UE, as specified in sub-clause 5.8.9.1a.1;
- the establishment of sidelink DRBs associated with the peer UE, as specified in sub-clause 5.8.9.1a.2;
- the modification for the parameters included in *SLRB-Config* of sidelink DRBs associated with the peer UE, as specified in sub-clause 5.8.9.1a.2;
- the (re-)configuration of the peer UE to perform NR sidelink measurement and report.
- the (re-)configuration of the sidelink CSI reference signal resources and CSI reporting latency bound.

In *RRC_CONNECTED*, the UE applies the NR sidelink communications parameters provided in *RRCReconfiguration* (if any). In *RRC_IDLE* or *RRC_INACTIVE*, the UE applies the NR sidelink communications parameters provided in system information (if any). For other cases, UEs apply the NR sidelink communications parameters provided in *SidelinkPreconfigNR* (if any). When UE performs state transition between above three cases, the UE applies the NR sidelink communications parameters provided in the new state, after acquisition of the new configurations. Before acquisition of the new configurations, UE continues applying the NR sidelink communications parameters provided in the old state.

[TS 38.331, clause 5.8.9.1.8]

The UE shall perform the following actions upon reception of the *RRCReconfigurationFailureSidelink*:

- 1> stop timer T400 for the destination, if running;

1> continue using the configuration used prior to corresponding *RRCReconfigurationSidelink* message;

1> if UE is in *RRC_CONNECTED*:

2> perform the sidelink UE information for NR sidelink communication procedure, as specified in 5.8.3.3 or sub-clause 5.10.15 in TS 36.331 [10];

[TS 38.331, clause 5.8.3.3]

The UE shall set the contents of the *SidelinkUEInformationNR* message as follows:

1> if the UE initiates the procedure to indicate it is (no more) interested to receive NR sidelink communication or to request (configuration/ release) of NR sidelink communication transmission resources or to report to the network that a sidelink radio link failure or sidelink RRC reconfiguration failure has been declared (i.e. UE includes all concerned information, irrespective of what triggered the procedure):

2> if *SIB12* including *sl-ConfigCommonNR* is provided by the PCell:

...

3> if configured by upper layers to transmit NR sidelink communication:

...

4> if a sidelink radio link failure or a sidelink RRC reconfiguration failure has been declared, according to clauses 5.8.9.3 and 5.8.9.1.8, respectively;

5> include *sl-FailureList* and set its fields as follows for each destination for which it reports the NR sidelink communication failure:

6> set *sl-DestinationIdentity* to the destination identity configured by upper layer for NR sidelink communication transmission;

...

6> else if *RRCReconfigurationFailureSidelink* is received:

7> set *sl-Failure* as *configFailure* for the associated destination for the NR sidelink communication transmission;

...

1> else:

2> submit the *SidelinkUEInformationNR* message to lower layers for transmission.

12.2.8.1.3 Test description

12.2.8.1.3.1 Pre-test conditions

System Simulator:

- NR Cell
 - NR Cell 1 is the serving cell.
 - System information combination NR-14 as defined in TS 38.508-1 [4] clause 4.4.3.1.2 is used in NR cell 1.
- NR-SS-UE
 - NR-SS-UE 1 operating as NR sidelink communication device on the resources (i.e. the frequency included in pre-configuration) that UE is expected to use for transmission and reception via PC5 interface.

UE:

- UE is authorised to perform NR sidelink communication.

- The UE is equipped with below information in UE or in a USIM containing default values (as per TS 38.508-1 [4]) except for those listed in Table 12.2.8.1.3.1-1.

Table 12.2.8.1.3.1-1: UE/ USIM configuration

USIM field	Priority	Value	Access Technology Identifier
EF _{UST}		As per TS 36.508 [18] clause 4.9.3.4	
EF _{VST}		Service n°119 is "available"	
EF _{V2XP_PC5}		As per TS 38.508-1[4] clause 4.8.3.3.3 SL-PreconfigurationNR included in V2X data policy over PC5 is defined in Table 12.2.8.1.3.3-1	

Preamble:

- The UE is in state 3N-B as defined in TS 38.508-1 [4], subclause 4.4A, using generic procedure parameter Sidelink (On), Unicast (On), and Test Mode (On) as defined in TS 38.508-1 [4], subclause 4.5.1.

12.2.8.1.3.2 Test procedure sequence

Table 12.2.8.1.3.2-1: Main behaviour

St	Procedure	Message Sequence		TP	Verdict
		U - S	Message		
1	The SS transmits a CLOSE UE TEST LOOP message to close UE test loop mode E (Transmit Mode).	<--	NR RRC: <i>DLInformationTransfer</i> TC: CLOSE UE TEST LOOP	-	-
2	The UE transmits a CLOSE UE TEST LOOP COMPLETE message	-->	NR RRC: <i>ULInformationTransfer</i> TC: CLOSE UE TEST LOOP COMPLETE	-	-
3	The SS transmits an RRCReconfiguration message to reconfigure SDAP entity of the established SL DRB associated to the PC5 unicast link between the UE and the NR-SS-UE 1 to sl-SDAP-Header = absent.	<--	NR RRC: <i>RRCReconfiguration</i>	-	-
4	The UE transmits an RRCReconfigurationComplete message	-->	NR RRC: <i>RRCReconfigurationComplete</i>	-	-
5	The UE transmits an <i>RRCReconfigurationSidelink</i> message to reconfigure the established SL DRB associated to the PC5 unicast link between the UE and the NR-SS-UE 1.	-->	NR PC5 RRC: <i>RRCReconfigurationSidelink</i>	-	-
6	The NR-SS-UE transmits an RRCReconfigurationFailureSidelink message	<--	NR RRC: <i>RRCReconfigurationFailureSidelink</i>	-	-
7	Check: Does the UE transmit a SidelinkUEInformationNR message to inform NR Cell 1 the PC5 RRC reconfiguration failure?	-->	NR RRC: <i>SidelinkUEInformationNR</i>	1	P
8	Check: Does the SDAP PDUs transmitted on the established SL DRB associated to the PC5 unicast link between the UE and the NR-SS-UE 1 without SDAP header?	-	-	1	F
9	The SS transmits an OPEN UE TEST LOOP message to open UE test loop mode E.	<--	NR RRC: <i>DLInformationTransfer</i> TC: OPEN UE TEST LOOP	-	-
10	The UE transmits an OPEN UE TEST LOOP COMPLETE message	-->	NR RRC: <i>ULInformationTransfer</i> TC: OPEN UE TEST LOOP COMPLETE	-	-

12.2.8.1.3.3 Specific message contents

Table 12.2.8.1.3.3-1: CLOSE UE TEST LOOP (Table 12.2.8.1.3.2-1, Step 1)

Derivation Path: 36.508 [7] Table 4.7A-3 with condition UE TEST LOOP MODE E(V2X Transmission)			
Information Element	Value/remark	Comment	Condition
UE test loop mode E LB setup			
Communication Transmit or Receive	0 0 0 0 0 0 1	'01' indicates V2X UE triggered to transmit NR sidelink communication with single spatial layer.	

Table 12.2.8.1.3.3-2: RRCReconfiguraion (Table 12.2.8.1.3.2-1, Step 3)

Derivation Path: TS 38.508-1 [4], Table 4.6.1-13 with condition SIDELINK			
Information Element	Value/remark	Comment	Condition
RRCReconfiguration ::= SEQUENCE {			
criticalExtensions CHOICE {			
rrcReconfiguration SEQUENCE {			
nonCriticalExtension SEQUENCE {			
nonCriticalExtension SEQUENCE {			
nonCriticalExtension SEQUENCE {			
nonCriticalExtension SEQUENCE {			
sl-ConfigDedicatedNR-r16 CHOICE {			
setup	SL-ConfigDedicatedNR	Table 12.2.8.1.3.3-3	
}			
}			
}			
}			
}			
}			
}			
}			
}			

Table 12.2.8.1.3.3-3: SL-ConfigDedicatedNR (Table 12.2.8.1.3.3-2)

Derivation Path: TS 38.508-1 [4], Table 4.6.6-7 with condition SL_DRB			
Information Element	Value/remark	Comment	Condition
SL-ConfigDedicatedNR-r16 ::= SEQUENCE {			
sl-RadioBearerToAddModList-r16 SEQUENCE (SIZE (1..maxNrofSLRB-r16)) OF SL-RadioBearerConfig-r16 {	1 entry		
SL-RadioBearerConfig-r16[1] SEQUENCE {		Entry 1	
slrb-Uu-ConfigIndex-r16	n	n is the SLRB-Uu-ConfigIndex of the SL-DRB associated with the PC5 unicast link between the UE and NR-SS-UE 1	
sl-SDAP-Config-r16 SEQUENCE {			
sl-SDAP-Header-r16	absent		
}			
}			
}			
}			

Table 12.2.8.1.3.3-4: RRCReconfigurationSidelink (Table 12.2.8.1.3.2-1, Step 5)

Derivation Path: TS 38.508-1 [4], Table 4.6.1A-3 with condition TX and SL_DRB			
---	--	--	--

Information Element	Value/remark	Comment	Condition
RRCReconfigurationSidelink ::= SEQUENCE {			
criticalExtensions CHOICE {			
rrcReconfigurationSidelink-r16 SEQUENCE {			
slrb-ConfigToAddModList-r16 SEQUENCE (SIZE (1..maxNrofSLRB-r16)) OF SLRB-Config-r16 {	1 entry		
SLRB-Config-r16[1] SEQUENCE {		entry 1	
sl-SDAP-ConfigPC5-r16 SEQUENCE {			
sl-MappedQoS-FlowsToAddList-r16	Not checked		
sl-SDAP-Header-r16	absent		
}			
sl-PDCP-ConfigPC5-r16	Not checked		
sl-RLC-ConfigPC5-r16	Not checked		
sl-MAC-LogicalChannelConfigPC5-r16	Not checked		
}			
}			
}			
}			
}			

Table 12.2.8.1.3.3-5: RRCReconfigurationFailureSidelink (Table 12.2.8.1.3.2-1, Step 5)

Derivation Path: TS 38.508-1 [4], Table 4.6.1A-5 with condition RX

Table 12.2.8.1.3.3-6: SidelinkUEInformationNR (Table 12.2.8.1.3.2-1, Step 7)

Derivation Path: TS 38.508-1 [4], Table 4.6.1-28A with condition SIDELINK_TX

Information Element	Value/remark	Comment	Condition
SidelinkUEInformationNR-r16 ::= SEQUENCE {			
criticalExtensions CHOICE {			
sidelinkUEInformationNR-r16 SEQUENCE {			
sl-FailureList-r16 SEQUENCE (SIZE (1..maxNrofSL-Dest-r16)) OF SL-Failure-r16 {	1 entry		
SL-Failure-r16[1] SEQUENCE {			
sl-DestinationIdentity-r16	SL-DestinationIdentity of NR-SS-UE 1		
sl-Failure-r16	configFailure		
}			
}			
}			
}			
}			

Table 12.2.8.1.3.3-7: RRCReconfigurationSidelink (Table 12.2.8.1.3.2-1, Step 3)

Derivation Path: TS 38.508-1 [4], Table 4.6.1A-3 with condition RX and SL_CSI

Table 12.2.8.1.3.3-8: RRCReconfigurationCompleteSidelink (Table 12.2.8.1.3.2-1, Step 4)

Derivation Path: TS 38.508-1 [4], Table 4.6.1A-4 with condition TX

12.2.8.2 Inter-carrier concurrent operation / Sidelink failure / PC5 RRC Reconfiguration Failure / Peer UE side

12.2.8.2.1 Test Purpose (TP)

(1)

```
with { UE in NR RRC_CONNECTED and having established PC5-RRC connection with peer UE on unicast
sidelink }
ensure that {
  when { UE receives an RRCReconfigurationSidelink that UE cannot comply from peer UE }
  then { UE continues to use the configuration used prior to the reception of the
RRCReconfigurationSidelink message and sends a RRCReconfigurationFailureSidelink message }
}
```

12.2.8.2.2 Conformance requirements

References: The conformance requirements covered in the current TC are specified in: TS 38.331, clause 5.8.9.1.3. Unless otherwise stated these are Rel-16 requirements.

[TS 38.331, clause 5.8.9.1.3]

The UE shall perform the following actions upon reception of the *RRCReconfigurationSidelink*:

...

- 1> if the UE is unable to comply with (part of) the configuration included in the *RRCReconfigurationSidelink* (i.e. sidelink RRC reconfiguration failure):
 - 2> continue using the configuration used prior to the reception of the *RRCReconfigurationSidelink* message;
 - 2> set the content of the *RRCReconfigurationFailureSidelink* message;
 - 3> submit the *RRCReconfigurationFailureSidelink* message to lower layers for transmission;

...

NOTE 1: When the same logical channel is configured with different RLC mode by another UE, the UE handles the case as sidelink RRC reconfiguration failure.

12.2.8.2.3 Test description

12.2.8.2.3.1 Pre-test conditions

System Simulator:

- SS-NW
 - NR Cell 1
 - System information combination 14 as defined in TS 38.508-1 [4] clause 4.4.3.1 is used in NR Cell 1.
- NR-SS-UE
 - NR-SS-UE1: Operating as NR sidelink communication transmitting and receiving device and uses GNSS as the synchronization reference source.
- GNSS simulator
- The GNSS simulator is started and configured for Scenario #1.

UE:

- UE is authorised to perform NR sidelink communication.

- The UE is equipped with a USIM Configuration FFS as defined in TS 38.508 [4] Table FFS.
- The UE uses GNSS as the synchronization reference source.

Preamble:

- The UE is in state 3N-B RRC_CONNECTED_with_SL as defined in TS 38.508-1 [4] subclause 4.4A on NR Cell 1, using generic parameters Sidelink (*On*), Cast Type (*Unicast*), GNSS Sync (*On*).

12.2.8.2.3.2 Test procedure sequence

Table 12.2.8.2.3.2-1: Main behaviour

St	Procedure	Message Sequence		TP	Verdict
		U - S	Message		
1	The NR-SS-UE1 transmits a <i>RRCReconfigurationSidelink</i> message that UE cannot comply on SL-SRB3.	<--	PC5 RRC: <i>RRCReconfigurationSidelink</i>	-	-
2	Check: Does the UE transmit a <i>RRCReconfigurationFailureSidelink</i> message on SL-SRB3?	-->	PC5 RRC: <i>RRCReconfigurationFailureSidelink</i>	1	P

12.2.8.2.3.3 Specific message contents

FFS

12.2.8.3 Inter-carrier concurrent operation / Sidelink failure / Sidelink radio link failure / transmission side

12.2.8.3.1 Test Purpose (TP)

(1)

```
with { UE is in connected state. UE has established PC5 RRC connection with peer UE on unicast
sidelink and has sent an RRCReconfigurationSidelink message to peer UE }
ensure that {
  when { UE doesn't receive RRCReconfigurationCompleteSidelink or RRCReconfigurationFailure before
T400 expires. }
  then { UE releases PC5-RRC connection and indicates the release to upper layer and sends a
SidelinkUEInformationNR message to indicate SL RLF. }
}
```

(2)

```
with { UE is in connected state. UE has established PC5 RRC connection with peer UE on unicast
sidelink and has established a AM SL DRB }
ensure that {
  when { Retransmission number of the AM SL DRB reaches the maximum number of retransmissions. }
  then { UE releases PC5-RRC connection and indicates the release to upper layer and sends a
SidelinkUEInformationNR message to indicate SL RLF. }
}
```

(3)

```
with { UE is in connected state. UE has established PC5 RRC connection with peer UE on unicast
sidelink. }
ensure that {
  when { MAC detects that maximum number of consecutive HARQ DTX has been reached. }
  then { UE releases PC5-RRC connection and indicates the release to upper layer and sends a
SidelinkUEInformationNR message to indicate SL RLF. }
}
```

12.2.8.3.2 Conformance requirements

References: The conformance requirements covered in the present TC are specified in: TS 38.331 [22], subclause 5.8.9.1, 5.8.10.2, 5.8.10.3, 5.8.10.4 and 5.8.10.5. Unless otherwise stated these are Rel-16 requirements.

[TS 38.331, clause 5.8.9.1.1]

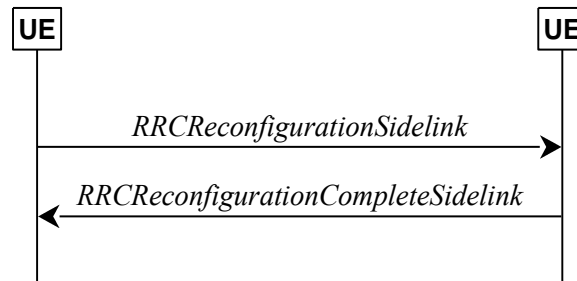

Figure 5.8.9.1.1-1: Sidelink RRC reconfiguration, successful

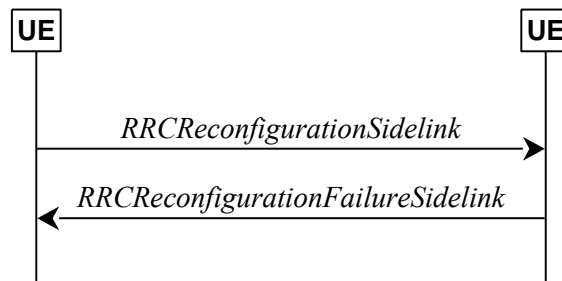

Figure 5.8.9.1.1-2: Sidelink RRC reconfiguration, failure

The purpose of this procedure is to modify a PC5-RRC connection, e.g. to establish/modify/release sidelink DRBs, to (re-)configure NR sidelink measurement and reporting, to (re-)configure sidelink CSI reference signal resources and CSI reporting latency bound.

The UE may initiate the sidelink RRC reconfiguration procedure and perform the operation in sub-clause 5.8.9.1.2 on the corresponding PC5-RRC connection in following cases:

- the release of sidelink DRBs associated with the peer UE, as specified in sub-clause 5.8.9.1a.1;
- the establishment of sidelink DRBs associated with the peer UE, as specified in sub-clause 5.8.9.1a.2;
- the modification for the parameters included in *SLRB-Config* of sidelink DRBs associated with the peer UE, as specified in sub-clause 5.8.9.1a.2;
- the (re-)configuration of the peer UE to perform NR sidelink measurement and report.
- the (re-)configuration of the sidelink CSI reference signal resources and CSI reporting latency bound.

In *RRC_CONNECTED*, the UE applies the NR sidelink communications parameters provided in *RRCReconfiguration* (if any). In *RRC_IDLE* or *RRC_INACTIVE*, the UE applies the NR sidelink communications parameters provided in system information (if any). For other cases, UEs apply the NR sidelink communications parameters provided in *SidelinkPreconfigNR* (if any). When UE performs state transition between above three cases, the UE applies the NR sidelink communications parameters provided in the new state, after acquisition of the new configurations. Before acquisition of the new configurations, UE continues applying the NR sidelink communications parameters provided in the old state.

[TS 38.331, clause 5.8.9.1.2]

The UE shall set the contents of *RRCReconfigurationSidelink* message as follows:

...

1> start timer T400 for the destination associated with the sidelink DRB;

...

The UE shall submit the *RRCReconfigurationSidelink* message to lower layers for transmission.

[TS 38.331, clause 5.8.9.3]

The UE shall:

- 1> upon indication from sidelink RLC entity that the maximum number of retransmissions for a specific destination has been reached; or
- 1> upon T400 expiry for a specific destination; or
- 1> upon indication from MAC entity that the maximum number of consecutive HARQ DTX for a specific destination has been reached; or
- 1> upon integrity check failure indication from sidelink PDCP entity concerning SL-SRB2 or SL-SRB3 for a specific destination:
 - 2> consider sidelink radio link failure to be detected for this destination;
 - 2> release the DRBs of this destination, in according to sub-clause 5.8.9.1a.1;
 - 2> release the SRBs of this destination, in according to sub-clause 5.8.9.1a.3;
 - 2> discard the NR sidelink communication related configuration of this destination;
 - 2> reset the sidelink specific MAC of this destination;
 - 2> consider the PC5-RRC connection is released for the destination;
 - 2> indicate the release of the PC5-RRC connection to the upper layers for this destination (i.e. PC5 is unavailable);
 - 2> if UE is in RRC_CONNECTED:
 - 3> perform the sidelink UE information for NR sidelink communication procedure, as specified in 5.8.3.3;

NOTE: It is up to UE implementation on whether and how to indicate to upper layers to maintain the keep-alive procedure [55].

[TS 38.331, clause 5.8.3.3]

The UE shall set the contents of the *SidelinkUEInformationNR* message as follows:

- 1> if the UE initiates the procedure to indicate it is (no more) interested to receive NR sidelink communication or to request (configuration/ release) of NR sidelink communication transmission resources or to report to the network that a sidelink radio link failure or sidelink RRC reconfiguration failure has been declared (i.e. UE includes all concerned information, irrespective of what triggered the procedure):
- 2> if *SIB12* including *sl-ConfigCommonNR* is provided by the PCell:
 - ...
 - 3> if configured by upper layers to transmit NR sidelink communication:
 - ...
 - 4> if a sidelink radio link failure or a sidelink RRC reconfiguration failure has been declared, according to clauses 5.8.9.3 and 5.8.9.1.8, respectively;
 - 5> include *sl-FailureList* and set its fields as follows for each destination for which it reports the NR sidelink communication failure:
 - 6> set *sl-DestinationIdentity* to the destination identity configured by upper layer for NR sidelink communication transmission;

6> if the sidelink RLF is detected as specified in sub-clause 5.8.9.3:

7> set *sl-Failure* as *rlf* for the associated destination for the NR sidelink communication transmission;

...

1> else:

2> submit the *SidelinkUEInformationNR* message to lower layers for transmission.

[TS 38.322, clause 5.3.2]

...

When an RLC SDU or an RLC SDU segment is considered for retransmission, the transmitting side of the AM RLC entity shall:

- if the RLC SDU or RLC SDU segment is considered for retransmission for the first time:
 - set the RETX_COUNT associated with the RLC SDU to zero.
- else, if it (the RLC SDU or the RLC SDU segment that is considered for retransmission) is not pending for retransmission already and the RETX_COUNT associated with the RLC SDU has not been incremented due to another negative acknowledgment in the same STATUS PDU:
 - increment the RETX_COUNT.
- if RETX_COUNT = *maxRetxThreshold*:
 - indicate to upper layers that max retransmission has been reached.

...

[TS 38.321, clause 5.22.1.3.3]

The HARQ-based Sidelink RLF detection procedure is used to detect Sidelink RLF based on a number of consecutive DTX on PSFCH reception occasions for a PC5-RRC connection.

RRC configures the following parameter to control HARQ-based Sidelink RLF detection:

- *sl-maxNumConsecutiveDTX*.

The following UE variable is used for HARQ-based Sidelink RLF detection.

- *numConsecutiveDTX*, which is maintained for each PC5-RRC connection.

The Sidelink HARQ Entity shall (re-)initialize *numConsecutiveDTX* to zero for each PC5-RRC connection which has been established by upper layers, if any, upon establishment of the PC5-RRC connection or (re)configuration of *sl-maxNumConsecutiveDTX*.

The Sidelink HARQ Entity shall for each PSFCH reception occasion associated to the PSSCH transmission:

- 1> if PSFCH reception is absent on the PSFCH reception occasion:
 - 2> increment *numConsecutiveDTX* by 1;
 - 2> if *numConsecutiveDTX* reaches *sl-maxNumConsecutiveDTX*:
 - 3> indicate HARQ-based Sidelink RLF detection to RRC.

1> else:

- 2> re-initialize *numConsecutiveDTX* to zero.

12.2.8.3.3 Test description

12.2.8.3.3.1 Pre-test conditions

System Simulator:

- NR Cell
 - NR Cell 1 is the serving cell.
 - System information combination NR-14 as defined in TS 38.508-1 [4] clause 4.4.3.1.2 is used in NR cell 1.
- NR-SS-UE
 - NR-SS-UE 1 operating as NR sidelink communication device on the resources (i.e. the frequency included in pre-configuration) that UE is expected to use for transmission and reception via PC5 interface.

UE:

- UE is authorised to perform NR sidelink communication.
- The UE is equipped with below information in UE or in a USIM containing default values (as per TS 38.508-1 [4]) except for those listed in Table 12.2.8.3.3.1-1.

Table 12.2.8.3.3.1-1: UE/ USIM configuration

USIM field	Priority	Value	Access Technology Identifier
EF _{UST}		As per TS 36.508 [18] clause 4.9.3.4	
EF _{VST}		Service n°119 is "available"	
EF _{V2XP_PC5}		As per TS 38.508-1[4] clause 4.8.3.3.3 SL-PreconfigurationNR included in V2X data policy over PC5 is defined in Table 12.2.8.3.3.3-1	

Preamble:

- The UE is in state 3N-B as defined in TS 38.508-1 [4], subclause 4.4A, using generic procedure parameter Sidelink (On), Unicast (On), and Test Mode (On) as defined in TS 38.508-1 [4], subclause 4.5.1.

12.2.8.3.3.2 Test procedure sequence

Table 12.2.8.3.3.2-1: Main behaviour

St	Procedure	Message Sequence		TP	Verdict
		U - S	Message		
1	The SS transmits a CLOSE UE TEST LOOP message to close UE test loop mode E (Transmit Mode).	<--	NR RRC: <i>DLInformationTransfer</i> TC: CLOSE UE TEST LOOP	-	-
2	The UE transmits a CLOSE UE TEST LOOP COMPLETE message	-->	NR RRC: <i>ULInformationTransfer</i> TC: CLOSE UE TEST LOOP COMPLETE	-	-
3	The SS transmits an RRCReconfiguration message to reconfigure PC5 RRC connection between the UE and the NR-SS-UE 1	<--	NR RRC: <i>RRCReconfiguration</i>	-	-
4	The UE transmits an RRCReconfigurationComplete message	-->	NR RRC: <i>RRCReconfigurationComplete</i>	-	-
5	The UE transmits an <i>RRCReconfigurationSidelink</i> message to reconfigure PC5 RRC connection between the UE and the NR-SS-UE 1.	-->	NR PC5 RRC: <i>RRCReconfigurationSidelink</i>	-	-
6	The NR-SS-UE waits until T400 expires.	-	-	-	-

7	Check: Does the UE transmit a SidelinkUEInformationNR message to inform NR Cell 1 the sidelink radio link failure?	-->	NR RRC: <i>SidelinkUEInformationNR</i>	1	P
8	The SS transmits an OPEN UE TEST LOOP message to open UE test loop mode E.	<--	NR RRC: <i>DLInformationTransfer</i> TC: OPEN UE TEST LOOP	-	-
9	The UE transmits an OPEN UE TEST LOOP COMPLETE message	-->	NR RRC: <i>ULInformationTransfer</i> TC: OPEN UE TEST LOOP COMPLETE	-	-
10	Check: Does the test result of generic test procedure in TS 38.508-1 [4] subclause 4.9.31 indicate that the UE is capable of exchanging IP data on PC5 unicast link between the UE and the NR-SS-UE 1?	-	-	1	F
11	The SS performs the generic procedure specified in subclause 4.9.22 to establish PC5 unicast link between the UE and the NR-SS-UE 1.	-	-	-	-
12	The SS transmits a CLOSE UE TEST LOOP message to close UE test loop mode E (Transmit Mode).	<--	NR RRC: <i>DLInformationTransfer</i> TC: CLOSE UE TEST LOOP	-	-
13	The UE transmits a CLOSE UE TEST LOOP COMPLETE message	-->	NR RRC: <i>ULInformationTransfer</i> TC: CLOSE UE TEST LOOP COMPLETE	-	-
14	The NR-SS-UE 1 stops transmitting RLC acknowledgments for the RLC PDUs transmitted by the UE	-	-	-	-
15	Check: Does the UE transmit a SidelinkUEInformationNR message to inform NR Cell 1 the sidelink radio link failure?	-->	NR RRC: <i>SidelinkUEInformationNR</i>	2	P
16	The SS transmits an OPEN UE TEST LOOP message to open UE test loop mode E.	<--	NR RRC: <i>DLInformationTransfer</i> TC: OPEN UE TEST LOOP	-	-
17	The UE transmits an OPEN UE TEST LOOP COMPLETE message.	-->	NR RRC: <i>ULInformationTransfer</i> TC: OPEN UE TEST LOOP COMPLETE	-	-
18	Check: Does the test result of generic test procedure in TS 38.508-1 [4] subclause 4.9.31 indicate that the UE is capable of exchanging IP data on PC5 unicast link between the UE and the NR-SS-UE 1?	-	-	2	F
19	The SS performs the generic procedure specified in subclause 4.9.22 to establish PC5 unicast link between the UE and the NR-SS-UE 1.	-	-	-	-
20	The SS transmits a CLOSE UE TEST LOOP message to close UE test loop mode E (Transmit Mode).	<--	NR RRC: <i>DLInformationTransfer</i> TC: CLOSE UE TEST LOOP	-	-
21	The UE transmits a CLOSE UE TEST LOOP COMPLETE message	-->	NR RRC: <i>ULInformationTransfer</i> TC: CLOSE UE TEST LOOP COMPLETE	-	-
22	The NR-SS-UE 1 stops transmitting HARQ ACK/NACK for the MAC PDUs transmitted by the UE.	-	-	-	-
23	Check: Does the UE transmit a SidelinkUEInformationNR message to inform NR Cell 1 the sidelink radio link failure?	-->	NR RRC: <i>SidelinkUEInformationNR</i>	3	P
24	The SS transmits an OPEN UE TEST LOOP message to open UE test loop mode E.	<--	NR RRC: <i>DLInformationTransfer</i> TC: OPEN UE TEST LOOP	-	-
25	The UE transmits an OPEN UE TEST LOOP COMPLETE message	-->	NR RRC: <i>ULInformationTransfer</i> TC: OPEN UE TEST LOOP COMPLETE	-	-
26	Check: Does the test result of generic test procedure in TS 38.508-1 [4] subclause 4.9.31 indicate that the UE is capable of exchanging IP data on PC5 unicast link between the UE and the NR-SS-UE 1?	-	-	3	F

12.2.8.3.3.3 Specific message contents

Table 12.2.8.3.3.3-1: CLOSE UE TEST LOOP (Table 12.2.8.3.3.2-1, Step 1, 12 and 20)

Derivation Path: 36.508 [7] Table 4.7A-3 with condition UE TEST LOOP MODE E(V2X Transmission)			
Information Element	Value/remark	Comment	Condition
UE test loop mode E LB setup			
Communication Transmit or Receive	0 0 0 0 0 0 1	'01' indicates V2X UE triggered to transmit NR sidelink communication with single spatial layer.	

Table 12.2.8.3.3.3-2: RRCReconfiguraion (Table 12.2.8.3.3.2-1, Step 3)

Derivation Path: TS 38.508-1 [4], Table 4.6.1-13 with condition SIDELINK			
Information Element	Value/remark	Comment	Condition
RRCReconfiguration ::= SEQUENCE {			
criticalExtensions CHOICE {			
rrcReconfiguration SEQUENCE {			
nonCriticalExtension SEQUENCE {			
nonCriticalExtension SEQUENCE {			
nonCriticalExtension SEQUENCE {			
nonCriticalExtension SEQUENCE {			
sl-ConfigDedicatedNR-r16 CHOICE {			
setup	SL-ConfigDedicatedNR	Table 12.2.8.3.3.3-3	
}			
}			
}			
}			
}			
}			
}			
}			
}			

Table 12.2.8.3.3.3-3: SL-ConfigDedicatedNR (Table 12.2.8.3.3.3-2)

Derivation Path: TS 38.508-1 [4], Table 4.6.6-7 with condition SL_DRB			
Information Element	Value/remark	Comment	Condition
SL-ConfigDedicatedNR-r16 ::= SEQUENCE {			
sl-RadioBearerToAddModList-r16 SEQUENCE (SIZE (1..maxNrofSLRB-r16)) OF SL-RadioBearerConfig-r16 {	1 entry		
SL-RadioBearerConfig-r16[1] SEQUENCE {		Entry 1	
slrb-Uu-ConfigIndex-r16	n	n is the SLRB-Uu-ConfigIndex of the SL-DRB associated with the PC5 unicast link between the UE and NR-SS-UE 1	
sl-SDAP-Config-r16 SEQUENCE {			
sl-SDAP-Header-r16	absent		
}			
}			
}			
}			

Table 12.2.8.3.3.3-4: RRCReconfigurationSidelink (Table 12.2.8.3.3.2-1, Step 5)

Derivation Path: TS 38.508-1 [4], Table 4.6.1A-3 with condition TX and SL_DRB			
---	--	--	--

Information Element	Value/remark	Comment	Condition
RRCReconfigurationSidelink ::= SEQUENCE {			
criticalExtensions CHOICE {			
rrcReconfigurationSidelink-r16 SEQUENCE {			
slrb-ConfigToAddModList-r16 SEQUENCE (SIZE (1..maxNrofSLRB-r16)) OF SLRB-Config-r16 {	1 entry		
SLRB-Config-r16[1] SEQUENCE {		entry 1	
sl-SDAP-ConfigPC5-r16 SEQUENCE {			
sl-MappedQoS-FlowsToAddList-r16	Not checked		
sl-SDAP-Header-r16	absent		
}			
sl-PDCP-ConfigPC5-r16	Not checked		
sl-RLC-ConfigPC5-r16	Not checked		
sl-MAC-LogicalChannelConfigPC5-r16	Not checked		
}			
}			
}			
}			
}			

Table 12.2.8.3.3.3-5: SidelinkUEInformationNR (Table 12.2.8.3.3.2-1, Step 7, 15 and 23)

Derivation Path: TS 38.508-1 [4], Table 4.6.1-28A with condition SIDELINK_TX			
Information Element	Value/remark	Comment	Condition
SidelinkUEInformationNR-r16 ::= SEQUENCE {			
criticalExtensions CHOICE {			
sidelinkUEInformationNR-r16 SEQUENCE {			
sl-FailureList-r16 SEQUENCE (SIZE (1..maxNrofSL-Dest-r16)) OF SL-Failure-r16 {	1 entry		
SL-Failure-r16[1] SEQUENCE {			
sl-DestinationIdentity-r16	SL-DestinationIdentity of NR-SS-UE 1		
sl-Failure-r16	r16		
}			
}			
}			
}			
}			

13 V2X NAS layer

13.1 V2X policy provisioning

13.1.1 V2X policy provisioning / Precedence / Validity timer expires / geographical area changes

13.1.1.1 Test Purpose (TP)

(1)

```
with { UE having V2XP over PC5 configured in the USIM and UE being out of NR network coverage }
ensure that {
  when { UE is required to start NR V2X communication }
  then { UE conducts V2X communication according to parameters of V2XP over PC5 from USIM }
}
```

(2)

```

with { UE having V2XP over PC5 configured in the USIM and UE being in NR network coverage }
ensure that {
  when { UE receives V2XP over PC5 from SS and then NR cell is off }
  then { UE conducts V2X communication according to parameters of V2XP over PC5 from SS }
}

```

(3)

```

with { UE having received V2XP over PC5 from SS }
ensure that {
  when { Validity timer expires and NR cell is on }
  then { UE initiates a UE-requested V2X policy provisioning procedure }
}

```

(4)

```

with { UE having received V2XP over PC5 from SS after UE initiates a UE-requested V2X policy
provisioning procedure }
ensure that {
  when { UE is located in the geographical area and UE is requested by a service to transmit a V2X
packet }
  then { UE initiates a V2X communication on the frequency associated with the service }
}

```

(5)

```

with { UE having initiated a V2X communication on the frequency associated with the service }
ensure that {
  when { UE moves out of the geographical area }
  then { UE cannot continue the V2X communication on the frequency associated with the service }
}

```

13.1.1.2 Conformance requirements

References: The conformance requirements covered in the present TC are specified in: TS 24.587, clauses 5.2.2 and 5.2.3. Unless otherwise stated these are Rel-16 requirements.

[TS 24.501, clause 5.2.2]

...

The UE shall use the V2X configuration parameters in the following order of decreasing precedence:

- a) the V2X configuration parameters provided as a V2XP using the UE policy delivery service as specified in annex D of 3GPP TS 24.501 [6];
- b) the V2X configuration parameters provided by a V2X application server via V1 reference point;
- c) the V2X configuration parameters configured in the USIM; and
- d) the V2X configuration parameters pre-configured in the ME.

[TS 24.501, clause 5.2.3]

The configuration parameters for V2X communication over PC5 consist of:

- a) a validity timer for the validity of the configuration parameters for V2X communication over PC5;
- b) a list of PLMNs and RATs in which the UE is authorized to use V2X communication over PC5 when the UE is served by E-UTRA or served by NR. Each entry of the list contains a PLMN ID and RATs in which the UE is authorized to use V2X communication over PC5;
- c) an indication of whether the UE is authorized to use V2X communication over PC5 when the UE is not served by E-UTRA and not served by NR;
- d) list of RATs in which the UE is authorized to use V2X communication over PC5 and the radio parameters of the RAT for V2X communication over PC5 applicable per geographical area with an indication of whether these

radio parameters of the RAT are "operator managed" or "non-operator managed" when the UE is not served by E-UTRA and not served by NR;

- e) void
- f) optionally, a list of V2X service identifier to PC5 RAT(s) and Tx profiles mapping rules. Each mapping rule contains one or more V2X service identifiers, PC5 RAT(s) and, if the PC5 RAT(s) include E-UTRA-PC5, Tx profiles corresponding to the E-UTRA-PC5;
- g) configuration parameters for privacy support, consisting of:
 - 1) a list of V2X services requiring privacy. Each entry of the list contains one or more V2X service identifiers and one or more geographical areas where the privacy is required; and
 - 2) a privacy timer value as specified in 3GPP TS 24.588 [7] clause 5.3;
- h) configuration parameters for a V2X communication over PC5 in E-UTRA-PC5, consisting of:
 - 1) a list of V2X service identifier to destination layer-2 ID mapping rules. Each mapping rule contains one or more V2X service identifiers and the destination layer-2 ID;
 - 2) optionally, a default destination layer-2 ID;
 - 3) a list of PPPP to PDB mapping rules. Each mapping rule contains a ProSe Per-Packet Priority (PPPP) and a Packet Delay Budget (PDB);
 - 4) optionally, list of V2X service identifier to V2X E-UTRA frequency mapping rules. Each mapping rule contains one or more V2X service identifiers and the V2X E-UTRA frequencies with associated geographical areas; and
 - 5) optionally, a list of the V2X services authorized for ProSe Per-Packet Reliability (PPPR). Each entry of the list contains one or more V2X service identifiers and a ProSe Per-Packet Reliability (PPPR) value; and
- i) configuration parameters for a V2X communication over PC5 in NR-PC5, consisting of:
 - 1) optionally, a list of V2X service identifier to V2X NR frequency mapping rules. Each mapping rule contains one or more V2X service identifiers and the V2X NR frequencies with associated geographical areas;
 - 2) a list of V2X service identifier to destination layer-2 ID for broadcast mapping rules. Each mapping rule contains one or more V2X service identifiers and the destination layer-2 ID for broadcast;
 - 3) optionally, a default destination layer-2 ID for broadcast;
 - 4) a list of V2X service identifier to destination layer-2 ID for groupcast mapping rules. Each mapping rule contains one or more V2X service identifiers and the destination layer-2 ID for groupcast;
 - 5) a list of V2X service identifier to default destination layer-2 ID for unicast initial signalling mapping rules. Each mapping rule contains one or more V2X service identifiers and the default destination layer-2 ID for initial signalling to establish unicast connection;
 - 6) a list of V2X service identifier to PC5 QoS parameters mapping rules. The PC5 QoS parameters are specified in clause 5.4.2 of 3GPP TS 23.287 [3];
 - 7) an AS configuration, including a list of SLRB mapping rules applicable when the UE is not served by E-UTRA and is not served by NR. Each SLRB mapping rule contains a PC5 QoS profile and an SLRB. The PC5 QoS profile contains the following parameters:
 - i) the PC5 QoS profile contains a PQI;
 - ii) if the PQI of the PC5 QoS profile identifies a GBR QoS, the PC5 QoS profile contains a PC5 flow bit rates consisting of a guaranteed flow bit rate (GFBR) and a maximum flow bit rate (MFBR);
 - iii) if the PQI of the PC5 QoS profile identifies a non-GBR QoS, the PC5 QoS profile contains the PC5 link aggregated bit rate consisting of a per link aggregate maximum bit rate (PC5 LINK-AMBR);

NOTE: PC5 link aggregated bit rate is only used for unicast mode communications over PC5.

- iv) the PC5 QoS profile contains a range, which is only used for groupcast mode communications over PC5; and
- v) the PC5 QoS profile can contain the priority level, the averaging window, and the maximum data burst volume. If one or more of the priority level, the averaging window or the maximum data burst volume are not contained in the PC5 QoS profile, their default values apply;
- 8) a list of NR-PC5 unicast security policies. Each entry in the list contains an NR-PC5 unicast security policy composed of:
 - i) one or more V2X service identifiers;
 - ii) the signalling integrity protection policy for the V2X service identifier(s);
 - iii) the signalling ciphering policy for the V2X service identifier(s);
 - iv) the user plane integrity protection policy for the V2X service identifier(s);
 - v) the user plane ciphering policy for the V2X service identifier(s); and
 - vi) one or more geographical areas where the NR-PC5 unicast security policy applies; and
- 9) a list of V2X service identifier to default mode of communication mapping rules. Each mapping rule contains one or more V2X service identifiers and the default mode of communication (one of unicast, groupcast or broadcast).

13.1.1.3 Test description

13.1.1.3.1 Pre-test conditions

SS-NW:

- NR Cell 1.
- System information combination NR-1 as defined in TS 38.508-1 [4] clause 4.4.3.1.3 is used in NR Cell 1.
- 1 GNSS simulator

NR-SS-UE:

- NR-SS-UE 1 is as defined in TS 38.508-1 [4], configured for and operating as NR Sidelink Communication receiving device on the resources which the UE is expected to use for transmission.
- NR-SS-UE 1 is synchronised on GNSS.

UE:

- The UE is equipped with a USIM configuration as defined in clause 4.8.3.3.3 of TS 38.508-1 [4].
- UE is synchronised on GNSS.

Preamble:

- UE is brought to state 4-A, Out of Coverage (NR sidelink), in accordance with the procedure described in TS 38.508-1 [4], Table 4.5.7.2-1 using generic procedure parameter Sidelink (*On*), Cast Type (*unicast*), UE initiating unicast mode NR sidelink communication, Test Loop Function (*On*) with UE test loop mode E.

13.1.1.3.2 Test procedure sequence

Table 13.1.1.3.2-1: Main behaviour

St	Procedure	Message Sequence		TP	Verdict
		U - S	Message		

1	The SS configures: SS-NW - NR Cell 1 as "Non-suitable "Off" cell" in accordance with TS 38.508-1 [4], Table 6.2.2.1-3. - GNSS simulator is configured for Scenario #1.	-	-	-	-
2	Check: Does the UE continuously send STCH SDAP PDUs on SL DRB#n in every PSSCH duration with the resources pre-configured in SL-PreconfigurationNR IE with NRf1 test frequency for NR Sidelink in USIM? (Note 1) NOTE: The UE has activated and closed test loop mode E in the preamble.	-->	V2X Data packet	1	P
3	Trigger the UE to open UE test loop mode E NOTE: The UE test loop mode E may be opened by MMI or AT command (+CCUTLE).	-	-	-	-
4	Trigger the UE to deactivate UE test loop mode. NOTE: The deactivation of UE test loop mode may be performed by MMI or AT command (+CATM).	-	-	-	-
5	The SS configures: SS-NW - NR Cell 1 as "Serving cell" in accordance with TS 38.508-1 [4], Table 6.2.2.1-3.	-	-	-	-
6	The UE performs Step 1-22a1 of Table 4.5.2.2-2 in TS 38.508-1 [4], with 'connected without release'.	-	-	-	-
7	SS-NW transmits a DL NAS TRANSPORT message containing a MANAGE UE POLICY COMMAND message to transfer the V2X policy to the UE.	<--	5GMM: DL NAS TRANSPORT PCF: MANAGE UE POLICY COMMAND	-	-
8	The UE transmits a UL NAS TRANSPORT message containing a MANAGE UE POLICY COMPLETE message	-->	5GMM: UL NAS TRANSPORT UE V2X: MANAGE UE POLICY COMPLETE	-	-
9	The SS configures: SS-NW - NR Cell 1 as "Non-suitable "Off" cell" in accordance with TS 38.508-1 [4], Table 6.2.2.1-3.	-	-	-	-
10	Trigger the UE to activate UE test loop mode NOTE: The activation of UE test loop mode may be performed by MMI or AT command (+CATM).	-	-	-	-
11	Trigger the UE to close UE test loop mode E (transmission mode). NOTE: The UE test loop mode E may be closed by MMI or AT command (+CCUTLE).	-	-	-	-
12	Check: Does the UE continuously send STCH SDAP PDUs on SL DRB#n in every PSSCH duration with the resources pre-configured in SL-PreconfigurationNR IE with NRf2 test frequency for NR Sidelink of V2X policy in step 7? (Note 1)	-->	V2X Data packet	2	P
13	The SS configures: SS-NW - NR Cell 1 as "Serving cell" in accordance with TS 38.508-1 [4], Table 6.2.2.1-3.	-	-	-	-
14	Check: Does the UE transmit a UL NAS TRANSPORT message containing a UE POLICY PROVISIONING REQUEST message within 30 seconds after step 7.	-->	5GMM: UL NAS TRANSPORT UE V2X: UE POLICY PROVISIONING REQUEST	3	P
15	SS-NW transmits a DL NAS TRANSPORT message containing a MANAGE UE POLICY COMMAND message	<--	5GMM: DL NAS TRANSPORT PCF: MANAGE UE POLICY COMMAND	-	-
16	The SS configures: SS-NW	-	-	-	-

	- NR Cell 1 as "Non-suitable "Off" cell" in accordance with TS 38.508-1 [4], Table 6.2.2.1-3.				
17	Trigger the UE to reset UTC time. NOTE: The UTC time reset may be performed by MMI or AT command (+CUTCR).	-	-	-	-
18	SS configures: GNSS simulator is configured for Scenario #2: move from inside Geographical area #1 to outside Geographical area #1, and starts step 1 to simulate a location in the centre of Geographical area #1 as defined in TS 38.508-1 [4] Table 4.11.2-2. Geographical area #1 is also pre-configured in the UE.	-	-	-	-
19	Check: Does the UE continuously send STCH SDAP PDUs on SL DRB#n in every PSSCH duration with the resources in SL-PreconfigurationNR IE with NRf3 test frequency for NR Sidelink of V2X policy in step 15? (Note 1)	-->	V2X Data packet	4	P
20	SS configures: GNSS simulator is triggered to start step 2 of Scenario #2 to simulate the UE moving to a location outside Geographical area #1 as defined in TS 38.508-1 [4] Table 4.11.2-2. The area outside Geographical area #1 is not pre-configured in the UE.	-	-	-	-
21	Wait for 71 sec (as detailed in TS 38.508-1 [4] Table 4.11.2-2) to allow the simulated location for the UE to leave Geographical area #1 and for the UE to acquire new location data.	-	-	-	-
22	Check: Does the UE continuously send STCH SDAP PDUs on SL DRB#n in every PSSCH duration with the resources in SL-PreconfigurationNR IE with NRf3 test frequency for NR Sidelink of V2X policy in step 15, in the next 10 seconds?	-->	V2X Data packet	5	F
23	Trigger the UE to open UE test loop mode E NOTE: The UE test loop mode E may be opened by MMI or AT command (+CCUTLE).	-	-	-	-
24	Trigger the UE to deactivate UE test loop mode. NOTE: The deactivation of UE test loop mode may be performed by MMI or AT command (+CATM).	-	-	-	-
Note 1: Although the UE is expected to transmit continuously, only one STCH SDAP SDU packet is shown explicitly in this step sequence.					

13.1.1.3.3 Specific message contents

Table 13.1.1.3.3-0: DL NAS TRANSPORT (step 7, 15, Table 13.1.1.3.2-1)

Derivation Path: TS 38.508-1 [4] Table 4.7.1-11			
Information Element	Value/remark	Comment	Condition
Payload container type	'0101'B	UE policy container type	
Payload container	Set according to Table 13.1.1.3.3-1		

Table 13.1.1.3.3-1: MANAGE UE POLICY COMMAND (step 7, 15, Table 13.1.1.3.2-1)

Derivation Path: TS 38.508-1 [4] Table 4.7.6-1			
Information Element	Value/remark	Comment	Condition
UE policy section management list			

UE policy section management list contents	1 entry		
UE policy section management sublist (PLMN-1)			
UE policy section management sublist contents			
Instruction 1			
UE policy section contents			
UE policy part 1			
UE policy part type	'0011'B	V2XP	
UE policy part contents	See Table 13.1.1.3.3-2		

Table 13.1.1.3.3-2: UE policy part contents (Table 13.1.1.3.3-1)

Derivation Path: TS 38.508-1 [4] Table 4.7.5.4-1			
Information Element	Value/remark	Comment	Condition
UE policy part contents={V2XP contents}	See Table 13.1.1.3.3-3		

Table 13.1.1.3.3-3: V2XP contents (Table 13.1.1.3.3-2)

Derivation Path: TS 38.508-1 [4] Table 4.7.5.4-2			
Information Element	Value/remark	Comment	Condition
V2XP info #1	See Table 13.1.1.3.3-4		
V2XP info #2	Not Present		

Table 13.1.1.3.3-4: V2XP info (Table 13.1.1.3.3-3)

Derivation Path: TS 38.508-1 [4] Table 4.7.5.4-3			
Information Element	Value/remark	Comment	Condition
V2XP info contents	See Table 13.1.1.3.3-5		

Table 13.1.1.3.3-5: V2XP info = {UE policies for V2X communication over PC5} (Table 13.1.1.3.3-4)

Derivation Path: TS 38.508-1 [4] Table 4.7.5.5-1			
Information Element	Value/remark	Comment	Condition
Validity timer	'FF FF FF FF FF FF FF FF FF FF'H	5 bytes, Expiration UTC time of validity of the UE policies, in seconds since midnight UTC of January 1, 1970 (not counting leap seconds)	Step 15
	Current GNSS UTC time + 30 seconds		Step 7
V2X service identifier to PC5 RAT and Tx profiles mapping rules	See Table 4.7.5.5-12 in TS 38.508-1 [4] with condition NR-PC5		
Not served by E-UTRA and not served by NR	See Table 13.1.1.3.3-6		

Table 13.1.1.3.3-6: Not served by E-UTRA and not served by NR (Table 13.1.1.3.3-5)

Derivation Path: TS 38.508-1 [4] Table 4.7.5.5-6			
Information Element	Value/remark	Comment	Condition
EPINENN	'0'B	UE is not authorized to use V2X communication over E-UTRA-PC5 when not served by E-UTRA and not served by NR	

E-UTRA radio parameters per geographical area list	Not present		
NR radio parameters per geographical area list	See Table 13.1.1.3.3-7		

Table 13.1.1.3.3-7: Radio parameters per geographical area list (Table 13.1.1.3.3-6)

Derivation Path: TS 38.508-1 [4] Table 4.7.5.5-7			
Information Element	Value/remark	Comment	Condition
Radio parameters per geographical area info 1	See Table 13.1.1.3.3-8		

Table 13.1.1.3.3-8: Radio parameters per geographical area info (Table 13.1.1.3.3-7)

Derivation TS 38.508-1 [4] Table 4.7.5.5-8			
Information Element	Value/remark	Comment	Condition
Radio parameters	See Table 13.1.1.3.3-9		

Table 13.1.1.3.3-9: Radio parameters (Table 13.1.1.3.3-8)

Derivation Path: TS 38.508-1 [4] Table 4.7.5.5-11			
Information Element	Value/remark	Comment	Condition
Radio parameters contents	See Table 13.1.1.3.3-10		

Table 13.1.1.3.3-10: SL-PreconfigurationNR (Table 13.1.1.3.3-9)

Derivation Path: TS 38.508-1 [4] Table 4.10.1-1			
Information Element	Value/remark	Comment	Condition
SL-PreconfigurationNR-r16 ::= SEQUENCE {			
sidelinkPreconfigNR-r16 SEQUENCE {			
sl-PreconfigFreqInfoList-r16 SEQUENCE (SIZE (1..maxNrofFreqSL-r16)) OF {	1 entry		
SL-FreqConfigCommon-r16[0]	See Table 13.1.1.3.3-11		
}			
}			
}			

Table 13.1.1.3.3-11: SL-FreqConfigCommon (Table 13.1.1.3.3-10)

Derivation Path: TS 38.508-1 [4] Table 4.6.6-11			
Information Element	Value/remark	Comment	Condition
SL-FreqConfigCommon-r16 ::= SEQUENCE {			
sl-SCS-SpecificCarrierList-r16 SEQUENCE (SIZE (1..maxSCSs)) OF SCS-SpecificCarrier {	1 entry		
SCS-SpecificCarrier[1]	See Table 13.1.1.3.3-12	entry 1	
}			
sl-AbsoluteFrequencyPointA-r16	sl-AbsoluteFrequencyPoint A as defined for the SL NRf2 frequency	See TS 38.508-1 [4] Table 6.2.3.7-1.	Step 7
	sl-AbsoluteFrequencyPoint A as defined for the SL NRf3 frequency	See TS 38.508-1 [4] Table 6.2.3.7-1.	Step 15
sl-AbsoluteFrequencySSB-r16	sl-AbsoluteFrequencySSB as defined for the SL NRf2 frequency	See TS 38.508-1 [4] Table 6.2.3.7-1.	Step 7
	sl-AbsoluteFrequencySSB as defined for the SL NRf3 frequency	See TS 38.508-1 [4] Table 6.2.3.7-1.	Step 15
}			

Table 13.1.1.3.3-12: SCS-SpecificCarrier (Table 13.1.1.3.3-11)

Derivation Path: TS 38.508-1 [4] Table 4.6.3-160			
Information Element	Value/remark	Comment	Condition
SCS-SpecificCarrier ::= SEQUENCE {			
offsetToCarrier	offsetToCarrier as defined for the SL NRf2 frequency	See TS 38.508-1 [4] Table 6.2.3.7-1.	Step 7
	offsetToCarrier as defined for the SL NRf3 frequency	See TS 38.508-1 [4] Table 6.2.3.7-1.	Step 15
}			

Table 13.1.1.3.3-13: UL NAS TRANSPORT (step 8, 14, Table 13.1.1.3.2-1)

Derivation Path: TS 38.508-1 [4] Table 4.7.1-11			
Information Element	Value/remark	Comment	Condition
Payload container type	'0101'B	UE policy container type	
Payload container	Set to MANAGE UE POLICY COMPLETE message		Step 8
	Set to UE POLICY PROVISIONING REQUEST message		Step 14

13.2 PC5 unicast

13.2.1 PC5 unicast / link establishment / Reject / Conflict Layer 2 ID

13.2.1.1 Test Purpose (TP)

(1)

```
with { UE being out of coverage, Test loopback activated}
ensure that {
  when { UE has a V2X packet to be transmitted over PC5 }
  then { UE initiates PC5 unicast link establishment }
}
```

(2)

```
with { UE having transmitted PC5 unicast link establishment Request message }
ensure that {
  when { The Layer 2 ID is conflicted }
  then { the PC5 unicast link establishment procedure fails }
}
```

13.2.1.2 Conformance requirements

References: The conformance requirements covered in the present TC are specified in: TS 24.587 [FFS], subclause 6.1.2.2.2 and 6.1.2.2.5. Unless otherwise stated these are Rel-16 requirements.

[TS 24.587, subclause 6.1.2.2.2]

The initiating UE shall meet the following pre-conditions before initiating this procedure:

- a) a request from upper layers to transmit the packet for V2X service over PC5;

- b) the communication mode is unicast mode (e.g. pre-configured as specified in clause 5.2.3 or indicated by upper layers);
- c) the link layer identifier for the initiating UE (i.e. layer-2 ID used for unicast communication) is available (e.g. pre-configured or self-assigned) and is not being used by other existing PC5 unicast links within the initiating UE;
- d) the link layer identifier for the destination UE (i.e. the unicast layer-2 ID of the target UE or the broadcast layer-2 ID) is available to the initiating UE (e.g. pre-configured, obtained as specified in clause 5.2.3 or known via prior V2X communication);

NOTE 1: In the case where different V2X services are mapped to distinct default destination layer-2 IDs, when the initiating UE intends to establish a single unicast link that can be used for more than one V2X service identifiers, the UE can select any of the default destination layer-2 ID for unicast initial signalling.

[TS 24.587, subclause 6.1.2.2.5]

If the DIRECT LINK ESTABLISHMENT REQUEST message cannot be accepted, the target UE shall send a DIRECT LINK ESTABLISHMENT REJECT message. The DIRECT LINK ESTABLISHMENT REJECT message contains a PC5 signalling protocol cause IE set to one of the following cause values:

- #1 direct communication to the target UE not allowed;
- #3 conflict of layer-2 ID for unicast communication is detected;
- #5 lack of resources for PC5 unicast link; or
- #111 protocol error, unspecified.

...

For a received DIRECT LINK ESTABLISHMENT REQUEST message from a layer-2 ID (for unicast communication), if the target UE already has an existing link established to a UE using this layer-2 ID or is currently processing a DIRECT LINK ESTABLISHMENT REQUEST message from the same layer-2 ID, and with one of following parameters different from the existing link or the link for which the link establishment is in progress:

- a) the source user info;
- b) type of data (e.g. IP or non-IP); or
- c) security policy,

the target UE shall send a DIRECT LINK ESTABLISHMENT REJECT message containing PC5 signalling protocol cause value #3 "conflict of layer-2 ID for unicast communication is detected".

NOTE: The type of data (e.g. IP or non-IP) is indicated by the optional IP address configuration IE included in the corresponding DIRECT LINK SECURITY MODE COMPLETE message, i.e. the type of data for the requested link is IP type if this IE is included, and the type of data for the requested link is non-IP if this IE is not included.

...

After sending the DIRECT LINK ESTABLISHMENT REJECT message, the target UE shall provide the following information along with the initiating UE's layer-2 ID for unicast communication and the target UE's layer-2 ID for unicast communication to the lower layer:

- a) an indication of deactivation of the PC5 unicast security protection and deletion of security context for the PC5 unicast link, if applicable.

Upon receipt of the DIRECT LINK ESTABLISHMENT REJECT message, the initiating UE shall stop timer T5000 and abort the PC5 unicast link establishment procedure.

...

After receiving the DIRECT LINK ESTABLISHMENT REJECT message, the initiating UE shall provide the following information along with the initiating UE's layer-2 ID for unicast communication and the target UE's layer-2 ID for unicast communication to the lower layer:

- a) an indication of deactivation of the PC5 unicast security protection and deletion of security context for the PC5 unicast link, if applicable.

13.2.1.3 Test description

13.2.1.3.1 Pre-test conditions

System Simulator:

- NR-SS-UE
 - NR-SS-UE1 operating as NR sidelink communication device on the resources (i.e. the frequency included in pre-configuration) that UE is expected to use for transmission and reception via PC5 interface.
 - NR-SS-UE 1 is synchronised on GNSS.
- GNSS simulator
 - The GNSS simulator is started and configured for Scenario #1.

UE:

- UE is authorised to perform NR sidelink communication.
- The UE is equipped with a USIM containing default values as per TS 38.508-1 [4] clause 4.8.3.3.3.
- UE is synchronised on GNSS.

Preamble:

- The UE is in state 4-A and Test Mode (*On*), Test Loop Function (*Off*) as defined in TS 38.508-1 [4], Table 4.5.7.2-1 using generic procedure parameter Sidelink (*On*), Cast Type (*Unicast*), UE initiating unicast mode NR sidelink communication, GNSS Sync (*On*).

13.2.1.3.2 Test procedure sequence

Table 13.2.1.3.2-1: Main behaviour

St	Procedure	Message Sequence		TP	Verdict
		U - S	Message		
1	The NR-SS-UE1 releases unicast mode sidelink connection by executing steps 1-2 of Table 4.9.30.2.2-1 in TS38.508-1 [4].	-	-	-	-
2	Trigger UE to close UE test loop mode E (transmission mode). NOTE: The UE test loop mode E may be closed by MMI or AT command (+CCUTLE).	-	-	-	-
3	The UE transmits a DIRECT LINK ESTABLISHMENT REQUEST message.	-->	PC5-S: DIRECT LINK ESTABLISHMENT REQUEST	1	P
4	The NR-SS-UE1 transmits a DIRECT LINK ESTABLISHMENT REJECT message with the PC5 signalling protocol cause set to 'conflict of layer-2 ID for unicast communication is detected'.	<--	PC5-S: DIRECT LINK ESTABLISHMENT REJECT	-	-
5	The NR-SS-UE1 transmits a DIRECT LINK SECURITY MODE COMMAND message	<--	PC5-S: DIRECT LINK SECURITY MODE COMMAND	-	-
-	EXCEPTION: Step 7 is optional and may occur during Step 6	-	-	-	-
6	Check: Does the UE transmit a DIRECT LINK SECURITY MODE COMPLETE message in	-->	PC5-S: DIRECT LINK SECURITY MODE COMPLETE	2	F

	the next 5 seconds?				
7	The UE sends a DIRECT LINK ESTABLISHMENT REQUEST message.	-	PC5-S: DIRECT LINK ESTABLISHMENT REQUEST	-	-
-	EXCEPTION: steps 8-13 are executed if UE has sent DIRECT LINK ESTABLISHMENT REQUEST message in step7.	-	-	-	-
8-13	Steps 3-8 of the procedure defined in Table 4.5.2.2-2 in TS 38.508-1 [4] is performed.	-	-	-	-
14	The SS sends AT COMMAND +CCUTLE to open test loop function.	-	-	-	-

13.2.1.3.3 Specific message contents

Table 13.2.1.3.3-1: Message DIRECT LINK ESTABLISHMENT REQUEST (step 3, Table 13.2.1.3.2-1)

Derivation path: TS 38.508-1 [4], Table 4.7.4-7 with condition Tx

Table 13.2.1.3.3-2: Message DIRECT LINK ESTABLISHMENT REJECT (step 4, Table 13.2.1.3.2-1)

Derivation path: TS 38.508-1 [4], Table 4.7.4-28 with condition Rx			
Information Element	Value/Remark	Comment	Condition
PC5 signalling protocol cause	'0000 0011'B	Conflict of layer-2 ID for unicast communication is detected	

Table 13.2.1.3.3-3: Message DIRECT LINK SECURITY MODE COMMAND (step 5, Table 13.2.1.3.2-1)

Derivation path: TS 38.508-1 [4], Table 4.7.4-18 with condition Rx

Table 13.2.1.3.3-4: Message DIRECT LINK SECURITY MODE COMPLETE (step 6, Table 13.2.1.3.2-1)

Derivation path: TS 38.508-1 [4], Table 4.7.4-19 with condition Tx

13.2.2 PC5 unicast / link Security Mode

13.2.2.1 Test Purpose (TP)

(1)

```
with { UE having received a DIRECT LINK SECURITY MODE COMMAND message }
ensure that {
  when { The DIRECT LINK SECURITY MODE COMMAND message includes non matching UE security capabilities }
  then { UE transmits a DIRECT LINK SECURITY MODE REJECT message }
}
```

13.2.2.2 Conformance requirements

References: The conformance requirements covered in the present TC are specified in: TS 24.587 [FFS], subclause 6.1.2.7.5. Unless otherwise stated these are Rel-16 requirements.

[TS 24.587, subclause 6.1.2.7.5]

If the DIRECT LINK SECURITY MODE COMMAND message cannot be accepted, the target UE shall send a DIRECT LINK SECURITY MODE REJECT message, and the target UE shall abort the ongoing procedure that triggered the initiation of the PC5 unicast link security mode control procedure unless the ongoing procedure is a PC5 unicast link establishment procedure and the Target user info is not included in the DIRECT LINK ESTABLISHMENT

REQUEST message. The DIRECT LINK SECURITY MODE REJECT message contains a PC5 signalling protocol cause IE indicating one of the following cause values:

- #7: integrity failure;
- #8: UE security capabilities mismatch;
- #9: LSBs of $K_{\text{NRP-seSS}}$ ID conflict;
- #10: UE PC5 unicast signalling security policy mismatch;
- #11: lack of resources for PC5 unicast link; or
- #111: protocol error, unspecified.

...

If the target UE detects that the received UE security capabilities IE in the DIRECT LINK SECURITY MODE COMMAND message has been altered compared to the latest values that the target UE sent to the initiating UE in the DIRECT LINK ESTABLISHMENT REQUEST message or DIRECT LINK REKEYING REQUEST message, the target UE shall include PC5 signalling protocol cause #8 "UE security capabilities mismatch" in the DIRECT LINK SECURITY MODE REJECT message.

...

After the DIRECT LINK SECURITY MODE REJECT message is generated, the target UE shall pass this message to the lower layers for transmission along with the initiating UE's layer-2 ID for unicast communication and the target UE's layer-2 ID for unicast communication.

Upon receipt of the DIRECT LINK SECURITY MODE REJECT message, the initiating UE shall stop timer T5007, provide an indication to the lower layer of deactivation of the PC5 unicast security protection and deletion of security context for the PC5 unicast link, if applicable and:

- a) if the PC5 signalling protocol cause IE in the DIRECT LINK SECURITY MODE REJECT message is set to #9 "LSBs of $K_{\text{NRP-seSS}}$ ID conflict", retransmit the DIRECT LINK SECURITY MODE COMMAND message with a different value for the 8 LSBs of $K_{\text{NRP-seSS}}$ ID and restart timer T5007; or
- b) if the PC5 signalling protocol cause IE is set to the value other than #9 "LSBs of $K_{\text{NRP-seSS}}$ ID conflict", abort the ongoing procedure that triggered the initiation of the PC5 unicast link security mode control procedure.

13.2.2.3 Test description

13.2.2.3.1 Pre-test conditions

System Simulator:

- NR-SS-UE
 - NR-SS-UE1 operating as NR sidelink communication device on the resources (i.e. the frequency included in pre-configuration) that UE is expected to use for transmission and reception via PC5 interface.
 - NR-SS-UE 1 is synchronised on GNSS.
- GNSS simulator
 - The GNSS simulator is started and configured for Scenario #1.

UE:

- UE is authorised to perform NR sidelink communication.
- The UE is equipped with a USIM containing default values as per TS 38.508-1 [4] clause 4.8.3.3.3.
- UE is synchronised on GNSS.

Preamble:

- The UE is in state 4-A and Test Mode (*On*), Test Loop Function (*Off*) as defined in TS 38.508-1 [4], Table 4.5.7.2-1 using generic procedure parameter Sidelink (*On*), Cast Type (*Unicast*), UE initiating unicast mode NR sidelink communication, GNSS Sync (*On*).

13.2.2.3.2 Test procedure sequence

Table 13.2.2.3.2-1: Main behaviour

St	Procedure	Message Sequence		TP	Verdict
		U - S	Message		
1	The NR-SS-UE1 releases unicast mode sidelink connection by executing steps 1-2 of Table 4.9.30.2.2-1 in TS 38.508-1 [4].	-	-	-	-
2	Trigger UE to close UE test loop mode E (transmission mode). NOTE: The UE test loop mode E may be closed by MMI or AT command (+CCUTLE).	-	-	-	-
3	The UE transmits a DIRECT LINK ESTABLISHMENT REQUEST message.	-->	PC5-S: DIRECT LINK ESTABLISHMENT REQUEST	-	-
4	The NR-SS-UE1 transmits a DIRECT LINK SECURITY MODE COMMAND message including non matching UE security capabilities	<--	PC5-S: DIRECT LINK SECURITY MODE COMMAND	-	-
5	The UE transmits a DIRECT LINK SECURITY MODE REJECT message with PC5 signalling protocol cause #8 UE security capabilities mismatch.	-->	PC5-S: DIRECT LINK SECURITY MODE REJECT	1	P
6-12	The UE establishes unicast mode sidelink connection by executing steps 2-8 of Table 4.9.22.2.2-1 in TS38.508-1 [4].	-	-	-	-
13	Trigger UE to deactivate UE test loop mode. NOTE: The deactivation of UE test loop mode may be performed by MMI or AT command (+CATM).	-	-	-	-

13.2.2.3.3 Specific message contents

Table 13.2.2.3.3-1: Message DIRECT LINK ESTABLISHMENT REQUEST (step 3, Table 13.2.2.3.2-1)

Derivation path: TS 38.508-1 [4], Table 4.7.4-7 with condition Tx

Table 13.2.2.3.3-2: Message DIRECT LINK SECURITY MODE COMMAND (step 4, Table 13.2.2.3.2-1)

Derivation path: TS 38.508-1 [4], Table 4.7.4-18 with condition Rx			
Information Element	Value/Remark	Comment	Condition
UE security capabilities			
Length of UE security capabilities contents	'02'H		
5G-EA algorithms	'1100 0000'B	5G-EA0 and 5G-EA1 supported	
5G-IA algorithms	'1100 0000'B	5G-IA0 and 5G-IA1 supported	

Table 13.2.2.3.3-3: Message DIRECT LINK SECURITY MODE REJECT (step 5, Table 13.2.2.3.2-1)

Derivation path: TS 38.508-1 [4], Table 4.7.4-20 with condition Tx			
Information Element	Value/Remark	Comment	Condition
PC5 signalling protocol cause	'0000 1000'B	UE security capabilities mismatch	

13.2.3 PC5 unicast / Link modification

13.2.3.1 Test Purpose (TP)

(1)

```
with { UE having set up a V2X PDU session over PC5}
ensure that {
  when { UE receives a DIRECT LINK MODIFICATION REQUEST to add a QoS flow to be used on an added
unicast SL-DRB }
  then { UE can communicate using the newly added QoS flow on added SL-DRB }
}
```

(2)

```
with { UE having set up a V2X PDU session over PC5}
ensure that {
  when { UE receives a DIRECT LINK MODIFICATION REQUEST to modify a QoS flow associated with the SL-
DRB}
  then { UE can communicate on the SL-DRB using the newly modified QoS }
}
```

(3)

```
with { UE having set up a V2X PDU session over PC5}
ensure that {
  when { UE receives a DIRECT LINK MODIFICATION REQUEST to delete a QoS flow and associated SL-DRB
is released}
  then { UE releases the SL-DRB and its associated QoS flow and sends the complete message}
}
```

13.2.3.2 Conformance requirements

References: The conformance requirements covered in the present TC are specified in: TS 24.587, subclause 6.1.2.3.2, 6.1.2.3.3. Unless otherwise stated these are Rel-16 requirements.

[TS 24.587, subclause 6.1.2.3.2]

The initiating UE shall meet the following pre-conditions before initiating this procedure for adding a new V2X service to the existing PC5 unicast link:

- a) there is a PC5 unicast link between the initiating UE and the target UE; and
- b) the pair of application layer IDs and the network layer protocol of this PC5 unicast link are identical to those required by the application layer in the initiating UE for this V2X service.
- c) the security policy corresponding to the V2X service identifier (e.g. ITS-AID of the new V2X service) is aligned with the security policy of the existing PC5 unicast link.

After receiving the service data or request from the upper layers, the initiating UE shall perform the PC5 QoS flow match as specified in clause 6.1.2.13. If there is no matched PC5 QoS flow, the initiating UE shall derive the PC5 QoS parameters and assign the PQFI(s) for the PC5 QoS flows(s) to be established as specified in clause 6.1.2.12.

If the PC5 unicast link modification procedure is to add new PC5 QoS flow(s) to the existing PC5 unicast link, the initiating UE shall create a DIRECT LINK MODIFICATION REQUEST message. In this message, initiating UE:

- a) shall include the PQFI(s) and the corresponding PC5 QoS parameters, including the V2X service identifier(s); and
- b) shall include the link modification operation code set to "add new PC5 QoS flow(s) to the existing PC5 unicast link".

If the PC5 unicast link modification procedure is to modify the PC5 QoS parameters for existing PC5 QoS flow(s) in the existing PC5 unicast link, the initiating UE shall create a DIRECT LINK MODIFICATION REQUEST message. In this message, the initiating UE:

- a) shall include the PQFI(s) and the corresponding PC5 QoS parameters, including the V2X service identifier(s); and
- b) shall include the link modification operation code set to "modify PC5 QoS parameters of the existing PC5 QoS flow(s)".

If the PC5 unicast link modification procedure is to associate new V2X service(s) with existing PC5 QoS flow(s), the initiating UE shall create a DIRECT LINK MODIFICATION REQUEST message. In this message, the initiating UE:

- a) shall include the PQFI(s) and the corresponding PC5 QoS parameters, including the V2X service identifier(s); and
- b) shall include the link modification operation code set to "associate new V2X service(s) with existing PC5 QoS flow(s)".

If the PC5 unicast link modification procedure is to remove the associated V2X service(s) from existing PC5 QoS flow(s), the initiating UE shall create a DIRECT LINK MODIFICATION REQUEST message. In this message, the initiating UE:

- a) shall include the PQFI(s) and the corresponding PC5 QoS parameters including the V2X service identifier(s); and
- b) shall include the link modification operation code set to "remove V2X service(s) from existing PC5 QoS flow(s)".

If the PC5 unicast link modification procedure is to remove any PC5 QoS flow(s) from the existing PC5 unicast link, the initiating UE shall create a DIRECT LINK MODIFICATION REQUEST message. In this message, the initiating UE:

- a) shall include the PQFI(s); and
- b) shall include the link modification operation code set to "remove existing PC5 QoS flow(s) from the existing PC5 unicast link".

After the DIRECT LINK MODIFICATION REQUEST message is generated, the initiating UE shall pass this message to the lower layers for transmission along with the initiating UE's layer-2 ID for unicast communication and the target UE's layer-2 ID for unicast communication, and start timer T5001. The UE shall not send a new DIRECT LINK MODIFICATION REQUEST message to the same target UE while timer T5001 is running.

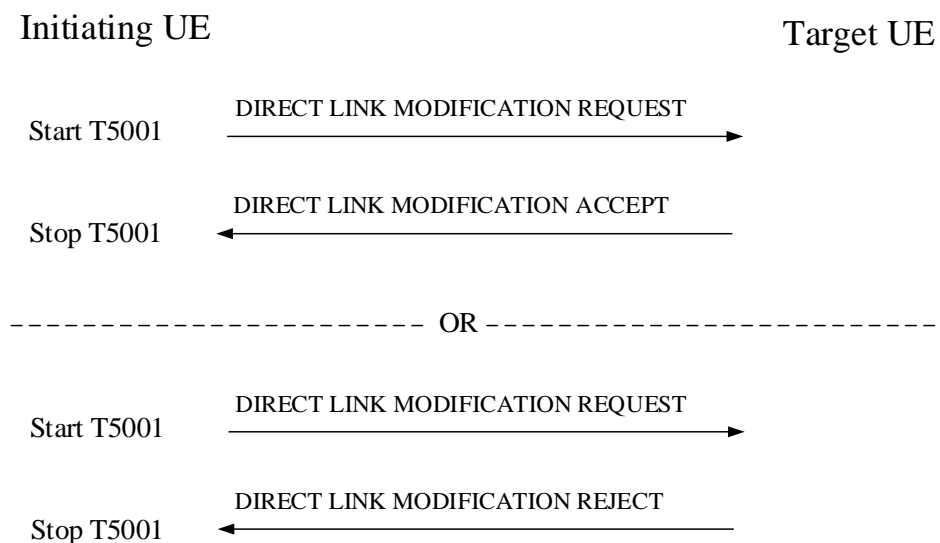

Figure 6.1.2.3.2: PC5 unicast link modification procedure

[TS 24.587, subclause 6.1.2.3.3]

If the DIRECT LINK MODIFICATION REQUEST message is accepted, the target UE shall respond with the DIRECT LINK MODIFICATION ACCEPT message.

If the DIRECT LINK MODIFICATION REQUEST message is to add a new V2X service, add new PC5 QoS flow(s) or modify any existing PC5 QoS flow(s) in the PC5 unicast link, the target UE shall include in the DIRECT LINK MODIFICATION ACCEPT message:

- a) the PQFI(s), the corresponding PC5 QoS parameters and the V2X service identifier(s) that the target UE accepts.

If the DIRECT LINK MODIFICATION REQUEST message is to remove an existing V2X service from the PC5 unicast link, the target UE shall delete the V2X service identifier received in the DIRECT LINK MODIFICATION REQUEST message and the corresponding PQFI(s) and PC5 QoS parameters from the profile associated with the PC5 unicast link.

If the DIRECT LINK MODIFICATION REQUEST message is to remove existing PC5 QoS flow(s) from the PC5 unicast link, the target UE shall delete the PQFI(s) and the corresponding PC5 QoS parameters from the profile associated with the PC5 unicast link.

If the DIRECT LINK MODIFICATION REQUEST message is to add a new V2X service, add new PC5 QoS flow(s) or modify any existing PC5 QoS flow(s) in the PC5 unicast link, after sending the DIRECT LINK MODIFICATION ACCEPT message, the target UE shall provide the added or modified PQFI(s) and corresponding PC5 QoS parameters along with PC5 link identifier to the lower layer.

If the DIRECT LINK MODIFICATION REQUEST message is to remove an existing V2X service or to remove the existing PC5 QoS flow(s) from the PC5 unicast link, after sending the DIRECT LINK MODIFICATION ACCEPT message, the target UE shall provide the removed PQFI(s) along with the PC5 link identifier to the lower layer.

If the target UE accepts the PC5 unicast link modification request, then the target UE may perform the PC5 QoS flow establishment over PC5 unicast link as specified in clause 6.1.2.12 and perform the PC5 QoS flow match over PC5 unicast link as specified in clause 6.1.2.13.

13.2.3.3 Test description

13.2.3.3.1 Pre-test conditions

System Simulator:

- NR-SS-UE
 - NR-SS-UE1 operating as NR sidelink communication device on the resources (i.e. the frequency included in pre-configuration) that UE is expected to use for transmission and reception via PC5 interface.
 - GNSS simulator
 - The GNSS simulator is started and configured for Scenario #1.
- NR-SS-UE 1 is synchronised on GNSS.

UE:

- UE is authorised to perform NR sidelink communication.
- The UE is equipped with a USIM containing default values as per TS 38.508-1 [4] clause 4.8.3.3.3.
- UE is synchronised on GNSS.

Preamble:

- The UE is in state 4-A with Test Mode (*On*), Test Loop Function (*Off*) as defined in TS 38.508-1 [4], Table 4.5.7.2-1 using generic procedure parameter Sidelink (*On*), NR-SS-UE initiating unicast mode NR sidelink communication, Cast Type (*Unicast*), GNSS Sync (*On*).

13.2.3.3.2 Test procedure sequence

Table 13.2.3.3.2-1: Main behaviour

	Procedure	Message Sequence		TP	Verdict
		U - S	Message		
1	The NR-SS-UE1 transmits a DIRECT LINK MODIFICATION REQUEST to add a QoS flow	<--	PC5-S: DIRECT LINK MODIFICATION REQUEST	-	-
2	Check: Does the UE transmit a DIRECT LINK MODIFICATION ACCEPT message?	-->	PC5-S: DIRECT LINK MODIFICATION ACCEPT	1	P
3	The NR-SS-UE sends a RRCReconfigurationSidelink message to establish a unicast mode SL-DRB#2.	<--	PC5-RRC: RRCReconfigurationSidelink	-	-
4	Check: Does the UE send a RRCReconfigurationCompleteSidelink message?	-->	PC5-RRC: RRCReconfigurationCompleteSidelink	1	P
5	Check: Does the test result of generic test procedure in TS 38.508-1 subclause 4.9.31 indicate that the UE has user plane connectivity on SL-DRB#2?	-	-	1	-
6	The NR-SS-UE1 transmits a DIRECT LINK MODIFICATION REQUEST to modify the QoS flow associated with SL=DRB#2.	<--	PC5-S: DIRECT LINK MODIFICATION REQUEST	-	-
7	Check: Does the UE transmit a DIRECT LINK MODIFICATION ACCEPT message?	-->	PC5-S: DIRECT LINK MODIFICATION ACCEPT	2	P
8	Check: Does the test result of generic test procedure in TS 38.508-1 subclause 4.9.31 indicate that the UE has user plane connectivity on SL-DRB#2?	-	-	2	-
9	The NR-SS-UE1 transmits a DIRECT LINK MODIFICATION REQUEST to release a QoS flow associated with SL=DRB#2	<--	PC5-S: DIRECT LINK MODIFICATION REQUEST	-	-
10	Check: Does the UE transmit a DIRECT LINK MODIFICATION ACCEPT message?	-->	PC5-S: DIRECT LINK MODIFICATION ACCEPT	3	P
11	The NR-SS-UE sends a RRCReconfigurationSidelink message to indicate release of unicast mode SL DRB.	<--	PC5-RRC: RRCReconfigurationSidelink	-	-
12	Check: The UE sends a RRCReconfigurationSidelinkComplete message?	-->	PC5-RRC: RRCReconfigurationSidelinkComplete	3	P

13.2.3.3.3 Specific message contents

Table 13.2.3.3.3-1: Message DIRECT LINK MODIFICATION REQUEST (step 1, Table 13.2.3.3.2-1)

Derivation path: TS 38.508-1 [4], Table 4.7.4-9 with condition Rx

Table 13.2.3.3.3-2: Message DIRECT LINK MODIFICATION ACCEPT (step 2, Table 13.2.3.3.2-1)

Derivation path: TS 38.508-1 [4], Table 4.7.4-10
--

Table 13.2.3.3.3-3: RRCReconfigurationSidelink (step 3, Table 13.2.3.3.2-1)

Derivation path: TS 38.508-1 [4], Table 4.6.1A-3 Conditions RX and SL_DRB			
RRCReconfigurationSidelink ::= SEQUENCE {			
criticalExtensions CHOICE {			
rrcReconfigurationSidelink-r16 SEQUENCE {			
slrb-ConfigToAddModList-r16 SEQUENCE (SIZE (1..maxNrofSLRB-r16)) OF SLRB-Config-r16 {	1 entry		
SLRB-Config-r16[1] SEQUENCE {		entry 1	
sl-SDAP-ConfigPC5-r16 SEQUENCE {			
sl-MappedQoS-FlowsToAddList-r16 SEQUENCE (SIZE (1.. maxNrofSL-QFIsPerDest-	1 entry		

r16)) OF SL-PQFI-r16 {			
SL-PQFI-r16[1]	2	entry 1	
}			
}			
sl-MAC-LogicalChannelConfigPC5-r16			
SEQUENCE {			
sl-LogicalChannelIdentity-r16	LogicalChannelIdentity with condition DRB2		
}			
}			
}			
}			
}			
}			
}			

Table 13.2.3.3.3-4: RRCReconfigurationSidelink (step 4, Table 13.2.3.3.2-1)

Derivation path: TS 38.508-1 [4], Table 4.6.1A-3 Conditions RX and SL_DRB

Table 13.2.3.3.3-5: Message DIRECT LINK MODIFICATION REQUEST (step 6, Table 13.2.3.3.2-1)

Derivation path: TS 38.508-1 [4], Table 4.7.4-9 with condition Rx			
Information Element	Value/remark	Comment	Condition
Link modification operation code	'0000 0100'B	Modify PC5 QoS parameters of the existing PC5 QoS flow(s)	
QoS flow descriptions			
Length of PC5 QoS flow descriptions contents	Set to the actual length of 'PC5 QoS flow descriptions contents' in bytes		
PC5 QoS flow description 1			
PQFI	'00 0010'B		
Operation Code	'011'B	Modify existing PC5 QoS flow description	
Number of parameters	5		
E	1	parameters list is included	
Associated V2X service identifiers			
Length of V2X service identifier contents	'04'H		
V2X service identifier 1	'00 00 00 02'H		
Parameters list			
Parameter 1			
Parameter identifier	'01'H	PQI	
Length of parameter contents	1		
Parameter contents	23	Platooning between UEs, See Table 5.4.4-1 in TS 23.287[xx]	
Parameter 2			
Parameter identifier	'02'H	GFBR	
Length of parameter contents	3		
Parameter contents	'0000 0111 0000 0000 0000 1100'B	12 * 4Mbps = 48Mbps.	
Parameter 3			
Parameter identifier	'03'H	MFBR	
Length of parameter contents	3		
Parameter contents	'0000 0111 0000 0000 0001 1000'B	24 * 4Mbps = 96Mbps.	
Parameter 4			
Parameter identifier	'04'H	Averaging window	
Length of parameter contents	2		

Parameter contents	'0000 0111 1101 0000'B	2000ms	
Parameter 5			
Parameter identifier	'06'H	Default priority level	
Length of parameter contents	1		
Parameter contents	3		

Table 13.2.3.3.3-6: Message DIRECT LINK MODIFICATION ACCEPT (step 7, Table 13.2.3.3.2-1)

Derivation path: TS 38.508-1 [4], Table 4.7.4-10			
QoS flow descriptions			
PC5 QoS flow descriptions IEI	'79'H		
Length of PC5 QoS flow descriptions contents	Set to the actual length of 'PC5 QoS flow descriptions contents' in bytes		
PC5 QoS flow description 1			
PQFI	'00 0010'B		
Operation Code	'011'B	Modify existing PC5 QoS flow description	
Number of parameters	5		
E	1	parameters list is included	
Associated V2X service identifiers			
Length of V2X service identifier contents	'04'H		
V2X service identifier 1	'00 00 00 02'H		
Parameters list			
Parameter 1			
Parameter identifier	'01'H	PQI	
Length of parameter contents	1		
Parameter contents	23	Platooning between UEs, See Table 5.4.4-1 in TS 23.287[xx]	
Parameter 2			
Parameter identifier	'02'H	GFBR	
Length of parameter contents	3		
Parameter contents	'0000 0111 0000 0000 0000 1100'B	12 * 4Mbps = 48Mbps.	
Parameter 3			
Parameter identifier	'03'H	MFBR	
Length of parameter contents	3		
Parameter contents	'0000 0111 0000 0000 0001 1000'B	24 * 4Mbps = 96Mbps.	
Parameter 4			
Parameter identifier	'04'H	Averaging window	
Length of parameter contents	2		
Parameter contents	'0000 0111 1101 0000'B	2000ms	
Parameter 5			
Parameter identifier	'06'H	Default priority level	
Length of parameter contents	1		
Parameter contents	3		

Table 13.2.3.3.3-7: Message DIRECT LINK MODIFICATION REQUEST (step 9, Table 13.2.3.3.2-1)

Derivation path: TS 38.508-1 [4], Table 4.7.4-9 with condition Rx			
Information Element	Value/remark	Comment	Condition
Link modification operation code	'0000 0101'B	Remove existing PC5 QoS flow(s) from the existing PC5 unicast link	
QoS flow descriptions			

Length of PC5 QoS flow descriptions contents	Set to the actual length of 'PC5 QoS flow descriptions contents' in bytes		
PC5 QoS flow description 1			
PQFI	'00 0010'B		
Operation Code	'010'B	Delete existing PC5 QoS flow description	
Number of parameters	0		
E	0	parameters list is not included	
Associated V2X service identifiers			
Length of V2X service identifier contents	'04'H		
V2X service identifier 1	'00 00 00 02'H		

Table 13.2.3.3.3-8: Message DIRECT LINK MODIFICATION ACCEPT (step 10, Table 13.2.3.3.2-1)

Derivation path: TS 38.508-1 [4], Table 4.7.4-10 with condition RX			
QoS flow descriptions			
PC5 QoS flow descriptions IEI	'79'H		
Length of PC5 QoS flow descriptions contents	Set to the actual length of 'PC5 QoS flow descriptions contents' in bytes		
PC5 QoS flow description 1			
PQFI	'00 0010'B		
Operation Code	'010'B	Delete existing PC5 QoS flow description	
Number of parameters	0		
E	0	parameters list is not included	
Associated V2X service identifiers			
Length of V2X service identifier contents	'04'H		
V2X service identifier 1	'00 00 00 02'H		

Table 13.2.3.3.3-9: RRCReconfigurationSidelink (step 11, Table Table 13.2.3.3.2-1)

Derivation path: TS 38.508-1 [4], Table 4.6.1A-3			
Information Element	Value/Remark	Comment	Condition
RRCReconfigurationSidelink ::= SEQUENCE {			
criticalExtensions CHOICE {			
rrcReconfigurationSidelink-r16 SEQUENCE {			
slrb-ConfigToReleaseList-r16 SEQUENCE (SIZE (1..maxNrofSLRB-r16)) OF SLRB-PC5-ConfigIndex-r16 {	1 entry		
SLRB-PC5-ConfigIndex-r16 [1]	2	entry 1	
}			
}			
}			
}			

13.2.4 PC5 unicast / link Release / Reestablish PC5 unicast link to same UE

13.2.4.1 Test Purpose (TP)

(1)

```
with { UE having established a V2X DIRECT LINK with a KNRP ID to a SS-UE, and released the DIRECT LINK after receiving a DIRECT LINK RELEASE REQUEST message }
ensure that {
  when { UE has a V2X packet to be transmitted over PC5 to the same SS-UE }
  then { UE transmits DIRECT LINK ESTABLISHMENT REQUEST }
}
```

13.2.4.2 Conformance requirements

References: The conformance requirements covered in the present TC are specified in: TS 24.587 , subclause 6.1.2.4.2, 6.1.2.4.4, 6.1.2.2.2. Unless otherwise stated these are Rel-16 requirements.

[TS 24.587, subclause 6.1.2.4.2]

The initiating UE shall initiate the procedure if a request from upper layers to release a PC5 unicast link with the target UE which uses a known layer-2 ID (for unicast communication) is received and there is an existing PC5 unicast link between these two UEs.

The initiating UE may initiate the procedure if the target UE has been non-responsive, e.g. no response in the PC5 unicast link modification procedure, PC5 unicast link identifier update procedure, PC5 unicast link re-keying procedure or PC5 unicast link keep-alive procedure.

The initiating UE may initiate the procedure to release an established PC5 unicast link if the UE has reached the maximum number of established PC5 unicast links and there is a need to establish a new PC5 unicast link. In this case, which PC5 unicast link is to be released is up to UE implementation.

The initiating UE may initiate the procedure to release an established PC5 unicast link upon expiry of the timer T5005.

In order to initiate the PC5 unicast link release procedure, the initiating UE shall create a DIRECT LINK RELEASE REQUEST message with a PC5 signalling protocol cause IE indicating one of the following cause values:

- #1 direct communication with the target UE not allowed;
- #2 direct communication to the target UE no longer needed;
- #4 direct connection is not available anymore;
- #5 lack of resources for PC5 unicast link; or
- #111 protocol error, unspecified.

The initiating UE shall include the new MSB of K_{NRP} ID in the DIRECT LINK RELEASE REQUEST message.

After the DIRECT LINK RELEASE REQUEST message is generated, the initiating UE shall pass this message to the lower layers for transmission along with the initiating UE's layer-2 ID for unicast communication and the target UE's layer-2 ID for unicast communication, and shall stop T5011 if running. The initiating UE shall start timer T5002.

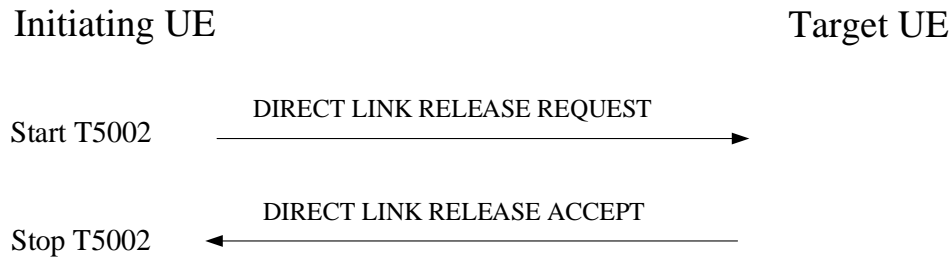

Figure 6.1.2.4.2.1: PC5 unicast link release procedure

[TS 24.587, subclause 6.1.2.4.4]

Upon receipt of the DIRECT LINK RELEASE ACCEPT message, the initiating UE shall stop timer T5002 and shall release the PC5 unicast link by performing the following behaviors:

- a) inform the lower layer along with the PC5 link identifier that the PC5 unicast link has been released; and
- b) delete the PC5 unicast link context of the PC5 unicast link after an implementation specific time.

The initiating UE shall form the new K_{NRP} ID from the MSB of K_{NRP} ID included in the DIRECT LINK RELEASE REQUEST message and the LSB of K_{NRP} ID received in the DIRECT LINK RELEASE ACCEPT message. The initiating UE shall replace the existing K_{NRP} ID with the new K_{NRP} ID. The initiating UE may include the new K_{NRP} ID in DIRECT LINK ESTABLISHMENT REQUEST message with the target UE as specified in clause 6.1.2.2.2.

[TS 24.587, subclause 6.1.2.2.2]

The initiating UE shall meet the following pre-conditions before initiating this procedure:

- a) a request from upper layers to transmit the packet for V2X service over PC5;
- b) the communication mode is unicast mode (e.g. pre-configured as specified in clause 5.2.3 or indicated by upper layers);
- c) the link layer identifier for the initiating UE (i.e. layer-2 ID used for unicast communication) is available (e.g. pre-configured or self-assigned) and is not being used by other existing PC5 unicast links within the initiating UE;
- d) the link layer identifier for the destination UE (i.e. the unicast layer-2 ID of the target UE or the broadcast layer-2 ID) is available to the initiating UE (e.g. pre-configured, obtained as specified in clause 5.2.3 or known via prior V2X communication);

NOTE 1: In the case where different V2X services are mapped to distinct default destination layer-2 IDs, when the initiating UE intends to establish a single unicast link that can be used for more than one V2X service identifiers, the UE can select any of the default destination layer-2 ID for unicast initial signalling.

- e) the initiating UE is either authorised for V2X communication over PC5 in NR-PC5 in the serving PLMN, or has a valid authorization for V2X communication over PC5 in NR-PC5 when not served by E-UTRA and not served by NR. The UE considers that it is not served by E-UTRA and not served by NR if the following conditions are met:
 - 1) not served by NR and not served by E-UTRA for V2X communication over PC5;
 - 2) in limited service state as specified in 3GPP TS 23.122 [2], if the reason for the UE being in limited service state is one of the following:
 - i) the UE is unable to find a suitable cell in the selected PLMN as specified in 3GPP TS 38.304 [9];
 - ii) the UE received a REGISTRATION REJECT message or a SERVICE REJECT message with the 5GMM cause #11 "PLMN not allowed" as specified in 3GPP TS 24.501 [6]; or

- iii) the UE received a REGISTRATION REJECT message or a SERVICE REJECT message with the 5GMM cause #7 "5GS services not allowed" as specified in 3GPP TS 24.501 [6]; or
- 3) in limited service state as specified in 3GPP TS 23.122 [2] for reasons other than i), ii) or iii) above, and located in a geographical area for which the UE is provisioned with "non-operator managed" radio parameters as specified in clause 5.2.3;
- f) there is no existing PC5 unicast link for the pair of peer application layer IDs, or there is an existing PC5 unicast link for the pair of peer application layer IDs and:
 - 1) the network layer protocol of the existing PC5 unicast link is not identical to the network layer protocol required by the upper layer in the initiating UE for this V2X service; or
 - 2) the security policy (either signalling security policy or user plane security policy) corresponding to the V2X service identifier is not compatible with the security policy of the existing PC5 unicast link; and
- g) the number of established PC5 unicast links is less than the implementation-specific maximum number of established NR PC5 unicast links allowed in the UE at a time.

After receiving the service data or request from the upper layers, the initiating UE shall derive the PC5 QoS parameters and assign the PQFI(s) for the PC5 QoS flows(s) to be established as specified in clause 6.1.2.12.

In order to initiate the PC5 unicast link establishment procedure, the initiating UE shall create a DIRECT LINK ESTABLISHMENT REQUEST message. The initiating UE:

- a) shall include the source user info set to the initiating UE's application layer ID received from upper layers;
- b) shall include the V2X service identifier(s) received from upper layer;
- c) shall include the target user info set to the target UE's application layer ID if received from upper layers or if the destination layer-2 ID is the unicast layer-2 ID of target UE;
- d) shall include the Key establishment information container if the UE PC5 unicast signalling integrity protection policy is set to "signalling integrity protection required" or "signalling integrity protection preferred", and may include the Key establishment information container if the UE PC5 unicast signalling integrity protection policy is set to "signalling integrity protection not needed";

NOTE 2: The Key establishment information container is provided by upper layers.

- e) shall include a Nonce_1 set to the 128-bit nonce value generated by the initiating UE for the purpose of session key establishment over this PC5 unicast link if the UE PC5 unicast signalling integrity protection policy is set to "signalling integrity protection required" or "signalling integrity protection preferred";
- f) shall include its UE security capabilities indicating the list of algorithms that the initiating UE supports for the security establishment of this PC5 unicast link;
- g) shall include the 8 MSBs of $K_{\text{NRP-sess}}$ ID chosen by the initiating UE as specified in 3GPP TS 33.536 [20] if the UE PC5 unicast signalling integrity protection policy is set to "signalling integrity protection required" or "signalling integrity protection preferred";
- h) may include a K_{NRP} ID if the initiating UE has an existing K_{NRP} for the target UE; and
- i) shall include its UE PC5 unicast signalling security policy. In the case where the different V2X services are mapped to the different PC5 unicast signalling security policies, when the initiating UE intends to establish a single unicast link that can be used for more than one V2X service, each of the signalling security policies of those V2X services shall be compatible, e.g. "signalling integrity protection not needed" and "signalling integrity protection required" are not compatible.

After the DIRECT LINK ESTABLISHMENT REQUEST message is generated, the initiating UE shall pass this message to the lower layers for transmission along with the initiating UE's layer-2 ID for unicast communication and the destination layer-2 ID, and start timer T5000. The UE shall not send a new DIRECT LINK ESTABLISHMENT REQUEST message to the same target UE identified by the same application layer ID while timer T5000 is running. If the target user info IE is not included in the DIRECT LINK ESTABLISHMENT REQUEST message (i.e. V2X service oriented PC5 unicast link establishment procedure), the initiating UE shall handle multiple DIRECT LINK ESTABLISHMENT ACCEPT messages, if any, received from different target UEs for the establishment of multiple PC5 unicast links before the expiry of timer T5000.

NOTE 3: In order to ensure successful PC5 unicast link establishment, T5000 should be set to a value larger than the sum of T5006 and T5007.

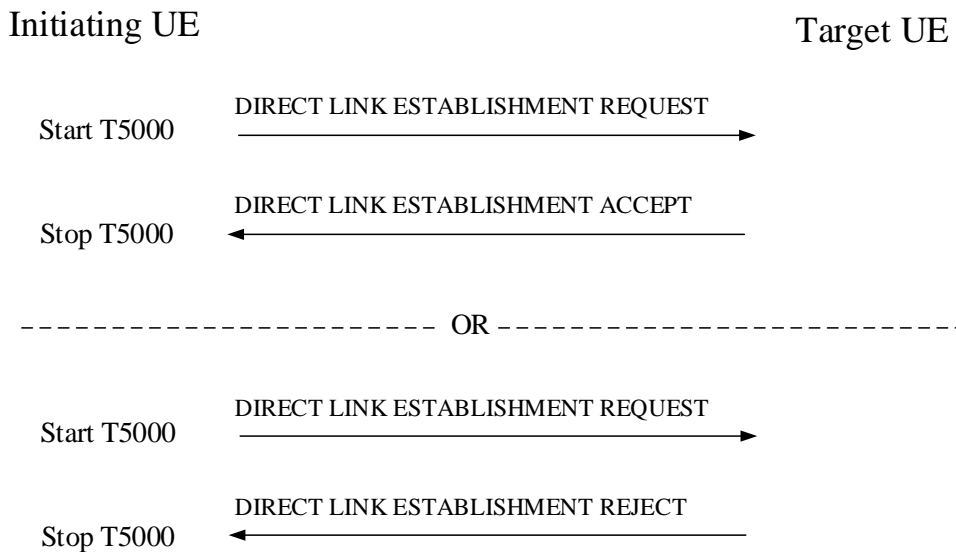

Figure 6.1.2.2.2: UE oriented PC5 unicast link establishment procedure

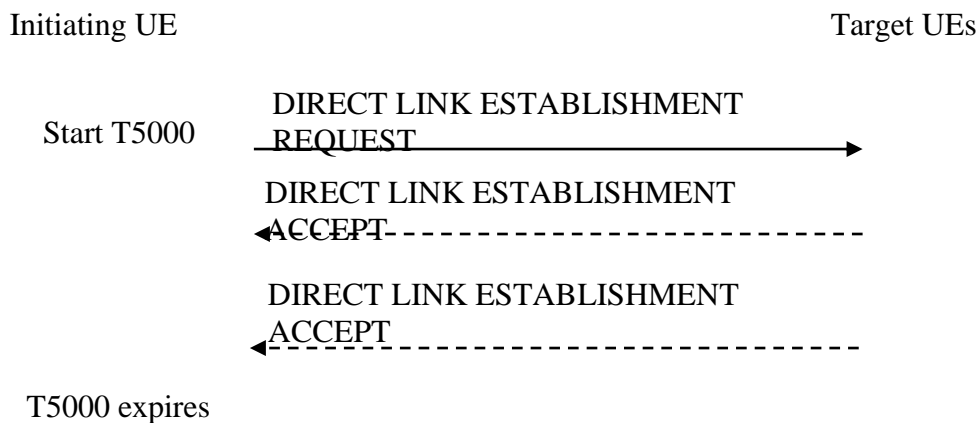

Figure 6.1.2.2.3: V2X service oriented PC5 unicast link establishment procedure

13.2.4.3 Test description

13.2.4.3.1 Pre-test conditions

System Simulator:

- NR-SS-UE

- NR-SS-UE1 operating as NR sidelink communication device on the resources (i.e. the frequency included in pre-configuration) that UE is expected to use for transmission and reception via PC5 interface.
- NR-SS-UE 1 is synchronised on GNSS.
- GNSS simulator
 - The GNSS simulator is started and configured for Scenario #1.

UE:

- UE is authorised to perform NR sidelink communication.
- The UE is equipped with a USIM containing default values as per TS 38.508-1 [4] clause 4.8.3.3.3.
- UE is synchronised on GNSS.

Preamble:

- The UE is in state 4-A with Test Mode (*On*), Test Loop Function (*Off*) as defined in TS 38.508-1 [4], Table 4.5.7.2-1 using generic procedure parameter Sidelink (*On*), NR-SS-UE initiating unicast mode NR sidelink communication, Cast Type (*Unicast*), GNSS Sync (*On*).

13.2.4.3.2 Test procedure sequence

Table 13.2.4.3.2-1: Main behaviour

	Procedure	Message Sequence		TP	Verdict
		U - S	Message		
1	The NR-SS-UE1 releases unicast mode sidelink connection by executing steps 1-2 of Table 4.9.30.2.2-1 in TS 38.508-1 [4].	-	-	-	-
2	Trigger UE to close UE test loop mode E (transmission mode). NOTE: The UE test loop mode E may be closed by MMI or AT command (+CCUTLE).	-	-	-	-
3	Check: Does the UE transmits a DIRECT LINK ESTABLISHMENT REQUEST message.	-->	PC5-S: DIRECT LINK ESTABLISHMENT REQUEST	1	P
4	The NR-SS-UE1 transmits a DIRECT LINK SECURITY MODE COMMAND message.	<<--	PC5-S: DIRECT LINK SECURITY MODE COMMAND		
5	Check: Does the UE transmit a DIRECT LINK SECURITY MODE COMPLETE message.	-->	PC5-S: DIRECT LINK SECURITY MODE COMPLETE	-	-
6	The NR-SS-UE1 transmits a DIRECT LINK ESTABLISHMENT ACCEPT message.	<<--	PC5-S: DIRECT LINK ESTABLISHMENT ACCEPT	-	-
7	Check: Does the UE send an RRCReconfigurationSidelink message to establish a unicast mode SL-DRB?	-->	PC5-RRC: RRCReconfigurationSidelink	-	-
8	The NR-SS-UE sends an RRCReconfigurationCompleteSidelink message.	<<--	PC5-RRC: RRCReconfigurationCompleteSidelink	-	-
9	UE continuously sends SDAP SDUs on SL-DRB	-	-	-	-
10	Trigger UE to deactivate UE test loop mode. NOTE: The deactivation of UE test loop mode may be performed by MMI or AT command (+CATM).	-	-	-	-

13.2.4.3.3 Specific message contents

Table 13.2.4.3.3-1: Message DIRECT LINK ESTABLISHMENT REQUEST (step 3, Table 13.2.1.3.2-1)

Derivation path: TS 38.508-1 [4], Table 4.7.4-7 with condition Tx

Table 13.2.4.3.3-2: Message DIRECT LINK SECURITY MODE COMMAND (step 4, Table 13.2.4.3.2-1)

Derivation path: TS 38.508-1 [4], Table 4.7.4-18 with condition Rx
--

Table 13.2.4.3.3-3: Message DIRECT LINK SECURITY MODE COMPLETE (step 5, Table 13.2.4.3.2-1)

Derivation path: TS 38.508-1 [4], Table 4.7.4-19 with condition Tx
--

Table 13.2.4.3.3-4: Message DIRECT LINK ESTABLISHMENT ACCEPT (step 6, Table 13.2.4.3.2-1)

Derivation path: TS 38.508-1 [4], Table 4.7.4-8 with condition Rx

Table 13.2.4.3.3-5: RRCReconfigurationSidelink (step 7, Table 13.2.4.3.2-1)

Derivation path: TS 38.508-1 [4], Table 4.6.1A-3 with condition TX
--

Table 13.2.4.3.3-6: RRCReconfigurationCompleteSidelink (steps 8, Table 13.2.4.3.2-1)

Derivation path: TS 38.508-1 [4], Table 4.6.1A-4 with condition RX
--

13.2.5 PC5 unicast / link identifier update

13.2.5.1 Test Purpose (TP)

(1)

```
with { UE having established a DIRECT LINK with Layer 2 ID-1 to a peer UE }
ensure that {
  when { UE receives a DIRECT LINK IDENTIFIER UPDATE REQUEST message with same Layer 2 ID-1 }
  then { UE transmits a DIRECT LINK IDENTIFIER UPDATE REJECT message }
}
```

(2)

```
with { UE having established a DIRECT LINK with old Layer 2 ID-1 to a peer UE. UE receives a DIRECT
LINK IDENTIFIER UPDATE REQUEST message and responds with a DIRECT LINK IDENTIFIER UPDATE ACCEPT
message with new Layer 2 ID-2 }
ensure that {
  when { UE receives a V2X packet from the peer UE }
  then { the Layer 2 ID associated with the V2X packet is the old Layer 2 ID-1 }
}
```

(3)

```
with { UE having established a DIRECT LINK with old Layer 2 ID-1 to a peer UE. UE receives a DIRECT
LINK IDENTIFIER UPDATE REQUEST message and responds with a DIRECT LINK IDENTIFIER UPDATE ACCEPT
message with new Layer 2 ID-2 }
ensure that {
  when { UE receives a DIRECT LINK IDENTIFIER UPDATE ACK message from the peer UE }
  then { UE transmits a V2X packet and the Layer 2 ID associated with the V2X packet is the new
Layer 2 ID-2 }
}
```

13.2.5.2 Conformance requirements

References: The conformance requirements covered in the present TC are specified in: TS 24.587, subclause 6.1.2.5.3, 6.1.2.5.4 and 6.1.2.5.6. Unless otherwise stated these are Rel-16 requirements.

[TS 24.587, subclause 6.1.2.5.3]

Upon receipt of a DIRECT LINK IDENTIFIER UPDATE REQUEST message, if the target UE determines:

- a) the PC5 unicast link associated with this request message is still valid; and
- b) the timer T5010 for the PC5 unicast link identified by this request message is not running,

then the target UE accepts this request, and responds with a DIRECT LINK IDENTIFIER UPDATE ACCEPT message.

The target UE shall create the DIRECT LINK IDENTIFIER UPDATE ACCEPT message. In this message, the target UE:

- a) shall include the target UE's new layer-2 ID assigned by itself;
- b) shall include the new LSB of $K_{\text{NRP-session}}$ ID;
- c) shall include the initiating UE's new MSB of $K_{\text{NRP-session}}$ ID;
- d) shall include the initiating UE's new layer-2 ID;
- e) shall include the target UE's new application layer ID if received from upper layer;
- f) shall include the initiating UE's new IP address/prefix if received from the initiating UE and IP communication is used;
- g) shall include the initiating UE's new application layer ID if received from the initiating UE; and
- h) shall include the target UE's new IP address/prefix if IP communication is used and changed.

After the DIRECT LINK IDENTIFIER UPDATE ACCEPT message is generated, the target UE shall pass this message to the lower layers for transmission along with the initiating UE's old layer-2 ID for unicast communication and the target UE's old layer-2 ID for unicast communication, and start timer T5010. The UE shall not send a new DIRECT LINK IDENTIFIER UPDATE ACCEPT message to the same initiating UE while timer T5010 is running.

Before target UE receives the traffic using the new layer-2 IDs, the target UE shall continue to receive the traffic with the old layer-2 IDs (i.e. initiating UE's old layer-2 ID and target UE's old layer-2 ID) from initiating UE.

Before target UE receives the DIRECT LINK IDENTIFIER UPDATE ACK message from initiating UE, the target UE shall keep sending traffic to the initiating UE using the old layer-2 IDs (i.e. initiating UE's old layer-2 ID for unicast communication and target UE's old layer-2 ID for unicast communication).

[24.587, subclause 6.1.2.5.4]

Upon receipt of the DIRECT LINK IDENTIFIER UPDATE ACCEPT message, the initiating UE shall stop timer T5009 and respond with a DIRECT LINK IDENTIFIER UPDATE ACK message. In this message, the initiating UE:

- a) shall include the target UE's new layer-2 ID;
- b) shall include the target UE's new LSB of $K_{\text{NRP-session}}$ ID;
- c) shall include the target UE's new application layer ID, if received; and
- d) shall include the target UE's new IP address/prefix, if received.

After the DIRECT LINK IDENTIFIER UPDATE ACK message is generated, the initiating UE shall pass this message to the lower layers for transmission along with the initiating UE's old layer-2 ID for unicast communication and the target UE's old layer-2 ID for unicast communication and shall stop timer T5011 if running and start a timer T5011 as configured if at least one of V2X service identifiers for the PC5 unicast link satisfying the privacy requirements as specified in clause 5.2.3.

Upon sending the DIRECT LINK IDENTIFIER UPDATE ACK message, the initiating UE shall update the associated PC5 unicast link context with the new identifiers and pass the new layer-2 IDs (i.e. initiating UE's new layer-2 ID for unicast communication and target UE's new layer-2 ID for unicast communication if changed) along with the PC5 link identifier down to the lower layer. Then the initiating UE shall use the new layer-2 IDs (i.e. initiating UE's new layer-2 ID for unicast communication and target UE's new layer-2 ID for unicast communication if changed) to transmit the PC5 signalling message and PC5 user plane data.

The initiating UE shall continue to receive traffic with the old layer-2 IDs (i.e. initiating UE's old layer-2 ID for unicast communication and target UE's old layer-2 ID for unicast communication) from the target UE until it receives traffic

with the new layer-2 IDs (i.e. initiating UE's new layer-2 ID and target UE's new layer-2 ID if changed) from the target UE.

[24.587, subclause 6.1.2.5.6]

If the DIRECT LINK IDENTIFIER UPDATE REQUEST message cannot be accepted, the target UE shall send a DIRECT LINK IDENTIFIER UPDATE REJECT message. The DIRECT LINK IDENTIFIER UPDATE REJECT message contains a PC5 signalling protocol cause IE set to one of the following cause values:

#3 conflict of layer-2 ID for unicast communication is detected; or

#111 protocol error, unspecified.

For a received DIRECT LINK IDENTIFIER UPDATE REQUEST message from a layer-2 ID (for unicast communication), if the target UE already has an existing link using this layer-2 ID or is currently processing a DIRECT LINK IDENTIFIER UPDATE REQUEST message from the same layer-2 ID, but with user info different from the user info IE included in this new incoming message, the target UE shall send a DIRECT LINK IDENTIFIER UPDATE REJECT message with PC5 signalling protocol cause value #3 "conflict of layer-2 ID for unicast communication is detected".

NOTE: After receiving the DIRECT LINK IDENTIFIER UPDATE REJECT message, whether the initiating UE initiates the PC5 unicast link release procedure or initiates another PC5 unicast link identifier update procedure with a new layer-2 ID depends on UE implementation.

For other reasons causing the failure of link identifier update, the target UE shall send a DIRECT LINK IDENTIFIER UPDATE REJECT message with PC5 signalling protocol cause value #111 "protocol error, unspecified".

Upon receipt of the DIRECT LINK IDENTIFIER UPDATE REJECT message, the initiating UE shall stop timer T5009 and abort this PC5 unicast link identifier update procedure.

13.2.5.3 Test description

13.2.5.3.1 Pre-test conditions

System Simulator:

- NR-SS-UE
 - NR-SS-UE1 operating as NR sidelink communication device on the resources (i.e. the frequency included in pre-configuration) that UE is expected to use for transmission and reception via PC5 interface.
 - NR-SS-UE1 uses GNSS as the synchronization reference source.
- GNSS simulator
 - The GNSS simulator is started and configured for Scenario #1.

UE:

- UE is authorised to perform NR sidelink communication.
- The UE uses GNSS as the synchronization reference source.
- The UE is equipped with a USIM containing default values as per TS 38.508-1 [4] clause 4.8.3.3.3.

Preamble:

- The UE is in state 4-A and Test Loop Function (*On*) with UE test loop mode E as defined in TS 38.508-1 [4], subclause 4.4A using generic procedure parameter Sidelink (*On*), Cast Type (*Unicast*), GNSS Sync (*On*) using NR-SS-UE initiated unicast mode NR sidelink communication procedure in subclause 4.9.23.

13.2.5.3.2 Test procedure sequence

Table 13.2.5.3.2-1: Main behaviour

St	Procedure	Message Sequence		TP	Verdict
		U - S	Message		
1	The NR-SS-UE1 transmits a DIRECT LINK IDENTIFIER UPDATE REQUEST message including new Layer 2 ID-2.	<--	PC5-S: DIRECT LINK IDENTIFIER UPDATE REQUEST	-	-
2	The UE transmits a DIRECT LINK IDENTIFIER UPDATE ACCEPT message.	-->	PC5-S: DIRECT LINK IDENTIFIER UPDATE ACCEPT	-	-
3	Trigger the UE to close UE test loop mode E (Receive Mode). NOTE: Closing of UE test loop mode E may be performed by MMI or AT command (+CCUTLE).	-	-	-	-
4	The NR-SS-UE1 transmits one V2X packet on old Layer 2 ID-1 to the UE. NOTE: This step verifies TP2 - it is expected that the UE shall receive the packet - if they were received is checked in step 5. FFS	<--	V2X packet	-	-
5	Trigger the UE to report the counter of successful reception of V2X packet. NOTE: Requesting the UE to report the counter of successful reception of V2X packet may be performed by MMI or AT command (+CUSPCREQ).	-	-	-	-
6	Check: Does the UE reported counter of successful reception of V2X packet?	-	-	2	P
7	The NR-SS-UE1 transmits a DIRECT LINK IDENTIFIER UPDATE ACK message.	<--	PC5-S: DIRECT LINK IDENTIFIER UPDATE ACK	-	-
8	The NR-SS-UE1 transmits one V2X packet on new Layer 2 ID-2 to the UE. NOTE: This step verifies TP3 - it is expected that the UE shall receive the packet - if they were received is checked in step 10.	<--	V2X packet	-	-
9	Trigger the UE to report the counter of successful reception of V2X packet. NOTE: Requesting the UE to report the counter of successful reception of V2X packet may be performed by MMI or AT command (+CUSPCREQ).	-	-	-	-
10	Check: Does the UE reported counter of successful reception of V2X packet?	-	-	3	P
11	Trigger the UE to open UE test loop mode E. NOTE: Opening of UE test loop mode E may be performed by MMI or AT command (+CCUTLE).	-	-	-	-
12	The NR-SS-UE1 transmits a DIRECT LINK IDENTIFIER UPDATE REQUEST message including Layer 2 ID-2.	<--	PC5-S: DIRECT LINK IDENTIFIER UPDATE REQUEST	-	-
13	Check: Does the UE transmit a DIRECT LINK IDENTIFIER UPDATE REJECT message?	-->	PC5-S: DIRECT LINK IDENTIFIER UPDATE REJECT	1	P

13.2.5.3.3 Specific message contents

Table 13.2.5.3.3-1: DIRECT LINK IDENTIFIER UPDATE REQUEST (step 1 & 10, Table 13.2.5.3.2-1)

Derivation path: TS 38.508-1 [4], Table 4.7.4-23 with condition Rx
--

Table 13.2.5.3.3-2: DIRECT LINK IDENTIFIER UPDATE ACCEPT (step 2, Table 13.2.5.3.2-1)

Derivation path: TS 38.508-1 [4], Table 4.7.4-24 with condition Tx
--

Table 13.2.5.3.3-3: DIRECT LINK IDENTIFIER UPDATE REJECT (step 11, Table 13.2.5.3.2-1)

Derivation path: TS 38.508-1 [4], Table 4.7.4-26 with condition Tx
--

13.2.6 PC5 unicast / link keep alive

13.2.6.1 Test Purpose (TP)

(1)

```
with { UE having transmitted a DIRECT LINK KEEPALIVE REQUEST message with Keep-alive counter value of n }
ensure that {
  when { UE does not receive DIRECT LINK KEEPALIVE RESPONSE message when T5004 expires }
  then { UE re-transmits a DIRECT LINK KEEPALIVE REQUEST message with same Keep-alive counter value of n }
}
```

(2)

```
with { UE having received a first DIRECT LINK KEEPALIVE REQUEST message with Keep-alive counter value of n1, and UE having sent a DIRECT LINK KEEPALIVE RESPONSE message}
ensure that {
  when { UE receives a second DIRECT LINK KEEPALIVE REQUEST message with Keep-alive counter value of n2 < n1}
  then { UE does not transmit a DIRECT LINK KEEPALIVE RESPONSE message for the second DIRECT LINK KEEPALIVE REQUEST message}
}
```

(3)

```
with { UE having transmitted a message and having started T5003}
ensure that {
  when { UE does not receive any message before T5003 expires }
  then { UE transmits a DIRECT LINK KEEPALIVE REQUEST message}
}
```

13.2.6.2 Conformance requirements

References: The conformance requirements covered in the present TC are specified in: TS 24.587 [FFS], subclause 6.1.2.8.5.1 and 6.1.2.8.5.2. Unless otherwise stated these are Rel-16 requirements.

[TS 24.587, subclause 6.1.2.8.5.1]

- a) Timer T5004 expires.

The initiating UE shall retransmit the DIRECT LINK KEEPALIVE REQUEST message with the last used value of the keep-alive counter and restart timer T5004. After reaching the maximum number of allowed retransmissions, the initiating UE shall abort the PC5 unicast link keep-alive procedure and locally release the PC5 unicast link.

NOTE: The maximum number of allowed retransmissions is UE implementation specific.

- b) The need to use this PC5 unicast link no longer exists before the PC5 unicast link keep-alive procedure is completed.

The initiating UE shall abort the PC5 unicast link keep-alive procedure and initiate a PC5 unicast link release procedure.

- c) The initiating UE receives a DIRECT LINK KEEPALIVE RESPONSE message with a keep-alive counter value different from the value which the initiating UE had included in the last sent DIRECT LINK KEEPALIVE REQUEST message.

The initiating UE shall discard the DIRECT LINK KEEPALIVE RESPONSE message.

- d) The initiating UE receives a PC5 signalling message other than a DIRECT LINK KEEPALIVE RESPONSE message or PC5 user plane data from the target UE over this PC5 unicast link while timer T5004 is running.

The initiating UE shall stop timer T5004, abort the PC5 unicast link keep-alive procedure, start timer T5003 and increment the keep-alive counter for the PC5 unicast link.

- e) The initiating UE receives a DIRECT LINK KEEPALIVE RESPONSE message when T5004 is not running.

The initiating UE shall discard the DIRECT LINK KEEPALIVE RESPONSE message.

[TS 24.587, subclause 6.1.2.8.5.2]

- a) Timer T5005 expires.

The target UE shall:

- 1) initiate a PC5 unicast link keep-alive procedure to check the link; or
- 2) initiate the PC5 unicast link release procedure.

Whether the UE chooses 1) or 2) is left to UE implementation.

- b) The target UE receives a DIRECT LINK KEEPALIVE REQUEST message with a keep-alive counter value lower than the value which the target UE had included in the last sent DIRECT LINK KEEPALIVE RESPONSE message.

The target UE shall discard the DIRECT LINK KEEPALIVE REQUEST message.

- c) The target UE receives a DIRECT LINK KEEPALIVE REQUEST message if there is a pending PC5 signalling message or PC5 user plane data to be sent to the initiating UE over this PC5 unicast link.

The target UE:

- 1) shall pass this PC5 signalling message to the lower layers for transmission along with the target UE's layer-2 ID for unicast communication and the initiating UE's layer-2 ID for unicast communication, or perform the data transmission over PC5 unicast link as specified in clause 6.1.2.9; and
- 2) shall consider transmission of this PC5 signalling message or PC5 user plane data to be an implicit DIRECT LINK KEEPALIVE RESPONSE message and skip generating a DIRECT LINK KEEPALIVE RESPONSE message. If a maximum inactivity period is included in the DIRECT LINK KEEPALIVE REQUEST message, the target UE shall stop T5005, if running, and start T5005 with its value set to the maximum inactivity period.

13.2.6.3 Test description

13.2.6.3.1 Pre-test conditions

System Simulator:

- NR-SS-UE
 - NR-SS-UE1 operating as NR sidelink communication device on the resources (i.e. the frequency included in pre-configuration) that UE is expected to use for transmission and reception via PC5 interface.
 - NR-SS-UE1 is synchronised on GNSS.
- GNSS simulator
 - The GNSS simulator is started and configured for Scenario #1.

UE:

- UE is authorised to perform NR sidelink communication.
- The UE is equipped with a USIM containing default values as per TS 38.508-1 [4] clause 4.8.3.3.3.

- UE is synchronised on GNSS.

Preamble:

- The UE is in state 4-A and Test Mode (*On*) , Test Loop Function(*Off*) as defined in TS 38.508-1 [4], Table 4.5.7.2-1 using generic procedure parameter Sidelink (*On*), NR-SS-UE initiating unicast mode NR sidelink communication , Cast Type (*Unicast*), GNSS Sync (*On*).

13.2.6.3.2 Test procedure sequence

Table 13.2.6.3.2-1: Main behaviour

St	Procedure	Message Sequence		TP	Verdict
		U - S	Message		
1	The UE transmits a DIRECT LINK KEEPALIVE REQUEST message with keep-alive counter = 0.	-->	PC5-S: DIRECT LINK KEEPALIVE REQUEST	-	-
2	The NR-SS-UE1 waits 5 seconds (T5004=5s).	-	-	-	-
3	Check: Does the UE transmit a DIRECT LINK KEEPALIVE REQUEST message with keep-alive counter = 0?	-->	PC5-S: DIRECT LINK KEEPALIVE REQUEST	1	P
4	The NR-SS-UE1 transmits a DIRECT LINK KEEPALIVE RESPONSE message with keep-alive counter = 0.	<--	PC5-S: DIRECT LINK KEEPALIVE RESPONSE	-	-
4A	The NR-SS-UE1 waits 5 seconds (T5003=5s).	-	-	-	-
4B	Check: Does the UE transmit a DIRECT LINK KEEPALIVE REQUEST message with keep-alive counter = 1?	-->	PC5-S: DIRECT LINK KEEPALIVE REQUEST	3	P
4C	The NR-SS-UE1 transmits a DIRECT LINK KEEPALIVE RESPONSE message with keep-alive counter = 1.	<--	PC5-S: DIRECT LINK KEEPALIVE RESPONSE	-	-
5	The NR-SS-UE1 waits 4 seconds (less than T5003 (5s))	-	-	-	-
6	The NR-SS-UE1 transmits a DIRECT LINK KEEPALIVE REQUEST message with keep-alive counter = 0.	<--	PC5-S: DIRECT LINK KEEPALIVE REQUEST	-	-
7	The UE transmits a DIRECT LINK KEEPALIVE RESPONSE message with keep-alive counter = 0.	-->	PC5-S: DIRECT LINK KEEPALIVE RESPONSE	-	-
8	The NR-SS-UE1 waits 4 seconds (less than T5003 (5s))	-	-	-	-
9	The NR-SS-UE1 transmits a DIRECT LINK KEEPALIVE REQUEST message with keep-alive counter = 1.	<--	PC5-S: DIRECT LINK KEEPALIVE REQUEST	-	-
10	The UE transmits a DIRECT LINK KEEPALIVE RESPONSE message with keep-alive counter = 1.	-->	PC5-S: DIRECT LINK KEEPALIVE RESPONSE	-	-
11	The NR-SS-UE1 waits 4 seconds (less than T5003 (5s))	-	-	-	-
12	The NR-SS-UE1 transmits a DIRECT LINK KEEPALIVE REQUEST message with keep-alive counter = 0.	<--	PC5-S: DIRECT LINK KEEPALIVE REQUEST	-	-
13	Check: Does the UE transmit a DIRECT LINK KEEPALIVE RESPONSE message in next 4 seconds?	-->	PC5-S: DIRECT LINK KEEPALIVE RESPONSE	2	F

13.2.6.3.3 Specific message contents

Table 13.2.6.3.3-1: Message DIRECT LINK KEEPALIVE REQUEST (step 1, step3, step 4B Table 13.2.6.3.2-1)

Derivation path: TS 38.508-1 [4], Table 4.7.4-13 with condition Tx			
Information Element	Value/Remark	Comment	Condition
Keep-alive counter	'00 00 00 00'H	Step 1,Step 3	

	'00 00 00 01'H	Step 4B	
--	----------------	---------	--

Table 13.2.6.3.3-2: Message DIRECT LINK KEEPALIVE REQUEST (step 6, step12 Table 13.2.6.3.2-1)

Derivation path: TS 38.508-1 [4], Table 4.7.4-13 with condition Rx
--

Table 13.2.6.3.3-3: Message DIRECT LINK KEEPALIVE REQUEST (step 9, Table 13.2.6.3.2-1)

Derivation path: TS 38.508-1 [4], Table 4.7.4-13 with condition Rx			
Information Element	Value/Remark	Comment	Condition
Keep-alive counter	'00 00 00 01'H		

Table 13.2.6.3.3-4: Message DIRECT LINK KEEPALIVE RESPONSE (step 4, step 4C Table 13.2.6.3.2-1)

Derivation path: TS 38.508-1 [4], Table 4.7.4-14 with condition Rx			
Information Element	Value/Remark	Comment	Condition
Keep-alive counter	'00 00 00 00'H	Step 4	
	'00 00 00 01'H	Step 4C	

Table 13.2.6.3.3-5: Message DIRECT LINK KEEPALIVE RESPONSE (step 7, Table 13.2.6.3.2-1)

Derivation path: TS 38.508-1 [4], Table 4.7.4-14 with condition Tx			
Information Element	Value/Remark	Comment	Condition
Keep-alive counter	'00 00 00 00'H		

Table 13.2.6.3.3-5: Message DIRECT LINK KEEPALIVE RESPONSE (step 10, Table 13.2.6.3.2-1)

Derivation path: TS 38.508-1 [4], Table 4.7.4-14 with condition Tx
--

Annex A (informative): Change history

Change history							
Date	Meeting	TDoc	CR	R ev	Cat	Subject/Comment	New version
2017-08	RAN5#76	R5-174427	-	-	-	Introduction of TS 38.523-1.	0.0.1
2017-12	RAN5#77	R5-176926	-	-	-	Addition of new NR PDCP test case 7.3.1.2	0.1.0
2017-12	RAN5#77	R5-176928	-	-	-	Addition of new NR MAC test case 7.1.3.1	0.1.0
2017-12	RAN5#77	R5-177072	-	-	-	Addition of new NR RLC UM test case 7.2.2.1	0.1.0
2017-12	RAN5#77	R5-177073	-	-	-	Addition of new NR RLC UM test case 7.2.2.2	0.1.0
2017-12	RAN5#77	R5-177074	-	-	-	Addition of new NR PDCP test case 7.3.1.1	0.1.0
2017-12	RAN5#77	R5-177075	-	-	-	Addition of new NR MAC test case 7.1.2.1	0.1.0
2018-03	RAN5#77	R5-181171	-	-	-	5GS RRC TC 8.2.2.2.1	0.2.0
2018-03	RAN5#77	R5-181172	-	-	-	5GS RRC TC 8.2.2.2.6	0.2.0
2018-03	RAN5#77	R5-181173	-	-	-	5GS RRC TC 8.2.3.1	0.2.0
2018-03	RAN5#77	R5-181174	-	-	-	5GS RRC TC 8.2.3.16	0.2.0
2018-03	RAN5#77	R5-181175	-	-	-	5GS RRC TC 8.2.5.1	0.2.0
2018-03	RAN5#77	R5-181176	-	-	-	5GS MAC Test case 7.1.1.2	0.2.0
2018-03	RAN5#77	R5-181177	-	-	-	Addition of new NR MAC test case 7.1.3.2	0.2.0
2018-03	RAN5#77	R5-181178	-	-	-	Addition of new NR MAC test case 7.1.3.3	0.2.0
2018-03	RAN5#77	R5-181179	-	-	-	Addition of new NR MAC test case 7.1.3.4	0.2.0
2018-03	RAN5#77	R5-181180	-	-	-	Addition of new NR MAC test case 7.1.3.5	0.2.0
2018-03	RAN5#77	R5-181181	-	-	-	Addition of new NR MAC test case 7.1.3.6	0.2.0
2018-03	RAN5#77	R5-181182	-	-	-	Addition of new NR RLC test case 7.2.3.1	0.2.0
2018-03	RAN5#77	R5-181183	-	-	-	Addition of new NR RLC test case 7.2.3.2	0.2.0
2018-03	RAN5#77	R5-181184	-	-	-	Addition of new NR PDCP test case 7.3.2.1	0.2.0
2018-03	RAN5#77	R5-181185	-	-	-	Addition of new NR PDCP test case 7.3.2.2	0.2.0
2018-03	RAN5#77	R5-181186	-	-	-	Addition of new NR PDCP test case 7.3.2.3	0.2.0
2018-03	RAN5#77	R5-181187	-	-	-	Addition of new NR PDCP test case 7.3.3.1	0.2.0
2018-03	RAN5#77	R5-181188	-	-	-	Addition of new NR PDCP test case 7.3.3.2	0.2.0
2018-03	RAN5#77	R5-181189	-	-	-	Addition of new NR PDCP test case 7.3.3.3	0.2.0
2018-03	RAN5#77	R5-181201	-	-	-	Addition of new NR MAC test case 7.1.5.1	0.2.0
2018-03	RAN5#77	R5-181202	-	-	-	Addition of new NR MAC test case 7.1.5.2	0.2.0
2018-03	RAN5#77	R5-181203	-	-	-	Addition of new NR PDCP test case 7.3.5.1	0.2.0
2018-03	RAN5#77	R5-181204	-	-	-	Addition of new NR RRC test case 8.2.2.2.5	0.2.0
2018-03	RAN5#77	R5-181205	-	-	-	Addition of new NR RRC test case 8.2.3.5	0.2.0
2018-03	RAN5#77	R5-181206	-	-	-	Update of NR MAC test cases	0.2.0
2018-03	RAN5#77	R5-181207	-	-	-	Update of NR RLC test cases	0.2.0
2018-03	RAN5#77	R5-181208	-	-	-	Update of NR PDCP test cases	0.2.0
2018-03	RAN5#77	R5-181209	-	-	-	5GS MAC Test case 7.1.5.3	0.2.0
2018-03	RAN5#77	R5-181312	-	-	-	Addition of new NR PDCP test case 7.3.5.2	0.2.0
2018-03	RAN5#77	R5-181334	-	-	-	Addition of new NR PDCP test case 7.3.4.2	0.2.0
2018-04	RAN5#2- 5G-NR Adhoc	R5-181805	-	-	-	Corrections to RRC TC 8.2.3.1 Measurement configuration control and reporting / Inter-RAT measurements / Event B1 / Measurement of NR cells	0.3.0
2018-04	RAN5#2- 5G-NR Adhoc	R5-181806	-	-	-	5GS RRC TC 8.2.1.2	0.3.0
2018-04	RAN5#2- 5G-NR Adhoc	R5-181914	-	-	-	Addition of 5GS NR RRC test case 8.2.3.6	0.3.0
2018-04	RAN5#2- 5G-NR Adhoc	R5-181951	-	-	-	Correction to RLC UM Test cases	0.3.0
2018-04	RAN5#2- 5G-NR Adhoc	R5-181952	-	-	-	Correction to RLC AM Test cases	0.3.0
2018-04	RAN5#2- 5G-NR Adhoc	R5-181967	-	-	-	Correction to PDCP ciphering test cases	0.3.0
2018-04	RAN5#2- 5G-NR Adhoc	R5-181980	-	-	-	5GS RRC TC 8.2.2.2.9	0.3.0

	5G-NR Adhoc						
2018-04	RAN5#2- 5G-NR Adhoc	R5-181981	-	-	-	Corrections to RRC TC 8.2.3.16 Handover with PSCell release / SCG DRB	0.3.0
2018-04	RAN5#2- 5G-NR Adhoc	R5-181982	-	-	-	5GS RRC TC 8.2.3.2	0.3.0
2018-04	RAN5#2- 5G-NR Adhoc	R5-181983	-	-	-	5GS RRC TC 8.2.3.3	0.3.0
2018-04	RAN5#2- 5G-NR Adhoc	R5-181984	-	-	-	5GS RRC TC 8.2.3.4	0.3.0
2018-04	RAN5#2- 5G-NR Adhoc	R5-181986	-	-	-	Addition of new NR RRC test case 8.2.2.4	0.3.0
2018-04	RAN5#2- 5G-NR Adhoc	R5-181988	-	-	-	Addition of new NR NAS test case for dedicated EPS bearer context activation	0.3.0
2018-04	RAN5#2- 5G-NR Adhoc	R5-181991	-	-	-	Addition of text to clarify that 5GS requirements may be implicitly tested in other specs	0.3.0
2018-04	RAN5#2- 5G-NR Adhoc	R5-181992	-	-	-	New NAS test case EPS bearer resource allocation / New EPS bearer context	0.3.0
2018-04	RAN5#2- 5G-NR Adhoc	R5-181994	-	-	-	Addition of new NR MAC test case 7.1.4.1.1	0.3.0
2018-04	RAN5#2- 5G-NR Adhoc	R5-181995	-	-	-	Addition of new NR MAC test case 7.1.4.1.2	0.3.0
2018-04	RAN5#2- 5G-NR Adhoc	R5-181996	-	-	-	Addition of new NR MAC test case 7.1.4.1.3	0.3.0
2018-04	RAN5#2- 5G-NR Adhoc	R5-181997	-	-	-	Addition of new NR MAC test case 7.1.4.1.4	0.3.0
2018-04	RAN5#2- 5G-NR Adhoc	R5-181998	-	-	-	Addition of new NR RLC test case 7.2.2.6	0.3.0
2018-04	RAN5#2- 5G-NR Adhoc	R5-181999	-	-	-	Addition of new NR RLC test case 7.2.3.5	0.3.0
2018-04	RAN5#2- 5G-NR Adhoc	R5-182050	-	-	-	Addition of new NR RLC test case 7.2.2.5	0.3.0
2018-04	RAN5#2- 5G-NR Adhoc	R5-182051	-	-	-	Addition of new NR RLC test case 7.2.3.6	0.3.0
2018-04	RAN5#2- 5G-NR Adhoc	R5-182052	-	-	-	Addition of new NR RLC test case 7.2.3.7	0.3.0
2018-04	RAN5#2- 5G-NR Adhoc	R5-182053	-	-	-	Addition of new NR RLC test case 7.2.3.8	0.3.0
2018-04	RAN5#2- 5G-NR Adhoc	R5-182054	-	-	-	Addition of new NR RLC test case 7.2.3.3	0.3.0
2018-04	RAN5#2- 5G-NR Adhoc	R5-182055	-	-	-	Addition of new NR RLC test case 7.2.3.4	0.3.0
2018-04	RAN5#2- 5G-NR Adhoc	R5-182056	-	-	-	Addition of new NR RRC test case 8.2.3.9	0.3.0
2018-04	RAN5#2- 5G-NR	R5-182057	-	-	-	Addition of new NR RRC test case 8.2.3.10	0.3.0

	Adhoc						
2018-04	RAN5#2-5G-NR Adhoc	R5-182058	-	-	-	Addition of new NR RRC test case 8.2.3.11	0.3.0
2018-04	RAN5#2-5G-NR Adhoc	R5-182059	-	-	-	Addition of new NR RRC test case 8.2.3.12	0.3.0
2018-04	RAN5#2-5G-NR Adhoc	R5-182060	-	-	-	Correction to MAC test case 7.1.2.1	0.3.0
2018-04	RAN5#2-5G-NR Adhoc	R5-182061	-	-	-	Addition of new NR RRC test case 8.2.3.19	0.3.0
2018-04	RAN5#2-5G-NR Adhoc	R5-182076	-	-	-	5GS PDCP Test case 7.3.4.1	0.3.0
2018-04	RAN5#2-5G-NR Adhoc	R5-182077	-	-	-	5GS PDCP Test case 7.3.5.4	0.3.0
2018-04	RAN5#2-5G-NR Adhoc	R5-182078	-	-	-	5GS RLC test case 7.2.3.11	0.3.0
2018-04	RAN5#2-5G-NR Adhoc	R5-182079	-	-	-	5GS RLC test case 7.2.3.12	0.3.0
2018-04	RAN5#2-5G-NR Adhoc	R5-182080	-	-	-	Addition of new NR RRC test case 8.2.3.7	0.3.0
2018-04	RAN5#2-5G-NR Adhoc	R5-182081	-	-	-	Addition of new NR RLC test case 7.2.2.3	0.3.0
2018-04	RAN5#2-5G-NR Adhoc	R5-182082	-	-	-	Addition of new NR RLC test case 7.2.2.4	0.3.0
2018-04	RAN5#2-5G-NR Adhoc	R5-182083	-	-	-	Addition of new NR RRC test case 8.2.3.17	0.3.0
2018-04	RAN5#2-5G-NR Adhoc	R5-182085	-	-	-	Correction to PDCP integrity protection test cases	0.3.0
2018-04	RAN5#2-5G-NR Adhoc	R5-182089	-	-	-	5GS RRC TC 8.2.5.5	0.3.0
2018-04	RAN5#2-5G-NR Adhoc	R5-182100	-	-	-	5GS RRC TC 8.2.5.6	0.3.0
2018-04	RAN5#2-5G-NR Adhoc	R5-182101	-	-	-	5GS RRC TC 8.2.5.7	0.3.0
2018-04	RAN5#2-5G-NR Adhoc	R5-182102	-	-	-	5GS RRC TC 8.2.2.2.7	0.3.0
2018-04	RAN5#2-5G-NR Adhoc	R5-182103	-	-	-	Corrections to RRC TC 8.2.5.1 RRC connection reconfiguration / PSCell addition failure	0.3.0
2018-04	RAN5#2-5G-NR Adhoc	R5-182104	-	-	-	Corrections to RRC TC 8.2.2.2.1 PSCell addition, modification and release / SCG DRB	0.3.0
2018-04	RAN5#2-5G-NR Adhoc	R5-182105	-	-	-	Corrections to RRC TC 8.2.2.2.6 Bearer Modification / SCG DRB / Split DRB Reconfiguration	0.3.0
2018-04	RAN5#2-5G-NR Adhoc	R5-182106	-	-	-	Addition of new NR RRC test case 8.2.2.1.2	0.3.0
2018-04	RAN5#2-5G-NR Adhoc	R5-182115	-	-	-	Introduction of 5GS RRC TC 8.2.4.3.1	0.3.0

2018-04	RAN5#2-5G-NR Adhoc	R5-182116	-	-	-	Adding NR test case 8.2.2.1.1	0.3.0
2018-04	RAN5#2-5G-NR Adhoc	R5-182117	-	-	-	Adding NR test case 8.2.2.1.3	0.3.0
2018-04	post RAN5#2-5G-NR Adhoc	-	-	-	-	Editorial update to apply with the 3GPP drafting rules (styles)	0.3.1
2018-05	RAN5#79	R5-183094	-	-	-	Addition of UE power headroom reporting test case 7.1.1.3.7	1.0.0
2018-05	RAN5#79	R5-183101	-	-	-	Addition of DRX Operation test case 7.1.1.5.4	1.0.0
2018-05	RAN5#79	R5-183102	-	-	-	Addition of Correct handling of DL assignment/Semi-persistent test case 7.1.1.6.1	1.0.0
2018-05	RAN5#79	R5-183103	-	-	-	Addition of AM RLC test case 7.1.2.3.10	1.0.0
2018-05	RAN5#79	R5-183227	-	-	-	Editorial updates to 38.523-1	1.0.0
2018-05	RAN5#79	R5-183229	-	-	-	Correction to PDCP Test case - PDCP reordering/Maximum re-ordering delay below t-Reordering/ t-Reordering timer operations	1.0.0
2018-05	RAN5#79	R5-183109	-	-	-	Update to MAC Test case - Random access procedure / Successful/ C-RNTI Based/Preamble selected by MAC itself	1.0.0
2018-05	RAN5#79	R5-183111	-	-	-	Update RLC test case - AM RLC / Re-transmission of RLC PDU with and without re-segmentation	1.0.0
2018-05	RAN5#79	R5-183112	-	-	-	Correction to MAC Test case - DRX operation / Short cycle configured / Parameters configured by RRC	1.0.0
2018-05	RAN5#79	R5-183113	-	-	-	Correction to PDCP Test case - PDCP handover / Lossless handover / PDCP sequence number maintenance/PDCP status report to convey the information on missing or acknowledged PDCP SDUs at handover/ In-order delivery and duplicate elimination in the downlink	1.0.0
2018-05	RAN5#79	R5-182497	-	-	-	Corrections to RRC TC - BandwidthPart Configuration / SCG	1.0.0
2018-05	RAN5#79	R5-183230	-	-	-	Corrections to RRC TC - PSCell addition, modification and release / SCG DRB	1.0.0
2018-05	RAN5#79	R5-183114	-	-	-	Corrections to RRC TC - Bearer Modification / Handling for bearer type change with security key change	1.0.0
2018-05	RAN5#79	R5-183115	-	-	-	Corrections to RRC TC - Bearer Modification / Uplink data path / Split DRB Reconfiguration	1.0.0
2018-05	RAN5#79	R5-183117	-	-	-	Corrections to RRC TC - Measurement configuration control and reporting / Inter-RAT measurements / Event B1 / Measurement of NR cells	1.0.0
2018-05	RAN5#79	R5-183116	-	-	-	Corrections to RRC TC - RRC connection reconfiguration / PSCell addition failure	1.0.0
2018-05	RAN5#79	R5-183231	-	-	-	Corrections to RRC TC - NR SCG Failure Information / RLC- MaxNumRetx	1.0.0
2018-05	RAN5#79	R5-183118	-	-	-	Corrections to RRC TC - SCG Reconfiguration Failure / SRB3	1.0.0
2018-05	RAN5#79	R5-183119	-	-	-	Corrections to RRC TC - SCG Reconfiguration Failure / SRB1	1.0.0
2018-05	RAN5#79	R5-182508	-	-	-	Void RRC TC - Handover with PSCell release / SCG DRB	1.0.0
2018-05	RAN5#79	R5-182509	-	-	-	Void RRC TC - Bearer Modification / SCG DRB / Split DRB Reconfiguration	1.0.0
2018-05	RAN5#79	R5-183120	-	-	-	Correction to NR RRC test case 8.2.3.17	1.0.0
2018-05	RAN5#79	R5-183121	-	-	-	Correction to NR RRC test case 8.2.3.19	1.0.0
2018-05	RAN5#79	R5-183228	-	-	-	Correction to NR MAC test case 7.1.1.3.2	1.0.0
2018-05	RAN5#79	R5-183122	-	-	-	Correction to NR PDCP test case 7.1.3.4.2	1.0.0
2018-05	RAN5#79	R5-183123	-	-	-	Addition of new NR RRC test case 8.2.5.2.1	1.0.0
2018-05	RAN5#79	R5-183124	-	-	-	Addition of new NR RRC test case 8.2.5.4.1	1.0.0
2018-05	RAN5#79	R5-182601	-	-	-	Removal of NR RRC test case 8.2.2.2.5	1.0.0
2018-05	RAN5#79	R5-183126	-	-	-	Addition of new 5GS RRC TC 8.2.4.3.1.1	1.0.0
2018-05	RAN5#79	R5-183127	-	-	-	Addition of new NR RRC test case - Bearer Modification / Handling for bearer type change without security key change / EN-DC	1.0.0
2018-05	RAN5#79	R5-182652	-	-	-	Void RRC TC - Bearer Modification / MCG DRB / SCG DRB Reconfiguration	1.0.0
2018-05	RAN5#79	R5-182774	-	-	-	Addition of 5GS NR RRC test case 8.2.3.8.1	1.0.0
2018-05	RAN5#79	R5-183130	-	-	-	Removal of RRC TC 8.2.4.3.1	1.0.0

2018-05	RAN5#79	R5-182798	-	-	-	Update of 5GS NR RRC test case 8.2.3.6	1.0.0
2018-05	RAN5#79	R5-183232	-	-	-	Addition of 5GS NR RRC test case 8.2.2.6.1	1.0.0
2018-05	RAN5#79	R5-183233	-	-	-	Addition of 5GS NR PDCP test case 7.1.3.5.3	1.0.0
2018-05	RAN5#79	R5-183132	-	-	-	Update of NR RRC TC - Measurement configuration control and reporting / Inter-RAT measurements / Event B1 / Measurement of NR cells / RSRQ based measurements	1.0.0
2018-05	RAN5#79	R5-183133	-	-	-	Update of NR RRC TC - Measurement configuration control and reporting / Inter-RAT measurements / Periodic reporting / Measurement of NR cells	1.0.0
2018-05	RAN5#79	R5-183134	-	-	-	Update of NR RRC TC - Measurement configuration control and reporting / Event A1 / Measurement of NR PSCell	1.0.0
2018-05	RAN5#79	R5-183135	-	-	-	Addition of NR RRC TC - PSCell addition, modification and release / Split DRB / EN-DC	1.0.0
2018-05	RAN5#79	R5-183137	-	-	-	Addition of 5GS NR RRC test case 8.2.1.1.1	1.0.0
2018-05	RAN5#79	R5-183138	-	-	-	Addition of new NR MAC UL TBS test case 7.1.1.4.2.1	1.0.0
2018-05	RAN5#79	R5-183139	-	-	-	Addition of new NR MAC UL TBS test case 7.1.1.4.2.2	1.0.0
2018-05	RAN5#79	R5-183140	-	-	-	Addition of new NR MAC UL TBS test case 7.1.1.4.2.3	1.0.0
2018-05	RAN5#79	R5-183141	-	-	-	Addition of new NR MAC UL TBS test case 7.1.1.4.2.4	1.0.0
2018-05	RAN5#79	R5-183142	-	-	-	Addition of Layer 2 test case specific parameters	1.0.0
2018-05	RAN5#79	R5-183143	-	-	-	Correction to MAC Pre-test conditions	1.0.0
2018-05	RAN5#79	R5-183144	-	-	-	Correction to RLC Pre-test conditions	1.0.0
2018-05	RAN5#79	R5-183145	-	-	-	Correction to PDCP Pre-test conditions	1.0.0
2018-05	RAN5#79	R5-183146	-	-	-	Correction to MAC RACH Test Cases	1.0.0
2018-05	RAN5#79	R5-182940	-	-	-	Correction to MAC DL Data Transfer test cases	1.0.0
2018-05	RAN5#79	R5-183147	-	-	-	Correction to MAC UL Data Transfer test cases	1.0.0
2018-05	RAN5#79	R5-183148	-	-	-	Correction to MAC DL-SCH TBS test cases	1.0.0
2018-05	RAN5#79	R5-183149	-	-	-	Correction to RLC UM Test cases	1.0.0
2018-05	RAN5#79	R5-183150	-	-	-	Correction to RLC AM Test cases	1.0.0
2018-05	RAN5#79	R5-182945	-	-	-	Corrections to PDCP sequence number test cases	1.0.0
2018-05	RAN5#79	R5-183151	-	-	-	Correction to PDCP integrity protection test cases	1.0.0
2018-05	RAN5#79	R5-182947	-	-	-	Correction to PDCP Ciphering test cases	1.0.0
2018-05	RAN5#79	R5-183152	-	-	-	Corrections to PDCP other test cases	1.0.0
2018-05	RAN5#79	R5-183153	-	-	-	Addition of new NR RACH test case 7.1.1.1.1	1.0.0
2018-05	RAN5#79	R5-182966	-	-	-	Correction to NR RLC test case 7.1.2.3.4	1.0.0
2018-05	RAN5#79	R5-183154	-	-	-	Correction to PDCP test case 7.1.3.5.2	1.0.0
2018-05	RAN5#79	R5-183155	-	-	-	Correction to NR MAC DRX Test cases	1.0.0
2018-05	RAN5#79	R5-183156	-	-	-	Correction to NR RRC intra frequency measurement Test case 8.2.3.9	1.0.0
2018-05	RAN5#79	R5-183157	-	-	-	Correction to NR RRC inter frequency measurement Test case 8.2.3.10	1.0.0
2018-05	RAN5#79	R5-183016	-	-	-	Removal of NR RRC test case 8.2.3.11	1.0.0
2018-05	RAN5#79	R5-183017	-	-	-	Removal of NR RRC test case 8.2.3.12	1.0.0
2018-05	RAN5#79	R5-183129	-	-	-	Addition of new 5GS RRC TC 8.2.3.13.1	1.0.0
2018-05	RAN5#79	R5-183136	-	-	-	Correction to NR RRC test case 8.2.3.5	1.0.0
2018-05	RAN5#79	R5-183263	-	-	-	Addition of new NR NAS test case Default EPS bearer context activation	1.0.0
2018-05	RAN5#79	R5-183265	-	-	-	Updates to session management TC 10.2.2.1	1.0.0
2018-06	RAN#80	RP-181210	-	-	-	put under revision control as v15.0.0 with small editorial changes	15.0.0
2018-09	RAN#81	R5-184226	0010	-	F	Addition of Correct handling of Configured UL grant Type 1 test case 7.1.1.6.2	15.1.0
2018-09	RAN#81	R5-184227	0011	-	F	Addition of Correct handling of Configured UL grant Type 2 test case 7.1.1.6.3	15.1.0
2018-09	RAN#81	R5-184228	0012	-	F	CR of Correct handling of DL assignment Semi persistent test case 7.1.1.6.1	15.1.0
2018-09	RAN#81	R5-184229	0013	-	F	CR of UE power headroom reporting test case 7.1.1.3.7	15.1.0
2018-09	RAN#81	R5-184343	0020	-	F	Correction to 5GS PDCP Test case 7.1.3.4.1 PDCP handover / Lossless handover / PDCP sequence number maintenance / PDCP status report to convey the information on missing or acknowledged PDCP SDUs at handover / In-order delivery and duplicate elimination in the downlink	15.1.0
2018-09	RAN#81	R5-184344	0021	-	F	Correction to 5GS PDCP Test case 7.1.3.5.4 PDCP reordering / Maximum re-ordering delay below t-Reordering / t-Reordering timer operations	15.1.0
2018-09	RAN#81	R5-184353	0023	-	F	Corrections to RRC TC - BandwidthPart Configuration / SCG	15.1.0

						/ EN-DC	
2018-09	RAN#81	R5-184500	0031	-	F	Addition of new 5GS RRC TC 8.2.4.3.1.3	15.1.0
2018-09	RAN#81	R5-184517	0032	-	F	Correction to NR PDCP test case 7.1.3.4.2	15.1.0
2018-09	RAN#81	R5-184523	0036	-	F	Corrections to MAC TBS test cases	15.1.0
2018-09	RAN#81	R5-184527	0040	-	F	Addition of new MAC test case for Reset	15.1.0
2018-09	RAN#81	R5-184680	0055	-	F	Update of RRC SCG failure TC 8.2.5.5.1	15.1.0
2018-09	RAN#81	R5-184681	0056	-	F	Update of RRC SCG failure TC 8.2.5.6.1	15.1.0
2018-09	RAN#81	R5-184760	0059	-	F	Correction to RRC TC - PSCell addition, modification and release / Split DRB / EN-DC	15.1.0
2018-09	RAN#81	R5-184761	0060	-	F	Correction to RRC TC - Measurement configuration control and reporting / Inter-RAT measurements / Periodic reporting / Measurement of NR cells / EN-DC	15.1.0
2018-09	RAN#81	R5-184763	0061	-	F	Correction to RRC TC - Measurement configuration control and reporting / Inter-RAT measurements / Event B1 / Measurement of NR cells / RSRQ based measurements / EN-DC	15.1.0
2018-09	RAN#81	R5-184769	0063	-	F	Update of 5GS NR RRC test case 8.2.2.6.1	15.1.0
2018-09	RAN#81	R5-185059	0001	1	F	Correction to NR MAC test case 7.1.1.3.2	15.1.0
2018-09	RAN#81	R5-185060	0004	1	F	Addition of Correct Handling of DL HARQ process PDSCH Aggregation test case 7.1.1.2.2	15.1.0
2018-09	RAN#81	R5-185061	0005	1	F	Addition of NR CA reconfiguration test case 8.2.4.2.1.1	15.1.0
2018-09	RAN#81	R5-185062	0006	1	F	Addition of NR CA reconfiguration test case 8.2.4.2.1.2	15.1.0
2018-09	RAN#81	R5-185064	0015	1	F	Addition of 5GS NR SDAP test case 7.1.4.1	15.1.0
2018-09	RAN#81	R5-185065	0016	1	F	Correction to 5GS MAC Test case 7.1.1.1.2 Random access procedure / Successful / C-RNTI Based / Preamble selected by MAC itself	15.1.0
2018-09	RAN#81	R5-185066	0017	1	F	Correction to 5GS MAC Test case 7.1.1.5.3 DRX operation / Short cycle configured / Parameters configured by RRC	15.1.0
2018-09	RAN#81	R5-185067	0018	1	F	Correction to 5GS RLC Test case 7.1.2.3.10 AM RLC / Re-transmission of RLC PDU with and without re-segmentation	15.1.0
2018-09	RAN#81	R5-185068	0019	1	F	Correction to 5GS RLC Test case 7.1.2.3.11 AM RLC / RLC re-establishment procedure	15.1.0
2018-09	RAN#81	R5-185069	0022	1	F	Addition of NR CA / NR SCell addition / modification / release / Success test cases 8.2.4.1.1.1, 8.2.4.1.1.2 and 8.2.4.1.1.3	15.1.0
2018-09	RAN#81	R5-185070	0027	1	F	Corrections to RRC TC - Measurement configuration control and reporting / Inter-RAT measurements / Event B1 / Measurement of NR cells / EN-DC	15.1.0
2018-09	RAN#81	R5-185071	0029	1	F	Correction to 5GS RRC TC 8.2.4.3.1.1	15.1.0
2018-09	RAN#81	R5-185072	0030	1	F	Addition of 5GS RRC TC 8.2.4.3.1.2	15.1.0
2018-09	RAN#81	R5-185073	0033	1	F	Corrections to Layer 2 test cases	15.1.0
2018-09	RAN#81	R5-185074	0034	1	F	Corrections to MAC test case 7.1.2.2.1	15.1.0
2018-09	RAN#81	R5-185075	0035	1	F	Corrections to MAC test case 7.1.2.3.1	15.1.0
2018-09	RAN#81	R5-185076	0037	1	F	Addition of new MAC RACH test case for PDCCH order	15.1.0
2018-09	RAN#81	R5-185077	0039	1	F	Addition of new MAC test case for SCell Activation Deactivation	15.1.0
2018-09	RAN#81	R5-185078	0041	1	F	Addition of new MAC UL TBS test case with transform precoding configured	15.1.0
2018-09	RAN#81	R5-185079	0042	1	F	Correction to default pre-test conditions for UM RLC test cases	15.1.0
2018-09	RAN#81	R5-185080	0043	1	F	New NAS test case 9.1.5.1.12	15.1.0
2018-09	RAN#81	R5-185082	0045	1	F	Correction to NR PDCP test case 7.1.3.5.1	15.1.0
2018-09	RAN#81	R5-185083	0046	1	F	Correction to NR RLC test case 7.1.2.3.3 and 7.1.2.3.4	15.1.0
2018-09	RAN#81	R5-185089	0049	1	F	Corrections to RRC TC - Measurement configuration control and reporting / Inter-RAT measurements / Event B2 / Measurement of NR cells / EN-DC	15.1.0
2018-09	RAN#81	R5-185090	0050	1	F	CR of AM RLC test case 7.1.2.3.10	15.1.0
2018-09	RAN#81	R5-185091	0051	1	F	Update of RRC SCG failure TC 8.2.5.1.1	15.1.0
2018-09	RAN#81	R5-185092	0052	1	F	Update of RRC SCG failure TC 8.2.5.2.1	15.1.0
2018-09	RAN#81	R5-185093	0053	1	F	Update of RRC SCG failure TC 8.2.5.3.1	15.1.0
2018-09	RAN#81	R5-185094	0054	1	F	Update of RRC SCG failure TC 8.2.5.4.1	15.1.0
2018-09	RAN#81	R5-185095	0057	1	F	Addition of 5GS NR SDAP test case 7.1.4.2	15.1.0
2018-09	RAN#81	R5-185096	0064	1	F	Update of 5GS NR RRC test case 8.2.3.6.1	15.1.0
2018-09	RAN#81	R5-185097	0066	1	F	Update of 5GS NR RRC test case 8.2.3.8.1	15.1.0
2018-09	RAN#81	R5-185098	0067	1	F	Update of 5GS NR RRC test case 8.2.1.1.1	15.1.0

2018-09	RAN#81	R5-185099	0068	1	F	L2 Preamble Parameter Update for Multi-PDN configuration	15.1.0
2018-09	RAN#81	R5-185100	0069	1	F	Correction to NR RLC test cases 7.1.2.2.3 and 7.1.2.2.4	15.1.0
2018-09	RAN#81	R5-185101	0070	1	F	Correction to NR RRC test case 8.2.3.14.1	15.1.0
2018-09	RAN#81	R5-185148	0007	1	F	Addition of NR CA reconfiguration test case 8.2.4.2.1.3	15.1.0
2018-09	RAN#81	R5-185149	0024	1	F	Corrections to RRC TC - PSCell addition, modification and release / SCG DRB / EN-DC	15.1.0
2018-09	RAN#81	R5-185150	0025	1	F	Corrections to RRC TC - Bearer Modification / Handling for bearer type change with security key change / EN-DC	15.1.0
2018-09	RAN#81	R5-185151	0026	1	F	Corrections to RRC TC - Bearer Modification / Uplink data path / Split DRB Reconfiguration / EN-DC	15.1.0
2018-09	RAN#81	R5-185152	0038	1	F	Addition of new MAC test case for Power Headroom report	15.1.0
2018-09	RAN#81	R5-185153	0047	1	F	Addition of RRC Default Pre-test conditions for NSA	15.1.0
2018-09	RAN#81	R5-185154	0058	1	F	Correction to RRC TC - Measurement configuration control and reporting / Event A1 / Measurement of NR PSCell / EN-DC	15.1.0
2018-09	RAN#81	R5-185155	0062	1	F	Updates to NAS test case 10.2.1.2	15.1.0
2018-09	RAN#81	R5-185167	0071	1	F	Update to EPS SM Test case for Multi-PDN	15.1.0
2018-12	RAN#82	R5-186649	0157	-	F	Correction to NR PDCP test case 7.1.3.5.1	15.2.0
2018-12	RAN#82	R5-186650	0158	-	F	Correction to NR PDCP test case 7.1.3.5.2	15.2.0
2018-12	RAN#82	R5-186679	0163	-	F	Corrections to PDCP test case 7.1.3.5.3	15.2.0
2018-12	RAN#82	R5-186725	0167	-	F	Correction to 5GS test case 7.1.2.2.5	15.2.0
2018-12	RAN#82	R5-186801	0178	-	F	Update RRC TC 8.2.2.2.1 - Split SRB Establishment and Release / EN-DC	15.2.0
2018-12	RAN#82	R5-186802	0179	-	F	Update RRC TC 8.2.2.7.1 - Bearer Modification / Handling for bearer type change without security key change / EN-DC	15.2.0
2018-12	RAN#82	R5-186803	0180	-	F	Update RRC TC 8.2.3.7.1 - Measurement configuration control and reporting / Event A4 (intra-frequency, inter-frequency and inter-band measurements) / Measurement of Neighbour NR cell / EN-DC	15.2.0
2018-12	RAN#82	R5-186872	0181	-	F	Removal of RRC SCG failure TC 8.2.5.5.1	15.2.0
2018-12	RAN#82	R5-186873	0182	-	F	Removal of RRC SCG failure TC 8.2.5.6.1	15.2.0
2018-12	RAN#82	R5-186890	0185	-	F	Correction to NR RRC test case 8.2.3.14.1	15.2.0
2018-12	RAN#82	R5-186891	0186	-	F	Correction to NR RRC test case 8.2.3.13.1	15.2.0
2018-12	RAN#82	R5-186892	0187	-	F	Correction to NR PDCP test case 7.1.3.4.2	15.2.0
2018-12	RAN#82	R5-186995	0228	-	F	CR of test case 8.2.4.2_NR CA release_Resubmission of 186101	15.2.0
2018-12	RAN#82	R5-187104	0229	-	F	Correction to MAC test cases	15.2.0
2018-12	RAN#82	R5-187105	0230	-	F	Correction to RLC UM test cases	15.2.0
2018-12	RAN#82	R5-187106	0231	-	F	Correction to RLC AM test cases	15.2.0
2018-12	RAN#82	R5-187236	0235	-	F	Update RRC TC 8.2.1.2.1 - BandwidthPart Configuration / SCG / EN-DC	15.2.0
2018-12	RAN#82	R5-187237	0236	-	F	Update RRC TC 8.2.2.4.1 - PSCell addition, modification and release / SCG DRB / EN-DC	15.2.0
2018-12	RAN#82	R5-187238	0237	-	F	Update RRC TC 8.2.2.8.1 - Bearer Modification / Handling for bearer type change with security key change / EN-DC	15.2.0
2018-12	RAN#82	R5-187239	0238	-	F	Update RRC TC 8.2.2.9.1 - Bearer Modification / Uplink data path / Split DRB Reconfiguration / EN-DC	15.2.0
2018-12	RAN#82	R5-187248	0247	-	F	Correction to MAC Test case 7.1.1.1.2 Random access procedure / Successful / C-RNTI Based / Preamble selected by MAC itself	15.2.0
2018-12	RAN#82	R5-187249	0248	-	F	Correction to MAC Test case 7.1.1.5.3 DRX operation / Short cycle configured / Parameters configured by RRC	15.2.0
2018-12	RAN#82	R5-187250	0249	-	F	Correction to RLC Test case 7.1.2.3.10 AM RLC / Re-transmission of RLC PDU with and without re-segmentation	15.2.0
2018-12	RAN#82	R5-187251	0250	-	F	Correction to RLC Test case 7.1.2.3.11 AM RLC / RLC re-establishment procedure	15.2.0
2018-12	RAN#82	R5-187252	0251	-	F	Correction to PDCP Test case 7.1.3.4.1 PDCP handover / Lossless handover / PDCP sequence number maintenance / PDCP status report to convey the information on missing or acknowledged PDCP SDUs at handover / In-order delivery and duplicate elimination	15.2.0
2018-12	RAN#82	R5-187254	0253	-	F	Update RRC TCs 8.2.4.1.1.1, 8.2.4.1.1.2 and 8.2.4.1.1.3 NR CA / NR SCell addition / modification / release / Success	15.2.0
2018-12	RAN#82	R5-187255	0254	-	F	Correction to EN-DC NAS test case 10.2.1.1 - Default EPS bearer context activation	15.2.0
2018-12	RAN#82	R5-187302	0260	-	F	Correction to test case 8.2.4.3.1.1	15.2.0

2018-12	RAN#82	R5-187410	0273	-	F	Update of 5GS NR RRC test case 8.2.2.6.1	15.2.0
2018-12	RAN#82	R5-187411	0274	-	F	Addition of 5GS NR MAC test case 7.1.1.3.9	15.2.0
2018-12	RAN#82	R5-187492	0278	-	F	Correction to test case 8.2.2.1.1	15.2.0
2018-12	RAN#82	R5-187497	0279	-	F	Correction to test case 8.2.2.3.1	15.2.0
2018-12	RAN#82	R5-187528	0285	-	F	Update to RRC TC - PSCell addition, modification and release / Split DRB / EN-DC	15.2.0
2018-12	RAN#82	R5-187530	0286	-	F	Update to RRC TC - Measurement configuration control and reporting / Inter-RAT measurements / Event B1 / Measurement of NR cells / RSRQ based measurements / EN-DC	15.2.0
2018-12	RAN#82	R5-187534	0287	-	F	Update to RRC TC - Measurement configuration control and reporting / Inter-RAT measurements / Periodic reporting / Measurement of NR cells / EN-DC	15.2.0
2018-12	RAN#82	R5-187540	0290	-	F	Update to 5G-NR RRC TCs for Multi-PDN support and specific message content IEs	15.2.0
2018-12	RAN#82	R5-187611	0294	-	F	Correction to MAC TBS test cases	15.2.0
2018-12	RAN#82	R5-187686	0283	1	F	Adding test case 6.1.1.7	15.2.0
2018-12	RAN#82	R5-187688	0202	1	F	Addition of NR test case 7.1.1.1.3_SI Request	15.2.0
2018-12	RAN#82	R5-187689	0203	1	F	Addition of NR test case 7.1.1.1.6_Random access	15.2.0
2018-12	RAN#82	R5-187690	0204	1	F	Addition of NR test case 7.1.1.2.3_CCCH HARQ	15.2.0
2018-12	RAN#82	R5-187691	0213	1	F	CR of NR test case 7.1.2.3.9_RLC Reassembling	15.2.0
2018-12	RAN#82	R5-187692	0252	1	F	Correction to PDCP Test case 7.1.3.5.4 PDCP reordering / Maximum re-ordering delay below t-Reordering / t-Reordering timer operations	15.2.0
2018-12	RAN#82	R5-187693	0234	1	F	Correction to SDAP test cases	15.2.0
2018-12	RAN#82	R5-187695	0243	1	F	Addition of 5GS SA RRC TC 8.1.1.1.1	15.2.0
2018-12	RAN#82	R5-187696	0246	1	F	Addition of 5GS SA RRC TC 8.1.5.2.1	15.2.0
2018-12	RAN#82	R5-187698	0159	1	F	Correction to NR RRC test case 8.2.3.5.1	15.2.0
2018-12	RAN#82	R5-187699	0160	1	F	Correction to NR RRC test case 8.2.3.9.1 and 8.2.3.10.1	15.2.0
2018-12	RAN#82	R5-187700	0239	1	F	Update RRC TC 8.2.3.1.1 - Measurement configuration control and reporting / Inter-RAT measurements / Event B1 / Measurement of NR cells / EN-DC	15.2.0
2018-12	RAN#82	R5-187701	0272	1	F	Update RRC TC 8.2.3.12.1	15.2.0
2018-12	RAN#82	R5-187702	0276	1	F	Update of 5GS NR RRC test case 8.2.3.6.1	15.2.0
2018-12	RAN#82	R5-187703	0277	1	F	Update of 5GS NR RRC test case 8.2.3.8.1	15.2.0
2018-12	RAN#82	R5-187704	0288	1	F	Update to RRC TC - Measurement configuration control and reporting / Event A1 / Measurement of NR PSCell / EN-DC	15.2.0
2018-12	RAN#82	R5-187705	0289	1	F	Update to 5G-NR RRC measurement report TCs for FR1/FR2 cell power level	15.2.0
2018-12	RAN#82	R5-187706	0168	1	F	Updates to EN-DC TC 8.2.5.3.1	15.2.0
2018-12	RAN#82	R5-187707	0140	1	F	Corrections to NAS test case 9.1.5.1.14	15.2.0
2018-12	RAN#82	R5-187778	0284	1	F	Adding test case 6.1.1.8	15.2.0
2018-12	RAN#82	R5-187779	0226	1	F	Addition of NR test case 7.1.1.1.4_Beam Failure	15.2.0
2018-12	RAN#82	R5-187780	0227	1	F	Addition of NR test case 7.1.1.1.5 SUL	15.2.0
2018-12	RAN#82	R5-187781	0281	1	F	Correction to NR MAC test case 7.1.1.3.2	15.2.0
2018-12	RAN#82	R5-187782	0291	1	F	Addition of 5GS NR MAC test case 7.1.1.8.1	15.2.0
2018-12	RAN#82	R5-187784	0184	1	F	Correction to the default Pre-Test Conditions for AM and UM RLC test cases	15.2.0
2018-12	RAN#82	R5-187785	0232	1	F	Correction to PDCP Ciphering test cases	15.2.0
2018-12	RAN#82	R5-187786	0233	1	F	Correction to PDCP Integrity test cases	15.2.0
2018-12	RAN#82	R5-187787	0216	1	F	Addition of NR test case 8.1.1.2.3_T300 expiry	15.2.0
2018-12	RAN#82	R5-187789	0245	1	F	Addition of 5GS SA RRC TC 8.1.1.2.5	15.2.0
2018-12	RAN#82	R5-187790	0275	1	F	Addition of 5GS NR RRC test case 8.1.1.3.2	15.2.0
2018-12	RAN#82	R5-187792	0224	1	F	Addition of NR test case 8.2.3.11.1_gapFR1	15.2.0
2018-12	RAN#82	R5-187794	0221	1	F	Addition of NR test case 8.1.5.3.1_PWS notification	15.2.0
2018-12	RAN#82	R5-187795	0240	1	F	Update RRC SCG failure TC 8.2.5.1.1	15.2.0
2018-12	RAN#82	R5-187797	0263	1	F	Addition of new 5GC TC 9.1.6.1.1	15.2.0
2018-12	RAN#82	R5-188159	0222	2	F	Addition of NR test case 9.1.5.1.1_Registration Request	15.2.0
2018-12	RAN#82	R5-188187	0296	-	F	Correction to NR MAC DRX test cases 7.1.1.5.1 and 7.1.1.5.2	15.2.0
2018-12	RAN#82	R5-188188	0217	2	F	Addition of NR test case 8.1.1.3.1_Redirection to NR	15.2.0
2018-12	RAN#82	R5-188190	0225	2	F	Addition of NR test case 8.2.3.11.2_gapFR2	15.2.0
2019-01	RAN#82	R5-188192	0205	2	F	Addition of NR test case 7.1.1.2.4_BCCH HARQ	15.2.1
2019-01	RAN#82	R5-188193	0295	2	F	Correction to Layer 2 Pre Test conditions	15.2.1
2019-01	RAN#82	R5-188194	0218	2	F	Addition of NR test case 8.1.3.1.1_Event A1	15.2.1

2019-01	RAN#82	R5-188195	0183	2	F	Update to 5G TC TA registration update	15.2.1
2019-01	RAN#82	R5-188202	0280	2	F	Update of 5GS NR RRC test case 8.2.1.1.1	15.2.1
2019-03	RAN#83	R5-191197	0421	-	F	Correction to 5GS RLC Test case 7.1.2.2.5	15.3.0
2019-03	RAN#83	R5-191198	0422	-	F	Correction to 5GS RLC Test case 7.1.2.3.8	15.3.0
2019-03	RAN#83	R5-191199	0423	-	F	Correction to 5GS RLC Test case 7.1.2.3.9	15.3.0
2019-03	RAN#83	R5-191200	0424	-	F	Correction to EN-DC RRC test case 8.2.5.3.1	15.3.0
2019-03	RAN#83	R5-191202	0426	-	F	Correction to 5GS RLC Test case 7.1.2.3.10	15.3.0
2019-03	RAN#83	R5-191203	0427	-	F	Correction to EN-DC RRC test case 8.2.2.2.1	15.3.0
2019-03	RAN#83	R5-191353	0431	-	F	Correcting test case 7.1.1.3.1	15.3.0
2019-03	RAN#83	R5-191393	0445	-	F	Correction to NR test case 7.1.1.1.6-Random access procedure	15.3.0
2019-03	RAN#83	R5-191397	0449	-	F	Correction to NR test case 7.1.2.3.9-RLC Reassembling	15.3.0
2019-03	RAN#83	R5-191403	0455	-	F	Correction to NR test case 8.1.3.1.1-Event A1 and A2	15.3.0
2019-03	RAN#83	R5-191405	0457	-	F	Correction to NR test case 8.2.3.11.2-ENDC measurement gap FR2	15.3.0
2019-03	RAN#83	R5-191415	0466	-	F	Addition of TC 8.1.3.2.3-inter-RAT measurement B2 RSRQ	15.3.0
2019-03	RAN#83	R5-191426	0475	-	F	Addition of NR test case 6.1.2.4-Cell Reselection for interband operation	15.3.0
2019-03	RAN#83	R5-191427	0476	-	F	Addition of NR test case 6.1.2.5-Cell Reselection for interband operation using Pcompensation Between FDD and TDD	15.3.0
2019-03	RAN#83	R5-191430	0479	-	F	Addition of NR test case 6.1.2.21-Cell reselection, SIntra SearchQ and SnonIntraSeqrchQ	15.3.0
2019-03	RAN#83	R5-191431	0480	-	F	Addition of NR test case 6.1.2.22-Inter-frequency cell reselection with parameters ThreshX, HighQ, ThreshX, LowQ and ThreshServing, LowQ	15.3.0
2019-03	RAN#83	R5-191432	0481	-	F	Correction to NR test case 7.1.1.3.7-Power Headroom Reporting	15.3.0
2019-03	RAN#83	R5-191433	0482	-	F	Correction to NR test case 7.1.1.6.1-Correct handling of DL assignment Semi persistent	15.3.0
2019-03	RAN#83	R5-191434	0483	-	F	Addition of NR test case 8.1.1.1.2-Paging	15.3.0
2019-03	RAN#83	R5-191435	0484	-	F	Correction to NR test case 8.1.1.2.1-T300 expiry	15.3.0
2019-03	RAN#83	R5-191436	0485	-	F	Addition of NR test case 8.1.5.3.3-PWS notification	15.3.0
2019-03	RAN#83	R5-191445	0494	-	F	Correction to NR test case 9.1.5.1.1-Initial Registration	15.3.0
2019-03	RAN#83	R5-191447	0495	-	F	Addition of NR test case 8.1.3.1.5-Two event A3 RSRQ	15.3.0
2019-03	RAN#83	R5-191448	0496	-	F	Addition of NR test case 8.1.3.1.6_Two event A5 SINR	15.3.0
2019-03	RAN#83	R5-191449	0497	-	F	Correction to NR test case 8.1.5.3.1-ETWS	15.3.0
2019-03	RAN#83	R5-191509	0504	-	F	Addition of new RRC TC 8.1.5.3.2	15.3.0
2019-03	RAN#83	R5-191621	0514	-	F	Update of 5GS NR RRC test case 8.1.1.3.2	15.3.0
2019-03	RAN#83	R5-191641	0523	-	F	Updates to 5GS SA RRC TC - RRC / Paging for connection / Multiple paging records	15.3.0
2019-03	RAN#83	R5-191642	0524	-	F	Updates to 5GS SA RRC TC - RRC connection establishment / RRC Reject with wait time	15.3.0
2019-03	RAN#83	R5-191643	0525	-	F	Updates to 5GS SA RRC TC - SI change / Notification of BCCH modification / Short message for SI update	15.3.0
2019-03	RAN#83	R5-191651	0530	-	F	Update EN-DC RRC TC 8.2.2.4.1	15.3.0
2019-03	RAN#83	R5-191652	0531	-	F	Update EN-DC RRC TC 8.2.2.8.1	15.3.0
2019-03	RAN#83	R5-191653	0532	-	F	Update EN-DC RRC TC 8.2.2.9.1	15.3.0
2019-03	RAN#83	R5-191654	0533	-	F	Update EN-DC RRC TC 8.2.4.1.1.1	15.3.0
2019-03	RAN#83	R5-191656	0535	-	F	Update EN-DC RRC TC 8.2.5.3.1	15.3.0
2019-03	RAN#83	R5-191660	0539	-	F	Addition of 5GC TC- PDU session authentication and authorization / during the UE-requested PDU session procedure	15.3.0
2019-03	RAN#83	R5-191661	0540	-	F	Addition of Idle Mode TC - Steering of UE in roaming during registration/security check successful using List Type 1	15.3.0
2019-03	RAN#83	R5-191663	0542	-	F	Addition of Idle mode Test Case - PLMN selection of RPLMN, HPLMN/EHPLMN, UPLMN and OPLMN / Automatic mode	15.3.0
2019-03	RAN#83	R5-191733	0546	-	F	Update RRC TC 8.2.2.1.1 - SRB3 Establishment, Reconfiguration and Release / NR addition, modification and release / EN-DC	15.3.0
2019-03	RAN#83	R5-191764	0550	-	F	Addition of new TC 8.2.3.15	15.3.0
2019-03	RAN#83	R5-191804	0552	-	F	Title correction to MAC TC 7.1.1.7.1.1	15.3.0
2019-03	RAN#83	R5-191806	0553	-	F	Addition of new RRC TC 8.1.1.4.3	15.3.0
2019-03	RAN#83	R5-191810	0554	-	F	Addition of new 5GC TC 9.1.5.2.9	15.3.0

2019-03	RAN#83	R5-191823	0555	-	F	Addition of new 5GC TC 9.1.6.1.4	15.3.0
2019-03	RAN#83	R5-191827	0556	-	F	Addition of new RRC TC 8.1.1.4.2	15.3.0
2019-03	RAN#83	R5-191859	0559	-	F	Addition of new 5G-NR Idle Mode TC 6.1.1.6 - PLMN selection / Periodic reselection / MinimumPeriodicSearchTimer	15.3.0
2019-03	RAN#83	R5-191869	0561	-	F	Update to 5G-NR RRC Measurement configuration and reporting TC 8.2.3.3.1	15.3.0
2019-03	RAN#83	R5-191877	0562	-	F	Update to 5G-NR RRC Measurement configuration and reporting TC 8.2.3.4.1	15.3.0
2019-03	RAN#83	R5-191897	0570	-	F	Update to TC 8.2.5.4.1 SCG change failure / EN-DC	15.3.0
2019-03	RAN#83	R5-191898	0571	-	F	Editorial update to TC 7.1.3.2.1	15.3.0
2019-03	RAN#83	R5-191911	0574	-	F	Correction to MAC TBS test cases	15.3.0
2019-03	RAN#83	R5-191916	0577	-	F	Introduction of Non 3GPP Access over WLAN test cases	15.3.0
2019-03	RAN#83	R5-192203	0587	-	F	Update to 5G-NR RRC Measurement configuration and reporting TCs 8.2.3.x.x	15.3.0
2019-03	RAN#83	R5-192222	0589	-	F	Correction to NR RRC test case 8.2.3.5.1	15.3.0
2019-03	RAN#83	R5-192282	0429	1	F	Addition of new 5G-NR Idle Mode TC 6.1.2.19 - Speed-dependent cell reselection	15.3.0
2019-03	RAN#83	R5-192283	0440	1	F	Addition of NR test case 6.1.2.15-Cell reselection in shared network environment	15.3.0
2019-03	RAN#83	R5-192284	0441	1	F	Addition of NR test case 6.1.2.17-Cell reselection	15.3.0
2019-03	RAN#83	R5-192285	0541	1	F	Addition of Idle mode Test Case 6.1.2.7: Cell reselection / Equivalent PLMN	15.3.0
2019-03	RAN#83	R5-192286	0446	1	F	Correction to NR test case 7.1.1.5.4-CDRX	15.3.0
2019-03	RAN#83	R5-192287	0447	1	F	Correction to NR test case 7.1.1.6.2-Configured grant Type 1	15.3.0
2019-03	RAN#83	R5-192288	0448	1	F	Correction to NR test case 7.1.1.6.3-Configured grant Type 2	15.3.0
2019-03	RAN#83	R5-192289	0548	1	F	Addition of a new test purpose to TC 7.1.1.2.1 and TC 7.1.1.3.1 for a TDD-UL-DL-ConfigCommon including pattern2	15.3.0
2019-03	RAN#83	R5-192291	0575	1	F	Reduction of loops in MAC TBS test cases	15.3.0
2019-03	RAN#83	R5-192293	0565	1	F	Correction to 5GS RLC Test case 7.1.2.3.11	15.3.0
2019-03	RAN#83	R5-192296	0536	1	F	Correction to PDCP Test case 7.1.3.4.1 PDCP handover / Lossless handover / PDCP sequence number maintenance / PDCP status report to convey the information on missing or acknowledged PDCP SDUs at handover / In-order delivery and duplicate elimination in th	15.3.0
2019-03	RAN#83	R5-192297	0544	1	F	Correction to SDAP Test Cases	15.3.0
2019-03	RAN#83	R5-192298	0451	1	F	Addition of NR test case 8.1.1.3.4-RRCRelease with priority information of E-UTRA	15.3.0
2019-03	RAN#83	R5-192299	0526	1	F	Addition of 5GS SA RRC TC - RRC connection release / With priority information / T320 expiry	15.3.0
2019-03	RAN#83	R5-192300	0527	1	F	Addition of 5GS SA RRC TC - RRC connection release / With priority information / T320 expiry / E-UTRA	15.3.0
2019-03	RAN#83	R5-192301	0528	1	F	Addition of 5GS SA RRC TC - RRC resume / Suspend-Resume / Success	15.3.0
2019-03	RAN#83	R5-192302	0588	1	F	Addition of 5GS SA RRC TC - 8.1.2.1.1	15.3.0
2019-03	RAN#83	R5-192303	0590	1	F	Addition of 5GS SA RRC TC - 8.1.2.1.3	15.3.0
2019-03	RAN#83	R5-192304	0591	1	F	Addition of 5GS SA RRC TC - 8.1.5.3.4	15.3.0
2019-03	RAN#83	R5-192307	0557	1	F	Update ENDC TC 8.2.2.3.1	15.3.0
2019-03	RAN#83	R5-192308	0420	1	F	Update to 5G-NR RRC Measurement configuration and reporting TC 8.2.3.2.1	15.3.0
2019-03	RAN#83	R5-192329	0456	1	F	Correction to NR test case 8.2.3.11.1-ENDC measurement gap FR1	15.3.0
2019-03	RAN#83	R5-192330	0428	1	F	Correction to NR RRC test case 8.2.3.13.1	15.3.0
2019-03	RAN#83	R5-192331	0579	1	F	Correction to NR RRC test case 8.2.3.12.1	15.3.0
2019-03	RAN#83	R5-192332	0581	1	F	Correction to NR RRC test case 8.2.3.14.1	15.3.0
2019-03	RAN#83	R5-192333	0582	1	F	Correction to NR RRC test case 8.2.3.1.1	15.3.0
2019-03	RAN#83	R5-192334	0596	1	F	Correction to NR RRC test case 8.2.3.9.1 and 8.2.3.10.1	15.3.0
2019-03	RAN#83	R5-192339	0534	1	F	Update EN-DC RRC TC 8.2.5.1.1	15.3.0
2019-03	RAN#83	R5-192340	0506	1	F	Update to 5G testcase 9.1.5.1.14	15.3.0
2019-03	RAN#83	R5-192341	0572	1	F	Update to 5G TC 9.1.5.2.1 TA registration update	15.3.0
2019-03	RAN#83	R5-192342	0543	1	F	Correction to EN-DC NAS test case 10.2.1.1 - Default EPS bearer context activation	15.3.0
2019-03	RAN#83	R5-192343	0537	1	F	Addition of 5GC TC SMS over NAS service	15.3.0
2019-03	RAN#83	R5-192383	0459	1	F	Addition of NR test case 9.1.5.1.10-PLMN not allowed	15.3.0

2019-03	RAN#83	R5-192385	0498	1	F	Addition of new 5GC TC 9.1.7.1	15.3.0
2019-03	RAN#83	R5-192386	0502	1	F	Addition of new 5GC TC 9.1.5.1.11	15.3.0
2019-03	RAN#83	R5-192387	0503	1	F	Addition of new 5GC TC 9.1.5.1.12	15.3.0
2019-03	RAN#83	R5-192388	0507	1	F	Addition of 5G testcase 9.1.5.1.4	15.3.0
2019-03	RAN#83	R5-192389	0508	1	F	Addition of 5G testcase 9.1.3.1	15.3.0
2019-03	RAN#83	R5-192390	0538	1	F	Addition of 5GC TC - Initial registration / 5GS services / NSSAI handling	15.3.0
2019-03	RAN#83	R5-192391	0545	1	F	Addition of new 5GC TC 9.1.5.1.5	15.3.0
2019-03	RAN#83	R5-192392	0547	1	F	Introduction of TC 9.1.1.1 EAP based primary authentication and key agreement	15.3.0
2019-03	RAN#83	R5-192393	0549	1	F	Introduction of TC 9.1.1.3 EAP based primary authentication and key agreement	15.3.0
2019-03	RAN#83	R5-192394	0558	1	F	Addition of new 5GC TC 9.1.5.1.7	15.3.0
2019-03	RAN#83	R5-192396	0564	1	F	Addition of new 5GC TC 9.1.5.1.8	15.3.0
2019-03	RAN#83	R5-192397	0566	1	F	Update TC 9.1.6.1.1	15.3.0
2019-03	RAN#83	R5-192398	0573	1	F	Introduction of TC 9.1.5.2.4 Mobility registration update / The lower layer requests NAS signalling connection recovery	15.3.0
2019-03	RAN#83	R5-192399	0580	1	F	New 5GC test case 9.1.2.2	15.3.0
2019-03	RAN#83	R5-192700	0499	1	F	Addition of new 5GC TC 10.1.3.2	15.3.0
2019-03	RAN#83	R5-192701	0500	1	F	Addition of new 5GC TC 10.1.6.1	15.3.0
2019-03	RAN#83	R5-192702	0501	1	F	Addition of new 5GC TC 10.1.6.2	15.3.0
2019-03	RAN#83	R5-192703	0563	1	F	Addition of new 5GC TC 10.1.2.2	15.3.0
2019-03	RAN#83	R5-192749	0474	1	F	Addition of NR test case 6.1.2.2-Cell selection based on Qqualmin	15.3.0
2019-03	RAN#83	R5-192750	0432	1	F	Correcting test case 6.1.1.7	15.3.0
2019-03	RAN#83	R5-192751	0433	1	F	Updating test case 6.1.1.8	15.3.0
2019-03	RAN#83	R5-192754	0599	-	F	Addition of NR test case 6.1.2.1-Cell selection based on Qrxlevmin and Cell Reselection for Intra Frequency	15.3.0
2019-03	RAN#83	R5-192756	0600	-	F	Addition of NR test case 6.1.2.3-Cell selection-Serving cell bar	15.3.0
2019-03	RAN#83	R5-192757	0470	1	F	Addition of NR test case 6.1.1.2- PLMN selection of Other PLMN	15.3.0
2019-03	RAN#83	R5-192758	0471	1	F	Addition of NR test case 6.1.1.3-Cell reselection of ePLMN	15.3.0
2019-03	RAN#83	R5-192759	0473	1	F	Addition of NR test case 6.1.1.5-PLMN selection	15.3.0
2019-03	RAN#83	R5-192760	0477	1	F	Addition of NR test case 6.1.2.9-Cell Reselection using Qhyst, Qoffset and Treselection	15.3.0
2019-03	RAN#83	R5-192761	0478	1	F	Addition of NR test case 6.1.2.20-Inter-frequency cell reselection according to priority	15.3.0
2019-03	RAN#83	R5-192762	0509	1	F	Adding test case 6.2.1.2	15.3.0
2019-03	RAN#83	R5-192763	0510	1	F	Adding test case 6.2.1.1	15.3.0
2019-03	RAN#83	R5-192764	0511	1	F	Adding test case 6.2.1.3	15.3.0
2019-03	RAN#83	R5-192765	0512	1	F	Adding test case 6.2.1.4	15.3.0
2019-03	RAN#83	R5-192766	0513	1	F	Adding test case 6.2.1.5	15.3.0
2019-03	RAN#83	R5-192767	0592	1	F	Addition of Idle Mode test case 6.1.2.8	15.3.0
2019-03	RAN#83	R5-192768	0472	1	F	Addition of NR test case 6.1.1.4-PLMN selection in shared network environment	15.3.0
2019-03	RAN#83	R5-192769	0444	1	F	Correction to NR test case 7.1.1.1.3-SI request	15.3.0
2019-03	RAN#83	R5-192770	0585	1	F	Update to NR MAC Bandwidth Part operation TC 7.1.1.8.1	15.3.0
2019-03	RAN#83	R5-192771	0521	1	F	Correction to 5GS PDCP Test case 7.1.3.5.3 PDCP Data Recovery	15.3.0
2019-03	RAN#83	R5-192772	0450	1	F	Addition of NR test case 8.1.1.3.3-RRC connection release-Success-With priority information	15.3.0
2019-03	RAN#83	R5-192774	0453	1	F	Addition of NR test case 8.1.4.2.2.1-L2NR handover success	15.3.0
2019-03	RAN#83	R5-192776	0464	1	F	Addition of TC 8.1.3.2.1-Event B1 E-UTRA	15.3.0
2019-03	RAN#83	R5-192777	0465	1	F	Addition of TC 8.1.3.2.2-Event B2 E-UTRA	15.3.0
2019-03	RAN#83	R5-192782	0488	1	F	Addition of NR test case 8.1.3.1.11.1_intra-band Contiguous CA Event A6	15.3.0
2019-03	RAN#83	R5-192783	0489	1	F	Addition of NR test case 8.1.3.1.11.2_inter-band CA Event A6	15.3.0
2019-03	RAN#83	R5-192784	0490	1	F	Addition of NR test case 8.1.3.1.11.3_intra-band non Contiguous CA Event A6	15.3.0
2019-03	RAN#83	R5-192785	0491	1	F	Addition of NR test case 8.1.3.1.12.1_ Additional intra-band Contiguous CA	15.3.0
2019-03	RAN#83	R5-192786	0492	1	F	Addition of NR test case 8.1.3.1.12.2_ Additional inter-band CA	15.3.0

2019-03	RAN#83	R5-192787	0493	1	F	Addition of NR test case 8.1.3.1.12.3_ Additional intra-band non Contiguous CA	15.3.0
2019-03	RAN#83	R5-192794	0516	1	F	Addition of 5GS NR RRC test case 8.1.5.1.1	15.3.0
2019-03	RAN#83	R5-192795	0586	1	F	Addition of TC 8.1.4.2.1.1 Inter-RAT handover / From NR to E-UTRA	15.3.0
2019-03	RAN#83	R5-192796	0598	1	F	New RRC test case 8.1.5.2.2 SI change / Notification of BCCH modification / Short message for SI update in NR RRC_CONNECTED state	15.3.0
2019-03	RAN#83	R5-192798	0425	1	F	Update to EN-DC test case 8.2.3.7.1	15.3.0
2019-03	RAN#83	R5-192800	0435	1	F	Addition of 5GC test case 9.1.1.2	15.3.0
2019-03	RAN#83	R5-192801	0458	1	F	Addition of NR test case 9.1.1.6-Authentication abnormal	15.3.0
2019-03	RAN#83	R5-192802	0460	1	F	Addition of NR test case 9.1.6.1.2-T3521 timeout	15.3.0
2019-03	RAN#83	R5-192803	0461	1	F	Addition of NR test case 9.1.6.2.1-Network-initiated deregistration-deregistration for 3GPP access-reregistration required	15.3.0
2019-03	RAN#83	R5-192805	0463	1	F	Addition of NR test case 9.1.7.2-Service request for user data pending	15.3.0
2019-03	RAN#83	R5-192806	0568	1	F	Addition of new 5GC TC 9.1.5.2.2	15.3.0
2019-03	RAN#83	R5-192815	0567	1	F	Addition of new 5GC TC 9.1.2.1	15.3.0
2019-03	RAN#83	R5-192816	0569	1	F	Addition of 5GC Test case 10.1.5.1	15.3.0
2019-03	RAN#83	R5-192819	0576	2	F	Update of 5GS NR MAC test case 7.1.1.9.1	15.3.0
2019-03	RAN#83	R5-192824	0560	2	F	Addition of new 5GC TC 9.1.5.1.13	15.3.0
2019-03	RAN#83	R5-192829	0517	2	F	Update of 5GS NR RRC test case 8.2.1.1.1	15.3.0
2019-03	RAN#83	R5-192830	0595	2	F	Addition of 5GS PDCP TC 7.1.3.5.5	15.3.0
2019-03	RAN#83	R5-192838	0603	-	F	Addition of 5GS SA RRC TC - 8.1.3.1.13	15.3.0
2019-03	RAN#83	R5-192839	0604	-	F	Addition of 5GS SA RRC TC - 8.1.3.1.14	15.3.0
2019-03	RAN#83	R5-192852	0601	1	F	Addition of NR test case Event A4	15.3.0
2019-03	RAN#83	R5-192853	0602	1	F	Addition of NR test case Event A5	15.3.0
2019-03	RAN#83	R5-192854	0518	2	F	Update of 5GS NR RRC test case 8.2.3.6.1 and 8.2.3.8.1	15.3.0
2019-03	RAN#83	R5-192855	0462	2	F	Addition of NR test case 9.1.6.2.2-Reregistration not required	15.3.0
2019-03	RAN#83	-	-	-	-	Editorial update to align referenced to TS 38.508-1 table numbers	15.3.0
2019-06	RAN#84	R5-193861	0676	-	F	Correction to NR RLC test cases 7.1.2.2.3 and 7.1.2.2.4	15.4.0
2019-06	RAN#84	R5-193869	0677	-	F	Correction to 5GMM test case 9.1.5.2.4	15.4.0
2019-06	RAN#84	R5-193884	0681	-	F	Update of TC 9.1.5.1.13	15.4.0
2019-06	RAN#84	R5-193898	0687	-	F	Removal of TC 9.1.5.1.7	15.4.0
2019-06	RAN#84	R5-193984	0689	-	F	Clarification on DRB to use in MAC test cases	15.4.0
2019-06	RAN#84	R5-193986	0691	-	F	Clarification on DRB to use in RLC test cases	15.4.0
2019-06	RAN#84	R5-193987	0692	-	F	Correction to NR RLC test case 7.1.2.3.9	15.4.0
2019-06	RAN#84	R5-193988	0693	-	F	Clarification on DRB to use in PDCP test cases	15.4.0
2019-06	RAN#84	R5-194008	0698	-	F	Correction to EN-DC RRC test case 8.2.5.2.1	15.4.0
2019-06	RAN#84	R5-194031	0703	-	F	Correction to PDCP test case 7.1.3.5.1	15.4.0
2019-06	RAN#84	R5-194033	0705	-	F	Correction to 5GC NAS test case 9.1.8.1 - SMS over NAS / MO and MT SMS over NAS - Idle mode	15.4.0
2019-06	RAN#84	R5-194045	0713	-	F	Updates to 5GS SA RRC TC 8.1.1.4.1	15.4.0
2019-06	RAN#84	R5-194046	0714	-	F	Updates to 5GS SA RRC TC 8.1.5.2.1	15.4.0
2019-06	RAN#84	R5-194050	0718	-	F	Addition of 5GS SA RRC TC - Intra NR handover / Success / Security key reconfiguration	15.4.0
2019-06	RAN#84	R5-194051	0719	-	F	Addition of 5GS SA RRC TC - Intra NR handover / Failure / Security key reconfiguration	15.4.0
2019-06	RAN#84	R5-194119	0730	-	F	Correction to EN-DC RRC measurement test cases	15.4.0
2019-06	RAN#84	R5-194266	0735	-	F	Correction to EN-DC RRC test case 8.2.5.1.1	15.4.0
2019-06	RAN#84	R5-194288	0742	-	F	Correction to EN-DC RRC test case 8.2.5.3.1	15.4.0
2019-06	RAN#84	R5-194296	0745	-	F	Correction to RLC test case - AM RLC / RLC re-establishment procedure	15.4.0
2019-06	RAN#84	R5-194395	0751	-	F	Update of NR RRC TC 8.2.3.12.1	15.4.0
2019-06	RAN#84	R5-194396	0752	-	F	Addition of new RRC TC 8.1.5.6.5.1	15.4.0
2019-06	RAN#84	R5-194448	0759	-	F	Addition of new TC 9.1.5.1.6	15.4.0
2019-06	RAN#84	R5-194481	0764	-	F	Updates to 5GC NAS test case 9.1.2.2	15.4.0
2019-06	RAN#84	R5-194514	0776	-	F	Update of TC 9.1.5.2.4 Mobility registration update / The lower layer requests NAS signalling connection recovery	15.4.0
2019-06	RAN#84	R5-194637	0786	-	F	Update to TC 8.1.4.2.1.1	15.4.0
2019-06	RAN#84	R5-194696	0791	-	F	Correction to NR RLC test case 7.1.2.3.1	15.4.0
2019-06	RAN#84	R5-194699	0793	-	F	Correction to NR PDCP test case 7.1.3.5.2	15.4.0
2019-06	RAN#84	R5-194787	0795	-	F	Correction to NR test case 6.1.2.3-Cell selection-Serving cell	15.4.0

						bar	
2019-06	RAN#84	R5-194788	0796	-	F	Correction to NR test case 6.1.2.9-Cell reselection using Qhyst, Qoffset and Tselection	15.4.0
2019-06	RAN#84	R5-194792	0797	-	F	Update to IDLE mode test case 6.1.1.1	15.4.0
2019-06	RAN#84	R5-194819	0727	1	F	Correction to MAC test cases	15.4.0
2019-06	RAN#84	R5-194822	0629	1	F	Correction to NR test case 7.1.1.1.3-SI request	15.4.0
2019-06	RAN#84	R5-194823	0611	1	F	Addition of NR test case 6.1.2.12-Cell reselection CellReservedForOtherUse	15.4.0
2019-06	RAN#84	R5-194833	0628	1	F	Correction to NR test case 6.1.2.1-Cell selection Qrxlevmin	15.4.0
2019-06	RAN#84	R5-194834	0746	1	F	Editorial Corrections to Test Cases 6.3.1.1, 6.1.1.1, 6.1.2.7, 7.1.1.1.3, 8.1.1.3.1, 8.1.1.3.5, 9.1.5.2.4	15.4.0
2019-06	RAN#84	R5-194835	0747	1	F	Corrections to Test Case 6.3.1.1	15.4.0
2019-06	RAN#84	R5-194836	0726	1	F	Correction to EN-DC RLC test cases 7.1.2.2.1, 7.1.2.2.2, 7.1.2.3.1 and 7.1.2.3.2	15.4.0
2019-06	RAN#84	R5-194837	0704	1	F	Correction to PDCP test case 7.1.3.5.4 - PDCP reordering / Maximum re-ordering delay below t-Reordering / t-Reordering timer operations	15.4.0
2019-06	RAN#84	R5-194838	0711	1	F	Updates to 5GS SA RRC TC 8.1.1.1.1	15.4.0
2019-06	RAN#84	R5-194839	0712	1	F	Updates to 5GS SA RRC TC 8.1.1.2.3	15.4.0
2019-06	RAN#84	R5-194840	0734	1	F	Correction of 5GC Test case 8.1.1.3.5	15.4.0
2019-06	RAN#84	R5-194841	0641	1	F	Correction of NR test case 8.1.3.1.5-Intra Freq Event A4	15.4.0
2019-06	RAN#84	R5-194842	0642	1	F	Correction of NR test case 8.1.3.1.8-Intra Freq Event A5	15.4.0
2019-06	RAN#84	R5-194843	0717	1	F	Removal of EN-DC RRC TC - BandwidthPart Configuration / SCG	15.4.0
2019-06	RAN#84	R5-194844	0770	1	F	Update of 5GS NR RRC test case 8.2.1.1.1	15.4.0
2019-06	RAN#84	R5-194845	0657	1	F	Correction to NR test case 8.2.3.11.1-ENDC measurement gap FR1	15.4.0
2019-06	RAN#84	R5-194846	0658	1	F	Correction to NR test case 8.2.3.11.2-ENDC measurement gap FR2	15.4.0
2019-06	RAN#84	R5-194847	0661	1	F	Corrections to 5G-NR RRC Measurement configuration and reporting test cases	15.4.0
2019-06	RAN#84	R5-194848	0673	1	F	Correction to EN-DC RRC test case 8.2.3.6.1	15.4.0
2019-06	RAN#84	R5-194849	0674	1	F	Correction to EN-DC RRC test case 8.2.3.7.1	15.4.0
2019-06	RAN#84	R5-194850	0675	1	F	Correction to EN-DC RRC test case 8.2.3.3.1	15.4.0
2019-06	RAN#84	R5-194851	0740	1	F	Correction to EN-DC RRC test case 8.2.3.8.1	15.4.0
2019-06	RAN#84	R5-194853	0741	1	F	Correction to EN-DC RRC test case 8.2.3.4.1 and 8.2.3.5.1	15.4.0
2019-06	RAN#84	R5-194854	0749	1	F	Update TC 8.2.3.15.1	15.4.0
2019-06	RAN#84	R5-194855	0755	1	F	Correction to EN-DC RRC measurement test cases 8.2.3.9.1 and 8.2.3.10.1 Editor's note: could not be implemented	15.4.0
2019-06	RAN#84	R5-194856	0665	1	F	Update of RRC TC 8.2.5.4.1	15.4.0
2019-06	RAN#84	R5-194857	0679	1	F	Correction to 5GMM test case 9.1.2.1	15.4.0
2019-06	RAN#84	R5-194858	0756	1	F	Correction to NR5GC testcase 9.1.3.1	15.4.0
2019-06	RAN#84	R5-194859	0659	1	F	Correction to NR test case 9.1.5.1.1-Registration Request	15.4.0
2019-06	RAN#84	R5-194867	0668	1	F	Update of TC 9.1.6.1.1	15.4.0
2019-06	RAN#84	R5-194868	0758	1	F	Correction to NR5GC testcase 9.1.5.1.14	15.4.0
2019-06	RAN#84	R5-194869	0609	1	F	Correction to 5GC TC 9.1.7.1	15.4.0
2019-06	RAN#84	R5-194871	0610	1	F	Correction to 5GC TC 10.1.3.2	15.4.0
2019-06	RAN#84	R5-194872	0680	1	F	Correction on 5GC TC 10.1.2.2	15.4.0
2019-06	RAN#84	R5-194873	0607	1	F	Correction to 5GC TC 10.1.6.1	15.4.0
2019-06	RAN#84	R5-194874	0608	1	F	Correction to 5GC TC 10.1.6.2	15.4.0
2019-06	RAN#84	R5-194890	0728	1	F	Introduction of Non 3GPP Access over WLAN test cases	15.4.0
2019-06	RAN#84	R5-195208	0765	1	F	Addition of new TC 9.1.5.1.9	15.4.0
2019-06	RAN#84	R5-195209	0707	1	F	Addition of 5GC NAS Test Case - Generic UE configuration update / New 5G-GUTI / NITZ / registration requested / Network slicing indication / New Allowed NSSAI / acknowledgement from the UE	15.4.0
2019-06	RAN#84	R5-195210	0708	1	F	Addition of 5GC NAS Test Case - UE-initiated de-registration / Abnormal / Change of cell into a new tracking area	15.4.0
2019-06	RAN#84	R5-195211	0757	1	F	Addition of NR5GC testcase 9.1.5.1.2	15.4.0
2019-06	RAN#84	R5-195212	0774	1	F	Introduction of TC 9.1.5.2.7 Mobility and periodic registration update / Rejected / UE identity cannot be derived by the network	15.4.0
2019-06	RAN#84	R5-195213	0775	1	F	Introduction of TC 9.1.5.2.8 Mobility and periodic registration update / Rejected / Implicitly de-registered	15.4.0

2019-06	RAN#84	R5-195226	0794	1	F	Addition of 5GSM test case 10.1.1.2	15.4.0
2019-06	RAN#84	R5-195228	0777	1	F	Introduction of TC 9.3.1.1 Mobility registration update / Single-registration mode with N26 / 5GMM-IDLE / 5GC to EPC	15.4.0
2019-06	RAN#84	R5-195229	0778	1	F	Introduction of TC 9.3.1.2 Mobility registration update / Single-registration mode with N26 / 5GMM-IDLE / EPC to 5GC	15.4.0
2019-06	RAN#84	R5-195230	0779	1	F	Introduction of TC 9.3.1.3 Mobility and periodic registration update / Rejected / Single-registration mode with N26 / Handling of EPS relevant parameters	15.4.0
2019-06	RAN#84	R5-195231	0682	1	F	New multilayer test case 11.1.3	15.4.0
2019-06	RAN#84	R5-195238	0780	1	F	Introduction of new TC 11.1.7 Emergency call setup from NR RRC_IDLE / Emergency Services Fallback to EPS with redirection / Single registration mode with N26 interface / Success	15.4.0
2019-06	RAN#84	R5-195243	0616	1	F	Addition of NR test case 6.2.3.3-Inter-RAT Cell reselection NR2L by priority Srxlev based	15.4.0
2019-06	RAN#84	R5-195244	0612	1	F	Addition of NR test case 6.1.2.13-Cell reselection CellReservedForOperatorUse with Access Identity 1-2-12-13-14	15.4.0
2019-06	RAN#84	R5-195245	0613	1	F	Addition of NR test case 6.1.2.14-Cell reselection CellReservedForOperatorUse with Access Identity 11-15	15.4.0
2019-06	RAN#84	R5-195247	0618	1	F	Addition of NR test case 6.2.3.5-Inter-RAT Cell reselection NR2L by priority from dedicated signalling	15.4.0
2019-06	RAN#84	R5-195249	0620	1	F	Addition of NR test case 6.2.3.7-Inter-RAT Cell reselection NR2L Snointrasearch	15.4.0
2019-06	RAN#84	R5-195252	0623	1	F	Addition of NR test case 6.4.2.1-Cell selection Qrxlevmin and Cell reselection	15.4.0
2019-06	RAN#84	R5-195256	0627	1	F	Addition of NR test case 6.4.1.2-Cell reselection of ePLMN in manual mode	15.4.0
2019-06	RAN#84	R5-195257	0709	1	F	Addition of Idle Mode Test Case - Steering of UE in roaming during registration/security check successful but SOR Transparent container indicates ACK has been NOT been requested	15.4.0
2019-06	RAN#84	R5-195259	0631	1	F	Addition of NR test case 8.1.3.1.6-Inter Freq Event A4	15.4.0
2019-06	RAN#84	R5-195260	0632	1	F	Addition of NR test case 8.1.3.1.7-Inter Band Event A4	15.4.0
2019-06	RAN#84	R5-195261	0633	1	F	Addition of NR test case 8.1.3.1.9-Inter Freq Event A5	15.4.0
2019-06	RAN#84	R5-195262	0634	1	F	Addition of NR test case 8.1.3.1.10-Inter Band Event A5	15.4.0
2019-06	RAN#84	R5-195268	0640	1	F	Addition of NR test case 8.1.3.2.5-Event A2 and B2	15.4.0
2019-06	RAN#84	R5-195269	0643	1	F	Correction of NR test case 8.1.3.1.11-Two Event A3 RSRQ	15.4.0
2019-06	RAN#84	R5-195270	0644	1	F	Correction of NR test case 8.1.3.1.12-Two Event A5 SINR	15.4.0
2019-06	RAN#84	R5-195271	0645	1	F	Correction of NR test case 8.1.3.1.17.1-Intra Band Event A6	15.4.0
2019-06	RAN#84	R5-195272	0646	1	F	Correction of NR test case 8.1.3.1.17.2-Inter Band Event A6	15.4.0
2019-06	RAN#84	R5-195273	0647	1	F	Correction of NR test case 8.1.3.1.17.3-Intra Band non Contiguous Event A6	15.4.0
2019-06	RAN#84	R5-195274	0648	1	F	Correction of NR test case 8.1.3.1.18.1-Additional Reporting Intra Band	15.4.0
2019-06	RAN#84	R5-195275	0649	1	F	Correction of NR test case 8.1.3.1.18.2-Additional Reporting Inter Band	15.4.0
2019-06	RAN#84	R5-195276	0650	1	F	Correction of NR test case 8.1.3.1.18.3-Additional Reporting Intra Band non Contiguous	15.4.0
2019-06	RAN#84	R5-195277	0782	1	F	Addition of 5GS NR RRC test case 8.1.3.1.2	15.4.0
2019-06	RAN#84	R5-195278	0783	1	F	Addition of 5GS NR RRC test case 8.1.3.1.3	15.4.0
2019-06	RAN#84	R5-195279	0784	1	F	Addition of 5GS NR RRC test case 8.1.3.1.4	15.4.0
2019-06	RAN#84	R5-195280	0790	1	F	Addition of 5GS NR RRC test case for Intra NR measurements / Blacklisting	15.4.0
2019-06	RAN#84	R5-195285	0699	1	F	New 5GS SA RRC TC 8.1.4.1.9.1	15.4.0
2019-06	RAN#84	R5-195286	0700	1	F	New 5GS SA RRC TC 8.1.4.1.9.2	15.4.0
2019-06	RAN#84	R5-195287	0701	1	F	New 5GS SA RRC TC 8.1.4.1.9.3	15.4.0
2019-06	RAN#84	R5-195288	0724	1	F	Addition of 5GS SA RRC TC - Intra NR handover / Failure / Re-establishment successful	15.4.0
2019-06	RAN#84	R5-195289	0725	1	F	Addition of 5GS SA RRC TC - Intra NR handover / Failure / Re-establishment failure	15.4.0
2019-06	RAN#84	R5-195290	0731	1	F	Addition of Intra-NR intra-frequency handover test case 8.1.4.1.1	15.4.0
2019-06	RAN#84	R5-195291	0732	1	F	Addition of Intra-NR inter-frequency handover test case	15.4.0

						8.1.4.1.2	
2019-06	RAN#84	R5-195292	0720	1	F	Addition of 5GS SA RRC TC - Redirection to NR / From E-UTRA / Success	15.4.0
2019-06	RAN#84	R5-195293	0736	1	F	New 5G Radio link failure test case 8.1.5.6.1	15.4.0
2019-06	RAN#84	R5-195294	0753	1	F	Addition of new RRC TC 8.1.5.6.5.2	15.4.0
2019-06	RAN#84	R5-195295	0754	1	F	Addition of new RRC TC 8.1.5.6.5.3 Editor's note: could not be implemented	15.4.0
2019-06	RAN#84	R5-195296	0768	1	F	Addition of 5GS NR RRC test case 8.1.5.4.1	15.4.0
2019-06	RAN#84	R5-195297	0771	1	F	New 5G Radio link failure test case 8.1.5.6.2	15.4.0
2019-06	RAN#84	R5-195298	0772	1	F	New 5G Radio link failure test case 8.1.5.6.3	15.4.0
2019-06	RAN#84	R5-195299	0773	1	F	New 5G Radio link failure test case 8.1.5.6.4	15.4.0
2019-06	RAN#84	R5-195300	0696	1	F	Correction to RRC test case 8.2.3.13.1	15.4.0
2019-06	RAN#84	R5-195301	0697	1	F	Correction to RRC test case 8.2.3.14.1	15.4.0
2019-06	RAN#84	R5-195302	0722	1	F	Addition of new EN-DC RRC TC - Measurement configuration control and reporting / Event A4 / Measurement of Neighbour NR cell / Inter-frequency measurements / EN-DC	15.4.0
2019-06	RAN#84	R5-195303	0723	1	F	Addition of new EN-DC RRC TC - Measurement configuration control and reporting / Event A4 / Measurement of Neighbour NR cell / Inter-band measurements / EN-DC	15.4.0
2019-06	RAN#84	R5-195336	0690	1	F	Correction to NR MAC test case 7.1.1.1.1	15.4.0
2019-06	RAN#84	R5-195338	0694	1	F	Correction to NR PDCP test case 7.1.3.4.1	15.4.0
2019-06	RAN#84	R5-195339	0715	1	F	Updates to PDCP Integrity Protection TCs 7.1.3.2.x	15.4.0
2019-06	RAN#84	R5-195340	0716	1	F	Updates to PDCP Ciphering and Deciphering TCs 7.1.3.3.x	15.4.0
2019-06	RAN#84	R5-195341	0662	1	F	Update of RRC TC 8.1.1.4.2	15.4.0
2019-06	RAN#84	R5-195342	0743	1	F	Correction to RRC test case 8.1.2.1.3	15.4.0
2019-06	RAN#84	R5-195343	0744	1	F	Correction to 5GS SA RRC TC - 8.1.2.1.1	15.4.0
2019-06	RAN#84	R5-195344	0669	1	F	Correction of NR test case 8.1.3.1.1-Intra Freq Event A1 A2	15.4.0
2019-06	RAN#84	R5-195345	0670	1	F	Correction of NR test case 8.1.3.2.1-Event B1	15.4.0
2019-06	RAN#84	R5-195346	0671	1	F	Correction of NR test case 8.1.3.2.2-Event B2	15.4.0
2019-06	RAN#84	R5-195347	0672	1	F	Correction of NR test case 8.1.3.2.3-Event B2 RSRQ	15.4.0
2019-06	RAN#84	R5-195350	0667	1	F	Update of 5GC TC 9.1.5.1.5	15.4.0
2019-06	RAN#84	R5-195351	0688	1	F	New multilayer test case 11.1.4	15.4.0
2019-06	RAN#84	R5-195352	0683	1	F	Addition of Multilayer test case 11.1.2	15.4.0
2019-06	RAN#84	R5-195353	0684	1	F	Addition of Multilayer test case 11.1.5	15.4.0
2019-06	RAN#84	R5-195354	0685	1	F	Addition of Multilayer test case 11.1.6	15.4.0
2019-06	RAN#84	R5-195355	0710	1	F	Addition of 5GS Multilayer Test Case 11.1.1 MO MMTEL voice call setup from NR RRC_IDLE / EPS Fallback with redirection / Single registration mode with N26 interface / Success	15.4.0
2019-06	RAN#84	R5-195358	0798	1	F	Update of EN-DC RRC TC 8.2.3.2.1	15.4.0
2019-06	RAN#84	R5-195363	0781	2	F	Update to NR MAC Bandwidth Part operation TC 7.1.1.8.1	15.4.0
2019-06	RAN#84	R5-195364	0695	2	F	Correction to NR PDCP test case 7.1.3.4.2	15.4.0
2019-06	RAN#84	R5-195365	0785	2	F	Addition of 5GS NR RRC test case 8.2.3.6.1a	15.4.0
2019-06	RAN#84	R5-195366	0787	2	F	Addition of 5GS NR RRC test case 8.2.3.6.1b	15.4.0
2019-06	RAN#84	R5-195367	0788	2	F	Addition of 5GS NR RRC test case 8.2.3.8.1a	15.4.0
2019-06	RAN#84	R5-195368	0789	2	F	Addition of 5GS NR RRC test case 8.2.3.8.1b	15.4.0
2019-06	RAN#84	R5-195369	0799	2	F	Correction to EN-DC RRC Measurement test cases for FR2 Power table	15.4.0
2019-06	RAN#84	R5-195370	0666	2	F	Update of 5GC TC 9.1.6.1.2	15.4.0
2019-06	RAN#84	-	-	-	-	Administrative release upgrade to match the release of 3GPP TS 38.508-1 which was upgraded at RAN#84 to Rel-16 due to Rel-16 relevant CR(s)	16.0.0
2019-09	RAN#85	R5-195649	0810	-	F	Addition of NR test case 6.4.1.1-HPLMN in Automatic PLMN Selection Mode in RRC_INACTIVE state	16.1.0
2019-09	RAN#85	R5-195650	0811	-	F	Addition of NR test case 6.4.2.2-Inter-Freq Cell reselection by priority of SIBs	16.1.0
2019-09	RAN#85	R5-195663	0824	-	F	Addition of NR test case 8.1.4.1.7.2-PCell Change and SCell addition Inter-band CA	16.1.0
2019-09	RAN#85	R5-195664	0825	-	F	Addition of NR test case 8.1.4.1.7.3-PCell Change and SCell addition Intra-band non-contiguous CA	16.1.0
2019-09	RAN#85	R5-195666	0827	-	F	Addition of NR test case 8.1.4.1.8.2-SCell no change Inter-band CA	16.1.0
2019-09	RAN#85	R5-195667	0828	-	F	Addition of NR test case 8.1.4.1.8.3-SCell no change Intra-band non-contiguous CA	16.1.0

2019-09	RAN#85	R5-195676	0837	-	F	Correction to NR test case 8.1.5.3.1-PWS reception in NR RRC_IDLE state	16.1.0
2019-09	RAN#85	R5-195677	0838	-	F	Correction to NR test case 8.1.5.3.3-PWS reception in NR RRC_CONNECTED state	16.1.0
2019-09	RAN#85	R5-195681	0842	-	F	Correction to NR test case 9.1.5.1.10-PLMN not allowed	16.1.0
2019-09	RAN#85	R5-195712	0850	-	F	Update to RRC measurement test cases in EN-DC for FR2 support	16.1.0
2019-09	RAN#85	R5-195929	0863	-	F	Update to PDCP test cases in EN-DC for FR2 support	16.1.0
2019-09	RAN#85	R5-195947	0870	-	F	Correction to references to test procedure for Switch off / Power off UE	16.1.0
2019-09	RAN#85	R5-195948	0871	-	F	Correction of power level units for test case 7.1.1.7.1	16.1.0
2019-09	RAN#85	R5-195949	0872	-	F	Correction of power level units for test cases 8.1.3.1.11, 8.1.3.1.12, 8.1.3.1.15A, 8.1.3.2.3	16.1.0
2019-09	RAN#85	R5-195981	0876	-	F	Correction to 5GC TC 10.1.6.1	16.1.0
2019-09	RAN#85	R5-195996	0878	-	F	Update PDCP test case 7.1.3.2.1	16.1.0
2019-09	RAN#85	R5-195997	0879	-	F	Update PDCP test case 7.1.3.3.1	16.1.0
2019-09	RAN#85	R5-196002	0884	-	F	Update RRC measurement test case 8.2.3.14	16.1.0
2019-09	RAN#85	R5-196039	0889	-	F	Addition of new 5GC TC 10.1.2.1	16.1.0
2019-09	RAN#85	R5-196046	0895	-	F	Correction to 5GC TC 8.1.5.1.1	16.1.0
2019-09	RAN#85	R5-196055	0902	-	F	Correction to TC 9.1.7.1-Service Request in Idle state	16.1.0
2019-09	RAN#85	R5-196093	0919	-	F	Correction to RLC test case 7.1.2.3.11	16.1.0
2019-09	RAN#85	R5-196109	0930	-	F	To void TC 8.1.1.3.5	16.1.0
2019-09	RAN#85	R5-196110	0931	-	F	To void TC 8.1.1.3.6	16.1.0
2019-09	RAN#85	R5-196111	0932	-	F	To void TC 8.1.1.4.3	16.1.0
2019-09	RAN#85	R5-196112	0933	-	F	To void TC 8.1.4.1.3	16.1.0
2019-09	RAN#85	R5-196113	0934	-	F	To void TC 8.1.4.1.4	16.1.0
2019-09	RAN#85	R5-196114	0935	-	F	Correction to EN-DC RRC TCs 8.2.2.4.1 & 8.2.2.5.1	16.1.0
2019-09	RAN#85	R5-196118	0939	-	F	Updates to EN-DC RRC TC 8.2.3.7.1a	16.1.0
2019-09	RAN#85	R5-196119	0940	-	F	Updates to EN-DC RRC TC 8.2.3.7.1b	16.1.0
2019-09	RAN#85	R5-196156	0947	-	F	Correction to NR Idle test case 6.1.1.6	16.1.0
2019-09	RAN#85	R5-196217	0954	-	F	Update of NR test case 6.1.2.2-Intra-NR Cell Selection Qqualmin based	16.1.0
2019-09	RAN#85	R5-196218	0955	-	F	Update of NR test case 6.1.2.21-Cell reselection, SIntraSearchQ and SnonIntraSeqrchQ	16.1.0
2019-09	RAN#85	R5-196261	0962	-	F	Correction to NR test case 7.1.3.4.1 - PDCP Lossless handover	16.1.0
2019-09	RAN#85	R5-196285	0964	-	F	Correction to EN-DC RRC test case 8.2.5.3.1	16.1.0
2019-09	RAN#85	R5-196306	0969	-	F	Removal of NR RRC test case 8.1.2.1.3	16.1.0
2019-09	RAN#85	R5-196353	0971	-	F	Correction to test cases 6.1.1.8	16.1.0
2019-09	RAN#85	R5-196354	0972	-	F	Update sub-clause 6.2.1 test cases with the latest generic procedure references	16.1.0
2019-09	RAN#85	R5-196355	0973	-	F	Update to test case 9.1.5.1.5	16.1.0
2019-09	RAN#85	R5-196489	0976	-	F	Update of RRC TC 8.1.5.6.5.2	16.1.0
2019-09	RAN#85	R5-196492	0977	-	F	New RRC TC 8.1.5.6.5.3	16.1.0
2019-09	RAN#85	R5-196598	0982	-	F	Correction to Idle TC 6.1.1.3	16.1.0
2019-09	RAN#85	R5-196610	0985	-	F	Correction to Idle TC 6.1.2.8	16.1.0
2019-09	RAN#85	R5-196614	0988	-	F	Deletion of TC 8.1.4.1.1	16.1.0
2019-09	RAN#85	R5-196624	0991	-	F	Correction to RLC TC 7.1.2.2.5 and 7.1.2.2.6	16.1.0
2019-09	RAN#85	R5-196633	0995	-	F	Correction to 5GC TC 9.1.6.1.4	16.1.0
2019-09	RAN#85	R5-196642	0996	-	F	Adding specs to TS 38.523-1 References section	16.1.0
2019-09	RAN#85	R5-196730	1009	-	F	Update of test case 9.3.1.1 Mobility registration update / Single-registration mode with N26 / 5GMM-IDLE / 5GC to EPC	16.1.0
2019-09	RAN#85	R5-196731	1010	-	F	Update of test case 9.3.1.2 Mobility registration update / Single-registration mode with N26 / 5GMM-IDLE / EPC to 5GC	16.1.0
2019-09	RAN#85	R5-196732	1011	-	F	Update of test case 9.3.1.3 Mobility and periodic registration update / Rejected / Single-registration mode with N26 / Handling of EPC relevant parameters	16.1.0
2019-09	RAN#85	R5-196745	1013	-	F	Correction to pre-condition of MAC test cases	16.1.0
2019-09	RAN#85	R5-196753	1019	-	F	Correction to ENDC test case 7.1.2.2.6	16.1.0
2019-09	RAN#85	R5-196755	1020	-	F	Correction to NR5GC test case 9.1.5.2.8	16.1.0
2019-09	RAN#85	R5-196779	1029	-	F	Update to TC 8.1.3.1.15A	16.1.0
2019-09	RAN#85	R5-196827	1031	-	F	Removal of Radio Link Failure test cases	16.1.0
2019-09	RAN#85	R5-196828	1032	-	F	Editorial changes to SERVICE REQUEST parameters for	16.1.0

						multi layer test cases	
2019-09	RAN#85	R5-196835	1036	-	F	Update to 5GS NR RRC test case 8.1.5.4.1	16.1.0
2019-09	RAN#85	R5-197001	0941	1	F	Correction of NR test case 7.1.1.3.3	16.1.0
2019-09	RAN#85	R5-197002	0943	1	F	Correction to test case 7.1.1.3.4	16.1.0
2019-09	RAN#85	R5-197003	0944	1	F	Correction to test case 7.1.1.3.5	16.1.0
2019-09	RAN#85	R5-197005	0905	1	F	Correction to test case 8.1.1.4.2	16.1.0
2019-09	RAN#85	R5-197006	0914	1	F	Correction to ENDC test case 10.2.2.1	16.1.0
2019-09	RAN#85	R5-197007	0983	1	F	Correction to RLC AM test case 7.1.2.3.9	16.1.0
2019-09	RAN#85	R5-197008	0953	1	F	Correction to RLC test case 7.1.2.3.10 in EN-DC	16.1.0
2019-09	RAN#85	R5-197011	1026	1	F	Correction to ENDC test case 7.1.2.3.5	16.1.0
2019-09	RAN#85	R5-197012	0918	1	F	Correction to PDCP test case 7.1.3.2.1	16.1.0
2019-09	RAN#85	R5-197013	1002	1	F	Correction to NR PDCP test case 7.1.3.4.2	16.1.0
2019-09	RAN#85	R5-197015	0904	1	F	Updates to EN-DC RRC measurement test case 8.2.3.3.1	16.1.0
2019-09	RAN#85	R5-197016	1012	1	F	Correction to EN-DC RRC test case 8.2.3.4.1 and 8.2.3.7.1	16.1.0
2019-09	RAN#85	R5-197017	0865	1	F	Update to NR RRC Idle mode test cases for FR2 support	16.1.0
2019-09	RAN#85	R5-197018	0864	1	F	Update to CA test cases in EN-DC for FR2 support	16.1.0
2019-09	RAN#85	R5-197019	0897	1	F	Correction to NR test case 6.1.2.1-cell selection	16.1.0
2019-09	RAN#85	R5-197020	0898	1	F	Correction to NR test case 6.1.2.13-Cell reselection CellReservedForOperatorUse with Access Identity 0-1-2-12-13-14	16.1.0
2019-09	RAN#85	R5-197021	0814	1	F	Correction to NR test case 7.1.1.1.4-BeamFailure	16.1.0
2019-09	RAN#85	R5-197022	0899	1	F	Correction to TC 7.1.1.3.5-Padding BSR	16.1.0
2019-09	RAN#85	R5-197023	0961	1	F	Correction to NR test case 7.1.1.9.1 - MAC Reset	16.1.0
2019-09	RAN#85	R5-197026	0978	1	F	Correction to Several MAC test cases	16.1.0
2019-09	RAN#85	R5-197027	0990	1	F	Correction to MAC TC 7.1.1.1.3	16.1.0
2019-09	RAN#85	R5-197029	0911	1	F	Correction to 5GS RLC test case 7.1.2.3.6	16.1.0
2019-09	RAN#85	R5-197030	0974	1	F	Correction to RLC test case 7.1.2.3.7	16.1.0
2019-09	RAN#85	R5-197051	0949	1	F	Updates to 5GS PDCP test cases 7.1.3.1.1 and 7.1.3.1.2	16.1.0
2019-09	RAN#85	R5-197052	0901	1	F	Correction to TC 8.1.1.3.4-NR2L reselection by RRCRelease	16.1.0
2019-09	RAN#85	R5-197053	0927	1	F	Updates to 5GS SA RRC TC 8.1.1.4.1	16.1.0
2019-09	RAN#85	R5-197054	0956	1	F	Correction to TC 8.1.1.2.1-T300 expiry	16.1.0
2019-09	RAN#85	R5-197055	0957	1	F	Correction to TC 8.1.1.3.3-T320 expiry	16.1.0
2019-09	RAN#85	R5-197057	0968	1	F	Correction to NR RRC Test case 8.1.2.1.1	16.1.0
2019-09	RAN#85	R5-197058	0832	1	F	Correction to NR test case 8.1.3.1.11-two RSRQ A3	16.1.0
2019-09	RAN#85	R5-197059	0833	1	F	Correction to NR test case 8.1.3.1.12-two SINR A5	16.1.0
2019-09	RAN#85	R5-197060	0834	1	F	Correction to NR test case 8.1.3.1.17.3-A6 intraband non contiguous	16.1.0
2019-09	RAN#85	R5-197061	0835	1	F	Correction to NR test case 8.1.3.1.18.3-A6 intraband non contiguous additional reporting	16.1.0
2019-09	RAN#85	R5-197062	0836	1	F	Correction to NR test case 8.1.3.2.5-A2 and B2	16.1.0
2019-09	RAN#85	R5-197063	0861	1	F	Editorial update MeasurementReport table	16.1.0
2019-09	RAN#85	R5-197064	1028	1	F	Correction to RRC TC 8.1.3.1.11, 8.1.3.1.12, 8.1.3.2.3 and 8.1.4.1.9.1	16.1.0
2019-09	RAN#85	R5-197065	0928	1	F	Updates to 5GS SA RRC TC 8.1.5.2.1	16.1.0
2019-09	RAN#85	R5-197066	0929	1	F	Updates to 5GS SA RRC TC 8.1.5.5.1	16.1.0
2019-09	RAN#85	R5-197067	1033	1	F	Updates to RLF test case 8.1.5.6.1	16.1.0
2019-09	RAN#85	R5-197068	1034	1	F	Updates to RLF test case 8.1.5.6.3	16.1.0
2019-09	RAN#85	R5-197070	1001	1	F	Correction to EN-DC RRC test case 8.2.1.1.1	16.1.0
2019-09	RAN#85	R5-197071	1003	1	F	Correction to EN-DC RRC test case 8.2.2.7.1	16.1.0
2019-09	RAN#85	R5-197072	0839	1	F	Correction to NR test case 8.2.3.15.1-A2 and A3	16.1.0
2019-09	RAN#85	R5-197073	0873	1	F	Correction to EN-DC RRC measurement test case 8.2.3.9.1	16.1.0
2019-09	RAN#85	R5-197074	1030	1	F	Correction to EN-DC RRC measurement test case 8.2.3.10.1	16.1.0
2019-09	RAN#85	R5-197075	0948	1	F	Correction to EN-DC RRC test case 8.2.4.3.1.1	16.1.0
2019-09	RAN#85	R5-197076	1035	1	F	Updates to test cases using SERVICE REQUEST procedure	16.1.0
2019-09	RAN#85	R5-197077	0840	1	F	Correction to NR test case 9.1.1.6-5G AKA authentication abnormal	16.1.0
2019-09	RAN#85	R5-197078	0993	1	F	Correction to 5GC TC 9.1.2.2	16.1.0
2019-09	RAN#85	R5-197079	0841	1	F	Correction to NR test case 9.1.5.1.1-Initial registration	16.1.0
2019-09	RAN#85	R5-197080	0843	1	F	Correction to NR test case 9.1.5.2.4-Mobility registration update by lower layer failure	16.1.0
2019-09	RAN#85	R5-197081	0896	1	F	Correction to 5GC TC 9.1.5.1.9	16.1.0
2019-09	RAN#85	R5-197082	0920	1	F	Correction to 5GC NAS test case 9.1.6.1.3	16.1.0
2019-09	RAN#85	R5-197083	0945	1	F	Update of 5GC TC 9.1.5.1.11	16.1.0
2019-09	RAN#85	R5-197084	0946	1	F	Update of 5GC TC 9.1.5.1.12	16.1.0

2019-09	RAN#85	R5-197085	0965	1	F	Correction to NR5GC testcase 9.1.5.1.2	16.1.0
2019-09	RAN#85	R5-197086	0966	1	F	Correction to NR5GC testcase 9.1.5.1.14	16.1.0
2019-09	RAN#85	R5-197087	0981	1	F	Correction to 5GC test case 9.1.6.1.1 De-registration	16.1.0
2019-09	RAN#85	R5-197088	0844	1	F	Correction to NR test case 9.1.7.2-Data pending without user-plane resource	16.1.0
2019-09	RAN#85	R5-197089	0924	1	F	Corrections to 5GS Multilayer Test Case 11.1.1	16.1.0
2019-09	RAN#85	R5-197090	0975	1	F	Correction to 5GS\EPS Fallback test case 11.1.3	16.1.0
2019-09	RAN#85	R5-197091	0997	1	F	Update of 5GS\EPS Fallback test cases for System information, type of cells and more	16.1.0
2019-09	RAN#85	R5-197092	1007	1	F	Correction to 5GS\EPS Fallback test case 11.1.4	16.1.0
2019-09	RAN#85	R5-197093	1015	1	F	Update multi-layer test case 11.1.2	16.1.0
2019-09	RAN#85	R5-197094	1016	1	F	Update multi-layer test case 11.1.5	16.1.0
2019-09	RAN#85	R5-197095	1017	1	F	Update multi-layer test case 11.1.6	16.1.0
2019-09	RAN#85	R5-197097	1039	-	F	Correction to NR test case 8.1.5.3.4-PWS reception using dedicatedSystemInformationDelivery	16.1.0
2019-09	RAN#85	R5-197185	0804	1	F	Addition of NR test case 6.2.3.1-Inter-RAT Cell reselection L2NR by priority Srxlev based	16.1.0
2019-09	RAN#85	R5-197186	0805	1	F	Addition of NR test case 6.2.3.2-Inter-RAT Cell reselection L2NR by priority Squal based	16.1.0
2019-09	RAN#85	R5-197187	0806	1	F	Addition of NR test case 6.2.3.4-Inter-RAT Cell reselection NR2L by priority Squal based	16.1.0
2019-09	RAN#85	R5-197188	0807	1	F	Addition of NR test case 6.2.3.6-Inter-RAT Cell reselection L2NR by priority from dedicated signalling	16.1.0
2019-09	RAN#85	R5-197189	0808	1	F	Addition of NR test case 6.2.3.8-Inter-RAT Cell reselection L2NR Snonintrasearch	16.1.0
2019-09	RAN#85	R5-197190	0809	1	F	Addition of NR test case 6.2.3.9-Inter-RAT Cell reselection NR2L Speed Dependent	16.1.0
2019-09	RAN#85	R5-197191	0812	1	F	Addition of NR test case 6.4.3.1-Inter-RAT Cell reselection NR2L Srxlev based	16.1.0
2019-09	RAN#85	R5-197192	1043	-	F	Correction to UE capability transfer test case 8.1.5.1.1	16.1.0
2019-09	RAN#85	R5-197193	0813	1	F	Update of NR test case 6.1.2.22-Inter-frequency cell reselection with parameters	16.1.0
2019-09	RAN#85	R5-197195	0846	1	F	Addition of test case 6.3.1.3 of TS 38.523-1	16.1.0
2019-09	RAN#85	R5-197196	0847	1	F	Addition of test case 6.3.1.4 of TS 38.523-1	16.1.0
2019-09	RAN#85	R5-197197	0848	1	F	Addition of test case 6.3.1.8 of TS 38.523-1	16.1.0
2019-09	RAN#85	R5-197198	0849	1	F	Addition of test case 6.3.1.9 of TS 38.523-1	16.1.0
2019-09	RAN#85	R5-197199	0893	1	F	Addition of NR Idle test case 6.1.2.23 - Cell reselection/MFBI	16.1.0
2019-09	RAN#85	R5-197201	1014	1	F	Update of 5GC test case 9.1.1.2	16.1.0
2019-09	RAN#85	R5-197202	1038	1	F	Addition of new NR MAC test case 7.1.1.3.2b	16.1.0
2019-09	RAN#85	R5-197203	0923	1	F	Addition of Idle Mode Test Case -Cell reselection, Sintrasearch, Snonintrasearch	16.1.0
2019-09	RAN#85	R5-197205	0866	1	F	Add RRC reconfiguration test case 8.1.2.1.4	16.1.0
2019-09	RAN#85	R5-197206	0867	1	F	Add RRC reconfiguration test case 8.1.2.1.5.1	16.1.0
2019-09	RAN#85	R5-197207	0868	1	F	Add RRC reconfiguration test case 8.1.2.1.5.2	16.1.0
2019-09	RAN#85	R5-197208	0869	1	F	Add RRC reconfiguration test case 8.1.2.1.5.3	16.1.0
2019-09	RAN#85	R5-197209	0817	1	F	Addition of NR test case 8.1.3.1.16-whitelisting	16.1.0
2019-09	RAN#85	R5-197210	0818	1	F	Addition of NR test case 8.1.3.1.20-GapFR1	16.1.0
2019-09	RAN#85	R5-197211	0819	1	F	Addition of NR test case 8.1.3.1.21-GapFR2	16.1.0
2019-09	RAN#85	R5-197213	0822	1	F	Addition of NR test case 8.1.3.2.4-Event B2 SINR	16.1.0
2019-09	RAN#85	R5-197214	0984	1	F	Addition of SA NR measurement test case TC 8.1.3.1.23	16.1.0
2019-09	RAN#85	R5-197215	0823	1	F	Addition of NR test case 8.1.4.1.7.1-PCell Change and SCell addition Intra-band Contiguous CA	16.1.0
2019-09	RAN#85	R5-197216	0826	1	F	Addition of NR test case 8.1.4.1.8.1-SCell no change Intra-band Contiguous CA	16.1.0
2019-09	RAN#85	R5-197217	0894	1	F	Addition of 5GC test case 9.1.1.4	16.1.0
2019-09	RAN#85	R5-197218	0887	1	F	Addition of new 5GC TC 10.1.3.1	16.1.0
2019-09	RAN#85	R5-197219	0998	1	F	Introduction of new TC 11.4.1 5GMM-REGISTERED.NORMAL-SERVICE / 5GMM-IDLE / Emergency call / Utilising emergency number stored on the USIM / New emergency PDU session	16.1.0
2019-09	RAN#85	R5-197220	0999	1	F	Introduction of new TC 11.4.2 5GMM-DEREGISTERED.LIMITED-SERVICE / Emergency call / Handling of forbidden PLMNs	16.1.0
2019-09	RAN#85	R5-197221	1000	1	F	Introduction of new TC 11.4.3 5GMM-DEREGISTERED.NO-	16.1.0

						SUPI / Emergency call / Utilisation of emergency numbers stored on the ME / Initial registration for emergency services	
2019-09	RAN#85	R5-197227	0979	1	F	Non 3GPP Access over WLAN test cases	16.1.0
2019-09	RAN#85	R5-197247	0877	1	F	Update MAC test case 7.1.1.1	16.1.0
2019-09	RAN#85	R5-197250	0989	1	F	Correction to RLC UM test case 7.1.2.2.5	16.1.0
2019-09	RAN#85	R5-197255	0938	1	F	Correction to PDCP TC 7.1.3.5.3	16.1.0
2019-09	RAN#85	R5-197256	0986	1	F	Corrections to TC 8.1.4.1.2	16.1.0
2019-09	RAN#85	R5-197258	1023	1	F	Correction to test cases 8.1.1.2.3	16.1.0
2019-09	RAN#85	R5-197259	0917	1	F	Correction to test case 10.1.5.1	16.1.0
2019-09	RAN#85	R5-197260	0880	1	F	Update PDCP test case 7.1.3.4.1	16.1.0
2019-09	RAN#85	R5-197263	0915	2	F	Correction to NR test case 7.1.1.2.1	16.1.0
2019-09	RAN#85	R5-197264	0916	2	F	Correction to NR test case 7.1.1.3.1	16.1.0
2019-09	RAN#85	R5-197266	1027	1	F	Correction to test case 7.1.2.3.8	16.1.0
2019-09	RAN#85	R5-197267	0922	1	F	Initial registration / 5GS services / NSSAI handling / NSSAI Storage	16.1.0
2019-09	RAN#85	R5-197292	1044	-	F	Update of 5GC test case 9.1.1.1	16.1.0
2019-09	RAN#85	R5-197297	1045	-	F	Update of 5GC test case 9.1.1.3	16.1.0
2019-09	RAN#85	R5-197299	1005	2	F	Correction to NR MAC test case 7.1.1.3.2	16.1.0
2019-09	RAN#85	R5-197661	1037	1	F	Update to NR MAC Bandwidth Part operation TC 7.1.1.8.1	16.1.0
2019-09	RAN#85	R5-197662	1042	1	F	Corrections to NR MAC test case 7.1.1.1.1a	16.1.0
2019-09	RAN#85	R5-197663	0900	2	F	Correction to TC 7.1.2.3.4-18 bit SN processing	16.1.0
2019-09	RAN#85	R5-197664	1022	3	F	Correction to ENDC test case 7.1.2.3.3	16.1.0
2019-09	RAN#85	R5-197665	1041	1	F	Correction to EN-DC RRC Test case 8.2.3.13.1	16.1.0
2019-09	RAN#85	R5-197666	1040	1	F	Correction to NR test case 9.1.3.1-Identification procedure	16.1.0
2019-12	RAN#86	R5-197740	1046	-	F	Update RRC reconfiguration test case 8.1.2.1.4	16.2.0
2019-12	RAN#86	R5-197741	1047	-	F	Update RRC reconfiguration test case 8.1.2.1.5.1	16.2.0
2019-12	RAN#86	R5-197744	1049	-	F	Update RRC reconfiguration test case 8.1.3.1.18.1	16.2.0
2019-12	RAN#86	R5-197745	1050	-	F	Update RRC reconfiguration test case 8.1.5.6.5.1	16.2.0
2019-12	RAN#86	R5-197838	1054	-	F	Update of TC 6.4.1.1-HPLMN in Automatic PLMN Selection Mode	16.2.0
2019-12	RAN#86	R5-197839	1055	-	F	Correction to NR test case 6.1.2.14-Cell reselection CellReservedForOperatorUse with Access Identity 11 or 15	16.2.0
2019-12	RAN#86	R5-197840	1056	-	F	Correction of NR test case 6.2.3.2-Inter-RAT cell reselection from L2NR	16.2.0
2019-12	RAN#86	R5-197841	1057	-	F	Correction of NR test case 6.2.3.4-Inter-RAT cell reselection from NR2L	16.2.0
2019-12	RAN#86	R5-197842	1058	-	F	Correction of NR test case 6.2.3.5-Inter-RAT cell reselection from N2L by dedicated signalling	16.2.0
2019-12	RAN#86	R5-197843	1059	-	F	Correction of NR test case 6.2.3.6-Inter-RAT cell reselection from L2N by dedicated signalling	16.2.0
2019-12	RAN#86	R5-197849	1065	-	F	Correction to NR test case 7.1.2.3.5-Control of receive window for AM RLC	16.2.0
2019-12	RAN#86	R5-197854	1070	-	F	Correction of NR test case 8.1.3.1.2 - Event A3 intra-Freq	16.2.0
2019-12	RAN#86	R5-197856	1072	-	F	Correction to NR TC 8.1.3.1.8-Event A5 Intra-Freq	16.2.0
2019-12	RAN#86	R5-197860	1076	-	F	Correction to NR test case 8.1.5.3.1-PWS reception in NR RRC_IDLE state	16.2.0
2019-12	RAN#86	R5-197867	1083	-	F	Correction to NR test case 9.1.6.2.2-Re-registration not required	16.2.0
2019-12	RAN#86	R5-197904	1089	-	F	Correction to NR MAC test case 7.1.1.3.5 to accommodate the DCI format change to DCI_0_1	16.2.0
2019-12	RAN#86	R5-198006	1099	-	F	Addition of new 5GC test case 9.1.2.3	16.2.0
2019-12	RAN#86	R5-198085	1110	-	F	Update of References in 38.523-1	16.2.0
2019-12	RAN#86	R5-198086	1111	-	F	Introduction of new TC 9.1.5.2.6 Mobility registration update / Registered slice(s) change	16.2.0
2019-12	RAN#86	R5-198147	1127	-	F	Updates to 5GMM test case 9.1.4.1 for NAS cells definition in pre-test conditions	16.2.0
2019-12	RAN#86	R5-198148	1128	-	F	Updates to 5GMM initial registration test cases for NAS cells definition in pre-test conditions	16.2.0
2019-12	RAN#86	R5-198180	1130	-	F	Correction to PDCP Test Case 7.1.3.5.3	16.2.0
2019-12	RAN#86	R5-198181	1131	-	F	Correction to EN-DC Inter-RAT Measurement Test Cases 8.2.3.1.1, 8.2.3.2.1, 8.2.3.3.1, 8.2.3.12.1	16.2.0
2019-12	RAN#86	R5-198184	1134	-	F	Corrections to 5GC NAS Test Case 10.1.1.1	16.2.0
2019-12	RAN#86	R5-198185	1135	-	F	Corrections to 5GC NAS Test Case 9.1.6.1.3	16.2.0
2019-12	RAN#86	R5-198186	1136	-	F	Corrections to 5GC NAS Test Case 9.1.4.1	16.2.0
2019-12	RAN#86	R5-198187	1137	-	F	Correction to RLC Test Case 7.1.2.3.5	16.2.0

2019-12	RAN#86	R5-198188	1138	-	F	Correction to RLC Test Case 7.1.2.3.11	16.2.0
2019-12	RAN#86	R5-198189	1139	-	F	Correction to 5GC NAS NSSAI Test Case 9.1.5.1.3a	16.2.0
2019-12	RAN#86	R5-198216	1149	-	F	Correction to TC 7.1.1.1.2	16.2.0
2019-12	RAN#86	R5-198235	1151	-	F	Correction to 5GC test case 9.1.1.1	16.2.0
2019-12	RAN#86	R5-198242	1153	-	F	Correction to 5GC test case 9.1.1.2	16.2.0
2019-12	RAN#86	R5-198299	1164	-	F	Correction to NR TC 9.1.5.1.9	16.2.0
2019-12	RAN#86	R5-198322	1166	-	F	Corrections to 5GC test case 10.1.1.2	16.2.0
2019-12	RAN#86	R5-198323	1167	-	F	Correction to NR MAC test case 7.1.1.1.2	16.2.0
2019-12	RAN#86	R5-198325	1168	-	F	Correction to 5GC test case 9.1.5.1.6	16.2.0
2019-12	RAN#86	R5-198331	1169	-	F	Correction to NR MAC test cases 7.1.1.2.1 and 7.1.1.3.1	16.2.0
2019-12	RAN#86	R5-198355	1174	-	F	Correction to ENDC RLC AM testcases 7.1.2.3.1 and 7.1.2.3.2	16.2.0
2019-12	RAN#86	R5-198361	1176	-	F	Update to test case 10.2.1.1 to align EPS bearer ID description	16.2.0
2019-12	RAN#86	R5-198362	1177	-	F	Update to test case 11.1.5 to align EPS bearer ID description	16.2.0
2019-12	RAN#86	R5-198438	1182	-	F	Updates of 5GC test case titles	16.2.0
2019-12	RAN#86	R5-198757	1199	-	F	Correction to test cases 8.1.1.2.3	16.2.0
2019-12	RAN#86	R5-198759	1200	-	F	Correction to NR MAC test case 7.1.1.3.2b	16.2.0
2019-12	RAN#86	R5-198772	1210	-	F	Correction to test case 9.1.5.2.7	16.2.0
2019-12	RAN#86	R5-198784	1214	-	F	Corrections to MAC Test Case 7.1.1.5.3	16.2.0
2019-12	RAN#86	R5-198786	1215	-	F	Update of 5GC TC 9.1.5.2.9	16.2.0
2019-12	RAN#86	R5-198825	1219	-	F	Update of test case 8.1.5.1.1	16.2.0
2019-12	RAN#86	R5-198874	1053	1	F	Addition of NR TC 6.1.2.11-systemInformationAreaID	16.2.0
2019-12	RAN#86	R5-198875	1060	1	F	Correction of NR test case 6.2.3.7-Inter-RAT cell reselection N2L, Snonintrasearch	16.2.0
2019-12	RAN#86	R5-198877	1132	1	F	Corrections to Idle Mode SoR Test Case 6.3.1.1	16.2.0
2019-12	RAN#86	R5-198878	1133	1	F	Corrections to Idle Mode SoR Test Case 6.3.1.2	16.2.0
2019-12	RAN#86	R5-198879	1178	1	F	Correction to FR1 power levels for several test cases	16.2.0
2019-12	RAN#86	R5-198880	1195	1	F	Update to test cases 6.1.1.7 and 6.1.1.8	16.2.0
2019-12	RAN#86	R5-198881	1196	1	F	Update to test cases 6.2.1.1 and 6.2.1.5	16.2.0
2019-12	RAN#86	R5-198882	1197	1	F	Update to test cases 6.2.1.2, 6.2.1.3 and 6.2.1.4	16.2.0
2019-12	RAN#86	R5-198883	1183	1	F	Update FR2 power of NR TC 7.1.1.1.3-SI request	16.2.0
2019-12	RAN#86	R5-198884	1091	1	F	Correction to NR MAC test case 7.1.1.4.2.1	16.2.0
2019-12	RAN#86	R5-198885	1129	1	F	Correction to NR MAC transport size selection test cases	16.2.0
2019-12	RAN#86	R5-198886	1145	1	F	Corrections to MAC Test Case 7.1.1.1.1	16.2.0
2019-12	RAN#86	R5-198887	1154	1	F	Update to NR MAC test case 7.1.1.1.5	16.2.0
2019-12	RAN#86	R5-198888	1158	1	F	Correction to EN-DC MAC Test Case 7.1.1.1.1a	16.2.0
2019-12	RAN#86	R5-198889	1184	1	F	Correction to MAC test case 7.1.1.7.1	16.2.0
2019-12	RAN#86	R5-198890	1186	1	F	Addition of new MAC test case for data inactivity timer	16.2.0
2019-12	RAN#86	R5-198891	1187	1	F	Split of CA MAC test case into 3 variants	16.2.0
2019-12	RAN#86	R5-198892	1095	1	F	Correction to NR test case 7.1.2.3.10-Re-transmission of RLC PDU	16.2.0
2019-12	RAN#86	R5-198893	1090	1	F	Correction to NR RLC test cases to accommodate the DCI format change to DCI_0_1	16.2.0
2019-12	RAN#86	R5-198894	1093	1	F	Correction to RLC UM test case 7.1.2.2.5	16.2.0
2019-12	RAN#86	R5-198900	1123	1	F	Correction to NR RLC test case 7.1.2.3.10	16.2.0
2019-12	RAN#86	R5-198901	1157	1	F	Correction to RLC test case 7.1.2.2.6 in EN-DC	16.2.0
2019-12	RAN#86	R5-198902	1172	1	F	Correction to RLC AM test case 7.1.2.3.9	16.2.0
2019-12	RAN#86	R5-198903	1193	1	F	Correction to RLC AM Test case 7.1.2.3.8	16.2.0
2019-12	RAN#86	R5-198904	1122	1	F	Correction to NR PDCP test case 7.1.3.4.2	16.2.0
2019-12	RAN#86	R5-198905	1141	1	F	Corrections to PDCP Test Case 7.1.3.5.2	16.2.0
2019-12	RAN#86	R5-198906	1150	1	F	Correction to PDCP TC 7.1.3.4.1	16.2.0
2019-12	RAN#86	R5-198907	1092	1	F	Corrections to SDAP test cases 7.1.4.1 and 7.1.4.2	16.2.0
2019-12	RAN#86	R5-198909	1221	-	F	Correction to NR TCs	16.2.0
2019-12	RAN#86	R5-198910	1175	1	F	Update to 5GS NR RRC test case 8.1.1.3.2	16.2.0
2019-12	RAN#86	R5-198911	1198	1	F	Correction to test case 8.1.1.2.1	16.2.0
2019-12	RAN#86	R5-198912	1201	1	F	Correction to test case 8.1.1.4.1	16.2.0
2019-12	RAN#86	R5-198913	1066	1	F	Addition of NR test case 8.1.2.1.2-uplinkTxDirectCurrentList	16.2.0
2019-12	RAN#86	R5-198914	1048	1	F	Update RRC reconfiguration test case 8.1.3.1.17.1	16.2.0
2019-12	RAN#86	R5-198915	1067	1	F	Addition of NR TC 8.1.3.3.1-CGI reporting of NR cell	16.2.0
2019-12	RAN#86	R5-198916	1068	1	F	Addition of NR TC 8.1.3.3.2-CGI reporting of E-UTRA cell	16.2.0
2019-12	RAN#86	R5-198917	1071	1	F	Correction to NR TC 8.1.3.1.5-Event A4 Intra-Freq	16.2.0
2019-12	RAN#86	R5-198918	1073	1	F	correction of NR TC 8.1.3.1.18.1-Additional measurement report of Intra-band Contiguous CA	16.2.0

2019-12	RAN#86	R5-198920	1222	-	F	correction of NR TCs 8.1.3.2.1 and TC 8.1.3.2.2	16.2.0
2019-12	RAN#86	R5-198921	1220	1	F	Update of test case 8.1.3.2.4	16.2.0
2019-12	RAN#86	R5-198922	1075	1	F	Correction to NR test case 8.1.4.2.2.1 E-UTRA To NR handover success	16.2.0
2019-12	RAN#86	R5-198923	1203	1	F	Correction to test case 8.1.4.2.2.1	16.2.0
2019-12	RAN#86	R5-198924	1119	1	F	Correction to 5GS SA RRC test case 8.1.4.1.5	16.2.0
2019-12	RAN#86	R5-198925	1077	1	F	Correction to NR test case 8.1.5.3.4-PWS reception using dedicatedSystemInformationDelivery	16.2.0
2019-12	RAN#86	R5-198926	1204	1	F	Correction to test case 8.1.5.5.1	16.2.0
2019-12	RAN#86	R5-198927	1173	1	F	Update to 5GS NR RRC test case 8.1.5.4.1	16.2.0
2019-12	RAN#86	R5-198928	1148	1	F	Correction to ENDC test case 8.2.2.8.1	16.2.0
2019-12	RAN#86	R5-198930	1216	1	F	Correction to test case 8.2.2.6.1	16.2.0
2019-12	RAN#86	R5-198931	1078	1	F	Correction to NR test case 8.2.3.11.X-ENDC-GAP	16.2.0
2019-12	RAN#86	R5-198932	1125	1	F	Correction to EN-DC RRC measurement test case 8.2.3.9.1	16.2.0
2019-12	RAN#86	R5-198933	1126	1	F	Correction to EN-DC RRC measurement test case 8.2.3.10.1	16.2.0
2019-12	RAN#86	R5-198935	1069	1	F	Addition of NR TC 8.2.6.2.1-Processing delay of ENDC	16.2.0
2019-12	RAN#86	R5-198937	1096	1	F	Addition of 5GC test case 9.1.1.5	16.2.0
2019-12	RAN#86	R5-198938	1152	1	F	Correction to 5GC test case 9.1.1.3	16.2.0
2019-12	RAN#86	R5-198939	1080	1	F	Correction to NR test case 9.1.2.1-NAS security mode command	16.2.0
2019-12	RAN#86	R5-198940	1100	1	F	Addition of new 5GC test case 9.1.2.4	16.2.0
2019-12	RAN#86	R5-198941	1101	1	F	Addition of new 5GC test case 9.1.2.5	16.2.0
2019-12	RAN#86	R5-198942	1103	1	F	Addition of new 5GC test case 9.1.2.7	16.2.0
2019-12	RAN#86	R5-198943	1104	1	F	Addition of new 5GC test case 9.1.2.8	16.2.0
2019-12	RAN#86	R5-198944	1102	1	F	Addition of new 5GC test case 9.1.2.6	16.2.0
2019-12	RAN#86	R5-198947	1052	1	F	Correction to 5GC TC 9.1.5.1.12	16.2.0
2019-12	RAN#86	R5-198948	1081	1	F	Correction to NR test case 9.1.5.1.10-PLMN not allowed	16.2.0
2019-12	RAN#86	R5-198949	1082	1	F	Correction to NR test case 9.1.6.1.2-Transmission failure of De-registration	16.2.0
2019-12	RAN#86	R5-198950	1084	1	F	Update of NR TC 9.1.7.2-Service request	16.2.0
2019-12	RAN#86	R5-198951	1140	1	F	Correction to 5GC NAS NSSAI Test Case 9.1.5.1.3	16.2.0
2019-12	RAN#86	R5-198952	1189	1	F	Correction to NR5GC testcase 9.1.5.1.5	16.2.0
2019-12	RAN#86	R5-198953	1208	1	F	Correction to test case 9.1.5.1.2	16.2.0
2019-12	RAN#86	R5-198954	1217	1	F	Update of 5GC TC 9.1.6.1.4	16.2.0
2019-12	RAN#86	R5-198972	1098	1	F	Correction to 5GC test case 10.1.2.1	16.2.0
2019-12	RAN#86	R5-198975	1112	1	F	Update of 11.1.7 Emergency call setup from NR RRC_IDLE - Emergency Services Fallback to EPS with redirection	16.2.0
2019-12	RAN#86	R5-198977	1224	-	F	Editorial improvements of Multilayer EPS Fallback test cases	16.2.0
2019-12	RAN#86	R5-198978	1161	1	F	Update EPS fallback test case 11.1.2	16.2.0
2019-12	RAN#86	R5-198979	1162	1	F	Update EPS fallback test case 11.1.5	16.2.0
2019-12	RAN#86	R5-198980	1163	1	F	Update EPS fallback test case 11.1.6	16.2.0
2019-12	RAN#86	R5-198981	1170	1	F	Correction to test case 11.1.4	16.2.0
2019-12	RAN#86	R5-198982	1171	1	F	Correction to test case 11.1.3	16.2.0
2019-12	RAN#86	R5-198985	1106	1	F	Addition of new UAC test case 11.3.4	16.2.0
2019-12	RAN#86	R5-198986	1113	1	F	Update to TC 11.4.1 5GMM-REGISTERED.NORMAL-SERVICE / 5GMM-IDLE / Emergency call / ... / New emergency PDU session	16.2.0
2019-12	RAN#86	R5-198987	1114	1	F	Update to TC 11.4.2 5GMM-DEREGISTERED.LIMITED-SERVICE / Emergency call / ... / Handling of forbidden PLMNs	16.2.0
2019-12	RAN#86	R5-198988	1115	1	F	Update to TC 11.4.3 5GMM-DEREGISTERED.NO-SUPI / Emergency call / ... / Initial registration for emergency services	16.2.0
2019-12	RAN#86	R5-198989	1116	1	F	Introduction of new TC 11.4.4 5GMM-REGISTERED.ATTEMPTING-REGISTRATION-UPDATE T3346 running / Emergency call establishment	16.2.0
2019-12	RAN#86	R5-198990	1117	1	F	Introduction of new 11.4.5 5GMM-REGISTERED.LIMITED-SERVICE / 5GMM-IDLE / Emergency call establishment and release / Handling of 5GS forbidden tracking areas for roaming	16.2.0
2019-12	RAN#86	R5-198991	1118	1	F	Introduction of new TC 11.4.6 5GMM-REGISTERED.NON-ALLOWED-SERVICE / Emergency call establishment and release / Handling of non-allowed tracking areas	16.2.0
2019-12	RAN#86	R5-199000	1185	1	F	Non 3GPP Access over WLAN test cases	16.2.0
2019-12	RAN#86	R5-199027	1190	1	F	Update of QBASED in pre-test condition for RSRQ test	16.2.0

						cases	
2019-12	RAN#86	R5-199028	1194	1	F	Addition of NR Idle mode cell reselection test case 6.1.2.16	16.2.0
2019-12	RAN#86	R5-199029	1202	1	F	Correction to test case 8.1.1.4.2	16.2.0
2019-12	RAN#86	R5-199030	1156	1	F	Correction to RRC test case 8.2.2.1.1	16.2.0
2019-12	RAN#86	R5-199033	1223	1	F	Corrections to Test Case 8.2.4.1.1.1 and 8.2.4.1.1.2 and 8.2.4.1.1.3	16.2.0
2019-12	RAN#86	R5-199034	1207	1	F	Correction to test case 9.1.3.1	16.2.0
2019-12	RAN#86	R5-199035	1227	-	F	New 5GC NAS test case 10.1.4.1	16.2.0
2019-12	RAN#86	R5-199036	1086	1	F	Addition of new NR test case 11.3.6-Access Identity 2-accessibility AC7-RRC_INACTIVE	16.2.0
2019-12	RAN#86	R5-199037	1105	1	F	Addition of new UAC test case 11.3.3	16.2.0
2019-12	RAN#86	R5-199038	1191	1	F	Correction to RRC test case 8.1.3.1.2	16.2.0
2019-12	RAN#86	R5-199072	1107	2	F	Update of 5G Idle test case 6.1.2.23	16.2.0
2019-12	RAN#86	R5-199095	1225	1	F	Correction to NR RRC Test case 8.1.5.6.3	16.2.0
2019-12	RAN#86	R5-199096	1212	1	F	Correction to test cases 8.2.3.6.1 / 1a and 1b	16.2.0
2019-12	RAN#86	R5-199097	1228	1	F	Corrections to EN-DC inter frequency and inter band measurement test cases	16.2.0
2019-12	RAN#86	R5-199098	1079	2	F	Correction to NR test case 9.1.1.6-5G AKA authentication abnormal	16.2.0
2019-12	RAN#86	R5-199099	1211	2	F	Correction to test case 9.1.7.1	16.2.0
2019-12	RAN#86	R5-199101	1051	2	F	Correction to 5GC TC 9.1.5.1.11	16.2.0
2019-12	RAN#86	R5-199102	1226	1	F	Correction to NR Idle mode test case 6.1.2.1	16.2.0
2020-03	RAN#87	R5-200148	1250	-	F	Correction to test case 6.1.1.6	16.3.0
2020-03	RAN#87	R5-200150	1252	-	F	Correction to test case 8.1.3.1.16	16.3.0
2020-03	RAN#87	R5-200175	1268	-	F	Correction to NR TC 6.2.3.9-Speed Dependent Cell Reselection N2L	16.3.0
2020-03	RAN#87	R5-200182	1275	-	F	Correction to NR TC 8.1.2.1.2-uplinkTxDirectCurrentList	16.3.0
2020-03	RAN#87	R5-200185	1278	-	F	Correction to NR TC 8.1.4.1.6-Handover Failure	16.3.0
2020-03	RAN#87	R5-200187	1280	-	F	Correction to NR TC 8.1.4.1.8.1-SCell no change Intra-band Contiguous CA	16.3.0
2020-03	RAN#87	R5-200188	1281	-	F	Correction to NR TC 8.1.4.2.2.1-L2N Handover	16.3.0
2020-03	RAN#87	R5-200195	1285	-	F	Correction to NR TC 9.1.1.1-EAP-AKA related procedures	16.3.0
2020-03	RAN#87	R5-200205	1295	-	F	Correction to NR TC 9.1.5.2.2-Periodic Register T3512	16.3.0
2020-03	RAN#87	R5-200206	1296	-	F	Correction to NR TC 9.1.5.2.8-Registration Reject 10	16.3.0
2020-03	RAN#87	R5-200208	1298	-	F	Correction to NR TC 9.1.6.1.3-Deregistration in new TA	16.3.0
2020-03	RAN#87	R5-200211	1301	-	F	Correction to NR TC 9.3.1.1-5GC to EPC	16.3.0
2020-03	RAN#87	R5-200213	1303	-	F	Correction to NR TC 10.1.1.1-Authentication during PDU establish	16.3.0
2020-03	RAN#87	R5-200214	1304	-	F	Correction to NR TC 10.1.1.2-Authentication after PDU establish	16.3.0
2020-03	RAN#87	R5-200221	1311	-	F	Correction to NR RLC testcase 7.1.2.3.10	16.3.0
2020-03	RAN#87	R5-200226	1313	-	F	Adding core specs to section References	16.3.0
2020-03	RAN#87	R5-200227	1314	-	F	Corrections to IMS Emergency Services TC 11.4.1	16.3.0
2020-03	RAN#87	R5-200229	1316	-	F	Corrections to IMS Emergency Services TC 11.4.2	16.3.0
2020-03	RAN#87	R5-200230	1317	-	F	Corrections to IMS Emergency Services TC 11.4.4	16.3.0
2020-03	RAN#87	R5-200232	1319	-	F	Corrections to IMS Emergency Services TC 11.4.6	16.3.0
2020-03	RAN#87	R5-200233	1320	-	F	Introduction of new TC 11.4.7 Handling of Local and extended emergency numbers / Mobility	16.3.0
2020-03	RAN#87	R5-200234	1321	-	F	Introduction of new TC 11.4.8 Handling of Local and extended emergency numbers / Switch-off and maximum local numbers storage	16.3.0
2020-03	RAN#87	R5-200250	1326	-	F	Corrections to NR RLC test case 7.1.2.3.8	16.3.0
2020-03	RAN#87	R5-200253	1329	-	F	Corrections to EN-DC test case 8.2.2.3.1	16.3.0
2020-03	RAN#87	R5-200254	1330	-	F	Corrections to 5GC test case 9.1.5.1.1	16.3.0
2020-03	RAN#87	R5-200338	1332	-	F	Correction to NR TC 6.1.1.3-Cell reselection of ePLMN in manual mode	16.3.0
2020-03	RAN#87	R5-200339	1333	-	F	Correction to NR TC 6.4.1.2-Cell reselection of ePLMN in manual mode INACTIVE	16.3.0
2020-03	RAN#87	R5-200341	1335	-	F	Correction to NR TC 8.1.3.1.17.1-Event A6	16.3.0
2020-03	RAN#87	R5-200347	1338	-	F	Correction to NR test case 8.1.5.2.1	16.3.0
2020-03	RAN#87	R5-200354	1342	-	F	Correction to 5G RRC test case 8.1.1.2.3	16.3.0
2020-03	RAN#87	R5-200355	1343	-	F	Correction to 5G RRC test case 8.1.1.4.1	16.3.0
2020-03	RAN#87	R5-200357	1345	-	F	Correction to 5G UAC test case 11.3.3	16.3.0
2020-03	RAN#87	R5-200358	1346	-	F	Correction to 5G UAC test case 11.3.4	16.3.0
2020-03	RAN#87	R5-200360	1348	-	F	Update of 5GC test case 10.1.3.1	16.3.0

2020-03	RAN#87	R5-200366	1351	-	F	Correction of NR test case 6.4.3.1-Inter-RAT cell reselection in RRC_INACTIVE	16.3.0
2020-03	RAN#87	R5-200551	1354	-	F	Correction to NR PDCP test case 7.1.3.5.5	16.3.0
2020-03	RAN#87	R5-200579	1358	-	F	Corrections to RRC TC 8.2.2.7.1	16.3.0
2020-03	RAN#87	R5-200583	1362	-	F	Correction to RRC TC 8.2.2.5.1	16.3.0
2020-03	RAN#87	R5-200587	1365	-	F	Correction to 5G TC 9.1.5.2.1	16.3.0
2020-03	RAN#87	R5-200616	1373	-	F	Update to 5G TC test case 9.1.1.3 in 38.523-1	16.3.0
2020-03	RAN#87	R5-200622	1375	-	F	Inclusion of 5G-NR Idle Mode TC 6.1.2.19 - Speed-dependent cell reselection	16.3.0
2020-03	RAN#87	R5-200623	1376	-	F	Update of RRC TC 8.1.5.6.5.1	16.3.0
2020-03	RAN#87	R5-200625	1377	-	F	Update of RRC TC 8.2.3.12.1	16.3.0
2020-03	RAN#87	R5-200634	1378	-	F	Corrections to NR MAC Test Case	16.3.0
2020-03	RAN#87	R5-200673	1382	-	F	Editorial correction: Assign title to section 10.1.4	16.3.0
2020-03	RAN#87	R5-200675	1384	-	F	Correction to NR Idle mode test case 6.1.2.1	16.3.0
2020-03	RAN#87	R5-200680	1386	-	F	Correction to NSSAI TC 9.1.5.1.3	16.3.0
2020-03	RAN#87	R5-200803	1398	-	F	Correction to NR TC 8.1.3.1.23-Intra NR measurements	16.3.0
2020-03	RAN#87	R5-200872	1403	-	F	Correction to Multilayer TC 11.1.5	16.3.0
2020-03	RAN#87	R5-200877	1404	-	F	Correction to Multilayer TC 11.1.6	16.3.0
2020-03	RAN#87	R5-200997	1249	1	F	Correction to EN-DC RRC Test case 8.2.3.2.1	16.3.0
2020-03	RAN#87	R5-200999	1230	1	F	Correction to NR RLC test case 7.1.2.3.5	16.3.0
2020-03	RAN#87	R5-201000	1248	1	F	Correction to NR PDCP test case 7.1.3.5.3	16.3.0
2020-03	RAN#87	R5-201001	1236	1	F	Correction to NR SDAP test case 7.1.4.2	16.3.0
2020-03	RAN#87	R5-201002	1243	1	F	Correction to 5GMM test case 9.1.5.1.8	16.3.0
2020-03	RAN#87	R5-201006	1389	1	F	Correction to NR TC 6.1.2.11-Area Specific SIBs using systemInformationAreaID	16.3.0
2020-03	RAN#87	R5-201007	1368	1	F	Editorial Correction to TC 8.1.1.1.2	16.3.0
2020-03	RAN#87	R5-201009	1379	1	F	Correction to Non 3GPP Access test cases	16.3.0
2020-03	RAN#87	R5-201018	1374	1	F	Correction to NR test case 8.2.3.8.1x	16.3.0
2020-03	RAN#87	R5-201031	1312	1	F	Adding generic test parameters references and updating subclause 5	16.3.0
2020-03	RAN#87	R5-201032	1315	1	F	Update to IMS Emergency Services TC 11.4.1 for adding new TPs	16.3.0
2020-03	RAN#87	R5-201033	1318	1	F	Update of TC 11.4.4 5G Emergency Services to add a new TP	16.3.0
2020-03	RAN#87	R5-201084	1287	1	F	Correction to NR TC 9.1.1.6-5G AKA abnormal	16.3.0
2020-03	RAN#87	R5-201085	1288	1	F	Correction to NR TC 9.1.2.2-Initial NAS msg ciphering	16.3.0
2020-03	RAN#87	R5-201086	1290	1	F	Correction to NR TC 9.1.5.1.2-Equivalent PLMN list handling	16.3.0
2020-03	RAN#87	R5-201087	1293	1	F	Correction to NR TC 9.1.5.1.9-Change of cell into a new tracking area	16.3.0
2020-03	RAN#87	R5-201088	1299	1	F	Correction to NR TC 9.1.7.2-Service Request	16.3.0
2020-03	RAN#87	R5-201089	1300	1	F	Correction to NR TC 9.1.8.1-SMS	16.3.0
2020-03	RAN#87	R5-201094	1353	1	F	Correction to EN-DC RLC test case 7.1.2.3.11	16.3.0
2020-03	RAN#87	R5-201095	1385	1	F	Correction to NR RLC AM test case 7.1.2.3.9	16.3.0
2020-03	RAN#87	R5-201096	1355	1	F	Correction to NR PDCP Test cases 7.1.3.2.1, 7.1.3.2.2 and 7.1.3.2.3	16.3.0
2020-03	RAN#87	R5-201097	1381	1	F	Correction to NR RRC measurement test case for SINR report of serving cell	16.3.0
2020-03	RAN#87	R5-201098	1393	1	F	Correction NR CA Test case 8.2.4.1.1.1	16.3.0
2020-03	RAN#87	R5-201100	1369	1	F	Corrections to MAC TC 7.1.1.1.2	16.3.0
2020-03	RAN#87	R5-201101	1359	1	F	Corrections to RRC TC 8.2.2.8.1	16.3.0
2020-03	RAN#87	R5-201103	1395	1	F	Correction to test case 11.1.2	16.3.0
2020-03	RAN#87	R5-201107	1256	1	F	Correction to 5G TC 10.1.3.2	16.3.0
2020-03	RAN#87	R5-201112	1262	1	F	Correction to NR TC 6.1.2.21-Cell reselection	16.3.0
2020-03	RAN#87	R5-201113	1322	1	F	Correction to NR TC 6.1.2.4-Cell Reselection for interband operation	16.3.0
2020-03	RAN#87	R5-201114	1323	1	F	Correction to NR TC 6.1.2.5-Cell reselection for interband operation Between FDD and TDD	16.3.0
2020-03	RAN#87	R5-201115	1334	1	F	Correction to NR TC 6.1.2.18-Cell reselection with parameters Sintrasearch and Snonintrasearch	16.3.0
2020-03	RAN#87	R5-201117	1336	1	F	Correction to NR test case 7.1.2.3.6	16.3.0
2020-03	RAN#87	R5-201118	1337	1	F	Correction to NR test case 8.1.3.2.2	16.3.0
2020-03	RAN#87	R5-201119	1339	1	F	Correction to NR test case 9.1.5.2.6	16.3.0
2020-03	RAN#87	R5-201125	1258	1	F	Correction to NR TC 6.1.1.2-PLMN selection of Other PLMN	16.3.0
2020-03	RAN#87	R5-201126	1259	1	F	Correction to NR TC 6.1.1.4-PLMN selection in shared network environment with Automatic mode	16.3.0

2020-03	RAN#87	R5-201127	1260	1	F	Correction to NR TC 6.1.1.5-PLMN selection with Automatic mode and user reselection	16.3.0
2020-03	RAN#87	R5-201128	1263	1	F	Correction to NR TC 6.1.2.22-Inter frequency cell reselection based on common priority information	16.3.0
2020-03	RAN#87	R5-201129	1264	1	F	Correction to NR TC 6.2.3.2-Inter-RAT cell reselection L2N	16.3.0
2020-03	RAN#87	R5-201130	1265	1	F	Correction to NR TC 6.2.3.5-Inter-RAT cell reselection N2L by dedicated signalling	16.3.0
2020-03	RAN#87	R5-201131	1266	1	F	Correction to NR TC 6.2.3.6-Inter-RAT cell reselection	16.3.0
2020-03	RAN#87	R5-201132	1267	1	F	Correction to NR TC 6.2.3.8-Inter-RAT cell reselection L2N Snointrasearch	16.3.0
2020-03	RAN#87	R5-201133	1269	1	F	Correction to NR TC 6.4.2.1-Inactive-Reselection	16.3.0
2020-03	RAN#87	R5-201134	1270	1	F	Correction to NR TC 7.1.1.1.4-Beam Failure	16.3.0
2020-03	RAN#87	R5-201135	1272	1	F	Correction to NR TC 8.1.1.3.1-Redirection	16.3.0
2020-03	RAN#87	R5-201136	1273	1	F	Correction to NR TC 8.1.1.3.3-With priority information of NR Cell	16.3.0
2020-03	RAN#87	R5-201137	1274	1	F	Correction to NR TC 8.1.1.3.4-With priority information of LTE Cell	16.3.0
2020-03	RAN#87	R5-201138	1276	1	F	Correction to NR TC 8.1.3.3.1-NR CGI	16.3.0
2020-03	RAN#87	R5-201139	1277	1	F	Correction to NR TC 8.1.3.3.2-LTE CGI	16.3.0
2020-03	RAN#87	R5-201140	1279	1	F	Correction to NRTC 8.1.4.1.7.1-PCell Change and SCell addition Intra-band Contiguous CA	16.3.0
2020-03	RAN#87	R5-201141	1282	1	F	Correction to NR TC 8.2.1.1.1-UE Capability	16.3.0
2020-03	RAN#87	R5-201142	1286	1	F	Correction to NR TC 9.1.1.2-Authentication Reject	16.3.0
2020-03	RAN#87	R5-201143	1289	1	F	Correction to NR TC 9.1.4.1-Generic UE configuration update	16.3.0
2020-03	RAN#87	R5-201144	1294	1	F	Correction to NR TC 9.1.5.1.14-RegisterReject 22 and T3346	16.3.0
2020-03	RAN#87	R5-201145	1297	1	F	Correction to NR TC 9.1.6.1.2-UE initiated deregistration procedure	16.3.0
2020-03	RAN#87	R5-201146	1306	1	F	Correction to NR TC 10.1.4.1-T3580	16.3.0
2020-03	RAN#87	R5-201149	1324	1	F	Update to NR MAC test case 7.1.1.1.5	16.3.0
2020-03	RAN#87	R5-201153	1310	1	F	Correction to NR RLC testcase 7.1.2.3.7	16.3.0
2020-03	RAN#87	R5-201170	1340	1	F	Correction to NR RRC measurement Test cases 8.1.3.1.13 and 8.1.3.1.14A	16.3.0
2020-03	RAN#87	R5-201171	1350	1	F	Correction to NR test case 6.2.3.1	16.3.0
2020-03	RAN#87	R5-201200	1302	1	F	Correction to NR TC 9.3.1.2-Inter-system mobility registration update EPC to 5GC	16.3.0
2020-03	RAN#87	R5-201204	1253	1	F	Update to test case 8.2.2.2.1	16.3.0
2020-03	RAN#87	R5-201206	1257	1	F	Correction to NR TC 6.1.1.1-PLMN selection with Automatic mode	16.3.0
2020-03	RAN#87	R5-201208	1231	1	F	Correction to Inter-frequency Cell reselection test case 6.1.2.20	16.3.0
2020-03	RAN#87	R5-201209	1232	1	F	Correction to NR Idle mode test case 6.1.2.9	16.3.0
2020-03	RAN#87	R5-201210	1233	1	F	Correction to NR MAC test case 7.1.1.1.2	16.3.0
2020-03	RAN#87	R5-201211	1234	1	F	Correction to NR RLC test case 7.1.2.2.6	16.3.0
2020-03	RAN#87	R5-201212	1237	1	F	Correction to NR RRC test case 8.1.1.4.1	16.3.0
2020-03	RAN#87	R5-201213	1239	1	F	Correction to NR5GC IRAT test case 8.1.3.2.1	16.3.0
2020-03	RAN#87	R5-201214	1247	1	F	Correction to NR5GC RRC test case 8.1.3.1.2	16.3.0
2020-03	RAN#87	R5-201215	1240	1	F	Correction to NR5GC IRAT test case 8.1.4.2.1.1	16.3.0
2020-03	RAN#87	R5-201216	1383	1	F	Correction to NR5GC RRC test case 8.1.1.2.1	16.3.0
2020-03	RAN#87	R5-201218	1327	1	F	Enhancement of NR PDCP test cases 7.1.3.1.x	16.3.0
2020-03	RAN#87	R5-201219	1328	1	F	Corrections to NR PDCP test case 7.1.3.4.1	16.3.0
2020-03	RAN#87	R5-201223	1347	1	F	Update of 5G Idle test case 6.1.2.23	16.3.0
2020-03	RAN#87	R5-201224	1341	1	F	Correction to 5G RRC test case 8.2.4.3.1	16.3.0
2020-03	RAN#87	R5-201225	1392	1	F	Correction to 5G RRC test case 8.2.4.3.1.3	16.3.0
2020-03	RAN#87	R5-201226	1352	1	F	Correction to 5GC test case 10.1.2.2	16.3.0
2020-03	RAN#87	R5-201227	1344	1	F	Correction to 5G UAC test case 11.3.6	16.3.0
2020-03	RAN#87	R5-201230	1399	1	F	Corrections to EN-DC RRC TC 8.2.2.1.1	16.3.0
2020-03	RAN#87	R5-201231	1402	1	F	Correction to Multilayer TC 11.1.1	16.3.0
2020-03	RAN#87	R5-201235	1396	2	F	Correction to NR Idle mode test case 6.1.2.3	16.3.0
2020-03	RAN#87	R5-201236	1397	2	F	Update of RRC TC 8.1.3.1.1	16.3.0
2020-03	RAN#87	R5-201241	1367	2	F	Correction to 5G TC 9.1.7.1	16.3.0
2020-06	RAN#88	R5-201326	1405	-	F	Correction to EN-DC Carrier Aggregation test case 8.2.4.1.1.1	16.4.0
2020-06	RAN#88	R5-201340	1408	-	F	Correction to NR TC 6.1.2.18-Cell reselection with	16.4.0

						Sintrasearch and Snonintrasearch	
2020-06	RAN#88	R5-201341	1409	-	F	Correction to NR TC 6.1.2.19-N2N Speed dependent cell reselection	16.4.0
2020-06	RAN#88	R5-201344	1412	-	F	Correction to NR TC 6.2.3.9-N2L Speed dependent cell reselection	16.4.0
2020-06	RAN#88	R5-201349	1417	-	F	Correction to NR TC 6.4.1.1-PLMN selection Automatic mode in RRC_INACTIVE state	16.4.0
2020-06	RAN#88	R5-201353	1421	-	F	Correction to NR TC 8.1.2.1.4-RRC reconfiguration Dedicated RLF timer	16.4.0
2020-06	RAN#88	R5-201356	1424	-	F	Correction to NR TC 8.1.3.1.23-Continuation of the measurements after RRC Resume	16.4.0
2020-06	RAN#88	R5-201361	1429	-	F	Correction to NR TC 8.1.5.4.1-Reception of CounterCheck message by the UE	16.4.0
2020-06	RAN#88	R5-201367	1434	-	F	Addition of NR TC 8.1.5.8.1-Connected state latency check	16.4.0
2020-06	RAN#88	R5-201372	1439	-	F	Correction to NR TC 9.1.5.1.2-Equivalent PLMN list handling	16.4.0
2020-06	RAN#88	R5-201379	1446	-	F	Addition of new NR TC 11.3.5-UAC AI1-accessibility AC5-MMTEL-Video call	16.4.0
2020-06	RAN#88	R5-201431	1461	-	F	Correction to ENDC TC 7.1.3.3.2-Correct functionality of encryption algorithm AES	16.4.0
2020-06	RAN#88	R5-201432	1462	-	F	Correction to ENDC TC 7.1.3.3.3-Correct functionality of encryption algorithm ZUC	16.4.0
2020-06	RAN#88	R5-201440	1470	-	F	Correction to NR TC 6.1.2.2-Qualmin Serving Cell non-suitable	16.4.0
2020-06	RAN#88	R5-201471	1479	-	F	Addition of NR TC 6.2.2.1-N2L Serving cell becomes non-suitable	16.4.0
2020-06	RAN#88	R5-201477	1482	-	F	Correction to FR1 power level table for several test cases to not to assign beyond maximum power level -78	16.4.0
2020-06	RAN#88	R5-201484	1485	-	F	Correction 7.1.2.3.7 to use downlink timing reference for scheduling less than 100ms timing gap	16.4.0
2020-06	RAN#88	R5-201499	1486	-	F	Correction to NR Idle mode test case 6.1.2.5	16.4.0
2020-06	RAN#88	R5-201500	1487	-	F	Correction to NR idle mode test case 6.4.2.2	16.4.0
2020-06	RAN#88	R5-201501	1488	-	F	Correction to NR MAC test case 7.1.1.1.1a	16.4.0
2020-06	RAN#88	R5-201502	1489	-	F	Correction to BWP Dependent Parameters for RA type 0 in MAC testcases	16.4.0
2020-06	RAN#88	R5-201519	1497	-	F	Corrections to MAC test cases for Logical Channel ID	16.4.0
2020-06	RAN#88	R5-201574	1499	-	F	Updates to NR RLC test case 7.1.2.3.11	16.4.0
2020-06	RAN#88	R5-201575	1500	-	F	Enhancement of NR PDCP test case 7.1.3.1.1	16.4.0
2020-06	RAN#88	R5-201578	1503	-	F	Correction to NR test cases 8.1.3.1.13 and 8.1.3.1.14A	16.4.0
2020-06	RAN#88	R5-201629	1510	-	F	Correction to 5GC TC 10.1.3.2	16.4.0
2020-06	RAN#88	R5-201632	1511	-	F	Corrections to RRC TCs 8.2.3.1.1, 8.2.3.2.1, 8.2.3.3.1 and 8.2.3.12.1	16.4.0
2020-06	RAN#88	R5-201633	1512	-	F	Addition of NR5G UAC TC 11.3.7	16.4.0
2020-06	RAN#88	R5-201637	1516	-	F	Corrections to NR5G MAC TC 7.1.1.3.1	16.4.0
2020-06	RAN#88	R5-201638	1517	-	F	Corrections to NR5G RRC TC 8.1.4.2.1.1	16.4.0
2020-06	RAN#88	R5-201644	1522	-	F	Corrections to NR5G NAS TC 9.1.6.1.4	16.4.0
2020-06	RAN#88	R5-201646	1524	-	F	Corrections to NR5G RRC TC 8.1.1.4.1	16.4.0
2020-06	RAN#88	R5-201650	1528	-	F	Corrections to NR5G SDAP TC 7.1.4.2	16.4.0
2020-06	RAN#88	R5-201651	1529	-	F	Corrections to NR5G RRC TC 8.1.5.4.1	16.4.0
2020-06	RAN#88	R5-201761	1538	-	F	Correction to NR UE Capability test case 8.2.1.1.1	16.4.0
2020-06	RAN#88	R5-201790	1539	-	F	Correction to NR idle mode test case 6.4.2.1	16.4.0
2020-06	RAN#88	R5-201791	1540	-	F	Correction to NR5GC IRAT test case 6.2.3.1	16.4.0
2020-06	RAN#88	R5-201793	1542	-	F	Removal of requirement of USIM configuration 14 from 5GMM Idle mode test cases	16.4.0
2020-06	RAN#88	R5-201802	1545	-	F	Update of RRC TC 8.2.3.12.1	16.4.0
2020-06	RAN#88	R5-201913	1547	-	F	Update of RRC TC 8.1.5.6.5.1	16.4.0
2020-06	RAN#88	R5-201943	1549	-	F	Correction to NR TC 6.2.3.4-inter-RAT reselection	16.4.0
2020-06	RAN#88	R5-202026	1559	-	F	Corrections to NR MAC Test Case 7.1.1.3.2b	16.4.0
2020-06	RAN#88	R5-202048	1560	-	F	Corrections to EN-DC test case 8.2.3.12.1	16.4.0
2020-06	RAN#88	R5-202107	1561	-	F	Editorial Corrections to NR5G MAC TC 7.1.1.1.2	16.4.0
2020-06	RAN#88	R5-202140	1564	-	F	Addition of new DRX TC 7.1.1.5.5 for short DRX configured and Long DRX command MAC CE is received	16.4.0
2020-06	RAN#88	R5-202178	1566	-	F	Correction to 5G test case 6.2.1.2	16.4.0
2020-06	RAN#88	R5-202183	1567	-	F	Editorial update to NR measurements test case 8.1.3.1.2	16.4.0
2020-06	RAN#88	R5-202185	1568	-	F	Correction to 5G test case 6.2.1.3	16.4.0
2020-06	RAN#88	R5-202205	1569	-	F	Correction to 5G test case 6.2.1.4	16.4.0

2020-06	RAN#88	R5-202221	1572	-	F	Removal of 5GC test case 10.1.3.1	16.4.0
2020-06	RAN#88	R5-202411	1581	-	F	Correction to EN-DC RRC test case 8.2.2.1.1	16.4.0
2020-06	RAN#88	R5-202506	1584	-	F	Correction to NR PDCP test case 7.1.3.5.5	16.4.0
2020-06	RAN#88	R5-202530	1585	-	F	Correction to NR CA RRC test cases 8.1.3.1.18.x	16.4.0
2020-06	RAN#88	R5-202535	1442	1	F	Correction to NR TC 9.3.1.3-Handling of EPC relevant parameters	16.4.0
2020-06	RAN#88	R5-202537	1586	-	F	Correction to NR RRC IDLE testcase 6.1.2.1	16.4.0
2020-06	RAN#88	R5-202538	1587	-	F	Correction to the ENDC testcase 7.1.1.3.7	16.4.0
2020-06	RAN#88	R5-202539	1588	-	F	Correction to NR MAC test case 7.1.1.3.3	16.4.0
2020-06	RAN#88	R5-202540	1589	-	F	Correction to NR TC 8.2.3.2.1	16.4.0
2020-06	RAN#88	R5-202543	1554	1	F	Correction to NR MAC test case 7.1.1.3.1	16.4.0
2020-06	RAN#88	R5-202550	1555	1	F	Corrections to IMS Emergency Services TC 11.4.2	16.4.0
2020-06	RAN#88	R5-202551	1556	1	F	Introduction of new IMS Emergency TC 11.4.9 5GMM-DEREGISTERED.LIMITED-SERVICE No suitable cells in tracking area call	16.4.0
2020-06	RAN#88	R5-202592	1577	1	F	Adding generic test parameters references to section 5.3	16.4.0
2020-06	RAN#88	R5-202593	1406	1	F	Correction to NR TC 6.1.1.1-PLMN selection Automatic mode	16.4.0
2020-06	RAN#88	R5-202594	1407	1	F	Correction to NR TC 6.1.1.5-PLMN selection with Automatic mode and user reselection	16.4.0
2020-06	RAN#88	R5-202595	1411	1	F	Correction to NR TC 6.2.3.3-From NR RRC_IDLE to E-UTRA_IDLE	16.4.0
2020-06	RAN#88	R5-202596	1413	1	F	Correction to NR TC 6.3.1.1-Security check successful using List Type 1	16.4.0
2020-06	RAN#88	R5-202597	1416	1	F	Correction to NR TC 6.3.1.4-Security check unsuccessful manual mode	16.4.0
2020-06	RAN#88	R5-202598	1449	1	F	Corrections to Idle Mode SoR Test Case 6.3.1.2	16.4.0
2020-06	RAN#88	R5-202599	1450	1	F	Corrections to Idle Mode SoR Test Case 6.3.1.3	16.4.0
2020-06	RAN#88	R5-202600	1452	1	F	Addition of Idle Mode SoR Test Case 6.3.1.5	16.4.0
2020-06	RAN#88	R5-202601	1453	1	F	Addition of Idle Mode SoR Test Case 6.3.1.7	16.4.0
2020-06	RAN#88	R5-202602	1480	1	F	Addition of NR TC 6.2.2.2-L2N Serving cell becomes non-suitable	16.4.0
2020-06	RAN#88	R5-202603	1531	1	F	Correction to NR5G Idle Mode TC 6.1.2.11	16.4.0
2020-06	RAN#88	R5-202604	1543	1	F	Correction to NR TC 6.3.1.8-SoR after registration Automatic mode	16.4.0
2020-06	RAN#88	R5-202605	1544	1	F	Correction to NR TC 6.3.1.9-SoR after registration Manual mode	16.4.0
2020-06	RAN#88	R5-202606	1570	1	F	Correction to test case 6.1.2.23	16.4.0
2020-06	RAN#88	R5-202607	1474	1	F	Correction to NR TC 7.1.1.4.2.x-TBS ambiguity of UL	16.4.0
2020-06	RAN#88	R5-202608	1490	1	F	Correction to NR MAC test case 7.1.1.4.2.3	16.4.0
2020-06	RAN#88	R5-202609	1558	1	F	Corrections to NR DRX Test Cases	16.4.0
2020-06	RAN#88	R5-202610	1574	1	F	Corrections to MAC TBS test cases with dynamicSwitch	16.4.0
2020-06	RAN#88	R5-202611	1583	1	F	Correction to NR MAC CA Test Case	16.4.0
2020-06	RAN#88	R5-202612	1498	1	F	Editorial corrections to NR RLC test cases 7.1.2.3.x	16.4.0
2020-06	RAN#88	R5-202613	1507	1	F	Correction to 7.1.2.3.3 and 7.1.2.3.4 to reduce test execution time	16.4.0
2020-06	RAN#88	R5-202614	1457	1	F	Correction to ENDC TC 7.1.3.2.1-Correct functionality of Integrity algorithm SNOW3G	16.4.0
2020-06	RAN#88	R5-202615	1458	1	F	Correction to ENDC TC 7.1.3.2.2-Correct functionality of Integrity algorithm AES	16.4.0
2020-06	RAN#88	R5-202616	1459	1	F	Correction to ENDC TC 7.1.3.2.3-Correct functionality of Integrity algorithm ZUC	16.4.0
2020-06	RAN#88	R5-202617	1460	1	F	Correction to ENDC TC 7.1.3.3.1-Correct functionality of encryption algorithm SNOW3G	16.4.0
2020-06	RAN#88	R5-202618	1520	1	F	Corrections to NR5G PDCP TC 7.1.3.4.1 and 7.1.3.4.2	16.4.0
2020-06	RAN#88	R5-202619	1418	1	F	Correction to NR TC 8.1.1.2.1-T300 expiry	16.4.0
2020-06	RAN#88	R5-202620	1419	1	F	Correction to NR TC 8.1.1.3.2-Redirection from NR to E-UTRA	16.4.0
2020-06	RAN#88	R5-202621	1464	1	F	Correction to test case 8.1.1.3.1	16.4.0
2020-06	RAN#88	R5-202622	1465	1	F	Correction to test case 8.1.1.3.3	16.4.0
2020-06	RAN#88	R5-202623	1466	1	F	Correction to test case 8.1.1.3.4	16.4.0
2020-06	RAN#88	R5-202624	1467	1	F	Correction to test case 8.1.1.4.1	16.4.0
2020-06	RAN#88	R5-202625	1468	1	F	Correction to test case 8.1.1.4.2	16.4.0
2020-06	RAN#88	R5-202626	1469	1	F	Correction to test case 8.1.2.1.1	16.4.0
2020-06	RAN#88	R5-202627	1515	1	F	Corrections to NR5G RRC TC 8.2.2.6.1	16.4.0

2020-06	RAN#88	R5-202628	1576	1	F	Update RRC TC 8.1.2.1.5	16.4.0
2020-06	RAN#88	R5-202629	1582	1	F	Corrections to EN-DC RRC TC 8.2.2.7.1	16.4.0
2020-06	RAN#88	R5-202630	1422	1	F	Correction to NR TC 8.1.3.1.11-Two RSRQ event A3	16.4.0
2020-06	RAN#88	R5-202631	1423	1	F	Correction to NR TC 8.1.3.1.16-Intra NR measurements with Whitelisting	16.4.0
2020-06	RAN#88	R5-202632	1425	1	F	Correction to NR TC 8.1.3.2.3-RSRQ event B2	16.4.0
2020-06	RAN#88	R5-202633	1426	1	F	Correction to NR TC 8.1.3.3.1-NR CGI	16.4.0
2020-06	RAN#88	R5-202634	1427	1	F	Correction to NR TC 8.1.3.3.2-LTE CGI	16.4.0
2020-06	RAN#88	R5-202635	1501	1	F	Corrections to NR measurement test cases 8.1.3.x	16.4.0
2020-06	RAN#88	R5-202636	1518	1	F	Corrections to NR5G RRC TC 8.1.3.1.15A	16.4.0
2020-06	RAN#88	R5-202637	1536	1	F	Correction to NR TC 8.1.3.1.15a-Intra NR measurements with Blacklisting	16.4.0
2020-06	RAN#88	R5-202638	1550	1	F	Correction to NR TC 8.1.3.2.4-SINR event B2	16.4.0
2020-06	RAN#88	R5-202639	1428	1	F	Correction to NR TC 8.1.4.2.2.1-L2N handover	16.4.0
2020-06	RAN#88	R5-202640	1492	1	F	Correction to NR5GC IRAT test case 8.1.4.2.1.1	16.4.0
2020-06	RAN#88	R5-202641	1563	1	F	Correction to NR RRC test case 8.1.4.1.2 to update the security	16.4.0
2020-06	RAN#88	R5-202642	1433	1	F	Addition of NR TC 8.1.5.7.1-MCG RLC failure	16.4.0
2020-06	RAN#88	R5-202643	1506	1	F	Updates on RRC others TC 8.1.5.2.2	16.4.0
2020-06	RAN#88	R5-202644	1546	1	F	Corrections to NR5G RRC TC 8.1.5.5.1	16.4.0
2020-06	RAN#88	R5-202645	1483	1	F	Correction to 8.2.2.8.1 not to check reception of RRCReconfigurationComplete if RRCReconfiguration is not sent	16.4.0
2020-06	RAN#88	R5-202646	1493	1	F	Correction to EN-DC RRC test case 8.2.2.7.1	16.4.0
2020-06	RAN#88	R5-202647	1505	1	F	Corrections to EN-DC test case 8.2.2.3.1	16.4.0
2020-06	RAN#88	R5-202648	1526	1	F	Addition of NRDC RRC TC 8.2.2.4.2	16.4.0
2020-06	RAN#88	R5-202649	1527	1	F	Addition of NRDC RRC TC 8.2.2.5.2	16.4.0
2020-06	RAN#88	R5-202650	1435	1	F	Addition of NR TC 8.2.3.16.1-MeasConfig via SRB3	16.4.0
2020-06	RAN#88	R5-202651	1504	1	F	Corrections to NR measurement test cases 8.2.3.x	16.4.0
2020-06	RAN#88	R5-202652	1475	1	F	Correction to NR TC 8.2.4.2.1.x-CA release	16.4.0
2020-06	RAN#88	R5-202653	1537	1	F	Corrections to EN-DC test case 8.2.4.3.1.1	16.4.0
2020-06	RAN#88	R5-202654	1436	1	F	Addition of NR TC 8.2.6.1.1-RLC failure	16.4.0
2020-06	RAN#88	R5-202655	1551	1	F	Corrections to 5GC Test Case 9.1.1.3	16.4.0
2020-06	RAN#88	R5-202656	1494	1	F	Correction to 5GMM test case 9.1.2.1	16.4.0
2020-06	RAN#88	R5-202657	1495	1	F	Correction to 5GMM test case 9.1.4.1	16.4.0
2020-06	RAN#88	R5-202658	1438	1	F	Correction to NR TC 9.1.5.1.3-NSSAI handling	16.4.0
2020-06	RAN#88	R5-202659	1440	1	F	Correction to NR TC 9.1.5.1.9-Change of cell into a new tracking area	16.4.0
2020-06	RAN#88	R5-202660	1508	1	F	Correction to NR TC 9.1.6.1.3-Deregistration in new TA	16.4.0
2020-06	RAN#88	R5-202661	1530	1	F	Corrections to NR5G NAS TC 9.1.7.2	16.4.0
2020-06	RAN#88	R5-202662	1578	1	F	Correction to test case 9.1.7.1	16.4.0
2020-06	RAN#88	R5-202663	1573	1	F	Addition to 5GC SMS test case 9.1.8.2	16.4.0
2020-06	RAN#88	R5-202664	1444	1	F	Correction to NR TC 10.1.4.1-T3580 expiry	16.4.0
2020-06	RAN#88	R5-202665	1476	1	F	Update of multilayer test case 11.1.5	16.4.0
2020-06	RAN#88	R5-202666	1477	1	F	Update of multilayer test case 11.1.6	16.4.0
2020-06	RAN#88	R5-202667	1478	1	F	Update of multilayer test case 11.1.2	16.4.0
2020-06	RAN#88	R5-202668	1445	1	F	Addition of new NR TC 11.3.1-UAC AI0-MTSI MO speech call-SMSoIP-Uplink User data transfer	16.4.0
2020-06	RAN#88	R5-202669	1447	1	F	Addition of new NR TC 11.3.9-UAC Operator Defined Access Category	16.4.0
2020-06	RAN#88	R5-202670	1513	1	F	Addition of NR5G UAC TC 11.3.8	16.4.0
2020-06	RAN#88	R5-202671	1571	1	F	Update to UAC test case 11.3.4	16.4.0
2020-06	RAN#88	R5-202672	1557	1	F	Introduction of new IMS emergency TC 11.4.10 5GMM-REGISTERED.NORMAL-SERVICE N26 interface not supported N1 to S1	16.4.0
2020-09	RAN#89	R5-203363	1590	-	F	Correction to NR TC 6.1.1.1-PLMN selection in automatic mode	16.5.0
2020-09	RAN#89	R5-203367	1594	-	F	Correction to NR TC 6.1.1.5-PLMN selection in Automatic mode User reselection	16.5.0
2020-09	RAN#89	R5-203372	1599	-	F	Correction to NR TC 6.1.2.21-Cell reselection	16.5.0
2020-09	RAN#89	R5-203373	1600	-	F	Correction to NR TC 6.1.2.23-Cell Reselection MFBI	16.5.0
2020-09	RAN#89	R5-203374	1601	-	F	Correction to NR TC 6.2.1.1-Selection of correct RAT for OPLMN	16.5.0
2020-09	RAN#89	R5-203375	1602	-	F	Correction to NR TC 6.2.1.4-Inter-RAT PLMN Selection with Manual mode	16.5.0

2020-09	RAN#89	R5-203377	1604	-	F	Correction to NR TC 6.2.3.9-Inter-RAT Speed Dependent Cell Reselection	16.5.0
2020-09	RAN#89	R5-203382	1609	-	F	Correction to NR TC 6.4.1.1-PLMN Selection	16.5.0
2020-09	RAN#89	R5-203383	1610	-	F	Correction to NR TC 7.1.1.1.1-Correct selection of RACH parameters	16.5.0
2020-09	RAN#89	R5-203389	1616	-	F	Correction to NR TC 8.1.1.3.1-Redirection to another NR frequency	16.5.0
2020-09	RAN#89	R5-203394	1621	-	F	Correction to NR TC 8.1.3.1.15A-Intra NR measurements Blacklisting	16.5.0
2020-09	RAN#89	R5-203396	1623	-	F	Correction to NR TC 8.1.5.7.1.X-RLC Failure MCG	16.5.0
2020-09	RAN#89	R5-203397	1624	-	F	Correction to ENDC TC 8.2.2.1.1-SRB3	16.5.0
2020-09	RAN#89	R5-203398	1625	-	F	Addition of NRDC TC 8.2.2.1.2-SRB3	16.5.0
2020-09	RAN#89	R5-203403	1630	-	F	Correction to ENDC TC 8.2.3.11.X-Measurement Gap	16.5.0
2020-09	RAN#89	R5-203405	1632	-	F	Correction to ENDC TC 8.2.6.1.1.X-RLC Failure SCG	16.5.0
2020-09	RAN#89	R5-203406	1633	-	F	Addition of NRDC TC 8.2.6.1.2.1-RLC Failure SCG intra-band	16.5.0
2020-09	RAN#89	R5-203407	1634	-	F	Addition of NRDC TC 8.2.6.1.2.2-RLC Failure SCG inter-band	16.5.0
2020-09	RAN#89	R5-203408	1635	-	F	Addition of NRDC TC 8.2.6.1.2.3-RLC Failure SCG intra-band NC	16.5.0
2020-09	RAN#89	R5-203409	1636	-	F	Correction to ENDC TC 8.2.6.2.1-Processing delay	16.5.0
2020-09	RAN#89	R5-203412	1639	-	F	Correction to NR TC 9.1.5.1.1-Initial registration with 5G-GUTI reallocation	16.5.0
2020-09	RAN#89	R5-203413	1640	-	F	Correction to NR TC 9.1.5.1.8-Serving network not authorized	16.5.0
2020-09	RAN#89	R5-203481	1648	-	F	Correction to NR TC 6.1.1.4-PLMN selection in shared network environment	16.5.0
2020-09	RAN#89	R5-203502	1652	-	F	Correction to 5G NR Idle mode test case 6.4.2.2	16.5.0
2020-09	RAN#89	R5-203503	1653	-	F	Correction to NR CA RRC test cases 8.1.3.1.18.x	16.5.0
2020-09	RAN#89	R5-203504	1654	-	F	Correction to NR RRC test cases 8.1.3.2.3 and 8.1.3.2.4	16.5.0
2020-09	RAN#89	R5-203505	1655	-	F	Correction to 5GMM test case 9.1.5.1.13	16.5.0
2020-09	RAN#89	R5-203524	1661	-	F	Corrections to NR MAC Test Case 7.1.1.5.4	16.5.0
2020-09	RAN#89	R5-203535	1662	-	F	Splitting and updates to NR RLC test case 7.1.2.3.5	16.5.0
2020-09	RAN#89	R5-203539	1666	-	F	Correction to NR test case 8.1.3.1.15A	16.5.0
2020-09	RAN#89	R5-203540	1667	-	F	Editorial correction to EN-DC test case 8.2.3.5.1	16.5.0
2020-09	RAN#89	R5-203567	1671	-	F	Correction to NR TC 7.1.1.1.2-Random access procedure for Preamble selected by MAC itself	16.5.0
2020-09	RAN#89	R5-203648	1690	-	F	Editorial updates to NR5G Idle Mode TC 6.1.2.11	16.5.0
2020-09	RAN#89	R5-203649	1691	-	F	Corrections to NR5G BWP TC 7.1.1.8.1	16.5.0
2020-09	RAN#89	R5-203650	1692	-	F	Corrections to NR5G RRC NR-DC TC 8.2.2.4.2 and 8.2.2.5.2	16.5.0
2020-09	RAN#89	R5-203656	1695	-	F	Corrections to NR5G MAC DRX TC 7.1.1.5.3	16.5.0
2020-09	RAN#89	R5-203657	1696	-	F	Corrections to NR5G RRC TC 8.1.3.1.16	16.5.0
2020-09	RAN#89	R5-203658	1697	-	F	Void NR5G NAS TC 9.1.5.2.6	16.5.0
2020-09	RAN#89	R5-203659	1698	-	F	Corrections to NR5G MAC TC 7.1.1.2.1	16.5.0
2020-09	RAN#89	R5-203665	1703	-	F	Corrections to NR5G RRC CA TCs to add Data Path verification	16.5.0
2020-09	RAN#89	R5-203666	1704	-	F	Corrections to ENDC RRC CA TCs to add Data Path verification	16.5.0
2020-09	RAN#89	R5-203706	1708	-	F	Correction to NR test case 7.1.2.3.1	16.5.0
2020-09	RAN#89	R5-203709	1711	-	F	Correction to NR test case 8.1.3.1.5	16.5.0
2020-09	RAN#89	R5-203710	1712	-	F	Correction to NR test case 8.1.3.1.8	16.5.0
2020-09	RAN#89	R5-203728	1715	-	F	Correction to NR test case 8.1.3.1.16	16.5.0
2020-09	RAN#89	R5-203739	1717	-	F	Corrections to 5GS Non-3GPP Access TC 9.2.1.1	16.5.0
2020-09	RAN#89	R5-203740	1718	-	F	Corrections to 5GS Non-3GPP Access TC 9.2.5.1.4	16.5.0
2020-09	RAN#89	R5-203741	1719	-	F	Corrections to 5GS Non-3GPP Access TC 9.2.7.1	16.5.0
2020-09	RAN#89	R5-203742	1720	-	F	Corrections to 5GS Non-3GPP Access TC 9.2.7.2	16.5.0
2020-09	RAN#89	R5-203745	1721	-	F	Correction to 5G NR Idle mode test case 6.4.3.1	16.5.0
2020-09	RAN#89	R5-203772	1727	-	F	Correction to NR5GC testcase 9.1.4.1	16.5.0
2020-09	RAN#89	R5-203785	1728	-	F	Correction to NR5GC testcase 10.1.1.2	16.5.0
2020-09	RAN#89	R5-203810	1729	-	F	Correction to NR5GC test case 6.1.2.9	16.5.0
2020-09	RAN#89	R5-203811	1730	-	F	Correction to NR CA RRC Test cases 8.1.3.1.17.x and 8.1.3.1.18.x	16.5.0
2020-09	RAN#89	R5-204015	1733	-	F	Correction of NR TC 6.2.2.1	16.5.0
2020-09	RAN#89	R5-204016	1734	-	F	Correction to NR TC 8.1.4.1.8.X-Scell no change	16.5.0
2020-09	RAN#89	R5-204018	1735	-	F	Correction of NR TC 6.2.2.2	16.5.0

2020-09	RAN#89	R5-204019	1736	-	F	Correction to NR5G UAC TC 11.3.8	16.5.0
2020-09	RAN#89	R5-204107	1740	-	F	Correction to NR test case 7.1.2.3.11	16.5.0
2020-09	RAN#89	R5-204217	1744	-	F	Addition of NR-DC RRC test case 8.2.2.9.2	16.5.0
2020-09	RAN#89	R5-204237	1746	-	F	Correction to NR5G RRC TC 8.1.4.1.2	16.5.0
2020-09	RAN#89	R5-204254	1748	-	F	Correction to NR UE Capability test case 8.1.5.1.1	16.5.0
2020-09	RAN#89	R5-204334	1749	-	F	Correction to NR5GC RRC test case 8.1.5.2.2	16.5.0
2020-09	RAN#89	R5-204336	1750	-	F	Correction to test case 11.1.3	16.5.0
2020-09	RAN#89	R5-204341	1751	-	F	Correction to the NR5GC testcase 8.1.3.1.12	16.5.0
2020-09	RAN#89	R5-204359	1754	-	F	Correction to NR test case 8.1.4.1.6	16.5.0
2020-09	RAN#89	R5-204363	1755	-	F	Corrections to NR5G PDCP TC 7.1.3.4.1	16.5.0
2020-09	RAN#89	R5-204372	1756	-	F	Correction to NR5GC CA RRC test cases 8.1.2.1.5.x	16.5.0
2020-09	RAN#89	R5-204379	1678	1	F	Correction to Idle mode test case 6.4.1.2	16.5.0
2020-09	RAN#89	R5-204380	1680	1	F	Correction to Idle mode test case 6.1.2.9	16.5.0
2020-09	RAN#89	R5-204381	1689	1	F	Correction to the power level of NR RRC TC 8.1.1.2.1 and 8.1.1.4.1	16.5.0
2020-09	RAN#89	R5-204382	1739	1	F	Correction to NR RRC TC 8.1.3.2.2	16.5.0
2020-09	RAN#89	R5-204403	1592	1	F	Correction to NR TC 6.1.1.2-access technology combinations	16.5.0
2020-09	RAN#89	R5-204404	1596	1	F	Correction to NR TC 6.1.1.7-PLMN selection of RPLMN or HPLMN in Automatic mode	16.5.0
2020-09	RAN#89	R5-204405	1598	1	F	Correction to NR TC 6.1.2.19-Speed-dependent cell reselection	16.5.0
2020-09	RAN#89	R5-204406	1603	1	F	Correction to NR TC 6.2.1.5-Inter-RAT Background HPLMN Search with Automatic Mode	16.5.0
2020-09	RAN#89	R5-204407	1605	1	F	Correction to NR TC 6.3.1.1-SOR during registration with security check successful using List Type 1	16.5.0
2020-09	RAN#89	R5-204408	1606	1	F	Correction to NR TC 6.3.1.2-SOR during registration with security check successful but no requested acknowledgement	16.5.0
2020-09	RAN#89	R5-204409	1608	1	F	Correction to NR TC 6.3.1.5-SOR during registration with no SOR information received	16.5.0
2020-09	RAN#89	R5-204410	1645	1	F	Correction to Idle Mode SoR TC 6.3.1.7	16.5.0
2020-09	RAN#89	R5-204411	1647	1	F	Correction to NR TC 6.3.1.8-Steering of UE in roaming after registration	16.5.0
2020-09	RAN#89	R5-204412	1669	1	F	Correction to NR TC 6.2.2.1-N2L cell reselection	16.5.0
2020-09	RAN#89	R5-204413	1670	1	F	Correction to NR TC 6.2.2.2-L2N cell reselection	16.5.0
2020-09	RAN#89	R5-204414	1677	1	F	Correction to the power level of Idle mode test cases	16.5.0
2020-09	RAN#89	R5-204415	1693	1	F	Corrections to NR5G Idle Mode TC 6.4.2.1	16.5.0
2020-09	RAN#89	R5-204416	1700	1	F	Corrections to NR5G Idle Mode TC 6.1.2.13	16.5.0
2020-09	RAN#89	R5-204417	1722	1	F	Correction to 5G NR Idle mode inter-RAT test cases	16.5.0
2020-09	RAN#89	R5-204418	1613	1	F	Correction to NR TC 7.1.1.9.1-MAC Reset	16.5.0
2020-09	RAN#89	R5-204419	1614	1	F	Correction to NR TC 7.1.1.2.2-PDSCH Aggregation	16.5.0
2020-09	RAN#89	R5-204420	1656	1	F	Correction to NR MAC test case 7.1.1.5.2	16.5.0
2020-09	RAN#89	R5-204421	1694	1	F	Corrections to NR5G MAC TC 7.1.1.2.4	16.5.0
2020-09	RAN#89	R5-204422	1699	1	F	Corrections to NR5G MAC TC 7.1.1.1.2	16.5.0
2020-09	RAN#89	R5-204423	1743	1	F	Addition of NR-DC MAC Test Case	16.5.0
2020-09	RAN#89	R5-204426	1682	1	F	Modification of PDCP TC 7.1.3.5.2 to add testing for change of ul-DataSplitThreshold and transmission of SRs	16.5.0
2020-09	RAN#89	R5-204429	1709	1	F	Correction to NR test case 7.1.3.5.5	16.5.0
2020-09	RAN#89	R5-204430	1724	1	F	Update to test case NR5GC 7.1.3.5.3 (NR-DC)	16.5.0
2020-09	RAN#89	R5-204431	1725	1	F	Correction to NR5GC SDAP test cases 7.1.4.1 and 7.1.4.2	16.5.0
2020-09	RAN#89	R5-204432	1617	1	F	Correction to NR TC 8.1.1.3.3-With priority information	16.5.0
2020-09	RAN#89	R5-204433	1685	1	F	Addition of new RRC TC for checking extended / spare field handling in SI	16.5.0
2020-09	RAN#89	R5-204434	1723	1	F	Correction to NR RRC IRAT test case 8.1.1.3.4	16.5.0
2020-09	RAN#89	R5-204435	1737	1	F	Correction to NR5GC testcase 8.1.1.3.2	16.5.0
2020-09	RAN#89	R5-204436	1745	1	F	Correction to NR5G RRC TC 8.1.1.4.1	16.5.0
2020-09	RAN#89	R5-204437	1619	1	F	Correction to NR TC 8.1.X on SINR related configuration	16.5.0
2020-09	RAN#89	R5-204438	1620	1	F	Correction to NR TC 8.1.3.1.13-CSI-RS based intra-freq	16.5.0
2020-09	RAN#89	R5-204439	1627	1	F	Correction to ENDC TC 8.2.2.6.1-PDCP version change	16.5.0
2020-09	RAN#89	R5-204440	1646	1	F	Correction to NR TC 8.1.3.1.14A-CSI-RS based inter-freq	16.5.0
2020-09	RAN#89	R5-204441	1649	1	F	Addition of new test purpose to test case 8.1.3.1.23	16.5.0
2020-09	RAN#89	R5-204442	1659	1	F	Correction to NR RRC test case 8.1.3.1.20	16.5.0
2020-09	RAN#89	R5-204444	1674	1	F	Correction to NR5GC test case 8.1.3.1.12	16.5.0
2020-09	RAN#89	R5-204445	1675	1	F	Addition of NR-DC RRC test case 8.2.2.8.2	16.5.0

2020-09	RAN#89	R5-204446	1622	1	F	Correction to NR TC 8.1.4.1.7.X-Scell Release	16.5.0
2020-09	RAN#89	R5-204447	1628	1	F	Correction to ENDC TC 8.2.3.9.1-CSI-RS based Intra-frequency measurements	16.5.0
2020-09	RAN#89	R5-204448	1629	1	F	Correction to ENDC TC 8.2.3.10.1-CSI-RS based Inter-frequency measurements	16.5.0
2020-09	RAN#89	R5-204449	1631	1	F	Addition of NRDC TC 8.2.3.16.2-Intra-NR Measurement configuration control and reporting	16.5.0
2020-09	RAN#89	R5-204450	1650	1	F	Correction to include data path check after handover in test case 8.1.4.1.2	16.5.0
2020-09	RAN#89	R5-204451	1672	1	F	Correction to Inter-RAT HO test case 8.1.4.2.2	16.5.0
2020-09	RAN#89	R5-204452	1679	1	F	Correction to Inter-RAT HO test case 8.1.4.2.1	16.5.0
2020-09	RAN#89	R5-204453	1702	1	F	Corrections to NR5G RRC IRAT TC 8.1.4.2.2.1	16.5.0
2020-09	RAN#89	R5-204454	1731	1	F	Addition of NR-DC RRC test case 8.2.3.14.2	16.5.0
2020-09	RAN#89	R5-204455	1742	1	F	Correction to MR-DC RRC TC 8.2.3.8.1	16.5.0
2020-09	RAN#89	R5-204456	1676	1	F	Correction to NR RRC TC 8.1.5.1.1	16.5.0
2020-09	RAN#89	R5-204457	1637	1	F	Correction to NR TC 9.1.1.3-EAP message transport abnormal	16.5.0
2020-09	RAN#89	R5-204458	1638	1	F	Correction to NR TC 9.1.1.6-5G AKA abnormal	16.5.0
2020-09	RAN#89	R5-204459	1716	1	F	Correction to 5GC TC 9.1.3.1	16.5.0
2020-09	RAN#89	R5-204460	1641	1	F	Correction to NR TC 9.1.5.1.9-Initial registration with Change of cell into a new tracking area	16.5.0
2020-09	RAN#89	R5-204461	1642	1	F	Correction to NR TC 9.1.6.1.4-Transmission failure with TAI change from lower layers	16.5.0
2020-09	RAN#89	R5-204462	1706	1	F	Correction to 5GC TC 9.1.5.2.9	16.5.0
2020-09	RAN#89	R5-204463	1752	1	F	Correction to NR TC 9.1.5.1.14	16.5.0
2020-09	RAN#89	R5-204464	1753	1	F	Corrections to NR5G NAS TC 9.1.6.1.3	16.5.0
2020-09	RAN#89	R5-204465	1726	1	F	Correction to Multilayer TC 11.1.2 and 11.1.5	16.5.0
2020-09	RAN#89	R5-204466	1732	1	F	Corrections to EPS Fallback regarding IMS procedures	16.5.0
2020-09	RAN#89	R5-204467	1738	1	F	Correction to test case 11.1.7	16.5.0
2020-09	RAN#89	R5-204468	1643	1	F	Correction to NR TC 11.3.9-UAC AI-0 Operator Defined Access Category	16.5.0
2020-09	RAN#89	R5-204512	1701	1	F	Corrections to NR5G RLC TC 7.1.2.3.11	16.5.0
2020-09	RAN#89	R5-204513	1660	1	F	Addition of new test case 8.1.4.2.1.2 for Inter-RAT handover from NR to EN-DC	16.5.0
2020-09	RAN#89	R5-204517	1658	1	F	Introduction of a new test case for voice fallback indication under EPS Fallback with redirection	16.5.0
2020-09	RAN#89	R5-204518	1747	1	F	Addition of NR5G UAC TC 11.3.2	16.5.0
2020-09	RAN#89	R5-204543	1607	1	F	Correction to NR TC 6.3.1.3-SOR during registration with security check unsuccessful for Automatic mode	16.5.0
2020-12	RAN#90	R5-205142	1758	-	F	Update of test case 9.3.1.2 Inter-system mobility registration update / Single-registration mode with N26 / 5GMM-IDLE / EPC to 5G	16.6.0
2020-12	RAN#90	R5-205176	1768	-	F	Correction to ENDC TC 8.2.6.2.1	16.6.0
2020-12	RAN#90	R5-205180	1770	-	F	Corrections to TC 8.1.4.2.2 regarding IMS usage	16.6.0
2020-12	RAN#90	R5-205192	1771	-	F	Correction to 5G NR Idle mode test case 6.1.2.14	16.6.0
2020-12	RAN#90	R5-205244	1778	-	F	Correction to the Preamble of Test case 8.1.4.1.2	16.6.0
2020-12	RAN#90	R5-205279	1779	-	F	Correction to NR-DC RRC test case 8.2.3.14.2	16.6.0
2020-12	RAN#90	R5-205292	1783	-	F	Corrections to EPS Fallback test cases regarding IMS usage	16.6.0
2020-12	RAN#90	R5-205320	1787	-	F	Correction to NR5G Idle Mode TC 6.1.1.1	16.6.0
2020-12	RAN#90	R5-205321	1788	-	F	Correction to NR5G UAC TC 11.3.2	16.6.0
2020-12	RAN#90	R5-205341	1790	-	F	Updates to PDCP default Pre-Test Conditions	16.6.0
2020-12	RAN#90	R5-205342	1791	-	F	Corrections to NR CA HO test cases 8.1.4.1.9.x	16.6.0
2020-12	RAN#90	R5-205361	1795	-	F	Correction to Idle Mode SoR Test Case 6.3.1.7	16.6.0
2020-12	RAN#90	R5-205365	1796	-	F	Correction to NR TC 6.1.2.9-Cell reselection using Qhyst and Qoffset	16.6.0
2020-12	RAN#90	R5-205366	1797	-	F	Correction to NR TC 6.1.2.13-Cell reselection CellReservedForOperatorUse with Access Identity 0-1-2-12-13-14	16.6.0
2020-12	RAN#90	R5-205368	1799	-	F	Correction to NR TC 6.3.1.3-SOR security check unsuccessful	16.6.0
2020-12	RAN#90	R5-205369	1800	-	F	Correction to NR TC 6.3.1.5-Steering of UE in roaming during registration	16.6.0
2020-12	RAN#90	R5-205373	1804	-	F	Correction to NR TC 8.1.3.1.11-RSRQ based	16.6.0
2020-12	RAN#90	R5-205374	1805	-	F	Correction to NR TC 8.1.3.2.X-Inter-RAT	16.6.0
2020-12	RAN#90	R5-205377	1808	-	F	Correction to MRDC TC 8.2.2.8.2-key change	16.6.0

2020-12	RAN#90	R5-205379	1810	-	F	Correction to MRDC TC 8.2.3.9.1-CSI-RS based intra-freq	16.6.0
2020-12	RAN#90	R5-205381	1812	-	F	Correction to MRDC TC 8.2.3.16.2-Measurement via SRB3	16.6.0
2020-12	RAN#90	R5-205383	1814	-	F	Correction to NR TC 9.1.4.1-Generic UE configuration update	16.6.0
2020-12	RAN#90	R5-205385	1816	-	F	Correction to NR TC 9.1.6.1.3-DeRegistration	16.6.0
2020-12	RAN#90	R5-205388	1819	-	F	Correction to NR TC 11.3.9-UAC AI-0 Operator Defined Access Category	16.6.0
2020-12	RAN#90	R5-205575	1862	-	F	Correction to NR PDCP test case 7.1.3.5.2 for NR-DC	16.6.0
2020-12	RAN#90	R5-205577	1864	-	F	Correction to ENDC CA RRC test cases 8.2.4.1.1.x	16.6.0
2020-12	RAN#90	R5-205578	1865	-	F	Correction to NR5G MAC TC 7.1.1.8.1	16.6.0
2020-12	RAN#90	R5-205579	1866	-	F	Correction NR5G NAS TC 9.1.1.2	16.6.0
2020-12	RAN#90	R5-205600	1871	-	F	Correction to NR TC 6.4.2.1-Cell Selection in RRC_INACTIVE state	16.6.0
2020-12	RAN#90	R5-205615	1879	-	F	Correction to 5GS Non-3GPP Access Test Case 9.2.4.1	16.6.0
2020-12	RAN#90	R5-205616	1880	-	F	Correction to 5GS Non-3GPP Access Test Case 9.2.5.1.2	16.6.0
2020-12	RAN#90	R5-205637	1882	-	F	Update to TC 7.1.3.5.5 PDCP Duplication	16.6.0
2020-12	RAN#90	R5-205671	1884	-	F	Correction to ENDC RLC TC 7.1.2.3.6	16.6.0
2020-12	RAN#90	R5-205673	1885	-	F	Correction to RLC TCs 7.1.2.3.7 and 7.1.2.3.8	16.6.0
2020-12	RAN#90	R5-205718	1887	-	F	Correction to NR testcases 8.1.3.1.11, 8.1.3.1.12	16.6.0
2020-12	RAN#90	R5-205752	1888	-	F	Correction to NR test case 8.2.2.1.2	16.6.0
2020-12	RAN#90	R5-205753	1889	-	F	Correction to NR test case 8.2.2.2.1	16.6.0
2020-12	RAN#90	R5-205759	1891	-	F	Correction to NR5G RRC TC 8.1.1.4.1	16.6.0
2020-12	RAN#90	R5-205856	1897	-	F	Correction to Inter-RAT Idle mode test case 6.2.1.4	16.6.0
2020-12	RAN#90	R5-205866	1903	-	F	Correction of NR test case 9.1.5.1.8	16.6.0
2020-12	RAN#90	R5-205942	1906	-	F	Update for Flexible PDU-PDN - Test Cases	16.6.0
2020-12	RAN#90	R5-206123	1907	-	F	Corrections to NR MAC Test Case 7.1.1.5.4	16.6.0
2020-12	RAN#90	R5-206265	1912	-	F	Correction of Idle TC 6.2.3.2	16.6.0
2020-12	RAN#90	R5-206280	1815	1	F	Correction to NR TC 9.1.5.2.9-Mobility and periodic registration update	16.6.0
2020-12	RAN#90	R5-206311	1772	1	F	Correction to Idle TC 6.3.1.9	16.6.0
2020-12	RAN#90	R5-206312	1792	1	F	Correction to Cell Reselection Test Case 6.1.2.18	16.6.0
2020-12	RAN#90	R5-206313	1793	1	F	Correction to Cell Reselection Test Case 6.1.2.21	16.6.0
2020-12	RAN#90	R5-206314	1798	1	F	Correction to NR TC 6.3.1.1-SOR	16.6.0
2020-12	RAN#90	R5-206315	1856	1	F	Addition of new NR TC-Additional extended field in LTE SIB1_schedulingInfoList-v12j0	16.6.0
2020-12	RAN#90	R5-206316	1857	1	F	Addition of new NR TC-Additional extended field in LTE SIB1_schedulingInfoListExt-r12	16.6.0
2020-12	RAN#90	R5-206317	1909	1	F	Correction to test case 6.2.3.9	16.6.0
2020-12	RAN#90	R5-206318	1910	1	F	Correction to NR IDLE mode test case 6.1.2.2	16.6.0
2020-12	RAN#90	R5-206319	1801	1	F	Correction to NR TC 7.1.1.5.5-Long DRX command MAC control element reception	16.6.0
2020-12	RAN#90	R5-206320	1802	1	F	Correction to NR TC 7.1.1.9.1-MAC Reset	16.6.0
2020-12	RAN#90	R5-206321	1858	1	F	Correction to MAC TC 7.1.1.8.1	16.6.0
2020-12	RAN#90	R5-206322	1869	1	F	Correction to NR TC 7.1.1.10.1-DataInactivityTimer expiry	16.6.0
2020-12	RAN#90	R5-206323	1892	1	F	Addition of MAC Test Case for Recommended Bit Rate	16.6.0
2020-12	RAN#90	R5-206324	1893	1	F	Corrections to MAC CA Power Headroom Test case	16.6.0
2020-12	RAN#90	R5-206325	1895	1	F	Correction to MAC CA test case	16.6.0
2020-12	RAN#90	R5-206326	1803	1	F	Correction to NR TC 7.1.2.3.3 and 7.1.2.3.4-SN	16.6.0
2020-12	RAN#90	R5-206327	1761	1	F	Correction to NR PDCP test cases 7.1.3.2.x	16.6.0
2020-12	RAN#90	R5-206328	1762	1	F	Correction to NR PDCP test cases 7.1.3.3.x	16.6.0
2020-12	RAN#90	R5-206329	1863	1	F	Correction to NR PDCP test case 7.1.3.5.5 for NR-DC	16.6.0
2020-12	RAN#90	R5-206330	1886	1	F	Update to test case NR5GC 7.1.3.5.3 (NR-DC)	16.6.0
2020-12	RAN#90	R5-206331	1769	1	F	Correction to SDAP testcase 7.1.4.1 and 7.1.4.2	16.6.0
2020-12	RAN#90	R5-206332	1785	1	F	Correction to NR5G RRC TC 8.1.1.3.4	16.6.0
2020-12	RAN#90	R5-206333	1896	1	F	Correction to NR5GC test case 8.1.2.1.4	16.6.0
2020-12	RAN#90	R5-206334	1781	1	F	Correction to RRC TC 8.1.3.1.2	16.6.0
2020-12	RAN#90	R5-206335	1786	1	F	Correction to NR5G RRC TC 8.1.3.1.2, 8.1.3.1.3 and 8.1.3.1.4	16.6.0
2020-12	RAN#90	R5-206336	1900	1	F	Correction to NR5GC test case 8.1.4.1.5	16.6.0
2020-12	RAN#90	R5-206337	1806	1	F	Correction to NR TC 8.1.5.2.2-SI Change in NR RRC_CONNECTED state	16.6.0
2020-12	RAN#90	R5-206338	1807	1	F	Correction to NR TC 8.1.5.7.1-MCG RLC failure	16.6.0
2020-12	RAN#90	R5-206339	1902	1	F	Correction to NR5GC test case 8.1.5.6.1	16.6.0
2020-12	RAN#90	R5-206340	1760	1	F	Correction to ENDC RRC test case 8.2.2.3.1	16.6.0

2020-12	RAN#90	R5-206341	1809	1	F	Correction to MRDC TC 8.2.2.9.2-split DRB	16.6.0
2020-12	RAN#90	R5-206342	1867	1	F	Correction to NRDC TC 8.2.2.4.2 and 8.2.2.5.2	16.6.0
2020-12	RAN#90	R5-206343	1890	1	F	Correction to NR5G RRC TC 8.2.2.1.2	16.6.0
2020-12	RAN#90	R5-206344	1911	1	F	Addition of NR-DC RRC test case 8.2.2.7.2	16.6.0
2020-12	RAN#90	R5-206345	1759	1	F	Correction to ENDC CA RRC test cases 8.2.4.3.1.x	16.6.0
2020-12	RAN#90	R5-206346	1777	1	F	Addition of new Test Case 8.2.5.1.2 Radio link failure / Random access problem / NR-DC	16.6.0
2020-12	RAN#90	R5-206347	1789	1	F	Addition of NRDC TC 8.2.5.2.2	16.6.0
2020-12	RAN#90	R5-206348	1813	1	F	Correction to MRDC TC 8.2.6.1.X-SCG RLC failure	16.6.0
2020-12	RAN#90	R5-206349	1773	1	F	Correction to 5GC TC 9.1.1.3	16.6.0
2020-12	RAN#90	R5-206350	1774	1	F	Correction to 5GC TC 9.1.1.6	16.6.0
2020-12	RAN#90	R5-206351	1766	1	F	Correction to NR5GC testcase 9.1.5.2.1	16.6.0
2020-12	RAN#90	R5-206352	1775	1	F	Correction to 5GC TC 9.1.5.1.3	16.6.0
2020-12	RAN#90	R5-206353	1859	1	F	Update preamble of 5GC TC 9.1.5.1.2, 9.1.5.1.4 and 9.1.5.1.14	16.6.0
2020-12	RAN#90	R5-206354	1868	1	F	Correction to NR5GC testcase 10.1.1.2	16.6.0
2020-12	RAN#90	R5-206355	1767	1	F	Correction to NR5GC testcase 10.1.3.2	16.6.0
2020-12	RAN#90	R5-206356	1872	1	F	Correction to NR5GC testcase 10.1.2.2	16.6.0
2020-12	RAN#90	R5-206357	1873	1	F	Correction to NR5GC testcase 10.1.4.1	16.6.0
2020-12	RAN#90	R5-206358	1874	1	F	Correction to NR5GC testcase 10.1.6.1	16.6.0
2020-12	RAN#90	R5-206359	1875	1	F	Correction to NR5GC testcase 10.1.6.2	16.6.0
2020-12	RAN#90	R5-206360	1776	1	F	Correction to Multilayer TC 11.1.4	16.6.0
2020-12	RAN#90	R5-206361	1817	1	F	Correction to NR TC 11.1.1-MO MMTEL voice call setup from NR RRC_IDLE with EPS Fallback	16.6.0
2020-12	RAN#90	R5-206362	1818	1	F	Correction to NR TC 11.1.3-MO MMTEL voice call setup from NR RRC_CONNECTED with EPS Fallback	16.6.0
2020-12	RAN#90	R5-206363	1784	1	F	Corrections to Unified Access Control test cases regarding IMS usage	16.6.0
2020-12	RAN#90	R5-206364	1794	1	F	Correction to Access Barring test 11.3.4	16.6.0
2020-12	RAN#90	R5-206365	1876	1	F	Correction to Emergency Services testcase 11.4.1	16.6.0
2020-12	RAN#90	R5-206366	1877	1	F	Correction to Emergency Services testcase 11.4.4	16.6.0
2020-12	RAN#90	R5-206396	1820	1	F	Addition of TC for DL assignment Multi Semi-persistent configuration	16.6.0
2020-12	RAN#90	R5-206397	1860	1	F	Addition of TC PDCP Duplication for Rel-16	16.6.0
2020-12	RAN#90	R5-206398	1908	1	F	New testcase for ethernet header compression and decompression for NR	16.6.0
2020-12	RAN#90	R5-206405	1824	1	F	Addition of NR TC 8.1.4.3.1-MobEnh DAPS handover	16.6.0
2020-12	RAN#90	R5-206411	1822	1	F	Addition of NR V2X TC 12.1.2.1.3-Network Scheduling	16.6.0
2020-12	RAN#90	R5-206412	1823	1	F	Addition of NR V2X TC 12.1.2.3.1-C1 and C2	16.6.0
2020-12	RAN#90	R5-206415	1904	1	F	Addition of eMIMO MAC Test Case	16.6.0
2020-12	RAN#90	R5-206417	1780	1	F	Addition of UE power saving test case 7.1.1.12.1	16.6.0
2020-12	RAN#90	R5-206418	1782	1	F	Addition of UE power saving test case 7.1.1.12.3	16.6.0
2020-12	RAN#90	R5-206429	1764	1	F	Update test case 8.1.5.1.1 to add UE capability nr-HO-ToEN-DC-r16	16.6.0
2020-12	RAN#90	R5-206430	1765	1	F	Update of test case 8.2.1.1.1 to support Inter-RAT handover from NR to EN-DC	16.6.0
2020-12	RAN#90	R5-206431	1878	1	F	Correction to 5GS Non-3GPP Access Test Case 9.2.2.1	16.6.0
2021-03	RAN#91	R5-210022	1913	-	F	Correction to NR MAC test case 7.1.1.4.2.5	16.7.0
2021-03	RAN#91	R5-210032	1920	-	F	Addition of new MDT test case 8.1.6.1.2.4	16.7.0
2021-03	RAN#91	R5-210033	1921	-	F	Addition of new MDT test case 8.1.6.1.2.5	16.7.0
2021-03	RAN#91	R5-210034	1922	-	F	Addition of new MDT test case 8.1.6.1.2.6	16.7.0
2021-03	RAN#91	R5-210037	1925	-	F	Addition of new MDT test case 8.1.6.1.2.9	16.7.0
2021-03	RAN#91	R5-210038	1926	-	F	Addition of new MDT test case 8.1.6.1.2.10	16.7.0
2021-03	RAN#91	R5-210039	1927	-	F	Addition of new MDT test case 8.1.6.1.2.11	16.7.0
2021-03	RAN#91	R5-210062	1930	-	F	Correction to NR Idle mode test case 6.4.1.1	16.7.0
2021-03	RAN#91	R5-210066	1934	-	F	Correction to NR5GC IRAT test case 8.1.4.2.1.1	16.7.0
2021-03	RAN#91	R5-210131	1939	-	F	Correction of NR CA TC 8.1.4.1.7.x	16.7.0
2021-03	RAN#91	R5-210133	1941	-	F	Update of power level tables for Multilayer EPSFB TC 11.1.x	16.7.0
2021-03	RAN#91	R5-210159	1944	-	F	Editorial changes to 38.523-1 Section 8	16.7.0
2021-03	RAN#91	R5-210160	1945	-	F	Editorial changes to 38.523-1 Sections 9-12	16.7.0
2021-03	RAN#91	R5-210163	1946	-	F	Update of TC for IMS emergency TC 11.4.10 5GMM-REGISTERED.NORMAL-SERVICE N26 interface not supported N1 to S1	16.7.0
2021-03	RAN#91	R5-210164	1947	-	F	Update to indication of Max nr cells in emergency test cases being active during test execution	16.7.0

2021-03	RAN#91	R5-210165	1948	-	F	Introduction of new IMS emergency TC 11.4.11 5GMM-REGISTERED.NORMAL-SERVICE N26 interface not supported S1 to N1	16.7.0
2021-03	RAN#91	R5-210191	1949	-	F	Correction of NR test case 9.1.5.1.8	16.7.0
2021-03	RAN#91	R5-210197	1950	-	F	Corrections to RLC test case 7.1.2.3.8	16.7.0
2021-03	RAN#91	R5-210200	1952	-	F	Corrections to test case 8.1.4.2.1.2	16.7.0
2021-03	RAN#91	R5-210320	1957	-	F	Correction to NR Idle mode test cases	16.7.0
2021-03	RAN#91	R5-210321	1958	-	F	Correction to UL-SCH TBS selection test cases common clause 7.1.1.4.2.0	16.7.0
2021-03	RAN#91	R5-210322	1959	-	F	Correction to 5GMM Initial Registration test cases	16.7.0
2021-03	RAN#91	R5-210356	1964	-	F	Corrections to test case 11.3.1	16.7.0
2021-03	RAN#91	R5-210361	1966	-	F	Correction to NR5G RRC TC 8.1.1.3.3	16.7.0
2021-03	RAN#91	R5-210366	1971	-	F	Correction to NR-DC RRC TC 8.2.5.2.2	16.7.0
2021-03	RAN#91	R5-210367	1972	-	F	Correction to NR5G RRC IRAT TC 8.1.4.2.1.1	16.7.0
2021-03	RAN#91	R5-210378	1974	-	F	Update of RRC TC 8.2.3.12.1	16.7.0
2021-03	RAN#91	R5-210379	1975	-	F	Update of RRC TC 8.1.5.6.5.1	16.7.0
2021-03	RAN#91	R5-210389	1977	-	F	Correction to MR-DC test case 8.2.3.2.1	16.7.0
2021-03	RAN#91	R5-210390	1978	-	F	Correction to MR-DC test case 8.2.3.6.1a and 8.2.3.6.1b	16.7.0
2021-03	RAN#91	R5-210392	1980	-	F	Correction to MR-DC test case 8.2.3.9.1	16.7.0
2021-03	RAN#91	R5-210397	1981	-	F	Correction to NR-DC Test case 8.2.2.8.2	16.7.0
2021-03	RAN#91	R5-210398	1982	-	F	Correction to NR5GC NAS test cases for handling additional PDN	16.7.0
2021-03	RAN#91	R5-210401	1983	-	F	Correction to NR Idle mode test case 6.1.1.6	16.7.0
2021-03	RAN#91	R5-210430	1985	-	F	Addition of new NAS Test case 9.1.9.2 for testing RACS UE Configuration Update	16.7.0
2021-03	RAN#91	R5-210542	1986	-	F	Corrections to MAC RACH Beam Failure test case	16.7.0
2021-03	RAN#91	R5-210561	1987	-	F	Correction to EN-DC test case 8.2.4.3.1.3	16.7.0
2021-03	RAN#91	R5-210567	1988	-	F	Corrections to DL SPS test case	16.7.0
2021-03	RAN#91	R5-210568	1989	-	F	Corrections to UL configured grant type 1 test case	16.7.0
2021-03	RAN#91	R5-210569	1990	-	F	Corrections to UL configured grant type 2 test case	16.7.0
2021-03	RAN#91	R5-210571	1991	-	F	Correction to 11.4.8	16.7.0
2021-03	RAN#91	R5-210575	1994	-	F	Correction to NR5G MAC TC 7.1.1.1.3	16.7.0
2021-03	RAN#91	R5-210610	1998	-	F	Correction to Inter-RAT Cell Reselection Test Case 6.4.3.1	16.7.0
2021-03	RAN#91	R5-210628	2002	-	F	Correction to NR TC 6.1.1.6-PLMN Selection with MinimumPeriodicSearchTimer	16.7.0
2021-03	RAN#91	R5-210630	2004	-	F	Correction to NR TC 6.1.2.9-Cell Reselection	16.7.0
2021-03	RAN#91	R5-210631	2005	-	F	Correction to NR TC 6.2.3.2-L2N cell reselection	16.7.0
2021-03	RAN#91	R5-210632	2006	-	F	Correction to NR TC 6.2.3.4-N2L cell reselection	16.7.0
2021-03	RAN#91	R5-210643	2017	-	F	Correction to NR TC 8.1.3.1.15A-bliacklisting	16.7.0
2021-03	RAN#91	R5-210644	2018	-	F	Correction to NR TC 8.1.3.2.2-Event B2	16.7.0
2021-03	RAN#91	R5-210645	2019	-	F	Correction to NR TC 8.1.5.6.1-RLF	16.7.0
2021-03	RAN#91	R5-210648	2022	-	F	Addition of NR TC 8.1.5.8.2.2-inter-band SCell Latency check	16.7.0
2021-03	RAN#91	R5-210649	2023	-	F	Addition of NR TC 8.1.5.8.2.3-intra-band non-contiguous SCell Latency check	16.7.0
2021-03	RAN#91	R5-210650	2024	-	F	Correction to NR-DC TC 8.2.2.7.2-bearer type change without security key change	16.7.0
2021-03	RAN#91	R5-210651	2025	-	F	Correction to NR-DC TC 8.2.2.9.2-Split DRB	16.7.0
2021-03	RAN#91	R5-210652	2026	-	F	Correction to NR-DC TC 8.2.3.16.2-Intra NR measurements	16.7.0
2021-03	RAN#91	R5-210799	2044	-	F	Addition of new MDT TC 8.1.6.1.3.2	16.7.0
2021-03	RAN#91	R5-210807	2046	-	F	Correction to NR Idle Mode Test Case 6.3.1.7	16.7.0
2021-03	RAN#91	R5-210809	2048	-	F	Correction to 5GS Non-3GPP Access Test Case 9.2.4.1	16.7.0
2021-03	RAN#91	R5-210810	2049	-	F	Correction to 5GS Non-3GPP Access Test Case 9.2.5.1.4	16.7.0
2021-03	RAN#91	R5-210880	2051	-	F	Correction to MultipleCoreset test case	16.7.0
2021-03	RAN#91	R5-211022	2056	-	F	Update to idle mode test cases 6.2.1.2, 6.2.1.3, 6.4.3.1	16.7.0
2021-03	RAN#91	R5-211173	2059	-	F	Correction NR RRC idle mode test case 6.1.2.14	16.7.0
2021-03	RAN#91	R5-211234	2060	-	F	Update to NR RRC UE capability transfer test case 8.1.5.1.1	16.7.0
2021-03	RAN#91	R5-211246	2061	-	F	Update to MR-DC RRC UE capability transfer test case 8.2.1.1.1	16.7.0
2021-03	RAN#91	R5-211312	2064	-	F	Correction to NR5GC RRC test case 8.1.1.2.4	16.7.0
2021-03	RAN#91	R5-211313	2065	-	F	Addition of TC 7.1.1.3.11 - UL grant prioritization	16.7.0
2021-03	RAN#91	R5-211321	2069	-	F	Voiding 5GS Non-3GPP Access Test Case 9.2.5.2.1	16.7.0
2021-03	RAN#91	R5-211329	1993	1	F	Correction to test case 6.1.1.3	16.7.0
2021-03	RAN#91	R5-211330	1995	1	F	Correction to test case 6.1.2.8	16.7.0

2021-03	RAN#91	R5-211331	1996	1	F	Correction to test case 6.4.1.2	16.7.0
2021-03	RAN#91	R5-211332	1935	1	F	Correction of NR RRC test case 8.1.4.1.5	16.7.0
2021-03	RAN#91	R5-211333	1992	1	F	Removing test case 9.1.5.2.9	16.7.0
2021-03	RAN#91	R5-211358	2070	-	F	Adding new test cases of SCell Dormancy Indication for UE power saving in NR	16.7.0
2021-03	RAN#91	R5-211377	1942	1	F	Editorial changes to 38.523-1 Section 6	16.7.0
2021-03	RAN#91	R5-211378	1968	1	F	Correction to NR5G Idle mode TCs	16.7.0
2021-03	RAN#91	R5-211379	2007	1	F	Correction to NR TC 6.3.1.1-SoR security check successful	16.7.0
2021-03	RAN#91	R5-211380	2008	1	F	Correction to NR TC 6.3.1.2-SoR ACK has NOT requested	16.7.0
2021-03	RAN#91	R5-211381	2066	1	F	Remove Idle Mode test case 6.2.3.9	16.7.0
2021-03	RAN#91	R5-211382	1931	1	F	Correction to NR MAC test case 7.1.1.8.1	16.7.0
2021-03	RAN#91	R5-211383	1943	1	F	Editorial changes to 38.523-1 Section 7	16.7.0
2021-03	RAN#91	R5-211384	2012	1	F	Correction to NR TC 7.1.1.2.2-PDSCH Aggregate	16.7.0
2021-03	RAN#91	R5-211385	2013	1	F	Correction to NR TC 7.1.1.3.8.X-PHR report	16.7.0
2021-03	RAN#91	R5-211386	2014	1	F	Correction to NR TC 7.1.2.3.3 and 7.1.2.3.4-RLC SN sequence	16.7.0
2021-03	RAN#91	R5-211387	2015	1	F	Correction to NR TC 7.1.3.1.1 and 7.1.3.1.2-PDCP SN sequence	16.7.0
2021-03	RAN#91	R5-211388	2054	1	F	Update to NR RRC test case 8.1.1.3.2	16.7.0
2021-03	RAN#91	R5-211389	1967	1	F	Correction to NR5G TCs 8.1.X on SINR reporting	16.7.0
2021-03	RAN#91	R5-211390	2016	1	F	Correction to NR test case 8.1.3.1.13-CSI-RS based intra-freq measure	16.7.0
2021-03	RAN#91	R5-211391	1940	1	F	Correction of NR CA TC 8.1.4.1.9.x	16.7.0
2021-03	RAN#91	R5-211392	2020	1	F	Correction to NR TC 8.1.5.8.1-Latency check	16.7.0
2021-03	RAN#91	R5-211393	2021	1	F	Addition of NR TC 8.1.5.8.2.1-intra-band SCell Latency check	16.7.0
2021-03	RAN#91	R5-211394	2062	1	F	Correction to test case 8.1.5.1.1	16.7.0
2021-03	RAN#91	R5-211395	2063	1	F	Correction to test case 8.2.1.1.1	16.7.0
2021-03	RAN#91	R5-211396	1979	1	F	Correction to MR-DC test case 8.2.3.7.1	16.7.0
2021-03	RAN#91	R5-211397	2000	1	F	Correction to NR-DC RRC test case 8.2.3.14.2	16.7.0
2021-03	RAN#91	R5-211398	1953	1	F	Addition of NR-DC RRC TC 8.2.5.3.2	16.7.0
2021-03	RAN#91	R5-211399	1954	1	F	Addition of NR-DC RRC TC 8.2.5.4.2	16.7.0
2021-03	RAN#91	R5-211400	1970	1	F	Correction to NR-DC RRC TC 8.2.5.1.2	16.7.0
2021-03	RAN#91	R5-211401	2027	1	F	Correction to NR-DC TC 8.2.6.1.2.1-RLC failure	16.7.0
2021-03	RAN#91	R5-211402	1914	1	F	Addition of new 5GS NAS test case to test handling of extended octets	16.7.0
2021-03	RAN#91	R5-211403	2053	1	F	Correction to NR TC 9.1.8.1-SMS	16.7.0
2021-03	RAN#91	R5-211404	2042	1	F	Correction to 5GMM Inter-system mobility test case 9.3.1.2	16.7.0
2021-03	RAN#91	R5-211405	2055	1	F	Update of Inter system mobility test case 9.3.1.1	16.7.0
2021-03	RAN#91	R5-211406	2028	1	F	Correction to NR TC 11.1.3-EPS Fallback with handover	16.7.0
2021-03	RAN#91	R5-211407	2068	1	F	Correction to EPS FallBack test cases 11.1.X	16.7.0
2021-03	RAN#91	R5-211408	1969	1	F	Correction to NR5G UAC TC 11.3.4	16.7.0
2021-03	RAN#91	R5-211409	2057	1	F	Update of UAC test case 11.3.6	16.7.0
2021-03	RAN#91	R5-211410	2067	1	F	Correction to NR5GC UAC test case 11.3.7	16.7.0
2021-03	RAN#91	R5-211411	1976	1	F	Correction to 11.4.2 and 11.4.3	16.7.0
2021-03	RAN#91	R5-211454	2041	1	F	Corrections to DL Multi SPS test case	16.7.0
2021-03	RAN#91	R5-211458	2038	1	F	Addition of NR TC 8.1.4.4.1-Conditional handover Success	16.7.0
2021-03	RAN#91	R5-211459	2039	1	F	Addition of NR TC 8.1.4.4.2 -Conditional handover modify conditional handover configuration	16.7.0
2021-03	RAN#91	R5-211460	2040	1	F	Addition of NR TC 8.1.4.4.3-Conditional handover Failure	16.7.0
2021-03	RAN#91	R5-211470	1917	1	F	Addition of new MDT test case 8.1.6.1.2.1	16.7.0
2021-03	RAN#91	R5-211471	1918	1	F	Addition of new MDT test case 8.1.6.1.2.2	16.7.0
2021-03	RAN#91	R5-211472	1919	1	F	Addition of new MDT test case 8.1.6.1.2.3	16.7.0
2021-03	RAN#91	R5-211473	1923	1	F	Addition of new MDT test case 8.1.6.1.2.7	16.7.0
2021-03	RAN#91	R5-211474	1924	1	F	Addition of new MDT test case 8.1.6.1.2.8	16.7.0
2021-03	RAN#91	R5-211475	1928	1	F	Addition of new MDT test case 8.1.6.1.2.12	16.7.0
2021-03	RAN#91	R5-211476	1929	1	F	Addition of new MDT test case 8.1.6.1.2.13	16.7.0
2021-03	RAN#91	R5-211477	1937	1	F	Addition of new test case 8.1.6.1.1.1 for NR Immediate MDT	16.7.0
2021-03	RAN#91	R5-211478	1938	1	F	Addition of new test case 8.1.6.1.1.2 for NR L2 measurement	16.7.0
2021-03	RAN#91	R5-211479	2030	1	F	Addition of MDT TC 8.1.6.1.4.3-CEF-intra-NR handover	16.7.0
2021-03	RAN#91	R5-211480	2031	1	F	Addition of MDT TC 8.1.6.1.4.4-CEF-RRC re-establishment	16.7.0
2021-03	RAN#91	R5-211481	2032	1	F	Addition of MDT TC 8.1.6.1.4.5-CEF-location info	16.7.0
2021-03	RAN#91	R5-211482	2033	1	F	Addition of MDT TC 8.1.6.1.4.6-CEF-intra-freq measurements	16.7.0

2021-03	RAN#91	R5-211483	2034	1	F	Addition of MDT TC 8.1.6.1.4.7-CEF-inter-freq measurements	16.7.0
2021-03	RAN#91	R5-211484	2035	1	F	Addition of MDT TC 8.1.6.1.4.8-CEF-rach failure	16.7.0
2021-03	RAN#91	R5-211485	2043	1	F	Addition of new MDT TC 8.1.6.1.3.1	16.7.0
2021-03	RAN#91	R5-211486	2045	1	F	Addition of new MDT TC 8.1.6.1.3.3	16.7.0
2021-03	RAN#91	R5-211493	1984	1	F	Addition of a new test case for 5G-SRVCC from NG-RAN to 3GPP UTRAN	16.7.0
2021-03	RAN#91	R5-211494	2036	1	F	Addition of 5G SRVCC TC 8.1.3.2.6-NR to UMTS Inter-RAT measurements-Event B1	16.7.0
2021-03	RAN#91	R5-211495	2037	1	F	Addition of 5G SRVCC TC 8.1.3.2.7-NR to UMTS Inter-RAT measurements-Event B2	16.7.0
2021-03	RAN#91	R5-211500	1916	1	F	Update test case 8.1.5.1.1 to add UE capability nr-HO-ToEN-DC-r16	16.7.0
2021-03	RAN#91	R5-211501	1915	1	F	Update of test case 8.2.1.1.1 to support Inter-RAT handover from NR to EN-DC	16.7.0
2021-03	RAN#91	R5-211502	2047	1	F	Correction to 5GS Non-3GPP Access Test Case 9.2.2.2	16.7.0
2021-03	RAN#91	R5-211503	1963	1	F	Introduction of a new test case for voice fallback indication under EPS Fallback with handover	16.7.0
2021-03	RAN#91	R5-211547	1956	1	F	Correction to EPS Fallback Test Case 11.1.1	16.7.0
2021-06	RAN#92	R5-212046	2076	-	F	Update test case 8.1.2.1.5.1	16.8.0
2021-06	RAN#92	R5-212079	2077	-	F	Correction to NR-DC RRC TC 8.2.5.2.2	16.8.0
2021-06	RAN#92	R5-212084	2080	-	F	Correction to Idle mode TC 6.4.2.1	16.8.0
2021-06	RAN#92	R5-212085	2081	-	F	Update of RSRP threshold in MAC TC 7.1.1.1.4	16.8.0
2021-06	RAN#92	R5-212086	2082	-	F	Update of servCellIndex in MAC TC 7.1.1.6.1 and 7.1.1.6.4	16.8.0
2021-06	RAN#92	R5-212087	2083	-	F	Update of cnType in RRC TC 8.1.1.3.2	16.8.0
2021-06	RAN#92	R5-212088	2084	-	F	Update of RRC message in RRC TC 8.1.1.3.3	16.8.0
2021-06	RAN#92	R5-212089	2085	-	F	Update of RSRP threshold in RRC TC 8.1.3.1.14A and 8.1.3.1.18.1	16.8.0
2021-06	RAN#92	R5-212090	2086	-	F	Update of MeasurementReport in RRC TC 8.1.3.1.20	16.8.0
2021-06	RAN#92	R5-212091	2087	-	F	Update of RRC messages in RRC TC 8.1.3.1.21, 8.1.3.3.1 and 8.1.3.3.2	16.8.0
2021-06	RAN#92	R5-212092	2088	-	F	Update of RRC message in RRC TC 8.1.4.1.9.1	16.8.0
2021-06	RAN#92	R5-212093	2089	-	F	Update of TAU Req for I-RAT TC 8.1.4.2.1.1	16.8.0
2021-06	RAN#92	R5-212094	2090	-	F	Update of RRC message in RRC TC 8.1.5.6.1	16.8.0
2021-06	RAN#92	R5-212095	2091	-	F	Correction of MR-DC RRC TC 8.2.3.1.1	16.8.0
2021-06	RAN#92	R5-212096	2092	-	F	Editorial correction of MR-DC RRC TC 8.2.3.6.1b and 8.2.3.7.1	16.8.0
2021-06	RAN#92	R5-212098	2094	-	F	Update of RSRP threshold in MR-DC RRC TC 8.2.3.8.1a and 8.2.3.15.1	16.8.0
2021-06	RAN#92	R5-212100	2096	-	F	Update of RSRP threshold in MR-DC RRC 8.2.4.3.1.3	16.8.0
2021-06	RAN#92	R5-212101	2097	-	F	Update of SMS over NAS TC 9.1.8.1	16.8.0
2021-06	RAN#92	R5-212106	2100	-	F	Editorial update TP of MDT TC 8.1.6.1.3.2	16.8.0
2021-06	RAN#92	R5-212107	2101	-	F	Update of RRC messages in MDT TC 8.1.6.1.2.7, 8.1.6.1.2.8, and 8.1.6.1.4.8	16.8.0
2021-06	RAN#92	R5-212113	2106	-	F	Update of EPSFB TC 11.1.8	16.8.0
2021-06	RAN#92	R5-212115	2107	-	F	Correction to test case 8.1.6.1.4.3	16.8.0
2021-06	RAN#92	R5-212116	2108	-	F	Correction to test case 8.1.6.1.4.8	16.8.0
2021-06	RAN#92	R5-212118	2109	-	F	Correction to NSSAI Test Case 9.1.5.1.3	16.8.0
2021-06	RAN#92	R5-212130	2111	-	F	Addition of 5G SRVCC TC 8.1.3.2.8-NR to UMTS Inter-RAT measurements-Periodic reporting	16.8.0
2021-06	RAN#92	R5-212155	2114	-	F	Editorial update of EPS Fallback test cases	16.8.0
2021-06	RAN#92	R5-212156	2115	-	F	Correction of TC 11.4.8 Handling of Local and extended emergency numbers	16.8.0
2021-06	RAN#92	R5-212159	2116	-	F	Update test case 9.3.1.2	16.8.0
2021-06	RAN#92	R5-212173	2117	-	F	Removal of technical content in 38.523-1 v15.4.0 and substitution with pointer to the next Release	16.8.0
2021-06	RAN#92	R5-212368	2128	-	F	Correction to NR Idle mode test case 6.4.3.1	16.8.0
2021-06	RAN#92	R5-212369	2129	-	F	Correction to NR Idle mode test case 6.2.3.4	16.8.0
2021-06	RAN#92	R5-212370	2130	-	F	Correction to NR PDCP test case 7.1.3.2.x	16.8.0
2021-06	RAN#92	R5-212371	2131	-	F	Correction to NR PDCP test case 7.1.3.3.x	16.8.0
2021-06	RAN#92	R5-212374	2134	-	F	Correction to NR5G IRAT test case 8.1.4.2.2.1	16.8.0
2021-06	RAN#92	R5-212383	2138	-	F	Correction of TC 11.4.10 N26 interface not supported - N1 to S1 transfer of an existing emergency PDU session	16.8.0
2021-06	RAN#92	R5-212384	2139	-	F	Correction of TC 11.4.11 N26 interface not supported - S1 to N1 transfer of an existing emergency PDN connection	16.8.0

2021-06	RAN#92	R5-212392	2142	-	F	Updates to NR-DC MAC TC 7.1.1.11.1	16.8.0
2021-06	RAN#92	R5-212393	2143	-	F	Updates to NR-DC RRC test cases for SysInfo combination	16.8.0
2021-06	RAN#92	R5-212411	2146	-	F	Correction to NR TC 6.1.2.2-Cell Selection Qqualmin	16.8.0
2021-06	RAN#92	R5-212413	2148	-	F	Correction to NR TC 6.3.1.7-Emergency service pending to be activated	16.8.0
2021-06	RAN#92	R5-212415	2150	-	F	Correction to NR TC 7.1.1.5.4-DRX command MAC control element reception	16.8.0
2021-06	RAN#92	R5-212417	2152	-	F	Correction to NR TC 7.1.3.3.1-Ciphering and deciphering SNOW3G	16.8.0
2021-06	RAN#92	R5-212420	2155	-	F	Correction to NR TC 8.1.5.8.1-Latency check	16.8.0
2021-06	RAN#92	R5-212424	2159	-	F	Correction to NR TC 11.1.2-EPS Fallback with redirection without N26	16.8.0
2021-06	RAN#92	R5-212425	2160	-	F	Correction to NR TC 11.1.4-Fallback with redirection	16.8.0
2021-06	RAN#92	R5-212431	2166	-	F	Correction to NR TC 11.3.8-UAC AIO Cell re-selection while T390 is running	16.8.0
2021-06	RAN#92	R5-212494	2176	-	F	Addition of NR MDT TC 8.1.6.3.1.3-inter system immediate-sensor	16.8.0
2021-06	RAN#92	R5-212495	2177	-	F	Addition of NR MDT TC 8.1.6.3.2.1-inter system logged-bluetooth	16.8.0
2021-06	RAN#92	R5-212538	2188	-	F	Remove MAC cross slot scheduling test cases	16.8.0
2021-06	RAN#92	R5-212763	2207	-	F	Editorial updates to NR5G Idle Mode Test Case 6.1.2.23	16.8.0
2021-06	RAN#92	R5-212764	2208	-	F	Void NR5G Idle Mode Test Cases 6.3.1.6, 6.1.2.6 and 6.1.2.10	16.8.0
2021-06	RAN#92	R5-212767	2211	-	F	Void NR5G RRC Test Case 8.1.5.2.1	16.8.0
2021-06	RAN#92	R5-212791	2222	-	F	Addition of NR5G RRC Test Case 8.1.1.3.7	16.8.0
2021-06	RAN#92	R5-212847	2233	-	F	Update of test case titles of 5GC	16.8.0
2021-06	RAN#92	R5-213064	2238	-	F	Addition of NR-DC TC 8.2.2.3.2-SRB3 and split SRB	16.8.0
2021-06	RAN#92	R5-213078	2242	-	F	Update test case 8.2.4.2.1.1	16.8.0
2021-06	RAN#92	R5-213108	2247	-	F	Correction to 5GMM test case 9.1.5.1.3	16.8.0
2021-06	RAN#92	R5-213111	2249	-	F	Correction to EN-DC SM Test case 10.2.2.1	16.8.0
2021-06	RAN#92	R5-213112	2250	-	F	Update to NR RRC test cases 8.1.1.1.1 and 8.1.1.1.2	16.8.0
2021-06	RAN#92	R5-213113	2251	-	F	Update to NR RRC test cases 8.1.3.1.23	16.8.0
2021-06	RAN#92	R5-213117	2252	-	F	Correction of NR test cases 9.1.5.1.3a	16.8.0
2021-06	RAN#92	R5-213121	2254	-	F	Editorial Correction to NR RRC test case 8.1.5.1.1	16.8.0
2021-06	RAN#92	R5-213132	2255	-	F	Correction to NR MAC test case 7.1.1.9.1	16.8.0
2021-06	RAN#92	R5-213161	2256	-	F	Update test case 10.2.1.1	16.8.0
2021-06	RAN#92	R5-213163	2257	-	F	Correction to test case 6.4.1.2	16.8.0
2021-06	RAN#92	R5-213164	2258	-	F	Update test case 10.2.1.2	16.8.0
2021-06	RAN#92	R5-213185	2262	-	F	New MAC test case on 2-Step RACH	16.8.0
2021-06	RAN#92	R5-213186	2263	-	F	New MAC test case on 2-Step RACH Explicitly signalled	16.8.0
2021-06	RAN#92	R5-213277	2270	-	F	Editorial correction to NR RRC test case 8.1.2.1.1	16.8.0
2021-06	RAN#92	R5-213349	2271	-	F	Correction to NR Idle mode SOR test case 6.3.1.1	16.8.0
2021-06	RAN#92	R5-213384	2273	-	F	Update of CellGroupConfig for RRC TC 8.1.4.1.8.1	16.8.0
2021-06	RAN#92	R5-213401	2274	-	F	Addition of unrestricted nr PDN parameter for Idle Mode TCs	16.8.0
2021-06	RAN#92	R5-213402	2275	-	F	Addition of unrestricted nr PDN parameter for RRC Connection Management Procedures TCs	16.8.0
2021-06	RAN#92	R5-213403	2276	-	F	Addition of unrestricted nr PDN parameter for RRC Handover TCs	16.8.0
2021-06	RAN#92	R5-213404	2277	-	F	Addition of unrestricted nr PDN parameter for RRC Others TCs	16.8.0
2021-06	RAN#92	R5-213410	2125	1	F	Corrections to NR MAC TC 7.1.1.3.9	16.8.0
2021-06	RAN#92	R5-213411	2153	1	F	Correction to NR TC 8.1.3.1.13-SS/PBCH block and CSI-RS based intra-frequency measurements	16.8.0
2021-06	RAN#92	R5-213412	2156	1	F	Correction to ENDC TC 8.2.2.3.1-SRB3 and Split SRB	16.8.0
2021-06	RAN#92	R5-213413	2135	1	F	Correction to 5GMM test case 9.1.5.1.15	16.8.0
2021-06	RAN#92	R5-213422	2174	1	F	Correction to 5G-SRVCC TC 8.1.3.2.6-MkHz typo	16.8.0
2021-06	RAN#92	R5-213455	2147	1	F	Correction to NR TC 6.2.3.4-N2L cell reselection	16.8.0
2021-06	RAN#92	R5-213456	2203	1	F	Addition of new test case 6.3.1.10	16.8.0
2021-06	RAN#92	R5-213457	2234	1	F	Update of clearing RPLMN in Idle mode TCs	16.8.0
2021-06	RAN#92	R5-213458	2149	1	F	Correction to NR TC 7.1.1.3.2b-Logical channel prioritization	16.8.0
2021-06	RAN#92	R5-213459	2221	1	F	Corrections to NR5G MAC BWP TC 7.1.1.8.1	16.8.0
2021-06	RAN#92	R5-213460	2144	1	F	Correction to RLC TCs to clarify reception of UL PDUs	16.8.0
2021-06	RAN#92	R5-213461	2132	1	F	Correction to NR PDCP test case 7.1.3.5.5	16.8.0
2021-06	RAN#92	R5-213462	2145	1	F	Correction to PDCP TCs to clarify reception of UL PDUs	16.8.0
2021-06	RAN#92	R5-213463	2133	1	F	Correction of NR RRC test case 8.1.1.3.2	16.8.0

2021-06	RAN#92	R5-213464	2209	1	F	Editorial Updates to NR5G RRC Test Cases 8.1.1.2.1, 8.1.1.3.3 and 8.1.1.3.4	16.8.0
2021-06	RAN#92	R5-213465	2210	1	F	Updates to NR5G RRC Test Case 8.1.1.4.1	16.8.0
2021-06	RAN#92	R5-213466	2237	1	F	Correction to NR SA TC 8.1.1.2.1-T300 expiry	16.8.0
2021-06	RAN#92	R5-213467	2246	1	F	Correction to test case RRC NR5GC TC 8.1.1.2.4	16.8.0
2021-06	RAN#92	R5-213468	2260	1	F	Correction to test case 8.2.1.1.1	16.8.0
2021-06	RAN#92	R5-213469	2119	1	F	Update test case 8.2.4.1	16.8.0
2021-06	RAN#92	R5-213470	2127	1	F	Update test case 8.2.2.5.1	16.8.0
2021-06	RAN#92	R5-213471	2137	1	F	Update test case 8.2.2.6.1	16.8.0
2021-06	RAN#92	R5-213472	2205	1	F	Correction to MR-DC RRC test case 8.2.2.2.1	16.8.0
2021-06	RAN#92	R5-213473	2272	1	F	Correction to NR CA RRC test cases 8.1.3.1.18.x	16.8.0
2021-06	RAN#92	R5-213474	2093	1	F	Correction to MR-DC RRC TC 8.2.3.9.1 and 8.2.3.10.1	16.8.0
2021-06	RAN#92	R5-213476	2216	1	F	Update test case 8.2.3.1.1	16.8.0
2021-06	RAN#92	R5-213477	2217	1	F	Update test case 8.2.3.2.1	16.8.0
2021-06	RAN#92	R5-213478	2218	1	F	Update test case 8.2.3.3.1	16.8.0
2021-06	RAN#92	R5-213479	2219	1	F	Update test case 8.2.3.12.1	16.8.0
2021-06	RAN#92	R5-213480	2126	1	F	Correction to NR CA test case 8.2.4.3.1.1	16.8.0
2021-06	RAN#92	R5-213481	2253	1	F	Correction to NR RRC testcase 8.1.5.4.1	16.8.0
2021-06	RAN#92	R5-213482	2259	1	F	Correction to test case 8.1.5.1.1	16.8.0
2021-06	RAN#92	R5-213483	2223	1	F	Addition of NRDC Test Case 8.2.6.2.2	16.8.0
2021-06	RAN#92	R5-213484	2245	1	F	Update test case 8.2.6.2.1	16.8.0
2021-06	RAN#92	R5-213485	2110	1	F	Correction of TC 9.1.5.1.15	16.8.0
2021-06	RAN#92	R5-213486	2157	1	F	Correction to NR TC 9.1.5.2.2-Periodic registration update accepted	16.8.0
2021-06	RAN#92	R5-213487	2158	1	F	Correction to NR TC 9.1.5.2.4-Mobility registration update	16.8.0
2021-06	RAN#92	R5-213488	2113	1	F	Update test case 9.3.1.1	16.8.0
2021-06	RAN#92	R5-213489	2120	1	F	Update test case 9.3.1.3	16.8.0
2021-06	RAN#92	R5-213490	2187	1	F	Correction to NR TC 10.1.4.1-T3580	16.8.0
2021-06	RAN#92	R5-213491	2278	1	F	Updates to test case 10.2.2.1	16.8.0
2021-06	RAN#92	R5-213492	2121	1	F	Update test case 11.1.1	16.8.0
2021-06	RAN#92	R5-213493	2122	1	F	Update test case 11.1.2	16.8.0
2021-06	RAN#92	R5-213494	2140	1	F	Update test case 11.1.3	16.8.0
2021-06	RAN#92	R5-213495	2141	1	F	Update test case 11.1.4	16.8.0
2021-06	RAN#92	R5-213496	2161	1	F	Correction to NR TC 11.1.5-Fallback with redirection without N26	16.8.0
2021-06	RAN#92	R5-213497	2162	1	F	Correction to NR TC 11.1.7-Emergency Services Fallback to EPS with redirection	16.8.0
2021-06	RAN#92	R5-213498	2204	1	F	Update test case 11.1.5	16.8.0
2021-06	RAN#92	R5-213499	2206	1	F	Update test case 11.1.6	16.8.0
2021-06	RAN#92	R5-213500	2213	1	F	Update test case 11.1.7	16.8.0
2021-06	RAN#92	R5-213501	2136	1	F	Correction to UAC test case 11.3.8	16.8.0
2021-06	RAN#92	R5-213502	2163	1	F	Correction to NR TC 11.3.1-UAC AI0 with 0 percentage access probability	16.8.0
2021-06	RAN#92	R5-213503	2165	1	F	Correction to NR TC 11.3.5-UAC AI1 MPS	16.8.0
2021-06	RAN#92	R5-213504	2220	1	F	Corrections to NR5G UAC TC 11.3.7	16.8.0
2021-06	RAN#92	R5-213505	2224	1	F	Corrections to NR5G UAC TC 11.3.2	16.8.0
2021-06	RAN#92	R5-213506	2239	1	F	Correction to NR TC 11.3.6-UAC AI2 MCS	16.8.0
2021-06	RAN#92	R5-213507	2243	1	F	Correction to NR5GC testcase 11.3.9	16.8.0
2021-06	RAN#92	R5-213508	2169	1	F	Correction to NR TC 11.4.4-Emergency call establishment before T3396 expiry	16.8.0
2021-06	RAN#92	R5-213510	2171	1	F	Correction to NR TC 11.4.6-Handling of non-allowed tracking areas	16.8.0
2021-06	RAN#92	R5-213512	2241	1	F	Correction to NR TC 11.4.1-Emergency Call with Network failing the authentication check	16.8.0
2021-06	RAN#92	R5-213553	2112	1	F	Addition of NR TC 8.1.4.3.4 for Mobility Enhancement Inter-frequency DAPS handover	16.8.0
2021-06	RAN#92	R5-213554	2173	1	F	Correction to NR TC 8.1.4.3.1-DAPS handover Success	16.8.0
2021-06	RAN#92	R5-213555	2236	1	F	Addition to NR TC 7.1.3.4.3-PDCP DAPS handover for Intra-frequency	16.8.0
2021-06	RAN#92	R5-213570	2268	1	B	Addition of NR V2X test case 12.1.7.1	16.8.0
2021-06	RAN#92	R5-213576	2228	1	F	Addition of Rel-16 NPN TC 6.5.1.2	16.8.0
2021-06	RAN#92	R5-213577	2229	1	F	Addition of Rel-16 NPN TC 6.5.2.2	16.8.0
2021-06	RAN#92	R5-213578	2230	1	F	Addition of Rel-16 NPN TC 6.5.1.1	16.8.0
2021-06	RAN#92	R5-213579	2231	1	F	Addition of Rel-16 NPN TC 6.5.2.1	16.8.0

2021-06	RAN#92	R5-213583	2225	1	F	Addition of Rel-16 RACS RRC TC 8.1.5.9.1	16.8.0
2021-06	RAN#92	R5-213584	2226	1	F	Addition of Rel-16 RACS TC 9.1.9.5	16.8.0
2021-06	RAN#92	R5-213585	2227	1	F	Addition of Rel-16 RACS TC 9.1.9.1	16.8.0
2021-06	RAN#92	R5-213603	2072	1	F	Addition of new test case 8.1.6.1.4.1 for Connection Establishment Failure	16.8.0
2021-06	RAN#92	R5-213604	2073	1	F	Addition of new test case 8.1.6.1.4.2 for Connection Establishment Failure	16.8.0
2021-06	RAN#92	R5-213605	2074	1	F	Addition of new test case 8.1.6.3.1.1 for Bluetooth measurement collection in Immediate MDT	16.8.0
2021-06	RAN#92	R5-213606	2075	1	F	Addition of new test case 8.1.6.3.1.2 for WLAN measurement collection in Immediate MDT	16.8.0
2021-06	RAN#92	R5-213607	2099	1	F	Update of MDT TC 8.1.6.1.3.1	16.8.0
2021-06	RAN#92	R5-213608	2102	1	F	Addition of new MDT TC 8.1.6.1.3.4	16.8.0
2021-06	RAN#92	R5-213609	2103	1	F	Addition of new MDT TC 8.1.6.1.3.5	16.8.0
2021-06	RAN#92	R5-213610	2104	1	F	Addition of new MDT TC 8.1.6.1.3.6	16.8.0
2021-06	RAN#92	R5-213611	2105	1	F	Addition of new MDT TC 8.1.6.1.3.7	16.8.0
2021-06	RAN#92	R5-213612	2178	1	F	Addition of NR MDT TC 8.1.6.3.2.2-inter system logged-WLAN	16.8.0
2021-06	RAN#92	R5-213613	2179	1	F	Addition of NR MDT TC 8.1.6.3.2.3-inter system logged-sensor	16.8.0
2021-06	RAN#92	R5-213614	2180	1	F	Addition of NR MDT TC 8.1.6.3.3.1-inter system RLF-blutetooth	16.8.0
2021-06	RAN#92	R5-213615	2181	1	F	Addition of NR MDT TC 8.1.6.3.3.2-inter system RLF-WLAN	16.8.0
2021-06	RAN#92	R5-213616	2182	1	F	Addition of NR MDT TC 8.1.6.3.3.3-inter system RLF-sensor	16.8.0
2021-06	RAN#92	R5-213617	2183	1	F	Correction to NR MDT TC 8.1.6.1.4.4-CEF-RRC re-establishment	16.8.0
2021-06	RAN#92	R5-213618	2184	1	F	Correction to NR MDT TC 8.1.6.1.4.5-CEF-location info	16.8.0
2021-06	RAN#92	R5-213619	2185	1	F	Correction to NR MDT TC 8.1.6.1.4.6-CEF-intra-freq measurements	16.8.0
2021-06	RAN#92	R5-213620	2186	1	F	Correction to NR MDT TC 8.1.6.1.4.7-CEF-inter-freq measurements	16.8.0
2021-06	RAN#92	R5-213621	2189	1	F	Update of MDT test case 8.1.6.1.2.1	16.8.0
2021-06	RAN#92	R5-213622	2190	1	F	Update of MDT test case 8.1.6.1.2.2	16.8.0
2021-06	RAN#92	R5-213623	2191	1	F	Update of MDT test case 8.1.6.1.2.3	16.8.0
2021-06	RAN#92	R5-213624	2192	1	F	Update of MDT test case 8.1.6.1.2.4	16.8.0
2021-06	RAN#92	R5-213625	2193	1	F	Update of MDT test case 8.1.6.1.2.5	16.8.0
2021-06	RAN#92	R5-213626	2194	1	F	Update of MDT test case 8.1.6.1.2.6	16.8.0
2021-06	RAN#92	R5-213627	2195	1	F	Update of MDT test case 8.1.6.1.2.7	16.8.0
2021-06	RAN#92	R5-213628	2196	1	F	Update of MDT test case 8.1.6.1.2.8	16.8.0
2021-06	RAN#92	R5-213629	2197	1	F	Update of MDT test case 8.1.6.1.2.9	16.8.0
2021-06	RAN#92	R5-213630	2198	1	F	Update of MDT test case 8.1.6.1.2.10	16.8.0
2021-06	RAN#92	R5-213631	2199	1	F	Update of MDT test case 8.1.6.1.2.11	16.8.0
2021-06	RAN#92	R5-213632	2200	1	F	Update of MDT test case 8.1.6.1.2.12	16.8.0
2021-06	RAN#92	R5-213633	2201	1	F	Update of MDT test case 8.1.6.1.2.13	16.8.0
2021-06	RAN#92	R5-213637	2267	1	F	New MAC test case for NR URLLC	16.8.0
2021-06	RAN#92	R5-213647	2214	1	F	Update test case 11.1.8	16.8.0
2021-06	RAN#92	R5-213648	2215	1	F	Update test case 11.1.9	16.8.0
2021-06	RAN#92	R5-213673	2079	1	F	Correction to Idle mode TC 6.1.1.1, 6.1.1.5 and 6.1.1.6	16.8.0
2021-09	RAN#93	R5-214208	2279	-	F	Addition of new test case 7.1.1.6.5 for Multi configured uplink grants in NR IIoT	16.9.0
2021-09	RAN#93	R5-214390	2284	-	F	Add test case 8.1.1.4.4	16.9.0
2021-09	RAN#93	R5-214391	2285	-	F	Add test case 8.1.1.4.5	16.9.0
2021-09	RAN#93	R5-214392	2286	-	F	Add test case 8.1.1.4.6	16.9.0
2021-09	RAN#93	R5-214433	2289	-	F	Add test case 8.1.1.4.7	16.9.0
2021-09	RAN#93	R5-214434	2290	-	F	Add test case 8.1.1.4.8	16.9.0
2021-09	RAN#93	R5-214435	2291	-	F	Add test case 8.1.1.4.9	16.9.0
2021-09	RAN#93	R5-214512	2296	-	F	Editorial changes of the title for subclause 8.1.6.3.2 and 8.1.6.3.3 in Inter-System MDT	16.9.0
2021-09	RAN#93	R5-214547	2297	-	F	Update of RSRP threshold for RRC TC 8.1.3.1.13	16.9.0
2021-09	RAN#93	R5-214548	2298	-	F	Correction of 5GMM TC 9.1.5.1.8	16.9.0
2021-09	RAN#93	R5-214550	2300	-	F	Update of MDT TC 8.1.6.1.3.2	16.9.0
2021-09	RAN#93	R5-214587	2303	-	F	Correction to NR MAC test cases 7.1.1.7.1.x	16.9.0
2021-09	RAN#93	R5-214588	2304	-	F	Correction to NR MAC test case 7.1.1.4.2.3	16.9.0
2021-09	RAN#93	R5-214591	2307	-	F	Correction to NR RRC test case 8.1.1.2.3	16.9.0
2021-09	RAN#93	R5-214592	2308	-	F	Correction to NR RRC test case 8.1.1.4.1	16.9.0

2021-09	RAN#93	R5-214593	2309	-	F	Correction to EPS fallback test case 11.1.4	16.9.0
2021-09	RAN#93	R5-214614	2312	-	F	Updates to NR CA test cases 8.1.3.1.18.x	16.9.0
2021-09	RAN#93	R5-214615	2313	-	F	Updates to NR CA test cases 8.1.4.1.8.x	16.9.0
2021-09	RAN#93	R5-214616	2314	-	F	Updates to NR CA test cases 8.1.5.6.5.x	16.9.0
2021-09	RAN#93	R5-214617	2315	-	F	Updates to NR CA test cases 8.1.5.7.1.x	16.9.0
2021-09	RAN#93	R5-214618	2316	-	F	Updates to NR CA test cases 8.1.5.8.2.x	16.9.0
2021-09	RAN#93	R5-214698	2319	-	F	Update of MDT TC 8.1.6.1.3.5	16.9.0
2021-09	RAN#93	R5-214703	2324	-	F	Correction of SIB1 for NR RRC TC 8.1.1.4.1	16.9.0
2021-09	RAN#93	R5-214704	2325	-	F	Correction of SIB1 for NR RRC TC 8.1.5.2.2	16.9.0
2021-09	RAN#93	R5-214707	2328	-	F	Update of TP for EPSFB TC 11.1.3	16.9.0
2021-09	RAN#93	R5-214708	2329	-	F	Update of TP for EPSFB TC 11.1.8	16.9.0
2021-09	RAN#93	R5-214739	2332	-	F	Updates to NR-DC RRC TC 8.2.6.2.2	16.9.0
2021-09	RAN#93	R5-214742	2335	-	F	Corrections to NR5G UAC TC 11.3.7	16.9.0
2021-09	RAN#93	R5-214746	2338	-	F	Update of Rel-16 NPN TC 6.5.2.2	16.9.0
2021-09	RAN#93	R5-214747	2339	-	F	Update of Rel-16 NPN TC 6.5.2.1	16.9.0
2021-09	RAN#93	R5-214749	2340	-	F	Correction to NR-DC RRC test case 8.2.2.4.2	16.9.0
2021-09	RAN#93	R5-214750	2341	-	F	Correction to NR-DC RRC test case 8.2.2.5.2	16.9.0
2021-09	RAN#93	R5-214751	2342	-	F	Correction to NR-DC RRC test case 8.2.2.9.2	16.9.0
2021-09	RAN#93	R5-214752	2343	-	F	Correction to NR-DC RRC test case 8.2.5.1.2	16.9.0
2021-09	RAN#93	R5-214753	2344	-	F	Correction to NR-DC RRC test case 8.2.5.3.2	16.9.0
2021-09	RAN#93	R5-214756	2346	-	F	Correction to MDT TC 8.1.6.1.1.1	16.9.0
2021-09	RAN#93	R5-214764	2352	-	F	Correction to NR TC 7.1.1.7.1.1-sCellDeactivationTimer	16.9.0
2021-09	RAN#93	R5-214767	2355	-	F	Correction to NR TC 8.1.1.3.7-Deprioritisation	16.9.0
2021-09	RAN#93	R5-214769	2357	-	F	Correction to NR TC 8.1.5.8.1-Latency check	16.9.0
2021-09	RAN#93	R5-214783	2369	-	F	Correction to NR TC 11.3.9-UAC for Operator Defined Access Category	16.9.0
2021-09	RAN#93	R5-214829	2386	-	F	Addition of MDT NR TC 8.1.6.3.4.2-Inter System_CEF_wlan	16.9.0
2021-09	RAN#93	R5-214830	2387	-	F	Addition of MDT NR TC 8.1.6.3.4.3-Inter System_CEF_sensor	16.9.0
2021-09	RAN#93	R5-214872	2400	-	F	Addition of new NR 2-step RACH test case 7.1.1.1.10	16.9.0
2021-09	RAN#93	R5-214890	2401	-	F	Void NR5G RRC TC 8.1.3.1.22	16.9.0
2021-09	RAN#93	R5-214894	2402	-	F	Editorial Updates to NR5G NPN TC 6.5.1.1	16.9.0
2021-09	RAN#93	R5-214895	2403	-	F	Updates to NR5G NPN TC 6.5.1.2	16.9.0
2021-09	RAN#93	R5-214899	2407	-	F	Addition of NR-DC TC 8.2.3.11.3	16.9.0
2021-09	RAN#93	R5-214946	2414	-	F	Addition of new NR 2-step RACH test case 7.1.1.1.9	16.9.0
2021-09	RAN#93	R5-215149	2427	-	F	Update to title of test case 8.1.3.1.23	16.9.0
2021-09	RAN#93	R5-215171	2431	-	F	Correction to NR MAC test case 7.1.1.9.1	16.9.0
2021-09	RAN#93	R5-215356	2437	-	F	Correction to 8.1.4.1.5	16.9.0
2021-09	RAN#93	R5-215404	2439	-	F	Correction to 5GMM TC 9.1.5.1.1	16.9.0
2021-09	RAN#93	R5-215407	2440	-	F	Correction to NR MAC test case 7.1.1.3.2	16.9.0
2021-09	RAN#93	R5-215437	2441	-	F	Update of specific message content for MAC TC 7.1.1.1.2	16.9.0
2021-09	RAN#93	R5-215507	2448	-	F	Update to test case 6.2.1.4	16.9.0
2021-09	RAN#93	R5-215578	2452	-	F	Resubmission of New MAC test case on 2-Step RACH	16.9.0
2021-09	RAN#93	R5-215579	2453	-	F	Resubmission of New MAC test case on 2-Step RACH Explicitly signalled	16.9.0
2021-09	RAN#93	R5-215671	2455	-	F	Addition of Rel-16 SNPN TC 9.1.10.2	16.9.0
2021-09	RAN#93	R5-215675	2456	-	F	Correction to NR TC 7.1.1.3.8.1-PHR report with Intra-band Contiguous CA	16.9.0
2021-09	RAN#93	R5-215677	2457	-	F	Addition of NR TC 8.2.3.18.1-Conditional PSCell change Success	16.9.0
2021-09	RAN#93	R5-215680	2458	-	F	Update of System information combination for NR-DC PDCP test cases	16.9.0
2021-09	RAN#93	R5-215681	2459	-	F	Corrections to Rel-16 MDT TC 8.1.6.1.4.4	16.9.0
2021-09	RAN#93	R5-215685	2460	-	F	Correction to NR testcase 8.1.5.4.1	16.9.0
2021-09	RAN#93	R5-215696	2462	-	F	Update of RRC messages for MAC TC 7.1.1.5.1 and 7.1.1.5.2	16.9.0
2021-09	RAN#93	R5-215697	2463	-	F	Update of RRC messages for MAC TC 7.1.1.3.11	16.9.0
2021-09	RAN#93	R5-215698	2464	-	F	Correction to NR TC 7.1.1.3.2b-Logical channel prioritization handling with Mapping restrictions	16.9.0
2021-09	RAN#93	R5-215699	2465	-	F	Correction to NR TC 6.4.1.2-Cell reselection of ePLMN in manual mode	16.9.0
2021-09	RAN#93	R5-215714	2429	1	F	Correction to SDAP TC 7.1.4.1	16.9.0
2021-09	RAN#93	R5-215715	2345	1	F	Correction to NR-DC RRC test case 8.2.5.2.2 and 8.2.5.4.2	16.9.0
2021-09	RAN#93	R5-215716	2406	1	F	Correction to NR5G NAS TC 9.1.5.1.3a	16.9.0

2021-09	RAN#93	R5-216162	2302	1	F	Correction to NR Idle mode test case 6.3.1.5	16.9.0
2021-09	RAN#93	R5-216163	2322	1	F	Correction of Srxlev for Idle TC 6.1.2.2	16.9.0
2021-09	RAN#93	R5-216164	2348	1	F	Correction to NR TC 6.2.3.10-Inter-RAT cell reselection schedulingInfoList-v12j0	16.9.0
2021-09	RAN#93	R5-216165	2349	1	F	Correction to NR TC 6.3.1.7-Emergency service pending to be activated	16.9.0
2021-09	RAN#93	R5-216166	2405	1	F	Corrections to Idle mode TC 6.2.3.10 and 6.2.3.11	16.9.0
2021-09	RAN#93	R5-216168	2442	1	F	Correction to Idle TC 6.3.1.10	16.9.0
2021-09	RAN#93	R5-216169	2331	1	F	Corrections to NR5G MAC BWP TC 7.1.1.8.1	16.9.0
2021-09	RAN#93	R5-216170	2424	1	F	Correction to NR MAC 7.1.1.4.x test cases	16.9.0
2021-09	RAN#93	R5-216171	2461	1	F	Corrections to NR MAC Recommended bit rate test case	16.9.0
2021-09	RAN#93	R5-216172	2426	1	F	Correction to the test cases 7.1.2.3.5 and 7.1.2.3.5a	16.9.0
2021-09	RAN#93	R5-216173	2305	1	F	Correction to NR PDCP test case 7.1.3.5.5	16.9.0
2021-09	RAN#93	R5-216174	2330	1	F	Updates to NR RRC TC 8.1.1.3.7	16.9.0
2021-09	RAN#93	R5-216175	2354	1	F	Correction to NR TC 8.1.1.2.1-T300 expired	16.9.0
2021-09	RAN#93	R5-216176	2466	1	F	Addition of NR5G RRC TC 8.1.1.3.7a	16.9.0
2021-09	RAN#93	R5-216177	2287	1	F	Correction to RRC reconfiguration Test Case 8.1.2.1.1	16.9.0
2021-09	RAN#93	R5-216178	2359	1	F	Addition of NR SA TC 8.1.3.1.19-SFTD	16.9.0
2021-09	RAN#93	R5-216179	2423	1	F	Update to NR RRC test cases 8.1.3.1.11 and 8.1.3.1.12	16.9.0
2021-09	RAN#93	R5-216180	2356	1	F	Correction to NR TC 8.1.4.1.9.1-Reestablish intra-band	16.9.0
2021-09	RAN#93	R5-216181	2358	1	F	Correction to NR-DC TC 8.2.2.3.2-Split SRB and SRB3	16.9.0
2021-09	RAN#93	R5-216182	2360	1	F	Addition of EN-DC TC 8.2.3.17.1-SFTD	16.9.0
2021-09	RAN#93	R5-216183	2361	1	F	Addition of NR-DC TC 8.2.3.17.2-SFTD	16.9.0
2021-09	RAN#93	R5-216184	2288	1	F	Correction to Carrier Aggregation Test Case 8.2.4.1.1.1	16.9.0
2021-09	RAN#93	R5-216185	2326	1	F	Correction of 5GMM capability for 5GMM TC 9.3.1.2	16.9.0
2021-09	RAN#93	R5-216186	2362	1	F	Correction to NR TC 10.1.1.1 and 10.3.1.1-PDU Establish Accept	16.9.0
2021-09	RAN#93	R5-216187	2327	1	F	Correction of 5GMM capability for EPSFB TC 11.1.7	16.9.0
2021-09	RAN#93	R5-216188	2363	1	F	Correction to NR TC 11.1.2-EPS Fallback from NR Idle	16.9.0
2021-09	RAN#93	R5-216189	2364	1	F	Correction to NR TC 11.1.5-EPS Fallback from NR connected	16.9.0
2021-09	RAN#93	R5-216190	2450	1	F	Correction to EPS FB Testcases 11.1.x for FR2	16.9.0
2021-09	RAN#93	R5-216191	2293	1	F	Corrections to NR5GC testcase 11.3.2	16.9.0
2021-09	RAN#93	R5-216192	2365	1	F	Correction to NR TC 11.3.1-UAC AI0 with 0 percentage access probability	16.9.0
2021-09	RAN#93	R5-216193	2367	1	F	Correction to NR TC 11.3.5-UAC Access Identity 1	16.9.0
2021-09	RAN#93	R5-216194	2368	1	F	Correction to NR TC 11.3.6-UAC AI2 MCS	16.9.0
2021-09	RAN#93	R5-216195	2422	1	F	Addition of new RRC Inactive UAC test case 11.3.1a	16.9.0
2021-09	RAN#93	R5-216196	2292	1	F	Correction to NR5GC testcase 11.4.6	16.9.0
2021-09	RAN#93	R5-216198	2371	1	F	Correction to NR TC 11.4.2-Handling of forbidden PLMNs	16.9.0
2021-09	RAN#93	R5-216199	2372	1	F	Correction to NR TC 11.4.3-Initial registration for emergency services	16.9.0
2021-09	RAN#93	R5-216200	2373	1	F	Correction to NR TC 11.4.4-T3346, T3396	16.9.0
2021-09	RAN#93	R5-216201	2374	1	F	Correction to NR TC 11.4.5-Handling of 5GS forbidden tracking areas for roaming	16.9.0
2021-09	RAN#93	R5-216202	2375	1	F	Correction to NR TC 11.4.9-Emergency call establishment and release	16.9.0
2021-09	RAN#93	R5-216203	2413	1	F	Correction of Emergency Number list for TC 11.4.8	16.9.0
2021-09	RAN#93	R5-216259	2376	1	F	Correction to NR TC 7.1.3.4.3-DAPS handover L2	16.9.0
2021-09	RAN#93	R5-216260	2377	1	F	Correction to NR TC 8.1.4.3.1-DAPS handover Success	16.9.0
2021-09	RAN#93	R5-216261	2378	1	F	Addition of NR TC 8.1.4.3.2-DAPS handover Success RLF in source	16.9.0
2021-09	RAN#93	R5-216272	2347	1	F	Addition of NR5G Power saving TC 8.1.5.10.1	16.9.0
2021-09	RAN#93	R5-216273	2454	1	F	Addition of Rel-16 SNPN TC 9.1.11.1	16.9.0
2021-09	RAN#93	R5-216276	2294	1	F	Update Test Case 8.1.5.1.1 to allow segmentation of UE Capability Information	16.9.0
2021-09	RAN#93	R5-216277	2295	1	F	Modification of the TC 8.2.1.1.1 to allow uplink segmentation for Rel-16 RACS	16.9.0
2021-09	RAN#93	R5-216278	2336	1	F	Updates to Rel-16 RACS RRC TC 8.1.5.9.1	16.9.0
2021-09	RAN#93	R5-216279	2337	1	F	Updates to Rel-16 RACS TC 9.1.9.5	16.9.0
2021-09	RAN#93	R5-216285	2280	1	F	Addition of new test case 8.1.6.2.1 for Immediate MDT in Inter-RAT MDT	16.9.0
2021-09	RAN#93	R5-216286	2281	1	F	Addition of new test case 8.1.6.2.2 for Logged MDT in Inter-RAT MDT	16.9.0
2021-09	RAN#93	R5-216287	2282	1	F	Addition of new test case 8.1.6.2.3 for Radio Link Failure in	16.9.0

						Inter-RAT MDT	
2021-09	RAN#93	R5-216288	2283	1	F	Addition of new test case 8.1.6.2.4 for Connection Establishment Failure in Inter-RAT MDT	16.9.0
2021-09	RAN#93	R5-216289	2299	1	F	Update of MDT TC 8.1.6.1.3.1	16.9.0
2021-09	RAN#93	R5-216290	2301	1	F	Update of MDT TC 8.1.6.1.3.3	16.9.0
2021-09	RAN#93	R5-216291	2318	1	F	Update of MDT TC 8.1.6.1.3.4	16.9.0
2021-09	RAN#93	R5-216292	2320	1	F	Update of MDT TC 8.1.6.1.3.6	16.9.0
2021-09	RAN#93	R5-216293	2381	1	F	Correction to NR TC 8.1.6.1.3.7-PLMN list	16.9.0
2021-09	RAN#93	R5-216294	2382	1	F	Correction to MDT NR TC 8.1.6.3.1.3-inter system immediate-sensor	16.9.0
2021-09	RAN#93	R5-216295	2384	1	F	Correction to MDT NR TC 8.1.6.1.4.6-CEF Intra-Freq measurements	16.9.0
2021-09	RAN#93	R5-216296	2385	1	F	Addition of MDT NR TC 8.1.6.3.4.1-Inter System_CEF_bluetooth	16.9.0
2021-09	RAN#93	R5-216297	2389	1	F	Update of MDT test case 8.1.6.1.2.1	16.9.0
2021-09	RAN#93	R5-216298	2390	1	F	Update of MDT test case 8.1.6.1.2.2	16.9.0
2021-09	RAN#93	R5-216299	2391	1	F	Update of MDT test case 8.1.6.1.2.3	16.9.0
2021-09	RAN#93	R5-216300	2392	1	F	Update of MDT test case 8.1.6.1.2.4	16.9.0
2021-09	RAN#93	R5-216301	2393	1	F	Update of MDT test case 8.1.6.1.2.5	16.9.0
2021-09	RAN#93	R5-216302	2394	1	F	Update of MDT test case 8.1.6.1.2.6	16.9.0
2021-09	RAN#93	R5-216303	2395	1	F	Update of MDT test case 8.1.6.1.2.7	16.9.0
2021-09	RAN#93	R5-216304	2397	1	F	Update of MDT test case 8.1.6.1.2.9	16.9.0
2021-09	RAN#93	R5-216305	2398	1	F	Update of MDT test case 8.1.6.1.2.10	16.9.0
2021-09	RAN#93	R5-216306	2399	1	F	Update of MDT test case 8.1.6.1.2.11	16.9.0
2021-09	RAN#93	R5-216307	2411	1	F	Correction to MDT TC 8.1.6.1.4.3	16.9.0
2021-09	RAN#93	R5-216308	2415	1	F	Correction to MDT test case 8.1.6.1.2.8	16.9.0
2021-09	RAN#93	R5-216309	2416	1	F	Correction to MDT test case 8.1.6.1.2.12	16.9.0
2021-09	RAN#93	R5-216310	2417	1	F	Correction to MDT test case 8.1.6.1.2.13	16.9.0
2021-09	RAN#93	R5-216311	2443	1	F	Correction of MDT Test Case 8.1.6.1.4.1 and 8.1.6.1.4.4	16.9.0
2021-09	RAN#93	R5-216312	2444	1	F	Correction of MDT Test Case 8.1.6.1.4.2 and 8.1.6.1.4.3	16.9.0
2021-09	RAN#93	R5-216313	2445	1	F	Correction of MDT Test Case 8.1.6.1.4.5	16.9.0
2021-09	RAN#93	R5-216314	2446	1	F	Correction of MDT Test Case 8.1.6.1.4.6 and 8.1.6.1.4.7	16.9.0
2021-09	RAN#93	R5-216316	2428	1	F	Correction to test case 11.2.1 5G-SRVCC from NG-RAN to 3GPP UTRAN	16.9.0
2021-09	RAN#93	R5-216317	2408	1	F	New UL TBS MAC test Case for NR URLLC	16.9.0
2021-09	RAN#93	R5-216318	2409	1	F	Addition of New DL MAC NR URLLC Test Case	16.9.0
2021-09	RAN#93	R5-216319	2410	1	F	Correction to NR URLLC Test Case	16.9.0
2021-09	RAN#93	R5-216325	2433	1	F	Addition of new test case 9.1.10.1 for R16 eNS	16.9.0
2021-09	RAN#93	R5-216326	2434	1	F	Addition of new test case 9.1.10.6 for R16 eNS	16.9.0
2021-12	RAN#94	R5-216480	2468	-	F	Correction to 5G-SRVCC test case 11.2.1	16.10.0
2021-12	RAN#94	R5-216482	2470	-	F	Update to 5GC test case 9.1.4.1	16.10.0
2021-12	RAN#94	R5-216483	2471	-	F	Update to 5GC test case 9.1.5.1.3	16.10.0
2021-12	RAN#94	R5-216484	2472	-	F	Update to 5GC test case 9.1.5.1.4	16.10.0
2021-12	RAN#94	R5-216490	2474	-	F	Update to 5GC test case 9.1.5.1.11	16.10.0
2021-12	RAN#94	R5-216491	2475	-	F	Update to 5GC test case 9.1.5.1.12	16.10.0
2021-12	RAN#94	R5-216492	2476	-	F	Update to 5GC test case 9.1.5.1.13	16.10.0
2021-12	RAN#94	R5-216493	2477	-	F	Update to 5GC test case 9.1.5.1.14	16.10.0
2021-12	RAN#94	R5-216494	2478	-	F	Update to 5GC test case 9.1.5.2.1	16.10.0
2021-12	RAN#94	R5-216496	2479	-	F	Update of cell power level for FR2 in NR Immediate MDT TC 8.1.6.1.1.1	16.10.0
2021-12	RAN#94	R5-216497	2480	-	F	Correction to Inter-RAT Immediate MDT TC 8.1.6.2.1	16.10.0
2021-12	RAN#94	R5-216498	2481	-	F	Update of cell power level for FR2 in Inter-RAT Logged MDT TC 8.1.6.2.2	16.10.0
2021-12	RAN#94	R5-216499	2482	-	F	Update of cell power level for FR2 in Radio Link Failure TC 8.1.6.2.3	16.10.0
2021-12	RAN#94	R5-216500	2483	-	F	Update of cell power level for FR2 in BT measurement collection TC 8.1.6.3.1.1	16.10.0
2021-12	RAN#94	R5-216501	2484	-	F	Update of cell power level for FR2 in WLAN measurement collection TC 8.1.6.3.1.2	16.10.0
2021-12	RAN#94	R5-216508	2485	-	F	Addition to NR TC 7.1.3.4.4-PDCP DAPS handover for Inter-frequency	16.10.0
2021-12	RAN#94	R5-216509	2486	-	F	Addition of NR TC 8.1.4.3.5-DAPS handover Success RLF in source for Inter-frequency	16.10.0
2021-12	RAN#94	R5-216560	2496	-	F	Update of MDT test case 8.1.6.1.2.7	16.10.0
2021-12	RAN#94	R5-216562	2498	-	F	Update of MDT test case 8.1.6.1.2.11	16.10.0

2021-12	RAN#94	R5-216637	2500	-	F	Removal of DL-only reference for neighbour cells in NR Measurements test cases	16.10.0
2021-12	RAN#94	R5-216639	2502	-	F	Introducing SCell types in Pre-test conditions in TC 8.2.4.3.1.1	16.10.0
2021-12	RAN#94	R5-216640	2503	-	F	Updates to NR/5GC TC 11.3.1a	16.10.0
2021-12	RAN#94	R5-216775	2505	-	F	Correction to NR RRC TC 8.1.1.2.1	16.10.0
2021-12	RAN#94	R5-216797	2510	-	F	Editorial changes to eNS TC 9.1.10.1 and 9.1.10.6	16.10.0
2021-12	RAN#94	R5-216799	2511	-	F	Updates to NR measurement test cases for event A3	16.10.0
2021-12	RAN#94	R5-216806	2514	-	F	Correction to EPS Fallback TC 11.1.8 and 11.1.9	16.10.0
2021-12	RAN#94	R5-216814	2516	-	F	Update to NR-DC TC 8.2.6.2.2	16.10.0
2021-12	RAN#94	R5-216816	2518	-	F	Correction to NR5G RRC TC 8.1.4.1.7.1	16.10.0
2021-12	RAN#94	R5-216995	2556	-	F	Correction to NR TC 6.4.1.1-PLMN Selection Higher priority	16.10.0
2021-12	RAN#94	R5-216996	2557	-	F	Correction to NR TC 6.1.2.9-Cell Selection Qqualmin	16.10.0
2021-12	RAN#94	R5-217001	2561	-	F	Correction to NR TC 11.3.2-Emergency Call	16.10.0
2021-12	RAN#94	R5-217002	2562	-	F	Correction to NR TC 11.3.5-UAC Access Identity 1	16.10.0
2021-12	RAN#94	R5-217011	2566	-	F	Correction to NR RRC TC 8.1.4.4.1-Conditional handover success	16.10.0
2021-12	RAN#94	R5-217012	2567	-	F	Correction to NR RRC TC 8.1.4.4.2-Conditional handover configuration update	16.10.0
2021-12	RAN#94	R5-217013	2568	-	F	Correction to NR RRC TC 8.1.4.4.3-Conditional handover failure	16.10.0
2021-12	RAN#94	R5-217014	2569	-	F	Correction to NR RRC TC 8.2.3.18.1-Conditional PSCell change	16.10.0
2021-12	RAN#94	R5-217053	2577	-	F	Correction to NR MDT TC 8.1.6.3.2.1-Inter System-Logged-Bluetooth	16.10.0
2021-12	RAN#94	R5-217054	2578	-	F	Correction to NR MDT TC 8.1.6.3.2.3-Inter System-Logged-Sensor	16.10.0
2021-12	RAN#94	R5-217055	2579	-	F	Correction to NR MDT TC 8.1.6.3.3.1-Inter System-RLF-Bluetooth	16.10.0
2021-12	RAN#94	R5-217056	2580	-	F	Correction to NR MDT TC 8.1.6.3.3.3-Inter System-RLF-sensor	16.10.0
2021-12	RAN#94	R5-217069	2582	-	F	Update of NR 2-step RACH test case 7.1.1.1.10	16.10.0
2021-12	RAN#94	R5-217075	2583	-	F	Update of FR2 q-RxLevMin for Idle mode TC 6.1.2.1	16.10.0
2021-12	RAN#94	R5-217076	2584	-	F	Editorial update of Idle mode TC 6.1.2.x	16.10.0
2021-12	RAN#94	R5-217077	2585	-	F	Update of exception for NRRC TC 8.1.4.2.2.1	16.10.0
2021-12	RAN#94	R5-217078	2586	-	F	Update of ServingCellConfig for MR-DC RRC TC 8.2.4.1.1.1	16.10.0
2021-12	RAN#94	R5-217079	2587	-	F	Update of TP for 5GC TC 9.1.5.1.15	16.10.0
2021-12	RAN#94	R5-217080	2588	-	F	Update of missing NAS message for 5GC TC 9.1.5.2.2	16.10.0
2021-12	RAN#94	R5-217081	2589	-	F	Update of step 5C for UAC TC 11.3.8	16.10.0
2021-12	RAN#94	R5-217188	2599	-	F	Editorial update of table numbers for Idle mode TC 6.2.3.3 and 6.2.3.4	16.10.0
2021-12	RAN#94	R5-217254	2600	-	F	Update of NR 2-step RACH test case 7.1.1.1.9	16.10.0
2021-12	RAN#94	R5-217275	2607	-	F	Correction to RRC test case 8.1.1.4.1	16.10.0
2021-12	RAN#94	R5-217279	2611	-	F	Correction to 5GSM test case 10.1.1.1	16.10.0
2021-12	RAN#94	R5-217280	2612	-	F	Correction to 5GSM test case 10.1.4.1	16.10.0
2021-12	RAN#94	R5-217281	2613	-	F	Correction to 5GSM test case 10.1.5.1	16.10.0
2021-12	RAN#94	R5-217288	2616	-	F	Updates to NR5G NPN TC 6.5.1.2	16.10.0
2021-12	RAN#94	R5-217290	2618	-	F	Corrections to MDT TC 8.1.6.3.1.3	16.10.0
2021-12	RAN#94	R5-217413	2627	-	F	Correction to NPN TC 6.5.2.2	16.10.0
2021-12	RAN#94	R5-217546	2636	-	F	Correction to NR TC 11.3.6	16.10.0
2021-12	RAN#94	R5-217683	2647	-	F	Correction of MFBI test case 6.1.2.23	16.10.0
2021-12	RAN#94	R5-217689	2648	-	F	Update of NR RRC test case 8.1.5.1.1	16.10.0
2021-12	RAN#94	R5-217690	2649	-	F	Update of MRDC RRC test case 8.2.1.1.1	16.10.0
2021-12	RAN#94	R5-217714	2652	-	F	Correction to EPS Fallback test case 11.1.7	16.10.0
2021-12	RAN#94	R5-217765	2659	-	F	Addition of RRC Resume NR DC Test Case	16.10.0
2021-12	RAN#94	R5-217771	2501	1	F	Update to SCell configuration in 8.1.4.1.7.x, 8.1.4.1.8.x and 8.1.4.1.9.x	16.10.0
2021-12	RAN#94	R5-217772	2653	1	F	Correction to Split SRB Establishment and Release Test Case 8.2.2.2.1	16.10.0
2021-12	RAN#94	R5-217775	2643	1	F	New testcase for Idle/Inactive measurements on E-UTRA cells in RRC_IDLE state with configuration through SIB11	16.10.0
2021-12	RAN#94	R5-217776	2644	1	F	New testcase for Idle/Inactive measurements on NR cells in RRC_IDLE state with configuration through RRCRelease	16.10.0
2021-12	RAN#94	R5-217777	2645	1	F	New testcase for Idle/Inactive measurements on E-UTRA cells in RRC_IDLE state with configuration through	16.10.0

						RRCRelease	
2021-12	RAN#94	R5-217805	2558	1	F	Correction to System Information Combination of SOR TCs 6.3.1.X	16.10.0
2021-12	RAN#94	R5-217806	2595	1	F	Correction to NR-DC testcase 7.1.1.11.1	16.10.0
2021-12	RAN#94	R5-217807	2633	1	F	NE-DC specific enhancements test case pre-conditions	16.10.0
2021-12	RAN#94	R5-217808	2634	1	F	NE-DC specific enhancements PDCP test case pre-conditions	16.10.0
2021-12	RAN#94	R5-217809	2519	1	F	Correction to SDAP TC 7.1.4.1	16.10.0
2021-12	RAN#94	R5-217810	2517	1	F	Addition of NR5G RRC TC 8.1.1.3.7b	16.10.0
2021-12	RAN#94	R5-217811	2507	1	F	Addition of new test case 8.2.1.1.2 for UE capability transfer in NE-DC	16.10.0
2021-12	RAN#94	R5-217812	2594	1	F	Correction to NR test Case 8.1.2.1.1	16.10.0
2021-12	RAN#94	R5-217813	2508	1	F	Addition of new test case 8.2.2.4.3 for SCG DRB in NE-DC	16.10.0
2021-12	RAN#94	R5-217814	2509	1	F	Addition of new test case 8.2.2.5.3 for Split DRB in NE-DC	16.10.0
2021-12	RAN#94	R5-217815	2559	1	F	Correction to NR TC 8.1.5.8.1_Latency check	16.10.0
2021-12	RAN#94	R5-217816	2560	1	F	Correction to NR TC 9.1.5.1.8-Serving network not authorized	16.10.0
2021-12	RAN#94	R5-217817	2654	1	F	Correction to PDU session authentication and authorization Test Case 10.1.2.2	16.10.0
2021-12	RAN#94	R5-217818	2655	1	F	Correction to PDU session authentication and authorization Test Case 10.1.4.1	16.10.0
2021-12	RAN#94	R5-217820	2564	1	F	Correction to NR TC 11.4.5-Handling of 5GS forbidden tracking areas for roaming	16.10.0
2021-12	RAN#94	R5-217821	2591	1	F	Correction to NR5GC testcase 11.4.3	16.10.0
2021-12	RAN#94	R5-217823	2593	1	F	Correction to NR5GC testcase 11.4.9	16.10.0
2021-12	RAN#94	R5-217824	2657	1	F	New Test Case 11.6.2 Data Off / MO Video Call	16.10.0
2021-12	RAN#94	R5-217825	2658	1	F	New Test Case 11.6.1 Data Off / MO Voice Call	16.10.0
2021-12	RAN#94	R5-217874	2565	1	F	Correction to NR TC 8.1.4.3.2-DAPS handover	16.10.0
2021-12	RAN#94	R5-217875	2570	1	F	Addition of NR RRC TC 8.1.4.4.4-Conditional handover and legacy handover	16.10.0
2021-12	RAN#94	R5-217876	2572	1	F	Addition of NR RRC TC 8.2.3.18.2-Conditional PSCell change failure	16.10.0
2021-12	RAN#94	R5-217890	2573	1	F	Addition of NR V2X TC 13.1.1-V2X policy delivery	16.10.0
2021-12	RAN#94	R5-217891	2601	1	F	Addition of NR V2X test case 12.1.3.2	16.10.0
2021-12	RAN#94	R5-217892	2603	1	F	Addition of NR V2X test case 12.2.3.2	16.10.0
2021-12	RAN#94	R5-217893	2615	1	F	Addition of NR V2X test case 13.2.5	16.10.0
2021-12	RAN#94	R5-217894	2617	1	F	Addition of NR V2X test case 12.1.1.2	16.10.0
2021-12	RAN#94	R5-217897	2522	1	F	Addition of NR5G SNPN TC 6.5.1.3	16.10.0
2021-12	RAN#94	R5-217898	2523	1	F	Addition of NR5G NPN TC 6.5.2.4	16.10.0
2021-12	RAN#94	R5-217899	2524	1	F	Addition of NR5G NPN TC 8.1.7.1.1	16.10.0
2021-12	RAN#94	R5-217901	2520	1	F	Correction to Rel-16 RACS TC 9.1.9.1, 9.1.9.2 and 9.1.9.5	16.10.0
2021-12	RAN#94	R5-217902	2521	1	F	Correction to Rel-16 RACS TC 8.1.5.9.1	16.10.0
2021-12	RAN#94	R5-217916	2469	1	F	Update of TC Title for matching TC content in TC 8.1.6.2.4	16.10.0
2021-12	RAN#94	R5-217917	2495	1	F	Update of MDT test case 8.1.6.1.2.3	16.10.0
2021-12	RAN#94	R5-217918	2497	1	F	Update of MDT test case 8.1.6.1.2.10	16.10.0
2021-12	RAN#94	R5-217919	2499	1	F	Addition of new test case 8.1.6.4.1 for RACH logging and reporting in NR SON/MDT	16.10.0
2021-12	RAN#94	R5-217920	2513	1	F	Correction to NR MDT test case 8.1.6.1.4.2	16.10.0
2021-12	RAN#94	R5-217921	2525	1	F	Correction to MDT TC 8.1.6.1.3.1 and 8.1.6.1.3.2	16.10.0
2021-12	RAN#94	R5-217922	2526	1	F	Correction to MDT TC 8.1.6.1.3.3	16.10.0
2021-12	RAN#94	R5-217923	2528	1	F	Correction to MDT TC 8.1.6.1.1.1, 8.1.6.1.3.5 and 8.1.6.1.4.5	16.10.0
2021-12	RAN#94	R5-217924	2574	1	F	Correction to MDT NR TC 8.1.6.1.4.6-CEF Intra-Freq measurements	16.10.0
2021-12	RAN#94	R5-217925	2575	1	F	Correction to MDT NR TC 8.1.6.1.4.7-CEF Inter-Freq measurements	16.10.0
2021-12	RAN#94	R5-217926	2590	1	F	Correction of MDT TC 8.1.6.1.4.8	16.10.0
2021-12	RAN#94	R5-217927	2596	1	F	Corrections to MDT TC 8.1.6.3.4.1	16.10.0
2021-12	RAN#94	R5-217928	2597	1	F	Corrections to MDT TC 8.1.6.3.4.2	16.10.0
2021-12	RAN#94	R5-217929	2598	1	F	Corrections to MDT TC 8.1.6.3.4.3	16.10.0
2021-12	RAN#94	R5-217930	2619	1	F	Corrections to MDT TC 8.1.6.3.2.2	16.10.0
2021-12	RAN#94	R5-217931	2620	1	F	Corrections to MDT TC 8.1.6.3.3.2	16.10.0
2021-12	RAN#94	R5-217934	2581	1	F	Correction to SRVCC TC 8.1.3.2.X - UTRA Inter-RAT	16.10.0
2021-12	RAN#94	R5-217939	2529	1	F	Correction to R16 eNS TC 9.1.10.1	16.10.0
2021-12	RAN#94	R5-217940	2631	1	F	New Test Case 9.1.10.3 NSSAA / Initial registration / Rejected NSSAI, pending NSSAI	16.10.0

2021-12	RAN#94	R5-217941	2632	1	F	New Test Case 9.1.10.4 NSSAA / Initial registration / Reject	16.10.0
2021-12	RAN#94	R5-217945	2650	1	F	Addition of new NR EIEI eCall only mode test case 11.5.1	16.10.0
2021-12	RAN#94	R5-217946	2651	1	F	Addition of new NR EIEI eCall only mode test case 11.5.2	16.10.0
2021-12	RAN#94	R5-217952	2642	1	F	New testcase for Idle/Inactive measurements on NR cells in RRC_IDLE state with configuration through SIB11	16.10.0
2021-12	RAN#94	R5-217988	2628	1	F	NE-DC specific enhancements for UE power headroom test case	16.10.0
2021-12	RAN#94	R5-217989	2625	1	F	NE-DC specific enhancements for PDCP split bearer test case	16.10.0
2021-12	RAN#94	R5-217996	2605	1	F	Correction to SOR test case 6.3.1.3	16.10.0
2021-12	RAN#94	R5-217997	2660	1	F	Correction to NR TC 8.1.4.1.9.1-Reestablish intra-band	16.10.0
2021-12	RAN#94	R5-217999	2621	1	F	Addition of new CVX TC 12.1.3.1-PC5-only operation / Measurement configuration and reporting via PC5 RRC / PSBCH-RSRP measurement configuration	16.10.0
2021-12	RAN#94	R5-218000	2622	1	F	Addition of new CVX TC 12.1.5.1-PC5-only operation / Sidelink CSI reporting / Configuration	16.10.0
2021-12	RAN#94	R5-218001	2623	1	F	Addition of new CVX TC 12.1.5.2- PC5-only operation / Sidelink CSI reporting / Reporting	16.10.0
2021-12	RAN#94	R5-218002	2624	1	F	Addition of new CVX TC 12.2.4.1-Inter-carrier concurrent operation / Sidelink Reconfiguration via Uu RRC / SL DRB management / transmission side	16.10.0
2021-12	RAN#94	R5-218003	2626	1	F	Addition of new CVX TC 12.2.5.3-Inter-carrier concurrent operation / Measurement configuration and reporting via PC5 RRC / PSBCH-RSRP measurement reporting / Periodical reporting	16.10.0
2021-12	RAN#94	R5-218004	2637	1	F	Addition of NR V2X TC 12.2.6.1	16.10.0
2021-12	RAN#94	R5-218005	2638	1	F	Addition of NR V2X TC 12.2.7.1	16.10.0
2021-12	RAN#94	R5-218006	2639	1	F	Addition of NR V2X TC 12.2.8.2	16.10.0
2021-12	RAN#94	R5-218007	2640	1	F	Addition of NR V2X TC 12.1.3.3	16.10.0
2021-12	RAN#94	R5-218012	2635	2	F	Addition of new eNS Abnormal test case	16.10.0
2022-03	RAN#95	R5-220046	2663	-	F	Addition of new test case for PDCP Duplication 3 RLC entities with NR intra-band non-contiguous CA in NR IIoT	16.11.0
2022-03	RAN#95	R5-220050	2664	-	F	Update of cell power level for FR2 in NR Immediate MDT TC 8.1.6.2.1	16.11.0
2022-03	RAN#95	R5-220052	2666	-	F	Update of cell power level for FR2 in NR Immediate MDT TC 8.1.6.2.3	16.11.0
2022-03	RAN#95	R5-220053	2667	-	F	Update of cell power level for FR2 in NR Immediate MDT TC 8.1.6.1.3.1	16.11.0
2022-03	RAN#95	R5-220054	2668	-	F	Update of cell power level for FR2 in NR Immediate MDT TC 8.1.6.1.3.4	16.11.0
2022-03	RAN#95	R5-220095	2670	-	F	Update the FR2 cell powers of test case 11.2.1	16.11.0
2022-03	RAN#95	R5-220098	2671	-	F	Update the FR2 cell powers of test case 8.1.3.2.6	16.11.0
2022-03	RAN#95	R5-220100	2673	-	F	Update the FR2 cell powers of test case 8.1.3.2.8	16.11.0
2022-03	RAN#95	R5-220156	2692	-	F	Correction to NR-DC TC 8.2.7.2.1	16.11.0
2022-03	RAN#95	R5-220188	2698	-	F	Editorial update of NR RRC TC 8.1.4.1.7.1	16.11.0
2022-03	RAN#95	R5-220189	2699	-	F	Editorial update of NR RRC TC 8.1.4.1.8.1	16.11.0
2022-03	RAN#95	R5-220287	2705	-	F	Correction to NR MAC test case 7.1.1.3.8.x	16.11.0
2022-03	RAN#95	R5-220289	2707	-	F	Correction to NR MDT test case 8.1.6.1.4.6	16.11.0
2022-03	RAN#95	R5-220329	2718	-	F	Update of MDT test case 8.1.6.1.2.1	16.11.0
2022-03	RAN#95	R5-220330	2719	-	F	Update of MDT test case 8.1.6.1.2.3	16.11.0
2022-03	RAN#95	R5-220331	2720	-	F	Update of MDT test case 8.1.6.1.2.4	16.11.0
2022-03	RAN#95	R5-220333	2722	-	F	Update of MDT test case 8.1.6.1.2.8	16.11.0
2022-03	RAN#95	R5-220334	2723	-	F	Update of MDT test case 8.1.6.1.2.9	16.11.0
2022-03	RAN#95	R5-220367	2726	-	F	Correction to NAS 5GMM test case 9.1.5.1.15	16.11.0
2022-03	RAN#95	R5-220392	2733	-	F	Align the terminology being used for OTA environment (MAC TCs)	16.11.0
2022-03	RAN#95	R5-220397	2738	-	F	Align the terminology being used for OTA environment (RRC 8.2.4.x)	16.11.0
2022-03	RAN#95	R5-220398	2739	-	F	Align the terminology being used for OTA environment (EPS Fallback TCs)	16.11.0
2022-03	RAN#95	R5-220453	2742	-	F	Deletion of Editor's Note below clause 7.1.2	16.11.0
2022-03	RAN#95	R5-220454	2743	-	F	Correction to 5GC test case 9.1.1.3	16.11.0
2022-03	RAN#95	R5-220531	2750	-	F	Update of NR5G NPN TC 6.5.2.2	16.11.0
2022-03	RAN#95	R5-220532	2751	-	F	Update of NR5G NPN TC 6.5.2.4	16.11.0
2022-03	RAN#95	R5-220543	2752	-	F	Correction to NR TC 6.4.1.1-PLMN Selection-Higher priority	16.11.0

						PLMN	
2022-03	RAN#95	R5-220544	2753	-	F	Correction to NR TC 7.1.1.5.3-Short Cycle DRX	16.11.0
2022-03	RAN#95	R5-220545	2754	-	F	Correction to NR SA TC 8.1.1.3.7-RRC release	16.11.0
2022-03	RAN#95	R5-220548	2757	-	F	Correction to NR SA TC 8.2.2.2.1-Split SRB	16.11.0
2022-03	RAN#95	R5-220549	2758	-	F	Correction to NR TC 9.1.4.1-Generic UE configuration update	16.11.0
2022-03	RAN#95	R5-220550	2759	-	F	Correction to NR TC 10.1.1.1-PDU session authentication and authorization	16.11.0
2022-03	RAN#95	R5-220551	2760	-	F	Correction to NR TC 10.1.1.2-After the UE-requested PDU session procedure	16.11.0
2022-03	RAN#95	R5-220552	2761	-	F	Correction to ENDC TC 10.2.2.1-EPS bearer resource allocation	16.11.0
2022-03	RAN#95	R5-220557	2766	-	F	Correction to NR TC 11.3.5-UAC New cell not in the country of its HPLMN	16.11.0
2022-03	RAN#95	R5-220559	2768	-	F	Correction to NR TC 11.3.9-UAC for ODAC	16.11.0
2022-03	RAN#95	R5-220560	2769	-	F	Correction to NR TC 11.4.1-emergency call and authentication failure	16.11.0
2022-03	RAN#95	R5-220612	2780	-	F	Correction to NR MDT TC 8.1.6.1.4.3-Intra NR_Connection Establishment Failure_Reporting at intra-NR handover	16.11.0
2022-03	RAN#95	R5-220613	2781	-	F	Correction to NR MDT TC 8.1.6.1.4.4-Intra NR_Connection Establishment Failure_RRC connection re-establishment	16.11.0
2022-03	RAN#95	R5-220641	2790	-	F	Correction to NR PDCP test case 7.1.3.5.2	16.11.0
2022-03	RAN#95	R5-220644	2791	-	F	Correction to NR5GC testcase 11.1.7	16.11.0
2022-03	RAN#95	R5-220648	2792	-	F	Correction to NR MAC testcase 7.1.1.3.3	16.11.0
2022-03	RAN#95	R5-220682	2800	-	F	Correction to NR5GC testcase 6.5.1.2	16.11.0
2022-03	RAN#95	R5-220849	2812	-	F	Editorial Updates to Clause 8.2	16.11.0
2022-03	RAN#95	R5-221041	2813	-	F	Updates to Inter-System MDT test cases 8.1.6.3.1.x	16.11.0
2022-03	RAN#95	R5-221105	2831	-	F	Correction to NR testcase 8.1.5.2.2	16.11.0
2022-03	RAN#95	R5-221238	2851	-	F	Addition of new test case 11.6.3 Data Off / SMSoIP	16.11.0
2022-03	RAN#95	R5-221368	2857	-	F	Correction to NR RRC test case 8.1.5.2.2	16.11.0
2022-03	RAN#95	R5-221391	2860	-	F	Correction to NR RRC test cases 8.2.1.1.1 and 8.2.1.1.2	16.11.0
2022-03	RAN#95	R5-221392	2861	-	F	Correction to the NR5GC testcases 8.1.4.1.9.1, 8.1.4.1.9.2 and 8.1.4.1.9.3	16.11.0
2022-03	RAN#95	R5-221406	2821	-	F	Correction to NR TC 11.1.2-EPS Fallback with redirection without N26	16.11.0
2022-03	RAN#95	R5-221418	2864	-	F	Removal of test case 11.4.10 - N26 not supported - N1 to S1 transfer of an existing emergency PDU session	16.11.0
2022-03	RAN#95	R5-221431	2697	1	F	Update of SIB modification steps for Idle TC 6.1.2.9, 6.1.2.18, 6.2.3.1 and 6.2.3.3	16.11.0
2022-03	RAN#95	R5-221432	2715	1	F	Correction to Idle Mode SOR test case 6.3.1.5	16.11.0
2022-03	RAN#95	R5-221433	2732	1	F	Align the terminology being used for OTA environment (Idle Mode TCs)	16.11.0
2022-03	RAN#95	R5-221434	2789	1	F	Correction to NR-DC testcase 7.1.1.11.1	16.11.0
2022-03	RAN#95	R5-221435	2716	1	F	Correction to NR SDAP test case 7.1.4.1	16.11.0
2022-03	RAN#95	R5-221436	2734	1	F	Align the terminology being used for OTA environment (RRC 8.1.1.x TCs)	16.11.0
2022-03	RAN#95	R5-221437	2793	1	F	Correction to NR test case 8.1.1.4.1	16.11.0
2022-03	RAN#95	R5-221438	2755	1	F	Correction to NR TC 8.1.2.1.1-RRC Reconfiguration	16.11.0
2022-03	RAN#95	R5-221439	2735	1	F	Align the terminology being used for OTA environment (RRC 8.1.3.x TCs)	16.11.0
2022-03	RAN#95	R5-221440	2706	1	F	Correction to NR RRC test case 8.1.4.1.2	16.11.0
2022-03	RAN#95	R5-221441	2736	1	F	Align the terminology being used for OTA environment (RRC 8.1.4.x TCs)	16.11.0
2022-03	RAN#95	R5-221442	2756	1	F	Correction to NR SA TC 8.1.4.1.7.x-SCell release	16.11.0
2022-03	RAN#95	R5-221443	2675	1	F	Addition of new test case 8.2.3.6.2 for Intra-frequency measurements Event A3 in NE-DC	16.11.0
2022-03	RAN#95	R5-221444	2676	1	F	Addition of new test case 8.2.3.6.2a for Inter-frequency measurements Event A3 in NE-DC	16.11.0
2022-03	RAN#95	R5-221445	2696	1	F	Addition of new test case 8.2.3.6.2b for Inter-band measurements Event A3 in NE-DC	16.11.0
2022-03	RAN#95	R5-221446	2709	1	F	Correction to NR-DC RRC test case 8.2.3.14.2	16.11.0
2022-03	RAN#95	R5-221447	2737	1	F	Align the terminology being used for OTA environment (RRC 8.2.3.x)	16.11.0
2022-03	RAN#95	R5-221448	2804	1	F	Correction to NR-DC RRC test case 8.2.3.11.3	16.11.0
2022-03	RAN#95	R5-221449	2795	1	F	Correction to NR testcases 8.2.4.1.1.1, 8.2.4.1.1.2 and	16.11.0

						8.2.4.1.1.3	
2022-03	RAN#95	R5-221450	2704	1	F	Clarifications on 5G NR connectivity options for SIG	16.11.0
2022-03	RAN#95	R5-221451	2677	1	F	Update of date for 5GC TC 9.1.4.1	16.11.0
2022-03	RAN#95	R5-221452	2703	1	F	Add test case 11.1.1a	16.11.0
2022-03	RAN#95	R5-221453	2762	1	F	Correction to NR TC 11.1.5-EPS Fallback from NR Connected without N26	16.11.0
2022-03	RAN#95	R5-221454	2763	1	F	Correction to NR TC 11.1.6-EPS Fallback from NR Idle without N26	16.11.0
2022-03	RAN#95	R5-221455	2833	1	F	Update to test cases 11.1.1, 11.1.3, 11.1.4, 11.1.8 and 11.1.9	16.11.0
2022-03	RAN#95	R5-221456	2713	1	F	Correction to UAC test case 11.3.2	16.11.0
2022-03	RAN#95	R5-221457	2714	1	F	Correction to UAC test case 11.3.6	16.11.0
2022-03	RAN#95	R5-221459	2764	1	F	Correction to NR TC 11.3.1-UAC for MO Speech Call and SMSolP	16.11.0
2022-03	RAN#95	R5-221460	2741	1	F	Addition of new 5GS IMS test case 11.4.12	16.11.0
2022-03	RAN#95	R5-221461	2836	1	F	Update to test case 11.6.1	16.11.0
2022-03	RAN#95	R5-221494	2821	1	F	Update of TC 7.1.3.5.6 for PDCP Duplication 3 RLC entities in NR IIoT	16.11.0
2022-03	RAN#95	R5-221495	2854	1	F	Modification of testcase 7.1.3.5.7 Ethernet header compression and decompression / Correct functionality of ethernet header compression and decompression	16.11.0
2022-03	RAN#95	R5-221496	2669	1	F	Addition of Rel-16 NR Mobility Enhancement test case for Conditional PSCell change / PCell change / PSCell change / EN-DC	16.11.0
2022-03	RAN#95	R5-221497	2777	1	F	Correction to NR TC 8.1.4.3.4-RRC DAPS HO Success Inter-frequency	16.11.0
2022-03	RAN#95	R5-221498	2779	1	F	Correction to NR TC 8.2.3.18.1-Conditional PSCell change Success	16.11.0
2022-03	RAN#95	R5-221518	2674	1	F	Addition of new CVX TC 12.2.1.6- Inter-carrier concurrent operation / Sidelink communication / RRC_CONNECTED / Reception	16.11.0
2022-03	RAN#95	R5-221519	2693	1	F	Addition of sub-clause titles for NR V2X TCs	16.11.0
2022-03	RAN#95	R5-221520	2771	1	F	Addition of V2X TC 13.2.1-Conflict Layer 2 ID	16.11.0
2022-03	RAN#95	R5-221521	2772	1	F	Addition of V2X TC 13.2.2-Security Mode	16.11.0
2022-03	RAN#95	R5-221522	2773	1	F	Addition of V2X TC 13.2.6-Link keep alive	16.11.0
2022-03	RAN#95	R5-221523	2794	1	F	Correction to NR V2X TC 13.1.1-policy provisioning	16.11.0
2022-03	RAN#95	R5-221524	2827	1	F	Addition of new NR V2X PC5 RRC reconfiguration failure / Initiating UE side	16.11.0
2022-03	RAN#95	R5-221525	2828	1	F	Addition of new NR V2X PC5 RRC reconfiguration failure / Peer UE side test case	16.11.0
2022-03	RAN#95	R5-221526	2829	1	F	Addition of new NR V2X Sidelink radio link failure / Transmission side test case	16.11.0
2022-03	RAN#95	R5-221530	2748	1	F	Correction to TC 7.1.1.12.3 DRX adaptation / UE wakeup indication	16.11.0
2022-03	RAN#95	R5-221531	2749	1	F	Update of NR5G NPN TC 6.5.2.1	16.11.0
2022-03	RAN#95	R5-221532	2799	1	F	Correction to NR5GC testcase 6.5.1.3	16.11.0
2022-03	RAN#95	R5-221533	2801	1	F	Correction to NR5GC testcase 6.5.1.1	16.11.0
2022-03	RAN#95	R5-221534	2826	1	F	Addition of new SNPN test case for EAP based primary authentication and key agreement	16.11.0
2022-03	RAN#95	R5-221536	2730	1	F	Addition of Rel-16 RACS TC 9.1.9.6	16.11.0
2022-03	RAN#95	R5-221537	2731	1	F	Addition of Rel-16 RACS TC 9.1.9.3	16.11.0
2022-03	RAN#95	R5-221538	2802	1	F	Correction to RACS test case 9.1.9.5	16.11.0
2022-03	RAN#95	R5-221539	2830	1	F	Addition of new RACS test case 9.1.9.4	16.11.0
2022-03	RAN#95	R5-221540	2863	1	F	Correction to NR5GC testcase 8.1.5.9.1	16.11.0
2022-03	RAN#95	R5-221556	2665	1	F	Update of cell power level for FR2 in NR Immediate MDT TC 8.1.6.2.2	16.11.0
2022-03	RAN#95	R5-221557	2679	1	F	Update of MDT TC 8.1.6.1.2.1	16.11.0
2022-03	RAN#95	R5-221558	2680	1	F	Update of MDT TC 8.1.6.1.2.2	16.11.0
2022-03	RAN#95	R5-221559	2681	1	F	Update of MDT TC 8.1.6.1.2.3	16.11.0
2022-03	RAN#95	R5-221560	2682	1	F	Update of MDT TC 8.1.6.1.2.4	16.11.0
2022-03	RAN#95	R5-221561	2683	1	F	Update of MDT TC 8.1.6.1.2.5	16.11.0
2022-03	RAN#95	R5-221562	2684	1	F	Update of MDT TC 8.1.6.1.2.6	16.11.0
2022-03	RAN#95	R5-221563	2685	1	F	Update of MDT TC 8.1.6.1.2.7	16.11.0
2022-03	RAN#95	R5-221564	2686	1	F	Update of MDT TC 8.1.6.1.2.8	16.11.0
2022-03	RAN#95	R5-221565	2687	1	F	Update of MDT TC 8.1.6.1.2.9	16.11.0

2022-03	RAN#95	R5-221566	2688	1	F	Update of MDT TC 8.1.6.1.2.10	16.11.0
2022-03	RAN#95	R5-221567	2689	1	F	Update of MDT TC 8.1.6.1.2.11	16.11.0
2022-03	RAN#95	R5-221568	2690	1	F	Update of MDT TC 8.1.6.1.2.12	16.11.0
2022-03	RAN#95	R5-221569	2691	1	F	Update of MDT TC 8.1.6.1.2.13	16.11.0
2022-03	RAN#95	R5-221570	2701	1	F	Update of MDT TC 8.1.6.1.4.7	16.11.0
2022-03	RAN#95	R5-221571	2724	1	F	Update of MDT test case 8.1.6.1.2.12	16.11.0
2022-03	RAN#95	R5-221572	2725	1	F	Update of MDT test case 8.1.6.1.2.13	16.11.0
2022-03	RAN#95	R5-221573	2746	1	F	Correction to SON-MDT test case 8.1.6.1.4.2	16.11.0
2022-03	RAN#95	R5-221574	2747	1	F	Update to test case 8.1.6.1.3.7	16.11.0
2022-03	RAN#95	R5-221575	2783	1	F	Correction to NR MDT TC 8.1.6.3.1.3-Inter System_Immediate MDT_Sensor	16.11.0
2022-03	RAN#95	R5-221576	2785	1	F	Correction to NR MDT TC 8.1.6.3.2.3-Inter System_Logged_Sensor	16.11.0
2022-03	RAN#95	R5-221577	2786	1	F	Correction to NR MDT TC 8.1.6.3.3.3-Inter System_RLF_Sensor	16.11.0
2022-03	RAN#95	R5-221578	2787	1	F	Correction to NR MDT TC 8.1.6.3.4.3-Inter System_Connection Establishment Failure_Sensor	16.11.0
2022-03	RAN#95	R5-221579	2796	1	F	Correction to MDT test case 8.1.6.1.3.3	16.11.0
2022-03	RAN#95	R5-221580	2808	1	F	Correction to NR MDT test case 8.1.6.1.3.4	16.11.0
2022-03	RAN#95	R5-221581	2814	1	F	Updates to Inter-System MDT test cases 8.1.6.3.2.x	16.11.0
2022-03	RAN#95	R5-221582	2815	1	F	Updates to Inter-System MDT test cases 8.1.6.3.3.x	16.11.0
2022-03	RAN#95	R5-221583	2816	1	F	Updates to Inter-System MDT test cases 8.1.6.3.4.x	16.11.0
2022-03	RAN#95	R5-221586	2822	1	F	Correction to NR URLLC MAC Test Case 7.1.1.4.1.5	16.11.0
2022-03	RAN#95	R5-221587	2823	1	F	Addition of new NR URLLC MAC Test Case for DL Grant Prioritisation	16.11.0
2022-03	RAN#95	R5-221588	2824	1	F	Addition of new NR URLLC MAC Test Case for UL Data prioritisation	16.11.0
2022-03	RAN#95	R5-221589	2832	1	F	Correction to NR URLLC MAC Test Case 7.1.1.4.2.6	16.11.0
2022-03	RAN#95	R5-221595	2817	1	F	Addition of new NR EIEI test case 11.5.5	16.11.0
2022-03	RAN#95	R5-222003	2834	1	F	New testcase for Idle/Inactive measurements on NR cells in RRC_INACTIVE state with configuration through SIB11	16.11.0
2022-03	RAN#95	R5-222004	2835	1	F	New testcase for Idle/Inactive measurements on E-UTRA cells in RRC_INACTIVE state with configuration through SIB11	16.11.0
2022-03	RAN#95	R5-222005	2855	1	F	New testcase for Idle/Inactive measurements on NR cells in RRC_INACTIVE state with configuration through RRCRelease	16.11.0
2022-03	RAN#95	R5-222006	2856	1	F	New testcase for Idle/Inactive measurements on E-UTRA cells in RRC_INACTIVE state with configuration through RRCRelease	16.11.0
2022-03	RAN#95	R5-222007	2805	1	F	Correction to R16 eNS TC 9.1.10.6	16.11.0
2022-03	RAN#95	R5-222008	2806	1	F	Correction to R16 eNS TC 9.1.10.3	16.11.0
2022-03	RAN#95	R5-222009	2807	1	F	Correction to R16 eNS TC 9.1.10.1	16.11.0
2022-03	RAN#95	R5-222010	2818	1	F	Correction to test case name of TC 9.1.10.3 and TC 9.1.10.4	16.11.0
2022-03	RAN#95	R5-222011	2825	1	F	Correction to Rel16 eNS EPS Mobility Management test case	16.11.0
2022-03	RAN#95	R5-222012	2853	1	F	Updates to test case 9.1.10.4	16.11.0
2022-03	RAN#95	R5-222013	2678	1	F	Update of date for 5GC TC 9.2.4.1	16.11.0
2022-03	RAN#95	R5-222014	2788	1	F	Correction to NR SRVCC TC 8.1.3.2.8-Inter RAT	16.11.0
2022-03	RAN#95	R5-222040	2775	1	F	Correction to NR TC 8.1.4.3.1-RRC DAPS HO Success	16.11.0
2022-03	RAN#95	R5-222041	2776	1	F	Correction to NR TC 8.1.4.3.2-RRC DAPS HO Failure	16.11.0
2022-03	RAN#95	R5-222042	2778	1	F	Correction to NR TC 8.1.4.4.4-Conditional handover and legacy handover	16.11.0
2022-03	RAN#95	R5-222043	2858	1	F	Correction to NR TCs 7.1.3.4.3 and TC 7.1.3.4.4 - PDCP DAPS HO	16.11.0
2022-03	RAN#95	R5-222044	2797	1	F	Correction to NR test case 7.1.1.9.1	16.11.0
2022-03	RAN#95	R5-222047	2710	1	F	Addition of new RACS test case 9.1.9.7	16.11.0
2022-03	RAN#95	R5-222048	2712	1	F	Correction to UAC test case 11.3.1a	16.11.0
2022-03	RAN#95	R5-222049	2695	1	F	Addition of NR V2X test case 12.2.1.2	16.11.0
2022-06	RAN#96	R5-222113	2880	-	F	Correction to NR MAC test case 7.1.1.2.4	16.12.0
2022-06	RAN#96	R5-222114	2881	-	F	Correction to NR SDAP test case 7.1.4.1	16.12.0
2022-06	RAN#96	R5-222115	2882	-	F	Correction to NR RRC test case 8.1.5.2.2	16.12.0
2022-06	RAN#96	R5-222116	2883	-	F	Correction to SON-MDT test case 8.1.6.1.2.1	16.12.0
2022-06	RAN#96	R5-222117	2884	-	F	Correction to SON-MDT test case 8.1.6.1.2.3	16.12.0
2022-06	RAN#96	R5-222118	2885	-	F	Correction to SON-MDT test case 8.1.6.1.2.4	16.12.0

2022-06	RAN#96	R5-222119	2886	-	F	Correction to SON-MDT test case 8.1.6.1.2.9	16.12.0
2022-06	RAN#96	R5-222120	2887	-	F	Correction to RACS test case 9.1.9.7	16.12.0
2022-06	RAN#96	R5-222178	2889	-	F	Update to Rel-16 NR Mobility Enhancement test case 8.2.3.18.3	16.12.0
2022-06	RAN#96	R5-222261	2894	-	F	Editorial update of NR RRC TC 8.1.1.3.7b	16.12.0
2022-06	RAN#96	R5-222262	2895	-	F	Editorial update of NR RRC TC 8.1.3.1.20	16.12.0
2022-06	RAN#96	R5-222271	2900	-	F	Correction to R16 eNS TC 9.1.10.1	16.12.0
2022-06	RAN#96	R5-222272	2901	-	F	Correction to EN-DC RRC TC 8.2.3.17.1	16.12.0
2022-06	RAN#96	R5-222273	2902	-	F	Editorial update of NR TC 10.1.3.2	16.12.0
2022-06	RAN#96	R5-222277	2903	-	F	Editorial update of NR TC 11.1.1	16.12.0
2022-06	RAN#96	R5-222362	2906	-	F	Correction to DRX adaptation test case 7.1.1.12.3	16.12.0
2022-06	RAN#96	R5-222376	2907	-	F	Correction to Inter-System MDT test case 8.1.6.3.3.3	16.12.0
2022-06	RAN#96	R5-222382	2908	-	F	Correction to NR PDCP test case 7.1.3.5.2	16.12.0
2022-06	RAN#96	R5-222384	2910	-	F	Update to UE Radio Capability Id field in RACS test cases	16.12.0
2022-06	RAN#96	R5-222418	2912	-	F	Correction to NR5GC testcase 8.1.5.9.1	16.12.0
2022-06	RAN#96	R5-222430	2913	-	F	Update test case 11.1.1a	16.12.0
2022-06	RAN#96	R5-222446	2915	-	F	Correction to NR testcase 8.1.4.4.2	16.12.0
2022-06	RAN#96	R5-222470	2921	-	F	Update of test case 8.2.2.4.3 for SCG DRB in NE-DC	16.12.0
2022-06	RAN#96	R5-222511	2923	-	F	Correction to NR PDCP test case 7.1.3.4.1	16.12.0
2022-06	RAN#96	R5-222653	2925	-	F	Correction to EN-DC TC 8.2.6.1.1.x - RLC failure	16.12.0
2022-06	RAN#96	R5-222715	2936	-	F	Update of TC 12.2.4.1- Inter-carrier concurrent operation / Sidelink Reconfiguration via Uu RRC / SL DRB management / transmission side	16.12.0
2022-06	RAN#96	R5-222811	2941	-	F	Correction to NR TC 7.1.1.10.1-DatInactivityTimer expiry	16.12.0
2022-06	RAN#96	R5-222813	2943	-	F	Correction to NR TC 11.3.1-UAC for MO Speech Call and SMSoIP	16.12.0
2022-06	RAN#96	R5-222941	2954	-	F	Correction to NR V2X test case 12.1.6.2	16.12.0
2022-06	RAN#96	R5-222942	2955	-	F	Correction to NR V2X test case 12.1.6.1	16.12.0
2022-06	RAN#96	R5-222953	2961	-	F	Correction to NR URLLC MAC Test Case 7.1.1.4.1.5	16.12.0
2022-06	RAN#96	R5-222954	2962	-	F	Correction to NR URLLC MAC Test Case 7.1.1.4.2.6	16.12.0
2022-06	RAN#96	R5-222995	2964	-	F	Correction to MDT test case 8.1.6.1.3.3	16.12.0
2022-06	RAN#96	R5-223052	2970	-	F	Update of NR MDT test case 8.1.6.1.4.5	16.12.0
2022-06	RAN#96	R5-223059	2971	-	F	Update of NR MDT test case 8.1.6.3.4.x	16.12.0
2022-06	RAN#96	R5-223064	2974	-	F	Correction to NR V2X NAS TC 13.2.1-Conflict Layer 2 ID	16.12.0
2022-06	RAN#96	R5-223065	2975	-	F	Correction to NR V2X NAS TC 13.2.2-link security mode	16.12.0
2022-06	RAN#96	R5-223085	2981	-	F	Correction to NR RLC test case 7.1.2.3.7	16.12.0
2022-06	RAN#96	R5-223249	2986	-	F	Update to NR EIEI test cases 11.5.1, 11.5.2, 11.5.5	16.12.0
2022-06	RAN#96	R5-223252	2987	-	F	Correction of USIM configuration in RACS test case 9.1.9.4	16.12.0
2022-06	RAN#96	R5-223264	2991	-	F	Update of test case 8.1.6.1.1.2	16.12.0
2022-06	RAN#96	R5-223273	2996	-	F	Update of test case TC 8.1.6.2.3	16.12.0
2022-06	RAN#96	R5-223274	2997	-	F	Update to test case 8.1.6.1.3.6	16.12.0
2022-06	RAN#96	R5-223340	2911	1	F	Editorial Correction to NR Test case 8.1.4.4.3	16.12.0
2022-06	RAN#96	R5-223342	2890	1	F	Update to SRVCC from 5G to 3G test case 8.1.3.2.6 and 8.1.3.2.7	16.12.0
2022-06	RAN#96	R5-223343	2977	1	F	Correction of cell number in the test procedure of 8.1.3.1.15A	16.12.0
2022-06	RAN#96	R5-223344	2920	1	F	Update of test case 8.2.1.1.2 for UE capability transfer in NE-DC	16.12.0
2022-06	RAN#96	R5-223345	2917	1	F	Update of test case 8.2.3.6.2 for Intra-frequency measurements Event A3 in NE-DC	16.12.0
2022-06	RAN#96	R5-223346	2918	1	F	Update of test case 8.2.3.6.2a for Inter-frequency measurements Event A3 in NE-DC	16.12.0
2022-06	RAN#96	R5-223347	2919	1	F	Update of test case 8.2.3.6.2b for Inter-band measurements Event A3 in NE-DC	16.12.0
2022-06	RAN#96	R5-223350	2920	-	F	Correction to emergency services test case 11.4.4	16.12.0
2022-06	RAN#96	R5-223358	2914	1	F	Correction to NR testcase 8.1.4.4.4	16.12.0
2022-06	RAN#96	R5-223366	2932	1	F	Update of TC 12.1.3.1- PC5-only operation / Measurement configuration and reporting via PC5 RRC / PSBCH-RSRP measurement configuration	16.12.0
2022-06	RAN#96	R5-223367	2933	1	F	Update of TC 12.1.5.1- PC5-only operation / Sidelink CSI reporting	16.12.0
2022-06	RAN#96	R5-223368	2934	1	F	Update of TC 12.1.5.2- PC5-only operation / Sidelink CSI reporting	16.12.0
2022-06	RAN#96	R5-223369	2935	1	F	Update of TC 12.2.1.6- Inter-carrier concurrent operation / Sidelink communication / RRC_CONNECTED / Reception	16.12.0
2022-06	RAN#96	R5-223370	2937	1	F	Update of TC 12.2.5.3- Inter-carrier concurrent operation /	16.12.0

						Measurement configuration and reporting via PC5 RRC / PSBCH-RSRP measurement reporting / Periodical reporting	
2022-06	RAN#96	R5-223371	2956	1	F	Addition of new NR V2X test case 12.1.4.1	16.12.0
2022-06	RAN#96	R5-223372	2957	1	F	Addition of new NR V2X test case 13.2.3	16.12.0
2022-06	RAN#96	R5-223373	2958	1	F	Addition of new NR V2X test case 13.2.4	16.12.0
2022-06	RAN#96	R5-223374	2963	1	F	Addition of new NR V2X test case 12.1.4.2	16.12.0
2022-06	RAN#96	R5-223375	2965	1	F	Update of NR V2X TC 12.1.3.3	16.12.0
2022-06	RAN#96	R5-223376	2976	1	F	Correction to NR V2X NAS TC 13.2.6-link keep alive	16.12.0
2022-06	RAN#96	R5-223379	2896	1	F	Addition of new NR5G NPN TC 6.5.2.3	16.12.0
2022-06	RAN#96	R5-223380	2922	1	B	Addition of new NR5GC CAG testcase 6.5.2.6	16.12.0
2022-06	RAN#96	R5-223381	2924	1	F	Correction to NR5GC CAG testcase 6.5.2.1	16.12.0
2022-06	RAN#96	R5-223382	2953	1	F	Update of NR5G NPN TC 6.5.2.2 and 6.5.2.4	16.12.0
2022-06	RAN#96	R5-223385	2904	1	F	Correction to NR MDT test case 8.1.6.1.4.8	16.12.0
2022-06	RAN#96	R5-223386	2979	1	F	Update of NR MDT test case 8.1.6.3.2.x	16.12.0
2022-06	RAN#96	R5-223392	2988	1	F	Addition of new NR EIEI test case 8.1.4.1.10	16.12.0
2022-06	RAN#96	R5-223393	2989	1	F	Addition of NR EIEI test case 11.5.6	16.12.0
2022-06	RAN#96	R5-223394	2990	1	F	Addition of NR EIEI test case 11.5.7	16.12.0
2022-06	RAN#96	R5-223395	2992	1	F	Addition of NR EIEI test case 11.5.9	16.12.0
2022-06	RAN#96	R5-223396	2993	1	F	Addition of NR EIEI test case 11.5.10	16.12.0
2022-06	RAN#96	R5-223397	2994	1	F	Addition of NR EIEI test case 11.5.11	16.12.0
2022-06	RAN#96	R5-223398	2995	1	F	Addition of NR EIEI test case 11.5.13	16.12.0
2022-06	RAN#96	R5-223402	2926	1	F	Modification of testcase 8.1.5.11.2 Idle/Inactive measurements	16.12.0
2022-06	RAN#96	R5-223403	2929	1	F	Modification of testcase 8.1.5.11.3 Idle/Inactive measurements	16.12.0
2022-06	RAN#96	R5-223404	2973	1	F	Modification of testcase 8.1.5.11.4 idle/inactive measurements	16.12.0
2022-06	RAN#96	R5-223405	2984	1	F	Modification of testcase 8.1.5.11.5 idle/inactive measurements	16.12.0
2022-06	RAN#96	R5-223406	2985	1	F	Modification of testcase 8.1.5.11.6 idle/inactive measurements	16.12.0
2022-06	RAN#96	R5-223418	2983	1	F	Correction to SOR test case 6.3.1.10	16.12.0
2022-06	RAN#96	R5-223419	2878	1	F	Correction to NR MAC test case 7.1.1.1.2	16.12.0
2022-06	RAN#96	R5-223420	2879	1	F	Correction to NR MAC test case 7.1.1.3.3	16.12.0
2022-06	RAN#96	R5-223421	2909	1	F	Corrections to NR IIoT PDCP test cases 7.1.3.5.6.x	16.12.0
2022-06	RAN#96	R5-223422	2916	1	F	Correction to NR5GC testcase 7.1.3.4.1	16.12.0
2022-06	RAN#96	R5-223423	2949	1	F	Correction to NR5GC testcase 8.1.1.2.4	16.12.0
2022-06	RAN#96	R5-223424	2946	1	F	Correction to NR CA TC 8.1.5.7.1-CA duplication	16.12.0
2022-06	RAN#96	R5-223425	2951	1	F	Update of RACS TC 8.1.5.9.1	16.12.0
2022-06	RAN#96	R5-223426	2930	1	F	Addition of new test case 8.2.5.3.3	16.12.0
2022-06	RAN#96	R5-223427	2952	1	F	Update of 5GMM TC 9.1.5.1.15	16.12.0
2022-06	RAN#96	R5-223428	2978	1	F	Correction of Equivalent PLMN ID in the test procedure of 9.1.5.1.2	16.12.0
2022-06	RAN#96	R5-223429	2899	1	F	Correction to R16 eNS TC 9.1.10.3	16.12.0
2022-06	RAN#96	R5-223430	2905	1	F	Correction to NR5GC testcase 11.1.2	16.12.0
2022-06	RAN#96	R5-223431	2945	1	F	Correction to NR TC 11.1.2-EPS Fallback with redirection without N26	16.12.0
2022-06	RAN#96	R5-223432	2950	1	F	Add test case 11.1.3a	16.12.0
2022-06	RAN#96	R5-223433	2968	1	F	Update of 5G-SRVCC TC 11.2.1	16.12.0
2022-06	RAN#96	R5-223434	2892	1	F	Correction to TC 11.3.8 UAC / Access Identity 0 / NR RRC_IDLE / Cell re-selection while T390 is running	16.12.0
2022-06	RAN#96	R5-223435	2928	1	F	Correction to UAC test case 11.3.1a	16.12.0
2022-06	RAN#96	R5-223436	2939	1	F	Correction to NR TC 11.3.5-UAC New cell not in the country of its HPLMN	16.12.0
2022-06	RAN#96	R5-223437	2940	1	F	Correction to NR TC 11.3.6-UAC for Access Identity 2	16.12.0
2022-06	RAN#96	R5-223438	2891	1	F	Correction of 5GS IMS test case 11.4.12	16.12.0
2022-06	RAN#96	R5-223439	2972	1	F	Correction to Emergency Call test cases 11.4.x	16.12.0
2022-06	RAN#96	R5-223440	2898	1	F	Correction to NR5GC testcase 11.6.x	16.12.0
2022-06	RAN#96	R5-223441	2980	1	F	Updates to test case 11.6.1	16.12.0
2022-06	RAN#96	R5-223495	2959	1	F	Addition of new SNPN test case	16.12.0
2022-06	RAN#96	R5-223496	2927	1	F	Correction to SON-MDT test case 8.1.6.1.2.x	16.12.0
2022-06	RAN#96	R5-223497	2960	1	F	Addition of new NR-NR Dual Connectivity test case	16.12.0
2022-09	RAN#97	R5-223931	3004	-	F	Corrections to NR MAC TC 7.1.1.3.12	16.13.0
2022-09	RAN#97	R5-223935	3005	-	F	Correction to NR MAC TC 7.1.1.1.3	16.13.0

2022-09	RAN#97	R5-223986	3009	-	F	Update of NR5GC CAG TC 6.5.2.4	16.13.0
2022-09	RAN#97	R5-223990	3010	-	F	Update of SRVCC TC 8.1.3.2.6	16.13.0
2022-09	RAN#97	R5-223991	3011	-	F	Update of SRVCC TC 8.1.3.2.7	16.13.0
2022-09	RAN#97	R5-223992	3012	-	F	Update of SRVCC TC 8.1.3.2.8	16.13.0
2022-09	RAN#97	R5-223993	3013	-	F	Update of NR MDT TC 8.1.6.1.2.7	16.13.0
2022-09	RAN#97	R5-223994	3014	-	F	Update of NR MDT TC 8.1.6.1.4.3	16.13.0
2022-09	RAN#97	R5-223995	3015	-	F	Update of NR MDT TC 8.1.6.1.4.4	16.13.0
2022-09	RAN#97	R5-223997	3017	-	F	Editorial update of UAC TC 11.3.2	16.13.0
2022-09	RAN#97	R5-224007	3018	-	F	Update of NR MDT TC 8.1.6.3.1.3	16.13.0
2022-09	RAN#97	R5-224029	3019	-	F	Update to 5GC test case 9.1.6.1.3	16.13.0
2022-09	RAN#97	R5-224031	3021	-	F	Editorial update to UAC test case titles in 38.523-1	16.13.0
2022-09	RAN#97	R5-224048	3023	-	F	New NE-DC RRC Radio Bearer test case 8.2.2.2.3	16.13.0
2022-09	RAN#97	R5-224050	3025	-	F	New NE-DC RRC Radio Bearer test case 8.2.2.8.3	16.13.0
2022-09	RAN#97	R5-224051	3026	-	F	New NE-DC RRC Radio Bearer test case 8.2.2.9.3	16.13.0
2022-09	RAN#97	R5-224127	3045	-	F	Correction to NR MAC test case 7.1.1.1.1	16.13.0
2022-09	RAN#97	R5-224128	3046	-	F	Editorial correction to NR MAC test case 7.1.1.1.1a	16.13.0
2022-09	RAN#97	R5-224129	3047	-	F	Correction to NR MAC test case 7.1.1.3.9	16.13.0
2022-09	RAN#97	R5-224130	3048	-	F	Correction to NR RRC test cases 8.1.4.1.5 and 8.1.4.1.6	16.13.0
2022-09	RAN#97	R5-224131	3049	-	F	Correction to Inter-RAT SON-MDT test case 8.1.6.2.1	16.13.0
2022-09	RAN#97	R5-224165	3052	-	F	Correction to NR5GC testcase 9.1.10.3	16.13.0
2022-09	RAN#97	R5-224180	3053	-	F	Correction to NR5GC MDT testcase 8.1.6.1.4.8	16.13.0
2022-09	RAN#97	R5-224191	3054	-	F	Correction to NR5GC MDT testcase 8.1.6.1.1.2	16.13.0
2022-09	RAN#97	R5-224192	3055	-	F	Correction to NR5GC MDT testcase 8.1.6.1.3.4	16.13.0
2022-09	RAN#97	R5-224195	3056	-	F	Correction to NR testcase 9.1.4.1	16.13.0
2022-09	RAN#97	R5-224200	3058	-	F	Correction to NR test case 8.1.5.2.2	16.13.0
2022-09	RAN#97	R5-224201	3059	-	F	Correction to NR test case 8.1.1.4.1	16.13.0
2022-09	RAN#97	R5-224202	3060	-	F	Correction to NR test case 7.1.1.1.2	16.13.0
2022-09	RAN#97	R5-224203	3061	-	F	Correction to NR testcase 7.1.1.1.1a	16.13.0
2022-09	RAN#97	R5-224340	3066	-	F	Editorial Correction - Add VOID to CAG TC 6.5.2.5	16.13.0
2022-09	RAN#97	R5-224342	3067	-	F	Correction to NR 5GC CAG TC 6.5.2.4	16.13.0
2022-09	RAN#97	R5-224344	3068	-	F	Correction to SNPN NAS test case 9.1.11.1	16.13.0
2022-09	RAN#97	R5-224352	3074	-	F	Editorial update to UAC test case 11.3.8	16.13.0
2022-09	RAN#97	R5-224354	3076	-	F	Corrections to NR TC 8.1.4.4.2	16.13.0
2022-09	RAN#97	R5-224355	3077	-	F	Correction to NR TC 8.1.4.4.4	16.13.0
2022-09	RAN#97	R5-224383	3080	-	F	Correction to NR testcase 8.2.6.2.2	16.13.0
2022-09	RAN#97	R5-224388	3084	-	F	Correction to NR5GC CAG TC 6.5.2.3	16.13.0
2022-09	RAN#97	R5-224440	3089	-	F	Addition of new NR EIEI test case 11.5.8	16.13.0
2022-09	RAN#97	R5-224445	3092	-	F	Addition of NR EIEI test case 11.5.12	16.13.0
2022-09	RAN#97	R5-224446	3093	-	F	Update to NR EIEI test case 11.5.5	16.13.0
2022-09	RAN#97	R5-224447	3094	-	F	Update to NR EIEI test cases 11.5.1, 11.5.2	16.13.0
2022-09	RAN#97	R5-224448	3095	-	F	Update to SDAP test case 7.1.4.1	16.13.0
2022-09	RAN#97	R5-224449	3096	-	F	Editorial update to test case 9.1.5.2.7	16.13.0
2022-09	RAN#97	R5-224450	3097	-	F	Editorial update to UAC Test Case 11.3.1a	16.13.0
2022-09	RAN#97	R5-224452	3098	-	F	Correction to NR DC test case 8.2.3.14.2	16.13.0
2022-09	RAN#97	R5-224455	3100	-	F	Editorial update to test case 11.3.6	16.13.0
2022-09	RAN#97	R5-224456	3101	-	F	Updates to NR MAC TC 7.1.1.3.9	16.13.0
2022-09	RAN#97	R5-224482	3104	-	F	Correction to 5GS Test case 11.3.4	16.13.0
2022-09	RAN#97	R5-224485	3107	-	F	Update of test case 8.1.6.4.1	16.13.0
2022-09	RAN#97	R5-224559	3110	-	F	Addition of NR SL SIG TC 12.1.2.1 - PC5 only SyncRef reselection	16.13.0
2022-09	RAN#97	R5-224560	3111	-	F	Addition of NR SL SIG TC 12.1.2.2 - PC5 only S-SSB Tx	16.13.0
2022-09	RAN#97	R5-224561	3112	-	F	Addition of NR SL SIG TC 12.2.2.1 - Concurrent SyncRef reselection	16.13.0
2022-09	RAN#97	R5-224562	3113	-	F	Addition of NR SL SIG TC 12.2.2.2 - Concurrent S-SSB Tx	16.13.0
2022-09	RAN#97	R5-224563	3114	-	F	Correction to NR SL SIG TC 12.2.3.1 - Concurrent Event C1 and C2	16.13.0
2022-09	RAN#97	R5-224564	3115	-	F	Addition of NR SL SIG TC 12.2.5.1 - Concurrent SL-RSRP Config	16.13.0
2022-09	RAN#97	R5-224565	3116	-	F	Addition of NR SL SIG TC 12.2.5.2 - Concurrent Event S1 and S2	16.13.0
2022-09	RAN#97	R5-224567	3118	-	F	Addition of NR SL SIG TC 12.2.8.1 - Concurrent Reconfig failure	16.13.0
2022-09	RAN#97	R5-224568	3119	-	F	Addition of NR SL SIG TC 12.2.8.3 - Concurrent SL radio link failure	16.13.0

2022-09	RAN#97	R5-224571	3121	-	F	Correction to NR TC 6.4.1.1- Automatic PLMN Selection	16.13.0
2022-09	RAN#97	R5-224572	3122	-	F	Correction to NR TC 6.4.1.2- ePLMN manual selection	16.13.0
2022-09	RAN#97	R5-224573	3123	-	F	Correction to NR TC 6.4.2.1- Cell Reselection	16.13.0
2022-09	RAN#97	R5-224574	3124	-	F	Correction to NR TC 6.4.2.2- Cell Reselection SIB priority	16.13.0
2022-09	RAN#97	R5-224575	3125	-	F	Correction to NR TC 8.1.3.1.12 - SINR A5	16.13.0
2022-09	RAN#97	R5-224577	3127	-	F	Correction to NE-DC TC 8.2.2.5.3 - Split DRB	16.13.0
2022-09	RAN#97	R5-224581	3130	-	F	Update of TC 12.2.1.2- Inter-carrier concurrent operation / Sidelink communication / RRC_IDLE / Reception	16.13.0
2022-09	RAN#97	R5-224582	3131	-	F	Update of TC 12.1.3.2- PC5-only operation / Measurement configuration and reporting via PC5 RRC / PSBCH-RSRP measurement reporting / Event S1 and S2	16.13.0
2022-09	RAN#97	R5-224597	3141	-	F	Addition of new NE-DC test case 8.2.3.12.2	16.13.0
2022-09	RAN#97	R5-224598	3142	-	F	Update of NE-DC test case 8.2.3.6.2	16.13.0
2022-09	RAN#97	R5-224599	3143	-	F	Update of test case 8.2.3.4.1	16.13.0
2022-09	RAN#97	R5-224713	3154	-	F	Correction to NR TC 7.1.1.4.2.4 - DCI format 0_1 256QAM	16.13.0
2022-09	RAN#97	R5-224716	3157	-	F	Correction to NR TC 11.3.7 - 0 accessibility for AC2	16.13.0
2022-09	RAN#97	R5-224717	3158	-	F	Correction to NR TC 11.3.9 - ODAC	16.13.0
2022-09	RAN#97	R5-224718	3159	-	F	Correction to NR TC 11.4.1 - Emergency call and AKA fail	16.13.0
2022-09	RAN#97	R5-224720	3161	-	F	Addition NR TC 11.4.10 back and rename it to 11.4.10a	16.13.0
2022-09	RAN#97	R5-224921	3174	-	F	Update to NR EIEI test case 11.5.6	16.13.0
2022-09	RAN#97	R5-224928	3179	-	F	Correction of UL Grant Prioritization MAC test case	16.13.0
2022-09	RAN#97	R5-224929	3180	-	F	Addition of new NR-NR Dual Connectivity test case	16.13.0
2022-09	RAN#97	R5-225052	3189	-	F	38523-1 correction of Back-off timer value in the test procedure of 10.1.3.2	16.13.0
2022-09	RAN#97	R5-225129	3195	-	F	38523-1 correction on handover type in test case 8.1.4.4.4	16.13.0
2022-09	RAN#97	R5-225171	3197	-	F	38523-1 power level adjustment in test case 8.1.4.4.3	16.13.0
2022-09	RAN#97	R5-225199	3201	-	F	Updates to test case 8.1.1.4.4	16.13.0
2022-09	RAN#97	R5-225200	3202	-	F	Updates to test case 8.1.1.4.7	16.13.0
2022-09	RAN#97	R5-225245	3204	-	F	Update test case 11.1.3a	16.13.0
2022-09	RAN#97	R5-225246	3205	-	F	Correction to the test case 8.1.4.2.1.2	16.13.0
2022-09	RAN#97	R5-225260	3206	-	F	Addition of new test case 11.3.10 for access category 9 on Access identity 0	16.13.0
2022-09	RAN#97	R5-225281	3057	1	F	Correction to NR testcases 8.1.5.7.1.1, 8.1.5.7.1.2 and 8.1.5.7.1.3	16.13.0
2022-09	RAN#97	R5-225282	3144	1	F	Correction to NR5GC RRC test case 8.2.2.1.1	16.13.0
2022-09	RAN#97	R5-225283	3073	1	F	Editorial Corrections for TC 9.1.2.6	16.13.0
2022-09	RAN#97	R5-225292	3128	1	F	Update of TC 13.2.5- PC5 unicast / link identifier update	16.13.0
2022-09	RAN#97	R5-225293	3129	1	F	Update of TC 12.2.3.2- Inter-carrier concurrent operation / Measurement configuration and reporting via Uu RRC / CBR measurement reporting / Periodical reporting	16.13.0
2022-09	RAN#97	R5-225294	3175	1	F	Correction of NR V2X test case 12.1.6.3	16.13.0
2022-09	RAN#97	R5-225295	3176	1	F	Correction of NR V2X test case 13.2.4	16.13.0
2022-09	RAN#97	R5-225297	3086	1	F	Correction of test cases 7.1.1.12.4	16.13.0
2022-09	RAN#97	R5-225302	3064	1	F	Correction to Idle Mode Test Case to enable SNPN Only UE	16.13.0
2022-09	RAN#97	R5-225303	3065	1	F	Correction to SNPN TC 6.5.1.2	16.13.0
2022-09	RAN#97	R5-225304	3069	1	F	Correction to NR 5GC CAG testcase 8.1.7.1.1	16.13.0
2022-09	RAN#97	R5-225305	3082	1	F	Correction to NR CAG testcase 6.5.2.1	16.13.0
2022-09	RAN#97	R5-225306	3203	1	F	Correction to NR CAG testcase 6.5.2.2	16.13.0
2022-09	RAN#97	R5-225307	3085	1	F	Correction to NR CAG testcase 6.5.2.6	16.13.0
2022-09	RAN#97	R5-225308	3177	1	F	Correction of NR SNPN test case 10.1.7.1	16.13.0
2022-09	RAN#97	R5-225317	3038	1	F	Update 2-step RACH test case 7.1.1.1.7	16.13.0
2022-09	RAN#97	R5-225318	3039	1	F	Update 2-step RACH test case 7.1.1.1.8	16.13.0
2022-09	RAN#97	R5-225319	3040	1	F	Update 2-step RACH test case 7.1.1.1.10	16.13.0
2022-09	RAN#97	R5-225320	3090	1	F	Addition of NR EIEI test case 11.5.4	16.13.0
2022-09	RAN#97	R5-225323	3062	1	F	Update RRC UE capability for PC1.5 duty cycle	16.13.0
2022-09	RAN#97	R5-225372	3103	1	F	Correction to idle mode test cases (applicable only for FR1 bands)	16.13.0
2022-09	RAN#97	R5-225373	3120	1	F	Correction to NR TC 6.1.2.11 - Area Specific SIBs	16.13.0
2022-09	RAN#97	R5-225374	3191	1	F	38523-1 correction on pre-test conditions of test case 6.1.1.1	16.13.0
2022-09	RAN#97	R5-225375	3196	1	F	Correction to NR testcase 6.3.1.3	16.13.0
2022-09	RAN#97	R5-225376	3200	1	F	Correction to NR testcase 6.3.1.5	16.13.0
2022-09	RAN#97	R5-225377	3081	1	F	Correction to NR testcase 7.1.1.6.3	16.13.0
2022-09	RAN#97	R5-225378	3155	1	F	Correction to NR TC 7.1.1.6.1 - SPS	16.13.0
2022-09	RAN#97	R5-225379	3099	1	F	Correction to PDCP test case 7.1.3.5.2	16.13.0

2022-09	RAN#97	R5-225380	3105	1	F	Correction to RRC Connection Management test cases (applicable only for FR1 bands)	16.13.0
2022-09	RAN#97	R5-225381	3194	1	F	Correction to NR5GC RRC test case 8.1.1.2.3	16.13.0
2022-09	RAN#97	R5-225382	3190	1	F	38523-1 correction to test case 8.1.2.1.1	16.13.0
2022-09	RAN#97	R5-225383	3106	1	F	Correction to RRC Measurement test cases (applicable only for FR1 bands)	16.13.0
2022-09	RAN#97	R5-225384	3006	1	F	Updates for NR RRC test case 8.1.5.1.1	16.13.0
2022-09	RAN#97	R5-225385	3193	1	F	Addition of test case for RRC downlink segmentation	16.13.0
2022-09	RAN#97	R5-225386	3016	1	F	Update of NR MDT TC 8.1.6.2.3	16.13.0
2022-09	RAN#97	R5-225387	3041	1	F	Update of Inter-RAT MDT test cases 8.1.6.2.x	16.13.0
2022-09	RAN#97	R5-225388	3042	1	F	Update of Inter-System MDT test cases 8.1.6.3.x	16.13.0
2022-09	RAN#97	R5-225389	3079	1	F	Correction to Intra NR MDT test cases 8.1.6.1.x	16.13.0
2022-09	RAN#97	R5-225390	3186	1	F	Update of NR MDT test case 8.1.6.1.3.6	16.13.0
2022-09	RAN#97	R5-225391	3007	1	F	Updates for EN-DC RRC test case 8.2.1.1.1	16.13.0
2022-09	RAN#97	R5-225392	3008	1	F	Updates for NE-DC RRC test case 8.2.1.1.2	16.13.0
2022-09	RAN#97	R5-225393	3022	1	F	New NR-DC RRC Radio Bearer test case 8.2.2.2.2	16.13.0
2022-09	RAN#97	R5-225394	3024	1	F	New NE-DC RRC Radio Bearer test case 8.2.2.7.3	16.13.0
2022-09	RAN#97	R5-225395	3027	1	F	New NE-DC measurements test case 8.2.3.1.2	16.13.0
2022-09	RAN#97	R5-225396	3030	1	F	New NE-DC measurements test case 8.2.3.2.2	16.13.0
2022-09	RAN#97	R5-225397	3031	1	F	New NE-DC measurements test case 8.2.3.7.2	16.13.0
2022-09	RAN#97	R5-225398	3032	1	F	New NE-DC measurements test case 8.2.3.7.2a	16.13.0
2022-09	RAN#97	R5-225399	3033	1	F	New NE-DC measurements test case 8.2.3.7.2b	16.13.0
2022-09	RAN#97	R5-225400	3034	1	F	New NE-DC measurements test case 8.2.3.8.2	16.13.0
2022-09	RAN#97	R5-225401	3035	1	F	New NE-DC measurements test case 8.2.3.8.2a	16.13.0
2022-09	RAN#97	R5-225402	3036	1	F	New NE-DC measurements test case 8.2.3.8.2b	16.13.0
2022-09	RAN#97	R5-225403	3108	1	F	Correction to ENDC Measurement test cases (applicable only for FR1 bands)	16.13.0
2022-09	RAN#97	R5-225404	3139	1	F	Addition of new NE-DC test case 8.2.3.4.2	16.13.0
2022-09	RAN#97	R5-225405	3140	1	F	Addition of new NE-DC test case 8.2.3.5.2	16.13.0
2022-09	RAN#97	R5-225406	3050	1	F	Correction to ENDC test cases 8.2.4.2.1.x	16.13.0
2022-09	RAN#97	R5-225407	3078	1	F	Editorial update to NR Test case 9.1.6.1.3	16.13.0
2022-09	RAN#97	R5-225408	3188	1	F	Update of test case 9.1.10.6	16.13.0
2022-09	RAN#97	R5-225409	3051	1	F	Correction to NR5GC IRAT test case 11.4.11	16.13.0
2022-09	RAN#97	R5-225410	3160	1	F	Correction to NR TC 11.4.5 - Emergency call and forbidden TA	16.13.0
2022-09	RAN#97	R5-225411	3192	1	F	Update of test case 11.4.5	16.13.0
2022-09	RAN#97	R5-225412	3183	1	F	Add new test case 11.8.5 Inter-system mobility between untrusted Non-3GPP and 3GPP system/Handover from 5GS to EPC/ePDG	16.13.0
2022-09	RAN#97	R5-225448	3117	1	F	Addition of NR SL SIG TC 12.2.7.2 - Concurrent SL CSI reporting	16.13.0
2022-09	RAN#97	R5-225449	3083	1	F	Correction to EPS FB Test case 11.1.2	16.13.0
2022-09	RAN#97	R5-224269	3063	-	F	Add Msg3 repetition protocol test case	17.0.0
2022-09	RAN#97	R5-225173	3199	-	F	New RedCap test case 11.7.2	17.0.0
2022-09	RAN#97	R5-225335	3133	1	F	Addition of new test case 10.1.8.1- NASC / PDU session establishment reject / Maximum number of PDU sessions reached / Back-off timer is neither zero nor deactivated	17.0.0
2022-09	RAN#97	R5-225336	3135	1	F	Addition of new test case 10.1.8.2- NASC / PDU session establishment reject / Maximum number of PDU sessions reached / Back-off timer is deactivated	17.0.0
2022-09	RAN#97	R5-225337	3136	1	F	Addition of new test case 10.1.8.3-NASC / PDU session establishment reject / Maximum number of PDU sessions reached / Back-off timer is zero or not included	17.0.0
2022-09	RAN#97	R5-225338	3137	1	F	Addition of new eNS Ph2 test case 9.1.12.1	17.0.0
2022-09	RAN#97	R5-225339	3138	1	F	Addition of new eNS Ph2 test case 9.1.12.2	17.0.0
2022-09	RAN#97	R5-225340	3178	1	F	Addition of new eNS Test Case for NSAC Initial registration rejected	17.0.0
2022-09	RAN#97	R5-225344	3152	1	F	Addition of RedCap TC 7.1.1.8.3 - Separate BWP	17.0.0
2022-09	RAN#97	R5-225345	3153	1	F	Addition of RedCap TC 7.1.1.1.16 - MSG3 identification on CCCH1	17.0.0
2022-09	RAN#97	R5-225346	3171	1	F	Addition of RedCap TC 6.1.2.26 - Cell Selection	17.0.0
2022-09	RAN#97	R5-225347	3172	1	F	Addition of RedCap TC 7.1.1.1.17 - Msg1-based UE identification	17.0.0
2022-09	RAN#97	R5-225348	3198	1	F	New RedCap test case 8.1.3.4.1	17.0.0

History

Document history		
V17.0.0	October 2022	Publication