

ETSI TS 137 145-2 V14.9.0 (2019-10)



**Universal Mobile Telecommunications System (UMTS);
LTE;
Active Antenna System (AAS) Base Station (BS)
conformance testing;
Part 2: radiated conformance testing
(3GPP TS 37.145-2 version 14.9.0 Release 14)**



Reference

RTS/TSGR-0437145-2ve90

Keywords

LTE,UMTS

ETSI

650 Route des Lucioles
F-06921 Sophia Antipolis Cedex - FRANCE

Tel.: +33 4 92 94 42 00 Fax: +33 4 93 65 47 16

Siret N° 348 623 562 00017 - NAF 742 C
Association à but non lucratif enregistrée à la
Sous-Préfecture de Grasse (06) N° 7803/88

Important notice

The present document can be downloaded from:

<http://www.etsi.org/standards-search>

The present document may be made available in electronic versions and/or in print. The content of any electronic and/or print versions of the present document shall not be modified without the prior written authorization of ETSI. In case of any existing or perceived difference in contents between such versions and/or in print, the prevailing version of an ETSI deliverable is the one made publicly available in PDF format at www.etsi.org/deliver.

Users of the present document should be aware that the document may be subject to revision or change of status.

Information on the current status of this and other ETSI documents is available at

<https://portal.etsi.org/TB/ETSIDeliverableStatus.aspx>

If you find errors in the present document, please send your comment to one of the following services:

<https://portal.etsi.org/People/CommiteeSupportStaff.aspx>

Copyright Notification

No part may be reproduced or utilized in any form or by any means, electronic or mechanical, including photocopying and microfilm except as authorized by written permission of ETSI.

The content of the PDF version shall not be modified without the written authorization of ETSI.

The copyright and the foregoing restriction extend to reproduction in all media.

© ETSI 2019.

All rights reserved.

DECT™, **PLUGTESTS™**, **UMTS™** and the ETSI logo are trademarks of ETSI registered for the benefit of its Members.

3GPP™ and **LTE™** are trademarks of ETSI registered for the benefit of its Members and of the 3GPP Organizational Partners.

oneM2M™ logo is a trademark of ETSI registered for the benefit of its Members and of the oneM2M Partners.

GSM® and the GSM logo are trademarks registered and owned by the GSM Association.

Intellectual Property Rights

Essential patents

IPRs essential or potentially essential to normative deliverables may have been declared to ETSI. The information pertaining to these essential IPRs, if any, is publicly available for **ETSI members and non-members**, and can be found in ETSI SR 000 314: *"Intellectual Property Rights (IPRs); Essential, or potentially Essential, IPRs notified to ETSI in respect of ETSI standards"*, which is available from the ETSI Secretariat. Latest updates are available on the ETSI Web server (<https://ipr.etsi.org/>).

Pursuant to the ETSI IPR Policy, no investigation, including IPR searches, has been carried out by ETSI. No guarantee can be given as to the existence of other IPRs not referenced in ETSI SR 000 314 (or the updates on the ETSI Web server) which are, or may be, or may become, essential to the present document.

Trademarks

The present document may include trademarks and/or tradenames which are asserted and/or registered by their owners. ETSI claims no ownership of these except for any which are indicated as being the property of ETSI, and conveys no right to use or reproduce any trademark and/or tradename. Mention of those trademarks in the present document does not constitute an endorsement by ETSI of products, services or organizations associated with those trademarks.

Legal Notice

This Technical Specification (TS) has been produced by ETSI 3rd Generation Partnership Project (3GPP).

The present document may refer to technical specifications or reports using their 3GPP identities. These shall be interpreted as being references to the corresponding ETSI deliverables.

The cross reference between 3GPP and ETSI identities can be found under <http://webapp.etsi.org/key/queryform.asp>.

Modal verbs terminology

In the present document "**shall**", "**shall not**", "**should**", "**should not**", "**may**", "**need not**", "**will**", "**will not**", "**can**" and "**cannot**" are to be interpreted as described in clause 3.2 of the [ETSI Drafting Rules](#) (Verbal forms for the expression of provisions).

"**must**" and "**must not**" are **NOT** allowed in ETSI deliverables except when used in direct citation.

Contents

Intellectual Property Rights	2
Legal Notice	2
Modal verbs terminology.....	2
Foreword.....	6
1 Scope	7
2 References	7
3 Definitions, symbols and abbreviations	8
3.1 Definitions	8
3.2 Symbols.....	10
3.3 Abbreviations	12
4 General test conditions and declarations	13
4.1 Measurement uncertainties and test requirements	13
4.1.1 General.....	13
4.1.2 Acceptable uncertainty of Test System.....	13
4.1.2.1 General	13
4.1.2.2 Measurement of transmitter	13
4.1.2.3 Measurement of receiver	13
4.1.3 Interpretation of measurement results.....	14
4.2 Conducted and radiated requirement reference points	14
4.3 Base station classes for AAS BS	15
4.4 Regional requirements.....	15
4.5 Operating bands and band categories	15
4.6 Channel arrangements	15
4.7 Requirements for AAS BS capable of multi-band operation	15
4.8 AAS BS configurations	15
4.8.1 Transmit configurations	15
4.8.2 Receive configurations	16
4.8.3 Power supply options.....	16
4.8.4 BS with integrated Iuant BS modem	16
4.9 Capability sets	17
4.10 Manufacturer declarations	17
4.11 Test signal configurations for testing	20
4.11.1 General.....	20
4.11.2 Test signal configurations.....	21
4.11.2.1 ATCR1: UTRA multicarrier operation	21
4.11.2.1.1 General	21
4.11.2.1.2 ATCR1a generation.....	21
4.11.2.1.3 ATCR1b generation.....	21
4.11.2.1.4 ATCR1 EIRP allocation	21
4.11.2.2 ANTCR1: UTRA FDD multicarrier non-contiguous operation.....	21
4.11.2.2.1 General	21
4.11.2.2.2 ANTCR1 generation.....	21
4.11.2.2.3 ANTCR1 EIRP allocation	22
4.11.2.3 ATCR2: E-UTRA multicarrier operation.....	22
4.11.2.3.1 General	22
4.11.2.3.2 ATCR2a generation.....	22
4.11.2.3.3 ATCR2b generation.....	22
4.11.2.3.4 ATCR2 EIRP allocation	23
4.11.2.4 ANTCR2: E-UTRA multicarrier non-contiguous operation.....	23
4.11.2.4.1 General	23
4.11.2.4.2 ANTCR2 generation.....	23
4.11.2.4.3 ANTCR2 EIRP allocation	24
4.11.2.5 ATCR3: UTRA and E-UTRA multi RAT operation	24
4.11.2.5.1 General	24

4.11.2.5.2	ATCR3a generation.....	24
4.11.2.5.3	ATCR3b generation.....	24
4.11.2.5.4	ATCR3 EIRP allocation.....	25
4.11.2.6	ANTCR3: UTRA and E-UTRA multi RAT non-contiguous operation.....	25
4.11.2.6.1	General.....	25
4.11.2.6.2	ANTCR3a generation.....	25
4.11.2.6.3	ANTCR3 EIRP allocation.....	26
4.11.2.7	ATCR4: Single carrier for receiver tests.....	26
4.11.2.7.1	ATCR4a generation.....	26
4.11.2.7.2	ATCR4b generation.....	26
4.11.2.7.3	ATCR4c generation.....	26
4.11.2.7.4	ATCR4 EIRP allocation.....	26
4.11.2.8	Generation of MB-MSR test configurations.....	26
4.11.2.8.1	ATCR5a: MB-MSR test configuration for full carrier allocation.....	26
4.11.2.8.2	ATCR5b: MB-MSR test configuration with high PSD per carrier.....	27
4.11.2.9	ATCR6: Single carrier for Transmitter tests.....	28
4.11.2.9.1	ATCR6a generation.....	28
4.11.2.9.2	ATCR6b generation.....	28
4.11.2.9.3	ATCR6c generation.....	28
4.11.2.9.4	ATCR6 EIRP allocation.....	28
4.12	RF channels and test models.....	29
4.12.1	RF channels.....	29
4.12.2	Test models.....	29
4.13	Format and interpretation of tests.....	30
4.14	Reference coordinate system.....	31
5	Applicability of Requirements.....	32
5.1	General.....	32
5.2	Test configurations for AAS BS for operating bands where MSR with more than 1 RAT is supported.....	33
5.3	Test configurations for multi-carrier capable AAS BS in operating bands where one RAT capability sets are supported.....	33
5.3.1	General.....	33
5.3.2	AAS BS supporting one RAT only MSR in the operating band.....	33
5.3.3	AAS BS supporting Single-RAT UTRA in the operating band.....	34
5.3.4	AAS BS supporting Single-RAT E-UTRA in the operating band.....	34
5.4	Test configurations for AAS BS operating bands with multi-band dependencies.....	35
5.4.1	AAS BS operating bands with multi-band dependencies supporting MSR operation.....	35
5.4.2	AAS BS operating bands with multi-band dependencies supporting Single-RAT only.....	35
6	Radiated transmitter characteristics.....	36
6.1	General.....	36
6.2	Radiated Transmit Power.....	36
6.2.1	Definition and applicability.....	36
6.2.2	Minimum Requirement.....	36
6.2.3	Test purpose.....	36
6.2.4	Method of test.....	37
6.2.4.1	Initial conditions.....	37
6.2.4.2	Procedure.....	37
6.2.5	Test Requirement.....	37
7	Radiated receiver characteristics.....	38
7.1	General.....	38
7.2	OTA sensitivity.....	38
7.2.1	Definition and applicability.....	38
7.2.2	Minimum Requirement.....	39
7.2.3	Test Purpose.....	39
7.2.4	Method of test.....	39
7.2.4.1	Initial conditions.....	39
7.2.4.2	Procedure.....	39
7.2.5	Test Requirements.....	40
7.2.5.1	General.....	40
7.2.5.2	UTRA FDD Test Requirements.....	40
7.2.5.3	UTRA TDD 1,28Mcp option Test Requirements.....	40

7.2.5.4	E-UTRA Test Requirements	40
Annex A (normative):	Test system characterization.....	42
Annex B (normative):	Calibration.....	43
Annex C (informative):	Test tolerances and derivation of test requirements.....	44
C.1	General	44
C.2	Measurement of transmitter (OTA).....	44
C.3	Measurement of receiver (OTA)	44
Annex D (informative):	Test system set-up	45
D.1	Transmitter	45
D1.1	Radiated Transmit Power	45
D.2	Receiver.....	46
D.2.1	OTA sensitivity	46
Annex E (normative):	Estimation of Measurement Uncertainty.....	47
E.1	General	47
E.2	Measurement methodology descriptions.....	47
E.3	Measurement uncertainty budget format.....	47
E.4	Measurement uncertainty budgets.....	47
E.5	Measurement error contribution descriptions.....	47
Annex F (informative):	Change history	48
History		49

Foreword

This Technical Specification has been produced by the 3rd Generation Partnership Project (3GPP).

The contents of the present document are subject to continuing work within the TSG and may change following formal TSG approval. Should the TSG modify the contents of the present document, it will be re-released by the TSG with an identifying change of release date and an increase in version number as follows:

Version x.y.z

where:

- x the first digit:
 - 1 presented to TSG for information;
 - 2 presented to TSG for approval;
 - 3 or greater indicates TSG approved document under change control.
- y the second digit is incremented for all changes of substance, i.e. technical enhancements, corrections, updates, etc.
- z the third digit is incremented when editorial only changes have been incorporated in the document.

1 Scope

The present document specifies radiated test methods and conformance requirements for *single RAT E-UTRA operation*, *single RAT UTRA operation* (FDD and TDD) and Multi-Standard Radio (MSR) UTRA and E-UTRA Active Antenna System (AAS) Base Station (BS). These have been derived from, and are consistent with non-AAS BS specifications in 3GPP TS 25.104 [2], 3GPP TS 25.105 [3], 3GPP TS 36.104 [4] or 3GPP TS 37.104 [5]. The technical specification 3GPP TS 37.145 is in 2 parts, part 3GPP TS 37.145-1 [9] covers conducted requirements and part 3GPP TS 37.145-2 (the present document) covers radiated requirements.

The present document does not establish radiated test methods and conformance requirements for Band 46 operation as it is not supported by AAS BS. Conducted Band 46 test requirements are still applicable for AAS BS for protection of and against Band 46 operation, as specified in 3GPP TS 37.145-1 [9].

2 References

The following documents contain provisions which, through reference in this text, constitute provisions of the present document.

- References are either specific (identified by date of publication, edition number, version number, etc.) or non-specific.
- For a specific reference, subsequent revisions do not apply.
- For a non-specific reference, the latest version applies. In the case of a reference to a 3GPP document (including a GSM document), a non-specific reference implicitly refers to the latest version of that document *in the same Release as the present document*.

- [1] 3GPP TR 21.905: "Vocabulary for 3GPP Specifications".
- [2] 3GPP TS 25.104: "Base Station (BS) radio transmission and reception (FDD)".
- [3] 3GPP TS 25.105: "Base Station (BS) radio transmission and reception (TDD)".
- [4] 3GPP TS 36.104: "Evolved Universal Terrestrial Radio Access (E-UTRA); Base Station (BS) radio transmission and reception".
- [5] 3GPP TS 37.104: "E-UTRA, UTRA and GSM/EDGE; Multi-Standard Radio (MSR) Base Station (BS) radio transmission and reception".
- [6] 3GPP TS 37.105: "Active Antenna System (AAS) Base Station (BS) transmission and reception".
- [7] 3GPP TR 37.842: "E-UTRA and UTRA; Radio Frequency (RF) requirement background for Active Antenna System (AAS) Base Station (BS)".
- [8] Recommendation ITU-R M.1545: "Measurement uncertainty as it applies to test limits for the terrestrial component of International Mobile Telecommunications-2000".
- [9] 3GPP TS 37.145-1: "Active Antenna System (AAS) Base Station (BS) conformance testing; Part 1: Conducted conformance testing".
- [10] 3GPP TS 25.141: "Base Station (BS) conformance testing (FDD)".
- [11] 3GPP TS 25.142: "Base Station (BS) conformance testing (TDD)".
- [12] 3GPP TS 36.141: "Evolved Universal Terrestrial Radio Access (E-UTRA); Base Station (BS) conformance testing".
- [13] 3GPP TS 37.141: "E-UTRA, UTRA and GSM/EDGE; Multi-Standard Radio (MSR) Base Station (BS) conformance testing".

3 Definitions, symbols and abbreviations

3.1 Definitions

For the purposes of the present document, the terms and definitions given in 3GPP TR 21.905 [1] and the following apply. A term defined in the present document takes precedence over the definition of the same term, if any, in 3GPP TR 21.905 [1].

AAS BS receiver: composite receiver function of an AAS BS receiving in an operating band

active antenna system base station: base station system which combines an Antenna Array with an Active transceiver unit array and a *Radio Distribution Network*

band category: group of operating bands for which the same MSR scenarios apply

Base Station RF Bandwidth: bandwidth in which a base station transmits and/or receives single or multiple carrier(s) and/or RATs simultaneously within a supported operating band

NOTE: In single carrier operation, the *Base Station RF Bandwidth* is equal to the channel bandwidth.

Base Station RF Bandwidth edge: frequency of one of the edges of the *Base Station RF Bandwidth*

beam: main lobe of a radiation pattern from an AAS BS

NOTE: For certain AAS antenna array, there may be more than one beam.

beam centre direction: direction equal to the geometric centre of the -3 dB EIRP contour of the beam

beam direction pair: data set consisting of the *beam centre direction* and the related *beam peak direction*

beam peak direction: direction where the maximum EIRP is supposed to be found

beamwidth: angles describing the major and minor axes of an ellipsoid closest fit to an essentially elliptic half-power contour of a beam

carrier: modulated waveform conveying the physical channels

carrier aggregation: aggregation of two or more E-UTRA component carriers in order to support wider *transmission bandwidths*

channel bandwidth: RF bandwidth supporting a single RF carrier with the *transmission bandwidth* configured in the uplink or downlink of a cell

NOTE 1: The *channel bandwidth* is measured in MHz and is used as a reference for transmitter and receiver RF requirements.

NOTE 2: For UTRA FDD, the *channel bandwidth* is the nominal channel spacing specified in 3GPP TS 25.104 [2], For UTRA TDD 1,28 Mcps, the *channel bandwidth* is the nominal channel spacing specified in 3GPP TS 25.105 [3].

NOTE 3: For E-UTRA, the *channel bandwidths* are specified in 3GPP TS 36.104 [4].

contiguous spectrum: spectrum consisting of a contiguous block of spectrum with no *sub-block gap(s)*

downlink operating band: part of the (FDD) operating band designated for downlink

EIRP accuracy directions set: *beam peak directions* for which the EIRP accuracy requirement is intended to be met. The *beam peak directions* are related to a corresponding contiguous range or discrete list of *beam centre directions* by the *beam direction pairs* included in the set

equivalent isotropic radiated power: equivalent power radiated from an isotropic directivity device producing the same field intensity at a point of observation as the field intensity radiated in the direction of the same point of observation by the discussed device

NOTE: Isotropic directivity is equal in all directions (0 dBi).

equivalent isotropic sensitivity: sensitivity for an isotropic directivity device equivalent to the sensitivity of the discussed device exposed to an incoming wave from a defined AoA

NOTE 1: The sensitivity is the minimum received power level at which a RAT specific requirement is met.

NOTE 2: Isotropic directivity is equal in all directions (0 dBi).

Inter RF Bandwidth gap: frequency gap between two consecutive *Base Station RF Bandwidths* that are placed within two supported operating bands

non-AAS BS: BS conforming to one of the RF requirement specifications 3GPP TS 25.104 [2], 3GPP TS 25.105 [3], 3GPP TS 36.104 [4] or 3GPP TS 37.104 [5]

non-contiguous spectrum: spectrum consisting of two or more *sub-blocks* separated by *sub-block gap(s)*

OTA sensitivity directions declaration: set of manufacturer declarations comprising one or more EIS values (with related RAT and *channel bandwidth*), and the directions where it (they) applies

NOTE: All the directions apply to all the EIS values in an OSDD.

Radio Bandwidth: frequency difference between the upper edge of the highest used carrier and the lower edge of the lowest used carrier.

radio distribution network: passive network which distributes radio signals generated by the transceiver unit array to the antenna array, and/or distributes the radio signals collected by the antenna array to the transceiver unit array

NOTE: In the case when the active transceiver units are physically integrated with the array elements of the antenna array, the radio distribution network is a one-to-one mapping.

rated beam EIRP: EIRP that is declared as being achieved in the *beam peak direction* associated with a particular *beam direction pair*

receiver target: angles of arrival in which reception is performed

receiver target redirection range: union of all the *sensitivity RoAoA* achievable through redirecting the *receiver target* related to the OSDD

receiver target reference direction: direction inside the *receiver target redirection range* declared by the manufacturer for conformance testing.

NOTE For an OSDD without *receiver target redirection range*, this is a direction inside the *sensitivity RoAoA*.

reference beam direction: declared *beam direction pair*, including reference *beam centre direction* and reference *beam peak direction* where the reference *beam peak direction* is the direction for the intended maximum EIRP within the EIRP accuracy compliance directions set

sensitivity RoAoA: RoAoA within which the declared EIS(s) of an OSDD is intended to be achieved at any instance of time for a specific AAS BS direction setting

single RAT E-UTRA operation: operation of AAS BS declared to be single RAT E-UTRA in the *operating band*

NOTE: *Single RAT E-UTRA operation* does not cover in-band NB-IoT, nor guardband NB-IoT operation.

single RAT UTRA operation: operation of AAS BS declared to be single RAT UTRA in the *operating band*

sub-block: one contiguous allocated block of spectrum for use by the same Base Station

NOTE There may be multiple instances of *sub-blocks* within a *Base Station RF Bandwidth*.

sub-block gap: frequency gap between two consecutive *sub-blocks* within an *Base Station RF Bandwidth*, where the RF requirements in the gap are based on co-existence for un-coordinated operation

TAB connector: transceiver array boundary connector

throughput: number of payload bits successfully received per second for a reference measurement channel in a specified reference condition

transceiver array boundary: conducted interface between the transceiver unit array and the composite antenna

transmission bandwidth: bandwidth of an instantaneous E-UTRA transmission from a UE or BS, measured in Resource Block units

uplink operating band: part of the (FDD) operating band designated for uplink

3.2 Symbols

For the purposes of the present document, the following symbols apply:

BeW_{θ}	The Beam width in θ
BeW_{ϕ}	The Beam width in ϕ
BW_{Channel}	Channel bandwidth (for E-UTRA)
$BW_{\text{Channel_CA}}$	Aggregated channel bandwidth, expressed in MHz. $BW_{\text{Channel_CA}} = F_{\text{edge_high}} - F_{\text{edge_low}}$.
BW_{Config}	Transmission bandwidth configuration (for E-UTRA), expressed in MHz, where $BW_{\text{Config}} = N_{\text{RB}} \times 180$ kHz in the uplink and $BW_{\text{Config}} = 15$ kHz + $N_{\text{RB}} \times 180$ kHz in the downlink.
$DwPTS$	Downlink part of the special subframe (for E-UTRA TDD operation)
f	Frequency
Δf	Separation between the Base Station RF bandwidth edge frequency and the nominal -3dB point of the measuring filter closest to the carrier frequency
Δf_{max}	The largest value of Δf used for defining the requirement
F_C	Carrier centre frequency
F_{filter}	Filter centre frequency
f_{offset}	Separation between the Base Station RF bandwidth edge frequency and the centre of the measuring filter
$f_{\text{offset_max}}$	The maximum value of f_{offset} used for defining the requirement
$F_{\text{BW RF,high}}$	Upper RF bandwidth edge, where $F_{\text{BW RF,high}} = F_{\text{C,high}} + F_{\text{offset, RAT}}$
$F_{\text{BW RF,low}}$	Lower RF bandwidth edge, where $F_{\text{BW RF,low}} = F_{\text{C,low}} - F_{\text{offset, RAT}}$
$F_{\text{C,high}}$	Centre frequency of the highest transmitted/received carrier.
$F_{\text{C,low}}$	Centre frequency of the lowest transmitted/received carrier.
$F_{\text{edge_low}}$	The lower edge of aggregated channel bandwidth, expressed in MHz. $F_{\text{edge_low}} = F_{\text{C,low}} - F_{\text{offset}}$.
$F_{\text{edge_high}}$	The upper edge of aggregated channel bandwidth, expressed in MHz. $F_{\text{edge_high}} = F_{\text{C,high}} + F_{\text{offset}}$.
	$F_{\text{offset, RAT}}$ Frequency offset from the centre frequency of the <i>highest</i> transmitted/received carrier to the <i>upper</i> RF bandwidth edge, sub-block edge or inter-RF bandwidth edge, or from the centre frequency of the <i>lowest</i> transmitted/received carrier to the <i>lower</i> RF bandwidth edge, sub-block edge or inter-RF bandwidth edge for a specific RAT.
$F_{\text{UL_low}}$	The lowest frequency of the <i>uplink operating band</i>
$F_{\text{UL_high}}$	The highest frequency of the <i>uplink operating band</i>
F_{uw}	Frequency offset of unwanted signal
N_{RB}	Transmission bandwidth configuration, expressed in units of resource blocks (for E-UTRA)
W_{gap}	<i>Sub-block gap</i> size or <i>Inter RF Bandwidth gap</i> size
θ	The angle in the reference coordinate system between the projection of the x/y plane and the radiation vector defined between -90° and 90°. 0° represents the direction perpendicular to the y/z plane. The angle is aligned with the down-tilt angle.
ϕ	The angle in the reference coordinate system between the x-axis and the projection of the radiation vector onto the x/y plane defined between -180° and 180°.

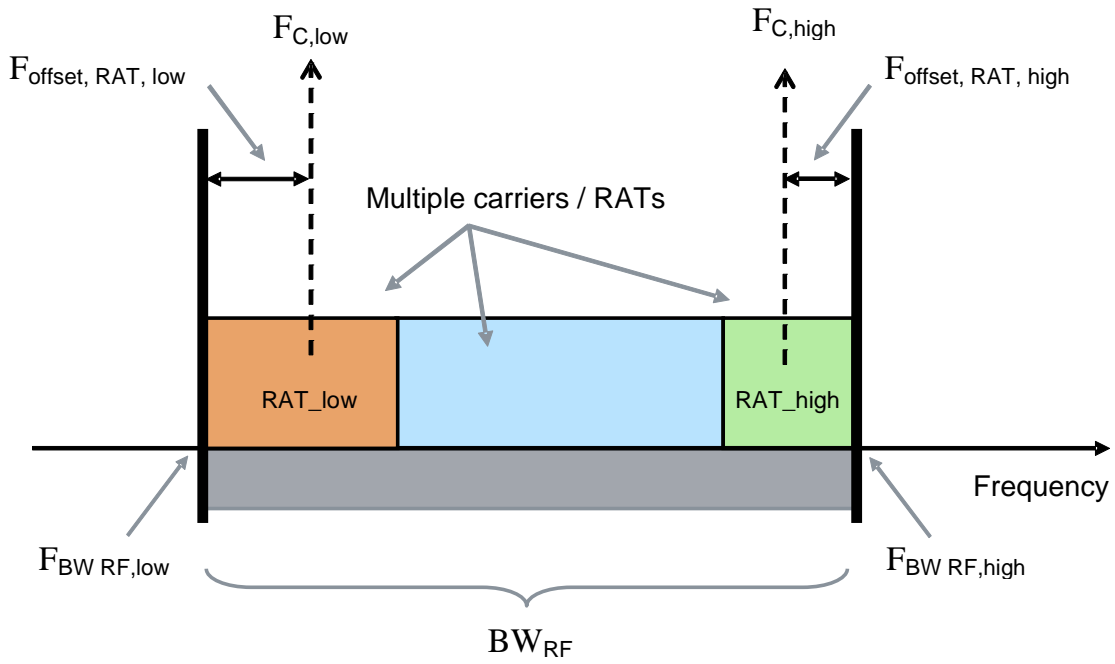

Figure 3.2-1: Illustration of RF bandwidth related symbols and definitions for Multi-standard Radio

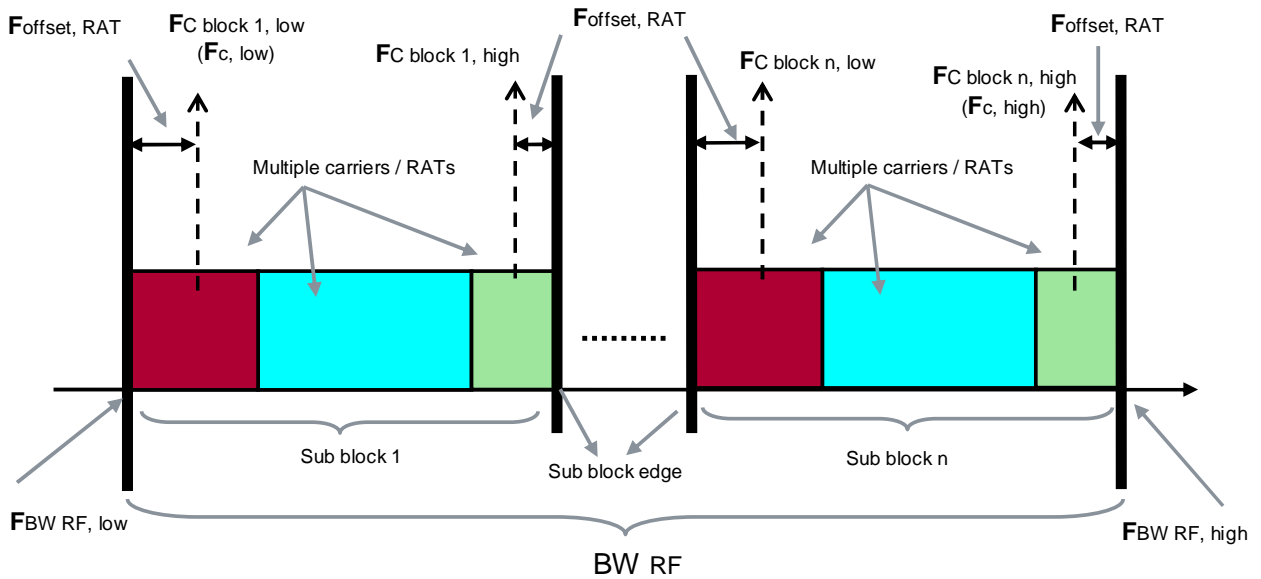

Figure 3.2-2: Illustration of RF bandwidth related symbols and definitions for non-contiguous Multi-standard Radio

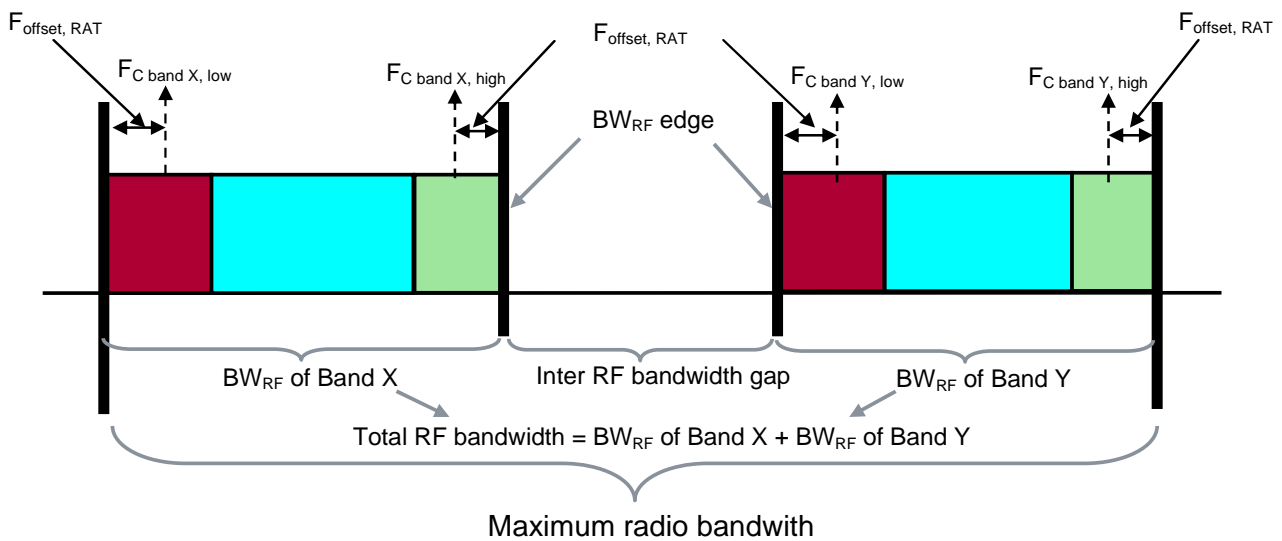

Figure 3.2-3: Illustration of maximum radio bandwidth and Total RF bandwidth for Multi-band Multi-standard Radio

3.3 Abbreviations

For the purposes of the present document, the abbreviations given in 3GPP TR 21.905 [1] and the following apply. An abbreviation defined in the present document takes precedence over the definition of the same abbreviation, if any, in 3GPP TR 21.905 [1].

AAS BS	Active Antenna System Base Station
AoA	Angle of Arrival
BC	Band Category
BER	Bit Error Rate
CA	Carrier Aggregation
EIRP	Equivalent Isotropic Radiated Power
EIS	Equivalent Isotropic Sensitivity
FDD	Frequency Division Duplex
FRC	Fixed Reference Channel
ITU	International Telecommunication Union
ITU-R	Radio communication Sector of the ITU
MB-MSR	Multi-Band Multi-Standard Radio
MBT	Multi-Band Testing
MC	Multi-Carrier in a Single RAT
OSDD	OTA Sensitivity Directions Declaration
OTA	Over The Air
RAT	Radio Access Technology
RB	Resource Block (for E-UTRA)
RDN	Radio Distribution Network
RF	Radio Frequency
RoAoA	Range of Angles of Arrival
SBT	Single Band Testing
SC	Single-Carrier
TAB	Tranceiver Array Boundary
TDD	Time Division Duplex
UE	User Equipment

4 General test conditions and declarations

4.1 Measurement uncertainties and test requirements

4.1.1 General

The requirements of this clause apply to all applicable tests in part 2 of this specification, i.e. to all AAS BS radiated tests.

The minimum requirements for AAS BS radiated requirements are given in 3GPP TS 37.105 [14] subclause 9 and 10 for the radiated transmitter and radiated receiver characteristics, respectively. Test Tolerances for the radiated test requirements explicitly stated in part 2 of the present specification are given in annex C of this specification.

Test Tolerances are individually calculated for each test. The Test Tolerances are used to relax the minimum requirements to create test requirements.

When a test requirement differs from the corresponding minimum requirement, then the Test Tolerance applied for the test is non-zero. The Test Tolerance for the test and the explanation of how the minimum requirement has been relaxed by the Test Tolerance are given in annex C.

4.1.2 Acceptable uncertainty of Test System

4.1.2.1 General

The maximum acceptable uncertainty of the Test System is specified below for each test defined explicitly in the present specification, where appropriate.

The Test System shall enable the stimulus signals in the test case to be adjusted to within the specified tolerance and the equipment under test to be measured with an uncertainty not exceeding the specified values. All tolerances and uncertainties are absolute values, and are valid for a confidence level of 95 %, unless otherwise stated.

A confidence level of 95 % is the measurement uncertainty tolerance interval for a specific measurement that contains 95 % of the performance of a population of test equipment.

4.1.2.2 Measurement of transmitter

Table 4.1.2.2-1: Maximum Test System uncertainty for transmitter tests

Subclause	Maximum Test System Uncertainty	Derivation of Test System Uncertainty
6.2 Radiated transmit power	±1.0 dB, $f \leq 3.0$ GHz ±1.2 dB, $3.0 \text{ GHz} < f \leq 4.2 \text{ GHz}$	See 3GPP TR 37.842 [7], subclause 10.3.2.2. Uncertainty budget contributors as well as uncertainty budget assessment described in annex E.

4.1.2.3 Measurement of receiver

Table 4.1.2.3-1: Maximum Test System Uncertainty for receiver tests

Subclause	Maximum Test System Uncertainty	Derivation of Test System Uncertainty
7.2 OTA Sensitivity	±1.3 dB, $f \leq 3.0$ GHz ±1.4 dB, $3.0 \text{ GHz} < f \leq 4.2 \text{ GHz}$	See 3GPP TR 37.842 [7], subclause 10.3.2.2. Uncertainty budget contributors as well as uncertainty budget assessment described in annex E.

4.1.3 Interpretation of measurement results

The measurement results returned by the Test System are compared - without any modification - against the test requirements as defined by the Shared Risk principle.

The Shared Risk principle is defined in Recommendation ITU-R M.1545 [8].

The actual measurement uncertainty of the Test System for the measurement of each parameter shall be included in the test report.

The recorded value for the Test System uncertainty shall be, for each measurement, equal to or lower than the appropriate figure in subclause 4.1.2 of the present document.

If the Test System for a test is known to have a measurement uncertainty greater than that specified in subclause 4.1.2, it is still permitted to use this apparatus provided that an adjustment is made as follows.

Any additional uncertainty in the Test System over and above that specified in subclause 4.1.2 shall be used to tighten the test requirement, making the test harder to pass. (For some tests e.g. receiver tests, this may require modification of stimulus signals). This procedure (defined in annex C) will ensure that a Test System not compliant with subclause 4.1.2 does not increase the chance of passing a device under test where that device would otherwise have failed the test if a Test System compliant with subclause 4.1.2 had been used.

4.2 Conducted and radiated requirement reference points

AAS BS requirements are defined for two points of reference, signified by radiated requirements and conducted requirements.

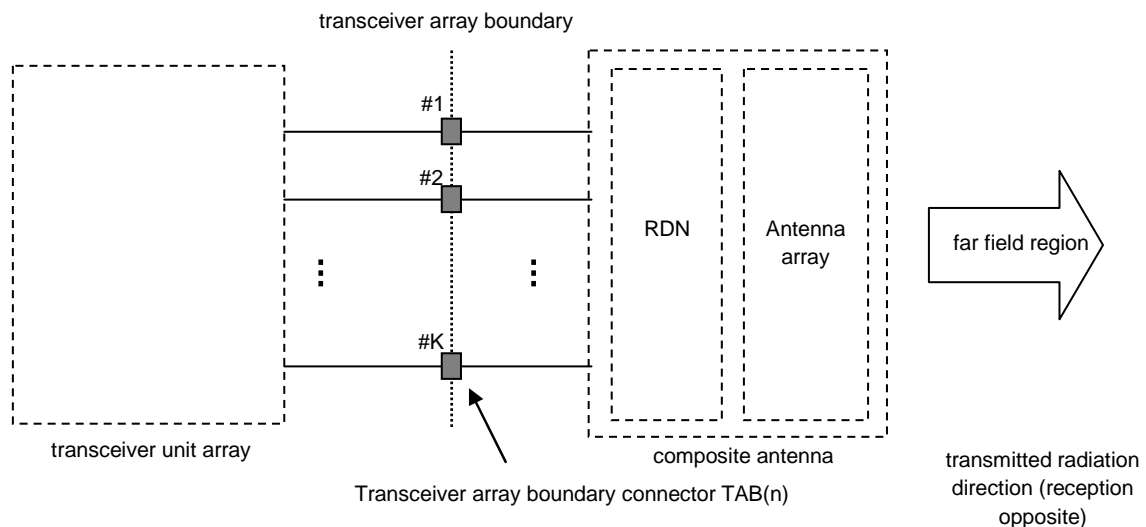

Figure 4.2-1: Radiated and conducted points of reference of AAS BS

Radiated characteristics are defined over the air (OTA) with a point of reference in the far field (Fraunhofer) region. Radiated requirements are also referred to as OTA requirements.

Conducted characteristics are defined at individual or groups of *TAB connectors* at the *transceiver array boundary*, which is the conducted interface between the transceiver unit array and the composite antenna.

The transceiver unit array is part of the composite transceiver functionality generating modulated transmit signal structures and performing receiver combining and demodulation.

The transceiver unit array contains an implementation specific number of transmitter units and an implementation specific number of receiver units. Transmitter units and receiver units may be combined into transceiver units. The transmitter/receiver units have the ability to receive/send parallel independent modulated symbol streams.

The composite antenna contains a *radio distribution network* (RDN) and an antenna array. The RDN is a linear passive network that distributes the RF power between the *transceiver array boundary* and the antenna array, in an implementation specific way.

How a conducted requirement is applied to the *transceiver array boundary* is detailed in the respective requirement subclause.

The present document details the test requirements of the radiated requirements only and hence only requires the radiated reference points.

4.3 Base station classes for AAS BS

The requirements in this specification apply to AAS BS of Wide Area BS, Medium Range BS and Local Area BS classes unless otherwise stated.

The base station classes are defined in 3GPP TS 37.105 [6].

4.4 Regional requirements

There are no regional radiated requirements in this part of the specification.

4.5 Operating bands and band categories

The operating bands and band categories for AAS BS are the same as for *non-AAS BS*, as described in 3GPP TS 37.104 [6].

NOTE 1: AAS BS does not support GSM, but BC2 is still applicable for protection of/against GSM operation in BC2 operating bands.

NOTE 2: AAS BS does not support Band 46 (and all its sub-bands defined in 3GPP TS 36.104 [4]) operation. Conducted Band 46 test requirements are still applicable for AAS BS for protection of and against Band 46 operation, as specified in 3GPP TS 37.145-1 [9].

4.6 Channel arrangements

The channel arrangements for AAS BS are the same as those for UTRA *non-AAS BS* and E-UTRA *non-AAS BS* as described in 3GPP TS 37.104 [5].

4.7 Requirements for AAS BS capable of multi-band operation

For AAS BS capable of operation in multiple operating bands, the RF requirements in clause 6 and 7 apply separately to each supported operating band unless otherwise stated.

4.8 AAS BS configurations

4.8.1 Transmit configurations

Unless otherwise stated, the radiated transmitter characteristics in clause 6 are specified in the far field. The AAS BS shall have a full complement of transceiver units for the configuration in normal operating conditions.

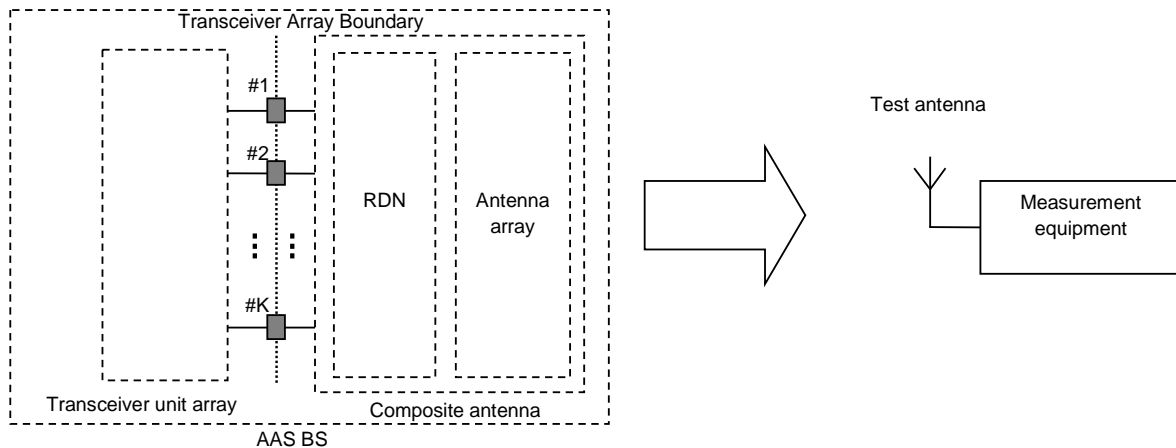

Figure 4.8.1-1: Transmitter test ports

4.8.2 Receive configurations

Unless otherwise stated, the radiated receiver characteristics in clause 7 are specified in the far field. The AAS BS shall have a full complement of transceiver units for the configuration in normal operating conditions.

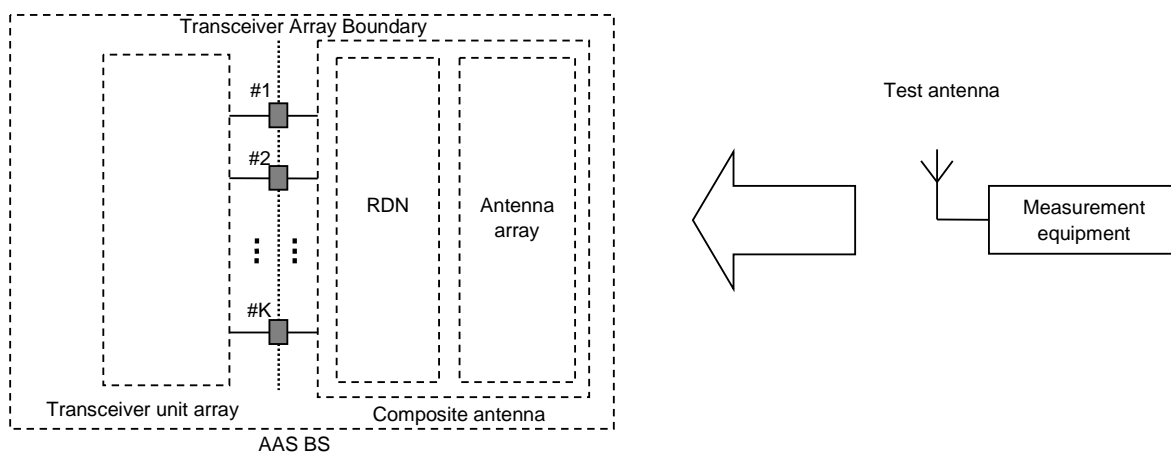

Figure 4.8.2-1: Receiver test ports

For the tests in clause 7 of the present document, the requirement applies for each manufacturer declared OSDD (see table 4.10-1).

4.8.3 Power supply options

If the AAS BS is supplied with a number of different power supply configurations, it may not be necessary to test RF parameters for each of the power supply options, provided that it can be demonstrated that the range of conditions over which the equipment is tested is at least as great as the range of conditions due to any of the power supply configurations.

4.8.4 BS with integrated Iuant BS modem

Unless otherwise stated, for the tests in the present document, the integrated Iuant BS modem shall be switched OFF.

4.9 Capability sets

A radiated capability set is defined as the AAS BS capability to support certain RAT combinations in an operating band.

The manufacturer shall declare the supported radiated capability set(s) according to table 4.9-1 for each supported operating band.

Table 4.9-1 Radiated capability sets

Radiated capability Set supported by the AAS BS	RCSA1	RCSA2	RCSA3	RCSA4	RCSA5
Supported RATs	AAS BS supports MSR operation of UTRA only in the band	AAS BS supports MSR operation of E-UTRA only in the band	AAS BS supports MSR in the band	AAS BS supports single-RAT UTRA in the band	AAS BS supports single-RAT E-UTRA in the band
Supported configurations	SR UTRA (SC, MC)	SR E-UTRA (SC, MC, CA)	MR UTRA + E-UTRA SR UTRA (SC, MC) SR E-UTRA (SC, MC, CA)	SR UTRA (SC, MC)	SR E-UTRA (SC, MC, CA)
Applicable BC	BC1, BC2 or BC3	BC1, BC2 or BC3	BC1, BC2 or BC3	BC1, BC2 or BC3	BC1, BC2 or BC3

The applicable test configurations for each RF requirement are defined in subclause 5.1, 5.2 and 5.3 for the declared radiated capability set(s). For beams with multi-band beam dependencies the applicable test configurations for each RF requirement are defined in subclause 5.4 for the declared radiated capability set(s).

NOTE: Not every supported configuration within a capability set is tested, but the tables in subclauses 5.2, 5.3 and 5.4 provide a judicious choice among the supported configurations and test configurations to ensure proper test coverage.

4.10 Manufacturer declarations

The following manufacturer's declarations are required for OTA requirements purposes:

Table 4.10-1: Manufacturer declarations

Declaration identifier	Declaration	Description
D9.1	Coordinate system reference point	Location of coordinated system reference point in reference to an identifiable physical feature of the AAS BS enclosure.
D9.2	Coordinate system orientation	Orientation of the coordinate system in reference to an identifiable physical feature of the AAS BS enclosure.
D9.3	Beam identifier	A unique title to identify a beam, e.g. a, b, c or 1, 2, 3. The vendor may declare any number of beams, the minimum requirement to declare for conformance are the beams with the highest intend EIRP for each of the beams widths below: <ol style="list-style-type: none"> 1) Narrowest intended BeW_{θ}, narrowest intended BeW_{ϕ} (possible when narrowest intended BeW_{θ}) at the reference beam direction. 2) Narrowest intended BeW_{ϕ}, narrowest intended BeW_{θ} (possible when narrowest intended BeW_{ϕ}) at the reference beam direction. 3) Widest intended BeW_{θ}, widest intended BeW_{ϕ} (possible when widest intended BeW_{θ} at the reference beam direction. 4) Widest intended BeW_{ϕ} – widest intended BeW_{θ} (possible when widest intended BeW_{ϕ}) at the reference beam direction.

Declaration identifier	Declaration	Description
		<p>5) BeW_{θ} and BeW_{ϕ} which provide highest intended EIRP of all possible beams at the reference beam direction.</p> <p>NOTE 1: Depending on the capability of the system some of these beams may be the same.</p> <p>When selecting the above five beam widths for declaration, all beams that the AAS BS is intended to produce shall be considered, including beams that during operation may be identified by any kind of cell or UE specific reference signals, with the exception of any type of beam that is created from a group of transmitters that are not all phase synchronised.</p>
D9.4	Operating bands and frequency ranges	<p>List of UTRA and/or E-UTRA operating band(s) supported by the BS and if applicable, frequency range(s) within the <i>operating band(s)</i> that the BS can operate in.</p> <p>Supported bands declared for every beam (D9.3).</p>
D9.5	Beam RAT support	RAT(s) supported by each beam for each supported operating band, declared for every beam identified in D9.3.
D9.6	Beam E-UTRA channel band width support	E-UTRA channel bandwidth supported for each beam and supported operating band identified in D9.3.
D9.7	Reference beam direction pair	The beam direction pair, describing the reference beam peak direction and the reference beam centre direction. Declared for every beam
D9.8	EIRP accuracy directions set	The EIRP accuracy directions set for each beam. Declared for every beam identified in D9.3.
D9.9	Maximum steering direction(s)	<p>The <i>beam direction pair(s)</i> corresponding to the following points:</p> <ol style="list-style-type: none"> 1) The <i>beam peak direction</i> corresponding to the maximum steering from the <i>reference beam centre direction</i> in the positive Φ direction, while the θ value being the closest possible to the <i>reference beam centre direction</i>. 2) The beam peak direction corresponding to the maximum steering from the reference beam centre direction in the negative Φ direction, while the θ value being the closest possible to the reference beam centre direction. 3) The beam peak direction corresponding to the maximum steering from the reference beam centre direction in the positive θ direction, while the Φ value being the closest possible to the reference beam centre direction. 4) The beam peak direction corresponding to the maximum steering from the reference beam centre direction in the negative θ direction, while the Φ value being the closest possible to the reference beam centre direction. <p>The maximum steering direction(s) may coincide with the <i>reference beam centre direction</i>.</p> <p>Declared for every beam identified in D9.3.</p>
D9.10	Rated beam EIRP	The rated EIRP level per carrier at the <i>beam peak direction</i> associated with a particular <i>beam direction pair</i> for each of the declared maximum steering directions (D9.9), as well as the reference <i>beam direction pair</i> (D9.7). Declared for every beam identified in D9.3.
D9.11	Beamwidth	The <i>beamwidth</i> for the reference <i>beam direction pair</i> and the four maximum steering directions. Declared for every beam identified in D9.3.
D9.12	Equivalent beams	<p>List of beams which are declared to be equivalent.</p> <p>Equivalent beams imply that the beams are expected to have identical EIRP accuracy directions sets and intended to have identical spatial properties at all steering directions within the EIRP accuracy directions set when presented with identical signals. All declarations (D9.4-D9.11) made for the beams are identical and the transmitter unit and associated <i>TAB connector(s)</i>, RDN and antenna array responsible for generating the beam are of identical design.</p>
D9.13	Parallel beams	List of beams which have been declared equivalent (D9.12) and can be generated in parallel using independent RF power resources. Independent power resources means that the beams are transmitted from mutually exclusive transmitter units.
D9.14	Number of carriers at maximum EIRP	The number of carriers per operating band the AAS BS is capable of generating at maximum EIRP declared each RAT (and multi-RAT) for every beam identified in D9.3.

Declaration identifier	Declaration	Description
D9.15	Multi-band transceiver units	Declared if an operating band is generated using Transceiver units supporting operation in multiple operating bands through common active electronic components(s).
D9.16	Operating bands with multi-band dependencies	List operating bands which are generated by multi-band transceiver units. Declared for each operating band for which multi-band transceiver units (D9.15) have been declared,
D9.15	Maximum radiated Base Station RF Bandwidth	Largest Base Station RF Bandwidth in the operating band, declared for each supported operating band identified in D9.4.
D9.18	Maximum radiated Base Station RF Bandwidth for contiguous operation.	Largest Base Station RF Bandwidth for contiguous spectrum operation, declared for each supported operating band identified in D9.4.
D9.19	maximum radiated Base Station RF Bandwidth for non- contiguous operation.	largest Base Station RF Bandwidth for non-contiguous spectrum operation, declared for each supported operating band identified in D9.4.
D9.20	Inter-band CA bands	Declared inter-band CA bands supported per operating band identified in D9.4.
D9.21	CA only operation	Capable of operating with CA only but not multiple carriers. Declared per operating band identified in D9.4.
D9.22	Single or multiple carrier	Capable of operating with a single carrier (only) or multiple carriers per operating band, per RAT.
D9.23	Reduced number of supported carriers at maximum EIRP in multi-RAT operations	Declared for each supported operating band identified in D9.4.
D9.24	Reduced maximum EIRP at the total number of supported carriers in multi-RAT operations	Declared for each supported operating band identified in D9.4.
D9.25	Radiated capability set (RCSA)	The manufacturer shall declare the supported radiated capability set(s) according to table 4.9-1 for each supported operating band identified in D9.4.
D9.26	Maximum <i>Radio Bandwidth</i> of the operating band with multi-band dependencies	Largest <i>Radio Bandwidth</i> that can be supported by the operating bands with multi-band dependencies. Declared for each supported operating band which has multi-band dependencies (D9.16)
D9.27	Total number of supported carriers for operating bands with multi-band dependencies	Total number of supported carriers for operating bands declared to have multi-band dependencies (D9.16).
D9.28	OTA contiguous or non-contiguous spectrum support	Ability of AAS BS to support contiguous or non-contiguous (or both) frequency distribution of carriers when operating multi-carrier in an operating band.
D9.29	OTA contiguous and non-contiguous parameters identical	Contiguous and non-contiguous operation is possible then parameters are the same.
D10.1	OSDD identifier	A unique identifier for the OSDD.
D10.2	OSDD operating band support	Operating band supported by the OSDD, declared for every OSDD identified in D10.1. NOTE 2: As each identified OSDD has a declared minimum EIS value (D10.6), multiple operating band can be only be declared if they have the same minimum EIS declaration.
D10.3	OSDD RAT support	RAT(s) supported by the OSDD for each supported operating band, declared for every OSDD identified in D10.1. NOTE 3: If the OSDD supports multiple RAT's with different minimum EIS value (D10.6) if all other parameters are the same then different EIS values for different RATS and signal BW's may be declared for an OSDD.
D10.4	OTA sensitivity E-UTRA supported channel BW	The E-UTRA channel BW's supported by each OSDD.
D10.5	Redirection of receiver target support	Ability to redirect the receiver target related to the OSDD
D10.6	Minimum EIS	The minimum EIS requirement (i.e. maximum allowable EIS value) applicable to all sensitivity RoAoA per OSDD. Declared for every supported RAT and E-UTRA supported channel BW for the OSDD. Declared per OSDD identified in D10.1. NOTE 4: If the AAS BS is not capable of redirecting the receiver target related to the OSDD then there is only one RoAoA applicable to the OSDD.

Declaration identifier	Declaration	Description
D10.7	Receiver target reference direction Sensitivity Range of Angle of Arrival	The sensitivity RoAoA associated with the receiver target reference direction (D10.9) for each OSDD.
D10.8	Receiver target redirection range	For each OSDD the associated union of all the sensitivity RoAoA achievable through redirecting the receiver target related to the OSDD
D10.9	Receiver target reference direction	For each OSDD an associated direction inside the receiver target redirection range (D10.8). NOTE 5: For an OSDD without receiver target redirection range, this is a direction inside the sensitivity RoAoA.
D10.10	Conformance test directions sensitivity RoAoA	For each OSDD that includes a receiver target redirection range, four sensitivity RoAoA comprising the conformance test directions (D10.11).
D10.11	Conformance test directions	For each OSDD four conformance test directions. If the OSDD includes a receiver target redirection range the following four directions shall be declared: <ol style="list-style-type: none"> 1) The direction determined by the maximum φ value achievable inside the receiver target redirection range, while θ value being the closest possible to the receiver target reference direction. 2) The direction determined by the minimum φ value achievable inside the receiver target redirection range, while θ value being the closest possible to the receiver target reference direction. 3) The direction determined by the maximum θ value achievable inside the receiver target redirection range, while φ value being the closest possible to the receiver target reference direction. 4) The direction determined by the minimum θ value achievable inside the receiver target redirection range, while φ value being the closest possible to the receiver target reference direction. If an OSDD does not include a receiver target redirection range the following 4 directions shall be declared: <ol style="list-style-type: none"> 1) The direction determined by the maximum φ value achievable inside the sensitivity RoAoA, while θ value being the closest possible to the receiver target reference direction. 2) The direction determined by the minimum φ value achievable inside the sensitivity RoAoA, while θ value being the closest possible to the receiver target reference direction. 3) The direction determined by the maximum θ value achievable inside the sensitivity RoAoA, while φ value being the closest possible to the receiver target reference direction. 4) The direction determined by the minimum θ value achievable inside the sensitivity RoAoA, while φ value being the closest possible to the receiver target reference direction.

4.11 Test signal configurations for testing

4.11.1 General

The test configurations shall be constructed using the methods defined below subject to the parameters declared by the manufacturer as listed in subclause 4.10.

For test contiguous spectrum operation configurations used in receiver tests only the carriers in the outermost frequency positions in the *Base Station RF Bandwidth* need to be generated by the test equipment. For non-contiguous spectrum operation test configurations used in receiver tests, outermost carriers for each sub-block need to be generated by the test equipment.

The applicable test models for generation of the carrier transmit test signal are defined in subclause 4.12.2.

NOTE: In case carriers are shifted to align with the channel raster Foffset.

4.11.2 Test signal configurations

4.11.2.1 ATCR1: UTRA multicarrier operation

4.11.2.1.1 General

The purpose of ATCR1 is to test UTRA OTA multi-carrier aspects.

4.11.2.1.2 ATCR1a generation

ATCR1 should be constructed using the following method:

- The *Base Station RF Bandwidth* shall be the declared maximum radiated *Base Station RF Bandwidth* for contiguous operation (see table 4.10-1, D9.18).
- Place one UTRA FDD carrier adjacent to the upper *Base Station RF Bandwidth edge* and one UTRA FDD carrier adjacent to the lower *Base Station RF Bandwidth edge*. The specified F_{Offset} shall apply.
- For transmitter tests, alternately place a UTRA FDD carrier adjacent to the already placed carriers at the low and high *Base Station RF Bandwidth edges* until there is no more space to fit a carrier or the beam does not support more carriers. The nominal carrier spacing defined in subclause 4.6 shall apply.
- The carrier(s) may be shifted maximum 100 kHz towards lower frequencies for B_{RFBW} and M_{RFBW} and towards higher frequencies for T_{RFBW} to align with the channel raster.

4.11.2.1.3 ATCR1b generation

ATCR1b is constructed using the following method:

- The *Base Station RF Bandwidth* shall be the declared maximum radiated *Base Station RF Bandwidth* for contiguous operation (see table 4.10-1, D6.20).
- Place one UTRA TDD carrier adjacent to the upper *Base Station RF Bandwidth edge* and one UTRA TDD carrier adjacent to the lower *Base Station RF Bandwidth edge*. The specified F_{Offset} shall apply.
- For transmitter tests, alternately place a UTRA TDD carrier adjacent to the already placed carriers at the low and high *Base Station RF Bandwidth edges* until there is no more space to fit a carrier or the beam does not support more carriers. The nominal carrier spacing defined in subclause 4.6 shall apply.

4.11.2.1.4 ATCR1 EIRP allocation

Set the number of carriers to the number of carriers at maximum EIRP (see table 4.10-1, D9.14) and set each beam to maximum EIRP (see table 4.10-1, D9.11) for the tested *beam direction pair*.

4.11.2.2 ANTCR1: UTRA FDD multicarrier non-contiguous operation

4.11.2.2.1 General

The purpose of ANTCR1 is to test UTRA FDD multicarrier non-contiguous aspects.

4.11.2.2.2 ANTCR1 generation

ANTCR1 is constructed as NTC1a in 3GPP TS 37.141 [13], subclause 4.8.1a.1

ANTCR1 is constructed using the following method:

- The *Base Station RF Bandwidth* of each supported operating band shall be the declared maximum radiated *Base Station RF Bandwidth* for non-contiguous operation (see table 4.10-1, D6.21). The *Base Station RF Bandwidth* consists of one sub-block gap and two sub-blocks located at the edges of the declared maximum *Base Station RF Bandwidth* for non-contiguous operation.

- For transmitter tests, place one UTRA carrier adjacent to the upper *Base Station RF Bandwidth edge* and one UTRA carrier adjacent to the lower *Base Station RF Bandwidth edge*. The specified $F_{\text{Offset-RAT}}$ shall apply.
- For receiver tests, place one UTRA carrier adjacent to the upper *Base Station RF Bandwidth edge* and one UTRA carrier adjacent to the lower *Base Station RF Bandwidth edge*. For single-band operation, if the maximum *Base Station RF Bandwidth* for non-contiguous operation is at least 35 MHz and the beam supports at least 4 UTRA FDD carriers, place a UTRA FDD carrier adjacent to each already placed carrier for each sub-block. The nominal carrier spacing defined in subclause 4.6 shall apply.
- The sub-block edges adjacent to the sub-block gap shall be determined using the specified $F_{\text{Offset-RAT}}$ for the carrier adjacent to the sub-block gap.
- The UTRA FDD carrier in the lower sub-block may be shifted maximum 100 kHz towards lower frequencies and the UTRA FDD carrier in the upper sub-block may be shifted maximum 100 kHz towards higher frequencies to align with the channel raster.

4.11.2.2.3 ANTCR1 EIRP allocation

Set the number of carriers to the number of carriers at maximum EIRP (see table 4.10-1, D9.14) and set each beam to maximum EIRP (see table 4.10-1, D9.11) for the tested *beam direction pair*.

4.11.2.3 ATCR2: E-UTRA multicarrier operation

4.11.2.3.1 General

The purpose of ATCR2a is to test E-UTRA multi-carrier aspects excluding CA occupied bandwidth.

The purpose of ATCR2b is to test E-UTRA Contiguous CA occupied bandwidth.

4.11.2.3.2 ATCR2a generation

ATCR2a is constructed using the following method:

- The *Base Station RF Bandwidth* of each supported operating band shall be the declared maximum radiated *Base Station RF Bandwidth* for contiguous operation (see table 4.10-1, D9.18).
- Select the narrowest supported E-UTRA carrier and place it adjacent to the low *Base Station RF Bandwidth edge*. Place a 5 MHz E-UTRA carrier adjacent to the high *Base Station RF Bandwidth edge*. The specified $F_{\text{Offset-RAT}}$ shall apply.
- For transmitter tests, select as many 5 MHz E-UTRA carriers that the beam supports and that fit in the rest of the *Base Station RF Bandwidth*. Place the carriers adjacent to each other starting from the high *Base Station RF Bandwidth edge*. The nominal carrier spacing defined in subclause 4.6 shall apply. The specified $F_{\text{Offset-RAT}}$ shall apply.
- If 5 MHz E-UTRA carriers are not supported by the beam the narrowest supported *channel bandwidth* (see table 4.10-1, D9.6) shall be selected instead.

The test configuration should be constructed on a per band basis for all component carriers of the inter-band CA bands declared to be supported by the beam (see table 4.10-1, D9.20). All configured component carriers are transmitted simultaneously in the tests where the transmitter should be on.

4.11.2.3.3 ATCR2b generation

ATCR2b is constructed on a per band basis using the following method:

- All component carrier combinations supported by the beam, which have different sum of *channel bandwidth* of component carrier, shall be tested. For all component carrier combinations which have the same sum of *channel bandwidth* of component carriers, only one of the component carrier combinations shall be tested.
- Of all component carrier combinations which have same sum of *channel bandwidth* of component carrier, select those with the narrowest carrier at the lower *Base Station RF Bandwidth edge*.

- Of the combinations selected in the previous step, select one with the narrowest carrier at the upper *Base Station RF Bandwidth edge*.
- If there are multiple combinations fulfilling previous steps, select the one with the smallest number of component carrier.
- If there are multiple combinations fulfilling previous steps, select the one with the widest carrier being adjacent to the lowest carrier.
- If there are multiple combinations fulfilling previous steps, select the one with the widest carrier being adjacent to the highest carrier
- If there are multiple combinations fulfilling previous steps, select the one with the widest carrier being adjacent to the carrier which has been selected in the previous step.
- If there are multiple combinations fulfilling previous steps, repeat the previous step until there is only one combination left.
- The nominal carrier spacing defined in subclause 4.6 shall apply.

4.11.2.3.4 ATCR2 EIRP allocation

Set the number of carriers to the number of carriers at maximum EIRP (see table 4.10-1, D9.14) and set each beam to maximum EIRP (see table 4.10-1, D9.11) for the tested *beam direction pair*.

For a beam declared to support only CA operation (see table 4.10-1, D6.23), set the power spectral density of the EIRP of each carrier to the same level so that the sum of the carrier EIRP equals the same value as above.

4.11.2.4 ANTCR2: E-UTRA multicarrier non-contiguous operation

4.11.2.4.1 General

The purpose of ANTCR2 is to test E-UTRA multicarrier non-contiguous aspects.

4.11.2.4.2 ANTCR2 generation

ANTCR2 is constructed as NTC2 in 3GPP TS 37.141 [13], subclause 4.8.2a.1

ANTCR2 is constructed using the following method:

- The *Base Station RF Bandwidth* of each supported operating band shall be the declared maximum radiated *Base Station RF Bandwidth* for non-contiguous operation (see table 4.10-1, D9.19). The *Base Station RF Bandwidth* consists of one sub-block gap and two sub-blocks located at the edges of the declared maximum radiated *Base Station RF Bandwidth* (see table 4.10-1, D9.17).
- For transmitter tests, place a 5MHz E-UTRA carrier adjacent to the upper *Base Station RF Bandwidth edge* and a 5MHz E-UTRA carrier adjacent to the lower *Base Station RF Bandwidth edge*. The specified $F_{\text{Offset-RAT}}$ shall apply. If 5 MHz E-UTRA carriers are not supported by the beam, the narrowest supported *channel bandwidth* shall be selected instead.
- For receiver tests, place a 5MHz E-UTRA carrier adjacent to the upper *Base Station RF Bandwidth edge* and a 5MHz E-UTRA carrier adjacent to the lower *Base Station RF Bandwidth edge*. If 5 MHz E-UTRA carriers are not supported by the beam, the narrowest supported *channel bandwidth* shall be selected instead.
- For single-band operation receiver tests, if the remaining gap is at least 15 MHz plus two times the *channel bandwidth* used in the previous step and the beam supports at least 4 E-UTRA carriers, place a E-UTRA carrier of this *channel bandwidth* adjacent to each already placed carrier for each sub-block. The nominal carrier spacing defined in subclause 4.5 shall apply.
- The sub-block edges adjacent to the sub-block gap shall be determined using the specified $F_{\text{Offset-RAT}}$ for the carrier adjacent to the sub-block gap.

4.11.2.4.3 ANTCR2 EIRP allocation

Set the number of carriers to the number of carriers at maximum EIRP (see table 4.10-1, D9.14) and set each beam to maximum EIRP (see table 4.10-1, D9.11) for the tested *beam direction pair*.

4.11.2.5 ATCR3: UTRA and E-UTRA multi RAT operation

4.11.2.5.1 General

The purpose of ATCR3 is to test UTRA and E-UTRA multi-RAT aspects.

If the maximum EIRP and total number of supported carriers at maximum EIRP are not simultaneously supported in Multi-RAT operations, two instances of ATCR3 shall be generated using the following values for rated total output power and the total number of supported carriers:

- 1) The maximum EIRP and the reduced number of supported carriers at the maximum EIRP in Multi-RAT operations.
- 2) The reduced maximum EIRP at the total number of supported carriers in Multi-RAT operations and the total number of supported carriers.

Tests that use ATCR3 shall be performed using both instances 1) and 2) of ATCR3.

4.11.2.5.2 ATCR3a generation

ATCR3a is constructed using the following method:

- The *Base Station RF Bandwidth* of each supported operating band shall be the declared maximum radiated *Base Station RF Bandwidth* (see table 4.10-1 D9.17).
- Select an FDD UTRA carrier to be placed at the lower *Base Station RF Bandwidth edge*. The specified $F_{\text{Offset-RAT}}$ shall apply. The UTRA FDD may be shifted maximum 100 kHz towards lower frequencies to align with the channel raster.
- Place a 5 MHz E-UTRA carrier at the upper *Base Station RF Bandwidth edge*. If that is not possible use the narrowest E-UTRA carrier supported by the beam. The specified $F_{\text{Offset-RAT}}$ shall apply.
- For transmitter tests, alternately add FDD UTRA carriers at the low end and 5 MHz E-UTRA carriers at the high end adjacent to the already placed carriers until the *Base Station RF Bandwidth* is filled or the total number of supported carriers (see table 4.10-1, D9.14) is reached. The nominal carrier spacing defined in subclause 4.6 shall apply.

4.11.2.5.3 ATCR3b generation

ATCR3b is constructed using the following method:

- The *Base Station RF Bandwidth* of each supported operating band shall be the declared maximum radiated *Base Station RF Bandwidth* (see table 4.10-1 D9.17).
- Select a UTRA TDD carrier to be placed at the lower *Base Station RF Bandwidth edge*. The specified $F_{\text{Offset-RAT}}$ shall apply.
- Place a 5 MHz E-UTRA carrier at the upper *Base Station RF Bandwidth edge*. If that is not possible use the narrowest E-UTRA carrier supported by the beam. The specified $F_{\text{Offset-RAT}}$ shall apply.
- For transmitter tests, alternately add UTRA TDD carriers at the low end and 5 MHz E-UTRA carriers at the high end adjacent to the already placed carriers until the *Base Station RF Bandwidth* is filled or the total number of supported carriers is reached. The nominal carrier spacing defined in clause 4.6 shall apply.

4.11.2.5.4 ATCR3 EIRP allocation

For ATCR3a set the number of carriers to the reduced number of carriers at maximum EIRP in multi-RAT operations (see table 4.10-1, D9.23) and set each carrier to maximum EIRP (see table 4.10-1, D9.11) for the tested *beam direction pair*.

For ATCR3b set the number of carriers to the reduced number of carriers at maximum EIRP (see table 4.10-1, D9.14) and set each carrier to the reduced maximum EIRP at the total number of supported carriers in Multi-RAT operations (see table 4.10-1, D9.24).

4.11.2.6 ANTCR3: UTRA and E-UTRA multi RAT non-contiguous operation

4.11.2.6.1 General

The purpose of ANTCR3 is to test UTRA and E-UTRA multi RAT non-contiguous aspects.

If the maximum EIRP and total number of supported carriers at maximum EIRP are not simultaneously supported in Multi-RAT operations, two instances of ANTCR3 shall be generated using the following values for rated total output power and the total number of supported carriers:

- 1) The maximum EIRP and the reduced number of supported carriers at the maximum EIRP in Multi-RAT operations.
- 2) The reduced maximum EIRP at the total number of supported carriers in Multi-RAT operations and the total number of supported carriers.

If the reduced number of supported carriers is 4 or more, only instance 1) of ANTCR3 shall be used in the tests, otherwise both instances 1) and 2) of ANTCR3 shall be used in the tests.

4.11.2.6.2 ANTCR3a generation

ANTCR3a is constructed using the following method:

- The *Base Station RF Bandwidth* of each supported operating band shall be the declared maximum radiated *Base Station RF Bandwidth* for non-contiguous operation (see table 4.10-1, D6.21). The *Base Station RF Bandwidth* consists of one sub-block gap and two sub-blocks located at the edges of the declared maximum *Base Station RF Bandwidth* for non-contiguous operation.
- For transmitter tests, place an UTRA carrier at the lower *Base Station RF Bandwidth edge* and a 5 MHz E-UTRA carrier at the upper *Base Station RF Bandwidth edge*. The specified $F_{\text{Offset-RAT}}$ shall apply. If 5 MHz E-UTRA carriers are not supported by the beam, the narrowest supported *channel bandwidth* shall be selected instead. The UTRA FDD may be shifted maximum 100 kHz towards lower frequencies to align with the channel raster.
- For receiver tests, place an UTRA carrier at the lower *Base Station RF Bandwidth edge* and a 5 MHz E-UTRA carrier at the upper *Base Station RF Bandwidth edge*. The specified $F_{\text{Offset-RAT}}$ shall apply. If 5 MHz E-UTRA carriers are not supported by the beam, the narrowest supported *channel bandwidth* shall be selected instead. The UTRA FDD may be shifted maximum 100 kHz towards lower frequencies to align with the channel raster.
- For single-band operation receiver tests, if the remaining gap is at least 20 MHz plus the *channel bandwidth* of the E-UTRA carrier used in the previous step and the beam supports at least 2 UTRA and 2 E-UTRA carriers, place an E-UTRA carrier of this *channel bandwidth* adjacent to the carrier at the lower *Base Station RF Bandwidth edge* and UTRA carrier adjacent to the carrier at the upper *Base Station RF Bandwidth edge*. The nominal carrier spacing defined in subclause 4.6 shall apply. The UTRA FDD may be shifted maximum 100 kHz towards higher frequencies to align with the channel raster.
- The sub-block edges adjacent to the sub-block gap shall be determined using the specified $F_{\text{Offset-RAT}}$ for the carrier adjacent to the sub-block gap.

4.11.2.6.3 ANTCR3 EIRP allocation

For case (1) in subclause 4.11.2.6.1 set the number of carriers to the reduced number of carriers at maximum EIRP in multi-RAT operations (see table 4.10-1, D9.23) and set each carrier to maximum EIRP (see table 4.10-1, D9.11) for the tested *beam direction pair*.

For case (2) in subclause 4.11.2.6.1 set the number of carriers to the reduced number of carriers at maximum EIRP (see table 4.10-1, D9.14) and set each carrier to the reduced maximum EIRP at the total number of supported carriers in Multi-RAT operations (see table 4.10-1, D9.24) for the tested *beam direction pair*.

4.11.2.7 ATCR4: Single carrier for receiver tests

4.11.2.7.1 ATCR4a generation

ATCR4a is constructed using the following method:

- Place a single UTRA carrier in the middle of the maximum radiated *Base Station RF Bandwidth*. The carrier may be shifted maximum 100 kHz towards lower frequencies for B_{RFBW} and M_{RFBW} and towards higher frequencies for T_{RFBW} to align with the channel raster.

4.11.2.7.2 ATCR4b generation

ATCR4b is constructed using the following method:

- Place the narrowest supported E-UTRA carrier in the middle of the maximum radiated *Base Station RF Bandwidth*.

4.11.2.7.3 ATCR4c generation

ATCR4c is constructed using the following method:

- Place a single UTRA TDD carrier in the middle of the maximum radiated *Base Station RF Bandwidth*.

4.11.2.7.4 ATCR4 EIRP allocation

Set the beam EIRP on the carrier such that its EIRP level is equal to the sum of *rated beam EIRPs* (see table 4.10-1, D9.12) when transmitting the maximum supported carriers at the *beam peak direction* (see table 4.10-1, D9.16).

4.11.2.8 Generation of MB-MSR test configurations

4.11.2.8.1 ATCR5a: MB-MSR test configuration for full carrier allocation

4.11.2.8.1.1 General

The purpose of ATCR5a is to test beams which have been generated using transceiver units supporting operation in multiple operating bands through common active electronic components(s), considering maximum supported number of carriers.

4.11.2.8.1.2 ATCR5a generation

ATCR5a is based on re-using the existing test configurations applicable per band on beams generated using Multi-band transceiver units and hence have declared multi-band dependencies (see table 4.10-1, D9.16). ATCR5a is constructed using the following method:

- The *Base Station RF Bandwidth* of each supported operating band shall be the declared maximum radiated *Base Station RF Bandwidth* (see table 4.10-1, D9.17).
- The number of carriers of each supported operating band shall be the declared maximum number of supported carriers by the multi-band dependencies in each band (see table 4.10-1, D9.16). Carriers shall first be placed at the outermost edges of the declared maximum radiated *Radio Bandwidth* (see table 4.10-1, D9.17). Additional carriers shall next be placed at the edges of the *Base Station RF Bandwidths*, if possible.

- The allocated *Base Station RF Bandwidth* of the outermost bands shall be located at the outermost edges of the declared maximum radiated *Radio Bandwidth* (see table 4.10-1, D9.17).
- Each concerned band shall be considered as an independent band and the corresponding test configuration shall be generated in each band. The mirror image of the single band test configuration shall be used in the highest band being tested for the beam.
- Band category and declared per band capability set (see table 4.10-1, D9.25) shall be used to generate per band RAT/carrier allocation according to table 4.11.2.8.1.2-1 for each band category and radiated capability set. If an operating band with multi-band dependencies supports three carriers only, two carriers shall be placed in one band according to the relevant test configuration while the remaining carrier shall be placed at the edge of the maximum *Radio Bandwidth* (DUID9) in the other band.
- If the sum of the *base Station RF bandwidths* of each of the supported operating bands is greater than the declared maximum *Radio Bandwidth* of the operating band with multi-band dependencies (see table 4.10-1, D9.26, D9.16) then repeat the steps above for test configurations where the *Base Station RF Bandwidth* of one of the operating band shall be reduced so that the declared maximum *Radio Bandwidth* is not exceeded and vice versa.
- If the sum of the maximum number of supported carrier of each supported operating bands with multi-band dependencies (see table 4.10-1, D9.16) is larger than the declared t Total number of supported carriers for operating bands with multi-band dependencies (see table 4.10-1, D9.27), repeat the steps above for test configurations where in each test configuration the number of carriers of one of the operating band shall be reduced so that the total number of supported carriers is not be exceeded and vice versa.

Table 4.11.2.8.1.2-1: The applicability of test configuration in each band

BC	RCSA 1	RCSA 2	RCSA 3	RCSA 4	RCSA 5
BC1	ATCR1a	ATCR2a	ATCR3a	ATCR1a	ATCR2a
BC2	ATCR1a	ATCR2a	ATCR3a	ATCR1a	ATCR2a
BC3	ATCR1b	ATCR2a	ATCR3b	ATCR1b	ATCR2a

4.11.2.8.1.3 ATCR5a EIRP allocation

Set the number of carriers to the total number of supported carriers for the declared multi-band dependencies (see table 4.10-1, D9.27) and set each beam to maximum EIRP (see table 4.10-1, D9.11) for the tested *beam direction pair*.

If the allocated number of carriers in an operating band exceeds the declared number of carriers at maximum EIRP in an operating band (see table 4.10-1, D9.14) the carriers should if possible be allocated to a different operating band.

4.11.2.8.2 ATCR5b: MB-MSR test configuration with high PSD per carrier

4.11.2.8.2.1 General

The purpose of ATCR5b is to test multi-band operation aspects considering higher PSD cases with reduced number of carriers and non-contiguous operation (if supported) in multi-band mode.

4.11.2.8.2.2 ATCR5b generation

ATCR5b is based on re-using the existing test configurations applicable for operating bands using multi-band transceiver units and hence have declared multi-band dependencies (see table 4.10-1, D9.16). ATCR5b is constructed using the following method:

- The *Base Station RF Bandwidth* of each supported operating band shall be the declared maximum radiated *Base Station RF Bandwidth* (see table 4.10-1, D9.17).
- The allocated *Radio Bandwidth* of the outermost bands shall be located at the outermost edges of the declared maximum *Radio Bandwidth* of the operating band with multi-band dependencies (see table 4.10-1, D9.26).
- The maximum number of carriers is limited to two per band. Carriers shall be placed at the outermost edges of the declared maximum *Radio Bandwidth* of the operating band with multi-band dependencies (see table 4.10-1, D9.26).

- Each concerned band shall be considered as an independent band and the corresponding test configuration for non-contiguous operation shall be generated in each band according to table 4.11.2.8.2.2-1. Narrowest supported E-UTRA *channel bandwidth* shall be used in the test configuration. The mirror image of the single band test configuration shall be used in the highest band being tested.
- For AAS BS supporting CSA4 in the band and supports three carriers only, two carriers shall be placed in one band according to AUTC2 while the remaining carrier shall be placed at the edge of the Maximum *Base Station RF Bandwidth* in the other band.
- If the sum of the *base Station RF bandwidths* of each of the supported operating bands is greater than the declared maximum *Radio Bandwidth* of the operating band with multi-band dependencies (see table 4.10-1, D9.26) for the declared multi-band dependencies (see table 4.10-1, D9.16) then repeat the steps above for test configurations where the *Base Station RF Bandwidth* of one of the operating band shall be reduced so that the declared maximum *Radio Bandwidth* of the operating band with multi-band dependencies (see table 4.10-1, D9.26) is not exceeded and vice versa.

Table 4.11.2.8.2.2-1: The applicability of test configuration in each band

BC	RCSA 1	RCSA 2	RCSA 3	RCSA 4	RCSA 5
BC1	ANTCR1a	ANTCR2	ANTCR3a	ANTCR1	ANTCR2
BC2	ANTCR1a	ANTCR2	ANTCR3a	ANTCR1	ANTCR2
BC3	ATCR1b	ANTCR2	ANTCR3a	N/A	ANTCR2

4.11.2.8.2.3 ATCR5b EIRP allocation

Set the number of carriers to the total number of supported carriers for the declared multi-band dependencies (see table 4.10-1, D9.27) and set each beam to maximum EIRP (see table 4.10-1, D9.11) for the tested *beam direction pair*.

If the sum of the EIRP for all carriers in an operating band(s) exceeds the sum of the maximum EIRP per carrier (see table 4.10-1, D9.14) for the number of carriers at maximum EIRP (see table 4.10-1, D9.10) in multi-band operation, the exceeded part shall, if possible, be reallocated into the other band(s). If the EIRP allocated for a carrier exceeds the declared maximum EIRP, the exceeded power shall, if possible, be reallocated into the other carriers.

4.11.2.9 ATCR6: Single carrier for Transmitter tests

4.11.2.9.1 ATCR6a generation

ATCR6a is constructed using the following method:

- Place a single UTRA carrier at the RF channel to be tested.

4.11.2.9.2 ATCR6b generation

ATCR6b is constructed using the following method:

- Place a 5 MHz E-UTRA carrier *i* at the RF channel to be tested. If 5 MHz carriers are not supported by the beam the narrowest supported channel BW shall be selected instead.

4.11.2.9.3 ATCR6c generation

ATCR6c is constructed using the following method:

- Place a single UTRA TDD carrier at the RF channel to be tested.

4.11.2.9.4 ATCR6 EIRP allocation

Set the number of carriers to 1. Set the beam parameters to those appropriate for the beam identifier of the beam under test and to the direction to be tested from the beam declarations (see table 4.10-1, D9.3 - 13).

4.12 RF channels and test models

4.12.1 RF channels

For single carrier tests unless otherwise stated the tests shall be performed with a single carrier at each of the RF channels B, M and T.

Many tests in this TS are performed with the maximum radiated *Base Station RF Bandwidth* located at the bottom, middle and top of the supported frequency range in the operating band. These are denoted as B_{RFBW} (bottom), M_{RFBW} (middle) and T_{RFBW} (top).

- Unless otherwise stated, the test shall be performed at B_{RFBW} , M_{RFBW} and T_{RFBW} defined as following:
- B_{RFBW} : maximum *Base Station RF Bandwidth* located at the bottom of the supported frequency range in the operating band.
- M_{RFBW} : maximum *Base Station RF Bandwidth* located in the middle of the supported frequency range in the operating band. M_{RFBW} may be shifted maximum 100 kHz towards lower frequencies to align carriers with the channel raster.
- T_{RFBW} : maximum *Base Station RF Bandwidth* located at the top of the supported frequency range in the operating band.

For the test of certain RF requirements the present specification refers to test procedures defined in the single-RAT specifications [2], [3], [4], [5]. In this case, the interpretation of the RF channels to be tested shall be according to the definitions in the corresponding single-RAT specifications [2], [3], [4], [5].

For an operating band which has multi-band beam dependencies capable of dual-band operation, unless otherwise stated, the test shall be performed at $B_{\text{RFBW_T'RFBW}}$ and $B'\text{RFBW_T'RFBW}$ defined as following:

- $B_{\text{RFBW_T'RFBW}}$: the *Base Station RF Bandwidths* located at the bottom of the supported frequency range in the lower operating band and at the highest possible simultaneous frequency position, within the maximum *Radio Bandwidth*, in the upper operating band.
- $B'\text{RFBW_T'RFBW}$: the *Base Station RF Bandwidths* located at the top of the supported frequency range in the upper operating band and at the lowest possible simultaneous frequency position, within the maximum *Radio Bandwidth*, in the lower operating band.

NOTE: $B_{\text{RFBW_T'RFBW}} = B'\text{RFBW_T'RFBW} = B_{\text{RFBW_T'RFBW}}$ when the declared maximum radiated *Radio Bandwidth* (see table 4.10-1, D9.17) spans both operating bands. $B_{\text{RFBW_T'RFBW}}$ means the *Base Station RF Bandwidths* are located at the bottom of the supported frequency range in the lower operating band and at the top of the supported frequency range in the upper operating band.

When a test is performed by a test laboratory, the position of B_{RFBW} , M_{RFBW} and T_{RFBW} in each supported operating band, the position of $B_{\text{RFBW_T'RFBW}}$ and $B'\text{RFBW_T'RFBW}$ in the supported operating band combinations shall be specified by the laboratory. The laboratory may consult with operators, the manufacturer or other bodies.

4.12.2 Test models

a) Unless otherwise stated, carriers used for transmitter tests shall be configured as follows:

- UTRA FDD carriers shall be configured according to TM1 as defined in 3GPP TS 25.141 [10], subclause 6.1.1.1.
- UTRA TDD carriers shall be configured according to table 6.1A as defined in 3GPP TS 25.142 [11], subclause 6.2.4.1.2.
- E-UTRA carriers shall be configured according to E-TM1.1 as defined in 3GPP TS 36.141 [12], subclause 6.1.1.1. For BC3 RCS3 BS testing, E-UTRA carriers shall be configured according to E-TM1_BC3CS3 defined in annex E of 3GPP TS 37.141 [13].

b) Unless otherwise stated, transmitter carriers used for receiver tests shall be configured as follows:

- UTRA FDD carriers shall be configured according to TM1 as defined in 3GPP TS 25.141 [10], subclause 6.1.1.1.
- UTRA TDD carriers shall be configured according to table 6.1A as defined in 3GPP TS 25.142 [11], subclause 6.2.4.1.2.
- E-UTRA carriers shall be configured according to E-TM1.1 as defined in 3GPP TS 36.141 [12], subclause 6.1.1.1. For BC3 CS3 BS testing, E-UTRA carriers shall be configured according to E-TM1_BC3CS3 defined in annex E of 3GPP TS 37.141 [13].

For the test of certain RF requirements clause 5 refers to the test configurations as defined in the single-RAT specifications. In this case, the transmitter test signals and test models as defined within the referred test specification for the RF requirement shall be used.

4.13 Format and interpretation of tests

Each test in the following clauses has a standard format:

X Title

All tests are applicable to all equipment within the scope of the present document, unless otherwise stated.

X.1 Definition and applicability

This subclause gives the general definition of the parameter under consideration and specifies whether the test is applicable to all equipment or only to a certain subset. Required manufacturer declarations may be included here.

X.2 Minimum requirement

This subclause contains the reference to the subclause to the 3GPP reference (or core) specification which defines the minimum requirement. For each requirement, there are separate references for MSR and single RAT, where applicable in the core requirement. If the requirement does not apply to a particular RAT, this is explicitly stated here (rather than through a reference).

X.3 Test purpose

This subclause defines the purpose of the test.

X.4 Method of test

X.4.1 General

In some cases there are alternative test procedures or initial conditions. In such cases, guidance for which initial conditions and test procedures can be applied are stated here. In the case only one test procedure is applicable, that is stated here.

X.4.2y First test method

X.4.2y.1 Initial conditions

This subclause defines the initial conditions for each test, including the test environment, the RF channels to be tested and the basic measurement set-up. The test system is assumed to be correctly calibrated as part of the initial conditions. Calibration is not explicitly mentioned.

X.4.2y.2 Procedure

This subclause describes the steps necessary to perform the test and provides further details of the test definition like point of access (e.g. test port), domain (e.g. frequency-span), range, weighting (e.g. bandwidth), and algorithms (e.g. averaging). The procedure may comprise data processing of the measurement result before comparison with the test requirement (e.g. average result from several measurement positions).

X.4.3y Alternative test method (if any)

If there are alternative test methods, each is described with its initial conditions and procedures.

X.5 Test requirement

This subclause defines the pass/fail criteria for the equipment under test, see subclause 4.1.3 Interpretation of measurement results. Test requirements for every minimum requirement referred in subclause X.2 are listed here. Cases where minimum requirements do not apply need not be mentioned.

The test requirements may be different depending on the test method applied. A test requirement for each test method applicable to the respective MSR/Single RAT requirement is given in separate subclauses where applicable.

4.14 Reference coordinate system

Radiated requirements are stated in terms of electromagnetic characteristics (e.g. EIRP and EIS) at certain angles with respect to the base station. To be able to declare radiated characteristics part of radiated requirements a reference coordinate system is required. The reference coordinate system is should be associated to an identifiable physical feature on the base station enclosure.. The location of the origin and the orientation of the reference coordinate system are for the base station manufacturer to declare.

The reference coordinate system is created of a Cartesian coordinate system with rectangular axis (x, y, z) and spherical angles (θ , ϕ) as showed in figure 4.14-1.

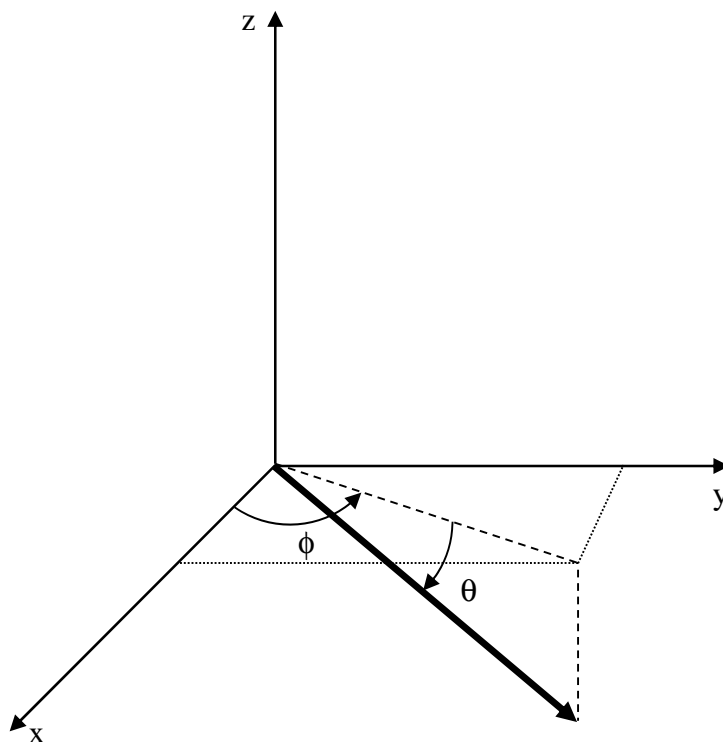

Figure 4.14-1: Reference coordinate system

ϕ is the angle in the x/y plane, between the x-axis and the projection of the radiating vector onto the x/y plane and is defined between -180° and $+180^\circ$, inclusive. θ is the angle between the projection of the vector in the x/y plane and the radiating vector and is defined between -90° and $+90^\circ$, inclusive. Note that θ is defined as positive along the down-tilt angle.

5 Applicability of Requirements

5.1 General

The present clause defines for each radiated test requirement the set of mandatory test configurations which shall be used for demonstrating conformance for radiated requirement.

Test configurations for beams supporting multiple RAT in the tested operating band are specified in subclause 5.1.

Test configurations for radiated requirements where the operating band has been declared to support single RAT requirements (see table 4.10-1, D9.5) by either MSR requirements for UTRA only or E-UTRA only or with a single-RAT UTRA requirements or single RAT E-UTRA requirements are specified in subclause 5.2.

Test configurations for an AAS BS with operating bands which have multi-band dependencies are specified in subclause 5.3.

Requirements apply to AAS BS according to the declared RAT radiated Capability Set (see table 4.10-1, D9.25) within each supported operating band the Band Category of the declared operating band (see table 4.10-1, D9.4), as listed in the heading of each table. Some RF requirements listed in the tables may not be mandatory or they may apply only regionally. This is further specified for each requirement in clauses 6 and 7, and in table 4.4-1.

For a declared RAT radiated Capability Set (see table 4.10-1, D9.25) in tables 5.2-1, 5.3.2-1, 5.3.3-1, 5.3.4-1, 5.4.1-1 or 5.4.2-1 only the requirements listed in the column for that radiated Capability Set apply. Requirements listed under RCSA other than the declared RCSA(s) need not be tested.

An AAS BS where the operating band is declared: to support multiple RATs (MSR) and to be capable of contiguous spectrum operation only, the test configuration(s) in tables 5.2-1 and 5.3.2-1 denoted by a "C" and entries that refer to single-RAT specifications shall be used for testing.

An AAS BS where the operating band is declared: to support multiple RATs (MSR), to be capable of contiguous and non-contiguous spectrum operation (see table 4.10-1, D9.28), where the parameters according to subclause 4.10 are identical for contiguous and non-contiguous operation (see table 4.10-1, D9.29). Shall use for each declared operating band the test configuration(s) in tables 5.2-1 and 5.3.2-1 denoted by "CNC" and entries that refer to single-RAT specifications shall be used.

An AAS BS where the operating band is declared: to support multiple RATs (MSR), to be capable of contiguous and non-contiguous spectrum operation (see table 4.10-1, D9.28), where the parameters according to subclause 4.10 are not identical for contiguous and non-contiguous operation (see table 4.10-1, D9.29). Shall use for each declared operating band the test configuration(s) in tables 5.2-1 and 5.3.2-1 denoted by "C/NC" and entries that refer to single-RAT specifications shall be used.

For an AAS BS operating bands which have multi-band dependencies which is MSR capable the applicability of the requirement for each operating band is determined by the RAT configuration within that operating band as identified in tables 5.2-1 and 5.3.2-1, unless otherwise stated. The testing of an AAS BS in operating bands with multi-band dependencies which are MSR capable shall be according to table 5.4.1-1 as follows:

- For requirements test denoted by SBT (Single Band Test), the test configuration (s) in tables 5.2-1 and 5.3.2-1 shall be used for each operating band depending on the RAT configuration within that band.
- For requirements test denoted by MBT (Multi-Band Test), the test configuration (s) in table 5.4.1-1 shall be used depending on the Band Category of the declared operating band combination.

For a single-RAT UTRA only operating bands subclause 5.3.3 defines for each radiated test requirement the set of mandatory test configurations which shall be used for demonstrating conformance. The applicable test configurations are specified in table 5.3.3-1 for each supported RF configuration, which shall be declared according to subclause 4.10. The generation and EIRP allocation for each test configuration is defined in subclause 4.11.2.

For a single-RAT E-UTRA only operating bands subclause 5.3.4 defines for each radiated test requirement the set of mandatory test configurations which shall be used for demonstrating conformance. The applicable test configurations are specified in table 5.3.4-1 for each supported RF configuration, which shall be declared according to subclause 4.10. The generation and EIRP allocation for each test configuration is defined in subclause 4.11.3.

For an AAS BS operating band declared to be capable of single carrier operation only (see table 4.10-1, D9.4), a single carrier (SC) shall be used for testing.

5.2 Test configurations for AAS BS for operating bands where MSR with more than 1 RAT is supported

Table 5.2-1: Test configuration applicability to requirements and capability sets for AAS BS supporting MSR operation

Test case	UTRA + E-UTRA (RCSA3)		
	BC1	BC2	BC3
6.2 Radiated transmit power	C: ATCR3a CNC: ATCR3a C/NC: ATCR3a, ANTCR3a	C: ATCR3a CNC: ATCR3a C/NC: ATCR3a, ANTCR3a	C: ATCR3b
7.2 OTA sensitivity	-	-	-
E-UTRA requirement	subclause 5.3.4	subclause 5.3.4	subclause 5.3.4
UTRA FDD requirement	subclause 5.3.3	subclause 5.3.3	N/A
UTRA TDD requirement	N/A	N/A	subclause 5.3.3

5.3 Test configurations for multi-carrier capable AAS BS in operating bands where one RAT capability sets are supported

5.3.1 General

A AAS BS may support only one RAT operation in an operating band by fulfilling different sets of requirements. Both UTRA and E-UTRA have two complete sets of requirements that may be fulfilled depending on whether the beam is declared to be MSR or single RAT in the operating band. MSR and single RAT requirements are addressed separately by separate test requirements (and corresponding core requirements). They are also identified by different capability sets as described in subclauses 4.11 and 5.2.

5.3.2 AAS BS supporting one RAT only MSR in the operating band

This subclause contains test configuration applicability to requirements and capability sets for AAS BS supporting one RAT only MSR operation operating with multiple carriers (MC).

Table 5.3.2-1: Test configuration applicability to requirements and capability sets for operating bands supporting one RAT only MSR operation

Capability Set Test case	UTRA (MC) capable BS (RCSA1)			E-UTRA (MC) capable BS (RCSA2)		
	BC1	BC2	BC3	BC1	BC2	BC3
6.2 Radiated transmit power	C: ATCR1a CNC: ATCR1a C/NC: ATCR1a, ANTCR1a	C: ATCR1a CNC: ATCR1a C/NC: ATCR1a, ANTCR1a	C: ATCR1b	C: ATCR2a CNC: ATCR2a C/NC: ATCR2a, ANTCR2	C: ATCR2a CNC: ATCR2a C/NC: ATCR2a, ANTCR2	C: ATCR2a CNC: ATCR2a C/NC: ATCR2a, ANTCR2
7.2 OTA sensitivity	-	-	-	-	-	-
E-UTRA requirement	N/A	N/A	N/A	subclause 5.3.4	subclause 5.3.4	subclause 5.3.4
UTRA FDD requirement	subclause 5.3.3	subclause 5.3.3	N/A	N/A	N/A	N/A
UTRA TDD requirement	N/A	N/A	subclause 5.3.3	N/A	N/A	N/A

5.3.3 AAS BS supporting Single-RAT UTRA in the operating band

This subclause contains the test configurations for AAS BS supporting single-RAT UTRA in the operating band. The test configurations apply to beams operating with multiple carriers (MC).

For a AAS BS declared to support multi-carrier operation in contiguous spectrum operation in single band only, the test configurations in the second column of table 5.3.3-1 for FDD, and in the fifth column of table 5.3.3-1 for TDD, shall be used for testing.

NOTE: The applicability of test configurations for TDD in this subclause is only applicable to UTRA TDD 1,28 Mcps option.

For FDD a AAS BS declared to support multi-carrier operation in contiguous and non-contiguous spectrum in single band and where the parameters in the manufacture's declaration according to subclause 4.10 are identical for contiguous (C) and non-contiguous (NC) spectrum operation, the test configurations in the third column of table 5.3.3-1 shall be used for testing.

For FDD a AAS BS declared to support multi-carrier operation in contiguous and non-contiguous spectrum in single band and where the parameters in the manufacture's declaration according to subclause 4.10 are not identical for contiguous and non-contiguous spectrum operation, the test configurations in the fourth column of table 5.3.3-1 shall be used for testing.

Table 5.3.3-1: Test configurations for a AAS BS supporting single-RAT UTRA operation

test case	Single-RAT UTRA FDD MC capable AAS BS operating band (RCSA4) C capable only	Single-RAT UTRA FDD MC capable AAS BS operating band (RCSA4) C and NC capable with identical parameters	Single-RAT UTRA FDD MC capable AAS BS operating band (RCSA4) C and NC capable with different parameters	Single-RAT UTRA TDD MC AAS BS operating band (RCSA4) C capable only
6.2 Base Station output power	ATCR1a	ATCR1a	ATCR1a, ANTCR1	ATCR1b
7.2 Reference sensitivity level	ATCR4a	ATCR4a	ATCR4a	ATCR4c

5.3.4 AAS BS supporting Single-RAT E-UTRA in the operating band

This subclause contains the test configurations for AAS BS supporting single-RAT E-UTRA in the operating band. The test configurations apply to AAS BS operating bands operating with multiple carriers (MC).

For an AAS BS declared to support multi-carrier and/or CA operation in contiguous spectrum operation in single band only, the test configurations in the second column of table 5.3.4-1 shall be used for testing.

For an AAS BS declared to support multi-carrier and/or CA operation in contiguous and non-contiguous spectrum in single band and where the parameters in the manufacture's declaration according to subclause 4.10 are identical for contiguous (C) and non-contiguous (NC) spectrum operation, the test configurations in the third column of table 5.3.4-1 shall be used for testing.

For an AAS BS declared to support multi-carrier and/or CA in contiguous and non-contiguous spectrum in single band and where the parameters in the manufacture's declaration according to subclause 4.10 are not identical for contiguous and non-contiguous spectrum operation, the test configurations in the fourth column of table 5.3.4-1 shall be used for testing.

Table 5.3.4-1: Test configurations for a AAS BS supporting single-RAT E-UTRA operation capable of both contiguous and non-contiguous spectrum in multi-carrier and/or CA operation in single band

test case		Single-RAT E-UTRA MC capable AAS BS operating band (RCSA5) C capable only	Single-RAT E-UTRA MC capable AAS BS operating band (RCSA5) C and NC capable BS with identical parameters	Single-RAT E-UTRA MC capable AAS BS operating band (RCSA5) C and NC capable BS with different parameters
6.2	Base Station output power	ATCR2a	ATCR2a	ATCR2a, ANTCR2
7.2	Reference sensitivity level	ATCR4b	ATCR4b	ATCR4b

5.4 Test configurations for AAS BS operating bands with multi-band dependencies

5.4.1 AAS BS operating bands with multi-band dependencies supporting MSR operation

Table 5.4.1-1: Test configuration for AAS BS operating bands containing beams with multi-band dependencies supporting MSR operation

test case	Test for AAS BS operating bands with multi-band dependencies RCSA1,RCSA2, RCSA3	Test configuration for MBT	
		BC1/BC2	BC3
6.2 Base Station output power	SBT, MBT	ATCR5a	ATCR5a
7.2 Reference sensitivity level	SBT	ATCR4a,ATCR4b	None

5.4.2 AAS BS operating bands with multi-band dependencies supporting Single-RAT only

For an AAS BS operating bands with multi-band dependencies supporting single-RAT only in the operational band, the test configurations in table 5.4.2-1, shall be used for testing.

Table 5.4.2-1: Test configuration for AAS BS operating bands with multi-band dependencies supporting Single-RAT only

test case	UTRA FDD RCSA4	UTRA TDD RCSA4	E-UTRA Test RCSA5
6.2 Base Station output power	ATCR1a/ANTCR1 (Note 1) ATCR5a	ATCR1b (Note 2), ATCR5a	ATCR2a/ANTCR2 (Note 3), ATCR5a
7.2 Reference sensitivity level	ATCR4a	ATCR4c	ATCR4b
NOTE 1: ATCR1a and/or ANTCR1 shall be applied in each supported operating band according to table 5.3.3-1.			
NOTE 2: ATCR1b shall be applied in each supported operating band according to table 5.3.3-1.			
NOTE 3: ATCR2 and/or ANTCR2 shall be applied in each supported operating band according to table 5.3.4-1.			

6 Radiated transmitter characteristics

6.1 General

General test conditions for transmitter tests are given in clause 4, including interpretation of measurement results and configuration for testing. AAS BS configurations for the tests are defined in subclause 4.8.

If beams have been declared equivalent and parallel (see table 4.10-1, D9.12, D9.13), only a representative beam is necessary to be tested to demonstrate conformance.

Any radiated transmitter test requirement specified in 3GPP TS 37.105 [6] is not applicable for AAS BS operation in Band 46.

6.2 Radiated Transmit Power

6.2.1 Definition and applicability

An AAS BS is declared to support one or more beams. Radiated transmit power is defined as the EIRP level for a declared beam at a specific *beam peak direction*.

For each beam, the requirement is based on declarations (see table 4.10-1) of a beam identifier (D9.3), *reference beam direction pair* (D9.7), *rated beam EIRP* (D9.10) at the *reference beam direction pair*, *EIRP accuracy directions set* (D9.8), the *beam direction pairs* at the maximum steering directions (D9.9) and their associated *rated beam EIRP* and *beamwidth(s)* (D9.11) for *reference beam direction pair* and maximum steering directions.

For a declared beam identifier and *beam direction pair*, the *rated beam EIRP* level is the maximum power that the base station is declared to radiate at the associated *beam peak direction* during the *transmitter ON period*.

For each *beam peak direction* associated with a *beam direction pair* within the *EIRP accuracy directions set*, a specific *rated beam EIRP* level may be claimed. Any claimed value shall be met within the accuracy requirement as described below. *Rated beam EIRP* is only required to be declared for the *beam direction pairs* subject to conformance testing as detailed in subclause 6.2.4.1.

NOTE 1: The *EIRP accuracy directions set* for a beam is the complete continuous or discrete set of all *beam direction* for which the EIRP accuracy is intended to be achieved for the beam.

NOTE 2: A *beam direction pair* consists of a *beam centre direction* and an associated *beam peak direction*.

NOTE 3: A declared EIRP value is a value provided by the manufacturer for verification according to the conformance specification declaration requirements, whereas a claimed EIRP value is provided by the manufacturer to the equipment user for normal operation of the equipment and is not subject to formal conformance testing.

6.2.2 Minimum Requirement

For AAS BS in *MSR operation* the minimum requirement is in TS 37.105 [6], subclause 9.2.2.

For AAS BS in *single RAT UTRA operation* the minimum requirement is in TS 37.105 [6], subclause 9.2.3.

For AAS BS in *single RAT E-UTRA operation* the minimum requirement is in TS 37.105 [6], subclause 9.2.4.

6.2.3 Test purpose

The test purpose is to verify the ability to accurately generate and direct radiated power per beam, across the frequency range and under normal conditions, for all declared beams of the AAS BS.

6.2.4 Method of test

6.2.4.1 Initial conditions

Test environment: Normal; see 3GPP TS 37.145-1 [9], clause B.2.

RF bandwidth positions to be tested: B_{RFBW} , M_{RFBW} and T_{RFBW} in single-band operation, see subclause 4.12.1.

$B_{\text{RFBW}}T_{\text{RFBW}}$ and $B'_{\text{RFBW}}T_{\text{RFBW}}$ in multi-band operation, see subclause 4.12.1.

Directions to be tested: The reference beam direction pair (see table 4.10-1, D9.7) and the maximum steering directions (see table 4.10-1, D9.9).

6.2.4.2 Procedure

OTA test requires correct use of an appropriate test facility which has been calibrated and is capable of performing measurements within the measurement uncertainties in subclause 4.1.2.

- 1) Place the AAS BS at the positioner.
- 2) Align the manufacturer declared coordinate system orientation (see table 4.10-1, D9.2) of the AAS BS with the test system.
- 3) Move the AAS BS on the positioner in order that the direction to be tested aligns with the test antenna.
- 4) Configure the beam peak direction of the AAS BS according to the declared beam direction pair.
- 5) Set the base station to transmit according to the applicable test configuration in clause 5 using the corresponding test model(s) in subclause 4.12.2.

In addition, for an AAS BS declared to be capable of multi-carrier and/or CA operation use the applicable test signal configuration and corresponding power setting specified in subclause 4.11.

- 6) Measure EIRP by either a) or b) below:
 - a) If the test facility only supports single polarization, then measure EIRP with the test facility's test antenna/probe polarization matched to the AAS BS.
 - b) If the test facility supports dual polarization then measure total EIRP for two orthogonal polarizations (denoted p_1 and p_2) and calculate total radiated transmit power for particular *beam direction pair* as $\text{EIRP} = \text{EIRP}_{p_1} + \text{EIRP}_{p_2}$.
- 7) Test steps 3 to 6 are repeated for all declared beams (see table 4.10-1, D9.3) and their reference *beam direction pairs* and *maximum steering directions* (see table 4.10-1, D9.7 and D9.11).

For multi-band capable AAS BS and single band tests, repeat the steps above per involved band where single band test configurations and test models shall apply with no carriers activated in the other band.

6.2.5 Test Requirement

For each declared conformance beam direction pair, in normal conditions, the EIRP measurement result in step 6 of subclause 6.2.4.2 shall for UTRA and E-UTRA remain:

- within +3.2 dB and -3.2 dB of the manufacturer's declared rated beam EIRP value for carrier frequency $f \leq 3.0$ GHz;
- within +3.4 dB and -3.4 dB of the manufacturer's declared rated beam EIRP value for carrier frequency $3.0 \text{ GHz} < f \leq 4.2 \text{ GHz}$.

7 Radiated receiver characteristics

7.1 General

OTA receiver characteristics requirements apply to the *AAS BS* including all its functional components active unless otherwise stated in each requirement.

Unless otherwise stated the requirements in clause 7 apply during the *AAS BS receive period*.

The requirements in clause 7 shall be met for any transmitter setting.

The (E-UTRA) throughput requirements defined for the receiver characteristics in this clause do not assume HARQ retransmissions.

When the *AAS BS* is configured to receive multiple carriers, all the throughput requirements are applicable for each received carrier.

Any radiated receiver test requirement specified in 3GPP TS 37.105 [6] is not applicable for *AAS BS* operation in Band 46.

7.2 OTA sensitivity

7.2.1 Definition and applicability

The OTA sensitivity requirement is based upon the declaration of one or more *OTA sensitivity direction declarations* (OSDD), related to an *AAS BS receiver*.

The *AAS BS receiver* may optionally be capable of redirecting/changing the *receiver target* by means of adjusting BS settings resulting in multiple *sensitivity RoAoA*. The *sensitivity RoAoA* resulting from the current *AAS BS* settings is the active *sensitivity RoAoA*.

If the *AAS BS* is capable of redirecting the *receiver target* related to the OSDD then the OSDD shall include:

- The set(s) of RAT, *Channel bandwidth* and declared minimum EIS level applicable to any active *sensitivity RoAoA* inside the *receiver target redirection range* in the OSDD.
- A declared *receiver target redirection range*, describing all the angles of arrival that can be addressed for the OSDD through alternative settings in the *AAS BS*.
- Five declared *sensitivity RoAoA* comprising the conformance testing directions as detailed in [7].
- The *receiver target reference direction*.

NOTE 1: Some of the declared *sensitivity RoAoA* may coincide depending on the redirection capability.

NOTE 2: In addition to the declared *sensitivity RoAoA*, several *sensitivity RoAoA* may be implicitly defined by the *receiver target redirection range* without being explicitly declared in the OSDD.

NOTE 3: (Void)

If the *AAS BS* is not capable of redirecting the *receiver target* related to the OSDD, then the OSDD includes only:

- The set(s) of RAT, *Channel bandwidth* and declared minimum EIS level applicable to the *sensitivity RoAoA* in the OSDD.
- One declared active *sensitivity RoAoA*.
- The *receiver target reference direction*.

NOTE 4: For *AAS BS* without target redirection capability, the declared (fixed) *sensitivity RoAoA* is always the active *sensitivity RoAoA*.

The OTA sensitivity EIS level declaration shall apply to each supported polarization, under the assumption of *polarization match*.

7.2.2 Minimum Requirement

For AAS BS in *single RAT UTRA operation* the minimum requirement is in TS 37.105 [6], subclause 10.2.3.

For AAS BS in *single RAT E-UTRA operation* the minimum requirement is in TS 37.105 [6], subclause 10.2.4.

7.2.3 Test Purpose

The test purpose is to verify that the AAS BS can meet the BER or throughput requirement for a specified measurement channel at the EIS level and the range of angles of arrival declared in the OSDD.

7.2.4 Method of test

7.2.4.1 Initial conditions

Test environment:

- Normal: see 3GPP TS 37.145-1 [9], annex B.2.

RF channels to be tested:

- B, M and T; see subclause 4.12.1.

Directions to be tested:

- *receiver target reference direction* (see table 4.10-1, D10.9),
- conformance test directions (see table 4.10-1, D10.10).

7.2.4.2 Procedure

OTA test requires correct use of an appropriate test facility which has been calibrated and is capable of performing measurements within the measurement uncertainties in subclause 4.1.2.

- 1) Place the AAS BS with its manufacturer declared coordinate system reference point in the same place as calibrated point in the test system, as shown in annex D1.1.
- 2) Align the manufacturer declared coordinate system orientation of the AAS BS with the test system.
- 3) Set the AAS BS in the declared direction to be tested.
- 4) Ensure the polarisation is accounted for such that all the power from the test antenna is captured by the AAS BS under test.
- 5) Configure the beam peak direction of the AAS BS according to declared reference beam direction pair for the appropriate beam identifier.
- 6) Set the AAS BS to transmit the beam(s) of the same operational band and RAT as the OSDD being tested according to the appropriate test configuration in clause 5.
- 7) Start the signal generator for the wanted signal to transmit:
 - 12.2 kbps DPCH with reference measurement channel defined in annex A in 3GPP TS 25.141 [10] (PN-9 data sequence or longer) for UTRA FDD.
 - UL reference measurement channel (12.2 kbps) defined in annex A.2.1 in 3GPP TS 25.142 [11] for UTRA TDD 1.28Mcps operation.
 - The test signal as specified in subclause 7.2.5.4 for E-UTRA.

8) Set the test signal mean power so the calibrated radiated power at the AAS BS Antenna Array coordinate system reference point is as specified in subclause 7.2.5.

9) Measure:

- BER according to annex C in 3GPP TS 25.141 [10] for FDD UTRA.
- BER according to annex F in 3GPP TS 25.142 [11] for TDD UTRA.
- Throughput according to annex E in 3GPP TS 36.141 [12] for E-UTRA.

10) Repeat steps 3 to 9 for all OSDD(s) declared for the AAS BS (see table 4.10-1, D10.1).

For multi-band capable AAS BS and single band tests, repeat the steps above per involved band where single band test configurations and test models shall apply with no carriers activated in the other band.

7.2.5 Test Requirements

7.2.5.1 General

The minimum EIS level is a declared figure for each OSDD (see table 4.10-1, D10.6). The test requirement is calculated from the declared value offset by the EIS Test Tolerance specified in subclause 4.1.2.3.

7.2.5.2 UTRA FDD Test Requirements

The BER measurement result in step 9 of subclause 7.2.4.2 shall not be greater than the limit specified in table 7.2.5.2-1.

Table 7.2.5.2-1: EIS levels

Reference measurement channel	Reference measurement channel data rate	OTA sensitivity (dBm)		BER
		$f \leq 3.0$ GHz	3.0 GHz $< f \leq 4.2$ GHz	
12.2kbps DPCH with reference measurement channel defined in annex A in 3GPP TS 25.141 [10] (PN-9 data sequence or longer)	12.2 kbps	Declared minimum EIS (D10.6) + 1.3 dB	Declared minimum EIS (D10.6) + 1.4 dB	BER shall not exceed 0.001

7.2.5.3 UTRA TDD 1,28Mcp option Test Requirements

The BER measurement result in step 9 of subclause 7.2.4.2 shall not be greater than the limit specified in table 7.2.5.3-1.

Table 7.2.5.3-1: EIS levels

Reference measurement channel	Reference measurement channel data rate	OTA sensitivity (dBm)		BER
		$f \leq 3.0$ GHz	3.0 GHz $< f \leq 4.2$ GHz	
UL reference measurement channel (12.2 kbps) defined in annex A.2.1 in 3GPP TS 25.142 [11]	12.2 kbps	Declared minimum EIS (D10.6) + 1.3 dB	Declared minimum EIS (D10.6) + 1.4 dB	BER shall not exceed 0.001

7.2.5.4 E-UTRA Test Requirements

For each measured E-UTRA carrier, the throughput measured in step 9 of subclause 7.2.4.2 shall be ≥ 95 % of the maximum throughput of the reference measurement channel as specified in 3GPP TS 36.141 [12] annex A.1 with parameters specified in table 7.2.5.4-1.

Table 7.2.5.4-1: EIS levels

E-UTRA channel bandwidth (MHz)	Reference measurement channel	OTA sensitivity (dBm)	
		$f \leq 3.0$ GHz	3.0 GHz $< f \leq 4.2$ GHz
1.4	FRC A1-1 in annex A.1 [12]	Declared minimum EIS (D10.6) + 1.3 dB	Declared minimum EIS (D10.6) + 1.4 dB
3	FRC A1-2 in annex A.1 [12]		
5	FRC A1-3 in annex A.1 [12]		
10	FRC A1-3 in annex A.1 [12] (Note)		
15			
20			
NOTE: EIS is the power level of a single instance of the reference measurement channel. This requirement shall be met for each consecutive application of a single instance of FRC A1-3 in [11] mapped to disjoint frequency ranges with a width of 25 Resource Blocks each.			

Annex A (normative): Test system characterization

The radiated measurement methods for AAS BS conformance testing were described in 3GPP TR 37.842 [7], including descriptions of their limitations and testing applicability.

Annex B (normative): Calibration

The radiated measurement methods for AAS BS conformance testing were described in 3GPP TR 37.842 [7]. Calibration stage description was covered for each of the identified Test Systems in the measurement's procedure description, which covered two distinct stages: calibration stage and measurement stage. This has been separately covered for transmitter and for receiver requirements.

Annex C (informative): Test tolerances and derivation of test requirements

C.1 General

The test requirements explicitly defined in this specification have been calculated by relaxing the minimum requirements of the core specification using the Test Tolerances defined here. When the Test Tolerance is non-zero, the test requirements will differ from the minimum requirements, and the formula used for this relaxation is given in the following tables.

The Test Tolerances are derived from Test System uncertainties.

The Test Tolerances should not be modified for any reason e.g. to take account of commonly known test system errors (such as mismatch, cable loss, etc.).

Note that a formula for applying Test Tolerances is provided for all tests.

NOTE: OTA test requirements for AAS BS are specified for Normal conditions, only.

C.2 Measurement of transmitter (OTA)

Table C.2-1: Derivation of Test Requirements (OTA transmitter tests)

Test	Minimum Requirement in 3GPP TS 37.105 [6]	Test Tolerance (TT)	Test Requirement in the present document
6.2 Radiated transmit power	See 3GPP TS 37.105 [6], subclause 9.2	1.0 dB, $f \leq 3.0$ GHz 1.2 dB, $3.0 \text{ GHz} < f \leq 4.2 \text{ GHz}$	Formula: Upper limit + TT, Lower limit – TT

C.3 Measurement of receiver (OTA)

Table C.2-1: Derivation of Test Requirements (OTA receiver tests)

Test	Minimum Requirement in 3GPP TS 37.105 [6]	Test Tolerance	Test Requirement in the present document
7.2 OTA sensitivity	See 3GPP TS 37.105 [6], subclause 10.2	1.3 dB, $f \leq 3.0$ GHz 1.4 dB, $3.0 \text{ GHz} < f \leq 4.2 \text{ GHz}$	Formula: Declared Minimum EIS + TT

Annex D (informative): Test system set-up

D.1 Transmitter

D1.1 Radiated Transmit Power

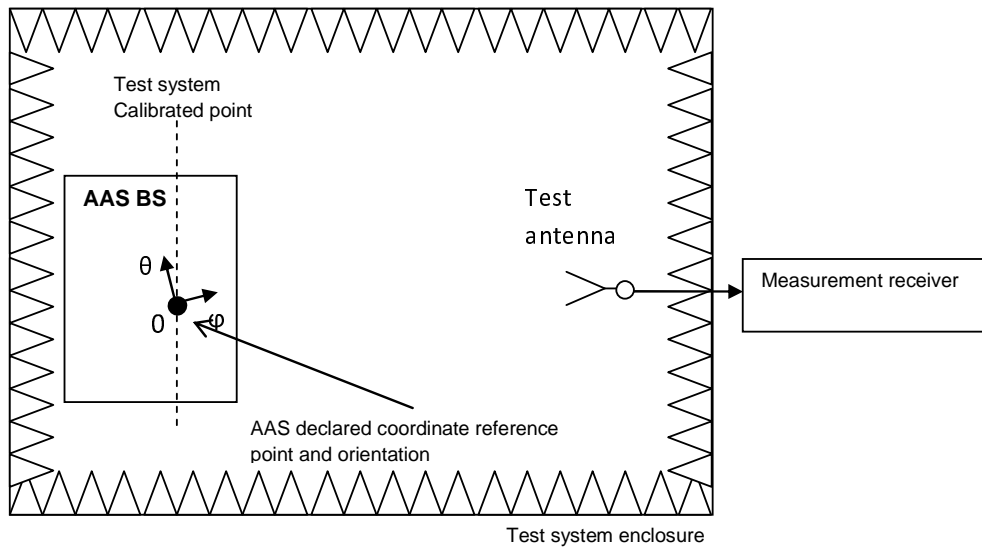

Figure D.1.1-1: Measurement set up for Radiated Transmit Power

D.2 Receiver

D.2.1 OTA sensitivity

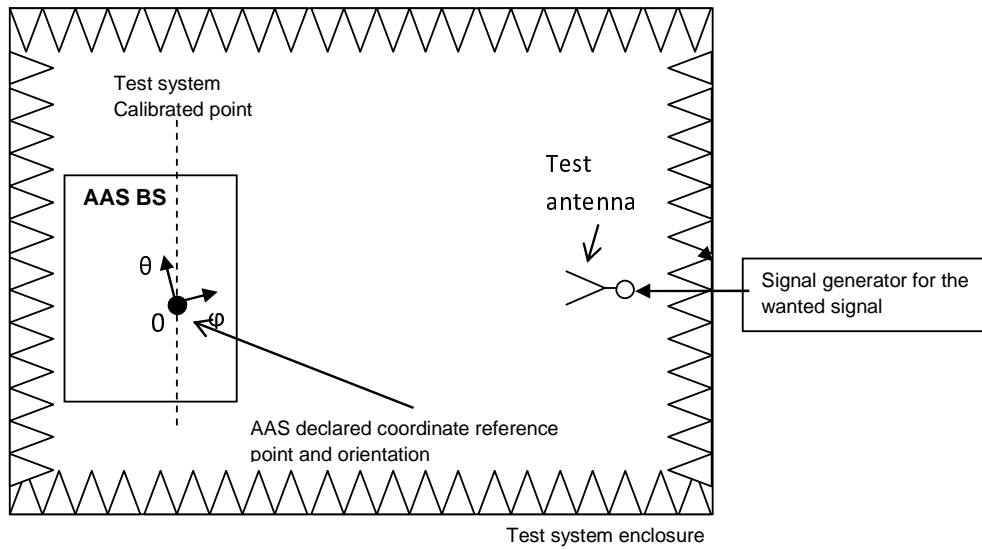

Figure D.2.1-1: Measurement set up for OTA sensitivity

Annex E (normative): Estimation of Measurement Uncertainty

E.1 General

Common measurement uncertainty budget calculation principle, was described in 3GPP TR 37.842 [7].

E.2 Measurement methodology descriptions

The AAS BS radiated measurement method descriptions, including description of the calibration stage, and the measurement stage, are described separately for each of the OTA tests, i.e. for radiated transmit power and for OTA sensitivity test in 3GPP TR 37.842 [7].

E.3 Measurement uncertainty budget format

Each test methodology is characterized by different uncertainty contributors. Moreover, within single test methodology, certain uncertainty contributors will need to be modified, depending on the transmitter, or receiver test. Therefore, separate uncertainty budget format were collected for all considered Test Systems in 3GPP TR 37.842 [7], specifying uncertainty contributors for calibration stage, as well as measurement stage.

E.4 Measurement uncertainty budgets

Descriptions of uncertainty assessment for radiated transmit power and for OTA sensitivity test were described separately for each of the considered Tests Systems as in 3GPP TR 37.842 [7].

E.5 Measurement error contribution descriptions

Detailed descriptions of the uncertainty contributors for the radiated transmit power and OTA sensitivity test were described separately for each of the considered Tests Systems as in 3GPP TR 37.842 [7].

Annex F (informative): Change history

Change history							
Date	Meeting	TDoc	CR	Rev	Cat	Subject/Comment	New version
2016-02	RAN4#78	R4-161118				Specification structure	0.1.0
2016-04	RAN4#78 bis	R4-162524				R4-161370 - TP for TS 37.145-2: Adding Annex for relations between core and conformance requirements	0.2.0
2016-05	RAN4#79	R4-164927				R4-164717 - TP to TS 37.145 (part 2) sections 1-5 R4-164718 - TP for TS 37.145-2: Addition of radiated transmit power conformance test requirement in clause 6 R4-164719 - TP to TS 37.145 (part 2) section 7 - Radiated receiver characteristics	0.3.0
2016-08	RAN4#80	R4-167179				R4-166422 - TP to 3GPP TS 37.145-2 - clean up R4-166218 - TP for TS 37.145-2: Editorial correction on table numbers R4-166567 - TP to TS 37.145-2: Manufacturer declarations consistency improvements R4-166938 - TP for TS 37.145-2: Improvements of text in subclause 4.8 R4-166940 TP for TS 37.145-2: Improvements on text relating to the reference coordinate system R4-166939 TP to TR 37.145-2: Test Requirements derivation: Annexes A, B, C, E R4-166929 TP to TS 37.145-2: Measurement uncertainties and TT values R4-166931 TP for TS 37.145-2 - On OTA RX sensitivity requirements for AAS R4-167191 TP to TR 37.145-2: definition and test procedure clarifications for EIRP and EIS	0.4.0
2016-09	RP-73	RP-161450				Editorial corrections after review by ETSI editHelp	1.0.0
2016-09	RP-73					TS was approved by RAN plenary	13.0.0
2016-12	RP-74	RP-162422	0003	-	A	Correction of Manufacturer declaration description list in TS 37.145-2	13.1.0
2017-03	RP-75	RP-170586	0005	1	F	TS 37.145-2: Clarification of test procedure for radiated transmit power	13.2.0
2017-03	RP-75	RP-170586	0006	1	F	TS 37.145-2: Corrections	13.2.0
2017-03	RP-75	-	-	-	-	Update to Rel-14 version (MCC)	14.0.0
2017-06	RP-76	RP-171306	0011		A	CR to TS 37.145-2: Isolation of Band 46 from the AAS BS specification	14.1.0
2017-09	RP-77	RP-171968	0013		A	CR to TS 37.145-2: Editorial corrections, Rel-14	14.2.0
2017-12	RAN#78	RP-172608	0015	1	A	Correction of maximum steering directions declarations	14.3.0
2018-03	RAN#79	RP-180280	0017		A	CR to TS 37.145-2: corrections to the EIS test requirements (7.2) Rel-14	14.4.0
2018-06	RAN#80	RP-181109	0019		A	CR to TR 37.145-2: Clarifications on OTA sensitivity requirement (7.2.1)	14.5.0
2018-09	RAN#81	RP-181910	0027		A	Clarification of BS alignment text for the EIRP accuracy procedure	14.6.0
2018-09	RAN#81	RP-181910	0031		A	CR to TS 37.145-2: Clarification on manufacturers declarations	14.6.0
2018-12	RAN#82	RP-182380	0045		A	CR to TS 37.145-2: corrections of declarations for the Radiated Transmit Power, Rel-14	14.7.0
2018-12	RAN#82	RP-182380	0051		A	CR to TS 37.145-2: terminology corrections for "Minimum requirements", Rel-14	14.7.0
2019-06	RAN#84	RP-191258	0132		A	CR to TS 37.145-2: mirror of operating band and frequency range declaration from NR, Rel-14	14.8.0
2019-09	RAN#85	RP-192050	0174		A	CR to 37.145-2: correction of equivalent beams testing, Rel-14	14.9.0

History

Document history		
V14.0.0	April 2017	Publication
V14.1.0	August 2017	Publication
V14.2.0	October 2017	Publication
V14.3.0	January 2018	Publication
V14.4.0	April 2018	Publication
V14.5.0	July 2018	Publication
V14.6.0	October 2018	Publication
V14.7.0	January 2019	Publication
V14.8.0	July 2019	Publication
V14.9.0	October 2019	Publication